

# SIEMENS



Motion Control System

# SIMOTION

Equipment for Production Machines

Catalog  
PM 21

Edition  
2017

[siemens.com/simotion](http://siemens.com/simotion)

## Related catalogs

<p><b>Motion Control Drives</b> D 31 SINAMICS Inverters for Single-Axis Drives and SIMOTICS Motors</p> <p>E86060-K5531-A101-A2-7600</p>		<p><b>SITRAIN</b> ITC Training for Industry</p> <p>Only available in German E86060-K6850-A101-C5</p>	
<p><b>SINAMICS G130</b> D 11 Drive Converter Chassis Units <b>SINAMICS G150</b> Drive Converter Cabinet Units</p> <p>E86060-K5511-A101-A6-7600</p>		<p><b>Products for Automation and Drives</b> CA 01 Interactive Catalog DVD</p> <p>E86060-D4001-A510-D7-7600</p>	
<p><b>SINAMICS S120</b> D 21.3 Chassis Format Units and Cabinet Modules <b>SINAMICS S150</b> Converter Cabinet Units PDF (E86060-K5521-A131-A5-7600)</p>		<p><b>Industry Mall</b> Information and Ordering Platform on the Internet:</p> <p><a href="http://www.siemens.com/industrymall">www.siemens.com/industrymall</a></p>	
<p><b>Motion Control Drives</b> D 21.4 SINAMICS S120 and SIMOTICS</p> <p>E86060-K5521-A141-A1-7600</p>			
<p><b>Motion Control</b> NC 62 SINUMERIK 840 Equipment for Machine Tools</p> <p>E86060-K4462-A101-A2-7600</p>			
<p><b>SIMATIC</b> ST 70 Products for Totally Integrated Automation</p> <p>E86060-K4670-A101-B5-7600</p>			
<p><b>SIMATIC HMI / PC-based Automation</b> ST 80/ST PC Human Machine Interface Systems PC-based Automation</p> <p>E86060-K4680-A101-C4-7600</p>			
<p><b>Industrial Communication</b> IK PI SIMATIC NET</p> <p>E86060-K6710-A101-B8-7600</p>			
<p><b>SITOP</b> KT 10.1 Power supply SITOP</p> <p>E86060-K2410-A101-B2-7600</p>			

# SIMOTION

## Equipment for Production Machines

### Motion Control

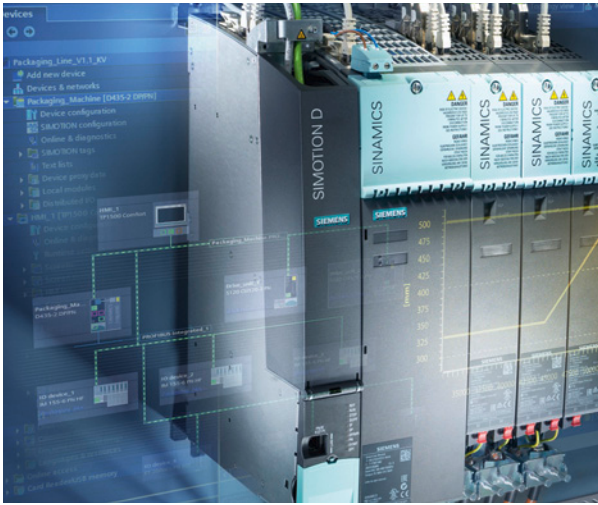

### Catalog PM 21 · 2017

Supersedes:  
Catalog PM 21 · 2013

Refer to the Industry Mall for current updates of  
this catalog:

[www.siemens.com/industrymall](http://www.siemens.com/industrymall)

The products contained in this catalog can also be found  
in the Interactive Catalog CA 01.

Article No.: E86060-D4001-A510-D7-7600

Please contact your local Siemens branch.

© Siemens AG 2017



Printed on paper from sustainably managed  
forests and controlled sources.

[www.pefc.org](http://www.pefc.org)



The products and systems described in this  
catalog are manufactured/distributed in  
accordance with the requirements of a  
quality management system which has been  
certified to DIN EN ISO 9001 (Certificate  
Registration No. 001258 QM) and  
DIN EN ISO 14001 (Certificate Registration  
No. 081342 UM). The certificate is  
recognized by all IQNet countries.

### System overview

Excellence in Motion Control  
SIMOTION – An overview

1

### SIMOTION Motion Control System

2

### SIMOTION system components

HMI devices,  
I/O components, power supplies,  
drives, motors, connection systems, measuring systems

3

### Communication

4

### Safety Integrated

5

### Industry-specific solutions

6

### Lifecycle Services

7

### Appendix

8

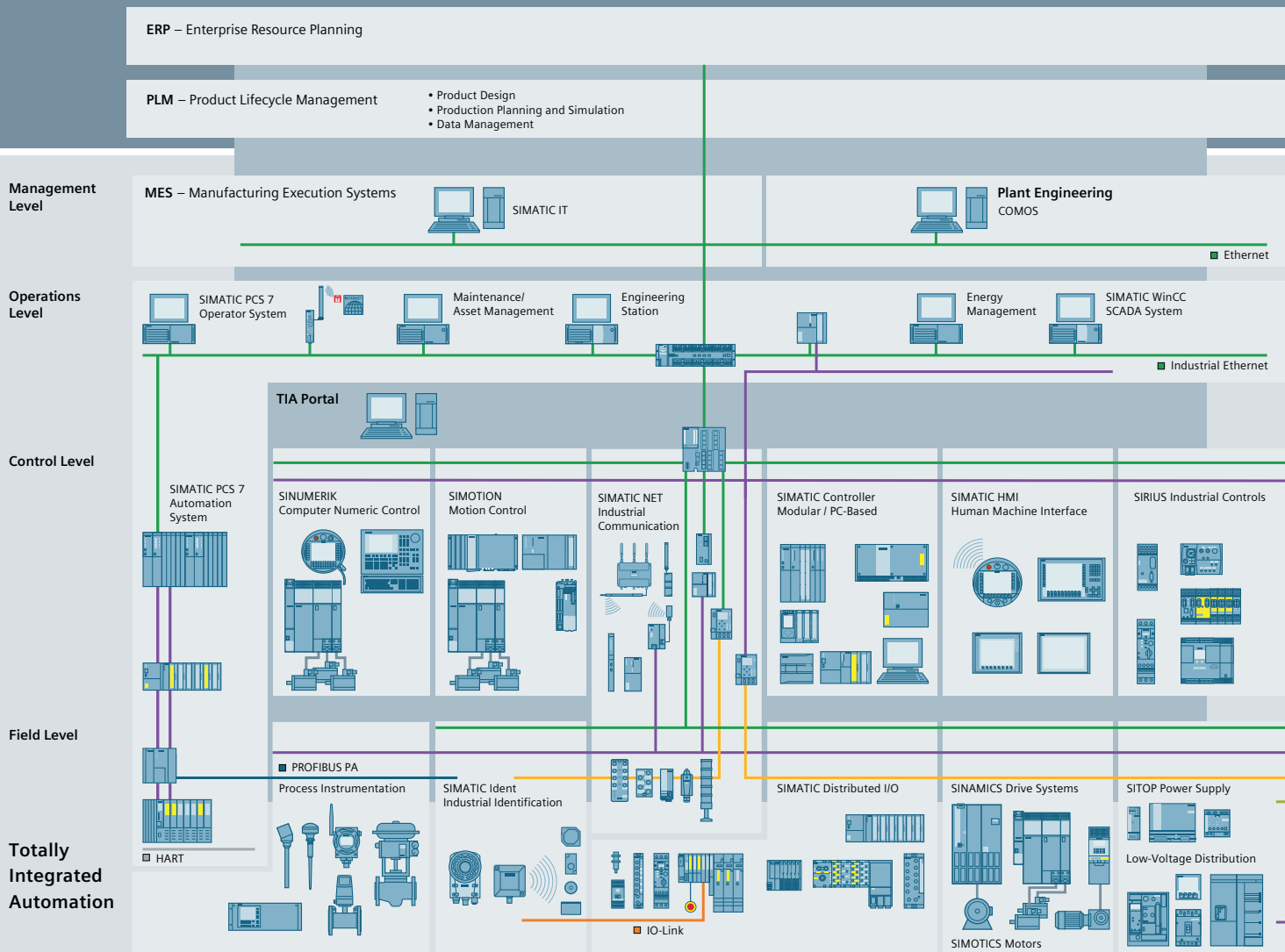

## Efficient automation starts with efficient engineering.

**Totally Integrated Automation: Efficiency driving productivity.**

Efficient engineering is the first step toward better production that is faster, more flexible, and more intelligent. With all components interacting efficiently, Totally Integrated Automation (TIA) delivers enormous time savings right from the engineering phase. The result is lower costs, faster time-to-market, and greater flexibility.

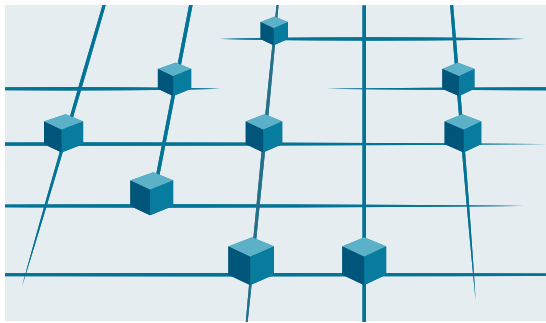

Totally Integrated Automation  
Efficient interoperability of all automation components



■ PROFINET  
■ Industrial Ethernet  
■ PROFIBUS  
■ AS-Interface  
■ KNX GAMMA instabus

**Totally Integrated Power**

## A unique complete approach for all industries

As one of the world's leading automation suppliers, Siemens provides an integrated, comprehensive portfolio for all requirements in process and manufacturing industries. All components are mutually compatible and system-tested. This ensures that they reliably perform their tasks in industrial use and interact efficiently, and that each automation solution can be implemented with little time and effort based on standard products. The integration of many separate individual engineering tasks into a single engineering environment, for example, provides enormous time and cost savings.

With its comprehensive technology and industry-specific expertise, Siemens is continuously driving progress in manufacturing industries – and Totally Integrated Automation plays a key role.

Totally Integrated Automation creates real value added in all automation tasks, especially for:

- **Integrated engineering**  
Consistent, comprehensive engineering throughout the entire product development and production process
- **Industrial data management**  
Access to all important data occurring in productive operation – along the entire value chain and across all levels
- **Industrial communication**  
Integrated communication based on international cross-vendor standards that are mutually compatible
- **Industrial security**  
Systematic minimization of the risk of an internal or external attack on plants and networks
- **Safety Integrated**  
Reliable protection of personnel, machinery, and the environment thanks to seamless integration of safety technologies into the standard automation

## Making things right with Totally Integrated Automation

Totally Integrated Automation, industrial automation from Siemens, stands for the efficient interoperability of all automation components. The open system architecture covers the entire production process and is based on end-to-end shared characteristics: consistent data management, global standards, and uniform hardware and software interfaces.

Totally Integrated Automation lays the foundation for comprehensive optimization of the production process:

- Time and cost savings due to efficient engineering
- Minimized downtime due to integrated diagnostic functions
- Simplified implementation of automation solutions due to global standards
- Better performance due to interoperability of system-tested components

The Siemens drive systems are part of Totally Integrated Automation – from the field level up to the manufacturing execution system – which means that they are perfectly embedded into the system architecture of the entire industrial production process.

With Integrated Drive Systems you reduce engineering time, lower maintenance costs and increase the availability of your plant.

# Integrated Drive Systems

Faster on the market and in the black with Integrated Drive Systems

Integrated Drive Systems are Siemens' trendsetting answer to the high degree of complexity that characterizes drive and automation technology today. The world's only true one-stop solution for entire drive systems is characterized in particular by its threefold integration: Horizontal, vertical, and lifecycle integration ensure that every drive system component fits seamlessly into the whole system, into any automation environment, and even into the entire lifecycle of a plant.

The outcome is an optimal workflow – from engineering all the way to service that entails more productivity, increased efficiency, and better availability. That's how Integrated Drive Systems reduce time to market and time to profit.

## Horizontal integration

**Integrated drive portfolio:** The core elements of a fully integrated drive portfolio are frequency converters, motors, couplings, and gear units. At Siemens, they're all available from a single source. Perfectly integrated, perfectly interacting. For all power and performance classes. As standard solutions or fully customized. No other player in the market can offer a comparable portfolio. Moreover, all Siemens drive components are perfectly matched, so they are optimally interacting.

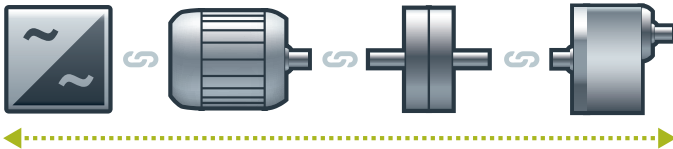

You can boost the availability of your application or plant to up to

**99%\***

\*e.g., conveyor application

## Vertical integration

Thanks to **vertical integration**, the complete drive train is seamlessly integrated in the entire automation environment – an important prerequisite for production with maximum value added. Integrated Drive Systems are part of Totally Integrated Automation (TIA), which means that they are perfectly embedded into the system architecture of the entire industrial production process. This enables optimal processes through maximum communication and control.

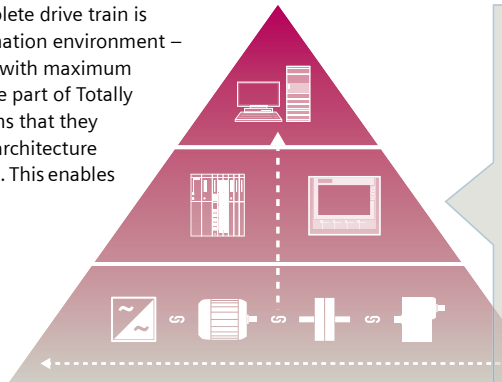

With TIA Portal you can cut your engineering time by up to

**30%**

## Lifecycle integration

**Lifecycle integration** adds the factor of time: Software and service are available for the entire lifecycle of an Integrated Drive System. That way, important optimization potential for maximum productivity, increased efficiency, and highest availability can be leveraged throughout the system's lifecycle – from planning, design, and engineering to operation, maintenance, and all the way even to modernization.

With Integrated Drive Systems, assets become important success factors. They ensure shorter time to market, maximum productivity and efficiency in operation, and shorter time to profit.

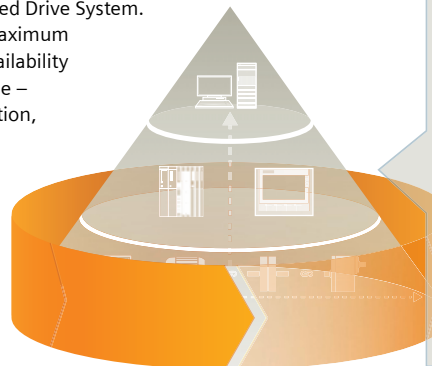

With Integrated Drive Systems you can reduce your maintenance costs by up to

**15%**

## System overview

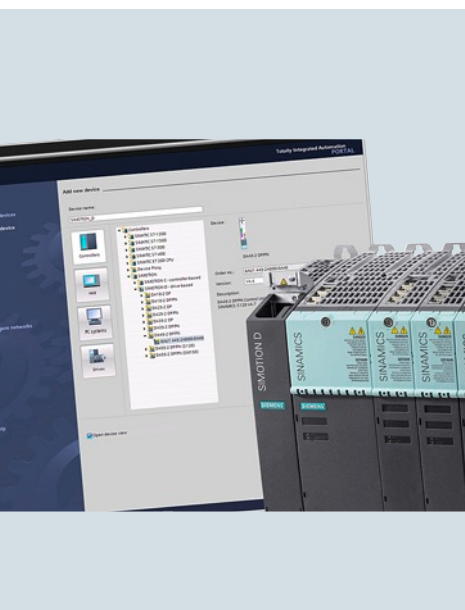

1/2

### Excellence in Motion Control

1/4

#### **SIMOTION – An overview**

1/4

The SIMOTION system

1/5

Hardware platforms

1/7

Runtime system

1/8

Engineering system

1/9

Standard modules and project generator

## System overview

Excellence in Motion Control

1

### Overview

#### **Motion Control Solutions "Made by Siemens"**

Thanks to strong innovation capacity, in-depth industry know-how and outstanding customer benefits of our automation solutions for production machines, Siemens is one of the leading suppliers of Motion Control Systems worldwide. For this reason, we can supply many references in different areas.



Our standard for our Motion Control Systems is very high: All products stand out through the use of the latest technologies, high functionality and quality. In addition, the individual systems and products are optimally matched to one another so that they can be easily and consistently combined into an economic machine solution.

Examples of this are the SIMOTION Motion Control System and the SINAMICS drive system. These products constitute an innovative system platform with which you can optimally adapt your machine to your specific requirements.

For perfect interaction of all the automation components, the engineering is implemented in the Totally Integrated Automation Portal (TIA Portal). The result is that you are provided with optimized, economic and future-oriented Motion Control solutions for many different sectors such as the packaging, printing, textile, plastics and metal forming, wood and glass industries and renewable energy applications. The Motion Control solution with SIMOTION can easily be expanded to meet increasing requirements, combined with the high-performance SIMOTICS motor portfolio from Siemens.

Furthermore, Siemens supports its customers over the entire life cycle of a machine, e.g. with worldwide presales and aftersales service at more than 295 service points in 130 countries.



#### **Application support: The safe path to effective solutions**

Siemens supports its customers with segment-specific industry know-how in machine applications and every aspect of Motion Control. Together we design and implement the ideal application for your machine. Our support ranges from the planning phase and engineering and implementation phase to commissioning and optimizing on-site.

Your benefits are:

- Competence in Motion Control solutions right from the start
- Best possible product selection, combination and integration
- Standardized, transparent and open solutions
- Close collaboration with product management and development
- Machine test bay
- Commissioning and optimization of the Motion Control solution on site

#### **Partnership for joint success**

During this cooperation Siemens not only supports its customers, but also includes them as technology partners in the development process of systems and components which results in practical and future-oriented automation solutions.

In this way Siemens helps its customers to increase productivity, competitiveness and profitability over the long term.



## Overview (continued)

### Digital Enterprise Software Suite Siemens' answer to the challenges presented by Industry 4.0

The business of our customers is more and more impacted by the Internet. Manufacturing companies are being forced to drastically shorten throughput times with massively improved flexibility in order to keep up with the increasingly strong trend toward individualized mass production. At the same time, they must consistently reduce their consumption of energy and raw materials.

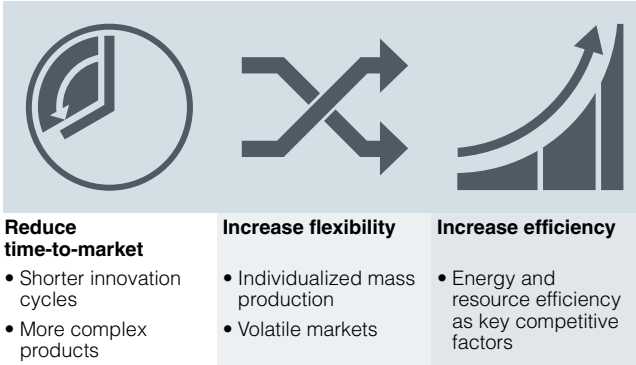

Over the past 15 years, Siemens has developed an extensive suite of software products and is now in a position to offer its customers a holistic automation solution covering all major Industry 4.0 requirements - the Digital Enterprise Software Suite. The backbone of the Digital Enterprise Software Suite is Teamcenter, our collaborative product data management platform.

The Siemens product portfolio already smoothly connects major parts of the product and production lifecycle today. Powerful software allows the development and optimization of new products on an entirely virtual basis. In the real manufacturing world the Totally Integrated Automation (TIA) concept, which has proven its worth for about 20 years now, ensures the efficient interoperability of all automation components. The Totally Integrated Automation Portal (TIA Portal), for example, already enables significant time and cost savings in engineering.

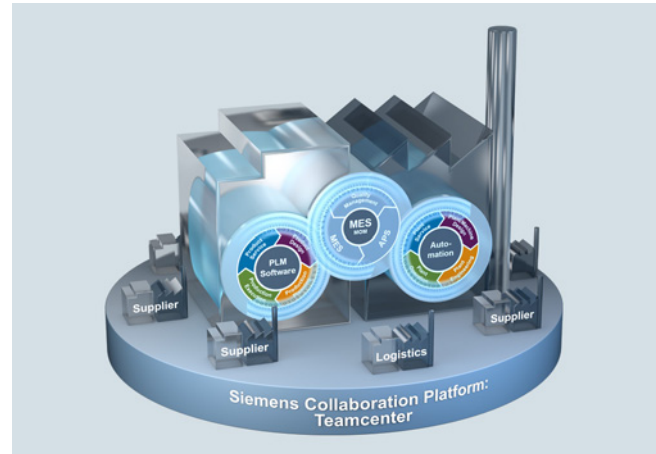

Product Lifecycle Management software supports you in the implementation of your innovations. Through digitalization and close interaction of the tools in the overall engineering workflow, even the "digital twin" can be checked against the original requirements in the end.

With the project generator SIMOTION easyProject, Siemens offers a tool that significantly speeds up the creation of a standardized project base for machine applications. Time and cost savings of up to 80 % are possible.

## More information

Additional information is available on the Internet.

- On the Digital Enterprise Software Suite:  
[www.industry.siemens.com/topics/global/en/digital-enterprise-suite](http://www.industry.siemens.com/topics/global/en/digital-enterprise-suite)
- On the project generator:  
[www.siemens.com/simotion-easyproject](http://www.siemens.com/simotion-easyproject)

## System overview

### SIMOTION – An overview

#### The SIMOTION system

1

#### Overview

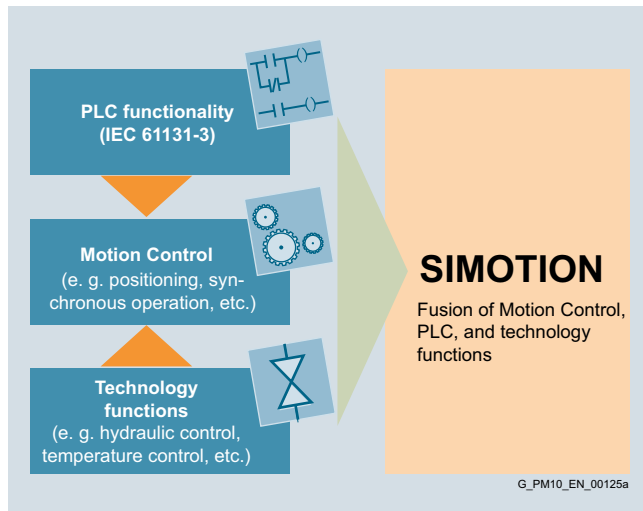

SIMOTION is recommended for all machines with Motion Control tasks – from simple to high-performance. The focus is on a simple and flexible solution to a wide variety of Motion Control tasks.

SIMOTION is based on the fusion of Motion Control with two other control functions which are found in most machines: PLC and technology functions.

This approach means that Motion Control of axes and control of the complete machine can be implemented within the same system. The same applies to technology functions, such as pressure control of a hydraulic axis. A seamless switch can be made from position-controlled positioning mode to pressure control.

**Combining the three open-loop control functions of Motion Control, PLC and technology functions has the following benefits:**

- Reduced engineering overhead and increased machine performance
- Fast system response – Time-critical interfaces between the individual components are no longer required
- Simple, uniform and transparent programming and diagnostics of the entire machine

The SIMOTION system is made up of three components:

#### Engineering system

It enables Motion Control, PLC and technology functions to be incorporated in one comprehensive, integrated system and provides all the necessary tools: From programming and parameterization through testing and commissioning, to diagnostics.

#### Runtime system

The runtime system offers a high-performance execution system for cyclic and sequential tasks. The runtime software modules make the different PLC, Motion Control and technology functions available. By selecting the appropriate modules, the overall functionality of the system can be flexibly adapted to the machine.

#### Hardware platforms

The hardware platforms are the basis of the SIMOTION Motion Control System. The application created with the engineering system and the associated runtime software modules can be implemented on different hardware platforms.

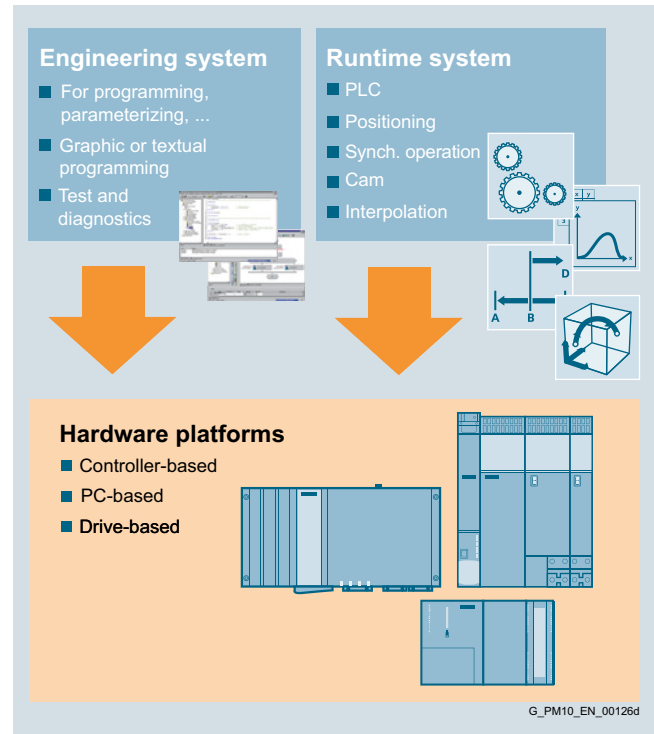

#### The fast path to the automation solution

Due to our multi-faceted industry solutions, engineering costs are reduced, project execution times are shortened, and automation solutions are implemented more quickly.

With the project generator SIMOTION easyProject, we also offer you a tool that significantly speeds up the creation of a standardized project base for machine applications.

### Overview

#### One concept – 3 platforms

Automation systems are primarily identified by the following characteristics:

- System-specific characteristics, e.g. functionality and engineering
- Hardware-dependent characteristics, e.g. performance, design and expandability

However, mechanical engineering demands vary greatly, depending on the version of the machine in question.

Every hardware platform has its benefits when used in certain applications.

The various platforms can also be combined very easily, which is a particular advantage in modular machines and plants. This is because the individual hardware platforms always have the same system characteristics, i.e. functionality and engineering are always identical, irrespective of the platform used.

PROFIBUS or PROFINET can be used to create the link to the drives and the I/Os remotely.

PROFINET/PROFIBUS can also be used for communication with HMI devices such as SIMATIC HMI or higher-level controllers such as SIMATIC S7. This means that SIMATIC HMI Panels as well as PCs with WinCC can be used as operator systems. Even 3rd party applications communicate with SIMOTION by means of the OPC interface.

#### SIMOTION D – Compact and integrated in the drive



In SIMOTION D, the SIMOTION functionality is integrated directly in the closed-loop control module of the SINAMICS S120 drive system. Therefore, the complete system (consisting of the open-loop control and the drive) is extremely compact and powerful.

Two SIMOTION D versions are available:

- As a SIMOTION D410-2 single-axis system with multi-axis option (blocksize format)
- As a SIMOTION D4x5-2 multi-axis system in four performance variants for up to 128 axes (booksize format)

This finely graded performance ensures the highest degree of scalability and flexibility. The field of application ranges from single axes to high-performance multi-axis machines. For visualization and operation, SIMATIC HMI devices can be connected via PROFINET, Ethernet or PROFIBUS depending on the SIMOTION D version. Distributed I/Os are connected via PROFINET or PROFIBUS.

## System overview

### SIMOTION – An overview

#### Hardware platforms

1

#### Overview (continued)

##### **SIMOTION P – Open for other tasks**

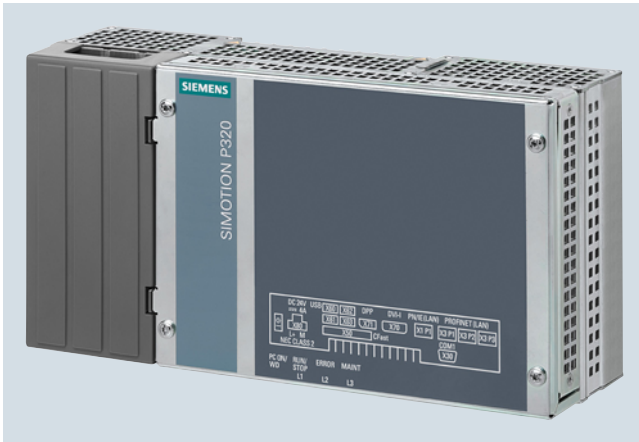

SIMOTION P is a PC-based Motion Control System which is available in two variants:

- SIMOTION P320-4 E (Embedded)  
Processor: high-performance Intel i3 processor  
Memory: internal CFast/CFast externally accessible  
Operating system: Windows Embedded Standard 7
- SIMOTION P320-4 S (Standard)  
Processor: high-performance Intel i7 processor  
Memory: Internal Solid State Disc (SSD)/  
externally accessible CFast  
Operating system: Windows 7 Ultimate

Thanks to the elimination of rotating parts in the PC, the SIMOTION P320-4 system is ideal for applications in harsh environments. Both PCs are equipped with the usual real-time expansion for SIMOTION. This means that in addition to SIMOTION machine applications, it is possible to run other PC applications at any time including, for example, the SIMOTION engineering system, an operator application, a process data evaluation routine or standard PC applications.

With its excellent processor performance, SIMOTION P320-4 is predestined for applications with superior performance requirements (such as hydraulic applications with highly dynamic position and pressure control loops).

SIMOTION P320-4 is particularly suitable for harsh operating environments. Its small footprint makes it the preferred choice for many applications in which available space and highly rugged design play a key role.

A comprehensive range of Industrial Flat Panels (IFP) in various screen sizes is available for the operation of SIMOTION P320-4 either using a keyboard and mouse or a touch screen.

The two SIMOTION P320-4 versions are equipped as standard with a fieldbus interface in the form of an integrated PROFINET interface (3 ports). The IsoPROFIBUS board can be installed in the expansion slot for PROFIBUS applications. The IsoPROFIBUS board features two additional PROFIBUS interfaces.

##### **SIMOTION C – Modularity and flexibility**



SIMOTION C is a Motion Controller based on the SIMATIC S7-300 design.

It is available in two variants which differ in terms of their interfaces, but not with respect to Motion Control functionality or performance. In addition to the already onboard I/Os, both controllers can be expanded using I/O modules from the SIMATIC S7-300 range.

SIMOTION C240 is the ideal solution for applications with analog setpoint interface and stepper drives. Its four onboard drive and encoder interfaces make this version especially suitable for machine retrofit projects.

SIMOTION C240 PN is available for PROFINET-based machine automation projects. This variant has three PROFINET ports that support PROFINET with IRT in addition to TCP/IP and RT communication. It is capable of operating PROFINET drives with PROFIdrive, as well as PROFINET I/Os such as the high-speed SIMATIC ET 200SP.

Both variants are equipped additionally with two PROFIBUS interfaces via which drives with PROFIdrive profile as well as standard I/Os can be connected. In addition, both controllers feature an Industrial Ethernet interface, thus offering further communication options.

### Overview

#### Multi-layer software architecture

With SIMOTION, motion tasks in many different machines are performed easily and uniformly.

To facilitate this, a very special, multi-layer architecture was chosen as the runtime software. All SIMOTION devices provide basic functionality such as PLC functionality with a command set according to IEC 61131-3. You can expand this basic functionality using the included technology packages and function libraries.

#### Scalable functionality

The technology packages, function libraries and multi-layer architecture of the runtime software combine to achieve the scalable functionality of SIMOTION.

#### Scalable

- Thanks to various functionality levels
- Thanks to software modules and technology packages with extensive functionality

#### Flexible

- Thanks to the integrated, freely programmable PLC following IEC 61131-3 standards
- Thanks to the technology objects that can be freely instantiated from the technology packages
- Thanks to a broad functional scope with a complex command set as well as function blocks according to the PLCopen standard
- Thanks to the option to run servo, vector, stepper, and hydraulic drives
- Thanks to the ability to combine the various technology packages and function libraries

#### Expandable

- Thanks to standard functions of the function libraries

#### Technology packages

Each of these packages provides complete functionality for the technology in question. For example, the Motion Control technology package provides all functions for precise positioning movements, including camming.

It also handles the cyclic exchange of setpoints and actual values with the drive including position control, calculation of the movement profile, removal or overriding of motions, homing functions, encoder changeover, axis release, status information, and more.

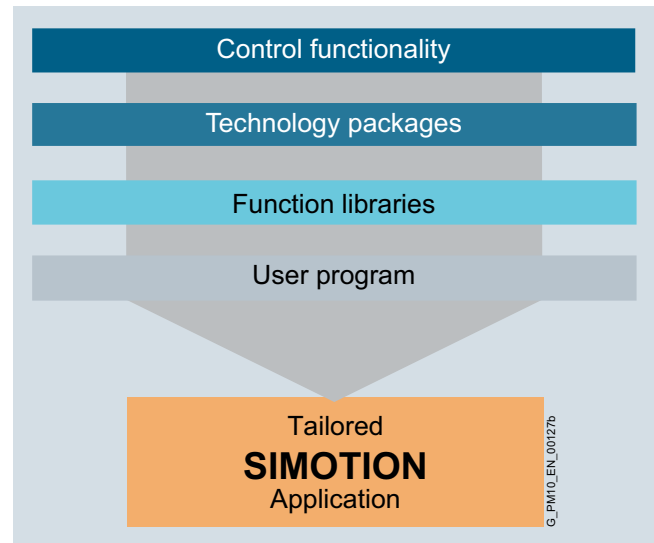

In addition to the Motion Control technology package (including positioning, synchronous operation, output cam, and path interpolation), packages for other technologies, e.g. temperature control, are also available.

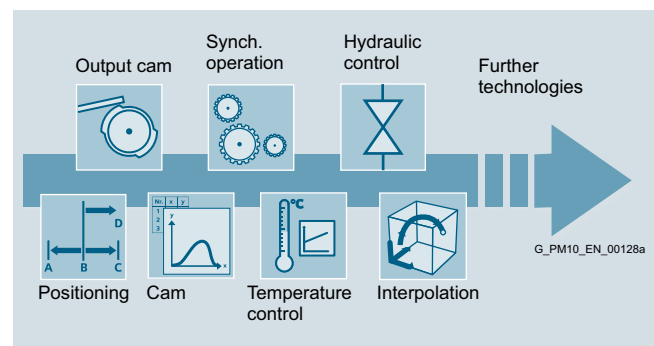

#### Function libraries

The function libraries offer standard functions

- For integration of special I/O modules (e.g. counter modules, communication modules, AS-Interface)
- For expanding the system functions (e.g. closed-loop controllers)

Modular user functions can also be stored as libraries for standardized implementation in projects.

## System overview

### SIMOTION – An overview

#### Engineering system

1

#### Overview

##### **Focus is on user friendliness**

As the performance capability of a system grows, so do the requirements of its user friendliness. This is the only means of ensuring the usability of the system. With SCOUT, the engineering system for SIMOTION, particular emphasis has therefore been placed on user friendliness:

- The engineering for Motion Control, PLC and technology as well as the drive configuration and commissioning are all performed in the same manner in the same engineering environment.
- All tasks are largely resolved in a graphical manner: Configuring, programming, testing and commissioning.
- Intuitive operation, context-sensitive help functions and automatic consistency checks make engineering easier, especially for those users who are new to in Motion Control programming.
- All the tools that are associated with the SCOUT engineering system are integrated, giving a uniform Look & Feel.

The SCOUT engineering system supports you step-by-step, making the engineering easy and efficient.

SCOUT can be used in SIMATIC STEP 7, either with standardized data management and configuring procedures, or as a stand-alone engineering tool (SCOUT Stand-Alone).

SCOUT TIA (SIMOTION in the TIA Portal) is available as an optional package for TIA Portal V13 and above and is included in the scope of supply of SCOUT.

##### **Programming for everyone**

The following options can be selected for programming SIMOTION with the SCOUT engineering system:

- Graphic programming with Motion Control Chart (MCC)
- Graphic programming with Drive Control Chart (DCC); (not for SCOUT TIA)
- Ladder logic (LAD)/Function block diagram (FBD), often used as PLC programming languages
- High-level language Structured Text (ST), including object-oriented programming

In addition to motion control commands (e.g. referencing of axis), commands for I/O access, logic and calculations, subroutine calls and control of the program flow are also available.

Complex motion relationships are also easy to set up using the graphical cam editors.

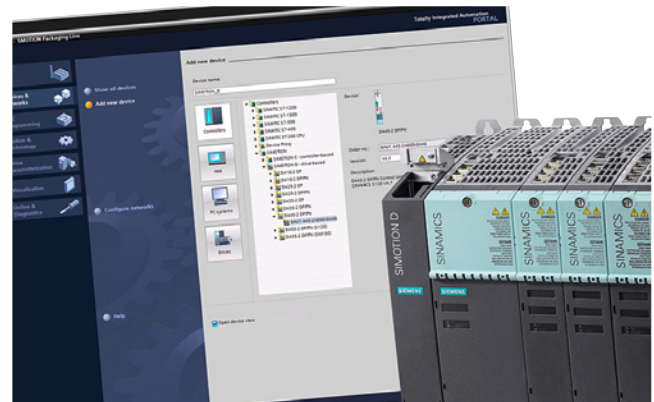

##### **Central management with integrated tools**

All the data for your complete machine can be managed in a single project: Configuration data, programs, movement profiles, and drive data.

The appropriate tools are then called from the central project management, e.g. for entering a cam or for commissioning a drive.

##### **Test and diagnostics**

SCOUT supports the testing, commissioning and error diagnostics of SIMOTION applications with a series of tools, such as those providing program status, control variables, trace, and the axis control panel.

### Overview

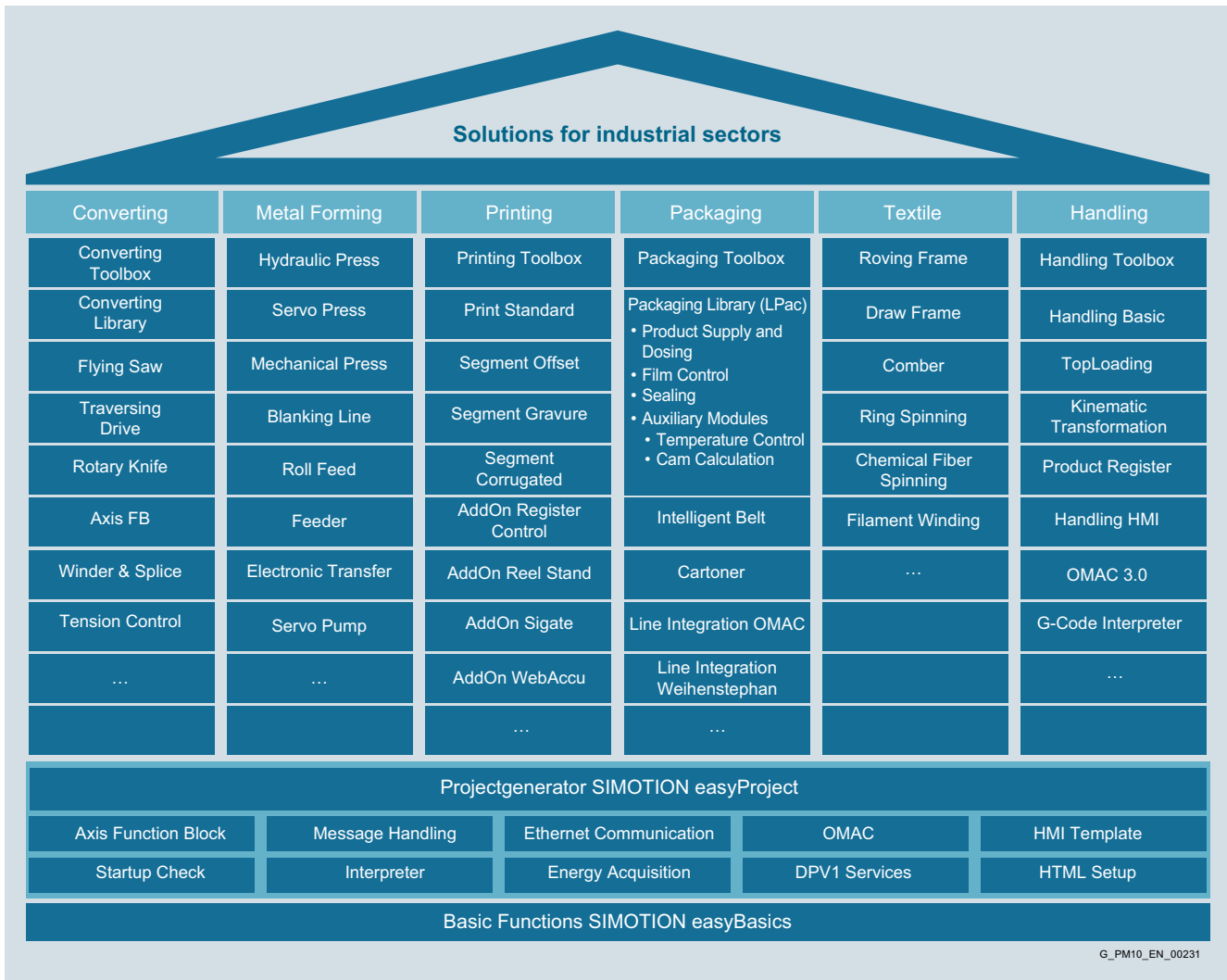

### **SIMOTION industry solutions**

The requirements for integrated solutions, uniform handling and engineering, and adequate scope for individual solutions in the industry sectors continues to increase. Therefore, the demand is for automation concepts which satisfy the customer-specific requirements in the individual industries and can be quickly and safely implemented by you, the machine manufacturer.

The goal is to create as much of the machine applications as possible using modular and reusable blocks. There are many tried and tested, well documented function modules available to you for SIMOTION – the basis for achieving tailored solutions with little cost and effort.

You benefit from preconfigured functions which can be freely and easily combined to correspond to the individual requirements of your machines. The modules are simply parameterized instead of being programmed at considerable expense.

### **Project generator SIMOTION easyProject: Considerably higher efficiency**

With SIMOTION easyProject, we offer you a tool that significantly speeds up the creation of a standardized project base for machine applications.

The selected basic and industry-specific standard modules are parameterized and automated and then integrated in a new or an existing project. The project can be loaded directly into the controller and is immediately executable.

Moreover, SIMOTION easyProject enables you to integrate your own blocks in this generic workflow of the automatic application creation. Thus, you are provided with a standardized and maintenance-friendly application structure.

## System overview

Notes

1



## SIMOTION Motion Control System









<b>2/2</b>	<b>Overview</b>
<b>2/4</b>	<b>SIMOTION D – Drive-based</b>
2/9	SIMOTION D410-2 Control Units
2/18	SIMOTION D4x5-2 Control Units
2/32	<u>Supplementary components</u>
2/32	SIMOTION CX32-2 Controller Extension
2/35	CBE30-2 Communication Board
2/36	TB30 Terminal Board
<b>2/38</b>	<b>SIMOTION P – PC-based</b>
2/38	SIMOTION P320-4 Motion Controller
<b>2/45</b>	<b>SIMOTION C – Controller-based</b>
2/45	SIMOTION C240/C240 PN Motion Controller
<b>2/52</b>	<b>SIMOTION software</b>
2/52	Overview
<b>2/53</b>	<b>SIMOTION runtime software</b>
2/53	Overview
2/56	SIMOTION Kernel
2/58	SIMOTION technology packages
2/65	SIMOTION PLCopen blocks
2/66	Overview of the licensing concept
2/68	Ordering of licenses for runtime software
<b>2/71</b>	<b>OPC server</b>
2/71	OPC server of SIMOTION and SIMATIC NET
<b>2/74</b>	<b>SIMOTION IT</b>
2/74	Web server functions for service and diagnostics
<b>2/77</b>	<b>SIMOTION engineering software</b>
2/77	Overview
2/79	<u>SIMOTION SCOUT</u>
2/81	Workbench
2/82	Hardware and network configuration
2/83	Creation of technology objects
2/84	Creation of cams (basic)
2/85	Structured Text (ST)
2/86	Motion Control Chart (MCC)
2/87	Ladder Diagram / Function Block Diagram (LAD/FBD)
2/88	Diagnostics for testing and commissioning
2/90	<u>Optional packages for SIMOTION SCOUT</u>
2/90	CamTool (graphical cam editor)
2/91	Drive Control Chart (DCC)
2/92	<u>Options for SIMOTION SCOUT</u>
2/92	SIMOTION easyProject project generator
2/95	SIMOTION Utilities & Applications
2/97	<u>Ordering of engineering software, information</u>
<b>2/99</b>	<b>Overview of SIMOTION functions</b>

# SIMOTION Motion Control System

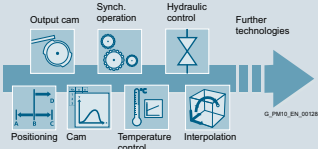
## Overview

2

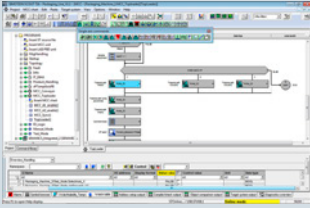
	Designation	Description	Page
<b>SIMOTION D – Drive-based</b>			<b>2/4</b>
	SIMOTION D410-2 Control Units	Compact Control Units for single-axis applications with multi-axis option	<b>2/9</b>
	SIMOTION D4x5-2 Control Units	Scalable Control Units for multi-axis applications	<b>2/18</b>
	Supplementary components	SIMOTION CX32-2 Controller Extension: Modular expansion of the drive's computing capacity	<b>2/32</b>
		CBE30-2 Communication Board: Option board for PROFINET	<b>2/35</b>
		TB30 Terminal Board: Option board with digital/analog inputs/outputs	<b>2/36</b>
<b>SIMOTION P – PC-based</b>			<b>2/38</b>
	SIMOTION P320-4 Motion Controller	Motion Controller for PC-based solutions	<b>2/38</b>
<b>SIMOTION C – Controller-based</b>			<b>2/45</b>
	SIMOTION C240/C240PN Motion Controller	Motion Controller for analog, stepper, PROFINET and PROFIBUS drives	<b>2/45</b>
<b>SIMOTION software</b>			<b>2/52</b>
<b>SIMOTION runtime software</b>			<b>2/53</b>
	SIMOTION Kernel	Structure and functions of the SIMOTION Kernel	<b>2/56</b>
	SIMOTION technology packages	Functions of the technology packages	<b>2/58</b>
	SIMOTION PLCopen blocks	PLCopen blocks for SIMOTION	<b>2/65</b>
	Runtime software licensing	Overview of the licensing concept	<b>2/66</b>
		Ordering of licenses for runtime software	<b>2/68</b>
<b>OPC server</b>			<b>2/71</b>
	OPC server	Standard communication to SIMOTION over OPC	<b>2/71</b>
<b>SIMOTION IT</b>			<b>2/74</b>
	SIMOTION IT	Web server functions for service and diagnostics	<b>2/74</b>

	Designation	Description	Page
<b>SIMOTION engineering software</b>			<b>2/77</b>
	SIMOTION SCOUT	The engineering system for SIMOTION Description of basic functions SCOUT Workbench, hardware and network configuration, generation of technological objects, generation of cams, Structured Text (ST), Motion Control Chart (MCC), ladder logic/function block diagram (LAD/FBD), diagnostics for testing and commissioning	<b>2/79</b> <b>2/81</b>
	Optional packages for SIMOTION SCOUT	CamTool (graphical cam editor) Drive Control Chart (DCC)	<b>2/90</b> <b>2/91</b>
	Options for SIMOTION SCOUT	Projects can be created more efficiently with SIMOTION easyProject	<b>2/92</b>
		SIMOTION Utilities & Applications – a comprehensive library with applications, examples, tools, scripts, FAQs, ...	<b>2/95</b>
	Ordering of engineering software	Selection and ordering data, information	<b>2/97</b>
<b>Overview of SIMOTION functions</b>			<b>2/99</b>
	System clocks	PROFINET and PROFIBUS DP cycle clocks; System cycles for Motion Control	<b>2/99</b>
	Dynamic Servo Control (DSC)	Position controller in the drive	<b>2/100</b>
	Memory for system data	Memory sizes	<b>2/100</b>
	Address ranges	Address ranges of the Motion Controller	<b>2/100</b>
	Drives on SIMOTION	Which drives can be operated on SIMOTION?	<b>2/101</b>
	Encoders on SIMOTION	Which encoders can be directly connected to SIMOTION? Are there other connection options?	<b>2/103</b>
	Measuring inputs	How many measuring inputs are provided on the SIMOTION platforms? Are there further options for implementing measuring inputs?	<b>2/103</b>
	Cam outputs	How many onboard cam outputs are provided on the SIMOTION platforms? Are there further options for implementing cam outputs?	<b>2/104</b>
	Integrated I/O interfaces	How many onboard I/O interfaces are provided? (digital, analog, relay outputs, etc.)	<b>2/105</b>
	SIMOTION C centralized I/O modules	How many centralized I/O modules can be added to SIMOTION C?	<b>2/106</b>
	Connectable distributed I/O modules	Which distributed I/O modules can be connected over PROFIBUS or PROFINET? Which SINAMICS drive I/O modules can be connected to SIMOTION?	<b>2/106</b>
	SIMATIC HMI devices	Which HMI devices can be connected to SIMOTION?	<b>2/107</b>
	HMI software for SIMOTION	Which HMI software can be employed for SIMOTION applications?	<b>2/107</b>
	Software for extended communication with SIMOTION	Communication according to the standards OPC and OPC XML-DA, SIMOTION Multipurpose Information Interface	<b>2/107</b>
Communication	Which communication interfaces are provided on the SIMOTION platforms?	<b>2/108</b>	
PROFIsafe drives on SIMOTION	How many PROFIsafe drives can be operated with SIMOTION?	<b>2/111</b>	
SIMOTION Kernel	Performance features of the SIMOTION Kernel and PLC command set	<b>2/112</b>	
Motion Control technology package	Features of the Motion Control technology package	<b>2/114</b>	
Other technology packages	SIMOTION technology packages for special areas of application	<b>2/115</b>	
SIMOTION IT	Software options for extending the service and diagnostic functions of SIMOTION	<b>2/115</b>	
SIMOTION SCOUT engineering system	SCOUT basic functionality and optional packages	<b>2/116</b>	
Testing and diagnostics with SIMOTION SCOUT	Program test functions, trace, comparison function for projects. etc.	<b>2/117</b>	
Engineering drives	Drive engineering tools for SIMOTION	<b>2/118</b>	

## SIMOTION Motion Control System

### SIMOTION D – Drive-based

#### Overview



SIMOTION D Control Units: D410-2, D4x5-2 (4 performance classes)

SIMOTION D is a compact, drive-based version of SIMOTION based on the SINAMICS S120 drives family.

The SIMOTION D Control Units are available in the following variants:

- SIMOTION D410-2 are compact Control Units for single-axis applications with multi-axis option. The Control Units are available in variants D410-2 DP and D410-2 DP/PN and are snapped onto the SINAMICS S120 Power Modules in blocksize format.
- SIMOTION D4x5-2 are Control Units for multi-axis applications in the SINAMICS S120 booksize format and are available in the following performance variants:
  - SIMOTION D425-2 DP and D425-2 DP/PN Control Units (BASIC performance) for up to 16 axes
  - SIMOTION D435-2 DP and D435-2 DP/PN Control Units (STANDARD Performance) for up to 32 axes
  - SIMOTION D445-2 DP/PN Control Unit (HIGH performance) for up to 64 axes
  - SIMOTION D455-2 DP/PN Control Unit (ULTRA-HIGH performance) for up to 128 axes or applications with very short control cycles

This fine scalability ensures a quick response to changing requirements in automation without having to change the system.

#### System concept

With SIMOTION D, the PLC, the Motion Control and technology functions as well as the SINAMICS S120 drive software run on a shared control hardware. The IEC 61131-3-compliant PLC integrated in SIMOTION D means that the system is not just capable of controlling sequences of motions, but the entire machine can also be controlled with a single compact unit.

Depending on the SIMOTION D platform, HMI devices can be operated on the PROFINET, Ethernet or PROFIBUS interfaces for operator control and monitoring. Functions such as remote maintenance, diagnostics and teleservice can also be used via these interfaces.

#### Benefits

- Cost-effective thanks to the integration of PLC, Motion Control and technology functions directly in the drive
- Employs the innovative SINAMICS S120 design
- Compact design reduces control cabinet size
- Ideally suited to modular and distributed machine concepts
- User-friendly operation
- Variable networking via a wide range of communication interfaces:
  - D410-2 DP, D4x5-2 DP: Industrial Ethernet and PROFIBUS DP onboard
  - D410-2 DP/PN, D4x5-2 DP/PN: PROFINET IO, Industrial Ethernet and PROFIBUS DP onboard
- Powerful thanks to a range of technology functions
- Very simple engineering, from drive commissioning to open-loop control and Motion Control applications
- Easy to service thanks to CompactFlash card, which can be easily replaced and contains all data (programs, data, drive parameters)
- Very fast response because the interfaces between PLC and Motion Control are no longer required

#### Application

##### ***SIMOTION D can be used optimally wherever***

- the SINAMICS S120 drive family is used
- the Motion Control and PLC functionality are directly executed in the drive (SINAMICS S120)
- a compact, space-saving construction is required
- high performance is required for Motion Control and high-speed I/O
- high electromagnetic compatibility and a high resistance to shock and vibration are required due to harsh ambient conditions
- modular machine concepts with high-speed isochronous coupling are required

##### ***The flexible solution for modular machine concepts***

SIMOTION D optimally supports the implementation of modular machine concepts in which single-axis drives and high-performance multi-axis drives have to be combined:

- SIMOTION D410-2 (blocksize format) is the most cost-effective solution for the compact design of drives, ranging from single units to small-scale multi-axis solutions with typically 2 to 3 axes (max. 8 axes).
- SIMOTION D4x5-2 (booksize format) performs the open-loop and closed-loop control functions for multi-axis groups with up to 128 axes.

### Application (continued)

#### Important applications include:

- Packaging machines
- Plastic and rubber processing machines
- Presses, wire-drawing machines
- Textile machines
- Printing machines
- Wood, glass, ceramics and stone working machines
- Converting
- Handling devices

Due to the increasing use of servo and vector drives, these machines require a high degree of integration of PLC, Motion Control and technology functions.

With SIMOTION D4x5-2 selected Control Units are also available as SIPLUS version for use under extremely difficult environmental conditions (e.g. in toxic atmospheres).

2

### Design

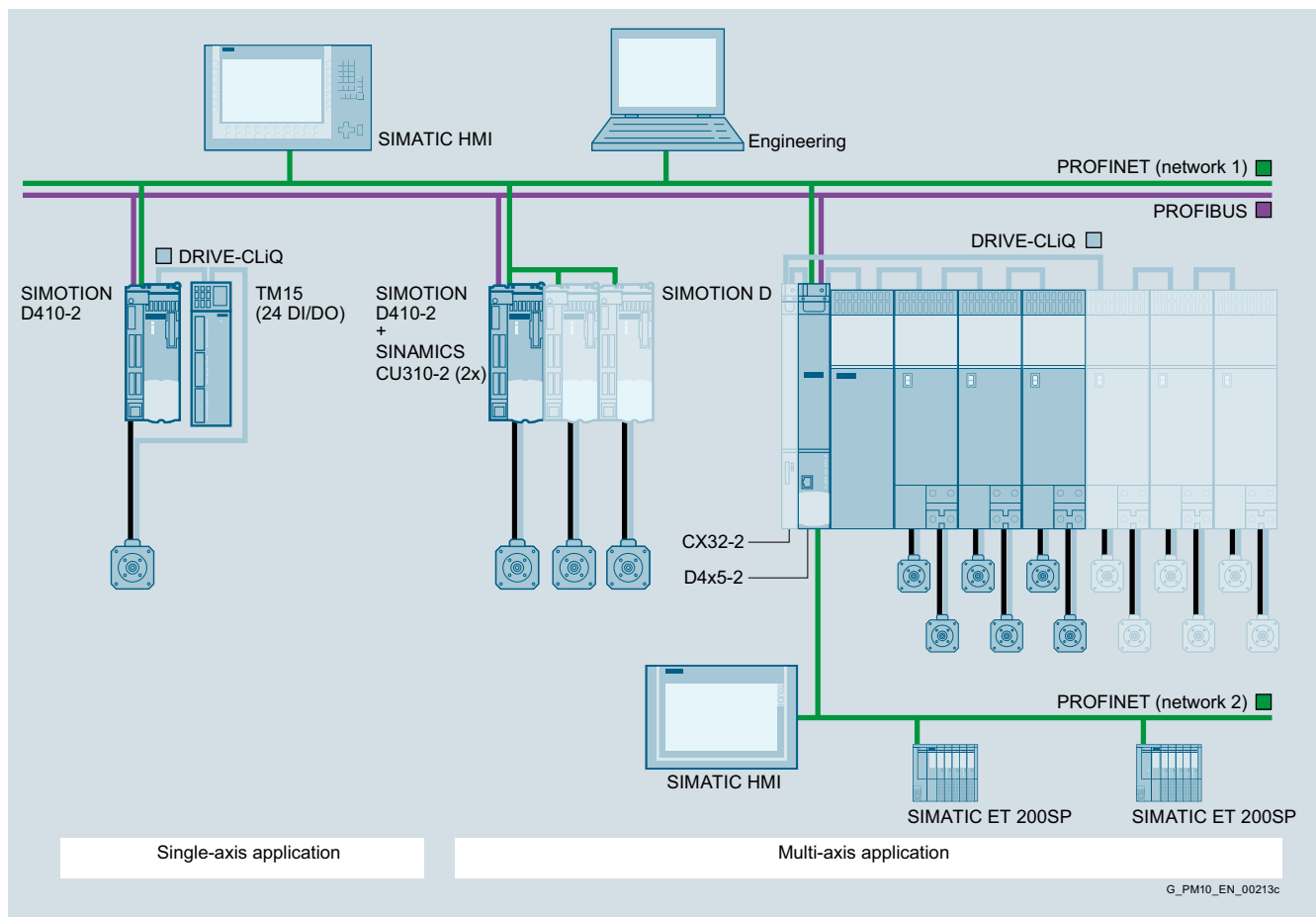

Typical design of an automation solution using SIMOTION D

## SIMOTION Motion Control System

### SIMOTION D – Drive-based

#### Design (continued)

##### **SIMOTION D components and interfaces**

- Various status/error displays
- Onboard digital inputs and outputs
- Option slot (receptacle, only for D4x5-2), e.g. for expansion with additional I/Os with the TB30 Terminal Board
- Integrated communications interfaces for linking:
  - SINAMICS S120 drive modules
  - Distributed I/Os
  - HMI systems
  - PG/PC
  - Other Motion Control and automation systems
  - Other SINAMICS S110/S120 drives with digital setpoint interface
- Slot for CompactFlash card for data backup

##### **Design of a single axis with SIMOTION D410-2**

The following components make up a SIMOTION D410-2 single-axis system:

- A SIMOTION D410-2 Control Unit, designed for open and closed-loop control of a single drive
- A SINAMICS S120 PM240-2 Power Module in blocksize format, combined infeed and power unit
- Other drive components, such as
  - Power supply
  - Filter
  - Reactor, etc.

The connection between SIMOTION D410-2 and the SINAMICS S120 Power Module is made with the integrated PM-IF interface or, when the CUA31/CUA32 Control Unit Adapter is used, via DRIVE-CLiQ.

##### **Design of an axis grouping with SIMOTION D410-2**

In order to create a multi-axis grouping with SIMOTION D410-2, additional SINAMICS S110/S120 Control Units are connected to the SIMOTION D410-2 by means of PROFINET or PROFIBUS.

Motion control is performed centrally by the SIMOTION D410-2 using the SIMOTION technology objects.

##### **Design of an axis grouping with SIMOTION D4x5-2**

The following components comprise a SIMOTION D4x5-2 axis grouping:

- A SIMOTION D4x5-2 Control Unit, designed for open and closed-loop control of a multiple axis grouping
- A SINAMICS S120 Line Module (infeed module)
- One or more SINAMICS S120 Motor Modules (power units)
- Other drive components, such as
  - Power supply
  - Filter
  - Reactor, etc.

DRIVE-CLiQ provides the link between the SIMOTION D Control Unit and the SINAMICS S120 drive modules.

##### **Note:**

SINAMICS S120 PM240-2 Power Modules in blocksize format can be operated on a SIMOTION D4x5-2/CX32-2 with the CUA31/CUA32 Control Unit Adapters.

##### **Expansion using I/O**

SIMOTION D can be expanded with the following I/O:

- Distributed I/O systems (e.g. SIMATIC ET 200SP)
- Drive-based control cabinet I/O (e.g. TM15, TM31 Terminal Modules, etc.)

#### Function

##### **Basic functionality**

The SIMOTION D basic functionality is supplied with the CompactFlash card (CF) and is loaded when the power is switched on. The basic functionality includes:

- SIMOTION runtime system
  - User-programmable with several languages conforming to IEC 61131
  - Various runtime levels (cyclic, sequential, event-driven)
  - PLC and arithmetic functionality
  - Communication and management functions
  - Motion Control functions (Motion Control Basic)
- SINAMICS S120 drive control
  - SIMOTION D410-2:
    - Current/speed control (based on CU310-2, firmware version V4.x) for up to 1 servo axis, 1 vector axis or 1 V/f axis
  - SIMOTION D4x5-2:
    - Current/speed control (based on CU320-2, firmware version V4.x) for up to 6 servo axes, 6 vector axes or 12 V/f axes, closed-loop control for infeed (Active Line Module)
- Testing and diagnostic tools

This basic functionality can be expanded with loadable technology packages, if required.

##### **Position-controlled motion control for drives**

- Integrated drives (SINAMICS Integrated):
  - The power units are connected over DRIVE-CLiQ or over the integrated PM-IF interface optionally for the SIMOTION D410-2.
- Drives with digital setpoint interface:
  - SIMOTION D enables position-controlled motion control for drives with digital setpoint interfaces via PROFINET IO/PROFIBUS DP with PROFIdrive.
- Drives with analog setpoint interface, e.g. for retrofit or hydraulic applications:
  - The ADI 4 (Analog Drive Interface for 4 Axes) or IM 174 (Interface Module for 4 Axes) module can be used to connect drives with analog  $\pm 10$  V setpoint interfaces. The IM 174 also makes it possible to connect stepper drives with a pulse direction interface.
  - Both modules are connected over PROFIBUS DP. The following can be connected to one ADI 4 or IM 174 module:
    - 4 drives
    - 4 encoders
    - Digital inputs and outputs

### Function (continued)

#### **SIMOTION technology packages**

A special feature of SIMOTION is that the basic functionality can be expanded by loading technology packages, such as:

- Motion Control with the technology functions:
  - POS – Positioning
  - GEAR – Synchronous operation/electronic gear
  - CAM – Cam
  - PATH - Path interpolation
- TControl – Temperature controller
- MIIF – Multipurpose Information Interface
- Vibration Extinction (VIBX)
- OACAMGEN

Since the technology functions have modular licenses, you only pay for what you will actually use.

#### **Performance**

Hardware-supported floating-point arithmetic enables complex arithmetic functions to be used effectively.

Fast instruction execution opens up completely new application possibilities in the mid-performance to high-performance range.

#### **Configuring/parameterizing/programming**

SIMOTION SCOUT is a powerful and user-friendly engineering tool. It is an integrated system for all engineering steps, from configuring and parameterization, through programming, to testing and diagnostics. Graphical operator prompting, using dialog boxes and wizards, as well as text-based and graphical languages for programming, considerably reduce the familiarization and training periods.

#### **Operator control and monitoring (HMI)**

Communication services which support user-friendly data exchange with SIMATIC HMI devices are integrated in the basic functionality of SIMOTION D.

These HMI devices can be connected to SIMOTION D over PROFINET, Industrial Ethernet or PROFIBUS and they are configured using SIMATIC WinCC (TIA Portal).

Version V7.0 and higher of the SCADA system SIMATIC WinCC features a SIMOTION channel which is included as standard on the WinCC DVD.

With the SIMATIC NET communications software, an open, standardized OPC interface is available for accessing SIMOTION from other Windows-based HMI systems.

#### **SIMOTION IT service and diagnostic functions**

SIMOTION IT provides SIMOTION D with an integrated web server on which, for example, user-specific web pages can be stored.

Read and write access can be made to the Control Unit variables. Java scripts or applets also allow the implementation of active operation and display functions in the web pages that can be executed on a client PC with an Internet browser.

#### **Process and data communication**

Thanks to its integrated interfaces, SIMOTION D supports both process and data communication.

PROFINET IO with IRT is available for exacting Motion Control applications. In addition to cycle clock synchronization, cycle times of minimum 125 µs and safety-related communication (PROFIsafe), the PROFINET interfaces on the SIMOTION D4xx-2 Control Units also support media redundancy (MRP/MRPD).

The SIMOTION SCOUT engineering system is provided for user-friendly communication configuration and diagnostics.

#### **Safety Integrated functions**

Highly effective protection of personnel and machinery can be implemented with SIMOTION D thanks to the integrated safety functions of SINAMICS S120.

The integrated safety functions that are currently available are described below. Their functional safety satisfies the requirements defined in the international standard IEC 61800-5-2 for variable-speed drive systems.

The safety functions integrated into the SINAMICS S120 drive system can be roughly divided into four categories:

- Functions for safely stopping a drive
  - Safe Torque Off (STO)
  - Safe Stop1 (SS1)
  - Safe Stop2 (SS2)
  - Safe Operating Stop (SOS)
- Functions for safe brake management
  - Safe Brake Control (SBC)
  - Safe Brake Test (SBT)  
(this diagnostic function exceeds the scope of IEC 61800-5-2)
- Functions for safely monitoring the motion of a drive
  - Safely Limited Speed (SLS)
  - Safe Speed Monitor (SSM)
  - Safe Direction (SDI)
- Functions for safely monitoring the position of a drive
  - Safely Limited Position (SLP)
  - Safe Position (SP)  
(this function exceeds the scope of IEC 61800-5-2)

#### **Activation of Safety Integrated functions**

Safety Integrated functions can be activated by the following methods:

- Via terminals on SIMOTION D4x5-2/CX32-2 and on the power unit (STO, SBC, SS1 only)
- Via fail-safe inputs on the TM54F Terminal Module
- Via fail-safe inputs on SIMOTION D410-2
- Via PROFINET/PROFIBUS with PROFIsafe.

The SLS and SDI functions can also be activated permanently via parameter assignment.

The Safety Integrated functions are implemented electronically and therefore offer short response times in comparison to solutions with externally implemented monitoring functions.

## SIMOTION Motion Control System

### SIMOTION D – Drive-based

#### Function (continued)

##### Safety Integrated functions via PROFIsafe

Safety Integrated functions are activated via "PROFINET with PROFIsafe" or "PROFIBUS with PROFIsafe" safe communication. The control (F logic) is implemented using an F-CPU connected via PROFINET or PROFIBUS. The connection for configuring the system with SCOUT TIA can only be made via PROFINET.

Safety Integrated functions are routed through from the SIMOTION D410-2 and D4x5-2 Control Units to the following drives:

- Integrated SINAMICS S120 drives on SIMOTION D410-2 and D4x5-2
- Drives on the SIMOTION CX32-2 Controller Extension
- Drives on SINAMICS Control Units connected via PROFIBUS to SIMOTION D.
- Drives on SINAMICS Control Units connected to SIMOTION D via PROFINET (the F-CPU must be connected via PROFINET in this case).

##### Note

For more information about possible topologies, axis quantity structures and suitable components, please contact your local Siemens sales office.

Detailed information can be found in the SIMOTION D Commissioning Manuals as well as in the SINAMICS documentation.

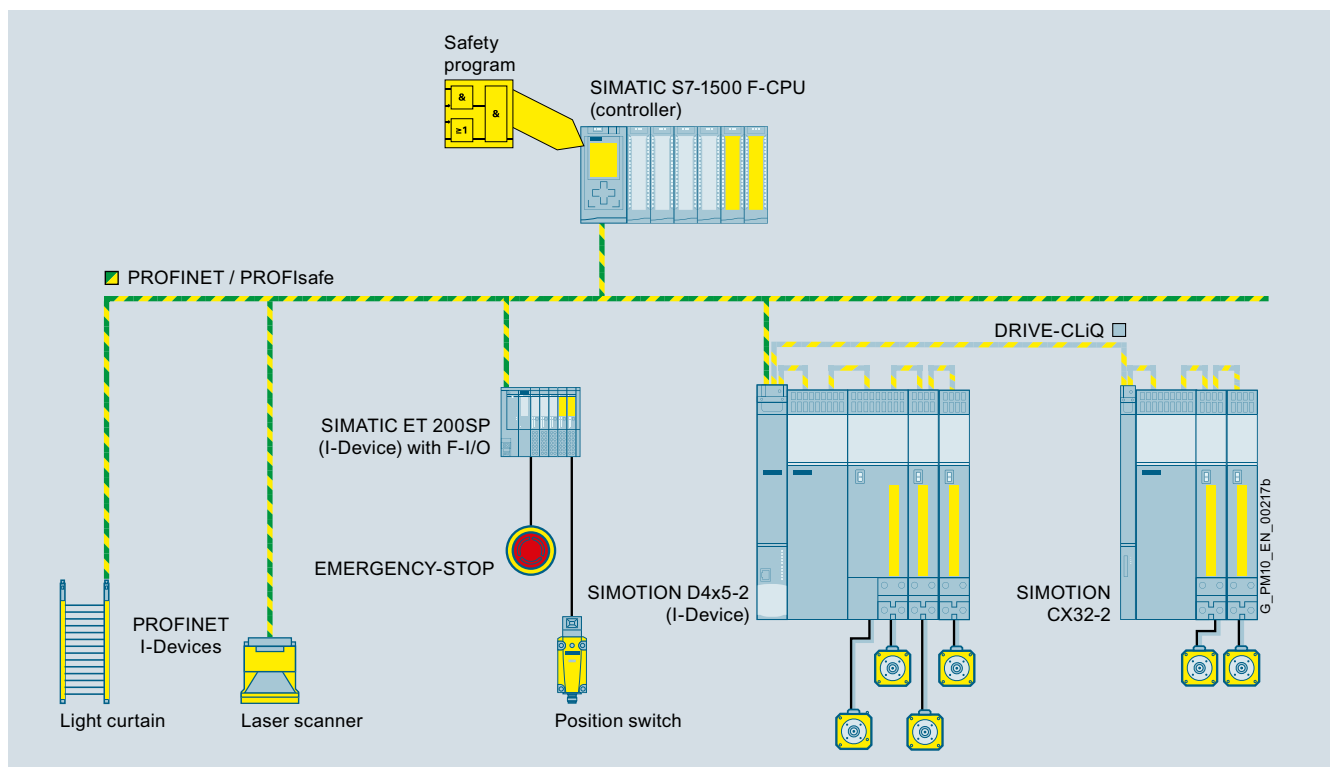

Safety Integrated solution with SIMOTION D4x5-2: Control of the safety functions via PROFINET with PROFIsafe



#### Overview



Left: SIMOTION D410-2 Control Unit attached to mounting plate

Right: SIMOTION D410-2 Control Unit, snapped onto Power Module

SIMOTION D410-2 is the SIMOTION D variant for single-axis applications with multi-axis option in blocksize format. The Control Units form part of the SIMOTION D4x5-2 controller family which is the preferred option for multi-axis applications in booksize format. The SIMOTION D410-2 Control Unit is available as a PROFIBUS variant (D410-2 DP) and as a PROFIBUS/PROFINET variant (D410-2 DP/PN).

The SIMOTION D410-2 Control Units are specially designed for use with the SINAMICS S120 PM240-2 Power Modules in blocksize format and can be directly connected to the Power Modules of this series. The SIMOTION D410-2 can also be installed on a mounting plate if required (to be ordered separately).

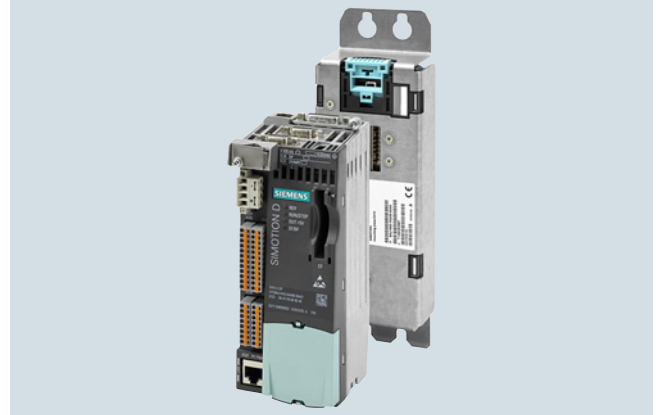

SIMOTION D410-2 Control Unit and mounting plate

The SIMOTION D410-2 handles the Motion Control, technology and PLC functions associated with a single axis and is also responsible for the drive control of that axis. The integrated inputs/outputs support up to 8 high-speed cam outputs or 8 measuring inputs.

The drive control supports servo control (for a highly dynamic response), vector control (for maximum torque accuracy) and V/f control.

SIMOTION D410-2 can be used in synchronized groups:

- For PROFINET: over controller – controller or controller – device relationship
- For PROFIBUS: over master – slave relationship

## SIMOTION Motion Control System

### SIMOTION D – Drive-based

#### SIMOTION D410-2 Control Units

##### Application

SIMOTION D410-2 is the ideal solution when Motion Control for one axis and PLC functionality are required in compact format. However, it can also be used for small multi-axis groupings with typically 2 to 3 axes (max. 8 axes) in blocksize format. With these applications, the SINAMICS Control Units are connected to the SIMOTION D410-2 via PROFINET or PROFIBUS.

Examples of SIMOTION D410-2 applications include:

- Autonomous control of single axes
- Cross cutters
- Winder applications
- Feeder devices/roller infeed/press feeders
- Synchronized machining equipment
- Compact machine modules, e.g.
  - Feeders in post press applications
  - Shrink wrapping machines
- Small multi-axis groupings (typically 2 to 3 axes) in blocksize format

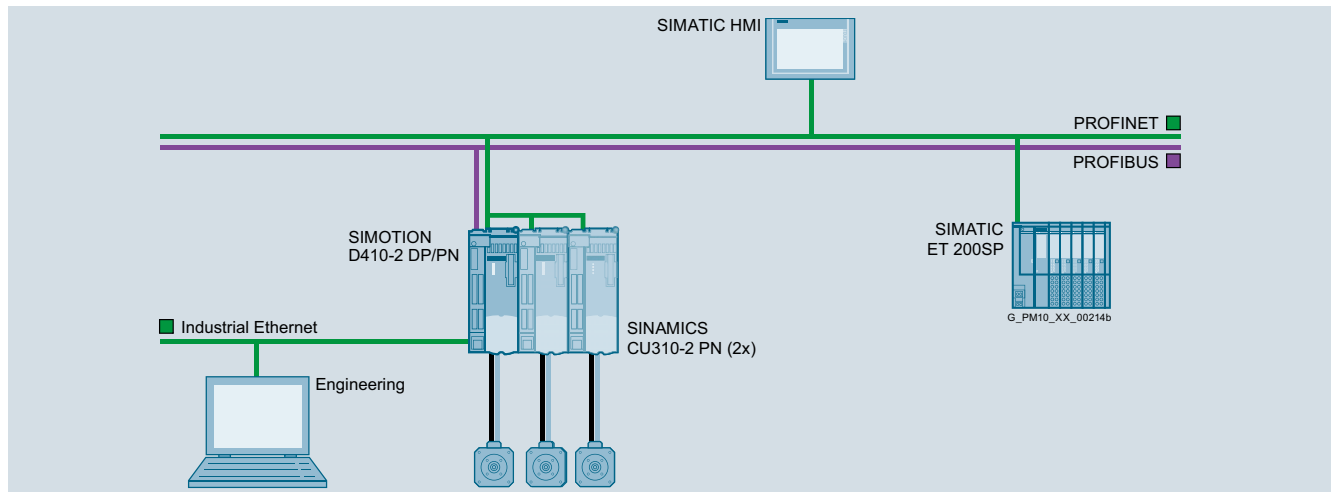

SIMOTION D410-2 axis grouping with 3 axes (1 × D410-2 DP/PN, 2 × CU310-2 PN)

SIMOTION D410-2 supports Motion Control with the technology functions positioning (POS), synchronous operation/electronic gear (GEAR), cam (CAM) and path interpolation (PATH).

##### Design

###### Interfaces

###### Display and diagnostics

- LEDs to display operating states and errors
- 3 measuring sockets
- Service selector switch and mode selector
- Diagnostics button

###### Onboard I/Os

- 5 digital inputs
- 8 digital inputs/outputs (max. 8 as cam outputs or 8 as measuring inputs)
- 3 fail-safe, two-channel inputs (F-DI); can also be used as 6 DI
- 1 fail-safe output (F-DO); can also be used as 1 DO
- 1 analog input (either  $\pm 10$  V or  $\pm 20$  mA)

###### Communication

- 1 × DRIVE-CLiQ
- 1 × PROFINET IO (1 interface with 2 ports, D410-2 DP/PN only)
- 1 × PROFIBUS DP (D410-2 DP: 2 × PROFIBUS DP)
- 1 × Industrial Ethernet

###### Data backup

- 1 slot for SIMOTION CompactFlash card

###### Additional interfaces

- Terminals for 24 V electronics power supply
- 1 × encoder input for
  - HTL/TTL incremental encoder
  - SSI absolute encoder (without incremental signals)
- 1 × temperature sensor input (KTY84-130, Pt1000 or PTC)
- PM IF interface (Power Module interface) on rear for direct operation with a SINAMICS S120 PM240-2 Power Module in blocksize format

### Design (continued)

#### Mounting

SIMOTION D410-2 can be directly plugged into the SINAMICS S120 Power Module in blocksize format.

Alternatively, the SIMOTION D410-2 can be mounted on a mounting plate (to be ordered separately) and connected to the Power Module via DRIVE-CLiQ. In this case, the CUA31/CUA32 Control Unit Adapter has to be connected to the Power Module. No more than one Control Unit Adapter can be connected to the SIMOTION D410-2.

#### Note:

It is not possible to use the Safety Integrated Extended Functions via the onboard terminals (F-DI, F-DO) when the Power Module is connected via CUA31/CUA32.

Power Modules in AC/AC chassis format are connected to the SIMOTION D410-2 over the DRIVE-CLiQ interface. Motor Modules in booksize format cannot be connected to SIMOTION D410-2.

A SIMOTION D410-2 mounted on the mounting plate can also be operated without a Power Module, e.g.

- for hydraulic applications with connected TM31 for the analog inputs and analog outputs
- for the connection of drives with analog  $\pm 10$  V setpoint interface (IM 174/ADI 4)
- for other drives connected via PROFINET/PROFIBUS in accordance with the PROFIdrive V4 specification and the application classes 1 to 4 (class 4 both with and without DSC).

#### Data storage/data backup

The SIMOTION D410-2 Control Units store the retentive process data permanently in a manner that requires no maintenance (refer to technical data for memory size). The real-time clock is backed up for several days via a SuperCap.

The runtime software, user data and user programs are backed up on the SIMOTION CompactFlash card. The retentive process data of the Control Unit can also be stored on this CompactFlash card via system command, e.g. if spare parts are required.

#### Connectable I/Os

PROFINET IO: (D410-2 DP/PN only)

- Certified PROFINET devices
- SIMATIC ET 200S/SP/M/MP/eco PN/pro/AL distributed I/Os
- SIMATIC HMI

PROFIBUS DP:

- Certified PROFIBUS standard slaves (DP-V0, DP-V1, DP-V2)
- SIMATIC ET 200S/SP/M/MP/eco/pro/AL distributed I/Os systems
- SIMATIC HMI

DRIVE-CLiQ:

Modules from the SINAMICS range:

- Terminal Modules (max. 8), of which
  - maximum 3 are TM15, TM41
  - maximum 8 are TM15 DI/DO, TM31
  - maximum 1 is TM54F
- SMC/SME Sensor Modules (maximum 5 encoder systems via DRIVE-CLiQ)
- DMC20/DME20 DRIVE-CLiQ Hub Module (max. 1)
- Motors with DRIVE-CLiQ interface

### Integration

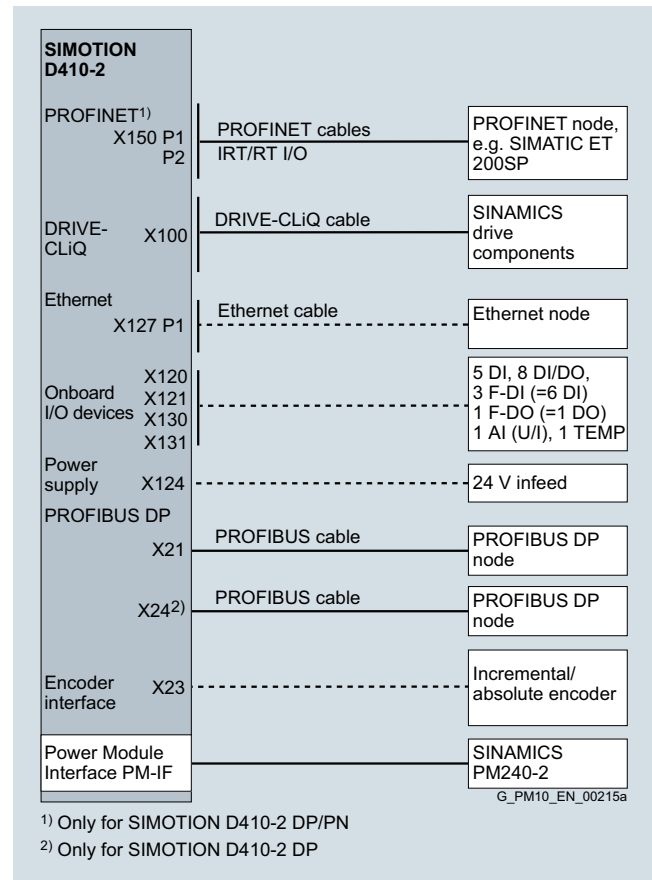

Overview of SIMOTION D410-2 connections

When dimensioning cables, you must always observe the maximum permissible cable lengths.

If these maximum lengths are exceeded, malfunctions can occur.

The permissible length of PROFIBUS DP cables depends on the configuration.

The DRIVE-CLiQ and encoder cables used for the SINAMICS S120 CU310-2 Control Unit can also be used for SIMOTION D410-2.

# SIMOTION Motion Control System

## SIMOTION D – Drive-based

### SIMOTION D410-2 Control Units

#### Technical specifications

Article number		6AU1410-2AA00-0AA0	6AU1410-2AD00-0AA0
Product brand name		SIMOTION	SIMOTION
Product type designation		D410-2 DP	D410-2 DP/PN
Version of Motion Control System		Single-axis system with multi-axis option	Single-axis system with multi-axis option
<b>PLC and Motion Control performance</b>			
Number of axes, maximum		8	8
Minimum PROFIBUS cycle clock	ms	1	1
Minimum PROFINET send cycle clock	ms	--	0.25
Minimum servo cycle clock	ms	0.5	0.5
Minimum interpolation cycle clock	ms	0.5	0.5
Note for minimum servo cycle clock		1 ms when using the TO axis and the integrated closed-loop drive control	1 ms when using the TO axis and the integrated closed-loop drive control
<b>Integrated drive control</b>			
Maximum number of axes for integrated drive control			
• Servo		1	1
• Vector		1	1
• V/f		1	1
• Note		Alternative control modes; drive control based on SINAMICS S120 CU310-2, firmware version V4.x	Alternative control modes; drive control based on SINAMICS S120 CU310-2, firmware version V4.x
<b>Memory</b>			
RAM (Random Access Memory)	MB	96	96
Additional RAM for Java applications	MB	20	20
RAM disk (load memory)	MB	47	47
Retentive memory	KB	108	108
Persistent memory (user data on CF)	MB	300	300
<b>Communication</b>			
DRIVE-CLiQ interfaces		1	1
Industrial Ethernet interfaces		1	1
PROFIBUS interfaces		2	1
• Note		Equidistant and isochronous; can be configured as master or slave	Equidistant and isochronous; can be configured as master or slave
PROFINET interfaces		0	1
• Note		--	Interface with 2 ports; supports PROFINET IO with IRT and RT; configurable as PROFINET IO Controller and/or Device; supports media redundancy (MRP and MRPD)
<b>General technical specifications</b>			
Fan		Integrated	Integrated
DC supply voltage			
• Rated value	V	24	24
• Permissible range	V	20.4 ... 28.8	20.4 ... 28.8
Current consumption, typical		800	800
• Note		Without load on inputs/outputs, without 24 V supply via DRIVE-CLiQ and PROFIBUS interface	Without load on inputs/outputs, without 24 V supply via DRIVE-CLiQ and PROFIBUS interface
Inrush current, typ.		A	3
Power loss [W] typical		W	20
Ambient temperature during			
• Long-term storage	°C (°F)	-25 ... +55 (-13 ... +131)	-25 ... +55 (-13 ... +131)
• Transport	°C (°F)	-40 ... +70 (-40 ... +158)	-40 ... +70 (-40 ... +158)
• Operation	°C (°F)	0 ... 55 (32 ... 131)	0 ... 55 (32 ... 131)
- Note		Maximum installation altitude 4000 m (13124 ft) above sea level. Above an altitude of 2000 m (6562 ft), the max. ambient temperature decreases by 7 °C (44.6 °F) every 1000 m (3281 ft).	Maximum installation altitude 4000 m (13124 ft) above sea level. Above an altitude of 2000 m (6562 ft), the max. ambient temperature decreases by 7 °C (44.6 °F) every 1000 m (3281 ft).
Relative humidity during operation		%	5 ... 95
Atmospheric pressure		hPa	620 ... 1 060
Degree of protection			IP20
Height		mm (in)	186.8 (7.35)
Width		mm (in)	73 (2.87)
Depth		mm (in)	74.4 (2.93)
Net weight		g (lb)	830 (1.8)

**Technical specifications (continued)**

	<b>6AU1410-2AA00-0AA0</b>		<b>6AU1410-2AD00-0AA0</b>	
Article number	6AU1410-2AA00-0AA0		6AU1410-2AD00-0AA0	
Product brand name	SIMOTION		SIMOTION	
Product type designation	D410-2 DP		D410-2 DP/PN	
<b>Digital inputs</b>				
Number of digital inputs	11		11	
• Note	of which: 5 DI and 3 F-DI (= 6 DI)		of which: 5 DI and 3 F-DI (= 6 DI)	
DC input voltage				
• Rated value	V	24	24	
• For signal "1"	V	15 ... 30	15 ... 30	
• For signal "0"	V	-3 ... +5	-3 ... +5	
Galvanic isolation	Yes		Yes	
Current consumption at signal level "1", typ.	mA	3.5	3.5	
Input delay time for				
• Signal "0" → "1", typ.	µs	50	50	
• Signal "1" → "0", typ.	µs	150	150	
<b>Digital inputs/outputs</b>				
Number of digital inputs/outputs	8		8	
Parameter assignment options for digital inputs and outputs	Parameterizable as DI, as DO, as measuring input (max. 8), as cam output (max. 8)		Parameterizable as DI, as DO, as measuring input (max. 8), as cam output (max. 8)	
<b>If used as an input</b>				
DC input voltage				
• Rated value	V	24	24	
• For signal "1"	V	15 ... 30	15 ... 30	
• For signal "0"	V	-3 ... +5	-3 ... +5	
Galvanic isolation	No		No	
Current consumption at signal level "1", typ.	mA	3.5	3.5	
Input delay time for				
• Signal "0" → "1", typ.	µs	5	5	
• Signal "1" → "0", typ.	µs	50	50	
Measuring input, reproducibility	µs	5	5	
• Note	Typical value		Typical value	
Measuring input, resolution	µs	1	1	
<b>If used as an output</b>				
Load voltage				
• Rated value	V	24	24	
• Permissible range	V	20.4 ... 28.8	20.4 ... 28.8	
Galvanic isolation	No		No	
Current-carrying capacity per output, max.	mA	500	500	
Residual current, max.	mA	2	2	
Output delay time for				
• Signal "0" → "1", typ.	µs	150	150	
• Signal "0" → "1", max.	µs	400	400	
• Signal "1" → "0", typ.	µs	75	75	
• Signal "1" → "0", max.	µs	100	100	
- Note	Data for Vcc = 24 V; 48 ohm load; "1" = 90 % VOut, "0" = 10 % VOut		Data for Vcc = 24 V; 48 ohm load; "1" = 90 % VOut, "0" = 10 % VOut	
Cam output, reproducibility	µs	125	125	
• Note	Typical value		Typical value	
Cam output, resolution	µs	125	125	
• Note	Typical value		Typical value	
Switching frequency of the outputs for				
• resistive load, max.	kHz	4	4	
• inductive load, max.	Hz	0.5	0.5	
• lamp load, max.	Hz	10	10	
Short-circuit protection	Yes		Yes	

# SIMOTION Motion Control System

## SIMOTION D – Drive-based

### SIMOTION D410-2 Control Units

#### Technical specifications (continued)

Article number	<b>6AU1410-2AA00-0AA0</b>		<b>6AU1410-2AD00-0AA0</b>	
Product brand name	SIMOTION		SIMOTION	
Product type designation	D410-2 DP		D410-2 DP/PN	
<b>Digital outputs</b>				
Number of digital outputs		1		1
Parameter assignment options for digital outputs		Can be parameterized as F-DO or DO		Can be parameterized as F-DO or DO
Load voltage				
• Rated value	V	24		24
• Permissible range	V	20.4 ... 28.8		20.4 ... 28.8
Galvanic isolation		Yes		Yes
Current-carrying capacity per output, max.	mA	500		500
Residual current, max.	mA	2		2
Output delay time for				
• Signal "0" → "1", typ.	µs	150		150
• Signal "0" → "1", max.	µs	400		400
• Signal "1" → "0", typ.	µs	75		75
• Signal "1" → "0", max.	µs	100		100
- Note		Data for Vcc = 24 V; 48 ohm load; "1" = 90 % VOut, "0" = 10 % VOut		Data for Vcc = 24 V; 48 ohm load; "1" = 90 % VOut, "0" = 10 % VOut
Short-circuit protection		Yes		Yes
<b>Analog input</b>				
Number of analog inputs		1		1
<b>If used as analog voltage input</b>				
Input voltage	V	-10 ... +10		-10 ... +10
Resolution	bit	12		12
• Note		+ sign		+ sign
Input resistance (Ri)	kΩ	100		100
<b>If used as analog current input</b>				
Input current	mA	-20 ... +20		-20 ... +20
Resolution	bit	11		11
• Note		+ sign		+ sign
Input resistance (Ri)	Ω	250		250
<b>Onboard encoder interface</b>				
Encoder interface		Optional TTL incremental encoder, HTL incremental encoder or SSI absolute encoder without TTL/HTL incremental signals		Optional TTL incremental encoder, HTL incremental encoder or SSI absolute encoder without TTL/HTL incremental signals
Encoder supply for				
• 24 V DC	A	0.35		0.35
• 5 V DC	A	0.35		0.35
Limit frequency, max.	kHz	500		500
SSI baud rate	kBd	100 ... 1 000		100 ... 1 000
Resolution absolute position SSI	bit	30		30
Cable length for				
• TTL incremental encoder, max.	m (ft)	100 (328)		100 (328)
• HTL incremental encoder for				
- unipolar signals, max.	m (ft)	100 (328)		100 (328)
- bipolar signals, max.	m (ft)	300 (984)		300 (984)
Note		TTL only bipolar signals; for bipolar signals, the signal lines must be twisted in pairs and shielded		TTL only bipolar signals; for bipolar signals, the signal lines must be twisted in pairs and shielded
• SSI absolute encoder, max.	m (ft)	100 (328)		100 (328)
- Note		Max. cable length depends on baud rate		Max. cable length depends on baud rate

**Technical specifications** (continued)

	<b>6AU1410-2AA00-0AA0</b>	<b>6AU1410-2AD00-0AA0</b>
Article number	SIMOTION	SIMOTION
Product brand name	D410-2 DP	D410-2 DP/PN
Product type designation		
<b>Additional technical specifications</b>		
Input for temperature sensing	KTY84-130, Pt1000 or PTC	KTY84-130, Pt1000 or PTC
Non-volatile data backup		
• of retentive data	Unlimited backup time	Unlimited backup time
• of real-time clock, min.	5	5
• Note	Data backup is maintenance-free	Data backup is maintenance-free
Approvals		
• USA	cULus	cULus
• Canada	cULus	cULus
• Australia	RCM (formerly C-Tick)	RCM (formerly C-Tick)
• Korea	KCC	KCC
• Russia, Belarus and Kazakhstan	EAC	EAC

# SIMOTION Motion Control System

## SIMOTION D – Drive-based

### SIMOTION D410-2 Control Units

#### Selection and ordering data

Description	Article No.
<b>SIMOTION D410-2 DP Control Unit</b>	<b>6AU1410-2AA00-0AA0</b>
<b>SIMOTION D410-2 DP/PN Control Unit</b>	<b>6AU1410-2AD00-0AA0</b>
<b>SIMOTION CompactFlash card (CF) 1 GB</b> with the current SIMOTION Kernel and SINAMICS S120 drive software V4.x <a href="#">Pre-installed license can be obtained using additional order codes <sup>1)</sup></a> <b>Note:</b> A separate CompactFlash card is available for the SIMOTION D4x5-2 Control Units. (6AU1400-2PA23-0AA0)	<b>6AU1400-1PA23-0AA0</b>
<b>MultiAxes Package license for SIMOTION D410-2</b> • As Z option • As single license	<b>M41</b> <b>6AU1820-0AA41-0AB0</b>

#### Accessories

Description	Article No.
<b>Accessories for SIMOTION D410-2</b>	
<b>Rear panel mounting plate</b> For installing the SIMOTION D410-2 in a different location if you do not wish to connect it to the Power Module.	<b>6AU1400-7AA05-0AA0</b>
<b>Accessories for PROFIBUS</b>	
<b>PROFIBUS RS485 bus connector with axial cable outlet (180°)</b> Max. transmission rate 12 Mbit/s • Without PG socket, with terminal blocks • Without PG socket, with FastConnect insulation displacement method	<b>6GK1500-0EA02</b> <b>6GK1500-0FC10</b>
<b>PROFIBUS RS485 bus connector with angular cable outlet (35°) and screw-type terminals</b> Max. transmission rate 12 Mbit/s • Without PG interface • With PG interface	<b>6ES7972-0BA42-0XA0</b> <b>6ES7972-0BB42-0XA0</b>
<b>PROFIBUS FastConnect RS485 bus connector with angular cable outlet (35°) and insulation displacement terminals</b> Max. transmission rate 12 Mbit/s • Without PG interface • With PG interface	<b>6ES7972-0BA61-0XA0</b> <b>6ES7972-0BB61-0XA0</b>
<b>PROFIBUS RS485 bus connector with cable outlet (90°) and screw-type terminals</b> Max. transmission rate 12 Mbit/s • Without PG interface • With PG interface	<b>6ES7972-0BA12-0XA0</b> <b>6ES7972-0BB12-0XA0</b>
<b>PROFIBUS FastConnect RS485 bus connector with cable outlet (90°) and insulation displacement terminals</b> Max. transmission rate 12 Mbit/s • Without PG interface • With PG socket	<b>6ES7972-0BA52-0XA0</b> <b>6ES7972-0BB52-0XA0</b>

Description	Article No.
<b>Accessories for PROFINET</b>	
<b>RJ45 FastConnect connector for Industrial Ethernet/PROFINET</b> 180° cable outlet • 1 pack = 1 unit • 1 pack = 10 units • 1 pack = 50 units	<b>6GK1901-1BB10-2AA0</b> <b>6GK1901-1BB10-2AB0</b> <b>6GK1901-1BB10-2AE0</b>
<b>RJ45 FastConnect connector for Industrial Ethernet/PROFINET</b> 145° cable outlet • 1 pack = 1 unit • 1 pack = 10 units • 1 pack = 50 units	<b>6GK1901-1BB30-0AA0</b> <b>6GK1901-1BB30-0AB0</b> <b>6GK1901-1BB30-0AE0</b>
<b>FastConnect cables for Industrial Ethernet/PROFINET <sup>2)</sup></b> • IE FC Standard Cable GP 2x2 • IE FC Flexible Cable GP 2x2 • IE FC Trailing Cable GP 2x2 • IE FC Trailing Cable 2x2 • IE FC Marine Cable 2x2	<b>6XV1840-2AH10</b> <b>6XV1870-2B</b> <b>6XV1870-2D</b> <b>6XV1840-3AH10</b> <b>6XV1840-4AH10</b>
<b>Stripping tool for Industrial Ethernet/PROFINET FastConnect cables</b> • IE FC Stripping Tool	<b>6GK1901-1GA00</b>
<b>Miscellaneous accessories</b>	
<b>Dust protection blanking plugs</b> (50 units) for sealing unused DRIVE-CLiQ, Ethernet and PROFINET ports	<b>6SL3066-4CA00-0AA0</b>

<sup>1)</sup> Note about licenses for runtime software:  
Runtime software licenses can either be pre-installed on a CompactFlash card (CF) or ordered separately. See Ordering of licenses for runtime software.

<sup>2)</sup> Sold by the meter; max. length (depending on cable type) 1000 m (3281 ft) or 2000 m (6562 ft); minimum order 20 m (65.6 ft).



## More information

### More information

- about SINAMICS S120 drive components such as Power Modules, Terminal Modules etc. can be found in Catalog D 21.4 – chapter SINAMICS S120 Drive System, and the Industry Mall under Drive Technology/Converters/AC Low-voltage converters/High performance converters SINAMICS S/...
- about signal and power cables for SINAMICS S120 can be found in Catalog D 21.4 – chapter MOTION-CONNECT connection systems, and the Industry Mall under Drive Technology/Further Components/MOTION-CONNECT connection systems.
- about PROFINET, Industrial Ethernet and PROFIBUS DP can be found in Catalog 1K PI and the Industry Mall under Automation Technology/Industrial Communication.

### Integrated drive control

The drive control functions integrated in a SIMOTION D410-2 are based on the drive control of a SINAMICS S120 CU310-2 (firmware version V4.x), although there is a slight difference in functionality. For example, the SIMOTION D410-2 does not have a basic positioner function (EPOS), as this is already covered by SIMOTION technology functions.

For more information, refer to the [documentation for SIMOTION and SINAMICS](#).

### Licensing notes

SIMOTION D410-2 has an integrated drive control for either a servo, a vector or a  $V/f$  axis and is therefore ideal for single-axis applications.

One real axis can be used without license on the Control Unit. Drive axes and virtual axes never require a license.

SIMOTION D410-2 can be extended with additional SINAMICS S110/S120 Control Units (e.g. CU305) and so can also be used for smaller multi-axis applications (e.g. with 2 - 3 axes). A license is required for any additional axes. Where a license is required for a POS axis, the POS single-axis license is the ideal solution. It is better to use the MultiAxes Package D410-2 in the case of GEAR/CAM or more than one POS license.

The axis license with the highest functionality is covered by the inclusive license (a real axis).

The functionality has the following granularity:  
CAM > GEAR > POS.

#### Example:

Application with 2 real axes: 1 POS, 1 CAM.

Only a POS license needs to be purchased because the higher-order CAM license is already included.

Licenses are also required for runtime functions subject to licensing, such as SIMOTION IT Virtual Machine. These can be pre-installed on the CompactFlash card (CF card) or ordered separately.

For more information, refer to [section Ordering of licenses for runtime software](#).

### SIZER for Siemens Drives engineering tool

With the SIZER for Siemens Drives engineering tool, you can easily configure, for example, the SINAMICS S110 and S120 drive families including SIMOTION. This tool supports you with the engineering of components for a Motion Control task. You can also determine the possible number of axes and the resulting utilization with SIZER for Siemens Drives in accordance with your performance requirements.

For more information about SIZER for Siemens Drives, refer to [section Lifecycle Services](#).

# SIMOTION Motion Control System

## SIMOTION D – Drive-based

### SIMOTION D4x5-2 Control Units

#### Overview

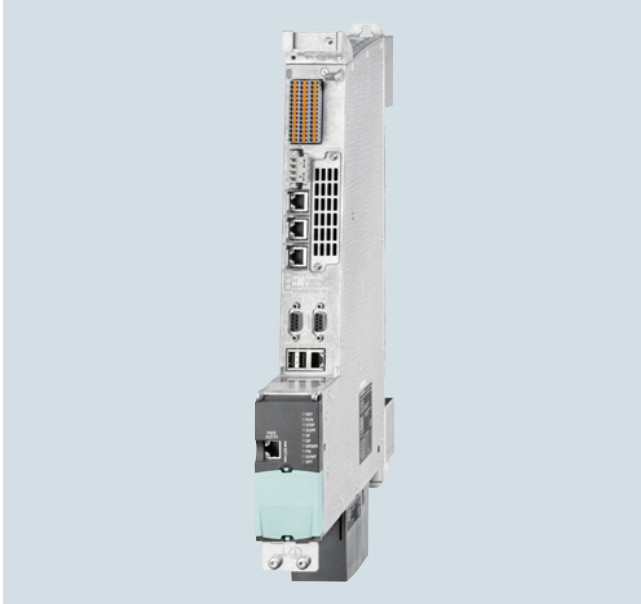

SIMOTION D4x5-2 are drive-based Control Units for multi-axis systems. The individual variants essentially differ in terms of their PLC and Motion Control performance, memory size and interfaces. The main distinguishing features are:

Distinguishing features <sup>2)</sup>	SIMOTION D425-2 DP	SIMOTION D425-2 DP/PN	SIMOTION D435-2 DP	SIMOTION D435-2 DP/PN	SIMOTION D445-2 DP/PN	SIMOTION D455-2 DP/PN
Performance class	BASIC	BASIC	STANDARD	STANDARD	HIGH	ULTRA-HIGH
Maximum number of axes	16	16	32	32	64	128
Available in SIPLUS version	–	–	–	•	–	•
Second runtime level SERVO <sub>Fast</sub> / IPO <sub>Fast</sub>	–	–	–	•	•	•
DRIVE-CLiQ interfaces	4	4	6	6	6	6
Communication interfaces						
- PROFIBUS	2	2	2	2	2	2
- PROFINET	–	1 (3 ports) <sup>1)</sup>	–	1 (3 ports) <sup>1)</sup>	1 (3 ports) <sup>1)</sup>	1 (3 ports) <sup>1)</sup>
- Ethernet	3	2	3	2	2	2

- Available
- Not available

The SIMOTION D425-2, D435-2, D445-2 and D455-2 Control Units feature PLC and Motion Control performance (open-loop control and Motion Control) for up to 16, 32, 64 or 128 axes, as required.

The integrated drive control enables each D4x5-2 Control Unit to operate up to 6 servo, 6 vector or 12 V/f axes.

The integrated drive control is based on the drive control of a SINAMICS S120 CU320-2 Control Unit (firmware version V4.x) and supports servo control (for a highly dynamic response), vector control (for maximum torque accuracy) and V/f control.

SIMOTION D435-2 DP/PN and D455-2 DP/PN are also available as SIPLUS version for use under harsh environmental conditions, e.g. in toxic atmospheres (for details refer to technical specifications). As BasedOn products, the SIPLUS versions have the same functionality as the standard modules and are configured in exactly the same way.

<sup>1)</sup> Optional second PROFINET interface via CBE30-2 (4 ports)

#### Extension of the drive computing performance

The Motion Control performance of a SIMOTION D4x5-2 can be utilized in full by expanding the computing performance at the drive in two different ways:

- SINAMICS S120 Control Units (e.g. CU320-2) can be connected together with further SINAMICS S120 drive modules via PROFINET or PROFIBUS.
- The SIMOTION CX32-2 Controller Extension can be connected over DRIVE-CLiQ. This module is extremely compact and can control up to 6 servo, 6 vector or 12 V/f axes.

<sup>2)</sup> For further details such as cycle times, memory configuration, etc., refer to technical specifications.

### Application

SIMOTION D4x5-2 Control Units are ideally suited for applications with many coordinated axes and short clock-pulse rates.

Typical applications include:

- Compact multi-axis machines
- High-performance applications with short machine cycles
- Compact machines
  - Including the complete machine control in the drive
  - With extensive connection possibilities for communication, HMI and I/O
- Distributed drive concepts
  - Applications with many axes
  - Synchronization of several SIMOTION D Control Units using distributed synchronous operation

### Design



SIMOTION D425-2 DP (on left) and SIMOTION D435-2 DP/PN with CBE30-2 inserted (on right)

#### Interfaces

##### Display and diagnostics

- LEDs to display operating states and errors
- 3 measuring sockets
- Service selector switch and mode selector
- Diagnostics button

##### Onboard I/Os

- 12 digital inputs
- 16 digital inputs/outputs (max. 16 as high-speed measuring inputs, max. 8 as high-speed cam outputs)

##### Communication

- 6 × DRIVE-CLiQ (4 × DRIVE-CLiQ for D425-2)
- 2 × Industrial Ethernet (3 × Industrial Ethernet for D4x5-2 DP), of which one interface easily accessible on the module front
- 2 × PROFIBUS DP
- 1 × PROFINET IO (1 interface with 3 ports, with D4x5-2 DP/PN only)
- 2 × USB

##### Data backup

- 1 slot for SIMOTION CompactFlash card

##### Additional interfaces

- Terminals for 24 V electronics power supply

#### Option Boards

With the TB30 Terminal Board, the SIMOTION D4x5-2 Control Units can be extended with 4 digital inputs, 4 digital outputs, 2 analog inputs and 2 analog outputs. The TB30 Terminal Board is plugged into the option slot on the Control Unit.

Using the CBE30-2 Communication Board for PROFINET IO, it is possible to equip the SIMOTION D4x5-2 DP/PN Control Units with a second PROFINET interface with 4 ports.

Applications for a second PROFINET interface:

- 2 separate networks (e.g. one local and one higher-level network)
- Address space can be doubled to 2 × 6 KB
- Maximum number of connectable devices can be doubled to 2 × 64
- Separation into a high-speed and a slow bus system/execution system in order to make efficient use of the controller's capacity (applies only to SIMOTION D435-2 DP/PN, D445-2 DP/PN and D455-2 DP/PN)
  - PROFINET onboard: SERVO<sub>Fast</sub> and IPO<sub>Fast</sub>
  - PROFINET via CBE30-2: SERVO/IPO/IPO2

#### Note:

The CBE30-2 cannot be used in SIMOTION D4x5 2 DP Control Units. If the CBE30-2 is used without SERVO<sub>Fast</sub> and IPO<sub>Fast</sub>, then both PROFINET interfaces are assigned to SERVO/IPO/IPO2.

#### Mounting

The SIMOTION D4x5-2 Control Units can be mounted in the control cabinet in one of three ways:

- Mounting with spacers
- Mounting without spacers (D425-2 and D435-2 only)
- Mounting without spacers (external cooling, D445-2 and D455-2 only)

With external air cooling, the cooling fins of the D445-2/D455-2 Control Unit are outside of the control cabinet. A seal (option) is available so that the Control Unit can be hermetically mounted in the rear cabinet panel.

The SIMOTION D4x5-2 Control Units come with pre-installed spacers. These can be removed if necessary.

#### Data storage/data backup

The SIMOTION D4x5-2 Control Units store the retentive process data permanently in a manner that requires no maintenance (refer to technical specifications for memory size).

The real-time clock is backed up for several days via a SuperCap. The backup time can be extended via a battery in the double fan/battery module.

The double fan/battery module incl. battery is contained in the scope of supply of the SIMOTION D4x5-2.

The runtime software, user data and user programs are stored retentively on the CompactFlash Card (CF). The retentive process data of the Control Unit can also be stored on this CompactFlash card via system command, e.g. if spare parts are required.

# SIMOTION Motion Control System

## SIMOTION D – Drive-based

### SIMOTION D4x5-2 Control Units

#### Design (continued)

#### Extended execution system ( $SERVO_{Fast}/IPO_{Fast}$ )

The SIMOTION D435-2 DP/PN, D445-2 DP/PN and D455-2 DP/PN Control Units have (in addition to SERVO, IPO and IPO2) an additional second runtime level ( $SERVO_{Fast}$  and  $IPO_{Fast}$ ).

The additional runtime level allows the distribution of electric and/or hydraulic axes with different dynamic responses on a slow and a fast bus system so that the performance of the controller can be used more efficiently.

It also enables a particularly fast I/O processing in conjunction with high-speed PROFINET I/O modules.

Thanks to the extended execution system, electrical positioning drives, for example, can be controlled with cycle times in the millisecond range requiring fewer resources and, at the same time, the pressure-controlled axes of a hydraulic press can be controlled highly dynamically with short cycle times.

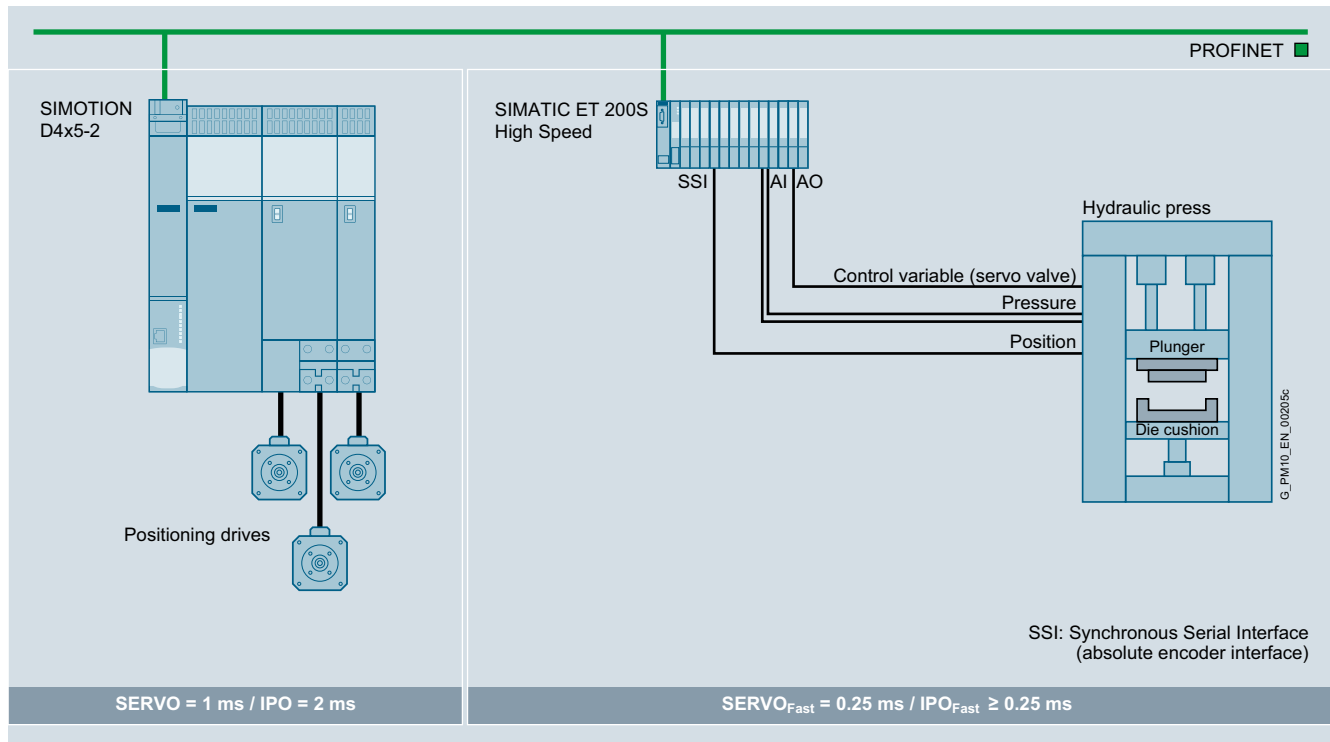

Closed-loop control of an hydraulic press with  $SERVO_{Fast}$  and  $IPO_{Fast}$

If  $SERVO_{Fast}$  and  $IPO_{Fast}$  are activated, the following assignment applies:

- $SERVO_{Fast}$  and  $IPO_{Fast}$  are assigned to the PROFINET.
- SERVO, IPO and IPO2 are assigned to the PROFIBUS or the integrated drives of the SIMOTION D4x5-2/CX32-2.

If a second PROFINET interface is provided by means of a CBE30-2, this will also be assigned to Servo, IPO and IPO2. In this case, the onboard PROFINET interface is always assigned to  $SERVO_{Fast}$  and  $IPO_{Fast}$ .

#### Connectable I/Os

##### PROFINET IO:

- Certified PROFINET devices
- SIMATIC ET 200S/SP/M/MP/eco PN/pro/AL distributed I/Os
- Drive systems (e.g. SINAMICS S110/S120)

##### PROFIBUS DP:

- Certified standard PROFIBUS slaves (DP-V0, DP-V1, DP-V2)
- SIMATIC ET 200S/SP/M/MP/eco/pro/AL distributed I/Os
- Drive systems (e.g. SINAMICS S110/S120)

##### DRIVE-CLiQ:

Modules from the SINAMICS S120 range:

- TM15, TM31, ... Terminal Modules
- SMC/SME Sensor Modules
- DMC20/DME20 DRIVE-CLiQ Hub Module

##### USB:

The integrated USB interface allows, for example, a USB memory stick to be connected for a project or firmware update.

##### Expansion with SINAMICS S120 drive modules

SINAMICS S120 drive modules in booksize format (Line Modules, Motor Modules, etc.) are connected to the SIMOTION D4x5-2 Control Unit over DRIVE-CLiQ.

SINAMICS S120 PM240-2 Power Modules in blocksize format can be operated on the SIMOTION D4x5-2 Control Units with the CUA31/CUA32 Control Unit Adapters.

##### Note:

DRIVE-CLiQ cables which are required to connect Line Modules and Motor Modules to SIMOTION D are supplied in a standard length with the relevant Line Module/Motor Module.

## Integration

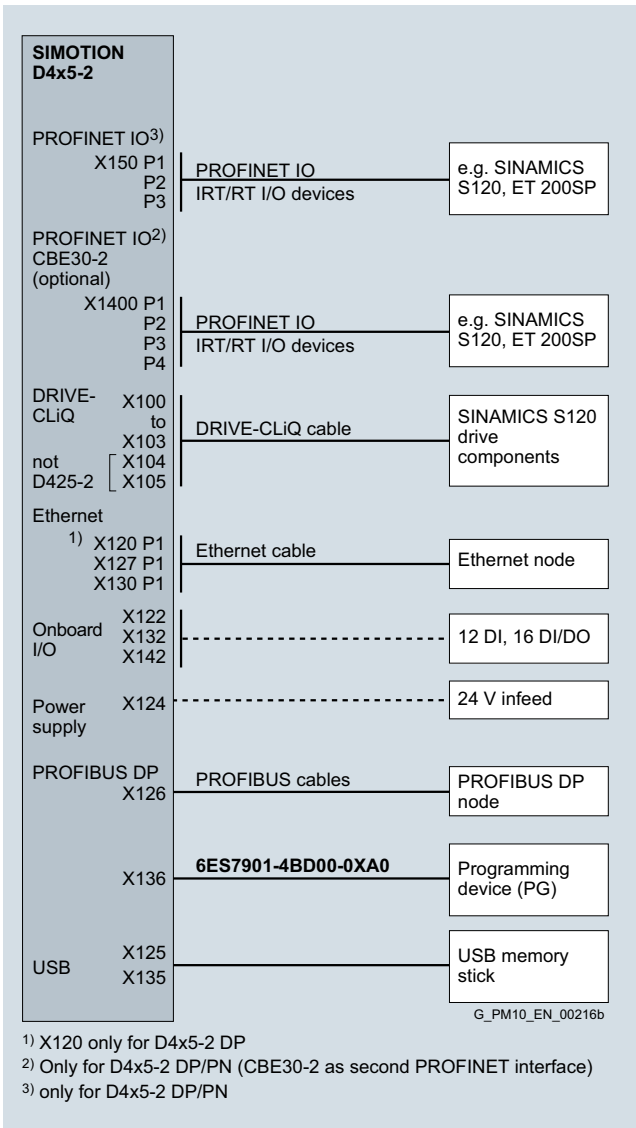

Overview of SIMOTION D4x5-2 Control Unit connections

When dimensioning cables, you must always observe the maximum permissible cable lengths.

If these maximum lengths are exceeded, malfunctions can occur.

The permissible length of PROFIBUS DP cables depends on the configuration.

The DRIVE-CLiQ cables used for the SINAMICS S120 CU320-2 Control Unit can also be used for SIMOTION D4x5-2 Control Units.

# SIMOTION Motion Control System

## SIMOTION D – Drive-based

### SIMOTION D4x5-2 Control Units

#### Technical specifications

Article number		6AU1425-2AA00-0AA0	6AU1425-2AD00-0AA0	6AU1435-2AA00-0AA0	6AU1435-2AD00-0AA0	6AU1445-2AD00-0AA0	6AU1455-2AD00-0AA0
Product brand name		SIMOTION	SIMOTION	SIMOTION	SIMOTION	SIMOTION	SIMOTION
Product type designation		D425-2 DP	D425-2 DP/PN	D435-2 DP	D435-2 DP/PN	D445-2 DP/PN	D455-2 DP/PN
Performance class for Motion Control System		BASIC Performance	BASIC Performance	STANDARD performance	STANDARD performance	HIGH performance	ULTRA-HIGH performance
Version of Motion Control System		Multi-axis system	Multi-axis system	Multi-axis system	Multi-axis system	Multi-axis system	Multi-axis system
<b>PLC and Motion Control performance</b>							
Number of axes, maximum		16	16	32	32	64	128
Minimum PROFIBUS cycle clock	ms	1	1	1	1	1	1
Minimum PROFINET send cycle clock	ms	--	0.25	--	0.25	0.25	0.25
Minimum servo cycle clock	ms	0.5	0.5	0.5	0.25	0.25	0.25
Minimum interpolation cycle clock	ms	0.5	0.5	0.5	0.25	0.25	0.25
Note for minimum servo cycle clock		--	--	--	0.25 ms for SERVO or SERVO-FAST	0.25 ms for SERVO or SERVO-FAST	0.125 ms (only with ET 200SP, SCOUT TIA (version V4.5 or higher) and SERVO-FAST)
<b>Integrated drive control</b>							
Maximum number of axes for integrated drive control							
• Servo		6	6	6	6	6	6
• Vector		6	6	6	6	6	6
• V/f		12	12	12	12	12	12
• Note		Alternative control modes; drive control based on SINAMICS S120 CU320-2, firmware version V4.x	Alternative control modes; drive control based on SINAMICS S120 CU320-2, firmware version V4.x	Alternative control modes; drive control based on SINAMICS S120 CU320-2, firmware version V4.x	Alternative control modes; drive control based on SINAMICS S120 CU320-2, firmware version V4.x	Alternative control modes; drive control based on SINAMICS S120 CU320-2, firmware version V4.x	Alternative control modes; drive control based on SINAMICS S120 CU320-2, firmware version V4.x
<b>Memory</b>							
RAM (Random Access Memory)	MB	64	64	86	86	160	320
Additional RAM for Java applications	MB	20	20	20	20	20	20
RAM disk (load memory)	MB	31	31	41	41	56	76
Retentive memory	KB	364	364	364	364	512	512
Persistent memory (user data on CF)	MB	300	300	300	300	300	300
<b>Communication</b>							
DRIVE-CLiQ interfaces		4	4	6	6	6	6
USB interfaces		2	2	2	2	2	2
Industrial Ethernet interfaces		3	2	3	2	2	2
PROFIBUS interfaces		2	2	2	2	2	2
• Note		Equidistant and isochronous; can be configured as master or slave	Equidistant and isochronous; can be configured as master or slave	Equidistant and isochronous; can be configured as master or slave	Equidistant and isochronous; can be configured as master or slave	Equidistant and isochronous; can be configured as master or slave	Equidistant and isochronous; can be configured as master or slave
PROFINET interfaces		0	1	0	1	1	1
• Note		--	1 interface with 3 ports onboard; 1 interface with 4 ports as an option via CBE30-2; Functionality: supports PROFINET IO with IRT and RT; configurable as PROFINET IO Controller and/or Device; supports media redundancy (MRP and MRPD)	--	1 interface with 3 ports onboard; 1 interface with 4 ports as an option via CBE30-2; Functionality: supports PROFINET IO with IRT and RT; configurable as PROFINET IO Controller and/or Device; supports media redundancy (MRP and MRPD)	1 interface with 3 ports onboard; 1 interface with 4 ports as an option via CBE30-2; Functionality: supports PROFINET IO with IRT and RT; configurable as PROFINET IO Controller and/or Device; supports media redundancy (MRP and MRPD)	1 interface with 3 ports onboard; 1 interface with 4 ports as an option via CBE30-2; Functionality: supports PROFINET IO with IRT and RT; configurable as PROFINET IO Controller and/or Device; supports media redundancy (MRP and MRPD)

### Technical specifications (continued)

Article number		6AU1425-2AA00-0AA0	6AU1425-2AD00-0AA0	6AU1435-2AA00-0AA0	6AU1435-2AD00-0AA0	6AU1445-2AD00-0AA0	6AU1455-2AD00-0AA0
Product brand name		SIMOTION	SIMOTION	SIMOTION	SIMOTION	SIMOTION	SIMOTION
Product type designation		D425-2 DP	D425-2 DP/PN	D435-2 DP	D435-2 DP/PN	D445-2 DP/PN	D455-2 DP/PN
<b>General technical specifications</b>							
Fan		Double fan/ battery module included in scope of delivery	Double fan/ battery module included in scope of delivery	Double fan/ battery module included in scope of delivery	Double fan/ battery module included in scope of delivery	Double fan/ battery module included in scope of delivery	Double fan/ battery module included in scope of delivery
DC supply voltage							
• Rated value	V	24	24	24	24	24	24
• Permissible range	V	20.4 ... 28.8	20.4 ... 28.8	20.4 ... 28.8	20.4 ... 28.8	20.4 ... 28.8	20.4 ... 28.8
Current consumption, typical	mA	700	1 000	700	1 000	1 900	1 900
• Note		Without load on inputs/outputs, without 24 V supply via DRIVE-CLiQ and PROFIBUS interface	Without load on inputs/outputs, without 24 V supply via DRIVE-CLiQ and PROFIBUS interface	Without load on inputs/outputs, without 24 V supply via DRIVE-CLiQ and PROFIBUS interface	Without load on inputs/outputs, without 24 V supply via DRIVE-CLiQ and PROFIBUS interface	Without load on inputs/outputs, without 24 V supply via DRIVE-CLiQ and PROFIBUS interface	Without load on inputs/outputs, without 24 V supply via DRIVE-CLiQ and PROFIBUS interface
Inrush current, typ.	A	5	5	5	5	5	5
Power loss, typical	W	17	24	17	24	46	46
Ambient temperature during							
• Long-term storage	°C (°F)	-25 ... +55 (-13 ... +131)	-25 ... +55 (-13 ... +131)	-25 ... +55 (-13 ... +131)	-25 ... +55 (-13 ... +131)	-25 ... +55 (-13 ... +131)	-25 ... +55 (-13 ... +131)
• Transport	°C (°F)	-40 ... +70 (-40 ... +158)	-40 ... +70 (-40 ... +158)	-40 ... +70 (-40 ... +158)	-40 ... +70 (-40 ... +158)	-40 ... +70 (-40 ... +158)	-40 ... +70 (-40 ... +158)
• Operation	°C (°F)	0 ... 55 (32 ... 131)	0 ... 55 (32 ... 131)	0 ... 55 (32 ... 131)	0 ... 55 (32 ... 131)	0 ... 55 (32 ... 131)	0 ... 55 (32 ... 131)
- Note		Maximum installation altitude 4000 m (13124 ft) above sea level. Above an altitude of 2000 m (6562 ft), the max. ambient temperature decreases by 7 °C (44.6 °F) every 1000 m (3281 ft).	Maximum installation altitude 4000 m (13124 ft) above sea level. Above an altitude of 2000 m (6562 ft), the max. ambient temperature decreases by 7 °C (44.6 °F) every 1000 m (3281 ft).	Maximum installation altitude 4000 m (13124 ft) above sea level. Above an altitude of 2000 m (6562 ft), the max. ambient temperature decreases by 7 °C (44.6 °F) every 1000 m (3281 ft).	Maximum installation altitude 4000 m (13124 ft) above sea level. Above an altitude of 2000 m (6562 ft), the max. ambient temperature decreases by 7 °C (44.6 °F) every 1000 m (3281 ft).	Maximum installation altitude 4000 m (13124 ft) above sea level. Above an altitude of 2000 m (6562 ft), the max. ambient temperature decreases by 7 °C (44.6 °F) every 1000 m (3281 ft).	Maximum installation altitude 4000 m (13124 ft) above sea level. Above an altitude of 2000 m (6562 ft), the max. ambient temperature decreases by 7 °C (44.6 °F) every 1000 m (3281 ft).
Relative humidity during operation	%	5 ... 95	5 ... 95	5 ... 95	5 ... 95	5 ... 95	5 ... 95
Atmospheric pressure	hPa	620 ... 1 060	620 ... 1 060	620 ... 1 060	620 ... 1 060	620 ... 1 060	620 ... 1 060
Degree of protection		IP20	IP20	IP20	IP20	IP20	IP20
Height	mm (in)	380 (15.0)	380 (15.0)	380 (15.0)	380 (15.0)	380 (15.0)	380 (15.0)
Width	mm (in)	50 (1.97)	50 (1.97)	50 (1.97)	50 (1.97)	50 (1.97)	50 (1.97)
Depth	mm (in)	270 (10.6)	270 (10.6)	270 (10.6)	270 (10.6)	270 (10.6)	270 (10.6)
• Note		With disassembled spacer 230 mm (9.05 in) depth	With disassembled spacer 230 mm (9.05 in) depth	With disassembled spacer 230 mm (9.05 in) depth	With disassembled spacer 230 mm (9.05 in) depth	With disassembled spacer 230 mm (9.05 in) depth	With disassembled spacer 230 mm (9.05 in) depth
Net weight	g (lb)	3 700 (8.1571)	3 700 (8.1571)	3 700 (8.1571)	3 700 (8.1571)	4 300 (9.47988)	4 300 (9.47988)
<b>Digital inputs</b>							
Number of digital inputs		12	12	12	12	12	12
DC input voltage							
• Rated value	V	24	24	24	24	24	24
• For signal "1"	V	15 ... 30	15 ... 30	15 ... 30	15 ... 30	15 ... 30	15 ... 30
• For signal "0"	V	-3 ... +5	-3 ... +5	-3 ... +5	-3 ... +5	-3 ... +5	-3 ... +5
Galvanic isolation		Yes	Yes	Yes	Yes	Yes	Yes
• Note		In groups of 6	In groups of 6	In groups of 6	In groups of 6	In groups of 6	In groups of 6
Current consumption at signal level "1", typ.	mA	9	9	9	9	9	9
Input delay time for							
• Signal "0" → "1", typ.	µs	50	50	50	50	50	50
• Signal "1" → "0", typ.	µs	150	150	150	150	150	150

# SIMOTION Motion Control System

## SIMOTION D – Drive-based

### SIMOTION D4x5-2 Control Units

#### Technical specifications (continued)

Article number		6AU1425-2AA00-0AA0	6AU1425-2AD00-0AA0	6AU1435-2AA00-0AA0	6AU1435-2AD00-0AA0	6AU1445-2AD00-0AA0	6AU1455-2AD00-0AA0
Product brand name		SIMOTION	SIMOTION	SIMOTION	SIMOTION	SIMOTION	SIMOTION
Product type designation		D425-2 DP	D425-2 DP/PN	D435-2 DP	D435-2 DP/PN	D445-2 DP/PN	D455-2 DP/PN
<b>Digital inputs/outputs</b>							
Number of digital inputs/outputs		16	16	16	16	16	16
Parameter assignment options for digital inputs and outputs		Parameterizable as DI, as DO, as measuring input (max. 16), as cam output (max. 8)	Parameterizable as DI, as DO, as measuring input (max. 16), as cam output (max. 8)	Parameterizable as DI, as DO, as measuring input (max. 16), as cam output (max. 8)	Parameterizable as DI, as DO, as measuring input (max. 16), as cam output (max. 8)	Parameterizable as DI, as DO, as measuring input (max. 16), as cam output (max. 8)	Parameterizable as DI, as DO, as measuring input (max. 16), as cam output (max. 8)
<b>If used as an input</b>							
DC input voltage							
• Rated value	V	24	24	24	24	24	24
• For signal "1"	V	15 ... 30	15 ... 30	15 ... 30	15 ... 30	15 ... 30	15 ... 30
• For signal "0"	V	-3 ... +5	-3 ... +5	-3 ... +5	-3 ... +5	-3 ... +5	-3 ... +5
Galvanic isolation		No	No	No	No	No	No
Current consumption at signal level "1", typ.	mA	9	9	9	9	9	9
Input delay time for							
• Signal "0" → "1", typ.	µs	5	5	5	5	5	5
• Signal "1" → "0", typ.	µs	50	50	50	50	50	50
Measuring input, reproducibility	µs	5	5	5	5	5	5
Measuring input, resolution	µs	1	1	1	1	1	1
<b>If used as an output</b>							
Load voltage							
• Rated value	V	24	24	24	24	24	24
• Permissible range	V	20.4 ... 28.8	20.4 ... 28.8	20.4 ... 28.8	20.4 ... 28.8	20.4 ... 28.8	20.4 ... 28.8
Galvanic isolation		No	No	No	No	No	No
Current-carrying capacity per output, max.	mA	500	500	500	500	500	500
Residual current, max.	mA	2	2	2	2	2	2
Output delay time for							
• Signal "0" → "1", typ.	µs	150	150	150	150	150	150
• Signal "0" → "1", max.	µs	400	400	400	400	400	400
• Signal "1" → "0", typ.	µs	75	75	75	75	75	75
• Signal "1" → "0", max.	µs	150	150	150	150	150	150
- Note		Data for Vcc = 24 V; 48 ohm load; "1" = 90 % VOut, "0" = 10 % VOut	Data for Vcc = 24 V; 48 ohm load; "1" = 90 % VOut, "0" = 10 % VOut	Data for Vcc = 24 V; 48 ohm load; "1" = 90 % VOut, "0" = 10 % VOut	Data for Vcc = 24 V; 48 ohm load; "1" = 90 % VOut, "0" = 10 % VOut	Data for Vcc = 24 V; 48 ohm load; "1" = 90 % VOut, "0" = 10 % VOut	Data for Vcc = 24 V; 48 ohm load; "1" = 90 % VOut, "0" = 10 % VOut
Cam output, reproducibility	µs	10	10	10	10	10	10
Cam output, resolution	µs	1	1	1	1	1	1
Switching frequency of the outputs for							
• resistive load, max.	kHz	4	4	4	4	4	4
• inductive load, max.	Hz	2	2	2	2	2	2
• lamp load, max.	Hz	11	11	11	11	11	11
Short-circuit protection		Yes	Yes	Yes	Yes	Yes	Yes



## SIMOTION Motion Control System

### SIMOTION D – Drive-based

#### SIMOTION D4x5-2 Control Units

#### Technical specifications (continued)

Article number	6AU1425-2AA00-0AA0	6AU1425-2AD00-0AA0	6AU1435-2AA00-0AA0	6AU1435-2AD00-0AA0	6AU1445-2AD00-0AA0	6AU1455-2AD00-0AA0
Product brand name	SIMOTION	SIMOTION	SIMOTION	SIMOTION	SIMOTION	SIMOTION
Product type designation	D425-2 DP	D425-2 DP/PN	D435-2 DP	D435-2 DP/PN	D445-2 DP/PN	D455-2 DP/PN
<b>Additional technical specifications</b>						
Non-volatile data backup						
• of retentive data	Unlimited backup time	Unlimited backup time	Unlimited backup time	Unlimited backup time	Unlimited backup time	Unlimited backup time
• of real-time clock, min.	4	4	4	4	4	4
• Note	Longer backup duration of the real-time clock via battery inserted in the double fan/battery module	Longer backup duration of the real-time clock via battery inserted in the double fan/battery module	Longer backup duration of the real-time clock via battery inserted in the double fan/battery module	Longer backup duration of the real-time clock via battery inserted in the double fan/battery module	Longer backup duration of the real-time clock via battery inserted in the double fan/battery module	Longer backup duration of the real-time clock via battery inserted in the double fan/battery module
Approvals						
• USA	cULus	cULus	cULus	cULus	cULus	cULus
• Canada	cULus	cULus	cULus	cULus	cULus	cULus
• Australia	RCM (formerly C-Tick)	RCM (formerly C-Tick)	RCM (formerly C-Tick)	RCM (formerly C-Tick)	RCM (formerly C-Tick)	RCM (formerly C-Tick)
• Korea	KCC	KCC	KCC	KCC	KCC	KCC
• Russia, Belarus and Kazakhstan	EAC	EAC	EAC	EAC	EAC	EAC

# SIMOTION Motion Control System

## SIMOTION D – Drive-based

### SIMOTION D4x5-2 Control Units

#### Technical specifications (continued)

		<b>6AG1435-2AD00-4AA0</b>	<b>6AG1455-2AD00-4AA0</b>
Article number		SIPLUS	SIPLUS
Product brand name		D435-2 DP/PN SIPLUS	D455-2 DP/PN SIPLUS
Product type designation		STANDARD performance	ULTRA-HIGH performance
Performance class for Motion Control system		Multi-axis system	Multi-axis system
Version of Motion Control System			
<b>PLC and Motion Control performance</b>			
Number of axes, maximum		32	128
Minimum PROFIBUS cycle clock ms		1	1
Minimum PROFINET send cycle clock ms		0.25	0.25
Minimum servo cycle clock ms		0.25	0.25
Minimum interpolation cycle clock ms		0.25	0.25
Note for minimum servo cycle clock		0.25 ms for SERVO or SERVO-FAST	0.125 ms (only with ET 200SP, SCOUT TIA (version V4.5 or higher) and SERVO-FAST)
<b>Integrated drive control</b>			
Maximum number of axes for integrated drive control			
• Servo		6	6
• Vector		6	6
• V/f		12	12
• Note		Alternative control modes; drive control based on SINAMICS S120 CU320-2, firmware version V4.x	Alternative control modes; drive control based on SINAMICS S120 CU320-2, firmware version V4.x
<b>Memory</b>			
RAM (Random Access Memory) MB		86	320
Additional RAM for Java applications MB		20	20
RAM disk (load memory) MB		41	76
Retentive memory KB		364	512
Persistent memory (user data on CF) MB		300	300
<b>Communication</b>			
DRIVE-CLiQ interfaces		6	6
USB interfaces		2	2
Industrial Ethernet interfaces		2	2
PROFIBUS interfaces		2	2
• Note		Equidistant and isochronous; can be configured as master or slave	Equidistant and isochronous; can be configured as master or slave
PROFINET interfaces		1	1
• Note		1 interface with 3 ports onboard; 1 interface with 4 ports as an option via CBE30-2; functionality: supports PROFINET IO with IRT and RT; configurable as PROFINET IO Controller and/or Device; supports media redundancy (MRP and MRPD)	1 interface with 3 ports onboard; 1 interface with 4 ports as an option via CBE30-2; functionality: supports PROFINET IO with IRT and RT; configurable as PROFINET IO Controller and/or Device; supports media redundancy (MRP and MRPD)
<b>General technical specifications</b>			
Fan		Double fan/battery module included in scope of delivery	Double fan/battery module included in scope of delivery
DC supply voltage			
• Rated value V		24	24
• Permissible range V		20.4 ... 28.8	20.4 ... 28.8
Current consumption, typical mA		1 000	1 900
• Note		Without load on inputs/outputs, without 24 V supply via DRIVE-CLiQ and PROFIBUS interface	Without load on inputs/outputs, without 24 V supply via DRIVE-CLiQ and PROFIBUS interface
Inrush current, typ. A		5	5
Power loss, typical W		24	46

**Technical specifications (continued)**

Article number	<b>6AG1435-2AD00-4AA0</b>		<b>6AG1455-2AD00-4AA0</b>	
Product brand name	SIPLUS		SIPLUS	
Product type designation	D435-2 DP/PN SIPLUS		D455-2 DP/PN SIPLUS	
<b>General technical specifications (continued)</b>				
Ambient temperature during				
• Long-term storage	°C (°F)	-25 ... +55 (-13 ... +131)	-25 ... +55 (-13 ... +131)	
• Transport	°C (°F)	-40 ... +70 (-40 ... +158)	-40 ... +70 (-40 ... +158)	
• Operation	°C (°F)	0 ... 55 (32 ... 131)	0 ... 55 (32 ... 131)	
- Note		Maximum installation altitude 4000 m (13124 ft) above sea level. Above an altitude of 2000 m (6562 ft), the max. ambient temperature decreases by 7 °C (44.6 °F) every 1000 m (3281 ft).	Maximum installation altitude 4000 m (13124 ft) above sea level. Above an altitude of 2000 m (6562 ft), the max. ambient temperature decreases by 7 °C (44.6 °F) every 1000 m (3281 ft).	
Relative humidity				
• during operation	%	0 ... 100	0 ... 100	
• with condensation, tested acc. to IEC 60068-2-38		Condensation/frost permitted (no commissioning when condensation is present)	Condensation/frost permitted (no commissioning when condensation is present)	
Conformal coating				
		Yes	Yes	
Resistance				
• to biologically active substances, conformity according to EN 60721-3-3		Yes	Yes	
- Note		Class 3B2 mold and fungal spores (except fauna); the supplied plug covers must be left on the unused interfaces during operation!	Class 3B2 mold and fungal spores (except fauna); the supplied plug covers must be left on the unused interfaces during operation!	
• to chemically active substances, conformity according to EN 60721-3-3		Yes	Yes	
- Note		Class 3C4 incl. salt spray according to EN 60068-2-52 (severity 3); the plug covers included in delivery must be left on the unused interfaces during operation!	Class 3C4 incl. salt spray according to EN 60068-2-52 (severity 3); the plug covers included in delivery must be left on the unused interfaces during operation!	
Atmospheric pressure	hPa	620 ... 1 060	620 ... 1 060	
Degree of protection				
		IP20	IP20	
Height	mm (in)	380 (15.0)	380 (15.0)	
Width	mm (in)	50 (1.97)	50 (1.97)	
Depth	mm (in)	270 (10.6)	270 (10.6)	
• Note		With disassembled spacer 230 mm (9.05 in) depth	With disassembled spacer 230 mm (9.05 in) depth	
Net weight	g (lb)	3 700 (8.1571)	4 300 (9.47988)	
<b>Digital inputs</b>				
Number of digital inputs				
		12	12	
DC input voltage				
• Rated value	V	24	24	
• For signal "1"	V	15 ... 30	15 ... 30	
• For signal "0"	V	-3 ... +5	-3 ... +5	
Galvanic isolation				
		Yes	Yes	
• Note		In groups of 6	In groups of 6	
Current consumption at signal level "1", typ.	mA	9	9	
Input delay time for				
• Signal "0" → "1", typ.	µs	50	50	
• Signal "1" → "0", typ.	µs	150	150	
<b>Digital inputs/outputs</b>				
Number of digital inputs/ outputs				
		16	16	
Parameter assignment options for digital inputs and outputs				
		Parameterizable as DI, as DO, as measuring input (max. 16), as cam output (max. 8)	Parameterizable as DI, as DO, as measuring input (max. 16), as cam output (max. 8)	

# SIMOTION Motion Control System

## SIMOTION D – Drive-based

### SIMOTION D4x5-2 Control Units

#### Technical specifications (continued)

Article number	<b>6AG1435-2AD00-4AA0</b>		<b>6AG1455-2AD00-4AA0</b>	
Product brand name	SIPLUS		SIPLUS	
Product type designation	D435-2 DP/PN SIPLUS		D455-2 DP/PN SIPLUS	
<b>If used as an input</b>				
DC input voltage				
• Rated value	V	24		24
• For signal "1"	V	15 ... 30		15 ... 30
• For signal "0"	V	-3 ... +5		-3 ... +5
Galvanic isolation		No		No
Current consumption at signal level "1", typ.	mA	9		9
Input delay time for				
• Signal "0" → "1", typ.	µs	5		5
• Signal "1" → "0", typ.	µs	50		50
Measuring input, reproducibility	µs	5		5
Measuring input, resolution	µs	1		1
<b>If used as an output</b>				
Load voltage				
• Rated value	V	24		24
• Permissible range	V	20.4 ... 28.8		20.4 ... 28.8
Galvanic isolation		No		No
Current-carrying capacity per output, max.	mA	500		500
Residual current, max.	mA	2		2
Output delay time for				
• Signal "0" → "1", typ.	µs	150		150
• Signal "0" → "1", max.	µs	400		400
• Signal "1" → "0", typ.	µs	75		75
• Signal "1" → "0", max.	µs	150		150
- Note		Data for Vcc = 24 V; 48 ohm load; "1" = 90 % VOut, "0" = 10 % VOut		Data for Vcc = 24 V; 48 ohm load; "1" = 90 % VOut, "0" = 10 % VOut
Cam output, reproducibility	µs	10		10
Cam output, resolution	µs	1		1
Switching frequency of the outputs for				
• resistive load, max.	kHz	4		4
• inductive load, max.	Hz	2		2
• lamp load, max.	Hz	11		11
Short-circuit protection		Yes		Yes
<b>Additional technical specifications</b>				
Non-volatile data backup				
• of retentive data		Unlimited backup time		Unlimited backup time
• of real-time clock, min.	d	4		4
• Note		Longer backup duration of the real-time clock via battery inserted in the double fan/battery module		Longer backup duration of the real-time clock via battery inserted in the double fan/battery module
Approvals				
• USA		cULus		cULus
• Canada		cULus		cULus
• Australia		RCM (formerly C-Tick)		RCM (formerly C-Tick)
• Korea		-		-
• Russia, Belarus and Kazakhstan		EAC		EAC

### Selection and ordering data

Description	Article No.
<b>SIMOTION D425-2 DP Control Unit</b> incl. double fan/battery module and battery	6AU1425-2AA00-0AA0
<b>SIMOTION D425-2 DP/PN Control Unit</b> incl. double fan/battery module and battery	6AU1425-2AD00-0AA0
<b>SIMOTION D435-2 DP Control Unit</b> incl. double fan/battery module and battery	6AU1435-2AA00-0AA0
<b>SIMOTION D435-2 DP/PN Control Unit</b> incl. double fan/battery module and battery	6AU1435-2AD00-0AA0
<b>SIPLUS D435-2 DP/PN Control Unit</b> incl. double fan/battery module and battery with conformal coating for use under harsh environmental conditions	6AG1435-2AD00-4AA0
<b>SIMOTION D445-2 DP/PN Control Unit</b> incl. double fan/battery module and battery	6AU1445-2AD00-0AA0
<b>SIMOTION D455-2 DP/PN Control Unit</b> incl. double fan/battery module and battery	6AU1455-2AD00-0AA0
<b>SIPLUS D455-2 DP/PN Control Unit</b> incl. double fan/battery module and battery with conformal coating for use under harsh environmental conditions	6AG1455-2AD00-4AA0
<b>CompactFlash card (CF) 1 GB for SIMOTION D4x5-2</b> with the current SIMOTION Kernel and SINAMICS S120 drive software V4.x Pre-installed license can be obtained using additional order codes <sup>1)</sup> <b>Note:</b> A separate CompactFlash card is available for the SIMOTION D410-2 Control Units (6AU1400-1PA23-0AA0).	6AU1400-2PA23-0AA0

Description	Article No.
<b>MultiAxes Package license for SIMOTION D425-x</b> • As Z option • As Z option incl. Safety Extended Functions • As single license • As single license incl. Safety Extended Functions	<b>M42</b> <b>S42</b>  <b>6AU1820-0AA42-0AB0</b> <b>6AU1820-0AS42-0AB0</b>
<b>MultiAxes Package license for SIMOTION D435-x</b> • As Z option • As Z option incl. Safety Extended Functions • As single license • As single license incl. Safety Extended Functions	<b>M43</b> <b>S43</b>  <b>6AU1820-0AA43-0AB0</b> <b>6AU1820-0AS43-0AB0</b>
<b>MultiAxes Package license for SIMOTION D445-x/D455-x</b> • As Z option • As Z option incl. Safety Extended Functions • As single license • As single license incl. Safety Extended Functions	<b>M44</b> <b>S44</b>  <b>6AU1820-0AA44-0AB0</b> <b>6AU1820-0AS44-0AB0</b>

#### MultiAxes Packages

The **MultiAxes Packages** support particularly simple licensing. They contain the license for unlimited use of the POS/GEAR/CAM technology functions on the SIMOTION D Control Unit.

#### MultiAxes and Safety Packages

In addition to unlimited use of the axes licenses, the **MultiAxes and Safety Packages** also contain the licenses of the Safety Integrated Extended functions for all integrated SINAMICS drives (SIMOTION D and Controller Extensions CX32-2).

<sup>1)</sup> Note about licenses for runtime software:  
Runtime software licenses can either be pre-installed on a CompactFlash card (CF) or ordered separately. See Ordering of licenses for runtime software.

# SIMOTION Motion Control System

## SIMOTION D – Drive-based

### SIMOTION D4x5-2 Control Units

#### Accessories

Description	Article No.
<b>Accessories for SIMOTION D4x5-2</b>	
<b>Double fan/battery module</b> incl. battery Spare part for SIMOTION D4x5-2	6FC5348-0AA02-0AA0
<b>Battery</b> Spare part for fan/ battery module	6FC5247-0AA18-0AA0
<b>Seal for external heat dissipation</b> (1 pack = 10 units) With external air cooling, the cooling fins of the Control Unit are outside of the control cabinet. A seal is required so that the D445-2/D455-2 can be hermetically mounted in the rear cabinet panel.	6FC5348-0AA07-0AA0
<b>Accessories for PROFIBUS</b>	
<b>PROFIBUS RS485 bus connector with angular cable outlet (35°) and screw-type terminals</b> Max. transmission rate 12 Mbit/s • Without PG interface • With PG interface	6ES7972-0BA42-0XA0 6ES7972-0BB42-0XA0
<b>PROFIBUS FastConnect RS485 bus connector with angular cable outlet (35°) and insulation displacement terminals</b> Max. transmission rate 12 Mbit/s • Without PG interface • With PG interface	6ES7972-0BA61-0XA0 6ES7972-0BB61-0XA0
<b>PROFIBUS adapter plug</b> for raising the PROFIBUS connector to create more wiring space	6FX2003-0BB00

Description	Article No.
<b>Accessories for PROFINET (interface X150)</b>	
<b>RJ45 FastConnect connector for Industrial Ethernet/PROFINET</b> 145° cable outlet (10/100 Mbit/s) • 1 pack = 1 unit • 1 pack = 10 units • 1 pack = 50 units	6GK1901-1BB30-0AA0 6GK1901-1BB30-0AB0 6GK1901-1BB30-0AE0
<b>FastConnect cables for Industrial Ethernet/PROFINET 1)</b> • IE FC Standard Cable GP 2x2 • IE FC Flexible Cable GP 2x2 • IE FC Trailing Cable GP 2x2 • IE FC Trailing Cable 2x2 • IE FC Marine Cable 2x2	6XV1840-2AH10 6XV1870-2B 6XV1870-2D 6XV1840-3AH10 6XV1840-4AH10
<b>Stripping tool for Industrial Ethernet/PROFINET FastConnect cables</b> • IE FC Stripping Tool	6GK1901-1GA00
<b>Accessories for Industrial Ethernet (X120, X127, X130 interfaces)</b>	
<b>RJ45 FastConnect connector for Industrial Ethernet/PROFINET</b> 180° cable outlet (10/100/1000 Mbit/s) • 1 pack = 1 unit • 1 pack = 10 units • 1 pack = 50 units	6GK1901-1BB11-2AA0 6GK1901-1BB11-2AB0 6GK1901-1BB11-2AE0
<b>FastConnect cables for Industrial Ethernet/PROFINET 1)</b> • IE FC Standard Cable GP 4x2 • IE FC Flexible Cable GP 4x2	6XV1878-2A 6XV1878-2B
<b>Stripping tool for Industrial Ethernet/PROFINET FastConnect cables</b> • IE FC Stripping Tool	6GK1901-1GA00
<b>Miscellaneous accessories</b>	
<b>Dust protection blanking plugs</b> (50 units) for sealing unused DRIVE-CLiQ, Ethernet and PROFINET ports	6SL3066-4CA00-0AA0

<sup>1)</sup> Sold by the meter; max. length (depending on cable type) 1000 m (3281 ft) or 2000 m (6562 ft); minimum order 20 m (65.6 ft).

### More information

More information

- about SINAMICS S120 drive components such as Line Modules, Motor Modules etc. can be found in Catalog D 21.4 – chapter SINAMICS S120 Drive System, and the Industry Mall under Drive Technology/Converters/AC Low-voltage converters/High performance converters SINAMICS S/....
- about signal and power cables for SINAMICS S120 can be found in Catalog D 21.4 – chapter MOTION-CONNECT connection systems, and the Industry Mall under Drive Technology/Further Components/MOTION-CONNECT connection systems.
- about PROFINET, Industrial Ethernet and PROFIBUS can be found in Catalog IK PI, and the Industry Mall under Automation Technology/Industrial Communication.

### Integrated drive control

The drive control functions integrated in SIMOTION D4x5-2 Control Units are based on the drive control of a SINAMICS S120 CU320-2 Control Unit (firmware version V4.x), although there is a slight difference in functionality. For example, the integrated drive control does not have a basic positioner function (EPOS), as this is already covered by SIMOTION technology functions.

For more information, refer to the documentation for SIMOTION and SINAMICS.

### SIZER for Siemens Drives engineering tool

With the SIZER for Siemens Drives engineering tool, you can easily configure, for example, the SINAMICS S110 and S120 drive families including SIMOTION. This tool supports you with the engineering of components for a Motion Control task. You can also determine the possible number of axes and the resulting utilization with SIZER for Siemens Drives in accordance with your performance requirements.

For more information about SIZER for Siemens Drives, refer to section Lifecycle Services.

### Connectors and cables

The adapter plug (Article No. 6FX2003-0BB00) is required for D4x5-2 when the bus cable has to be looped through the left-hand PROFIBUS interface (X126) (2 PROFIBUS cables wired to the plug) and also

- Ethernet interface X120, in the case of D4x5-2 DP or
- Port 3 of the PROFINET interface X150 in the case of D4x5-2 DP/PN

has to be wired to a FastConnect plug. When using the adapter plug, the PROFIBUS connector is higher, which creates extra wiring space.

Ethernet interfaces X120, X127 and X130 support 10, 100 and 1000 Mbit/s. For 1000 Mbit/s, 8-core cables (4x2) must be used as well as the 1000 Mbit version of the 180° FastConnect plug.

The 145° FastConnect plugs cannot be used for Ethernet interface X130 (cable outlet downwards). They also only support a maximum of 100 Mbit/s.

## SIMOTION Motion Control System

### SIMOTION D – Drive-based

#### Supplementary components > SIMOTION CX32-2 Controller Extension

##### Overview



The SIMOTION CX32-2 Controller Extension is a module in SINAMICS S120 booksize format. It enables the extension of the drive-side computing performance of the SIMOTION D4x5-2 Control Units.

The integrated drive computing performance enables the SIMOTION D4x5-2 Control Units to operate up to 6 servo, 6 vector or 12  $V/f$  axes.

The SIMOTION CX32-2 Controller Extension extends the drive computing performance by up to 6 additional servo, 6 vector or 12  $V/f$  axes. This allows the number of axes of a multi-axis system to be increased according to the requirements of the application.

If required, several CX32-2 Controller Extensions can be operated on one SIMOTION D4x5-2 Control Unit.

##### Benefits

- With a width of 25 mm, the CX32-2 Controller Extension requires very little space and is therefore well-suited for use in compact machines.
- The CX32-2 Controller Extension is connected to the SIMOTION D4x5-2 via DRIVE-CLiQ, so high-performance, isochronous closed-loop control of the drives is possible without the need for additional modules. The communication interfaces on the SIMOTION D4x5-2 remain available for other connections.
- The addressing of the Controller Extension is independent of the addressing on PROFINET/PROFIBUS. This is advantageous for modular machine concepts.
- Simple cabling and configuration
- The Control operation signal from an infeed connected to the SIMOTION D4x5-2 is particularly easy to interconnect to the drives of the CX32-2 Controller Extension.
- The CX32-2 Controller Extension does not require its own CompactFlash card. Data is managed centrally on the CompactFlash card of the SIMOTION D4x5-2 Control Unit. This has the following advantages:
  - Simple module replacement (no operator action required on the CX32-2, such as memory card replacement)
  - During firmware upgrades, the CX32-2 Controller Extension is automatically upgraded with the integrated drive of the SIMOTION D4x5-2 Control Unit
  - Central license handling via the SIMOTION D4x5-2

##### Design

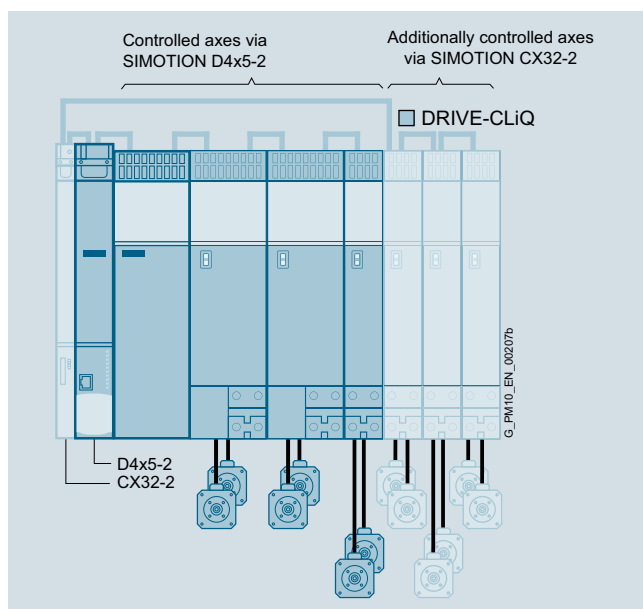

Example: Group of 12 axes with SIMOTION D4x5-2 and SIMOTION CX32-2 Controller Extension

The SIMOTION CX32-2 Controller Extension is connected to the SIMOTION D4x5-2 via DRIVE-CLiQ.

In this way, a very compact axis grouping can be implemented, for example, with 12 servo axes.

If required, several SIMOTION CX32-2 Controller Extensions can be operated on one SIMOTION D4x5-2 Control Unit:

- Max. 3 CX32-2 units on one SIMOTION D425-2
- Max. 5 CX32-2 units on one SIMOTION D435-2, D445-2 or D455-2

In principle, a 4th or 6th CX32-2 Controller Extension can also be connected. In this case, no drives/drive components can be connected any longer to the integrated drive control of the SIMOTION D4x5-2. All drives must then be operated via the connected Controller Extensions. This can be useful, for example, when implementing distributed, modular machine concepts.

Additional drive controls can be implemented with SINAMICS S110/S120 Control Units via PROFINET or PROFIBUS.

##### Note

The SIMOTION CX32-2 Controller Extension can only be used with SIMOTION D4x5-2 Control Units. Operation with SIMOTION D4x5 Control Units is not possible.

The SIMOTION CX32 Controller Extension must be used for the SIMOTION D435 and D445-1 Control Units (Article No. 6SL3040-0NA00-0AA0).



**Technical specifications**

Article number	<b>6AU1432-2AA00-0AA0</b>	
Product brand name	SIMOTION	
Product type designation	CX32-2	
Version of Motion Control System	Controller Extension	
<b>Integrated drive control</b>		
Maximum number of axes for integrated drive control		
• Servo	6	
• Vector	6	
• V/f	12	
• Note	Alternative control modes; drive control based on SINAMICS S120 CU320-2, firmware version V4.x	
<b>Communication</b>		
DRIVE-CLiQ interfaces	4	
<b>General technical specifications</b>		
Fan	No fan	
DC supply voltage		
• Rated value	V	24
• Permissible range	V	20.4 ... 28.8
Current consumption, typical	mA	300
• Note	Without load on inputs/outputs, without 24 V supply via DRIVE-CLiQ interface	
Inrush current, typ.	A	1.6
Active power loss, typical	W	7
Ambient temperature during		
• Long-term storage	°C (°F)	-25 ... +55 (-13 ... +131)
• Transport	°C (°F)	-40 ... +70 (-40 ... +158)
• Operation	°C (°F)	0 ... 55 (32 ... 131)
- Note	Maximum installation altitude 4000 m (13124 ft) above sea level. Above an altitude of 2000 m (6562 ft), the max. ambient temperature decreases by 7 °C (44.6 °F) every 1000 m (3281 ft).	
Relative humidity during operation	%	5 ... 95
Atmospheric pressure	hPa	620 ... 1 060
Degree of protection	IP20	
Height	mm (in)	380 (15.0)
Width	mm (in)	25 (0.98)
Depth	mm (in)	270 (10.6)
• Note	With disassembled spacer 230 mm (9.05 in) depth	
Net weight	g (lb)	2 600 (5.73202)
<b>Digital inputs</b>		
Number of digital inputs	6	
DC input voltage		
• Rated value	V	24
• For signal "1"	V	15 ... 30
• For signal "0"	V	-3 ... +5
Galvanic isolation	Yes	
• Note	In groups of 6	
Current consumption at signal level "1", typ.	mA	3.5
Input delay time for		
• Signal "0" → "1", typ.	µs	50
• Signal "1" → "0", typ.	µs	150
<b>Digital inputs/outputs</b>		
Number of digital inputs/outputs	4	
Parameter assignment options for digital inputs and outputs	Parameterizable as DI, as DO, as measuring input (max. 4)	

# SIMOTION Motion Control System

## SIMOTION D – Drive-based

### Supplementary components > SIMOTION CX32-2 Controller Extension

#### Technical specifications (continued)

Article number	<b>6AU1432-2AA00-0AA0</b>	
Product brand name	SIMOTION	
Product type designation	CX32-2	
<b>If used as an input</b>		
DC input voltage		
• Rated value	V	24
• For signal "1"	V	15 ... 30
• For signal "0"	V	-3 ... +5
Galvanic isolation		No
Current consumption at signal level "1", typ.	mA	3.5
Input delay time for		
• Signal "0" → "1", typ.	µs	5
• Signal "1" → "0", typ.	µs	50
Measuring input, reproducibility	µs	5
Measuring input, resolution	µs	1
<b>If used as an output</b>		
Load voltage		
• Rated value	V	24
• Permissible range	V	20.4 ... 28.8
Galvanic isolation		No
Current-carrying capacity per output, max.	mA	500
Residual current, max.	mA	2
Output delay time for		
• Signal "0" → "1", typ.	µs	150
• Signal "0" → "1", max.	µs	400
• Signal "1" → "0", typ.	µs	75
• Signal "1" → "0", max.	µs	100
- Note		Data for Vcc = 24 V; 48 ohm load; "1" = 90 % VOut, "0" = 10 % VOut
Switching frequency of the outputs for		
• resistive load, max.	kHz	4
• inductive load, max.	Hz	2
• lamp load, max.	Hz	11
Short-circuit protection		Yes
<b>Additional technical specifications</b>		
Non-volatile retentive data backup		Unlimited backup time
Approvals		
• USA		cULus
• Canada		cULus
• Australia		RCM (formerly C-Tick)
• Korea		KCC
• Russia, Belarus and Kazakhstan		EAC

#### Selection and ordering data

Description	Article No.
<b>SIMOTION CX32-2 Controller Extension for SIMOTION D4x5-2</b>	<b>6AU1432-2AA00-0AA0</b>

### Overview



The CBE30-2 Communication Board can be installed in order to provide the SIMOTION D4x5-2 DP/PN with a second PROFINET interface.

### Application

Applications for a second PROFINET interface are as follows:

- 2 separate networks (e.g. one local and one higher-level network)
- Address space can be doubled to 2 × 6 KB
- Maximum number of connectable devices can be doubled to 2 × 64
- Separation into a fast and a slow bus system/execution system in order to make efficient use of the controller's capacity (applies only to SIMOTION D435-2 DP/PN, D445-2 DP/PN and D455-2 DP/PN)

### Function

The CBE30-2 Communication Board provides the following functions:

- PROFINET IO controller, I-Device (also controller and device simultaneously)
- 100 Mbit/s full-duplex/autocrossing
- Supports real-time classes of PROFINET IO:
  - RT (Real Time)
  - IRT (Isochronous Real Time)
- Integration of distributed I/Os as PROFINET IO devices
- Integration of drives as PROFINET IO devices through PROFIdrive according to the V4 specification
- Support for standard Ethernet communication, e.g.
  - for communication with SIMOTION SCOUT
  - for the connection of HMI systems
  - for communication with any other devices over TCP/IP or UDP communication
- Integrated 4-port switch with four RJ45 sockets. The optimum topology (line, star, tree) can therefore be configured without additional external switches.
- Support for media redundancy (MRP/MRPD).

### Integration

The CBE30-2 Communication Board is plugged into the option slot on the SIMOTION D4x5-2 DP/PN.

#### Note

The CBE30-2 Communication Board can only be used with the SIMOTION D4x5-2 DP/PN Control Units.

It is not compatible with SIMOTION D425, D435, D445-1 and D4x5-2 DP.

### Technical specifications

CBE30-2 Communication Board	
<b>Current requirement at 24 V DC</b>	0.25 A
<b>Permissible ambient temperature</b>	
• Storage and transport	-40 ... +70 °C (-40 ... +158 °F)
• Operation	0 ... 55 °C (32 ... 131 °F)
<b>Weight, approx.</b>	100 g (0.22 lb)
<b>Dimensions (W × H × D)</b>	25 × 95 × 143 mm (0.98 × 3.74 × 5.63 in)
<b>Approvals</b>	
• USA	cULus
• Canada	cULus
• Australia	RCM (formerly C-Tick)
• Korea	KCC
• Russia, Belarus and Kazakhstan	EAC

### Selection and ordering data

Description	Article No.
<b>CBE30-2 Communication Board</b> for SIMOTION D4x5-2 DP/PN	<b>6FC5312-0FA00-2AA0</b>

### Accessories

Description	Article No.
<b>RJ45 FastConnect connector for Industrial Ethernet/PROFINET</b>	
• 145° cable outlet (10/100 Mbit/s)	
- 1 pack = 1 unit	<b>6GK1901-1BB30-0AA0</b>
- 1 pack = 10 units	<b>6GK1901-1BB30-0AB0</b>
- 1 pack = 50 units	<b>6GK1901-1BB30-0AE0</b>
<b>FastConnect cables for Industrial Ethernet/PROFINET<sup>1)</sup></b>	
• IE FC Standard Cable GP 2x2	<b>6XV1840-2AH10</b>
• IE FC Flexible Cable GP 2x2	<b>6XV1870-2B</b>
• IE FC Trailing Cable GP 2x2	<b>6XV1870-2D</b>
• IE FC Trailing Cable 2x2	<b>6XV1840-3AH10</b>
• IE FC Marine Cable 2x2	<b>6XV1840-4AH10</b>
<b>Stripping tool for Industrial Ethernet/PROFINET FastConnect cables</b>	
• IE FC Stripping Tool	<b>6GK1901-1GA00</b>

### More information

More information about FastConnect cables can be found in Catalog IK PI (Industrial Communication) – chapter PROFINET/Industrial Ethernet and the Industry Mall under Automation Technology/Industrial Communication/Industrial Ethernet/Cabling Technology/....

<sup>1)</sup> Sold by the meter; max. length (depending on cable type) 1000 m (3281 ft) or 2000 m (6562 ft); minimum order 20 m (65.6 ft).

# SIMOTION Motion Control System

## SIMOTION D – Drive-based

### Supplementary components > TB30 Terminal Board

#### Overview

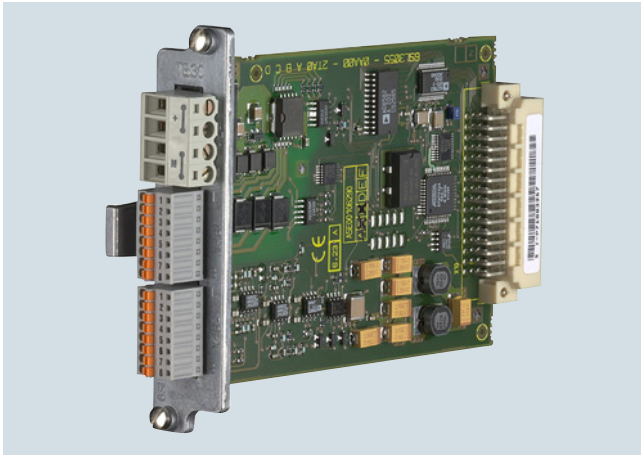

TB30 Terminal Board

The TB30 Terminal Board supports the addition of digital inputs/digital outputs and analog inputs/analog outputs to a Control Unit.

#### Design

The following are located on the TB30 Terminal Board:

- Power supply for digital inputs/digital outputs
- 4 digital inputs
- 4 digital outputs
- 2 analog inputs
- 2 analog outputs

A shield connection for the signal cable shield is located on the Control Unit.

#### Technical specifications

<b>TB30 Terminal Board 6SL3055-0AA00-2TA0</b>	
<b>Current requirement, max.</b> at 24 V DC via Control Unit without taking account of digital outputs	0.05 A
• Conductor cross-section, max.	2.5 mm <sup>2</sup>
• Fuse protection, max.	20 A
<b>Digital inputs</b> In accordance with IEC 61131-2 Type 1	
• Voltage	-3 ... +30 V
• Low level (an open digital input is interpreted as "low")	-3 ... +5 V
• High level	15 ... 30 V
• Current consumption at 24 V DC, typ.	6 mA
• Delay time of digital inputs <sup>1)</sup> , approx.	
- L → H	50 μs
- H → L	100 μs
• Conductor cross-section, max.	0.5 mm <sup>2</sup>
<b>Digital outputs</b> (sustained-short-circuit-proof)	
• Voltage	24 V DC
• Load current per digital output, max.	500 mA
• Delay time of digital outputs <sup>1)</sup> , approx.	150 μs
• Conductor cross-section, max.	0.5 mm <sup>2</sup>
<b>Analog inputs</b> (difference)	
• Voltage range (an open analog input is interpreted as 0 V)	-10 ... +10 V
• Internal resistance $R_i$	65 kΩ
• Resolution <sup>2)</sup>	13 bit + sign
• Conductor cross-section, max.	0.5 mm <sup>2</sup>
<b>Analog outputs</b> (sustained-short-circuit-proof)	
• Voltage range	-10 ... +10 V
• Load current, max.	-3 ... +3 mA
• Resolution	11 bit + sign
• Settling time, approx.	200 μs
• Conductor cross-section, max.	0.5 mm <sup>2</sup>
<b>Power loss, max.</b>	3 W
<b>Weight, approx.</b>	0.1 kg (0.22 lb)
<b>Certificate of suitability</b>	cULus

<sup>1)</sup> The specified delay times refer to the hardware. The actual reaction time depends on the time slot in which the digital input/output is processed.

<sup>2)</sup> If the analog input is to be operated in the signal processing sense with continuously variable input voltage, the sampling frequency  $f_a = 1/t_{\text{time slice}}$  must be at least twice the value of the highest signal frequency  $f_{\text{max}}$ .

## Integration

The TB30 Terminal Board plugs into the option slot on a Control Unit.

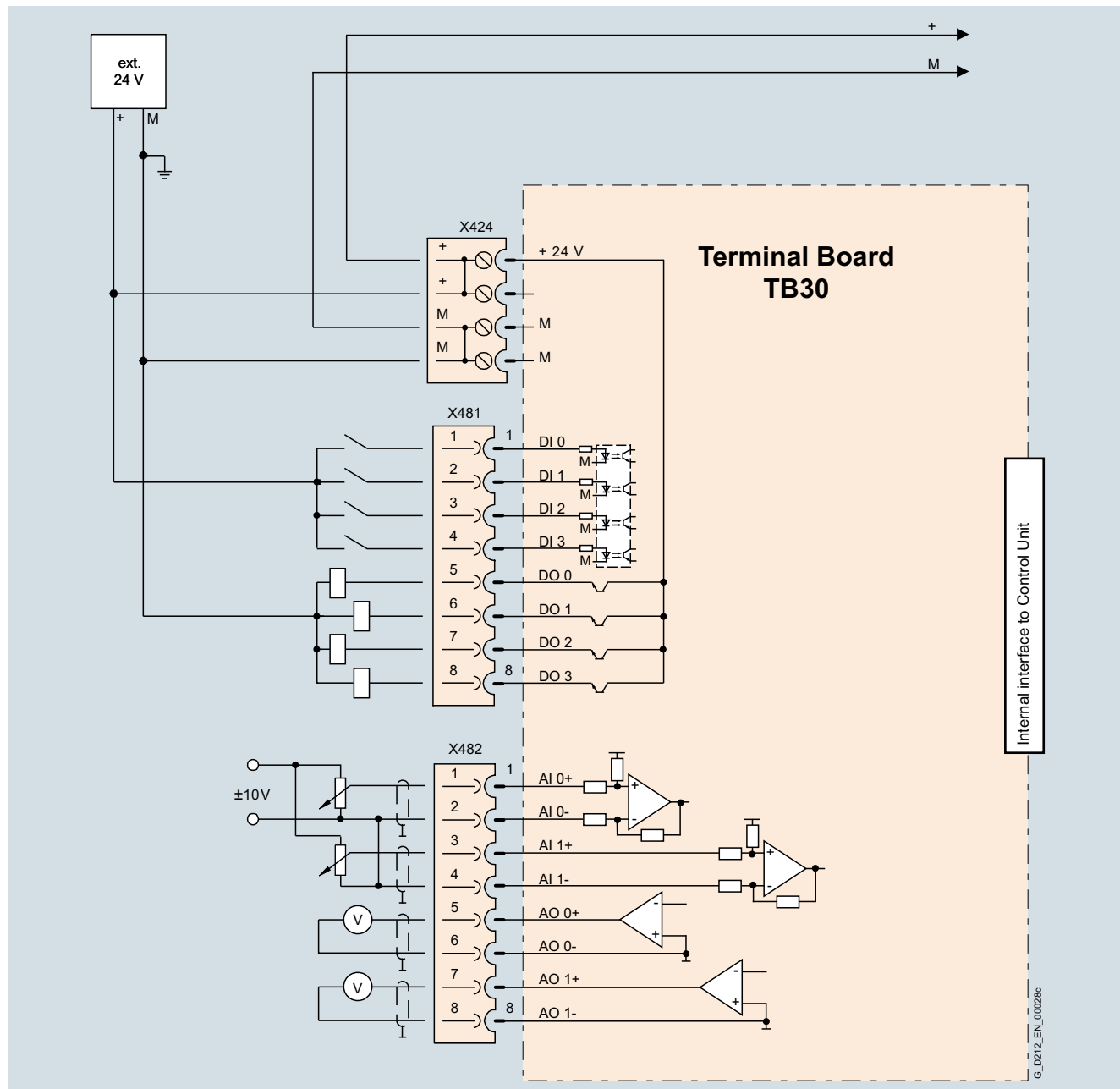

Connection example of a TB30 Terminal Board

## Selection and ordering data

Description	Article No.
<b>TB30 Terminal Board</b>	<b>6SL3055-0AA00-2TA0</b>

## SIMOTION Motion Control System

### SIMOTION P – PC-based

#### SIMOTION P320-4 Motion Controller

##### Overview



#### **SIMOTION P – PC-based Motion Control**

Extensive range of Motion Control functions compactly integrated in an industrial PC: SIMOTION P320-4

SIMOTION P320-4 is a high-performance, ultra-compact and maintenance-free industrial PC that has proven itself even under tough operating conditions. SIMOTION P320-4 combines the ruggedness of a PLC with the full Motion Control functionality of SIMOTION.

SIMOTION P320-4 is available in two high-performance versions:

- SIMOTION P320-4 E (Embedded)  
Processor: Intel i3 processor (3rd generation)  
Memory: Internal CFast/externally accessible CFast  
Operating system: Windows Embedded Standard 7
- SIMOTION P320-4 S (Standard)  
Processor: Intel i7 processor  
Memory: Internal Solid State Drive (SSD)/externally accessible CFast  
Operating system: Windows 7 Ultimate

#### SIMOTION P320-4 scope of supply:

SIMOTION P320-4 is delivered including the mass storage and the associated SIMOTION runtime software.

- Internal mass storage: Windows operating system and SIMOTION runtime firmware
- Externally accessible mass storage: SIMOTION project and user data

#### **Openness thanks to the Windows operating system**

This openness is the distinguishing feature of a PC-based solution:

- Flexible networking
- High data storage capacity
- Data backup concepts
- Integrated communication

Complex data evaluation, visualization tasks and even engineering can be easily implemented with SIMOTION P directly on the PC. The standardized OPC interface is provided to allow access to SIMOTION variables via Windows software when necessary.

One of the functions of the integrated Ethernet interface is to allow access to data on the integrated web server by means of SIMOTION IT. The communication link uses standard IT protocols, e.g. for the purpose of commissioning, diagnostics and servicing.

Functions such as remote maintenance, diagnostics and teleservice can also be utilized. In addition, standard PC interfaces are available and can be used for purposes such as:

- Hardware, such as a printer, keyboard, mouse
- Software, such as visualization software or Microsoft Office programs.

#### **Real-time capability thanks to the SIMOTION operating system**

The fully independent SIMOTION operating system runs in parallel to Windows on SIMOTION P. This real-time expansion makes it possible to implement complex Motion Control applications with high performance requirements on the SIMOTION P platform.

#### **High-performance PC technology**

- The latest PC processor technology ensures optimum performance.
- Fast instruction execution opens up completely new application possibilities in the mid-performance to high-performance range.

#### **Benefits**

- Open-loop control, Motion Control, technology, visualization and standard Microsoft applications on the same platform – ready to use without the need for time-consuming installation
- Performance gains due to the latest, powerful PC processor architecture
- Openness to standard applications on the basis of the Windows operating system
- Standard PC communication mechanisms can be used over Industrial Ethernet
- Simple software updates
- User-friendly operation
- Flexible networking over the existing communication interfaces. The SIMOTION P320-4 system has an integrated, onboard PROFINET and Industrial Ethernet interface. For applications that also require a PROFIBUS DP connection, the option module IsoPROFIBUS board with two PROFIBUS interfaces is available.
- Powerful thanks to a range of integrated functions
- Easy engineering for open-loop control and Motion Control applications in the same program

### Application

#### **SIMOTION P320-4 is suitable for applications for which**

- the available mounting space is minimal
- rugged hardware is extremely important, without rotating parts such as fan or hard disk
- no display is needed in normal operation (headless mode). Connections are available for operation of a monitor or display. SIMOTION P320-4 features a DVI-I and a DisplayPort (DP) interface.
- A Windows operating system is required for the relevant applications.

#### **SIMOTION P320-4 is suitable for high-performance applications for which**

- complex data management and data evaluation are a prerequisite
- Motion Control, open-loop control and visualization functions need to be implemented on one platform to save space
- highly dynamic position and pressure control loops are needed, as in the case of hydraulic applications
- the openness provided by the Windows operating system can be optimally utilized (software, drivers, etc.)

#### **Important applications include:**

- Packaging machines
- Plastic and rubber processing machines
- Presses, wire-drawing machines
- Textile machines
- Printing machines
- Wood, glass, ceramics and stone working machines
- Production lines in the renewable energy sector, e.g. solar technology,
- wind energy plants

Due to the increasing use of servo drives, these machines require a high degree of integration of PLC, Motion Control and technology functions.

### Design

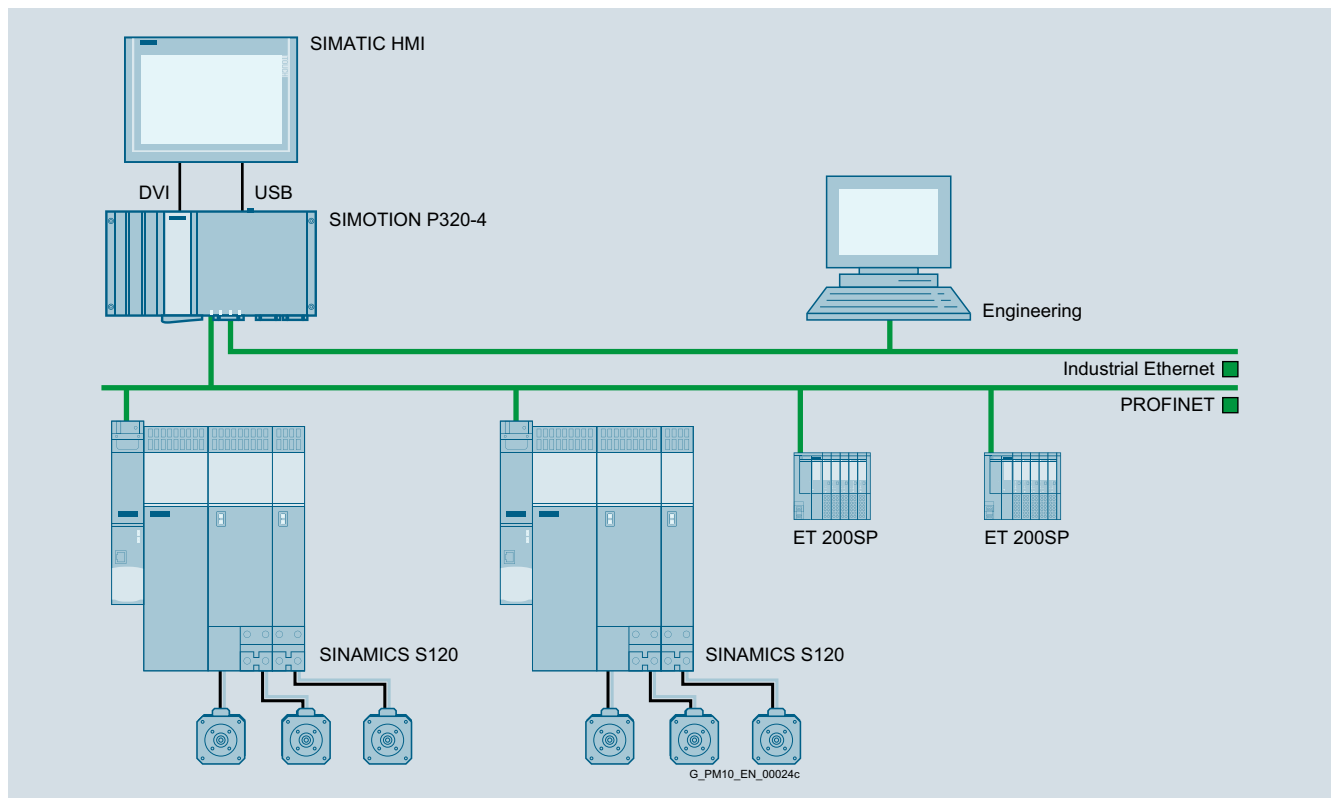

Typical design of an automation solution using SIMOTION P

# SIMOTION Motion Control System

## SIMOTION P – PC-based

### SIMOTION P320-4 Motion Controller

#### Design (continued)

##### Equipment provided on SIMOTION P basic units

The SIMOTION P320-4 E and P320-4 S Motion Controllers are ready-to-run PC systems comprising:

- Hardware platform SIMOTION P320-4
- Windows operating system and real-time expansion for SIMOTION P
- SIMOTION Kernel

Both SIMOTION P320-4 versions have an integrated, onboard PROFINET and Industrial Ethernet interface. For applications that also require a PROFIBUS DP connection, the option module IsoPROFIBUS board with two PROFIBUS interfaces is available.

##### Power supplies for SIMOTION P

SIMOTION P320-4 requires a 24 V operating voltage. We recommend that you use an uninterruptible power supply (UPS). SITOP power supply units and DC UPS modules are examples of systems that are suitable for this application.

An appropriate power supply can be selected via the Internet: [www.siemens.com/sitop-selection-tool](http://www.siemens.com/sitop-selection-tool)

##### Operator control and monitoring

SIMOTION P320-4 can be operated without a display or monitor (headless mode).

In addition, displays and monitors can be directly connected via the integrated DVI or DisplayPort interface. Using the SIMATIC Industrial Flat Panel (IFP), it is possible to operate SIMOTION P320-4 at a distance of up to 30 m (98.4 ft) in a distributed configuration.

##### Engineering

Engineering is performed either using a separate programming device with SIMOTION SCOUT or, in the case of the SIMOTION P320-4 S version, directly with SIMOTION SCOUT on the SIMOTION P system.

##### Communication interfaces on SIMOTION P320-4

###### PROFINET

With its integrated PROFINET interface with 3 ports, SIMOTION P320-4 can be connected to a PROFINET IO network. The PROFINET interface supports PROFINET IO with IRT and RT. Standard Ethernet communication (TCP/IP) is also possible over this interface.

The properties of the integrated PROFINET interface are as follows:

- Communication as a PROFINET IO controller, I-Device (controller and device simultaneously)
- 100 Mbit/s full duplex
- Support for real time classes RT (Real Time) and IRT (Isochronous Real Time)
- Integrated 3-port switch with 3 RJ45 sockets. The optimum topology (line, star, tree) can therefore be configured without additional external switches.

###### PROFIBUS

The connection to a PROFIBUS network is made via the IsoPROFIBUS board (available as optional module). This is a PCI card with two interfaces for PROFIBUS DP (max. 12 Mbit/s). The clock-pulse rate can be parameterized on the bus.

##### Integration in Local Area Networks

With the onboard Industrial Ethernet interface, the SIMOTION P320-4 system is ready for integration in LANs (Local Area Networks). An external operator station or an engineering system can also be connected (e.g. for remote maintenance).

##### Expansion using distributed I/Os and drives

SIMOTION P320-4 Motion Controllers can control (depending on device and device variant) drives and distributed I/O systems via PROFINET or PROFIBUS DP (optional). In this case, the drives are connected using the PROFIdrive V4 profile.

Available I/O systems include, for example:

- SIMATIC ET 200SP, ET 200S
- SIMATIC ET 200MP, ET 200M
- SIMATIC ET 200pro
- SIMATIC ET 200eco, ET 200eco PN
- SIMATIC ET 200AL

The high-performance I/O systems transfer the required process signals digitally and free of interference to the SIMOTION P system.

##### High-speed I/Os for time-critical applications

Cycle times of 250  $\mu$ s can be achieved with SIMOTION P, PROFINET and high-speed I/Os. This is particularly necessary for applications with fast response times (e.g. hydraulic axes).

##### Interfaces

The following interfaces are available on the SIMOTION P320-4 system:

- 1  $\times$  COM 1 (V.24)
- 1  $\times$  DVI-I (DVI / VGA)
- 1  $\times$  DisplayPort (DP)
- 4  $\times$  USB 3.0
- 1  $\times$  Industrial Ethernet (10/100/1000 Mbit/s)
- 1  $\times$  PROFINET IO (1 interface with 3 ports)
- 2  $\times$  PROFIBUS DP optional (IsoPROFIBUS board)

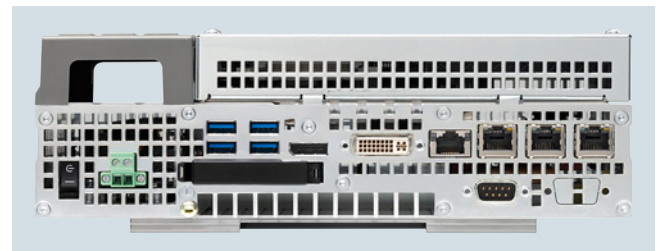

##### Ruggedness

In order to optimize the rugged design of the system, SIMOTION P320-4 contains no rotating parts at all. An externally accessible CFast card can be used. The features of the internal storage medium differ according to the device version:

Storage media:

- Freely accessible (exchangeable): CFast (4 GB)
- Internal (non-exchangeable):
  - SIMOTION P320-4 E: CFast (4 GB)
  - SIMOTION P320-4 S: SSD (80 GB)

No tools are needed to insert or remove the CFast card.

System data are stored on the non-exchangeable storage medium. Application data can be stored, for example, on the freely accessible CFast card. Separate administration of system and application data is therefore possible.



### Design (continued)

#### High system availability

The following features of the SIMOTION P320-4 Motion Controller afford an especially high degree of system availability:

- Integrated monitoring functions for battery, temperature and program execution
- LEDs on front panel for efficient diagnosis
- An integrated power supply with capacity to bridge brief supply failures (not a UPS).

#### Flexible mounting in the control cabinet

SIMOTION P320-4 can be mounted in a variety of positions in the control cabinet, e.g. on a standard rail, cabinet wall or by portrait assembly kit. This means that valuable space inside the cabinet can be saved for other purposes.

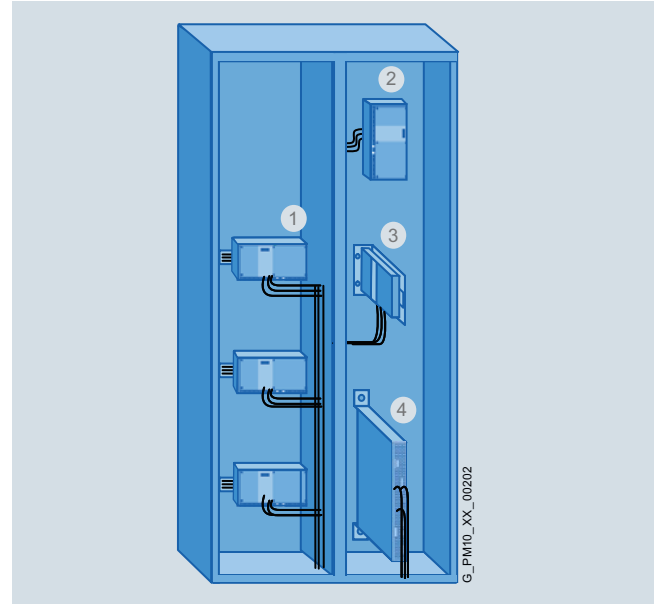

Flexible mounting in the control cabinet: (1) Standard rail mounting, (2) Wall mounting, (3) Portrait assembly, (4) Front portrait assembly

### Function

#### System concept

The control and Motion Control software execute on the basic system (SIMOTION Kernel).

The internal PC communication provides high-performance data exchange between the SIMOTION Kernel and the Microsoft Windows operating system. Further processing of this data, e.g. using OPC server, is possible in any Microsoft program.

#### SIMOTION basic functionality

The SIMOTION P systems provide the following basic functionality for a wide variety of automation requirements:

- SIMOTION runtime system
  - User-programmable with several languages conforming to IEC 61131
  - Various methods of program execution (cyclic, sequential, event-driven)
  - PLC and arithmetic functionality
  - Communication and management functions
  - Technology functions for Motion Control Basic
- Testing and diagnostic tools

This basic functionality can be expanded with loadable technology packages, if required.

#### SIMOTION technology packages

A special feature of SIMOTION is that the operating system functionality can be expanded by loading technology packages, such as:

- Motion Control with the functions
  - POS – Positioning
  - GEAR – Synchronous operation/electronic gear
  - CAM – Cam
  - PATH - Path interpolation
- TControl – Temperature controller
- MIIF – Multipurpose Information Interface
- Vibration Extinction (VIBX)
- OACAMGEN

Since the technology functions have modular licenses, you only pay for what you will actually use: "only pay for what you need"

#### Configuring/parameterizing/programming

SIMOTION SCOUT is a powerful and user-friendly engineering tool. It is an integrated system for all engineering steps, from configuring and parameterization, through programming, to testing and diagnostics. Graphical operator prompting, using dialog boxes and wizards, as well as text-based and graphical languages for programming, considerably reduce the familiarization and training periods.

#### Series commissioning with optional USB flash drive

For the purpose of commissioning several Motion Controllers at once, it is possible to copy a pre-generated data image to the USB flash drive using SIMATIC IPC Image & Partition Creator (own software).

The SIMATIC IPC Image & Partition Creator must either be ordered separately, or is pre-installed on the SIMATIC IPC USB flash drive (see selection and ordering data).

# SIMOTION Motion Control System

## SIMOTION P – PC-based

### SIMOTION P320-4 Motion Controller

#### Function (continued)

##### Operator control and monitoring (HMI)

Operator control and monitoring can be performed:

- separately on an HMI panel or
- by connecting a SIMATIC Industrial Flat Panel (IFP).

Communication utilities which support user-friendly data exchange with HMI systems are integrated in the basic functionality of SIMOTION P. Both PROFINET and PROFIBUS (optional) as well as Industrial Ethernet can be used for communication.

The HMI devices can be connected to SIMOTION P over PROFINET, Industrial Ethernet or PROFIBUS. They are configured by means of SIMATIC WinCC (TIA Portal).

With the SIMATIC NET communications software, an open, standardized OPC interface is available for accessing SIMOTION from other Windows-based HMI systems.

##### SIMOTION IT service and diagnostic functions

SIMOTION IT provides SIMOTION P with an integrated web server on which, for example, user-specific web pages can be stored. Read and write access can be made to the Motion Controller variables. Java scripts or applets also allow the implementation of active operation and display functions in the web pages that can be executed on a client PC with standard Internet browser.

##### Process and data communication

Thanks to its integrated interfaces, SIMOTION P supports both process and data communication. The SCOUT engineering system is provided for user-friendly communication configuration and diagnostics.

##### Position-controlled motion control for servo drives

###### Drives with digital setpoint interface

SIMOTION P Motion Controllers enable position-controlled motion control for drives with digital setpoint interface via PROFINET IO with PROFIdrive or optionally with PROFIBUS DP.

##### Position control and pressure control for hydraulic drives

With SIMOTION P and the SIMATIC ET 200S High Speed I/Os, minimum cycle times of 250  $\mu$ s can be achieved over PROFINET with IRT (Isochronous Real Time).

Highly dynamic control loops can therefore be achieved for hydraulic applications with position and pressure control.

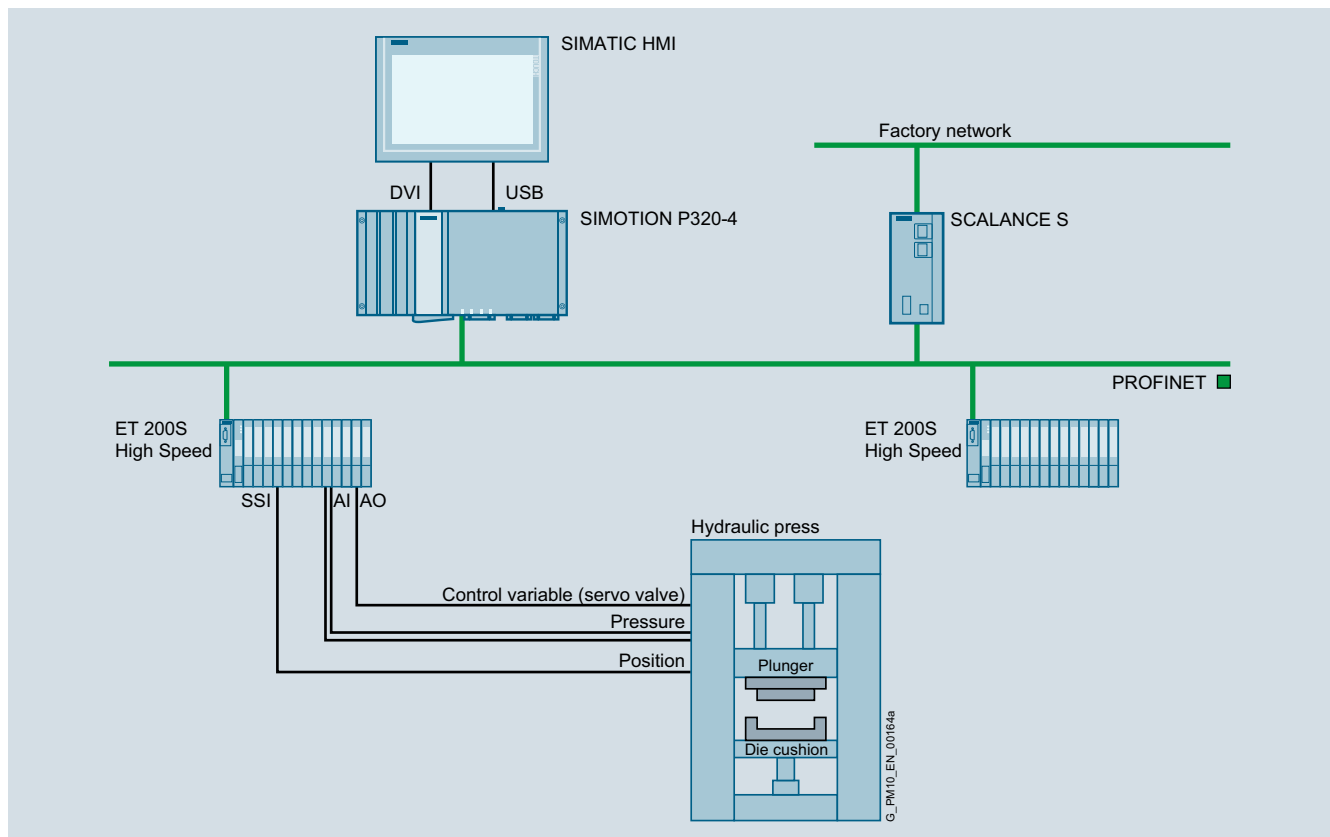

Example: Closed-loop control of a hydraulic press with SIMOTION P320-4

### Function (continued)

The necessary sensors and actuators, such as

- position encoders connected through the SSI interface,
- pressure sensors connected through analog inputs (AI),
- servo valves connected through analog outputs (AO) and
- digital I/Os for tool safety and cam signal output

are connected over the SIMATIC ET 200S distributed I/O system, which was equipped with the necessary high-speed I/O modules beforehand to suit the application.

On the basis of PROFINET, it is therefore possible to synchronize hydraulic drives as well as electrical drives. In conveyor systems and press lines in the automotive industry, plant-wide automation solutions can be implemented in which both electrical drives (winders, cross cutters, roller feeds) and hydraulic drives (e.g. deep-drawing presses) are deployed.

### Indication and diagnosis of operating status

A SIMOTION P system does not have any pushbuttons or switches for changing operating modes (RUN/STOP). This task is performed (when a monitor/display is connected) by a software monitor (SIMOTION P State), which is operated using the keyboard or mouse.

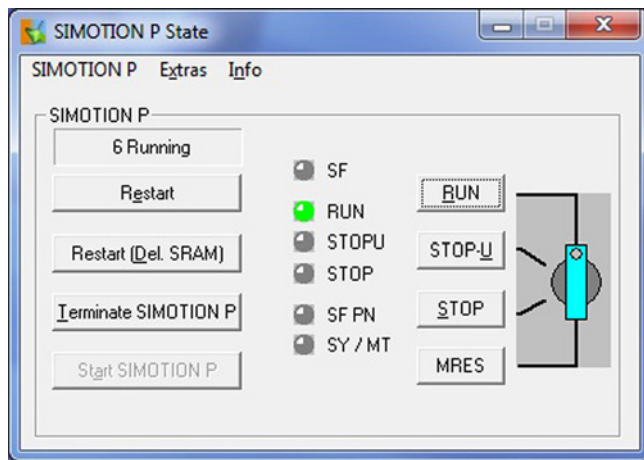

SIMOTION P State

This monitor (with English as interface language) visualizes the operating states during start-up and operation. Other functions are, for example, loading (Restore) and saving (Save) user programs or starting (Restart) or shutting down (Terminate) the Motion Controller. During shutdown, important data (retain data) are stored on the external CFast card while the device's power supply is shutting down so that the most current data is ready for use as soon as the device is restarted.

The SIMOTION P intelligent diagnostic system constantly checks the functionality of the system and registers errors or specific system events (e.g. timing errors, module or network failures).

### Integration

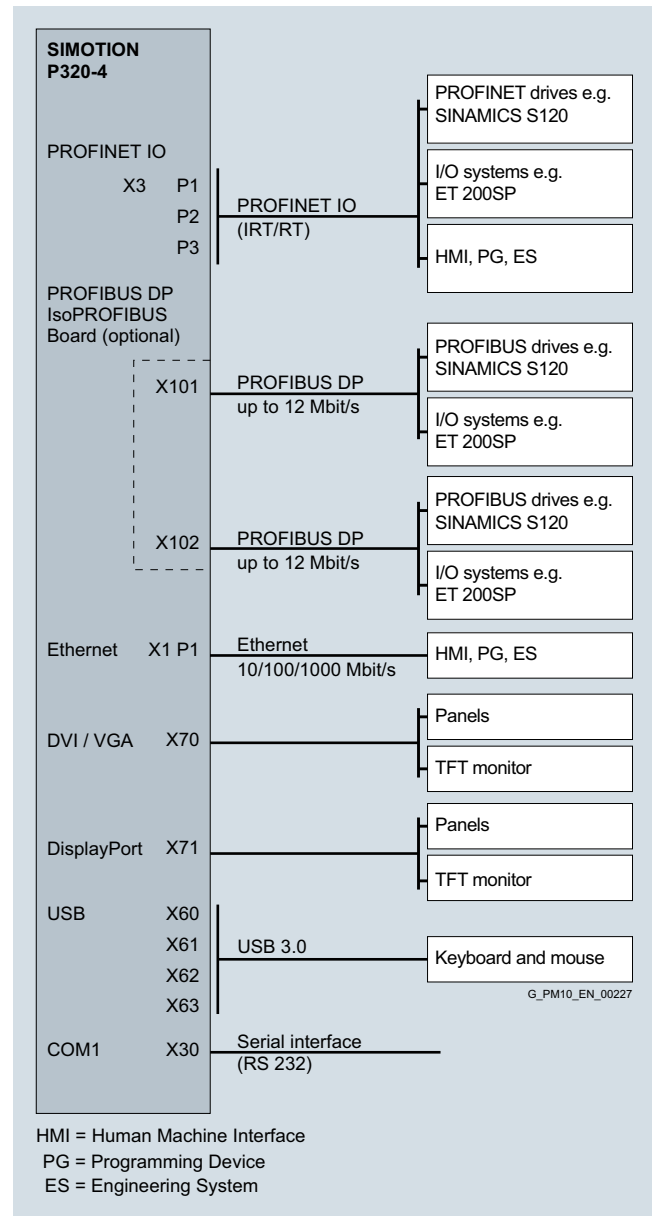

Overview of SIMOTION P320-4 connections

# SIMOTION Motion Control System

SIMOTION P – PC-based

## SIMOTION P320-4 Motion Controller

### Technical specifications

SIMOTION P320-4 Motion Controller	
PLC and Motion Control performance	
<b>P320-4 E</b>	Processor: Intel Core i3, 2x1.6 GHz, 3 MB cache Internal memory: CFast External memory: CFast Operating system: Windows Embedded Standard 7 32 Bit
<b>P320-4 S</b>	Intel Core i7-3517UE 2x1.7 GHz, 4 MB cache Internal memory: SSD (Solid State Disk) External memory: CFast Operating system: Windows 7 Ultimate 32 Bit
<b>Maximum number of axes</b>	128
<b>Minimum PROFINET send cycle clock</b>	250 µs
<b>Minimum servo/interpolator clock cycle</b>	250 µs
Memory	
<b>RAM (Random Access Memory, Windows)</b>	4 GB DDR3 RAM
<b>Retentive memory</b>	364 KB
<b>CFast card</b>	4 GB
<b>Persistent memory (user data on CFast)</b>	3.7 GB
Communication	
<b>USB interfaces</b>	4 × USB 3.0
<b>Ethernet interfaces</b>	1 × RJ45 (10/100/1000 Mbit/s)
<b>PROFINET interfaces</b>	<ul style="list-style-type: none"> <li>• 1 interface with 3 ports</li> <li>• Supports PROFINET IO with IRT and RT</li> <li>• Can be configured as PROFINET IO controller and/or device</li> </ul>
General technical specifications	
<b>Input voltage</b>	24 V DC
<b>Power consumption, max.</b>	72 W (P320-4 E) or 105 W (P320-4 S)
<b>Mains buffering, max.</b>	5 ms
<b>Degree of protection acc. to EN 60529 (IEC 60529)</b>	IP20
<b>Temperature change, max.</b>	10°K/h
<b>Limit values for rel. humidity in accordance with EN 60068-2-78, EN 60068-2-30</b>	
• Storage and transport	5 ... 95 % at 25 °C (77 °F)
• Operation	5 ... 80 % at 25 °C (77 °F)
<b>Permissible ambient temperature</b>	
• Storage and transport	-20 ... +60 °C (-4 ... +140 °F)
• Operation	
- Portrait assembly, front and wall mounting	0 ... 45 °C (32 ... 113 °F)
- Standard rail mounting	0 ... 55 °C (32 ... 131 °F)
<b>Weight, approx.</b>	2 kg (4.41 lb)
<b>Dimensions (W × H × D)</b>	262 × 142 × 47 mm (10.3 × 5.59 × 1.85 in)
<b>Approvals, according to</b>	
• USA	cULus
• Canada	cULus
• Australia	RCM (formerly C-Tick)
• Korea	KCC
• Russia, Belarus and Kazakhstan	EAC

### Selection and ordering data

Description	Article No.
<b>SIMOTION P320-4 E Motion Controller<sup>1)</sup></b> Processor: Intel Core i3, 2x1.6 GHz, 3 MB cache Internal memory: CFast External memory: CFast Operating system: Windows Embedded Standard 7 32 Bit	<b>6AU1320-4DE65-3AF0</b>
<b>SIMOTION P320-4 S Motion Controller<sup>1)</sup></b> Intel Core i7-3517UE 2x1.7 GHz, 4 MB cache Internal memory: SSD (Solid State Disk) External memory: CFast Operating system: Windows 7 Ultimate 32 Bit	<b>6AU1320-4DS66-3AG0</b>

### Accessories

Description	Article No.
<b>IsoPROFIBUS board</b> with 2 isochronous PROFIBUS interfaces	<b>6AU1390-0AA00-0AA1</b>
<b>SIMATIC IPC portrait assembly kit</b>	<b>6ES7648-1AA20-0YP0</b>
<b>SIMATIC IPC Image &amp; Partition Creator V3.3</b>	<b>6ES7648-6AA03-3YA0</b>
<b>SIMATIC IPC USB flash drive</b> 16 GB, USB 3.0, metal enclosure, bootable, SIMATIC IPC Image & Partition Creator 3.4 and SIMATIC IPC BIOS Manager V3.3 (Win PE) preinstalled, incl. CD	<b>6AV7672-8JD02-0AA0</b>
<b>Spare parts</b> Motherboard battery	<b>A5E30314053</b>

### More information

#### SIZER for Siemens Drives engineering tool

With the SIZER for Siemens Drives engineering tool, you can easily configure, for example, the SINAMICS S120 drive family, including SIMOTION. This tool supports you with the engineering of components for a Motion Control task. You can also determine the possible number of axes and the resulting utilization with SIZER for Siemens Drives in accordance with your performance requirements.

For more information about SIZER for Siemens Drives, refer to the Lifecycle Services section.

#### More information

- about suitable I/O modules for SIMOTION can be found in section SIMOTION system components/I/O components.
- about the functionality of SIMOTION platforms can be found in section Overview of SIMOTION functions.
- about engineering and the SIMOTION runtime system can be found in section SIMOTION software.
- about operator control and monitoring can be found in section SIMOTION system components/HMI devices.
- about SIMATIC NET communication software can be found in section SIMOTION runtime software.

<sup>1)</sup> Note about licenses for runtime software:  
Licenses for runtime software can be ordered individually or by means of order code (Z option) for SIMOTION P320-4. See Ordering of licenses for runtime software.

### Overview



SIMOTION C is the controller variant of the SIMOTION family with the proven design of the SIMATIC S7-300. Flexible modular expansion of SIMOTION C is possible thanks to use of the SIMATIC S7 module spectrum. The SIMOTION C240 and C240 PN designs represent two powerful Motion Controllers for advanced control and Motion Control tasks. Although the two SIMOTION C240 and SIMOTION C240 PN controller versions have the same PLC and Motion Control performance, they do not have the same interfaces.

Depending on the SIMOTION C platform, HMI devices can be operated directly on the onboard PROFIBUS, Ethernet or PROFINET interfaces for operator control and monitoring. These interfaces also support functions such as remote maintenance, diagnostics and teleservice.

### Benefits

- Flexible application thanks to use of the SIMATIC S7-300 module spectrum and thus optimal adaptation to the automation task
- For universal use with digital and analog coupling to servo/vector, stepper and hydraulic drives (depending on the variant)
- User-friendly mounting and simple design with no moving parts
- Versatile networking through onboard PROFIBUS DP, Industrial Ethernet and PROFINET IO interfaces
- Powerful thanks to a range of integrated functions
- Easy engineering for open-loop control and Motion Control applications in the same program

### Application

#### **SIMOTION C can be used wherever:**

- Motion Control, technology and control functionalities are to be programmed, configured and executed as a unit
- a modularly expandable device is to be placed near or in the machine
- communication with other programmable controllers is necessary

SIMOTION C is universally applicable and meets the highest standards with respect to suitability for industrial use, thanks to high EMC compatibility and resistance against shock and vibration loads.

#### **Important applications include:**

- Packaging machines
- Plastic and rubber processing machines
- Presses, wire-drawing machines
- Textile machines
- Printing machines
- Wood, glass, ceramics and stone working machines
- Retrofit

Due to the increasing use of servo drives, these machines require a high degree of integration of PLC, Motion Control and technology functions.

### Design

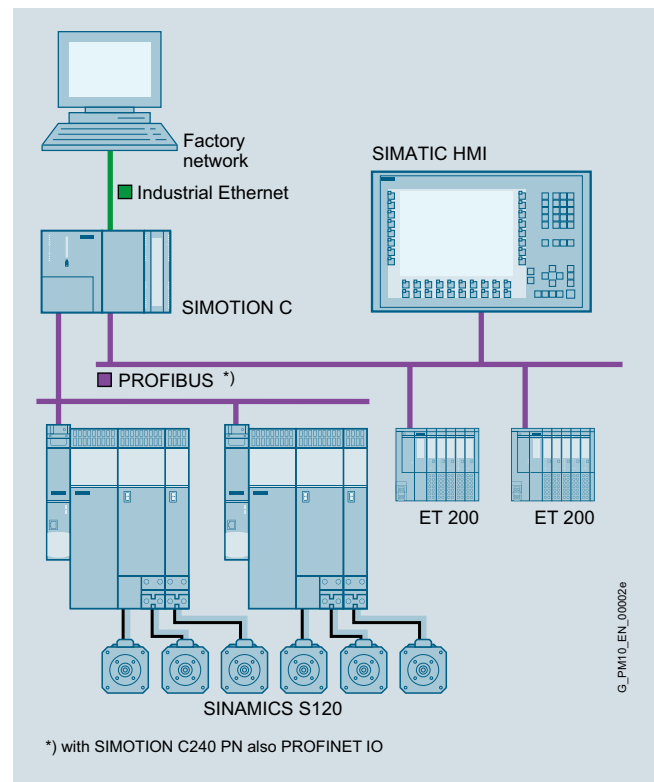

SIMOTION C with central and distributed I/Os

The SIMOTION C Motion Control System is modular in design. It consists of a comprehensive and individually combinable hardware spectrum that uses components of the SIMATIC S7-300 series and Siemens drive technology.

## SIMOTION Motion Control System

### SIMOTION C – Controller-based

#### SIMOTION C240/240 PN Motion Controller

#### Design (continued)

##### Components and interfaces of the SIMOTION C Motion Controller:

- Analog drive interfaces (for C240)
  - For setpoint outputs to servo/vector drives
  - For setpoint outputs to the actuating valves of hydraulic drives
  - As analog outputs for optional use
- Pulse outputs for controlling stepper drives (for C240)
- Interfaces for incremental/absolute encoders for cyclic acquisition of an actual position value or as freely assignable up/down counter (for C240)
- Onboard I/O for high-speed I/O signals
- SIMOTION Micro Memory Card (MMC) for storing:
  - SIMOTION Kernel
  - User programs
  - User variables
- Integrated communications interfaces for linking:
  - Distributed I/Os
  - HMI systems
  - PG/PC
  - Other Motion Control and automation systems
  - Drives with digital setpoint interface
- Various status/error displays and mode selectors

##### The following components make up a SIMOTION C system:

- Motion Controller and Micro Memory Card (MMC)
- Other system components (depending on requirements) such as:
  - Load power supplies (PS) for connecting SIMOTION C to a power supply of 120 V/230 V AC
  - Central (not onboard) and distributed I/O components
  - Servo/vector drives with analog or digital setpoint interface or stepper drives

##### Mounting and connection technology

Its simple design makes SIMOTION C flexible and easy to maintain:

- Rail mounting  
Simply attach the module to the standard mounting rail, swing it in and screw it tight.
- Integrated backplane bus  
The backplane bus is integrated in the Motion Controller. The Motion Controller is connected to the I/O modules via bus connectors which are plugged into the rear of the housing.
- The front connector coding prevents front connectors from being plugged into the wrong module type.
- Screw-type terminals or spring-loaded terminals for I/O modules
- TOP connect  
This connection method provides pre-assembled wiring with 1 to 3-wire connection systems with screw-type or spring-loaded terminals as an alternative to wiring directly on the I/O module.
- This system uses a defined mounting depth since all connections and connectors are recessed in the module and are protected and covered by doors on the front.
- No slot rules.

##### Expansion with central I/O modules

Up to 8 slots can be used to the right of the Motion Controller in the SIMOTION device for SIMATIC S7-300 I/O modules.

The IM 365 can be used to connect an expansion rack (two-tier design) to increase the number of slots available for I/O modules from 8 to 16 (including a maximum total of 4 analog modules). Multi-tier configuration with IM 360/IM 361 is not supported by SIMOTION C.

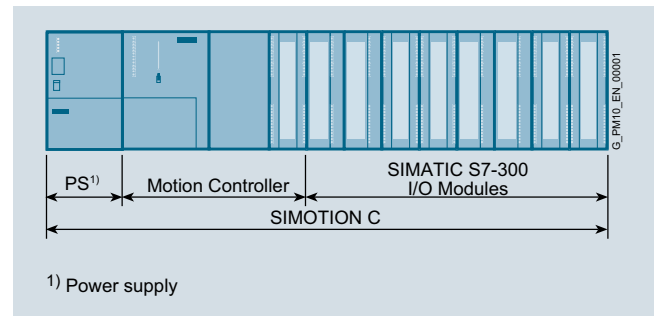

SIMOTION C can be mounted horizontally or vertically.

If additional I/O modules are required, the distributed SIMATIC ET 200 I/Os can be connected to a SIMOTION C via PROFIBUS DP or PROFINET IO (for C240 PN).

The number of pluggable I/O modules is also limited by the power required from the backplane bus. The power consumption of all modules which are connected to the same backplane bus must not exceed 1.2 A.

##### Expansion using distributed I/Os

The following can be used as distributed I/O components:

- PROFIBUS DP:
  - All certified standard PROFIBUS slaves (DP-V0, DP-V1, DP-V2)
  - SIMATIC ET 200S/SP/M/MP/eco/pro/AL distributed I/O systems
  - SINAMICS S120 servo converters over PROFIBUS DP interface with PROFIdrive
  - Stepper drives over PROFIBUS DP interface with PROFIdrive
- PROFINET IO (C240 PN):
  - SIMATIC ET 200S/SP/M/MP/pro/eco PN/AL distributed I/O systems
  - SINAMICS S120 servo converters over PROFINET IO with IRT (PROFIdrive)

### Design (continued)

#### Interfaces

##### Operation, display and diagnostics

- 1 × mode selector
- 1 × LED strip for fault and status indicators

##### Onboard I/O

- 18 digital inputs  
(C240: of which 2 for local measuring inputs and 4 for global measuring inputs/zero marks, C240 PN: of which 4 for global measuring inputs)
- 8 digital outputs

##### Drive interfaces (C240)

- 1 × setpoint output interface for up to 4 axes (optionally for analog, stepper or hydraulic drives; also usable as freely assignable analog outputs)
- 4 × encoder inputs for incremental or absolute encoders (can also be used as freely assignable up/down counters)

##### Communication

- 1 × interface for Industrial Ethernet
- 2 × interfaces for PROFIBUS DP  
(of which one interface is for MPI)
- 1 × interface (3 ports) for PROFINET IO (C240 PN)

##### Data backup

- 1 × slot for SIMOTION Micro Memory Card (MMC)

##### Additional interfaces

- Power supply terminals

#### **Data storage/data backup**

The SIMOTION C Motion Controller has an integrated non-volatile data memory for storing process variables.

The data is backed up on a SIMOTION Micro Memory Card (MMC).

### Function

#### **Basic functionality**

SIMOTION C provides the following basic functionality for a wide variety of automation requirements:

- SIMOTION runtime system
  - User-programmable with several languages conforming to IEC 61131
  - Various methods of program execution (cyclic, sequential, event-driven)
  - PLC and arithmetic functionality
  - Communication and management functions
  - Motion Control functions (Motion Control Basic)
- Testing and diagnostic interfaces

This basic functionality can be expanded with loadable technology packages, if required.

#### **SIMOTION technology packages**

A special feature of SIMOTION is that the operating system functionality can be expanded by loading technology packages, such as:

- Motion Control with the functions:
  - POS – Positioning
  - GEAR – Synchronous operation/electronic gear
  - CAM – Cam
  - PATH - Path interpolation
- TControl – Temperature controller
- MIIF – Multipurpose Information Interface
- Vibration Extinction (VIBX)
- OACAMGEN

Since the technology functions have modular licenses, you only pay for what you use.

#### **Configuring/parameterizing/programming**

SIMOTION SCOUT is a powerful and user-friendly engineering tool. It is an integrated system for all engineering steps, from configuring and parameterization, through programming, to testing and diagnostics. Graphical operator prompting, using dialog boxes and wizards, as well as text-based and graphical languages for programming, considerably reduce the familiarization and training periods.

#### **Operator control and monitoring (HMI)**

Communication utilities which support user-friendly data exchange with HMI devices are integrated in the basic functionality of the SIMOTION C Controller. The HMI devices can be connected to a SIMOTION C via Industrial Ethernet, PROFIBUS or PROFINET (for C240 PN). They are configured by means of SIMATIC WinCC (TIA Portal).

The SIMATIC NET communication software provides an open, standardized OPC interface for accessing SIMOTION from other Windows-based HMI systems.

SIMOTION IT provides SIMOTION C with an integrated web server on which, for example, user-specific web pages can be stored. Read and write access can be made to the Motion Controller variables. Java scripts or applets also allow the implementation of active operation and display functions in the web pages that can be executed on a client PC with an Internet browser.

# SIMOTION Motion Control System

## SIMOTION C – Controller-based

### SIMOTION C240/240 PN Motion Controller

#### Function (continued)

##### Process and data communication

Thanks to its integrated interfaces, SIMOTION C supports both process and data communication. The SIMOTION SCOUT engineering system is provided for user-friendly communication configuration and diagnostics.

##### Open-loop control and motion control functions

The open-loop control and motion control functions are executed centrally on the SIMOTION C controller.

The functionality ranges from simple positioning to complex motion control tasks over cams and interpolation.

##### Position-controlled motion control

###### Setpoint output/actual value acquisition

- Position control with analog setpoint output  
Per axis, the SIMOTION C240 Motion Controller provides one analog output for the speed setpoint and one encoder input for cyclic detection of the actual position value. In the case of hydraulic drives, the setpoint for the positioning valve is specified via the analog output.
- Position control with pulse direction output for stepper drives  
Per axis, the SIMOTION C240 Motion Controller provides one pulse output for the position setpoint. Stepper drives can either be operated without an encoder or be position-controlled with an encoder.
- Position control with digital setpoint output  
The PROFIBUS DP interface with PROFIdrive or the PROFINET interface for the C240 PN is available for this purpose. The actual position value is retrieved and the speed setpoint output over PROFIBUS DP or PROFINET.
- Position control with mixed setpoint output  
Analog, stepper and PROFIBUS drives can be used in a mixed configuration on the SIMOTION C240 Motion Controller. The channels of the 4 onboard interfaces can be used for analog, stepper or hydraulic drives. PROFIBUS and PROFINET drives can be operated as a mixed configuration with the C240 PN.
- Incremental position sensing (C240)  
Incremental encoders supply counter pulses for the traversed distance in accordance with their resolution. It is usually necessary to search for homing references. The following can be used:
  - Rotary encoders
  - Translatory encoders (length dimensions)
- Absolute position sensing (C240)  
Absolute encoders with a serial interface (SSI absolute encoders) can be used. It is not necessary to search for homing references.
- Position control/position sensing via ADI 4 or IM 174  
The ADI 4 (Analog Drive Interface for 4 Axes) or IM 174 (Interface Module for 4 Axes) module can be used to connect drives with an analog setpoint interface. The IM 174 also makes it possible to connect stepper drives with a pulse direction interface. Both modules are connected over PROFIBUS DP. The following can be connected to one ADI 4 or IM 174 module:
  - 4 drives
  - 4 encoders
  - Digital inputs and outputs
- Isochronous PROFIBUS encoder

#### Integration

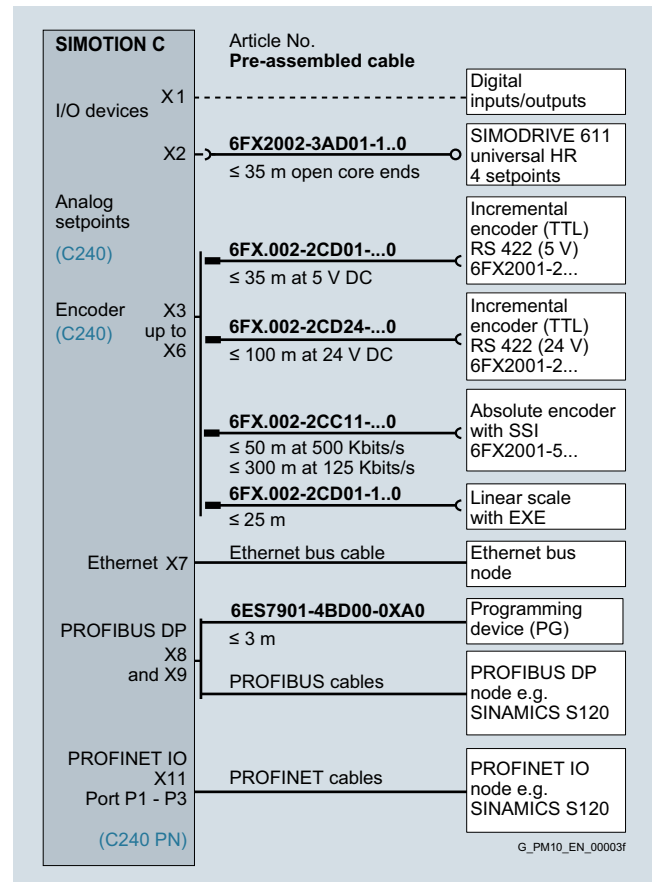

##### Overview of SIMOTION C connections

When dimensioning cables, you must always observe the maximum permissible cable lengths.

If these maximum lengths are exceeded, malfunctions can occur.

The permissible length of PROFIBUS DP cables depends on the configuration.

For information about MOTION-CONNECT connections, see [More information on page 2/51](#).



### Technical specifications

PLC and Motion Control performance	
Maximum number of axes	32
Minimum PROFIBUS cycle clock	1 ms
Minimum PROFINET send cycle clock (C240 PN only)	0.5 ms
Minimum servo/interpolator clock cycle	0.5 ms
Memory	
RAM (Random Access Memory)	67 MB
RAM disk (load memory)	29 MB
Retentive memory	107 KB
Persistent memory (user data on MMC)	48 MB
Communication	
Ethernet interfaces	1
PROFIBUS interfaces	2
PROFINET interfaces (C240 PN only)	<ul style="list-style-type: none"> <li>• 1 interface with 3 ports</li> <li>• Supports PROFINET IO with IRT and RT</li> <li>• Can be configured as PROFINET IO controller and/or device</li> </ul>
General technical specifications	
<b>Supply voltage</b>	
• Rated value	24 V DC
• Permissible range	20.4 ... 28.8 V
<b>Current consumption, typ.</b>	1.2 A
<b>Inrush current, typ.</b>	8.0 A
<b>Power loss</b>	15 W
<b>Permissible ambient temperature</b>	
• Storage and transport	-40 ... +70 °C (-40 ... +158 °F)
• Operation	0 ... 55 °C (32 ... 131 °F)
<b>Permissible relative humidity (without condensation)</b>	5 ... 95 %
<b>Atmospheric pressure</b>	700 ... 1060 hPa
<b>Degree of protection acc. to EN 60529 (IEC 60529)</b>	IP20
<b>Dimensions (W x H x D)</b>	200 x 125 x 118 mm (7.87 x 4.92 x 4.65 in)
<b>Weight</b>	
• SIMOTION C2xx	1150 g (2.54 lb)
• Memory card	16 g (0.56 oz)
<b>Relay outputs</b>	<b>5 (C240)</b> <b>1 (C240 PN)</b>
of which for	
• Controller enable (C240 only)	4
• READY	1
<b>Electrical specifications</b>	
• Operational voltage, max.	50 V DC
• Max. switching current	1 A
• Switching capacity, max.	30 W
<b>Operating cycles</b>	
• at 24 V, 1 A	3 x 10 <sup>6</sup>

PLC and Motion Control performance (continued)	
<b>Drive interfaces (C240 only)</b>	<b>4</b>
Can be optionally used for analog, stepper or hydraulic drives, alternatively also as standard analog outputs	
When used as an analog output	
• Voltage range	± 10.5 V
• Resolution	16 bit, including sign
• Galvanic isolation	No
• Load impedance	≥ 3 kOhm
• Cable length, max.	35 m (115 ft)
When used as a pulse output for stepper drives	
• Output voltage for "1" signal, I <sub>O</sub> = -20 mA	3.7 V
• Output voltage for "0" signal, I <sub>O</sub> = 20 mA, max.	1 V
• Load resistance, min.	55 Ω
• Cable length, max.	50 m (164 ft)
• Max. pulse frequency	750 kHz
<b>Integrated digital inputs</b>	<b>18</b>
of which with special functions for:	
• Measuring input (C240 only)	2
• BERO connection (can also be used as measuring input with C240, can only be used as measuring input with C240 PN)	4
(all inputs can be used as standard inputs)	
<b>Input voltage</b>	
• Rated value	24 V DC
• For "1" signal	11 ... 30 V
• For signal "0"	-3 ... +5 V
<b>Galvanic isolation</b>	
• Inputs in groups of	18
<b>Input current</b>	
• For signal "1", min. / typ.	6 mA/8 mA
<b>Input delay (at rated value of input voltage)</b>	
• 0 → 1, typ./max.	6 μs/15 μs
• 1 → 0, typ./max.	40 μs/150 μs
<b>Connection of 2-wire BERO</b>	Yes
• Permitted quiescent current	2 mA
<b>Integrated digital outputs</b>	<b>8</b>
• of which for fast cam output, max.	8
<b>Rated load voltage</b>	24 V DC
• Permissible range	20.4 ... 28.8 V
<b>Output voltage</b>	
• For signal "1", max.	L+
<b>Galvanic isolation in groups of</b>	8
<b>Output current</b>	
• For signal "1", minimum current per channel	5 mA
• For signal "0", max.	0.5 mA
<b>Residual current, max.</b>	2 mA
<b>Derated loading</b>	
• at 40 °C (104 °F)	4 A
• at 55 °C (131 °F)	2 A
<b>Switching frequency of the outputs</b>	
• With resistive load	100 Hz
• With inductive load	2 Hz

# SIMOTION Motion Control System

## SIMOTION C – Controller-based

### SIMOTION C240/240 PN Motion Controller

#### Technical specifications (continued)

PLC and Motion Control performance (continued)	
Lamp load	5 W
Purge energy/channel	400 mJ (not simultaneous)
Output delay, typ.	150 µs
Short-circuit protection	Yes
Encoder inputs, max. (C240 only)	4
Optionally for incremental or absolute encoder Can be used alternatively as up/down counter	
Incremental encoder inputs	
• Interface type (RS 422)	5 V
• Encoder power supply	5 V/0.3 A
• Galvanic isolation	No
• Encoder frequency, max.	1 MHz
• Cable length, max.	
- at 1 MHz	10 m (32 ft)
- at 500 kHz and 300 mA	25 m (82 ft)
- at 500 kHz and 210 mA	35 m (115 ft)

PLC and Motion Control performance (continued)	
Inputs, SSI absolute encoder	
• Interface type (RS 422)	5 V synchronous serial, single- or multi-turn
• Encoder power supply	24 V/0.3 A
• Galvanic isolation	No
• Transfer rate	187.5/375/750/1500 kbit/s
• Message length, max.	25 bit
• Cable length, max.	
- at 187.5 kbit/s	250 m (820 ft)
- at 1500 kbit/s	10 m (32.8 ft)
Monitoring	
• Short-circuit of the sensor supply	Yes
• Wire break	Yes
Additional technical specifications	
Real-time clock buffering	
• Buffer time, typ.	4 weeks
• Charging time, typ.	1 h
Approvals, according to	
• USA	cULus
• Canada	cULus
• Australia	RCM (formerly C-Tick)
• Korea	KCC
• Russia, Belarus, Kazakhstan	EAC

#### Selection and ordering data

Description	Article No.
<b>SIMOTION C240 Motion Controller</b>	<b>6AU1240-1AA00-0AA0</b>
<b>SIMOTION C240 MultiAxes Bundle</b> Consists of 1 item each • SIMOTION C240 Motion Controller • Micro Memory Card (MMC) 64 MB with MultiAxes Package license for SIMOTION C	<b>6AU1240-1AA00-0CA0</b>
<b>SIMOTION C240 PN Motion Controller</b>	<b>6AU1240-1AB00-0AA0</b>
<b>SIMOTION C240 PN MultiAxes Bundle</b> Consists of 1 item each • SIMOTION C240 PN Motion Controller • Micro Memory Card (MMC) 64 MB with MultiAxes Package license for SIMOTION C	<b>6AU1240-1AB00-0CA0</b>
<b>Micro Memory Card (MMC) 64 MB</b> for SIMOTION C240/C240 PN Pre-installed license can be obtained using additional order codes <sup>1)</sup>	<b>6AU1720-1KA00-0AA0</b>
<b>Micro Memory Card (MMC) 64 MB</b> for SIMOTION C240/C240 PN with MultiAxes Package license for SIMOTION C	<b>6AU1720-1KA00-0AA0-Z M24</b>

#### Accessories

Description	Article No.
<b>Accessories for SIMOTION C240/C240 PN</b>	
<b>Front connector 40-pin</b> for connection of onboard I/Os • With screw-type contacts • With spring-loaded contacts	<b>6ES7392-1AM00-0AA0</b> <b>6ES7392-1BM01-0AA0</b>
<b>Connecting comb PS – C2xx</b> for PS307 power supply	<b>6ES7390-7BA00-0AA0</b>
<b>IM 365 Interface Module</b> for expanding the Motion Controller with max. 1 expansion unit, 2 modules with permanent connecting cable (1 m (3.28 ft)) • Standard temperature range	<b>6ES7365-0BA01-0AA0</b>
<b>SIMATIC S7-300 mounting rail</b> • L = 160 mm (6.30 in) • L = 480 mm (18.9 in) • L = 530 mm (20.9 in) • L = 830 mm (32.7 in) • L = 2000 mm (78.7 in)	<b>6ES7390-1AB60-0AA0</b> <b>6ES7390-1AE80-0AA0</b> <b>6ES7390-1AF30-0AA0</b> <b>6ES7390-1AJ30-0AA0</b> <b>6ES7390-1BC00-0AA0</b>
<b>Accessories for PROFINET</b>	
<b>RJ45 FastConnect connector for Industrial Ethernet/PROFINET</b> • 145° cable outlet - 1 pack = 1 unit - 1 pack = 10 units	<b>6GK1901-1BB30-0AA0</b> <b>6GK1901-1BB30-0AB0</b>
<b>FastConnect cables for Industrial Ethernet/PROFINET <sup>2)</sup></b> • IE FC Standard Cable GP 2x2 • IE FC Flexible Cable GP 2x2 • IE FC Trailing Cable GP 2x2 • IE FC Trailing Cable 2x2 • IE FC Marine Cable 2x2	<b>6XV1840-2AH10</b> <b>6XV1870-2B</b> <b>6XV1870-2D</b> <b>6XV1840-3AH10</b> <b>6XV1840-4AH10</b>
<b>Stripping tool for Industrial Ethernet/PROFINET FastConnect cables</b> • IE FC Stripping Tool	<b>6GK1901-1GA00</b>

<sup>1)</sup> See Ordering of licenses for runtime software.

<sup>2)</sup> Sold by the meter; max. length (depending on cable type) 1000 m (3281 ft) or 2000 m (6562 ft); minimum order 20 m (65.6 ft).

**More information**

More information

- about power supplies can be found in section SIMOTION system components/Power supplies.
- about I/O modules can be found in section SIMOTION system components/I/O components.
- about TOP connect can be found in the Industry Mall under Automation Technology/Automation Systems/System Cabling/Control Cabinets/SIMATIC TOP connect system cabling.
- about the functionality of SIMOTION platforms can be found in section Overview of SIMOTION functions.
- about runtime software and engineering software can be found in section SIMOTION software.
- about the communication functions of the Motion Controllers can be found in section SIMOTION runtime software.
- about operator control and monitoring can be found in section SIMOTION system components/HMI devices.
- about SIMATIC NET communication software can be found in section SIMOTION runtime software.
- about PROFIBUS DP, Industrial Ethernet and PROFINET can be found in Catalog IK PI and the Industry Mall under Automation Technology/Industrial Communication.

***SIZER for Siemens Drives engineering tool***

With the SIZER for Siemens Drives engineering tool, you can easily configure, for example, the SINAMICS S120 drive family, including SIMOTION. This tool supports you with the engineering of components for a Motion Control task. You can also determine the possible number of axes and the resulting utilization with SIZER for Siemens Drives in accordance with your performance requirements.

For more information about SIZER for Siemens Drives, refer to section Lifecycle Services.

***MOTION-CONNECT connection systems***

For more information about MOTION-CONNECT connection systems, refer to

- Catalog D 21.4
- Interactive Catalog CA 01, and
- The Internet at:  
[www.siemens.com/motion-connect](http://www.siemens.com/motion-connect)  
[www.siemens.com/industrymall](http://www.siemens.com/industrymall)

# SIMOTION Motion Control System

SIMOTION software

## Overview

### Overview

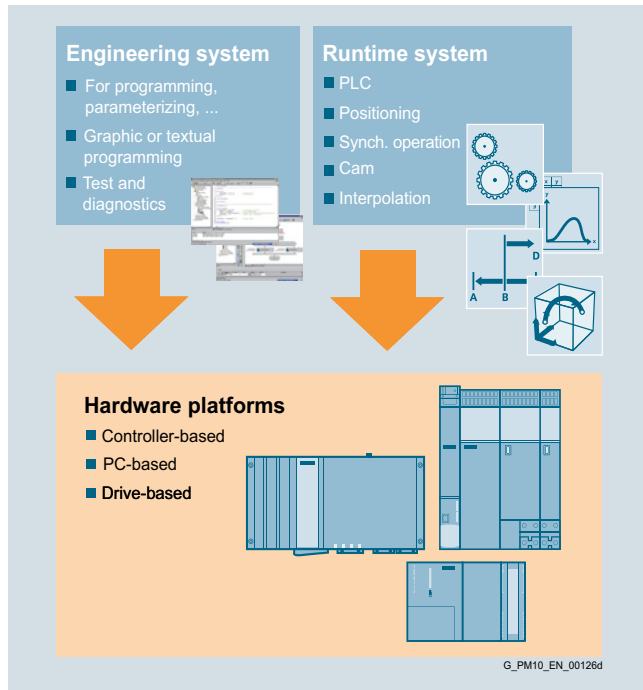

### **SIMOTION – The scalable system platform for Motion Control applications**

The SIMOTION system has created a scalable system platform for automation tasks, particularly Motion Control applications. The scalability of the system makes it possible to implement tailor-made and cost-effective applications. The modular SIMOTION software is perfectly integrated and offers easy-to-use functions for all phases of the automation process.

### **SIMOTION – Software for runtime, engineering and commissioning**

The software for SIMOTION is divided into the following categories:

#### Runtime software

SIMOTION Kernel – Basic functionality

The SIMOTION Kernel provides the basic functionality and is a component of all SIMOTION devices.

SIMOTION technology packages

The scope of functions can be modularly expanded by integrating SIMOTION technology packages.

SIMOTION IT – Web server functions for service and diagnostics  
Supports simple diagnostics, service or HMI applications without SIMOTION SCOUT.

#### Engineering software

- SIMOTION SCOUT engineering software (with integrated STARTER commissioning tool)
- Optional CamTool package (cam editor)
- Optional Drive Control Chart (DCC) package

The SIMOTION SCOUT engineering system provides high-performance tools that provide simple, optimal support for all engineering steps required in the context of machine automation. The SIMOTION CamTool is available as an optional package which permits simple creation of cams.

The optional Drive Control Chart package is available for easy graphical configuring of technology functions using predefined function blocks (Drive Control Blocks DCB) (not for SCOUT TIA – SIMOTION in the TIA Portal).

The SIMOTION SCOUT engineering system can be used in SIMATIC STEP 7 (with integrated data management and configuration), or as a stand-alone engineering tool. SIMOTION

SCOUT TIA (SIMOTION in the TIA Portal) can be used in the TIA Portal environment in version V13 and above and is included in the scope of supply of SCOUT.

### **Supplementary software**

In addition to the SIMOTION software, other standard software is available, for example, for easy programming of HMIs on Operator Panels/Touch Panels/Mobile Panels, as well as Panel PCs or PC systems.

### SIMATIC HMI software

With the SIMATIC WinCC (TIA Portal) and SIMATIC WinCC product families, SIMATIC HMI offers visualization and engineering software for the entire HMI spectrum.

See also Industry Mall under Automation Technology/Operator control and monitoring systems SIMATIC HMI/HMI Software/...

The currently available Comfort Panels and the Basic Panels (2nd generation) can be used as HMI panels for SIMOTION.

Three different possibilities are available for the HMI engineering:

- SIMATIC WinCC (TIA Portal - migration)

The entire system is configured in TIA Portal on the basis of SCOUT TIA and SIMATIC WinCC. For this purpose, a project created with SCOUT in the STEP 7 V5.5 environment is first migrated to TIA Portal. All subsequent configuration steps are then performed using the integrated engineering in the TIA Portal project.

- SIMATIC WinCC (TIA Portal - partial migration)

With partial migration, the SIMOTION CPU is configured, as before, using SCOUT in the STEP 7 V5.5 environment. The data relating to HMI is then supplied to a device proxy in TIA Portal, so that only the HMI configuration is performed in TIA Portal. The SIMOTION CPU is configured, as before, with SCOUT in the STEP 7 V5.5 environment. This requires SCOUT/SCOUT TIA V4.4 or higher and a SIMOTION C, P or D controller of version V4.3 or higher.

- SIMATIC NET for implementing HMI over OPC in Windows environments.

### SIMOTION Utilities & Applications

The SIMOTION Utilities & Applications DVD, which is available free of charge, supplements the SIMOTION software with a wide range of valuable information and tools for SIMOTION applications as well as SIMOTION easyProject.

The project generator SIMOTION easyProject enables basic and modular machine functions to be integrated into SCOUT engineering projects. The project generator is not currently available for SCOUT TIA (SIMOTION in the TIA Portal).

### **More information**

#### **Security information:**

Siemens provides products and solutions with industrial security functions that support the secure operation of plants, solutions, machines, devices, and/or networks. They are important components in a holistic industrial security concept. With this in mind, Siemens products and solutions undergo continuous development. Siemens recommends that you inform yourself regularly about product updates.

To ensure the secure operation of Siemens products and solutions, it is necessary to take suitable preventive measures (e.g. cell protection concept) and integrate each component into a state-of-the-art holistic industrial security concept. Third-party products that may be in use should also be considered. You will find more information about industrial security at [www.siemens.com/industrialsecurity](http://www.siemens.com/industrialsecurity)

To stay informed about product updates as they occur, sign up for our product-specific newsletter. Further information can be found at

<https://support.industry.siemens.com>

### Overview

SIMOTION provides suitable functions for all tasks in mechanical engineering applications.

The basis is a PLC in accordance with IEC 61131-3 for automation of the machine, e.g. for monitoring, sequential control, input/output processing, calculations, etc.

A scalable functionality is available for motion control, from cam controller to positioning, gearing and camming, up to 3D path interpolation for various handling kinematics. The functionality is rounded off by technological functions that are frequently required for production machines, e.g. a pressure regulator or temperature controller.

SIMOTION thus offers a comprehensive, scalable functionality with all the functions required for a production machine, from

basic single-axis to complex multi-axis applications, from low PLC performance to high PLC performance.

### **SIMOTION runtime structure**

The structure of the SIMOTION runtime system comprises multiple subcomponents that create tailor-made SIMOTION applications by virtue of their interaction.

- SIMOTION Kernel – Basic functionality
- Technology packages
- Function libraries
- User program

2

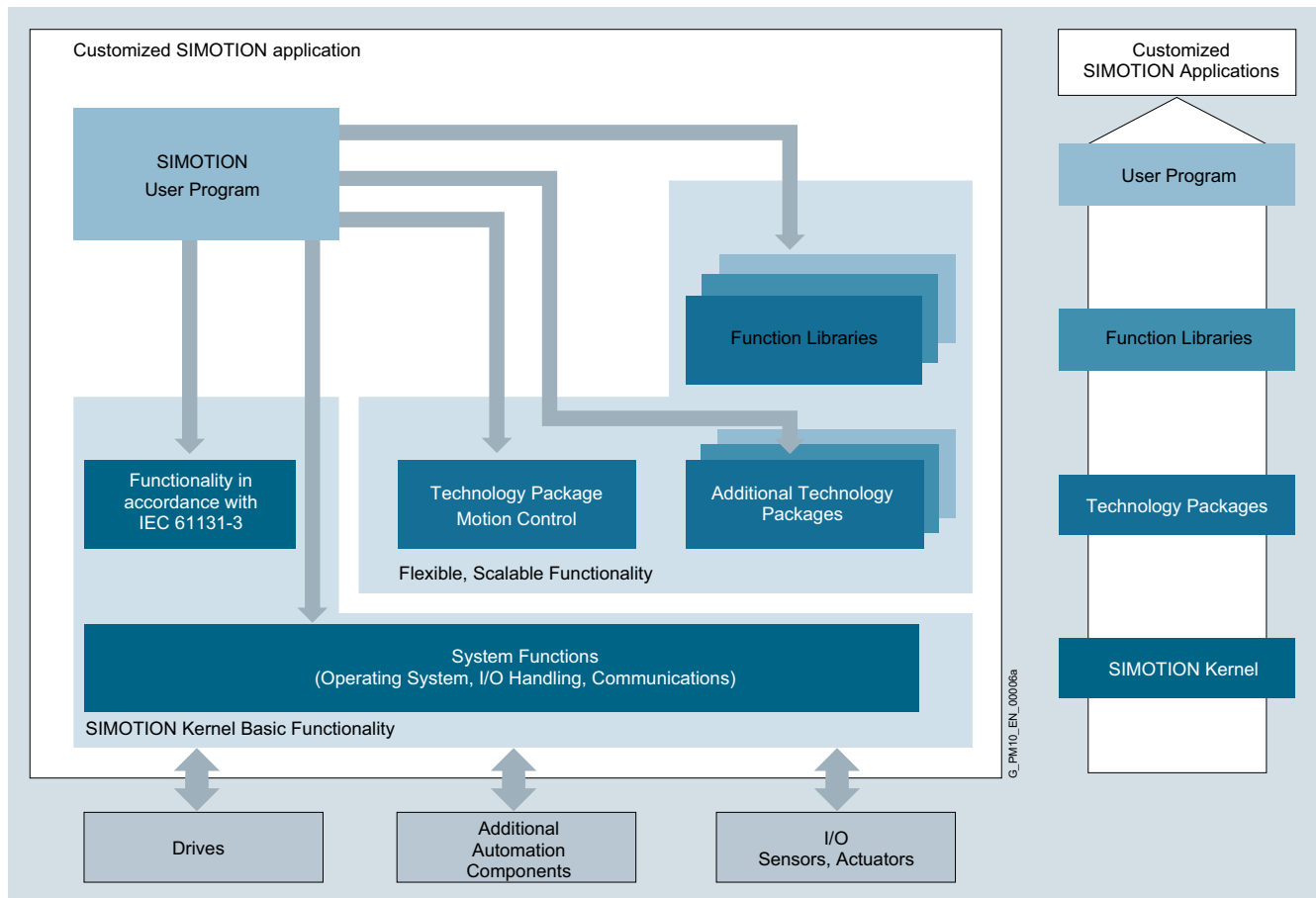

Software structure of a SIMOTION application

### **SIMOTION Kernel – Basic functionality**

The basic functionalities of the SIMOTION devices are combined within the SIMOTION Kernel.

The SIMOTION Kernel provides, among other features, high-performance functions for

- PLC functionality (to IEC 61131-3)
- Program control
- Timers, counters
- I/O operation
- Communication

It also provides a powerful runtime system with

- Cyclical (synchronized and cyclic) tasks
- Sequential tasks
- Time-driven tasks
- Event-driven tasks

The scope of the language is compatible with the IEC 61131-3 standard and contains all of the necessary PLC commands for I/O management, process or machine control. LAD (Ladder Diagram), FBD (Function Block Diagram), ST (Structured Text), MCC (Motion Control Chart) and DCC (Drive Control Chart) are used for programming.

The SIMOTION Kernel basic functionality can be expanded by loading SIMOTION technology packages.

# SIMOTION Motion Control System

## SIMOTION runtime software

### Overview

#### Overview (continued)

##### **SIMOTION technology packages**

SIMOTION technology packages combine software functions which are required for automation in mechanical engineering in a very wide variety of sectors. They are loaded into the controller during configuration and expand the basic functionality through additional system functions. The functions of the technology packages can be accessed in the SCOUT command library during engineering.

The technology packages enable the generation of technological objects, e.g. technology object "positioning axis", which are all set up, configured and parameterized by the same method.

##### **Motion Control technology package**

The comprehensive Motion Control functions in this technology package offer very open and flexible ways of programming applications and provide users with the assurance that they can implement even complex Motion Control applications.

The SIMOTION Motion Control technology package contains the following functions:

- Motion Control Basic
- POS – Positioning
- GEAR – Synchronous operation/electronic gear
- CAM – Cam
- PATH - Path interpolation
- Supplementary technology functions

The technology object functions in the technology package are accessed via additional language commands and system variables, as well as with function blocks in accordance with PLCopen. Programming of motion sequences is therefore simple and integrated.

##### **Technology package for temperature control (TControl)**

The SIMOTION technology package for temperature control provides temperature channels with extensive functions. These functions are also accessed via additional language commands and system variables.

##### **Technology package for Drive Control Chart (DCC)**

The SIMOTION technology package for Drive Control Chart (DCC) provides a library of "Drive Control Blocks" (DCBs). These blocks can be used to graphically configure open and closed-loop control functions using an optional DCC editor that can be integrated into SCOUT. DCC is not available for SCOUT TIA (SIMOTION in the TIA Portal).

##### **Multipurpose Information Interface (MIIF) technology package**

The SIMOTION technology package MIIF functions as a server to permit symbolic access to SIMOTION data and makes them available to clients (e.g. operator panel) via Ethernet.

##### **Vibration extinction (VIBX) technology package**

The SIMOTION technology package VIBX provides vibration damping functionality in the form of a setpoint filter that is applied to SIMOTION axes.

##### **OACAMGEN technology package**

The SIMOTION technology package OACAMGEN can be used to calculate motion profiles and dimension drives for servo presses.

##### **SIMOTION function libraries for I/O interfacing**

These function libraries contain standard functions for integrating intelligent I/O and communication modules. They are a component part of the SCOUT command library and make it extremely easy to integrate modules such as FM 350-1/-2, FM 352, CP 340/341, SIWAREX FTA or identification systems into the SIMOTION user program. Programming examples and standard applications are also available in the SIMOTION Utilities & Applications. The SIMOTION Utilities & Applications are supplied free of charge with SCOUT.

##### **SIMOTION function libraries for technological functions**

Designed on the basis of the functions from the Motion Control technology package, a large number of additional standardized, sector-specific technology functions (winder and unwinder functions, for example) are also available.

##### **SIMOTION user program**

In the SIMOTION user program, the functions of the technology packages, function libraries and functions of the SIMOTION Kernel are accessed in a uniform manner by means of language commands.

The structure of the SIMOTION application program therefore supports merging of PLC functions with Motion Control functions and technology functions. This simplifies the optimization of motion sequences (no PLC/Motion interface), reducing engineering costs and increases both product quality and machine productivity (machine cycle and output) by eliminating interfaces and dead times.

A SIMOTION application can be programmed in different ways:

- The graphical programming languages LAD (Ladder Diagram), FBD (Function Block Diagram) and MCC (Motion Control Chart) make graphical programming particularly user-friendly.
- Programming can also be performed textually using Structured Text (ST).
- Using the optional technology package for Drive Control Chart (DCC), drive-based open and closed-loop control functions can be easily configured graphically (not for SIMOTION in the TIA Portal).

Deep integration of SINAMICS drives allows:

- Easy symbolic assignment of the drives (power units and encoders), e.g. to a positioning axis
- Easy symbolic utilization of the drive peripherals (I/Os, cams, probes)
- Automatic comparison of all relevant characteristic variables of the complete drive train
- Increased uniformity as far as the drive (access to control/status words and drive data, flexible torque limits, additive torque setpoint)
- Highly-dynamic applications with servo drives thanks to DSC (Dynamic Servo Control) allows position control cycles of 125  $\mu$ s
- Highly dynamic applications with hydraulic drives with position control cycles and pressure/force control cycles of 250  $\mu$ s (SIMOTION D455-2 DP/PN with SCOUT TIA: minimum 125  $\mu$ s)
- Synchronization with drives and modular open-loop controls

### Overview (continued)

Apart from electrical drives, hydraulic drives within a controller or distributed over several controllers can be synchronized with each other. This supports the implementation of integrated automation solutions such as conveyor systems and press lines in the automotive industry, in which both electrical drives (winders, cross cutters, roller feeds) and hydraulic drives (e.g. deep-drawing presses) are implemented in the same system.

The project generator SIMOTION easyProject enables basic and modular machine functions to be integrated into SCOUT engineering projects. The project generator is not currently available for SCOUT TIA (SIMOTION in the TIA Portal).

#### **SIMOTION isochronous mode**

In the SIMOTION system, all the components (one or more control units, drives, isochronous I/Os) are synchronized to the communication cycle of the machine, the PROFINET/PROFIBUS DP cycle. The application is also synchronized with this cycle through synchronous application tasks (in the servo and interpolator cycle). Isochronous mode therefore permeates the whole machine application (also in the case of distributed systems) and this provides considerable advantages:

- Short response times from terminal to terminal and terminal to axis
- High machine cycle times
- Programming of synchronous closed-loop control tasks
- High product quality thanks to a deterministic and reproducible machine response

#### **Modular concepts – Modular machines**

SIMOTION supports modular machine concepts and thus reduces engineering and commissioning costs through:

- Modular software development with libraries and reusable modules,
- Division into individual machine modules, which are linked, for example, through distributed synchronous operation (over PROFINET IO with IRT or PROFIBUS DP),
- Reconfiguration of a project during runtime, e.g. via HMI.
- Activation/deactivation of PROFINET IO devices/DP slaves (I/O components) and technology objects (axes, drives, external encoders, probes and cams) during engineering and at runtime.
- Easy, modular configuration of projects using the project generator SIMOTION easyProject.

The modular machine concept means that scalable solutions and large axis line-ups can be achieved. Standardized modules can be easily adapted to special requirements and separately tested. These modules are then easily combined to form individual machine variants.

#### **Communication using Ethernet/PROFINET**

The following communication functions are available via Ethernet/PROFINET on all platforms:

- I/O communication between SIMOTION and/or SIMATIC controllers
- Communication with SIMOTION devices, SIMATIC CPUs and non-Siemens devices via UDP and TCP/IP
- Communication with programming devices (programming device functions)
- Communication with SIMATIC HMI devices
- Communication via OPC UA server to clients on any other devices
- Communication via the SCADA system WinCC
- Communication with PCs on which SIMATIC NET OPC is installed.  
A prerequisite on the PC side is the SIMATIC NET SOFTNET S7 software.

#### **Communication via PROFIBUS**

The communication functions are available via PROFIBUS on all platforms:

- I/O communication between SIMOTION and/or SIMATIC controllers
- Communication with programming devices (programming device functions)
- Communication with SIMATIC HMI devices
- Communication with PCs on which SIMATIC NET OPC is installed.  
A prerequisite on the PC side is the SIMATIC NET SOFTNET S7 software.

#### **SIMOTION IT**

SIMOTION IT enables additional communication functions via Industrial Ethernet:

- In-depth service and diagnostic functions without the need for a project and engineering system via the integrated standard web pages of SIMOTION IT
- Diagnostics, commissioning and operation via user-defined web applications
- Communication and application access to process values via OPC XML-DA
- SIMOTION IT Virtual Machine: Integration of individual Java applications into the integrated SIMOTION Java runtime environment, for parallel operation with automation functions.

# SIMOTION Motion Control System

SIMOTION runtime software

## SIMOTION Kernel

### Function

The SIMOTION Motion Control System uses high-performance CPUs on which a real-time operating system suitable for fast control processes is implemented.

This real-time operating system organizes an execution system comprising different execution levels.

#### Execution system

The SIMOTION execution system makes a distinction between system execution levels and user execution levels (tasks):

System tasks process operations that are necessary for general operation of the system. With technology objects, closed-loop position control and characteristic variable calculation is performed in the SERVO, IPO and IPO2 system tasks.

System tasks are regularly executed by the system. The system cycle clock can be specified.

Execution levels with different execution characteristics are available for task-related user programming (user program tasks).

The execution levels define the chronological sequence of programs in the execution system. Each execution level contains one or more tasks. The individual user programs are assigned to these tasks.

#### Task structure of a SIMOTION application

All programs – and thus also tasks – can execute PLC, technology and Motion Control tasks.

Task types for task-related execution are:

- Synchronous tasks
- Cyclic tasks
- Sequential tasks
- Time-triggered tasks, and
- Interrupt-driven tasks

Synchronous tasks are synchronized with the system tasks and the control cycle of the drives or the isochronous PROFINET/PROFIBUS.

With the help of these synchronous tasks, the whole application is in isochronous mode (user program ↔ Drives ↔ I/O). This results in short response times and the application is easily reproducible.

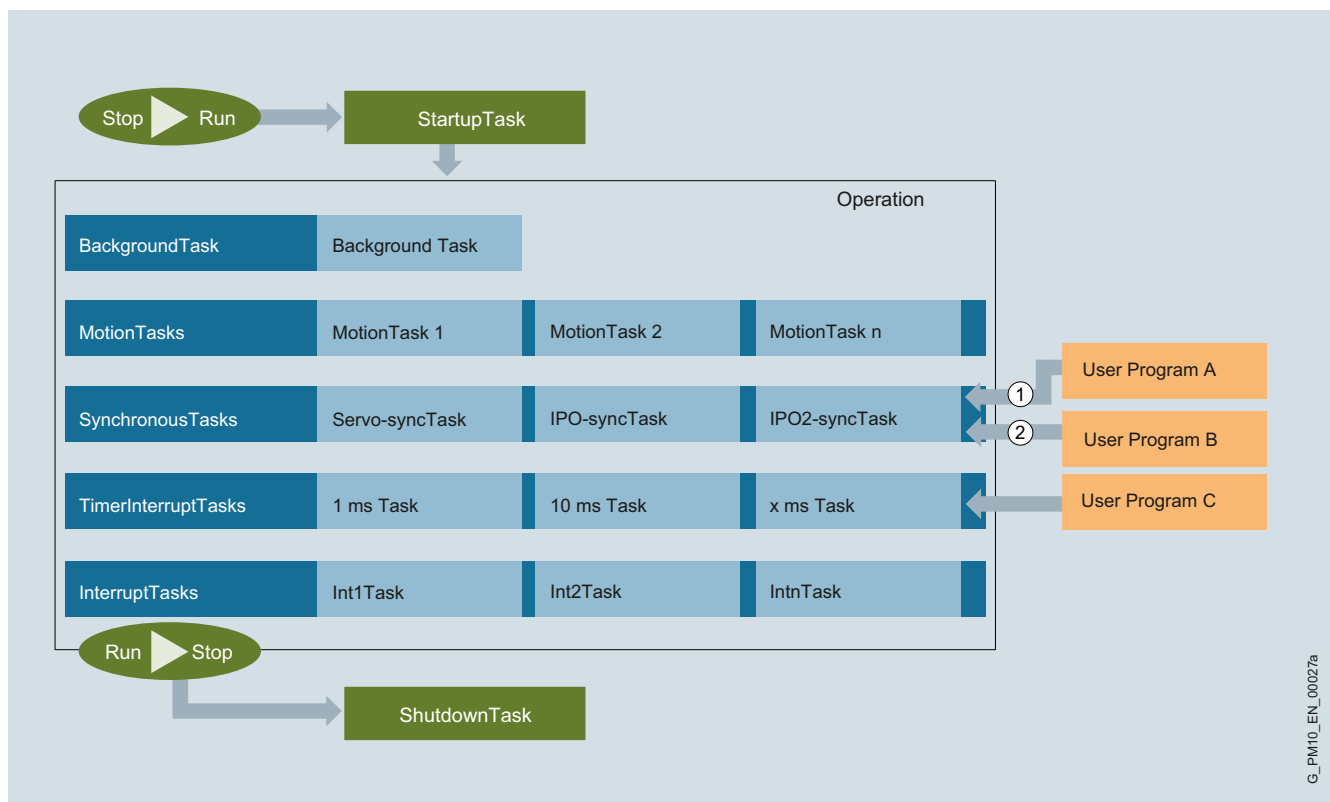

Task structure of a SIMOTION application

G\_PM10\_EN\_00027a



### Function (continued)

The following execution levels are available to the application:

#### **StartupTask**

The StartupTask is executed once at the operating mode transition from STOP to RUN; it controls the system start-up.

#### **BackgroundTask**

The BackgroundTask is executed cyclically and is used for general PLC tasks. Cycle time monitoring checks the maximum processing time of the BackgroundTask. The BackgroundTask can be compared with the OB1 of a SIMATIC controller.

#### **MotionTasks**

MotionTasks are used for motion sequences.

Command sequences in the same Motion Task are usually executed sequentially, for example, the next motion command is only started when the previous command has been completed.

The MotionTasks do not require any CPU time during these waiting times, but respond immediately on receipt of the wait event.

#### **SynchronousTasks**

In servo-synchronous user tasks, time-critical terminal-to-terminal responses for I/Os or fast influencing of setpoints can be implemented on the servo level (synchronous to the system cycle SERVO of the technology objects, e.g. position controllers).

The IPO synchronous user tasks are started synchronously immediately before the interpolator cycle IPO or the slower IPO2.

Fast Motion Control reactions can be implemented here, as well as closed-loop control tasks in which the acquisition of actual values and output of setpoints must be synchronized.

The characteristic variables for the technology objects are calculated in system cycles IPO and IPO2.

The user program is therefore synchronized with the control cycle of the drives and with I/O processing. Synchronization ensures short response times and, above all, deterministic and reproducible machine behavior.

#### **DCC tasks**

Drive Control Chart (option) uses the above-mentioned SynchronousTasks. In addition, further synchronous execution levels (special tasks for DCC) can be assigned to the blocks.

#### **TimerInterruptTasks**

Several time-triggered tasks are available. The call cycles can be parameterized. Periodically repeated tasks are normally placed here.

#### **InterruptTasks**

InterruptTasks are used for a fast response to internal events that are signaled using interrupts. InterruptTasks can be activated by system interrupts, such as alarms and timeouts, or by user interrupts.

#### **ShutdownTask**

The ShutdownTask is called when there is a transition to STOP mode. The specific behavior for the transition into this system state can be defined here.

The complete instruction set is available for all user tasks. This allows the current positioning command from a MotionTask to be superimposed with an additional movement which was triggered by a UserInterruptTask, for example.

#### **Runtime levels of the technology packages**

The execution cycle can be set object-specifically for Motion Control technology objects.

Technology objects are executed in the execution levels SERVO cycle and IPO cycle or IPO2 cycle that are synchronized with the PROFINET or PROFIBUS cycle.

- Command evaluation and motion control in the IPO/IPO2 cycle
- Position and setpoint control in the SERVO cycle
- IPO/IPO2 cycle can be reduced relative to the SERVO cycle to allow optimization of the system's performance to meet requirements.

The SIMOTION D435-2 DP/PN, D445-2 DP/PN and D455-2 DP/PN Control Units have an additional runtime level (SERVO<sub>Fast</sub>, IPO<sub>Fast</sub>).

This additional runtime level enables the performance of the controller to be utilized more efficiently. Electrical and/or hydraulic axes can be distributed over one slow and one fast bus system depending on the dynamic response required.

Electrical positioning drives, for example, can be controlled with cycle times in the millisecond range requiring fewer resources and, at the same time, the pressure-controlled axes of an hydraulic press can be controlled highly dynamically with short cycle times.

The runtime level (SERVO<sub>Fast</sub>, IPO<sub>Fast</sub>) also enables a particularly fast I/O processing in conjunction with, for example, high-speed PROFINET I/O modules.

#### **Further characteristics of the execution system**

- Operating states – Run, Stop, StopU (Stop User Program for test and commissioning functions)
- Process images for inputs/outputs, is separate for BackgroundTask, SynchronousTasks and TimerInterruptTasks
- Debug functions such as
  - Controlling and monitoring of variables
  - Display of the program status
  - Breakpoints and single step
  - Trace functions
- Kernel updates can be implemented with new SCOUT versions.

## SIMOTION Motion Control System

SIMOTION runtime software

### SIMOTION technology packages

#### Overview

##### Scope of functions scaled by technology packages

The SIMOTION technology packages expand the basic functionality of the SIMOTION devices with additional language commands which makes adaptation to the respective automation task easy.

The loadable technology packages support the creation of technology objects (e.g. positioning and synchronous axis, cam paths, external encoders) which can be accessed over system functions and system variables for use in every SIMOTION programming language.

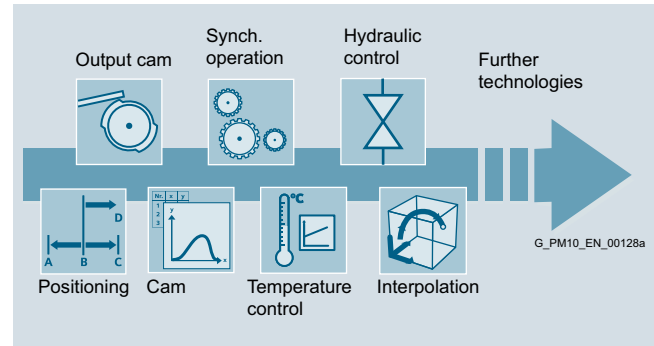

SIMOTION technology objects

#### Function

##### SIMOTION Motion Control technology package

The Motion Control Basic technology functions can be used without a license. Use of the extended functions of the Motion Control technology package is subject to a license.

The comprehensive functions of the Motion Control technology package offer very open and flexible ways of influencing application programming and ensure that you can also implement future Motion Control applications.

Using the Motion Control functions in conjunction with the powerful PLC functionality results in high machine cycles thanks to short response times as well as high product quality thanks to reproducible machine behavior.

##### Technology functions for Motion Control Basic

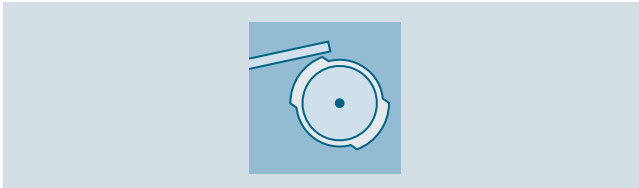

##### The speed-controlled axis technology object

- Speed setpoints are defined in the program (for servo and vector drives)
- In addition, accumulative torque setpoints and torque limits can be defined, for example, for controlling a winder drive with tension control
- Access to status and control words of the drive  
Release sequence of the PROFIdrive units can be specifically controlled (e.g. for braking control signal)
- Reading and writing of drive parameters

- Support for SINAMICS drives which can perform safety-related motion monitoring functions such as Safe Operating Stop (SOS), Safely Limited Speed (SLS), Safe Speed Monitor (SSM) and Safe Direction (SDI), safety-related position monitoring such as Safely Limited Position (SLP) and safe position transmission (SP) or safe stop reactions such as Safe Torque Off (STO), Safe Stop 1 (SS1), Safe Stop 2 (SS2). The purpose of this support is to prevent stop reactions by the drive, where SIMOTION uses the application to regulate the drive, e.g. within permissible velocity limits (with SLS) or stop the drive (e.g. with SOS).  
Activation and deactivation of SINAMICS Safety Integrated Extended Functions STO, SS1, SS2, SOS, SLS, SDI, SLP as well as their status are indicated on the axis by specific technology alarms and system variables.

Further information about SINAMICS Safety Integrated can be found in section Safety Integrated.

##### External encoder technology object

External encoders can be used to detect actual position values of axes (on PROFINET/PROFIBUS, onboard for C240 and as a 2nd encoder on the drive).

##### Cam and cam track technology object

- Generates position-dependent switching signals
- Number of cams and cam tracks depend on available system resources
- Each cam track can have up to 32 cams on one output

The following cam types are available:

- Trip cams
- Position-position cams
- Position-time cams
- Position-time-based cams with maximum ON length
- Counter cams
- Exact time setting of an output, exact time output cams

The cam statuses can be output with:

- Internal variables
- Standard digital outputs (SIMATIC ET 200SP, SIMATIC ET 200MP, ...)
- Onboard outputs of SIMOTION C, D and cam outputs on TM15, ET 200SP and ET 200MP TM Timer DIDQ (for high accuracy requirements in the  $\mu$ s range)
- The output can be inverted

**Function** (continued)

The following can be used as reference points for the switching edges of the cams:

- Setpoints for real and virtual axes
- Actual values of real axes and external encoders

The following functions are available:

- Parameterizable hysteresis and effective direction
- Activation and deactivation times can be specified separately (dead time compensation)
- One-time and cyclic output of cam paths
- Parameterizable start/stop mode for cam tracks (immediately, with next track cycle, etc.)
- The status of each individual cam (activated/deactivated) can be read
- Single output cams on a cam track can also be directly defined as valid/invalid

**Measuring input technology object**

Measuring inputs can be assigned to positioning and synchronous axes, external encoders or virtual axes and supply the axis position at the time of measuring.

The following functions are available:

- One-time measurement
- Cyclic measurement (2 edges per servo/IPO cycle in conjunction with measuring inputs on ET 200SP and ET 200MP TM Timer DIDQ or SIMOTION C240, D4x5-2)
- Measuring on virtual axes (in conjunction with measuring inputs on TM15, ET 200SP and ET 200MP TM Timer DIDQ, D4xx-2, CX32-2, CUxx or C240)
- Several active measuring inputs on one axis or one measuring input for several axes (in conjunction with measuring inputs on TM15, ET 200SP and ET 200MP TM Timer DIDQ, D4xx-2, CX32-2, CUxx or C240)
- Parameterizable edge evaluation (rising, falling, both edges)
- Dynamic resolution range

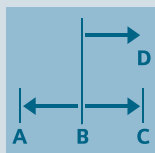
**POS – Positioning technology functions**

**The positioning axis technology object**

- Contains the functions of the drive axis technology object
- Supported axis types:
  - Linear axis, rotary axis
  - Modulo axis for linear and rotary axes
  - Real and virtual axis
  - Simulation axis
- Position control for:
  - Electrical drives
    - Position control with digital setpoint output:  
The following PROFINET/PROFIBUS DP protocol is used for this purpose: Drive technology profile, PROFIdrive, version 4 (isochronous mode)  
Highly dynamic movements can be programmed using Dynamic Servo Control (DSC and DSC with spline) in combination with the position control in the drive in a cycle of 125 µs, for example
    - Position control with analog setpoint output:  
Onboard I/Os for C240, ADI 4, IM 174
  - Hydraulic drives
    - Position control with analog setpoint output:  
Onboard I/Os for C240, ADI 4, IM 174, analog outputs in the I/O range, e.g. in combination with ET 200 High Speed I/Os  
The characteristics of the hydraulic valves are specified with cams
  - Stepper motors
    - Position control with pulse direction output for stepper drives:  
Onboard I/Os for C240, IM 174  
Alternatively, stepper drives can be linked with a PROFINET/PROFIBUS interface provided that they support the PROFIdrive profile. Stepper drives can be operated without an encoder or be position-controlled with an encoder.
- Position-controlled positioning:
  - Axes can be manipulated individually without interpolation context by specifying, for example:
    - Axis name
    - Position
    - Velocity
    - Acceleration/delay, jerk
    - Transition behavior to next motion
- Speed-controlled operation of positioning axes
- Monitoring and limiting (standstill, positioning, dynamic following error, standstill signal, controlled variables, hardware/software end positions, encoder limit frequency, velocity error, measuring system difference/slip, limits for the dynamic response)
- Reversing block (prevents the output of setpoints which would cause a reversing motion)
- Movement profiles on axis defined over cams:
  - Path over time
  - Velocity over time
  - Velocity over path
- Force and pressure control of an axis:
  - On-the-fly switchover from position to pressure-controlled operation and vice versa
  - Several pressure sensors possible
  - Pressure difference measurement
- Force and pressure limitation of an axis:
- Force and pressure profiles specifiable over cams:
  - For closed-loop control and limitation
  - Force/pressure over time
  - Force/pressure over path
- Traveling to a fixed stop point:
  - Stop on reaching a following error limit
  - Stop on reaching a torque limit
  - Stop with defined torque
- Traversing with additive torque, adjustable torque limiting and flexible torque limits B+/B-
- Transition behavior of successive motions:
  - attach, i.e. each motion is completed and the axis stops between motions (exact stop)
  - continuous move, i.e. the transition to the next motion begins when braking starts.
  - replace, i.e. the programmed motion is performed immediately. The active command is aborted.

## SIMOTION Motion Control System

### SIMOTION runtime software

#### SIMOTION technology packages

##### Function (continued)

- An additional motion can be performed during an active motion, for example, an active positioning motion can be performed simultaneously to a compensation motion.
- Concurrent start of positioning axes
- Homing:
 

The following homing types are currently supported:

  - Active homing (reference point approach)/passive homing (on-the-fly homing)
    - o With reference cam and encoder zero mark
    - o With external zero mark only
    - o With encoder zero mark only
    - o BERO proximity switch and hardware limit switch as reversing cam
    - o Hardware limit switch as reference cam
  - Direct homing / setting the home position
  - Relative direct homing (shift by specified offset)
  - Absolute encoder homing / absolute encoder calibration
- Compensations and reference points:
  - Reference point offset
  - Backlash compensation
  - Static friction compensation
  - Sliding friction compensation for hydraulics
  - Drift compensation for analog drives
- Print mark correction
- Encoder switchover:
 

Up to 8 encoders can be specified for an axis:

  - For the position control, only one encoder is active at any one time:
  - The switchover between encoders can be performed on-the-fly (with a change-over smoothing filter)..
  - The actual value of the non-active encoder can be read with the user program and used for specific monitoring, for example.
- Override:
  - Factors can be superimposed online on the current traverse velocity and acceleration/deceleration.

##### **GEAR – Synchronous operation/electronic gear technology functions**

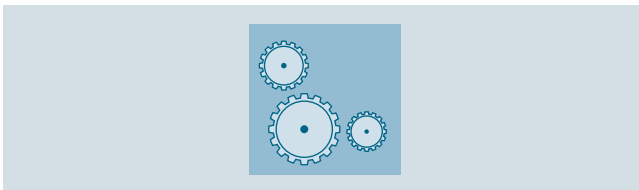

##### Synchronized axis technology object

- Contains the functions of the positioning axis technology object
  - Synchronized speed for position-controlled axes
  - Angular synchronization, electronic gear:
 

Stable, long-time angular synchronization over several axes is ensured. The gear ratio can be adjusted in small steps.
  - Absolute and relative gearbox synchronism
  - Offset of the following axis
- Leading axis:
 

The master value can be changed immediately between master value sources (transition dynamics must be specified). The following can be used as a leading axis or master value sources for the following axes:

    - Virtual axis:
 

The virtual axis only exists in the control and therefore does not have a real drive, motor or encoder. A virtual axis can be controlled with commands in the same way as a real axis. The motion control calculates the setpoints with the interpolator which can be used as a master value for synchronous operation, for example.
    - Real axis:
 

The real axis is a leading axis which is part of the SIMOTION system and can be coupled over a setpoint and actual value.
    - External encoder:
 

The actual value is detected with an external encoder and supplied as a master value after conditioning.
  - Setpoint value linkage as well as actual-value linkage with compensation of dead times.
  - Angular position and electronic gear ratio for axes can also be changed during operation.
  - Engaging/disengaging:
 

Following axes can be stopped for one cycle or moved for only one cycle to remove a faulty component, for example. This can be flexibly implemented with the programmable synchronism functionality.
  - Synchronization and desynchronization:
    - Following axes can be synchronized and desynchronized while the leading axis is in motion or standing still.
    - The synchronous position of the master value and the following axis can be specified.
  - Different synchronization modes are available:
    - Synchronization via a specifiable master value distance
    - Synchronization based on specifiable dynamic response parameters (jerk-limited)
    - Synchronizing position for synchronization and desynchronization at a precision position
    - Position of synchronizing range (before, after and symmetrically with synchronous position)
  - Terminating synchronized operation of/to positioning
  - Comprehensive synchronized operation monitoring functions
  - External synchronization:
 

Material slip can be corrected, for example, by flying measurement of, for example, a print-mark and a superimposed positioning function.
  - Simultaneous motion during synchronous operation:
 

A positioning motion or other synchronous operation can be performed during synchronous operation.
  - Distributed synchronous operation and the option to implement synchronous operation beyond device limits.
    - PROFIBUS: Leading axis to PROFIBUS master, following axes to PROFIBUS slaves.
    - PROFINET: Changeover possible between leading axes on different SIMOTION controllers. Cascading of the synchronous operations over several SIMOTION controllers.
    - Dead times are compensated automatically.
    - Also possible across different projects (independent projects)

**Function** (continued)

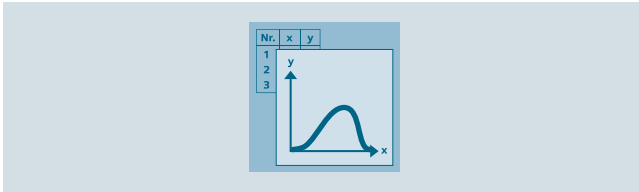
**CAM – Cam technology functions**

Cam technology object

- The number of cams depends on the available system resources
- The number of support points or segments per cam depends on the available system resources
- Cam functions:
  - Definition using table interpolation points or polynomials up to the 6th order with trigonometric component
  - Motion laws can be implemented in accordance with VDI 2143
  - Transition between support points/polynomials: Linear, continuous, spline

Technology object synchronous axis with camming

- Contains the functions of the synchronous axis technology object
- Scalability, cam functions can be offset and switched even during operation:
  - The leading and following axis positions of the cam functions can be scaled and offset during operation.
  - The active cam function can be defined and switched during operation.
- Non-cyclic and cyclic editing of cams
- Absolute and relative camming
- Absolute and relative master value referencing
- Synchronization and desynchronization (see synchronized axis technology object)
- Overriding of 2 synchronized cams
- Cams can be defined and modified with the SIMOTION SCOUT engineering system or with an application program during runtime.

**PATH – Path interpolation technology functions**

Path interpolation technology object

The path interpolation technology object is primarily intended for the automation of handling kinematics and features the following functions:

- Linear, circular and polynomial interpolation in 2D and 3D
- Transformation for standard kinematics
- Synchronization with conveyor belts (conveyor tracking)
- Dynamic planning across three traversing blocks
- The path dynamics (acceleration, jerk) are specified on the path, axis limits are generally applicable regardless of the path limits
- Continuous geometric movement between two traversing blocks
- Intuitive operation with SIMOTION SCOUT (path control panel for efficient traversing of the path axes, screens to support the calibration procedure of the coordinate system)
- Interconnection of a path object is possible with:
  - Up to 3 interpolating path axes
  - One positioning axis for path-synchronized motion
  - One cam for specifying velocity profiles
- Connection of path-based cams, cam tracks and measuring inputs over the positioning axis for path-synchronized motion
- Interconnection of the Cartesian path coordinates with positioning axes is possible. Cams, cam tracks and measuring inputs can also be implemented on the path
- Kinematic transformations for:
  - Swivel arm
  - SCARA L
  - Cartesian gantries (2D/3D)
  - Articulated arm (toploader)
  - Cylindrical robot
  - Roller pickers (2D/3D)
  - Delta pickers (2D/3D)
  - Spare transformation interface for customer-specific kinematics
- Programming in ST and MCC

A pre-configured standard application can be used for easy implementation of handling kinematics, which allows both jog mode and the creation of motion programs (see SIMOTION Utilities & Applications which is supplied with SIMOTION SCOUT).

## SIMOTION Motion Control System

SIMOTION runtime software

### SIMOTION technology packages

#### Function (continued)

#### Kinematics in the Motion Control technology package

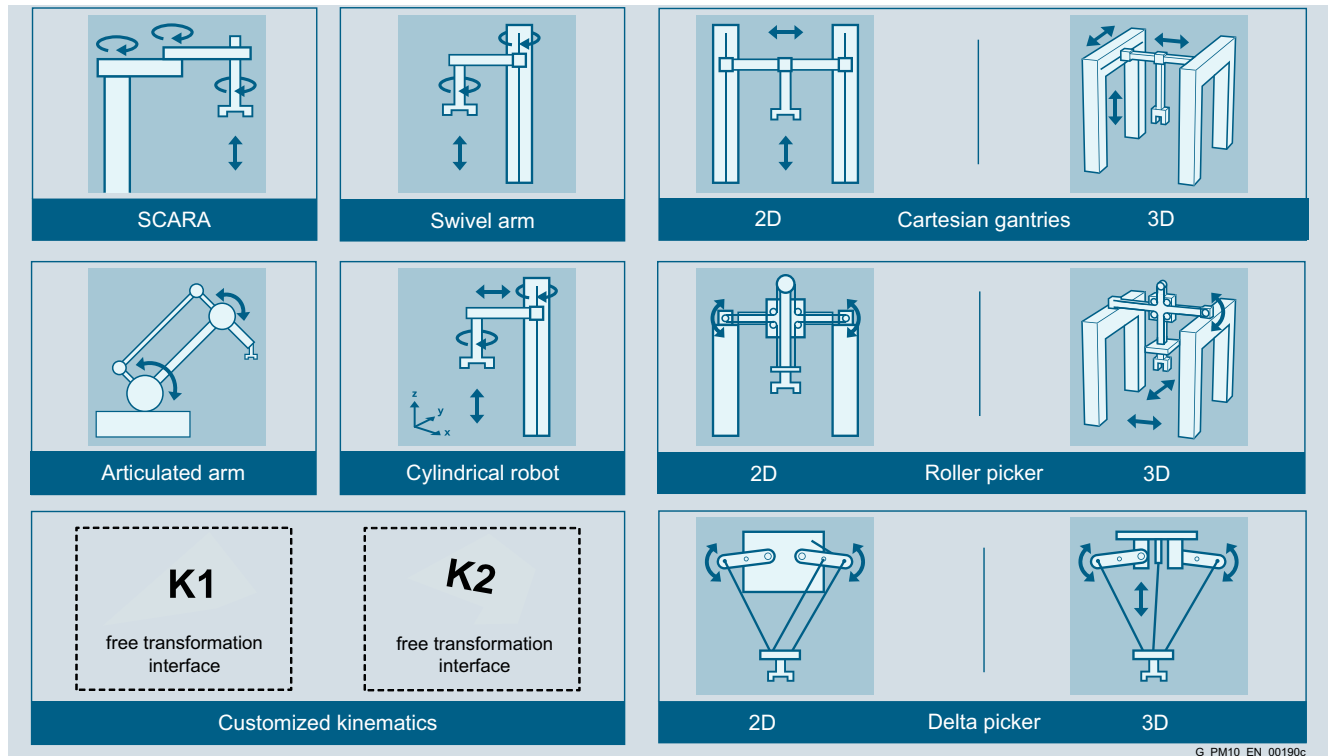

G\_PM10\_EN\_00190c

#### Kinematics in the Motion Control technology package

Interpolation in machines for material machining is covered by the SINUMERIK machine tool controllers. (Further information about SINUMERIK control systems can be found in Catalogs NC 62 and NC 82).

#### Supplementary technology functions

##### Fixed gear technology object

You can use the "Fixed gear" technology object to implement a fixed synchronous operation (without synchronization/desynchronization) using a specified gear ratio. Fixed gearing converts an input variable to an output variable with a configured transmission ratio (gear ratio).

A Fixed gear technology object can be used as follows, for example:

- To make allowance for diameters in a master variable.
- To implement a fixed gear ratio without coupling
- For speed synchronization on speed-controlled axes
- As a motion-coupled gear on master value, following axes are engaged or disengaged. In this way, the gear is always synchronized with the master value. Example: A paper web runs synchronously with the master.

##### Summator technology object

The addition object can be used to add up to four input vectors (motion vectors) to one output vector. An addition object can be used as follows, for example:

- To add up superimpositions/offsets in the main signal path, e.g. color register, cut-off register on the paper web

##### Formula technology object

Formula object for scalable variables and motion vectors. A formula object can be used between interconnected objects to modify scalar variables in the main signal path, e.g.:

- Superimposition of torque
- Superimposition of master velocity
- Modification of torque variables B+, B-
- Enabling of torque limitations
- Enabling of torque

##### Sensor technology object

The sensor object can be used to acquire scalar measuring values. A sensor object reads out a value from the I/O and supplies an actual value as an output signal in standardized formats.

##### Controller technology object

The controller object can be used to prepare and control scalar variables.

A controller object can be used as a universal PIDT1 controller for scalar control variables as well as a PI and P controller.

##### Interconnection of technology objects

The individual technology objects can be interconnected. The supplementary technology functions, for example, can be used to implement tension-controlled winder applications directly on the system level.

##### Note:

No license is necessary for using the supplementary technology functions.

**Function** (continued)

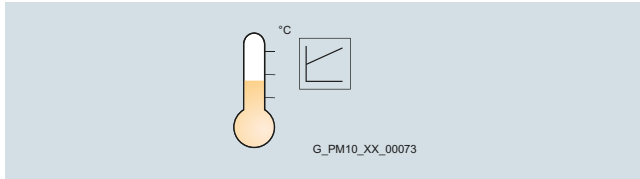
**SIMOTION TControl technology package**
**TControl – Temperature controller technology functions**

**Temperature channel technology object**

The controller core of the temperature technology package has a DPID structure. Pure heating controllers and cooling controllers as well as combined heating/cooling controllers can be configured and parameterized.

User-assignable functions are available for each temperature channel:

- Each temperature channel can either be configured as a heating or cooling section or as a combined heating/cooling section.
- The controllers either use a PID or DPID control algorithm or use the optional control zone functionality.
- In manual output mode, a replacement value can be output.
- You can select the operating mode for each controller channel separately. In this way, for example, you can switch the output to a fixed control variable.  
The following operating modes are available:
  - Closed-loop control for operating setpoint
  - Actual value acquisition and output of the manual manipulated variable value
  - Actual value acquisition and output of "0"
  - Self tuning
- Actual value acquisition and processing
  - Plausibility check for each new actual value and correction before corresponding filter measures
  - Filtering (by PT1 element)
- Actuating signal preparation and output
  - Digital, pulse-length modulated actuating signal
  - Prevention of minimal pulse durations for I/O cycles by integration of lost pulses
  - Manual actuating value (for manual output mode)
  - Output value limitation
  - Replacement value (calculated dynamically)
- Self-tuning for heating controllers
  - This ensures fast startup without overshooting and maintains the setpoint value without lasting system deviations.
  - Self-tuning can be used in parallel for all desired channels to ensure optimal parameter acquisition even for strongly coupled temperature sections.
- Monitoring and alarm functions
  - Actual value monitoring by definition of tolerance bands. The inner and outer tolerance bands can be defined independently as absolute or relative tolerance bands.
  - Measuring circuit monitoring for increased operational safety of a plant
  - Plausibility check
  - Alarm functions

The use of the TControl technology package is clarified by an application example. The application example provides functional expansions, function interfaces to the application and data interfaces to the HMI. It is contained in the Utilities & Applications which are supplied with SIMOTION SCOUT.

**SIMOTION technology package for Drive Control Chart (DCC)**
**Technology functions for Drive Control Chart**

With Drive Control Chart (DCC), open-loop and closed-loop control functions can be easily configured graphically. For this purpose, multi-instance function blocks are selected from a block library using drag and drop, and then graphically interconnected and parameterized. The control structures are presented clearly.

DCC is not available for SIMOTION in the TIA Portal (SCOUT TIA).

The block library comprises a large selection of

- control blocks,
- calculation blocks, and
- logic blocks as well as
- comprehensive open-loop and closed-loop control functions.

Further functions:

- For logically combining, evaluating and acquiring binary signals, all commonly used logic functions are available for selection including, for example,
  - AND
  - XOR
  - On/Off delays
  - RS flip-flops or counters
- For monitoring and evaluating numerical values, numerous arithmetic functions are available, such as:
  - Summation
  - Divider
  - Minimum/maximum evaluation
- Apart from the automatic speed control, winders, PI controls, ramp-function generators and wobble generators can easily be configured.

[More information about Drive Control Chart \(DCC\) can be found in section Option packages for SIMOTION SCOUT.](#)

## SIMOTION Motion Control System

SIMOTION runtime software

### SIMOTION technology packages

**Function** (continued)

#### **SIMOTION technology package Multipurpose Information Interface (MIIF)**

The SIMOTION technology package MIIF (Multipurpose Information Interface) functions as a server to permit symbolic access to SIMOTION data and makes them available to clients (e.g. operator panel) via Ethernet.

Access to SIMOTION variables is purely symbolic. The client application is not in any way dependent on the SIMOTION application. The communication is TCP/IP-based. Several controllers and HMI stations can be operated on an Ethernet line.

The server is active after being loaded to the controller. The server does not need to be configured in the application.

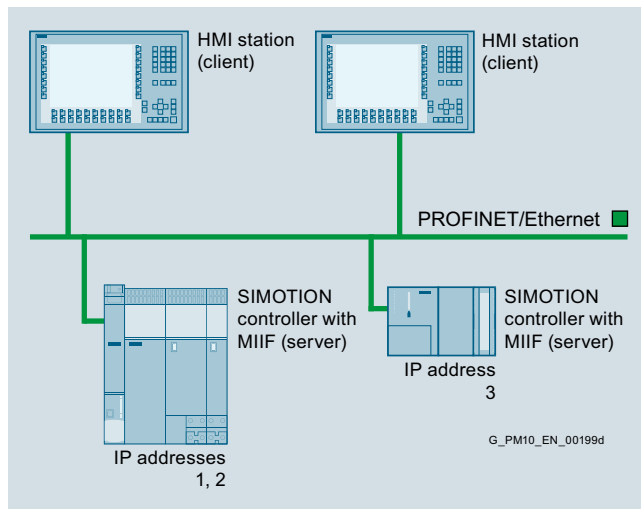

Symbolic access to SIMOTION data with MIIF

The server allows variables to be read and written within SIMOTION RT. System variables of the device, system variables of technology objects and UNIT global variables are supported here. Global device variables and I/O variables are not supported in the OAMIIF V1.0. If these are displayed/changed, they need to be copied by the application.

#### **SIMOTION Vibration Extinction (VIBX) technology package**

The VIBX (VIBration eXtinction) technology package provides vibration damping functionality in the form of a setpoint filter (axis setpoint filter) that is applied to SIMOTION axes. By altering the setpoint for an axis, the technology package reduces the vibrations caused by the natural frequency of the moving mechanical components. Axes can be positioned without vibration and wear on mechanical components is reduced. This increases the availability of the machine and improves the rate of part production and thus overall productivity. Structural changes or additional sensors or actuators are not required.

#### **SIMOTION OACAMGEN technology package**

The SIMOTION technology package OACAMGEN can be used to calculate motion profiles and dimension drives for servo presses. It enables motion profiles to be calculated taking account of boundary conditions, such as maximum eccentric speed, maximum ram velocity and maximum acceleration, while simultaneously minimizing the drive load.



## Overview



### **Library containing function blocks certified in accordance with PLCopen**

PLCopen is an association of leading PLC manufacturers that was formed for the purpose of defining international standards in the field of PLC programming and promoting their use.

The PLCopen function blocks integrated into the Motion Control Technology Package are designed for use in cyclic programs/tasks; they enable Motion Control programming in a PLC environment. The function blocks can be selected from the SCOUT command library and can therefore be easily used in all SIMOTION programming languages. They should preferably be used in LAD/FBD.

The following certified single-axis and multi-axis PLCopen blocks as well as extended functions are available:

#### Single-axis function blocks

- `_MC_Power` (axis enables)
- `_MC_Stop` (stop axis)
- `_MC_Reset` (reset axis)
- `_MC_Home` (reference point approach for axes)
- `_MC_MoveAbsolute` (absolute positioning of axes)
- `_MC_MoveRelative` (relative positioning of axes)
- `_MC_MoveVelocity` (traversing axes at a specified velocity)
- `_MC_MoveAdditive` (relative traversal of axis by a defined path added to the remaining path)
- `_MC_MoveSuperimposed` (relative superimposition of a new motion in addition to existing motion)
- `_MC_PositionProfile` (traversing axis by a predefined and specified position/time profile)
- `_MC_VelocityProfile` (traversing axis by a predefined and specified velocity/time profile)
- `_MC_ReadActualPosition` (read actual position of axis)
- `_MC_ReadStatus` (read status of an axis)
- `_MC_ReadAxisError` (read error of an axis)
- `_MC_ReadParameter` (axis parameter, read LREAL data type)
- `_MC_ReadBoolParameter` (axis parameter, read BOOL data type)
- `_MC_WriteParameter` (axis parameter, write LREAL data type)
- `_MC_WriteBoolParameter` (axis parameter, write BOOL data type)

#### Multi-axis function blocks

- `_MC_CamIn` (insert cam with synchronization) contains implicit `_MC_CamTableSelect` (selection of cam)
- `_MC_CamOut` (remove cam with desynchronization)
- `_MC_GearIn` (synchronize)
- `_MC_GearOut` (desynchronize)
- `_MC_Phasing` (phase shift)

Apart from the standard PLCopen functions, the following additional standard axis function is included:

- `_MC_Jog` (continuous or incremental jogging)

## SIMOTION Motion Control System

### SIMOTION runtime software

#### Overview of the licensing concept

##### Overview

###### **The basic concept: "pay only for what you need"**

The functionally scalable licenses for SIMOTION runtime software and axis-specific licensing result in a simple pricing structure, allowing you to only pay for what you really need.

Runtime licenses are not bound to specific versions and are therefore valid for all firmware versions. In case of a firmware update the runtime licenses remain valid. The license key generated from the runtime licenses and the serial number of the memory card or SIMOTION P is stored on the memory card or on SIMOTION P.

###### **How can licenses be obtained for runtime software?**

Licenses for SIMOTION runtime software can be obtained as follows:

- Pre-installed licenses can be ordered when purchasing a SIMOTION memory card (SIMOTION C, D) or for SIMOTION P. The article number is expanded with one or more additional order codes (Z options) that specify the required licenses. Alternatively, pre-installed runtime licenses can be ordered using the configurator for SIMOTION runtime licenses in the Industry Mall.  
Homepage: [www.siemens.com/industrymall](http://www.siemens.com/industrymall)
- Licenses can be ordered separately, independently of purchase of a SIMOTION controller or a SIMOTION memory card. The required software options are assigned to hardware (memory cards or SIMOTION P) by generating a license key over the Internet at:  
Homepage: [www.siemens.com/automation/license](http://www.siemens.com/automation/license)  
Using this method, it is possible to store additional licenses on a memory card.

###### **When do licenses need to be obtained for runtime software?**

When configuring using SIMOTION SCOUT, the required licenses are displayed.

A license is required for the runtime software:

- When it is used in a machine or a machine component before it is supplied by the manufacturer
- When it is used by the customer on completion of initial commissioning
- When it is retrofitted following completion of initial commissioning
- In large-scale plants that are installed directly at the production site without previous initial commissioning by the manufacturer, on completion of initial commissioning before test operation commences.

###### **Unlicensed basic functions**

The rights of use for these software components are included when the basic unit is purchased:

- SIMOTION Kernel runtime software  
The SIMOTION Kernel is already installed on the device.
- Technology functions for Motion Control Basic  
Use of technology functions for drive axes, single output cams and cam tracks, measuring inputs, and external encoders.
- Technology functions for Drive Control Chart  
By installing the optional SCOUT package Drive Control Chart, the technology functions of Drive Control Chart are made available to the SIMOTION runtime system.
- Supplementary technology functions  
Use of supplementary technology functions, such as addition objects, formula objects and fixed gears.
- Function libraries for I/O interfacing
- Communication functions  
This covers SIMATIC S7 communication functions on the SIMOTION side (PG/OP communication to programming devices, for engineering and communication to HMI devices and PCs with SIMATIC HMI), SIMOTION IT DIAG and SIMOTION IT OPC XML-DA or OPC UA, as well as UDP and TCP/IP communication.

###### **Motion Control technology functions under license**

The Motion Control Basic technology functions can be used without a license. When other technology functions of the Motion Control technology package are used, a license is required for each axis used. Licenses are only necessary for real axes; virtual axes and drive axes are not subject to license. A license is obtained for the different axis types using a separate article number for each.

###### POS, GEAR, CAM axis licenses

Three different axis licenses are available:

- POS – Use of the positioning technology function for a created positioning axis
- GEAR – Use of the positioning and synchronous operation technology functions for a created synchronous axis as well as additional path interpolation for a created path axis
- CAM – Use of the positioning, synchronous operation, path interpolation and cam technology functions for a created synchronous axis with cam

###### MultiAxes Packages

The platform-independent MultiAxes Package supports particularly simple licensing. It contains the license for unlimited use of the POS/GEAR/CAM technology functions on one SIMOTION Controller. Variably priced, platform-specific packages for C2xx, P320 or D410-2, D425-x, D435-x and D445-x/D455-x are offered in addition to the platform-independent MultiAxes Package.

**Overview** (continued)

**Other technology functions which are subject to a license**
TControl technology functions

The functions of the TControl technology package are licensed for specific channels in packages, each package containing 8 temperature channels.

Multipurpose Information Interface (MIIF), Vibration Extinction (VIBX) and OACAMGEN technology functions

To use the functions of these technology packages, a separate license is to be obtained for each SIMOTION Controller.

SIMOTION IT communication functions

A license to use these functions must be obtained for each SIMOTION Controller.

For version V4.2 and higher of SIMOTION Kernel, a license need be purchased only to cover the use of SIMOTION IT Virtual Machine. The licenses for SIMOTION IT DIAG and SIMOTION IT OPC XML-DA are no longer required.

The license SIMOTION IT Virtual Machine can continue to be used as a combined license for SIMOTION IT DIAG, OPC XML-DA and Virtual Machine in the case of version V4.2 and lower of SIMOTION Kernel.

**Safety Integrated functions for SINAMICS S120 which are subject to license**

SINAMICS S120 drives with safety functions can be integrated into a SIMOTION D application.

The following must be noted with regard to use of Safety Integrated functions:

- The Safety Integrated basic functions are unlicensed.
- A license for integrated SINAMICS drives (SIMOTION D and CX32-2 Controller Extensions) is, however, required for each axis with safety functions in the case of Safety Integrated Extended Functions.
- MultiAxes and Safety Packages are available for SIMOTION D4x5-x that, in addition to unlimited use of the axes licenses, also contain the licenses of the Safety Integrated Extended functions for all integrated SINAMICS drives (SIMOTION D and Controller Extensions CX32-2).

**Note regarding SIMOTION D410-2**

SIMOTION D410-2 has an integrated drive control for either a servo, a vector or a V/f axis and is therefore ideal for single-axis applications.

One real axis can be used without license on the Control Unit. Drive axes and virtual axes never require a license.

SIMOTION D410-2 can be extended with additional SINAMICS S110/S120 Control Units (e.g. CU305) and so can also be used for smaller multi-axis applications (e.g. with 2 to 3 axes). A license is required for any additional axes. Where a license is required for a POS axis, the POS single-axis license is the ideal solution; it is better to use the MultiAxes Package D410-2 in the case of GEAR/CAM or more than one POS license.

The axis license with the highest functionality is covered by the inclusive license (a real axis).

The functionality has the following granularity: CAM > GEAR > POS.

Example:

Application with 2 real axes: 1 POS, 1 CAM.  
Only a POS license needs to be purchased because the higher-order CAM license is already included.

Licenses are also required for runtime functions such as SIMOTION IT Virtual Machine. These can be pre-installed on the CompactFlash card (CF card) or ordered separately.

## SIMOTION Motion Control System

### SIMOTION runtime software

#### Ordering of licenses for runtime software

##### Overview

##### **Runtime licenses for SIMOTION C and D**

For SIMOTION C and D, licenses for runtime software can be ordered individually or as pre-installed software (by order code/ Z option) on memory card.

In both cases, the license certificate is enclosed.

##### **Runtime licenses for SIMOTION P**

Licenses for runtime software can be ordered individually or by means of order code (Z option) for SIMOTION P320-4.

When ordered by means of order code (Z option), the runtime licenses are not pre-installed, the license certificate is enclosed.

##### **Ordering individual licenses**

The article numbers can be found in column "Single-user license" in the ordering data table.

If several licenses of the same type are needed, e.g. 3 × POS license, the article number must be repeated for each license.

##### Example:

A 1 GB CompactFlash card for SIMOTION D4x5-2 has been purchased, but without pre-installed runtime licenses. During the configuring process with SIMOTION SCOUT, a message is displayed to indicate that the following runtime licenses are needed: 1 × POS axis license, 1 × TControl license.

The ordering data table specifies the following:

- POS axis license: 6AU1820-1AA20-0AB0
- TControl license: 6AU1820-2AA20-0AB0

The required software options are assigned to hardware (memory cards or SIMOTION P) by generating a license key over the Internet at:

Homepage: [www.siemens.com/automation/license](http://www.siemens.com/automation/license)

##### **Ordering pre-installed licenses**

To order pre-installed licenses on memory card, the type and number of required licenses must be specified in the order using order codes (Z options). These order codes are added to the article number for the SIMOTION memory card.

Step 1: The article number of the SIMOTION memory card must be stated first:

- Memory card for SIMOTION C:  
Micro memory card 64 MB: 6AU1720-1KA00-0AA0
- Memory card for SIMOTION D410-2:  
CompactFlash card 1 GB: 6AU1400-1PA23-0AA0
- Memory card for SIMOTION D4x5-2:  
CompactFlash card 1 GB: 6AU1400-2PA23-0AA0

Step 2: The following order codes must be stated in order to specify the type and quantity of required runtime licenses:

Each order code begins with the characters "-Z" and is listed in the column headed "Order codes for pre-installed licenses" in the ordering data table.

##### Example 1:

64 MB micro memory card for SIMOTION C240 with

- MultiAxes Package license for SIMOTION C2xx:

Article No.: 6AU1720-1KA00-0AA0 **-Z M24**

##### Example 2:

1 GB CompactFlash card for SIMOTION D4x5-2 with

- 3 POS licenses
- 2 CAM licenses
- 1 TControl license and
- 1 SINAMICS Safety Integrated Extended Functions license:

Article No.: 6AU1400-2PA23-0AA0 **-Z P03 + C02 + T01 + F01**

##### **Configurator for runtime licenses**

An electronic ordering configurator is available in the Industry Mall for ordering SIMOTION hardware with corresponding runtime licenses.

Homepage: [www.siemens.com/industrymall](http://www.siemens.com/industrymall)

This will guide you step by step through the process of selecting and ordering SIMOTION hardware with pre-installed runtime licenses.

### Selection and ordering data

License type	Single-user license Article No.	Order codes for pre-installed licenses on SIMOTION memory cards	Licensed functions	License object	Instructions
<b>Axis licenses</b>					
• POS axis license	<b>6AU1820-1AA20-0AB0</b>	<b>Pxx</b> – POS license and quantity (e.g. P02 = 2 POS licenses)	Positioning	Per axis	In the case of D410-2, required only for 2 axes or more
• GEAR axis license	<b>6AU1820-1AB20-0AB0</b>	<b>Gxx</b> – GEAR license and quantity (e.g. G03 = 3 GEAR licenses)	Positioning, synchronous operation, path interpolation		
• CAM axis license	<b>6AU1820-1AC20-0AB0</b>	<b>Cxx</b> – CAM license and quantity (e.g. C01 = 1 CAM license)	Positioning, synchronous operation, path interpolation, cam (all functions of the Motion Control technology package)		
<b>MultiAxes Packages</b>					
• Platform-independent	<b>6AU1820-0AA20-0AB0</b>	<b>M00</b> – MultiAxes Package license (platform-independent)	Positioning, synchronous operation, path interpolation, cam	Unlimited axes on one controller	(all functions of the Motion Control technology package)
• For C2xx	<b>6AU1820-0AA24-0AB0</b>	<b>M24</b> – MultiAxes Package license for C2xx			
• For P320	<b>6AU1820-0AA32-0AB0</b>	<b>M32</b> – MultiAxes Package license for P320			
• For D410-2	<b>6AU1820-0AA41-0AB0</b>	<b>M41</b> – MultiAxes Package license for D410-2			
• For D425-x	<b>6AU1820-0AA42-0AB0</b>	<b>M42</b> – MultiAxes Package license for D425-x			
• For D435-x (incl. D425-x)	<b>6AU1820-0AA43-0AB0</b>	<b>M43</b> – MultiAxes Package license for D435-x			
• For D445-x/D455-x (incl. D435-x and D425-x)	<b>6AU1820-0AA44-0AB0</b>	<b>M44</b> – MultiAxes Package license for D445-x/D455-x			
<b>MultiAxes and Safety Packages</b>					
• For D425-x	<b>6AU1820-0AS42-0AB0</b>	<b>S42</b> – MultiAxes license and Safety Package for D425-x	Positioning, synchronous operation, path interpolation, cam	Unlimited axes (incl. SINAMICS Safety Integrated Extended Functions) on one controller	SINAMICS Safety Integrated Extended Functions for integrated SINAMICS drives with SIMOTION D and CX32-2 Controller Extension
• For D435-x (incl. D425-x)	<b>6AU1820-0AS43-0AB0</b>	<b>S43</b> – MultiAxes license and Safety Package for D435-x	(all functions of the Motion Control technology package) plus SINAMICS Safety Integrated Extended Functions for SIMOTION D		
• For D445-x/D455-x (incl. D435-x and D425-x)	<b>6AU1820-0AS44-0AB0</b>	<b>S44</b> – MultiAxes license and Safety Package for D445-x/D455-x			
<b>Licenses for other technology packages / technology functions</b>					
• TControl	<b>6AU1820-2AA20-0AB0</b>	<b>Txx</b> – TControl license and quantity (e.g. T03 = 3 TControl licenses)	Temperature control	8 temperature channels per license	
• MIIF (Multipurpose Information Interface)	<b>6AU1820-3DA20-0AB0</b>	<b>B02</b> – MIIF license	Multipurpose Information Interface	Per controller	On one C2xx, P3xx or D4xx-2
• VIBX (Vibration Extinction)	<b>6AU1820-3CA20-0AB0</b>	<b>B03</b> – VIBX license	Vibration damping of axes	Per controller	On one C2xx, P3xx or D4xx-2
• OACAMGEN (cam generation)	<b>6AU1820-3EA20-0AB0</b>	<b>B04</b> – OACAMGEN license	Motion profiles for servo presses	Per controller	On one C2xx, P3xx or D4xx-2
• Safety Integrated	<b>6AU1820-2AF20-0AB0</b>	<b>Fxx</b> – Safety license and quantity (e.g. F02 = 2 Safety Integrated Extended Functions licenses)	SINAMICS Safety Integrated Extended Functions for SIMOTION D	Per safety axis with Safety Integrated Extended Functions	For integrated SINAMICS drives with SIMOTION D and CX32-2 Controller Extension
• High output frequency	<b>6AU1820-2AH20-0AB0</b>	<b>H00</b> – High output frequency license	SINAMICS high output frequency	Per controller	High output frequency for integrated SINAMICS drives with SIMOTION D and CX32-2 Controller Extension

## SIMOTION Motion Control System

### SIMOTION runtime software

#### Ordering of licenses for runtime software

##### Selection and ordering data (continued)

License type	Single-user license Article No.	Order codes for pre-installed licenses on SIMOTION memory cards	Licensed functions	License object	Instructions
<b>Licenses for SIMOTION IT communication functions</b>					
• SIMOTION IT DIAG <sup>1)</sup>	<b>6AU1820-8BA20-0AB0</b>	<b>D00</b> – IT DIAG license	Integrated web server	Per controller	On platforms with Ethernet and/or PROFINET interface
• SIMOTION IT OPC XML-DA <sup>1)</sup>	<b>6AU1820-8BB20-0AB0</b>	<b>X00</b> – license IT OPC XML-DA	Communication via OPC XML-DA	Per controller	
• SIMOTION IT Virtual Machine	<b>6AU1820-8BD20-0AB0</b>	<b>J00</b> – SIMOTION IT Virtual Machine license	For SIMOTION Kernel versions earlier than V4.2, usable as combined license for SIMOTION IT DIAG, OPC XML-DA and Virtual Machine.	Per controller	

<sup>1)</sup> Subject to license for SIMOTION Kernel versions earlier than V4.2

## Overview

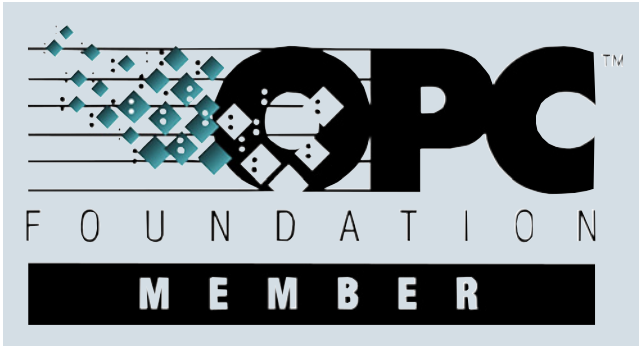

OPC (Openness, Productivity & Collaboration) is a standardized, open, multi-vendor interface that is widely used in automation engineering. A distinction is made between the classic OPC and further developments of the classic version, i.e. OPC XML-DA and OPC UA (Unified Architecture).

2

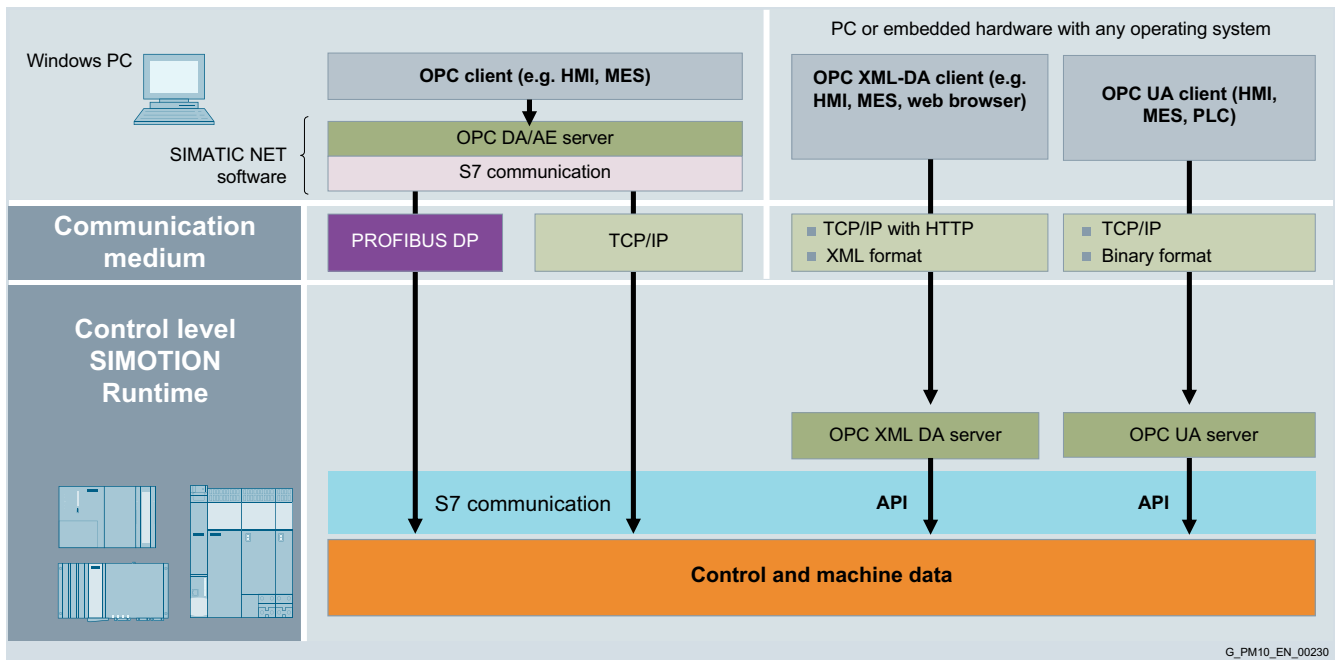

G\_PM10\_EN\_00230

SIMOTION supports all three kinds of OPC.

- **Classic OPC DA (Data Access) and OPC AE (Alarm & Events) with SIMATIC NET**

By installing the SIMATIC NET PC software on a PC with a Windows 7 or Windows 8 operating system, it is possible to access SIMOTION data and alarms using an OPC client. In this case, the OPC DA and OPC AE server is a component of the SIMATIC NET software and it communicates with SIMOTION by means of the S7 software via PROFIBUS or Ethernet TCP/IP. The OPC server itself is installed on the Windows PC and utilizes Windows COM and DCOM mechanisms to communicate.

- **OPC XML-DA**

The OPC XML-DA server of SIMOTION is located directly in the SIMOTION system. The associated OPC client can be installed on any external device. OPC XML-DA uses the SOAP (Simple Object Access Protocol) communication protocol that employs XML data structures to transfer data content. SOAP utilizes HTTP communication and therefore Ethernet. This open, standardized mechanism is based on web mechanisms. It functions independently of Windows and is thus extremely flexible to use.

- **OPC UA**

OPC UA is an advanced version of OPC XML-DA. It has more data transfer mechanisms than its predecessor. In addition to its web service-based XML mechanism, it also offers transmission in purely binary data format via TCP/IP, a method that is optimized for speed and data throughput. OPC UA provides an object model that permits the integration of automation data (DA), alarms, events (AC) and historical data (HA) and methods into a server. SIMOTION only supports OPC UA-DA. OPC UA fulfills every requirement with respect to security and provides mechanisms that ensure the authentication, confidentiality and integrity of the data exchanged between the client and server.

### Benefits

- Functions independently of the communication technology specific to a manufacturer, sector, operating system (OPC UA and XML-DA) or programming language
- Supports communication links to the smallest embedded devices, other controllers, PCs, HMIs, control systems and even cloud applications
- Transmission security and authentication at user level (OPC UA)

## SIMOTION Motion Control System

### OPC server

#### OPC server of SIMOTION and SIMATIC NET

##### Function

The operating principle of the OPC server in the SIMATIC NET software and of the OPC UA server is described below.

[Information about the scope of functions of the OPC XML-DA server can be found in section SIMOTION IT.](#)

##### **OPC DA (Data Access) and OPC AE (Alarm & Events) with SIMATIC NET**

###### Programming

- Synchronous and asynchronous reading and writing of variables
- Monitoring of variables using the OPC server with a signal to the client when a change occurs
- Transmission of alarms and events to client
- Use of batch operations, so a large volume of data can be processed in a short time

###### Interfaces

- Custom Interface (C++) for high OPC performance
- Automation Interface (VB, Excel, Access, Delphi, etc.) for ease-of-use
- Graphics with OCX for configuring instead of programming

###### Bus systems

Communication over OPC for Industrial Ethernet/PROFINET and PROFIBUS is supported.

###### Operating systems

- For Windows 7 Professional/Ultimate 32/64 bit
- For Windows 8.1 Professional 64 bit

###### Requirements for communication via PROFIBUS

- PC/PG with CP 5622 PCI card and license for SOFTNET S7 communication software for PROFIBUS DP, or
- PG/Notebook with CP 5711 PCMCIA card and license for SOFTNET S7 communication software for PROFIBUS DP

###### OPC on PC and PG

The SOFTNET S7 communication software for PC/PG is available for PROFINET/Industrial Ethernet and PROFIBUS DP. It contains the S7 communication software, the S5-compatible communication functions and the functions for communication with SIMOTION.

[For license, see selection and ordering data](#)

##### **OPC UA server in SIMOTION runtime**

The SIMOTION runtime software includes an OPC UA server in addition to the OPC XML-DA server. The OPC UA (Unified Architecture) is an extension of the OPC industrial standard. OPC UA is the latest OPC standard that has been designed to ensure secure, reliable multi-vendor, multi-platform communication. It therefore supports data exchange between different operating systems installed on devices of different brands.

- Standardized communication via the Internet and firewalls  
The OPC UA server integrated in SIMOTION utilizes a TCP-based, optimized, binary protocol to exchange data. In this case, data are transferred via the IANA-registered port 4840. HTTP and web service are also optionally supported. It is sufficient to enable port 4840 in order to transfer data.
- Service-oriented architecture  
OPC UA defines generic services based on the Service Oriented Architecture (SOA) design paradigm. This architecture provides service providers with requests that can be edited and whose results are returned as responses. A WDSL for describing the services of the kind required for classic web services is no longer necessary. Generic services are already defined and standardized for OPC UA.
- Security concept  
To protect against unauthorized access, the data are encrypted using recognized Internet standards (SSL, TLS, AES). The security mechanisms belong to the standard and are mandatory for manufacturers.
- Scope of functions
  - Read and write variables (symbolic access)
  - Browse variables
  - Subscriptions
- Access to variables  
It is possible to access the following SIMOTION variables:
  - Device system variables
  - TO system variables
  - TO configuration variables
  - Drive parameters
  - Global user variables
  - Interface variables
  - I/O variables



### Integration

A variety of different requirements must be fulfilled in order to set up a communication link from a PC/PG to SIMOTION via OPC with SIMATIC NET:

#### Requirements for communication via Industrial Ethernet

- PC/PG with standard Ethernet interface and SOFTNET S7 communication software for Industrial Ethernet or SOFTNET S7/LEAN for Industrial Ethernet (only 8 connections)

#### Requirements for communication via PROFIBUS

- PC/PG with CP 5612/5622 PCI card and SOFTNET S7 communication software for PROFIBUS DP, or
- PG/Notebook with CP 5711 PCMCIA card and SOFTNET S7 communication software for PROFIBUS DP

Use of the OPC XML-DA and OPC UA servers in the SIMOTION runtime software does not require a license.

### Selection and ordering data

Description	Article No.
<b>SIMATIC NET SOFTNET-PB S7</b> Software for S7 communication including OPC server and configuring software. CD with license key on a USB stick. Can be used in combination with CP5612, CP5622, CP5711	<b>6GK1704-5CW14-0AA0</b>
<b>CP 5711 communications processor</b> CP 5711 communications processor with USB adapter (USB V2.0) for connecting a PG or notebook to PROFIBUS or MPI	<b>6GK1571-1AA00</b>
<b>SIMATIC NET SOFTNET-IE S7</b> Software for S7 communication including OPC server and configuring software <ul style="list-style-type: none"> <li>• DVD with license key on a USB stick</li> <li>• License key for download (Email address required for delivery)</li> </ul>	<b>6GK1704-1CW14-0AA0</b> <b>6GK1704-1CW14-0AK0</b>
<b>SIMATIC NET SOFTNET-IE S7 Lean</b> Software for S7 communication including OPC server and configuring software <ul style="list-style-type: none"> <li>• DVD with license key on a USB stick</li> <li>• License key for download (Email address required for delivery)</li> </ul>	<b>6GK1704-1LW14-0AA0</b> <b>6GK1704-1LW14-0AK0</b>

#### Note

As of SIMOTION Kernel V4.2, the SIMOTION IT function OPC XML-DA is included in the standard firmware of the SIMOTION controllers and does not require a license.

For further details, refer to section SIMOTION IT.

### More information

More information about the SIMATIC NET software package with OPC server can be found in Catalog IK PI and the Industry Mall under Automation Technology/Industrial Communication.

More information about OPC can be found on the Internet at: [www.opcfoundation.org](http://www.opcfoundation.org)

# SIMOTION Motion Control System

## SIMOTION IT

### Web server functions for service and diagnostics

#### Overview

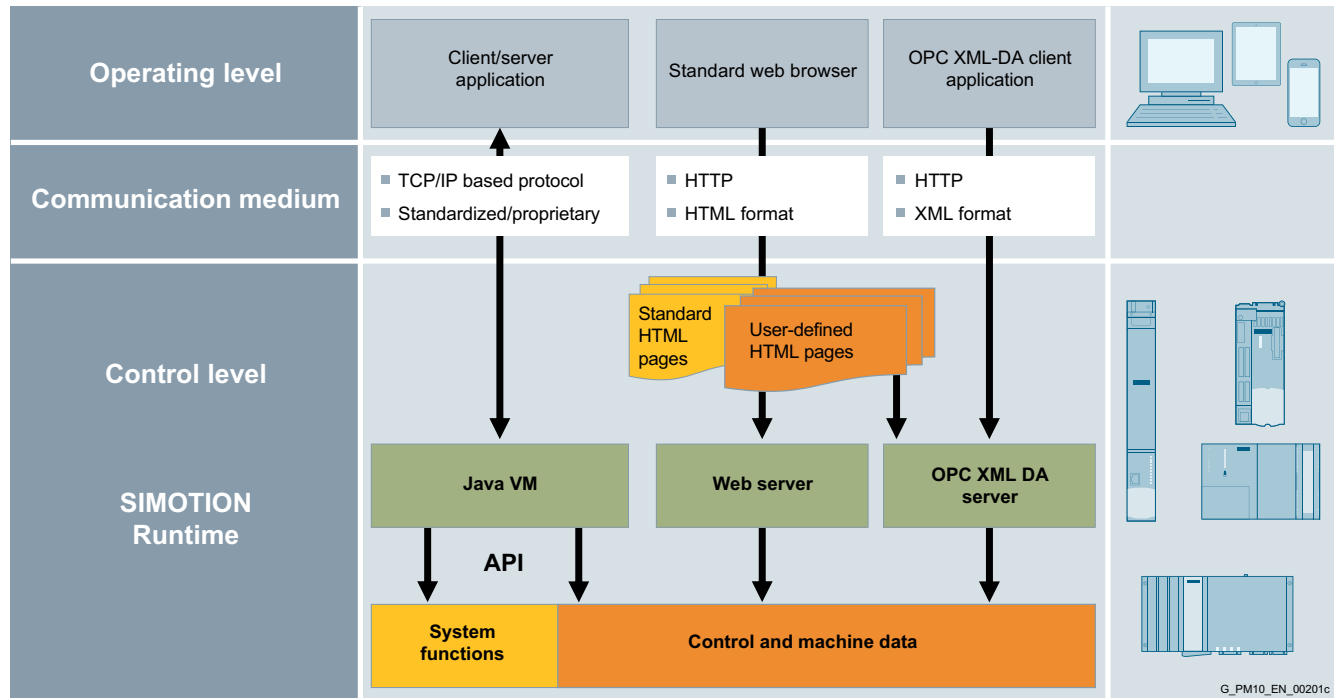

SIMOTION IT: Three different technologies for easy access to control and machine data

#### **SIMOTION IT: Service and diagnostics via the Internet**

The SIMOTION controllers support communication with the outside world through the integrated Ethernet or PROFINET interfaces using standard IT protocols such as HTTP. Using the web functions integrated in SIMOTION IT, machine manufacturers and users can perform commissioning, diagnostic and service procedures on their production machines easily and without additional engineering tools.

#### **SIMOTION IT offers three different technologies:**

SIMOTION IT DIAG and SIMOTION IT OPC XML-DA each provide a communications server on the SIMOTION controller. Via Industrial Ethernet/PROFINET, a client application can then access data in the SIMOTION controller for diagnostic or service purposes or for visualization.

SIMOTION IT Virtual Machine provides a Java runtime environment on the SIMOTION controller. This means that Java applications can be executed on the SIMOTION controller. This allows you to create your own programs for commissioning, service and preventative maintenance.

#### **Licensing of SIMOTION IT**

For version V4.2 and higher of SIMOTION Kernel, a license need be purchased only to cover the use of SIMOTION IT Virtual Machine. SIMOTION IT DIAG and OPC XML-DA are included in this case in the standard firmware of the SIMOTION controllers and do not require a license.

#### **Note:**

For SIMOTION Kernel versions earlier than V4.2, it is still necessary to purchase a license for the SIMOTION IT DIAG and OPC XML-DA functions. A license must be obtained on the basis of the relevant software options. The SIMOTION IT Virtual Machine license can continue to be used as a combined license for SIMOTION IT DIAG, OPC XML-DA and VM for SIMOTION Kernel version V4.2 or earlier.

G\_PM10\_EN\_00201c

## Function

### **SIMOTION IT DIAG (web server)**

SIMOTION controllers have a web server integrated into their runtime system. The web pages integrated as standard offer extensive help functions for a variety of applications:

- **Device information**  
Detailed information about the firmware versions, hardware components and technology objects of the device
- **Diagnostics**  
Information about device resources: CPU load, memory usage, task duration times and operating state, diagnostic buffer, extended diagnostic buffer and technology object alarms, axis overview, watch tables and runtime trace. The diagnostic pages for SIMOTION D also display drive alarms, drive diagnostic buffer and parameters of the integrated SINAMICS drive. The watch tables support simultaneous access to the variables of all accessible SIMOTION controllers in the network (V4.5 and higher).
- **Runtime trace**  
Recorded data can be stored on the HMI device (e.g. PC). The supplied Web Trace Viewer offers a wide scope of options for evaluating recorded data: Graphical, with zoom and dual measuring cursor. SIMOTION D offers the Web Trace Viewer as a direct download from the standard web pages. The Web Trace Viewer is compatible with Windows XP and Windows 7 32/64 bit Professional or Ultimate.
- **System trace**  
As with the SIMOTION SCOUT engineering system, a distributed trace for recording variables can be configured and started across different controllers in the system.
- **Access to the device file system**  
A web browser can be used to store and access any number of files in a specially provided directory of the file system of the SIMOTION controller. In this way, documentation and service instructions can be stored directly in the controller, for example.
- **Project update and firmware update**  
The SIMOTION project as well as the firmware of the SIMOTION controller can be updated from the standard web pages.
- **Access protection**  
SIMOTION IT features extensive security functions, such as security levels, user administration and access protection. All protocols (HTTP/HTTPS/FTP/Telnet) can be enabled individually in the SIMOTION SCOUT engineering project.
- **User-specific web pages**  
The user can create web pages and save them on the SIMOTION controller.  
Read and write access to the SIMOTION variables is possible. JavaScript can be used to implement active operation and display functions on the web pages. This is supported by existing JavaScript libraries.  
All current web technology tools (HTML4/HTML5) can be employed to create user pages.

### **SIMOTION IT OPC XML-DA**

SIMOTION controllers have an OPC XML-DA server integrated into their runtime system. OPC XML-DA is an interface specified by the OPC Foundation and is based on the standard IT protocol HTTP. The data requests of a client are coded in XML symbolically and transmitted to SIMOTION using the HTTP protocol. These are evaluated by the integrated OPC XML DA server and the response is then sent back to the client over the same path.

It is therefore possible, for example, to create HMI applications in different programming languages (C#, Visual Basic, Java, JavaScript) on any client systems independently of the operating system.

The client application only works with the symbolic names of the SIMOTION variables and has thus only a loose link to the SIMOTION SCOUT database. A symbol export, similar to the Windows-based process on the SIMATIC NET OPC DA server, is not required. This ensures that consistency problems between the version of the client application and the project version in SIMOTION are avoided from the beginning.

The OPC XML-DA server offers the following functions for access to the data of the SIMOTION controller:

- Read and write access to the SIMOTION variables
- Access to diagnostic buffer, extended diagnostic buffer and technology alarm objects
- Symbolic browsing function via all the SIMOTION variables
- Intelligent polling of variables using "subscriptions"
- Access protection (password-based) can be configured, if required.

The functionality responds in accordance with the specification of the OPC Foundation "OPC XML-DA Specification Version 1.01".

#### Note:

SIMOTION offers two further access options via OPC. In addition to the method already described via OPC XML-DA, OPC DA and OPC UA are also supported. OPC DA requires that the SIMATIC NET package is installed on the client PC. OPC DA and OPC UA are described in the OPC server section.

More information about OPC can be found on the Internet at [www.opcfoundation.org](http://www.opcfoundation.org).

# SIMOTION Motion Control System

## SIMOTION IT

### Web server functions for service and diagnostics

#### Function (continued)

##### **SIMOTION IT Virtual Machine**

SIMOTION controllers have a Java runtime environment (Virtual Machine) integrated in their runtime system. Use of this function is licensed through the SIMOTION IT Virtual Machine license.

Java applications can be executed on a SIMOTION controller with SIMOTION IT Virtual Machine. This allows you to develop your own programs and concepts for commissioning, service and preventative maintenance.

The programs can be created with the standard development tools that are available on the market, such as Eclipse or NetBeans. When they have been created, the programs can be downloaded into the SIMOTION controller online. There is no dependency on SIMOTION SCOUT.

All Java applications on the SIMOTION controller are executed in asynchronous tasks in the SIMOTION task system, not in real-time tasks.

The Java environment provides an interface (API) to the SIMOTION runtime system over special system functions. The following functions are available:

- Read and write access to the SIMOTION variables
- Read and write access to the non-volatile memory (NVRAM)
- Use of system functions (functions of the technology objects)
- Use of standard Java classes in the device (file access, network functions, string functions, etc.)
- Creation of servlets  
Servlets are ideal for implementing user-specific interaction between the controller and a specific web application.

#### Selection and ordering data

Description	Article No.
As of SIMOTION Kernel V4.2, the SIMOTION IT functions IT DIAG and OPC XML-DA are included in the standard firmware of the SIMOTION controllers and do not require a license. Use of the function SIMOTION IT Virtual Machine must be licensed via the following software option:	
<b>SIMOTION IT Virtual Machine</b> License for SIMOTION IT Virtual Machine on one controller <b>Note</b> For SIMOTION Kernel versions earlier than V4.2, usable as combined license for SIMOTION IT DIAG, OPC XML-DA and Virtual Machine.  For SIMOTION Kernel versions earlier than V4.2, it is still necessary to purchase a license for the SIMOTION IT DIAG and OPC XML-DA functions. A license must be obtained on the basis of the following software options.	<b>6AU1820-8BD20-0AB0</b>
<b>SIMOTION IT DIAG</b> License for SIMOTION IT DIAG on SIMOTION Kernel earlier than V4.2	<b>6AU1820-8BA20-0AB0</b>
<b>SIMOTION IT OPC XML-DA</b> License for SIMOTION IT OPC XML-DA on SIMOTION Kernel earlier than V4.2	<b>6AU1820-8BB20-0AB0</b>

##### Note

SIMOTION IT is available only on SIMOTION controllers with Ethernet or PROFINET interface.

### Overview

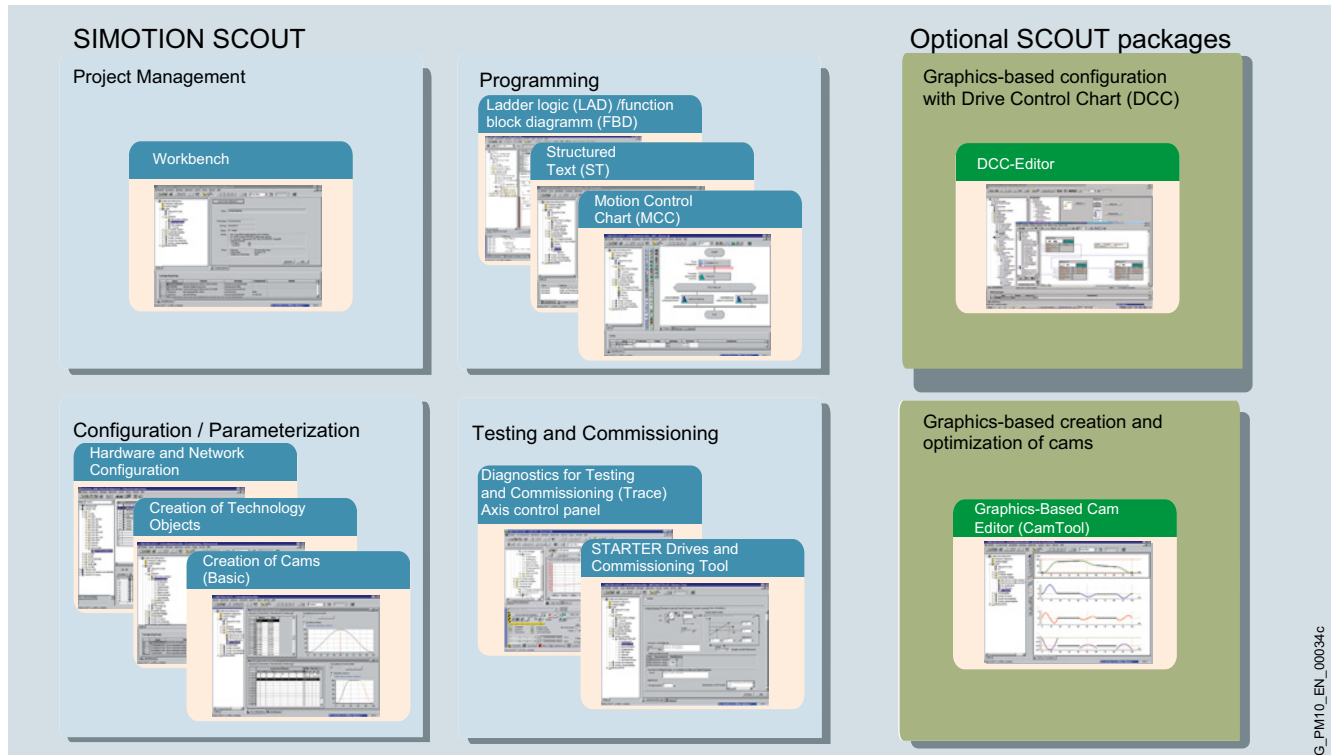

SIMOTION SCOUT: a uniform view of your automation task

#### **SIMOTION SCOUT – The holistic engineering system for your Motion Control applications**

The SIMOTION Motion Control System provides a wide variety of preprogrammed functions and you can assign parameters and program it for customized use.

For practical implementation of your automation tasks, you therefore require a user-friendly tool that will support you in completing all the necessary engineering steps:  
SIMOTION SCOUT

SCOUT is the environment for uniform automation in mechanical engineering. It supports simple engineering of complex production machines with demanding PLC and Motion Control functions.

SCOUT is available in a number of different versions that can be optimally integrated into the SIMATIC landscape to ensure Totally Integrated Automation (TIA).

- SCOUT TIA for the TIA Portal,
- SCOUT for STEP 7 (SIMATIC Manager) and
- SCOUT stand-alone if STEP 7 is not installed

SCOUT provides

- an integrated, function-oriented view of your automation task, combined with
- a high level of user friendliness

The possible SIMOTION applications range from a simple, parameterizable, speed-controlled single axis through to complex, mechatronically-coupled and programmable multi-axis machines.

Therefore, SCOUT provides views adapted to the task and can be expanded with additional tools (e.g. tool for the graphic creation of cams).

#### **SIMOTION SCOUT – A tool for engineering, testing and diagnostics**

SCOUT supports all the steps required for creating a Motion Control application: configuration, parameterization, programming, testing and diagnostics. The integrated test and diagnostics functions are useful when commissioning and servicing.

The graphical menu system of SCOUT supports the user with important tasks, such as:

- Creation of the hardware and network configuration
- Creation, configuration and parameterization of technology objects such as axes, measuring inputs, output cams, cam tracks and cams.

# SIMOTION Motion Control System

## SIMOTION engineering software

### Overview

#### Overview (continued)

#### **SIMOTION SCOUT – Support for text-based and graphical programming**

SIMOTION has the right programming language for any task:

- LAD (Ladder Diagram) and FBD (Function Block Diagram)
  - Graphical programming languages in accordance with IEC 61131
  - Especially for cyclic tasks (e.g. logic)
  - Programmer can switch between LAD and FBD at any time
  - Program status indication for testing and diagnostics
- Structured Text (ST)
  - Text-based high-level language in accordance with IEC 61131; including object-oriented programming
  - The "all-rounder" capable of any task
  - Debug functions for online testing and diagnostics
- Motion Control Chart (MCC)
  - Graphical programming (flowchart)
  - Especially for sequential tasks (e.g. Motion Control)
  - Structuring based on module creation
  - Simple diagnostics by means of graphical step tracing and single step mode
- Drive Control Chart (DCC)
  - Graphical configuration of open-loop and closed-loop control functions
  - Block library with a large selection of control, calculation and logic blocks
  - Not for SCOUT TIA (SIMOTION in the TIA Portal)

The SIMOTION execution system offers cyclic tasks (including tasks that are synchronized with control and interpolator cycles), sequential, time-triggered and event-triggered tasks, as well as one StartupTask and one ShutdownTask per system.

- User programs may be "hooked into" each task.
- The programming languages (LAD, FBD, ST, MCC) can be freely mixed in the programming of applications.
- Modularization of software is supported by a "unit concept"
  - "Encapsulation" of data and functions
  - Reliable, reusable program code

The object-oriented programming concept provides you with powerful tools for creating systematically standardized, modularized software – to ensure that you are well-equipped to meet future challenges in the field of machinery and plant engineering.

#### **Optional CamTool package (cam editor)**

The optional CamTool package expands SCOUT with a powerful graphical tool for creation and optimization of cams. Simple editors for creating cams are already integrated in SCOUT as standard.

The CamTool option package fully integrates into the SCOUT user interface.

#### **Optional Drive Control Chart (DCC) package**

With Drive Control Chart (DCC), drive-based open-loop and closed-loop control functions can be easily configured graphically. Multi-instance function blocks are selected from a standard function block library, and then graphically linked by means of drag and drop and parameterized. The control structures are presented clearly in SCOUT. DCC is not available for SCOUT TIA (SIMOTION in the TIA Portal).

Challenge	Software requirements	The solution: Object-oriented configuration mechanisms
<ul style="list-style-type: none"> <li>• Pressure to develop innovative machine designs</li> <li>• More flexible machines</li> <li>• Optimized software development processes</li> <li>• Increased effort and expense in maintaining software</li> <li>• Digitization/Industrie 4.0</li> </ul>	Modularization of software must be made easier	Objects: Modules that function autonomously
	Software must be more standardized and reusable	Libraries
	Programming outlay must be reduced	Inheritance of program code (software need not be adapted)
	Software must be easier to maintain and change	Inheritance of debugging mechanisms in all derivations
	Larger-scale software projects must be easier to implement with fewer errors	Encapsulation, inheritance and overwriting
	Increased security	Encapsulation of objects
Improved support for independent development of software components	Freely combinable object types	

### Overview

The SIMOTION SCOUT software package is the basis for implementation of the SIMOTION Motion Control System.

It essentially contains the SIMOTION SCOUT engineering system including the integrated STARTER commissioning tool and the runtime software for all SIMOTION platforms.

SCOUT also supports the engineering of SIMOTION platforms with older runtime versions.

### SIMOTION SCOUT

The SIMOTION SCOUT engineering system offers the user numerous advantages in terms of operability. The focus is on easy connection of the SINAMICS S120 drive system, comprehensive comparison functionality and a number of usability functions.

#### Connection to SINAMICS S120

The most important advantage of the SIMOTION SCOUT engineering system is the extremely easy connection to the SINAMICS S120 drive system. Drives and their components are integrated automatically to the greatest possible extent. The connections to the drive objects are simply interconnected, whereby the required message frames are automatically generated by the engineering system.

#### Project comparison based on programming languages ST, LAD/FBD and MCC

The detail comparison option is available as a textual comparison, but also in the graphical programming languages LAD/FBD and MCC (Motion Control Chart). This enables the graphical comparison of programs, where the different structures and commands can be recognized through colored highlighting. It is easy to transfer program sections containing deviations identified by the comparison process into the reference project (merge function). The comparison function is available for offline-offline and also for offline-online comparison.

#### Uniform display of lists

The display of all lists in the system has been simplified and adapted to the well-known look and feel of Office applications. The highest possible data security was observed during the implementation. If there are any input errors (e.g. error in copy and paste operation), the system restores the data. In this way, even beginners can become familiar with the engineering software intuitively, quickly and safely.

#### System trace across several Motion Controllers

The so-called system trace feature is available for analysis or system optimization. This enables up to 128 signals from SIMOTION controllers networked via PROFINET to be recorded synchronously.

#### Trace for technology objects

With TO trace, all events affecting a technology object can be recorded in real time and displayed in detail in a chronological sequence in the engineering system.

#### Watch tables

The watch tables provide extensive functions and diagnostic options. They allow different variables of the project (also different devices) to be collected. The watch tables can be clearly displayed and controlled with current values. Stored control value tables can also be used to perform comprehensive test sequences quickly and easily.

#### Diagnostics and troubleshooting

Functions such as the "Trace" in the MCC editor, which make the program sequence visible and understandable even with rapid command transitions, provide greater clarity in diagnostics and troubleshooting. Or "talking" icons in the tabs of the opened programs that refer to active status or debug functions.

#### Easy programming

Greater clarity in general programming is provided through features such as display of the variable type, display of the current value when there is an online connection and language-dependent comments when the cursor is moved over the code ("tooltips").

Rollout tips provide the user with information on input errors or system information that is still missing when working in tables or entry fields.

The system-wide effective automatic completion of user entries ("Auto-Complete") with automatic correction of upper/lower case makes the editing process more efficient and provides an easily readable program code.

The local and project-wide find/replace function finds the variable in question quickly and replaces it if required. Filters activated with check boxes enable the search to be restricted or expanded as required.

Functions available in editors of all languages, such as "Go to: next place used, previous place used, declaration, or additional places of use", support efficient searching for variables used.

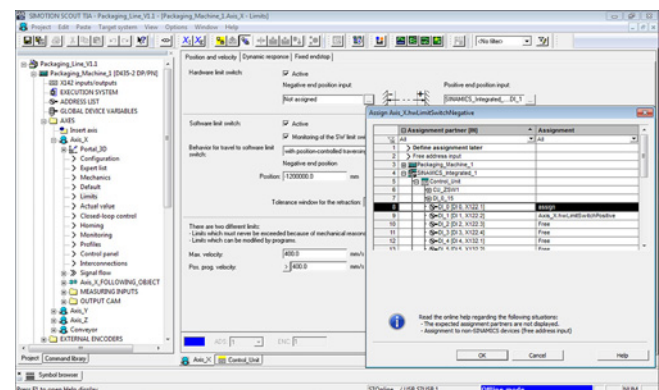

Simple interconnection of the drive I/Os

# SIMOTION Motion Control System

## SIMOTION engineering software

### SIMOTION SCOUT

#### Overview (continued)

2

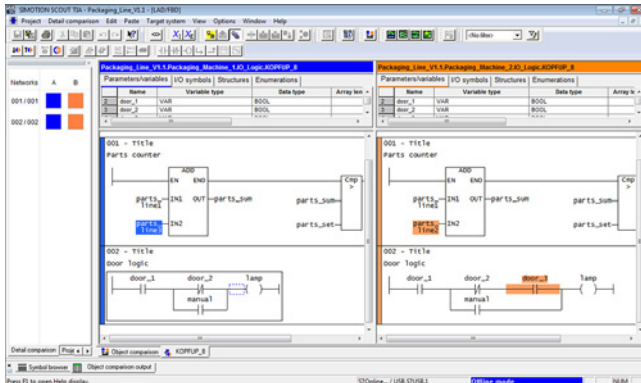

Detail comparison with ladder logic (LAD)

#### **Integrated STARTER commissioning tool**

The STARTER commissioning tool is directly integrated in SCOUT. It supports the simple and rapid commissioning, optimization and diagnostics of all new-generation Siemens drives with only one tool.

The STARTER tool integrated in SCOUT TIA can be used to commission SINAMICS S120 drives connected to the SIMOTION system.

#### **SIMOTION SCOUT stand-alone**

If STEP 7 is not installed, the SIMOTION SCOUT stand-alone software package can be used. It also contains the components of STEP 7 that are required for SIMOTION SCOUT as well as the license for SCOUT stand-alone.

It is not possible to operate the SCOUT and SCOUT stand-alone software packages on the same machine.

#### **SCOUT TIA V4.5 (SIMOTION in the TIA Portal)**

Now that the SIMOTION Motion Control System has been integrated into the Totally Integrated Automation Portal, the TIA Portal offers the full Motion Control functional scope of SIMOTION including comprehensive integration of drive technology.

New, highly efficient, user-friendly mechanisms for configuring hardware and networks are now also available in the TIA Portal in a consistent, fully graphical editor, as well as easy connection to HMI (including the new SIMATIC Comfort Panels and the Basic Panels of the 2nd generation).

All the automation components are combined in the TIA Portal project.

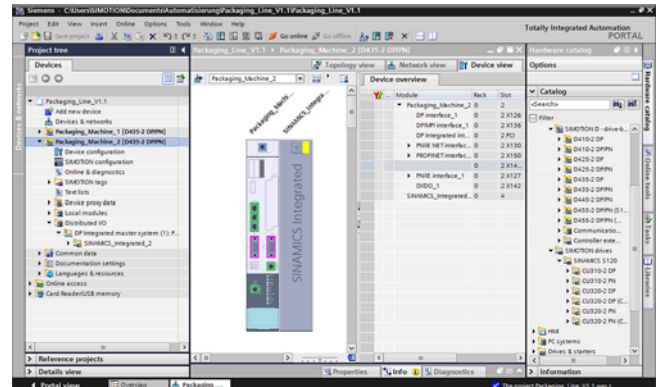

With SCOUT TIA V4.5, the SIMOTION C240/C240 PN and SIMOTION P320-4 Motion Controllers as well as the SIMOTION D410-2 and D4x5-2 Control Units complete with CX32-2/ CBE30-2 can be configured in the TIA Portal. The runtime version must be V4.3 or higher.

The "SIMOTION Drives" are also available in the TIA Portal. These are SINAMICS S120 drives with firmware versions V4.5, V4.7 and V4.8, which are networked with the SIMOTION CPU on the basis of PROFINET or PROFIBUS.

#### Migration of SCOUT project to SCOUT TIA

The "Migration tool" of the TIA Portal and the additional "Migration tool plug-in" of SCOUT TIA can be used in principle to migrate an existing SCOUT project in version V4.4 or higher to SCOUT TIA V4.5 (TIA Portal V14). Both are an integral part of the TIA Portal installation and the SCOUT TIA installation.

#### Notes about usage

The following functions of SCOUT and the TIA Portal in particular are not supported by SIMOTION SCOUT TIA V4.5:

- DCC SIMOTION/DCC SINAMICS
- Scripting of HWCN data; which also affects SIMOTION easyProject (project generator)
- XML export/import of HWCN data (note: XML export/import of pure SCOUT/SCOUT TIA data is possible)
- PROFIBUS: F-Proxy as an I-Slave



### Overview

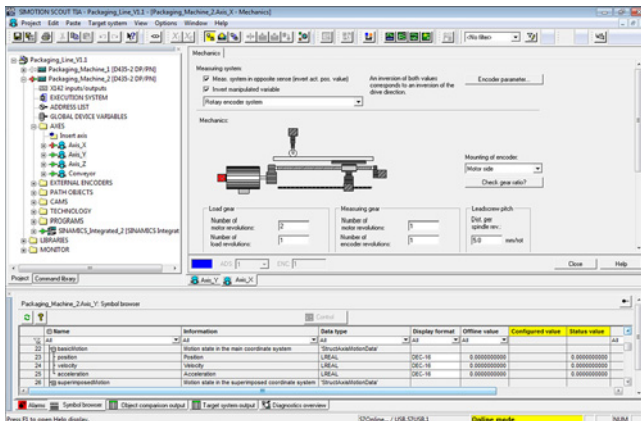

The SCOUT Workbench is the common frame for all tools of the engineering system. The Workbench is the central navigation point for the individual engineering steps. It is used for the creation and management of SIMOTION projects and provides a uniform and integrated view of all devices, data and programs.

#### The SCOUT Workbench:

##### Project navigator – Work area – Information area

- Project navigator (left): The project navigator displays the technological tree structure of the project. All devices (controller, drives, etc.), all technological objects (axes, cam tracks, cams, etc.) and user programs are displayed in filterable hierarchical views. From here, new objects/programs can be created or existing ones called for modification.
- Work area (right): All editing tools of the engineering system (parameterization dialogs, program editors, etc.) can be integrated (SNAP IN) in this work area. This provides you with an individual view adapted to the situation in a fixed outer frame for each engineering task. If more than one window is open at the same time, they can be arranged as required or you can toggle between them by selecting the tabs.
- Information area (bottom): The situation-dependent views for data and messages provided by the detailed display can be activated and deactivated. The data involves system variables provided by the devices and the technology objects, the peripheral data (inputs/outputs) and the user variables that you have defined. Their current states for an online connection with the SIMOTION device can be visualized. The message view refers both to the messages and alarms reported online from the SIMOTION devices and to warnings and errors generated during programming.

### Benefits

- Holistic, function-oriented view optimized for maximum ease of use
- Integrated intuitive-to-operate engineering system
- Central data and program management, even if system is distributed
- Function-oriented, technological project structure with filterable views
- Fast access to the individual engineering tools, such as configuration, programming and commissioning

# SIMOTION Motion Control System

## SIMOTION engineering software

### SIMOTION SCOUT > Hardware and network configuration

#### Overview

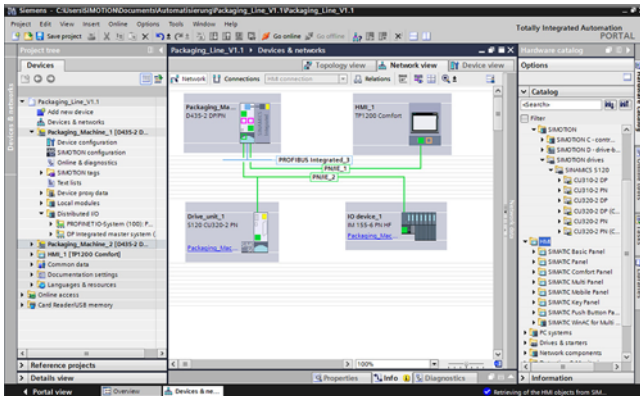

One of the first engineering steps required to specify the automation topology and parameterize the components and networks is to create the

- Hardware configuration
- Network configuration

With SCOUT TIA (SIMOTION in the TIA Portal) the tools of TIA Portal are used for this purpose (in the case of SCOUT, the STEP 7 tools HW-Config and NetPro).

With the selection from a hardware catalog, all the required hardware components are graphically assembled in the working area, parameterized and the bus connections between the individual components are created. In this way, invalid options are indicated at an early stage so that only plausible configurations can be created.

### Overview

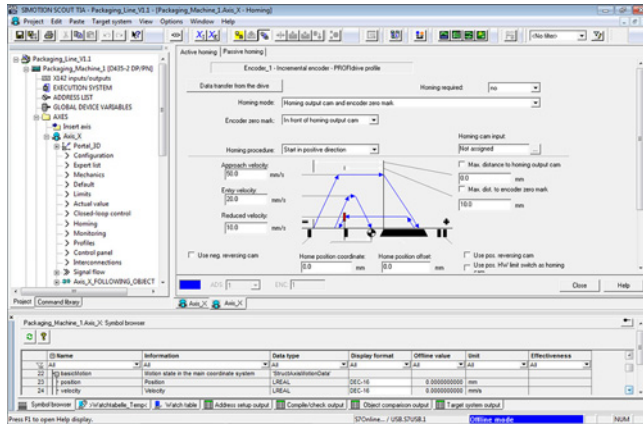

All SIMOTION controllers feature basic functions which are predefined by the SIMOTION Kernel. The scope of the language is compatible with the IEC 61131-3 standard and contains all of the necessary PLC commands for I/O management, process or machine control.

Additional functions such as positioning, synchronous operation, cams and temperature channels are available with loadable technology packages.

These technology packages permit the generation of technology objects which provide you with a very simple and uniform view of the functions of the technology packages.

There are many technology objects, but all are generated, configured and parameterized in the same way.

In addition, the technology objects have programming interfaces through which you can use the functionality from application programs.

### Working with technology objects

A brief description of the individual engineering steps will be given using the example of the technology object "Axis".

#### Generating

A new axis object is generated by double-clicking the "Insert New Axis" tab.

#### Configuration

A wizard helps to specify object properties such as:

- Name of the axis
- Functional quality (e.g. positioning axis or synchronous axis)
- Connection to the drive (e.g. SINAMICS S120 over PROFIBUS IO or PROFINET DP or an analog drive on SIMOTION C240)

After the axis has been generated or configured, it is displayed in the project tree under its name along with additional tabs for parameterizing the axis and an option for generating other technological objects associated with the axis (e.g. cam paths, measuring inputs).

### Parameter assignment

By double-clicking the "Referencing" tab, for example, all parameters for referencing can be set.

The "axis" object generated in this way also has a specified number of system variables which can be shown in a structured display in the detailed view when the axis is selected in the project tree.

The system variables are mainly used to visualize axis states such as:

- Display of the following error
- Target position to be reached
- Motion status (axis is accelerating, braking, motionless, etc.)

These system variables can also be used for:

- Online diagnostics
- Display on HMI
- Logging using the SIMOTION trace function
- Application programming through querying/comparing these system variables

Application programs access the axis functionality with system functions (selected from the command library), which are part of the "axis" object when it is generated.

The command `_pos (axis:=Axis_X, position:=100, velocity:=123)` would cause axis "Axis\_X" to move to Position 100 at Velocity 123 (example of system function in Structured Text).

### Benefits

- Easy generation of the technology object for determining the quantity structure
  - Axes
  - Cams and cam tracks
  - Measuring inputs
  - Cam disks, etc.
- Menu-guided parameterization, graphically supported for easy understanding
- Easy visualization and access to functions through system variables and system functions of the technology objects
- User-friendly diagnostic information for function optimization of the technology objects
- Meaningful alarms in the form of numbers and plain text in the event of errors

# SIMOTION Motion Control System

## SIMOTION engineering software

### SIMOTION SCOUT > Creation of cams (basic)

#### Overview

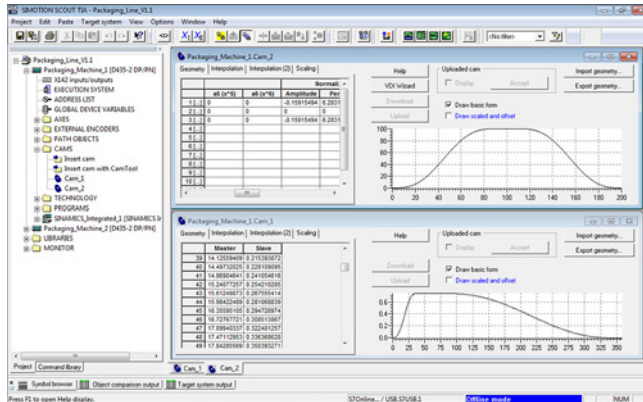

A cam generally specifies the motion relationship between a leading axis (master axis) and a following axis (slave axis). Cams can also mirror velocity profiles, pressure characteristics or valve characteristic compensation for hydraulic axes. The cam technology object can process cams which are defined as interpolation point tables or polynomial descriptions.

The basic scope of SCOUT contains editors to create simple cams in the form of text in a table or using polynomials (VDI assistant) in the form of graphics symbols with configuration support.

#### Creation of cams

When the technological object "Cam" is generated, the type "Interpolation point table" or "Polynomial" is defined.

- **Interpolation point table:**  
With this type, the master and slave positions are entered in a two-column table. It is also possible to use external interpolation point tables (ASCII file, Excel table).
- **Polynomials:**  
Polynomials describe motion laws in accordance with VDI 2143. SIMOTION supports polynomials up to the 6th degree. In polynomial mode, the cam is described by a number of consecutive polynomials. Polynomials are entered in the form of a polynomial table. Users can use a polynomial description dialog and/or VDI assistant.

The result of the input is displayed in the right-hand side of the window in the form of a curve in the coordinate system.

In addition, other parameters such as the interpolation type between the curve support points or the scale of the cam can be specified. The SIMOTION CamTool option package can be used to display and optimize cams graphically.

#### Benefits

- Editors for simple cams are included in the basic scope of functions of SCOUT
- Graphic visualization of the cam so that input errors can be quickly identified
- Representation as interpolation point table with options to transfer data from external sources (ASCII, Excel)
- Alternative: Representation by polynomials up to the 6th degree with inputs supported by polynomial description dialog and VDI wizard

## Overview

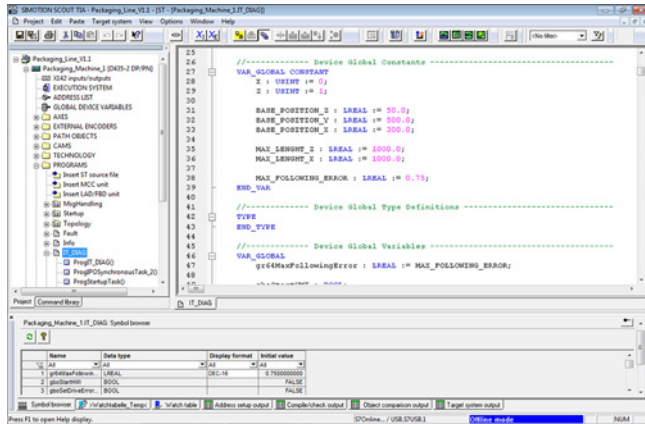

The high-level language ST (Structured Text) provides all language elements as text commands. This enables well-structured applications to be created.

The basic scope of commands includes:

- Commands for data management
- Arithmetic functions
- Control structures
- Commands for accessing I/O
- Communication functions
- Object-oriented programming according to IEC 61131-3 ED3

The addition of technology packages for Motion Control adds powerful, extremely flexible Motion Control commands to the instruction set (e.g.: `_pos(...)` for positioning axes). The system functions can be selected from a clearly arranged library and can be used in the ST source by means of drag & drop.

An ST source file basically consists of continuous text. This text can be structured by dividing it into sections. These sections represent logical units of an ST source.

These sections can be:

- a program that is assigned to a runtime level,
- a class with its subordinate methods,
- a function block with its own memory, or
- a function without its own memory

Function blocks, classes and functions are not allocated to a runtime level, but are instead called and supplied with parameters in programs.

## Benefits

- Motion Control, PLC and technology functions in a single language
- Well-structured programs with comment capability
- High-performance editor functions such as syntax coloring, Autocomplete and automatic indenting
- Easy-to-use debug functions for online testing and diagnostics: for example, the display of the current variable contents of the code sequence and breakpoints visible in the editor.

# SIMOTION Motion Control System

## SIMOTION engineering software

### SIMOTION SCOUT > Motion Control Chart (MCC)

#### Overview

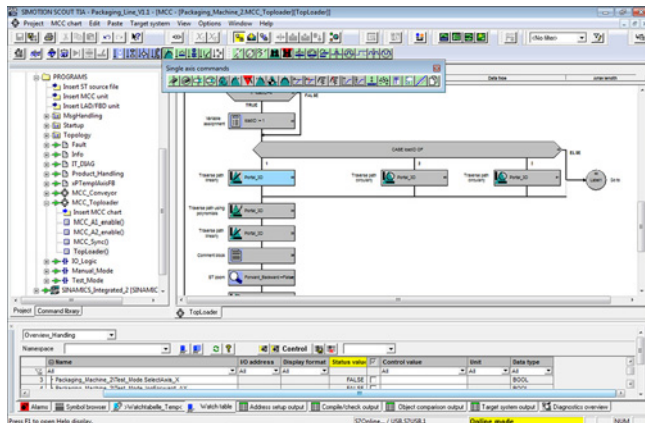

MCC (Motion Control Chart) is a "flow diagram language" that can be used to graphically formulate the process procedures in production machines in a simple manner. The result is one or more flow diagrams, comprising MCC blocks that describe the time sequence of the individual machine actions. Due to its special means of expression, MCC (Motion Control Chart) is ideally suited to programming sequential processes.

Motion Control Chart supports the simple description of the movement sequences of machines using powerful Motion Control commands, for example: Axis referencing, axis positioning, cam synchronization and desynchronization, and much more.

Various MCC blocks are available for controlling the machine, for example, conditions must be fulfilled, I/O signals can be read or set, calculations can be formulated and different control structures such as condition (IF), cases (CASE) and loops (WHILE, REPEAT UNTIL) can be programmed.

Several MCC programs may be created to describe different process situations. For example, you can create one MCC program to bring the machine to a defined initial state when it is switched on, a second MCC program for the normal production sequence, and a third MCC program to specify what the machine has to do in the event of a fault.

All MCC blocks – a selection of the most important SIMOTION functions – are available in toolbars. They are grouped according to function and automatically inserted in the flow diagram at the marked point by clicking. By clicking on different elements, individual dialogs for further parameterization are opened. Of course, it is also possible to include individual comments to document the process sequence. Functions from the SIMOTION command library that are not individually offered as MCC blocks can be used in an MCC program by means of a special command.

#### Benefits

- Representation as graphical flowcharts makes programming especially easy
- Hierarchical command library for Motion Control, PLC, and technology functions.
- Control structures (IF, WHILE, CASE, etc.)
- Zoom-in functions for LAD, FBD and ST
- Subprogram calls (FB/FC/methods)
- Structuring based on module creation, i.e. combination of command sequences to form a module command. Clicking on the module command invokes the corresponding command sequence.
- Powerful test functions for online connection with the SIMOTION controller such as graphical step tracing, single-step mode and breakpoints.

## Overview

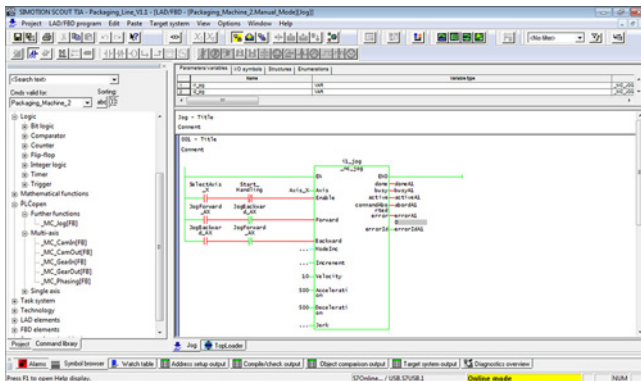

A powerful editor for LAD/FBD programming is available for ladder diagrams (LAD) or function block diagrams (FBD).

LAD/FBD also include commands for SIMOTION control using standard logic functions. Motion Control tasks are preferably programmed with PLCopen blocks. Blocks which have been programmed in other SIMOTION languages can be called without problems. User-friendly functions such as "on the fly" variable declarations or automatic syntax checks are available when programming in LAD or FBD. It is possible to switch over between LAD and FBD in the editor at any time. A program can therefore be viewed and processed in either LAD or FBD.

## Benefits

- The LAD/FBD blocks are stored in the SIMOTION project
- Existing PLCopen, ST, LAD/FBD or MCC blocks can be called from within the LAD/FBD program.
- Network titles and comments are available.
- Special functions such as automatic syntax checking or "on the fly" variable declaration can be activated.
- The commands are loaded from a library

For startup and troubleshooting purposes, the status of the LAD/FBD programs is displayed in online mode. In addition, break points can also be defined in LAD/FBD programs.

2

# SIMOTION Motion Control System

## SIMOTION engineering software

### SIMOTION SCOUT > Diagnostics for testing and commissioning

#### Overview

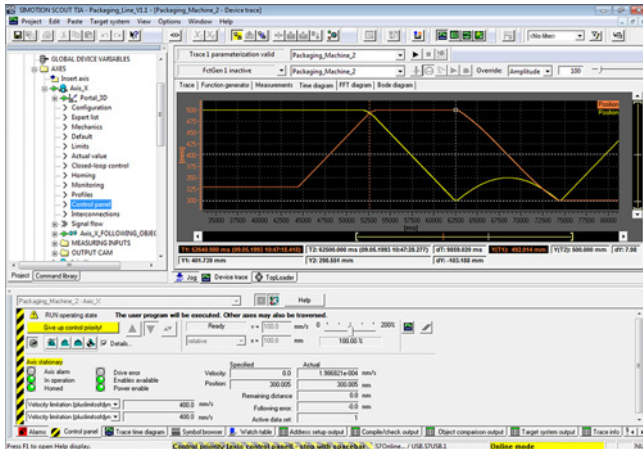

SCOUT includes a number of diagnostic tools to make testing and startup of SIMOTION applications as simple as possible:

- Device diagnostics can be used to display program execution status, system load and memory usage.
- The diagnostic buffer is used to log the fault history. The following events are logged in the diagnostic buffer of the SIMOTION device:
  - All system status changes (RUN, STOP, etc.)
  - System interrupts with date and time.
- All error messages related to technology objects (e.g. axis errors) are displayed in the Alarms window of SCOUT with the fault number and description.
- All SIMOTION system and application variables can be dynamically updated, monitored and controlled while online with the SIMOTION controller.
- All programming errors are displayed with the location and cause during compilation.
- The status display for programs with possible break points (LAD/FBD, MCC, ST) and additional step-by-step tracing (MCC) helps the user to troubleshoot and optimize their code. During program execution, the values of the variables are displayed as they arise, Not only at the end of the cycle when the sum of all changes has been implemented.
- Watch tables can be used to combine important variables of different objects in the project to monitor them, even those of different SIMOTION devices.

#### Axis control panel

The axis control panel can be used to commission the axes with SIMOTION SCOUT. The axes can also be traversed and optimized directly from SCOUT without any user programs.

#### Path control panel

SIMOTION SCOUT provides a path control panel for commissioning handling kinematics. This supports easy commissioning and optimization of kinematics directly from SCOUT, even without a user program.

#### Trace function

The most powerful tool for testing and commissioning is the trace function integrated in SCOUT.

In this manner, a selection of any of the data in the system (user variables, I/O variables, data of the technology objects such as actual position of an axis) can be recorded and traced, real-time. Up to 32 signals are possible in test mode.

Each SIMOTION device has a trace buffer which can be configured with the trace functionality of SCOUT. When the trace is started, the configured data is logged in the SIMOTION device. On completion of the trace, the contents of the trace buffer are read by SCOUT and displayed graphically.

The trace parameterization and the trace recordings can be stored in non-volatile memory on a memory card.

In the system trace, up to 128 signals can be recorded time synchronized from several SIMOTION controllers.

#### Configuring the trace function

The trace function can be configured using the following parameters.

- Trigger condition (e.g. rising edge of a definable signal) and pre-trigger
- Time Limit Recording (a multiple of the basic cycle of the SIMOTION device)
- Continuous recording (or endless trace with ring buffer)
- System variables to be logged (system, I/O and user variables)

#### Evaluating the trace data

The logged data is displayed in the form of graphs over time for evaluation. The following functions are offered here:

- Different colors can be selected for the curves. Curves can be switched off and on again.
- The zoom function can be used to show details.
- Rules support the measuring of, for example, signal level and duration.
- Possible changes can be viewed by superimposing measuring curves from different trace logs.

Apart from recording, the trace function also offers a "function generator" and mathematical functions.

The traced curves can be stored or exported to Microsoft Excel as a table for further evaluation. Of course, the plots can also be stored for documentation purposes, inserted in documents or printed out.

#### Automatic optimization of the control loops

Automatic optimization of the control loops makes commissioning of the axes and drives particularly easy. For SINAMICS S120 drives, the parameters for the speed controller and the position controller are automatically determined (with DSC).

#### Integrated measuring functions

The integrated measuring functions support the recording of, for example, step responses for optimization as well as the detection of electromagnetic weak points or resonant frequencies (using, for example, bode diagrams and FFT analysis). Electronic filters can be optimally placed at these resonant frequencies to achieve higher dynamics.



### Overview (continued)

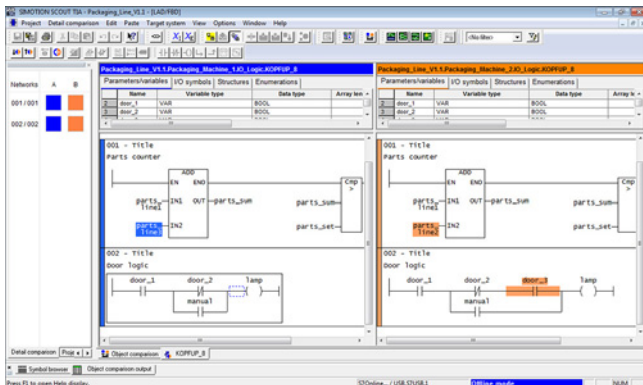

Detail comparison with ladder logic (LAD)

### Comparison function for projects

It is possible to compare and, if necessary, match the components of different projects.

It is therefore possible to perform a CPU-based comparison between the objects of a project.

An overview of the differences between objects is displayed. Objects with differences can be matched.

If necessary, to a highly detailed degree: Objects can be matched right down to data level also for individual data.

### Advantages for practical working with SIMOTION:

- Online/offline comparisons allow the target device and project to be matched
- Offline/offline comparisons make it possible to merge programs
- Detailed differences between data can be identified in the detailed comparison
- Data missing from the engineering project are easy to restore if the source data are stored in the target system.

### Benefits

- Numerous easy-to-use and expressive diagnostic tools are fully integrated in SCOUT
- Extremely useful support with optimizing and troubleshooting
- All information can be printed in the form displayed on the screen for documentation purposes
- Axis control panel for commissioning and optimizing the axes without the need for an application program
- Path control panel for commissioning and optimizing kinematics without the need for a user program
- Automatic controller optimization for fast commissioning
- Comprehensive, integrated comparison functions for the ST, MCC and LAD/FBD languages enable differences to be identified between projects or between the current project and the device.

# SIMOTION Motion Control System

## SIMOTION engineering software

### Optional packages for SIMOTION SCOUT > CamTool (graphical cam editor)

#### Overview

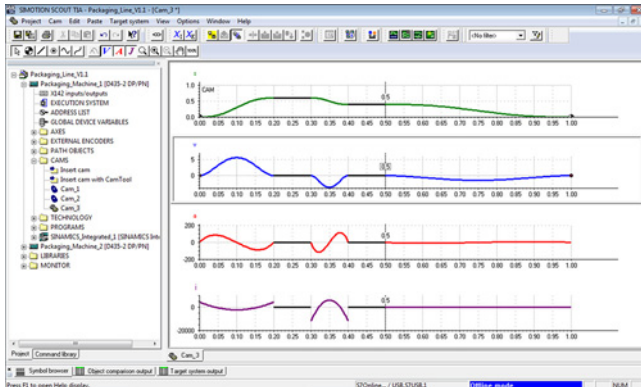

SIMOTION CamTool is a powerful, graphical editor for creating and optimizing cams.

SIMOTION CamTool can be used as an expansion package for SIMOTION SCOUT and is completely integrated in the SCOUT user interface.

#### Benefits

- Precise graphical representation of the cam profile
- Entries can be made quickly and easily by inserting curve elements with drag & drop operation
- Fast and easy optimization of the curve by means of "dragging the profile"
- Simultaneous display of position, speed, acceleration, and jerk characteristics immediately indicates the effect on the maximum speed, the required motor torque, and the mechanical load
- Curve can also be optimized with respect to speed, acceleration, or jerk
- Basic principles of motion correspond to VDI 2143

#### Function

- The curve is displayed graphically in an x-y-diagram (positions of leading and following axes). The curve profile is first roughly entered here with individual elements such as fixed points, lines and support points. Lines can be entered as straight lines, sine curves or arc sine curves.
- SIMOTION CamTool then connects these individual elements automatically to a continuous curve. The transitions between the individual curve sections are shaped as homogeneously as possible.
- You can optimize the curve by simply moving the specified curve sections with the mouse. The curve profile is immediately adapted to your changes.
- In addition, SIMOTION CamTool can display the course of the velocity, acceleration and jerk of the following axis over the motion of the leading axis.
- SCOUT can be used to convert cams created with CamEdit to the format used by CamTool or vice versa.

### Overview

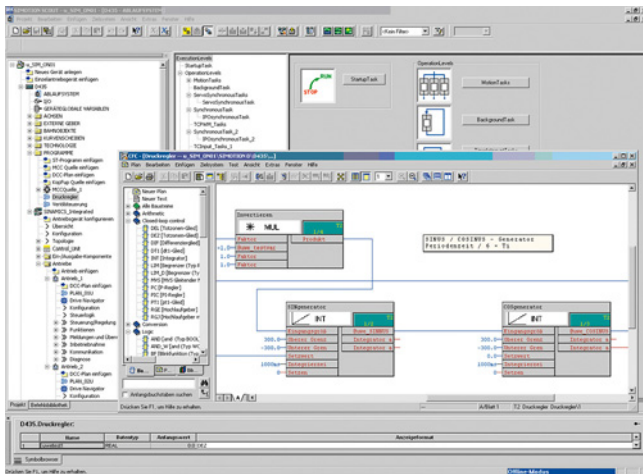

The Drive Control Chart (DCC) option packages for SIMOTION and SINAMICS extend the range of tools provided in SIMOTION SCOUT for easy graphical configuring of technology functions using predefined function blocks.

Multi-instance function blocks are selected from a predefined library and graphically interconnected using drag and drop. The function block library comprises of a large number of control, calculation and logic blocks as well as extensive open-loop and closed-loop control functions. Numerous calculation functions, such as summation, division and minimum/maximum evaluation are available for monitoring and evaluating numeric variables.

Drive Control Chart (DCC) does not limit the number of functions that can be used.

Note: DCC is not available for SCOUT TIA (SIMOTION in the TIA Portal and its drives).

### Benefits

- Clear presentation of technical control structures
- High degree of reusability of previously created plans
- Graphical editor for configuring open-loop and closed-loop control functions which can be operated without any programming know-how
- With Drive Control Chart for SIMOTION, closed-loop control structures can be programmed almost without constraints. These can then be combined with other program sections to form an overall program.
- Drive Control Chart for SINAMICS S120 provides a convenient basis for implementing drive tasks directly in the converter.

# SIMOTION Motion Control System

SIMOTION engineering software

Options for SIMOTION SCOUT > SIMOTION easyProject project generator

## Overview



### Standard modules in project generator

#### Technologies

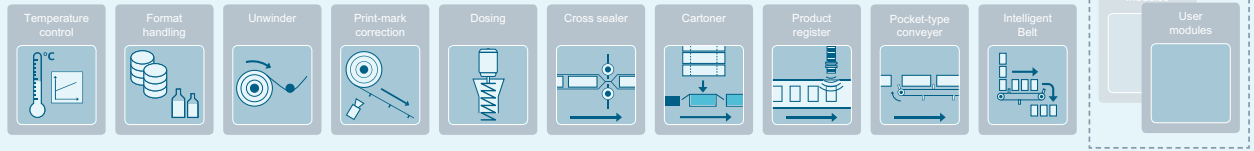

#### Basic

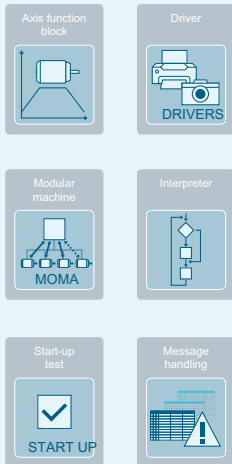

#### Diagnostics

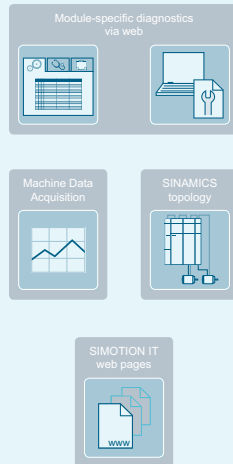

#### Operating mode management

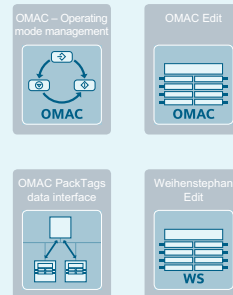

#### Communication

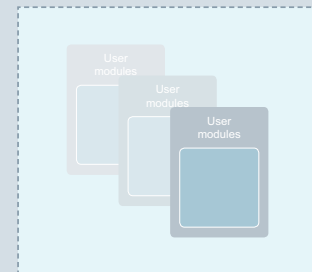
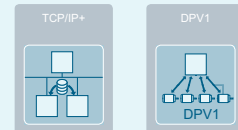

G\_PM10\_EN\_00225

If the complex processes associated with production machines are to be managed efficiently, there is no alternative but to modularize the automation software. This kind of software comprises modules that are designed to function autonomously without influencing the operation of other modules. The data of individual modules are "encapsulated" and the modules are only allowed to interact through specially defined interfaces. Modularized software can be created using one of the standard programming methods provided in SIMOTION.

It is possible to go a step further by creating software modules that are scalable and hardware-neutral and program them with configurable functions. The SIMOTION easyProject project generator can then be used to combine these individual modules to form a complete project.

Engineering projects can be developed faster and cheaper if they are created using standard modules and the automatic project generation functions provided by easyProject. The process of engineering automation solutions is made even more efficient.

SIMOTION easyProject can be opened directly from SIMOTION SCOUT and is included on the SIMOTION Utilities & Applications DVD that is supplied free of charge with SIMOTION SCOUT.

#### Note:

The SIMOTION easyProject project generator is not currently available for SCOUT TIA (SIMOTION in the TIA Portal).

A wide variety of applications have been realized in different sectors using the SIMOTION Motion Control System, and various basic, technology and application modules have been developed and optimized for this purpose. These well-proven software modules that have become quasi standard can now be integrated into a new or existing engineering project in an extremely easy manner with the project generator. This is done by first selecting the SIMOTION components and then the required modules in simple selection screens. Their integral or predefined functions are then configured with a mouse click. The engineering project is finally generated ready for loading and execution. This saves complicated programming work and at the same time creates the preconditions for a uniform and therefore standardized project structure.

The project generator includes standard modules for basic functions as well as functions relating to diagnostics, operating mode, communication and technology.

### Overview (continued)

The basic functions that can be used in practically every SIMOTION application and which are provided by the project generator include:

- **Message handling:**  
Centralized error message handling for all components including archiving and display on a visualization system (HMI)
- **Startup check:**  
A startup check for all connected components (provides information about the status of the configured devices connected to the various field buses or internal connections)
- **OMAC:**  
Operating mode management
- **Ethernet communication:**  
Machine-to-machine coupling via Ethernet communication over TCP/IP
- **Axis function block:**  
Easy activation of basic Motion Control functions (up to and including cam synchronization) via a central (generic) axis function block
- **Interpreter:**  
A sequence interpreter for easy configuration of machine sequences using tables

These basic functions alone remove most of the manual programming and configuration work that would normally be necessary and consequently minimize the associated working time and possibilities for error.

In addition to the standard modules for basic, diagnostic, operating mode and communication functions, the project generator also offers a large number of sector-specific technology functions (see also [Solutions for industrial sectors in section Utilities & Applications](#)).

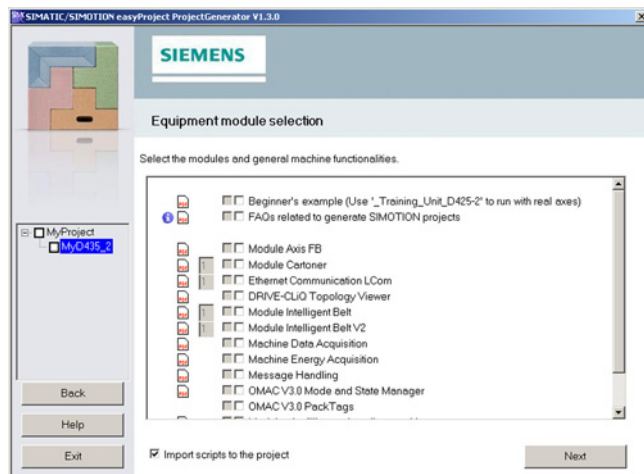

### Automatic generation of the project

When the project is generated, all the necessary technology objects (TOs) are created and connected, libraries and program modules (only the currently selected modules) are automatically linked into the project and the programs are assigned to the respective execution levels. This results in a loadable and executable SIMOTION SCOUT project comprising the required machine functions without having to write a single line of code. You can concentrate fully on the special functions of your machine (sequence, signal connections, special functions, etc.) saving a considerable amount of work so that you achieve your objective much more quickly.

SIMOTION easyProject is also designed so that it can integrate its own blocks in this generic workflow of the automatic application creation.

The uniform structure also makes a project generated in this manner extremely easy to maintain. The generated program modules can be edited and modified by the user. If standard modules of the project have been changed centrally or if new standard modules need to be linked into the project, this can be done simply by running the project generator again. During the generator run, the originally used and, where applicable, updated modules and libraries will be recognized and displayed. These can then also be updated in the project automatically.



### Web-based diagnostics

The project generator also creates specific web pages for the separate modules. These can be loaded into the SIMOTION controller, if required, to offer additional customized diagnostic functions to those provided by every device via the integrated web server and the standard diagnostic pages of SIMOTION IT. This means that commissioning or specific service tasks can also be performed using a standard web browser – without the need for an engineering system. It is of no consequence here whether you connect to the controller via a network cable or via a secure connection over the Internet (e.g. through a VPN tunnel).

# SIMOTION Motion Control System

## SIMOTION engineering software

Options for SIMOTION SCOUT > SIMOTION easyProject project generator

### Overview (continued)

#### Standard blocks – two examples:

Example 1: Axis function block:  
The standard "axis function block" covers a range of requirements that concern the activation of axis technology objects and simplifies programming, commissioning and testing of each axis object due to its central interface. The integrated HTML control panel enables the axes controlled by the axis function block to be tested easily – without any HMI or engineering system.

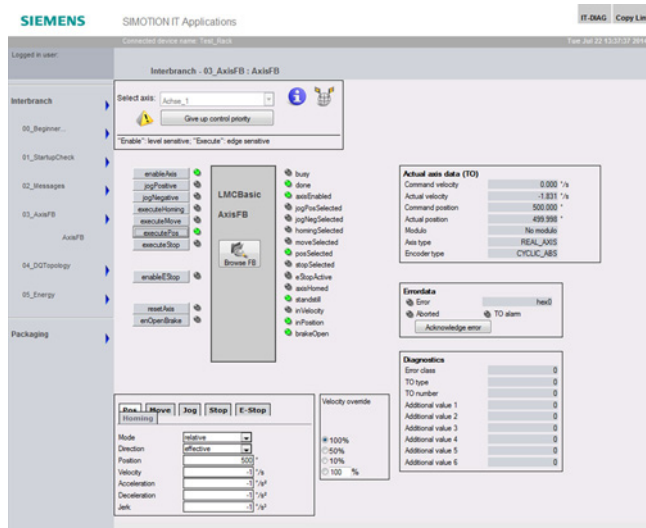

#### Example 2: Message handling:

The core tasks of the generic basic module "Error message handling" include the chronological collection of system, TO, drive, I/O and user messages and their conditioning for display on the operator panel – or their direct display via a web browser. The specific diagnostic pages are a huge advantage during initial commissioning, but particularly in the event of a fault or during servicing, because fault states can be diagnosed without the need for an engineering system and standstill times can be minimized.

#### Modular machine functions

The project generator also supports the modularization of machine functions in accordance with the specification of international standard ISA-88. The module structure is defined in ISA-88. This ensures a simple and uniform structure for machines. Basic, technology and application modules are combined to implement clearly comprehensible modularization for machines using functional units.

#### Additional information

For more information, go to <https://support.industry.siemens.com/cs/ww/en/view/62049135>

### Overview

The SIMOTION Utilities & Applications DVD, which is available free of charge, provides you with a wide range of valuable information and tools for SIMOTION.

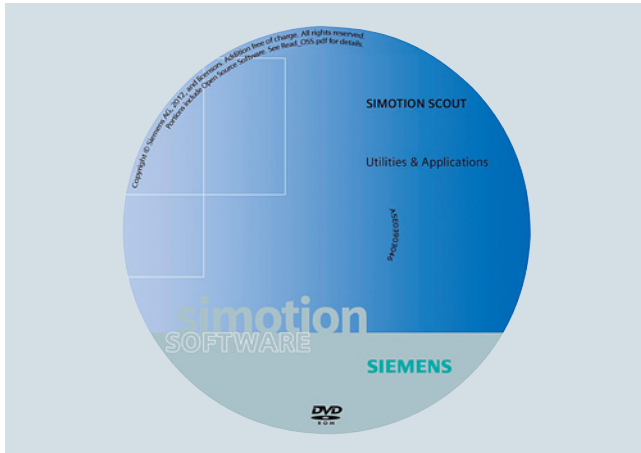

- SIMOTION easyProject project generator
- Applications
- SIMOTION IT
- FAQs
- Examples
- Tools and documentation
- Scripts for SIMOTION

SIMOTION Utilities & Applications is part of the scope of delivery of SIMOTION SCOUT.

#### **SIMOTION easyProject project generator**

See [SIMOTION easyProject project generator](#) for further details, page 2/92.

#### **Applications for industry solutions**

So that you don't have to reinvent the wheel every time, we have developed a range of applications for SIMOTION that are available as well-documented master solutions and that can be easily adapted to your specific projects with minimal engineering outlay.

Simple HMI faceplates are also included that have been adapted to the application. The diagram of industrial sector solutions provides an overview of the applications that are currently available.

#### **SIMOTION IT**

Diagnostics, maintenance and operation can be performed locally or remotely using a PC with standard browser installed thanks to the web servers available on all SIMOTION devices. You will find helpful examples and tools here for creating your own HTML pages.

#### **FAQs (Frequently Asked Questions)**

We provide answers to the questions most frequently asked about SIMOTION.

#### **Examples**

Based on comprehensively documented examples, we make it easy to get started with SIMOTION and show how even complex applications can be easily implemented.

#### **Tools and documentation**

You will find easy-to-use tools for many tasks, as well as detailed documentation.

#### **Scripts for SIMOTION**

Numerous engineering tasks can be automated with the SIMOTION scripting function. The selection of documents and scripts provided here show how you can use scripts in your projects.

A number of example scripts that you can implement directly will make working with SIMOTION even easier.

#### **Additional information**

For more information, go to

<https://support.industry.siemens.com/cs/ww/en/view/62049289>

# SIMOTION Motion Control System

SIMOTION engineering software

Options for SIMOTION SCOUT > SIMOTION Utilities & Applications

## Overview (continued)

### Solutions for industrial sectors

Converting	Metal Forming	Printing	Packaging	Textile	Handling
Converting Toolbox	Hydraulic Press	Printing Toolbox	Packaging Toolbox	Roving Frame	Handling Toolbox
Converting Library	Servo Press	Print Standard	Packaging Library (LPac) • Product Supply and Dosing • Film Control • Sealing • Auxiliary Modules • Temperature Control • Cam Calculation	Draw Frame	Handling Basic
Flying Saw	Mechanical Press	Segment Offset		Comber	TopLoading
Traversing Drive	Blanking Line	Segment Gravure		Ring Spinning	Kinematic Transformation
Rotary Knife	Roll Feed	Segment Corrugated		Chemical Fiber Spinning	Product Register
Axis FB	Feeder	AddOn Register Control	Intelligent Belt	Filament Winding	Handling HMI
Winder & Splice	Electronic Transfer	AddOn Reel Stand	Cartoner	...	OMAC 3.0
Tension Control	Servo Pump	AddOn Sigate	Line Integration OMAC		G-Code Interpreter
...	...	AddOn WebAccu	Line Integration Weihenstephan		...
		...	...		
Projectgenerator SIMOTION easyProject					
Axis Function Block	Message Handling	Ethernet Communication	OMAC	HMI Template	
Startup Check	Interpreter	Energy Acquisition	DPV1 Services	HTML Setup	
Basic Functions SIMOTION easyBasics					

G\_PM10\_EN\_00231



### Overview

#### Scope of supply

SIMOTION SCOUT engineering software (including SCOUT TIA)

- SIMOTION SCOUT/SCOUT TIA software
- License for SIMOTION SCOUT/SCOUT TIA
- Integrated STARTER commissioning tool

Optional packages for SIMOTION SCOUT

- Optional CamTool package without license  
The license must be ordered separately.
- Optional Drive Control Chart (DCC) package without license  
The license must be ordered separately; DCC cannot be used with SCOUT TIA (SIMOTION in the TIA Portal).

Documentation

- Complete SIMOTION documentation on DVD

Other software

- SIMOTION – Utilities & Applications  
Free utilities (e.g. calculation tools, optimization tools, etc.) and application examples (ready-to-apply solutions such as winders, cross cutters or handling) as well as the project generator SIMOTION easyProject
- SIMATIC software:  
A suitable STEP 7 package or TIA Portal Framework must be purchased separately for use with SCOUT.  
The necessary components of STEP 7 for SIMOTION are integrated in SCOUT stand-alone.

#### **SCOUT V4.5 in the STEP 7 environment (SIMATIC Manager)**

Software requirements

- Windows 7 Professional or Ultimate (32/64 bit)
- SIMATIC STEP 7 V5.5 SP4  
(not required for SCOUT stand-alone)

Hardware requirements

Minimum system requirements PG/PC for SCOUT:

- As of Pentium V 1.5 GHz, 2 GB RAM (4 GB recommended)
- Screen resolution: 1024 × 768 pixels, 16-bit color depth
- Free hard disk memory: 3 GB

For an installation of WinCC flexible (ES) integrated in SCOUT, a main memory of 4 GB RAM is recommended.

Use of a programming device or a PC with conventional performance capacity is recommended for processing extensive SIMOTION projects with several modules:

- PG or PC with Intel® Core™ i5-3320M, 3.3 GHz or higher, or a comparable device
- Windows 7 64 bit, 8 GB RAM
- Screen resolution: 1920 × 1080 pixels, 32-bit color depth

#### **SCOUT TIA V4.5 (SIMOTION in the TIA Portal)**

SCOUT TIA always requires that a TIA Portal Framework is installed beforehand using another TIA Portal client (such as: STEP 7, WinCC, Startdrive).

We recommend that the latest update for TIA Portal is always installed.

System requirements for SIMOTION SCOUT TIA V4.5

The system requirements of the TIA Portal or its client (e.g. STEP 7, WinCC, Startdrive) are applicable, because SCOUT TIA can only be installed in parallel with these.

Any deviating requirements are described in the currently valid readme file.

<sup>1)</sup> Up-to-date information and availability for download, see under:  
[www.siemens.com/tia-online-software-delivery](http://www.siemens.com/tia-online-software-delivery)

### Selection and ordering data

Description	Article No.
<b>SIMOTION SCOUT software package</b>	<b>Note</b> Licenses for SIMOTION SCOUT V4.4 are also valid for SIMOTION SCOUT V4.5. For users with a V4.4 license, it is sufficient to order the software with a trial license. The licenses can also be used for SCOUT TIA.
<b>SCOUT V4.5 (DVD)</b> On DVD, including SCOUT TIA, STARTER, runtime software and documentation Languages: English, French, German, Italian • Single license incl. software • Upgrade incl. software • Software with trial license	<b>6AU1810-1BA45-0XA0</b> <b>6AU1810-1BA45-0XE0</b> <b>6AU1810-1BA45-0XT7</b>
<b>SCOUT V4.5 (OSD)</b> Online software delivery Email address required for delivery <sup>1)</sup> • Single license; key for download • Upgrade; key for download • Software with trial license; software for download	<b>6AU1810-1BA44-0XH5</b> <b>6AU1810-1BA44-0XK5</b> <b>6AU1810-1BA45-0XG7</b>
<b>SCOUT V4.5 stand-alone (DVD)</b> On DVD, including SCOUT TIA, STARTER, runtime software and documentation Languages: English, French, German, Italian • Single license incl. software • Upgrade incl. software • Software with trial license	<b>6AU1810-1CA45-0XA0</b> <b>6AU1810-1CA45-0XE0</b> <b>6AU1810-1CA45-0XT7</b>
<b>SCOUT V4.5 stand-alone (OSD)</b> Online software delivery Email address required for delivery <sup>1)</sup> • Single license; key for download • Upgrade; key for download • Software with trial license; software for download	<b>6AU1810-1CA44-0XH5</b> <b>6AU1810-1CA44-0XK5</b> <b>6AU1810-1CA45-0XG7</b>
<b>Software update service</b> Requires latest software version • for SIMOTION SCOUT (incl. SCOUT TIA) • for SIMOTION SCOUT stand-alone (incl. SCOUT TIA)	<b>6AU1810-0BA00-0XL0</b> <b>6AU1810-0CA00-0XL0</b>
<b>Optional packages for SIMOTION SCOUT</b>	
<b>SIMOTION CamTool V3.0 SP3</b> High-performance graphical cam editor Languages: English, German • Single license, with data storage medium • Upgrade, with data storage medium	<b>6AU1810-0FA30-3XA0</b> <b>6AU1810-0FA30-3XE0</b>
<b>DCC-SIMOTION/SINAMICS V2.4 for SCOUT V4.5 (not for: SCOUT TIA/SIMOTION in the TIA Portal)</b> Graphical configuring with Drive Control Chart DCC editor + DCB libraries for use on SIMOTION and SINAMICS S120 • Single engineering license • Upgrade	<b>6AU1810-1JA24-0XA0</b> <b>6AU1810-1JA24-0XE0</b>

## SIMOTION Motion Control System

### SIMOTION engineering software

#### Ordering of engineering software, information

##### More information

##### Important information about SCOUT, SCOUT stand-alone and SCOUT TIA:

The following engineering packages are available to order:

- SIMOTION SCOUT: this version can be used only if STEP 7 (SIMATIC Manager) is already installed
- SIMOTION SCOUT stand-alone: this version can be used if STEP 7 (SIMATIC MANAGER) is not installed.

Both delivery versions also include SIMOTION SCOUT TIA as an optional package for the TIA Portal.

The SCOUT license as well as the SCOUT stand-alone license is valid for SCOUT TIA.

SCOUT stand-alone also includes the components of STEP 7 that are required for SIMOTION SCOUT (SIMATIC CPUs cannot be programmed).

Users who switch over from SCOUT stand-alone to SCOUT (or vice versa) must install new software for the relevant SCOUT version and purchase a new license (the license for SCOUT and SCOUT stand-alone are different).

It is not possible to install SCOUT and SCOUT stand-alone "side by side" on the same PC.

It is possible to install SCOUT TIA and SCOUT (or SCOUT stand-alone) "side by side" on the same PC if the software version is V4.4 or higher. Only one single SCOUT license is required for "side-by-side" installations.

##### Compatibility list of software products in the SIMOTION environment

A number of additional software products can be used in conjunction with SIMOTION SCOUT. It must be ensured that the corresponding versions of these software products are compatible. Please consult the Compatibility list of software products in the SIMOTION environment.

<http://support.automation.siemens.com/WW/view/en/18857317>

##### SIMOTION Kernel updates

SIMOTION Kernel updates for all SIMOTION platforms are supplied on SCOUT DVDs and can then be copied from the PG/PC to the SIMOTION Micro Memory Card (SIMOTION C) or SIMOTION CompactFlash card (SIMOTION D) or installed on SIMOTION P320-4.

A PC card adapter is needed to write to the SIMOTION MMC (Micro Memory Card) or the SIMOTION CF (CompactFlash card). Adapters can usually be found in PC shops and at electronics shops.

With the device update tool, SIMOTION offers a user-friendly solution to update SIMOTION devices. SIMOTION D4x5-2 can also be updated using a USB stick.

<ul style="list-style-type: none"> <li>● Basic version (function or license is purchased with the device or SCOUT)</li> <li>○ Option (must be acquired as software/hardware)</li> <li>– Not possible</li> </ul>	Notes	SIMOTION C240/C240 PN	SIMOTION P320-4	SIMOTION D410-2	SIMOTION D4x5-2
<b>System clocks</b>					
<b>PROFIBUS cycle</b>	SIMOTION D: For integrated drives and drives on connected CX32-2: 0.5 ... 8 ms <sup>1)</sup> P320-4: With IsoPROFIBUS board option	1 ... 8 ms  (in 0.25 ms steps)	1 ... 8 ms  (in 0.125 ms steps)	1 ... 8 ms  (in 0.125 ms steps)	1 ... 8 ms  (in 0.125 ms steps)
<b>PROFINET cycle</b>	D455-2 DP/PN: min. 0.125 ms (only with SCOUT TIA) Please observe the notes about usage in the SIMOTION D4x5-2 manuals.	C240 PN: 0.5 ... 4 ms  (in 0.25 ms steps)	0.25 ... 4 ms  (in 0.125 ms steps)	D410-2 DP/PN: 0.25 ... 4 ms  (in 0.125 ms steps)	D4x5-2 DP/PN: 0.25 ... 4 ms <sup>4)</sup>  (in 0.125 ms steps)
<b>Position control and interpolation cycle</b>					
<ul style="list-style-type: none"> <li>● Minimum position control cycle</li> </ul>	The position control cycle (SERVO) includes the position controller, the actual-value and setpoint system and the axis monitoring functions.	0.5 ms	0.25 ms	1/0.5 ms <sup>3)</sup>	0.5 ms  As of D435-2 (DP/PN only): 0.25 ms <sup>4)</sup>
<ul style="list-style-type: none"> <li>● Position control cycle to PROFIBUS cycle</li> <li>● Position control cycle to PROFINET cycle</li> </ul>		1:1, 2:1  1:1 ... 16:1	1:1, 2:1  1:1 ... 16:1	1:1 ... 8:1  1:1 ... 16:1	1:1 ... 8:1  1:1 ... 16:1 (1:1) <sup>2)</sup>
<ul style="list-style-type: none"> <li>● Interpolation cycle 1 (IPO) to Position control cycle</li> </ul>	The axis motion control functions are performed in the interpolation cycle. The position control cycle and the interpolation cycle are a multiple of the PROFINET/PROFIBUS cycle. The transformation ratios are adjustable.	1:1 ... 6:1	1:1 ... 6:1	1:1 ... 6:1	1:1 ... 6:1 (1:1 ... 4:1) <sup>2)</sup>
<ul style="list-style-type: none"> <li>● Interpolation cycle 2 (IPO2) to interpolation cycle 1 (IPO1)</li> </ul>		2:1 ... 64:1	2:1 ... 64:1	2:1 ... 64:1	2:1 ... 64:1
<ul style="list-style-type: none"> <li>● Fast position control cycle (SERVO<sub>Fast</sub>) to PROFINET cycle</li> <li>● Fast interpolation cycle (IPO<sub>Fast</sub>) to fast position control cycle (SERVO<sub>Fast</sub>)</li> </ul>	Values with SERVO <sub>Fast</sub> and IPO <sub>Fast</sub> activated for D435-2 DP/PN, D445-2 DP/PN and D455-2 DP/PN (for details, see SIMOTION D4x5-2 manuals)	–	–	–	1:1  1:1 ... 4:1

Notes:**Communication via PROFINET and PROFIBUS**

The availability of a PROFINET or PROFIBUS interface depends on the controller variant implemented. The SIMOTION controllers are equipped with PROFINET and/or PROFIBUS as standard. This must be considered for connection options and functions via PROFINET and PROFIBUS.

**SIZER for Siemens Drives engineering tool**

The performance requirements for a SIMOTION application can be estimated using the engineering tool SIZER for Siemens Drives. For more information about SIZER for Siemens Drives, refer to section Drive Technology/Selection and engineering tools/SIZER for Siemens Drives engineering tool in the Industry Mall, and chapter Lifecycle Services in Catalog PM 21.

<sup>1)</sup> D435-2 DP/PN, D445-2 DP/PN, D455-2 DP/PN: from 0.25 ms onwards

<sup>2)</sup> Values in brackets with SERVO<sub>Fast</sub> and IPO<sub>Fast</sub> activated (for details, see SIMOTION D4x5-2 manuals).

<sup>3)</sup> 1 ms when using the TO axis and the integrated drive control

<sup>4)</sup> D435-2 DP/PN, D445-2 DP/PN, D455-2 DP/PN: 0.25 ms; D455-2 DP/PN: 0.125 ms (only with ET 200SP, SCOUT TIA and SERVO<sub>Fast</sub>)  
You will find detailed information on the cycle clock settings, particularly for cycle clocks ≤ 0.25 ms, in the SIMOTION D4x5-2 manuals.

## SIMOTION Motion Control System

### Overview of SIMOTION functions

	Notes	SIMOTION C240/C240 PN	SIMOTION P320-4	SIMOTION D410-2	SIMOTION D4x5-2
<ul style="list-style-type: none"> <li>● Basic version (function or license is purchased with the device or SCOUT)</li> <li>○ Option (must be acquired as software/hardware)</li> <li>– Not possible</li> </ul>					
<b>Dynamic Servo Control (DSC)</b>					
<ul style="list-style-type: none"> <li>● With Dynamic Servo Control (DSC) the control loop of the position controller is located in the drive (with cycles of 125 µs or higher).</li> </ul>	With SINAMICS S120 drives	●	●	●	●
<b>Memory for system data</b>					
<ul style="list-style-type: none"> <li>● Storage media (externally pluggable)</li> </ul>	MMC: Micro Memory Card CF: CompactFlash card CFast: CFast card SSD: Solid State Drive P320-4, internal: P320-4 E: CFast, 8 GB P320-4 S: SSD, 160 GB	MMC 64 MB	CFast 4 GB	CF 1 GB	CF 1 GB
<ul style="list-style-type: none"> <li>● Retentive memory (for retentive user data/ retain variables)</li> </ul>		107 KB	364 KB	108 KB	D425-2/ D435-2: 364 KB D445-2/ D455-2: 512 KB
<ul style="list-style-type: none"> <li>● Persistent memory (for user data/data storage on exchangeable memory medium)</li> </ul>		48 MB	3.7 GB	300 MB	300 MB
<ul style="list-style-type: none"> <li>● RAM disk (Load memory for user data/ for download of the configuration and programs)</li> </ul>	Memory sizes can be configured with SIMOTION P	29 MB production version ≥ G and V4.4 and above	76 MB	47 MB	D425-2: 31 MB D435-2: 41 MB D445-2: 56 MB D455-2: 76 MB
<ul style="list-style-type: none"> <li>● RAM (user memory for code and data)</li> </ul>	D410-2 and D4x5-2: additional 20 MB for Java applications	67 MB production version ≥ G and V4.4 and above	256 MB	96 MB	D425-2: 64 MB D435-2: 86 MB D445-2: 160 MB D455-2: 320 MB
<b>Address ranges</b>					
<ul style="list-style-type: none"> <li>● Logical I/O address space in KB</li> </ul>		4	4	16	16
<ul style="list-style-type: none"> <li>● Physical I/O address space in KB <ul style="list-style-type: none"> <li>- PROFIBUS: max. per ext. subnet each for inputs and outputs</li> <li>- PROFINET: max. for inputs and outputs (each)</li> </ul> </li> </ul>	When PROFIBUS and PROFINET are used, the total address space applies  D4x5-2 DP/PN: If CBE30-2 is used as a second PROFINET interface, 2 × 6 KB physical address space is available.	1	1	1	1
		4	4	6	6
<ul style="list-style-type: none"> <li>● Permanent process image for BackgroundTask (I/O variables) in bytes</li> </ul>		64	64	64	64
<ul style="list-style-type: none"> <li>● Additional configurable process image for each cyclic task (I/O variables)</li> </ul>		●	●	●	●
<ul style="list-style-type: none"> <li>● Address space for each PROFIBUS DP station</li> </ul>		244 bytes	244 bytes	244 bytes	244 bytes
<ul style="list-style-type: none"> <li>● Address space for each PROFINET device</li> </ul>	1400 bytes	1400 bytes	1400 bytes	1400 bytes	

## SIMOTION Motion Control System

### Overview of SIMOTION functions

	Notes	SIMOTION C240/C240 PN	SIMOTION P320-4	SIMOTION D410-2	SIMOTION D4x5-2
<ul style="list-style-type: none"> <li>● Basic version (function or license is purchased with the device or SCOUT)</li> <li>○ Option (must be acquired as software/hardware)</li> <li>– Not possible</li> </ul>					
<b>Drives on SIMOTION</b>					
<b>Maximum number of axes</b>	Higher number of axes possible using multiple synchronized devices	32 axes	128 axes	8 axes (typ. 2 to 3 axes)	D425-2: 16 axes D435-2: 32 axes D445-2: 64 axes D455-2: 128 axes
<b>Integrated drive control</b> The drive control integrated in SIMOTION D is based on SINAMICS S120 Control Units: <ul style="list-style-type: none"> <li>● With SIMOTION D410-2 on the CU310-2 Control Unit, firmware version V4.x</li> <li>● With SIMOTION D4x5-2/CX32-2 on the CU320-2 Control Unit, firmware version V4.x</li> </ul> The BOP20 Basic Operator Panel and the basic positioner EPos are not supported by the integrated drive control.	SIMOTION D4x5-2: CX32-2 Controller Extension can be used to provide additional drive controls: D425-2: max. 3 CX32-2 <sup>1)</sup> D435-2: max. 5 CX32-2 <sup>1)</sup> D445-2: max. 5 CX32-2 <sup>1)</sup> D455-2: max. 5 CX32-2 <sup>1)</sup>  Per CX32-2: Servo: 1..6 Vector: 1..6 V/f: 1..12 (alternatively)	–	–	Servo: 1 Vector: 1 V/f: 1 (alternatively)	Servo: 1..6 Vector: 1..6 V/f: 1..12 (alternatively)
<b>Speed-controlled axis over PROFIBUS DP</b> <ul style="list-style-type: none"> <li>● SINAMICS S/SINAMICS G (servo/vector control)</li> <li>● Drives with speed profile in accordance with standard message frames (PROFdrive profile 1-6)</li> </ul>	SIMOTION D: SINAMICS as the standard drive technology	●	○	●	●
<b>Position-controlled axis over PROFIBUS DP with PROFdrive</b> <ul style="list-style-type: none"> <li>● SINAMICS S110 (blocksize format) <ul style="list-style-type: none"> <li>- Servo control</li> </ul> </li> <li>● SINAMICS S120 (blocksize, booksize and chassis formats) <ul style="list-style-type: none"> <li>- Servo control</li> <li>- Vector control</li> </ul> </li> <li>● Certified servo/vector/stepper drives in acc. with standard message frames (PROFdrive profile 1-6)</li> </ul>	SIMOTION D: SINAMICS as the standard drive technology  Also linear motor <sup>2)</sup>  With external encoder (limited dynamic response)	●	○	●	●

2

<sup>1)</sup> In principle, a 4th or 6th CX32-2 Controller Extension can also be connected, e.g. for implementing modular machine concepts. In this case, no drives/drive components can be connected any longer to the integrated drive control of the SIMOTION D4x5-2. All drives must then be operated via the Controller Extensions.

<sup>2)</sup> See chapter SIMOTICS linear and torque motors in Catalog D 21.4 and Motors for Motion Control/SIMOTICS L linear motors and .../SIMOTICS T torque motors in the Industry Mall.

# SIMOTION Motion Control System

## Overview of SIMOTION functions

<ul style="list-style-type: none"> <li>● Basic version (function or license is purchased with the device or SCOUT)</li> <li>○ Option (must be acquired as software/hardware)</li> <li>– Not possible</li> </ul>	Notes	SIMOTION C240/C240 PN	SIMOTION P320-4	SIMOTION D410-2	SIMOTION D4x5-2
<b>Drives on SIMOTION (continued)</b>					
<b>Speed and position-controlled axis over PROFINET IO with IRT (PROFdrive)</b> <ul style="list-style-type: none"> <li>● SINAMICS S110 (blocksize format) <ul style="list-style-type: none"> <li>- Servo control</li> </ul> </li> <li>● SINAMICS S120 (blocksize, booksize and chassis formats) <ul style="list-style-type: none"> <li>- Servo control</li> <li>- Vector control</li> </ul> </li> <li>● Certified servo/vector/stepper drives in acc. with standard message frames (PROFdrive profile 1-6)</li> </ul>	SIMOTION D: SINAMICS as the standard drive technology  Also linear motor <sup>1)</sup> With external encoder (limited dynamic response)	– (C240) ● (C240 PN)	●	– D410-2 DP ● D410-2 DP/PN	– D4x5-2 DP ● D4x5-2 DP/PN
<b>Distributed servo drive (SINAMICS S120M)</b>	SIMOTION C/P/D: Via CU320-2 D4x5-2: On integrated drive control	●	●	●	●
<b>Drives with analog ±10 V setpoint interface</b> <ul style="list-style-type: none"> <li>● Via onboard drive interface</li> <li>● Via ADI 4 (Analog Drive Interface for 4 Axes)</li> <li>● Via IM 174 (Interface Module for 4 Axes)</li> </ul>	Configuration either as analog or stepper drive  See SIMOTION system components → I/O components in Catalog PM 21.	4 (C240) – (C240 PN)	–	–	–
<b>Hydraulic drives over ±10 V setpoint interface</b> <ul style="list-style-type: none"> <li>● Via onboard drive interface</li> <li>● Via ADI 4 (Analog Drive Interface for 4 Axes)</li> <li>● Via IM 174 (Interface Module for 4 Axes)</li> <li>● Analog outputs through I/O</li> <li>● Encoders through I/O</li> </ul>		●	○	●	●
		●	○	●	●
		●	●	●	●
		●	●	●	●
		●	●	●	●
<b>Stepper drives</b> <ul style="list-style-type: none"> <li>● Onboard pulse direction interface for stepper drives</li> <li>● Via IM 174 (Interface Module for 4 Axes)</li> </ul>	Configuration either as analog or stepper drive	4 (C240) – (C240 PN)	–	–	–
		●	○	●	●

<sup>1)</sup> See chapter SIMOTICS linear and torque motors in Catalog D 21.4 and Motors for Motion Control/SIMOTICS L linear motors and .../SIMOTICS T torque motors in the Industry Mall.

<ul style="list-style-type: none"> <li>● Basic version (function or license is purchased with the device or SCOUT)</li> <li>○ Option (must be acquired as software/hardware)</li> <li>– Not possible</li> </ul>	Notes	SIMOTION C240/C240 PN	SIMOTION P320-4	SIMOTION D410-2	SIMOTION D4x5-2
<b>Encoders on SIMOTION</b>					
<b>Measuring systems that can be connected over integrated interface</b>		See Measuring systems in Catalog D 21.4.			
• Qty.	SIMOTION D/ CX32-2: Encoder connection via DRIVE-CLiQ	4 (C240) – (C240 PN)	–	1	–
• Absolute encoder with SSI interface		● (C240) – (C240 PN)	–	●	–
• Incremental measuring systems	C240: TTL D410-2: TTL/HTL	● (C240) – (C240 PN)	–	●	–
<b>Measuring systems that can be connected over bus</b>					
• Resolver, absolute encoder (SSI and EnDat), incremental encoder (TTL and sin/cos), etc.	Motor encoder on drive or encoder on ADI 4/IM 174 or PROFINET and PROFIBUS encoder	●	●	●	●
<b>Connection options for direct measuring systems (2nd to 8th encoders and external encoder)</b>					
• Via onboard interfaces		● (C240) – (C240 PN)	–	●	–
• Via SINAMICS S110/S120	SIMOTION D/ CX32-2: Encoder connection via DRIVE-CLiQ	●	●	●	●
• Isochronous PROFIBUS encoder	See Measuring systems in Catalog D 21.4.	●	○	●	●
• PROFINET encoder with IRT	See Measuring systems in Catalog D 21.4.	– (C240) ● (C240 PN)	●	– D410-2 DP ● D410-2 DP/PN	– D4x5-2 DP ● D4x5-2 DP/PN
• Encoder on ADI 4 (Analog Drive Interface for 4 Axes)	At least one electric or hydraulic axis must be configured on ADI 4/IM 174.	●	○	●	●
• Encoder on IM 174 (Interface Module for 4 Axes)		●	○	●	●
<b>Measuring inputs</b>					
<b>Onboard measuring inputs</b>					
• Qty.		C240: 2+4 C240 PN:4	–	8	16
• Reproducibility		6 μs	–	Typ. 5 μs	5 μs
<b>Measuring inputs on the drives</b>					
• SINAMICS S110 (CU305)		2/closed-loop control	2/closed-loop control	2/closed-loop control	2/closed-loop control
• SINAMICS S120 (CU310-2)		8/closed-loop control	8/closed-loop control	8/closed-loop control	8/closed-loop control
• SINAMICS S120 (CU320-2)		8/closed-loop control	8/closed-loop control	8/closed-loop control	8/closed-loop control
• SIMOTION CX32-2	D425-2: max. 3 CX32-2 <sup>1)</sup> D435-2: max. 5 CX32-2 <sup>1)</sup> D445-2: max. 5 CX32-2 <sup>1)</sup> D455-2: max. 5 CX32-2 <sup>1)</sup>	–	–	–	4/closed-loop control

<sup>1)</sup> In principle, a 4th or 6th CX32-2 Controller Extension can also be connected, e.g. for implementing modular machine concepts. In this case, no drives/drive components can be connected any longer to the integrated drive control of the SIMOTION D4x5-2. All drives must then be operated via the Controller Extensions.

## SIMOTION Motion Control System

### Overview of SIMOTION functions

<ul style="list-style-type: none"> <li>● Basic version (function or license is purchased with the device or SCOUT)</li> <li>○ Option (must be acquired as software/hardware)</li> <li>– Not possible</li> </ul>	Notes	SIMOTION C240/C240 PN	SIMOTION P320-4	SIMOTION D410-2	SIMOTION D4x5-2
<b>Measuring inputs (continued)</b>					
<b>Measuring inputs on the drives (continued)</b>					
<ul style="list-style-type: none"> <li>● Over TM15 Terminal Module on SINAMICS S120 or SIMOTION D/CX32-2</li> <li>- Number of measuring inputs per Terminal Module, max.</li> <li>- Reproducibility</li> </ul>	See SIMOTION system components→ I/O components in Catalog PM 21.	24	24	24	24
		125 µs	125 µs	125 µs	125 µs
<ul style="list-style-type: none"> <li>● Via ET 200MP TM Timer DIDQ 16×24V</li> <li>- Number of measuring inputs per Technology Module, max.</li> <li>- Reproducibility</li> </ul>	Can only be used with SCOUT TIA; Standard or High Feature interface module required.	8	8	8	8
		2 µs	2 µs	2 µs	2 µs
<ul style="list-style-type: none"> <li>● Via ET 200SP TM Timer DIDQ 10×24V</li> <li>- Number of measuring inputs per Technology Module, max.</li> <li>- Reproducibility</li> </ul>	Can be used with SCOUT and SCOUT TIA; High Feature interface module required.	4	4	4	4
		5 µs	5 µs	5 µs	5 µs
<b>Cam outputs</b>					
<b>High-speed output cams (hardware-supported output cams with higher resolution)</b>					
<ul style="list-style-type: none"> <li>● Onboard cam outputs</li> <li>- Number of cam outputs, max.</li> <li>- Reproducibility</li> </ul>		●	–	●	●
		8	70 µs	–	8
<ul style="list-style-type: none"> <li>● Over TM15 Terminal Module to SINAMICS S120 or SIMOTION D/CX32-2</li> <li>- Number of cam outputs per Terminal Module, max.</li> <li>- Reproducibility</li> </ul>	See SIMOTION system components→ I/O components in Catalog PM 21.	24	24	24	24
		125 µs	125 µs	125 µs	125 µs
<ul style="list-style-type: none"> <li>● Via ET 200MP TM Timer DIDQ 16×24 V</li> <li>- Number of cam outputs per Technology Module, max.</li> <li>- Reproducibility</li> </ul>	Can only be used with SCOUT TIA; Standard or High Feature interface module required.	16	16	16	16
		2 µs	2 µs	2 µs	2 µs
<ul style="list-style-type: none"> <li>● Via ET 200SP TM Timer DIDQ 10×24V</li> <li>- Number of cam outputs per Technology Module, max.</li> <li>- Reproducibility</li> </ul>	Can be used with SCOUT and SCOUT TIA; High Feature interface module required.	6	6	6	6
		5 µs	5 µs	5 µs	5 µs



## SIMOTION Motion Control System

### Overview of SIMOTION functions

	Notes	SIMOTION C240/C240 PN	SIMOTION P320-4	SIMOTION D410-2	SIMOTION D4x5-2
<ul style="list-style-type: none"> <li>● Basic version (function or license is purchased with the device or SCOUT)</li> <li>○ Option (must be acquired as software/hardware)</li> <li>– Not possible</li> </ul>					
<b>Cam outputs (continued)</b>					
<b>Standard output cams</b> (updated in position controller cycle or IPO cycle, reproducibility of the output cam depends on the implemented I/O)					
<ul style="list-style-type: none"> <li>● Onboard cam outputs</li> </ul>		●	–	●	●
<ul style="list-style-type: none"> <li>● Over TM15 Terminal Module to SINAMICS S120 or SIMOTION D/CX32-2</li> </ul>	See SIMOTION system components → I/O components in Catalog PM 21.	●	●	●	●
<ul style="list-style-type: none"> <li>● Over S7-300 backplane bus of SIMOTION C</li> </ul>		●	–	–	–
<ul style="list-style-type: none"> <li>● Over PROFIBUS DP</li> </ul>	P320-4: IsoPROFIBUS board option	●	○	●	●
<ul style="list-style-type: none"> <li>● Over PROFINET IO</li> </ul>		– C240 ● C240 PN	●	– D410-2 DP ● D410-2 DP/PN	– D4x5-2 DP ● D4x5-2 DP/PN
<ul style="list-style-type: none"> <li>● Output to internal system variable</li> </ul>		●	●	●	●
<b>Integrated I/O interfaces</b>					
<b>Programmable digital inputs/outputs</b> (can be parameterized individually as either input or output)					
<ul style="list-style-type: none"> <li>● of which for output cam, max.</li> <li>● of which as measuring inputs, max.</li> </ul>	Further inputs/outputs can be implemented for output cam or measuring inputs via the TM15 and ET 200SP/MP TM Timer DIDQ.	–	–	8	16
		–	–	8	8
		–	–	8	16
<b>Digital inputs</b> (fixed inputs, cannot be parameterized)					
<ul style="list-style-type: none"> <li>● of which inputs with specific functions <ul style="list-style-type: none"> <li>- Measuring inputs, max.</li> </ul> </li> <li>- External zero mark signal for referencing, max.</li> <li>- Fail-safe digital inputs (F-DI)</li> </ul>	D410-2: The 3 F-DI can also be used as 6 DI.	18	–	5 + 6 (3 F-DI)	12
		2+4 (C240) 4 (C240 PN)	–	–	–
		4 (C240)	–	–	–
		–	–	3	–
<b>Digital outputs</b> (fixed outputs, cannot be parameterized)					
<ul style="list-style-type: none"> <li>● of which for outputs with specific functions <ul style="list-style-type: none"> <li>- High-speed cam outputs, max.</li> <li>- Fail-safe digital outputs (F-DO)</li> </ul> </li> </ul>	D410-2: The F-DO can also be used as DO.	8	–	1 (1 F-DO)	–
		8	–	–	–
		–	–	1	–
<b>Relay outputs with specific functions</b>					
<ul style="list-style-type: none"> <li>● Controller enable</li> <li>● Ready</li> </ul>		4 (C240)	–	–	–
		1	–	–	–
<b>Analog inputs</b>					
SIMOTION D: D410-2: Also over TM31 D4x5-2: Over TM31 or TB30	TM31 see Catalog D 21.4	–	–	1 (onboard) ○ (TM31)	○

# SIMOTION Motion Control System

## Overview of SIMOTION functions

	Notes	SIMOTION C240/C240 PN	SIMOTION P320-4	SIMOTION D410-2	SIMOTION D4x5-2
<ul style="list-style-type: none"> <li>● Basic version (function or license is purchased with the device or SCOUT)</li> <li>○ Option (must be acquired as software/hardware)</li> <li>– Not possible</li> </ul>					
<b>Integrated I/O interfaces (continued)</b>					
<b>Analog outputs</b> SIMOTION C240: Can be used as drive interface or standard analog outputs. SIMOTION D: D410-2: Over TM31 D4x5-2: Over TM31 or TB30	TM31 see Catalog D 21.4	4 (C240)	–	○	○
<b>Pulse direction interface for stepper drives</b>	SIMOTION C240: Configuration either as analog or stepper drive.	4 (C240)	–	–	–
<b>Centralized I/O modules with SIMOTION C</b>					
<ul style="list-style-type: none"> <li>● Centralized I/O modules per system, max.</li> </ul>		16	–	–	–
<ul style="list-style-type: none"> <li>● Central/expansion rack, max.</li> </ul>	SIMOTION C: max. two-tier configuration with IM 365 Interface Module	○	–	–	–
<ul style="list-style-type: none"> <li>● Connectable central SIMATIC S7-300 I/Os</li> </ul>	See SIMOTION system components → I/O components in Catalog PM 21.	●	–	–	–
<b>Connectable distributed I/O modules</b>					
<b>Distributed I/Os (over PROFIBUS DP)</b>  <ul style="list-style-type: none"> <li>● SIMATIC ET 200S, ET 200SP</li> <li>● SIMATIC ET 200pro</li> <li>● SIMATIC ET 200M, ET 200MP <sup>1)</sup></li> <li>● SIMATIC ET 200eco</li> <li>● SIMATIC ET 200AL</li> <li>● ADI 4 (Analog Drive Interface for 4 Axes)</li> <li>● IM 174 (Interface Module for 4 Axes)</li> <li>● All certified standard slaves (DP-V0, DP-V1, DP-V2)</li> </ul>	See SIMOTION system components → I/O components in Catalog PM 21.  Isochronous: SIMATIC ET 200S SIMATIC ET 200M ADI 4 IM 174	●	○	●	●
<b>Distributed I/Os (over PROFINET IO)</b>  <ul style="list-style-type: none"> <li>● SIMATIC ET 200S, ET 200SP</li> <li>● SIMATIC ET 200M, ET 200MP <sup>1)</sup></li> <li>● SIMATIC ET 200pro</li> <li>● SIMATIC ET 200eco PN</li> <li>● SIMATIC ET 200AL</li> <li>● All certified PROFINET devices</li> </ul>	Isochronous: SIMATIC ET 200S, SIMATIC ET 200SP, SIMATIC ET 200MP	– (C240) ● (C240 PN)	●	– D410-2 DP ● D410-2 DP/PN	– D4x5-2 DP ● D4x5-2 DP/PN

<sup>1)</sup> ET 200MP only with SCOUT TIA.

## SIMOTION Motion Control System

### Overview of SIMOTION functions

<ul style="list-style-type: none"> <li>● Basic version (function or license is purchased with the device or SCOUT)</li> <li>○ Option (must be acquired as software/hardware)</li> <li>– Not possible</li> </ul>	Notes	SIMOTION C240/C240 PN	SIMOTION P320-4	SIMOTION D410-2	SIMOTION D4x5-2
<b>Connectable distributed I/O modules</b> (continued)					
<b>SINAMICS drive I/O (over DRIVE-CLiQ)</b>					
<ul style="list-style-type: none"> <li>● Over TM15, TM31, TM41, TM54F Terminal Modules</li> </ul>	For connection to SIMOTION C and P over SINAMICS S120	●	●	●	●
<ul style="list-style-type: none"> <li>● Via TB30 Terminal Board</li> </ul>	Plug-in card for SIMOTION D4x5-2 and SINAMICS CU320-2	●	●	●	●
<b>SIMATIC HMI devices</b>					
<b>Configuration with TIA WinCC Basic/Comfort/Advanced</b>					
<ul style="list-style-type: none"> <li>● SIMATIC HMI Comfort Panels               <ul style="list-style-type: none"> <li>- Touch panels TP</li> <li>- Key panels KP</li> <li>- Key and Touch Panels KTP</li> </ul> </li> <li>● SIMATIC HMI Basic Panels (2nd generation)</li> <li>● SIMATIC HMI Mobile Panels (2nd generation)</li> </ul>		●	●	●	●
<b>HMI software for SIMOTION</b>					
<ul style="list-style-type: none"> <li>● WinCC (SCADA system, V7.0 and higher)</li> <li>● TIA WinCC Basic/Comfort/Advanced/Professional</li> </ul>		○	○	○	○
<b>Software for extended communication with SIMOTION</b>					
<ul style="list-style-type: none"> <li>● SIMATIC NET OPC server</li> <li>● SIMOTION IT OPC XML-DA (via Ethernet)               <ul style="list-style-type: none"> <li>- Open communication over TCP/IP and SOAP standard protocols</li> <li>- Clients on any hardware with various operating systems (Windows, Linux, etc.)</li> <li>- According to OPC Foundation standard OPC XML-DA V1.01</li> </ul> </li> <li>● SIMOTION OPC UA (Unified Architecture)               <ul style="list-style-type: none"> <li>- Open communication via Ethernet TCP/IP</li> <li>- OPC UA server in SIMOTION runtime according to specification of OPC Foundation</li> <li>- Support for Data Access</li> </ul> </li> <li>● SIMOTION MIIF: Multipurpose Information Interface               <ul style="list-style-type: none"> <li>- Symbolic access to SIMOTION data via Ethernet</li> <li>- SIMOTION as server, e.g. operator panels as clients</li> </ul> </li> </ul>	See <a href="#">SIMOTION runtime software in Catalog PM 21</a> .	○	○	○	○
		● <sup>1)</sup>	●	●	●
		●	●	●	●
		○	○	○	○

<sup>1)</sup> Subject to license for SIMOTION Kernel versions earlier than V4.2.

# SIMOTION Motion Control System

## Overview of SIMOTION functions

	Notes	SIMOTION C240/C240 PN	SIMOTION P320-4	SIMOTION D410-2	SIMOTION D4x5-2
<ul style="list-style-type: none"> <li>● Basic version (function or license is purchased with the device or SCOUT)</li> <li>○ Option (must be acquired as software/hardware)</li> <li>– Not possible</li> </ul>					
<b>Communication</b>					
<b>Ethernet interfaces</b>					
<ul style="list-style-type: none"> <li>• Number and transmission rates</li> </ul>		1 × 10/100 Mbit/s	1 × 10/100/1000 Mbit/s	1 × 10/100 Mbit/s	D4x5-2 DP: 3 × 10/100/1000 Mbit/s D4x5-2 DP/PN: 2 × 10/100/1000 Mbit/s
<b>PROFIBUS DP interfaces</b>					
<ul style="list-style-type: none"> <li>• Onboard/support isochronous communication</li> </ul>	P320-4: IsoPROFIBUS board option	2/2	2/2	D410-2 DP: 2/2 D410-2 DP/PN: 1/1	2/2
<ul style="list-style-type: none"> <li>• Onboard CP5621</li> </ul>	For PG/PC and HMI	–	–	–	–
<ul style="list-style-type: none"> <li>• Transmission rates in Mbit/s</li> </ul>		1.5 / 3 / 6 / 12	1.5 / 3 / 6 / 12	1.5 / 3 / 6 / 12	1.5 / 3 / 6 / 12
<ul style="list-style-type: none"> <li>• Number of PROFIBUS DP slaves</li> </ul>	Per PROFIBUS DP subnet	64	64	64	64
<b>PROFINET interfaces</b>					
<ul style="list-style-type: none"> <li>• Onboard ports</li> </ul>		C240: – C240 PN: 3	3	D410-2 DP: – D410-2 DP/PN: 2	D4x5-2 DP: – D4x5-2 DP/PN: 3
<ul style="list-style-type: none"> <li>• Number of PROFINET devices (provided that PROFINET interface is onboard or optionally retrofitted)</li> </ul>	D4x5-2: CBE30-2 can be implemented as second PROFINET interface for D4x5-2 DP/PN. Per PROFINET interface	64	64	64	64
<ul style="list-style-type: none"> <li>• Media redundancy (MRP and MRPD)</li> </ul>		●	●	●	●
<b>Further communication interfaces</b>					
<ul style="list-style-type: none"> <li>• Serial interfaces</li> </ul>		–	1	–	–
<ul style="list-style-type: none"> <li>• USB interfaces</li> </ul>	D4x5-2: for upgrading from D4x5-2 Control Units using a USB memory stick	–	4 × USB 3.0	–	2
<ul style="list-style-type: none"> <li>• DRIVE-CLiQ interfaces</li> </ul>		–	–	1	D425-2: 4 D435-2: 6 D445-2: 6 D455-2: 6
<b>Connections over PROFIBUS DP and Ethernet/PROFINET</b>					
<ul style="list-style-type: none"> <li>• PROFIBUS DP</li> <li>• Ethernet/PROFINET</li> </ul>	SIMOTION C: PROFINET with C240 PN only P320-4: PROFIBUS only with IsoPROFIBUS board (optional)	● C240: ●/– C240 PN: ●/●	○ ●	● D410-2 DP: ●/– D410-2 DP/PN: ●/●	● D4x5-2 DP: ●/– D4x5-2 DP/PN: ●/●

## SIMOTION Motion Control System

### Overview of SIMOTION functions

<ul style="list-style-type: none"> <li>● Basic version (function or license is purchased with the device or SCOUT)</li> <li>○ Option (must be acquired as software/hardware)</li> <li>– Not possible</li> </ul>	Notes	SIMOTION C240/C240 PN	SIMOTION P320-4	SIMOTION D410-2	SIMOTION D4x5-2
<b>Communication (continued)</b>					
<b>Online connections, max.</b>	The connection resources can be assigned as required, over PROFIBUS DP or Ethernet.	16	16	16	16
<ul style="list-style-type: none"> <li>● SIMOTION SCOUT engineering system (SCOUT occupies up to 3 online connections)</li> </ul>		2	2	2	2
<ul style="list-style-type: none"> <li>● HMI</li> </ul>		5	5	5	5
<ul style="list-style-type: none"> <li>● OPC</li> </ul>		●	●	●	●
<ul style="list-style-type: none"> <li>● Basic communication Xsend / Xreceive (not via Ethernet)</li> </ul>		5	5	5	5
<ul style="list-style-type: none"> <li>● Standard TCP/IP connections</li> </ul>		45	75	45	75
<ul style="list-style-type: none"> <li>● SIMOTION IT</li> </ul>		●	●	●	●
<b>Communication functions over PROFIBUS between:</b>	Basic version from SIMOTION viewpoint	●	●	●	●
<ul style="list-style-type: none"> <li>● SIMOTION – SIMATIC HMI/WinCC <ul style="list-style-type: none"> <li>- HMI data exchange: Support from the SIMOTION operating system</li> <li>- Plant-wide access to process data and displays</li> <li>- Interrupt mechanism: Alarms are event-driven</li> </ul> </li> </ul>					
<ul style="list-style-type: none"> <li>● SIMOTION – SIMOTION <ul style="list-style-type: none"> <li>- Distributed I/O mechanisms</li> <li>Process image, e.g. (% I1.3)</li> <li>I/O variables (symbolic)</li> <li>- XSND/XRCV, max. 200 bytes</li> </ul> </li> </ul>					
<ul style="list-style-type: none"> <li>● SIMOTION – SIMATIC S7 <ul style="list-style-type: none"> <li>- Distributed I/O mechanisms</li> <li>Process image, e.g. (% I1.3)</li> <li>I/O variables</li> <li>- XSND/XRCV, max. 76 bytes</li> </ul> </li> </ul>					
<ul style="list-style-type: none"> <li>● SIMOTION – SIMATIC NET OPC</li> </ul>					
<ul style="list-style-type: none"> <li>● SIMOTION – PG/PCs with STEP 7 and SCOUT</li> </ul>					
<ul style="list-style-type: none"> <li>● PROFIBUS DP slave-to-slave communication <sup>1)</sup></li> </ul>					

<sup>1)</sup> For SIMOTION in the TIA Portal (SCOUT TIA) only "I-Slave to DP-Slave" or "I-Slave to I-Slave".

# SIMOTION Motion Control System

## Overview of SIMOTION functions

<ul style="list-style-type: none"> <li>● Basic version (function or license is purchased with the device or SCOUT)</li> <li>○ Option (must be acquired as software/hardware)</li> <li>– Not possible</li> </ul>	Notes	SIMOTION C240/C240 PN	SIMOTION P320-4	SIMOTION D410-2	SIMOTION D4x5-2
<b>Communication (continued)</b>					
<b>Communication functions over PROFINET IO between:</b>		Basic version with regard to SIMOTION			
<ul style="list-style-type: none"> <li>● SIMOTION – SIMOTION               <ul style="list-style-type: none"> <li>- Distributed I/O mechanisms</li> <li>Process image, e.g. (% I1.3)</li> <li>I/O variables (symbolic)</li> </ul> </li> </ul>	PROFINET standard feature on C240 PN, P320-4, D410-2 DP/PN and D4x5-2 DP/PN	●	●	●	●
<ul style="list-style-type: none"> <li>● SIMOTION – SIMATIC S7               <ul style="list-style-type: none"> <li>- Distributed I/O mechanisms</li> <li>Process image, e.g. (% I1.3)</li> <li>I/O variables</li> <li>- For SIMATIC – SIMOTION: SIMOTION as I-Device</li> <li>- For SIMOTION – SIMATIC: SIMATIC as I-Device</li> </ul> </li> </ul>		●	●	●	●
<ul style="list-style-type: none"> <li>● Slave-to-slave communication between SIMOTION controllers</li> </ul>		●	●	●	●
<b>Communication functions over Ethernet/PROFINET between:</b>					
<ul style="list-style-type: none"> <li>● SIMOTION – SIMATIC HMI/WinCC               <ul style="list-style-type: none"> <li>- HMI data exchange: Support from the SIMOTION operating system</li> <li>- Plant-wide access to process data and displays</li> <li>- Interrupt mechanism: Alarms are event-driven</li> </ul> </li> </ul>		●	●	●	●
<ul style="list-style-type: none"> <li>● SIMOTION – SIMATIC NET OPC</li> </ul>		●	●	●	●
<ul style="list-style-type: none"> <li>● SIMOTION OPC UA (Unified Architecture)               <ul style="list-style-type: none"> <li>- Open communication via Ethernet TCP/IP</li> <li>- OPC UA server in SIMOTION runtime according to specification of OPC Foundation</li> <li>- Support for Data Access</li> </ul> </li> </ul>		●	●	●	●
<ul style="list-style-type: none"> <li>● SIMOTION IT OPC XML-DA               <ul style="list-style-type: none"> <li>- Open communication over TCP/IP and SOAP standard protocols</li> <li>- Clients on any hardware with various operating systems (Windows, Linux, etc.)</li> <li>- According to OPC Foundation standard OPC XML-DA V1.01</li> </ul> </li> </ul>		● <sup>1)</sup>	●	●	●
<ul style="list-style-type: none"> <li>● SIMOTION MIIF: Multipurpose Information Interface               <ul style="list-style-type: none"> <li>- Symbolic access to SIMOTION data via Ethernet</li> <li>- SIMOTION as server, e.g. operator panels as clients</li> </ul> </li> </ul>		○	○	○	○
<ul style="list-style-type: none"> <li>● SIMOTION – PG/PCs with STEP 7 and SCOUT</li> </ul>		●	●	●	●
<ul style="list-style-type: none"> <li>● S7 routing Ethernet/PROFIBUS DP</li> </ul>		●	●	●	●

<sup>1)</sup> Subject to license for SIMOTION Kernel versions earlier than V4.2.

## SIMOTION Motion Control System

### Overview of SIMOTION functions

<ul style="list-style-type: none"> <li>● Basic version (function or license is purchased with the device or SCOUT)</li> <li>○ Option (must be acquired as software/hardware)</li> <li>– Not possible</li> </ul>	Notes	SIMOTION C240/C240 PN	SIMOTION P320-4	SIMOTION D410-2	SIMOTION D4x5-2
<b>Communication (continued)</b>					
<b>UDP and TCP/IP communication functions over Ethernet/PROFINET between:</b> <ul style="list-style-type: none"> <li>● SIMOTION – SIMOTION</li> <li>● SIMOTION – SIMATIC</li> <li>● SIMOTION – PC</li> </ul>		●	●	●	●
<b>Serial communication over point-to-point link</b> <ul style="list-style-type: none"> <li>● CP 340, CP 341 communication modules</li> <li>● 1SI communication module (connected over ET 200S)</li> </ul>	Basic version from SIMOTION viewpoint	●	●	●	●
<b>Communication via AS-Interface</b> <ul style="list-style-type: none"> <li>● CP 343-2 P communication module</li> <li>● DP/AS-Interface Link 20E/Link Advanced</li> <li>● IE/AS-Interface link PN IO</li> </ul>	Basic version from SIMOTION viewpoint	●	●	●	●
<b>Connectable network couplers</b> <ul style="list-style-type: none"> <li>● DP/DP coupler for connecting two PROFIBUS DP networks</li> <li>● PN/PN coupler for connecting two PROFINET IO networks</li> </ul>	Basic version from SIMOTION viewpoint	●	●	●	●
<b>PROFIsafe drives on SIMOTION</b>					
<b>Max. number of PROFIsafe drives on SIMOTION with SINAMICS S120 drive system:</b> <ul style="list-style-type: none"> <li>● Via PROFIBUS with PROFIsafe <ul style="list-style-type: none"> <li>- with 1 PROFIBUS interface</li> <li>- with 2 PROFIBUS interfaces</li> </ul> </li> <li>● Via PROFINET with PROFIsafe <ul style="list-style-type: none"> <li>- SIMOTION as Shared I-Device over PROFIsafe on PROFINET</li> </ul> </li> </ul>	SIMOTION as I-Slave on SIMATIC F-CPU over PROFIBUS <sup>1)</sup> P320-4: IsoPROFIBUS board option SIMOTION as I-Device on SIMATIC F-CPU over PROFINET Configuration: A higher-level SIMATIC F-CPU controls the safety functions of the SINAMICS S120 drives that are assigned to SIMOTION via the I-Slave/I-Device interface of the SIMOTION controller. SIMOTION routes the safety message frames through to the drives. SIMOTION as Shared I-Device to higher-level S7 F-CPU and second CPU (S7 or SIMOTION C/P/D)	16 32 32	16 32 128	8 8 D410-2 DP: – D410-2: DP/PN: 8	16 32 D425-2: 16 axes D435-2: 32 axes D445-2: 64 axes D455-2: 128 axes

<sup>1)</sup> Not for SIMOTION in the TIA Portal (SCOUT TIA).

# SIMOTION Motion Control System

## Overview of SIMOTION functions

	Notes	SIMOTION C240/C240 PN	SIMOTION P320-4	SIMOTION D410-2	SIMOTION D4x5-2
<ul style="list-style-type: none"> <li>● Basic version (function or license is purchased with the device or SCOUT)</li> <li>○ Option (must be acquired as software/hardware)</li> <li>– Not possible</li> </ul>					
<b>SIMOTION Kernel</b>					
<b>Execution system</b>					
<ul style="list-style-type: none"> <li>● System tasks for Motion Control               <ul style="list-style-type: none"> <li>- SERVO (position control cycle)</li> <li>- IPO (interpolation cycle)</li> <li>- SERVO<sub>Fast</sub></li> <li>- IPO<sub>Fast</sub></li> </ul> </li> </ul>		●	●	●	●
	SERVO <sub>Fast</sub> and IPO <sub>Fast</sub> allow axes with differing dynamic responses to be assigned to a slow bus system and a fast bus system, as well as especially fast I/O processing. High-speed PROFINET I/O modules are used for this purpose.	–	–	–	D425-2 DP: – D425-2 DP/PN: – D435-2 DP: – D435-2 DP/PN: ● D445-2 DP/PN: ● D455-2 DP/PN: ●
<ul style="list-style-type: none"> <li>- MotionTasks (sequential)</li> <li>- ServoSynchronousTask (cyclic, synchronous with the position control cycle)</li> </ul>		20	32	32	32
		1	1	1	1 (2) <sup>1)</sup>
<ul style="list-style-type: none"> <li>● Task structure/program execution               <ul style="list-style-type: none"> <li>- BackgroundTask (cyclic)</li> <li>- TimerInterruptTasks (time-controlled down to 1 ms)</li> <li>- IPoSynchronousTask (cyclic, synchronous with the interpolation cycle)</li> <li>- InterruptTasks (for user) (event-controlled)</li> <li>- TControlTasks (temperature control)</li> <li>- StartupTask (for transition from STOP to RUN)</li> <li>- ShutdownTask (for transition from RUN to STOP)</li> </ul> </li> </ul>	Adjustable monitoring time	1	1	1	1
		5	5	5	5
		2	2	2	2 (3) <sup>1)</sup>
		2	2	2	2
		5	5	5	5
		1	1	1	1
		1	1	1	1
<ul style="list-style-type: none"> <li>● Task structure/error processing (SystemInterruptTasks)               <ul style="list-style-type: none"> <li>- ExecutionFaultTask (starts in the event of an error when executing a program)</li> <li>- TechnologicalFaultTask (starts in the event of an error on a technology object)</li> <li>- PeripheralFaultTask (starts in the event of an error on the I/O)</li> <li>- TimeFaultTask (starts in the event of a TimerInterruptTask timeout)</li> <li>- TimeFaultBackgroundTask (starts in the event of a BackgroundTask timeout)</li> </ul> </li> </ul>	Central troubleshooting is possible				
		1	1	1	1
		1	1	1	1
		1	1	1	1
		1	1	1	1
		1	1	1	1

<sup>1)</sup> Values in brackets with SERVO<sub>Fast</sub> and IPO<sub>Fast</sub> activated for D435-2 DP/PN, D445-2 DP/PN and D455-2 DP/PN



## SIMOTION Motion Control System

### Overview of SIMOTION functions

<ul style="list-style-type: none"> <li>● Basic version (function or license is purchased with the device or SCOUT)</li> <li>○ Option (must be acquired as software/hardware)</li> <li>– Not possible</li> </ul>	Notes	SIMOTION C240/C240 PN	SIMOTION P320-4	SIMOTION D410-2	SIMOTION D4x5-2
<b>SIMOTION Kernel</b> (continued)					
<b>Execution system</b> (continued)					
<ul style="list-style-type: none"> <li>● Program organization               <ul style="list-style-type: none"> <li>- Units (source program)</li> <li>- Programs</li> <li>- Function blocks (FBs)</li> <li>- Functions (FCs)</li> <li>- Classes</li> <li>- Methods</li> <li>- System functions (SFs)</li> <li>- Libraries</li> </ul> </li> </ul>		●	●	●	●
<b>PLC command set</b>					
(according to IEC 61131-3; optionally expandable by technology functions)					
System functions, e.g. for					
<ul style="list-style-type: none"> <li>● Interrupt and error handling</li> <li>● Copying data</li> <li>● Clock functions</li> <li>● Diagnostic functions</li> <li>● Module parameterization</li> <li>● Operating mode transitions, Run/Stop</li> <li>● Reading and writing of data blocks from the user program from and to an exchangeable memory medium</li> <li>● DPV1 communication to DP slaves/PROFINET devices</li> <li>● Read/write drive parameters</li> <li>● DP slaves/PROFINET devices can be connected to and disconnected from application</li> <li>● DP slave, IP address and NameOfStation can be adjusted via user program</li> <li>● DP station diagnostics</li> <li>● Activate/deactivate technology objects</li> <li>● Counter (IEC commands)</li> <li>● Timer (IEC commands)</li> <li>● Real-time clock, format [DATE_AND_TIME]</li> <li>● Text files on memory card</li> </ul>		●	●	●	●

# SIMOTION Motion Control System

## Overview of SIMOTION functions

<ul style="list-style-type: none"> <li>● Basic version (function or license is purchased with the device or SCOUT)</li> <li>○ Option (must be acquired as software/hardware)</li> <li>– Not possible</li> </ul>	Notes	SIMOTION C240/C240 PN	SIMOTION P320-4	SIMOTION D410-2	SIMOTION D4x5-2
<b>Motion Control technology package</b>					
<b>Technology functions</b>					
<ul style="list-style-type: none"> <li>● Motion Control Basic</li> <li>● POS – Positioning</li> <li>● GEAR – Synchronous operation</li> <li>● CAM – Cam</li> <li>● PATH - Path interpolation</li> </ul> <p>The technology package functions are accessed via language commands, system variables and through function blocks in accordance with PLCopen.</p>	<p>No license required</p> <p>Use of the functions during runtime is subject to license. SIMOTION D410-2 already contains the technology functions for precisely one axis.</p>	●	●	●	●
		● <sup>1)</sup>	● <sup>1)</sup>	● <sup>1)</sup>	● <sup>1)</sup>
		● <sup>1)</sup>	● <sup>1)</sup>	● <sup>1)</sup>	● <sup>1)</sup>
		● <sup>1)</sup>	● <sup>1)</sup>	● <sup>1)</sup>	● <sup>1)</sup>
		● <sup>1)</sup>	● <sup>1)</sup>	● <sup>1)</sup>	● <sup>1)</sup>
<b>Axis types</b>					
<ul style="list-style-type: none"> <li>● Electrical/hydraulic/stepper motor axes</li> </ul>		●	●	●	●
<ul style="list-style-type: none"> <li>● Drive axis</li> </ul>		●	●	●	●
<ul style="list-style-type: none"> <li>● Positioning axis               <ul style="list-style-type: none"> <li>- Rotary axis</li> <li>- Linear axis</li> <li>- Modulo for linear and rotary axes</li> <li>- Force/pressure-controlled axis</li> <li>- Force/pressure-limited axis</li> </ul> </li> </ul>	Included with POS license or higher	● <sup>1)</sup>	● <sup>1)</sup>	● <sup>1)</sup>	● <sup>1)</sup>
<ul style="list-style-type: none"> <li>● Synchronous axis</li> </ul>	Included with GEAR license or higher	● <sup>1)</sup>	● <sup>1)</sup>	● <sup>1)</sup>	● <sup>1)</sup>
<ul style="list-style-type: none"> <li>● Path axis</li> </ul>	Included with GEAR license or higher	● <sup>1)</sup>	● <sup>1)</sup>	● <sup>1)</sup>	● <sup>1)</sup>
<ul style="list-style-type: none"> <li>● Synchronous axis with curve synchronization</li> </ul>	Included with CAM license or higher	● <sup>1)</sup>	● <sup>1)</sup>	● <sup>1)</sup>	● <sup>1)</sup>
<ul style="list-style-type: none"> <li>● Virtual axis</li> </ul>		●	●	●	●
<ul style="list-style-type: none"> <li>● Simulation axis</li> </ul>		●	●	●	●
<b>Systems of units</b>					
<ul style="list-style-type: none"> <li>● Metric (mm, m, Nm, Pa, ...)</li> </ul>		●	●	●	●
<ul style="list-style-type: none"> <li>● US (inch, feet, PSI, lb, ...)</li> </ul>		●	●	●	●
<b>Axis monitoring functions</b>					
<p>The activated monitoring functions are executed cyclically.</p> <ul style="list-style-type: none"> <li>● Watchdog</li> <li>● Hardware and software limit switches</li> <li>● Position/zero-speed monitoring</li> <li>● Dynamic following error monitoring</li> <li>● Encoder monitoring, cable break</li> <li>● Force/pressure monitoring</li> <li>● Setpoint</li> <li>● Data exchange plausibility</li> </ul>		●	●	●	●

<sup>1)</sup> Use of the functions during runtime is subject to license. Exception: SIMOTION D410-2 already contains the Motion Control technology functions for just one axis.

## SIMOTION Motion Control System

### Overview of SIMOTION functions

<ul style="list-style-type: none"> <li>● Basic version (function or license is purchased with the device or SCOUT)</li> <li>○ Option (must be acquired as software/hardware)</li> <li>– Not possible</li> </ul>	Notes	SIMOTION C240/C240 PN	SIMOTION P320-4	SIMOTION D410-2	SIMOTION D4x5-2
<b>Other technology packages</b>					
<b>TControl technology package</b> <ul style="list-style-type: none"> <li>• With technology functions for temperature control</li> </ul>	Technology package integrated in SCOUT	● <sup>1)</sup>	● <sup>1)</sup>	● <sup>1)</sup>	● <sup>1)</sup>
<b>Drive Control Chart (DCC) technology package <sup>3)</sup></b> <ul style="list-style-type: none"> <li>• With technology functions for Drive Control Chart</li> </ul>	Technology package integrated in SCOUT <sup>3)</sup>	●	●	●	●
<b>Multipurpose Information Interface (MIIF) technology package</b> <ul style="list-style-type: none"> <li>• With multi-functional communication functions</li> </ul>	Technology package can be purchased via your Siemens contact	○ <sup>1)</sup>	○ <sup>1)</sup>	○ <sup>1)</sup>	○ <sup>1)</sup>
<b>Vibration Extinction (VIBX) technology package</b> <ul style="list-style-type: none"> <li>• Vibration damping of axes</li> </ul>		○ <sup>1)</sup>	○ <sup>1)</sup>	○ <sup>1)</sup>	○ <sup>1)</sup>
<b>OACAMGEN technology package</b> <ul style="list-style-type: none"> <li>• Motion profiles for servo presses</li> </ul>		○ <sup>1)</sup>	○ <sup>1)</sup>	○ <sup>1)</sup>	○ <sup>1)</sup>
<b>SIMOTION IT</b>					
<b>SIMOTION IT DIAG</b> <p>Integrated web server on the SIMOTION controller</p> <ul style="list-style-type: none"> <li>• Service and diagnostic functions provided via commonly used standard web browsers with extensive information functions (hardware/software version display, process utilization, memory usage, diagnostic buffer, task runtimes, user logbook, operating state, time of day, etc.)</li> <li>• Access to all variables on the control system using variable browser functions</li> <li>• Watch tables (control variable diagnostics in freely configurable status and control tables. Variables of multiple SIMOTION controllers can be accessed simultaneously in a combined watch table)</li> <li>• Trace (control variable tracing for one controller or several synchronously)</li> <li>• Generation of diagnostic data (diagnostic buffer, alarms, states of variables, ...)</li> <li>• Project update</li> <li>• Firmware update</li> <li>• Password-protected access</li> <li>• Remote access to SIMOTION file system</li> <li>• User-defined service and diagnostic pages</li> </ul>		● <sup>2)</sup>	●	●	●

<sup>1)</sup> Use of the functions during runtime is subject to license.

<sup>2)</sup> Subject to license for SIMOTION Kernel versions earlier than V4.2.

<sup>3)</sup> Not for SIMOTION in the TIA Portal (SCOUT TIA).

# SIMOTION Motion Control System

## Overview of SIMOTION functions

<ul style="list-style-type: none"> <li>● Basic version (function or license is purchased with the device or SCOUT)</li> <li>○ Option (must be acquired as software/hardware)</li> <li>– Not possible</li> </ul>	Notes	SIMOTION C240/C240 PN	SIMOTION P320-4	SIMOTION D410-2	SIMOTION D4x5-2
<b>SIMOTION IT (continued)</b>					
<b>SIMOTION IT OPC XML-DA</b> Integrated OPC XML-DA server on the SIMOTION controller <ul style="list-style-type: none"> <li>● Read/write variables</li> <li>● Browse variables</li> <li>● Trace interface via SOAP</li> <li>● Password-protected access</li> </ul>		● <sup>1)</sup>	●	●	●
<b>SIMOTION OPC UA</b> Integrated on the SIMOTION controller <ul style="list-style-type: none"> <li>● Read/write variables</li> <li>● Browse variables</li> <li>● User authentication and encryption</li> </ul>		●	●	●	●
<b>SIMOTION IT Virtual Machine</b> (integrated Java runtime environment on the SIMOTION controller) <ul style="list-style-type: none"> <li>● Read and write access to the SIMOTION variables</li> <li>● Read and write access to the non-volatile memory (NVRAM)</li> <li>● Use of system functions (functions of technology objects)</li> <li>● Use of standard Java classes in the device (file access, network functions, string functions, etc.)</li> <li>● Creation of servlets for the purpose of integrating user-specific web server functions</li> </ul>	Licensing through SIMOTION IT Virtual Machine  Note: For SIMOTION Kernel < V4.2, can be used as combined license for SIMOTION IT DIAG, OPC XML-DA and Virtual Machine.	●	●	●	●
<b>SIMOTION SCOUT engineering system</b>					
<b>SIMOTION SCOUT basic functions</b> <ul style="list-style-type: none"> <li>● SCOUT Workbench</li> <li>● STARTER Drive commissioning/ Parameter assignment</li> <li>● Hardware and network configuration</li> <li>● Diagnostics for testing and commissioning</li> <li>● Axis control panel</li> <li>● Program editors/ Programming languages (command set in accordance with IEC 61131-3)               <ul style="list-style-type: none"> <li>- Structured Text (ST)</li> <li>- Ladder Diagram (LAD)</li> <li>- Function Block Diagram (FBD)</li> <li>- Motion Control Chart (MCC)</li> </ul> </li> <li>● Creation of cams (basic)</li> <li>● Creation of technology objects</li> <li>● Technology tools (function generator)</li> <li>● Operator interface, online help and documentation in English, French, German and Italian</li> </ul>		●	●	●	●

<sup>1)</sup> Subject to license for SIMOTION Kernel versions earlier than V4.2.

## SIMOTION Motion Control System

### Overview of SIMOTION functions

	Notes	SIMOTION C240/C240 PN	SIMOTION P320-4	SIMOTION D410-2	SIMOTION D4x5-2
<ul style="list-style-type: none"> <li>● Basic version (function or license is purchased with the device or SCOUT)</li> <li>○ Option (must be acquired as software/hardware)</li> <li>– Not possible</li> </ul>					
<b>SIMOTION SCOUT engineering system</b> (continued)					
<b>SIMOTION SCOUT optional packages</b>					
<ul style="list-style-type: none"> <li>● CamTool (graphical cam editor)</li> </ul>		○	○	○	○
<ul style="list-style-type: none"> <li>● DCC Editor (graphical editor for Drive Control Chart)</li> </ul>		○ <sup>1)</sup>	○ <sup>1)</sup>	○ <sup>1)</sup>	○ <sup>1)</sup>
<b>Testing and diagnostics with SIMOTION SCOUT</b>					
<b>Information functions</b>					
<ul style="list-style-type: none"> <li>● Hardware/software version</li> <li>● Processor utilization</li> <li>● Memory utilization</li> <li>● Diagnostic buffer</li> <li>● Task runtimes</li> <li>● User logbook</li> <li>● Operating state</li> <li>● Time</li> </ul>		●	●	●	●
<b>Comparison functions for projects</b>					
<ul style="list-style-type: none"> <li>● Comparison of objects in projects: <ul style="list-style-type: none"> <li>-between offline projects</li> <li>-between online and offline projects</li> </ul> </li> <li>● Detailed comparison: Shows differences between objects in detail</li> <li>● Matching: Projects and objects can be merged</li> </ul>		●	●	●	●
<b>Program test functions</b>					
<ul style="list-style-type: none"> <li>● Control/status variables</li> <li>● Watch tables</li> <li>● Status program/FB/FC (with specification of the call point)</li> <li>● Single-step MCC</li> <li>● Breakpoints in all languages (ST, MCC, LAD/FBD)</li> <li>● Tracer for MCC (for fast program sequences)</li> <li>● Trace technology object (recording of all technology object commands)</li> </ul>		●	●	●	●

<sup>1)</sup> Not for SIMOTION in the TIA Portal (SCOUT TIA).

## SIMOTION Motion Control System

### Overview of SIMOTION functions

<ul style="list-style-type: none"> <li>● Basic version (function or license is purchased with the device or SCOUT)</li> <li>○ Option (must be acquired as software/hardware)</li> <li>– Not possible</li> </ul>	Notes	SIMOTION C240/C240 PN	SIMOTION P320-4	SIMOTION D410-2	SIMOTION D4x5-2
<b>Testing and diagnostics with SIMOTION SCOUT (continued)</b>					
<b>Trace</b>					
<ul style="list-style-type: none"> <li>● Recording of I/O, system and program variables (on one controller as well as over several synchronously)</li> <li>● Recording from position control cycle onwards (n × position control cycle)</li> <li>● Trigger: Instantaneous, rising/falling edge, at code point system variable</li> <li>● Measuring functions for optimizing the speed/position controller (step response, ramp, frequency curve)</li> <li>● Automatic setting of the speed controller/position controller</li> <li>● Bode diagram, FFT analysis, function generator, mathematical functions</li> <li>● Endless trace</li> <li>● Recording over defined measuring period</li> <li>● Parameterization and trace data in non-volatile memory on memory card (optional)</li> </ul>		●	●	●	●
<b>Further diagnostic functions</b>					
<ul style="list-style-type: none"> <li>● Module diagnostics               <ul style="list-style-type: none"> <li>- Centralized</li> <li>- Distributed (e.g. ET 200)</li> </ul> </li> </ul>		●	●	●	●
<ul style="list-style-type: none"> <li>● PROFIBUS DP station diagnostics</li> <li>● PROFINET station diagnostics</li> </ul>	PROFINET standard feature on C240 PN, P320-4, D410-2 DP/PN and D4x5-2 DP/PN	●	●	●	●
<ul style="list-style-type: none"> <li>● Diagnostic buffer               <ul style="list-style-type: none"> <li>- No. of entries, max.</li> </ul> </li> </ul>	On SIMOTION D, one diagnostic buffer is provided for SIMOTION and another for the integrated SINAMICS drive.	200	200	2 × 100	2 × 200
<ul style="list-style-type: none"> <li>● Process fault diagnostics (Alarm_S)               <ul style="list-style-type: none"> <li>- Messages from user program</li> <li>- No. of entries, max.</li> </ul> </li> </ul>		●	●	●	●
<b>Engineering drives</b>					
<b>STARTER (integrated in SCOUT)</b> Drive/commissioning software for SINAMICS S/SINAMICS G	With SIMOTION in the TIA Portal (SCOUT TIA), only "SIMOTION Drives" are supported. These are SINAMICS S120 drives of versions V4.5, V4.7 and V4.8, which are networked with the SIMOTION CPU on the basis of PROFIBUS or PROFINET.	●	●	●	●

## SIMOTION system components



<b>3.1/1</b>	<b>HMI devices</b>
<b>3.2/1</b>	<b>I/O components</b>
<b>3.3/1</b>	<b>Power supplies</b>
<b>3.4/1</b>	<b>Drives</b>
<b>3.5/1</b>	<b>Motors</b>
<b>3.6/1</b>	<b>Connection systems</b>
<b>3.7/1</b>	<b>Measuring systems</b>

## SIMOTION system components

### Notes

3









<b>3.1/2</b>	<b>Introduction</b>
3.1/2	Overview
3.1/2	SIMATIC HMI devices for Motion Control
3.1/3	Configuration at a glance
3.1/4	Overview of the SIMATIC Panels for SIMOTION
<b>3.1/5</b>	<b>Key Panels</b>
3.1/5	Overview
3.1/5	Benefits
3.1/5	Application
3.1/5	Design
3.1/5	More information
<b>3.1/6</b>	<b>Basic Panels</b>
3.1/6	Overview
3.1/6	Benefits
3.1/6	Application
3.1/6	Design
3.1/6	More information
<b>3.1/7</b>	<b>Comfort Panels</b>
3.1/7	Overview
3.1/7	Benefits
3.1/7	Application
3.1/8	Design
3.1/8	More information
<b>3.1/9</b>	<b>Mobile Panels</b>
3.1/9	Overview
3.1/9	Benefits
3.1/9	Application
3.1/10	Design
3.1/10	More information
<b>3.1/11</b>	<b>HMI software</b>
3.1/11	Overview
3.1/11	SIMATIC WinCC (TIA Portal)
3.1/12	SIMATIC SCADA systems
3.1/13	PC-based HMI solutions
3.1/13	More information

# SIMOTION system components

## HMI devices

### Introduction

#### Overview

	SIMATIC HMI devices for Motion Control			
Panel family	Key Panel	Basic Panel	Comfort Panel	Mobile Panel
				
Used for	Flexible expansion by key or even safety functions	Cost-efficient, high-resolution visualization tasks	Maximum performance and functionality requirements	Maximum mobility and flexibility
Brief description	<ul style="list-style-type: none"> <li>• Fast commissioning</li> <li>• Simple networking</li> <li>• Intuitive status detection</li> </ul>	<ul style="list-style-type: none"> <li>• Intuitive operator control from 4" to 12"</li> <li>• Integrated HMI basic functionality</li> <li>• Perfect interaction with solutions at optimum cost</li> </ul>	<ul style="list-style-type: none"> <li>• Brilliant displays from 4" to 22"</li> <li>• Innovative commissioning and service concept</li> <li>• Energy management with PROFinergy</li> </ul>	<ul style="list-style-type: none"> <li>• Innovative operator control with or without cable</li> <li>• Rugged for site-related local operator control</li> <li>• Integrated safety concept</li> </ul>
Application examples	Suitable for most industries (automotive, food and beverage, oil and gas) thanks to a smooth and rugged front	Operation and monitoring of compact machines and plants directly on site	Operation and monitoring of machines and plants directly on site – whether in factory automation, process automation or building automation	When mobility is required for operating and monitoring machines and plants on-site
Catalog	ST 80/ST PC			

#### **SIMATIC HMI Panels – Brilliant HMI devices for efficient machine-level HMI**

A complete range of powerful and innovative HMI devices is available for implementing efficient, machine-level HMI solutions in the most diverse applications and industries. One unique and highly efficient feature is the integrated configuration via SIMATIC WinCC in the TIA Portal, with which the user can achieve significant savings with regard to engineering time, costs and effort.

[www.siemens.com/hmi-panels](http://www.siemens.com/hmi-panels)

#### **Key Panels – Innovative operator panels – Pre-assembled and ready to use**

Key Panels (KP) are the innovative alternative to conventionally wired operator keypads. The pre-assembled and ready-to-use bus-enabled operator panels ensure time savings of up to 60 % during installation and reductions in material costs of more than 30 %.

[www.siemens.com/key-panels](http://www.siemens.com/key-panels)

#### **Basic Panels – Basic functions for simple HMI applications**

The 2nd Generation Basic Panels are optimized for small machines and applications. The device family offers panels with high-resolution widescreen displays in sizes from 4" to 12", as well as combined key and touch operation. Variants can be selected for connection to PROFINET/Ethernet or PROFIBUS DP/MPI.

[www.siemens.com/basic-panels](http://www.siemens.com/basic-panels)

#### **Comfort Panels – The first choice for demanding HMI tasks**

Comfort Panels offer high-end functionality for demanding applications. They are especially powerful and equipped with high-resolution widescreen displays in sizes from 4" to 22", with a choice of touch screen (TP) or keypad (KP) operation. In size 4" also with touch screen and additional keys (KTP).

The Comfort Panels are equipped with PROFINET/Ethernet as well as PROFIBUS DP/MPI interfaces.

The Comfort product line is expanded by extremely rugged daylight-readable Outdoor Panels.

The Outdoor Panels are especially well suited for outdoor areas and therefore open up many new application areas – oil platforms, ships, from the engine room to the bridge, and many other outdoor applications. Outdoor Panels especially stand out due to their expanded temperature range, special daylight-readable displays, UV resistance and corrosion-resistant fronts.

[www.siemens.com/comfort-panels](http://www.siemens.com/comfort-panels)

#### **Mobile Panels – Power and safety in your hands**

The 2nd Generation Mobile Panels are portable, wired operator panels with high performance for demanding mobile applications and operator control and monitoring with direct access and line of sight to the process. They offer a choice of high-resolution 7" and 9" widescreen displays with a unique illuminated EMERGENCY STOP button, flexible evaluation options for the safety operating elements, and connection point detection. For wireless freedom with optional safety functionality, the Mobile Panel 277(F) IWLAN 8" is offered.

[www.siemens.com/mobile-panels](http://www.siemens.com/mobile-panels)

**Overview** (continued)**Rugged and compact for use at machine level**

With IP65/NEMA 4 degree of protection at the front, high EMC and extreme vibration resistance, the SIMATIC HMI devices are ideally suited for use in harsh industrial environments. Thanks to their compact design with a shallow mounting depth, the stationary operator panels can be fitted anywhere, even where only restricted space is available. For distributed configurations, devices are also available with all-round IP65/NEMA 4 protection.

The extremely rugged and shock-proof enclosure with degree of protection IP65 makes the Mobile Panels especially suitable for industrial applications. Their low weight and ergonomic design means that they are user-friendly and easy to operate.

**One configuration software for everything**

SIMATIC WinCC (TIA Portal) is a tool for plant-wide configuration of all SIMATIC HMI Panels, as well as PC-based systems. Graded variants are available for every task. The software permits simple and efficient configuration. Programming experience is not required.

Once created, configurations can be reused within the family.

**Component of Totally Integrated Automation**

Siemens provides the complete modular system of matched components for automation solutions from a single source and – with Totally Integrated Automation – one of the most globally successful automation concepts.

**Configuration at a glance**

WinCC engineering software (TIA Portal)				
	Basic	Comfort	Advanced	Professional
Basic Panels 2 <sup>nd</sup> Generation <sup>1)</sup>	✓	✓	✓	✓
Comfort Panels	–	✓	✓	✓
Mobile Panels 2 <sup>nd</sup> Generation	–	✓ <sup>2)</sup>	✓ <sup>2)</sup>	✓ <sup>2)</sup>
Mobile Panels x77 series	–	✓	✓	✓
WinCC Runtime Advanced	–	–	✓	✓

SIMATIC WinCC (TIA Portal) is an integral component of this world. It offers crucial advantages. Thanks to the triple uniformity in configuration/programming, data management and communication, the engineering costs of an automation solution are significantly reduced.

**Innovative operator control and monitoring**

SIMATIC HMI Panels support innovative operation and monitoring in combination with ruggedness, stability and ease of use. On the Comfort Panels in particular, standard hardware and software interfaces, e.g. the multimedia card/SD card, USB, Ethernet, PROFIBUS DP and Visual Basic scripts, provide more flexibility and openness as well as access to the Office world.

**Global use**

The SIMATIC HMI Panels are ideally equipped for global use. Online language switching permits the selection of up to 32 languages during ongoing operation simply by pressing a button. The wide variety of languages available also includes, for example, Asian logographic languages for China, Taiwan, Korea and Japan or Russia. The configuration interface of WinCC (TIA Portal) including the online help and the complete documentation is also multilingual. Up to 32 languages can be administered in one project. And all this is complemented by global service and support from Siemens.

<sup>1)</sup> As of WinCC (TIA Portal) V13

<sup>2)</sup> As of WinCC (TIA Portal) V13 SP1

# SIMOTION system components

## HMI devices

### Introduction

#### Overview (continued)

##### Overview of the SIMATIC Panels for SIMOTION

Panel	Group
<b>Basic Panels 2<sup>nd</sup> Generation</b>	
KTP400 Basic	Basic 2nd
KTP700 Basic DP	Basic 2nd
KTP700 Basic	Basic 2nd
KTP900 Basic	Basic 2nd
KTP1200 Basic DP	Basic 2nd
KTP1200 Basic	Basic 2nd
<b>Comfort Panels</b>	
TP700 Comfort	Comfort
TP900 Comfort	Comfort
TP1200 Comfort	Comfort
TP1500 Comfort	Comfort
TP1900 Comfort	Comfort
TP2200 Comfort	Comfort
KP400 Comfort	Comfort
KP700 Comfort	Comfort
KP900 Comfort	Comfort
KP1200 Comfort	Comfort
KP1500 Comfort	Comfort
KTP400 Comfort	Comfort
<b>Mobile Panels</b>	
KTP700 Mobile	KTP Mobile
KTP700F Mobile	KTP Mobile
KTP900 Mobile	KTP Mobile
KTP900F Mobile	KTP Mobile
Mobile Panel 177 6" DP	Mobile
Mobile Panel 177 6" PN	Mobile
Mobile Panel 277 10"	Mobile
Mobile Panel 277 8"	Mobile
Mobile Panel 277 8" IWLAN V2	Mobile
Mobile Panel 277F 8" IWLAN V2	Mobile
Mobile Panel 277F 8" IWLAN V2	Mobile
Mobile Panel 277F 8" IWLAN V2 (RFID Tag)	Mobile
Mobile Panel 277F 8" IWLAN (RFID Tag)	Mobile

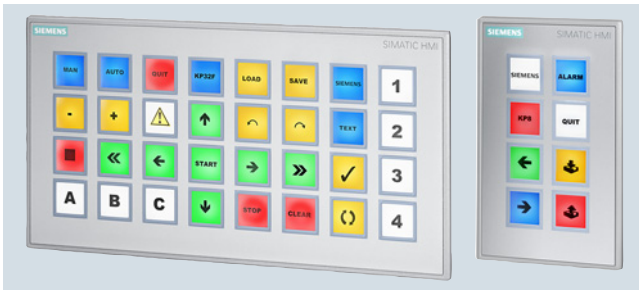
**Overview****SIMATIC HMI Key Panels**

The Key Panels, PROFINET successors to the PROFIBUS-based Push Button Panels, are operator panels which are immediately ready-to-run without any configuration effort.

Key Panels are alternatives to individually wired long-stroke keys and are designed for direct operator control of the machine.

Key Panels provide many basic functions for direct operator control and monitoring instead of machine operation as a cost-effective, flexible and space-saving combination, and they reduce configuration and installation costs to a minimum.

- SIMATIC HMI blank front design
- SIMATIC HMI KP8 PN
- SIMATIC HMI KP8F PN
- SIMATIC HMI KP32F PN (PROFIsafe can be switched off)

**Benefits**

- Less planning and installation overhead than for discrete components, thanks to modular arrangement
- Savings in terms of hardware costs: distributed I/O, 2 PROFINET connections, and I/O are combined in one device
- Keys and lamps can be labeled using a standard printer in IP65 (black and white or color)
- A high degree of flexibility due to user-configurable colors, switch/button function, and integrated diagnostic function
- Any key color can be dynamically adapted to the process
- Integrated standard inputs and outputs for actuators and sensors, and each pin can be used as an input or output
- Blank front designs can be used to reserve space for later system expansions or for the easy installation of 22.5 mm (0.89 in) standard operator controls
- The design and functions are optimally harmonized with the SIMATIC HMI range of products, e.g. in PRO device Extension Units
- SIL 2/3 safety in the F-versions, e.g. emergency stop can be connected directly

**Application**

- Suitable for most industries (automotive, food and beverage, oil and gas) thanks to the smooth and rugged front, even in hazardous areas
- For extremely easy, intuitive and fast operation with minimum wiring
- Language-neutral feedback possible, even in sunlight, due to multi-color LEDs in the keys
- Expansions possible without stock-removing tools even when installed
- Special-purpose machine manufacturing benefits from the high degree of flexibility

**Design****SIMATIC HMI Key Panel – Blank front design**

- Easy, seamless installation with mounting clips
- Rugged design, thus also suitable for harsh industrial environments
- Prepared for the installation of 22.5 mm (0.89 in) standard elements
- Extremely easy installation or retrofit of standard 22.5 mm (0.89 in) operator controls during operation

**SIMATIC HMI Key Panel – Basic functions**

- Smooth front, therefore easy to clean
- Large mechanical illuminated pushbuttons can be programmed as a switch or pushbutton
- 24 V DC power supply that can be looped through, thus no additional terminals are needed
- One PROFINET interface (2 ports) – perfect for line operation
- Suitable for ring operation thanks to Media Redundancy Protocol (MRP). Everything continues to run even in the event of physical interruption of the PROFINET network cable
- Inputs and outputs on the rear, each pin can be used as an input or output
- The F variants are additionally equipped with SIL 2/3 inputs

**SIMATIC HMI KP8 PN**

- 8 large mechanical illuminated pushbuttons with excellent tactile feedback, thus also suitable for harsh industrial environments
- 8 freely configurable digital I/Os
- For standard CPUs

**SIMATIC HMI KP8F PN**

- Additional digital fail-safe inputs for the connection of 1-channel or 1 × 2-channel sensors, such as emergency stop
- For fail-safe CPUs

**SIMATIC HMI KP32F PN**

- 32 large mechanical illuminated pushbuttons with excellent tactile feedback, thus also suitable for harsh industrial environments
- 16 freely configurable I/Os
- Additional digital fail-safe inputs for the connection of 4 × 1-channel or 2 × 2-channel sensors, such as emergency stop
- For fail-safe and standard CPUs

**More information**

Further information can be found on the Internet at:  
[www.siemens.com/key-panels](http://www.siemens.com/key-panels)

Technical specifications can be found in the Catalog ST 80/ST PC – Chapter Operator control and monitoring systems/PC-based Automation

For configuration information, see the Configuration Manual at:  
<https://support.industry.siemens.com/cs/document/56652789>

## SIMOTION system components

### HMI devices

#### Basic Panels

##### Overview



##### Basic Panels 2<sup>nd</sup> Generation

SIMATIC HMI Basic Panels 2<sup>nd</sup> Generation with their well-proven HMI basic functions represent the ideal entry-level series for simple HMI applications.

The device family offers panels with 4", 7", 9" and 12" displays with combined key and touch operation.

- SIMATIC HMI KTP400 Basic
- SIMATIC HMI KTP700 Basic
- SIMATIC HMI KTP700 Basic DP
- SIMATIC HMI KTP900 Basic
- SIMATIC HMI KTP1200 Basic
- SIMATIC HMI KTP1200 Basic DP

The innovative high-resolution widescreen displays with 64000 colors are also suitable for upright installation and they can be dimmed by up to 100 %. The innovative operator interface with improved usability opens up a diverse range of options thanks to new controls and graphics. The new USB interface enables the connection of keyboard, mouse or barcode scanner and supports the simple archiving of data on a flash drive.

The integrated Ethernet or RS 485/422 interface (version-specific) enables simple connection to the controller

##### Benefits

- Integral component of Totally Integrated Automation (TIA): Increase in productivity, minimization of the engineering overhead, reduction of lifecycle costs
  - Can be used even when installation space is limited due to upright configuration
  - Short configuring and commissioning times
  - Service-friendly due to maintenance-free design
- Simple and operator-friendly display of process values through the use of, for example, input/output fields, vector graphics, curves, bars, texts and bitmaps
- Flexible connection of flash drive, keyboard, mouse or barcode scanner via USB interface
- Graphics library with pre-configured image objects available
- Can be used worldwide:
  - 32 languages can be configured (including Asian and Cyrillic character sets)
  - Up to 10 languages can be selected online
  - Language-dependent texts and graphics

##### Application

The SIMATIC HMI Basic Panels can be used wherever compact machines and plants need to be operated and monitored locally, for example in factory automation, process automation or building automation. They are in use in a wide range of different industries and applications.

##### Design

The SIMATIC HMI Basic Panels are installation-compatible with the existing touch devices of the Panels and Multi Panels family of products.

##### KTP400 Basic

- Dimmable 4.3" widescreen TFT display with 64000 colors
- 1 Ethernet interface (TCP/IP, PROFINET)
- 1 USB interface
- Touch screen and 4 tactile function keys

##### KTP700 Basic

- Dimmable 7" widescreen TFT display with 64000 colors
- 1 Ethernet interface (TCP/IP, PROFINET) or 1 RS 485/422 interface (MPI, PROFIBUS DP; separate variant)
- 1 USB interface
- Touch screen and 8 tactile function keys

##### KTP900 Basic

- Dimmable 9" widescreen TFT display with 64000 colors
- 1 Ethernet interface (TCP/IP, PROFINET)
- 1 USB interface
- Touch screen and 8 tactile function keys

##### KTP1200 Basic

- Dimmable 12" widescreen TFT display with 64000 colors
- 1 Ethernet interface (TCP/IP, PROFINET) or 1 RS 485/422 interface (MPI, PROFIBUS DP; separate variant)
- 1 USB interface
- Touch screen and 10 tactile function keys

##### More information

Further information can be found on the Internet at: [www.siemens.com/basic-panels](http://www.siemens.com/basic-panels)

#### Overview



Excellent HMI functionality for demanding applications

- Widescreen TFT displays with diagonal sizes of 4", 7", 9", 12", 15", 19", 22" (all with 16 million colors) with up to 40 % more visualization area compared to predecessor devices
- Integrated high-end functionality with archives, scripts, PDF/Word/Excel viewer, Internet Explorer, Media Player and Web server
- Dimmable displays from 0 to 100 % via PROFlenergy, via the HMI project, or via a controller
- Modern industrial design, cast aluminum fronts starting at 7"
- Upright installation for all touch devices
- Ideal selection options: seven Touch and five Key versions
- Data security in the event of a power outage for the device and for the SIMATIC HMI memory card
- Innovative service and commissioning concept due to second SD card (automatic backup)
- Maximum performance for short image refresh times
- Suitable for the harshest industrial environments with expanded approvals such as ATEX 2/22 and marine approvals
- Wide range of communication options: PROFIBUS and PROFINET onboard, starting at 7" PROFINET interface with integrated 2-port switch, starting at 15" also 1 x PROFINET with Gigabit support
- All versions can be used as an OPC UA client or as a server
- Key devices with an LED in each function key and new text entry mechanism, based on mobile telephone keypads
- All keys have a service life of 2 million key presses
- Configuration with the engineering software WinCC TIA (TIA Portal)

#### Note:

A 7" and 15" Comfort Outdoor variant will be available soon. For more information, visit:

[www.siemens.com/hmi](http://www.siemens.com/hmi)

The following SIMATIC HMI Comfort Panels are available.

- Comfort Panels
  - Standard Comfort Panels
  - Touch and Key Panels: KTP400 Comfort
  - Touch Panels: TP700 Comfort, TP900 Comfort, TP1200 Comfort, TP1500 Comfort, TP1900 Comfort, TP2200 Comfort
  - Key Panels: KP400 Comfort, KP700 Comfort, KP900 Comfort, KP1200 Comfort, KP1500 Comfort
  - Comfort Outdoor Panels (Touch Panels): TP700 Comfort Outdoor, TP1500 Comfort Outdoor
- Comfort Panels for special requirements (INOX)
  - Touch Panels: TP700 Comfort INOX, TP900 Comfort INOX, TP1200 Comfort INOX, TP1500 Comfort INOX, TP1900 Comfort INOX

#### Benefits

- Integral component of Totally Integrated Automation (TIA): Increase in productivity, minimization of the engineering overhead, reduction of lifecycle costs
  - Can be used even when installation space is limited due to upright configuration (all Touch devices)
- Reduction of service and commissioning costs through:
  - Short configuring and commissioning times due to efficient engineering and fast project download
  - Automatic backup via optional SIMATIC HMI memory card
  - Long service life of the backlighting
  - Maintenance-free design
  - Data security in the event of a power outage
- Simple and operator-friendly display of process values through the use of, for example, input/output fields, graphics, curves, bars, texts and bitmaps
- Graphics library with pre-configured image objects available
- Can be used worldwide:
  - 32 languages can be configured (including Asian and Cyrillic character sets)
  - Up to 32 languages can be selected online
  - Language-dependent texts and graphics
- Standard hardware and software interfaces for increasing the flexibility and for saving additional hardware:
  - PROFIBUS and PROFINET onboard (as of 7" PROFINET interface with integrated 2-port switch)
  - Two SD card slots for storing archives, recipes, user data and for automatic backup
  - USB device interface for easy project download
  - USB host interfaces for connecting a USB stick, keyboard, mouse, printer
  - Starting at 7" Audio IN/OUT interface for use with the integrated media player
  - Standard Windows storage formats (CSV) for archives and recipes allow further processing with standard tools (e.g. Microsoft Excel)
  - Modularly expandable with the Sm@rtServer option for communication between various SIMATIC HMI systems and for remote maintenance

#### Application

The SIMATIC HMI Comfort Panels can be used wherever machines and plants are operated and monitored locally – whether in factory automation, process automation or building automation. They are in use in a wide range of different industries and applications. They are perfectly suitable for demanding visualization tasks and due to the integrated functionality, the right device can be selected for any application.

## SIMOTION system components

### HMI devices

#### Comfort Panels

##### Design

###### **KTP400 Comfort**

- 4.3" widescreen TFT display, resolution 480 × 272, 16 million colors
- 1 PROFINET and 1 PROFIBUS interface
- Touch screen and membrane keyboard with 4 tactile function keys
- Innovative successor to the TP 177B 4" Touch Panel

###### **KP400 Comfort**

- 4.3" widescreen TFT display, resolution 480 × 272, 16 million colors
- 1 PROFINET and 1 PROFIBUS interface
- Membrane keyboard with 8 tactile function keys + system keyboard
- Innovative successor to the OP 77B Operator Panel

###### **TP700 Comfort**

- 7.0" widescreen TFT display, resolution 800 × 480, 16 million colors
- 1 PROFINET (2 ports with integrated switch) and 1 PROFIBUS interface
- Touch screen
- Innovative successor to the Touch Panels TP 177B/TP 277 and Multi Panel MP 177 6"

###### **KP700 Comfort**

- 7.0" widescreen TFT display, resolution 800 × 480, 16 million colors
- 1 PROFINET (2 ports with integrated switch) and 1 PROFIBUS interface
- Membrane keyboard with 24 function keys + system keyboard
- Innovative successor to the OP 177B/OP 277 6" Operator Panels

###### **TP900 Comfort**

- 9.0" widescreen TFT display, resolution 800 × 480, 16 million colors
- 1 PROFINET (2 ports with integrated switch) and 1 PROFIBUS interface
- Touch screen
- Innovative successor to the MP 277 8" Touch Multi Panel

###### **KP900 Comfort**

- 9.0" widescreen TFT display, resolution 800 × 480, 16 million colors
- 1 PROFINET (2 ports with integrated switch) and 1 PROFIBUS interface
- Membrane keyboard with 26 function keys + system keyboard
- Innovative successor to the MP 277 8" Key Multi Panel

###### **TP1200 Comfort**

- 12.1" widescreen TFT display, resolution 1280 × 800, 16 million colors
- 1 PROFINET (2 ports with integrated switch) and 1 PROFIBUS interface
- Touch screen
- Innovative successor to the MP 277 10" Touch Multi Panel

###### **KP1200 Comfort**

- 12.1" widescreen TFT display, resolution 1280 × 800, 16 million colors
- 1 PROFINET (2 ports with integrated switch) and 1 PROFIBUS interface
- Membrane keyboard with 34 function keys + system keyboard
- Innovative successor to the MP 277 10" Key Multi Panel

###### **TP1500 Comfort**

- 15.4" widescreen TFT display, resolution 1280 × 800, 16 million colors
- 2 PROFINET (2 ports with integrated switch + additional interface with Gigabit support) and 1 PROFIBUS interface
- Touch screen
- Innovative successor to the MP 377 12" Touch Multi Panel

###### **KP1500 Comfort**

- 15.4" widescreen TFT display, resolution 1280 × 800, 16 million colors
- 2 PROFINET (2 ports with integrated switch + additional interface with Gigabit support) and 1 PROFIBUS interface
- Membrane keyboard with 36 function keys + system keyboard
- Innovative successor to the MP 377 12" Key Multi Panel

###### **TP1900 Comfort**

- 18.5" widescreen TFT display, resolution 1366 × 768, 16 million colors
- 2 PROFINET (2 ports with integrated switch + additional interface with Gigabit support) and 1 PROFIBUS interface
- Touch screen
- Innovative successor to the MP 377 15" Touch Multi Panel

###### **TP2200 Comfort**

- 21.5" widescreen TFT display, resolution 1920 × 1080, 16 million colors
- 2 PROFINET (2 ports with integrated switch + additional interface with Gigabit support) and 1 PROFIBUS interface
- Touch screen
- Innovative successor to the MP 377 19" Touch Multi Panel

##### More information

Further information can be found on the Internet at:  
[www.siemens.com/comfort-panels](http://www.siemens.com/comfort-panels)



#### Overview



#### Mobile Panels 2<sup>nd</sup> Generation

The second generation of SIMATIC HMI Mobile Panels impresses with its convenience, performance and quality.

The highlights: A brilliant widescreen display, particularly simple configuration, and the unique illuminated emergency stop button.

The device family offers panels with 4", 7" and 9" displays, each of which is available with or without safety operating elements.

The Mobile Panels of the 2<sup>nd</sup> Generation are the successors to the SIMATIC HMI Mobile Panels x77 with cable connections. The following Mobile Panels are available:

- SIMATIC HMI KTP400F Mobile
- SIMATIC HMI KTP700 Mobile
- SIMATIC HMI KTP700F Mobile
- SIMATIC HMI KTP900 Mobile
- SIMATIC HMI KTP900F Mobile

#### Benefits

##### Brilliant widescreen display

With a 16:9 aspect ratio, the display offers an extremely sharp, bright and detailed image, and with 16 million colors and approximately 40 % larger display area it can even display complex operating screens and graphics. The display can be dimmed by up to 100 % and can thus be adapted to different environments.

##### Unique safety solution

The device variants with the EMERGENCY STOP pushbutton on the top and acknowledgment button on the rear of the device permit the flexible configuration of the safety solution. The EMERGENCY STOP button is only active and illuminated in red if the device is integrated into a safety circuit via the connection box. The new devices support the evaluation of safety elements using permanently wired safety relays (e.g. SIRIUS 3SK1), fail-safe I/Os (e.g. SIMATIC ET 200), as well as PROFIsafe with fail-safe controllers (e.g. SIMATIC S7-1500F).

#### Innovative service and commissioning concept

Reduction of service and commissioning costs through:

- Short configuring and commissioning times due to efficient engineering and fast project download
- Automatic backup via optional SIMATIC HMI memory card
- Long service life of the backlighting
- Maintenance-free design

#### Rugged industrial design

- Dust-tight and jet-proof enclosure with all-round IP65 degree of protection
- Extremely impact-resistant device that can withstand a fall of 1.2 meters
- Resistant to operating substances

#### Efficient engineering

The second generation of the Mobile Panels has the same aspect ratio and the same resolution as the Comfort Panels. With the new and innovative Style Editor, operating screens can now be easily configured both for stationary and mobile applications via the engineering tool TIA Portal (WinCC). The user merely has to select the new Mobile Panel in the TIA Portal configuration. The configuration can then be expanded with specific functions for mobile use.

#### Application

Regardless of the industry or application, if mobility is required for on-site operator control and monitoring of machines and plants, SIMATIC HMI Mobile Panels offer some decisive advantages: The machine operators or commissioning engineers are able to work exactly where they have the best view of the work-piece or process.

Even for larger production facilities, complex or enclosed machines, long materials handling or production lines and conveyor systems, mobile operator panels allow fast and precise setting up and positioning during commissioning. They also ensure shorter downtimes during retooling, maintenance or repairs.

## SIMOTION system components

### HMI devices

#### Mobile Panels

##### Design

###### **KTP700 Mobile**

- Dimmable 7.0" widescreen TFT display, resolution 800 × 480, 1 million colors
- 1 Ethernet interface (TCP/IP, PROFINET)
- 1 USB interface
- 1 SD card slot
- Touch screen and 8 tactile function keys, incl. LED
- 2 illuminated pushbuttons

###### **KTP700F Mobile**

- Dimmable 7.0" widescreen TFT display, resolution 800 × 480, 16 million colors
- 1 Ethernet interface (TCP/IP, PROFINET, PROFI-safe)
- 1 USB interface
- 1 SD card slot
- Touch screen and 8 tactile function keys, incl. LED
- 2 illuminated pushbuttons
- 1 key-operated switch
- 1 three-stage acknowledgment button
- 1 EMERGENCY STOP/stop button

###### **KTP900 Mobile**

- Dimmable 9.0" widescreen TFT display, resolution 800 × 480, 16 million colors
- 1 Ethernet interface (TCP/IP, PROFINET)
- 1 USB interface
- 1 SD card slot
- Touch screen and 10 tactile function keys, incl. LED
- 2 illuminated pushbuttons

###### **KTP900F Mobile**

- Dimmable 9.0" widescreen TFT display, resolution 800 × 480, 16 million colors
- 1 Ethernet interface (TCP/IP, PROFINET, PROFI-safe)
- 1 USB interface
- 1 SD card slot
- Touch screen and 10 tactile function keys, incl. LED
- 2 illuminated pushbuttons
- 1 key-operated switch
- 1 three-stage acknowledgment button
- 1 EMERGENCY STOP/stop button

##### More information

Further information can be found on the Internet at:  
[www.siemens.com/mobile-panels](http://www.siemens.com/mobile-panels)

## Overview

### SIMATIC HMI – Efficient to a new level

Innovative, efficient, scalable and open software for the machine-level area and for SCADA solutions.

With the SIMATIC WinCC (TIA Portal), SIMATIC WinCC and SIMATIC WinCC Open Architecture product families, SIMATIC HMI offers visualization and configuration software for the entire HMI spectrum, from the machine-level area all the way to SCADA systems:

- SIMATIC WinCC (TIA Portal)  
Creation of applications in the machine-level area and of process visualization or SCADA systems
- SIMATIC WinCC flexible  
Maintenance of existing visualization solutions in the machine-level area
- SIMATIC WinCC SCADA system  
Creation of process visualization or SCADA systems
- SIMATIC WinCC Open Architecture SCADA system  
Creation of applications with a high demand for customer-specific adaptations, large and/or complex applications, as well as projects that demand special system requirements and functions.

### SIMATIC WinCC (TIA Portal)

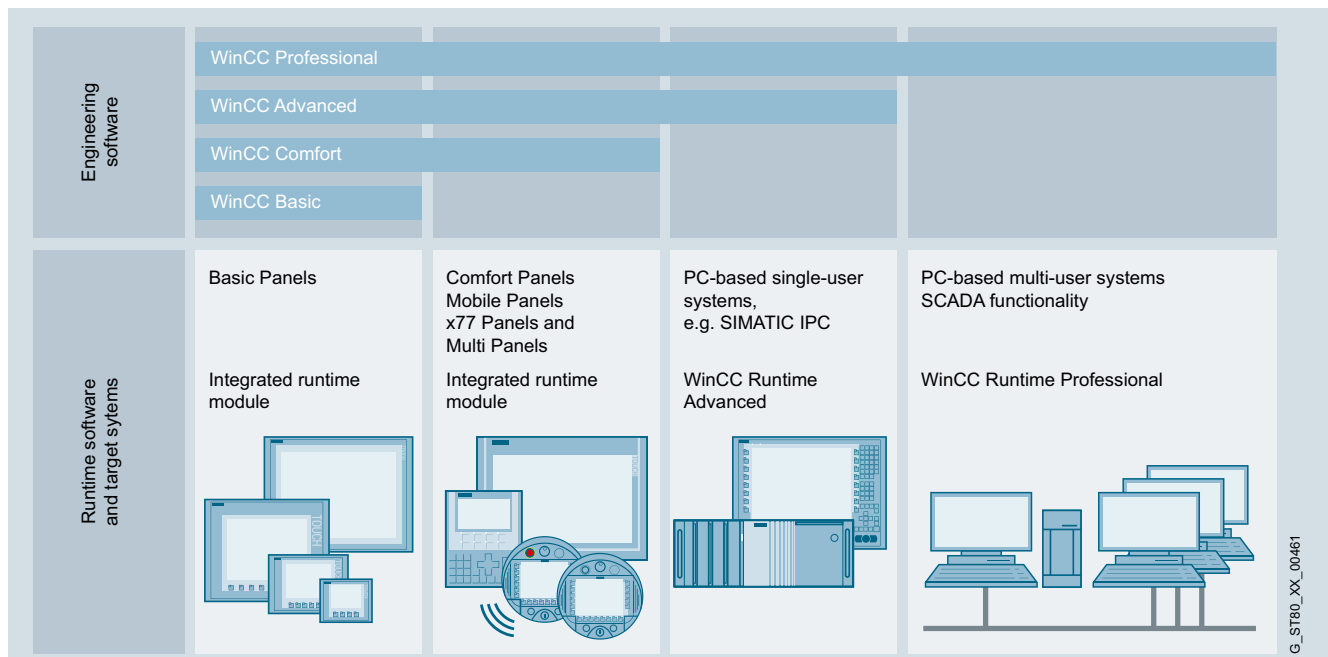

WinCC (TIA Portal) is based on the central engineering framework, the Totally Integrated Automation Portal (TIA Portal), which offers users a uniform, efficient and intuitive solution to all their automation tasks. SIMATIC WinCC (TIA Portal) covers applications at the machine level and applications in the process visualization or SCADA environments. WinCC (TIA Portal) offers the totally integrated and scalable configuration tools WinCC Basic, Comfort, Advanced and Professional for configuring the SIMATIC HMI devices:

- SIMATIC Basic Panels
- SIMATIC Comfort Panels
- SIMATIC Mobile Panels
- PC-based systems for the machine-level area
  - SIMATIC WinCC Runtime Advanced
  - SIMATIC WinCC Runtime Professional

In addition, WinCC (TIA Portal) offers:

- Intuitive user interface with maximum user friendliness
- Clear configuration of devices and network topologies
- Shared data management and uniform symbols via controller and HMI
- Optimum interaction with the controller and HMI in a working environment
- Powerful editors for efficient engineering
- Intelligent mass data operations for efficient configuration
- System diagnostics as an integral component
- Universal library concept

## SIMOTION system components

### HMI devices

#### HMI software

#### Overview (continued)

##### **SIMATIC SCADA systems**

The data volume in modern industrial plants is growing continuously – and along with it the challenges faced by the SCADA solutions used: Enormous data volumes must be administered and archived for the long term. This is accompanied by increasing demands on performance. Technologies, including some from the consumer environment, are finding their way into industry. Globalization calls for higher-level SCADA systems that can be used worldwide – and the need for mobile access to plant information is also growing. On top of all these requirements – in times of ever increasing (energy) costs – is the need to improve energy efficiency and productivity.

##### **With SIMATIC SCADA systems, you are fit for the future**

###### Efficiency

As a key to greater productivity, SIMATIC SCADA systems combine efficient engineering with high-performance archiving and maximum data security. These features provide the basis for efficient operations management and intelligent production analyses.

###### Scalability

We offer stationary and mobile solutions to cover increasing demands – security guaranteed. In this area, we apply more than 15 years of SCADA know-how from all industrial sectors. No matter how big or small your requests are – we have the right answer.

###### Innovation

Keep up-to-date with mobile SCADA solutions anywhere and at any time – including with existing tablet and smartphone hardware. The use of multi-touch gestures in the industrial environment opens the door for modern operating concepts.

###### Openness

Due to the support of international standards and system-internal script and programming interfaces, special requests can also be easily implemented.



##### **SIMATIC WinCC SCADA system**

The SCADA system SIMATIC WinCC is the process visualization or SCADA system for visualizing and operating processes, production flows, machines and plants in all industries – from the simple single-user station through to distributed multi-user systems with redundant servers and cross-site solutions with web clients.

WinCC acts as an information hub for company-wide vertical integration (process visualization and platform for IT and business integration).

- All HMI functions on-board with industry-standard functions for signaling and acknowledging events, archiving of messages and measured values, logging of all process and configuration data, user administration and visualization (WinCC basic software)
- Universally scalable client/server structures with operator stations on the Web, distributed servers and data integrity thanks to redundancy
- Easy to integrate over standard interfaces such as OPC (OLE for Process Control), WinCC OLE-DB, VBA (Visual Basic for Applications), VB Script, C-API (ODK)
- Integration platform in the company due to the Historian functionality integrated into WinCC based on the Microsoft SQL Server, standard and programming interfaces and tools and clients for evaluation
- Modular expansion with options and add-ons as well as individual functional expansions with VB Script, Visual Basic for Applications, C-API (ODK) and integration of ActiveX elements

**Overview** (continued)**SIMATIC WinCC Open Architecture SCADA system**

The SCADA system SIMATIC WinCC Open Architecture is suitable for applications with demanding customization requirements, large and/or complex applications, as well as projects that require special system requirements and functions.

SIMATIC WinCC Open Architecture demonstrates its performance capability particularly in networked and redundant high-end control systems. From the field level to the control station, from the machine to the company headquarters – integrated, high-performance communication is ensured. In every situation, a high level of availability, reliable information, fast interaction and user friendliness is guaranteed. Applications can also be changed even without interrupting the process. Profitability, efficiency and safety are therefore always in equilibrium.

With its disaster recovery system and SIL3 certification, SIMATIC WinCC Open Architecture demonstrates its reliability in a wide range of critical applications. SIMATIC WinCC Open Architecture can be used on any platform and is available for Windows, Linux and Solaris.

SIMATIC WinCC Open Architecture is open for independent in-house developments, which means that ideas can be turned into new applications quickly and easily.

- Object-orientation supports efficient engineering and flexible plant expansion
- For large, distributed systems with up to 2048 servers
- Scalable – from a small single-user system up to a networked, redundant high-end system
- WinCC OA can be used on any platform and is available for Windows, Linux and Solaris
- Hot-standby redundancy and disaster recovery system assure maximum fail-safety and availability
- WinCC OA offers a platform for customer-specific solutions
- Extensive driver and interfacing options: S7, SINAUT, OPC, OPC UA, Modbus, IEC60870-5-101/104, DNP3, BACnet, and many more
- Flexible logging of data either in file-based value archive or in a relational database (ORACLE)
- Modular expansion is possible using options and add-ons as well as individual functional expansions by means of own script language CONTROL, API(C++) and integration of ActiveX elements

**PC-based HMI solutions (machine-level / SCADA) with SIMATIC industrial PCs**

Our reliable and innovative SIMATIC IPC industrial PCs are the ideal PC hardware platforms. SIMATIC industrial PCs are offered with low-cost software packages for the runtime versions with the SIMATIC WinCC V7, WinCC Runtime Professional or WinCC Runtime Advanced visualization software, as well as the SIMATIC WinAC RTX (F) software controller. The simultaneous purchase of industrial PC and software package results in a price advantage.

**More information**

Further information on SCADA systems can be found on the Internet at:  
[www.siemens.com/scada](http://www.siemens.com/scada)

Further information on PC-based HMI solutions can be found on the Internet at:  
[www.siemens.com/pc-based](http://www.siemens.com/pc-based)  
and in the Catalog ST 80/ST PC – Chapter HMI Software

## SIMOTION system components

### Notes

3  
1



### 3.2/2 Distributed I/O

- 3.2/2 Overview
- 3.2/2 Perfect communication on all levels
- 3.2/3 PROFINET
- 3.2/3 PROFIBUS
- 3.2/3 AS-Interface
- 3.2/3 IO-Link
- 3.2/4 Solutions in the control cabinet (IP20)
  - SIMATIC ET 200SP
  - SIMATIC ET 200MP
- 3.2/5 • SIMATIC ET 200S
- 3.2/6 • SIMATIC ET 200M
- 3.2/7 Solutions without a control cabinet (IP65/67)
  - SIMATIC ET 200pro
  - SIMATIC ET 200eco PN
  - SIMATIC ET 200eco
  - SIMATIC ET 200AL

### 3.2/12 Other I/O components

- 3.2/12 Overview
- 3.2/13 SIMATIC S7-300 I/O
- 3.2/14 TM15 Terminal Module
- 3.2/15 ADI 4 Analog Drive Interface
- IM 174 Interface Module
- 3.2/16 Function blocks for I/O components



# SIMOTION system components

## I/O components

### Distributed I/O

#### Overview

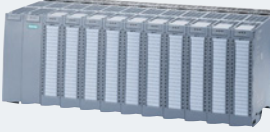
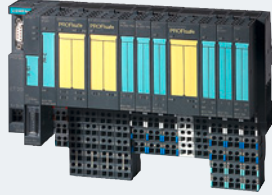
SIMATIC ET 200 distributed I/O for the control cabinet

SIMATIC ET 200 Distributed I/O	SIMATIC ET 200SP	SIMATIC ET 200MP	SIMATIC ET 200S	SIMATIC ET 200M
				
Brief description	Scalable, highly flexible I/O of the new generation	The multi-channel and multi-functional I/O of the S7-1500	The all-rounder with a comprehensive range of functions	Modular design with S7-300 modules
Degree of protection	IP20	IP20	IP20	IP20
Design	Scalable, bit-modular	Modular	Bit-modular, block	Modular
Technology functions	Yes	Yes	Yes	Yes
Isochronous mode	Yes	Yes	Yes	Yes
Fail-safe modules	Yes	Yes	Yes	Yes
Catalog	ST 70, IK PI			

#### Perfect communication on all levels

Distributed machine and plant configurations have now become common practice in automation technology. This reduces the wiring outlay and significantly increases flexibility and reliability.

PROFINET and PROFIBUS DP are available for connecting distributed I/O.

AS-Interface and IO-Link handle communication on the

actuator/sensor level. This allows problem-free data exchange throughout the whole automation world.



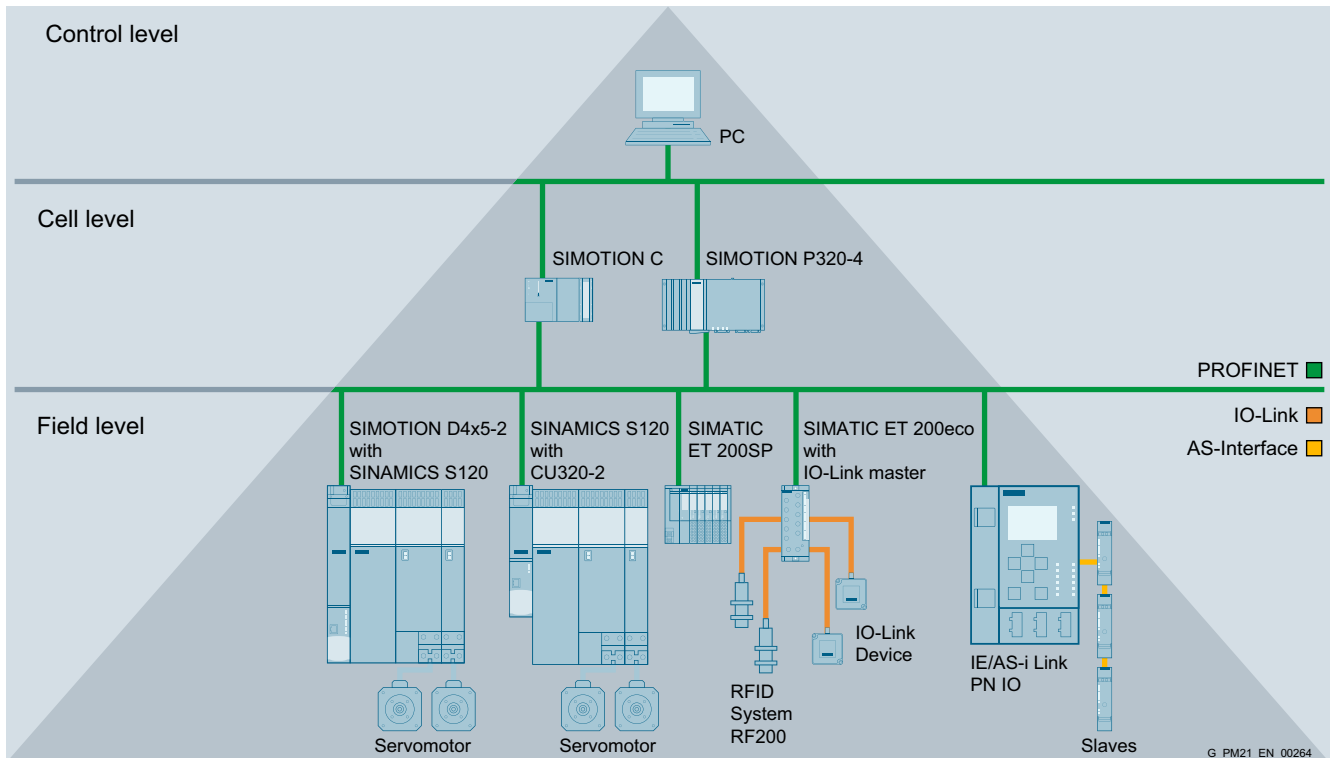

The AS-Interface and IO-Link components are coupled via master modules of the ET200 stations, which are connected to SIMOTION via PROFINET or PROFIBUS.



G\_PM21\_EN\_00264



SIMATIC ET 200 distributed I/O without control cabinet

SIMATIC ET 200pro	SIMATIC ET 200eco PN	SIMATIC ET 200eco	SIMATIC ET 200AL	SIMATIC ET 200 Distributed I/O
				
Modular design and multi-functional	Low-cost-space-saving block-type I/O	Low-cost, digital block-type I/O	Modular, distributed I/O system with compact I/O modules	Brief description
IP65/67	IP65/67	IP65/67	IP65/67	Degree of protection
Modular	Block	Block	Modular, block	Design
No	No	No	No	Technology functions
No	No	No	No	Isochronous mode
Yes	No	Yes	No	Fail-safe modules
ST 70, IK PI				Catalog

### PROFINET

PROFINET is the open, cross-vendor Industrial Ethernet standard (IEC 61158/61784) for automation.

Based on Industrial Ethernet, PROFINET enables direct communication between field devices (IO devices) and controllers (IO controllers), up to and including the solution of isochronous drive controls for Motion Control applications.

As PROFINET is based on Standard Ethernet according to IEEE 802.3, any devices from the field level to the control level can be connected.

In this way, PROFINET enables system-wide communication, supports plant-wide engineering and applies IT standards, such as Web server or FTP, right down to field level. Tried and tested fieldbus systems, such as PROFIBUS or AS-Interface, can be easily integrated without any modification to the existing devices.

### PROFIBUS

PROFIBUS is the international standard (IEC 61158/61784) for the field level. It is the only fieldbus to allow communication both in manufacturing applications and in process-oriented applications.

PROFIBUS is used to connect field devices such as distributed I/O devices or drives to automation systems such as SIMATIC S7, SIMOTION, SINUMERIK or PCs.

PROFIBUS is standardized in accordance with IEC 61158 and is a powerful, open and rugged fieldbus system with short response times. PROFIBUS is available in different forms for various applications.

### AS-Interface

AS-Interface is the international standard (IEC 62026/EN 50295) which, as an alternative to the cable harness, links particularly economical sensors and actuators in the field level by means of a simple two-wire cable. This two-wire cable is also used to supply the individual stations with power. Therefore the AS-Interface is the ideal partner for the fieldbus PROFIBUS DP.

### IO-Link

The IO-Link communication standard creates an intelligent connection between sensors and switching devices at the control level. IO-Link simplifies the integration of all of the components in the control cabinet and at the field level for maximum uniformity and seamless communication in the last meters to the process.

IO-Link solutions from Siemens ensure highest precision and profitability in any production. IO-Link is completely integrated into Totally Integrated Automation (TIA) and offers many benefits.

- The open standard permits the networking of devices from different manufacturers
- Simple wiring facilitates the installation process
- Reduced wiring effort saves time and money during installation
- Efficient engineering facilitates configuration and commissioning
- High-speed diagnostics ensures short plant standstill times and high plant availability
- High process transparency permits, for example, efficient energy management

## SIMOTION system components

### I/O components

#### Distributed I/O

##### Overview (continued)

##### Solutions in the control cabinet (IP20)

- **SIMATIC ET 200SP:**  
The SIMATIC ET 200SP distributed I/O system is a scalable and extremely flexible distributed I/O system for interfacing the process signals to a central control system via PROFINET and PROFIBUS. The distributed I/O system is particularly easy to use and, with its compact design, offers maximum economy in the control cabinet. High speed and transmission rates provide significantly stronger performance than conventional systems.
- **SIMATIC ET 200MP:**  
The modular SIMATIC ET 200MP I/O system with high channel densities based on the SIMATIC S7-1500 design permits the shortest bus cycle times and fastest response time even with large volumes of data.
- **SIMATIC ET 200S:**  
The finely scalable I/O system for control cabinet installation and time-critical applications in particular; including motor starters, safety technology and individual grouping of load groups.
- **SIMATIC ET 200M:**  
The modular I/O system with high channel densities based on the SIMATIC S7-300 design.

#### Distributed I/O in the control cabinet (IP20)

##### SIMATIC ET 200SP

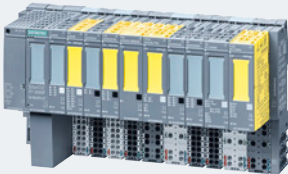

The scalable SIMATIC ET 200SP I/O system is a highly flexible modular I/O system with IP20 degree of protection. Via Interface Modules with PROFINET or PROFIBUS interface it can exchange I/O data of the connected I/O modules with a higher-level control system. ET 200SP components are available as SIPLUS version for extreme requirements and a high degree of ruggedness.

##### Design

The ET 200SP has a very compact design and makes optimum use of the available space in the control cabinet. Depending on the Interface Module used, up to 64 modules, each with a maximum of 16 signals, can be configured. The depth is approx. 75 mm (2.95 in).

##### Components

An ET 200SP station consists of an Interface Module (IM) for connecting to PROFINET or PROFIBUS, the I/O modules, and a server module that terminates the station. The modules are plugged into passive Base Units (BUs) that in turn are mounted on a standard DIN rail.

The Base Units (BUs) connect the modules of the ET 200SP station electrically and mechanically with each other. The terminal box of a Base Unit can be simply replaced in the case of terminal damage, for example.

The PROFINET connection is via bus adapters (BAs) on the IM with which the connections and physical characteristics can be selected freely in accordance with the requirements, e.g. RJ45 connector or direct connection.

##### Interface Module:

The Interface Module connects the ET 200SP to PROFINET or PROFIBUS and exchanges data between the higher-level controller and the I/O modules.

##### I/O modules:

An I/O module determines the function at the terminals. The controller uses the connected sensors to determine the current process state and initiates corresponding responses via the connected actuators. Some I/O modules have expanded functions, which to some extent are also designed as an independent operating mode. I/O modules are divided into various module types, with the fail-safe versions being identified by a preceding "F-" and a yellow module enclosure. The I/O modules are 1, 2, 4, 8 and 16-channel modules and permit the scalable and cost-optimized design of the ET 200SP. Digital and analog input/output modules, technology modules, (counting, positioning, weighing, time-based I/O with  $\mu$ s-precise time stamping of the signals for cam and measuring input applications), communication modules and special modules are available.

##### Configuration, parameter assignment and diagnostics

The ET 200SP is configured and parameterized via STEP 7 or the TIA Portal. Depending on the I/O module selected, the user has comprehensive diagnostic information at his disposal.

## Overview (continued)

## Distributed I/O in the control cabinet (IP20)

## SIMATIC ET 200MP



The SIMATIC ET 200MP is a modular, scalable and universally usable I/O system with IP20 degree of protection, which provides the same system benefits as the S7-1500. The SIMATIC ET 200MP permits the shortest bus cycle times and fastest response time even with large volumes of data.

**Design**

SIMATIC ET 200MP is characterized by its variable and scalable station configuration. The maximum configuration can have up to 30 I/O modules with a maximum of 512 input and output bytes each per station. With its compact dimensions, the SIMATIC ET 200MP can fit into the existing installation space of a SIMATIC S7-300 or ET 200M without any problems. There is a uniform 40-pin front connector for all I/O modules.

**Components**Interface Modules:

The Interface Module connects the SIMATIC ET 200MP to PROFINET or PROFIBUS and exchanges data between the higher-level controller and the I/O modules.

- Interface Module for connecting the S7-1500 I/O module to PROFINET; up to 30 modules can be connected to one Interface Module.
- Interface Module for connecting the S7-1500 I/O module to PROFIBUS; up to 12 modules can be connected to one Interface Module

I/O modules:

Digital and analog input/output modules, technology modules, (counting, positioning, time-based I/O with  $\mu$ s-precise time stamping of the signals for cam and measuring input applications), and communication modules are available. F-modules are available for safety-engineering applications.

Various module classes are available to allow the user optimal scalability in his application. The modules themselves are marked accordingly:

- BA (Basic): Simple, low-cost modules without diagnostics and without parameters
- ST (Standard): Modules with module or load group-granular diagnostics and, if applicable, with parameters; for analog modules: accuracy class 0.3 %
- HF (High Feature): Modules with channel-granular diagnostics and parameter settings; for analog modules: accuracy class 0.1 %, increased interference immunity and electrical isolation
- HS (High Speed): Modules with the shortest filter and conversion times for very fast applications; e.g. 8-channel analog modules with a conversion time of 125  $\mu$ s

**Configuration, parameter assignment and diagnostics**

The ET 200MP can be configured and parameterized via the TIA Portal. Depending on the I/O module selected, the user has comprehensive diagnostic information at his disposal. It must be observed that ET 200MP is only supported by SIMOTION in combination with SCOUT TIA.

## SIMOTION system components

### I/O components

#### Distributed I/O

#### Overview (continued)

##### Distributed I/O in the control cabinet (IP20)

##### SIMATIC ET 200S

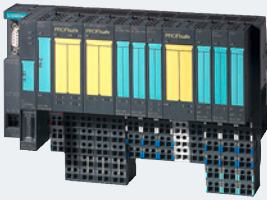

SIMATIC ET 200S is the multifunctional and bit-modular I/O system with IP20 degree of protection and can be exactly tailored to the automation task. Thanks to its rugged design, it can also be used for increased mechanical loads.

##### Design

A SIMATIC ET 200S station comprises up to 63 I/O modules. The I/O modules can be combined as required.

The SIMATIC ET 200S is configured with permanent wiring: All of the modules are plugged into purely mechanical Terminal Modules. These Terminal Modules contain all the wiring and can be optionally mounted on 35 × 15 mm or 35 × 7.5 mm standard mounting rails.

This has the following advantages:

- Easy implementation of the wiring without additional electronic components
- Fast and safe wiring check even when energized
- Tool-free replacement of the electronic modules
- Automatic encoding of the electronic modules to ensure confusion-free replacement

##### Components

The SIMATIC ET 200S distributed I/O system consists of the following components:

- IM 151, IM 151-3 PN Interface Module
- Digital and analog electronic modules
- Technology modules, e.g. for counting and position detection tasks
- Motor starter and frequency converter
- Terminating module (included in scope of delivery of IM 151)
- Power Modules

##### SIMATIC ET 200S Compact

- Expandable block I/O with IP20 degree of protection with 32 channels onboard, consisting of terminal block and electronic block

##### Configuration and parameter assignment

The ET 200S is configured and parameterized via STEP 7 or via the TIA Portal.

### Overview (continued)

#### Distributed I/O in the control cabinet (IP20)

##### SIMATIC ET 200M



The SIMATIC ET 200M is a modular I/O system with IP20 degree of protection, which is especially well-suited for user-specific and complex automation tasks.

#### Design

The SIMATIC ET 200M comprises one IM 153 Interface Module, up to 12 I/O modules of the S7-300 automation system and, where applicable, a power supply.

There are no slot rules for the I/O modules. They can be combined in any way.

The simple design with bus connectors of the SIMATIC S7-300 makes the ET 200M flexible and service-friendly.

#### Components

##### Interface Module:

The ET 200M is connected to PROFINET or PROFIBUS DP via an IM 153 Interface Module. A fiber-optic connection to PROFIBUS DP is possible via an additional OLM (Optical Link Module) or an OBT (Optical Bus Terminal).

##### I/O modules:

Depending on the quantity structure of the Interface Module (IM), various quantities and types of I/O modules (signal, communication and function modules of the SIMATIC S7-300) can be connected.

##### Power supply:

Single-phase power supplies with 2 A, 5 A and 10 A are available for the ET 200M as special version.

#### Configuration, parameter assignment and diagnostics

The ET 200M is configured and parameterized via STEP 7 or the TIA Portal.

The ET 200M is checked for flawless functioning via diagnostic functions.

The ET 200M diagnoses module faults, short-circuits (outputs), bus faults, i.e. erroneous data transmission, and the 24 V DC load voltage supply.

## SIMOTION system components

### I/O components

#### Distributed I/O

##### Overview (continued)

##### **Solutions without a control cabinet (IP65/67)**

SIMATIC ET 200 systems for cabinet-free configuration are housed in a rugged enclosure and are therefore impact-resistant, dirt-resistant and watertight. In addition, they need even fewer additional components, save on wiring costs, and benefit from extremely fast response times.

- **SIMATIC ET 200pro:**  
The modular I/O system for cabinet-free use close to the machine; with features such as small size, integrated PROFI-safe safety technology, PROFINET connection and hot swapping of modules

- **SIMATIC ET 200eco:**  
The compact, economical I/O system for local use without a control cabinet with flexible and fast ECOFAST or M12 connection system over PROFIBUS DP
- **SIMATIC ET 200eco PN:**  
The compact, economical I/O system for local use without a control cabinet with flexible and fast M12 connection system over PROFINET IO
- **SIMATIC ET 200AL:**  
Modular, distributed I/O system with compact I/O modules

#### Distributed I/O without control cabinet (IP65/IP67)

##### **SIMATIC ET 200pro**



SIMATIC ET 200pro is the modular I/O system with high IP65/66/67 degree of protection for local, cabinet-free use.

- Small size and innovative design concept
- Flexible adaptation to the requirements of the respective automation task with regard to connection technology, necessary I/Os, and fieldbus connection
- Can be used in a very broad range of applications due to new features such as integrated safety technology in accordance with PROFI-safe, PROFINET connection, and module replacement while energized
- Integrated motor starters allow the ideal use for conveyor applications or for the cabinet-free control of drives up to 5.5 kW
- Separation of module and bus/energy connection technology for the digital and analog expansion modules
  - Interface Module: T-functionality for bus and 24 V power supply
  - Expansion modules: Pre-wiring of sensor/actuator connections
- Especially high plant availability due to permanent wiring
  - In case of service, replacement of exactly one electronic module by means of hot swapping, without shutting down the rest of the station
  - The station continues to work flawlessly during the replacement
  - All of the I/O wiring can remain on the connection module when the electronics are replaced and does not have to be marked or removed

##### **Design**

The modules of the ET 200pro are generally structured in two or three parts. Interface Modules and power modules as well as digital and analog expansion modules are comprised of a bus connector, an electronic module or Interface Module, and a Terminal Module.

Motor starters are only capable of functioning with a backplane bus module.

##### Station:

- One module rack each
- One Interface Module for PROFINET IO/PROFIBUS DP
- One connection module for the PROFINET IO/PROFIBUS DP Interface Module or optionally
- One CPU or F-CPU each
- Maximum of 16 expansion modules, which can be mounted on up to 1 m of station width

##### **Components**

The following expansion modules are available:

Digital inputs/outputs, analog inputs, analog outputs, connection modules I/O, power modules for electronic modules, connection modules for power modules, fail-safe electronic modules, motor starters, Safety motor starters, frequency converters, RFID communication modules, pneumatic Interface Modules, module racks

##### **Configuration and parameter assignment**

The configuration of the SIMATIC ET 200pro is conveniently done via STEP 7 or the TIA Portal.

### Overview (continued)

#### Distributed I/O without control cabinet (IP65/IP67)

#### SIMATIC ET 200eco PN



The compact block I/O SIMATIC ET 200eco PN is a distributed I/O device with degree of protection IP65/66/67 with easy handling and installation. With ET 200eco PN, digital, analog and IO-Link signals can be processed on PROFINET. With a high degree of protection, ruggedness and small dimensions, the ET 200eco PN is especially well-suited for use at the machine level. The ET 200eco PN is an ideal supplement in addition to the modular ET 200pro I/O family for applications with a high degree of protection.

#### Design

- Compact module with M12 connection technology
- Coordinated range of modules for I/Os for the use and integration of PROFINET applications
- Two load voltage supplies (4 A each) which are used by the compact module and can be looped through to an additional compact module (line topology)
- Alternative connection of load voltage supplies via additional terminal block with higher current carrying capacity (10 A each) and looping through via ET 200eco PN
- Splitting of the supplied load voltage supplies into 4 lines by means of a voltage distributor – the distributed load voltages are electronically protected against short-circuits
- PROFINET connection via an M12 connector and looping through to an additional PROFINET device as needed

#### Components

Various compact modules are available for the applications: 8 DI, 16 DI, 8 DO, 16 DO, 8 DI/DO, 8 AI, 4 AO and IO-Link master. The modules are also available in various designs (e.g. with regard to maximum output current).

#### IO-Link:

The IO-Link master module 4 IO-L + 8 DI + 4 DO allows the easy integration of IO-Link sensors and actuators from various manufacturers into PROFINET.

Up to 4 IO-Link devices (3-wire connection) can be connected to each IO-Link master module. In addition, up to 8 standard sensors and 4 standard actuators can be connected.

#### Configuration and parameter assignment

The ET 200eco PN is configured and parameterized via STEP 7 or the TIA Portal.

## SIMOTION system components

### I/O components

#### Distributed I/O

#### Overview (continued)

##### Distributed I/O without control cabinet (IP65/IP67)

##### SIMATIC ET 200eco



SIMATIC ET 200eco is a distributed I/O device with IP65/67 degree of protection.

- Simple handling and installation
- Cost-effective processing of digital signals (also fail-safe) on the PROFIBUS DP
- Can be used at the machine level due to high degree of protection and ruggedness
- PROFIBUS DP interface connection via M12 or via standardized hybrid fieldbus connection (ECOFAST) thanks to flexible connection blocks

The compact ET 200eco block I/O is an ideal addition to the modular ET 200pro I/O family for applications in a high degree of protection.

#### Design

ET 200eco consists of a basic module and connection block.

A compact, coordinated range of modules for digital I/Os is available for applications and integration of PROFIBUS applications.

The PROFIBUS DP can be connected via the variable and flexible connection blocks, depending on the customer's wishes, via 2 × M12, 2 × 7/8" or 2 × hybrid fieldbus interface connection (ECOFAST).

The T functionality for PROFIBUS DP and the power supply are already integrated in the connection block so that plants can now be handled without interruption and without the use of additional components during commissioning and servicing of bus cables.

The pin assignment for the actuators and sensors is adapted to the IP65/67 standardization trend.

Depending on the connection block, the setting of the PROFIBUS address is either visible or can be connected.

With ECOFAST interfaces, the proven identification connector is used; with M12, 7/8" interfaces, two externally visible rotary coding switches are used to set the PROFIBUS address.

The connection block can be removed from the basic module and screwed on again under power, so that PROFIBUS and power supply remain permanently active in the application.

#### Components

Various modules are available for the applications:

8 DI, 16 DI, 8 DI/8 DO (1.3 A), 8 DI/8 DO (2 A), 8 DO (2 A), 16 DO (0.5 A) and 4/8 F-DI

#### Configuration and parameter assignment

The ET 200eco is configured and parameterized via STEP 7 or the TIA Portal.



## Overview (continued)

## Distributed I/O without control cabinet (IP65/IP67)

## SIMATIC ET 200AL



SIMATIC ET 200AL is a distributed I/O device with IP65/67 degree of protection.

- Simple handling and installation
- Machine-level use and use on moving parts of the plant
  - due to high degree of protection and ruggedness
  - due to small dimensions and low weight

SIMATIC ET 200AL provides the user with the capability of cost-effectively accessing digital and analog signals and data from IO-Link via PROFINET or PROFIBUS DP.

**Design**

- Variable and modular station configuration
- Compact dimensions for use in extremely tight spaces
- Flexible mounting directly in a machine or assembly line

**Components**Interface Modules:

- IM 157-1 PN, for connecting ET 200AL with PROFINET
- IM 157-1 DP, for connecting ET 200AL with PROFIBUS DP

The Interface Modules have two backplane bus outputs (ET connection 1 and 2) to which the I/O modules are connected.

I/O modules:

The I/O modules are connected to the I/O system ET 200SP via a bus adapter of the ET 200SP.

The following I/O modules are available:

- Digital input modules with different numbers of channels and versions
- Digital output modules
- Digital input modules and digital output modules in different versions
- Analog input module
- IO-Link master CM IO-Link

**Configuration, parameter assignment and diagnostics**

The ET 200AL is configured and parameterized via STEP 7 or the TIA Portal.

The IO-Link master is configured using the S7-PCT (Port Configuration Tool).

The comprehensive, module-precise diagnostics with plain text messages allows the fast localization and clearing of system faults in the shortest possible time. Annoying plant downtimes are thus a thing of the past and the availability increases considerably.

**More information**

For information about SIMATIC distributed I/O, also see the Catalogs ST 70 and IK PI.

**Complete list of I/O that can be used**

A list of all the I/O modules that can currently be used with SIMOTION is available at the following link:





<https://support.industry.siemens.com/cs/document/11886029>

## SIMOTION system components

### I/O components

#### Other I/O components

#### Overview

Other I/O components				
Other I/O components	<b>SIMATIC S7-300 I/O</b> 	<b>TM15 Terminal Module</b> 	<b>Analog Drive Interface for 4 Axes ADI 4, IM 174 Interface Module</b> 	<b>Function blocks for I/O modules</b> 
Brief description	<ul style="list-style-type: none"> <li>Encompasses a large number of signal and function modules, which can be used as central or distributed I/O</li> <li>Particularly predestined for centralized use with SIMOTION C</li> </ul>	<ul style="list-style-type: none"> <li>Expansion of the SIMOTION D Control Units by digital inputs and outputs</li> </ul>	<ul style="list-style-type: none"> <li>Used for the connection of drives with analog <math>\pm 10</math> V setpoint interface</li> <li>Connection of stepper drives with pulse/direction interface via the IM 174</li> </ul>	<ul style="list-style-type: none"> <li>Integral part of the SCOUT command library</li> <li>Import into the user program using drag and drop</li> </ul>
Catalog	ST 70	D 21.4	NC 62 (ADI 4), ST 70 (IM 174)	PM 21

**Overview** (continued)

## Other I/O components

**SIMATIC S7-300 I/O**

SIMATIC S7-300 digital modules, analog modules, function modules (FM350-1, FM350-2, FM352, FM352-5), communication modules (CP340, CP341) and the SM374 simulator module can be used as:

- Central I/O within SIMOTION C240  
Central I/O configuration amounts to two tiers with max. 8 I/O modules per tier, of which up to 4 modules can be analog modules. The second tier is connected via the IM 365 Interface Module.
- Distributed I/O in the SIMATIC 200M modular I/O system with the head module IM 153 (depending on the head module, up to 8 or 12 I/O modules per SIMATIC ET 200M)

For information about SIMATIC S7-300 I/O, see also [Catalog ST 70](#).

## SIMOTION system components

### I/O components

#### Other I/O components

#### Overview (continued)

##### Other I/O components

##### TM15 Terminal Module



The TM15 Terminal Module can be used to implement measuring inputs and cam outputs for the SIMOTION Motion Control System. Furthermore, the Terminal Module provides drive-related digital inputs/outputs with short signal delay times.

Integration into SIMOTION is conveniently done via the technology objects "Measuring input", "Cam" and "Cam track".

#### Application

The main application area of TM15 are applications in which measuring inputs and cam outputs are needed, in addition to digital inputs/outputs. Several measuring inputs or cam outputs can be assigned to a real or virtual axis or to an external encoder.

#### Examples for precise sensing of binary signals:

Edge detection, quality monitoring (e.g. product good/bad), product tracing (e.g. product available/not available), detection of print marks, print mark correction, tool monitoring (e.g. for presses), machine status monitoring (e.g. for broken threads in the textile industry)

#### Examples for precise output of binary signals:

Position-dependent switching of actuators (camera trigger signal, control of an air nozzle for blowing away cut-offs, control of a nozzle for applying glue), product extraction from production line, implementation of line controllers, output of pulse patterns

#### Design

##### Interfaces

- 24 DI/DO, parameterizable channel-by-channel
- DRIVE-CLiQ sockets
- Connection for the electronic power supply over the 24 V DC infeed connector

##### Configuration and parameter assignment

The status of the TM15 is indicated via a multi-color LED. The logical status of a channel is indicated with the corresponding green status LED.

Each of the 24 digital I/Os can be parameterized channel-by-channel as: digital input (DI) or digital output (DO), measuring input, cam output. Furthermore, each channel can be optionally inverted.

The SIMOTION SCOUT engineering software is used for parameterization.

##### Integration

The TM15 Terminal Module can be connected directly to SIMOTION D via DRIVE CLiQ. Alternatively, a TM15 Terminal Module can be connected to a SINAMICS CU310-2 or CU320-2 Control Unit, which is connected with SIMOTION C/P/D over PROFINET or PROFIBUS. The number of Terminal Modules which can be used depends on the number of axes configured with SIMOTION as well as the functionality configured for the TM15 Terminal Module.

For information about the TM15 Terminal Module, see also Catalog D 21.4.

## Overview (continued)

## Other I/O components

## ADI 4 Analog Drive Interface for 4 Axes and IM 174 Interface Module



The ADI 4 Analog Drive Interface for 4 Axes and the IM 174 Interface Module can be used to connect drives with an analog  $\pm 10$  V setpoint interface.

The IM 174 Interface Module also allows stepper drives with a pulse/direction interface to be connected.

**Application**

Up to four drives with an analog setpoint interface can be operated on each of these modules. The isochronous PROFIBUS DP is used for coupling to SIMOTION.

The following can be connected:

- Electric servo drives with analog  $\pm 10$  V setpoint interface
- Hydraulic drives with analog  $\pm 10$  V setpoint interface (e.g. for servo-hydraulic valve)
- Stepper drives with pulse/direction interface (IM 174 Interface Module only)

ADI 4 and IM 174 can also be used for "external encoders", where at least one axis must be created. Mixed operation of the 4 drive interfaces is possible.

**Interfaces**Display and diagnostics

Onboard status display via 4 diagnostics LEDs

Drive interfaces

- 4 analog outputs  $\pm 10$  V for connecting drives with analog setpoint interface
- For IM 174 only: 4 interfaces for controlling stepper drives with or without encoder connection
- 4 relay contacts for drive enable of axes 1 to 4

Encoder interfaces

• 4 encoder inputs for position sensing. Each input can be connected either to an RS422 incremental encoder or to an SSI absolute encoder.

Encoders with SINE/COSINE signals ( $1 V_{pp}$ ) can be connected using external pulse shaping electronics (EXE), which convert the signals to the 5 V TTL level.

Communication

- PROFIBUS DP interface with Motion Control functionality (isochronous, max. 12 Mbit/s)

Digital inputs and outputs

- 10 DI, 24 V DC (e.g. for BERO, measuring inputs and Drive Ready signal)
- 8 DO, 24 V DC, 0.5 A (e.g. for drive enable)

Additional interfaces

- 2 relay contacts with Ready signal

An external power source (24 V DC) is required for supplying power to the module and digital outputs. All connections are located on the front panel.

**Function**

The following functions are available in connection with SIMOTION:

- Speed-controlled axes
- Position-controlled axes
- External encoder for SIMOTION (at least one axis must be configured.)
- Homing via BERO or
- Homing via zero mark (non-distance-coded zero marks/reference marks)
- Measuring via Sensor 1 and Sensor 2 (one edge, rising or falling)

**Integration**

The modules are not certified PROFIBUS DP standard slaves and can therefore only be used in combination with controllers intended for this purpose (e.g. SIMOTION C/P/D). For example, the modules do not support acyclic communication and the I/O interfaces can only be used in combination with the encoder or drive functions.

ADI 4 and IM 174 must be operated on an isochronous PROFIBUS DP.

Supported PROFIBUS DP cycles:

- ADI 4: 1 ms and above (isochronous, max. 12 Mbit/s)
- IM 174: 1.5 ms and above (isochronous, max. 12 Mbit/s)

[For information on the ADI 4 Analog Drive Interface, see also Catalog NC 62.](#)

[For information on the IM 174 Interface Module, see also Catalog ST 70.](#)

## SIMOTION system components

### I/O components

#### Other I/O components

#### Overview (continued)

##### Other I/O components

##### Function blocks for I/O modules

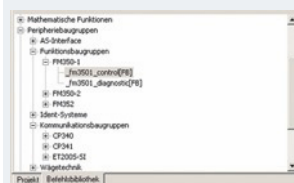

Function blocks for I/O modules are available as an integral component of the SCOUT command library. The function blocks can be easily copied into the user program by means of drag and drop. Sample programs are also provided in SIMOTION Utilities & Applications which demonstrate the integration of the function blocks. SIMOTION Utilities & Applications are included in the scope of supply of SIMOTION SCOUT.

Function blocks for the following I/O modules are available in the SCOUT command library:

- FM 350-1, single-channel Counter Module
- FM 350-2, 8-channel Counter Module
- FM 352, cam controller
- CP 340, Communication Module
- CP 341, Communication Module
- SIWAREX FTA, Weighing Module
- ET 200S, serial Interface Module 1SI (3964R, ASCII)
- ET 200S, frequency converter
- ASM 456, RFID system
- DP/AS-Interface Link 20E (connects PROFIBUS DP to AS-Interface)
- CP 343-2P is the AS-Interface master for SIMATIC S7
- ASIsafe safety monitor (with one or two enabling circuits)

#### More information

##### **Complete list of I/O that can be used**

A list of all the I/O modules that can currently be used with SIMOTION is available at the following link:

<https://support.industry.siemens.com/cs/document/11886029>

**3.3/2 SITOP power supplies**

3.3/2 Overview

3.3/4 SITOP lite

3.3/4 SITOP smart

3.3/4 SITOP power supplies in

SIMATIC design

3.3/4 SITOP modular

3.3/5 SITOP modular,

PSU8600 power supply system

3.3/5 SITOP expansion modules

3.3/6 SITOP uninterruptible power supplies  
(DC UPS)**3.3/6 More information**

## SIMOTION system components

### Power supplies

#### SITOP power supplies





##### Overview

SITOP power supplies			
SITOP power supplies	SITOP lite	SITOP smart	SITOP power supplies in SIMATIC design
			
Brief description	The low-cost basic power supply	The powerful standard power supply	The optimum supply for the SIMATIC S7 and more
Input	1-phase 120/230 V AC	1-phase 120/230 V AC 3-phase 400 ... 500 V AC	1-phase 120/230 V AC
Outputs	24 V/2.5 A, 5 A, 10 A	24 V/2.5 A, 5 A, 10 A, 20 A 24 V/5 A, 10 A, 20 A, 40 A	S7-300: 24 V/2 A, 5 A and 10 A S7-1500: 24 V/3 A and 8 A ET 200pro: 24 V/8 A
Catalog	KT 10.1		

A safe and reliable power supply must supply the process with power in all areas of plant and mechanical engineering. The need is multi-faceted and our offering is aligned accordingly:

- Power supplies for SIMOTION C/ET 200M
- Stabilized power supplies SITOP power
- Uninterruptible power supply DC UPS with output currents from 6 A to 40 A



SITOP power supplies				
SITOP modular	SITOP modular, PSU8600 power supply system	Expansion modules	SITOP DC UPS	SITOP power supplies
				
The technology power supply for demanding solutions	The power supply system with TIA integration	<p><i>Redundancy modules</i> Protection against failure of a power supply unit due to redundant design of the power supply</p> <p><i>Selectivity modules</i> Protection against overload and short-circuit through electronic protection of 24 V feeders</p> <p><i>Buffer module</i> Protection against power failures in the seconds range</p>	<p><i>SITOP UPS500 with capacitors</i> Protection against power failures on the input side by buffering up to the minutes range</p> <p><i>SITOP UPS1600 with battery modules</i> Protection against power failure on the input side by buffering up to the hours range DC UPS with Ethernet/PROFINET – open and system-integrated in TIA</p>	Brief description
1-phase 120/230 V AC 1 and 2-phase 100 ... 230 V AC 3-phase 400 ... 500 V AC	3-phase 400 ... 500 V AC			Input
24 V/5 A, 10 A, 20 A, 40 A 24 V/5 A, 10 A 24 V/20 A, 40 A	24 V/20 A, 40 A 24 V/20 A/4x5 A, 40 A/4x10 A			Outputs
KT 10.1				Catalog

## SIMOTION system components

### Power supplies

#### SITOP power supplies

#### Overview (continued)

##### SITOP

##### SITOP lite



##### The low-cost basic power supply

The SITOP lite power supplies are designed for standard requirements in industrial environments and offer all important functions at a favorable price.

The wide range input with manual switchover supports connection to a variety of single-phase supply systems.

Thanks to the slim design, the power supplies have a low space requirement on the standard mounting rail, and their excellent degree of efficiency ensures low thermal losses in the control cabinet.

##### Essential product features

- 24 V DC/2.5 A, 5 A and 10 A
- For industrial applications with basic requirements
- Single-phase wide range input with manual switchover

##### SITOP smart



##### The powerful standard power supply

SITOP smart are the universal and powerful standard power supplies for machinery and plant engineering.

Despite their compact design, they offer excellent overload behavior:

Thanks to 150 % extra power, loads with high power consumption can be connected without any problems and the permanent overload capability of 120 % offers power reserves in case of expansions. The high degree of efficiency results in low energy consumption and minimal heat generation inside the control cabinet.

##### Essential product features

- 1-phase, 24 V DC/2.5 A, 5 A, 10 A and 20 A as well as 12 V/7 A and 14 A
- 3-phase, 24 V DC/5 A, 10 A, 20 A and 40 A
- Compact design - no lateral installation clearances required
- Extra power with 1.5 times the rated current for 5 s/min for brief overloads
- 120 % of the rated power continuously usable at up to 45 °C ambient temperature (24 V versions)
- 24 V power supply units expandable with add-on modules and DC UPS
- High efficiency up to 91.5 %

##### SITOP power supplies in SIMATIC design



##### The optimum supply for the SIMATIC S7 and more

The original power supplies of the SIMATIC ideally fit into the PLC network in terms of design and functionality. In addition to the SIMATIC controllers S7-1500, S7-300, SIMOTION C and the distributed I/O ET 200MP, ET 200M and ET 200pro, they also reliably supply other loads with 24 V DC.

##### SITOP modular



##### The technology power supply for demanding solutions

SITOP modular offers maximum functionality for use in complex plants and machines. The wide-range input enables connection to any power system in the world and ensures high safety even in the event of extreme voltage fluctuations. The Power Boost function briefly supplies up to three times the rated current. And in the event of an overload there is a choice between constant current with automatic restart or latching disconnection. The high degree of efficiency keeps energy consumption and heating in the control cabinet low, and the compact metal housing also saves space.

##### Essential product features

- 1-phase, 24 V DC/5 A, 10 A, 20 A, 40 A
- 1 and 2-phase, 24 V DC/5 A, 10 A
- 3-phase, 24 V DC/20 A, 40 A, 36 V/13 A and 48 V/10 A, 20 A
- DC/DC converter 24 V DC/20 A for drive and battery networks
- Extremely slim design – no lateral clearances required
- Extra power function for brief operational overloads
- Power boost for tripping protective devices

**Overview (continued)**
**SITOP**
**SITOP modular, PSU8600 power supply system**

As a unique power supply system with complete integration in Totally Integrated Automation (TIA), SITOP PSU8600 sets new standards in industrial power supplies.

The benefits of this integration are not only apparent during engineering in TIA Portal but also result in reliable operation.

The voltage and current response threshold can be individually set for each output of the power supply system and the selective monitoring of each output for overload allows quick localization of faults.

Depending on requirements additional modules from the modular system, such as are used for buffering short power failures, can be added without wiring overhead.

Comprehensive diagnostics and maintenance information is available via PROFINET and can be evaluated directly in the SIMATIC S7 and visualized in SIMATIC WinCC.

Optimal support is also provided for energy management of plant or machines:

From the acquisition of energy data of the individual outputs and individual switching on/off of the outputs via PROFenergy to direct integration into energy management systems.

Essential product features

- 3-phase wide range input 400 to 500 V 3 AC for global use
- Versions with a parameterizable output with a maximum of 20 A or 40 A and selective monitoring
- Versions with four integrated, individually parameterizable outputs with a maximum of 5 A or 10 A and selective monitoring
- Integrated Ethernet/PROFINET interface (2 ports)
- Extremely slim design with very high efficiency of up to 94 %
- Extra power with 1.5 times the rated current (5 s/min) for brief operational overloads
- Easy configuration in the TIA Portal
- Individual expansion options from the modular system (CNX8600 expansion modules, BUF8600 buffer modules) without wiring overhead

**SITOP expansion modules**

**Expansion modules for increasing system availability**

A power supply unit on its own cannot guarantee fault-free 24 V supply. Power failures, extreme variations in the mains voltage, or a faulty load can bring plant operation to a standstill and cause high costs.

The expansion modules offer extensive protection against malfunctions on the primary and secondary circuits, right through to complete all-round protection.

## SIMOTION system components

### Power supplies

#### SITOP power supplies

#### Overview (continued)

##### SITOP

##### SITOP uninterruptible power supplies (DC UPS)



To combat prolonged mains failures the 24 V SITOP power supply units can be upgraded into a 24 V DC uninterruptible power supply. SITOP offers two systems with different energy stores for this purpose:

- Capacitors for 24 V buffering in the minutes range
- Battery modules which provide a buffer in the hours range

The DC UPS systems are used for example in machine-tool building, in the textile industry, on all types of production lines and filling plants, and in conjunction with 24 V industrial PCs. They prevent the negative consequences which often result from mains failures.

##### SITOP DC UPS with capacitors

To bridge brief mains failures, 24 V SITOP power supply units can be expanded with a SITOP UPS500 uninterruptible DC power supply (DC UPS).

In PC-based automation solutions, the highly capacitive double-layer capacitors of the SITOP UPS500 supply enough energy to safeguard operating and application data and close software applications in a defined manner.

##### Essential product features

- Buffering into the minutes range depending on the load current and DC UPS configuration
- Absolutely maintenance-free double-layer capacitors
- Short charging times
- IP65 variant for use outside the control cabinet
- USB interface for PC communication

##### SITOP UPS1600 with battery modules

By combining one SITOP UPS1600 DC UPS module with at least one UPS1100 battery module and a SITOP power supply, longer power failures can be bridged absolutely free of interruptions.

Intelligent battery management automatically detects the UPS1100 energy storage device, and ensures optimum temperature-controlled charging and continuous monitoring.

The compact DC UPS modules are overload-capable in order to supply e.g. the inrush current for industrial PCs. They enable starting from the battery for stand-alone operation.

The DC UPS communicates openly through USB or Ethernet/PROFINET.

Via two Ethernet/PROFINET ports, it can be easily integrated into the PC or PLC world.

Complete integration in TIA offers user-friendly engineering in the TIA Portal and is supported by ready-to-use function blocks for S7 user programs and WinCC faceplates for rapid visualization.

Use of the SITOP UPS manager also enables easy monitoring and configuration in PC systems, e.g. the shutting down of several PCs in accordance with the master-slave principle. The integrated web server also allows remote monitoring of the DC UPS.

##### Essential product features

- Compact SITOP UPS1600 DC UPS modules with digital inputs/outputs, USB interface or two Ethernet/PROFINET interfaces
- SITOP UPS1100 battery modules with maintenance-free rechargeable lead-gel batteries
- High dynamic overload capability and high charging currents



#### More information

For further information see Catalog KT 10.1.

#### **SITOP Selection Tool – find the appropriate power supply quickly and easily**

With the SITOP Selection Tool, not only the DC supply can be selected, but also the appropriate uninterruptible power supply (DC UPS) with capacitor or battery technology.

[www.siemens.com/sitop-selection-tool](http://www.siemens.com/sitop-selection-tool)



**3.4/2 SINAMICS drive family**

- 3.4/2 Overview
- 3.4/2 Variants
- 3.4/3 Energy efficiency
- 3.4/3 Platform concept

**3.4/4 SINAMICS drives for Motion Control**

- 3.4/4 Overview
- 3.4/5 More information

## SIMOTION system components

### Drives

#### SINAMICS drive family



##### Overview







SINAMICS is the comprehensive family of drives from Siemens designed for machine and plant engineering applications. SINAMICS offers solutions for all drive tasks:

- Simple pump and fan applications in the process industry
- Demanding single drives in centrifuges, presses, extruders, elevators, as well as conveyor and transport systems
- Drive line-ups in textile, plastic film, and paper machines as well as in rolling mill plants
- Highly dynamic and precise servo drives for machine tools, as well as packaging and printing machines

##### Variants

Depending on the application, the SINAMICS range offers the ideal variant for any drive task.

SINAMICS		
		
<b>SINAMICS V</b>	<b>SINAMICS G</b>	<b>SINAMICS S</b>
When it comes to hardware and functionality, SINAMICS V converters focus on the essential. This results in a high degree of ruggedness while at the same time reducing investment costs.	SINAMICS G converters function perfectly for low and medium demands on the dynamic response of the control system.	SINAMICS S converters have been specially developed for use in demanding single-axis and multi-axis applications in mechanical and plant engineering and for a broad range of Motion Control tasks.

SINAMICS						
Low voltage						
SINAMICS family	Basic Performance		General Performance			
						
	<b>SINAMICS V20</b>	<b>SINAMICS V90</b>	<b>SINAMICS G120C / G120 / G120P / G120P Cabinet</b>	<b>SINAMICS G110D / G120D / G110M</b>	<b>SINAMICS G130 / G150</b>	<b>SINAMICS G180</b>
Power range	0.12 ... 30 kW	0.05 ... 7 kW	0.37 ... 630 kW	0.37 ... 7.5 kW	75 ... 2700 kW	2.2 ... 6600 kW
Application examples	Pumps, fans, compressors, conveyor belts, mixers, mills, spinning frames, textile machines	Handling machines, packaging machines, automatic assembly machines, metal forming machines, printing machines, winding and unwinding units	Pumps, fans, compressors, conveyor belts, mixers, mills, extruders, building management systems, process industry, HVAC, single-axis positioning applications in mechanical and plant engineering	Conveyor technology, single-axis positioning applications (G120D)	Pumps, fans, compressors, conveyor belts, mixers, mills, extruders	Sector-specific for pumps, fans, compressors, conveyor belts, extruders, mixers, mills, kneaders, centrifuges, separators
Catalog	V20 (brochure)	V90 (brochure)	D 31, D 35	D 31	D 11	D 18.1

**Overview** (continued)**Energy efficiency**





In conventional drive systems, the energy produced during braking is converted to heat using braking resistors. The regenerative versions of the SINAMICS G drives efficiently feed the energy produced during braking back into the supply system and therefore do not need any braking resistors – energy that can be re-used elsewhere in the plant. Furthermore, this reduced power loss simplifies the cooling of the system, enabling a more compact design. The multi-axis drive system SINAMICS S solves this task even more elegantly by distributing the energy produced during the braking of an axis to motor axes within the drive line-up. Thus, only excess energy has to be recovered and fed back into the supply system.

Together with the energy-efficient SIMOTICS motors, SINAMICS drives contribute to reducing operating costs – and protecting the environment.

**Platform concept**

All SINAMICS variants are based on a platform concept. Joint hardware and software components, as well as standardized tools for dimensioning, configuration, and commissioning tasks ensure high-level integration across all components. SINAMICS handles a wide variety of drive tasks with no system gaps. The different SINAMICS variants can be easily combined with each other.

## SINAMICS

SINAMICS						
Low voltage		Direct voltage		Medium voltage		SINAMICS family
General Performance	High Performance	DC applications	Applications with high outputs			
						
<b>SINAMICS S110</b>	<b>SINAMICS S120 / S120M</b>	<b>SINAMICS S150</b>	<b>SINAMICS DCM</b>	<b>SINAMICS GH180 / GM150 / SM150</b>		
0.55 ... 132 kW	0.25 ... 5700 kW	75 ... 1200 kW	6 kW ... 30 MW	0.15 ... 85 MW		Power range
Single-axis positioning applications for machine and plant engineering	Production machines (packaging, textile, printing, paper, plastic), machine tools, plants, process lines and rolling mills, ships and test bays	Test bays, cross cutters, centrifuges	Rolling mill drives, wire-drawing machines, extruders and kneaders, cableways and lifts, test bay drives	Pumps, fans, compressors, mixers, extruders, mills, crushers, rolling mills, conveyor technology, excavators, test bays, marine drives, blast furnace fans, retrofit		Application examples
D 31	D 21.3, D 21.4	D 21.3	D 23.1, D 23.2	D 15.1, D 12		Catalog

## SIMOTION system components

### Drives

#### SINAMICS drives for Motion Control

##### Overview

	Designation	Description
	S120 multi-axis drives (DC/AC)	<p>Thanks to its modular design, the SINAMICS S120 drive system can be perfectly adapted to a wide range of different drive tasks and is the ideal drive for Motion Control with SIMOTION. A SINAMICS S120 multi-axis system comprises a Control Unit, an infeed and several Motor Modules, which are coupled via a shared DC link. The SINAMICS CU320-2 Control Unit controls multiple drives and the supply/feedback into the line system. Instead of this Control Unit, a SIMOTION D module, in which the functionality of the CU320-2 Control Unit is integrated, can be used. Therefore, the complete system (consisting of the open-loop control and the drive) is extremely compact and powerful.</p> <p>Symbolic assignment facilitates the configuration of the technological relationships, including communication between SIMOTION and the SINAMICS S120 drives. As a result, only compatible assignment partners are offered in an assignment dialog, axis telegrams and addresses are automatically set up, telegrams are expanded depending on the selected technology, and the assignments in the drive are automatically created. All the relevant parameters of the complete drive train are automatically balanced between SIMOTION and SINAMICS S120.</p> <ul style="list-style-type: none"> <li>• Power range: 0.9 ... 800 kW at line voltage 380 ... 480 V 3 AC</li> <li>• Power range: 75 ... 1500 kW at line voltage 500 ... 690 V 3 AC</li> <li>• Interface to SIMOTION via PROFINET or PROFIBUS, for SIMOTION D via DRIVE-CLiQ</li> </ul> <p>For further information, see <a href="#">Catalogs D 21.4</a> and <a href="#">Catalog D 21.3</a>.</p>
	S120M motor-integrated drives	<p>The SINAMICS S120M drives are ready-to-connect drive units, comprising synchronous servomotors with multi-turn absolute encoders and an integrated power unit (Motor Module), as a distributed expansion of the SINAMICS S120 multi-axis system. The power unit moves from the control cabinet to the motor and is directly integrated in the driven axis. This brings advantages and freedoms for existing or new machine concepts. An AM600 adapter module and a hybrid cable are required for integration in the SINAMICS S120 multi-axis system. Central communication is handled by the CU320-2 Control Unit or SIMOTION D.</p> <ul style="list-style-type: none"> <li>• Power range: 0.25 ... 1.5 kW at line voltage 380 ... 480 V 3 AC</li> <li>• Interface to SIMOTION via PROFINET or PROFIBUS, for SIMOTION D via DRIVE-CLiQ</li> </ul> <p>For further information see <a href="#">Catalog D 21.4</a>.</p>
	S120 single-axis drives (AC/AC)	<p>The SINAMICS S120 single-axis drives comprise a CU310-2 Control Unit and a PM240-2 Power Module or a Power Module in chassis format. The electrical and mechanical connection between the Control Unit and Power Module is implemented via a system interface. Instead of the CU310-2, a SIMOTION D410-2 module with integrated SINAMICS control or a CUA31 or CUA32 Control Unit Adapter can be used. Thanks to the Control Unit Adapter, SINAMICS S120 single-axis drives can be operated via DRIVE-CLiQ with CU320-2 Control Units or with SIMOTION D4x5-2 modules.</p> <ul style="list-style-type: none"> <li>• Power range: 0.55 ... 4 kW at line voltage 200 ... 240 V 1 AC</li> <li>• Power range: 0.55 ... 55 kW at line voltage 200 ... 240 V 3 AC</li> <li>• Power range: 0.55 ... 250 kW at line voltage 380 ... 480 V 3 AC</li> <li>• Power range: 11 ... 132 kW at line voltage 500 ... 690 V 3 AC</li> <li>• Interface to SIMOTION via PROFINET or PROFIBUS or DRIVE-CLiQ when using a Control Unit Adapter</li> </ul> <p>For further information see <a href="#">Catalog D 21.4</a> and <a href="#">Catalog D 31</a>.</p>
	S110 single-axis drives (AC/AC)	<p>The SINAMICS S110 single-axis drives consist of a CU305 Control Unit and a PM240-2 Power Module.</p> <p>The communication between SIMOTION and the CU305 Control Unit can take place via PROFINET or PROFIBUS, with a minimum bus cycle of 1 ms. Alternatively, the setpoints can also be specified via a pulse-direction interface (max. 500 kHz).</p> <ul style="list-style-type: none"> <li>• Power range: 0.55 ... 4 kW at line voltage 200 ... 240 V 1 AC</li> <li>• Power range: 0.55 ... 132 kW at line voltage 380 ... 480 V 3 AC</li> <li>• Interface to SIMOTION via PROFINET or PROFIBUS, for SIMOTION C also pulse-direction interface</li> </ul> <p>For further information see <a href="#">Catalog D 31</a>.</p>



### Overview (continued)

SIMOTION provides functions for controlling and monitoring a SINAMICS drive via the technology object "Axis". The following axis technologies are distinguished during the configuration phase:

- Drive axis  
Motion Control is performed using a speed setpoint without position control. For a drive axis, any drive that supports telegram 1 or 2 as per the PROFIdrive profile can be used, e.g. a SINAMICS G converter.
- Positioning axis, synchronous axis, path axis  
Motions are position-controlled. To this end, the drive must provide an actual position value which SIMOTION uses along with other signals to coordinate the axes. SINAMICS S drives must be used for these axes.

### More information

Further information about SINAMICS is available on the Internet at [www.siemens.com/sinamics](http://www.siemens.com/sinamics)

Specific application examples and descriptions can be found on the Internet at [www.siemens.com/sinamics-applications](http://www.siemens.com/sinamics-applications)

## SIMOTION system components

### Notes

3  
4

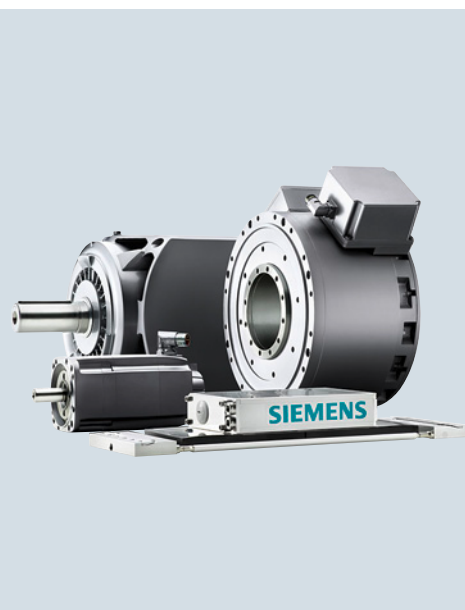

## 3.5/2

### **SIMOTICS motors**

3.5/2

Overview

3.5/4

SIMOTICS S servomotors

3.5/4

SIMOTICS S servo geared motors

3.5/5

SIMOTICS M main motors

3.5/5

SIMOTICS L linear motors

3.5/6

SIMOTICS T torque motors

## 3.5/6







### **More information**

## SIMOTION system components

### Motors

#### SIMOTICS motors

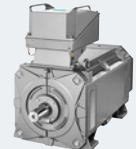
#### Overview

SIMOTICS							
	 <p>Low-voltage motors for line and converter operation</p>						
SIMOTICS family	General Purpose	Severe Duty	Explosion Protected	Definite Purpose	Flexible Duty	Transnorm	High Torque
	GP	SD	XP	DP	FD	TN	HT
							
Brief description	Motors for everyday applications in industry under standard environmental conditions	Motors with cast-iron housing for applications under harsh environmental conditions	Motors for operation in hazardous areas	Special motors, e.g. marine motors, roller table motors, smoke-extraction motors	Converter-optimized motors for flexible applications with higher power ratings and with various cooling methods	Motors with cast-iron housing with higher power ratings for standard and harsh ambient conditions	Torque motors for applications with high torques without gear units, even at low speeds
Application examples	<ul style="list-style-type: none"> <li>• Pumps/fans/compressors</li> <li>• Drives for the process industry, e.g.:               <ul style="list-style-type: none"> <li>- Mixers</li> <li>- Mills</li> <li>- Extruders</li> </ul> </li> <li>• Motors with explosion protection</li> <li>• Drives for ship propellers</li> <li>• Paper machines</li> <li>• Centrifuges</li> </ul>						
Catalog	D 81.1 NEMA: D 81.2	D 81.1 NEMA: D 81.2	D 81.1, D 83.1 NEMA: D 81.2	D 81.1	D 81.8	D 84.1	D 86.1

#### A clearly structured portfolio

The entire SIMOTICS product portfolio is transparently organized according to application-specific criteria in order to help users select the optimum motor for their application.







The product range extends from standard motors for pumps, fans and compressors to highly dynamic, precise motion control motors for positioning tasks and motion control in handling applications, as well as production machinery and machine tools, to DC motors and powerful high-voltage motors. Whatever it is that you want to move – we can supply the right motor for the task.

#### An outstanding performance for any job

A key characteristic of all SIMOTICS motors is their quality. They are robust, reliable, dynamic and precise to assure the requisite performance level for any process and deliver exactly the capabilities demanded by the application in hand. Thanks to their compact design, they can be integrated as space-saving units into installations. Furthermore, their impressive energy efficiency makes them effective as a means of reducing operating costs and protecting the environment.

#### Perfection of the complete drive train

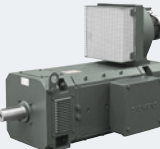
SIMOTICS is perfectly coordinated with other Siemens product families. In combination with the SINAMICS integrated converter family and the SIRIUS complete portfolio of industrial controls, SIMOTICS fits seamlessly as part of the complete drive train into automation solutions which are based on the SIMOTION, SIMATIC and SINUMERIK control systems.

SIMOTICS							
Motors for Motion Control applications				DC motors	High-voltage motors		
Servo	Main	Linear	Torque	Direct Current	High Voltage		SIMOTICS family
S	M	L	T	DC	HV		
							
Servomotors with the highest dynamics and precision characteristics	Main motors with very large power range and selection flexibility due to their modular design	Linear motors for extreme dynamic performance, peak force, and precision for linear traversing motion	Torque motors with the highest precision through the whole torque range in a highly compact design	DC motors for speed-controlled operation with low shaft height at high torque: robust, compact, low-noise	High-voltage motors for line and converter operation: compact, flexible, high availability		Brief description
<ul style="list-style-type: none"> <li>• Production machines, e.g.:               <ul style="list-style-type: none"> <li>- Packaging/plastic/textile</li> <li>- Wood/glass/ceramic</li> <li>- Printing machines/presses</li> </ul> </li> <li>• Handling systems</li> <li>• Robots</li> <li>• Machine tools, e.g.:               <ul style="list-style-type: none"> <li>- Turning/milling/grinding</li> </ul> </li> </ul>				Drive applications in all industries with direct current	<ul style="list-style-type: none"> <li>• Pumps</li> <li>• Compressors</li> <li>• Main drives with high power rating for:               <ul style="list-style-type: none"> <li>- Ships</li> <li>- Rolling mills</li> <li>- Mills</li> </ul> </li> </ul>		Application examples
D 21.4, D 41	D 21.4	D 21.4	D 21.4	DA 12	D 84.1, D 86.1, D 84.9, D 83.2		Catalog

### SIMOTICS motors for Motion Control applications

With the SIMOTICS servo, main, torque and linear motors, Siemens offers a comprehensive range of motors for Motion Control tasks. Perfectly coordinated for operation with SINAMICS converters, all products in the portfolio impress with their compact dimensions, precision and dynamic response.

They provide you with precisely tailored, state-of-the-art Motion Control solutions in all performance classes created using globally available standard components. Electronic rating plates and the ability to integrate the motors via the DRIVE-CLiQ system interface ensure quick commissioning as well as problem-free operation. Thanks to the integral encoders with redundant encoder tracks and safety functions which are integrated in the drive, modern safety concepts are easy to implement.

## SIMOTION system components

### Motors

#### SIMOTICS motors

#### Overview (continued)

##### SIMOTICS S servomotors

###### Servomotors for highly dynamic, exact positioning and precise motion control

Whether they are used for positioning in printing machines, in pick and place applications, as cyclic drives in packaging machines, or for path control in handling systems: Our permanent-magnet, highly energy efficient SIMOTICS S servomotors are the first choice for any application which demands highly dynamic and precise motional sequences. They are equipped with state-of-the-art encoder technology and optimized for operation on the SINAMICS S120 drive system/SIMOTION Motion Control System.

##### SIMOTICS S-1FK7 servomotors

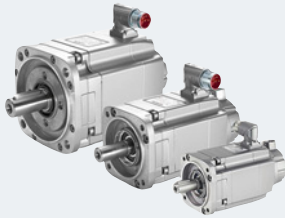

SIMOTICS S-1FK7 servomotors are compact permanent-magnet synchronous motors.

The motors are designed for operation without external cooling and the heat is dissipated through the motor surface. The 1FK7 motors have a high overload capability and are available with different rotor inertias as Compact, High Dynamic and High Inertia versions.

- Shaft heights: SH 20 ... 100
- Degree of protection: IP64 (optional IP65)
- Rated power: 0.05 ... 8.2 kW
- Rated torque: 0.08 ... 37 Nm

For further information see Catalog D 21.4 – Chapter SIMOTICS servomotors.

##### SIMOTICS S-1FT7 servomotors

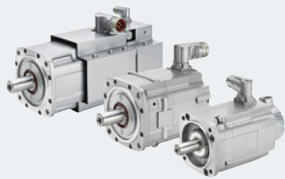

The SIMOTICS S-1FT7 servomotors are permanent-magnet synchronous motors with very compact dimensions. They fulfill the highest standards in terms of dynamic performance, speed setting range, shaft and flange accuracy.

Natural cooling, forced ventilation or water cooling are available as cooling methods. The 1FK7 motors have up to 4 times overload capability and are available with different rotor inertias as Compact and High Dynamic versions.

- Shaft heights: SH 36 ... 132 (SH 132 only with natural cooling)
- Degree of protection: IP64 (optional IP65, IP67)
- Rated power: 0.88 ... 34.2 kW
- Rated torque: 1.4 ... 125 Nm

For further information see Catalog D 21.4 – Chapter SIMOTICS servomotors.

##### SIMOTICS S servo geared motors

###### Servomotors with planetary gear units and coaxial and right-angle gear units

In combination with helical, bevel or parallel-shaft and helical worm gear units, our servomotors offer the right solution in applications such as palletizers, storage and retrieval units with lifting, traversing and fork drive, dosing pumps, or actuators.

Servomotors with planetary gear units are the right choice, especially for high requirements for precision and dynamics such as for positioning and adjustment axes, and they are optimized for operation on the SINAMICS S120 drive system and SIMOTION Motion Control System. They are also used in tight spaces and when the smallest possible dimensions of the geared motor are required.

##### SIMOTICS S-1FK7/1FT7 planetary geared motors

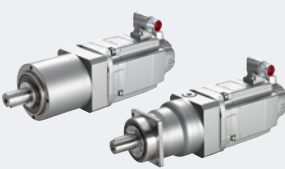

The SIMOTICS S-1FK7 and SIMOTICS S-1FT7 servomotors can be combined with planetary gear units to form compact coaxial drive units. The motors can be supplied ex works (Siemens AG) complete with flange-mounted planetary gear unit. Planetary gear units of the LP+ and SP+ series are available for this.

- Motor shaft heights: SH 28 ... 100
- Gear unit sizes: 50 ... 240
- Gear ratio: 4 ... 50
- Max. operating torque: 13 ... 4500 Nm

For further information see Catalog D 21.4 – Chapter SIMOTICS servomotors.

##### SIMOTICS S-1FG1 servo geared motors

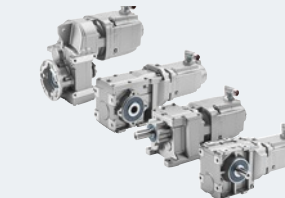

SIMOTICS S-1FG1 servo geared motors are pre-assembled as a complete unit and supplied with a gear unit filled with oil. The range of available types comprises helical, parallel-shaft, bevel and helical worm geared motors, which are available with up to 25 transmission ratios depending on the type of gear unit and size.

SIMOTICS S-1FG1 servo geared motors are designed for operation without external cooling and the heat is dissipated through the motor surface and the gear unit mounting surface. The motors can be selected with different rotor inertias as Compact or High Dynamic versions.

- Motor shaft heights: SH 36 ... 100
- Gear unit sizes: 29 ... 149
- Gear ratio: 3.4 ... 413
- Max. operating torque: 14 ... 8160 Nm

For further information see Catalog D 41.

**Overview (continued)**
**SIMOTICS M main motors**
**Main motors for precise concentricity in rotary axes and main drives**

Whether as main drives for presses, as roller drives in printing and paper-making machines, textile and plastics-processing machines: The SIMOTICS M main motors are particularly suitable for applications where continuous, precise rotation of the axes is the primary concern. SIMOTICS M motors were designed specifically for use in conjunction with the SINAMICS S120 drive system/SIMOTION Motion Control System. Depending on the control requirements, appropriate encoder systems are available for the motors for sensing the motor speed and indirect position.

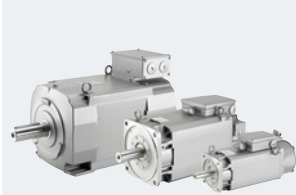
**SIMOTICS M-1PH8 asynchronous motors**

SIMOTICS M-1PH8 motors are compact asynchronous squirrel-cage motors. The motors are available as forced-ventilated, open-circuit ventilated and water-cooled models.

- Shaft heights: SH 80 ... 355
- Degree of protection: IP55, IP23 (open-circuit cooling), IP65 (water cooling only)
- Rated power: 2.8 ... 1340 kW
- Rated torque: 13 ... 12435 Nm

For further information see Catalog D 21.4 – Chapter SIMOTICS main motors (SH 80 - 280) or Catalog CR1 - Chapter Motors (SH 355).

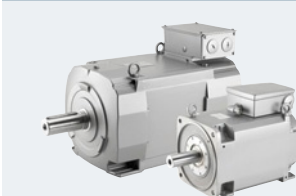
**SIMOTICS M-1PH8 synchronous motors**

SIMOTICS M-1PH8 motors are compact permanent-magnet synchronous motors. The motors are available as forced-ventilated and water-cooled models.

- Shaft heights: SH 132 ... 225
- Degree of protection: IP55, IP65 (water cooling only)
- Rated power: 15.7 ... 310 kW
- Rated torque: 94 ... 1650 Nm

For further information see Catalog D 21.4 – Chapter SIMOTICS main motors.

**SIMOTICS L linear motors**
**Linear motors for outstanding dynamic response and precision for linear traversing motions**

Linear motors are the ideal solution for any application which requires linear movements to be performed with maximum dynamic response and precision. The effects of elasticity, backlash and friction as well as natural oscillation in the drive train are largely eliminated because no mechanical transmission elements such as ball screw, coupling and belt are needed when linear motors are used. In combination with the SINAMICS S120 drive system and the SIMOTION Motion Control System, the SIMOTICS L linear motors provide an optimally tuned linear direct drive system for the requirements of modern mechanical engineering.

**SIMOTICS L-1FN3 linear motors**

The SIMOTICS L-1FN3 linear motors comprise a water-cooled primary section and a secondary section with magnets made of rare-earth material. The primary section has fixed dimensions, while the secondary section is made up of individual elements (segments) to suit the required traversing range. Through parallel operation of the motors, feed force and length can be scaled beyond the available spectrum.

- Width of primary section: 67 ... 342 mm (2.64 ... 13.5 in) (without precision cooling)
- Degree of protection: IP65 (primary section)
- Feed force  $F_{rated}$ : 150 ... 10375 N
- Max. velocity at  $F_{rated}$ : 105 ... 836 m/min

For further information see Catalog D 21.4 – Chapter SIMOTICS linear and torque motors.

## SIMOTION system components

### Motors

#### SIMOTICS motors

#### Overview (continued)

##### SIMOTICS T torque motors

##### Torque motors for the gearless direct drive of rotary axes

Whether as complete or built-in torque motors: Optimized for high torques at low rated speeds, the SIMOTICS T motors with their high precision and dynamics are very convincing. In combination with the SINAMICS S120 drive system and the SIMOTION Motion Control System, the SIMOTICS T torque motors provide an optimally tuned rotary direct drive system for the requirements of modern mechanical engineering. Complete torque motors are used in converting applications, e.g. as extruder main drives or roller and winder drives; built-in torque motors are used, for example, in rotary indexing machines, rotary tables, or for swivel and rotary axes.

Thanks to the omission of mechanical transmission elements such as gear units, the number of components susceptible to wear is reduced.

##### SIMOTICS T-1FW3 complete torque motors

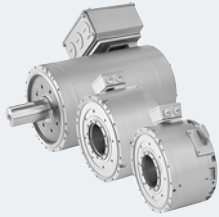

The SIMOTICS T-1FW3 complete torque motors are water-cooled, high-pole (slow running) permanent magnet synchronous motors. The 1FW3 range of motors comprises three external diameters in various shaft lengths as well as three different shaft versions (hollow shaft, plug-on shaft and solid shaft).

- Shaft heights: SH 150 ... 280
- Degree of protection: IP54 (hollow shaft), IP55 (plug-on and solid shaft)
- Rated power: 2.8 ... 435 kW
- Rated torque: 95 ... 7000 Nm

For further information see [Catalog D 21.4 – Chapter SIMOTICS linear and torque motors](#).

##### SIMOTICS T-1FW6 built-in torque motors

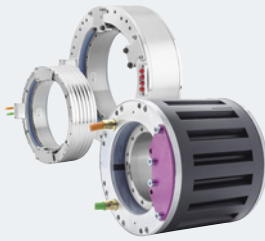

SIMOTICS T-1FW6 built-in torque motors are liquid-cooled or naturally cooled multi-pole permanent-magnet AC synchronous motors with hollow shaft. The motors are supplied as built-in components; for a complete drive unit an additional bearing and rotary encoder are required. Most stators and rotors are equipped with flanges at each end with centering surfaces and threaded holes for installation in the machine.

- External diameter: 159 ... 730 mm (6.26 ... 28.7 in)
- Degree of protection: IP23
- Rated torque  $M_{rated}$ : 9.9 ... 5760 Nm
- Max. speed at  $M_{rated}$ : 38 ... 940 rpm

For further information see [Catalog D 21.4 – Chapter SIMOTICS linear and torque motors](#).

#### More information

Further information on SIMOTICS can be found on the Internet at [www.siemens.com/simotics](http://www.siemens.com/simotics)



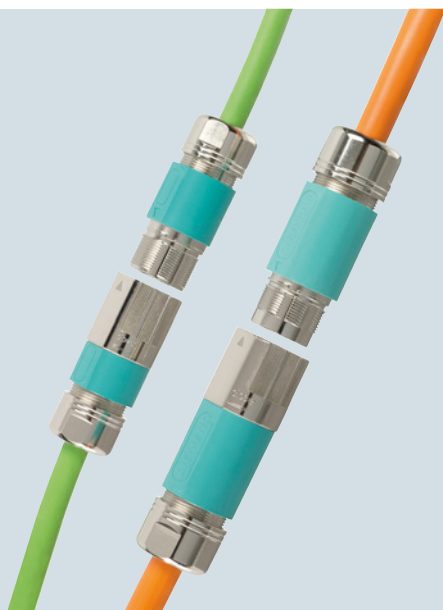

**3.6/2** **MOTION-CONNECT**  
**connection systems**

3.6/2 Overview

3.6/2 More information

## SIMOTION system components

### Connection systems

#### MOTION-CONNECT connection systems

##### Overview

MOTION-CONNECT includes connection systems and components which are optimally tailored to individual areas of application. MOTION-CONNECT cables feature state-of-the-art connection systems to ensure fast, reliable connection of different components, and offer maximum quality as well as system-tested reliability.



MOTION-CONNECT cables are available as fully-assembled power and signal cables or sold by the meter.

The pre-assembled cables can be ordered in length units of 10 cm (3.94 in) and can be extended, if necessary.

Whatever your machine requirements, MOTION-CONNECT offers the solution.

- **Rugged, high-performance and easy to use**  
thanks to pre-assembled cables with a rugged metal connector in degree of protection IP67 and reliable SPEED-CONNECT quick-release lock
- **Outstanding and proven quality**  
achieved by consistent quality management and system-tested cables

Cables are available in two different qualities – MOTION-CONNECT 500 and MOTION-CONNECT 800PLUS.

MOTION-CONNECT 500	MOTION-CONNECT 800PLUS
<ul style="list-style-type: none"> <li>• Cost-effective solution for predominantly fixed installation</li> <li>• Tested for travel distances up to 5 m (16.4 ft)</li> </ul>	<ul style="list-style-type: none"> <li>• Meets requirements for use in cable carriers</li> <li>• Oil-resistant</li> <li>• Tested for travel distances of up to 50 m (164 ft)</li> </ul>

##### More information

For further information on MOTION-CONNECT connection systems, refer to

- Catalog D 21.4
- Interactive Catalog CA 01 as well as
- The Internet at:  
[www.siemens.com/motion-connect](http://www.siemens.com/motion-connect)  
[www.siemens.com/industrymall](http://www.siemens.com/industrymall)



**3.7/2 Motion Control Encoder measuring systems**







- 3.7/2 Overview
- 3.7/2 Application
- 3.7/2 Design
- 3.7/2 More information

## SIMOTION system components

### Measuring systems

#### Motion Control Encoder measuring systems

#### Overview

Motion Control Encoder measuring systems								
Encoder type	Incremental encoders			Absolute encoders				
								
Interface	sin/cos 1 V <sub>pp</sub>	RS422 (TTL)	HTL	DRIVE-CLiQ	SSI	EnDat	PROFIBUS DP	PROFINET IO
Resolution	1000 S/R	500 S/R	100 S/R	Single-turn	Single-turn	Single-turn	Single-turn	Single-turn
	1024 S/R	1000 S/R	500 S/R	24 bit	13 bit (8192 steps)	13 bit (8192 steps)	13 bit (8192 steps)	13 bit (8192 steps)
	2500 S/R	1024 S/R	1000 S/R	Multi-turn 36 bit (24 bit single-turn + 12 bit multi-turn)	Multi-turn 25 bit (8192 steps × 4096 revolutions)	Multi-turn 25 bit (8192 steps × 4096 revolutions)	Multi-turn 27 bit (8192 steps × 16384 revolutions)	Multi-turn 27 bit (8192 steps × 16384 revolutions)
		1250 S/R	2500 S/R					
		1500 S/R						
		2000 S/R						
		2048 S/R						
		2500 S/R						
		3600 S/R						
		5000 S/R						
Catalog	D 21.4							

Motion control encoders are optoelectronic built-on encoders that detect the traversing distances, angles of rotation, speeds or positions of machine axes. Motion control encoders are direct measuring systems that are built-on to shafts, axes or motors. They can be used in conjunction with numerical and programmable logic controllers, drives and position displays. Motion control encoders are system-tested, certified components that have been harmonized for use with the following systems:

- SINUMERIK CNC controls
- SIMOTION Motion Control Systems
- SIMATIC programmable logic controllers
- SINAMICS drive systems

#### Application

Motion control encoders are used with machine tools and production machines as additional external measuring systems. They are available as incremental or absolute encoders.

- In the case of incremental encoders, the machine must travel to a reference point after each power-off state, as the position is not usually stored in the controller, and movements of the machine while the power is off are not recorded.
- Absolute encoders, on the other hand, also record movements while the power is off and return the actual position after power on. Travel to a reference point is not necessary.

#### Design

All motion control encoders are available in Synchro flange and clamp flange versions. The absolute encoders are also available with a hollow shaft and torque arm.

The motion control encoders are driven via a plug-in coupling or spring disk coupling. Alternatively, pulleys can also be used.

The motion control encoder supply voltage is 5 V DC or alternatively 10 to 30 V DC. The 10 to 30 V DC version supports longer cable lengths. Most control systems apply the supply voltage directly on the measuring circuit connector. With SINAMICS, the measuring systems are provided with power via the Sensor Modules.

For motion control encoders with cables, the cable length including the connector is 1 m (3.28 ft).

The following bending radii must be observed for the cable to the built-on encoder:

- One-time bending: ≥ 20 mm (0.79 in)
- Continuous bending: ≥ 75 mm (2.95 in)

#### More information

For further information on measuring systems, see Catalog D 21.4 in Chapter Motion Control Encoder measuring systems and on the Internet at [www.siemens.com/industrymall](http://www.siemens.com/industrymall) under Drive Technology > Motors > Motion Control Encoder measuring systems

## Communication

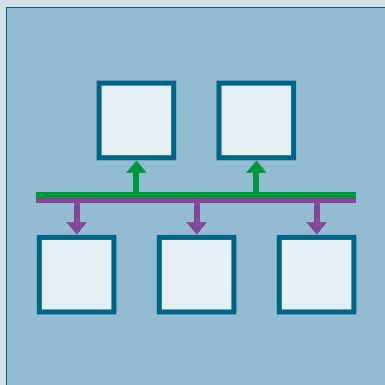

4/2	PROFINET
4/6	PROFINET for SIMOTION and SINAMICS S
4/7	PROFIdrive
4/8	PROFIBUS
4/9	Industrial Ethernet

## Communication

### PROFINET

#### Overview



#### **PROFINET – the Ethernet standard for automation**

PROFINET is the world's leading Industrial Ethernet standard for automation with more than 10 million nodes installed worldwide.

PROFINET makes companies more successful, because it speeds up processes and raises both productivity and plant availability.

#### Your advantages at a glance

##### Flexibility

Tailor-made plant concepts

- ▶ Industrial Wireless LAN
- ▶ Safety
- ▶ Flexible topologies
- ▶ Open standard
- ▶ Web tools
- ▶ Expandability

##### Efficiency

Optimal use of resources

- ▶ One cable for everything
- ▶ Device/network diagnostics
- ▶ Energy efficiency
- ▶ Simple wiring
- ▶ Fast device replacement
- ▶ Ruggedness/stability

##### Performance

Increased productivity

- ▶ Speed
- ▶ High precision
- ▶ Large quantity structures
- ▶ High transmission rate
- ▶ Redundancy
- ▶ Fast start-up

G\_IK10\_XX\_10304

**Overview** (continued)**Flexibility**

Short response times and optimized processes are the basic requirements for competitiveness in global markets because the product lifecycles are becoming shorter and shorter.

PROFINET ensures maximum flexibility in plant structures and production processes, and it enables you to implement innovative machine and plant concepts. For example, mobile devices can also be integrated at locations that are difficult to access.

Flexible topologies

In addition to the linear structure characterized by the established fieldbuses, PROFINET also enables the use of star, tree and ring topologies. This is made possible by switching technology via active network components, such as Industrial Ethernet switches and media converters, or by integrating switch functionality into the field devices. This results in increased flexibility in the planning of machines and plants, as well as savings in cabling.

The PROFINET network can be installed without any specialist knowledge at all and meets all requirements that are relevant to the industrial environment. The "PROFINET Installations Guidelines" assist manufacturers and users with network planning, installation and commissioning. Symmetrical copper cables or RFI-resistant fiber-optic cables are used, depending on the application. Devices from different manufacturers are easily connected via standardized and rugged plug-in connectors (up to IP65/IP67 degree of protection).

By integrating switch functionality into the devices, linear topologies can be created that are directly oriented toward an existing machine or plant structure. This reduces cabling overhead and cuts down on components such as external switches.

IWLAN

PROFINET also supports wireless communication with Industrial Wireless LAN, thus opening up new fields of application. For example, technologies subject to wear, such as trailing cables, can be replaced and automated guided vehicle systems and mobile operator panels can be used.

Safety

The PROFIsafe safety profile, which has been tried and tested with PROFIBUS and which permits the transmission of standard and safety-related data on a single bus cable, can also be used with PROFINET. No special network components are necessary for fail-safe communication, which means that standard switches and standard network transitions can continue to be used without any restrictions. In addition, fail-safe communication is equally possible via Industrial Wireless LAN (IWLAN).

Open standard

PROFINET, the open vendor-independent standard (IEC 61158/IEC 61784), is supported by PROFIBUS and PROFINET International (PI). It stands for maximum transparency, open IT communication, network security and simultaneous real-time communication.

Thanks to its openness, PROFINET provides the basis for a standardized automation network in the plant, to which all other machines and devices can be connected. Even the integration of existing plant components, for example using PROFIBUS, presents no problems due to the use of network transitions.

Use of web tools

Thanks to the unrestricted support of TCP/IP, PROFINET permits the use of standard web services in the device, such as web servers. Irrespective of the tool used, information from the automation level can be accessed from virtually any location using a commercially available Internet browser. This considerably simplifies commissioning and diagnostics. Users can then decide for themselves how much openness to the IT world they want to allow for their machine or plant. This means that PROFINET can be used simply as an isolated plant network or connected via appropriate security modules, such as the SCALANCE S modules, to the office network or the Internet. In this way, new remote maintenance concepts or the high-speed exchange of production data become possible.

Expandability

On the one hand, PROFINET facilitates the integration of existing systems and networks without any great effort. In this way, PROFINET safeguards investments in existing plant components that communicate via PROFIBUS and other fieldbuses such as AS-Interface. On the other hand, additional PROFINET nodes can be added at any time. By using additional network components, network infrastructures can be expanded using cabling or wireless methods – even while the plant is operating.

## Communication

### PROFINET

#### Overview (continued)

##### **Efficiency**

Greater global competition means that companies must use their resources economically and efficiently. This applies in particular to production. This is where PROFINET ensures greater efficiency. Simple engineering guarantees fast commissioning, while reliable devices ensure a high level of plant availability. Comprehensive diagnostic and maintenance concepts help to reduce plant downtimes and keep maintenance costs to a minimum.

##### One cable for everything

PROFINET permits simultaneous fieldbus communication with isochronous mode and standard IT communication (TCP/IP) on one cable. This real-time communication for the transmission of user/process data and diagnostic data takes place on a single cable. Specific profile communication (PROFIsafe, PROFIdrive and PROFlenergy) can be integrated without any additional cabling. This solution offers a wide scope of functions at a low level of complexity.

##### Device and network diagnostics

By retaining the tried and tested PROFIBUS device model, the same diagnostics information is available with PROFINET. In addition, module-specific and channel-specific data can also be read out from the devices during device diagnosis, enabling faults to be located quickly and easily. Apart from the availability of device information, the reliability of network operation has top priority in the network management.

In existing networks the Simple Network Management Protocol (SNMP) has established itself as the de facto standard for the maintenance and monitoring of the network components and their functions. PROFINET uses this standard and gives users the opportunity to maintain their networks with tools that are familiar to them, such as the SINEMA Server network management software.

For easier maintenance of PROFINET devices, both on-site and remotely via a secure VPN connection, application-specific web-sites can be set up on the integrated web server of the field devices using the familiar HTML standard.

##### Energy efficiency

Moving toward the green factory: PROFlenergy is a profile that provides functions and mechanisms for PROFINET field devices that support energy-efficient production.

The profile, which is defined by the PNO and is independent of any manufacturers or devices, enables energy demand and costs to be significantly reduced: Using PROFlenergy, any specific loads that are not currently being used can be switched off. This achieves a noticeable reduction in energy costs during breaks in production. PROFlenergy permits the simple, automated activation and deactivation of technologically related plant components. It is coordinated centrally by means of a higher-level controller and is networked via PROFINET. This ensures that as much energy as possible is saved during long breaks. Temporarily switching off plant components contributes to the even distribution and most efficient use of energy.

The use of PROFlenergy is made easy for the machine builder by its integration into familiar series of products. In addition, PROFlenergy is defined in such a way that the necessary function blocks can easily be integrated into existing automation systems at a later stage.

##### Simple wiring

Particularly stringent demands are made on the installation of cables in the industrial environment. In addition, there is a requirement to set up industry-standard networks in the shortest possible time without any special knowledge.

With FastConnect, Siemens offers a high-speed installation system that meets all of these requirements. FastConnect is the standard-compliant, industry-standard cabling system consisting of cables, connectors and assembly tools for PROFINET networks. The time required for connecting terminals is minimized by the simple installation method using just a single tool, while installation errors are prevented by the practical color-coding. Both copper cables and glass fiber optic cables can be easily assembled on site in this way.

##### Fast device replacement

PROFINET devices are identified by means of a name assigned during configuration. When replacing a defective device, a new device can be recognized from its topology information by the IO controller and a new name can be assigned to it automatically. This means that no engineering tool is necessary for the replacement of equipment.

This mechanism can even be used for the initial commissioning of a complete system. This speeds up commissioning, particularly in the case of series machines.

##### Ruggedness

An automation network must be able to withstand most external sources of interference. The use of Switched Ethernet prevents faults in one section of the network from affecting the entire plant network. For areas that are particularly prone to radio frequency interference (RFI), PROFINET allows the use of fiber optic cables.

##### **Performance**

Productivity and product quality determine the level of success in the market. Precise motion control, dynamic drives, high-speed controllers and the deterministic synchronization of devices are therefore key factors in achieving superior production. They facilitate high production rates and optimum product quality at the same time.

##### Speed and precision

Fast motion control applications demand precise and deterministic exchange of data. This is implemented by means of drive controllers using isochronous real time (IRT).

With IRT and isochronous mode, PROFINET permits fast and deterministic communication. This synchronizes the various cycles of a system (input, network, CPU processing and output), even in the case of parallel TCP/IP traffic. The short cycle times of PROFINET make it possible to raise the productivity of machines and plants and to guarantee the product quality and high level of precision.

The standardized PROFIdrive profile permits vendor-independent communication between CPUs and drives.



**Overview** (continued)Large quantity structures

The use of PROFINET makes it possible to overcome the existing restrictions regarding the scope of machines and systems that can be implemented. In one network, several different controllers can interact with their assigned field devices. The number of field devices per PROFINET network is virtually unlimited – the entire range of IP addresses is available.

High transmission rate

By using 100 Mbit/s in full duplex mode, PROFINET achieves a significantly higher transmission rate than previous fieldbuses. This means that other plant data can be transmitted over TCP/IP without any problems, in addition to the process data. PROFINET therefore meets the combined industrial demands for simultaneously transmitting high-speed IO data and large volumes of data for additional sections of the application. Even the transmission of large volumes of data, such as that from cameras, has no adverse effect on the speed and precision of the IO data transmission, thanks to PROFINET mechanisms.

Media redundancy

A higher plant availability can be achieved with a redundant installation (ring topology). The media redundancy can be implemented not only with the aid of external switches, but also by means of integrated PROFINET interfaces. Using the media redundancy protocol (MRP), reconfiguration times of 200 ms can be achieved. If communication is interrupted in just one part of the ring installation this means that a plant standstill is prevented and any necessary maintenance or repair work can be performed without any time pressure.

For Motion Control applications, PROFINET with IRT in ring topologies offers extended media redundancy for planned duplication (MRPD) which operates in a bumpless mode without any re-configuration time. If communication is interrupted (e.g. a cable break) the process can continue operating without interruption.

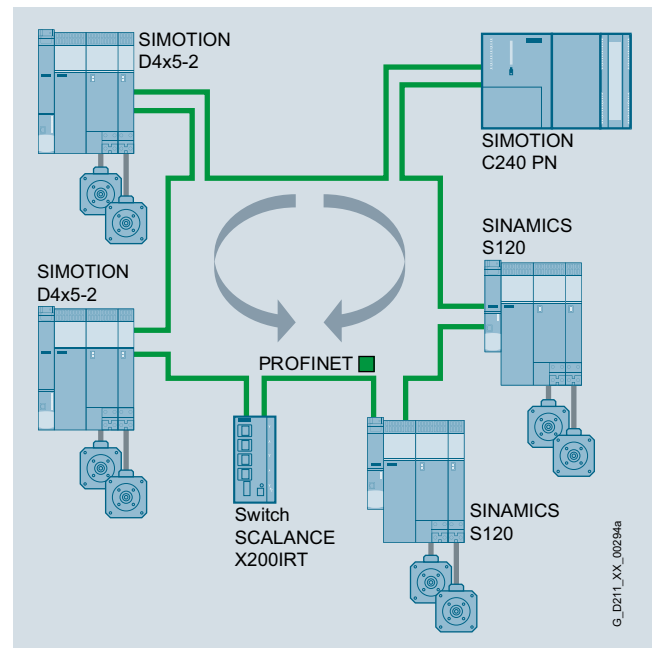

Bumpless media redundancy illustrated by example of SINAMICS S120 with SIMOTION and SCALANCE X200IRT

**Benefits**

- PROFINET is the open Industrial Ethernet standard for automation
- PROFINET is based on Industrial Ethernet
- PROFINET uses TCP/IP and IT standards
- PROFINET is real-time Ethernet
- PROFINET permits seamless integration of fieldbus systems
- PROFINET supports fail-safe communication via PROFI-safe and also via IWLAN

**More information**

Further information can be found at [www.siemens.com/profinet](http://www.siemens.com/profinet)

# Communication

## PROFINET for SIMOTION and SINAMICS S

### Overview

#### PROFINET – SIMOTION Motion Controller functions

SIMOTION device	C240 PN	D410-2 DP/PN	D425-2 DP/PN	D435-2 DP/PN	D445-2 DP/PN	D455-2 DP/PN	P320-4
Number of PROFINET interfaces	1	1	1 ... 2 (second interface is an option)	1 ... 2 (second interface is an option)	1 ... 2 (second interface is an option)	1 ... 2 (second interface is an option)	1
<b>Interface 1</b>							
PROFINET with IRT (isochronous mode)	✓	✓	✓	✓	✓	✓	✓
Number of ports	3	2	3	3	3	3	3
Max. number of devices	64	64	64	64	64	64	64
Min. send clock in ms	0.5	0.25	0.25	0.25	0.25	0.125 <sup>3)</sup>	0.25
I-Device	✓	✓	✓	✓	✓	✓	✓
Shared I-Device	✓	✓	✓	✓	✓	✓	✓
Bumpless media redundancy (MRPD) <sup>1)</sup>	✓	✓	✓	✓	✓	✓	✓
Step-change media redundancy (MRP)	✓	✓	✓	✓	✓	✓	✓
PROFIsafe routing	✓	✓	✓	✓	✓	✓	✓
PROFInergy (as controller)	✓	✓	✓	✓	✓	✓	✓
PROFInergy (as device)	✓	✓	✓	✓	✓	✓	✓
<b>Interface 2 (option)<sup>2)</sup></b>							
PROFINET with IRT (isochronous mode)	–	–	✓	✓	✓	✓	–
Number of ports (CBE30-2 option board)	–	–	4	4	4	4	–
Max. number of devices	–	–	64	64	64	64	–
Min. send clock in ms	–	–	0.5	0.5	0.5	0.5	–
I-Device	–	–	✓	✓	✓	✓	–
Shared I-Device	–	–	✓	✓	✓	✓	–
Bumpless media redundancy (MRPD)	–	–	✓	✓	✓	✓	–
Step-change media redundancy (MRP)	–	–	✓	✓	✓	✓	–
PROFIsafe routing	–	–	✓	✓	✓	✓	–
PROFInergy (as controller)	–	–	✓	✓	✓	✓	–
PROFInergy (as device)	–	–	✓	✓	✓	✓	–

<sup>1)</sup> To establish bumpless media redundancy (MRPD), a separate switch from the SCALANCE X200IRT series is required.

<sup>2)</sup> Optional second PROFINET interface via CBE30-2 (4 ports), only with SIMOTION D4x5-2 DP/PN.

<sup>3)</sup> Supported only with SCOUT TIA and ServoFast/IPOFast.

#### PROFINET – SINAMICS S110/SINAMICS S120 functions

SINAMICS S120	CU320-2 PN	CU320-2 DP (CBE20)	CU310-2 PN	CU305 PN
PROFINET with IRT (isochronous mode)	✓	✓	✓	✓
Number of ports	2	4	2	2
Min. send clock in ms	0.25	0.5	0.25	1
Shared device	✓	✓	✓	✓
Bumpless media redundancy (MRPD)	✓	✓	✓	✓
Step-change media redundancy (MRP)	✓	✓	✓	✓
PROFIsafe	✓	✓	✓	✓
PROFInergy	✓	✓	✓	✓
PROFIdrive	✓	✓	✓	✓

## Overview



### **PROFIdrive – The standardized drive interface for PROFINET and PROFIBUS**

PROFIdrive defines the device behavior and the access procedure to internal device data for electrical drives on PROFIBUS and PROFINET, from simple frequency converters up to high-performance servo controllers.

It contains a detailed description of how the communication functions "slave-to-slave communication", "constant bus cycle time" and "isochronous operation" are expediently used in drive applications. In addition, it clearly specifies all device characteristics which influence the interface to a controller connected over PROFIBUS or PROFINET. This includes the State Machine (sequence control), encoder interface, standardization of values, definition of standard telegrams, and access to drive parameters, etc.

The PROFIdrive profile supports both central and distributed Motion Control concepts.

#### **What are profiles?**

Profiles specify specific properties and responses for devices and systems in automation. In this manner, manufacturers and users pursue the goal of defining common standards. Devices and systems that comply with such a multi-vendor profile can interoperate on a fieldbus and can be operated interchangeably to a certain extent.

#### **Do different profile types exist?**

A distinction is made between so-called application profiles (general or specific) and system profiles:

- Application profiles (also known as device profiles) mainly refer to devices (e.g. drives) and contain an agreed selection of bus communication modes, as well as specific device applications.
- System profiles describe system classes and include the master functionality, program interfaces and integration methods.

#### **Is PROFIdrive future-proof?**

PROFIdrive was specified by PROFIBUS and PROFINET International (PI) and was laid down in IEC 61800-7 as a future-proof standard.

#### **The basic philosophy: Keep it simple**

The PROFIdrive profile tries to keep the drive interface as simple as possible and free from technology functions. This philosophy ensures that reference models as well as the functionality and performance of the PROFINET/PROFIBUS master have no or very little effect on the drive interface.

### **One drive profile – Different application categories**

The integration of drives into automation solutions depends strongly upon the drive task. To cover the entire, extensive range of drive applications from the simple frequency converter up to highly dynamic, synchronized multi-axis systems with a single profile, PROFIdrive defines six application classes to which most drive applications can be assigned:

- Class 1 – Standard drives (such as pumps, fans, stirring units, etc.)
- Class 2 – Standard drives with technology functions
- Class 3 – Positioning drives
- Class 4 – Motion Control drives with central, higher-level Motion Control intelligence and the patented "Dynamic Servo Control" positioning concept
- Class 5 – Motion Control drives with central, higher-level Motion Control intelligence and position setpoint interface
- Class 6 – Motion Control drives with distributed Motion Control intelligence integrated in the drives

## Design

### **The PROFIdrive device model**

PROFIdrive defines a device model comprising function modules, which interoperate inside the device and which reflect the intelligence of the drive system. These modules have objects assigned to them which are described in the profile and are defined with respect to their functions. The overall functionality of a drive is therefore described through the sum of its parameters.

In contrast to other drive profiles, PROFIdrive defines only the access mechanisms to the parameters as well as a few profile parameters (about 30) such as the fault buffer, drive control and device identification.

All other parameters are vendor-specific which gives drive manufacturers great flexibility with respect to implementing control functions. The elements of a parameter are accessed acyclically over data records.

As a communication protocol, PROFIdrive uses DP-V0, DP-V1, and the DP-V2 expansions for PROFIBUS including the functions "Slave-to-Slave Communication" and "Isochronous Mode", or PROFINET IO with real-time classes RT and IRT.

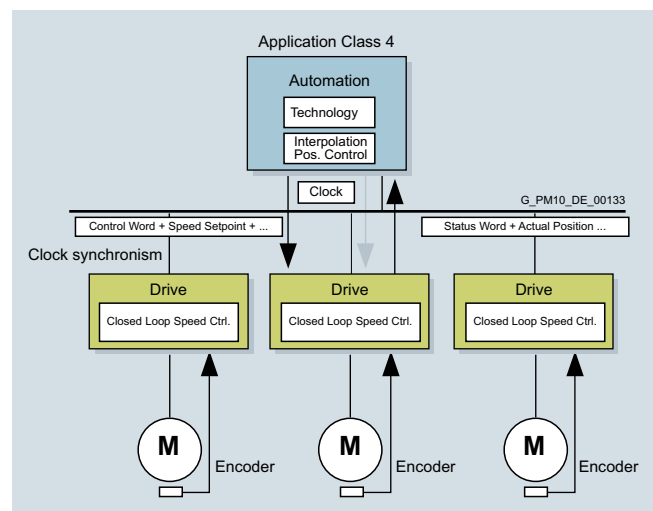

### **More information**

Further information on PROFINET and PROFIBUS can be found at [www.profinet.com](http://www.profinet.com)

## Communication

### PROFIBUS

#### Overview



#### **PROFIBUS – The proven, rugged bus system for automation engineering applications**

The demands of users for an open, vendor-independent communication system resulted in the specification and standardization of the PROFIBUS protocol.

PROFIBUS defines the technical and functional features of a serial fieldbus system with which distributed programmable field controllers of the low-end (sensor/actuator level) to mid performance range (cell level) can be networked.

Standardization according to IEC 61158/EN 50170 provides future protection for your investments.

Through the conformity and interoperability test performed by the test laboratories authorized by PROFIBUS & PROFINET International (PI) and the certification of the devices by PI, the user can rest assured that quality and functionality are also ensured for multi-vendor installations.

#### **PROFIBUS variants**

Two different PROFIBUS variants have been defined to fulfill the wide range of different requirements at the field level:

- PROFIBUS PA (Process Automation) – the variant for applications in process automation. PROFIBUS PA uses the intrinsically safe transmission technology specified in IEC 61158-2.
- PROFIBUS DP (Distributed Peripherals) – this variant, which is optimized for speed, is tailored especially for the communication of automation systems with distributed IO stations and drives. PROFIBUS DP is characterized by its very short response times and high degree of fault tolerance and replaces cost-intensive parallel signal transmission with 24 V and the measured value transmission with 0/4 ... 20 mA technology.

#### Design

##### **Bus nodes for PROFIBUS DP**

PROFIBUS DP distinguishes between two different master classes and one slave class:

##### DP master class 1

The DP master class 1 is the central component in PROFIBUS DP. The central master station exchanges information with distributed stations (DP slaves) in a fixed, consistently repeated message cycle.

##### DP master class 2

Devices of this type (programming, configuration or control devices) are used during start-up, for configuring the DP system, for diagnostics or controlling the plant during normal operation. A DP master class 2 can be used, for example, to read the input, output, diagnostics and configuration data of the slaves.

##### DP slave

A DP slave is an I/O device which receives output information or setpoints from the DP master and sends input information, measured values or actual values to the DP master in response. A DP slave never sends data automatically, it must always be prompted by the DP master.

The volume of input and output data depends on the device and can be up to 244 bytes per DP slave and transfer direction.

#### Function

##### **Functional scope in DP masters and DP slaves**

The functional scope can differ between DP masters and DP slaves. The functional scope is different for DP-V0, DP-V1 and DP-V2.

##### DP-V0 communication functions

The DP-V0 master functions comprise the functions "Configuration", "Parameter Assignment", "Read Diagnostics Data" as well as cyclic reading of input data/actual values and writing output data/setpoints.

##### DP-V1 communication functions

The DP-V1 function expansions make it possible to perform acyclic read and write functions as well as processing cyclic data communication. This type of slave must be supplied with extensive parameterization data during start-up and during normal operation. These acyclically transferred parameterization data are only rarely changed in comparison to the cyclic setpoints, actual values, and measured values, and are transferred at lower priority in parallel with the cyclic high-speed user data transfer. Detailed diagnostic information can be transferred in the same way.

##### DP-V2 communication functions

The extended DP-V2 master functions mainly comprise functions for isochronous operation and direct data exchange between DP slaves.

- Isochronous mode:  
Isochronous mode is implemented by means of an equidistant signal in the bus system. This cyclic, equidistant cycle is sent by the DP master to all bus nodes in the form of a Global Control Telegram. Master and slaves can then synchronize their applications with this signal. The signal jitter between cycles is less than 1 µs.
- Slave-to-slave communication:  
The "publisher/subscriber" model is used to implement slave-to-slave communication. Slaves declared as publishers make their input data/actual values and measured values available to other slaves, the subscribers, for reading. This is performed by sending the response frame to the master as a broadcast. Slave-to-slave communication is therefore a cyclic process.

#### Integration

##### **PROFIBUS for SIMOTION**

SIMOTION uses the PROFIBUS protocol PROFIBUS DP. SIMOTION can be used both as a DP master and a DP slave. The DP-V0, DP-V1 and DP-V2 communication functions are supported.

## Overview



Ethernet is the basic Internet technology for worldwide networking. The many possibilities of intranet and Internet, which have been available for office applications for a long time, are now utilized for production automation with Industrial Ethernet.

Apart from the use of information technology, the deployment of distributed automation systems is also on the increase. This entails breaking up complex control tasks into smaller, manageable and drive-based control systems. This increases the demand for communication and consequently a comprehensive and powerful communication system.

Industrial Ethernet offers a powerful area and cell network according to the IEEE 802.3 (ETHERNET) standard for industrial applications.

## Benefits

Ethernet enables a very fast data transfer (10/100 Mbit/s, 1/10 Gbit/s) and at the same time has full-duplex capability. It therefore provides an ideal basis for communication tasks in the industrial field. With a share of over 90 %, Ethernet is the number one network worldwide and offers important features which have essential advantages:

- Fast commissioning thanks to the simplest connection method
- High availability since existing networks can be extended without any adverse effects
- Almost unlimited communication performance because scalable performance is available through switching technology and high data rates when required
- Networking of different application areas such as office and production areas
- Company-wide communication based on WAN (Wide Area Network) technology or the Internet
- Investment protection due to continuous compatibility with further developments
- Wireless communication using Industrial Wireless LAN

In order to make Ethernet suitable for industrial applications, considerable expansions with respect to functionality and design are required:

- Network components for use in harsh industrial environments
- Fast assembly of the RJ45 connectors
- Failure protection through redundancy
- Expanded diagnostics and message concept
- Use of future-oriented network components (e.g. switches)

SIMATIC NET offers corresponding network components and products.

## Integration

### Industrial Ethernet for SIMOTION

SIMOTION can be perfectly integrated into any Industrial Ethernet communication architecture because each SIMOTION device offers at least one Ethernet interface as standard.

Industrial Ethernet is used in SIMOTION for data communication. Cyclic process communication with SINAMICS drives and distributed I/O is implemented over PROFINET IO or PROFIBUS DP and PROFIdrive.

### PG/PC/HMI communication

- Engineering and diagnostics with SIMOTION SCOUT
- Connection of SIMATIC HMI Panels with Ethernet interface using WinCC Basic/Comfort/Advanced
- Open communication of, for example, vendor-specific HMI tools over OPC server from SIMATIC NET

### Standard communication

This uses the basic protocols UDP and TCP/IP, which are also used with Ethernet. SIMOTION offers the corresponding system functions for UDP and TCP/IP communication. This permits data to be exchanged over TCP/IP and UDP communication between:

- Different SIMOTION devices
- SIMOTION and SIMATIC S7 devices
- SIMOTION devices and any other device which uses standard TCP/IP or UDP communication. Such devices can be any kind of PC with any kind of operating system or other programmable controllers

### IT communication

IT communication is performed using protocols which are based on the basic TCP/IP protocol. The most important IT protocols are:

- HTTP/HTTPS: Hypertext Transfer Protocol
- FTP: File Transfer Protocol
- SMTP: Simple Mail Transfer Protocol
- SNMP: Simple Network Management Protocol

SIMOTION supports the HTTP/HTTPS and FTP protocols. In addition, the following communication options are available for SIMOTION:

- Web pages in the SIMOTION device  
A standard Internet browser can be used to access pre-defined web pages with diagnostics information on the SIMOTION device. Furthermore, user-defined web pages can be stored in the SIMOTION device which contain information defined by the user.
- OPC XML-DA  
SIMOTION offers an OPC XML-DA server integrated into the device. This server supplies process data to SIMOTION. Communication from any external device is performed with the SOAP protocol (in accordance with the specification of the OPC Foundation), which is integrated into the HTTP protocol.
- OPC UA  
With the further development of the OPC XML-DA standard to OPC UA, SIMOTION is offering a runtime-integrated OPC UA server. This server supplies process data to SIMOTION. OPC UA permits standardized communication between SIMOTION and any external device. TCP/IP with binary data protocol according to the OPC Foundation's specification is used.

## Communication

### Notes

4

## Safety Integrated



**5/2**

5/2

5/3

5/10

### Overview

Overview

Function

More information

# Safety Integrated

## Overview

### Overview



#### Legal framework

Machine manufacturers and manufacturing plants must ensure that their machines or plants cannot cause danger due to malfunctions in addition to the general risks of electric shock, heat or radiation.

In Europe, for example, compliance with the Machinery Directive 2006/42/EC is required by law by the EC occupational health and safety directive. In order to ensure the conformity with this directive, it is recommended that the corresponding harmonized European standards are applied. This triggers the "assumption of conformity" and gives manufacturers and operators the legal security in terms of compliance with both national regulations and EU directives. The machine manufacturer uses the CE marking to document the compliance with all relevant directives and regulations in the free movement of goods.

#### Safety-related standards

Functional safety is specified in various standards. EN ISO 12100, for example, is concerned with the risk assessment and risk reduction of machines. IEC 61508 specifies the basic requirements for electronic and programmable safety-related systems. EN 62061 (only applicable for electrical and electronic control systems) and EN ISO 13849-1, which replaces the now withdrawn EN 954-1, define the functional and safety-related requirements of control systems with relevance to safety.

The above-mentioned standards define different safety requirements that the machine has to satisfy in accordance with the risk, frequency of a dangerous situation, probability of occurrence and the opportunities for recognizing impending danger:

- EN ISO 13849-1: Performance Level PL a ... e; Categories B, 1 ... 4
- EN 62061: Safety Integrity Level SIL 1 ... 3

#### Trend toward integrated safety systems

The trend toward greater complexity and increasing modularity of machines has caused the safety functions to move away from the classical central safety functions (for example, deactivation of the complete machine using a main switch) and into the machine control system and the drives. This is often accompanied by a significant increase in productivity because the changeover times are shortened and during this changeover, depending on the type of machine, some subcomponents can even continue to manufacture.

Integrated safety functions act much faster than those of a conventional design. The safety of a machine is thus increased further with Safety Integrated. Furthermore, thanks to the faster method of operation, safety measures controlled by integrated safety systems are perceived as less of a hindrance by the machine operator, therefore significantly reducing the motivation to consciously bypass safety functions.



## Function

### Drive-integrated safety functions with SIMOTION D and SINAMICS S110/S120

The main functions of the SINAMICS S120 drive system are integrated into the SIMOTION D Motion Control System. The safety functions of the SINAMICS S120 integrated into the drive can therefore also be used in combination with SIMOTION D.

SIMOTION D and SINAMICS S110/S120 are characterized by a large number of integrated safety functions. In combination with the sensors and safety control generally required for the safety functionality, they ensure that highly-effective protection for persons and machines is implemented in a practice-oriented manner.

They comply with the requirements of the following safety categories:

- PL d and Category 3 according to EN ISO 13849-1
- SIL 2 according to IEC 61508 and IEC 61800-5-2

#### Note:

The Safe Brake Test (SBT) diagnostic function meets the requirements of Category 2 according to EN ISO 13849-1.

The Safety Integrated functions are generally certified by independent institutes. You can obtain the corresponding test certificates and manufacturer's declarations from your Siemens contacts.

### Drive Safety Data Block (DSDB)

The safety functions of a SIMOTION-assigned drive are controlled via PROFIsafe or fail-safe digital inputs directly at the drive.

Depending on the safety function that is selected, it makes sense to respond appropriately to the selection of the function in the SIMOTION user program to avoid limit violations on the drive end.

Thus, for example, if the SLS function is selected, the speed of the affected drives must be controlled by SIMOTION in the available time, under the respective SLS limit value.

If SOS is selected, the relevant axes must be brought to a standstill and kept in that state.

The information about which safety function has been selected and which setpoint speed limit is currently in effect is transferred via the DSDB. As a rule, the information is transferred from the drive to the SIMOTION user program.

The selection of the SBT diagnostic function is transferred in the opposite direction from the user program to the drive.

The integrated safety functions that are currently available are described in the following. Their functional safety satisfies the requirements defined in the international standard IEC 61800-5-2 for variable-speed drive systems.

The safety functions integrated into the SINAMICS drive system can be roughly divided into four categories:

- **Functions for safely stopping a drive**
  - Safe Torque Off (STO)
  - Safe Stop 1 (SS1)
  - Safe Stop 2 (SS2)
  - Safe Operating Stop (SOS)
- **Functions for safe brake management**
  - Safe Brake Control (SBC)
  - Safe Brake Test (SBT)  
(this diagnostic function exceeds the scope of IEC 61800-5-2)

- **Functions for safely monitoring the motion of a drive**

- Safely Limited Speed (SLS)
- Safe Speed Monitor (SSM)
- Safe Direction (SDI)

- **Functions for safely monitoring the position of a drive**

- Safely Limited Position (SLP)
- Safe Position (SP)  
(this function exceeds the scope of IEC 61800-5-2)

### Safe Torque Off (STO)

The STO function is the most common and basic drive-integrated safety function. It ensures that no torque-generating energy can continue to affect a motor and prevents unintentional start-ups.

#### Effect

This function is a mechanism that prevents the drive from restarting unexpectedly, in accordance with EN 60204-1, Section 5.4. The STO function disables the drive pulses (corresponds to Stop Category 0 according to EN 60204-1). The drive is reliably torque-free. This state is monitored internally in the drive.

#### Application

STO has the immediate effect that the drive cannot supply any torque-generating energy. STO can be used wherever the drive will naturally reach a standstill due to load torque or friction in a sufficiently short time or when coasting down of the drive will not have any relevance for safety.

STO makes it possible for persons to work safely when the protective door is open (restart interlock) and is used on machines/installations with moving axes, e.g. on handling or conveyor systems.

#### Customer benefits

The advantage of the integrated STO safety function compared to standard safety technology using electromechanical switchgear is the elimination of separate components and the effort that would be required to wire and service them. Because of the fast electronic switching times, the function provides a shorter reaction time than the conventional solution comprising electro-mechanical components.

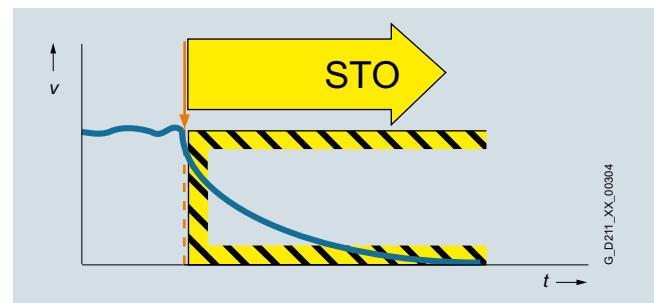

## Safety Integrated

### Overview

#### Function (continued)

##### Safe Stop 1 (SS1)

The SS1 function causes a motor to stop rapidly and safely and switches the motor to torque-free mode after the standstill by activating STO.

##### Effect

The SS1 function can safely stop the drive in accordance with EN 60204-1, Stop Category 1. When the SS1 function is selected, the drive brakes autonomously along a quick-stop ramp and automatically activates the Safe Torque Off and Safe Brake Control functions (if configured) when the parameterized safety delay time expires.

If the variant "SS1 with external stop (SS1E)" is parameterized, the drive does not brake autonomously when the function is selected. In this case, the higher-level control must bring the drive to a standstill within a parameterized STO transition time. The SBR (Safe Brake Ramp) and SAM (Safe Acceleration Monitor) functions are not active. SS1E is a useful function for drives that need to be stopped as a group by the Motion Control system in order to prevent potential damage to the machine or product.

##### Application

The SS1 function is used when, in the event of a safety-related incident, the drive must stop as quickly as possible with a subsequent transition into the STO state (e.g. EMERGENCY STOP). It is thus used to bring large centrifugal masses to a stop as quickly as possible for the safety of the operating personnel, or to brake motors at high speeds as quickly as possible. Examples of typical application are saws, grinding machine spindles, centrifuges, winders and storage and retrieval machines.

##### Customer benefits

The targeted stopping of a drive by means of SS1 reduces the risk of danger, increases the productivity of a machine, and allows safety clearances in a machine to be reduced. The principle is to bring the drive actively to a standstill, compared with just using the STO function. Complex mechanical brakes that are susceptible to wear are not normally required to brake the motor.

##### Safe Stop 2 (SS2)

The SS2 function brings the motor to a standstill quickly and safely and then activates the SOS function once the motor has stopped.

##### Effect

The Safe Stop 2 function can safely stop the drive in accordance with EN 60204-1, Stop Category 2. When the SS2 function is selected, the drive brakes autonomously along a quick-stop ramp. In contrast to SS1, the drive control remains operational afterwards, i.e. the motor can supply the full torque required to maintain zero speed. Standstill is safely monitored (Safe Operating Stop function).

##### Application

As with SS1, the SS2 function ensures the quickest possible deceleration of the motor. However, the motor power is not switched off. Instead, a control system prevents it from leaving the standstill position – even if it is affected by external forces. Typical applications for SS2 include machine tools, for example.

##### Customer benefits

The SS2 function ensures a rapid axis stop. Because the control remains active, after the safety function is deselected, productive operation can continue without referencing. This ensures short setup and standstill times and high productivity.

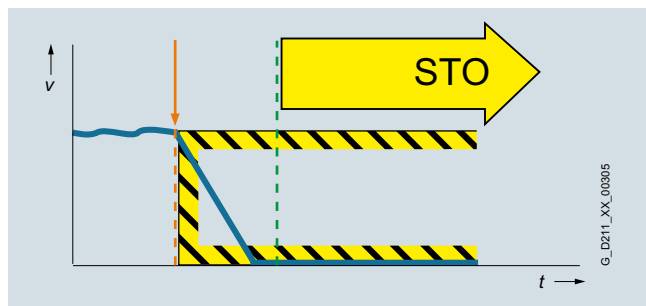
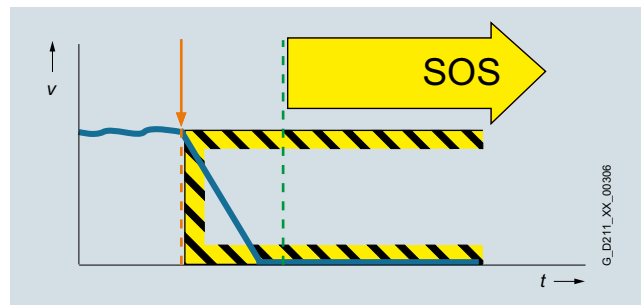

**Function** (continued)**Safe Operating Stop (SOS)**

With the SOS function, the stopped motor is kept in position and monitored by drive control.

Effect

The SOS function constitutes safe standstill monitoring. The drive control remains in operation. The motor can therefore deliver the full torque to hold the current position. The actual position is reliably monitored. In contrast to safety functions SS1 and SS2, the speed setpoint is not influenced autonomously. After SOS has been activated, the higher-level control must bring the drive to a standstill within a parameterized time and then hold the position setpoint.

Application

SOS is an ideal solution for all those applications for which the machine or parts of the machine must be at a safe standstill for certain steps, but the drive must also supply a holding torque. It is ensured that despite counter torque the drive remains in its current position. In contrast to SS1 and SS2, the drive does not brake autonomously in this case. It expects the higher-level controller to ramp down the relevant axes as a coordinated group within an adjustable delay time. This can be used to prevent any damage to the machine or product. Typical applications for SOS include winders, converting and packaging machines and machine tools.

Customer benefits

No mechanical components are necessary to keep the axis in position despite any counterforce that may occur. Due to the short switching times and the fact that the drive control always remains active, setup and downtimes are reduced. Recalibration of the axis after exiting the SOS function is not necessary. The axis can immediately be moved again after deactivation of the SOS function.

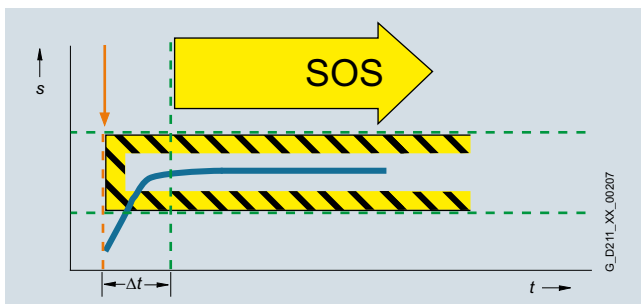
**Safe Brake Control (SBC)**

The SBC function permits the safe control of a holding brake. SBC is always activated in parallel with STO.

Effect

A holding brake which is active in a de-energized state is controlled and monitored using safe two-channel technology. Due to the two-channel control, the brake may still be activated in the event of an insulation fault in the control cable. Errors of this kind are detected early by means of test pulses.

Note

Safe Brake Control does not detect mechanical faults in the brake itself, such as worn brake linings. For Motor Modules in booksize format, the terminals for the motor brake are integrated. An additional Safe Brake Relay is required for Power Modules in blocksize format. An additional Safe Brake Adapter is necessary for Power Modules in chassis format.

Application

The SBC function is used in conjunction with the functions STO or SS1 to prevent the movement of an axis in the torque-free state, e.g. because of gravity.

Customer benefits

Again, the function saves the use of external hardware and the associated wiring.

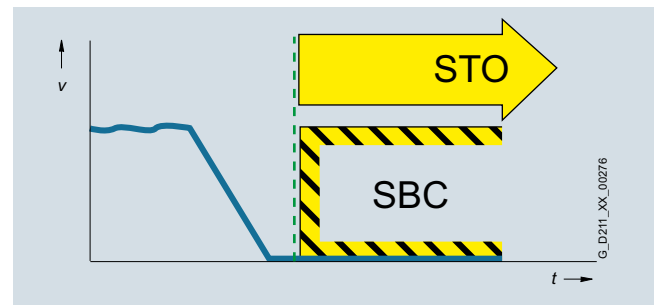
**Safe Brake Test (SBT)**

The SBT diagnostic function carries out a brake function test at regular intervals or before personnel enter the danger zone.

Effect

A good way to check the proper functioning of brakes that have become worn is to apply a torque to the closed brake. Drive systems that have two brakes, e.g. motor brake and external brake, can be tested with different torque values.

Application

The SBT diagnostic function is suitable for implementing a safe brake in combination with the SBC function.

Customer benefits

The function detects faults or wear in the mechanical components of the brake. Automatically testing the effectiveness of brakes reduces maintenance costs and increases the safety and availability of the machine or plant.

Note:

The SBT function is not available for SINAMICS S110.

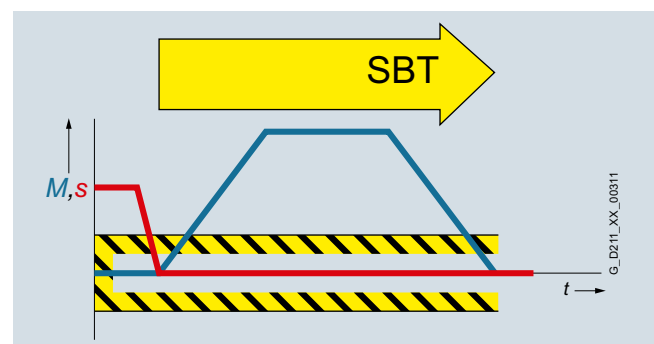

# Safety Integrated

## Overview

### Function (continued)

#### **Safely Limited Speed (SLS)**

The SLS function monitors the drive to ensure that it does not exceed a preset speed or velocity limit.

##### Effect

The SLS function monitors the drive against a parameterized speed limit. Four different limit values can be selected. As in the case of SOS, the speed setpoint is not influenced independently. After SLS has been selected, the higher-level control must bring the drive down below the selected speed limit within a parameterizable time. If the speed limit is exceeded, a customizable drive-integrated fault reaction occurs.

A factor can be applied to SLS limit 1 that is transferred over PROFIsafe in 16-bit resolution. This allows an almost unlimited number of limits to be specified.

**Note:** This function is not available for SINAMICS S110.

##### Application

The SLS function is used if people are in the danger zone of a machine and their safety can only be guaranteed by reduced speed. Typical application cases include those in which an operator must enter the danger zone of the machine for the purposes of maintenance or setting up, such as a winder in which the material is manually threaded by the operator. To prevent injury to the operator, the roller may only spin at a safe reduced speed. SLS is often also used as part of a two-stage safety concept. While a person is in a less critical zone, the SLS function is activated, and the drives are only stopped in a smaller area with higher potential risk. SLS can be used not only for operator protection, but also for machinery protection, e.g. if a maximum speed must not be exceeded.

##### Customer benefits

The SLS function can contribute to a significant reduction in downtime, or greatly simplify or even accelerate setup. The overall effect achieved is a higher availability of the machine. Moreover, external components such as speed monitors can be omitted.

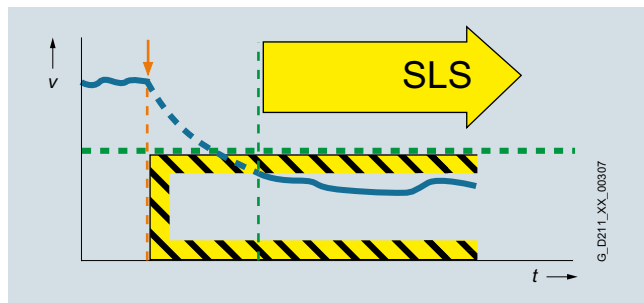

#### **Safe Speed Monitor (SSM)**

The SSM function warns when a drive is working below an adjustable speed limit. As long as it remains below the threshold, the function issues a safety-related signal.

##### Effect

If a speed value drops below a parameterized limit, a safety-related signal is generated. This can, for example, be processed in a safety controller to respond to the event by programming, depending on the situation.

##### Application

With the SSM function, in the simplest case, a safety door can be unlocked if the speed drops below a non-critical level. Another typical example is that of a centrifuge that may be filled only when it is operating below a configured speed limit.

#### Customer benefits

Unlike SLS, there is no drive-integrated fault reaction when the speed limit is exceeded. The safe feedback can be evaluated in a safety controller, allowing the user to respond appropriately to the situation.

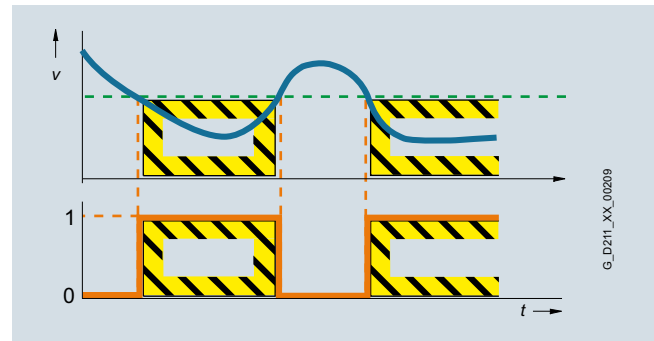

#### **Safe Direction (SDI)**

The SDI function ensures that the drive can only move in the selected direction.

##### Effect

A deviation from the direction of motion currently being monitored is detected reliably and the configured drive-integrated fault reaction is initiated. It is possible to select which direction of rotation is to be monitored.

##### Application

The SDI function is used when the drive may only move in one direction. A typical application is to make a danger area accessible to the operator, provided the machine is moving in the safe direction, i.e. away from the operator. In this status, the operator can safely feed material into or remove it from the working area.

##### Customer benefits

The function saves the use of external components such as speed monitors and the associated wiring. The release of a danger zone while the machine is moving away from the operator increases productivity. Without the SDI function, the machine would have to be stopped safely while material is fed in or removed.

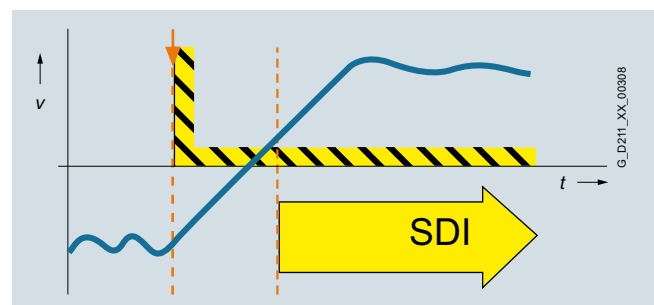

**Function** (continued)**Safely Limited Position (SLP)**

The SLP function monitors the axis to ensure that it remains within the permissible traversing range.

Effect

When SLP is activated, the traversing range limited by the configured software limit switches is safely monitored. If the permitted traversing range is exited, a configurable fault reaction occurs. It is possible to toggle between two traversing ranges, even when the machine is in operation.

Application

SLP is used for applications in which machine operators have to enter a protection area, e.g. for feeding in and removing material. Safe monitoring of the axis position ensures that the axis cannot move into the protection area released for operators and so place them in danger, for example, on storage and retrieval machines, gantry cranes or machining centers.

Customer benefits

SLP can be used for highly-effective protection area monitoring. The function does away with the use of external components such as hardware limit switches and the associated wiring expense. Due to the short reaction time following a limit overshoot, safety clearances can be reduced.

Note:

The SLP function is not available for SINAMICS S110.

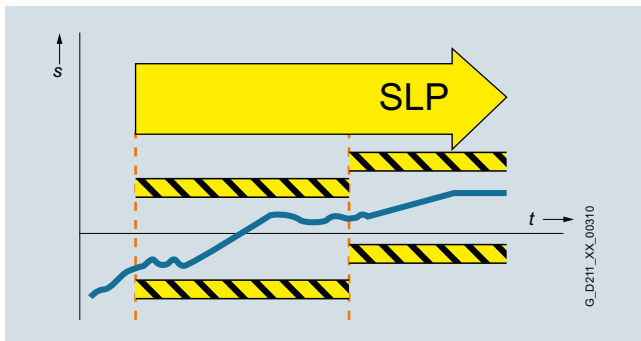
**Safe Position (SP)**

The SP function transfers the actual position values determined safely in the drive over safe PROFIsafe communication to a safety control.

Effect

In contrast to the SLP function that monitors the current actual position value against a limit and, in the case of an overshoot, activates a drive-integrated fault reaction, SP transfers the current actual position values to the safety control. Position monitoring is implemented in the safety program of the control. Extended PROFIsafe telegrams are available for transferring the position values. The position values can be transferred in 16-bit or 32-bit resolution, as required. A time stamp is also transferred with the position values.

Application

Tailor-made safety concepts can be created using the SP function. It is ideal for use on machines that require flexible safety functions. It is extremely versatile and can be used, for example, to implement safe, axis-specific range detection by means of safe cams. The SP function can also be used to implement multi-axis safety concepts, multi-dimensional protection areas and zone concepts.

Customer benefits

Position monitoring or speed monitoring is implemented in the safety program of the control, so the user has the flexibility for implementing tailor-made safety functions. The reaction to a limit overshoot must also be specified in the safety program. This means a higher initial programming outlay, but it does offer the opportunity for initiating different fault reactions.

Note:

The SP function is not available for SINAMICS S110.

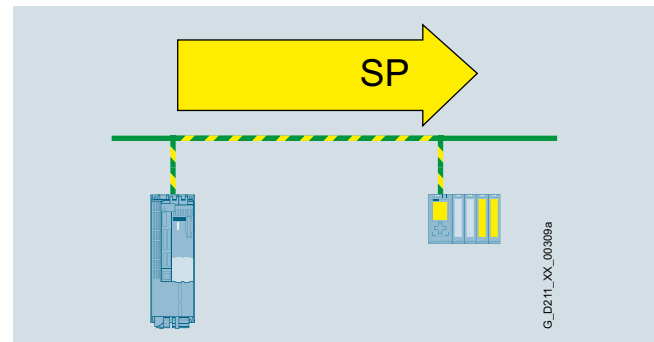
**Basic Functions and Extended Functions**

The Safety Integrated functions for SIMOTION D and SINAMICS S110/S120 are grouped into Basic Functions and Extended Functions.

The Basic Functions are included in the standard scope of supply.

The Extended Functions must be activated by a license.

- Basic Functions
  - Safe Torque Off (STO)
  - Safe Brake Control (SBC)
  - Safe Stop 1 (SS1)
- Extended Functions
  - Safe Stop 1 (SS1) with SBR or SAM
  - Safe Stop 2 (SS2) with SBR or SAM
  - Safe Operating Stop (SOS)
  - Safely Limited Speed (SLS)
  - Safe Speed Monitor (SSM)
  - Safe Direction (SDI)
  - Safely Limited Position (SLP)
  - Safe Position (SP)
  - Safe Brake Test (SBT) diagnostic function

With the Extended Functions SS1 and SS2 with SAM, Safe Acceleration Monitoring (SAM) is performed during braking to ensure that a fault is detected already during the braking phase.

With SS1 and SS2, a Safe Brake Ramp (SBR) can be configured as an alternative.

The Basic Functions – activated via on-board terminals on the device, TM54F Terminal Module or via PROFIsafe – do not require an encoder.



**Function** (continued)**Safe speed/position sensing**

Incremental encoders or absolute encoders can be used for safe sensing of the position values on a drive.

Safe actual value sensing relies on the redundant evaluation of the incremental channels A/B that supply sin/cos signals with  $1 V_{pp}$ . Only encoders of the type whose A/B track signals are created and processed using purely analog techniques can be used.

HTL/TTL incremental encoders may also be used. In this case, safe actual value sensing is achieved by using two independent encoders. The minimum possible speed resolution must also be taken into account.

The encoder signals are read via Sensor Modules.

For information on the Sensor Modules, see the Industry Mall under Drive Technology/Converters/AC Low-voltage converters/High performance converters SINAMICS S/SINAMICS S120 built-in units/Supplementary system components/Encoder system connection or the Catalog D 21.4 SINAMICS S120 and SIMOTICS – Motion Control Drives.

As an alternative, motors with an integrated DRIVE-CLiQ interface can be used. The speed or position actual values are generated directly in the motor as safe values and are made available to the Control Unit over safe communication via DRIVE-CLiQ.

Certified built-on rotary encoders with DRIVE-CLiQ interface may also be used (see <https://support.industry.siemens.com/cs/document/65402168>).

The encoder must be mechanically attached in such a manner that the encoder shaft is unable to unplug or slide off. For notes on this, see IEC 61800-5-2: 2007, Table D.16.

A list of Siemens motors that fulfill the electrical and mechanical requirements is available at: <https://support.industry.siemens.com/cs/document/33512621>

The following can be used for safe speed/position sensing:

- Single-encoder systems or
- Dual-encoder systems

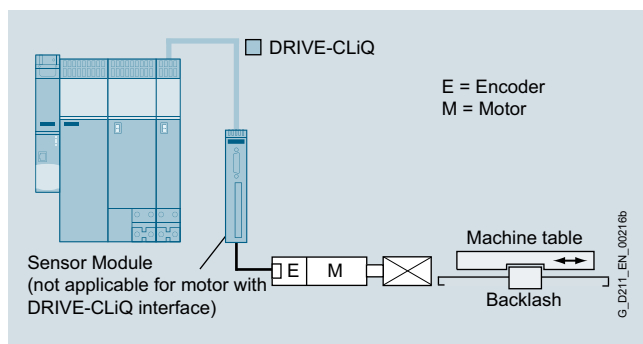
**Single-encoder system**

Example: Single-encoder system

In a single-encoder system, the motor encoder is used exclusively for safe actual value sensing.

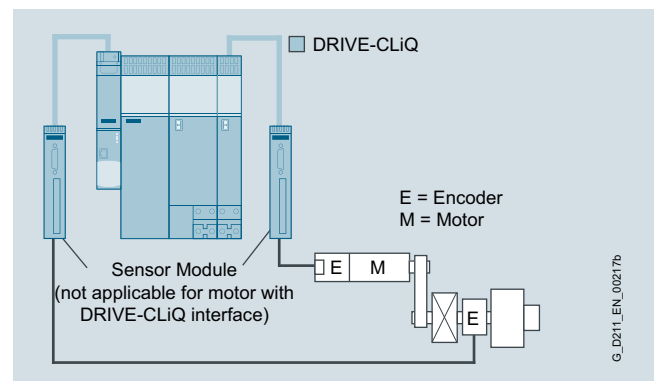
**Dual-encoder system**

Example: Dual-encoder system on a spindle

In the case of the dual-encoder system, the safe actual values for a drive are provided by two separate encoders. The actual values are transferred to the Control Unit over DRIVE-CLiQ. When motors without a DRIVE-CLiQ connection are used, a Sensor Module must be provided.

HTL/TTL incremental encoders can be used as an alternative with a dual-encoder system. Either two HTL/TTL encoders, one dual-HTL/TTL encoder or one HTL/TTL encoder and one sin/cos encoder can be used.

**Safe actual value sensing without encoder**

The Extended Functions Safe Stop 1 (SS1) with SAM/SBR, Safely Limited Speed (SLS), Safe Speed Monitor (SSM) and Safe Direction (SDI) are also available for use without encoders (only in combination with asynchronous (induction) motors and SIEMOSYN motors).

An encoder that is used for the purposes of motor control has no significance for the safety function here.

**Note:**

The Safety Integrated Extended Functions "without encoder" must not be used if the motor can be accelerated by the load, e.g. if a vertical axis is under a load due to gravity.

The Safety Integrated Function Manual contains additional information about the encoderless safety functions.

<http://support.automation.siemens.com/WW/view/en/27103700/133300>

# Safety Integrated

## Overview

### Function (continued)

The safety functions are listed below with criteria for actual value sensing:

	Functions	Abbreviation	With encoder	Without encoder	Description
<b>Basic Functions</b>	Safe Torque Off	STO	Yes	Yes	Safe torque off
	Safe Stop 1	SS1	Yes	Yes	Safe stopping process in accordance with stop category 1
	Safe Brake Control	SBC	Yes	Yes	Safe brake control
<b>Extended Functions</b>	Safe Torque Off	STO	Yes	Yes	Safe torque off
	Safe Stop 1	SS1	Yes	Yes <sup>1)</sup>	Safe stopping process in accordance with stop category 1
	Safe Brake Control	SBC	Yes	Yes	Safe brake control
	Safe Operating Stop	SOS	Yes	No	Safe monitoring of the standstill position
	Safe Stop 2	SS2	Yes	No	Safe stopping process in accordance with stop category 2
	Safely Limited Speed	SLS	Yes	Yes <sup>1)</sup>	Safely limited speed
	Safe Speed Monitor	SSM	Yes	Yes <sup>1)</sup>	Safe speed monitoring
	Safe Direction	SDI	Yes	Yes <sup>1)</sup>	Safe monitoring of the direction of motion
	Safely Limited Position	SLP	Yes	No	Safely limited position
	Safe Position	SP	Yes	Yes <sup>2)</sup>	Safe transfer of position values
	Safe Brake Test	SBT	Yes	No	Diagnostic function for safe testing of the required holding torque of a brake

<sup>1)</sup> The use of this safety function without encoder is permitted for asynchronous (induction) motors or synchronous motors of the SIEMOSYN series.

<sup>2)</sup> Only for the transmission of relative position values. An encoder is required to transmit absolute position values.

5

### Licensing

The Safety Integrated Basic Functions do not require a license.

In the case of Safety Integrated Extended Functions, however, a license is required for each axis equipped with safety functions. It is of no consequence here which safety functions are used and how many.

The required licenses can be optionally ordered with the CompactFlash card.

For article numbers of the CompactFlash cards, see chapter SIMOTION D – Drive-based or the Catalog D 21.4 SINAMICS S120 and SIMOTICS – Motion Control Drives.

### More information

The Safety Integrated Function Manual contains detailed information about the safety functions.

<https://support.industry.siemens.com/cs/document/99668646>

Further manuals pertaining to Safety Integrated in drive systems can be found on the Internet at

<https://support.industry.siemens.com/cs/ww/en/ps/13231/man>

Further information about Safety Integrated in SIMOTION can be found on the Internet at

[www.siemens.com/simotion-d-safety-integrated](http://www.siemens.com/simotion-d-safety-integrated)

Further information about Safety Integrated can be found on the Internet at

[www.siemens.com/safety-drives](http://www.siemens.com/safety-drives)



## Industry-specific solutions

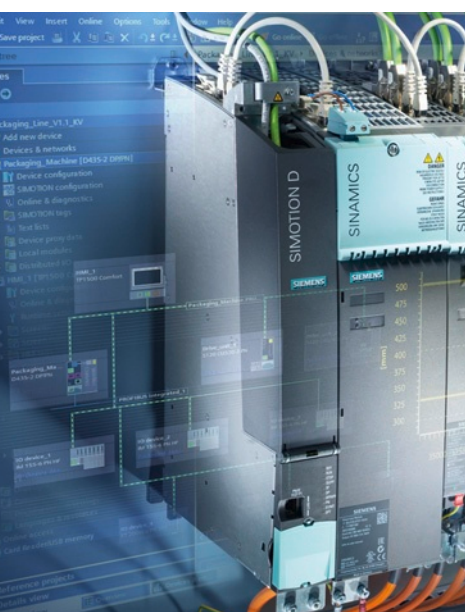

<b>6/2</b>	<b>Packaging machines</b>
6/2	Overview
6/2	Benefits
6/3	Design
6/3	More information
<b>6/4</b>	<b>Printing presses</b>
6/4	Overview
6/4	Benefits
6/5	Design
6/5	More information
<b>6/6</b>	<b>Textile machines</b>
6/6	Overview
6/6	Benefits
6/7	Design
6/7	More information
<b>6/8</b>	<b>Converting</b>
6/8	Overview
6/9	Benefits
6/9	Design
6/9	More information
<b>6/10</b>	<b>Tire production machines</b>
6/10	Overview
6/10	Benefits
6/11	Design
6/11	More information
<b>6/12</b>	<b>Metal forming technology</b>
6/12	Overview
6/12	Benefits
6/13	Design
6/13	More information
<b>6/14</b>	<b>Glass production machines</b>
6/14	Overview
6/14	Benefits
6/15	Design
6/15	More information
<b>6/16</b>	<b>Handling systems</b>
6/16	Overview
6/16	Benefits
6/17	Design
6/17	More information
<b>6/18</b>	<b>Solar production machines</b>
6/18	Overview
6/19	Benefits
6/19	Design
6/19	More information
<b>6/20</b>	<b>Ceramics and stone processing machines</b>
6/20	Overview
6/21	Benefits
6/21	Design

## Industry-specific solutions

### Packaging machines

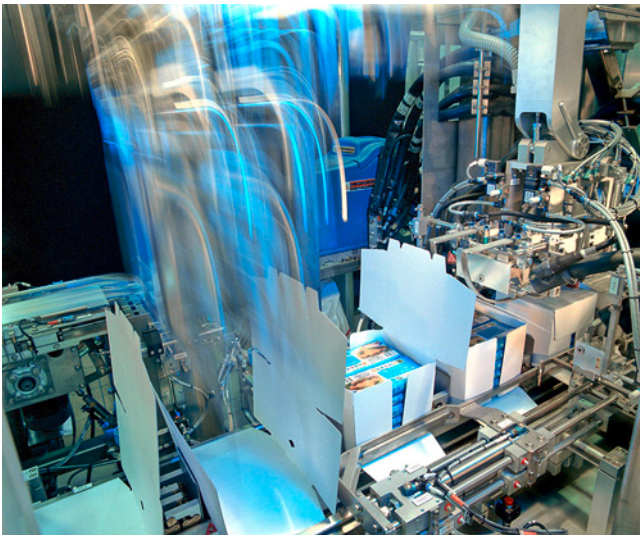

#### Overview

##### **Efficiently automating packaging machines**

From dosing and filling to transporting, Siemens provides support for individual and efficient system solutions for any packaging machine from beginning to end. For all industries, whether Food & Beverage, Non Food or Pharmaceuticals, we rely on our holistic and integrated automation solutions for maximum reliability and availability. With a common standard for automation and communication and for open and modular concepts, we have been providing solutions for every need for many years. And, not least, we are also the perfect partner for realizing the individual requirements of the respective packaging machine.

##### **System-based implementation of individual solutions**

Individualization and modularization in mechanical engineering also imply growing demands for packaging machines, to which we do justice with our Packaging Toolbox for all aspects of drive and automation technology. The solutions for the individual machine types are both segment-dependent and machine type-dependent.

With the SIMATIC, SIMOTION and SINAMICS system families, Siemens offers a wide range of automation products for every packaging machine, which allow Siemens to provide a perfectly tailored solution.

A large number of machine types, such as horizontal or vertical tubular bag machines, deep-drawing/tray-seal machines, filling, labeling, packaging, cartoning, palletizing and transporting machines, can be precisely implemented with our applications for the respective system.

The innovative Multi-Carrier System solution ensures greater flexibility for production processes:

The integration of linear motor technology into plant mechanics, combined with powerful control technology, allows innovative transport solutions for the production of batches of just 1 in series production.

The segments combined in the packaging industry

- Food
- Beverages
- Non Food
- Pharmaceuticals/Cosmetics
- Tobacco
- General machine types

Visit: [www.siemens.com/packaging](http://www.siemens.com/packaging)

#### Benefits

- A large number of freely available applications in our Packaging Toolbox allows easy configuration, handling and operation of the motion controller
- Efficient automation of the packaging machines, e.g. through easy adaptation by means of parameterization and project generation, and the use of open, preconfigured and fully tested blocks
- International standards such as OMAC (Organization for Machine Automation and Control) and Weihenstephan are universally usable and permit standardization in programming and seamless line integration
- Integration of many industry-wide standards such as PROFINET, PROFIsafe or OPC UA facilitates the integration into existing systems
- Flexible design of automation and drive architecture due to modular control, Motion Control and drives portfolio

## Design

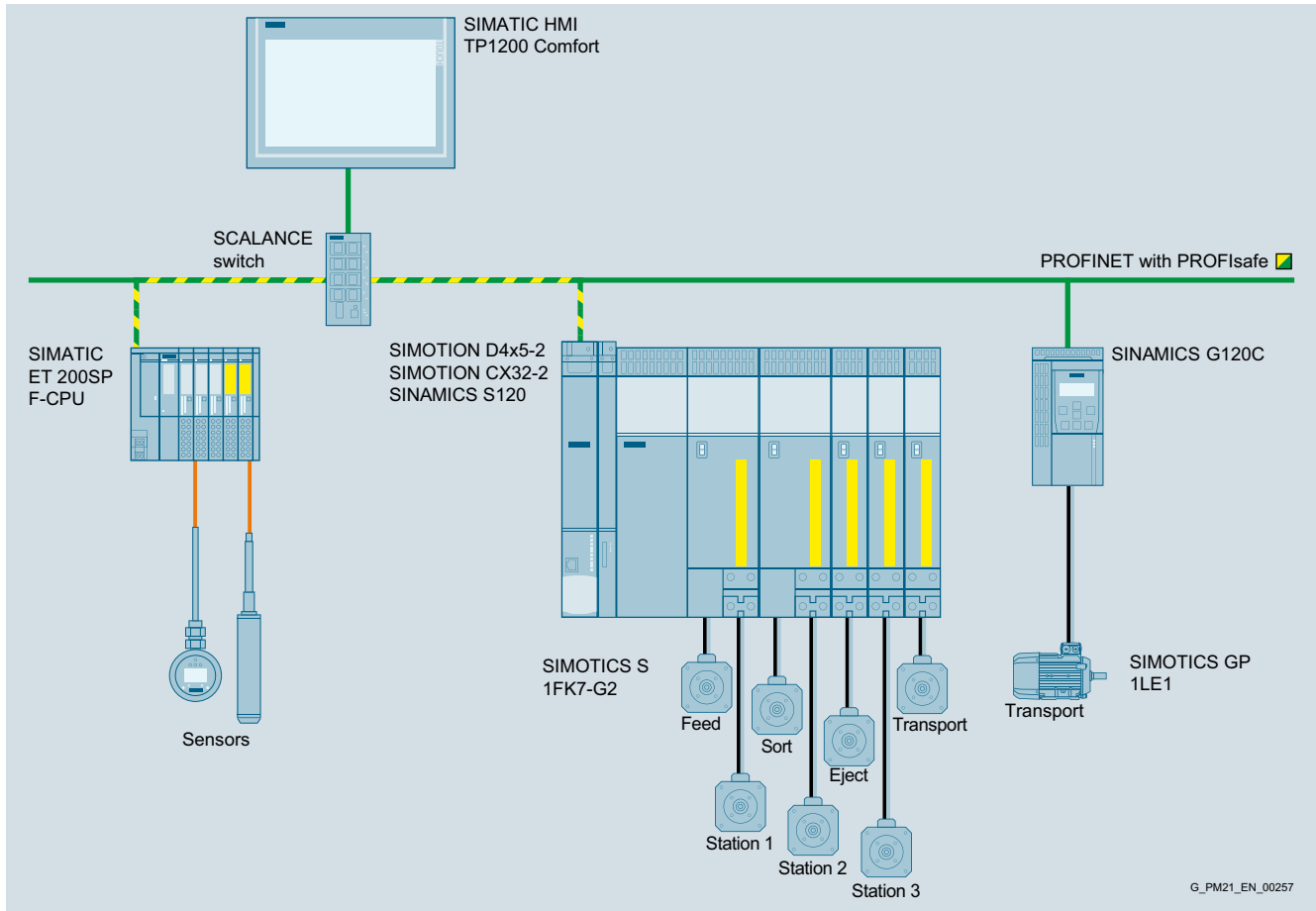

Example of cartoner

## More information

For more information, see  
[www.siemens.com/packaging](http://www.siemens.com/packaging)

## Industry-specific solutions

### Printing presses

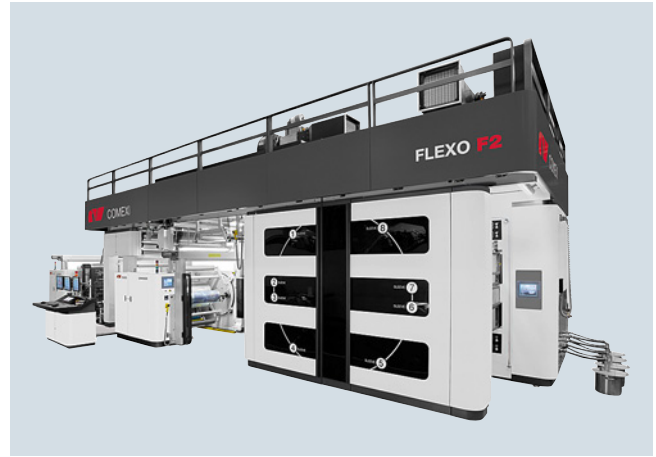
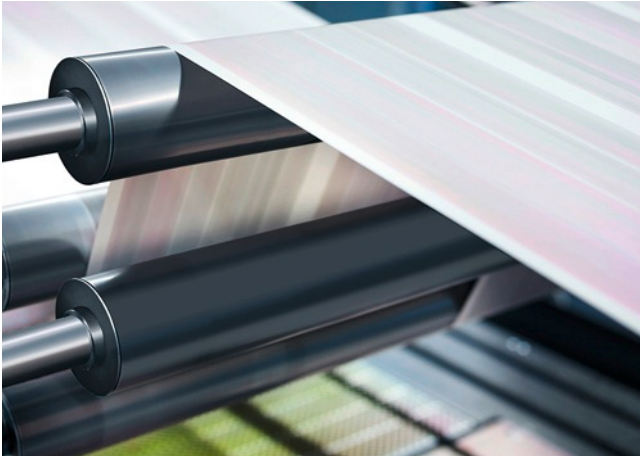

#### Overview

##### **From the individual product to the complete solution**

Newspapers, books, flyers, brochures, packaging, organic electronics ... no matter what you want to print – with its integrated SIMOTION, SINAMICS and SIMATIC system families, Siemens offers a wide portfolio of drive-related products, systems and applications for your printing press. We are pursuing one goal with pioneering concepts: More performance for every printing press – and thus more success for the customer.

##### **System-based implementation of individual solutions**

The demands placed on modern printing presses are continuously increasing. The required solutions of the individual machine types are both segment and machine type-dependent. The main demands are for high precision, performance, quality, less waste, and high availability. Our solutions are perfectly tailored to these requirements. Our many years of experience in the printing industry have gone into this, in combination with our expertise in all aspects of drive and automation technology.

Our products, both in combination with the application software solutions for machine concepts and for control-related special topics, provide the right combination of solutions for every segment and every machine.

An overview of example solutions for the segments

- Offset printing
- Flexo printing
- Rotogravure / Rotogravure package printing
- Digital printing
- Functional printing
- Print finishing

Visit: [www.siemens.com/printing](http://www.siemens.com/printing)

#### Benefits

- High-performance SIMOTION Motion Control System for high-precision and reliable synchronization of individual drives
- Open and expandable software package SIMOTION Print Standard for motion control in printing presses with simple example segments and many add-on modules, e.g. for winding, tension control, etc.
- Efficient automation of the printing presses, e.g. through easy adaptation by means of parameterization and project generation, and the use of open, preconfigured and fully tested blocks
- Module for compact, SIMOTION-integrated register control for controlling point and wedge-shaped marks with sensors for communication via PROFINET with IRT
- Wide range of products and services for motors, converters, controllers and much more



## Industry-specific solutions

### Textile machines



#### Overview

##### ***From the individual product to the complete solution***

Every day, the textile machine manufacturing industry is facing new challenges: Short-term trends, harsh competition, permanent innovations, and extremely high cost pressure place high requirements on the manufacturers. With the flexible, modular and economic automation and drive solutions provided by Siemens for your complete machinery, you always stay ahead of the competition. No matter whether this concerns textile machines for natural or for chemical fibers.

##### ***System-based implementation of individual solutions***

A wide range of requirements are placed on modern textile machines. Depending on the segment and type of machine, the required automation solutions range from very simple to complex multi-axis configurations with demanding Motion Control functionality. In each case, the automation equipment is required to be extremely cost-effective and to function reliably over many years, even in the most difficult ambient conditions. The Siemens solutions are perfectly tailored to these requirements. Many years of experience in the textile machine industry have gone into this, in combination with expertise in all aspects of drive and automation technology.

Our products, both in combination with the application software solutions for machine concepts and for control-related special topics, provide the right combination of solutions for every segment and every machine.

An overview of example solutions from the segments

- Chemical fiber production
- Yarn production
- Textile fabric production
- Finishing
- Ready-to-wear clothing

Visit: [www.siemens.com/textile](http://www.siemens.com/textile)

#### Benefits

- Synchronize individual drives with high precision and without any problems using the SIMOTION Motion Control System
- The SINAMICS converter family provides the right device version for every textile machine.
- Quickly and easily create finishing solutions due to the use of preconfigured blocks from our Finishing Toolbox, which is available to customers as a free download
- Find the right solution for your requirements in our wide range of products and services from a single source, i.e. motors, controllers, HMI, networking, and much more

Design

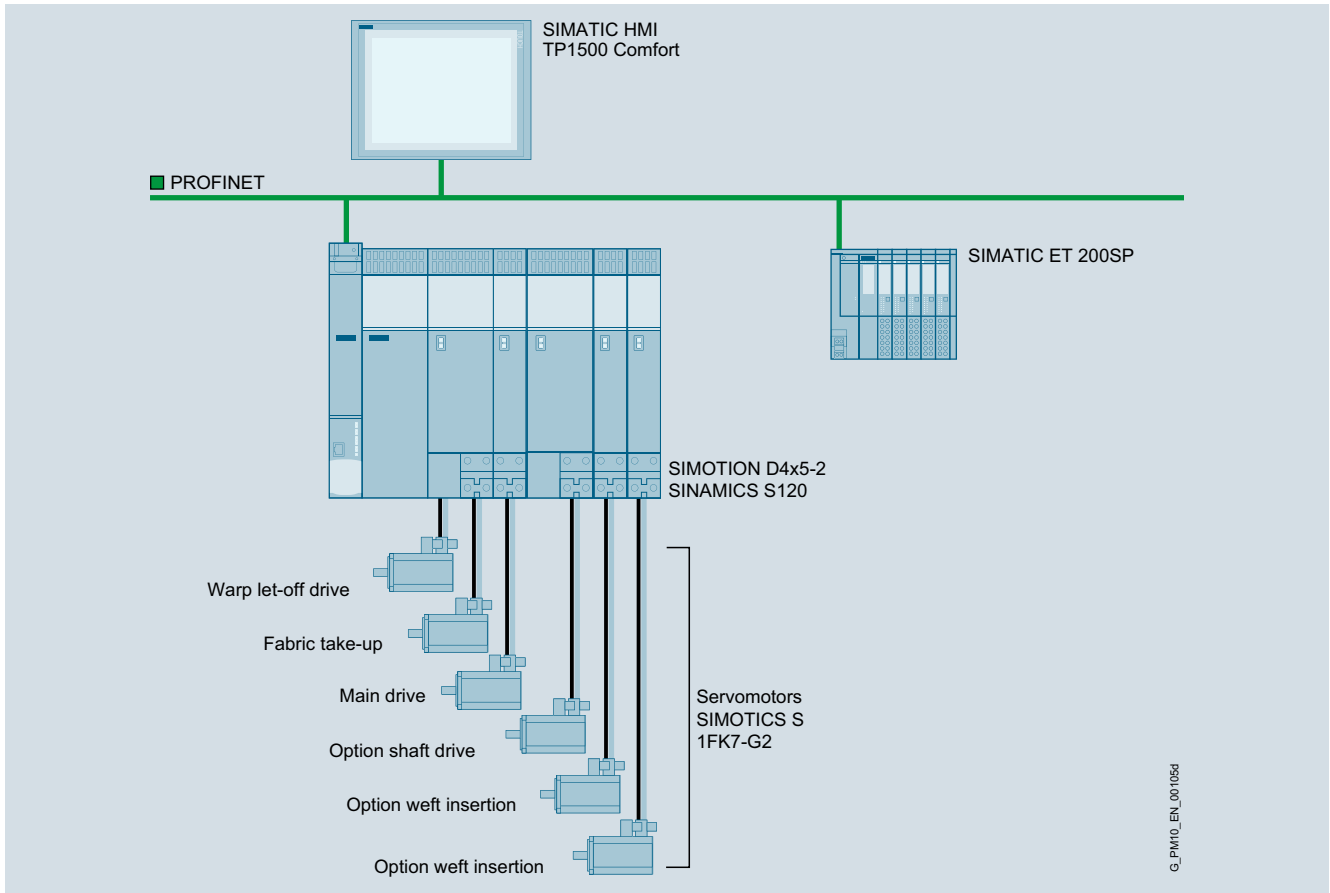

Example fleece folding machine

More information

For more information, see [www.siemens.com/textile](http://www.siemens.com/textile)

## Industry-specific solutions

### Converting

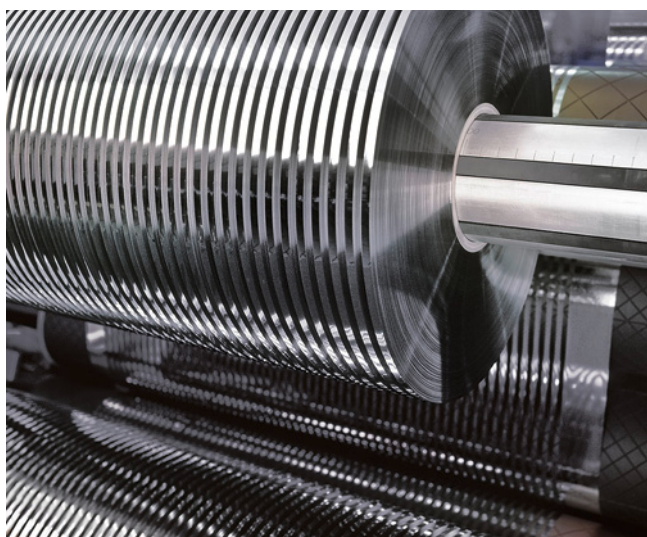

#### Overview

##### **Tailored solutions for production machines**

Our converting solutions create the ideal prerequisites for continually optimizing the productivity of your machines. With our products, systems and services you rely on the latest technology, custom-tailored functions and excellent quality – all of this is included in our portfolio, which is globally unique and covers the entire range for production machines.

##### **The perfect converting solution in record time**

In the converting segment, extremely complex requirements must be met. Whether for the manufacture of toiletries, the processing of material webs, or cable production: In any case, there is a demand for faster production speeds, maximum availability, best possible product quality, and minimal lifecycle costs. Siemens provides the perfect answer to these requirements.

Our products, both in combination with the application software solutions for production machine concepts and for control-related special topics, provide the right combination of solutions for every segment and every machine.

An overview of typical application areas for our solutions from the Converting Toolbox

- Winding
- Automatic roll change
- Tension control
- Traversing
- Flying saw/flying shears
- Material web storage
- Axis control

Visit: [www.siemens.com/converting](http://www.siemens.com/converting)



**Benefits**

- Available for SIMOTION, SIMATIC and SINAMICS
- Rapid and safe automation of converting functions
  - through the use of open, preconfigured and fully tested blocks
  - through the easy adaptation of the parameter assignment and project generation
- Easy adaptation to individual requirements
  - through freely combinable blocks
  - through easy modification of the standard blocks
  - through easy supplementing with dedicated blocks
- Protection of company-specific know-how by access protection

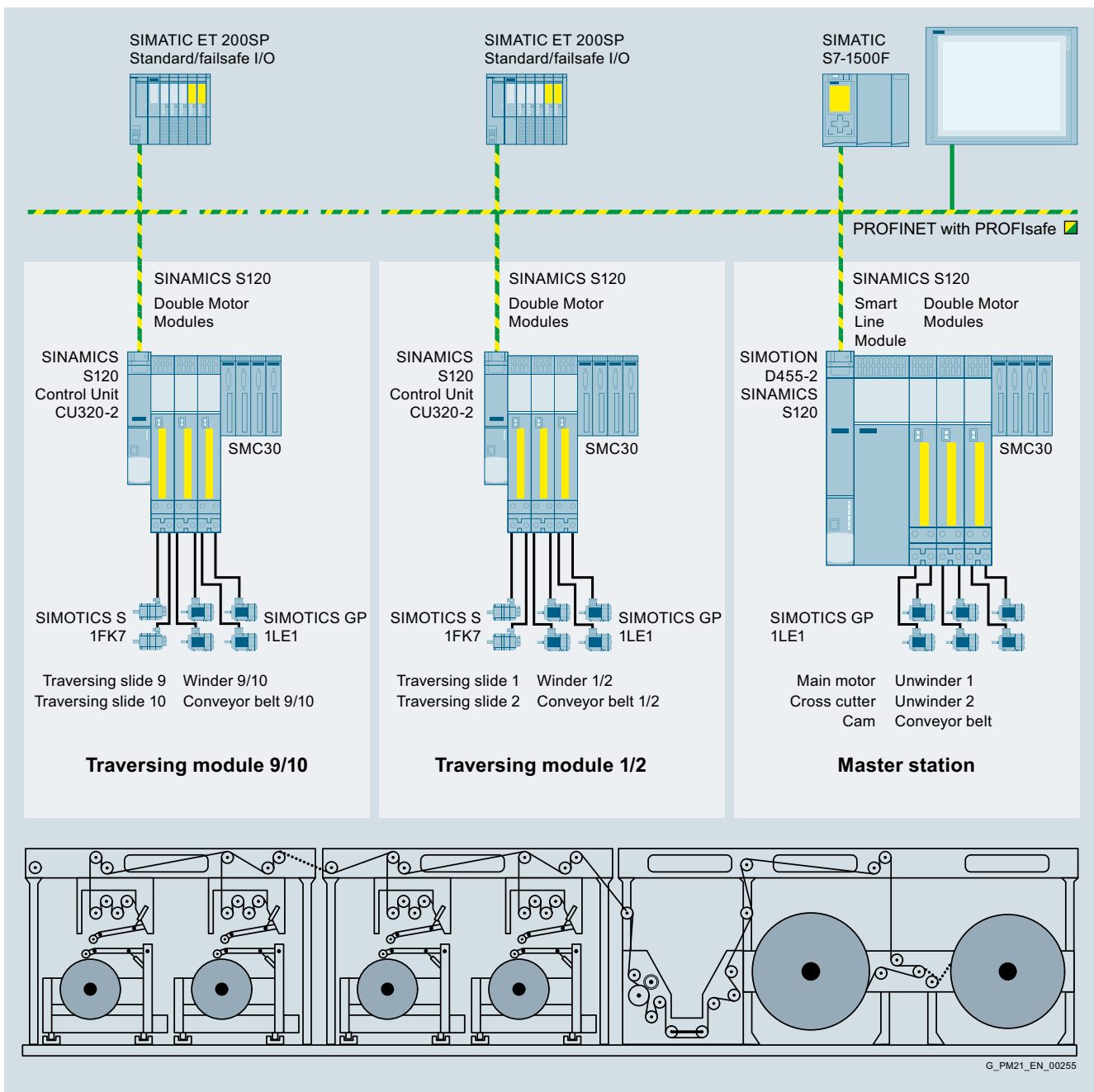
**Design**

Example of a fully automatic traversing system

**More information**

For more information, see  
[www.siemens.com/converting](http://www.siemens.com/converting)

## Industry-specific solutions

### Tire production machines

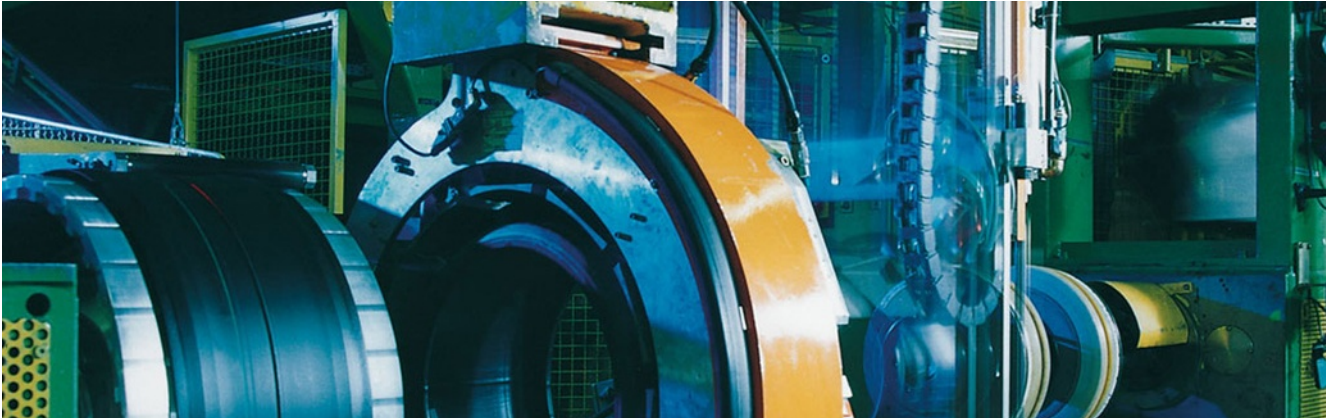

#### Overview

##### ***From the individual product to the complete solution***

Drive systems with optimum energy consumption and excellent performance: our automation and drive products provide systematic quality. You increase the performance of your tire production machines on the basis of our fast and variable SIMOTION, SINAMICS and SIMOTICS drive systems in combination with SIMATIC controllers.

##### ***System-based implementation of individual solutions***

We are facing the ever more complex production environments with a flexible range of products and systems. The requirements for productivity and availability of a tire production machine are constantly increasing. The required solutions of the individual machine types differ from customer to customer. Maximum performance and ruggedness are required of the drive and automation system with fixed quality characteristics. Perfectly coordinated components increase the efficiency of tire production and effectively improve competitiveness.

Our products, combined with our expertise in drive and automation systems both for machine concepts and for control-related special topics, provide the right solution for every machine type.

An overview of example solutions for the machine types

- Car tire production machine
- Truck tire production machine
- Agricultural tire production machine
- Special tire production machine (e.g.: mining trucks)

can be found at: [www.siemens.com/tire](http://www.siemens.com/tire)

#### Benefits

- High-performance SIMOTION Motion Control System for high-precision and reliable synchronization of large numbers of individual drives
- A high degree of ruggedness against extreme environmental influences in the SIPLUS version (e.g. SIPLUS D435-2 DP/PN)
- High standards for safety and know-how protection
- A wide range of products and services for motors, converters and controllers for holistic solutions

## Design

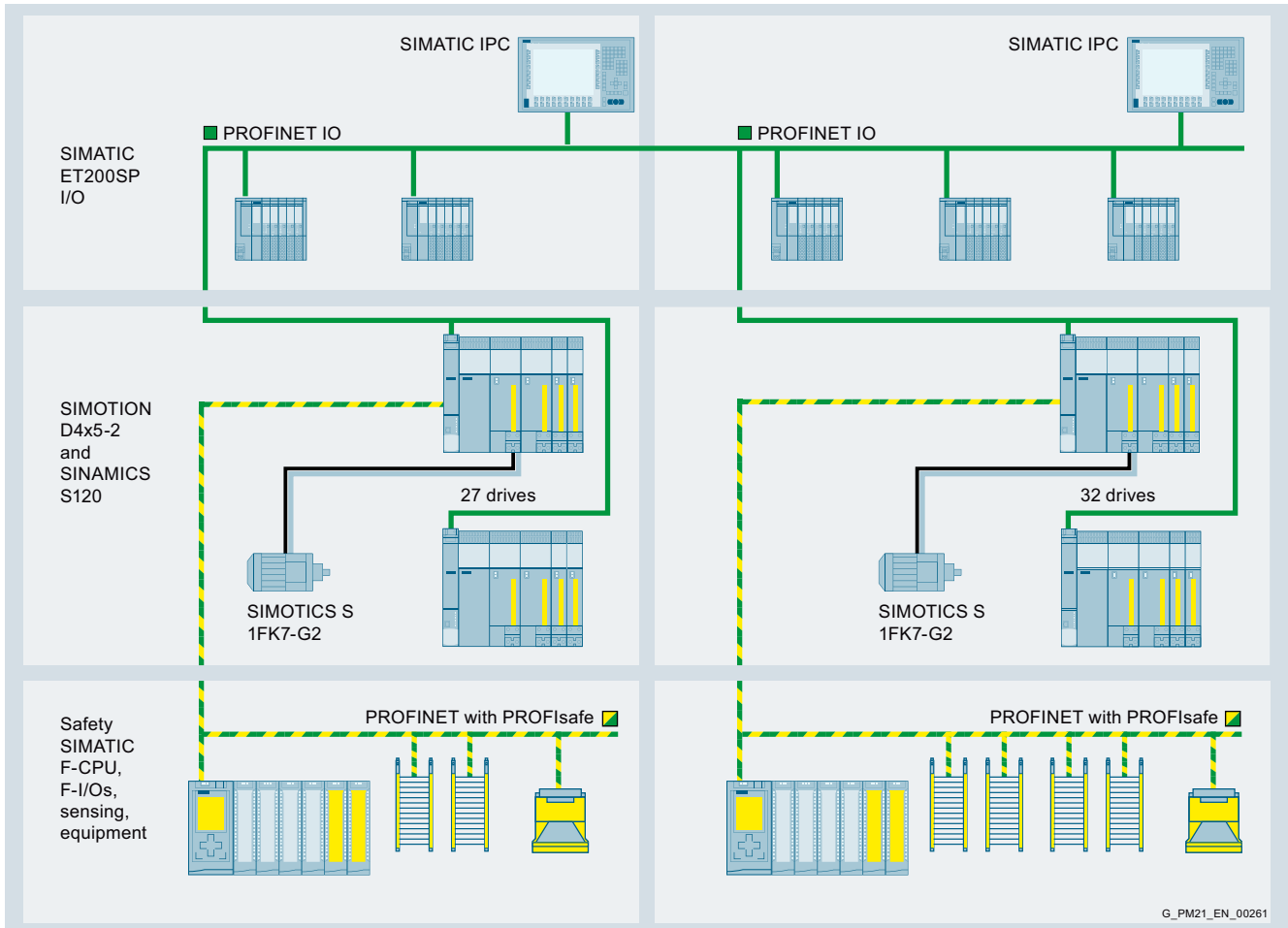

Car tire production machine example

## More information

For more information, see  
[www.siemens.com/tire](http://www.siemens.com/tire)

## Industry-specific solutions

### Metal forming technology

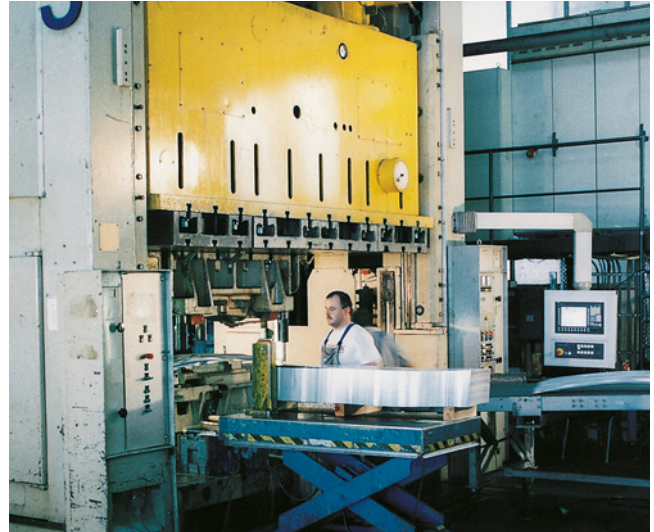
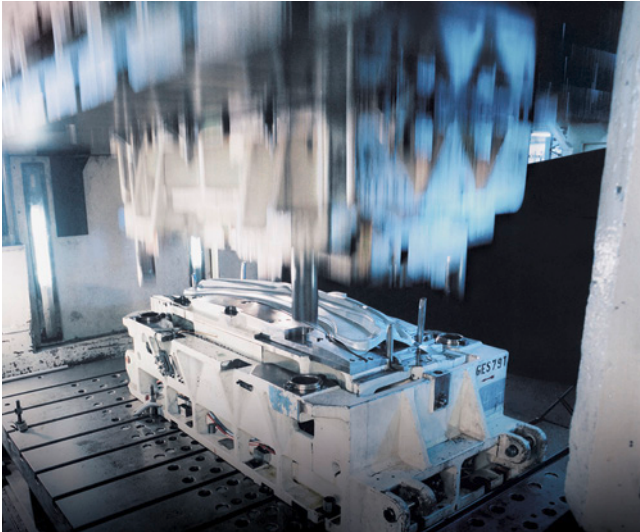

#### Overview

##### ***The comprehensive portfolio for sheet metal processing***

Siemens offers tailored solutions for the entire range of metal forming technology, from press applications and handling systems all the way to safety technology. The solutions are based on the latest technology such as the SIMATIC S7 industrial controllers, the SIMOTION Motion Control System, the SINAMICS S120 drives, and the SIMOTICS T Heavy Duty torque motors, which have been specifically developed for use in presses. Since all of the automation and drive components efficiently interact in the Totally Integrated Automation Portal (TIA Portal), we are helping our customers to improve their development processes and increase efficiency and to reduce costs in the long term.

In addition to the products and systems, Siemens also provides comprehensive services, e.g. control panel building, application services, machine simulation or analysis, condition monitoring (CMS) and press simulation (PLS), and thus ensures maximum flexibility in the configuration and commissioning of customer-specific machines and plants.

##### ***System-based implementation of individual solutions***

When implementing modern metal forming machines and plants, in the automotive industry for example, a largely modular configuration of the software and hardware ensures maximum flexibility and the shortest possible configuration times. The Metal Forming Solution Package provides all of the functions needed for this and supports mechanical engineers in quickly implementing their designs. Choosing from the comprehensive range of preconfigured software modules, the user selects the one that is right for him, individually configures it, and then integrates it into the machine-specific software.

An overview of example solutions for the segments

- Mechanical presses (servo presses, flywheel presses)
- Hydraulic presses (valve-controlled presses, servo hydraulic presses)
- Handling systems (electronic transfer, press feeders, roll feeding)
- Conveyor systems
- Slitting and cross-cutting stations
- Wire-drawing machines
- Pipe and wire bending machines
- Wire winding machines

can be found at: [www.siemens.com/metal-forming](http://www.siemens.com/metal-forming)

#### Benefits

- High-performance and scalable SIMOTION Motion Control System for high-precision and reliable synchronization of individual drives and machine modules (e.g. servo press and electronic transfer)
- Open and expandable software modules for the SIMOTION and SINAMICS S120 platforms
- Wide range of products and services for motors, converters, and controllers
- SIMOTICS S-1FT7 and SIMOTICS T-1FW3/1FW4 motors in vibration-resistant design
- Certified library with safety functions for press applications for SIMATIC F-CPU

## Design

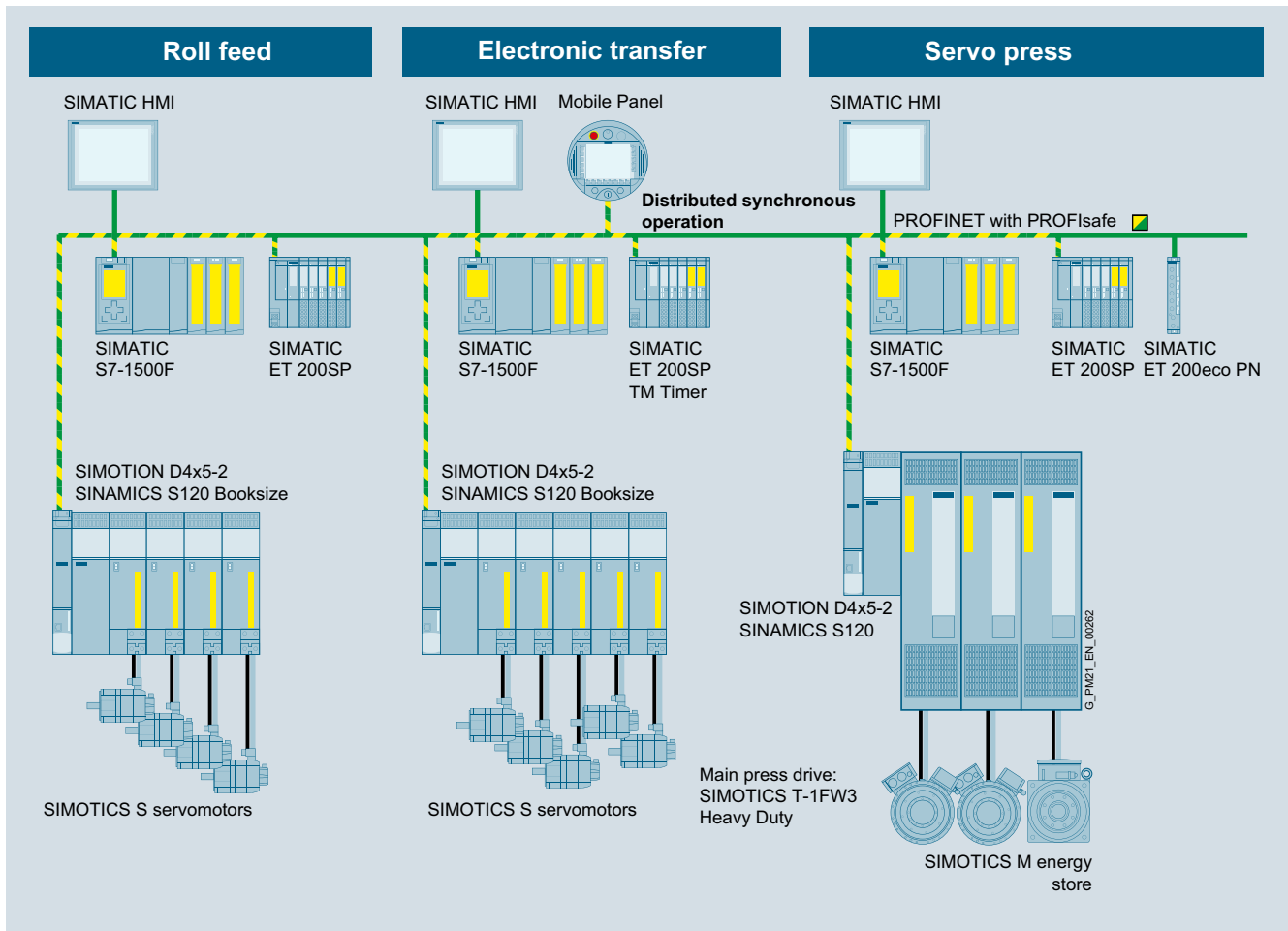

Example of servo press with roll feeds, electronic transfer

## More information

For more information, see  
[www.siemens.com/metal-forming](http://www.siemens.com/metal-forming)

## Industry-specific solutions

### Glass production machines



#### Overview

##### **Solutions for mechanical engineering in the glass industry**

Glass is one of the oldest materials in the world and yet it is always innovative. New technologies in glass manufacturing and glass finishing give glass specific characteristics, which also make it suitable for the most demanding tasks. Siemens provides innovative solutions for these new technologies in the glass industry in the fields of automation and drive technology – both for the flat glass segment and for the hollow glass and special glass segments. Siemens Motion Control Systems are used for quick and precise motion control in the production machines used for this.

##### **System-based implementation of individual solutions**

Along with the increasing requirements for application capabilities, the demands for consistent quality are also on the rise.

Whether high-value goblets, glass-ceramic cooktops, composite safety glass for windshields, or solar panels – the immaculate state of the end product stands and falls with state-of-the-art automation solutions and drive technology. With the SIMOTION, SINAMICS and SIMATIC system families in combination with application solutions, Siemens offers mutually coordinated products and systems especially for the glass industry.

An overview of the solutions for the segments

- Flat glass – cold end
- Flat glass – further processing
- Insulating glass
- Hollow glass – IS machine
- Hollow glass – rotary machine

can be found at: [www.siemens.com/motioncontrol/glass](http://www.siemens.com/motioncontrol/glass)

#### Benefits

- Easy integration, maintenance and expandability thanks to the modular architecture with SIMOTION
- High energy efficiency with the SINAMICS drive family over the entire glass process
- High-performance solutions and remote diagnostics with SIMOTION
- Reduced operating costs due to energy recovery and reactive power compensation with SINAMICS Integrated

## Design

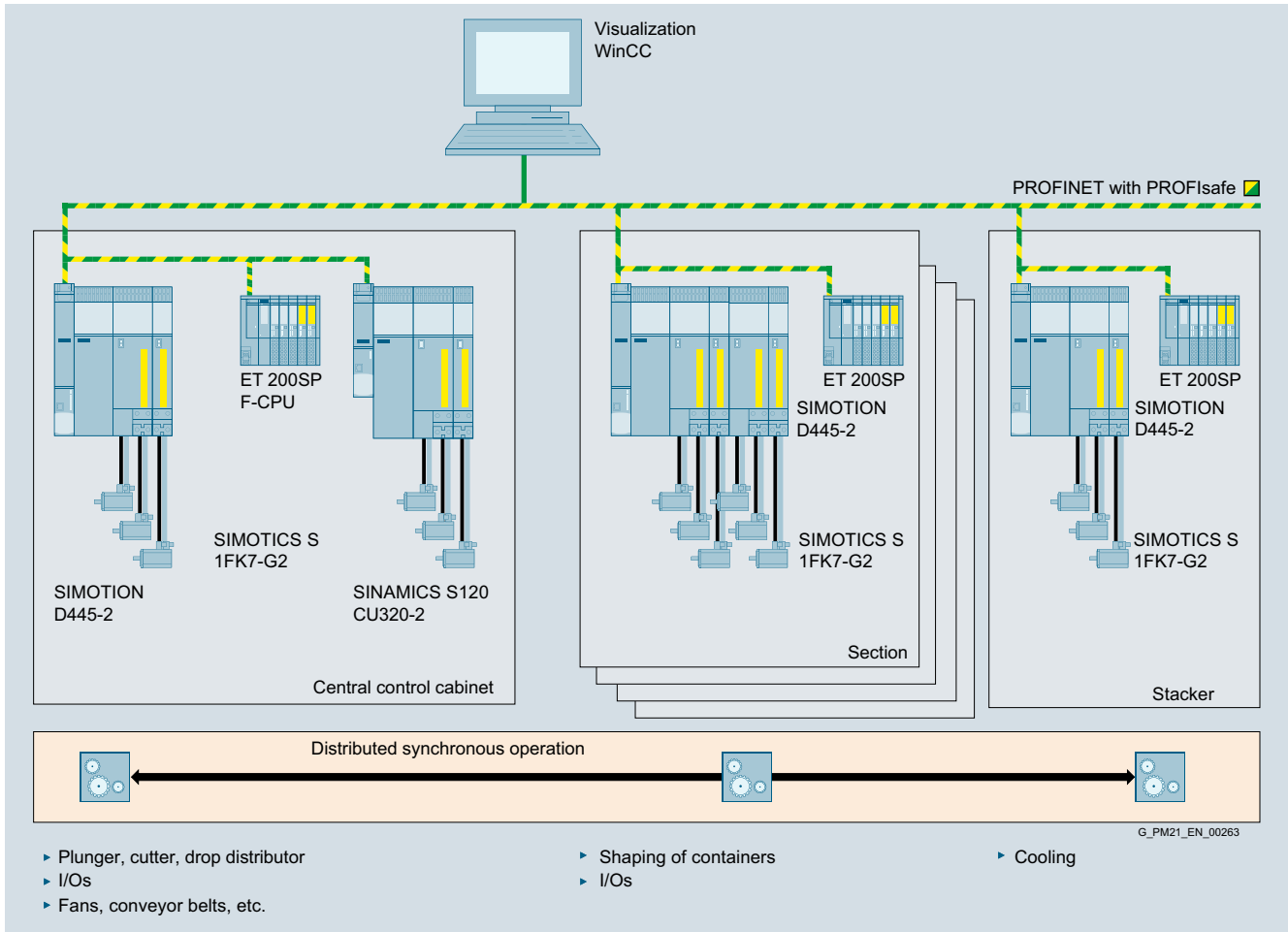

Example of an Individual Section machine

## More information

For more information, see  
[www.siemens.com/motioncontrol/glass](http://www.siemens.com/motioncontrol/glass)

## Industry-specific solutions

### Handling systems

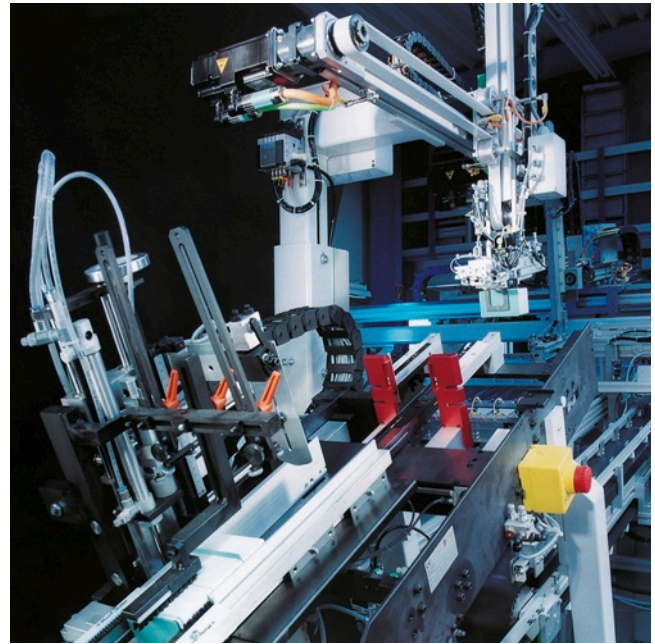
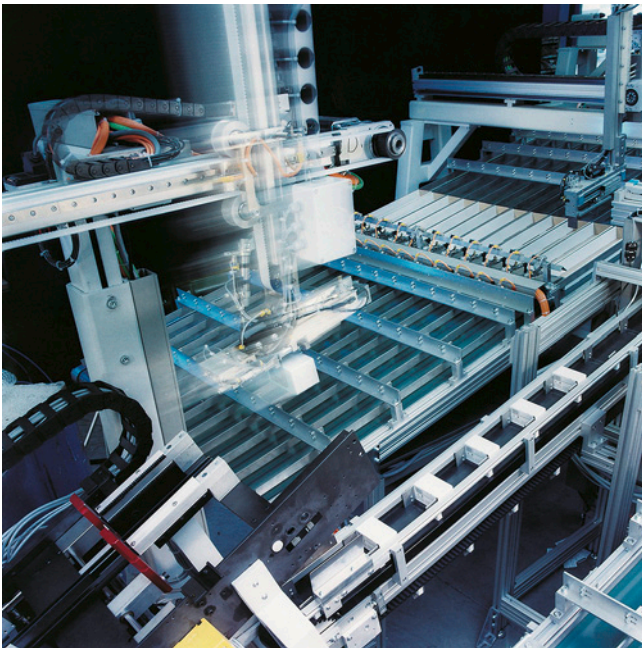

#### Overview

##### **Controlled motion sequences – faster, easier and more economical**

The interaction of production machines and handling units is becoming more and more important.

In the past, where dedicated handling robots were used, line-integrated handling modules are now increasingly being used in primary and secondary processes to guarantee productivity with ever shorter product switching times.

Whether you are dealing with highly dynamic applications such as pick-and-place applications in secondary packaging processes or contour-precise application of polymeric reactive materials: Our solutions are tailored to the specific requirements.

##### **One integrated automation solution**

Our SIMOTION-based solutions are an integral part of the entire machine automation system.

The advantage is clear: Both handling and the machine itself can be implemented with just one system. Synchronization with proprietary control architectures is no longer necessary. Real-time synchronization and integrated data management are thus possible without any problems. Familiarization periods for special robot programming languages are not required.

With the SIMOTION Handling Toolbox, Siemens provides a standardized and modular software library for handling modules, which can be used on all SIMOTION platforms and allows scalable, machine-integrated solutions that are tailored to customer solutions.

#### Benefits

- Efficient engineering thanks to standardized software
- All commonly used kinematics (such as Delta picker 3D, SCARA) are integrated in the system
- Integration of customized kinematics via transformation equations
- Highly dynamic and fully automatic synchronization on conveyor belts due to preconfigured software blocks
- Connection to CAD/CAM systems with G-Code Interpreter for SIMOTION
- Maximum motion quality thanks to intelligent algorithms for the pre-control of the entire drive train in real time



## Design

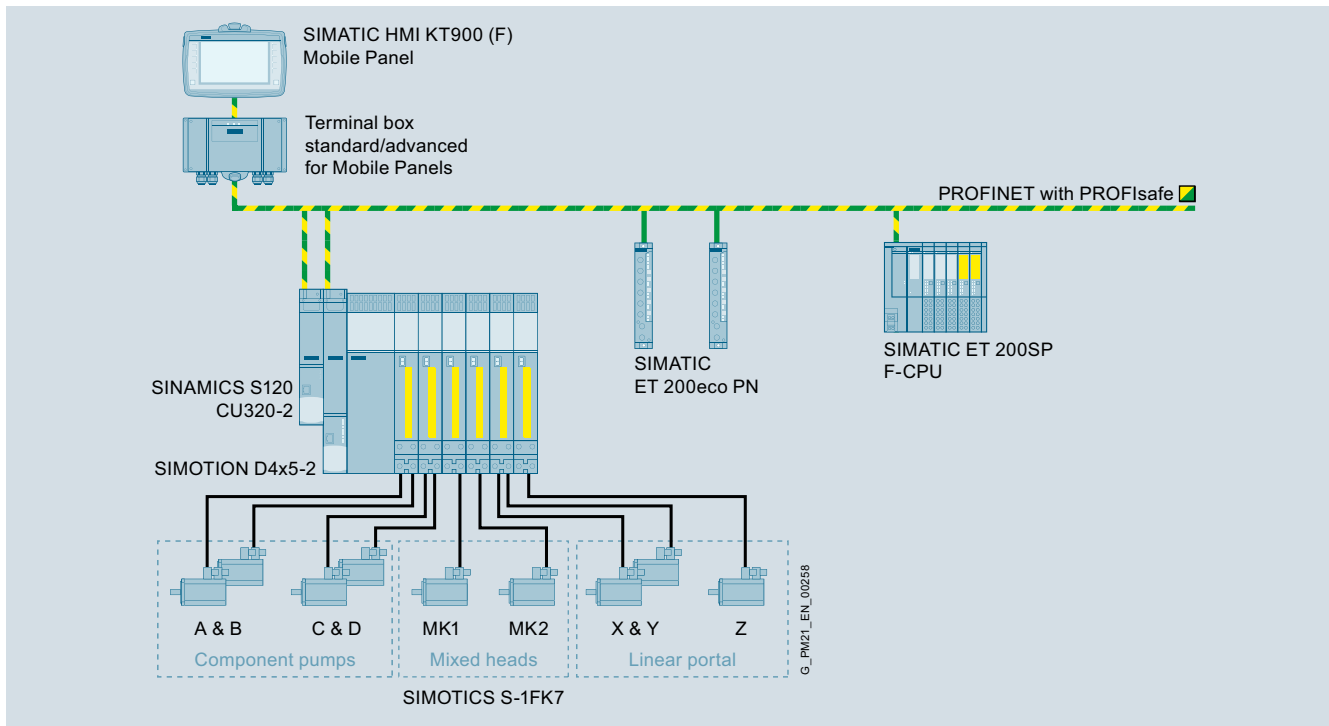

Example of a mixing/dosing plant for sealing foams and handling with linear portal

## More information

For more information, see  
[www.siemens.com/handling](http://www.siemens.com/handling)

## Industry-specific solutions

### Solar production machines

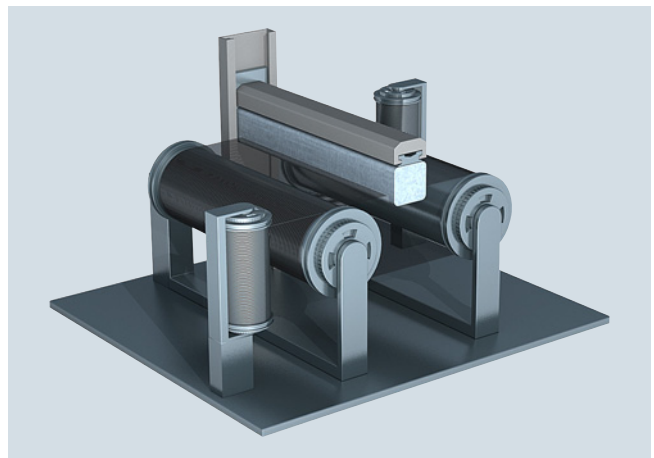
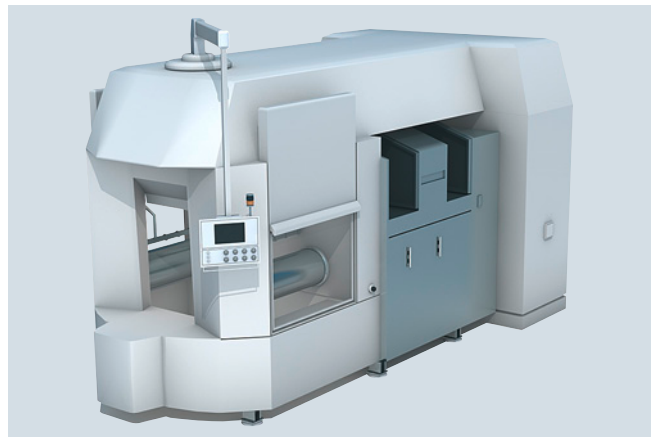

#### Overview

##### **Optimized automation and drive solutions for production machines along the entire production chain in the solar industry**

Many different process steps and automation requirements must be considered when manufacturing photovoltaic modules. The field ranges from slow processes for raw silicon block production up to high-speed machines for wafer cutting, reliable machines for the cell coating process, and the handling or transport of individual components. Continuous quality control of each production step is just as important as an integrated process and high-precision machines.

Siemens provides a wide range of scalable automation and drive products for the entire solar manufacturing chain. This ranges from dynamic motors of the SIMOTICS series and SINAMICS drives to the SIMOTION and SIMATIC controllers, for all applications with the most diverse requirements. The efficient interaction of all the automation and drive components is ensured by Totally Integrated Automation (TIA). In this way, we help our customers increase their productivity and product quality and reduce costs sustainably. Our products are ideally suited to photovoltaic manufacturers and OEMs from the solar industry. We also provide innovative solutions for precise solar tracking of the solar modules.

##### **System-based implementation of individual solutions**

The wafer, cell and module manufacturing process demands short cycle times in order to ensure a high throughput. In addition, complex handling kinematics are required to some extent. Siemens provides the right solutions for this, based on the controller portfolio of SIMATIC and SIMOTION, e.g. the Handling Toolbox with preconfigured software modules and handling kinematics. Cartesian gantry systems, roller pickers, SCARA, delta pickers (2D/3D) with interpolation functionality are system-integrated and incorporated in the Handling Toolbox. Additional functions such as conveyor synchronization and camera integration are also available.

An overview of our concepts and solutions for

- Crystal drawing systems
- Silicon ingot cutting machines, squarers and wire saws for manufacturing wafers
- Machines for the production of solar cells and modules (e.g. stringers, layup stations, laminators, framing stations, and quality test systems) including transport and sorting systems
- Thin-film coating plants (TCO, CVD, PVD)

can be found at:

[www.siemens.com/solar-industry](http://www.siemens.com/solar-industry)

On the website you will likewise find all the information for solar tracking system solutions, including the Solar Tracking Software Toolbox.

**Benefits**

- High-precision Motion Control with SIMOTION or SIMATIC ensures high-quality and high-value production of thinner and thinner wafers
- Cost savings thanks to efficient engineering and technology functions integrated in the drive
- Safety functions in the drive, thus avoiding complex, conventional protective circuitry
- Space savings due to compact and flexible SINAMICS drive system
- Wide range of products such as asynchronous, servo and torque motors for the machines

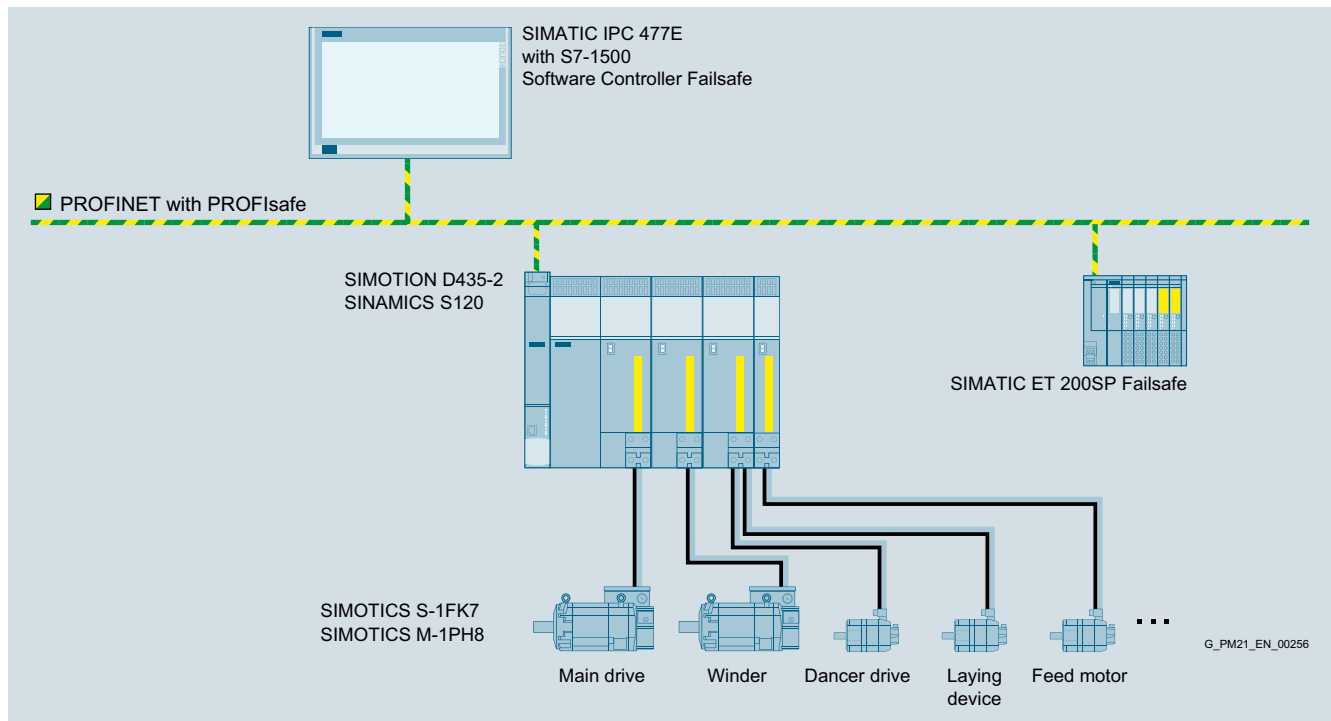
**Design**

Example wire saw

**More information**

For more information, see  
[www.siemens.com/solar-industry](http://www.siemens.com/solar-industry)

## Industry-specific solutions

### Ceramics and stone processing machines

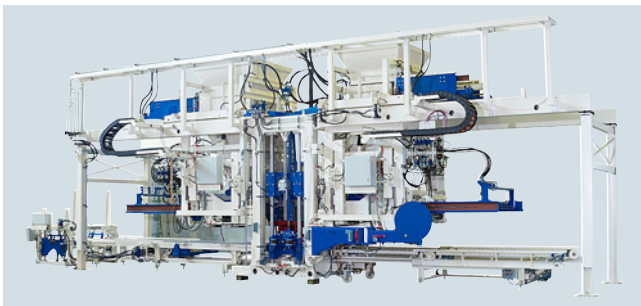

#### Overview

Construction materials are the basis for creating infrastructure and are therefore always in demand worldwide. To manufacture construction materials with a consistently high quality, the use of fully automatic machines and plants is indispensable. Based on the latest technology, such as the SIMATIC S7 industrial controllers, the SIMOTION Motion Control System and the SINAMICS S120 drives, Siemens provides innovative solutions for technologies that produce construction material end products made of ceramics and stone.

The ceramics and stone segments are divided into the following subsegments:

- Coarse ceramics (bricks for walls, tiles for roofs)
- Fine ceramics (tiles, bath/kitchen ceramics, technical ceramics)
- Block casting (pre-cast concrete blocks, sand-lime bricks)
- Natural stone finishing

#### Solutions for the ceramics and stone segments

For the coarse ceramics and fine ceramics subsegments and for block casting, the molding is in the foreground. Whereas molded blocks (pre-cast concrete blocks, sand-lime bricks) are only dried after the molding process, ceramic materials are dried and baked in a kiln after the molding. In stone finishing, the focus is on the natural stone. Various processing steps take place during this, starting with a stone block taken directly from the quarry to the finished natural stone end product.

#### From the individual machine to the complete plant

Siemens equips individual machines and complete plants with automation and drive technology. In extensive facilities, such as a brickworks (coarse ceramics), the advantages of the SIMATIC family of controllers are utilized. For natural stone finishing centers, the Siemens CNC systems of the SINUMERIK family provide advantages. Whenever the timing of several axes must be coordinated with high precision, the advantages of the SIMOTION Motion Control System come to the fore.

Examples of typical SIMOTION applications are:

- Brick placing system
- Concrete block molding machine
- Sand-lime brick press
- Grinding and polishing machines for natural stone slabs

#### Servo pump as energy-saving hydraulic drive

Hydraulic drives are primarily used for the molding processes. Siemens provides the servo pump as an innovative, energy-saving solution concept for this. The principle behind this is not primarily to control the pressure and volumetric flow by means of valve technology, but directly via the torque and speed of a servomotor. As a result, energy is only provided by the motor when it is actually required at the cylinder. Especially for clocked manufacturing processes, which are commonly applied, for example, in fine ceramic presses, sand-lime brick presses and concrete block molding machines, this principle leads to considerable energy savings.

6

#### Classic hydraulics

Control of:

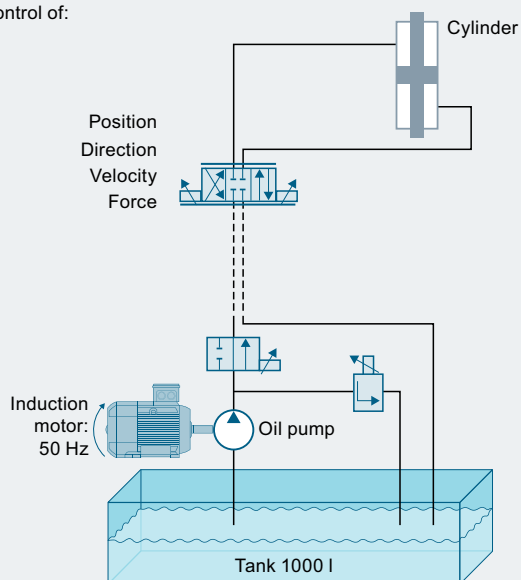

#### Servo pump

Control of:

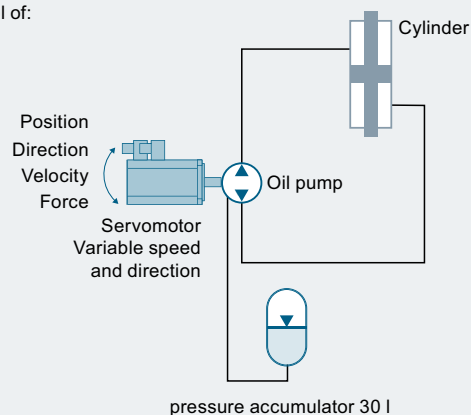

G\_PM21\_EN\_00259

### Benefits

- High energy and cost-efficiency through the use of speed-controlled hydraulics (servo pump)
- Availability of the solution based on the servo pump, both for single and multi-axis systems
- High dynamics thanks to SIMOTICS servomotors with low rotor moment of inertia
- SIMOTION Motion Control System for electrical and hydraulic multi-axis systems for high-precision synchronization of the individual drives

### Design

Closed systems are very compact, because only a small pressure accumulator is required. Open servo pump systems allow the sequential propulsion of several cylinders with only one single servo pump system. Thus, for example, as shown in the

figure, three cylinders can be driven in succession using a single servo pump system (consisting of two individual pumps).

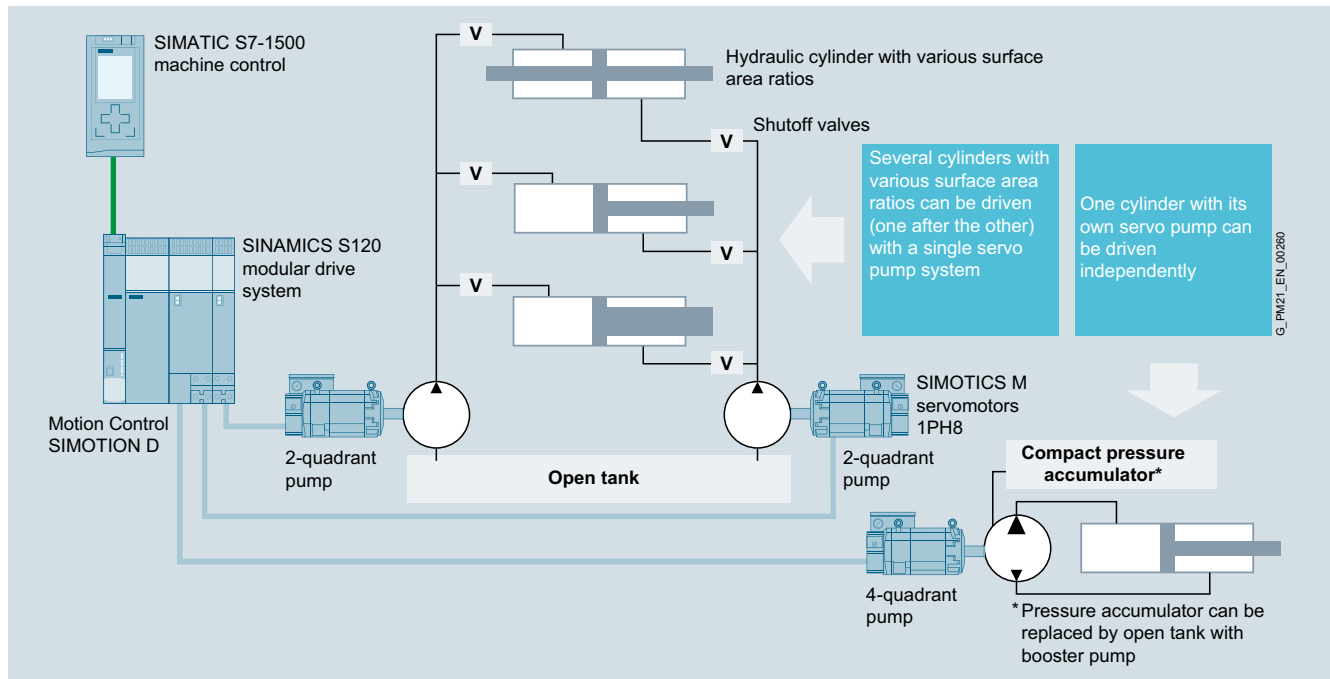

Servo pump systems for block molding machine with four main axes

## Industry-specific solutions

### Notes

## Lifecycle Services

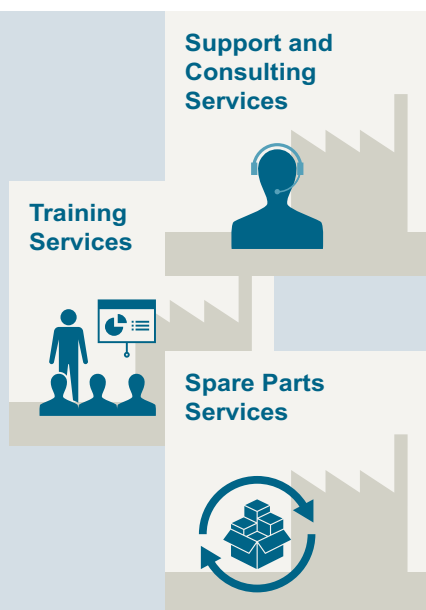

<b>7/2</b>	<b>Further product information</b>
<b>7/3</b> 7/3	<b>Dimensioning and engineering tools</b> SIZER for Siemens Drives engineering tool
7/4 7/5	Drive Technology Configurator CAD CREATOR
<b>7/6</b> 7/6	<b>Applications</b> Application centers and application consulting
<b>7/7</b> 7/7	<b>Control cabinets</b> Overview
<b>7/9</b> 7/9	<b>SITRAIN – Training for Industry</b> Overview
7/10	SIMOTION training courses
7/11	SINAMICS training courses
7/12	SIMOTION D425-2 DP/PN training case
7/13	SINAMICS S120 training case
7/14	SIMOTION D425-2 DP/PN upgrade kit
<b>7/15</b> 7/15	<b>Siemens Automation Cooperates with Education</b> Simplify your education in automation
<b>7/17</b>	<b>Partner at Siemens</b>
<b>7/18</b> 7/18	<b>Online services</b> Information and ordering options available on the Internet and on DVD
7/19	Information and Download Center, Social Media, Mobile Media
<b>7/20</b> 7/20	<b>Industry Services</b> Overview
7/21	Portfolio
7/23	Online Support

## Lifecycle Services

Further product information

### Overview

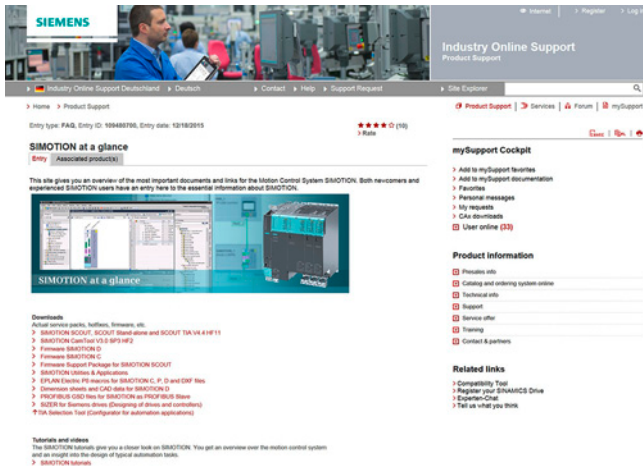

### **SIMOTION in the WWW**

More information on our products can be found at [www.siemens.com/SIMOTION](http://www.siemens.com/SIMOTION)

### **SIMOTION documentation**

The SIMOTION documentation is included as electronic documentation in the scope of delivery of SIMOTION SCOUT. It comprises 10 documentation packages:

- SIMOTION Engineering System Handling
- SIMOTION System and Function Descriptions
- SIMOTION Service and Diagnostics
- SIMOTION IT
- SIMOTION Programming
- SIMOTION Programming Reference Lists
- SIMOTION C
- SIMOTION P
- SIMOTION D
- SIMOTION Supplementary Documentation

Click the following link to find information on the following topics:

- Download of individual documents from the Internet
- Download of complete documentation packages from the Internet
- Compile your own documentation with My Documentation Manager

<https://support.industry.siemens.com/cs/ww/en/view/109479653>

### **SIMOTION at a glance – The SIMOTION information portal**

We have compiled an overview page from our range of information about SIMOTION with the most important information on frequently asked topics - which can be opened with just one click.

<https://support.industry.siemens.com/cs/ww/en/view/109480700>



## Overview

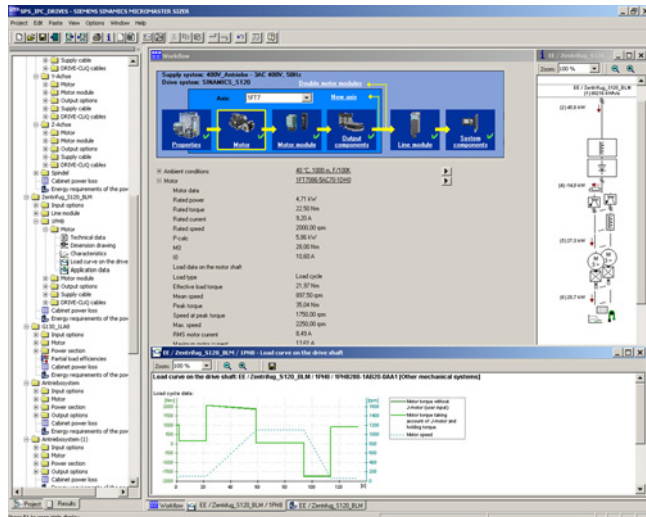

The following drives and controls can be engineered in a user-friendly way using the SIZER for Siemens Drives engineering tool:

- SIMOTICS low-voltage motors including servo geared motors
- SINAMICS low-voltage drive systems
- Motor starters
- SINUMERIK CNC
- SIMOTION Motion Control System
- SIMATIC controller

It provides support when selecting the technologies involved in the hardware and firmware components required for a drive task. SIZER for Siemens Drives supports the complete configuration of the drive system, from basic single drives to complex multi-axis applications.

SIZER for Siemens Drives supports all of the configuring steps in one workflow:

- Configuring the power supply
- Designing the motor and gearbox, including calculation of mechanical transmission elements
- Configuring the drive components
- Selecting the required accessories
- Selecting the line-side and motor-side power options, e.g. cables, filters, and reactors

When SIZER for Siemens Drives was being designed, particular importance was placed on a high degree of usability and a universal, function-based approach to the drive application. The extensive user guidance makes using the tool easy. Status information keeps you continually informed about the progress of the configuration process.

The SIZER for Siemens Drives user interface is available in English, French, German and Italian.

The drive configuration is saved in a project. In the project, the components and functions used are displayed in a hierarchical tree structure.

The project view permits the configuration of drive systems and the copying/inserting/modifying of drives already configured.

The configuration process produces the following results:

- A parts list of the required components (export to Excel, use of the Excel data sheet for import to SAP)
- Technical specifications of the system
- Characteristic curves
- Comments on system reactions
- Mounting arrangement of drive and control components and dimensional drawings of motors
- Energy requirements of the configured application

These results are displayed in a results tree and can be reused for documentation purposes.

Technological online help is available:

- Detailed technical specifications
- Information about the drive systems and their components
- Decision-making criteria for the selection of components
- Online help in English, French, German, Italian, Chinese and Japanese

### System requirements

- PG or PC with Pentium III min. 800 MHz (recommended > 1 GHz)
- 512 MB RAM (1 GB RAM recommended)
- At least 4.1 GB of free hard disk space
- An additional 100 MB of free hard disk space on the Windows system drive
- Screen resolution 1024 × 768 pixels (1280 × 1024 pixels recommended)
- Operating system:
  - Windows 7 Professional (32/64 bit)
  - Windows 7 Enterprise (32/64 bit)
  - Windows 7 Ultimate (32/64 bit)
  - Windows 7 Home (32/64 bit)
  - Windows 8.1 Professional (32/64 bit)
  - Windows 8.1 Enterprise (32/64 bit)
- Microsoft Internet Explorer V5.5 SP2

### Selection and ordering data

Description	Article No.
<b>SIZER for Siemens Drives engineering tool</b> on DVD-ROM	<b>6SL3070-0AA00-0AG0</b>
English, French, German, Italian	

### More information

The SIZER for Siemens Drives engineering tool is available free on the Internet at

[www.siemens.com/sizer](http://www.siemens.com/sizer)

## Lifecycle Services

### Dimensioning and engineering tools

#### Drive Technology Configurator

##### Overview

The Drive Technology (DT) Configurator helps you to configure the optimum drive technology products for your application – starting with gear units, motors, inverters as well as the associated options and components and ending with controllers, software licenses and connection systems. Whether with little or detailed knowledge of products: You can easily, quickly and efficiently configure your particular drive using product group preselectors, targeted navigation through selection menus or by entering article numbers directly to select the products.

In addition, comprehensive documentation comprising technical data sheets, 2D dimensional drawings/3D CAD models, operating instructions, certificates, etc. can be selected in the DT Configurator. The products that you select can be directly ordered by transferring a parts list to the shopping cart of the Industry Mall.

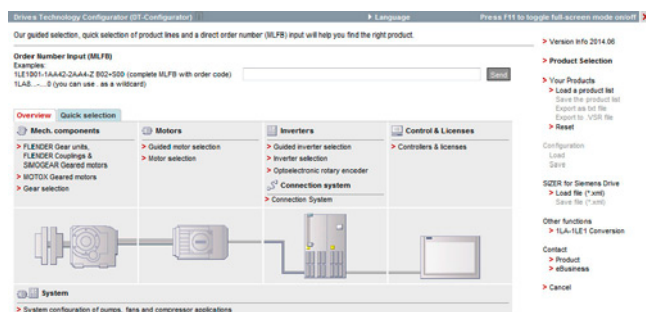

##### Drive Technology Configurator for efficient drive configuration with the following functions

- Quick, efficient configuration of drive products and associated components – gear units, motors, inverters, controllers, connection systems
- Configuration of drive systems for pumps, fans and compressor applications from 1 kW to 2.6 MW
- Retrievable documentation for configured products and components, such as
  - Data sheets in up to 9 languages in PDF or RTF format
  - 2D dimensional drawings/3D CAD models in various formats
  - Terminal box drawing and terminal connection diagram
  - Operating instructions
  - Certificates
  - Start-up calculation for SIMOTICS motors
  - EPLAN macros
- Support with retrofitting in conjunction with Spares On Web ([www.siemens.com/sow](http://www.siemens.com/sow))
- Ability to order products directly through the Siemens Industry Mall

##### Access to the Drive Technology Configurator

The Drive Technology Configurator can be called up without registration and without a login:

[www.siemens.com/dt-configurator](http://www.siemens.com/dt-configurator)

##### Selection and ordering data

Description	Article No.
<b>Interactive catalog CA 01</b> on DVD-ROM including Drive Technology Configurator English	<b>E86060-D4001-A510-D7-7600</b>

##### More information

[Online access to Drive Technology Configurator](#)

More information about the Drive Technology Configurator is available on the Internet at

[www.siemens.com/dtconfigurator](http://www.siemens.com/dtconfigurator)

[Offline access to the Drive Technology Configurator in the Interactive Catalog CA 01](#)

In addition, the Drive Technology Configurator is also included in the Interactive Catalog CA 01 on DVD-ROM - the offline version of the Siemens Industry Mall.

The interactive catalog CA 01 can be ordered from the relevant Siemens sales office or via the Internet:

[www.siemens.com/automation/CA01](http://www.siemens.com/automation/CA01)

## Overview

### **CAD CREATOR – Dimensional drawing and 2D/3D CAD generator**

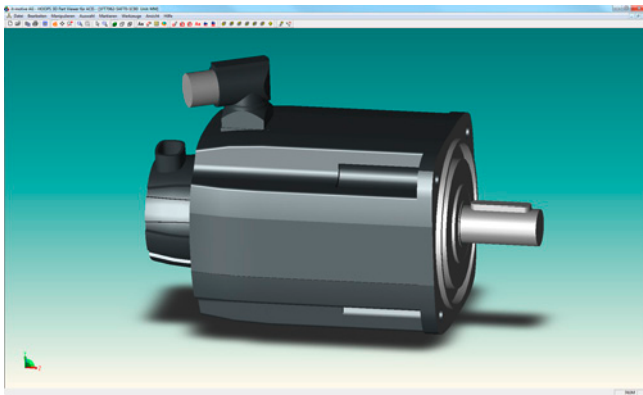

Thanks to the user-friendly operator interface of the CAD CREATOR, it is easy to configure controllers, drives and motors. With the assistance of the CAD CREATOR, product-specific dimensional drawings and 2D/3D CAD models can be created quickly. The CAD CREATOR assists the machine manufacturer's designers, offer drafting engineers and project engineers.

## Benefits

- Provision of dimensional drawings as 2D/3D CAD models in mm and inches
- Display of 2D/3D CAD models and dimensional drawings on integrated viewers
- With the online version, 3D models and dimensional drawings can also be displayed in the form of a downloadable PDF
- Support for all general geometry interfaces STEP, IGES, Parasolid, SAT, VDA, and for special interfaces such as Ideas, NX, Solid Edge, Pro/Engineer, Autocad, Inventor, Mechanical Desktop, Catia and Solidworks
- Multi-language operator interface in English, French, German, Italian and Spanish, and direct Help (English, German)

Dimensional drawings and 2D/3D CAD models for:

- SIMOTICS motors for Motion Control
  - SIMOTICS S-1FK7, S-1FT7 servomotors
  - SIMOTICS S geared motors
  - SIMOTICS M-1PH8, M-1FE1 main motors
  - SIMOTICS L-1FN3 linear motors
  - SIMOTICS T-1FW3, T-1FW6 torque motors
  - 2SP1 motor spindles
- Components
  - Measuring systems
  - MOTION-CONNECT connection system
- SINAMICS S110, SINAMICS S120
  - Control Units
  - Power Modules (Blocksize/Chassis/Combi)
  - Line Modules (Booksize/Chassis)
  - Line-side components
  - Motor Modules (Booksize/Chassis)
  - DC link components
  - Supplementary system components
  - Load-side power components
  - Encoder system connection
- SINUMERIK
  - CNC systems
  - Operator components for CNC systems
- SIMOTION
  - SIMOTION D
  - SIMOTION C
  - SIMOTION P

The CAD CREATOR offers a variety of options for configuring, but also different methods for searching for a product:

- According to Article No.
- According to technical description

After successful configuration of the product, the dimensional drawings and models are displayed with the integrated viewers and made available for export.

## Selection and ordering data

Description	Article No.
<b>CAD CREATOR</b> Dimensional drawing and 2D/3D CAD generator on DVD-ROM English, French, German, Italian, Spanish	<b>6SL3075-0AA00-0AG0</b>

## More information

The CAD CREATOR is available on DVD-ROM and as an Internet application.

More information is available on the Internet at [www.siemens.com/cadcreator](http://www.siemens.com/cadcreator)

## Lifecycle Services

### Applications

#### Application centers and application consulting

#### Overview



Our understanding of an application is the customer-specific solution of an automation task based on standard hardware and software components. In this respect, industry-specific knowledge and technological expertise are just as important as expert knowledge about how our products and systems work. We are setting ourselves this challenge with more than 280 application engineers in 19 countries.

#### Application centers

We currently have application centers in:

- Germany: Head Office Erlangen and in other German regions, e.g. in Munich, Nuremberg, Stuttgart, Mannheim, Frankfurt, Chemnitz, Cologne, Bielefeld, Bremen, Hanover, Hamburg
- Belgium: Brussels
- Brazil: Sao Paulo
- China: Beijing and 12 regions
- Denmark: Ballerup
- France: Paris
- Great Britain: Manchester
- India: Mumbai
- Italy: Bologna, Milan
- Japan: Tokyo, Osaka
- The Netherlands: The Hague
- Austria: Vienna
- Sweden: Göteborg
- Switzerland: Zurich, Lausanne
- Spain: Madrid
- South Korea: Seoul
- Taiwan: Taipei
- Turkey: Istanbul
- USA: Atlanta

These application centers specialize in the use of SIMOTION/SIMATIC/SINAMICS. You can therefore rely on automation and drive specialists for implementing successful applications. By involving your personnel at an early stage in the process, we can provide a solid basis for rapid knowledge transfer, maintenance and further development of your automation solution.

#### Advice on applications and implementation

We offer a variety of consultation services to help you find the optimum solution for the SIMOTION/SIMATIC/SINAMICS application you want to implement:

The quotation phase includes

- clarification of technical questions
- discussion of machine concepts and customer-specific solutions
- selection of suitable technology, and
- suggestions for implementation.

A technical feasibility study is also performed at the outset. In this way, difficult points of the application can be identified and solved early on. If desired, we also configure and implement your application as a complete solution from a single source.

A large number of proven standard applications are available for use during the implementation phase. This saves engineering costs.

The system can be commissioned by experienced, competent personnel, if required. This saves time and trouble.

If servicing is required, we can support you on site or remotely. For further information about servicing, please see the section "Industry Services".

#### On-site application training

Training for the implemented applications can also be organized and carried out on site. This training for machine manufacturers and their customers does not deal with individual products, but the entire hardware and software system (for example, automation, drives and visualization).

From an initial concept to successful installation and commissioning: We provide complete support for SIMOTION/SIMATIC/SINAMICS! Contact your Siemens representative.

You can find further information at [www.siemens.com/machinebuilding](http://www.siemens.com/machinebuilding)

**Overview**
**Complete equipment for machine tools and production machines**

Our supplied range of products and services also includes complete equipment for machine tools and production systems with all services in the process chain from consulting through to after-sales service.

We support you in the areas of engineering, production and logistics:

**Engineering support**

Siemens supports you with advice on design in accordance with standards and concepts for drive systems, control, operation and safety.

Our engineers configure for you in EPLAN P8 and other commonly used CAD systems, execute projects designed to cost and adapt your documents where necessary to UL or new systems.

Our Technical Competence Center Cabinets in Chemnitz supports you with selecting and optimizing the suitable control cabinet air-conditioning system. Apart from calculation and simulation, we also use instrumentation testing in our heat laboratory with load simulation.

We also offer the following services:

- Vibration measurements and control cabinet certification in the field
- Measurement of conducted interference voltages in our laboratory



Control cabinet engineering

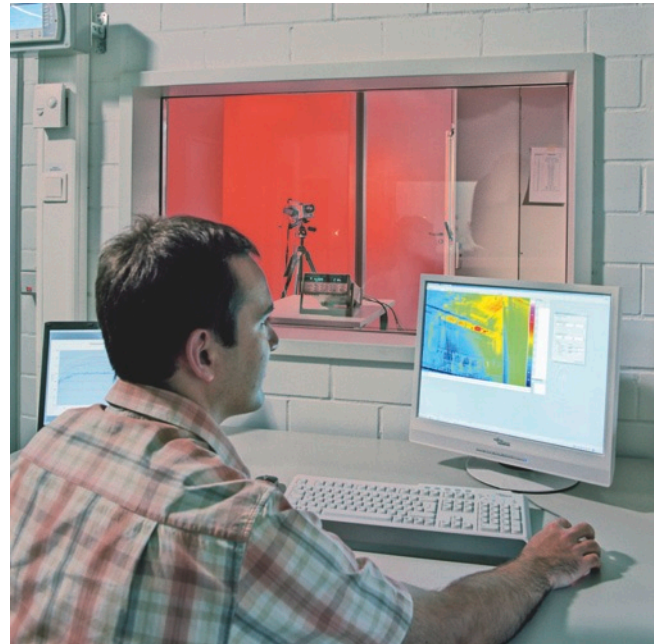

Testing in the heat laboratory

**Production at a high level of quality**

Complete equipment is manufactured at a high industrial level. This means:

- Examining consistency of the order documentation
- Checking for adherence to current regulations
- Collision check in 3D layout, taking into account the free space required thermally and electrically
- Automatic preparation of enclosures, cables and cable bundles
- Automated inspection and shipment free of faults
- Documentation and traceability
- Declaration of conformity regarding the Low-Voltage Directive and manufacturer's declaration regarding the Machinery Directive
- UL label on request

**Superior logistics**

Everything from a single source offers you the following advantages:

- Cost savings for procurement, stockkeeping, financing
- Reduction in throughput times
- Just-in-time delivery

**Individual support and maximum flexibility**

Our technical consultants for complete equipment support customers and sales departments in the various regions. Our control cabinet customers are supported in the Systems Engineering Plant Chemnitz (WKC) by ordering centers and production teams that are permanently assigned to customers.

Distance does not present a problem; we also use web cams for consulting our customers.

## Lifecycle Services

### Control cabinets

#### Overview

#### Overview (continued)



Worldwide repair service

Customer-specific logistics models, flexible production capacity and production areas as well as change management in all process phases ensure maximum flexibility.

#### **Customized supplementary products**

As part of its complete equipment program, Siemens also offers the development and construction of customized supplementary products, e.g. special operator panels and power supply systems.

#### **Liability for defects**

Of course we accept the same liability for defects for our complete equipment as for our SIMOTION, SINUMERIK and SINAMICS products.

Furthermore, you can use our worldwide repair service anywhere and at any time.

#### **Your benefits**

One partner, one quotation, one order, one delivery, one invoice, and one contact partner for liability of defects.

For series production or individual items, Siemens is your competent partner for complete equipment.

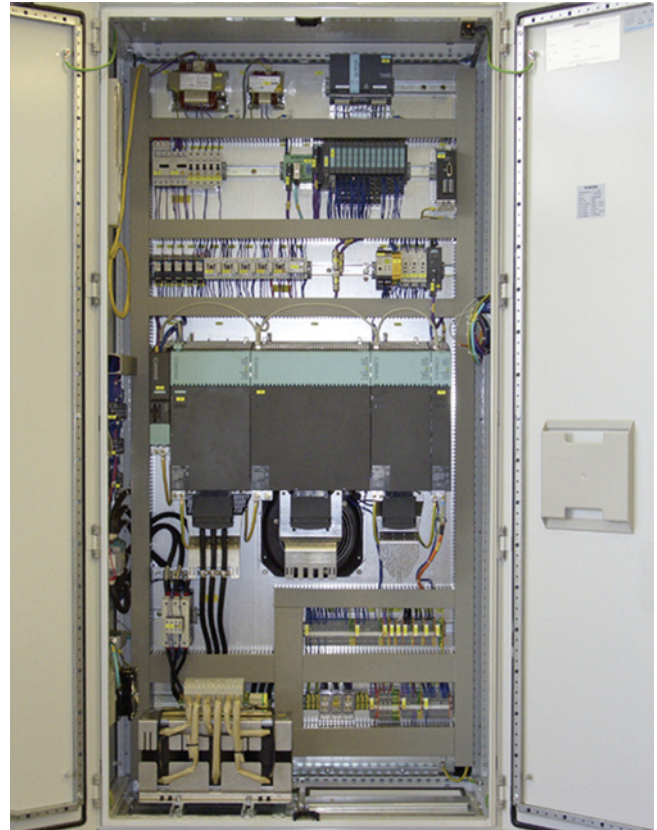

Control cabinet with SINAMICS S120 in booksize format



### **Your benefit from practical training directly from the manufacturer**

SITRAIN – Training for Industry – provides you with comprehensive support in solving your tasks.

Training directly from the manufacturer enables you to make correct decisions with confidence.

### **Increased profits and lower costs:**

- Shorter times for commissioning, maintenance and servicing
- Optimized production operations
- Reliable configuration and startup
- Shorten commissioning times, reduce downtimes, and faster troubleshooting
- Exclude expensive faulty planning right from the start.
- Flexible plant adaptation to market requirements
- Compliance with quality standards in production
- Increased employee satisfaction and motivation
- Shorter familiarization times following changes in technology and staff

### **Contact**

Visit our site on the Internet at:  
[www.siemens.com/sitrain](http://www.siemens.com/sitrain)

or let us advise you personally. You can request our latest training catalog from:

**SITRAIN – Training for Industry**  
**SITRAIN Customer Support Germany:**

Tel.: +49 911 895-7575

Fax: +49 911 895-7576

Email: [info@sitrain.com](mailto:info@sitrain.com)

### **Your benefits with SITRAIN – Training for Industry**

#### Certified top trainers

Our trainers are skilled specialists with practical experience. Course developers have close contact with product development, and pass on their knowledge to the trainers and then to you.

#### Practical application with practice

Practice, practice, practice! We have designed the trainings with an emphasis on practical exercises. They take up to half of the course time in our trainings. You can therefore implement your new knowledge in practice even faster.

#### 300 courses in more than 60 countries

We offer a total of about 300 classroom-based courses. You can find us at more than 50 locations in Germany, and in 62 countries worldwide. You can find which course is offered at which location at:

[www.siemens.com/sitrain](http://www.siemens.com/sitrain)

#### Skills development

Do you want to develop skills and fill in gaps in your knowledge? Our solution: We will provide a program tailored exactly to your personal requirements. After an individual requirements analysis, we will train you in our training centers near you or directly at your offices. You will practice on the most modern training equipment with special exercise units. The individual training courses are optimally matched to each other and help with the continuous development of knowledge and skills. After finishing a training module, the follow-up measures make success certain, as well as the refreshment and deepening of the knowledge gained.

## Lifecycle Services

### SITRAIN – Training for Industry

#### SIMOTION training courses

##### Overview

##### Training courses for SIMOTION Motion Control System



The SITRAIN training courses for SIMOTION offer a broad spectrum of courses that makes users fit for their tasks in project engineering, commissioning and maintenance. The standard courses are offered in Nuremberg-Moorenbrunn or also somewhere close to you. We also offer customer-specific courses in our training centers or at the customer site.

The practical exercises are based on the course content and are performed on specially developed and well-equipped training devices.

You will find further information about course contents and dates in Catalog ITC and on the Internet.

Title	Target group			Duration	Course code
(all courses are available in English and German)	Planners, decision- makers, sales personnel	Commissioning engineers, programmers	Service personnel, maintenance personnel		
SIMOTION System and Programming Course	–	✓	✓	5 days	MC-SMO-SYS
SIMOTION Programming Course	–	✓	–	5 days	MC-SMO-PRG
SIMOTION and SINAMICS S120 Diagnostics and Service	–	–	✓	5 days	MC-SMO-DG



### Overview

#### Training courses for SINAMICS S120 drive system



This provides an overview of the training courses available for the SINAMICS S120 drive system.

The courses are modular in design and are directed at a variety of target groups as well as individual customer requirements.

The system overview will acquaint decision-makers and sales personnel with the system very quickly.

The configuration course provides all the information you need to configure the drive system.

The courses dedicated to diagnostics and servicing, parameterization and commissioning, as well as extended functions such as Safety Integrated are sure to provide all the technical knowledge service engineers will need.

All courses contain as many practical exercises as possible to enable intensive and direct training on the drive system and with the tools in small groups.

Please also take note of the training options available for SIMOTICS motors. You will find further information about course contents and dates in Catalog ITC and on the Internet.

Title	Target group			Duration	Course code
(all courses are available in English and German)	Planners, decision-makers, sales personnel	Commissioning engineers, configuring engineers	Service personnel, maintenance personnel		
SINAMICS and SIMOTICS - Basics of Drive Technology	✓	✓	✓	5 days	DR-GAT
SINAMICS and SIMOTICS System Overview	✓	–	–	3 days	DR-SYS
SINAMICS S120 Designing and Engineering	✓	–	–	5 days	DR-S12-PL
SINAMICS S120 Parameterizing and Commissioning	–	✓	–	5 days	DR-S12-PM
SINAMICS S120 Parameterizing Advanced	–	✓	–	5 days	DR-S12-PA
SINAMICS S120 Parameterizing and Optimization	–	✓	–	3 days	DR-S12-OPT
SINAMICS S120 Parameterizing Safety Integrated	–	✓	–	4 days	DR-S12-SAF
SINAMICS S120 Diagnostics and Service	–	–	✓	5 days	DR-S12-DG
SINAMICS S120 Diagnostics at Chassis and Cabinet Units	–	✓	✓	3 days	DR-S12-CHA
SINAMICS Diagnostics PROFINET and PROFIBUS	–	✓	✓	3 days	DR-S12-NET

## Lifecycle Services

SITRAIN – Training for Industry

### SIMOTION D425-2 DP/PN training case

#### Application



SIMOTION D425-2 DP/PN training case

The training case can be used for training in the SIMOTION D Motion Control System. It is also suitable for testing purposes in the laboratory.

#### Design

- Case optimized in terms of weight and volume
- Set up complete with castors and ready for connection
- Regenerative feedback not possible
- Drive system comprising:
  - SIMOTION D425-2 DP/PN controller with TB30 Terminal Board
  - Smart Line Module 5 kW (training version)
  - Double Motor Module 3/3 A
  - SIMOTICS 1FK7022-5AK71-1AG3 synchronous servomotor with incremental encoder sin/cos  $1 V_{pp}$  via SMC20
  - SIMOTICS 1FK7022-5AK71-1LG3 synchronous servomotor with IC2048S/R absolute encoder and DRIVE-CLiQ interface
  - Reference disks for position monitoring and zero mark
- Control box for setpoint/actual-value linking via terminals
- Prepared connection option for external motors (e.g. asynchronous motor)
- Intermediate connector for quick connection of a CU320-2 in lateral mounting bracket

The training case is supplied ready-to-use with a demo project and MultiAxes Package license on CompactFlash card and documentation. The scope of supply includes the SCOUT and SCOUT TIA engineering software.

#### Technical specifications

Training case SIMOTION D425-2 DP/PN	6ZB2470-0AL00
Degree of protection according to DIN VDE 0470 Part 1/ EN 60529/IEC 529	IP20
Supply voltage <sup>1)</sup>	230 V 1 AC/50 Hz via line adapter 115 V 1 AC (USA, not included in scope of supply)
Dimensions (W × H × D) in mm (in)	320 × 650 × 330 (12.60 × 25.59 × 12.99 in)
Weight, approx.	34 kg (75 lb)

<sup>1)</sup> The connection conditions of the respective network operator shall be observed.

#### Selection and ordering data

Description	Article No.
<b>SIMOTION D425-2 DP/PN training case</b>	<b>6ZB2470-0AL00</b>
<u>TK-SIM-D425-2</u> CompactFlash card with demo project, MultiAxes Package license for D425-2, SIMOTION SCOUT/SCOUT TIA	

**Overview**

SINAMICS S120 training case with CU320-2 Control Unit

The SINAMICS S120 training case is used to teach students to use and understand the SINAMICS S120 drive system. It is suitable for direct customer presentations as well as for tests in technical departments. The SIMOTION D425-2 DP/PN upgrade kit can be used to convert the SINAMICS S120 training case to a SIMOTION D training case.

The case is optimized in terms of weight and volume and is assembled complete with castors and ready for connection. It contains the following components:

- SINAMICS CU320-2 DP or CU320-2 PN Control Unit with TB30 Terminal Board
- SINAMICS Smart Line Module 5 kW
- SINAMICS Double Motor Module 3 A
- SIMOTICS 1FK7022-5AK71-1AG3 synchronous servomotor with incremental encoder sin/cos 1 V<sub>pp</sub> via SMC20
- SIMOTICS 1FK7022-5AK71-1LG3 synchronous servomotor with IC2048S/R absolute encoder and DRIVE-CLiQ interface
- Reference discs for position monitoring
- Control box for setpoint/actual-value linking via terminals
- Prefabricated connections for an external motor (e.g. asynchronous motor)

The SINAMICS S120 training case is supplied ready-to-use with a demo project on the CompactFlash card and documentation.

**Technical specifications**

<b>SINAMICS S120 training case</b>	<b>6ZB2480-0CM00</b> <b>6ZB2480-0CN00</b>
Supply voltage	230 V 1 AC 50 Hz 115 V 1 AC 60 Hz with line adapter (not included in scope of supply)
Degree of protection	IP20
Dimensions	
• Width	320 mm (12.60 in)
• Height	650 mm (25.59 in)
• Depth	330 mm (12.99 in)
Weight, approx.	30 kg (66 lb)

**Selection and ordering data**

Description	Article No.
<b>SINAMICS S120 training case</b>	
• PROFIBUS variant with SINAMICS CU320-2 DP Control Unit	<b>6ZB2480-0CM00</b>
• PROFINET variant with SINAMICS CU320-2 PN Control Unit	<b>6ZB2480-0CN00</b>
<b>Accessories</b>	
<b>SIMOTION D425-2 DP/PN upgrade kit</b>	<b>6ZB2470-0AM00</b>
<b>Operator control box</b>	<b>6AG1064-1AA01-0AA0</b>

## Lifecycle Services

SITRAIN – Training for Industry

### SIMOTION D425-2 DP/PN upgrade kit

#### Application

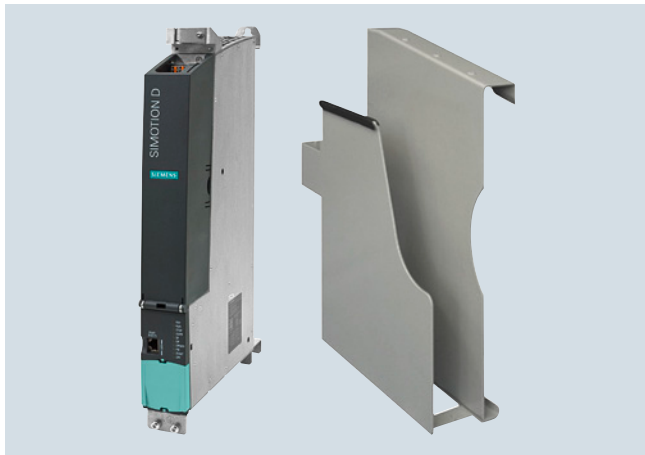

SIMOTION D425-2 DP/PN upgrade kit

The SIMOTION D425-2 DP/PN upgrade kit is designed for easy conversion of the SINAMICS S120 training case for teaching students to use and understand the SIMOTION D Motion Control System.

It is also suitable for testing purposes in the laboratory.

#### Design

The upgrade kit consists of:

- SIMOTION D425-2 DP/PN Control Unit with TB30 Terminal Board
- Mounting bracket
- CompactFlash card with MultiAxes Package license D425-2
- The scope of supply includes the SCOUT and SCOUT TIA engineering software.

#### Selection and ordering data

Description	Article No.
<b>SIMOTION D425-2 DP/PN upgrade kit</b>	<b>6ZB2470-0AM00</b>
for training case 6ZB2480-0CM00 or 6ZB2480-0CN00 with CompactFlash card and MultiAxes Package license for D425-2 and SIMOTION SCOUT/SCOUT TIA	

### Unique support for educators and students in educational institutions

Cooperates  
with Education

Automation

SIEMENS

#### Siemens Automation Cooperates with Education (SCE)

offers a global system for sustained support of technical skills. SCE supports educational institutions in their teaching assignment in the industrial automation sector and offers added value in the form of partnerships, technical expertise, and know-how. As the technological leader, our comprehensive range of services can support you in the knowledge transfer for Industry 4.0.

#### Our services at a glance

- Training curriculums for your lessons
- Trainer packages for hands-on learning
- Courses convey up-to-date specialist knowledge
- Support for your projects / textbooks
- Complete didactic solutions from our partners
- Personal contact for individual support

#### Training curriculums for your lessons



Use our profound industrial know-how for practice-oriented and individual design of your course. We offer you more than 100 didactically prepared training curriculums on the topics of automation and drives technology free of charge. These materials are perfectly matched to your curricula and syllabuses, and optimally suited for use with our trainer packages. This takes into account all aspects of a modern industrial solution: installation, configuration, programming, and commissioning. All documents, including projects, can be individually matched to your specific requirements.

#### Particular highlights:

- The new SIMATIC PCS 7 curriculums and trainer packages. Using plant simulation, you can pass on basic, practice-oriented PCS 7 knowledge at universities within about 60 hours (= 1 semester).
- The new TIA Portal training materials for SIMATIC S7-1500 / S7-1200 / S7-300 are available in English, German, French, Italian, Spanish, Portuguese and Chinese for download.

[www.siemens.com/sce/curriculums](http://www.siemens.com/sce/curriculums)

#### Trainer packages for hands-on learning



Our SCE trainer packages offer a specific combination of original industrial components which are perfectly matched to your requirements and can be conveniently used in your course. These price-reduced bundles available exclusively to schools include innovative and flexible hardware and software packages.

SCE currently offers more than 80 SCE trainer packages including related equipment e.g. Micro Memory. These cover both the factory and process automation sectors. You can use them to impart the complete course contents on industrial automation at a very low cost.

#### Trainer packages are available for:

- Introduction to automation technology with LOGO! logic module
- PLC engineering with SIMATIC S7 hardware and STEP 7 software (S7-1500, S7-1200, S7-300 and TIA Portal)
- Operator control and monitoring with SIMATIC HMI
- Industrial networking over bus systems with SIMATIC NET (PROFINET, PROFIBUS, IO-Link)
- Sensor systems with VISION, RFID and SIWAREX
- Process automation with SIMATIC PCS 7
- Networked drive and motion technologies with SINAMICS/SIMOTION
- Power Monitoring Devices SENTRON PAC 4200
- Motor Management SIMOCODE
- CNC programming with SinuTrain

#### Important ordering notes:

Only the following institutions are authorized to obtain trainer packages: vocational schools, Colleges and Universities, in-house vocational training departments, non commercial research institutions and non commercial training departments.

To purchase a trainer package, you require a specific end-use certificate, which you can obtain from your regional sales office.

[www.siemens.com/sce/tp](http://www.siemens.com/sce/tp)

## Lifecycle Services

### Siemens Automation Cooperates with Education

#### Simplify your education in automation

#### Unique support for educators and students in educational institutions (continued)

##### **Courses convey up-to-date specialist knowledge**



Profit from our excellent know-how as the leader in industrial technologies. We offer you specific courses for automation and drive technology worldwide. These support you in the practice-oriented transferring of product and system know-how, are in conformance with curriculums, and derived from the training fields. Compact technical courses especially for use at universities are also available.

Our range of courses comprises a wide variety of training modules based on the principle of Totally Integrated Automation (TIA). The focus is on the same subject areas as with the SCE trainer packages.

Every PLC and drive course is oriented on state-of-the-art technology. Your graduates can thus be prepared optimally for their future professional life.

In some countries we are offering classes based on our training curriculums. Please inquire with your SCE contact partner.

[www.siemens.com/sce/courses](http://www.siemens.com/sce/courses)

##### **Support for your projects/textbooks**



Automation and drive technology is characterized by continuous and rapid developments. Service and Support therefore play an important role.

We can provide you with consulting for selected projects and support from your personal SCE contact as well as our web-based and regional Customer Support.

As a particular service, SCE supports technical authors with our know-how as well as with intensive technical consulting. Siemens library of special textbooks covering the industrial automation sector provides an additional resource for you and your students. These can be found at the SCE web site.

[www.siemens.com/sce/contact](http://www.siemens.com/sce/contact)  
[www.siemens.com/sce/books](http://www.siemens.com/sce/books)

##### **Complete didactic solutions from our partners**



Our partners for learning systems offer a wide range of training systems and solutions for use in your courses or laboratory.

These models have been designed based on our trainer packages and thus save you the time and cost of selfconstruction of individual components. The Partner systems provide you with simple and effective help in the fulfillment of your teaching assignment.

[www.siemens.com/sce/partner](http://www.siemens.com/sce/partner)

##### **Contact for individual support**

You can find your personal SCE contact on our Internet site. Your local SCE Promoter will answer all your questions concerning the complete SCE offering, and provide you with timely and competent information about innovations. When you encounter challenges, you can profit from our global team of excellence.

If a direct SCE contact is not listed for your country, please contact your local Siemens office.

[www.siemens.com/sce/contact](http://www.siemens.com/sce/contact)

##### **SCE Support Finder for your Internet request**

You are an educator and need support on the topic of industry automation? Send us your request:

[www.siemens.com/sce/supportfinder](http://www.siemens.com/sce/supportfinder)

Discover  
SCE



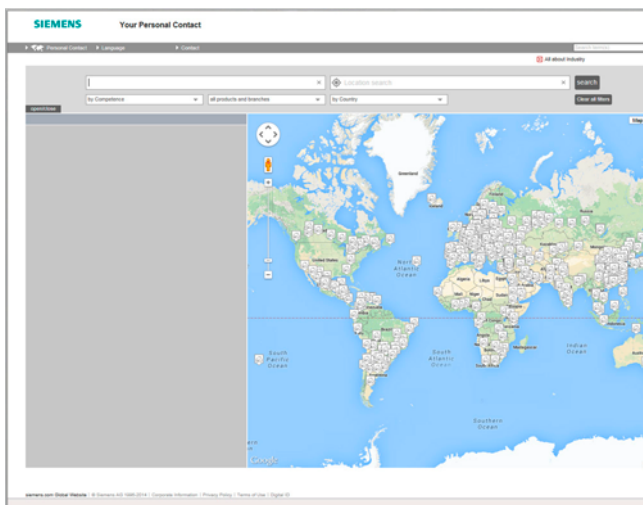

At Siemens we are resolutely pursuing the same goal: long-term improvement of your competitive ability. We are committed to this goal. Thanks to our commitment, we continue to set new standards in automation and drive technology. In all industries – worldwide.

At your service locally, around the globe for consulting, sales, training, service, support, spare parts ... on the entire Digital Factory and Process Industries and Drives.

Your personal contact can be found in our Contacts Database at: [www.siemens.com/automation-contact](http://www.siemens.com/automation-contact)

You start by selecting

- the required competence,
- products and branches,
- a country,
- a city

or by a

- location search or
- person search.

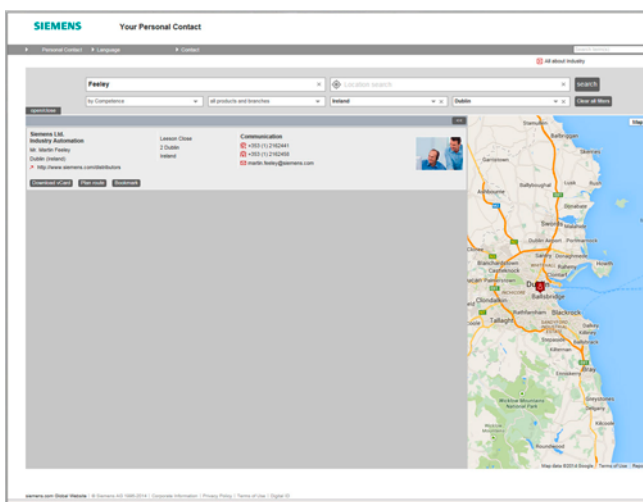
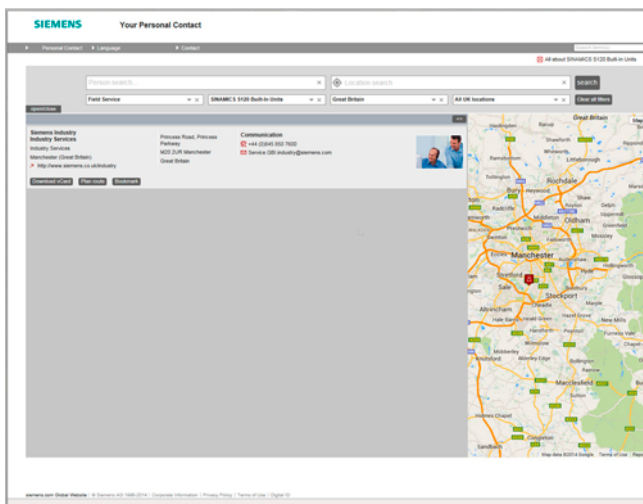

## Lifecycle Services

### Online Services

#### Information and Ordering Options on the Internet and DVD

##### The Future of Manufacturing on the Internet



Detailed knowledge of the range of products and services available is essential when planning and engineering automation systems. It goes without saying that this information must always be as up-to-date as possible.

Industry is on the threshold of the fourth industrial revolution as digitization now follows after the automation of production. The goals are to increase productivity and efficiency, speed, and quality. In this way, companies can remain competitive on the path to the future of industry.

You will find everything you need to know about products, systems and services on the internet at:

[www.siemens.com/industry](http://www.siemens.com/industry)

##### Product Selection Using the Interactive CA 01 Automation and Drives Catalog

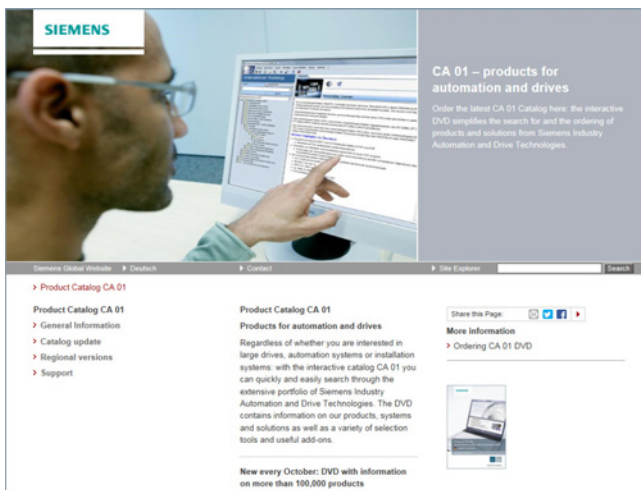

Detailed information together with user-friendly interactive functions:

The CA 01 interactive catalog covers more than 100000 products, thus providing a comprehensive overview of the product range provided by Siemens.

You will find everything you need here for solving tasks in the fields of automation, switching, installation and drives. All information is provided over a user interface that is both user-friendly and intuitive.

You can order the CA 01 product catalog from your Siemens sales contact or in the Information and Download Center:

[www.siemens.com/industry/infocenter](http://www.siemens.com/industry/infocenter)

Information about the CA 01 interactive catalog can be found on the Internet at:

[www.siemens.com/automation/ca01](http://www.siemens.com/automation/ca01)

or on DVD.

##### Easy Shopping with the Industry Mall

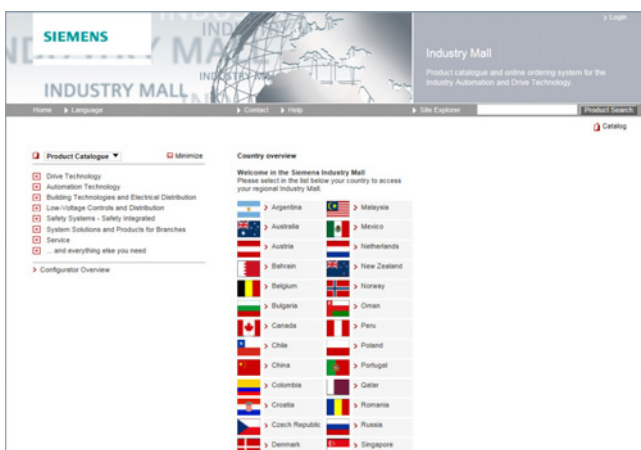

The Industry Mall is the electronic ordering platform of Siemens AG on the Internet. Here you have online access to a huge range of products presented in an informative and attractive way.

Data transfer via EDIFACT allows the whole procedure, from selection through ordering to tracking and tracing, to be carried out online. Availability checks, customer-specific discounts and bid creation are also possible.

Numerous additional functions are provided for your support. For example, powerful search functions make it easy to select the required products. Configurators enable you to configure complex product and system components quickly and easily. CAx data types are also provided here.

You can find the Industry Mall on the Internet at:

[www.siemens.com/industrymall](http://www.siemens.com/industrymall)

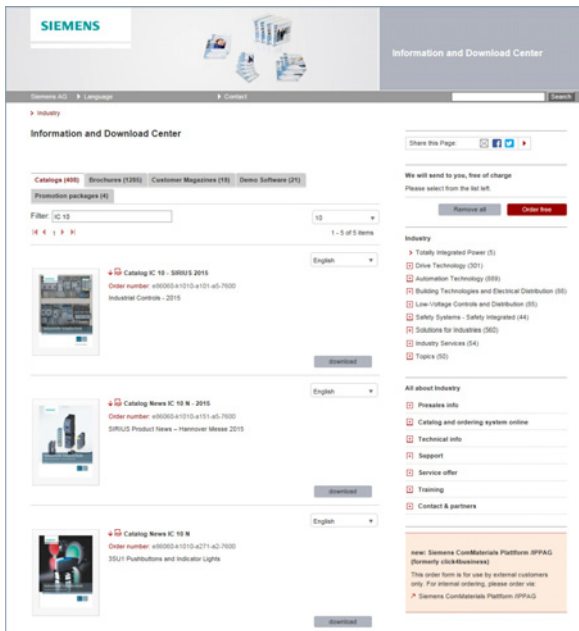

**Downloading Catalogs**

In addition to numerous other useful documents, you can also find the catalogs listed on the back inside cover of this catalog in the Information and Download Center. You can download these catalogs in PDF format without having to register.

The filter dialog above the first catalog displayed makes it possible to carry out targeted searches. If you enter "MD 3" for example, you will find both the MD 30.1 and MD 31.1 catalogs. If you enter "IC 10", both the IC 10 catalog and the associated news or add-ons are displayed.

Visit us at:

[www.siemens.com/industry/infocenter](http://www.siemens.com/industry/infocenter)

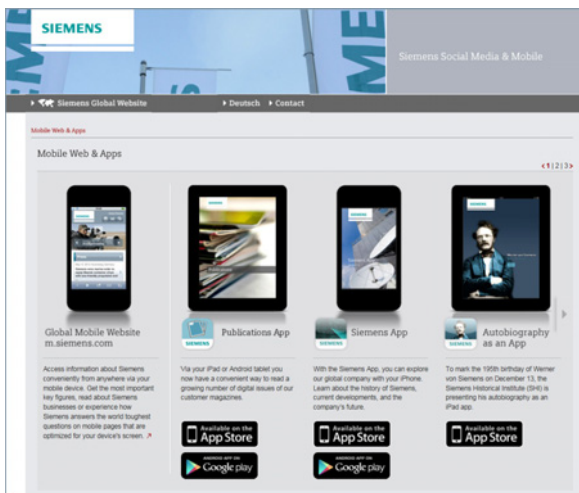
**Social and Mobile Media**

Connect with Siemens through social media: visit our social networking sites for a wealth of useful information, demos on products and services, the opportunity to provide feedback, to exchange information and ideas with customers and other Siemens employees, and much, much more. Stay in the know and follow us on the ever-expanding global network of social media.

To find out more about Siemens' current social media activities, visit us at:

[www.siemens.com/socialmedia](http://www.siemens.com/socialmedia)

Or via our product pages at:

[www.siemens.com/automation](http://www.siemens.com/automation) or [www.siemens.com/drives](http://www.siemens.com/drives)

Connect with Siemens Industry at our central access point to read all the news on the future of manufacturing, watch current videos and inform yourself about all the latest industry developments:

[www.siemens.com/future-of-manufacturing/news.html](http://www.siemens.com/future-of-manufacturing/news.html)

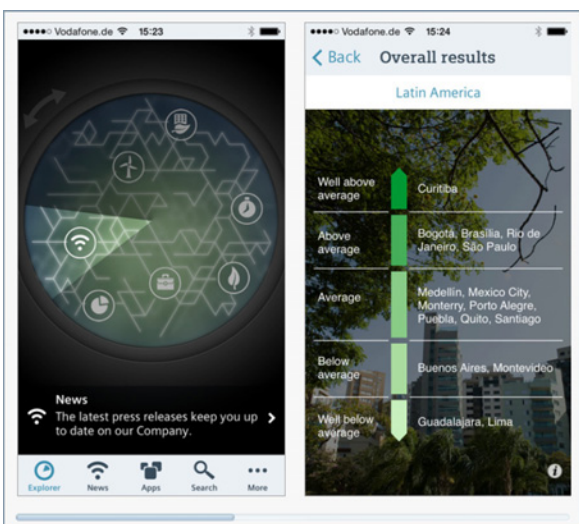

Discover the world of Siemens.

We are also constantly expanding our offering of cross-platform apps for smartphones and tablets. You will find the current Siemens apps at the App Store (iOS) or at Google Play (Android):

<https://itunes.apple.com/en/app/siemens/id452698392?mt=8>

<https://play.google.com/store/search?q=siemens>

The Siemens app, for example, tells you all about the history, latest developments and future plans of the company – with informative pictures, fascinating reports and the most recent press releases.

## Lifecycle Services

### Industry Services

#### Overview

#### Overview

**Unleash potential – with Siemens services**

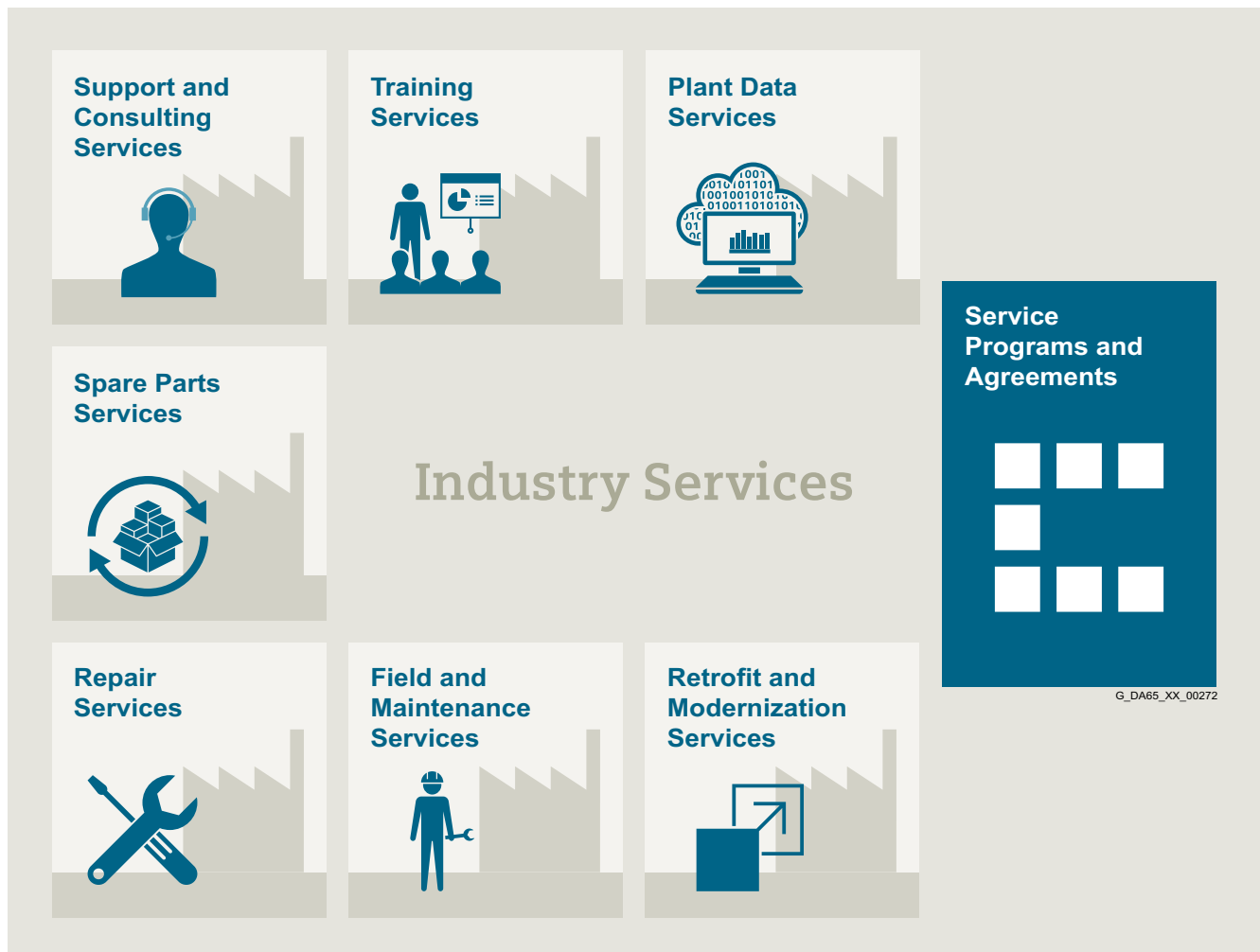

#### **Increase your performance – with Industry Services**

Optimizing the productivity of your equipment and operations can be a challenge, especially with constantly changing market conditions. Working with our service experts makes it easier. We understand your industry's unique processes and provide the services needed so that you can better achieve your business goals.

You can count on us to maximize your uptime and minimize your downtime, increasing your operations' productivity and reliability. When your operations have to be changed quickly to meet a new demand or business opportunity, our services give you the flexibility to adapt. Of course, we take care that your production is protected against cyber threats. We assist in keeping your operations as energy and resource efficient as possible and reducing your total cost of ownership. As a trendsetter, we ensure that you can capitalize on the opportunities of digitalization and by applying data analytics to enhance decision making: You can be sure that your plant reaches its full potential and retains this over the longer lifespan.

You can rely on our highly dedicated team of engineers, technicians and specialists to deliver the services you need – safely, professionally and in compliance with all regulations. We are there for you, where you need us, when you need us.

**Overview**
**Plant Data Services**

Make your industrial processes transparent to gain improvements in productivity, asset availability, and energy efficiency.

Production data is generated, filtered and translated with intelligent analytics to enhance decision-making.

This is done whilst taking data security into consideration and with continuous protection against cyber attack threats.

[www.industry.siemens.com/services/global/en/portfolio/plant-data-services/pages/index.aspx](http://www.industry.siemens.com/services/global/en/portfolio/plant-data-services/pages/index.aspx)

**Support and Consulting Services**

**Industry Online Support** site for comprehensive information, application examples, FAQs and support requests.

**Technical and Engineering Support** for advice and answers for all inquiries about functionality, handling, and fault clearance.

**Information & Consulting Services**, e.g. System Audit; clarity about the state and service capability of your automation system or Lifecycle Information Services; transparency on the lifecycle of the products in your plants.

[www.industry.siemens.com/services/global/en/portfolio/support-consulting/pages/index.aspx](http://www.industry.siemens.com/services/global/en/portfolio/support-consulting/pages/index.aspx)

**Training Services**

From the basics and advanced to specialist skills, SITRAIN courses provide expertise right from the manufacturer – and encompass the entire spectrum of Siemens products and systems for the industry.

Worldwide, SITRAIN courses are available wherever you need a training course in more than 170 locations in over 60 countries.

[www.industry.siemens.com/services/global/en/portfolio/training/pages/index.aspx](http://www.industry.siemens.com/services/global/en/portfolio/training/pages/index.aspx)

**Spare Parts Services**

Are available worldwide for smooth and fast supply of spare parts – and thus optimal plant availability. Genuine spare parts are available for up to ten years. Logistic experts take care of procurement, transport, custom clearance, storage and order management. Reliable logistics processes ensure that components reach their destination as needed.

Asset optimization services help you design a strategy for parts supply where your investment and carrying costs are reduced and the risk of obsolescence is avoided.

[www.industry.siemens.com/services/global/en/portfolio/spare\\_parts/pages/index.aspx](http://www.industry.siemens.com/services/global/en/portfolio/spare_parts/pages/index.aspx)

## Lifecycle Services

### Industry Services

#### Portfolio

#### Overview (continued)

##### Repair Services



Are offered on-site and in regional repair centers for fast restoration of faulty devices' functionality.

Also available are extended repair services, which include additional diagnostic and repair measures, as well as emergency services.

[www.industry.siemens.com/services/global/en/portfolio/repair\\_services/pages/index.aspx](http://www.industry.siemens.com/services/global/en/portfolio/repair_services/pages/index.aspx)

##### Retrofit and Modernization Services



Provide a cost-effective solution for the expansion of entire plants, optimization of systems, or upgrading existing products to the latest technology and software, e.g. migration services for automation systems.

Service experts support projects from planning through commissioning and, if desired over the entire extended lifespan, e.g. Retrofit for Integrated Drive Systems for an extended lifetime of your machines and plants.

[www.industry.siemens.com/services/global/en/portfolio/retrofit-modernization/pages/index.aspx](http://www.industry.siemens.com/services/global/en/portfolio/retrofit-modernization/pages/index.aspx)

##### Field and Maintenance Services

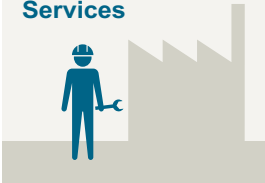

Siemens specialists are available globally to provide expert field and maintenance services, including commissioning, functional testing, preventive maintenance and fault clearance.

All services can be included in customized service agreements with defined reaction times or fixed maintenance intervals.

[www.industry.siemens.com/services/global/en/portfolio/field\\_service/pages/index.aspx](http://www.industry.siemens.com/services/global/en/portfolio/field_service/pages/index.aspx)

##### Service Programs and Agreements

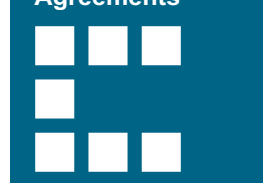

A technical Service Program or Agreement enables you to easily bundle a wide range of services into a single annual or multi-year agreement.

You pick the services you need to match your unique requirements or fill gaps in your organization's maintenance capabilities.

Programs and agreements can be customized as KPI-based and/or performance-based contracts.

[www.industry.siemens.com/services/global/en/portfolio/service\\_programs/pages/index.aspx](http://www.industry.siemens.com/services/global/en/portfolio/service_programs/pages/index.aspx)

**Overview**

Online Support is a comprehensive information system for all questions relating to products, systems, and solutions that Siemens has developed for industry over time. With more than 300,000 documents, examples and tools, it offers users of automation and drive technology a way to quickly find up-to-date information. The 24-hour service enables direct, central access to detailed product information as well as numerous solution examples for programming, configuration and application.

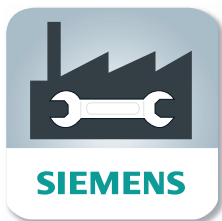
**Online Support app**

Using the Online Support app, you can access over 300,000 documents covering all Siemens industrial products – anywhere, any time. Regardless of whether you need help implementing your project, fault-finding, expanding your system or are planning a new machine.

You have access to FAQs, manuals, certificates, characteristic curves, application examples, product notices (e.g. announcements of new products) and information on successor products in the event that a product is discontinued.

Just scan the product code printed on the product directly using the camera of your mobile device to immediately see all technical information available on this product at a glance. The graphical CAx information (3D model, circuit diagrams or EPLAN macros) is also displayed. You can forward this information to your workplace using the e-mail function.

The search function retrieves product information and articles and supports you with a personalized suggestion list. You can find your favorite pages – articles you need frequently – under "mySupport". You also receive selected news on new functions, important articles or events in the News section.

The content, in six languages, is increasingly multimedia-based – and now also available as a mobile app. Online support's "Technical Forum" offers users the opportunity to share information with each other. The "Support Request" option can be used to contact Siemens' technical support experts. The latest content, software updates, and news via newsletters and Twitter ensure that industry users are always up to date.

[www.siemens.com/industry/onlinesupport](http://www.siemens.com/industry/onlinesupport)

Scan the QR code  
for information on  
our Online Support  
app.



The app is available free of charge in the Apple App Store (iOS) or in the Google Play Store (Android).

<https://support.industry.siemens.com/cs/ww/en/sc/2067>

## Lifecycle Services

### Notes

## Appendix



<b>8/2</b>	<b>Certificates of suitability</b>
8/2	Certificates of suitability (approvals)
<b>8/4</b>	<b>Notes on software</b>
8/4	Information on software licensing
8/5	Usage and copy rights
<b>8/6</b>	<b>Indexes</b>
8/6	Subject index
8/13	Article number index
<b>8/14</b>	<b>Conversion tables</b>
<b>8/16</b>	<b>Conditions of sale and delivery</b>

## Appendix

### Certificates of suitability

#### Certificates of suitability (approvals)







##### Overview

Many of the products in this catalog fulfill requirements, e.g. for UL, CSA or FM and are labeled with the corresponding approval designation.

All certificates of suitability, approvals, certificates, declarations of conformity, test certificates, e.g. CE, UL, Safety Integrated etc. have been performed with the associated system components as they are described in the Configuration Manuals.

The certificates are only valid if the products are used with the described system components, are installed according to the Installation Guidelines and are used for their intended purpose.

In other cases, the vendor of these products is responsible for arranging for new certificates to be issued.

Test symbol	Tested by	Device series/component	Test standard	Product category/File No.
<b>UL: Underwriters Laboratories Independent public testing body in North America</b>				
	UL according to UL standard	SINUMERIK	Standard UL 508, CSA C22.2 No. 142	NRAQ/7.E164110 NRAQ/7.E217227
		SIMOTION	Standard UL 508, CSA C22.2 No. 142	NRAQ/7.E164110
	UL according to CSA standard	SINAMICS	Standard UL 508, 508C, 61800-5-1 CSA C22.2 No. 142, 274	NRAQ/7.E164110, NMMS/2/7/8.E192450, NMMS/2/7/8.E203250, NMMS/7.E214113, NMMS/7.E253831
				NMMS/2/7/8.E121068 NMMS/7.E355661 NMMS/7.E323473
	UL according to UL and CSA standards			
	UL according to UL standard	SIMODRIVE	Standard UL 508C, CSA C22.2 No. 274	NMMS/2/7/8.E192450 NMMS/7.E214113
		Motors	Standard UL 1004-1, 1004-6, 1004-8, CSA C22.2 No. 100	PRGY2/8.E227215 PRHZ2/8.E93429 PRHJ2/8.E342747 PRGY2/8.E253922 PRHZ2/8.E342746
	UL according to CSA standard			
	UL according to UL and CSA standards	Line/motor reactors	Standard UL 508, 506, 5085-1, 5085-2, 1561, CSA C22.2 No. 14, 47, 66.1-06, 66.2-06	XQNX2/8.E257859 NMTR2/8.E219022 NMMS2/8.E333628 XPTQ2/8.E257852 XPTQ2/8.E103521 NMMS2/8.E224872 XPTQ2/8.E354316 XPTQ2/8.E198309 XQNX2/8.E475972
		Line filters, dv/dt filters, sine-wave filters	UL 1283, CSA C22.2 No. 8	FOKY2/8.E70122
		Resistors	UL 508, 508C, CSA C22.2 No. 14, 274	NMTR2/8.E224314 NMMS2/8.E192450 NMTR2/8.E221095 NMTR2/8.E226619





**TUV: TÜV Rheinland of North America Inc.  
Independent public testing body in North America, Nationally Recognized Testing Laboratory (NRTL)**

**TÜV: TÜV SÜD Product Service  
Independent public testing body in Germany, Nationally Recognized Testing Laboratory (NRTL) for North America**

	TUV according to UL and CSA standards	SINAMICS	NRTL Listing according to standard UL 508C	U7V 12 06 20078 013 U7 11 04 20078 009 U7 11 04 20078 010 U7 11 04 20078 011
		SIMOTION	NRTL Listing according to standard UL 508	U7V 13 03 20078 01
		SIMODRIVE	NRTL Listing according to standard UL 508C, CSA C22.2. No. 14	CU 72090702
		Motion Control Encoder	NRTL Listing according to UL 61010-1 CSA C22.2 No. 61010-1	U8V 10 06 20196 024



#### Overview (continued)

Test symbol	Tested by	Device series/component	Test standard	Product category/File No.
<b>CSA: Canadian Standards Association</b> Independent public testing body in Canada				
	CSA according to CSA standard	SINUMERIK	Standard CSA C22.2 No. 142	2252-01 : LR 102527
<b>FMRC: Factory Mutual Research Corporation</b> Independent public testing body in North America				
	FM according to FM standard	SINUMERIK	Standard FMRC 3600, FMRC 3611, FMRC 3810, ANSI/ISA S82.02.1	–
<b>EAC: Ivanovo Certificate</b> Independent public testing body in the Russian Federation				
	EAC according to EAC Directive	SINAMICS	Standard IEC 61800-5-1 /-2, IEC 61800-3	–
		SINUMERIK	Standard IEC 61800-5-1 /-2, IEC 61800-3	–
		SIMOTION	Standard IEC 61800-5-1 /-2, IEC 61800-3	–
<b>RCM: Australian Communications and Media Authority</b> Independent public testing body in Australia				
	RCM according to EMC standard	SINAMICS	Standard IEC AS 61800-3, EN 61800-3	–
		SINUMERIK	Standard IEC AS 61800-3, EN 61800-3	–
		SIMOTION	Standard IEC AS 61800-3, EN 61800-3	–
<b>KC: National Radio Research Agency</b> Independent public testing body in South Korea				
	KC according to EMC standard	SINAMICS	Standard KN 11	–
		SINUMERIK	Standard KN 11	–
		SIMOTION	Standard KN 11	–
<b>BIA</b> Federal Institute for Occupational Safety				
–	Functional safety	SINAMICS	Standard EN 61800-5-2	–
		SINUMERIK	Standard EN 61800-5-2	–
		SIMOTION	Standard EN 61800-5-2	–
<b>TÜV SÜD Rail</b>				
–	Functional safety	SINAMICS	Standard EN 61800-5-2	–
		SINUMERIK	Standard EN 61800-5-2	–
		SIMOTION	Standard EN 61800-5-2	–

More information about certificates can be found online at:  
<https://support.industry.siemens.com/cs/ww/en/ps/cert>

## Appendix

### Notes on software

#### Information on software licensing

##### Overview

##### **Software types**

Software requiring a license is categorized into types. The following software types have been defined

- Engineering software
- Runtime software

##### **Engineering software**

This includes all software products for creating (engineering) user software, e.g. for configuring, programming, parameterizing, testing, commissioning or servicing. Data generated with engineering software and executable programs can be duplicated for your own use or for use by third-parties free-of-charge.

##### **Runtime software**

This includes all software products required for plant/machine operation, e.g. operating system, basic system, system expansions, drivers, etc.

The duplication of the runtime software and executable programs created with the runtime software for your own use or for use by third-parties is subject to a charge. You can find information about license fees according to use in the ordering data (e.g. in the catalog). Examples of categories of use include per CPU, per installation, per channel, per instance, per axis, per control loop, per variable, etc.

Information about extended rights of use for parameterization/configuration tools supplied as integral components of the scope of delivery can be found in the readme file supplied with the relevant product(s).

##### **License types**

Siemens Digital Factory offers various types of software license:

- Floating license
- Single license
- Rental license
- Rental floating license
- Trial license
- Demo license
- Demo floating license

##### **Floating license**

The software may be installed for internal use on any number of devices by the licensee. Only the concurrent user is licensed. The concurrent user is the person using the program. Use begins when the software is started. A license is required for each concurrent user.

##### **Single license**

Unlike the floating license, a single license permits only one installation of the software per license. The type of use licensed is specified in the ordering data and in the Certificate of License (CoL). Types of use include, for example, per instance, per axis, per channel, etc. One single license is required for each type of use defined.

##### **Rental license**

A rental license supports the "sporadic use" of engineering software. Once the license key has been installed, the software can be used for a specific period of time (the operating hours do not have to be consecutive). One license is required for each installation of the software.

##### **Rental floating license**

The rental floating license corresponds to the rental license, except that a license is not required for each installation of the software. Rather, one license is required per object (for example, user or device).

##### **Trial license**

A trial license supports "short-term use" of the software in a non-productive context, e.g. use for testing and evaluation purposes. It can be transferred to another license.

##### **Demo license**

The demo license supports the "sporadic use" of engineering software in a non-productive context, for example, use for testing and evaluation purposes. It can be transferred to another license. After the installation of the license key, the software can be operated for a specific period of time, whereby usage can be interrupted as often as required.

One license is required for each installation of the software.

##### **Demo floating license**

The demo floating license corresponds to the demo license, except that a license is not required for each installation of the software. Rather, one license is required per object (for example, user or device).

##### **Certificate of license (CoL)**

The CoL is the licensee's proof that the use of the software has been licensed by Siemens. A CoL is required for every type of use and must be kept in a safe place.

##### **Downgrading**

The licensee is permitted to use the software or an earlier version/release of the software, provided that the licensee owns such a version/release and its use is technically feasible.

##### **Delivery versions**

Software is constantly being updated. The following delivery versions

- PowerPack
- Upgrade

can be used to access updates.

Existing bug fixes are supplied with the ServicePack version.

##### **PowerPack**

PowerPacks can be used to upgrade to more powerful software.

The licensee receives a new license agreement and CoL (Certificate of License) with the PowerPack. This CoL, together with the CoL for the original product, proves that the new software is licensed.

A separate PowerPack must be purchased for each original license of the software to be replaced.

##### **Upgrade**

An upgrade permits the use of a new version of the software on the condition that a license for a previous version of the product is already held.

The licensee receives a new license agreement and CoL with the upgrade. This CoL, together with the CoL for the previous version, proves that the new software is licensed. A separate upgrade must be purchased for each original license of the software to be upgraded.

##### **ServicePack**

ServicePacks are used to debug existing products. ServicePacks may be duplicated for the use as prescribed according to the number of existing original licenses.

#### Overview (continued)

##### License key

Siemens Digital Factory supplies software products with and without license key.

The license key serves as an electronic license stamp and is also the "switch" for activating the software (floating license, rental license, etc.)

The complete installation of software products requiring license keys includes the program to be licensed (the software) and the license key (which represents the license).

##### Software Update Service (SUS)

As part of the SUS contract, all software updates for the respective product are made available to you free of charge for a period of one year from the invoice date. The contract will automatically be extended for one year if it is not canceled three months before it expires.

The possession of the current version of the respective software is a basic condition for entering into an SUS contract.

You can download explanations concerning license conditions from

[www.siemens.com/automation/salesmaterial-as/catalog/en/terms\\_of\\_trade\\_en.pdf](http://www.siemens.com/automation/salesmaterial-as/catalog/en/terms_of_trade_en.pdf)

### Usage and copy rights

#### Overview

The "General License Conditions for Software Products for Automation and Drives" are applicable for the delivery of Siemens Digital Factory software products.

##### Legal notes during setup for new software products

All software products feature a uniform reference to the license conditions. The license conditions are enclosed either with the documentation or in the software pack. When software is downloaded from the Internet, the license contract is displayed before the ordering procedure and must be accepted by the user before downloading can continue.

##### Notice:

This software is protected by German and/or US copyright law and the regulations of international agreements. Unauthorized reproduction or sale of this software or parts of it is a criminal offense. This will lead to criminal and civil prosecution, and may result in significant fines and/or claims for damages. Prior to installing and using the software, please read the applicable licensing conditions for this software. You will find these in the documentation or packaging.

If you have received this software on a CD/DVD that is marked "Trial version" or accompanying software that is licensed for your use, the software is only permitted to be used for test and validation purposes in accordance with the accompanying conditions for the trial license. To this end, it is necessary that programs, software libraries, etc., are installed on your computer. We therefore urgently recommend that installation is performed on a single-user computer or on a computer that is not used in the production process or for storing important data, since it cannot be completely excluded that existing files will be modified or overwritten. We accept no liability whatsoever for damage and/or data losses that result from this installation or the non-observance of this warning. Every other type of use of this software is only permitted if you are in possession of a valid license from Siemens.

If you are not in possession of a valid license that can be proven by presenting an appropriate Certificate of License/software product certificate, please abort installation immediately and contact a Siemens office without delay to avoid claims for damages.

#### Software Update Services

##### Order

To order the Software Update Service, an article number must be specified. The Software Update Service can be ordered when the software products are ordered or at a later date. Subsequent orders require that the ordering party is in possession at least of a single license.

##### Note:

It is recommended that the Software Update Service is ordered as early as possible. If a new software version of a software product is released for delivery by Siemens, only those customers will receive it automatically who are entered in the appropriate delivery list at Siemens at this time. Previous software versions, or the current software version are not supplied when the Software Update Service is ordered. The Software Update Service requires that the software product is up-to-date at the time of completion of the contract for the Software Update Service.

##### Delivery

When a Software Update Service is ordered, you will be sent the contractual conditions of this service and the price is due for payment. At the same time, you will be included in a delivery list for the software product to be updated. If Siemens releases a new software version for the corresponding software product for general sale (function or product version), it will be delivered automatically to the goods recipient specified in the delivery address within the contract period.

#### More information

##### Security note

In the case of software for teleservice or connection to higher-level networks, suitable protection measures must be taken (including industrial security, e.g. network segmentation) to guarantee safe operation of the system. Additional information about Industrial Security can be found in the Internet at

[www.siemens.com/industrialsecurity](http://www.siemens.com/industrialsecurity)

# Appendix

## Indexes

### Subject index

<b>A</b>	
Absolute encoder .....	3.7/2
Activation of the integrated safety functions .....	5/8
Address ranges .....	2/100
ADI4	
• Analog Drive Interface .....	3.2/12, 3.2/15
Agricultural tire production machines .....	6/10
Analog Drive Interface for 4 axes ADI 4 .....	3.2/12, 3.2/15
Appendix .....	8/1 ... 8/16
Application centers .....	7/6
Application consulting .....	7/6
Application support .....	1/2
Applications .....	7/6
• SIMOTION SCOUT .....	2/95
Approvals .....	8/2, 8/3
Article number index .....	8/13
Automatic roll change .....	6/8
Automation	
• Education .....	7/15
Axis control .....	6/8
Axis licenses	
• SIMOTION .....	2/69
<b>B</b>	
Basic Functions	
• Safety Integrated .....	5/7, 5/10
Basic Panels .....	3.1/2, 3.1/6
Basic Performance	
• SINAMICS .....	3.4/2
Battery modules	
• SITOP power supplies with .....	3.3/6
Beverages .....	6/2
Buffer module .....	3.3/3
<b>C</b>	
CA 01	
• Interactive catalog .....	7/18
CAD CREATOR .....	7/5
Cam editor	
• Graphical, CamTool .....	2/90
Cam outputs .....	2/104
Cams	
• SIMOTION SCOUT .....	2/84
CamTool	
• SIMOTION SCOUT .....	2/90
Capacitors	
• SITOP power supplies with .....	3.3/6
Car tire production machines .....	6/10
Catalog CA 01 .....	7/18
CBE30-2 Communication Board .....	2/35
Central I/O modules .....	2/106
Ceramics processing machines .....	6/20
Certificates of suitability .....	8/2, 8/3
Chemical fiber production .....	6/6
Comfort Panels .....	3.1/2, 3.1/7
Commissioning and testing	
• Diagnostics, SIMOTION SCOUT .....	2/88
Communication .....	2/108, 4/1 ... 4/9
• Extended, software for SIMOTION .....	2/107
• Industrial Ethernet .....	4/9
• PROFIBUS .....	4/8
• PROFIdrive .....	4/7
• PROFINET .....	4/2 ... 4/6
Communication functions	
• SIMOTION .....	2/70
CompactFlash card	
• SIMOTION .....	2/16, 2/29
<b>C (continued)</b>	
Conditions of sale and delivery .....	8/16
Connectable distributed I/O modules .....	2/106
Connection systems	
• MOTION-CONNECT .....	3.6/1, 3.6/2
Control cabinets .....	7/7, 7/8
Control Units	
• SIMOTION D410-2 .....	2/9 ... 2/17
• SIMOTION D4x5-2 .....	2/18 ... 2/31
Controller Extension	
• SIMOTION CX32-2 .....	2/32 ... 2/34
Controller-based	
• SIMOTION C .....	2/45 ... 2/51
Conversion tables .....	8/14
Converter operation	
• Low-voltage motors for .....	3.5/2
Converting .....	6/8
• Automatic roll change .....	6/8
• Axis control .....	6/8
• Flying saw/Flying shears .....	6/8
• Material web storage .....	6/8
• Tension control .....	6/8
• Traversing .....	6/8
• Winding .....	6/8
Conveyor systems .....	6/12
Copy rights .....	8/5
Creation	
• of cams, SIMOTION SCOUT .....	2/84
Creation of technology objects	
• SIMOTION SCOUT .....	2/83
<b>D</b>	
DC	
• DC motors .....	3.5/3
DC applications	
• SINAMICS .....	3.4/3
DC motors .....	3.5/3
DCM	
• SINAMICS .....	3.4/3
DC UPS	
• SITOP power supplies .....	3.3/3, 3.3/6
DIAG	
• SIMOTION IT .....	2/76
Diagnostic and service functions	
• SIMOTION IT .....	2/7
Diagnostics and service	
• Web server functions, SIMOTION .....	2/74 ... 2/76
Diagnostics and testing .....	2/117
Digital Enterprise Software Suite .....	1/3
Digital printing .....	6/4
Dimensional drawings	
• CAD CREATOR .....	7/5
Dimensioning and engineering tools .....	7/3 ... 7/5
Direct voltage	
• SINAMICS .....	3.4/3
Distributed I/O .....	3.2/2 ... 3.2/11
Distributed I/Os, connectable .....	2/106
Documentation .....	7/2
Download Center .....	7/19
Downloading catalogs .....	7/19
Drive Control Chart (DCC)	
• SIMOTION SCOUT .....	2/91
Drive Safety Data Block (DSDB) .....	5/3
Drive Technology Configurator .....	7/4
Drive-based	
• SIMOTION D .....	2/4 ... 2/37

**D (continued)**

Drives	
• Motor-integrated	3.4/4
• Multi-axis	3.4/4
• SINAMICS	3.4/1 ... 3.4/5
• Single-axis	3.4/4
Drives on SIMOTION	2/101
DSDB	
• Drive Safety Data Block	5/3
Dynamic Servo Control (DSC)	2/100

**E**

easyProject	
• Project generator, SIMOTION SCOUT	2/92
Education	
• Siemens Automation cooperates with	7/15
Electronic transfer	6/12
Encoder	
• Absolute encoder	3.7/2
• Incremental encoder	3.7/2
• Motion Control measuring system	3.7/1, 3.7/2
Encoders on SIMOTION	2/103
Engineering drives	2/118
Engineering software	
• SIMOTION	2/77 ... 2/98
Engineering system	1/8
• SIMOTION SCOUT	2/116
Engineering tools	7/3 ... 7/5
ET 200	
• SIMATIC, distributed I/O	3.2/2 ... 3.2/11
Excellence in Motion Control	1/2
Expansion modules	3.3/5
• Buffer module	3.3/3
• Redundancy modules	3.3/3
• Selectivity modules	3.3/3
Extended Functions	
• Safety Integrated	5/7, 5/10

**F**

Finishing	6/6
Flat glass – cold end	6/14
Flat glass – further processing	6/14
Flexo printing	6/4
Flying saw/Flying shears	6/8
Flywheel presses	6/12
Food	6/2
F-Proxy	
• SIMOTION I-Device F-Proxy	5/8
Function Block Diagram (FBD)	
• SIMOTION SCOUT	2/87
Function blocks	
• for I/O modules	3.2/12, 3.2/16
Functional printing	6/4
Functions	
• PROFINET	4/6
Further product information	7/2

**G**

General machine types	6/2
General Performance	
• SINAMICS	3.4/3
General Performance SINAMICS	3.4/2
Glass production machines	6/14
• Flat glass	6/14
• Hollow glass	6/14
• Insulating glass	6/14
Graphical cam editor	
• CamTool, SIMOTION SCOUT	2/90

**H**

Handling systems	6/12, 6/16
Hardware and network configuration	
• SIMOTION SCOUT	2/82
Hardware platforms	1/5
High Performance	
• SINAMICS	3.4/3
High-voltage motors	3.5/3
HMI	
• Operator control and monitoring, SIMOTION	2/7
HMI devices	2/107, 3.1/1 ... 3.1/13
HMI software	3.1/11
HMI software for SIMOTION	2/107
Hollow glass – IS machine	6/14
Hollow glass – rotary machine	6/14
Hydraulic presses	6/12

**I**

I/O components	3.2/1 ... 3.2/16
I/O devices	
• Distributed	3.2/2 ... 3.2/11
• Other I/O components	3.2/12 ... 3.2/16
• SIMATIC ET 200	3.2/2 ... 3.2/11
• SIMATIC S7-300	3.2/12, 3.2/13
I/O modules	
• Central	2/106
• Function blocks for	3.2/12, 3.2/16
I-Device F-Proxy	5/8
IDC - Information and Download Center	7/19
IM 174	
• Interface Module	3.2/12, 3.2/15
IM 174 Interface Module	3.2/12, 3.2/15
Image & Partition Creator	
• SIMATIC IPC	2/44
Incremental encoder	3.7/2
Industrial Ethernet	4/9
• Standard, PROFINET	4/2 ... 4/6
Industry Mall	7/18
Industry Services	7/20 ... 7/23
• Online Support	7/23
• Portfolio	7/21
Industry-specific solutions	6/1 ... 6/21
• Ceramics processing machines	6/20
• Converting	6/8
- Automatic roll change	6/8
- Axis control	6/8
- Flying saw/Flying shears	6/8
- Material web accumulators	6/8
- Tension control	6/8
- Traversing	6/8
- Winding	6/8
• Glass production machines	6/14
- Flat glass	6/14
- Hollow glass	6/14
- Insulating glass	6/14
• Handling systems	6/16
• Metal forming technology	6/12
- Conveyor systems	6/12
- Electronic transfer	6/12
- Flywheel presses	6/12
- Handling systems	6/12
- Hydraulic presses	6/12
- Mechanical presses	6/12
- Pipe bending machines	6/12
- Press feeders	6/12
- Roll feeds	6/12
- Servo hydraulic presses	6/12
- Servo presses	6/12
- Slitting and cross-cutting stations	6/12
- Valve-controlled presses	6/12
- Wire bending machines	6/12
- Wire winding machines	6/12
- Wire-drawing machines	6/12

# Appendix

## Indexes

### Subject index

#### I (continued)

Industry-specific solutions (continued)

• Packaging machines	
- Beverages	6/2
- Food	6/2
- General machine types	6/2
- Non Food	6/2
- Pharmaceuticals/Cosmetics	6/2
- Tobacco	6/2
• Printing presses	6/4
- Digital printing	6/4
- Flexo printing	6/4
- Functional printing	6/4
- Offset printing	6/4
- Print finishing	6/4
- Rotogravure/Rotogravure package printing	6/4
• Solar production machines	6/18
- Wafer production	6/18
• Stone processing machines	6/20
• Textile machines	6/6
- Chemical fiber production	6/6
- Finishing	6/6
- Textile fabric production	6/6
- Yarn production	6/6
• Tire production machines	6/10
- Agricultural tire production machines	6/10
- Special tire production machines	6/10
Information and Download Center	7/19
Information and Ordering Options on the Internet and DVD	7/18
Information on software licensing	8/4, 8/5
Information portal	7/2
Insulating glass	6/14
Integrated I/O interfaces	2/105
Interactive catalog CA 01	7/18
IsoPROFIBUS board	2/44
IT	
• SIMOTION	2/74 ... 2/76
IWLAN	
• PROFINET, PROFIsafe	4/5
<b>K</b>	
Kernel	
• SIMOTION	2/56, 2/57, 2/112
Key Panels	3.1/2, 3.1/5

#### L

Ladder Diagram (LAD)	
• SIMOTION SCOUT	2/87
License	
• MultiAxes Package for SIMOTION D	2/16, 2/29
Licensing	
• Extended Functions, Safety Integrated	5/10
Licensing concept	
• SIMOTION	2/66, 2/67
Lifecycle Services	7/1 ... 7/23
• Applications	7/6
• Control cabinets	7/7, 7/8
• Dimensioning and engineering tools	7/3 ... 7/5
• Engineering tools	7/3 ... 7/5
• Further product information	7/2
• Industry Services	7/20 ... 7/23
• Online Services	7/18, 7/19
• Partner at Siemens	7/17
• SITRAIN - Training for Industry	
- SIMOTION D425-2 DP/PN training case	7/12
- SIMOTION D425-2 DP/PN upgrade kit	7/14
- SIMOTION training courses	7/10
- SINAMICS S120 training case	7/13
- SINAMICS training courses	7/11
Line operation	
• Low-voltage motors for	3.5/2
Linear motors	3.5/3, 3.5/5
Low voltage	
• SINAMICS	3.4/2, 3.4/3
Low-voltage motors for line and converter operation	3.5/2
<b>M</b>	
Main	
• Main motors	3.5/3
Main motors	3.5/3, 3.5/5
Mall	7/18
Manufacturing on the Internet	7/18
Material web accumulators	6/8
Measuring inputs	2/103
Measuring systems Motion Control Encoder	3.7/1, 3.7/2
Mechanical presses	6/12
Media	
• Mobile Media	7/19
• Social Media	7/19
Medium voltage	
• SINAMICS	3.4/3
Memory for system data	2/100
Metal forming technology	6/12
• Conveyor systems	6/12
• Electronic transfer	6/12
• Flywheel presses	6/12
• Handling systems	6/12
• Hydraulic presses	6/12
• Mechanical presses	6/12
• Pipe bending machines	6/12
• Press feeders	6/12
• Roll feeds	6/12
• Servo hydraulic presses	6/12
• Servo presses	6/12
• Slitting and cross-cutting stations	6/12
• Valve-controlled presses	6/12
• Wire bending machines	6/12
• Wire winding machines	6/12
• Wire-drawing machines	6/12
Micro Memory Card (MMC)	
• for SIMOTION C	2/50
Mobile Media	7/19

**M (continued)**

Mobile Panels .....	3.1/2, 3.1/9
Motion Control	
• Excellence in .....	1/2
• SIMOTICS motors .....	3.5/3
• SINAMICS drives .....	3.4/4, 3.4/5
Motion Control Chart (MCC)	
• SIMOTION SCOUT .....	2/86
Motion Control Encoder, measuring systems .....	3.7/1, 3.7/2
Motion Controller	
• SIMOTION	
- C240/240 PN .....	2/45 ... 2/51
• SIMOTION P320-4 .....	2/38 ... 2/44
MOTION-CONNECT connection systems .....	3.6/1, 3.6/2
Motor-integrated drives .....	3.4/4
Motors	
• DC .....	3.5/3
• High-voltage .....	3.5/3
• Low-voltage motors for line and converter operation .....	3.5/2
• SIMOTICS .....	3.5/1 ... 3.5/6
MultiAxes and Safety Packages	
• SIMOTION .....	2/69
MultiAxes Bundle	
• SIMOTION C .....	2/50
MultiAxes Package	
• License for SIMOTION D .....	2/16, 2/29
MultiAxes Package license	
• for SIMOTION D .....	2/16, 2/29
MultiAxes Packages	
• SIMOTION .....	2/69
Multi-axis drives .....	3.4/4

**N**

Network configuration	
• SIMOTION SCOUT .....	2/82
Non Food .....	6/2
Notes on software .....	8/4, 8/5

**O**

Objects	
• Creation of technology .....	2/83
Offset printing .....	6/4
Online Support .....	7/23
Online Services .....	7/18, 7/19
OPC server of SIMOTION and SIMATIC NET .....	2/71 ... 2/73
OPC XML-DA	
• SIMOTION IT .....	2/76
Operator control and monitoring (HMI)	
• SIMOTION .....	2/7
Ordering of	
• licenses for runtime software, SIMOTION .....	2/68 ... 2/70
Other I/O components .....	3.2/12 ... 3.2/16
Overview of functions	
• Address ranges .....	2/100
• Cam outputs .....	2/104
• Centralized I/O modules .....	2/106
• Communication .....	2/108
• Distributed I/Os, connectable .....	2/106
• Drives on SIMOTION .....	2/101
• Dynamic Servo Control (DSC) .....	2/100
• Encoders on SIMOTION .....	2/103
• Engineering drives .....	2/118
• HMI software for SIMOTION .....	2/107
• Integrated I/O interfaces .....	2/105
• Measuring inputs .....	2/103
• Memory for system data .....	2/100
• Motion Control technology package .....	2/114
• PROFIsafe drives on SIMOTION .....	2/111
• SIMATIC HMI devices .....	2/107
• SIMOTION .....	2/99 ... 2/118
• SIMOTION IT .....	2/115
• SIMOTION Kernel .....	2/112
• SIMOTION SCOUT engineering system .....	2/116
• SIMOTION SCOUT, testing and diagnostics .....	2/117
• Software for extended communication with SIMOTION .....	2/107
• System clocks .....	2/99
• Technology packages, other .....	2/115

# Appendix

## Indexes

### Subject index

- P**
- Packaging machines .....6/2
    - Beverages .....6/2
    - Food .....6/2
    - General machine types .....6/2
    - Non Food .....6/2
    - Pharmaceuticals/Cosmetics .....6/2
    - Tobacco .....6/2
  - Panels .....3.1/2 ... 3.1/10
  - Partner at Siemens .....7/17
  - PC-based
    - SIMOTION P .....2/38 ... 2/44
  - PC-based HMI solutions .....3.1/13
  - Pharmaceuticals/Cosmetics .....6/2
  - Pipe bending machines .....6/12
  - Planetary geared motors .....3.5/4
  - PLCopen blocks
    - SIMOTION .....2/65
  - Portrait assembly kit
    - SIMATIC IPC .....2/44
  - Position sensing, safe .....5/9
  - Power supplies .....3.3/1 ... 3.3/6
    - SITOP .....3.3/1 ... 3.3/6
    - Technology .....3.3/4
  - Press feeders .....6/12
  - Print finishing .....6/4
  - Printing presses .....6/4
    - Digital printing .....6/4
    - Flexo printing .....6/4
    - Functional printing .....6/4
    - Offset printing .....6/4
    - Print finishing .....6/4
    - Rotogravure/Rotogravure package printing .....6/4
  - PROFIBUS .....4/8
    - IsoPROFIBUS board .....2/44
    - PROFIdrive .....4/7
  - PROFIdrive .....4/7
  - PROFINET .....4/2 ... 4/6
    - for SIMOTION and SINAMICS S .....4/6
    - Functions .....4/6
    - PROFIdrive .....4/7
  - PROFIsafe .....5/8
    - PROFINET .....4/5
  - PROFIsafe drives on SIMOTION .....2/111
  - Project generator SIMOTION easyProject .....1/9
  - PSU8600
    - Power supply system, SITOP modular .....3.3/3, 3.3/5
- R**
- Ready-to-wear clothing .....6/6
  - Redundancy modules .....3.3/3
  - Roll feeds .....6/12
  - Rotogravure/Rotogravure package printing .....6/4
  - Runtime software licenses
    - SIMOTION .....2/68 ... 2/70
  - Runtime software SIMOTION .....2/53 ... 2/70
  - Runtime system .....1/7
- S**
- S7-300
    - SIMATIC, I/O .....3.2/12, 3.2/13
  - Safe Brake Control (SBC) .....5/5
  - Safe Brake Test (SBT) .....5/5
  - Safe Direction (SDI) .....5/6
  - Safe Operating Stop (SOS) .....5/5
  - Safe Position (SP) .....5/7
  - Safe Speed Monitor (SSM) .....5/6
  - Safe speed/position sensing .....5/9
  - Safe Stop (SS1, SS2) .....5/4
  - Safe Torque Off (STO) .....5/3
  - Safely Limited Position (SLP) .....5/7
  - Safely Limited Speed (SLS) .....5/6
  - Safety and MultiAxes Packages SIMOTION .....2/69
  - Safety engineering .....5/2
  - Safety functions .....5/3
  - Safety Integrated .....5/1 ... 5/10
  - Safety Integrated functions .....2/7
  - Safety-related standards .....5/2
  - SCOUT
    - SIMOTION .....2/77 ... 2/98
  - Security note .....8/5
  - Selection Tool
    - SITOP .....3.3/6
  - Selectivity modules .....3.3/3
  - Service
    - Lifecycle Services .....7/1 ... 7/23
  - Service and diagnostic functions .....2/7
  - Service and diagnostics
    - Web server functions, SIMOTION .....2/74 ... 2/76
  - Services from Siemens .....7/20, 7/21
  - Servo geared motors .....3.5/4
  - Servo hydraulic presses .....6/12
  - Servo presses .....6/12
  - Servomotors .....3.5/3, 3.5/4
  - Siemens Automation Cooperates with Education .....7/15
  - Siemens services .....7/20, 7/21
  - SIMATIC
    - ET 200 distributed I/O .....3.2/2 ... 3.2/11
    - HMI .....2/107
    - HMI devices .....3.1/2 ... 3.1/10
    - HMI software .....3.1/11
    - Industrial PCs
      - PC-based HMI solutions .....3.1/13
    - OPC server .....2/71 ... 2/73
    - Panels .....3.1/2 ... 3.1/10
      - Basic Panels .....3.1/6
      - Comfort Panels .....3.1/7
      - Mobile Panels .....3.1/9
    - S7-300 I/O .....3.2/12, 3.2/13
    - SCADA system SIMATIC WinCC .....3.1/11
    - SCADA system SIMATIC WinCC Open Architecture .....3.1/11
    - SITOP power supplies in SIMATIC design .....3.3/2, 3.3/4
    - WinCC .....3.1/11
    - WinCC flexible .....3.1/11
  - SIMATIC IPC
    - Image & Partition Creator .....2/44
    - Portrait assembly kit .....2/44
    - USB flash drive .....2/44
  - SIMOTICS
    - Motors .....3.5/1 ... 3.5/6
    - Motors for Motion Control .....3.5/3



**S (continued)**

SIMOTION	
• Axis licenses .....	2/69
• C	
- Controller-based .....	2/45 ... 2/51
- Micro Memory Card (MMC) .....	2/50
- MultiAxes Bundle .....	2/50
- Overview .....	1/6
• C240/240 PN	
- Motion Controller .....	2/45 ... 2/51
• CompactFlash card .....	2/16, 2/29
• CX32-2	
- Controller Extension .....	2/32 ... 2/34
• D	
- Drive-based .....	2/4 ... 2/37
- Overview .....	1/5
• D410-2	
- Control Units .....	2/9 ... 2/17
• D4x5-2	
- Control Units .....	2/18 ... 2/31
• Documentation .....	7/2
• Drives on .....	2/101
• Encoders on .....	2/103
• Engineering software .....	2/77 ... 2/98
- Instructions .....	2/97
- Ordering of .....	2/97
• Further product information .....	7/2
• Information portal .....	7/2
• Kernel .....	2/56, 2/57, 2/112
• Licenses for runtime software .....	2/68 ... 2/70
• Licensing concept, overview .....	2/66, 2/67
• Motion Control System .....	2/1 ... 2/118
• MultiAxes and Safety Packages .....	2/69
• MultiAxes Packages .....	2/69
• OPC server .....	2/71 ... 2/73
• Overview .....	1/4
• Overview of functions .....	2/99 ... 2/118
• Overview of the licensing concept .....	2/66, 2/67
• P	
- Overview .....	1/6
- PC-based .....	2/38 ... 2/44
• P320-4	
- Motion Controller .....	2/38 ... 2/44
• PLCopen blocks .....	2/65
• PROFINET for SIMOTION .....	4/6
• Project generator .....	1/9, 2/92
• Runtime software .....	2/53 ... 2/70
• Safety and MultiAxes Packages .....	2/69
• Safety Integrated functions .....	2/7
• SCOUT .....	2/77 ... 2/98
- Diagnostics, testing and commissioning .....	2/88
- easyProject project generator .....	2/92
- Utilities & Applications .....	2/95
• SCOUT, CamTool .....	2/90
• SCOUT, creation of cams .....	2/84
• SCOUT, creation of technology objects .....	2/83
• SCOUT, Drive Control Chart (DCC) .....	2/91
• SCOUT, hardware and network configuration .....	2/82
• SCOUT, Ladder Diagram/Function Block Diagram (LAD/FBD) .....	2/87
• SCOUT, Motion Control Chart (MCC) .....	2/86
• SCOUT, Structured Text (ST) .....	2/85
• SCOUT, Workbench .....	2/81
• SIMOTION D425-2 DP/PN training case .....	7/12
• SIMOTION D425-2 DP/PN upgrade kit .....	7/14
• SIMOTION I-Device F-Proxy .....	5/8
• Software .....	2/52 ... 2/98
• Standard modules .....	1/9

**S (continued)**

SIMOTION (continued)	
• Supplementary components	
- CBE30-2 Communication Board .....	2/35
- CX32-2 Controller Extension .....	2/32 ... 2/34
- TB30 Terminal Board .....	2/36, 2/37
• System components .....	3.1/1 ... 3.7/2
- Distributed I/O .....	3.2/2 ... 3.2/11
- HMI devices .....	3.1/1 ... 3.1/13
- Basic Panels .....	3.1/2, 3.1/6
- Comfort Panels .....	3.1/2, 3.1/7
- HMI software .....	3.1/11
- Key Panels .....	3.1/2, 3.1/5
- Mobile Panels .....	3.1/2, 3.1/9
- WinCC engineering software .....	3.1/3
- I/O components .....	3.2/1 ... 3.2/16
- Motion Control Encoder measuring systems .....	3.7/1, 3.7/2
- MOTION-CONNECT connection systems .....	3.6/1, 3.6/2
- Other I/O components .....	3.2/12 ... 3.2/16
- Power supplies .....	3.3/1 ... 3.3/6
- SIMOTICS motors .....	3.5/1 ... 3.5/6
- SINAMICS drives .....	3.4/1 ... 3.4/5
• System overview .....	1/1 ... 1/8
- Application support .....	1/2
- Digital Enterprise Software Suite .....	1/3
- Engineering system .....	1/8
- Runtime system .....	1/7
- SIMOTION – An overview .....	1/4
- Hardware platforms .....	1/5
• Technology packages .....	2/7, 2/58 ... 2/64, 2/69
• Training courses .....	7/10
SIMOTION D425-2 DP/PN training case .....	7/12
SIMOTION D425-2 DP/PN upgrade kit .....	7/14
SIMOTION easyProject project generator .....	2/92
SIMOTION IT .....	2/7, 2/74 ... 2/76, 2/115
• Communication functions .....	2/70
• DIAG .....	2/76
• OPC XML-DA .....	2/76
• Service and diagnostic functions .....	2/7
• Virtual Machine .....	2/76
SIMOTION Motion Control System .....	2/1 ... 2/118
SINAMICS	
• Basic Performance .....	3.4/2
• DC applications .....	3.4/3
• DCM .....	3.4/3
• Direct voltage .....	3.4/3
• Drives .....	3.4/1 ... 3.4/5
• Drives for Motion Control .....	3.4/4, 3.4/5
• G .....	3.4/2, 3.4/3
• General Performance .....	3.4/2, 3.4/3
• High Performance .....	3.4/3
• Low voltage .....	3.4/2, 3.4/3
• Medium voltage .....	3.4/3
• Motor-integrated drives .....	3.4/4
• Multi-axis drives .....	3.4/4
• PROFINET for SINAMICS S .....	4/6
• S .....	3.4/2 ... 3.4/5
• SINAMICS S120 training case .....	7/13
• Single-axis drives .....	3.4/4
• Training courses .....	7/11
• V .....	3.4/2
SINAMICS S120 training case .....	7/13
Single-axis drives .....	3.4/4

# Appendix

## Indexes

### Subject index

#### S (continued)

SITOP	
• DC UPS, power supplies	3.3/3, 3.3/6
• Expansion modules for power supplies	3.3/3, 3.3/5
• lite	3.3/2, 3.3/4
• modular	3.3/3, 3.3/4, 3.3/5
• Power supplies	
- Expansion modules	3.3/3, 3.3/5
• Power supplies in SIMATIC design	3.3/2, 3.3/4
• PSU8600 power supply system	3.3/3, 3.3/5
• Selection Tool	3.3/6
• smart	3.3/2, 3.3/4
SITOP power supplies	3.3/1 ... 3.3/6
SITRAIN - Training for Industry	7/9
• SIMOTION D425-2 DP/PN training case	7/12
• SIMOTION D425-2 DP/PN upgrade kit	7/14
• SIMOTION training courses	7/10
• SINAMICS S120 training case	7/13
• SINAMICS training courses	7/11
SIZER for Siemens Drives engineering tool	7/3
Slitting and cross-cutting stations	6/12
Social Media	7/19
Software	
• Engineering software	
- SIMOTION, ordering, instructions	2/97
• for extended communication with SIMOTION	2/107
• Information on licensing of the	8/4, 8/5
• Notes on	8/4, 8/5
• SIMOTION	2/52 ... 2/98
• SIMOTION runtime software	2/53 ... 2/70
• WinCC engineering software	3.1/3
Software Update Services	8/5
Solar production machines	6/18
• Wafer production	6/18
Special tire production machines	6/10
Speed sensing, safe	5/9
Standard modules	1/9
Standards	
• Safety-related	5/2
Stone processing machines	6/20
Structured Text (ST)	
• SIMOTION SCOUT	2/85
Support	
• Online Support	7/23
Synchronous motors	3.5/5
System clocks	2/99
System components	3.1/1 ... 3.7/2
• Distributed I/O	3.2/2 ... 3.2/11
• HMI devices	3.1/1 ... 3.1/13
• I/O components	3.2/1 ... 3.2/16
• Motion Control Encoder measuring systems	3.7/1, 3.7/2
• MOTION-CONNECT connection systems	3.6/1, 3.6/2
• Other I/O components	3.2/12 ... 3.2/16
• SIMOTICS motors	3.5/1 ... 3.5/6
• SINAMICS drives	3.4/1 ... 3.4/5
System data	
• Memory for	2/100
System overview	
• Engineering system	1/8
• Excellence in Motion Control	1/2
• Hardware platforms	1/5
• Runtime system	1/7
• SIMOTION – An overview	1/4
System overview, SIMOTION	1/1 ... 1/8

#### T

TB30 Terminal Board	2/36, 2/37
Technology package	
• Motion Control	2/114
Technology packages	
• Other	2/115
• SIMOTION	2/7, 2/58 ... 2/64, 2/69
Technology power supplies	3.3/4
Tension control	6/8
Terminal Board TB30	2/36, 2/37
Terminal Module TM15	3.2/12, 3.2/14
Testing and commissioning	
• Diagnostics, SIMOTION SCOUT	2/88
Testing and diagnostics	2/117
Textile fabric production	6/6
Textile machines	6/6
• Chemical fiber production	6/6
• Finishing	6/6
• Textile fabric production	6/6
• Yarn production	6/6
TIA Portal	3.1/11
Tire production machines	6/10
• Agricultural tire production machines	6/10
• Car tire production machines	6/10
• Special tire production machines	6/10
• Truck tire production machines	6/10

#### U

Uninterruptible power supplies	
• SITOP DC UPS	3.3/3
Update	
• Software Update Services	8/5
UPS	
• SITOP DC UPS power supplies	3.3/3, 3.3/6
Usage and copy rights	8/5
USB flash drive	
• SIMATIC IPC	2/44
Utilities & Applications	
• SIMOTION SCOUT	2/95

#### V

Valve-controlled presses	6/12
Virtual Machine	
• SIMOTION IT	2/76

#### W

Web server functions for service and diagnostics	
• SIMOTION	2/74 ... 2/76
WinCC	
• Engineering software	3.1/3
WinCC engineering software	3.1/3
Winding	6/8
Wire bending machines	6/12
Wire winding machines	6/12
Wire-drawing machines	6/12
Workbench	
• SIMOTION SCOUT	2/81
Y	
Yarn production	6/6

<b>6AG1...-...</b>		
6AG1064-1AA01-0AA0 .....	7/13	
6AG1435-2AD00-4AA0 .....	2/26, 2/27, 2/28	
6AG1455-2AD00-4AA0 .....	2/26, 2/27, 2/28	
<b>6AU12...-...</b>		
6AU1240-1AA00-0AA0 .....	2/50	
6AU1240-1AA00-0CA0 .....	2/50	
6AU1240-1AB00-0AA0 .....	2/50	
6AU1240-1AB00-0CA0 .....	2/50	
<b>6AU13...-...</b>		
6AU1320-4DE65-3AF0 .....	2/44	
6AU1320-4DS66-3AG0 .....	2/44	
6AU1390-0AA00-0AA1 .....	2/44	
<b>6AU14...-...</b>		
6AU1400-1PA23-0AA0 .....	2/16	
6AU1400-7AA05-0AA0 .....	2/16	
6AU1410-2AA00-0AA0 .....	2/16	
6AU1410-2AD00-0AA0 .....	2/16	
6AU1425-2AA00-0AA0 .....	2/22, 2/23, 2/24, 2/25	
6AU1425-2AD00-0AA0 .....	2/22, 2/23, 2/24, 2/25	
6AU1432-2AA00-0AA0 .....	2/34	
6AU1435-2AA00-0AA0 .....	2/22, 2/23, 2/24, 2/25	
6AU1435-2AD00-0AA0 .....	2/22, 2/23, 2/24, 2/25	
6AU1445-2AD00-0AA0 .....	2/22, 2/23, 2/24, 2/25	
6AU1455-2AD00-0AA0 .....	2/22, 2/23, 2/24, 2/25	
<b>6AU17...-...</b>		
6AU1720-1KA00-0AA0 .....	2/50	
6AU1720-1KA00-0AA0-Z .....	2/50	
<b>6AU18...-...</b>		
6AU1810-0BA00-0XL0 .....	2/97	
6AU1810-0CA00-0XL0 .....	2/97	
6AU1810-0FA30-3XA0 .....	2/97	
6AU1810-0FA30-3XE0 .....	2/97	
6AU1810-1BA44-0XH5 .....	2/97	
6AU1810-1BA44-0XK5 .....	2/97	
6AU1810-1BA45-0XA0 .....	2/97	
6AU1810-1BA45-0XE0 .....	2/97	
6AU1810-1BA45-0XG7 .....	2/97	
6AU1810-1BA45-0XT7 .....	2/97	
6AU1810-1CA44-0XH5 .....	2/97	
6AU1810-1CA44-0XK5 .....	2/97	
6AU1810-1CA45-0XA0 .....	2/97	
6AU1810-1CA45-0XE0 .....	2/97	
6AU1810-1CA45-0XG7 .....	2/97	
6AU1810-1CA45-0XT7 .....	2/97	
6AU1810-1JA24-0XA0 .....	2/97	
6AU1810-1JA24-0XE0 .....	2/97	
6AU1820-0AA41-0AB0 .....	2/16	
6AU1820-8BA20-0AB0 .....	2/76	
6AU1820-8BB20-0AB0 .....	2/76	
6AU1820-8BD20-0AB0 .....	2/76	
<b>6AV76...-...</b>		
6AV7672-8JD02-0AA0 .....	2/44	
<b>6ES73...-...</b>		
6ES7365-0BA01-0AA0 .....	2/50	
6ES7390-1AB60-0AA0 .....	2/50	
6ES7390-1AE80-0AA0 .....	2/50	
6ES7390-1AF30-0AA0 .....	2/50	
6ES7390-1AJ30-0AA0 .....	2/50	
6ES7390-1BC00-0AA0 .....	2/50	
6ES7390-7BA00-0AA0 .....	2/50	
6ES7392-1AM00-0AA0 .....	2/50	
6ES7392-1BM01-0AA0 .....	2/50	
<b>6ES76...-...</b>		
6ES7648-1AA20-0YP0 .....	2/44	
6ES7648-6AA03-3YA0 .....	2/44	
<b>6ES79...-...</b>		
6ES7972-0BA12-0XA0 .....	2/16	
6ES7972-0BA42-0XA0 .....	2/16	
6ES7972-0BA52-0XA0 .....	2/16	
6ES7972-0BA61-0XA0 .....	2/16	
6ES7972-0BB12-0XA0 .....	2/16	
6ES7972-0BB42-0XA0 .....	2/16	
6ES7972-0BB52-0XA0 .....	2/16	
6ES7972-0BB61-0XA0 .....	2/16	
<b>6FC53...-...</b>		
6FC5312-0FA00-2AA0 .....	2/35	
<b>6GK15...-...</b>		
6GK1500-0EA02 .....	2/16	
6GK1500-0FC10 .....	2/16	
6GK1571-1AA00 .....	2/73	
<b>6GK17...-...</b>		
6GK1704-1CW14-0AA0 .....	2/73	
6GK1704-1CW14-0AK0 .....	2/73	
6GK1704-1LW14-0AA0 .....	2/73	
6GK1704-1LW14-0AK0 .....	2/73	
6GK1704-5CW14-0AA0 .....	2/73	
<b>6GK19...-...</b>		
6GK1901-1BB10-2AA0 .....	2/16	
6GK1901-1BB10-2AB0 .....	2/16	
6GK1901-1BB10-2AE0 .....	2/16	
6GK1901-1BB30-0AA0 .....	2/16, 2/35, 2/50	
6GK1901-1BB30-0AB0 .....	2/16, 2/35, 2/50	
6GK1901-1BB30-0AE0 .....	2/16, 2/35	
6GK1901-1GA00 .....	2/16, 2/35, 2/50	
<b>6SL30...-...</b>		
6SL3055-0AA00-2TA0 .....	2/37	
6SL3066-4CA00-0AA0 .....	2/16	
6SL3070-0AA00-0AG0 .....	7/3	
6SL3075-0AA00-0AG0 .....	7/5	
<b>6XV18...-...</b>		
6XV1840-2AH10 .....	2/16, 2/35, 2/50	
6XV1840-3AH10 .....	2/16, 2/35, 2/50	
6XV1840-4AH10 .....	2/16, 2/35, 2/50	
6XV1870-2B .....	2/16, 2/35, 2/50	
6XV1870-2D .....	2/16, 2/35, 2/50	
<b>6ZB24...-...</b>		
6ZB2470-0AL00 .....	7/12	
6ZB2470-0AM00 .....	7/13, 7/14	
6ZB2480-0CM00 .....	7/13	
6ZB2480-0CN00 .....	7/13	
<b>A</b>		
A5E30314053 .....	2/44	
<b>E</b>		
E86060-D4001-A510-D7-7600 .....	7/4	

## Appendix

### Conversion tables

Rotary inertia (to convert from A to B, multiply by entry in table)

A \ B	lb-in <sup>2</sup>	lb-ft <sup>2</sup>	lb-in-s <sup>2</sup>	lb-ft-s <sup>2</sup> slug-ft <sup>2</sup>	kg-cm <sup>2</sup>	kg-cm-s <sup>2</sup>	gm-cm <sup>2</sup>	gm-cm-s <sup>2</sup>	oz-in <sup>2</sup>	oz-in-s <sup>2</sup>
lb-in <sup>2</sup>	1	$6.94 \times 10^{-3}$	$2.59 \times 10^{-3}$	$2.15 \times 10^{-4}$	2.926	$2.98 \times 10^{-3}$	$2.92 \times 10^3$	2.984	16	$4.14 \times 10^{-2}$
lb-ft <sup>2</sup>	144	1	0.3729	$3.10 \times 10^{-2}$	421.40	0.4297	$4.21 \times 10^5$	429.71	2304	5.967
lb-in-s <sup>2</sup>	386.08	2.681	1	$8.33 \times 10^{-2}$	$1.129 \times 10^3$	1.152	$1.129 \times 10^6$	$1.152 \times 10^3$	$6.177 \times 10^3$	16
lb-ft-s <sup>2</sup> slug-ft <sup>2</sup>	$4.63 \times 10^3$	32.17	12	1	$1.35 \times 10^4$	13.825	$1.355 \times 10^7$	$1.38 \times 10^4$	$7.41 \times 10^4$	192
kg-cm <sup>2</sup>	0.3417	$2.37 \times 10^{-3}$	$8.85 \times 10^{-4}$	$7.37 \times 10^{-5}$	1	$1.019 \times 10^{-3}$	1000	1.019	5.46	$1.41 \times 10^{-2}$
kg-cm-s <sup>2</sup>	335.1	2.327	0.8679	$7.23 \times 10^{-2}$	980.66	1	$9.8 \times 10^5$	1000	$5.36 \times 10^3$	13.887
gm-cm <sup>2</sup>	$3.417 \times 10^{-4}$	$2.37 \times 10^{-6}$	$8.85 \times 10^{-7}$	$7.37 \times 10^{-8}$	$1 \times 10^{-3}$	$1.01 \times 10^{-6}$	1	$1.01 \times 10^{-3}$	$5.46 \times 10^{-3}$	$1.41 \times 10^{-5}$
gm-cm-s <sup>2</sup>	0.335	$2.32 \times 10^{-3}$	$8.67 \times 10^{-4}$	$7.23 \times 10^{-5}$	0.9806	$1 \times 10^{-3}$	980.6	1	5.36	$1.38 \times 10^{-2}$
oz-in <sup>2</sup>	0.0625	$4.34 \times 10^{-4}$	$1.61 \times 10^{-4}$	$1.34 \times 10^{-5}$	0.182	$1.86 \times 10^{-4}$	182.9	0.186	1	$2.59 \times 10^{-3}$
oz-in-s <sup>2</sup>	24.13	0.1675	$6.25 \times 10^{-2}$	$5.20 \times 10^{-3}$	70.615	$7.20 \times 10^{-2}$	$7.09 \times 10^4$	72.0	386.08	1

Torque (to convert from A to B, multiply by entry in table)

A \ B	lb-in	lb-ft	oz-in	N-m	kg-cm	kg-m	gm-cm	dyne-cm
lb-in	1	$8.333 \times 10^{-2}$	16	0.113	1.152	$1.152 \times 10^{-2}$	$1.152 \times 10^3$	$1.129 \times 10^6$
lb-ft	12	1	192	1.355	13.825	0.138	$1.382 \times 10^4$	$1.355 \times 10^7$
oz-in	$6.25 \times 10^{-2}$	$5.208 \times 10^{-3}$	1	$7.061 \times 10^{-3}$	$7.200 \times 10^{-2}$	$7.200 \times 10^{-4}$	72.007	$7.061 \times 10^4$
N-m	8.850	0.737	141.612	1	10.197	0.102	$1.019 \times 10^4$	$1 \times 10^7$
kg-cm	0.8679	$7.233 \times 10^{-2}$	13.877	$9.806 \times 10^{-2}$	1	$10^{-2}$	1000	$9.806 \times 10^5$
kg-m	86.796	7.233	$1.388 \times 10^3$	9.806	100	1	$1 \times 10^5$	$9.806 \times 10^7$
gm-cm	$8.679 \times 10^{-4}$	$7.233 \times 10^{-5}$	$1.388 \times 10^{-2}$	$9.806 \times 10^{-5}$	$1 \times 10^{-3}$	$1 \times 10^{-5}$	1	980.665
dyne-cm	$8.850 \times 10^{-7}$	$7.375 \times 10^{-8}$	$1.416 \times 10^{-5}$	$10^{-7}$	$1.0197 \times 10^{-6}$	$1.019 \times 10^{-8}$	$1.019 \times 10^{-3}$	1

Length (to convert from A to B, multiply by entry in table)

A \ B	inches	feet	cm	yd	mm	m
inches	1	0.0833	2.54	0.028	25.4	0.0254
feet	12	1	30.48	0.333	304.8	0.3048
cm	0.3937	0.03281	1	$1.09 \times 10^{-2}$	10	0.01
yd	36	3	91.44	1	914.4	0.914
mm	0.03937	0.00328	0.1	$1.09 \times 10^{-3}$	1	0.001
m	39.37	3.281	100	1.09	1000	1

Force (to convert from A to B, multiply by entry in table)

A \ B	lb	oz	gm	dyne	N
lb	1	16	453.6	$4.448 \times 10^5$	4.4482
oz	0.0625	1	28.35	$2.780 \times 10^4$	0.27801
gm	$2.205 \times 10^{-3}$	0.03527	1	$1.02 \times 10^{-3}$	N.A.
dyne	$2.248 \times 10^{-6}$	$3.59 \times 10^{-5}$	980.7	1	0.00001
N	0.22481	3.5967	N.A.	100000	1

Mass (to convert from A to B, multiply by entry in table)

A \ B	lb	oz	gm	kg	slug
lb	1	16	453.6	0.4536	0.0311
oz	$6.25 \times 10^{-2}$	1	28.35	0.02835	$1.93 \times 10^{-3}$
gm	$2.205 \times 10^{-3}$	$3.527 \times 10^{-2}$	1	$10^{-3}$	$6.852 \times 10^{-5}$
kg	2.205	35.27	$10^3$	1	$6.852 \times 10^{-2}$
slug	32.17	514.8	$1.459 \times 10^4$	14.59	1

Rotation (to convert from A to B, multiply by entry in table)

A \ B	rpm	rad/s	degrees/s
rpm	1	0.105	6.0
rad/s	9.55	1	57.30
degrees/s	0.167	$1.745 \times 10^{-2}$	1

### Temperature Conversion

°F	°C	°C	°F
0	-17.8	-10	14
32	0	0	32
50	10	10	50
70	21.1	20	68
90	32.2	30	86
98.4	37	37	98.4
212	100	100	212
subtract 32 and multiply by $\frac{5}{9}$		multiply by $\frac{9}{5}$ and add 32	

### Mechanism Efficiencies

Acme-screw with brass nut	~0.35–0.65
Acme-screw with plastic nut	~0.50–0.85
Ball-screw	~0.85–0.95
Chain and sprocket	~0.95–0.98
Preloaded ball-screw	~0.75–0.85
Spur or bevel-gears	~0.90
Timing belts	~0.96–0.98
Worm gears	~0.45–0.85
Helical gear (1 reduction)	~0.92

### Friction Coefficients

Materials	$\mu$
Steel on steel (greased)	~0.15
Plastic on steel	~0.15–0.25
Copper on steel	~0.30
Brass on steel	~0.35
Aluminum on steel	~0.45
Steel on steel	~0.58
Mechanism	$\mu$
Ball bushings	<0.001
Linear bearings	<0.001
Dove-tail slides	~0.2++
Gibb ways	~0.5++

### Material Densities

Material	lb-in <sup>3</sup>	gm-cm <sup>3</sup>
Aluminum	0.096	2.66
Brass	0.299	8.30
Bronze	0.295	8.17
Copper	0.322	8.91
Hard wood	0.029	0.80
Soft wood	0.018	0.48
Plastic	0.040	1.11
Glass	0.079–0.090	2.2–2.5
Titanium	0.163	4.51
Paper	0.025–0.043	0.7–1.2
Polyvinyl chloride	0.047–0.050	1.3–1.4
Rubber	0.033–0.036	0.92–0.99
Silicone rubber, without filler	0.043	1.2
Cast iron, gray	0.274	7.6
Steel	0.280	7.75

### Wire Gauges<sup>1)</sup>

Cross-section mm <sup>2</sup>	Standard Wire Gauge (SWG)	American Wire Gauge (AWG)
0.2	25	24
0.3	23	22
0.5	21	20
0.75	20	19
1.0	19	18
1.5	17	16
2.5	15	13
4	13	11
6	12	9
10	9	7
16	7	6
25	5	3
35	3	2
50	0	1/0
70	000	2/0
95	00000	3/0
120	0000000	4/0
150	–	6/0
185	–	7/0

<sup>1)</sup> The table shows approximate SWG/AWG sizes nearest to standard metric sizes; the cross-sections do not match exactly.

## Appendix

### Conditions of sale and delivery

#### 1. General Provisions

By using this catalog you can acquire hardware and software products described therein from Siemens AG subject to the following Terms and Conditions of Sale and Delivery (hereinafter referred to as "T&C"). Please note that the scope, the quality and the conditions for supplies and services, including software products, by any Siemens entity having a registered office outside Germany, shall be subject exclusively to the General Terms and Conditions of the respective Siemens entity. The following T&C apply exclusively for orders placed with Siemens Aktiengesellschaft, Germany.

##### 1.1 For customers with a seat or registered office in Germany

For customers with a seat or registered office in Germany, the following applies subordinate to the T&C:

- the "General Terms of Payment"<sup>1)</sup> and,
- for software products, the "General License Conditions for Software Products for Automation and Drives for Customers with a Seat or Registered Office in Germany"<sup>1)</sup> and,
- for other supplies and services, the "General Conditions for the Supply of Products and Services of the Electrical and Electronics Industry"<sup>1)</sup>.

##### 1.2 For customers with a seat or registered office outside Germany

For customers with a seat or registered office outside Germany, the following applies subordinate to the T&C:

- the "General Terms of Payment"<sup>1)</sup> and,
- for software products, the "General License Conditions for Software Products for Automation and Drives for Customers with a Seat or Registered Office outside of Germany"<sup>1)</sup> and
- for other supplies and/or services, the "General Conditions for Supplies of Siemens Industry for Customers with a Seat or Registered Office outside of Germany"<sup>1)</sup>.

#### 2. Prices

The prices are in € (Euro) ex point of delivery, exclusive of packaging.

The sales tax (value added tax) is not included in the prices. It shall be charged separately at the respective rate according to the applicable statutory legal regulations.

Prices are subject to change without prior notice. We will charge the prices valid at the time of delivery.

To compensate for variations in the price of raw materials (e.g. silver, copper, aluminum, lead, gold, dysprosium and neodym), surcharges are calculated on a daily basis using the so-called metal factor for products containing these raw materials. A surcharge for the respective raw material is calculated as a supplement to the price of a product if the basic official price of the raw material in question is exceeded.

The metal factor of a product indicates the basic official price (for those raw materials concerned) as of which the surcharges on the price of the product are applied, and with what method of calculation.

An exact explanation of the metal factor can be downloaded at:

[www.siemens.com/automation/salesmaterial-as/catalog/en/terms\\_of\\_trade\\_en.pdf](http://www.siemens.com/automation/salesmaterial-as/catalog/en/terms_of_trade_en.pdf)

To calculate the surcharge (except in the cases of dysprosium and neodym), the official price from the day prior to that on which the order was received or the release order was effected is used.

To calculate the surcharge applicable to dysprosium and neodym ("rare earths"), the corresponding three-month basic average price in the quarter prior to that in which the order was received or the release order was effected is used with a one-month buffer (details on the calculation can be found in the explanation of the metal factor).

#### 3. Additional Terms and Conditions

The dimensions are in mm. In Germany, according to the German law on units in measuring technology, data in inches apply only to devices for export.

Illustrations are not binding.

Insofar as there are no remarks on the individual pages of this catalog - especially with regard to data, dimensions and weights given - these are subject to change without prior notice.

#### 4. Export regulations

We shall not be obligated to fulfill any agreement if such fulfillment is prevented by any impediments arising out of national or international foreign trade or customs requirements or any embargoes and/or other sanctions.

Export of goods listed in this catalog may be subject to licensing requirements. We will indicate in the delivery details whether licenses are required under German, European and US export lists. Goods labeled with "AL" not equal to "N" are subject to European or German export authorization when being exported out of the EU. Goods labeled with "ECCN" not equal to "N" are subject to US re-export authorization.

The export indications can be viewed in advance in the description of the respective goods on the Industry Mall, our online catalog system. Only the export labels "AL" and "ECCN" indicated on order confirmations, delivery notes and invoices are authoritative.

Even without a label, or with label "AL:N" or "ECCN:N", authorization may be required i .a. due to the final disposition and intended use of goods.

If you transfer goods (hardware and/or software and/or technology as well as corresponding documentation, regardless of the mode of provision) delivered by us or works and services (including all kinds of technical support) performed by us to a third party worldwide, you must comply with all applicable national and international (re-)export control regulations.

If required for the purpose of conducting export control checks, you (upon request by us) shall promptly provide us with all information pertaining to the particular end customer, final disposition and intended use of goods delivered by us respectively works and services provided by us, as well as to any export control restrictions existing in this relation.

The products listed in this catalog may be subject to European/German and/or US export regulations. Any export requiring approval is therefore subject to authorization by the relevant authorities.

Errors excepted and subject to change without prior notice.

1) The text of the Terms and Conditions of Siemens AG can be downloaded at [www.siemens.com/automation/salesmaterial-as/catalog/en/terms\\_of\\_trade\\_en.pdf](http://www.siemens.com/automation/salesmaterial-as/catalog/en/terms_of_trade_en.pdf)

Further information can be obtained from our branch offices listed at [www.siemens.com/automation-contact](http://www.siemens.com/automation-contact)

<b>Interactive Catalog on DVD</b> Products for Automation and Drives	<i>Catalog</i> <b>CA 01</b>	<b>Low-Voltage Power Distribution and Electrical Installation Technology</b>	<i>Catalog</i>
<b>Building Control</b> GAMMA Building Control	ET G1	SETRON · SIVACON · ALPHA Protection, Switching, Measuring and Monitoring Devices, Switchboards and Distribution Systems	LV 10
<b>Drive Systems</b> SINAMICS G130 Drive Converter Chassis Units	D 11	Standards-Compliant Components for Photovoltaic Plants	LV 11
SINAMICS G150 Drive Converter Cabinet Units		Electrical Components for the Railway Industry	LV 12
SINAMICS GM150, SINAMICS SM150 Medium-Voltage Converters	D 12	TÜV-certified Power Monitoring System	LV 14
SINAMICS PERFECT HARMONY GH180 Medium-Voltage Air-Cooled Drives (Germany Edition)	D 15.1	Components for Industrial Control Panels according to UL Standards	LV 16
SINAMICS G180	D 18.1	3WT Air Circuit Breakers up to 4000 A	LV 35
Converters – Compact Units, Cabinet Systems, Cabinet Units Air-Cooled and Liquid-Cooled		3VT Molded Case Circuit Breakers up to 1600 A	LV 36
SINAMICS S120 Chassis Format Units and Cabinet Modules	D 21.3	<i>Digital: SIVACON System Cubicles, System Lighting and System Air-Conditioning</i>	LV 50
SINAMICS S150 Converter Cabinet Units		<i>Digital: ALPHA Distribution Systems</i>	LV 51
SINAMICS S120 and SIMOTICS	D 21.4	ALPHA FIX Terminal Blocks	LV 52
SINAMICS DCM DC Converter, Control Module	D 23.1	SIVACON S4 Power Distribution Boards	LV 56
SINAMICS DCM Cabinet	D 23.2	SIVACON 8PS Busbar Trunking Systems	LV 70
SINAMICS Inverters for Single-Axis Drives and SIMOTICS Motors	D 31	<i>Digital: DELTA Switches and Socket Outlets</i>	ET D1
<i>Digital: SINAMICS G120P and SINAMICS G120P Cabinet pump, fan, compressor converters</i>	D 35	<b>Motion Control</b>	
LOHER VARIO High Voltage Motors	D 83.2	SINUMERIK 840	NC 62
Flameproof, Type Series 1PS4, 1PS5, 1MV4 and 1MV5 Frame Size 355 to 1000, Power Range 80 to 7100 kW		Equipment for Machine Tools	
Three-Phase Induction Motors	D 84.1	SINUMERIK 808	NC 81.1
SIMOTICS HV, SIMOTICS TN		Equipment for Machine Tools	
High Voltage Three-phase Induction Motors	D 84.9	SINUMERIK 828	NC 82
SIMOTICS HV Series A-compact PLUS		Equipment for Machine Tools	
Three-Phase Induction Motors SIMOTICS HV, Series H-compact	D 86.1	SIMOTION	PM 21
Synchronous Motors with Permanent-Magnet Technology, HT-direct	D 86.2	Equipment for Production Machines	
DC Motors	DA 12	<i>Digital: Drive and Control Components for Cranes</i>	CR 1
SIMOREG DC MASTER 6RA70 Digital Chassis Converters	DA 21.1	<b>Power Supply</b>	
SIMOREG K 6RA22 Analog Chassis Converters	DA 21.2	SITOP Power supply	KT 10.1
<i>Digital: SIMOREG DC MASTER 6RM70 Digital Converter Cabinet Units</i>	DA 22	<b>Safety Integrated</b>	
SIMOVERT PM Modular Converter Systems	DA 45	Safety Technology for Factory Automation	SI 10
SIEMOSYN Motors	DA 48	<b>SIMATIC HMI / PC-based Automation</b>	
MICROMASTER 420/430/440 Inverters	DA 51.2	Human Machine Interface Systems/ PC-based Automation	ST 80/ ST PC
MICROMASTER 411/COMBIMASTER 411	DA 51.3	<b>SIMATIC Ident</b>	
<b>Low-Voltage Three-Phase-Motors</b>		Industrial Identification Systems	ID 10
SIMOTOCS S-1FG1 Servo geared motors	D 41	<b>SIMATIC Industrial Automation Systems</b>	
SIMOTICS Low-Voltage Motors	D 81.1	Products for Totally Integrated Automation	ST 70
SIMOTICS FD Low-Voltage Motors	D 81.8	SIMATIC PCS 7 Process Control System System components	ST PCS 7
LOHER Low-Voltage Motors	D 83.1	SIMATIC PCS 7 Process Control System Technology components	ST PCS 7 T
MOTOX Geared Motors	D 87.1	Add-ons for the SIMATIC PCS 7 Process Control System	ST PCS 7 AO
SIMOGEAR Geared Motors	MD 50.1	<b>SIMATIC NET</b>	
SIMOGEAR Gearboxes with adapter	MD 50.11	Industrial Communication	IK PI
<b>Mechanical Driving Machines</b>		<b>SIRIUS Industrial Controls</b>	
FLENDER Standard Couplings	MD 10.1	SIRIUS Industrial Controls	IC 10
FLENDER High Performance Couplings	MD 10.2	<i>Digital: These catalogs are only available as a PDF.</i>	
FLENDER Backlash-free Couplings	MD 10.3	<b>Information and Download Center</b>	
FLENDER SIP Standard industrial planetary gear units	MD 31.1	Digital versions of the catalogs are available on the Internet at: <a href="http://www.siemens.com/industry/infocenter">www.siemens.com/industry/infocenter</a> There you'll find additional catalogs in other languages. Please note the section "Downloading catalogs" on page "Online services" in the appendix of this catalog.	
<b>Process Instrumentation and Analytics</b>			
<i>Digital: Field Instruments for Process Automation</i>	FI 01		
<i>Digital: Display Recorders SIREC D</i>	MP 20		
<i>Digital: SIPART Controllers and Software</i>	MP 31		
Products for Weighing Technology	WT 10		
Process Analytical Instruments	AP 01		
<i>Digital: Process Analytics, Components for Continuous Emission Monitoring</i>	AP 11		

## Get more information

Motion Control System SIMOTION:

[www.siemens.com/simotion](http://www.siemens.com/simotion)

Local partners worldwide:

[www.siemens.com/automation-contact](http://www.siemens.com/automation-contact)

Siemens AG  
Digital Factory Division  
Postfach 31 80  
91050 ERLANGEN  
GERMANY

© Siemens AG 2017  
Subject to change without prior notice  
Article No. E86060-K4921-A101-A4-7600  
V6.MKKATA.PMA.101 / Dispo 09405  
KG 0217 8. AUM 268 En  
Printed in Germany

The information provided in this catalog contains merely general descriptions or characteristics of performance which in case of actual use do not always apply as described or which may change as a result of further development of the products. An obligation to provide the respective characteristics shall only exist if expressly agreed in the terms of contract. Availability and technical specifications are subject to change without notice.

All product designations may be trademarks or product names of Siemens AG or supplier companies whose use by third parties for their own purposes could violate the rights of the owners.

**Token fee: 5.00 €**

## Security information

Siemens provides products and solutions with industrial security functions that support the secure operation of plants, systems, machines and networks.

In order to protect plants, systems, machines and networks against cyber threats, it is necessary to implement – and continuously maintain – a holistic, state-of-the-art industrial security concept. Siemens' products and solutions only form one element of such a concept.

Customer is responsible to prevent unauthorized access to its plants, systems, machines and networks. Systems, machines and components should only be connected to the enterprise network or the internet if and to the extent necessary and with appropriate security measures (e.g. use of firewalls and network segmentation) in place.

Additionally, Siemens' guidance on appropriate security measures should be taken into account. For more information about industrial security, please visit [www.siemens.com/industrialsecurity](http://www.siemens.com/industrialsecurity)

Siemens' products and solutions undergo continuous development to make them more secure. Siemens strongly recommends to apply product updates as soon as available and to always use the latest product versions. Use of product versions that are no longer supported, and failure to apply latest updates may increase customer's exposure to cyber threats.

To stay informed about product updates, subscribe to the Siemens Industrial Security RSS Feed under [www.siemens.com/industrialsecurity](http://www.siemens.com/industrialsecurity)

Scan the QR code  
for information on  
SIMOTION.

