

SIEMENS

SICAM RTUs

SM-2558/DPMiA0

PROFIBUS-DP Master with
external Fieldbus Gateway
netHOST

System Element Manual

Preface, Table of Contents

Introduction 1

Protocol Element SM 2558/DPMiA0 2

System Components 3

Protocol Description 4

Message Conversion 5

PROFIBUS-DP Data Formats A

SYCON.net + netHOST Quick Start
Instructions B

PROFIBUS-DP Basics C

Literature

**Hint**

Please observe Notes and Warnings for your own safety in the Preface.

Disclaimer of Liability

Although we have carefully checked the contents of this publication for conformity with the hardware and software described, we cannot guarantee complete conformity since errors cannot be excluded. The information provided in this manual is checked at regular intervals and any corrections that might become necessary are included in the next releases. Any suggestions for improvement are welcome.

Subject to change without prior notice.
Document Label:
SICRTUs-HBSM2558DPMiA0-ENG_V2.03
Date of issue:
2015.08.25

Copyright

Copyright © Siemens AG 2017
The reproduction, transmission or use of this document or its contents is not permitted without express written authority. Offenders will be liable for damages. All rights, including rights created by patent grant or registration of a utility model or design, are reserved.

Preface

This document is applicable to the following product(s):

- SICAM AK
- SICAM AK 3
- SICAM TM

Purpose of this manual

This manual describes the functioning of the system element SM-2558/DPMiA0 "PROFIBUS-DP Master with the external Fieldbus Gateway "netHOST" and essentially contains:

- Functional descriptions
- Technical Specifications
- Descriptions of interfaces to the process and other system elements
- Possible Configurations

Target Group

The document you are reading right now is addressed to users, who are in charge of the following engineering tasks:

- Conceptual activities, as for example design and configuration
- Creation of the assembly technical documentation using the designated engineering tools
- System parameterization and system diagnostic, using the designated engineering tools
- Technical system maintenance
- Above applies, as far as these tasks do not involve manipulations of the hardware.

Manipulating the hardware itself, as for example "unplugging" and "plugging" printed circuit boards and modules, or working on terminals and/or connectors – for instance when applying changes to the wiring – **are** – also if they are an issue in the context of configuration, parameterization and diagnostic – **not subject of this document**.



For activities, which comprise hardware manipulations, it is essential to pay attention to the appropriate safety instructions and to strictly adhere to the appropriate safety regulations.

Instructions and regulations are also stated in installation manuals or manuals which deal with hardware installation and other hardware manipulations.

Notes on Safety

This manual does not constitute a complete catalog of all safety measures required for operating the equipment (module, device) in question because special operating conditions might require additional measures. However, it does contain notes that must be adhered to for your own personal safety and to avoid damage to property. These notes are highlighted with a warning triangle and different keywords indicating different degrees of danger.



Danger

means that death, serious bodily injury or considerable property damage will occur, if the appropriate precautionary measures are not carried out.



Warning

means that death, serious bodily injury or considerable property damage can occur, if the appropriate precautionary measures are not carried out.

Caution

means that minor bodily injury or property damage could occur, if the appropriate precautionary measures are not carried out.



Hint

is important information about the product, the handling of the product or the respective part of the documentation, to which special attention is to be given.



Qualified Personnel

Commissioning and operation of the equipment (module, device) described in this manual must be performed by qualified personnel only. As used in the safety notes contained in this manual, qualified personnel are those persons who are authorized to commission, release, ground, and tag devices, systems, and electrical circuits in accordance with safety standards.

Use as Prescribed

The equipment (device, module) must not be used for any other purposes than those described in the Catalog and the Technical Description. If it is used together with third-party devices and components, these must be recommended or approved by Siemens.

Correct and safe operation of the product requires adequate transportation, storage, installation, and mounting as well as appropriate use and maintenance.

During operation of electrical equipment, it is unavoidable that certain parts of this equipment will carry dangerous voltages. Severe injury or damage to property can occur if the appropriate measures are not taken:

- Before making any connections at all, ground the equipment at the PE terminal.
 - Hazardous voltages can be present on all switching components connected to the power supply.
 - Even after the supply voltage has been disconnected, hazardous voltages can still be present in the equipment (capacitor storage).
 - Equipment with current transformer circuits must not be operated while open.
 - The limit values indicated in the manual or the operating instructions must not be exceeded; that also applies to testing and commissioning.
-

Table of Contents

1	Introduction.....	9
1.1	Application	10
1.2	Overview.....	11
1.3	Mechanics.....	12
2	Protocol Element SM 2558/DPMiA0.....	13
2.1	Features and Functions.....	14
2.1.1	Restrictions	18
2.2	Modes of Operation.....	19
2.3	Communication	20
2.4	Configurations	21
2.5	Engineering.....	22
2.6	Block Diagram.....	23
2.7	Technical Specifications	24
2.8	Status and Function display.....	25
2.9	Pin Assignment	26
3	System Components.....	27
3.1	Hardware	28
3.2	Firmware.....	28
3.3	Can be equipped optional.....	28
3.4	Accessories.....	29
4	Protocol Description	31
4.1	Overview.....	32
4.2	PROFIBUS Overview	33
4.2.1	PROFIBUS-DP Versions	34
4.3	Configurations with PROFIBUS-DP	35
4.3.1	Schematic Configuration.....	35
4.3.2	Supported Configurations	37
4.3.2.1	SICAM RTUs as Single PROFIBUS-DP Master	37
4.3.2.2	SICAM RTUs as PROFIBUS-DP Master in Multi-Master Configuration ..	37
4.3.2.3	SICAM RTUs as PROFIBUS-DP Slave (using DP-DP Coupler)	38
4.3.2.4	SICAM RTUs with PROFIBUS-DP Master Redundancy	39
4.3.2.4.1	Single PROFIBUS + redundant CPU's.....	39
4.3.2.4.2	Single PROFIBUS + redundant AU's	39
4.3.2.4.3	Redundant PROFIBUS + redundant CPU's.....	40
4.3.2.4.4	Redundant PROFIBUS + redundant AU's	41
4.4	Protocol Element for PROFIBUS-DP Master.....	42
4.4.1	Definition of the Connections (Connection, Station Definition)	43

4.4.1.1	TCP/IP Connection to netHOST	43
4.4.1.2	Station Definition	45
4.4.2	Data Exchange Procedure.....	46
4.4.2.1	Failure Monitoring.....	49
4.4.2.2	PROFIBUS Diagnostic Information	50
4.4.3	General Interrogation, Outstation Interrogation	51
4.4.4	Clock Synchronization	51
4.4.5	Command Transmission.....	52
4.4.6	Transmission of Integrated Totals.....	53
4.5	Functions for supporting Redundant Communication Routes	54
4.5.1	PROFIBUS-DP Master with “single ROFIBUS“	55
4.5.2	PROFIBUS-DP Master with “redundant PROFIBUS“	60
4.6	Special Functions	62
4.6.1	DP/DP Coupler.....	62
4.7	Protocol Element Control and Return Information	64
4.7.1	Protocol Element Control.....	65
4.7.2	Protocol Element Return Information	66
5	Message Conversion	67
5.1	Overview.....	68
5.2	Message Conversion in Transmit Direction (Master à Slave).....	70
5.2.1	Commands.....	71
5.2.2	Indications.....	77
5.2.3	Measured Values / Setpoint Values	81
5.3	Message Conversion in Receive Direction (Master i Slave)	86
5.3.1	Indications.....	87
5.3.2	Measured Values	91
5.3.3	Integrated totals.....	96
5.3.4	Commands.....	101
A	PROFIBUS-DP Data Formats	107
A.1	PROFIBUS-DP Data Formats.....	108
B	SYCON.net + netHOST Quick Start Instructions	115
B.1	Overview.....	116
B.1.1	Download SYCON.net.....	116
B.1.2	Installation of SYCON.net.....	117
B.1.3	Update netHOST Firmware	118
B.2	Workflow	120
B.2.1	Setting the IP-address for netHOST.....	120
B.2.2	SYCON.net – Configuration.....	120
B.2.3	Connecting SYCON.net with netHOST in Operation	122
B.2.4	Save SYCON.net Configuration Data in TOOLBOX II	123

C	PROFIBUS-DP Basics	127
C.1	PROFIBUS Characteristics	128
5.3.5	PROFIBUS Bus Access Protocol	129
C.2	PROFIBUS-DP	131
C.3	Diagnostics	135
C.4	System Configuration and Device Types	136
C.5	System Behavior	138
C.6	Fail Safe Mode	138
C.7	Synchronization of In-/Outputs	139
C.8	Device Engineering	140
C.8.1	General Information	140
C.8.2	GSD-Files	140
C.8.3	Ident Number	141
C.9	Transmission Layer (Layer 1)	142
5.3.6	General Information	142
C.9.1	Transmission according RS485	142
C.9.2	Bus Connector Assignment	143

1 Introduction

Contents

1.1	Application	10
1.2	Overview	11
1.3	Mechanics.....	12

1.1 Application

The protocol element SM-2558/DPMi00 "PROFIBUS-DP Master" is used in combination with the external Fieldbus Gateway "netHOST" in automation units of the systems SICAM AK and SICAM TM for the interfacing of PROFIBUS-DP slave devices (DP-V0). It is deployed in the field of telecontrol and automation.

The protocol element is used in combination with the external Fieldbus Gateway "netHOST" for the exchange of data - and thereby for the transmission of messages - over a communication interface to other automation units or with devices with the Fieldbus protocol PROFIBUS-DP (DP-V0).

The protocol element SM-2558/DPMi00 in combination with the external Fieldbus Gateway "netHOST" is the master station for the communication.

Products	SICAM AK, SICAM AK 3, SICAM TM
System element type	Protocol Element
consists of	Module SM-2558 with firmware DPMiA0
can be used in	SICAM AK, SICAM AK 3, SICAM TM
Engineering	SICAM RTUs: SICAM TOOLBOX II and OPM II Hilscher netHOST: SYCON.net

1.2 Overview

Protocol Element for PROFIBUS-DP Master.

- PROFIBUS-DP Master (DP-V0) for max. 100 PROFIBUS-DP Slaves
(external Fieldbus Gateway for PROFIBUS-DP Master "Hilscher netHOST" required)
 - Data conversion IEC 60870-5-101/104 to PROFIBUS-DP Master
 - Interface between SM-2558 <-> netHOST:
 - Fast Ethernet 100 Mbit/s, IEEE 802.3, 100Base-TX, electrical
 - TCP/IP
 - Hilscher Marshaller Protocol
 - Interface Hilscher netHOST <-> PROFIBUS-DP Slaves:
 - PROFIBUS-DP (electrical, 9,6kBit/s ... 12MBit/s)
 - PROFIBUS-DP Protocol according IEC 61158 Type 3 "PROFIBUS DP-V0"
(former DIN 19245 and EN50170)

The protocol element can be attached to master control and communication elements of SICAM RTUs, in addition the external Fieldbus Gateway "netHOST" is required.

1.3 Mechanics

SIM SM-2558 can be attached to master control and communication elements of SICAM RTUs platforms.

View

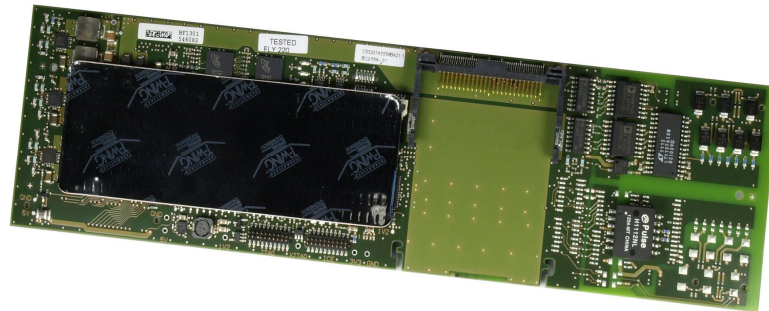

Optionally it can be expanded with a serial interface by SM-0551/PROTOCOL.

In addition the external Fieldbus Gateway “netHOST” from Hilscher as PROFIBUS-DP Master is required. Hilscher netHOST can be ordered in 2 different colors (red, dark-grey) – the ordering numbers are included in chapter “system components”.

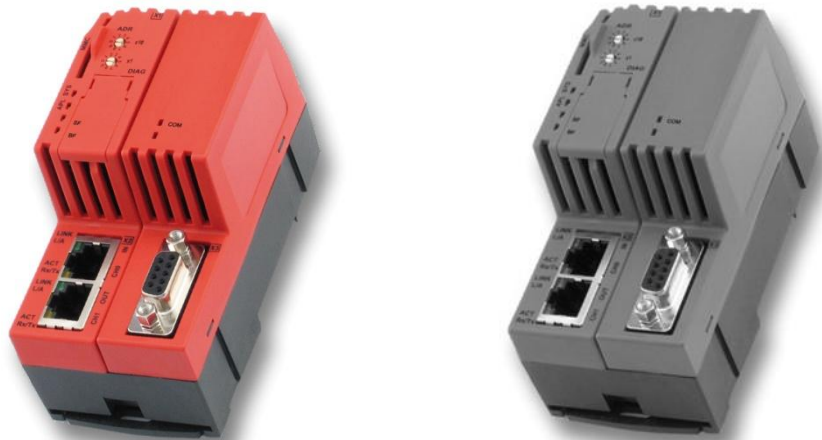

2 Protocol Element SM 2558/DPMiA0

Contents

2.1	Features and Functions.....	14
2.2	Modes of Operation.....	19
2.3	Communication	20
2.4	Configurations	21
2.5	Engineering.....	22
2.6	Block Diagram.....	23
2.7	Technical Specifications	24
2.8	Status and Function display.....	25
2.9	Pin Assignment	26

2.1 Features and Functions

The following firmwares are available for the different systems:

Firmware	System	Standard and Function
<i>DPMiA0</i>	SICAM AK SICAM TM SICAM AK 3	PROFIBUS-DP Master ¹⁾

¹⁾ in addition the external Fieldbus Gateway "netHOST" required!

General Functions

Function	DPM00	DPMiA0
· PROFIBUS-DP Master		
– DP-V0	Ü	Ü
– DP-V1		
– DP-V2		
– max. number of PROFIBUS-DP Slaves	100	100
– PROFIBUS-DP Slave address range	0-99	0-99
– max. number of process information in command direction (transmit direction)	1000	1000
– max. number of process information in monitoring direction (receive direction)	1000	5000
– Cycle time (data exchange)	0-25,5 sec	10-1000 ms
· LAN/WAN communication (SM-2558 ß à netHOST)		
– 100 MBit (Full Duplex)		Ü
– Auto-MDIX (Auto Medium Dependent Interface Crossover)		
– Hilscher "Marshaller Protocol" (proprietary)		Ü
· Supported Ports		
– Port 50111: netHOST – Hilscher "Marshaller protocol" (proprietary)		Ü
– Port 50112: netHOST – "reserved"		
· PROFIBUS-DP communication (netHOST ß à PROFIBUS-DP Slaves)		
– PROFIBUS-DP according IEC 61158 Type 3 "PROFIBUS DP-V0" (former DIN 19245 or EN50170)	Ü	Ü
– Data rate 9,6kBit/s ... 12MBit/s	Ü	Ü
· Acquisition of events (transmission of data ready to be sent)	Ü	Ü
· General interrogation, outstation interrogation	Ü	Ü
– Interrogation command "station interrogation (global)" ¹⁾	Ü	Ü
– Interrogation command "interrogation of group 1-16"		
· Command transmission	Ü	Ü
– Set control location		
– Check control location		

Function	DPM00	DPMiA0
· Transmission of integrated totals ²⁾	Ü	Ü
– Counter interrogation command (general request counter)	Ü	Ü
– Counter interrogation command (request counter group 1-4)	Ü	Ü
· Supported message formats in command direction (=transmit direction) IEC60870-5-101/-104 à PROFIBUS-DP		
– <TI:=30> Single-point information with time tag CP56Time2a	Ü	Ü
– <TI:=31> Double-point information with time tag CP56Time2a	Ü	Ü
– <TI:=33> Bitstring of 32 bit with time tag CP56Time2a		Ü
– <TI:=34> Measured value, normalized value with time tag CP56Time2a		Ü
– <TI:=35> Measured value, scaled value with time tag CP56Time2a	Ü	Ü
– <TI:=36> Measured value, short floating point value with time tag CP56Time2a	Ü	Ü
– <TI:=37> Integrated totals with time tag CP56Time2a	Ü	Ü
– <TI:=45> Single command	Ü	Ü
– <TI:=46> Double command	Ü	Ü
– <TI:=47> Regulating step command		Ü
– <TI:=48> Set point command, normalized value		Ü
– <TI:=49> Set point command, scaled value	Ü	Ü
– <TI:=50> Set point command, short floating point	Ü	Ü
– <TI:=51> Bitstring of 32 bit	Ü	Ü
– <TI:=100> Interrogation command		Ü
– <TI:=101> Counter interrogation command		Ü
· Supported message formats in monitoring direction (receive direction) IEC60870-5-101/-104 à PROFIBUS-DP		
– <TI:=30> Single-point information with time tag CP56Time2a	Ü	Ü
– <TI:=31> Double-point information with time tag CP56Time2a	Ü	Ü
– <TI:=33> Bitstring of 32 bit with time tag CP56Time2a	Ü	Ü
– <TI:=34> Measured value, normalized value with time tag CP56Time2a		Ü
– <TI:=35> Measured value, scaled value with time tag CP56Time2a	Ü	Ü
– <TI:=36> Measured value, short floating point value with time tag CP56Time2a	Ü	Ü
– <TI:=37> Integrated totals with time tag CP56Time2a	Ü	Ü
– <TI:=45> Single command	Ü	Ü
– <TI:=46> Double command	Ü	Ü
– <TI:=47> Regulating step command	Ü	Ü
· Supported PROFIBUS-DP data formats in command direction (=transmit direction)		
– 1BIT	Ü	Ü
– 1BIT/PULSE	Ü	Ü
– 2BIT	Ü	Ü
– 2BIT/PULSE	Ü	Ü
– BYTE/FLAG	Ü	Ü

Function	DPM00	DPMiA0
– INT8, UINT8	Ü	Ü
– INT16, UINT16	Ü	Ü
– INT32, UINT32	Ü	Ü
– FLOAT32	Ü	Ü
– S5INT12	Ü	Ü
– S5INT12S		
– S5INT13S		
• Supported PROFIBUS-DP data formats in monitoring direction (=receive direction)		
– 1BIT	Ü	Ü
– 1BIT/PULSE	Ü	Ü
– 2BIT	Ü	Ü
– 2BIT/PULSE	Ü	Ü
– BYTE/FLAG	Ü	Ü
– INT8, UINT8	Ü	Ü
– INT16, UINT16	Ü	Ü
– INT32, UINT32	Ü	Ü
– FLOAT32	Ü	Ü
– S5INT12		
– S5INT12S	Ü	Ü
– S5INT13S	Ü	Ü
– DP/DP STATUS ("data valid")	Ü	Ü
• Protocol element control and return information		
Protocol element control		
– Send (general) interrogation command to all	Ü	Ü
– Send (general) interrogation command to GI group		
– Set control location		
Protocol element return information		
– Station failure	Ü	Ü
– Protocol specific return information 0 ... 7		
• Redundancy (functions for the support of redundant communication routes)		
– PROFIBUS redundancy with singular PROFIBUS	Ü	Ü
– PROFIBUS redundancy with redundant PROFIBUS	Ü	Ü
• SICAM TOOLBOX II connection over LAN/WAN ("remote connection")		
– Remote connection based on http/https		
– Remote connection based on integrated terminal server		
• WEB Server		
• Special Functions		
– Siemens DP/DP Coupler	Ü	Ü

Function	DPM00	DPMiA0
· Engineering		
– SICAM TOOLBOX II + OPM	ü	ü
· Engineering (netHOST + PROFIBUS-DP)		
– Hilscher SYCON (integrated in SICAM TOOLBOX II)	ü	
– Hilscher SYCON.net		ü

- 1) PROFIBUS-DP protocol does not define a general interrogation.
 The actual state of data will be read cyclic from netHOST.
 After SICAM RTUs internal IEC60870-5-101/-104 general interrogation command from BSE à PRE the interrogated data will be sent to BSE with cause of transmission COT= 20 (interrogated by station interrogation) after next cyclic reading of data.
- 2) PROFIBUS-DP protocol does not define a counter interrogation procedure.
 The actual state of data will be read cyclic from netHOST.
 After SICAM RTUs internal IEC60870-5-101/-104 counter interrogation command from BSE à PRE the interrogated counters will be sent to BSE with cause of transmission COT= 37 (requested by general counter request) or with COT= 38-41 (requested by group 1-4 counter request) from PRE internal data base.



Hints

The above mentioned functions are described in detail in the chapter *Protocol Description*.

This protocol element supports only a restricted area of the protocol functionality for coupling to systems of other product groups or to systems of third party suppliers.

For using this protocol element in your project you have to verify if the supported functionality and supported data formats of the protocol element will be compatible to the required functionality and data formats for interfacing a specific 3rd party system.

2.1.1 Restrictions

- No emulation of ACTCON/ACTERM for commands/set points/counters according IEC60870-5-101/104.
- Control location is not supported.
- “Select-Before-Operate” is not supported for commands/setpoint commands.
- PROFIBUS-DP slave address only supported in range 0-99 (PROFIBUS-DP defines slave address in range 0-125)
- The parameterized cycle time for data exchange between protocol element and netHOST cannot be guaranteed in all cases. (the PRE internal processing time depends on number of configured data points and the number of data changes)
- The output of short changes of indications on PROFIBUS-DP cannot be guaranteed caused by cyclic data exchange.
- Short changes of indications on PROFIBUS-DP inputs cannot be guaranteed processed by protocol element caused by cyclic data exchange.
- Commands in receive direction (PROFIBUS-DP → SICAM RTUs) must be transmitted as pulse via PROFIBUS-DP (= edge sensitive processing), to prevent of unwanted actions in case of state transmission (unwanted actions possible when using state transmission after power up).
- Intermediate state and indeterminate state suppression for double point information in receive direction is not supported



Hint

The external Fieldbus Gateway netHOST should be connected directly to SICAM RTUs Ethernet interface!

Using switches or other network devices are not recommended!

Cause:

- high load of network data traffic caused by communication from/to netHOST
 - time critical Watch-Dog supervision in netHOST.
-

2.2 Modes of Operation

Operating mode	Patch Plug/Module	Extras ¹⁾	Note
Electrical Ethernet-interface (twisted pair)	CM-2860	Hilscher netHOST	Communication between SM-2558 <-> Hilscher netHOST: <ul style="list-style-type: none"> · Fast Ethernet acc. IEEE 802.3, 100Base-TX · Transmission rate up to 100 Mbps · RJ45 connector 8-pin according to IEC 603.7
Optical Ethernet interface (multimode fiber optic)	CM-2860	Media Converter or Switch (on both sides) + netHOST	Communication between SM-2558 <-> Hilscher netHOST: <ul style="list-style-type: none"> · Fast Ethernet acc. IEEE 802.3, 100Base-TX · Transmission rate up to 100 Mbps · RJ45 connector 8-pin according to IEC 603.7
PROFIBUS-DP interface (from netHOST to PROFIBUS-DP Slaves)			Communication between netHOST <-> PROFIBUS-DP Slaves: <ul style="list-style-type: none"> · Transmission rate 9,6kbps ... 12Mbps · 9pin-SUB-D connector according PROFIBUS

¹⁾ Extras are optional equipments

2.3 Communication

For the stations to communicate with each other, suitable transmission facilities and/or network components may be needed in addition. An optical connection is possible via media converter or switch.

Own Station (PROFIBUS-DP Master)

System	System Element	Protocol Element	Note
SICAM AK	CP-2014/CPCX25 CP-2017/PCCX25	SM-2558/DPMiA0	max. 100 Slaves ¹⁾
SICAM AK 3	CP-2016/CPCX26 CP-2019/PCCX26	SM-2558/DPMiA0	max. 100 Slaves ¹⁾
SICAM TM	CP-6014/CPCX65	SM-2558/ DPMiA0	max. 100 Slaves ¹⁾

1) external Fieldbus Gateway "netHOST" is required!

Remote Station (PROFIBUS-DP Slaves)

System	System Element	Protocol Element	Note
SIEMENS PROFIBUS-DP Slave devices			PROFIBUS-DP (DP-V0) compatible
SIEMENS PROFIBUS DP/DP coupler			PROFIBUS-DP (DP-V0) compatible
3 rd party system			PROFIBUS-DP (DP-V0) compatible

2.4 Configurations

The following table lists supported configurations. In addition to one or two SM-2558, all parts (SIM, carrier module, connection board, patch plug, etc.) listed for the chosen configuration are needed:

Configuration			Interfaces			
Carrier Module	Connection Board ¹⁾	Patch Plug ¹⁾	SIM0		SIM1	
			SI0	SI1	SI2	SI3
CP-2014	CM-2839	2)	ü ⁴⁾	ü		
CP-2017	CM-2838	2)	ü ⁴⁾	ü	ü ⁴⁾	ü
CP-6014	---	2)	ü ⁴⁾	ü	ü ⁴⁾	ü

- 1) one connection board for each carrier module, one patch plug for each interface
- 2) For patch plugs for standard protocols in standard configurations as supported see modes of operation of the respective protocol element; for patch plugs in other than standard configurations see SICAM RTUs Platforms Configuration Automation Units and Automation Networks (DC0-021-2)
- 4) serial interface (V.28) – can be added optionally (SM-0551)

The following table lists the BSE's in SICAM AK 3 where the protocol element can be used and the interface where the protocol is supported.

Basic System Element	Protocol Element	BSE Interface			
		X0	X1	X2	X3
CP-2016	SM-2558/DPMiA0	-	-	ü ¹⁾	ü
CP-2019	SM-2558/DPMiA0	-	-	ü ¹⁾	ü

- 1) serial interface (V.28) – can be added optionally (SM-0551)



Hint

Details on assembly of SIMs and Patch Plugs can be found in the user manual of the respective SICAM RTU, chapter *Setup of external Communication Connections*.

Details on assembly of the protocol elements for SICAM AK 3 can be found in *SICAM AK 3 user manual*, chapter *Setup of external Communication Connections*.

2.5 Engineering

For diagnosis, testing, parameter setting or documentation, the system element is supported by the engineering tools of SIEMENS TOOLBOX II. OPM II is required.

For diagnosis, testing, parameter setting of the external Fieldbus Gateway “netHOST” for PROFIBUS-DP Master the software SYCON.net (Hilscher) is required.



Hint

Please use always latest version of SYCON.net software!

The newest version of SYCON.net software for netHOST can be downloaded from <https://www.hilscher.com/support/downloads/>.

Notes:

- SYCON.net software version included in netHOST package's DVD may be not up to date.
- Before 1st usage of netHOST please download the newest firmware for netHOST and load firmware into netHOST device (netHOST will not be delivered with latest firmware version).
- The newest firmware for netHOST is included in SYCON.net software.

à For more details on firmware update of netHOST see chapter appendix B SYCON.net + netHOST Quick Start Instructions.

2.6 Block Diagram

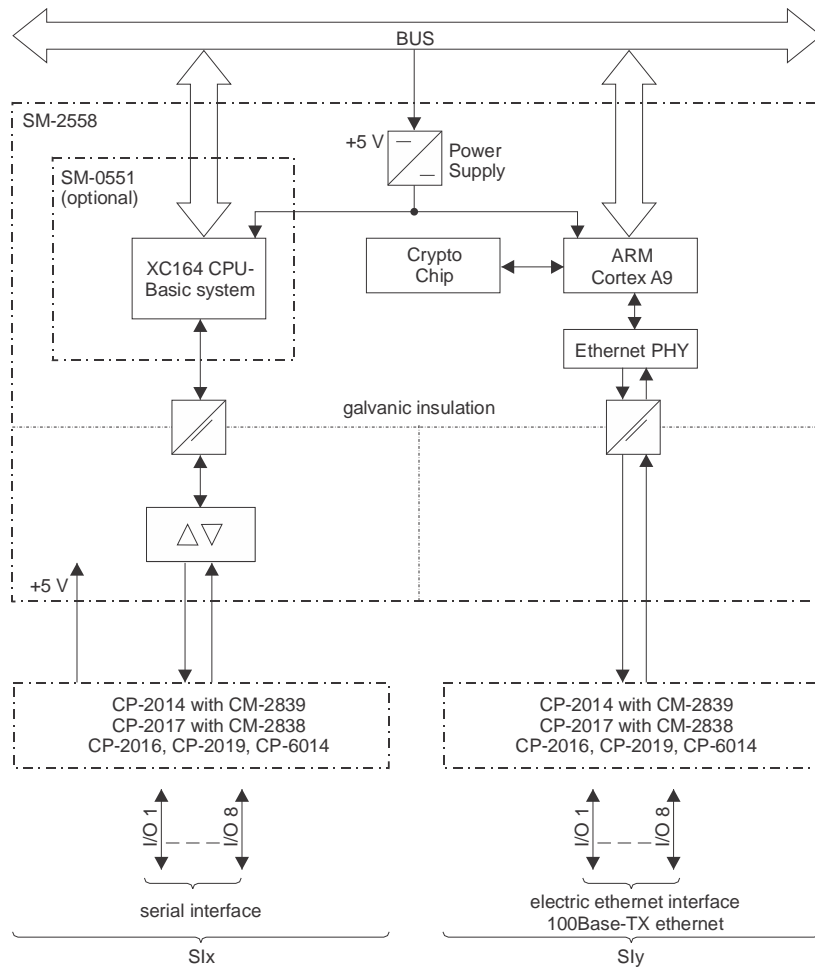

2.7 Technical Specifications

Communication Circuits			
Electrical LAN interface (twisted pair)	Fast Ethernet acc. IEEE 802.3, 100Base-TX Data rate 100 Mbps Line lengths up to 100 m (with CAT 5e cable)		
1 serial interface (SM--0551 can be added optional)	Technical Specifications see datasheet <i>SM-x551/PROTOCOL (MC0-003-2.00)</i>		
Power Supply			
Operating voltage	4.75 .. 5.25 VDC,	typ. 400 mA,	max. 500 mA (without SM-0551)
	4.75 .. 5.25 VDC,	typ. 525 mA,	max. 770 mA (with SM-0551)
The voltage is supplied by the carrier module.			
Mechanics			
Dimensions	227.3 x 63.5 mm		
Weight	Approx. 90 g		

2.8 Status and Function display

The protocol element SM-2558/DPMi00 has neither a front panel nor LEDs to display status and functions.

It use the LEDs of the master control unit or communication elements. The meaning of these LED displays is described in the manual of the concerning system element.

Protocol elements – Mounting place and LED display SICAM AK/SICAM TM

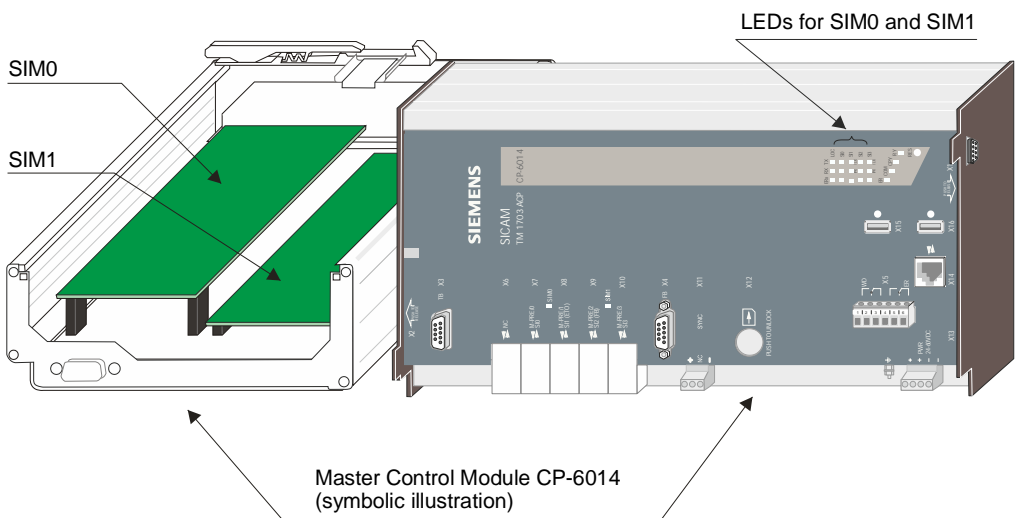
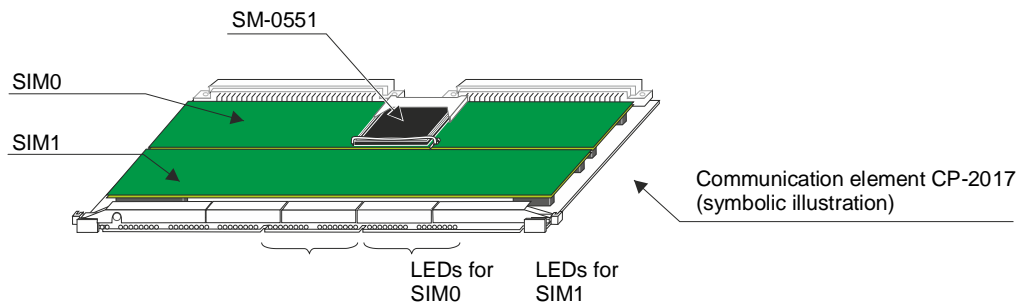
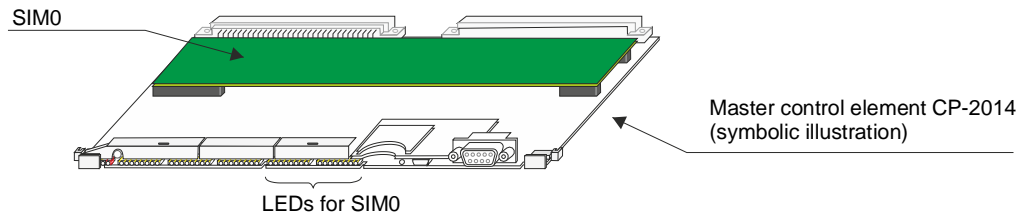

2.9 Pin Assignment

According to its application, the interfaces of a communication element (RJ45 socket connector) are on the carrier module itself (SICAM AK 3), on the connection board (SICAM AK) or on the housing (SICAM TM).

RJ45 socket connector	
SI1	on CM-2839 with CP-2014
SI1, SI3	on CM-2838 with CP-2017
X3	on CP-2016 or CP-2019
SI1	on housing of CP-6014

Pin	Signal	Meaning
1	TxD+	Transmit Data +
2	TxD-	Transmit Data -
3	RxD+	Receive Data +
4	-	not used
5	-	not used
6	RxD-	Receive Data -
7	-	not used
8	-	not used

3 System Components

Contents

3.1	Hardware	28
3.2	Firmware	28
3.3	Can be equipped optional	28
3.4	Accessories.....	29

3.1 Hardware

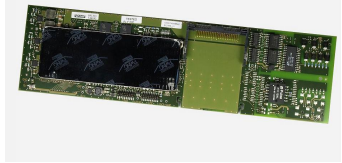
	<table border="1"> <thead> <tr> <th>Designation</th> </tr> </thead> <tbody> <tr> <td>SM-2558 Ethernet-Interface 1x100Base-TX, (+1 ser. interface)</td> </tr> </tbody> </table>	Designation	SM-2558 Ethernet-Interface 1x100Base-TX, (+1 ser. interface)	<table border="1"> <thead> <tr> <th>Item-Number/MLFB</th> </tr> </thead> <tbody> <tr> <td>BC2-558 6MF10130CF580AA0</td> </tr> </tbody> </table>	Item-Number/MLFB	BC2-558 6MF10130CF580AA0
Designation						
SM-2558 Ethernet-Interface 1x100Base-TX, (+1 ser. interface)						
Item-Number/MLFB						
BC2-558 6MF10130CF580AA0						





3.2 Firmware

	<table border="1"> <thead> <tr> <th>Designation</th> </tr> </thead> <tbody> <tr> <td>DPMiA0 PROFIBUS-DP Master + netHOST</td> </tr> <tr> <td>TU DPMiA0 TB II-Update</td> </tr> </tbody> </table>	Designation	DPMiA0 PROFIBUS-DP Master + netHOST	TU DPMiA0 TB II-Update	<table border="1"> <thead> <tr> <th>Item-Number/MLFB</th> </tr> </thead> <tbody> <tr> <td>SC0-589-1</td> </tr> <tr> <td>SC0-589-1.XX/53</td> </tr> </tbody> </table>	Item-Number/MLFB	SC0-589-1	SC0-589-1.XX/53
Designation								
DPMiA0 PROFIBUS-DP Master + netHOST								
TU DPMiA0 TB II-Update								
Item-Number/MLFB								
SC0-589-1								
SC0-589-1.XX/53								

3.3 Can be equipped optional

	<table border="1"> <thead> <tr> <th>Designation</th> </tr> </thead> <tbody> <tr> <td>SM-0551 Serial Interface Processor, 1 serial interface</td> </tr> </tbody> </table>	Designation	SM-0551 Serial Interface Processor, 1 serial interface	<table border="1"> <thead> <tr> <th>Item-Number/MLFB</th> </tr> </thead> <tbody> <tr> <td>BC0-551 6MF10130AF510A00</td> </tr> </tbody> </table>	Item-Number/MLFB	BC0-551 6MF10130AF510A00
Designation						
SM-0551 Serial Interface Processor, 1 serial interface						
Item-Number/MLFB						
BC0-551 6MF10130AF510A00						

3.4 Accessories

	Designation	Item-Number/MLFB
	netHOST PROFIBUS Master NHST-T100-DP/DPM Art.Nr.:1890.410 Color: red	- Note: This accessory must be ordered directly from Hilscher. Web: www.hilscher.com http://de.hilscher.com/sales_subsidiaries.html http://de.hilscher.com/sales_distributors.html
	netHOST PROFIBUS Master NHST-T100-DP\GR/DPM Art.Nr.:1891.410 Color: dark grey	- Note: This accessory must be ordered directly from Hilscher. Web: www.hilscher.com http://de.hilscher.com/sales_subsidiaries.html http://de.hilscher.com/sales_distributors.html
	SYCON.net (Windows based PROFIBUS configuration software) Note: SYCON.net is automatically included in package list for NHST-T100-DP\GR/DPM and will be shipped on DVD or available via download.	- Web: https://www.hilscher.com/support/downloads/
	CM-2860 Patch Plug Standard V.28, ET, TR Note: Not required for SICAM AK 3	CA2-860 6MF12110CJ600AA0



Hint

Before 1st usage of netHOST please download the newest firmware for netHOST and load firmware into netHOST device (netHOST will not be delivered with latest firmware version). The newest firmware for netHOST is included in SYCON.net. The newest version of SYCON.net can be downloaded from <https://www.hilscher.com/support/downloads/>. For more details on firmware update of netHOST see chapter appendix B SYCON.net + netHOST Quick Start Instructions.

4 Protocol Description

Contents

4.1	Overview	32
4.2	PROFIBUS Overview	33
4.3	Configurations with PROFIBUS-DP	35
4.4	Protocol Element for PROFIBUS-DP Master	42
4.5	Functions for supporting Redundant Communication Routes	54
4.6	Special Functions	62
4.7	Protocol Element Control and Return Information	64

4.1 Overview

PROFIBUS (PROcess Field BUS) is a non-vendor-dependent, open field bus standard featuring a broad spectrum of possible usage in manufacturing and process automation. Actually PROFIBUS-DP is standardized in IEC61158.

PROFIBUS-DP defines master- and slave stations.

The protocol element for PROFIBUS-DP in SICAM RTUs supports in combination with the external Fieldbus Gateway netHOST the function for "PROFIBUS-DP Master".

The external Fieldbus gateway netHOST is connected via LAN interface (Ethernet) to SICAM RTUs.

The configuration of PROFIBUS-DP master in netHOST is to be done with the Windows based software "SYCON.net" from Hilscher. The configuration data will be loaded directly from SYCON.net into netHOST. The PROFIBUS-DP protocol is executed by netHOST.

The processing of data from/to PROFIBUS-DP slaves in SICAM RTUs will be controlled by protocol element SM-2558/DPMiA0.

The data communication between SICAM RTUs & netHOST is controlled by the protocol element using LAN based Hilscher Marschaller protocol. The initialization of the netHOST and the data exchange from/to PROFIBUS-DP slaves is done via this protocol.

The message conversion from IEC60870-5-101/-104 & PROFIBUS-DP will be done by SICAM RTUs protocol element.

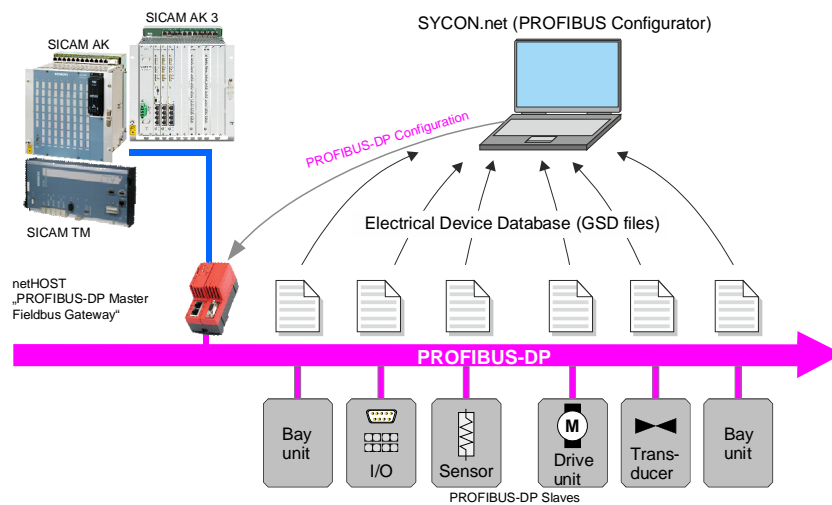

Hint

The GSD File can be requested from the manufacturer of the PROFIBUS-DP Slave.

For some PROFIBUS-DP Slave devices an updated GSD file must be used after updating the firmware of PROFIBUS-DP Slave device (GSD file must be applicable for used revision of firmware).

4.2 PROFIBUS Overview

The PROFIBUS protocol was defined in the early 1991 in standard DIN 19245 "PROFIBUS" (PROcess FieLd BUS) and 1996 published as European standard EN 50170. Since 1999 PROFIBUS-DP is defined in the standard IEC61158.

With the definition of PROFIBUS an open and company independent Fieldbus protocol standard was defined, so devices from different manufactures are equipped with defined interface. Based on various but also specific functionality PROFIBUS supports applications in field level and also great range in sensor-/actuator- and cell level.

PROFIBUS supports functional grouped communication protocols (communication profiles): DP, PA and FMS.

PROFIBUS communication profiles defines how members on the PRFIBUS network can transport their data via serial communication medium.

PROFIBUS Variants	Function	DPM00	DPMiA0
PROFIBUS-DP	<p>DP "Decentralize Periphery"</p> <ul style="list-style-type: none"> - PROFIBUS-DP used for control of sensors/actuators by central control logic of the manufacturing technology. - data rates up to <u>12 Mbps</u> supported via 2 wire twisted pair cables or optical cables. - PROFIBUS-DP DP is the most used communication profile. - PROFIBUS-DP is optimized for data rate, efficiency and low cost interface and especially designed for applications in automation systems with the decentralized peripheries. - PROFIBUS-DP can be used also as replacement for the conventional parallel signal transmission using 24V in the manufacturing technology but also for analog signal transmission using 4 ... 20 mA or Hart in process automation technology. 	ü	ü
PROFIBUS-PA	<p>PA "Process-Automation"</p> <p>PROFIBUS-PA will be used for communication between measuring devices, process devices, actuators and process control systems or PLC in the process engineering.</p> <p>PROFIBUS PA can be segmented using couplers.</p> <p>The 2 wire bus cable will be used for communication and also for power supply of the devices connected to PROFIBUS-PA.</p> <p>Caused by limitation of the power PROFIBUS PA can be used also in areas exposed to explosion hazards.</p> <p>PROFIBUS PA defines a data rate of <u>31.25 kbps</u>.</p>		
PROFIBUS-FMS	<p>FMS "Fieldbus Message Specification"</p> <p>PROFIBUS-FMS was designed for applications in complex machines and plant. This communication profile was replaced by PROFIBUS-DP. Today PROFIBUS-FMS is not longer part of the international standard for Fieldbus.</p>		

4.2.1 PROFIBUS-DP Versions

PROFIBUS-DP Versions	Functions	DPM00	DPMiA0
DP-V0	<p>“cyclic data exchange and diagnostics“</p> <ul style="list-style-type: none"> - general process automation - machinery control - more than 90% of the applications use PROFIBUS-DP-V0 <p><u>Functions:</u></p> <ul style="list-style-type: none"> - Cyclic Data Exchange between PLC and Slave Devices - GSD Configuration - Diagnosis 	ü	ü
DP-V1	<p>“acyclic data exchange and alarming“</p> <ul style="list-style-type: none"> - process technology <p><u>Functions:</u> (extensions based on DP-V0)</p> <ul style="list-style-type: none"> - cyclic Data Exchange between PC or PLC and Slave Devices - Integration within Engineering: EDD and FDT - Portable PLC Software Function Blocks (IEC 61131-3) - Fail-Safe Communication (PROFIsafe) - Alarms 		
DP-V2	<p>“isochron data exchange, Slave cross traffic, clock synchronization“</p> <ul style="list-style-type: none"> - manufacturing - robot control <p><u>Functions:</u> (extensions based on DP-V0 and DP-V1)</p> <ul style="list-style-type: none"> - Peer Slave Communication (Publisher / Subscriber) - Isochron Mode (Equidistance) - Clock Synchronization & Time Stamps - HARTon DP - PROFIdrive - Redundancy 		

4.3 Configurations with PROFIBUS-DP

4.3.1 Schematic Configuration

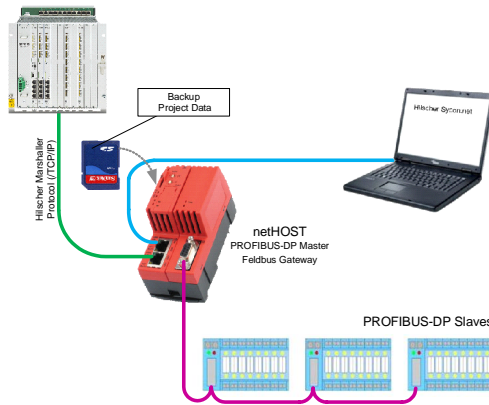

- The external Fieldbus Gateway netHOST should be connected in local network only.
- Up to 100 PROFIBUS-DP Slave devices can be connected to one PROFIBUS-DP Master interface.
- All the input/output data of all PROFIBUS-DP Slaves will be mapped in one global byte oriented process data base in netHOST.
The input-/output addresses of the bytes can be set automatic (by "auto addressing"=Enabled) in SYCON.net or free defined by user ("auto addressing"=Disabled).
- The DPMiA0 firmware reads/writes cyclic the total input/output process data base from the netHOST.
- The configuration data for netHOST can be stored optionally on FLASH-Card.
The FLASH card can be inserted in netHOST and enables fast change of netHOST device in case of error.
The netHOST firmware checks after restart if there is a FLASH-Card inserted with valid configuration file. If yes, parameter are loaded from FLASH-card.
(works only with not damaged FLASH-Card).
Note:
 - The netHOST can be used also without FLASH-Card.
(parameters will be stored in netHOST internal memory)



Hint

The external Fieldbus Gateway netHOST should be connected directly to SICAM RTUs Ethernet interface!

Using switches or other network devices are not recommended.

Cause:

- high load of network data traffic caused by communication from/to netHOST
- time critical Watch-Dog supervision in netHOST.

netHOST

The netHOST device from Hilscher is a Fieldbus Gateway for PROFIBUS-DP Master with access control via Ethernet. The netHOST product enables PC card 'slot-less' compact industrial PCs or other embedded systems connectivity to and control of Fieldbus Systems over Ethernet.

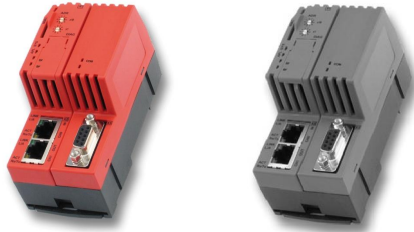

netHOST – Overview of important Functions:

- netHOST with integrated PROFIBUS-DP Master according IEC 61158 (DP, DP-V1; Class 1/Class 2 Master; 125 Slaves; 5736 Bytes I and O data)
- access control for netHOST via TCP/IP protocol (Hilscher Marshaller protocol)
- netHOST + PROFIBUS-DP configuration with **SYCON.net**
 - configuration via Ethernet interface
 - configuration can be stored to memory card (SD,SDHC, SDXC) (optional)
- remote IP-address setting for netHOST
- Operating Temperature 0 ... +60 °C
- Operating Voltage 18 ... 30 V / 130 mA @ 24 V
- netHOST mounting: DIN rail
- ready for redundancy

Note:

More technical details are included in netHOST documentation.

4.3.2 Supported Configurations

PROFIBUS-DP Master interface (SM-2558 + netHOST) can be used with SICAM AK 3, SICAM AK and SICAM TM.
SICAM AK 3 only will be used in configuration drawings below.

4.3.2.1 SICAM RTUs as Single PROFIBUS-DP Master

- singular PROFIBUS
- PROFIBUS-DP Slaves with singular PROFIBUS interface
- singular SICAM RTUs as PROFIBUS-DP Master
 - singular PROFIBUS-DP interface (1x netHOST)

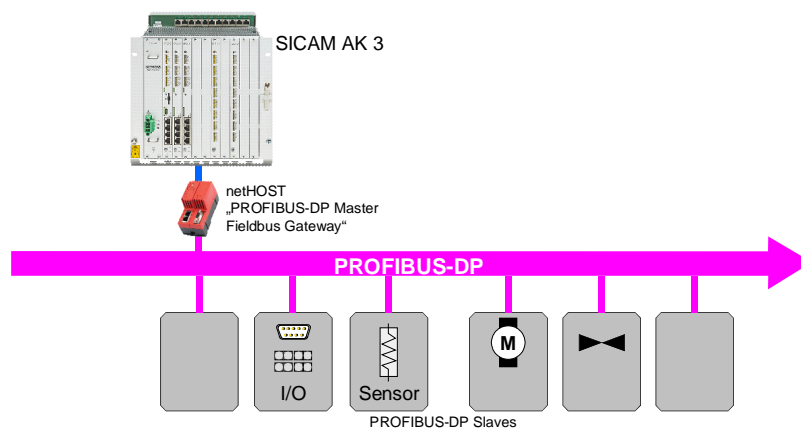

4.3.2.2 SICAM RTUs as PROFIBUS-DP Master in Multi-Master Configuration

- singular PROFIBUS
- PROFIBUS-DP Slaves with single PROFIBUS interface
- PROFIBUS-DP Master in Multi-Master configuration
- singular SICAM RTUs as PROFIBUS-DP Master
 - singular PROFIBUS-DP interface (1x netHOST)

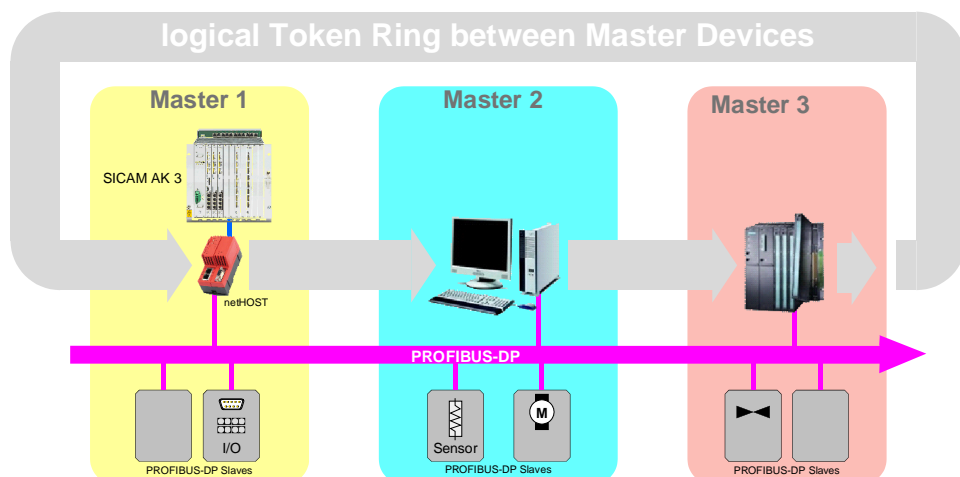

4.3.2.3 SICAM RTUs as PROFIBUS-DP Slave (using DP-DP Coupler)

- PROFIBUS-DP with single Master or multi Master
- SICAM RTUs as PROFIBUS-DP Slave connected via DP/-DP coupler
 - SICAM RTUs with PROFIBUS-DP Interface (SM-2558/DPMiA0 + netHOST)
 - Siemens DP/-DP coupler for interfacing 2 different PROFIBUS configurations

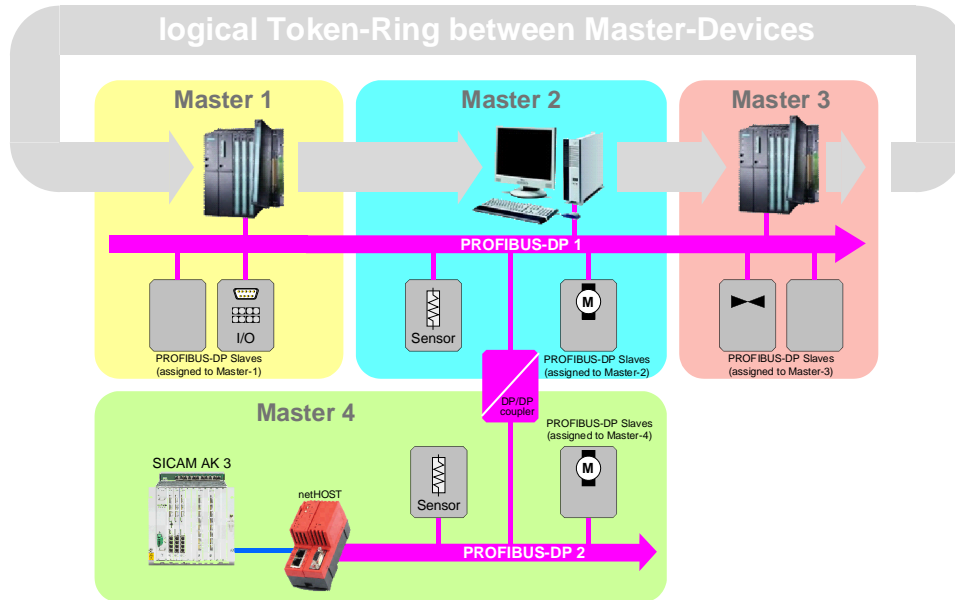

4.3.2.4 SICAM RTUs with PROFIBUS-DP Master Redundancy

4.3.2.4.1 Single PROFIBUS + redundant CPU's

- singular PROFIBUS
- PROFIBUS-DP Slaves with singular PROFIBUS interface
- singular SICAM RTUs automation unit (AU) as PROFIBUS-DP Master - redundant PROFIBUS-DP Master interfaces (2x netHOST)

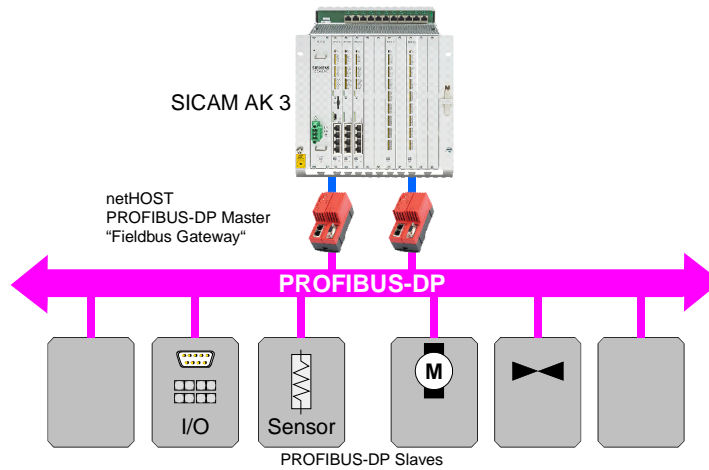

4.3.2.4.2 Single PROFIBUS + redundant AU's

- singular PROFIBUS
- PROFIBUS-DP Slaves with singular PROFIBUS interface
- redundant SICAM RTUs automation unit (AU) as PROFIBUS-DP Master - redundant PROFIBUS-DP Master interfaces (2x netHOST)

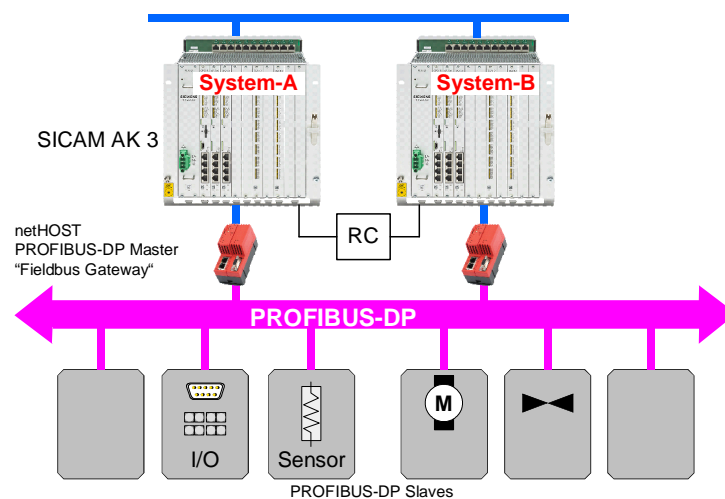

4.3.2.4.3 Redundant PROFIBUS + redundant CPU's

- redundant PROFIBUS
- PROFIBUS-DP Slaves with redundant PROFIBUS interface
- singular SICAM RTUs automation unit (AU) as PROFIBUS-DP Master
 - redundant PROFIBUS-DP Master interfaces (2x netHOST)

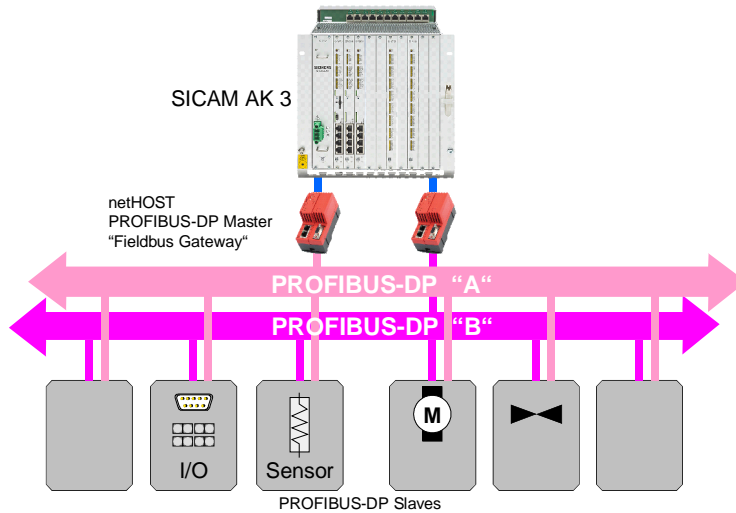

- redundant PROFIBUS
- redundant PROFIBUS-DP Slaves
- singular SICAM RTUs automation unit (AU) as PROFIBUS-DP Master
 - redundant PROFIBUS-DP Master interfaces (2x netHOST)

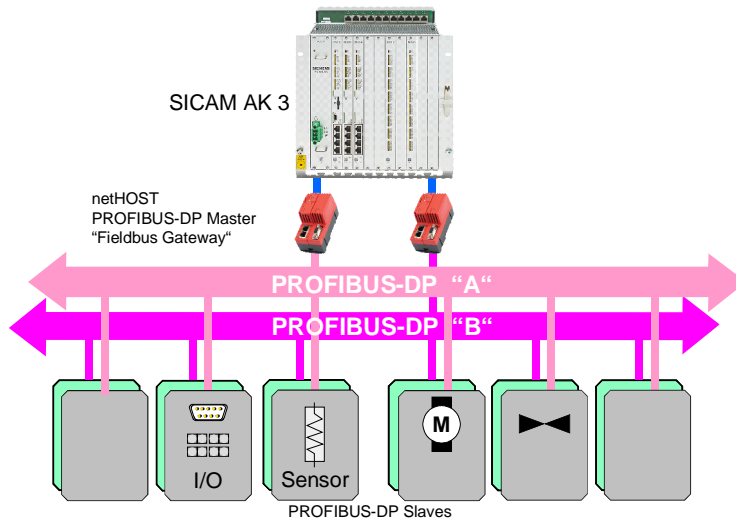

4.3.2.4.4 Redundant PROFIBUS + redundant AU's

- redundant PROFIBUS
- PROFIBUS-DP Slaves with redundant PROFIBUS interface
- redundant SICAM RTUs automation unit (AU) as PROFIBUS-DP Master
 - redundant PROFIBUS-DP Master interfaces (2x netHOST)

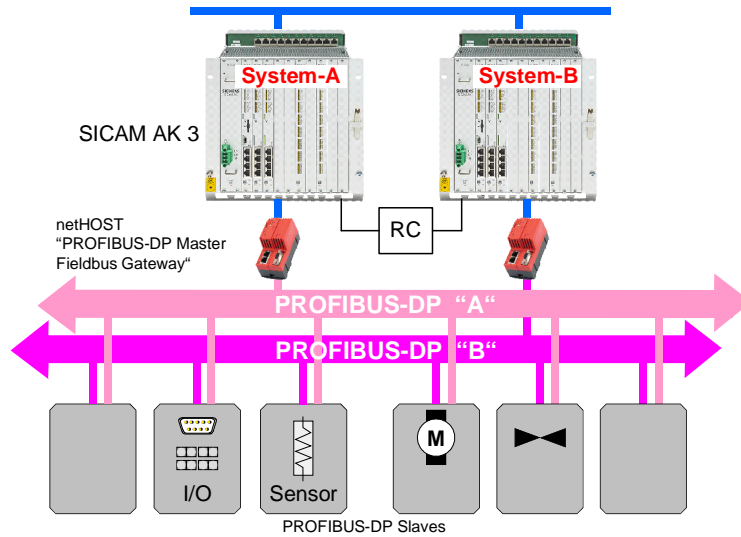

- redundant PROFIBUS
- redundant PROFIBUS-DP Slaves
- redundant SICAM RTUs automation unit (AU) as PROFIBUS-DP Master
 - redundant PROFIBUS-DP Master interfaces (2x netHOST)

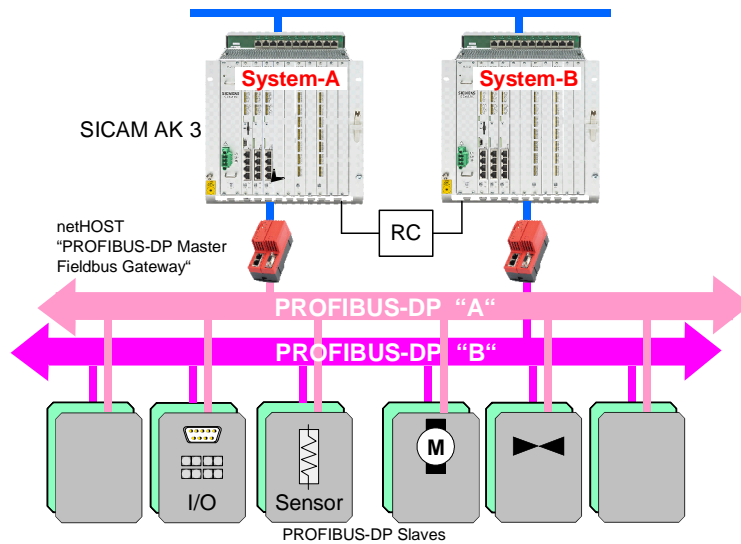

4.4 Protocol Element for PROFIBUS-DP Master

The protocol element in SICAM RTUs for PROFIBUS-DP Master is a LAN based protocol element. The PROFIBUS-DP Master is implemented in external Fieldbus Gateway “netHOST”. Hilscher’s proprietary Marshaller protocol is used as communication protocol between SICAM RTUs and netHOST.

Presentation of SICAM RTUs protocol element for PROFIBUS-DP based on the OSI layer model:

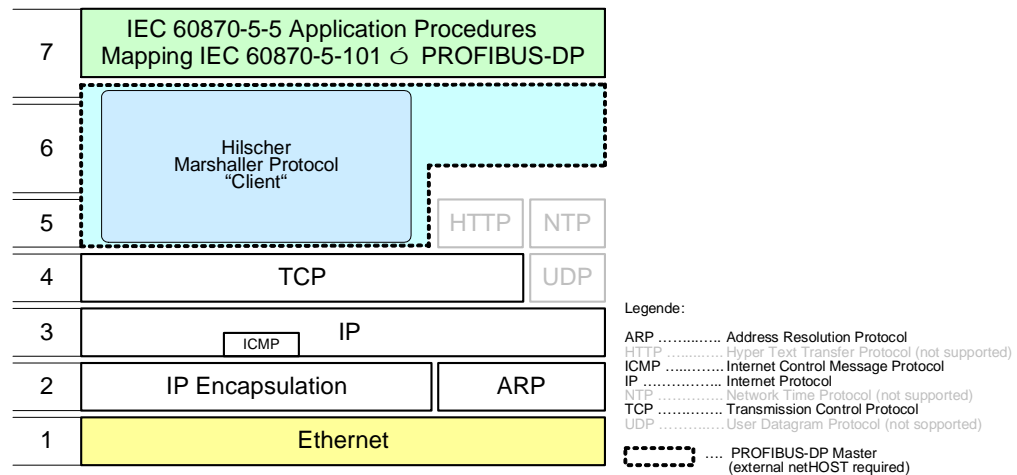

Layer	Task	Functions, Characteristics, Comments
7 - Application	Application	<ul style="list-style-type: none"> · Transmit handling · Receive handling · Management of multiple connections
6 - Presentation	Data format	<ul style="list-style-type: none"> · PROFIBUS-DP Master Application Layer · Data exchange with PROFIBUS-DP Slaves via Hilscher Marshaller Protocol
5 - Session	Interface between data format and communication protocol	<ul style="list-style-type: none"> · Hilscher Marshaller Protocol
4 - Transport 3 - Network	Communication protocol	<ul style="list-style-type: none"> · TCP/IP according to RFC 791 and RFC 793 · ICMP according to RFC 792
2 - Data Link 1 - Physical	LAN interface	<ul style="list-style-type: none"> · Ethernet 100 Mbps according to IEEE 802.3 · Connection technique (on the master control or communication element) · RJ45 for copper · ARP according to RFC 826 · IP Encapsulation according to RFC 894

4.4.1 Definition of the Connections (Connection, Station Definition)

4.4.1.1 TCP/IP Connection to netHOST

One TCP/IP connection will be established by SICAM RTUs for the data communication between SICAM RTUs protocol element and the external Fieldbus Gateway "netHOST".

Device	TCP/IP Connection
SICAM RTUs SM-2558/DPMiA0	Client
netHOST	Server

IP Addresses

Every device which is connected to a TCP/IP network has an unambiguous IP address. The protocol firmware supports only IP addresses in the format IPv4 (=32 Bit). With that, 2^{32} , in other words 4,294,967,296 addresses can be represented. The IP address is mostly represented in the *dotted decimal notation*.

Example: 192.168.122.195

Port numbers

Every IP connection is defined by the IP address of the own station and the remote station and the port number. The port numbers are defined by the IANA (Internet Assigned Numbers Authority).

Port numbers used in the LAN/WAN protocol firmware:

Port Number	Protocol	Standard	DPMiA0
50111 ¹⁾	Hilscher Marshaller Protocol	Hilscher Marshaller Protocol	C
50112 ^{1) 2)}			

1) this port number is not registered at IANA!!

2) this port number is actually not supported!

Own IP Address

The IP address of the own station is to be parameterized in the system-technical parameters with the parameter `IP address | own IP address`.

IP Address of the Remote Station (netHOST)

The IP address of the remote station (netHOST) is to be parameterized in the system-technical parameters with the parameter `IP address | IP-address of remote station (netHOST)`.

Default Gateway

If the own network is connected by means of a router, then the IP address of the default router is to be set in the system-technical parameters of the protocol firmware with the parameter `IP address | Default gateway`.

Note:

- Based on availability requirements it is strongly recommended to connect netHOST only via direct link or via local LAN (à no default gateway required)
IP address for `Default gateway` = 0.0.0.0

Subnet Mask

The subnet mask is a bit mask, which splits up an IP address into a network part and a device part (host part). It is used in IP networks to make routing decisions.

The subnet mask is to be set in the system-technical parameters of the protocol firmware with the parameter `IP address | Subnet mask`.

4.4.1.2 Station Definition

Station specific parameters of the connected PROFIBUS-DP Slaves must be set in the parameters for **station definition** in the protocol element of PROFIBUS-DP Master.

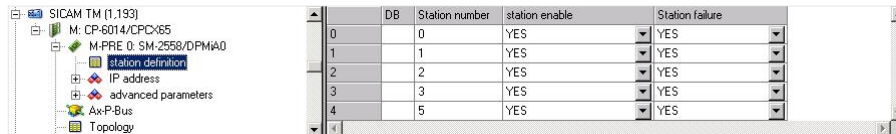

	DB	Station number	station enable	Station failure
0		0	YES	YES
1		1	YES	YES
2		2	YES	YES
3		3	YES	YES
4		5	YES	YES

The following parameters can be set per station (for each PROFIBUS-DP Slave):

- Parameter "Station number"**

The station number is used at PROFIBUS-DP as station address for PROFIBUS-DP slave and SICAM RTUs internal for the routing of the data, diagnostic treatment and failure management.

The station number (Stat. No.) is to be entered on the protocol element in the parameters of the **station definition** in the field **Station number** for each slave.
- Parameter "Station Enable"**

A parameterized station can be enabled/not enabled on the protocol element selectively per station in the system technical parameters of the **station definition** in the field **Station Enable**.

e.g. this way stations can be prepared, that are first activated at a later time by means of parameter setting.

Data to "prepared stations" are fetched from the protocol element and discarded without error.
- Parameter "Station failure"**

For certain operating modes the failure of a connection can be suppressed on the protocol element for SICAM RTUS internal diagnostic selectively per station in the system technical parameters of the **station definition** in the field **Station failure**.

If the station failure will be suppressed, station will never be reported as failed in the diagnostics, no data emulation with NT bit =1 and no general interrogation after station failure will be done.

4.4.2 Data Exchange Procedure

The data exchange between protocol element and netHOST is controlled by the protocol element using Hilscher's LAN based Marschaller protocol. Request-/response services from Hilscher Marshaller protocol are used for the Initialization and data exchange from/to PROFIBUS-DP slaves.

The data communication on PROFIBUS-DP level is controlled by PROFIBUS-DP Master in netHOST.

The input data from PROFIBUS-DP slaves are read cyclic by the protocol from netHOST internal data base and the output data for PROFIBUS-DP slaves are written cyclic by the protocol into netHOST internal data base.
The message conversion IEC60870-5-101/-104 to PROFIBUS-DP and the conversion of cyclic data exchange on PROFIBUS-DP to spontaneous data exchange used by IEC60870-5-101/-104 is performed by the protocol element.

Input data received from PROFIBUS-DP Slaves (read from netHOST) will be sent from protocol element to BSE with system internal time.

Cyclic Processing of Input-/Output Data from/to PROFIBUS-DP Slaves

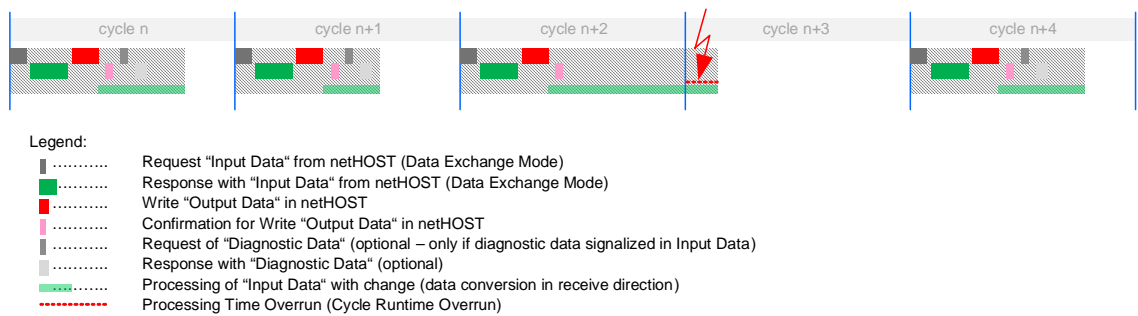

Acyclic Processing of Diagnostic Data/Output Data from/to PROFIBUS-DP Slaves

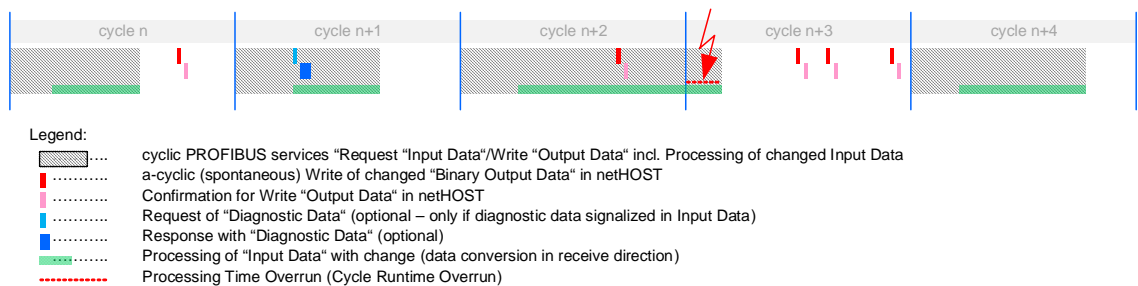

Processing of Input Data in Redundancy State "PASSIVE" with singular PROFIBUS

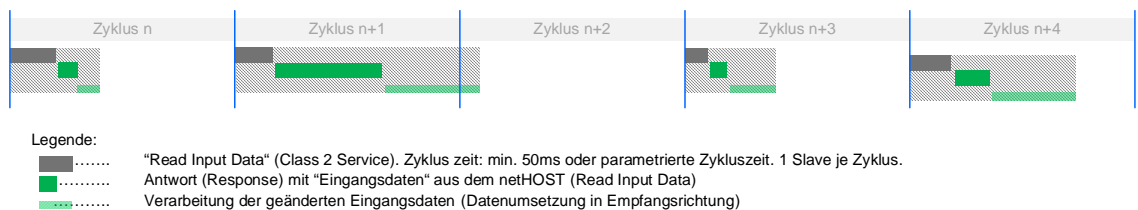

Cycle Time for Data Exchange

The data exchange between the protocol element and netHOST is done cyclic.

During data exchange the total input process data base of all PROFIBUS-DP Slaves will be read from netHOST and the total output process data base of all PROFIBUS-DP Slaves will be written into netHOST.

Binary information in control direction (indications, commands) will be written cyclic and also spontaneous in case of change of data.

If the conversion of data takes more time than the parameterized cycle time for data exchange than the next data exchange will be started earliest after finished data conversion. With this a very short cycle time for data exchange cannot be guaranteed in all cases.

The cycle time for data exchange can be set on the protocol element with the system technical parameter [advanced parameters | cycle time for data exchange](#).

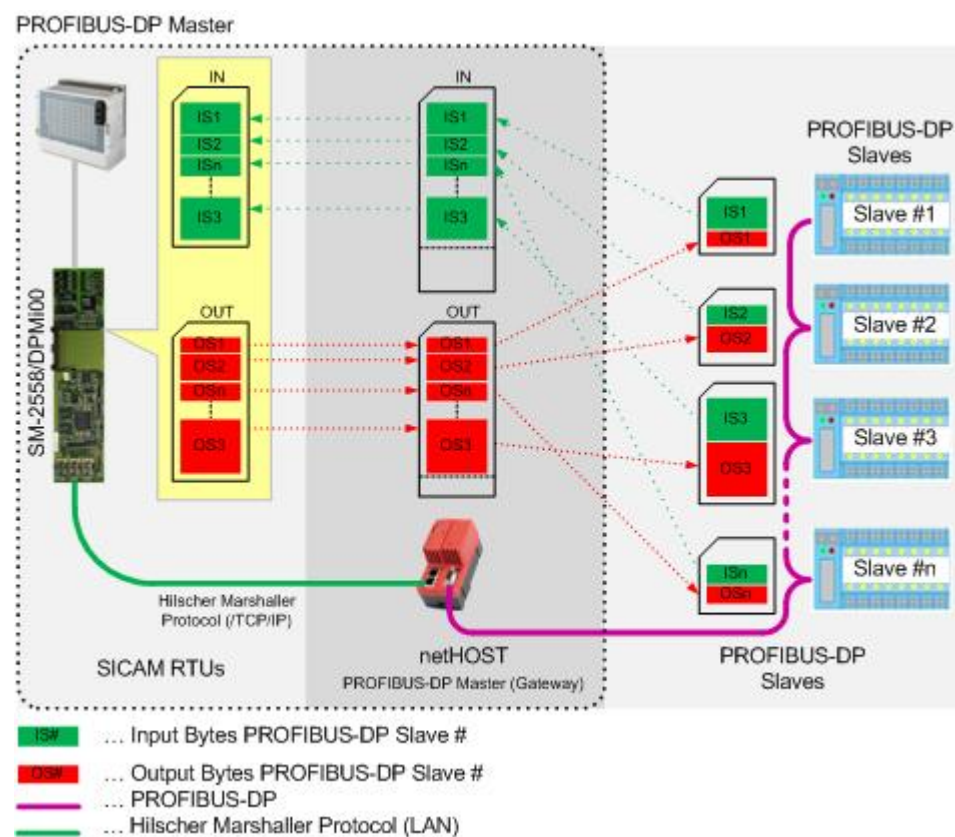

Note:

The communication on PROFIBUS network runs independent from the communication for data exchange between protocol element and netHOST.

Startup Delay

After startup of the protocol element in SICAM RTUs the data communication from/to PROFIBUS-DP will be started after startup delay. During startup delay the protocol element internal data base in control direction will be updated by SICAM RTUs internal general interrogation.

After startup delay the communication to netHOST will be started.

The startup delay time can be set on the protocol element with the system technical parameter [advanced parameters | Startup delay](#).

Runtime Overrun Monitoring

The data exchange between the protocol element and netHOST is done cyclic.

During data exchange the total input process data base of all PROFIBUS-DP Slaves will be read from netHOST and the total output process data base of all PROFIBUS-DP Slaves will be written into netHOST by the protocol element.

If the processing of input data by the protocol element takes more time (=runtime overrun) in consecutive cycles as parameterized with [cycle time for data exchange](#) a warning will be set.

The number of runtime overruns until warning is to be set on protocol element with system technical parameter [advanced parameters | No. of runtime overruns til warning](#).

Example: "number of runtime overruns til warning = 3"

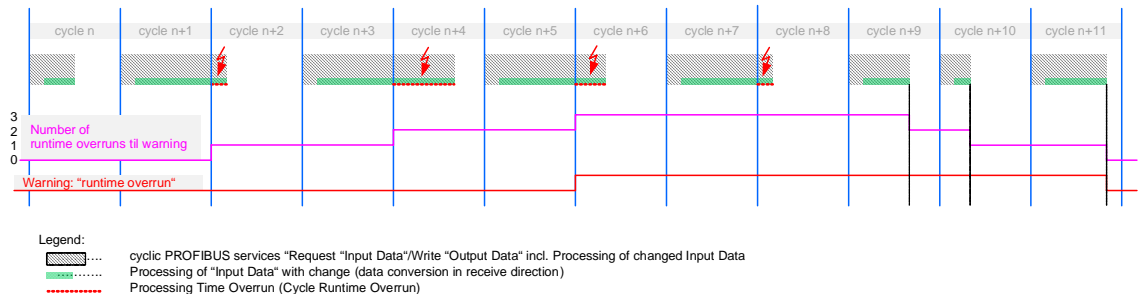

Note:

The runtime overrun monitoring will not be done in redundancy state of the firmware "STANDBY" (=SICAM RTUs redundancy state "PASSIVE" + Listening mode)!

4.4.2.1 Failure Monitoring

Failure Monitoring for Communication to netHOST

The data exchange between the protocol element and netHOST will be done cyclic. The data communication from/to netHOST is monitored by the protocol element. Each request must be answered by a response sent from netHOST during response timeout.

In case of communication failure to netHOST, all parameterized PROFIBUS-DP slaves will be reported as failed.

The response timeout can be set on the protocol element with the system technical parameter [advanced parameters | Marshaller response timeout](#).

Failure Monitoring of PROFIBUS-DP Slaves

Following status information will be included in input process data received from netHOST for each single PROFIBUS-DP slave:

- Slave Config
... this status bit will not be evaluated!
- Slave State
<0>:= PROFIBUS-DP slave is not in data exchange mode.
à PROFIBUS-DP slave will be set as failed in SICAM RTUs.
<1>:= PROFIBUS-DP slave is in data exchange mode.
- Slave Diag
<1>:= PROFIBUS-DP diagnostic information is ready for transmission in netHOST.
Note: The diagnostic information will be read by the protocol element in the following data exchange cycles.

Failure Monitoring by netHOST

The netHOST supports integrated Watch-Dog function.
The Watch-Dog function in netHOST will be activated by protocol element after initialization sequence for communication with netHOST.

The Watch-Dog time must be set in netHOST using SYCON.net (default = 1 second).

The Watch-Dog timer in netHOST will be retriggered cyclic by protocol element every 500ms.

In case of Watch-Dog timer expires the PROFIBUS communication will be stopped.
All PROFIBUS-DP slaves assigned to this PROFIBUS-DP master will get "Bus failure".

4.4.2.2 PROFIBUS Diagnostic Information

PROFIBUS-DP provides a comfortable and multifaceted possibility to process diagnostic information due to error states.

The diagnostic information of a DP slave consists of standard diagnostic information (6 bytes) and optional application specific diagnostic information.

Selected standard diagnostic information of PROFIBUS-DP will be reported as SICAM RTUs internal diagnostic information with class "EXTERN".

Selected external PROFIBUS-DP diagnostic information can be disabled (suppressed) by the protocol element from reporting to SICAM RTUs internal diagnostic with the system technical parameters `advanced parameters | suppress external errors |`

PROFIBUS Designation	can be suppressed
Slave is not ready for cyclic data transfer	
Configuration data faulty	ü
Requested service is not supported by the slave	ü
Incorrect parameterization (Ident number etc.)	ü
Slave is parameterized by another master	ü
Slave requires new parameterization and configuration	ü
Watchdog timer supervision expired	ü
Overflow of extended diagnostics data	ü

4.4.3 General Interrogation, Outstation Interrogation

The general interrogation function (RTU interrogation) is used for updating the master station after startup, redundancy switchover or after communication error.

The PROFIBUS-DP protocol does not define a general interrogation procedure!

After SICAM RTUs internal IEC60870-5-101/-104 general interrogation command the interrogated data (parameterized and GI enabled data) of the PROFIBUS-DP slaves will be sent with the actual state to BSE without change detection and with cause of transmission COT= 20 (interrogated by station interrogation) after next cyclic data exchange between protocol element and netHOST.

SICAM RTUs internal the general interrogation command will be sent always station selective to PRE from BSE.

The protocol element for PROFIBUS-DP Master supports only a general interrogation command with qualifier of interrogation = station interrogation (global").

Restrictions:

- a general interrogation command for groups is not supported!
- the protocol element for PROFIBUS-DP does not send ACTCON / ACTTERM for general interrogation command!
- no interrogated data will be sent from protocol element for failed PROFIBUS-DP Slaves

4.4.4 Clock Synchronization

The PROFIBUS-DP protocol does not define a clock synchronization procedure!

A clock synchronization of PROFIBUS-DP slaves is not supported!

4.4.5 Command Transmission

Commands in Control Direction (SICAM RTUs à PROFIBUS-DP Slave)

Commands to PROFIBUS-DP slaves will be transmitted as “1 bit pulse“ or as “2 bit pulse“.

The command output will be emulated by the protocol element for 1 or 2 bits in the output data base for PROFIBUS-DP slaves with assigned command output time.

More details see chapter message conversion in transmit direction for commands.

Commands in Monitor Direction (PROFIBUS-DP Slave à SICAM RTUs)

Commands from PROFIBUS-DP slaves will be transmitted as “1 bit pulse“ or as “2 bit pulse“.

The processing of commands in receive direction is done by the protocol element with edge sensitive handling (only pos. edge is evaluated).

Therefore it is important that commands has to be sent from PROFIBUS-DP slaves as pulse with limited pulse duration.

More details see chapter message conversion in receive direction for commands.

4.4.6 Transmission of Integrated Totals

The PROFIBUS-DP protocol does not define a counter interrogation procedure!

A counter interrogation command initiated in the SICAM RTUs system is not transmitted to the PROFIBUS-DP Slaves.

The actual state of integrated totals will be updated in PRE's internal data base during cyclic data exchange procedure from netHOST à protocol element.

Forwarding of integrated totals to BSE:

- counter interrogation command
After a counter interrogation command (SICAM RTUs internally) the integrated totals will be forwarded to BSE directly from protocol element internal data base.
- cyclic in the parameterized time frame
After timeout for cyclic counter reading (SICAM RTUs internally) the integrated totals will be forwarded to BSE at next cyclic data exchange cycle.

The sequence number in the counter message is incremented with every counter interrogation message, or with cyclic counter interrogation, in the parameterized time frame.

Restrictions:

- protocol element for PROFIBUS-DP does not send ACTCON / ACTTERM for counter interrogation command!
- protocol element for PROFIBUS-DP does not send requested counters for failed PROFIBUS-DP slave stations.

4.5 Functions for supporting Redundant Communication Routes

To increase the availability both master stations as well as remote terminal units can be designed redundant.

In this section, the possible redundancy concepts themselves that can be realized are not described, rather only those functions for the support of redundant communication routes supported by the protocol element.

The protocol element for PROFIBUS-DP Master in SICAM RTUs supports following redundancy modes:

- PROFIBUS-DP Master Redundancy with “singular PROFIBUS”
 - redundant PROFIBUS-DP Master are connected to same PROFIBUS
 - only 1 PROFIBUS-DP Master is “ACTIVE” on Bus (Master Class 1)
 - 2nd PROFIBUS-DP Master is “STANDBY” on Bus (Master Class 2)
- PROFIBUS-DP Master Redundancy with “redundant PROFIBUS”
 - redundant PROFIBUS-DP Masters are connected to separate PROFIBUS
 - PROFIBUS-DP Slaves are doubled or supporting 2 PROFIBUS-DP interfaces
 - both PROFIBUS-DP Masters are “ACTIVE” on Bus (Master Class 1)

Redundancy States

SICAM RTUs Redundancy State	Redundancy State of the Firmware <i>[operation if passive]</i>	PROFIBUS-DP Masters in netHOST
ACTIVE	AKTIVE <i>[=normal mode]</i>	OPERATE (Master Class 1)
PASSIVE	STANDBY <i>[=listening mode (single PROFIBUS-DP)]</i>	STANDBY (Master Class 2)
PASSIVE	PASSIVE <i>[=normal mode (redundant PROFIBUS-DP)]</i>	OPERATE (Master Class 1)

4.5.1 PROFIBUS-DP Master with “single PROFIBUS”

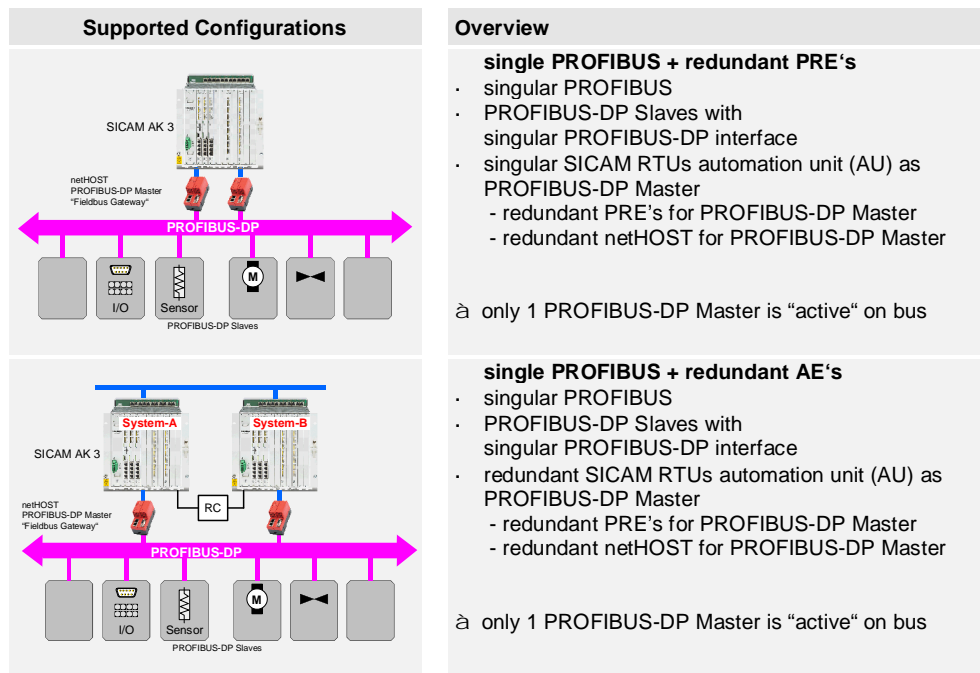

The switchover of the redundancy state in the master station takes place system-internal through redundancy control messages – supported redundancy states:

- **ACTIVE** (netHOST: PROFIBUS-DP Master = “OPERATE”)
- **PASSIVE** (netHOST: PROFIBUS-DP Master = “STANDBY”)

In redundancy state “PASSIVE” the PROFIBUS-DP Master in netHOST will be set to “STANDBY” (=Master Class 2). The data exchange with PROFIBUS-DP Slaves is done using Master Class 2 Service “Read Input”.

The operating mode of the interface with redundancy state “PASSIVE” must be set with the parameter `Redundancy | operation if passive` to “*listening mode (single PROFIBUS-DP)*”.

The bus address of each device must be unique for communication on PROFIBUS.

The PROFIBUS-DP Master address for redundancy state “PASSIVE” must be set also on protocol element with the parameter `Redundancy | PROFIBUS-DP master address` and must be equal with the configuration in netHOST.

The parameter settings for Master address will be checked by protocol element.

The PROFIBUS-DP Master address on bus will be assigned to netHOST in state “STANDBY” based on the redundancy state and the parameter `Redundancy | System A/B`.

Cause:

After restart of SICAM RTUs all interfaces are in state “PASSIVE” for a short time.

Based on the fact that the configured PROFIBUS-DP master address cannot be read from netHOST in this phase, a unique PROFIBUS-DP Master address will be assigned to netHOST.

The configured PROFIBUS-DP Master address in netHOST will be used for communication on PROFIBUS in redundancy state “ACTIVE” (=operate).

In redundancy state “PASSIVE” (netHOST = “STANDBY”) the configured PROFIBUS-DP Master address in netHOST will be used by netHOST only for failure monitoring of the “ACTIVE” Master.

Example: "PROFIBUS-DP Master Address = 1" (=netHOST "default" configuration):

PROFIBUS-DP Master Address on Bus	Redundancy State	System-A/B	Algorithm
1	"ACTIVE"	A, B	= configured address
0	"PASSIVE"	A	= configured address - 1
2	"PASSIVE"	B	= configured address + 1

Delay Time passiv => aktiv

In the master station a delay for the switchover of the redundancy state from PASSIVE (=STANDBY) to ACTIVE can be set with the parameter `Redundancy | Delay time passive=>active`.

During delay time, PRE's internal data base in transmit direction (output data) will be updated using system internal general interrogation.

The PROFIBUS-DP Master in netHOST will be set to "AKTIVE (=Operate)" after timeout of delay time.



Hint

In case of redundancy switchover from "PASSIVE" à "ACTIVE" all data in the PRE's data base for PROFIBUS-DP Slaves (= "Output Data") must be updated within the parameterized delay time. Not updated data will be set to parameterized initial values.

After delay time the communication on PROFIBUS will be started and the "Output Data" from PRE's data base will be transferred to PROFIBUS-DP Slaves.

Listening Mode "Failure Monitoring Time"

A station selective failure monitoring for PROFIBUS-DP Slaves will be done in redundancy state "PASSIVE". The monitoring will be enabled with the parameter `redundancy | listening_mode (failure monitoring "<>0"` (0=no monitoring).

The monitoring time will be retriggered per station at receive of response for "Read Input". The station will be marked as failed at timeout of monitoring time.

The failure monitoring time will be started for all parameterized stations at redundancy switchover from redundancy state "ACTIVE" à "PASSIVE".

The failure monitoring time will be stopped for all parameterized stations at redundancy switchover from redundancy state "PASSIVE" à "ACTIVE".



Hint

In case of failure of the "ACTIVE" Master, no input data will be received from PROFIBUS-DP Slaves by "PASSIVE" Master (no NT-Bit emulation for input data).

Error will be set in case of PROFIBUS-DP Slave failure (incl. Emulation of input data with NT=1).

Forwarding of Input Data in Listening Mode

In Listening mode received input data can be forwarded to BSE.

The forwarding of input data in listening mode to BSE can be enabled/disabled with the parameter `redundancy | Forwarding of input data in listening mode`.



Hint

Input data can be inconsistent to input data of "ACTIVE" Master!
Cause: Different procedures for requesting of input data by ACTIVE/PASSIVE Master!!

Behavior of the Master Station in Redundancy State "ACTIVE":

- PROFIBUS-DP Master = Master Class 1 on bus (=“normal mode“)
- Data communication on PROFIBUS-DP started in netHOST (“Data Exchange Mode“)
 - cyclic reading of input data from PROFIBUS-DP Slaves from netHOST
 - cyclic writing of output data to PROFIBUS-DP Slaves in netHOST
 - spontaneous writing of binary output data in case of change of data
 - reading of PROFIBUS-DP Slave diagnostic information (indicated in input data)
- Received input data will be marked with R=0 by basic system element (data received from “ACTIVE“ interface)
- Failure monitoring of netHOST via Marshaller protocol
- Failure monitoring of PROFIBUS-DP Slaves via cyclic “Data Exchange Mode“ (no failure monitoring of the redundant PROFIBUS-DP Master)

Behavior of the Master Station at Redundancy Switchover “ACTIVE“ à "PASSIVE":

- Reset netHOST
- Start PROFIBUS-DP Master in netHOST in “STANDBY-Mode“

Behavior of the Master Station at Redundancy Switchover “PASSIVE“ à "ACTIVE":

- Start of delay time passive=>active
- Initialization of PRE's internal data base in transmit direction with parameterized initial values
- Update of PRE's internal data base in transmit direction by internal GI
- After timeout of delay time:
Start PROFIBUS-DP Master in netHOST in “Operate-Mode“

Behavior of the Master Station in Redundancy State "PASSIVE":

- PROFIBUS-DP Master = “Master Class 2“ on Bus
- cyclic reading of input data from PROFIBUS-DP Slaves using Class 2 Service “Read Input“
- Received input data will be (if forwarding to BSE is enabled) marked with R=1 by BSE (data received from “PASSIVE“ interface)
- In redundancy state “PASSIVE“ output data in transmit direction from BSE à PRE will be sent to PRE or deleted on BSE (depending on BSE parameter setting). Output data sent to PRE will be deleted on PRE.
- Failure monitoring of netHOST via Marshaller protocol
- Failure monitoring of PROFIBUS-DP Slaves via cyclic “Read Input“ service. (no failure monitoring of the redundant PROFIBUS-DP Master)

**Hint**

The watchdog function in the PROFIBUS-DP Slave must be enabled for PROFIBUS-DP redundancy. To avoid bus failure during redundancy switchover, the Watchdog time in PROFIBUS-DP Slaves must be adjusted.

à The Watchdog in PROFIBUS-DP Slave will be retriggered by “Data Exchange“ service.

à At Watchdog timeout the outputs in PROFIBUS-DP Slave will be set to “OFF“ or in set to a save state (depending on supported PROFIBUS-DP Slave functionality).

Example: netHOST Settings

Sycon.net Parameter	Function
Station Address	PROFIBUS-DP Master address for netHOST on bus
Highest Station Address (HSA)	Highest station address of PROFIBUS-DP Masters on bus. (Default = 126) For redundant PROFIBUS-DP Masters HSA should be set to "0,1,2". The default value should be changed mandatory otherwise the bus reconfiguration at slow baud rates takes longer time if new Master will be attached to PROFIBUS.
Watchdog Control Time	Watchdog Time for PROFIBUS-DP Slave à The WDC timeout must be set higher as: twdc >= tmstio + tred + tres twdc Watchdog Control time tmstio Marshaller-Timeout (default = 2,5 sec) tred Delay time for redundancy switchover passive=>active (default = 2 sec) tres reserve
Data Control Time	Must be set to the 6x of Watchdog Control Time
Overwrite slave specific Watchdog Control Time	With this parameter enabled, the watch dog control time in all PROFIBUS-DP Slaves will be set to configured Watchdog Control time in netHOST.

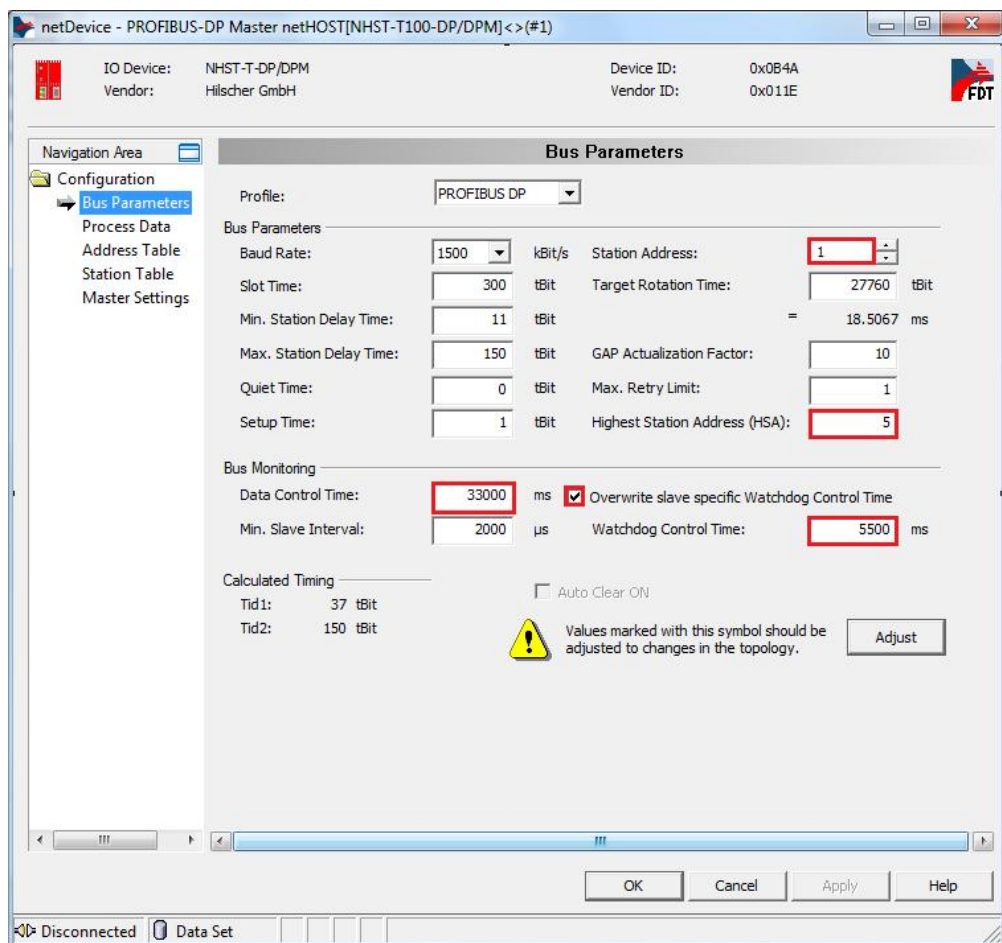

4.5.2 PROFIBUS-DP Master with “redundant PROFIBUS”

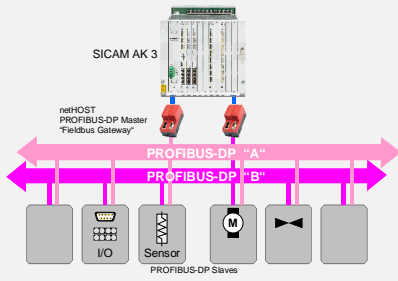
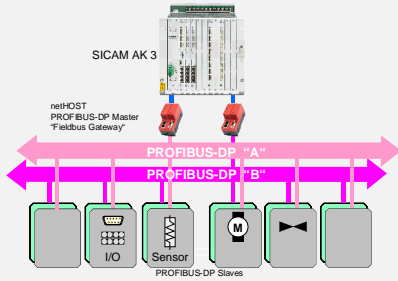
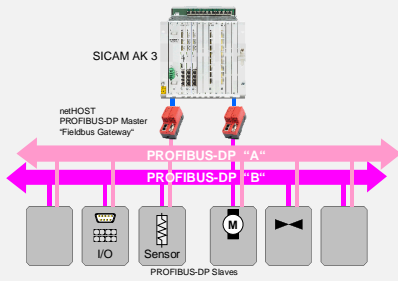
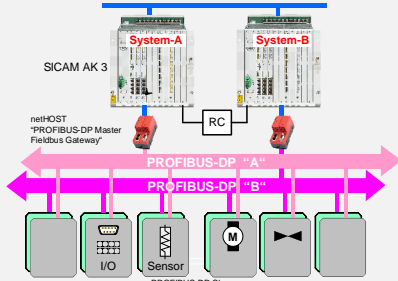
Supported Configurations	Overview
	<p>redundant PROFIBUS-DP + redundant PRE's</p> <ul style="list-style-type: none"> • redundant PROFIBUS • PROFIBUS-DP Slaves with redundant PROFIBUS-DP interface • singular SICAM RTUs automation unit (AU) as PROFIBUS-DP Master <ul style="list-style-type: none"> - redundant PRE's for PROFIBUS-DP Master - redundant netHOST for PROFIBUS-DP Master <p>à both PROFIBUS-DP Masters are “active” on Bus</p>
	<p>redundant PROFIBUS-DP + redundant PRE's</p> <ul style="list-style-type: none"> • redundant PROFIBUS • redundant PROFIBUS Slaves • singular SICAM RTUs automation unit (AU) as PROFIBUS-DP Master <ul style="list-style-type: none"> - redundant PRE's for PROFIBUS-DP Master - redundant netHOST for PROFIBUS-DP Master <p>à both PROFIBUS-DP Masters are “active” on Bus</p>
	<p>redundant PROFIBUS-DP + redundant AU's</p> <ul style="list-style-type: none"> • redundant PROFIBUS • PROFIBUS-DP Slaves with redundant PROFIBUS-DP interface • redundant SICAM RTUs automation unit (AU) as PROFIBUS-DP Master <ul style="list-style-type: none"> - redundant PRE's for PROFIBUS-DP Master - redundant netHOST for PROFIBUS-DP Master <p>à both PROFIBUS-DP Masters are “active” on Bus</p>
	<p>redundant PROFIBUS-DP + redundant AU's</p> <ul style="list-style-type: none"> • redundant PROFIBUS • redundant PROFIBUS Slaves • redundant SICAM RTUs automation unit (AU) as PROFIBUS-DP Master <ul style="list-style-type: none"> - redundant PRE's for PROFIBUS-DP Master - redundant netHOST for PROFIBUS-DP Master <p>à both PROFIBUS-DP Masters are “active” on Bus</p>

The switchover of the redundancy state in the master station takes place system-internal through redundancy control messages – supported redundancy states:

- ACTIVE (netHOST: PROFIBUS-DP Master = “Operate”)
- PASSIVE (netHOST: PROFIBUS-DP Master = “Operate”)

In this redundancy state the operating mode on PROFIBUS will not be changed at redundancy switchover.

Both PROFIBUS-DP Masters (“ACTIVE” + “PASSIVE” interfaces) are operating as Master Class 1 on PROFIBUS in “Data Exchange Mode”.

The operating mode of the interface with redundancy state "PASSIVE" must be set with the parameter `Redundancy | operation if passive` to *"normal operation (redundant PROFIBUS-DP)"*.

Behavior of the Master Station in Redundancy State "ACTIVE":

- PROFIBUS-DP Master = Master Class 1 on bus (=“normal mode“)
- Data communication on PROFIBUS-DP started in netHOST (“Data Exchange Mode“)
 - cyclic reading of input data from PROFIBUS-DP Slaves from netHOST
 - cyclic writing of output data to PROFIBUS-DP Slaves in netHOST
 - spontaneous writing of binary output data in case of change of data
 - reading of PROFIBUS-DP Slave diagnostic information (indicated in input data)
- Received input data will be marked with R=0 by basic system element (data received from "ACTIVE" interface)
- Failure monitoring of netHOST via Marshaller protocol
- Failure monitoring of PROFIBUS-DP Slaves via cyclic “Data Exchange Mode“ (no failure monitoring of the redundant PROFIBUS-DP Master)

Behavior of the Master Station in Redundancy State "PASSIVE:

- ... same behavior as in redundancy state „ACTIVE“ except:
- Received input data will be marked with R=1 by basic system element (data received from "PASSIVE" interface)
- In redundancy state “PASSIVE” output data in transmit direction from BSE à PRE will be sent to PRE or deleted on BSE (depending on BSE parameter setting). Output data sent to PRE will be sent to PROFIBUS-DP Slaves.



Hint

- To enable sending of output data to redundant PROFIBUS the user data filter on MCPU must be disabled (= user data filter deactivated) with the parameter `redundancy | Settings for PREs (line. red. w. appl. voting) | Option: user data filter`.
- During redundancy switchover unwanted state of outputs (“initial values”) in PROFIBUS-DP Slaves is possible.
Example:
 - Setpoint value to PROFIBUS-DP Slave (setpoint value from SCADA system via IEC60870-5-104)
 - Restart of redundant PROFIBUS-DP interface (restart of AU, or CPU selective restart,...)
 - As setpoint values are not sent during GI according IEC60870-5-104, the setpoint value in PRE's internal data base will not be updated (setpoint value will be initialized with "Initial value")
 - Output of setpoint value at PROFIBUS-DP with "Initial value"

4.6 Special Functions

4.6.1 DP/DP Coupler

A PROFIBUS DP/DP coupler is used to connect two PROFIBUS-DP networks and to exchange data from the master of the one network to the master of the other network.

The DP/DP-coupler includes two PROFIBUS-DP slaves; one slave for the first master (e.g. DPMiA0) and one slave for the second master (e.g. S7). The output data of the one slave will become the input data of the other slave and reverse.

SIEMENS DP/DP Coupler:



Schematic Function of DP/DP Coupler:

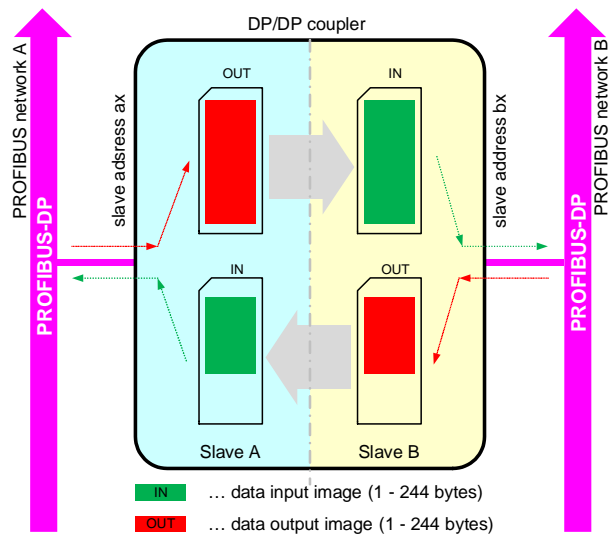

DP/DP Coupler Status

Some PROFIBUS DP/DP couplers on the market supports "data valid" information in input data range. The data valid bit is included in the input data and includes the state of the communication to the master on the other side of the DP/DP coupler. The NT bit (not topical) can be generated by from "data valid" information.

Example: Siemens DP/DP coupler

"data valid" information can be enabled via DP/DP coupler DIP switch.

"data valid" information will be mapped into 1. bit of 1. Input byte:

- "0" à PROFIBUS communication to remote station failed
- "1" à PROFIBUS communication to remote station OK

The "data valid" information will be used by the protocol element for generating the NT bit of the associated data read from the DP/DP coupler.

In message address conversion the PROFIBUS-DP format "DP/DP STATUS" must be assigned to the "data valid" information

In case of change of the "data valid" information all data of the associated PROFIBUS-DP slave will be sent to BSE with the according state of NT bit or IV bit for <TI:=37> integrated totals.

The "NT bit" of the "data valid" information will not be set.

Processing of data after new initialization of DP/DP coupler (e.g. after Power ON):

- PROFIBUS communication to remote station failed:
 - à all input data of the PROFIBUS-DP slave (except "data valid") will be sent to BSE with state "0" and "NT=1"
 - Note: after restart of DP/DP coupler all input data will be sent with state "0".
- PROFIBUS communication to remote station OK:
 - à in some cases all input data of the PROFIBUS-DP slave will be sent from DP/DP coupler with state "0" and "data valid"="1".
 - à caused by this behavior the data will be forwarded to BSE for a short time with the not up to date state "0" and NT="0" (data valid).
 - à by delayed processing of all data after change of DP/DP coupler status from "data invalid" à "valid" the forwarding of probably not up to date data can be suppressed.

The delayed processing of data by the protocol element after change of DP/DP coupler status from "data invalid" à "valid" can be set with the system technical parameter [advanced parameters | DP/DP coupler delay](#).



Note

In case of failure of the PROFIBUS communication in one network the slave in the other PROFIBUS network runs without errors.
Only "data valid" information (if supported from DP/DP coupler) will be "0"!

4.7 Protocol Element Control and Return Information

This function is used for the user-specific influencing of the functions of the protocol elements.

This function contains two separate independent parts:

- Protocol element control
- Protocol element return information

The **Protocol Element Control** enables:

- Protocol element internal functions
- Protocol element system functions

The **Protocol Element Return Information** enables:

- States of certain status lines to be used as process information
- Information to be obtained about the station status/failure

Block Diagram

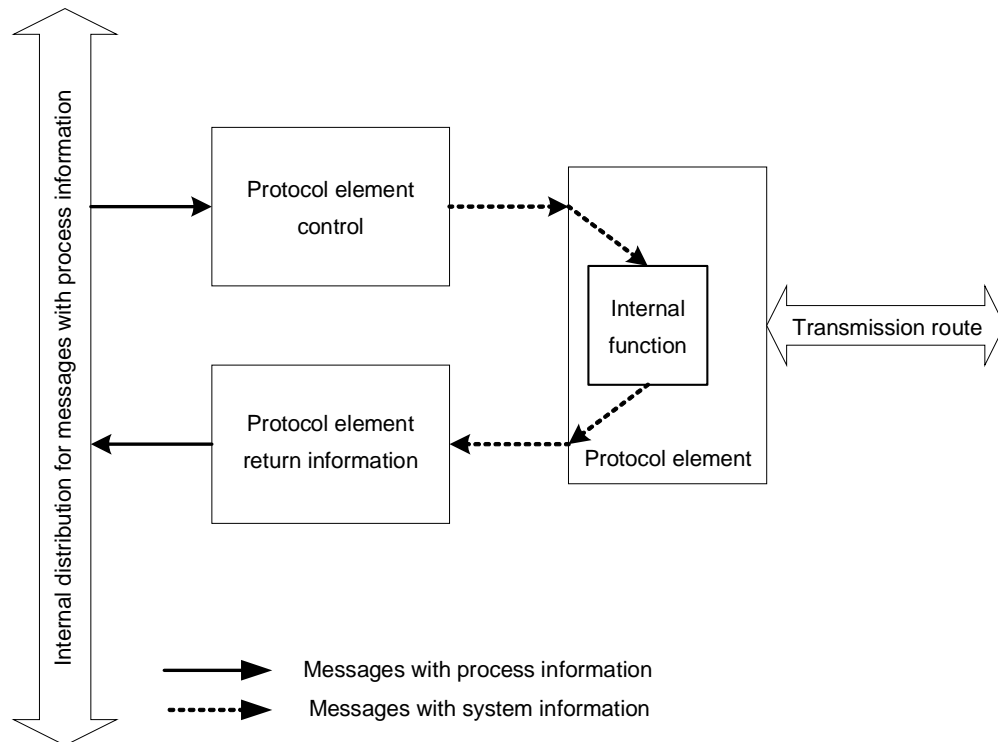

4.7.1 Protocol Element Control

With the help of *messages with process information*, the protocol element control on the basic system element enables specific functions of the protocol elements to be controlled.

The specific functions are determined by the protocol element implemented.

The assignment of the *messages with process information* to the functions is carried out with the help of process-technical parameters of the SICAM RTUs system data *protocol element control message*.

The messages for protocol control are transmitted immediately from the basic system element to the protocol element, regardless of the user data to be sent and the priority control.

For *messages with process information* which are used in SICAM RTUs as *protocol element control message*, an unused CASDU is to be used! All CASDU's for process information are distributed automatically to the corresponding remote terminal unit.

Possible functions:

Function **)	Parameter				Note
	SF	Station	Z-Par	FI	
Send (general) interrogation command	244	-	CASDU		This function is processed on the BSE and sent to the protocol element as system message and not using PRE-control message! CASDU = selective

Legend:

SF Control function_(PRE)

Station Station number

0 - 99 station 0 - 99 of the selected protocol element

125 all stations of the selected protocol element (=BROADCAST)

Z-Par Additional parameter_(PRE)

FI Edge

4.7.2 Protocol Element Return Information

The protocol element return information generates on the basic system element *messages with process information in monitor direction* and thereby enables states of the protocol elements to be displayed and processed.

Supported categories of return information:

- Station failure

The assignment of the *messages with process information* to the return information is carried out on the basic system element with the help of process-technical parameters of the SICAM RTUs system data *protocol element return information*.

From which source the parameterized return information are to be generated, is set with the parameters "Supplementary system element" and "Station number".

Messages for protocol element return information are transmitted to the basic system element by the protocol element spontaneously with change or as response to a general interrogation command.

Possible master station return information:

	Parameter	
Return information function_(PRE)	Station	Note
Station failure	0 – 99	1 = Station failed

Legend:

Station Station number
 0 - 99 Station 0-99 of the selected protocol element

5 Message Conversion

Contents

5.1	Overview	68
5.2	Message Conversion in Transmit Direction (Master à Slave)	70
5.3	Message Conversion in Receive Direction (Master ì Slave)	86

5.1 Overview

Data in transmit direction are transferred from the basic system element to the protocol element in the SICAM RTUs internal IEC 60870-5-101-/104 format. The conversion of the data format from IEC60870-5-101-/104 à PROFIBUS-DP is done by the protocol element. The transmission of the data to the external Fieldbus Gateway “netHOST” is done cyclic and spontaneous via the proprietary Hilscher Marshaller Protocol. The transmission of the data TO the PROFIBUS-DP slaves is CONTROLLED by netHOST.

Data in receive direction will be read cyclic by the protocol element from the external Fieldbus Gateway “netHOST” then converted by the protocol element from the PROFIBUS-DP to a SICAM RTUs internal IEC 60870-5-101/104 format and transferred to the basic system element.

The conversion of the message formats SICAM RTUs « PROFIBUS-DP and the conversion of the address information is called message conversion.

The parameterization for the conversion of the address information from IEC 60870-5-101/104 ó PROFIBUS-DP is to be done with TOOLBOX II (OPM) using "SIP Message Address Conversion". The parameterization for the conversion of the address information includes also mapping PROFIBUS-DP ó IEC 60870-5-101/104 type identification.

Categories for SIP Message Address Conversion:

Data	Direction	Category	DPMiA0
Indications Commands	Receive Direction	<i>firmware /Rec_binary_information</i>	Ü
Measurands	Receive Direction	<i>firmware /Rec_measured_values</i>	Ü
Counters	Receive Direction	<i>firmware /Rec_counter_value</i>	Ü
Commands Indications	Transmit Direction	<i>firmware /Trans_binary_information</i>	Ü
Measurands Setpoint Values	Transmit Direction	<i>firmware /Trans_values</i>	Ü

Following parameters valid for all parameter categories:

Parameter	
Lk_Reg	Link Region Number ... data point assigned to automation unit (AU) with selected region number.
Lk_Comp	Link Component Number ... data point assigned to automation unit (AU) with selected component number.
Lk_BSE	Link BSE ... data point assigned to BSE (basic system element) in selected automation unit (AU).
Lk_SSE	Link SSE ... data point assigned to selected SSE of selected BSE in selected automation unit (AU).
Lk_DS	Link Destination Station Number ... data point assigned to selected destination station (DS) of selected SSE of selected BSE in selected automation unit (AU).
Lk_Cat	Link Category
Lk_Prep	Link Prepared: Data point: - prepared ... Signal will not be converted/loaded into destination system - activated ... Signal is activated and will be converted/loaded into destination system.

5.2 Message Conversion in Transmit Direction (Master à Slave)

Message Conversion in Transmit Direction IEC60870-5-101/104 à PROFIBUS-DP

IEC 60870-5-101/104		↔	PROFIBUS-DP Data Format
Type ID	Designation		Designation
<TI=30>	Single-point information with time tag CP56Time2a		1BIT, BYTE/FLAG
<TI=31>	Double-point information with time tag CP56Time2a		2BIT
<TI=33>	Bitstring of 32 bit with time tag CP56Time2a		UINT32
<TI=34>	Measured value, normalized value with time tag CP56Time2a		INT8, UINT8, INT16, UINT16, INT32, UINT32, FLOAT32, S5INT12
<TI=35>	Measured value, scaled value with time tag CP56Time2a		INT8, UINT8, INT16, UINT16, INT32, UINT32, FLOAT32, S5INT12
<TI=36>	Measured value, short floating point value with time tag CP56Time2a		INT8, UINT8, INT16, UINT16, INT32, UINT32, FLOAT32, S5INT12
<TI=37>	Integrated totals with time tag CP56Time2a		INT16, UINT16, INT32, UINT32, FLOAT32
<TI=45>	Single command		1BIT/PULSE
<TI=46>	Double command		2BIT/PULSE
<TI=47>	Regulating step command		2BIT/PULSE
<TI=48>	Set point command, normalized value		INT8, UINT8, INT16, UINT16, INT32, UINT32, FLOAT32, S5INT12
<TI=49>	Set point command, scaled value		INT8, UINT8, INT16, UINT16, INT32, UINT32, FLOAT32, S5INT12
<TI=50>	Set point command, short floating point		INT8, UINT8, INT16, UINT16, INT32, UINT32, FLOAT32, S5INT12
<TI=51>	Bitstring of 32 bit		UINT32
<TI=100>	Interrogation command		-
<TI=101>	Counter interrogation command		-



Hint

The Parameters "initial values", "substitute value" and "error behavior" must be set according requirements for specific application ! (especially for setpoint commands)

5.2.1 Commands

The parameterization of the address and message conversion for commands in transmit direction is to be done with TOOLBOX II / OPM with the parameter category *firmware / Trans_binary_information*.

Parameter Category:

firmware / Trans_binary_information

Parameter	Value
Lk_Reg	249
Lk_Comp	60
Lk_BSE	002 CP-2017/PCCX25
Lk_SSE	131 SM-2558/DPMiA0
Lk_DS	Protocols
Lk_Cat	DPMiA0/Trans_binary_information
Lk_Prep	Activated
CASDU1	249
CASDU2	3
IOA1	208
IOA2	255
IOA3	0
TI	Single command (TI 45)
DP-slave_addr	3
PD service	cyclic I/O data exchange
A-Address	0
Bit offset	0
DP-data_format	Pulse
error behaviour	keep value
initial values	0
Substitute value	0

Parameter	
TI .. type identification	Supported Type Identifications: <ul style="list-style-type: none"> · <TI:=45> .. single command · <TI:=46> .. double command · <TI:=47> .. regulating step command
CASDU, IOA	SICAM RTUs internal IEC608705-101/-104 message address
DP-slave_addr	Address of the DP-Slave on PROFIBUS: <ul style="list-style-type: none"> · 0-99
DP service	PROFIBUS-DP Service: <ul style="list-style-type: none"> · cyclic I/O data exchange
A-Address	Output address at the PROFIBUS corresponding to the parameterized A-Adr in SYCON.net for netHOST: <ul style="list-style-type: none"> · 0-5759
Bit offset	Bit offset in corresponding output byte: <ul style="list-style-type: none"> · 0-7 ... single command · 0-6 ... double command or regulating step command
DP-data_format	Data format on PROFIBUS: <ul style="list-style-type: none"> · pulse [single command] · pulse OFF/ON [double command, regulating step command] · pulse ON/OFF [double command, regulating step command]
Error behaviour	Output value on PROFIBUS-DP if NT=1 or IV=1: <ul style="list-style-type: none"> · keep value
Initial values	After restart of PRE this initial value will be sent to PROFIBUS-DP Slave. <ul style="list-style-type: none"> · "0"
Substitute value	Substitute value if error behavior is set to "output substitute value". <ul style="list-style-type: none"> · "0"

Supported Data Formats:

TI	SICAM RTUs 101/-104 Data Format			
45	single command			Ê
46	double command		Ê	
47	regulating step command	Ê		
Format	DP Data Format ¹⁾			
BYTE/FLAG	Byte/Flag			
1BIT	Bit			
2BIT	OFF/ON			
2BIT	ON/OFF			
1BIT/PULSE	Pulse			Û
2BIT PULSE	Pulse OFF/ON	Û	Û	
2BIT PULSE	Pulse ON/OFF	Û	Û	

- 1) As PROFIBUS-DP does not define the presentation of data formats in the output bytes the PROFIBUS-DP format must be selected for the conversion from SICAM RTUs à PROFIBUS-DP. Supported data formats see appendix "PROFIBUS-DP Data Formats".

Command Output Time for Single-/Double Commands

Commands on PROFIBUS will be transmitted as pulse (1 or 2 bit). The protocol element converts a command output to a pulse with 1 or 2 bits in the output byte of PROFIBUS-DP slave with parameterized command output time.

The command output time (duration of the pulse) is set for commands with qualifier of command = <0> "no additional definition" on protocol element with the system technical parameter [advanced parameters | Command output time](#).

The command output time (duration of the pulse) is set for commands with qualifier of command = <1> "short pulse duration" on basic system element (M:) with the system technical parameter [AU common settings | Short pulse duration](#).

Note:

This parameter is valid for the all commands with qualifier of command <1> of the automation unit!

The command output time (duration of the pulse) is set for commands with qualifier of command = <2> "long pulse duration" on basic system element (M:) with the system technical parameter [AU common settings | Long pulse duration](#).

Note:

This parameter is valid for the all commands with qualifier of command <1> of the automation unit!

Max. 10 commands (single-, double-, regulation step commands) executed at the same time will be supported.

Single Command

The output on PROFIBUS for single command with command state = "ON" is a pulse with the duration of the parameterized command output time on 1 bit in the output byte.

DP-Data Format	Command State	Command Output (1 bit in output byte)
pulse	SCS=ON	 <p>tp ... command output time (pulse duration)</p>
	SCS=OFF	Note: The OFF State is not evaluated!

A command output in progress will be retrigged when receiving same command with same command state.

Double Command / Regulating Step Command

The output on PROFIBUS for double command with command state = "ON/OFF" or regulating step command with command state = "Higher/Lower" is a pulse with the duration of the parameterized command output time on 2 bits in the output byte.

DP-Data Format	Command State	A-Address
pulse ON/OFF	ON	configured a-address; bit offset
	OFF	configured a-address; bit offset + 1
pulse OFF/ON	ON	configured a-address; bit offset + 1
	OFF	configured a-address; bit offset

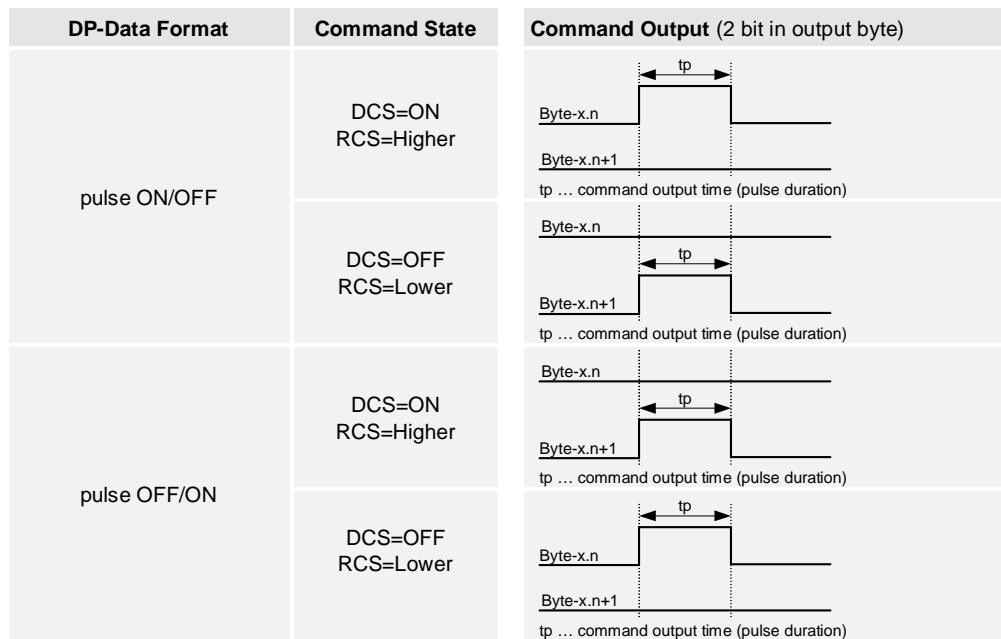

A command output in progress will be retriggered when receiving same command with same command state.

A command output in progress will be stopped when receiving same command with opposite command state; new command output will be started with new command state.

Message Conversion

The table describes the evaluated elements of the IEC 60870-5-101/104 message during message conversion.

Elements of the message		
TI	.. Type identification	TI 45 .. single command TI 46 .. Double command TI 47 .. regulating step command
CASDU, IOA	.. Message address	can be set by parameter
Cause of transmission		
06	.. activation	evaluated (only "activation" accepted)
xx	.. other COTs	not accepted (only "activation" accepted)
T	.. test	not supported
Information		
SCO/DCO/RCO		
SCS	single command state	[<TI:=45> only]
	0 .. OFF	not evaluated
	1 .. ON	evaluated
DCS	double command state	[<TI:=46> only]
	0 .. not permitted	not supported
	1 .. OFF	evaluated
	2 .. ON	evaluated
	3 .. not permitted	not supported
RCS	regulating step command state	[<TI:=47> only]
	0 .. not permitted	not supported
	1 .. next step LOWER	evaluated
	2 .. next step HIGHER	evaluated
	3 .. not permitted	not supported
QOC	S/E	
	0 = execute	evaluated, only "execute" accepted)
	1 = select	not supported
QU	qualifier of command	
	0 .. no additional determinations	evaluated
	1 .. short output time	evaluated
	2 .. long output time	evaluated
	3 .. Persistent command	not supported

... elements of IEC60870-5-101/-104 message not included in table are not evaluated/not supported!

5.2.2 Indications

The parameterization of the address and message conversion for indications in transmit direction is to be done with TOOLBOX II / OPM with the parameter category *firmware / Trans_binary_information*.

Parameter Category:

firmware / Trans_binary_information

Parameter	Value
Lk_Reg	249
Lk_Comp	60
Lk_BSE	002 CP-2017/PCCX25
Lk_SSE	131 SM-2558/DPMiA0
Lk_DS	Protocols
Lk_Cat	DPMiA0/Trans_binary_information
Lk_Prep	Activated
CASDU1	20
CASDU2	38
IOA1	3
IOA2	20
IOA3	36
TI	Single pt. information (TI 30)
DP-slave_addr	3
PD service	cyclic I/O data exchange
A-Address	1
Bit offset	0
DP-data_format	Bit
error behaviour	keep value
initial values	1
Substitute value	0

Parameter	
TI .. type identification	Supported Type Identifications: <ul style="list-style-type: none"> · <TI:=30> .. single point information with time tag CP56Time2a · <TI:=31> .. single point information with time tag CP56Time2a
CASDU, IOA	SICAM RTUs internal IEC608705-101/-104 message address
DP-slave_addr	Address of the DP-Slave on PROFIBUS: <ul style="list-style-type: none"> · 0-99
DP service	PROFIBUS-DP Service: <ul style="list-style-type: none"> · Cyclic I/O data exchange
A-address	Output address at the PROFIBUS corresponding to the parameterized A-Adr in SYCON.net for netHOST: <ul style="list-style-type: none"> · 0-5759
Bit offset	Bit offset in corresponding output byte: <ul style="list-style-type: none"> · 0-7 ... single point information · 0-6 ... double point information
DP-data_format	Data format on PROFIBUS: <ul style="list-style-type: none"> · Byte/Flag [single point information] · Bit [single point information] · OFF/ON [double point information] · ON/OFF [double point information] · Pulse · Pulse OFF/ON · Pulse ON/OFF
Error behaviour	Output value on PROFIBUS-DP if NT=1 or IV=1: <ul style="list-style-type: none"> · keep value · output substitute value
Initial values	After restart of PRE this initial value will be sent to PROFIBUS-DP Slave. <small>Note:</small> <ul style="list-style-type: none"> - the initial value output on PROFIBUS will be overwritten by valid data as soon as available. - valid range of value see appendix "PROFIBUS-DP Data Formats"
Substitute value	Substitute value if error behavior is set to "output substitute value". <small>Note:</small> <ul style="list-style-type: none"> - valid range of value see appendix "PROFIBUS-DP Data Formats"



Hint

The Parameters "initial values", "substitute value" and "error behavior" must be set according requirements for specific application!

Supported Data Formats:

TI	SICAM RTUs 101/-104 Data Format		
30	single point information with time tag CP56Time2a		Ê
31	double point information with time tag CP56Time2a	Ê	
Format	DP Data Format ¹⁾		
BYTE/FLAG	Byte/Flag		Û
1BIT	Bit		Û
2BIT	OFF/ON	Û	
2BIT	ON/OFF	Û	
1BIT/PULSE	Pulse		
2BIT PULSE	Pulse OFF/ON		
2BIT PULSE	Pulse ON/OFF		

- 1) As PROFIBUS-DP does not define the presentation of data formats in the output bytes the PROFIBUS-DP format must be selected for the conversion from SICAM RTUs to PROFIBUS-DP. Supported data formats see appendix "PROFIBUS-DP Data Formats".

Message Conversion

The table describes the evaluated elements of the IEC 60870-5-101/104 message during message conversion.

Elements of the message		
TI	.. Type identification	TI 30 .. single point information with time tag CP56Time2a TI 31 .. double point information with time tag CP56Time2a
CASDU, IOA .. Message address		can be set by parameter
QDS .. Quality descriptor		
BL	.. blocked	not evaluated
SB	.. substituted	not evaluated
NT	.. not topical	NT=1: As selected with parameter "error behavior" the actual state or the parameterized substitute value will be written in output byte.
IV	.. invalid	IV=1: As selected with parameter "error behavior" the actual state or the parameterized substitute value will be written in output byte.
Cause of transmission		
xx	..	not evaluated
T	.. Test	not evaluated
Information		
Single point information		
SPI	0 .. OFF	evaluated
	1 .. ON	evaluated
Double point information		
DPI	0 .. indeterminate or intermediate state	evaluated
	1 .. OFF	evaluated
	2 .. ON	evaluated
	3 .. intermediate state	evaluated
time tag		
CP56Time2a	.. date + time	not evaluated

... elements of IEC60870-5-101/-104 message not included in table are not evaluated/not supported!

5.2.3 Measured Values / Setpoint Values

The parameterization of the address and message conversion for measured values/setpoint values in transmit direction is to be done with TOOLBOX II / OPM with the parameter category *firmware / Trans_values*.

Parameter Category:

firmware / Trans_values

Parameter	Value
Lk_Reg	249
Lk_Comp	60
Lk_BSE	002 CP-2017/PCCX25
Lk_SSE	131 SM-2558/DPMiA0
Lk_DS	Protocols
Lk_Cat	DPMiA0/Trans_values
Lk_Prep	Prepared
CASDU1	255
CASDU2	255
IOA1	110
IOA2	255
IOA3	0
TI	Setpoint val. positioning comm. scaled (TI 49)
DP-slave_addr	3
PD service	cyclic I/O data exchange
A-Address	2004
DP-data_format	Integer 16
error behaviour	keep value
initial values	32767
Substitute value	0
X_0%	0
X_100%	0
Y_0%	0
Y_100%	0

Parameter	
TI .. type identification	<p>Supported Type Identifications:</p> <ul style="list-style-type: none"> · <TI:=33> .. bitstring of 32 bit with time tag CP56Time2a · <TI:=34> .. measured value, normalized value with time tag CP56Time2a · <TI:=35> .. measured value, normalized value with time tag CP56Time2a · <TI:=36> .. measured value, normalized value with time tag CP56Time2a · <TI:=37> .. integrated totals with time tag CP56Time2a · <TI:=48> .. set-point command normalized value · <TI:=49> .. set-point command, scaled value · <TI:=50> .. set-point command, short floating point number · <TI:=51> .. bitstring of 32 bit
CASDU, IOA	SICAM RTUs internal IEC608705-101/-104 message address
DP-slave_addr	<p>Address of the DP-Slave on PROFIBUS:</p> <ul style="list-style-type: none"> · 0-99
DP service	<p>PROFIBUS-DP Service:</p> <ul style="list-style-type: none"> · cyclic I/O data exchange
A-address	<p>Output address at the PROFIBUS corresponding to the parameterized A-Adr in SYCON.net for netHOST:</p> <ul style="list-style-type: none"> · 0-5759
DP-data_format	<p>Data format on PROFIBUS:</p> <ul style="list-style-type: none"> · Integer 8, 16, 32 · Unsigned integer 8, 16, 32 · Short Floating Point (IEEE 754) · Simatic S5, 12 Bit Binary (Setpoint Format)
Error behaviour	<p>Output value on PROFIBUS-DP if NT=1 or IV=1:</p> <ul style="list-style-type: none"> · keep value · output substitute value
Initial values	<p>After restart of PRE this initial value will be sent to PROFIBUS-DP Slave.</p> <p>Note:</p> <ul style="list-style-type: none"> - the initial value output on PROFIBUS will be overwritten by valid data as soon as available. - valid range of value see appendix "PROFIBUS-DP Data Formats"
Substitute value	<p>Substitute value if error behavior is set to "output substitute value".</p> <p>Note:</p> <ul style="list-style-type: none"> - valid range of value see appendix "PROFIBUS-DP Data Formats"
X_0%, X_100% Y_0%, Y_100%	<p>Parameters for value adaption: (scaling)</p> <p>Note:</p> <ul style="list-style-type: none"> - valid range of value for X_0% and X_100% see appendix "PROFIBUS-DP Data Formats". - <TI:=34, 48> .. Y_0% and Y_100% must not be greater or smaller than ± 1. - <TI:=35, 49> .. Y_0% and Y_100% must not be smaller than - 32768 and not greater than +32767. - value adaption inactive when Y_0% and Y_100 = 0



Hint

The Parameters "initial values", "substitute value" and "error behavior" must be set according requirements for specific application!

Supported Data Formats:

TI	SICAM RTUs 101/-104 Data Format																			
33	bitstring of 32 bit with time tag CP56Time2a																			Ê
34	measured value, normalized value with time tag CP56Time2a																			Ê
35	measured value, normalized value with time tag CP56Time2a																			Ê
36	measured value, normalized value with time tag CP56Time2a																			Ê
37	integrated totals with time tag CP56Time2a																			Ê
48	set-point command normalized value																			Ê
49	set-point command, scaled value																			Ê
50	set-point command, short floating point number																			Ê
51	bitstring of 32 bit																			Ê
Format	DP Data Format ¹⁾																			
INT8	Signed Integer 8 Bit (7 Bit Binary + sign)																			
INT16	Signed Integer 16 Bit (15 Bit Binary + sign)																			
INT32	Signed Integer 32 Bit (31 Bit Binary + sign)																			
UINT8	Unsigned Integer 8 Bit (8 Bit Binary)																			
UINT16	Unsigned Integer 16 Bit (16 Bit Binary)																			
UINT32	Unsigned Integer 32 Bit (32 Bit Binary)																			
FLOAT32	Short Floating Point (IEEE 754)																			
S5INT12	Simatic S5, 12 Bit (11 Bit Binary + Sign) "Setpoint Format"																			

1) As PROFIBUS-DP does not define the presentation of data formats in the output bytes the PROFIBUS-DP format must be selected for the conversion from SICAM RTUs to PROFIBUS-DP. Supported data formats see appendix "PROFIBUS-DP Data Formats".

Value Adaption: [not for <TI:=33, 37, 51>]

The adaption is defined by the parameters X_0%, X_100%, Y_0%, Y_100%.

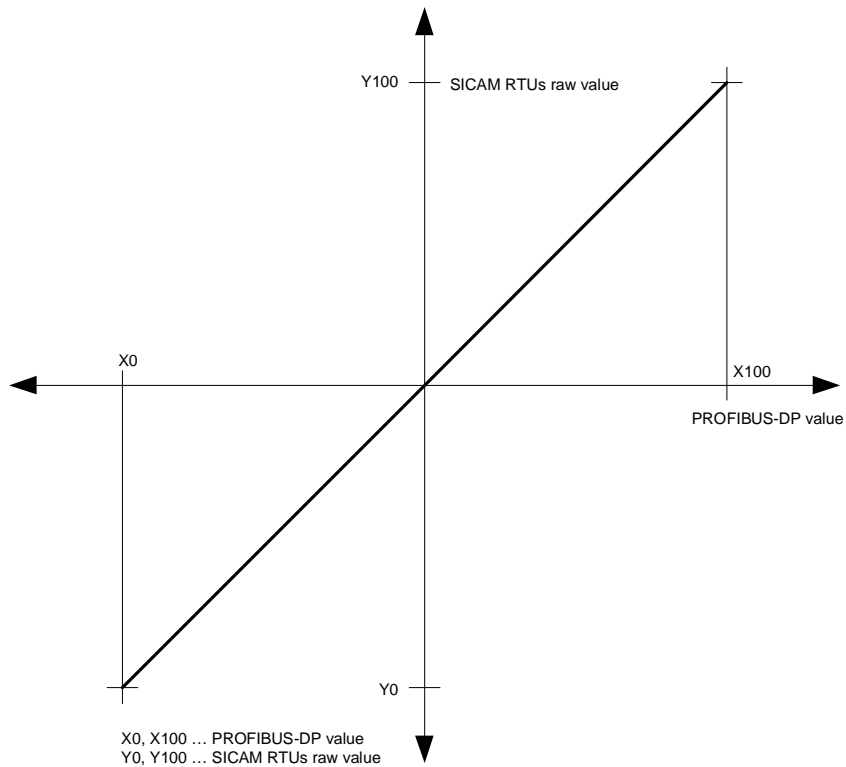

The value adaption is only enabled if Y_0% or Y_100% is parameterized <> "0".

Notes:

- If value adaption is enabled and if SICAM RTUs raw value is less than Y_0% or greater than Y_100% no conversion is performed and the error "format conversion in transmit direction" is set.
The output on PROFIBUS-DP will be furthermore the last valid value.
- If value adaption is disabled (=direct forwarding) and if SICAM RTUs raw value is outside of the selected PROFIBUS-DP range of value no conversion is performed and the error "format conversion in transmit direction" is set.
The output on PROFIBUS-DP will be furthermore the last valid value.

Message Conversion

The table describes the evaluated elements of the IEC 60870-5-101/104 message during message conversion.

Elements of the message		
TI	.. Type identification	TI 33 .. bitstring of 32 bit with time tag CP56Time2a TI 34 .. measured value, normalized value with time tag CP56Time2a TI 35 .. measured value, normalized value with time tag CP56Time2a TI 36 .. measured value, normalized value with time tag CP56Time2a TI 37 .. integrated totals with time tag CP56Time2a TI 48 .. set-point command normalized value TI 49 .. set-point command, scaled value TI 50 .. set-point command, short floating point number TI 51 .. bitstring of 32 bit
CASDU, IOA	.. Message address	can be set by parameter
QDS	.. Quality descriptor	
BL	.. blocked	not evaluated
SB	.. substituted	not evaluated
NT	.. not topical	NT=1: As selected with parameter "error behavior" the actual state or the parameterized substitute value will be written in output byte.
IV	.. invalid	IV=1: As selected with parameter "error behavior" the actual state or the parameterized substitute value will be written in output byte.
Cause of transmission		not evaluated
QDS	.. Quality descriptor	
06	.. activation	evaluated (only "activation" accepted) [<TI:=48, 49, 50, 51> only]
xx	.. other COTs	not evaluated [<TI:=33, 34, 35, 36, 37> only]
T	.. Test	not evaluated
Information		
Value	..	normalized value scaled value IEEE STD 754 = short floating point number binary counter reading bitstring of 32 bit
S	.. sign	
QOS	S/E	[<TI:=48, 49, 50> only]
	0 = execute	evaluated, only "execute" accepted)
	1 = select	not supported
time tag		
CP56Time2a	.. date + time	not evaluated

... elements of IEC60870-5-101/-104 message not included in table are not evaluated/not supported!

5.3 Message Conversion in Receive Direction (Master to Slave)

Message Conversion in Receive Direction IEC60870-5-101/104 to PROFIBUS-DP:

IEC 60870-5-101/104		PROFIBUS-DP Data Format
Type ID	Designation	Designation
<TI=30>	Single-point information with time tag CP56Time2a	1BIT, BYTE/FLAG, DP/DP STATUS
<TI=31>	Double-point information with time tag CP56Time2a	2BIT
<TI=33>	Bitstring of 32 bit with time tag CP56Time2a	INT8, UINT8, INT16, UINT16, INT32, UINT32, FLOAT32, S5INT12S, S5INT13S
<TI=34>	Measured value, normalized value with time tag CP56Time2a	INT8, UINT8, INT16, UINT16, INT32, UINT32, FLOAT32, S5INT12S, S5INT13S
<TI=35>	Measured value, scaled value with time tag CP56Time2a	INT8, UINT8, INT16, UINT16, INT32, UINT32, FLOAT32, S5INT12S, S5INT13S
<TI=36>	Measured value, short floating point value with time tag CP56Time2a	INT8, UINT8, INT16, UINT16, INT32, UINT32, FLOAT32, S5INT12S, S5INT13S
<TI=37>	Integrated totals with time tag CP56Time2a	INT16, UINT16, INT32, UINT32, FLOAT32
<TI=45>	Single command	1BIT/PULSE
<TI=46>	Double command	2BIT/PULSE
<TI=47>	Regulating step command	2BIT/PULSE

5.3.1 Indications

The parameterization of the address and message conversion for indications in receive direction is to be done with TOOLBOX II / OPM with the parameter category *firmware / Rec_binary_information*.

Parameter Category:	
<i>firmware / Rec_binary_information</i>	
Parameter	Value
Lk_Reg	249
Lk_Comp	60
Lk_BSE	002 CP-2017/PCCX25
Lk_SSE	131 SM-2558/DPMiA0
Lk_DS	Protocols
Lk_Cat	DPMiA0/Rec_binary_information
Lk_Prep	Activated
DP-slave_addr	3
PD service	cyclic I/O data exchange
DP data type	process data
I-address	0
Bit offset	0
DP-data_format	OFF/ON
IEC-qualifier_of_command	no definition
CASDU1	249
CASDU2	3
IOA1	0
IOA2	255
IOA3	0
TI	Double pt. information (TI 31)

Parameter	
TI .. type identification	Supported Type Identifications: <ul style="list-style-type: none"> · <TI:=30> .. single point information with time tag CP56Time2a · <TI:=31> .. single point information with time tag CP56Time2a
CASDU, IOA	SICAM RTUs internal IEC608705-101/-104 message address
DP-slave_addr	Address of the DP-Slave on PROFIBUS: <ul style="list-style-type: none"> · 0-99
DP service	PROFIBUS-DP Service: <ul style="list-style-type: none"> · cyclic I/O data exchange
DP data type	Used data type on PROFIBUS: <ul style="list-style-type: none"> · process data
I-address	Input address on the PROFIBUS corresponding to the parameterized I-adr in SYCON: <ul style="list-style-type: none"> · 0-5711
Bit offset	Bit offset in corresponding input byte: <ul style="list-style-type: none"> · 0-7 ... single point information · 0-6 ... double point information
DP-data_format	Data format on PROFIBUS: <ul style="list-style-type: none"> · Byte/Flag [single point information] · Bit [single point information] · OFF/ON [double point information] · ON/OFF [double point information] · DP/DP-Coupler status [only for single point information]
IEC-qualifier of command	IEC qualifier of command: [not relevant] <ul style="list-style-type: none"> · no definition · short · long

Supported Data Formats:

TI	SICAM RTUs 101/-104 Data Format		
30	single point information with time tag CP56Time2a		Ê
31	double point information with time tag CP56Time2a	Ê	
Format	DP Data Format ¹⁾		
BYTE/FLAG	Byte/Flag		Û
1BIT	Bit		Û
DP/DP STATUS	DP/DP coupler status		Û
2BIT	OFF/ON	Û	
2BIT	ON/OFF	Û	
1BIT/PULSE	Pulse		
2BIT PULSE	Pulse OFF/ON		
2BIT PULSE	Pulse ON/OFF		

- 1) As PROFIBUS-DP does not define the presentation of data formats in the input bytes the PROFIBUS-DP format must be selected for the conversion from SICAM RTUs à PROFIBUS-DP. Supported data formats see appendix "PROFIBUS-DP Data Formats".

Message Conversion

The table describes the evaluated elements of the IEC 60870-5-101/104 message during message conversion.

Elements of the message		
TI	.. Type identification	TI 30 .. single point information with time tag CP56Time2a TI 31 .. double point information with time tag CP56Time2a
CASDU, IOA	.. Message address	can be set by parameter
QDS	.. Quality descriptor	
BL	.. blocked	not supported (BL="0")
SB	.. substituted	not supported (SB="0")
NT	.. not topical	NT=1 if DP/DP coupler status "data valid = 0" (otherwise NT="0")
IV	.. invalid	not supported (IV="0")
Cause of transmission		
03	.. spontaneous	upon change of information state or quality descriptor
20	.. interrogated by station interrogation	On reception of a GI request
xx	.. other COTs	not supported
T	.. Test	not supported
Information		
Single point information		
SPI	0 .. OFF	supported
	1 .. ON	supported
Double point information		
DPI	0 .. indeterminate or intermediate state	supported
	1 .. OFF	supported
	2 .. ON	supported
	3 .. indeterminate	supported
time tag		
CP56Time2a	.. date + time	PRE internal time (receive time)

... elements of IEC60870-5-101/-104 message not included in table are not evaluated/not supported!

5.3.2 Measured Values

The parameterization of the address and message conversion for measured values in receive direction is to be done with TOOLBOX II / OPM with the parameter category *firmware / Rec_measured_values*.

Parameter Category:	
<i>firmware / REC_measured_values</i>	
Parameter	Value
Lk_Reg	249
Lk_Comp	60
Lk_BSE	002 CP-2017/PCCX25
Lk_SSE	131 SM-2558/DPMiA0
Lk_DS	Protocols
Lk_Cat	DPMiA0/Rec_measured_values
Lk_Prep	Activated
DP-slave_addr	10
PD service	cyclic I/O data exchange
DP data type	process data
I-address	2
DP-data_format	short floating point (IEEE)
X_0%	0
X_100%	0
Y_0%	0
Y_100%	0
thresh_uncond	0
thresh_additive	0
thresh_unit	%
CASDU1	249
CASDU2	10
IOA1	20
IOA2	255
IOA3	0
TI	Measured val. 15 bit + sign normalized (TI 34)

Parameter	
TI .. type identification	<p>Supported Type Identifications:</p> <ul style="list-style-type: none"> · <TI:=33> .. bitstring of 32 bit with time tag CP56Time2a · <TI:=34> .. measured value, normalized value with time tag CP56Time2a · <TI:=35> .. measured value, normalized value with time tag CP56Time2a · <TI:=36> .. measured value, normalized value with time tag CP56Time2a
CASDU, IOA	SICAM RTUs internal IEC608705-101/-104 message address
DP-slave_addr	<p>Address of the DP-Slave on PROFIBUS:</p> <ul style="list-style-type: none"> · 0-99
DP service	<p>PROFIBUS-DP Service:</p> <ul style="list-style-type: none"> · cyclic I/O data exchange
DP data type	<p>Used data type on PROFIBUS:</p> <ul style="list-style-type: none"> · process data
I-address	<p>Input address on the PROFIBUS corresponding to the parameterized I-adr in SYCON:</p> <ul style="list-style-type: none"> · 0-5711
DP-data_format	<p>Data format on PROFIBUS:</p> <ul style="list-style-type: none"> · integer 8, 16, 32 · unsigned integer 8, 16, 32 · Short Floating Point (IEEE 754) · S5 measured value 12 Bit, 13 Bit
X_0%, X_100% Y_0%, Y_100%	<p>Parameters for value adaption (scaling)</p> <p>Note:</p> <ul style="list-style-type: none"> - valid range of value for X_0% and X_100% see appendix "PROFIBUS-DP Data Formats". - <TI:=34> .. Y_0% and Y_100% must not be greater or smaller than ± 1. - <TI:=35> .. Y_0% and Y_100% must not be smaller than - 32768 and not greater than +32767. - value adaption inactive when X_0% and X_100 = 0
thresh_uncond	<p>Value will be sent to BSE immediately when change of value > thresh_uncond.</p>
thresh_additive	<p>Value will not be sent immediately to BSE when change of value <= thresh_uncond. Additive change monitoring will be activated.</p> <p>Additive Change Monitoring: If summarized changes (=adding the changes with sign since last forwarding) > thresh_additive value will be forwarded to BSE.</p>
thresh_unit	<ul style="list-style-type: none"> · Absolute value [received value from PROFIBUS] · %

Supported Data Formats:

TI	SICAM RTUs 101/-104 Data Format				
33	bitstring of 32 bit with time tag CP56Time2a				Ë
34	measured value, normalized value with time tag CP56Time2a			Ë	
35	measured value, normalized value with time tag CP56Time2a		Ë		
36	measured value, normalized value with time tag CP56Time2a	Ë			
Format	DP Data Format ¹⁾				
INT8	Signed Integer 8 Bit (7 Bit Binary + sign)	Û	Û	Û	Û
INT16	Signed Integer 16 Bit (15 Bit Binary + sign)	Û	Û	Û	Û
INT32	Signed Integer 32 Bit (31 Bit Binary + sign)	Û	Û	Û	Û
UINT8	Unsigned Integer 8 Bit (8 Bit Binary)	Û	Û	Û	Û
UINT16	Unsigned Integer 16 Bit (16 Bit Binary)	Û	Û	Û	Û
UINT32	Unsigned Integer 32 Bit (32 Bit Binary)	Û	Û	Û	Û
FLOAT32	Short Floating Point (IEEE 754)	Û	Û	Û	Û
S5INT12S	Simatic S5, 12 Bit (11 Bit Binary + Status + Sign) "Setpoint Format"	Û	Û	Û	Û
S5INT13S	Simatic S5, 13 Bit (12 Bit Binary + Status + Sign) "Setpoint Format"	Û	Û	Û	Û

1) As PROFIBUS-DP does not define the presentation of data formats in the input bytes the PROFIBUS-DP format must be selected for the conversion from SICAM RTUs à PROFIBUS-DP. Supported data formats see appendix "PROFIBUS-DP Data Formats".

Value Adaption: [not for <TI:=33>]

The adaption is defined by the parameters X_0%, X_100%, Y_0%, Y_100%.

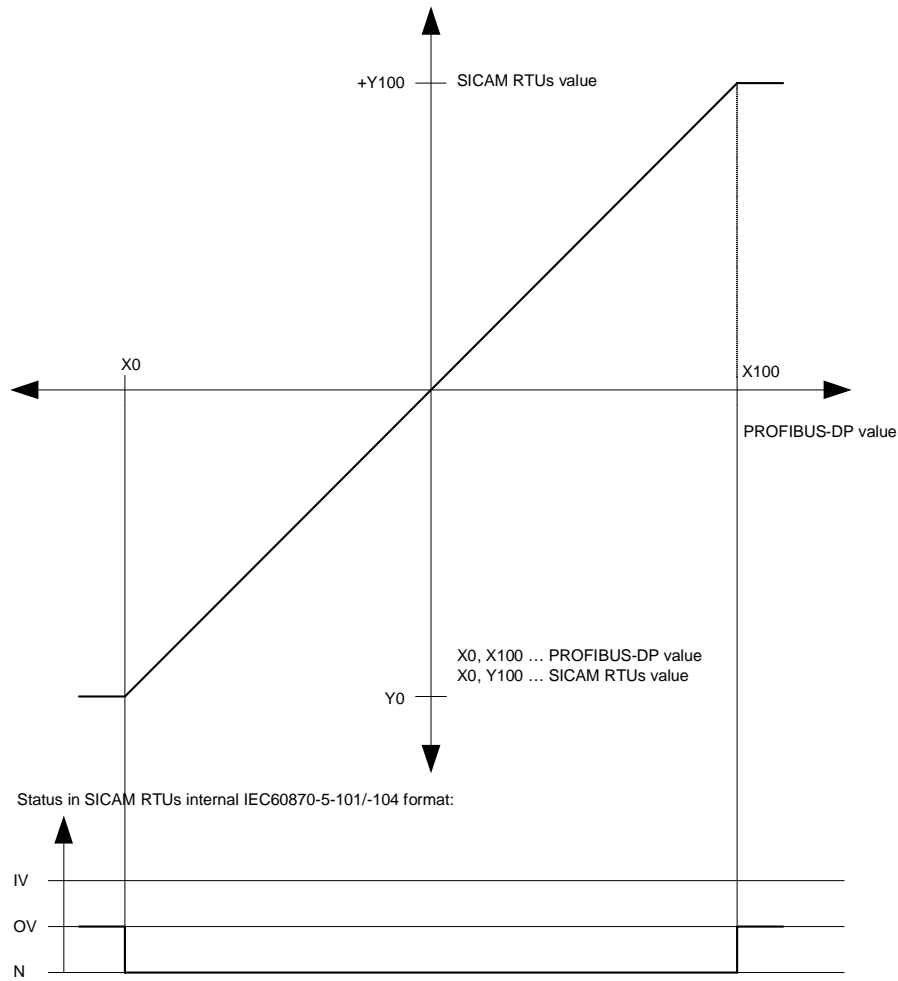

The value adaption is only enabled if X_0% or X_100% is parameterized <> "0".

Note:

- OV="1" if value adaption is disabled (direct forwarding) and if PROFIBUS-DP raw value is outside of the value range specified for the selected IEC60870-5-101/-104 type identification.

Message Conversion

The table describes the evaluated elements of the IEC 60870-5-101/104 message during message conversion.

Elements of the message		
TI	.. Type identification	TI 33 .. bitstring of 32 bit with time tag CP56Time2a TI 34 .. Measured value, normalized value with time tag CP56Time2a TI 35 .. Measured value, scaled value with time tag CP56Time2a TI 36 .. Measured value, short floating point number with time tag CP56Time2a
CASDU, IOA	.. Message address	can be set by parameter
QDS	.. Quality descriptor	
BL	.. blocked	not supported (BL="0")
SB	.. substituted	not supported (SB="0")
NT	.. not topical	NT="1" if DP/DP coupler status "data valid = 0" (otherwise NT="0")
IV	.. invalid	IV=1: - FLOAT32 format if value = "NAN" ("Not A Number") - S5INT12S, S5INT13S if F="1" (broken wire) ... otherwise IV="0".
OV	.. overflow	OV=1: <u>Value adaption enabled:</u> - PROFIBUS-DP value is outside of the range of the selected TI <u>Value adaption disabled:</u> - PROFIBUS-DP value is smaller than X_0% or greater than X_100% - S5INT12S, S5INT13S with OV="1" (Overflow)
Cause of transmission		
03	.. spontaneous	Alteration of the measured value depending on the thresholds or alteration of the quality descriptor
20	.. interrogated by station interrogation	On reception of a GI request
xx	.. other COTs	not supported
T	.. Test	not supported
Information		
value	..	normalized value
S	.. sign	scaled value
		IEEE STD 754 = short floating point number
		bitstring of 32 bit
time tag		
CP56Time2a	.. date + time	PRE internal time (receive time)

... elements of IEC60870-5-101/-104 message not included in table are not evaluated/not supported

5.3.3 Integrated totals

The parameterization of the address and message conversion for integrated totals in receive direction is to be done with TOOLBOX II / OPM with the parameter category *firmware / Rec_Counter_value*.

Parameter Category:

firmware / REC_Counter_value

Parameter	Value
Lk_Reg	249
Lk_Comp	60
Lk_BSE	002 CP-2017/PCCX25
Lk_SSE	131 SM-2558/DPMiA0
Lk_DS	Protocols
Lk_Cat	DPMiA0/Rec_counter_value
Lk_Prep	Activated
DP-slave_addr	10
PD service	cyclic I/O data exchange
DP data type	process data
I-address	42
DP-data_format	Integer 8
Transmit	1 minute
IEC-group	Group 1
Overflow	31 Bit Integer
CASDU1	249
CASDU2	10
IOA1	80
IOA2	255
IOA3	0
TI	Count 31 bit + sign (TI 37)

Parameter	
TI .. type identification	Supported Type Identifications: <ul style="list-style-type: none"> · <TI:=37> .. integrated totals with time tag CP56Time2a
CASDU, IOA	SICAM RTUs internal IEC608705-101/-104 message address
DP-slave_addr	Address of the DP-Slave on PROFIBUS: <ul style="list-style-type: none"> · 0-99
DP service	PROFIBUS-DP Service: <ul style="list-style-type: none"> · cyclic I/O data exchange
DP data type	Used data type on PROFIBUS: <ul style="list-style-type: none"> · process data
I-address	Input address on the PROFIBUS corresponding to the parameterized I-adr in SYCON: <ul style="list-style-type: none"> · 0-5711
DP-data_format	Data format on PROFIBUS: <ul style="list-style-type: none"> · integer 8, 16, 32 · unsigned integer 8, 16, 32 · Short Floating Point (IEEE 754)
Transmit	Definition for transmit integrated totals to BSE (counter freeze and read): <ul style="list-style-type: none"> · counter interrogation · periodic forwarding: 1, 2, 3, 5, 10, 15, 30, 60 minute(s)
IEC-group	Request Counter Group: <ul style="list-style-type: none"> · Request counter group 1, 2, 3, 4
Overflow	Overflow for integrated totals at: <ul style="list-style-type: none"> · 24, 31 bit integer · 2, 3, 4, 5, 6, 7, 8, 9 decades BCD

Supported Data Formats:

TI	SICAM RTUs 101/-104 Data Format	
37	integrated totals with time tag CP56Time2a	Ë
Format	DP Data Format ¹⁾	
INT8	Signed Integer 8 Bit (7 Bit Binary + sign)	Ü
INT16	Signed Integer 16 Bit (15 Bit Binary + sign)	Ü
INT32	Signed Integer 32 Bit (31 Bit Binary + sign)	Ü
UINT8	Unsigned Integer 8 Bit (8 Bit Binary)	Ü
UINT16	Unsigned Integer 16 Bit (16 Bit Binary)	Ü
UINT32	Unsigned Integer 32 Bit (32 Bit Binary)	Ü
FLOAT32	Short Floating Point (IEEE 754)	Ü

- 1) As PROFIBUS-DP does not define the presentation of data formats in the input bytes the PROFIBUS-DP format must be selected for the conversion from SICAM RTUs to PROFIBUS-DP. Supported data formats see appendix "PROFIBUS-DP Data Formats".

Message Conversion

The table describes the evaluated elements of the IEC 60870-5-101/104 message during message conversion.

Elements of the message		
TI	.. Type identification	TI 37 .. integrated totals with time tag CP56Time2a
CASDU, IOA	.. Message address	can be set by parameter
data point quality descriptor		
	sequence number	With each trigger for latching for a group the sequence number is incremented in the range from 1 .. 31.
CY	.. Carry	On overflow of the count in the associated count period
CA	.. presets	not supported
IV	.. invalid	IV="1" if DP/DP coupler status "data valid = 0" (otherwise IV="0")
Cause of transmission		
03	.. spontaneous	for transmit = periodic forwarding
37	.. requested by general counter interrogation	for general request counter (all counter groups)
38-41	.. interrogated by group 1-4 interrogation	For request counter group (1..4)
T	.. Test	not supported
Information		
value	..	Binary counter reading
S	.. sign	
time tag		
CP56Time2a	.. date + time	PRE internal time

... elements of IEC60870-5-101/-104 message not included in table are not evaluated/not supported!

Message Conversion “Counter Interrogation Command” (SICAM RTUs internal only)

This table describes the data point quality descriptor and the cause of transmission according to IEC 60870-5-101/104.

Elements of the message		
TI .. Type identification		TI 101 .. Counter Interrogation Command
CASDU, IOA .. Message address		Defined
QCC .. Identifier counter interrogation		
FRZ	RQT	FRZ ... Freeze RQT ... Request
0	1..4	read (no freeze or reset) request counter group (1..4)
	5	read (no freeze or reset) general request counter (all counter groups)
1	1..4	counter freeze without reset request counter group (1..4)
	5	counter freeze without reset all counter groups
2	1..4	counter freeze with reset request counter group (1..4)
	5	counter freeze with reset all counter groups
3	1..4	counter reset request counter group (1..4)
	5	counter reset all counter groups
x	0; 6 .. 63	not supported
Cause of transmission		
06 .. activation		must be set
xx .. other COTs		not supported
T .. Test		not supported

5.3.4 Commands

The parameterization of the address and message conversion for commands in receive direction is to be done with TOOLBOX II / OPM with the parameter category *firmware / Rec_binary_information*.

Parameter Category:

firmware / Rec_binary_information

Parameter	Value
Lk_Reg	249
Lk_Comp	60
Lk_BSE	002 CP-2017/PCCX25
Lk_SSE	131 SM-2558/DPMiA0
Lk_DS	Protocols
Lk_Cat	DPMiA0/Rec_binary_information
Lk_Prep	Activated
DP-slave_addr	3
PD service	cyclic I/O data exchange
DP data type	process data
I-address	0
Bit offset	0
DP-data_format	Pulse
IEC-qualifier_of_command	no definition
CASDU1	249
CASDU2	3
IOA1	208
IOA2	255
IOA3	0
TI	Single command (TI 45)

Parameter	
TI .. type identification	Supported Type Identifications: <ul style="list-style-type: none"> · <TI:=45> .. single command · <TI:=46> .. double command · <TI:=47> .. regulating step command
CASDU, IOA	SICAM RTUs internal IEC608705-101/-104 message address
DP-slave_addr	Address of the DP-Slave on PROFIBUS: <ul style="list-style-type: none"> · 0-99
DP service	PROFIBUS-DP Service: <ul style="list-style-type: none"> · cyclic I/O data exchange
DP data type	Used data type on PROFIBUS: <ul style="list-style-type: none"> · process data
I-address	Input address on the PROFIBUS corresponding to the parameterized I-adr in SYCON: <ul style="list-style-type: none"> · 0-5711
Bit offset	Bit offset in corresponding input byte: <ul style="list-style-type: none"> · 0-7 ... single command · 0-6 ... double command or regulating step command
DP-data_format	Data format on PROFIBUS: <ul style="list-style-type: none"> · pulse [single command] · pulse OFF/ON [double command, regulating step command] · pulse ON/OFF [double command, regulating step command]
IEC-qualifier of command	IEC qualifier of command: <ul style="list-style-type: none"> · no definition · short · long

Supported Data Formats:

TI	SICAM RTUs 101/-104 Data Format			
45	single command			Ë
46	double command		Ë	
47	regulating step command	Ë		
Format	DP Data Format ¹⁾			
BYTE/FLAG	Byte/Flag			
1BIT	Bit			
DP/DP STATUS	DP/DP coupler status			
2BIT	OFF/ON			
2BIT	ON/OFF			
1BIT/PULSE	Pulse			Û
2BIT PULSE	Pulse OFF/ON	Û	Û	
2BIT PULSE	Pulse ON/OFF	Û	Û	

- 1) As PROFIBUS-DP does not define the presentation of data formats in the input bytes the PROFIBUS-DP format must be selected for the conversion from SICAM RTUs to PROFIBUS-DP. Supported data formats see appendix "PROFIBUS-DP Data Formats".

Commands in Receive Direction

Commands from PROFIBUS-DP Slaves to SICAM RTUs must be transmitted as "1 bit pulse" or as "2 bit pulse" with limited pulse duration. The processing of commands in receive direction is done by the protocol element with edge sensitive handling (only pos. edge is evaluated).

The transmission of commands as pulse is necessary to prevent of unwanted actions in case of state transmission after power up.

Command Output Time

The command output time (=qualifier of command) can be set for each command in field IEC-qualifier of command:

- no definition <0> "no additional definition"
- short <1> "short pulse duration"
- long <2> "long pulse duration"

Single Command

A pulse with pos. edge in PROFIBUS-DP input data will be converted to IEC60870-5-101 single command with command state = "ON".
 Neg. edge is not evaluated; pulse duration is not supervised.

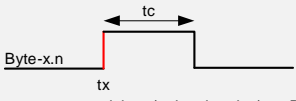
DP-Data Format	Command State	Command Pulse (1 bit in input byte)
pulse	SCS=ON	 <p>tc ... command time (pulse duration) on PROFIBUS tx ... single command at pos. edge</p>
	SCS=OFF	Note: The OFF State is not evaluated!

Double Command / Regulating Step Command

A pulse with pos. edge in PROFIBUS-DP input data will be converted to IEC60870-5-101 double command or regulating step command with command state DCS = "ON/OFF" or RCS = "Higher/Lower".
 Neg. edge is not evaluated; pulse duration is not supervised.

DP-Data Format	Command State	I-Address
pulse ON/OFF	ON	configured I-address; bit offset
	OFF	configured I-address; bit offset + 1
pulse OFF/ON	ON	configured I-address; bit offset + 1
	OFF	configured I-address; bit offset

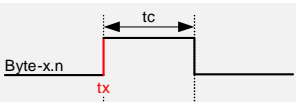
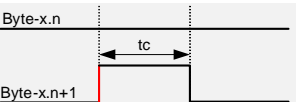
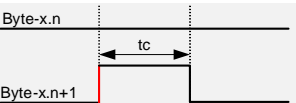
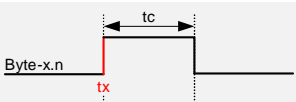
DP-Data Format	Command State	Command Pulse (2 bit in input byte)
pulse ON/OFF	DCS=ON RCS=Higher	 <p>tc ... command time (pulse duration) on PROFIBUS tx ... double command/regulating step command at pos. edge</p>
	DCS=OFF RCS=Lower	 <p>tc ... command time (pulse duration) on PROFIBUS tx ... double command/regulating step command at pos. edge</p>
pulse OFF/ON	DCS=ON RCS=Higher	 <p>tc ... command time (pulse duration) on PROFIBUS tx ... double command/regulating step command at pos. edge</p>
	DCS=OFF RCS=Lower	 <p>tc ... command time (pulse duration) on PROFIBUS tx ... double command/regulating step command at pos. edge</p>

Message Conversion

The table describes the evaluated elements of the IEC 60870-5-101/104 message during message conversion.

Elements of the message		
TI	.. Type identification	TI 45 .. single command TI 46 .. Double command TI 47 .. regulating step command
CASDU, IOA	.. Message address	can be set by parameter
Cause of transmission		
06	.. activation	supported
xx	.. other COTs	not supported
T	.. test	not supported
Information		
SCO/DCO/RCO		
SCS	single command state	[<TI:=45> only]
	0 .. OFF	not supported
	1 .. ON	evaluated
DCS	double command state	[<TI:=46> only]
	0 .. not permitted	not supported
	1 .. OFF	supported
	2 .. ON	supported
	3 .. not permitted	not supported
RCS	regulating step command state	[<TI:=47> only]
	0 .. not permitted	not supported
	1 .. next step LOWER	supported
	2 .. next step HIGHER	supported
	3 .. not permitted	not supported
QOC	S/E	
	0 = execute	supported
	1 = select	not supported
QU	qualifier of command	
	0 .. no additional determinations	supported
	1 .. short output time	supported
	2 .. long output time	supported
	3 .. Persistent command	not supported

... elements of IEC60870-5-101/-104 message not included in table are not evaluated/not supported!

A PROFIBUS-DP Data Formats

Contents

A.1	PROFIBUS-DP Data Formats.....	108
-----	-------------------------------	-----

A.1 PROFIBUS-DP Data Formats

Data from/to PROFIBUS-DP slaves will be sent with PROFIBUS-DP data formats specified below.

Data formats greater than 1 byte will always be represented/transmitted in "Big Endian (HIGH before LOW order)

Supported PROFIBUS-DP Data Formats:

Format #	Format	Designation
General Formats		
1	1BIT	1 Bit (ON, OFF)
2	1BIT/PULSE	1 Bit (ON, OFF) OFF controlled by PRE after Timeout (command output time)
3	2BIT	2 Bit (ON, OFF) ("OFF before ON" or "ON before OFF")
4	2BIT/PULSE	2 Bit (ON, OFF) ("OFF before ON" or "ON before OFF") OFF controlled by PRE after Timeout (command output time)
5	BYTE/FLAG	8 Bit Binary (0=OFF, <> 0 = ON)
6	INT8	Signed Integer 8 Bit (7 Bit Binary + Sign)
7	UINT8	Unsigned Integer 8 Bit (8 Bit Binary)
8	INT16	Signed Integer 16 Bit (15 Bit Binary + Sign)
9	UINT16	Unsigned Integer 16 Bit (16 Bit Binary)
10	INT32	Signed Integer 32 Bit (31 Bit Binary + Sign)
11	UINT32	Unsigned Integer 32 Bit (32 Bit Binary)
12	FLOAT32	Short Floating Point (IEEE 754)
Device Specific Formats		
100	S5INT12	Simatic S5, 12 Bit (11 Bit Binary + Sign) "Setpoint Format"
101	S5INT12S	Simatic S5, 12 Bit (11 Bit Binary + Status + Sign) "Measured Value Format"
102	S5INT13S	Simatic S5, 13 Bit (12 Bit Binary + Status + Sign) "Measured Value Format"
110	DP/DP STATUS	DP/DP coupler status; 1 Bit ("data valid" Indication)

Format-1: 1BIT

Single bit in input/output byte represented by Offset= x / Bit#=n (0-7).

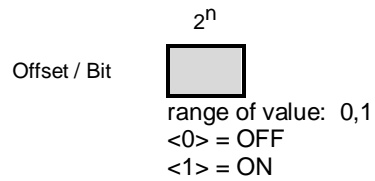
**Format-2: 1BIT/PULSE**

Pulse command in output byte represented by Offset= x / Bit#=n (0-7).

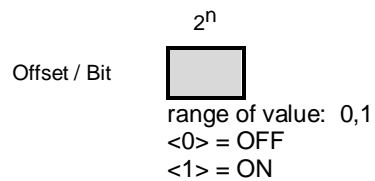

Note:

State will be set to OFF by PRE after expiration of command output time.

Format-3: 2BIT – OFF/ON, ON/OFF

2 neighboring bit in input/output byte represented by Offset= x / Bit#=n (0-6), Bit#=n+1(1-7).
 Note: 2 Bits must always be located in same input/output byte.

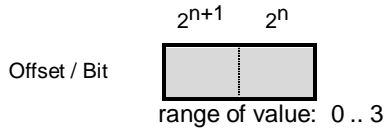

Coding: "2BIT – OFF/ON"

<00> = indeterminate or intermediate state

<01> = OFF

<10> = ON

<11> = indeterminate state

Coding: "2BIT – ON/OFF"

<00> = indeterminate or intermediate state

<01> = ON

<10> = OFF

<11> = indeterminate state

Format-4: 2BIT/PULSE – OFF/ON, ON/OFF

2 neighboring bit (pulse command) in input/output byte represented by Offset= x / Bit#=n (0-6), Bit#=n+1(1-7).

Note: 2 Bits must always be located in same input/output byte.

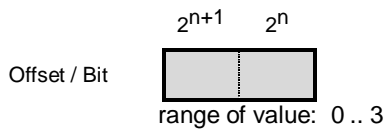

Coding: "2BIT/PULSE – OFF/ON"

<00> = inactive

<01> = OFF

<10> = ON

<11> = not valid

Coding: "2BIT/PULSE – ON/OFF"

<00> = inactive

<01> = ON

<10> = OFF

<11> = not valid

Note:

State will be set to "inactive" by PRE after expiration of command output time.

Format-5: BYTE/FLAG (8 Bit Binary)

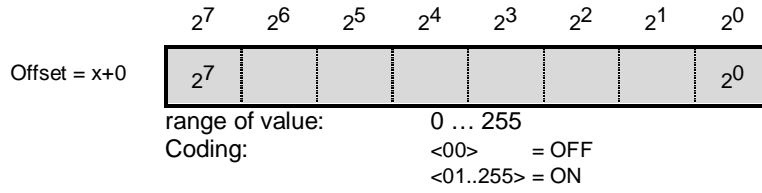

Format-6: INT8 – Signed Integer 8 Bit (7 Bit Binary + Sign)

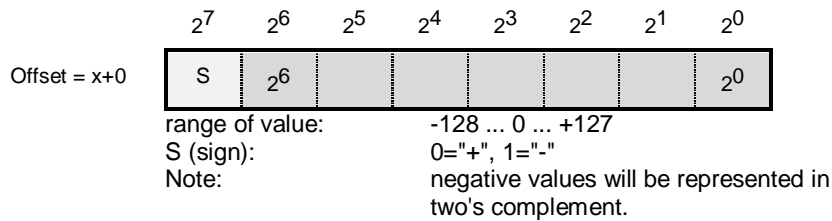

Format-7: UINT8 - Unsigned Integer 8 Bit (8 Bit Binary)

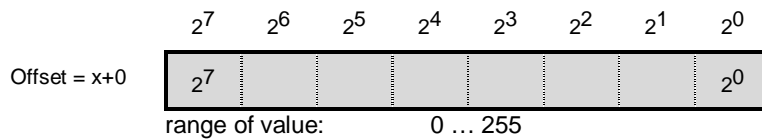

Format-8: INT16 – Signed Integer 16 Bit (15 Bit Binary + Sign)

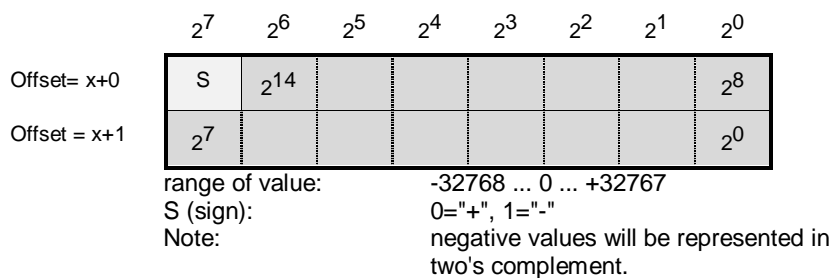

Format-9: UINT16 - Unsigned Integer 16 Bit (16 Bit Binary)

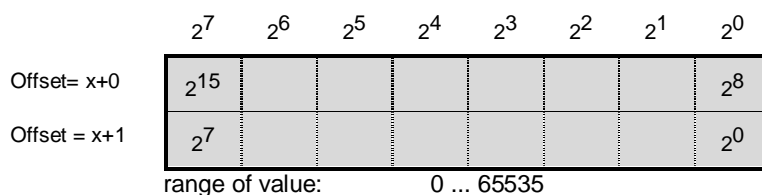

Format-10: INT32 – Signed Integer 32 Bit (31 Bit Binary + Sign)

	2^7	2^6	2^5	2^4	2^3	2^2	2^1	2^0	
Offset = x+0	S	2^{30}						2^{24}	
Offset = x+1	2^{23}							2^{16}	
Offset = x+2	2^{15}							2^8	
Offset = x+3	2^7							2^0	

range of value: -2 147 483 648 ... 0 ... +2 147 483 647
 S (sign): 0="+", 1="-"
 Note: negative values will be represented in two's complement.

Format-11: UINT32 - Unsigned Integer 32 Bit (32 Bit Binary)

	2^7	2^6	2^5	2^4	2^3	2^2	2^1	2^0	
Offset = x+0	2^{31}							2^{24}	
Offset = x+1	2^{23}							2^{16}	
Offset = x+2	2^{15}							2^8	
Offset = x+3	2^7							2^0	

range of value: 0 ... 4 294 967 295

Format-12: FLOAT32 - Short Floating Point (IEEE 754)

Note: Format is according IEEE 754 Floating Point Format.

	2^7	2^6	2^5	2^4	2^3	2^2	2^1	2^0	
Offset = x+0	S	2^7						2^1	exponent, S (=sign)
Offset = x+1	2^0	2^{22}						2^{16}	mantissa
Offset = x+2	2^{15}							2^8	mantissa
Offset = x+3	2^7							2^0	mantissa

range of value: $-2^{128} + 2^{104} \dots + 2^{128} - 2^{104}$
 $-3,4 \cdot 10^{38} \dots + 3,4 \cdot 10^{38}$
 S (sign): 0="+", 1="-"
 Smallest negative number: $-2^{-149} = -1,4 \cdot 10^{-45}$
 Smallest positive number: $+2^{-149} = +1,4 \cdot 10^{-45}$

**Format-100: S5INT12 - Simatic S5, 12 Bit
(11 Bit Binary + Sign) "Setpoint Format"**

	2^7	2^6	2^5	2^4	2^3	2^2	2^1	2^0
Offset= x+0	S	2^{10}						2^4
Offset = x+1	2^3			2^0	0	0	0	0

range of value: -2048 ... 0 ... +2047
 S (sign): 0="+", 1="-"
 Note: negative values will be represented in two's complement.

**Format-101: S5INT12S - Simatic S5, 12 Bit
(11 Bit Binary + Status + Sign)
"Measured Value Format"**

	2^7	2^6	2^5	2^4	2^3	2^2	2^1	2^0
Offset= x+0	S	2^{10}						2^4
Offset = x+1	2^3			2^0	X	X	F	OV

range of value: -2048 ... 0 ... +2047
 S (sign): 0="+", 1="-"
 Note: negative values will be represented in two's complement.

Status: F Faulty Bit ("broken wire")
 OV ... Overflow Bit
 X not used (=0)

**Format-102: S5INT13S - Simatic S5, 13 Bit
(12 Bit Binary + Status + Sign)
"Measured Value Format"**

	2^7	2^6	2^5	2^4	2^3	2^2	2^1	2^0
Offset= x+0	S	2^{11}						2^5
Offset = x+1	2^4				2^0	X	F	OV

range of value: -4096 ... 0 ... +4095
 S (sign): 0="+", 1="-"
 Note: negative values will be represented in two's complement.

Status: F Faulty Bit ("broken wire")
 OV ... Overflow Bit
 X not used (=0)

Format-110: DP/DP STATUS

This bit indicates if the received data from DP/DP coupler's (e.g.: Siemens DP/DP coupler) slave are valid.

Single bit in input byte represented by Offset= x / Bit#=n (0-7).

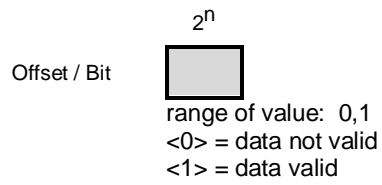

B SYCON.net + netHOST Quick Start Instructions

Contents

B.1	Overview	116
B.2	Workflow	120

B.1 Overview

The external Fieldbus gateway “netHOST” for PROFIBUS-DP master must be ordered from company Hilscher directly. The required software SYCON.net (=PROFIBUS configuration software) will be automatic included in package when ordering netHOST (no extra ordering position required) .



Hint

Please use always latest version of SYCON.net software!

The newest version of SYCON.net software for netHOST can be downloaded from <https://www.hilscher.com/support/downloads/>.

Notes:

- SYCON.net software version included in netHOST package's DVD may be not up to date.
- Before 1st usage of netHOST please download the newest firmware for netHOST and load firmware into netHOST device (netHOST will not be delivered with latest firmware version).
- The newest firmware for netHOST is included in SYCON.net software.

B.1.1 Download SYCON.net

The newest version of SYCON.net software for netHOST can be downloaded from <https://www.hilscher.com/support/downloads/>.

Home | Support | Downloads

netX ▾ Products ▾ Services ▾ Applications ▾ Support ▾ Sales ▾ Company ▾

Downloads

Product DVD center Glossary

netHOST

The netHOST DVD contains configuration and diagnostic software, firmware, device driver, device description files, documentation, commissioning videos, and tools for users as well as driver toolkit, examples and API for developers.

netHOST DVD 2016-02-1/V1.0370.150722.15176

B.1.2 Installation of SYCON.net

After download and unzip of SYCON.net software “netHOST DVD“ the installation will be started with netHOST_Solutions.exe.



Please follow installation instruction for SYCON.net.

B.1.3 Update netHOST Firmware

- Start SYCON.net 
- Connect netHOST
- Create new project with gateway = "NHST-T100-DP" or open existing project (drag & drop NHST-T100-DP/DPM from sheet "fieldbus" into project area)

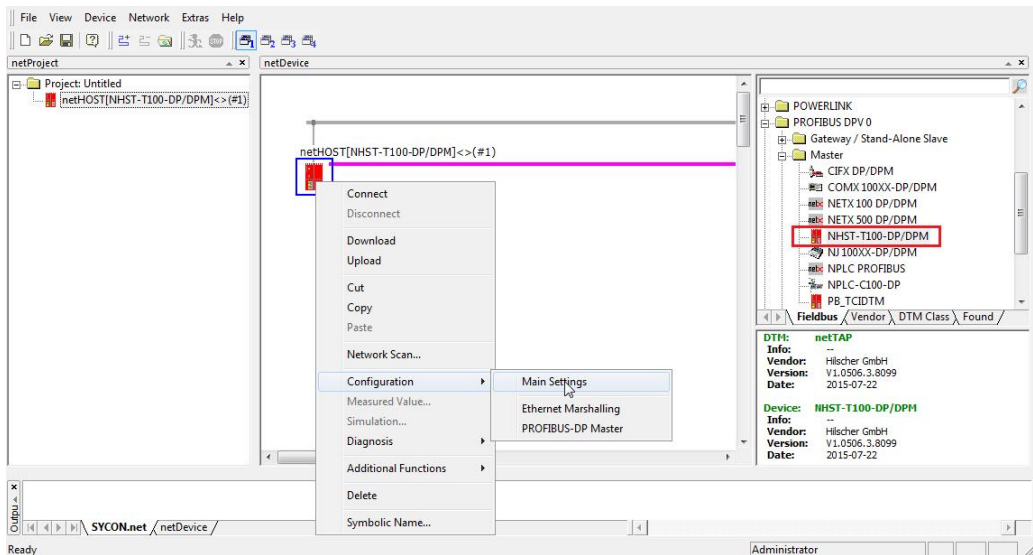

- Select netHOST (move mouse over netHOST icon) à press <right mouse button> | Configuration | Settings

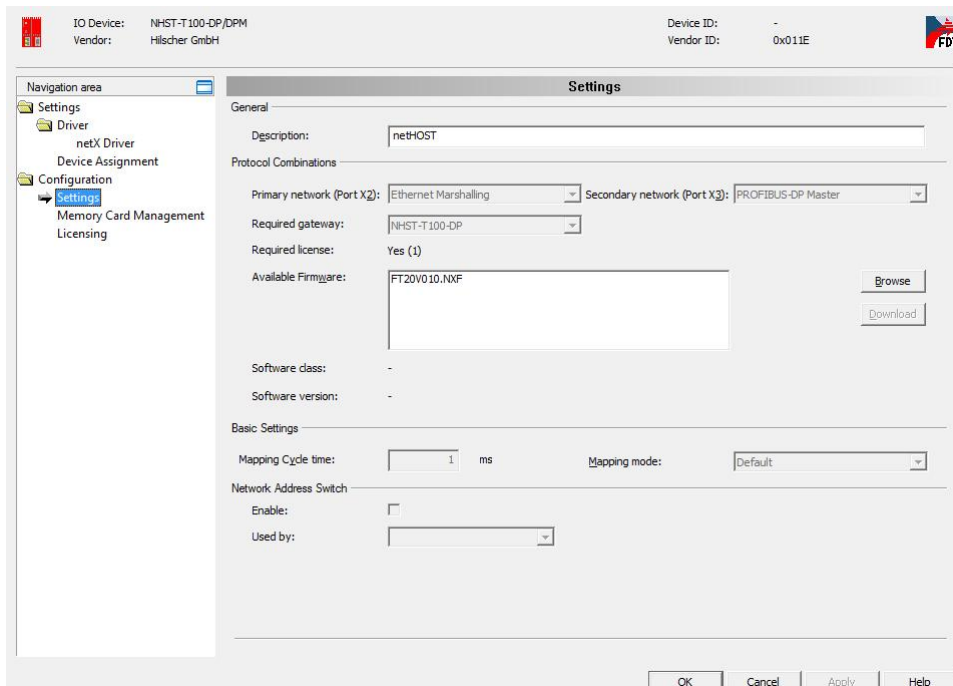

- Available Firmware <Browse>

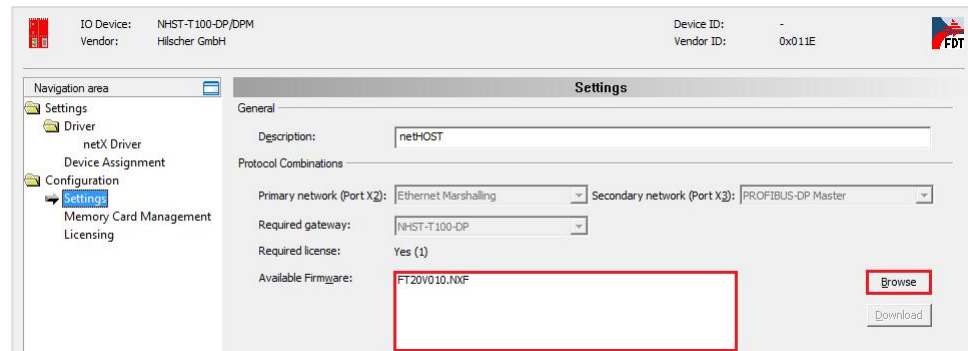

- select latest NetHOST firmware à <Open>

Note:

The location for firmware files on computer depends on installation of SYCON.net - typically firmware's stored in folder `C:\Program Files (x86)\Hilscher GmbH\SYCONnet\netGatewayDTM\Firmware`.

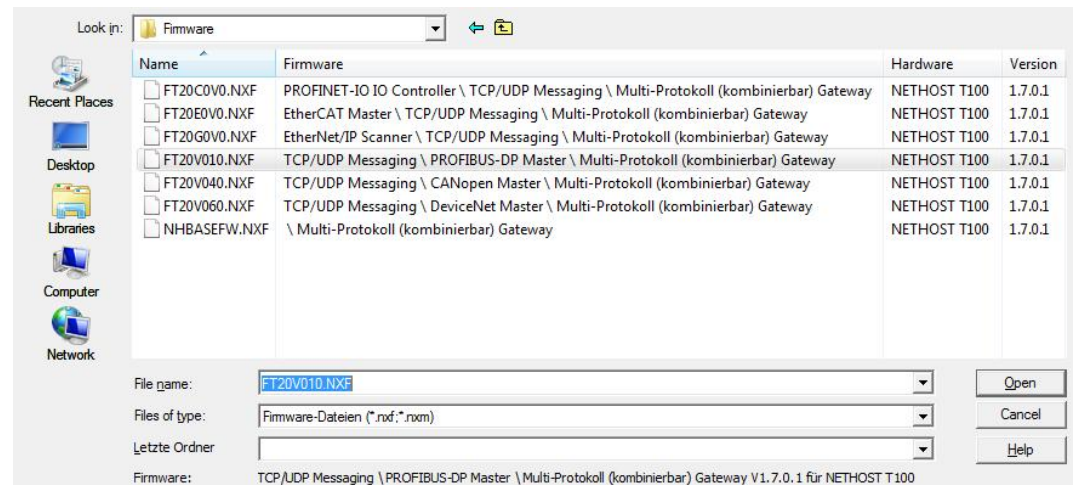

- download selected software in netHOST with <Download>

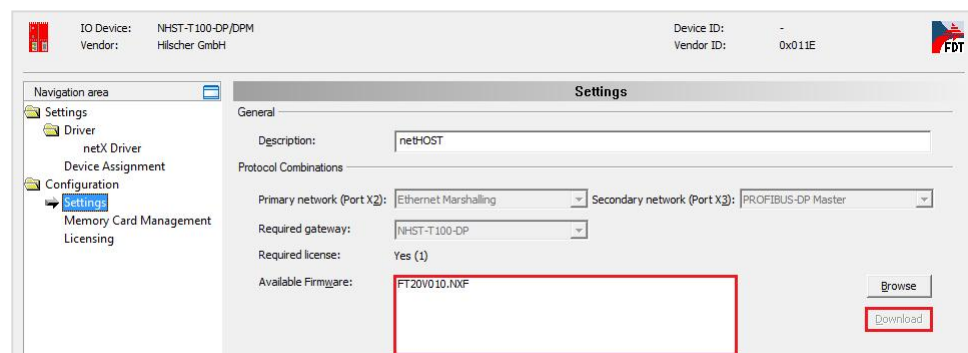

- after firmware update of netHOST, configuration must be loaded again (same procedure as during 1st configuration)

B.2 Workflow

B.2.1 Setting the IP-address for netHOST

The default setting (factory default) for the IP-address of the netHOST is 0.0.0.0.

The IP address of the netHOST can be set via LAN network.

Detailed description is included in Hilscher's documentation: [Ethernet Device Configuration - Address Setting for Ethernet capable Hilscher Devices \(Operating instruction manual\)](#)

Note:

A quick start installation guide including video is part of the installation CD contained in package.

B.2.2 SYCON.net – Configuration

Required Steps for Configuration with SYCON.net:

- IP address setting for netHOST
- device assignment
- configuration of PROFIBUS network
- load configuration in netHOST

Detailed description is included in Hilscher documentation: [Configuration of Fieldbus Devices with Remote Access \(Operating instruction manual\)](#)

Note:

A quick start installation guide including video is part of the installation CD contained in package.

The configuration/parameterization of all connected PROFIBUS will be done with SYCON.net. For configuration all GSD files from different PROFIBUS-DP slave devices must be imported in SYCON.net.

**Hint**

Following settings in SYCON.net are mandatory for PROFIBUS-DP Master function in SICAM RTUs using external Fieldbus gateway netHOST:

- Start of bus communication = “Controlled by application”
- Module Alignment = “Byte boundaries”
- Process image store format = “Big Endian (MSB first)”
- Advanced:
Enable configuration download during network state “operate” = “not activated”
- Application monitoring (Watchdog) must be greater or equal 1000ms

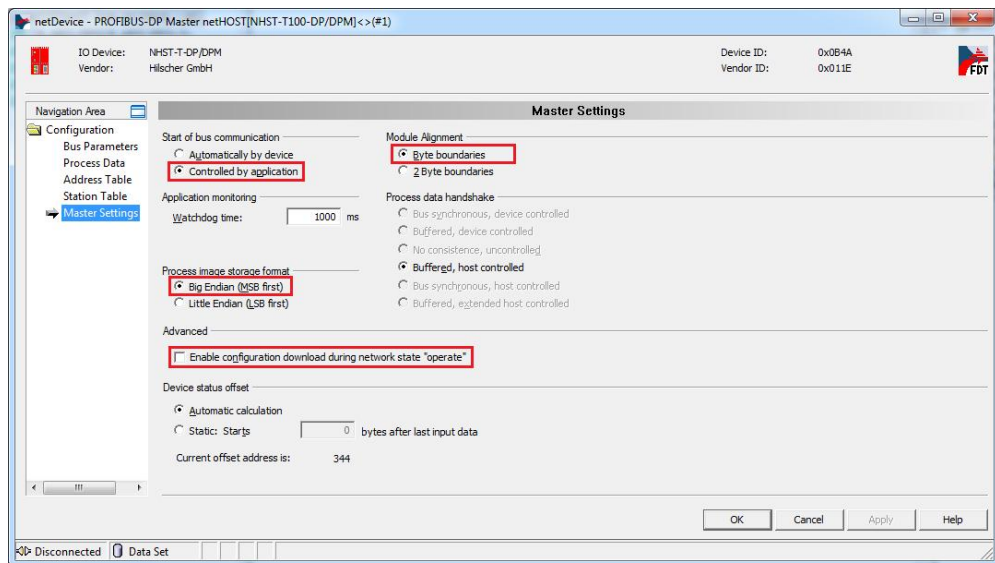

B.2.3 Connecting SYCON.net with netHOST in Operation

Changes of the PROFIBUS configuration and reading diagnostic information from netHOST can be done only with SYCON.net.

The communication of the protocol element with netHOST must be stopped to enable communication from SYCON.net with netHOST in operation.

How to Stop the Communication between Protocol Element and netHOST:

- Disconnect the LAN cable between SICAM RTUs and netHOST
 - à Only possible at site!
- Stop protocol element with ST-Emulation (TOOLBOX II)
Requirements:
 - local/ remote connection with TOOLBOX II to automation unit required
 - specific user rights management settings in TOOLBOX II required!
 - à Can be done at site or with remote connection!
For remote connection with SYCON.net to netHOST via LAN required network infrastructure must be installed.

Behavior after Stop of the Communication between Protocol Element and netHOST:

- failure of the protocol element in SICAM RTUs
- failure of all PROFIBUS-DP Slaves in SICAM RTUs!
- Watch Dog failure in "netHOST"
 - à communication on PROFIBUS will be stopped.
 - à BUS failure will be identified by all connected PROFIBUS-DP slaves

As soon as the communication between the protocol element and the netHOST is stopped user can start to communicate between SYCON.net and netHOST for loading new/changed PROFIBUS configuration data into the netHOST or reading diagnostic information from the netHOST.

After finishing the work with SYCON.net the communication between SYCON.net and netHOST must be stopped (disconnect LAN cable or close SYCON.net software).

After disconnecting SYCON.net from netHOST the communication between protocol element and netHOST must be re-started.

Starting the Communication between Protocol Element and netHOST:

- Re-connect LAN cable between SICAM RTUs and netHOST
 - à Only possible at site!
- re-start protocol element using service function online from TOOLBOX II (restart)
Requirements:
 - local/ remote connection with TOOLBOX II to automation unit required
 - specific user rights management settings in TOOLBOX II required!
 - à Can be done at site or with remote connection!

**Hint**

Only authorized persons are allowed to connect SYCON.net to netHOST in operation!

B.2.4 Save SYCON.net Configuration Data in TOOLBOX II

The project specific configuration data from SYCON.net must be managed/archived/saved by user.

When using TOOLBOX II for configuration of the SICAM RTUs system the PROFIBUS configuration data from SYCON.net including GSD files can be stored in technological parameters of the plant in TOOLBOX II.

All required PROFIBUS configuration data files/*.GSD files must be included (stored) in one ZIP file and this ZIP file will be imported in technological parameters of the TOOLBOX II. After import this ZIP file is part of the plant parameters and this ZIP file will be included in parameter export/import.

It can be defined by user at which level of the technological parameters of the plant the PROFIBUS configuration data should be imported. Also the directory structure and the filenames for the SYCON.net PROFIBUS configuration data must be defined by user.



Hint

New import of PROFIBUS configuration data must be done always after change of PROFIBUS configuration data!

Required steps in OPM of TOOLBOX II:

- **Create new image in OPM**
 - à open window "Edit image"
 - à select level
 - à click right mouse button
 - à create new image(s) "Typeless..."

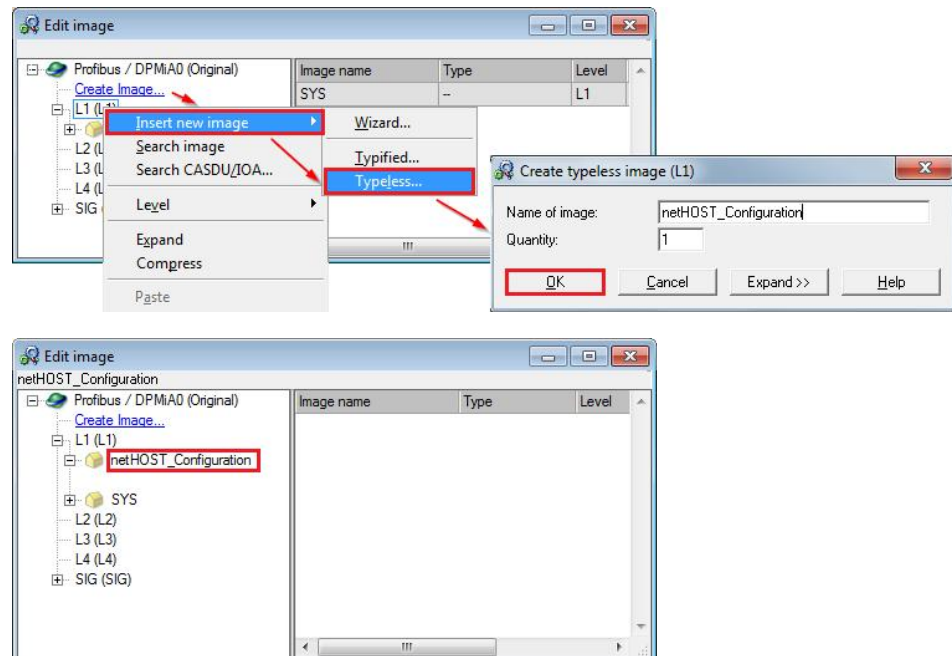

• **Create new info type**

à open "Type overview"

à create new info type...

Name of info type name of info type "short name"

Long text name of info type "long name"

Default value --- (not used)

Access group name of access group

With this name the new infotype is created in the type overview

Domain OPMSTD_DOCUMENT

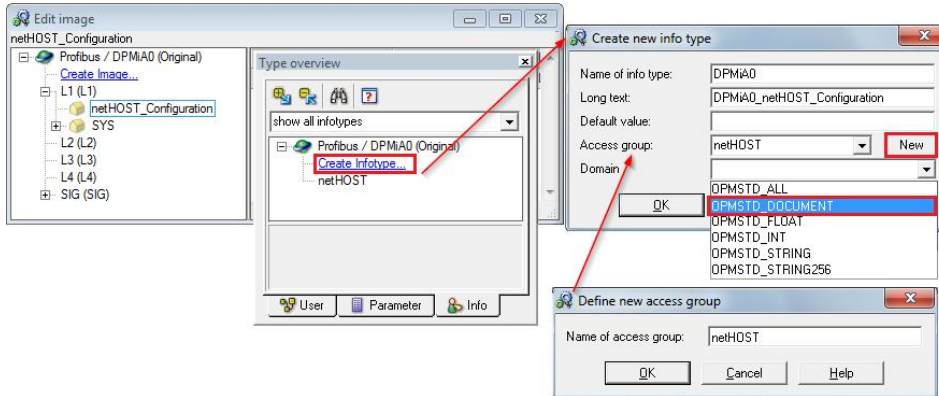

• **Assign infotype**

à use Drag & Drop to assign created type from type overview to image defined for including SYCON.net PROFIBUS configuration data file.

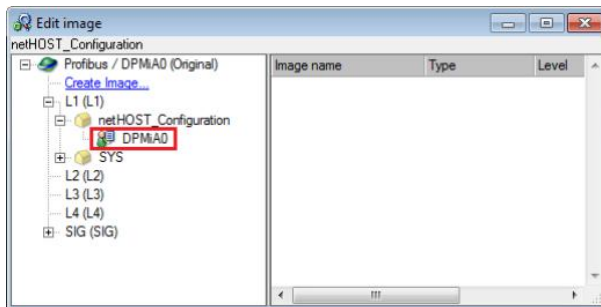
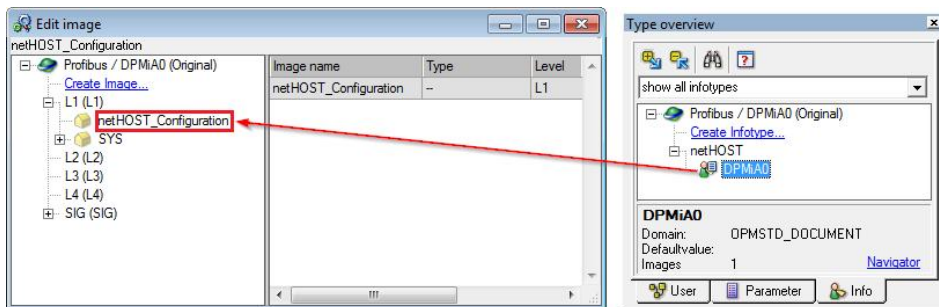

- **Import PROFIBUS Configuration Data (ZIP File)**
 - à select infotype object in edit image window
 - à press right mouse button
 - à select “Import document ...”
 - à Import previous created ZIP file including SYCON.net PROFIBUS configuration data and GSD files.

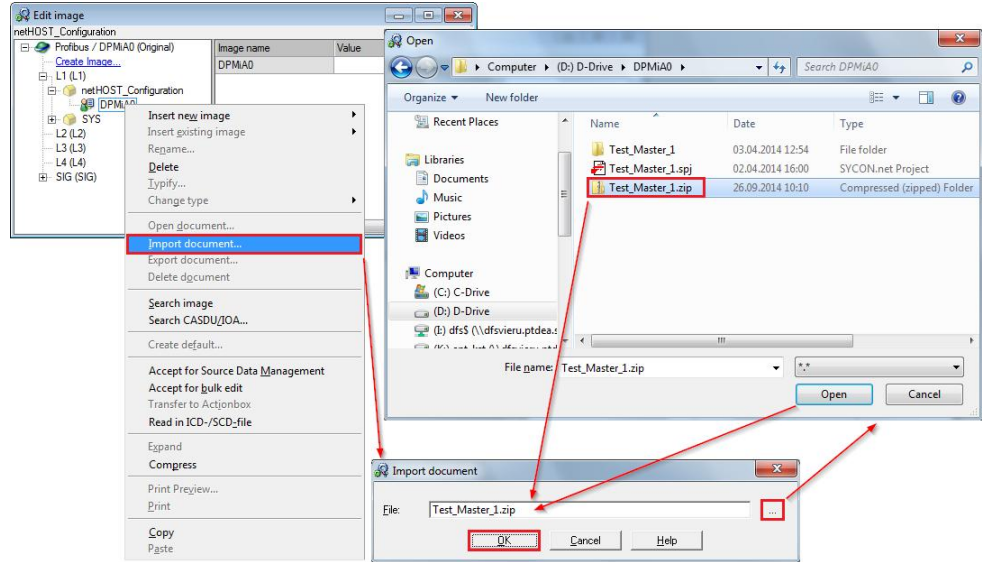

- **Export PROFIBUS Configuration Data (ZIP File)**
 - à select infotype object in edit image window
 - à press right mouse button
 - à select “Export document ...”
 - à ... select destination folder/destination file name

Notes:

After export the PROFIBUS configuration data and GSD files must be imported in SYCON.net or copied in SYCON.net project folders.

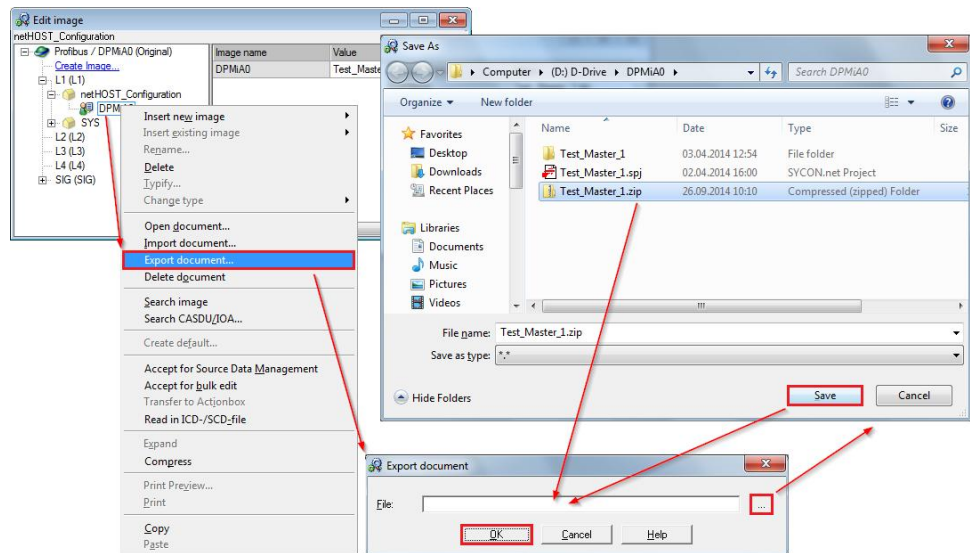

C PROFIBUS-DP Basics

Contents

C.1	PROFIBUS Characteristics.....	128
C.2	PROFIBUS-DP.....	131
C.3	Diagnostics.....	135
C.4	System Configuration and Device Types.....	136
C.5	System Behavior	138
C.6	Fail Safe Mode	138
C.7	Synchronization of In-/Outputs.....	139
C.8	Device Engineering	140
C.9	Transmission Layer (Layer 1)	142

C.1 PROFIBUS Characteristics

PROFIBUS defines the technical features of a serial field bus system used to network distributed digital automation devices, from the field level down to the cell level. PROFIBUS is a multi-master system and, as such, permits the simultaneous operation of several automation, engineering, or visualization systems with the decentral peripherals at one bus. PROFIBUS distinguishes between the following device types.

Master Devices determine data traffic at the bus. A master may send messages without external request if it holds the bus access authorization (token). Masters are also called active users.

Slave Devices are peripheral devices such as input/output devices, valves, drives, and measuring transducers. They are not given any bus access authorization, i.e., all they may do is acknowledge messages they received or transmit messages to a master if so requested by such master. Slaves are called passive users. They only take up a small portion of the bus protocol so that low-effort implementation is rendered possible.

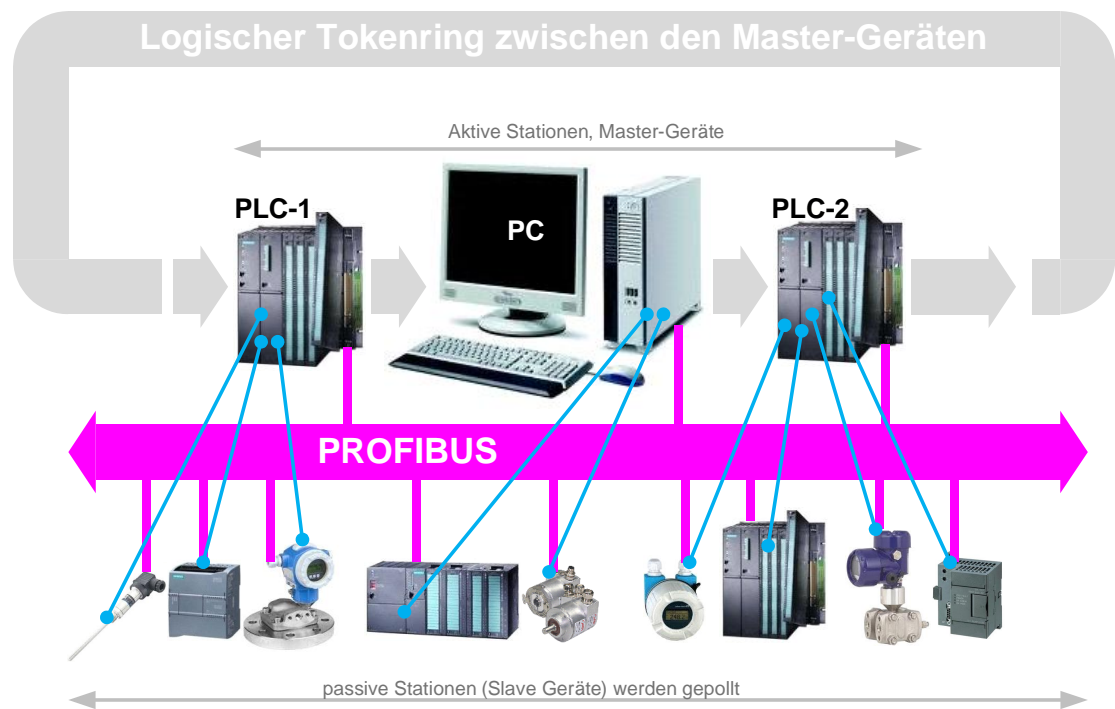

PROFIBUS structure with three active users (masters) and nine passive users (slaves). The three master devices form a logic token ring.

5.3.5 PROFIBUS Bus Access Protocol

PROFIBUS communication profiles use a consistent bus access protocol. The bus access control (MAC, Medium Access Control) determines the procedure at what time a bus user may send data. MAC must ensure that at any one time only one bus user holds the sending authority. For the PROFIBUS protocol, two essential requirements in terms of bus access control were taken into account:

- On the one hand, it must be ensured for the communication between complex automation devices (masters) that within a defined time grid each of these bus users is allowed enough time for the execution of its communication tasks
- On the other hand, a cyclic, real-time-related data exchange must be implemented with as little effort as possible for the communication between a complex automation device and its associated simple peripherals (slaves)

Therefore, the PROFIBUS bus access procedure (see Figure 1) incorporates the token-passing method for the communication between complex bus users (masters) and underlays the master-slave method for the communication of the complex bus users with the low-effort peripherals (slaves).

The **token-passing method** guarantees the assignment of the bus access authorization, the so-called token, within an accurately defined time frame. In this method, the token message, a special message for passing on the transmission authorization from one master to the next, must be passed on once to all masters within a (parameterizable) maximum token round-trip time. In the case of PROFIBUS, the token-passing method is used only between complex bus users (masters).

The **master-slave method** allows the master (active user), which at the moment holds the transmission authorization, to address its associated slave devices (passive users). At this time, the master has the opportunity to retrieve messages from the slaves.

This accessing method permits the implementation of the following system configurations:

- pure master-slave system
- pure master-master system (token passing); or
- a combination of both methods

A token ring is to be understood as the organizational sequential arrangement of active users, which through their bus addresses form a logic ring. In this ring, the token, i.e., the bus access authorization, is passed on from one master to the next in a predefined sequence (ascending addresses). If an active user receives the token message, it may execute the "master function" via the bus for a certain time (token holding time T_H).

In this connection, the token holding time (T_H) must be dimensioned such that a master, while it possesses the token, will be able to exchange data once with each of its associated slaves. Possible message retries caused by EMC problems were not factored in in this time interval.

It is the task of the bus access control (MAC) of the active users to detect this logic allocation in the "startup phase" of the bus system and to establish the token ring. In ongoing operations, a defective or shut down (active) bus user is to be removed from the ring, while a newly added active user is to be integrated. Furthermore, the bus access control makes sure that the token is passed on from one master to the next in an ascending order of addresses.

The token holding time of a master results from the configured token round-trip time. In addition to the detection of defects in the transmission medium and at the receiver as well as of errors in bus user addressing (e.g. multiple assignment) or in token passing (e.g. multiple token or loss of token), these performance features are characteristic of the properties of PROFIBUS access control.

PROFIBUS layer 2 works in a connectionless manner. In addition to logic point-to-point data transmission it also permits multi point transmission with broadcast and multicast communication.

In the case of **broadcast communication**, an active user sends an unacknowledged message to all other bus users (master and slaves).

In the case of **multicast communication**, an active users sends an unacknowledged message to a group of bus users (master and slaves).

Each of the PROFIBUS communication profiles uses a specific subset of layer 2 services. The services are invoked via the service access points (SAPs) of layer 2 from the higher-level layers. In the case of FMS, these service access points are used for addressing of the logic communication relations. In the case of DP, each service access point used is assigned an exactly defined function. In all active and passive users, several service access points can be used simultaneously.

C.2 PROFIBUS-DP

General Information

The DP communication profile was designed for efficient data exchange on the field level. This is where the central automation devices such as PLC/PC or process control systems communicate via a fast serial connection with decentral field devices such as I/O, drives, valves, and measuring transducers. Most of the data exchange with decentral devices takes place cyclically. The communication functions needed for this purpose are defined by means of DP's basic functions to EN 50 170. Beyond these basic functions, DP also offers extended acyclic communication services for parameter setting, operator control, monitoring and alarm management of intelligent field device.

Basic Functions

In one PROFIBUS message to EN 50 170, up to 244 bytes of net data can be transmitted, and bus users having addresses from 0 to 126 can be connected. One must keep in mind that the address 126 may only be used for commissioning purposes. User data must not be communicated by using address 126. Every data exchange takes place via service access points (SAPs) in the message header. PROFIBUS-DP uses SAPs 54 through 62 and the default SAP. When operating DP and FMS at the same time, FMS users must not use these service access points so as to allow for an unambiguous distinction of the messages. Likewise, in the mixed operation of DP and FMS, the slower bus reaction times to the FMS specification shall apply. Each message at the bus is detected by each bus user and checked for its plausibility. Thus, the available PROFIBUS ASICs guarantee that only the message for the own station address will be accepted, and that in such case only a correctly received message is passed on to the user process. All messages are transmitted "sliplessly" with Hamming distance 4.

Each PROFIBUS slave has the same priority. The possibility of prioritizing individual bus users has not been provided for, as the bus communication only constitutes a fraction of the entire data exchange anyhow. When using 12 Mbps technology, the data transmission times are in the μ s range.

Cyclically, the central control (master) reads the input information from the slaves and writes the output information to the slaves. In this case, the bus cycle time should be shorter than the program cycle time of the central automation system, which in many applications is about 10ms. In addition to the cyclic transmission of user data, DP also provides powerful functions for diagnostics and commissioning. The data traffic is monitored by monitoring functions at master and slave ends.

A high data throughput alone is not enough for the successful use of a bus system. Rather, simple handling, good diagnostic functions, and an interference-proof communication technology must be provided in order to meet user requirements. In DP, these characteristics were combined in perfect style.

PROFIBUS-DP Basic Functions

Bus access:

- token-passing method between masters and master-slave method between master and slaves
- mono-master or multi-master systems are possible
- master and slave devices, up to 126 bus users at one bus

communication:

- point-to-point (user data traffic) or multicast (control commands)
- cyclic master-slave user data traffic

Operating states:

- operate: cyclic transmission of input and output data
- clear: inputs are read, outputs remain in safe state
- stop: diagnostics and parameterization, no user data transmission

Synchronization:

- control commands permit the synchronization of inputs and outputs
- sync mode: outputs are synchronized
- freeze mode: inputs are synchronized

Functionality:

- cyclic user data transfer between DP master and slave(s)
- dynamic activation or deactivation of individual slaves
- checking of configuration of slaves
- powerful diagnostics functions, 3 graduated diagnostics information levels
- synchronization of the inputs and/or outputs
- address assignment for the slaves is possible optionally via the bus
- up to 244 bytes input and output data possible per slave

Protective functions:

- all messages are transmitted with Hamming distance $HD = 4$
- response monitoring at the DP slave detects failure of associated master
- access protection for inputs/outputs of the slaves
- monitoring of user data traffic with adjustable monitoring timer at master

Device types:

- DP master class 2 (DPM2), e.g. engineering or diagnostics tool
- DP master class 1 (DPM1), e.g. central automation devices such as PLC, PC ...
- DP slave, e.g., devices with binary or analog inputs/outputs, drives, valves

The length of the data to be exchanged is defined by the device manufacturer in the Device Master File (GSD file) and is checked by means of the configuration message from the slave user, and, if appropriate, declared valid. In modular systems, it is possible to define several configurations in the GSD file, one of which is valid.

After a master has received its master parameter record, it will start to exchange data with its associated slaves. The master parameter record consists of parameterizing/configuring data and address assignment lists of the connected slaves and the bus parameters.

During startup, it establishes the communication connections and time-monitors them. Upon each validly received message, also the slave user will retrigger the monitoring time set by the master. Any abnormal behavior in communications will be detected immediately by the bus users involved and signaled in a diagnostic message. The slave will set its outputs to the safe state. Subsequently, it will have to be re-parameterized and reconfigured by the master.

When dimensioning the monitoring times, you should do so on the basis of the bus cycle (one passage around the bus) plus a safety margin for possible message retries. A simple calculation of the bus cycle is contained in the chapter "Message/Bus Cycle Calculation".

Following a reset or after the return of the voltage, the master will attempt to establish contact with all associated slaves, the order of communication being defined as ascending from the smallest to the largest address.

A bus cycle is identified by the target rotation time (T_{TR} = ascending time interval monitored by the master until the token must be returned to it) which must be greater than the real rotation time (T_{RR} = time of actual token receipt).

The length of the input and output data to be exchanged is defined by the user already in the configuration message, and in every data exchange each bus user monitors the compliance with the agreed data length. Therefore, for reasons of safety, it cannot happen that I/Os are in an undefined state.

The total length of a message including the message header is 255 bytes. All message headers are 11 bytes long (exception: Data_Exchange has a 9-byte header). Each master is able to read the I/O data of any slave, using Read_Inputs or Read_Outputs. The "Read_Inputs" and "Read_Outputs" messages have the same structure as the "Data_Exchange" message. The only difference is that "Read_Inputs" and "Read_Outputs" contain a DSAP and an SSAP. Thus, the message header is 2 bytes longer. To ensure that every master is able to read the inputs/outputs of the other slave bus users completely no more than 244 bytes of user data should be exchanged.

For reasons of safety, a slave may be written on only by such master that previously parameterized and configured it. Only through these two messages will be ensured that the degree of expansion and functioning mode of the slave are known to the master. If another slave is to be added to the bus, the user must carry out a new configuration so that the master is informed about the new degree of expansion. The already existing configuration may serve as a basis. A PROFIBUS master detects a new bus user automatically.

In addition, PROFIBUS-DP supports multicast and broadcast messages, i.e., a multicast message is sent to a selected group, and only this group receives this message. A broadcast message is received by all bus users. In PROFIBUS, multicast and broadcast messages are sent as global control messages with address 127 and a group number for a selected group.

Each message contains an SSAP (source service access point) and a DSAP (destination service access point) in the message header in order to indicate the services to be executed (exception: the Data_Exchange is carried out by means of default SAP). Thus, every bus user can detect clearly, on the basis of the detected SAPs, which data were requested and which reply data are to be provided.

Following SAP's are permanently reserved for PROFIBUS-DP:

SAP	
Default-SAP	Data exchange (Write_Read_Data)
SAP54	Master-Master SAP (M-M Kommunikation)
SAP55	Changing of station address (Set_Slave_Add)
SAP56	Reading of inputs (Rd_Inp)
SAP57	Reading of outputs (Rd_Outp)
SAP58	Control commands to the DP-Slave (Global_Control)
SAP59	Read configuration data (Get_Cfg)
SAP60	Read diagnostic information (Slave_Diagnosis)
SAP61	Send parameterization data (Set_Prm)
SAP62	Check configuration data (Chk_Cfg)

C.3 Diagnostics

PROFIBUS-DP provides a comfortable and multifaceted possibility to process diagnostic information due to error states. During startup, prior to the parameterization message, and prior to the state machine entering into the Data Exchange mode, the master will generally request diagnostic data.

As soon as a diagnostic information becomes necessary at the slave end, the slave will reply in the current data exchange with a high-priority reply message (see description of the function code). Then, in the following bus cycle, the master will request a diagnosis from such slave instead of carrying out a normal data exchange.

All masters (not only the assigned one) can request the diagnostic data from any slave.

The diagnostic information of a DP slave consist of standard diagnostic information (6 bytes) and possibly user-specific diagnostic information:

- Station-related diagnosis
Information on the general operability of a bus user.
- Module-related diagnosis
This type of information indicates that a diagnosis is pending within a given I/O subsection (e.g. 8-bit output module) of a bus user.
- Channel-related diagnosis
Here, the cause of an error is indicated as related to a single input/output bit (channel) such as short-circuit at output 7

C.4 System Configuration and Device Types

PROFIBUS-DP allows you to implement mono- or multi-master systems. This permits a high degree of versatility in system configuring. The definitions made for system configuring include the number of stations, the assignment of the station address to the I/O addresses, the data consistency of the I/O data, the format of the diagnostic information, and the bus parameters used. Each DP system consists of different device types. We distinguish between three device types:

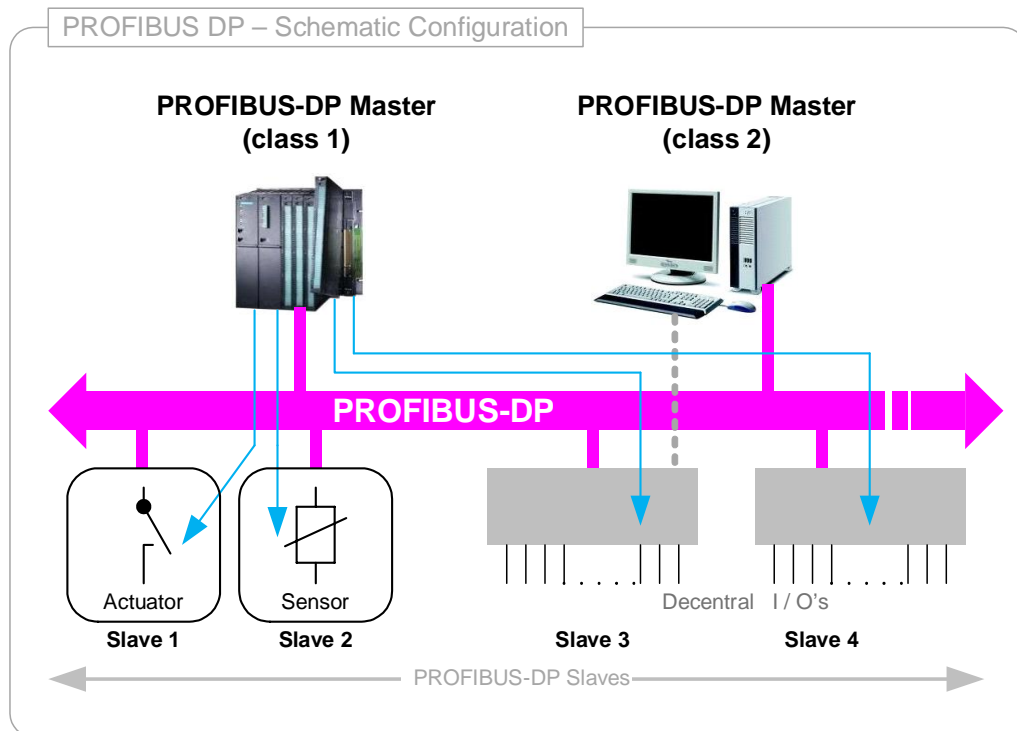

PROFIBUS-DP Multi-Master System

In the above example, the class 1 master has user data traffic with slaves 1 to 3 and x. Subsequently, it passes the token on to the class 2 master. This master reads the data from slave 3 and passes the token back to the class 1 master, and so on.

To make the communication as simple and fast as possible, no class 1 master-to-master communication was provided. It is recommended anyhow to use a mono-master configuration so as to be able to fully capitalize on the strengths of fast data exchange between master and slaves. However, the use of such configuration is not mandatory. The data exchange between two class 1 masters is limited to granting the bus access authorization by means of token passing.

In the case of PROFIBUS-DP, there are two types of master. The class 1 master carries out the user data traffic with the slaves assigned to it. The class 2 master is provided for commissioning purposes. For controlling purposes, a class 2 master may briefly assume control over a slave.

Class 1 DP-Master (DPM1)

What we are dealing with here is a central control unit which cyclically exchanges information with decentral stations (slaves) in a defined message cycle. Typical devices are, e.g., programmable logic controllers (PLCs) or PCs.

Class 2 DP-Master (DPM2)

Devices of this type are engineering, configuring, or operator-control devices. During commissioning, they are used for maintenance and diagnostics in order to configure the connected devices, evaluate measured values and parameters, and query the device status.

Slave

A slave is a peripheral device (I/O, drives, HMI, valves, measuring transducers) which reads in input information and sends out output information to the peripherals. It may also be a device providing either only input or only output information.

The quantity of input and output information is device-dependent and may comprise up to 246 bytes of input and 246 bytes of output data.

In the case of **mono-master systems**, only one master is active at the bus during the operating phase of the bus system. The PLC is the central control component. The slaves are coupled decentral to the PLC via the transmission medium. This system configuration permits the shortest possible bus cycle time.

In the **multi-master mode**, there are several masters at one bus. They either form independent subsystems, each consisting of one DPM1 and the associated slaves, or additional configuring and diagnostics devices. The input and output images of the slaves can be read from all DP-Masters. Yet, only one DP-Master (the DPM1 assigned in configuring) is able to write outputs.

C.5 System Behavior

To accomplish a high degree of interchangeability of devices, DP also provides for standardized system behavior. It is essentially determined by the operating state of the DPM1.

This state can either be controlled locally or via the bus from the configuring device. We distinguish between the following three main states:

- Stop
No data traffic takes place between the DPM1 and the slave
- Clear
The DPM1 reads the input information of the slaves and maintains the outputs of the slaves in the safe state.
- Operate
The DPM1 is in the data transfer phase. In a cyclic data traffic, the inputs are read from the slaves and the output information is transmitted to the slaves. The DPM1 sends its status at configurable intervals with a multicast command cyclically to all slaves assigned to it.

C.6 Fail Safe Mode

For reasons of safety, a class 1 PROFIBUS master signals its current state at certain intervals to the connected slaves in a "global control" message. If the master changes over to the clear mode, it will send a "global control" message to all slaves. In the next data cycle, the master will send data messages to all bus users with the agreed output data length being equal to "0". Thus, the slaves can assume the safe state. If the "global control" message is disturbed, a slave cannot distinguish the Clear state from the normal Data Exchange.

When creating the GSD file, the user may specify whether the slave supports the Fail Safe Mode. The master detects this upon the receipt of the configuration data and sends a data message without data to the slave in the Clear Mode (only the message header is sent).

The parameterization message from the master to the slave specifies in a user-specific manner what the output data assignment of the slave must look like if the master causes the slave to change over to the Clear Mode.

A slave that does not support the Fail Safe Mode continues to receive a data message with the output data set to "0".

C.7 Synchronization of In-/Outputs

Using an SDN service (see layer 2), the master is able to send commands (Sync, Unsync, Freeze, Unfreeze, and Clear Data) in the "global control" message to a group of slaves for synchronization purposes. The affiliation to groups is defined during startup in the parameterization message. There is no reply to an SDN message. The description of the message header is contained in the chapter "Data Link Layer".

The SYNC and FREEZE modes are optional services. Because of the Clear Data service, however, each master and slave must be able to process a "global control" message so as to be able to switch the outputs to the safe state in the event of an error.

A FREEZE message allows the master to cause a slave or a group of slaves to "freeze" the inputs in the current state. A SYNC message causes the currently active output data to be transmitted to the peripherals and be "frozen" in this state. An UNSYNC / UNFREEZE command cancels this state.

C.8 Device Engineering

C.8.1 General Information

PROFIBUS devices have different performance specifications. They differ with regard to the available functionality (e.g. number of I/O signals, diagnostic information), or possible bus parameters, such as baud rate and time watchdogs. These parameters are specific to each device type and manufacturer. Usually, they are documented in the related device user's guide. To accomplish a simple plug-and-play configuration for PROFIBUS, electronic device data sheets (GSD files) were defined for the communication features of the devices.

For configuring a PROFIBUS network, the "SYCON" Configuring Tool made by HILSCHER is used, which based on the GSD files permits simple configuring of PROFIBUS networks that include devices made by different manufacturers.

C.8.2 GSD-Files

The characteristic communication features of a PROFIBUS device are defined in the form of an electronic device data sheet (device master data file, GSD file). GSD files must be made available for all PROFIBUS devices by the respective manufacturer.

The device master data describe the features of a device type unambiguously and completely in an accurately defined format. The GSD are generated by the device manufacturer specifically for each device type and provided to the user in the form of a file. Based on the defined file format, the configuring system is able to read in the device master data of any given PROFIBUS device without problems and take them into account automatically when configuring the bus system. The configuring system is able, already during the configuring phase, to automatically carry out checks for entry errors and check the consistency of the entered data in relation to the whole system. The device master data file is subdivided into three sections:

- General Definitions
This section contains specifications regarding manufacturer and device names, hardware and software output levels, as well as supported baud rates, possible time intervals for monitoring times, and the signal assignment at the bus connector.
- MASTER related Definitions
In this section, all parameter are entered that apply only to master devices such as the max. number of connectable slaves or the upload and download capabilities. This section is not available for slave devices.
- SLAVE related Definitions
This is where all slave-specific specifications such as the number and type of I/O channels, the definition of diagnostic texts, as well as specifications regarding the available modules in modular devices are made.

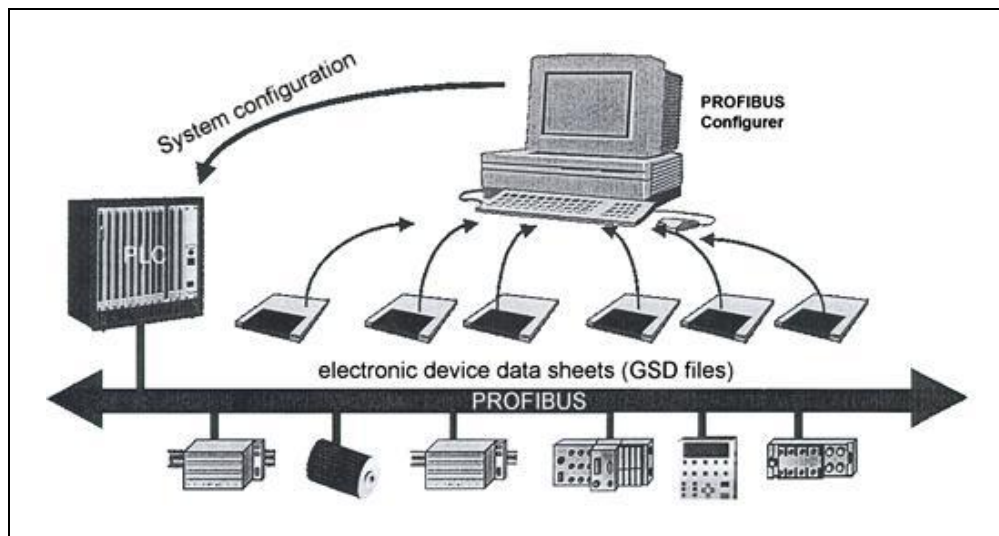

master data of devices permit the open configuration

C.8.3 Ident Number

Every PROFIBUS slave and every class 1 master must have an ident number. It is needed for a master to identify the types of connected devices without significant protocol overhead. The master compares the ident numbers of connected devices to the ident numbers in the configuration data specified by the configuring tool. The user data transfer will be started only if the correct device types with the correct station addresses were connected to the bus. This helps achieve a high degree of protection against configuration errors.

For every device type, the device manufacturers must request an ident number with the PROFIBUS user organization which also manages the ident numbers.

- è The Configuring Tool generates a parameter file (5 Kbytes max.) out of the sum of GSD files, which loads all relevant parameters of the DP master as well as of all slaves into the PROFIBUS master.
Furthermore, the Configuring Tools provide a key of the representation of input and output data (offsets) in the process image

C.9 Transmission Layer (Layer 1)

5.3.6 General Information

The scope of use of a field bus system is determined to a great extent by the available transmission methods. In addition to the general requirements, such as high transmission security, large reach, and high transmission rate, the use in process automation also requires its operation in explosion-hazard-prone zones and the transmission of data and energy over a common cable. As it is not possible to satisfy all these requirements with one single transmission method, three transmission methods are currently available for use with PROFIBUS.

- RS-485 transmission for universal use in manufacturing.
- IEC 1158-2 transmission for the use in process automation in explosion-hazard-prone zones such as in the chemical and petrochemical industries (for PROFIBUS PA only).
- fiber optics (optical waveguides) for enhanced interference immunity and reach.

For the transition points between the various transmission methods, couplers or links are available. While couplers convert the protocol transparently, taking the physical conditions into account, links have their own intelligence, thereby offering extended capabilities for the configuration of PROFIBUS networks.

C.9.1 Transmission according RS485

In EN 50 170, the bus line is specified as line type A and can be used in accordance with the following table. For the sake of completeness, tables 1 and 2 also specify the bus parameters and line lengths for line B. However, when planning a new plant, only line A should be used because of its greater expansion.

The line parameters are as follows:

Parameter	Line A	Line B ^{*)}
surge impedance in W	135 ... 165	100 ... 130
capacitance per unit length (pF/m)	< 30	< 60
loop resistance (W/km)	110	---
core diameter (mm)	0,64	> 0,53
core cross-section (mm ²)	> 0,34	> 0,22

*) should no longer be used, if possible!

The specified line parameters yield the following lengthwise expansions of a bus segment.

Baud Rate in kbps	9,6	19,2	93,75	187,5	500	1500	12000
Line A	1200	1200	1200	1000	400	200	100
Line B	1200	1200	1200	600	200		

If line A to EN 50170 is used, the bus termination resistor combination is defined as follows in order to ensure a defined idle state on the line:

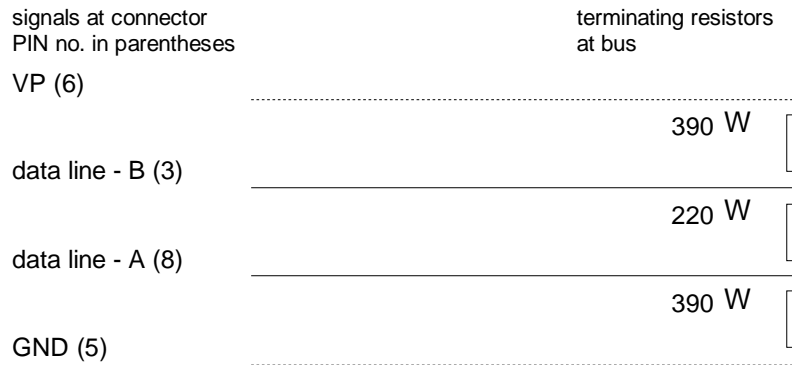

C.9.2 Bus Connector Assignment

Pin no.	Signal	Meaning
1	shield	shield / protective ground
2	M24	chassis ground of 24V output voltage, not assigned
3	RxD/TxD-P *	receive/transmit data-plus
4	CNTR-P	control signal for repeater (directional control)
5	DGND *	data transmission potential (chassis ground to 5V)
6	VP *	supply voltage of terminating resistors-P, (P5V)
7	P24	output voltage plus 24V, not assigned
8	RxD/TxD-N *	receive/transmit line of the data-N
9	CNTR-N	repeater control signal (directional control)

* It is absolutely necessary that the user provide the Mandatory Signals.

Literature

SICAM RTUs • Ax 1703 Common Functions Protocol Elements	DC0-023-2
SICAM RTUs Common Functions System and Basic System Elements	DC0-015-2
SICAM RTUs Platforms Configuration Automation Units and Automation Networks	DC0-021-2

Documents on Interoperability

Ax 1703 Interoperability IEC 60870-5-101 bzw. -104	DA0-046-2
SICAM RTUs Interoperability IEC 60870-5-101/104	DC0-013-2

International Standards

IEC 60870-5-101	
IEC 60870-5-104	
DIN 19245	
EN 50170	
IEC 61158 Type 3 (PROFIBUS DP-V0) former EN 50170	

Other

Hilscher netHOST (NHST-100-DP/DPM)	
Datasheets netHOST FB Datasheet (Datasheet)	
Documentation Overview netHOST - For Users and Developers (Documentations overview)	
Configuration Software Ethernet Device Configuration - Address Setting for Ethernet capable Hilscher Devices (Operating instruction manual) Configuration of LAN Controlled Master Devices (netHOST) (Operating instruction manual)	
Users Manual netHOST NHST-T100 - LAN controlled master devices for Fieldbus and Real-Time Ethernet Systems (User manual)	
Software netHOST Solutions DVD (DVD)	
Software SYCON.net https://kb.hilscher.com/display/SYCON/SYCON.net	

