

Switching devices – Contactors and contactor assemblies – for switching motors

**Price groups**

PG 41B, 41E, 41H, 42F

3/2

Introduction**Power contactors for switching motors**

- 3/8 General data
- 3/18 SIRIUS 3RT contactors, 3-pole up to 250 kW
- Accessories for SIRIUS 3RT contactors and SIRIUS 3RH2 contactor relays
- 3/71 - General data
- 3/83 - Auxiliary switches, instantaneous **NEW**
- 3/100 - Auxiliary switches, delayed
- 3/102 - Surge suppressors
- 3/104 - Modules for contactor control
- 3/109 - Link modules
- 3/115 - Connection modules/adapters
- 3/118 - Covers
- 3/119 - Miscellaneous accessories
- Spare parts for SIRIUS 3RT contactors and SIRIUS 3RH2 contactor relays
- 3/122 - Solenoid coils
- 3/126 - Contacts and arc chutes
- 3/127 SIRIUS 3RT12 and 3TF6 vacuum contactors
- 3/134 Accessories and spare parts for SIRIUS 3RT12 and 3TF6 vacuum contactors
- 3/139 3TG10 power relays/miniature contactors
- Reversing contactor assemblies**
- 3/143 SIRIUS 3RA23 reversing contactor assemblies, up to 55 kW
- 3/154 Reversing contactor assemblies consisting of SIRIUS 3RT1 and 3TF6 contactors, up to 335 kW
- Contactor assemblies for star-delta (wye-delta) starting**
- 3/159 SIRIUS 3RA24 contactor assemblies for star-delta (wye-delta) starting, up to 90 kW
- 3/172 Contactor assemblies for star-delta (wye-delta) starting consisting of SIRIUS 3RT and 3TF6 contactors, up to 710 kW

Switching devices – Contactors and contactor assemblies – for switching motors

Introduction

Overview

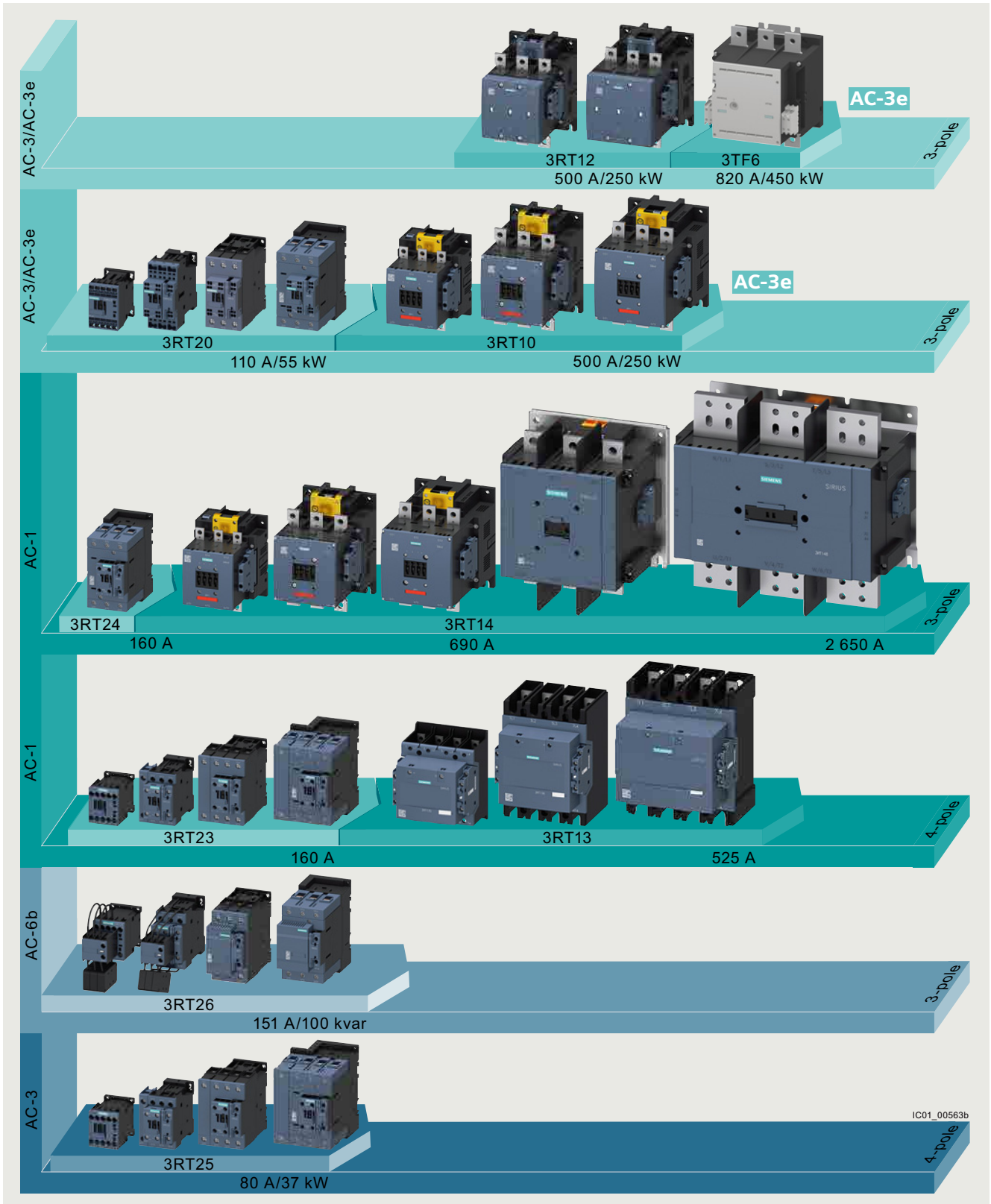

Overview of the 3RT and 3TF contactors

Switching devices – Contactors and contactor assemblies – for switching motors

Introduction

More information

Homepage, see www.siemens.com/siriusSiePortal, see www.siemens.com/product?3RT_3TK_3TCConversion tool, see www.siemens.com/conversion-toolTIA Selection Tool Cloud (TST Cloud), see www.siemens.com/tstcloud/?node=ContactorSize
Type**S00**
3RT201**S0**
3RT202**3RT20 contactors**

Type		3RT2015	3RT2016	3RT2017	3RT2018	3RT2023	3RT2024	3RT2025	3RT2026	3RT2027	3RT2028
AC, DC operation		(p. 3/47, 3/54 ... 3/57)				(p. 3/48 ... 3/50, 3/58 ... 3/60, 3/62)					
AC-3 and AC-3e											
I_e /AC-3/AC-3e/400 V	A	7	9	12	16	9	12	17	25	32	38
400 V	kW	3	4	5.5	7.5	4	5.5	7.5	11	15	18.5
230 V	kW	1.5	2.2	3	4	2.2	3	4	5.5	7.5	11
500 V	kW	6	7.7	9.2	12.4	9	12	17	18	32	32
690 V	kW	4	5.5	5.5	7.5	7.5	7.5	11	11	18.5	18.5
1 000 V	kW	--	--	--	--	--	--	--	--	--	--
AC-4 (at $I_a = 6 \times I_e$)											
400 V	kW	3	4	4	5.5	4	5.5	7.5	7.5	11	11
400 V (200 000 operating cycles)	kW	1.15	2	2	2.5	2	2.6	3.5	4.4	6	6
AC-1 (40 °C, ≤ 690 V)											
I_e	A	18	22	22	22	40	40	40	40	50	50

Accessories for contactors

Auxiliary switches	<ul style="list-style-type: none"> On the front Lateral 	3RH29, 3RA28		(p. 3/91 ... 3/100)	3RH29, 3RA28		(p. 3/91 ... 3/100)
		3RH29		(p. 3/95 ... 3/99)	3RH29		(p. 3/95 ... 3/99)
Function modules	<ul style="list-style-type: none"> Direct-on-line starting, star-delta (wye-delta) starting IO-Link, AS-Interface 	3RA281.		(p. 3/105)	3RA281.		(p. 3/105)
		3RA271.-.AA00		(p. 3/106, 3/107)	3RA271.-.AA00		(p. 3/106, 3/107)
Surge suppressors		3RT2916		(p. 3/102, 3/103)	3RT2926		(p. 3/102, 3/103)

3RU2 and 3RB3 overload relays

3RU thermal overload relays	3RU2116	0.11 ... 16 A		(p. 7/86)	3RU2126	1.8 ... 40 A		(p. 7/86)
3RB electronic overload relays	3RB3016, 3RB3113	0.1 ... 16 A		(p. 7/98, 7/100, 7/102)	3RB3026, 3RB3123	0.1 ... 40 A		(p. 7/98, 7/100, 7/102)

3RV20 motor starter protectors

Motor starter protectors	3RV2011	0.11 ... 16 A		(p. 7/26)	3RV2021	0.45 ... 40 A		(p. 7/27)
Link modules	3RA1921, 3RA2911			(p. 7/61)	3RA2921			(p. 7/61)

3RA23 reversing contactor assemblies

Complete units	Type	3RA2315	3RA2316	3RA2317	3RA2318	--	3RA2324	3RA2325	3RA2326	3RA2327	3RA2328
		(p. 3/150)					(p. 3/151)				
400 V	kW	3	4	5.5	7.5		5.5	7.5	11	15	18.5
Assembly kits/wiring modules		3RA2913-2AA.					3RA2923-2AA.				
		(p. 3/109)					(p. 3/109)				
Function modules		3RA271.-.BA00					3RA271.-.BA00				
		(p. 3/106)					(p. 3/106)				

3RA24 contactor assemblies for star-delta (wye-delta) starting

Complete units	Type	3RA2415	3RA2416	3RA2417		3RA2423	3RA2425	3RA2426
		(p. 3/168)				(p. 3/169)		
400 V	kW	5.5	7.5	11		11	15/18.5	22
Assembly kits/wiring modules		3RA2913-2BB.				3RA2923-2BB.		
		(p. 3/110)				(p. 3/110)		
Function modules		3RA271.-.CA00				3RA271.-.CA00		
		(p. 3/106)				(p. 3/106)		

Note:

Safety characteristics for contactors, see "Standards and approvals", page 16/9.

Switching devices – Contactors and contactor assemblies – for switching motors

Introduction

Size
Type**S2**
3RT203**S3**
3RT204**3RT20 contactors**

Type		3RT2035	3RT2036	3RT2037	3RT2038	3RT2045	3RT2046	3RT2047
AC, DC operation		(p. 3/51, 3/53, 3/61, 3/63, 3/65)				(p. 3/52, 3/53, 3/61, 3/64, 3/65)		
AC-3 and AC-3e								
I_e /AC-3/AC-3e/400 V	A	41	51	65	80	80	95	110
400 V	kW	18.5	22	30	37	37	45	55
230 V	kW	11	15	18.5	22	22	22	30
500 V	kW	22	30	37	37	45	55	75
690 V	kW	22	22	37	45	55	75	90
1 000 V	kW	--	--	--	--	37	37	37
AC-4 (at $I_a = 6 \times I_e$)								
400 V	kW	18.5	22	30	37	37	45	55
400 V (200 000 operating cycles)	kW	11.6	12.6	14.7	15.8	17.9	22	24.3
AC-1 (40 °C, ≤ 690 V)								
I_e	A	60	70	80	90	125	130	130

Accessories for contactors

Auxiliary switches	<ul style="list-style-type: none"> On the front Lateral 	3RH29, 3RA28			(p. 3/91 ... 3/100)	3RH29, 3RA28		(p. 3/91 ... 3/100)
		3RH29			(p. 3/95 ... 3/99)	3RH29		(p. 3/95 ... 3/99)
Function modules	<ul style="list-style-type: none"> Direct-on-line starting, star-delta (wye-delta) starting IO-Link, AS-Interface 	3RA28			(p. 3/105)	3RA28		(p. 3/105)
		3RA271.-AA00			(p. 3/106, 3/107)	3RA271.-AA00		(p. 3/106, 3/107)
Surge suppressors		3RT2936			(p. 3/102, 3/103)	3RT2936, 3RT2946		(p. 3/102, 3/103)
Terminal covers		3RT2936-4EA2			(p. 3/118)	3RT2946-4EA2		(p. 3/118)

3RU2 and 3RB3 overload relays

3RU thermal overload relays	3RU2136	11 ... 80 A			(p. 7/87)	3RU2146	28 ... 100 A	(p. 7/87)
3RB electronic overload relays	3RB3036, 3RB3133	12.5 ... 80 A			(p. 7/98, 7/100, 7/102)	3RB3046, 3RB3143	12.5 ... 115 A	(p. 7/98, 7/100, 7/102)

3RV20 motor starter protectors

Motor starter protectors	3RV2031, 3RV2032	9.5 ... 80 A			(p. 7/29)	3RV2041, 3RV2042	28 ... 100 A	(p. 7/29)
Link modules	3RA2931				(p. 7/61)	3RA1941		(p. 7/61)

3RA23 reversing contactor assemblies

Complete units	Type	3RA2335	3RA2336	3RA2337	3RA2338	3RA2345	3RA2346	3RA2347
		(p. 3/152)				(p. 3/153)		
400 V	kW	18.5	22	30	37	37	45	55
Assembly kits/wiring modules		3RA2933-2AA.				(p. 3/109)	3RA2943-2AA.	
						(p. 3/106)	(p. 3/106)	
Function modules		3RA271.-BA00				(p. 3/106)	3RA271.-BA00	
						(p. 3/114)	(p. 3/114)	
Mechanical interlocks		3RA2934-2B				(p. 3/114)	3RA2934-2B	
						(p. 3/114)	(p. 3/114)	

3RA24 contactor assemblies for star-delta (wye-delta) starting

Complete units	Type	3RA2434	3RA2435	3RA2436	3RA2437	3RA2444	3RA2445	3RA2446
		(p. 3/170)				(p. 3/171)		
400 V	kW	22/30	37	45	55	55	75	90
Assembly kits/wiring modules		3RA2933-2BB./-2C				(p. 3/110)	3RA2943-2BB./-2C	
						(p. 3/106)	(p. 3/106)	
Function modules		3RA271.-CA00				(p. 3/106)	3RA271.-CA00	
						(p. 3/106)	(p. 3/106)	

Note:

Safety characteristics for contactors, see "Standards and approvals", page 16/9.



Size	S6			S10			S12			
Type	3RT105			3RT1.6			3RT1.7			
3RT10 contactors · 3RT12 vacuum contactors										
Type	3RT1054	3RT1055	3RT1056	3RT1064	3RT1065	3RT1066	3RT1075	3RT1076		
AC, DC operation	(p. 3/66 ... 3/68)			(p. 3/66 ... 3/68)			(p. 3/66 ... 3/68)			
Type	--	--	--	3RT1264	3RT1265	3RT1266	3RT1275	3RT1276		
				(p. 3/131)			(p. 3/131)			
AC-3 and AC-3e										
I_e /AC-3/AC-3e/400 V	A	115	150	185	225	265	300	400	500	
400 V	kW	55	75	90	110	132	160	200	250	
230 V	kW	37	45	55	55	75	90	132	160	
500 V	kW	75	90	132	160	160	200	250	315 (355) ¹⁾	
690 V	kW	110	132	160	200	250	250	400	400 (500) ¹⁾	
1 000 V	kW	75	90	90	90 (315) ¹⁾	132 (355) ¹⁾	132 (400) ¹⁾	250 (560) ¹⁾	250 (710) ¹⁾	
AC-4 (at $I_a = 6 \times I_e$)										
400 V	kW	55	75	90	110	132	160	200	250	
400 V (200 000 operating cycles)	kW	29	38	45	54 (55) ¹⁾	66 (65) ¹⁾	71 (79) ¹⁾	84 (98) ¹⁾	98 (122) ¹⁾	
AC-1 (40 °C, ≤ 690 V)										
I_e	A	160	185	215	275 (330) ¹⁾	330	330	430 (610) ¹⁾	610	
3RT14 AC-1 contactors										
Type	3RT1456			(p. 4/17, 4/18)		3RT1466	3RT1467	(p. 4/17, 4/18)	3RT1476	
I_e /AC-1/40 °C/≤ 690 V	A	275			400	500		690		
Accessories for contactors										
Auxiliary switches	• On the front • Lateral	3RH19, 3RT1926 3RH19			(p. 3/94, 3/101) (p. 3/96 ... 3/99)					
Surge suppressors		3RT1956-1C (RC element)			(p. 3/103)					
Terminal covers		3RT1956-4EA.			(p. 3/118)	3RT1966-4EA.		(p. 3/118)		
Box terminal blocks		3RT1955-4G, 3RT1956-4G			(p. 3/116)	3RT1966-4G			(p. 3/116)	
3RB2 overload relays										
3RB electronic overload relays		3RB2056	50 ... 200 A	(p. 7/99, 7/101)	3RB2066	55 ... 250 A or 160 ... 630 A		(p. 7/99, 7/101)		
		3RB2153	50 ... 200 A	(p. 7/103)	3RB2163			(p. 7/103)		
3VA2 molded case motor starter protectors										
Molded case motor starter protectors									(See Catalog LV 10)	
• for 3RT10 • for 3RT12		3VA21 3VA21	3VA22 3VA22	3VA22 3VA22	3VA23 3VA23	3VA23 3VA23	3VA24 3VA24	3VA24 3VA24	3VA25 3VA25	
Reversing contactor assemblies²⁾										
Complete units	Type	--								
400 V	kW	55	75	90	110	132	160	200	250	
Assembly kits/wiring modules		3RA1953-2A			(p. 3/109)	3RA1963-2A		(p. 3/109)	3RA1973-2A	(p. 3/109)
Mechanical interlocks		3RA1954-2A							(p. 3/114)	
Contactor assemblies for star-delta (wye-delta) starting²⁾										
Complete units	Type	--								
400 V	kW	--								
Assembly kits/wiring modules		3RA1953-2B			(p. 3/112)	3RA1963-2B		(p. 3/112)	3RA1973-2B	(p. 3/112)

¹⁾ Value applies for 3RT12 contactors.

²⁾ Contactor assemblies for customer assembly:
- Reversing contactor assemblies, see pages 3/155 to 3/157,
- Contactor assemblies for star-delta (wye-delta) starting,
see pages 3/173 to 3/178.

Note:

Safety characteristics for contactors, see "Standards and approvals", page 16/9.

Switching devices – Contactors and contactor assemblies – for switching motors

Introduction



Size **14**
Type **3TF68**

Size **14**
Type **3TF69**

3TF68/3TF69 vacuum contactors

Type	3TF68 (p. 3/132, 3/133)	3TF69 (p. 3/132, 3/133)
------	-----------------------------------	-----------------------------------

AC-3 and AC-3e

I_e /AC-3/AC-3e/690 V	A	630 (552) ¹⁾	820 (630) ¹⁾
400 V	kW	355 (315)¹⁾	450 (355)¹⁾
230 V	kW	200 (160) ¹⁾	260 (200) ¹⁾
690 V	kW	600 (560) ¹⁾	800 (600) ¹⁾
1 000 V	kW	600	800

AC-4 (at $I_a = 6 \times I_e$)

400 V	kW	355	400
400 V (200 000 operating cycles)	kW	168	191

AC-1 (40 °C, ≤ 690 V)

I_e	A	700	910
-------	---	------------	------------

Accessories for contactors**Auxiliary switches**

• Lateral	3TY7561	(p. 3/134)
-----------	----------------	------------

Surge suppressors	3TX7572	(p. 3/135)
--------------------------	----------------	------------

Terminal covers	3TX7686, 3TX7696	(p. 3/135)
------------------------	-------------------------	------------

3RB2 overload relays

3RB electronic overload relays	3RB2066, 3RB2163	55 ... 250 A or 160 ... 630 A	(p. 7/99, 7/101) (p. 7/103)	3RB3016-1NB0 with series transformer 3UF1868-3GA00	0.32 ... 1.25 A 205 ... 820 A	(p. 7/98) (p. 10/21)
---------------------------------------	-------------------------	-------------------------------------	--------------------------------	---	----------------------------------	-------------------------

3VA2 molded case motor starter protectors

Molded case motor starter protectors	3VA25	(See Catalog LV 10)
---	--------------	---------------------

Reversing contactor assemblies²⁾

Complete units	Type	--
400 V	kW	335
Assembly kits/wiring modules	3TX7680-1A	(p. 3/136)
Mechanical interlocks	3TX7686-1A	(p. 3/136)

Contactor assemblies for star-delta (wye-delta) starting²⁾

Complete units	Type	--
400 V	kW	710
Assembly kits/wiring modules	3TX7680-1B	(p. 3/136)

¹⁾ Value applies for utilization category AC-3e.

²⁾ Contactor assemblies for customer assembly:

- Reversing contactor assemblies, see page 3/158,
- Contactor assemblies for star-delta (wye-delta) starting, see page 3/179.

Note:

Safety characteristics for contactors, see "Standards and approvals", page 16/9.





Type	3TG10		
3TG10 power relays/miniature contactors			
Number of main contacts	4		
AC, DC operation	(p. 3/139)		
AC-1			
I_e at 400 V	55 °C	A	20
P at 400 V		kW	13
At 230 V		kW	7.5
AC-3			
I_e up to 400 V		A	8.4
P at 400 V		kW	4
AC-3e			
I_e up to 400 V		A	6.4
P at 400 V		kW	3

Connection methods

The 3RT contactors are available with screw terminals (box terminals or flat connectors) or with spring-loaded terminals.

The 3TG10 power relays/miniature contactors are available with screw terminals or flat connectors.

-  Screw terminals
-  Spring-loaded terminals
-  Flat connectors

The terminals are indicated in the corresponding tables by the symbols shown on orange backgrounds.

Voltage data

The data for 3-phase power systems according to IEC 60947-4-1 are valid for the following line system configurations:

Voltage U_e	Line system configurations	
	Three-phase four-wire systems	Three-phase three-wire systems
230	--	230
400	230/400	400
440	260/440	440
500	--	500
690	400/690	690 (only from size S3)
1 000	--	1 000

-- Not specified

Use of 3RT contactors, 3RT and 3TF vacuum contactors, reversing contactor assemblies, and contactor assemblies for star-delta (wye-delta) starting with IE3 and IE4 motors

Note:

For the use of 3RT contactors, 3RT and 3TF vacuum contactors, reversing contactor assemblies and contactor assemblies for star-delta (wye-delta) starting in conjunction with highly efficient IE3 and IE4 motors, please observe the information on dimensioning and configuring, [see Application Manual](#).

For more information, [see page 1/8](#).

Switching devices – Contactors and contactor assemblies – for switching motors

Power contactors for switching motors

General data

Overview

The SIRIUS family of controls

The SIRIUS modular system with its components for the switching, starting, protection and monitoring of motors and industrial systems stands for the fast, flexible and space-saving construction of control cabinets.

3RT2.1 contactors · Size S00 with mountable accessories

The figure shows the version with screw terminals

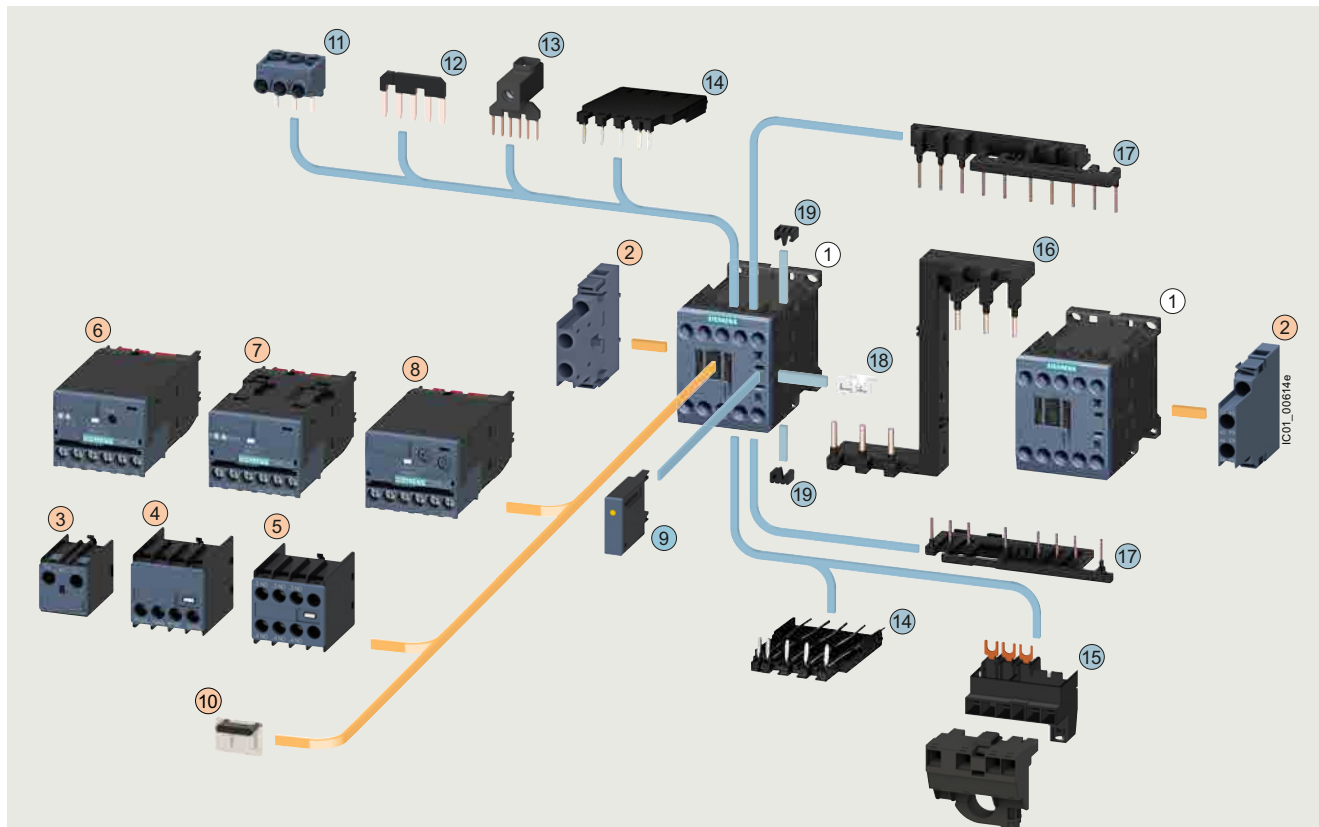

① Contactor, size S00

② 2-pole auxiliary switch, laterally mountable

③ 1-pole auxiliary switch, for snapping onto the front, cable entry from the top

④ 2-pole auxiliary switch, for snapping onto the front, cable entry from the bottom

⑤ 4-pole auxiliary switch, for snapping onto the front

⑥ 3RA27 function module for AS-Interface

⑦ 3RA27 function module for IO-Link

⑧ 3RA28 function module

⑨ Surge suppressor with/without LED

⑩ Cover, sealable

⑪ 3-phase infeed terminal

⑫ Star jumper, 3-pole, without connecting terminal

⑬ Link for paralleling, 3-pole, with connecting terminal

⑭ Solder pin adapter

⑮ Connection module (adapter and connector) for contactors with screw terminals

⑯ Safety main current connector for two contactors

Assembly kit 3RA2913-2AA1

Consisting of:

⑰ Wiring modules on the top and bottom for connecting the main, auxiliary and control current paths, electrical interlock¹⁾ included, interruptible (NC contact interlock)

⑱ Mechanical interlocks²⁾

⑲ Two connecting clips for two contactors²⁾

○ For contactors

○ For contactors and coupling contactors

¹⁾ 3RT201. contactors with one NC contact in the basic unit are required for the electrical interlock. An additional NO contact is required for momentary-contact operation.

²⁾ The parts ⑱ and ⑲ can only be ordered together as 3RA2912-2H mechanical connectors.

Accessories and spare parts, see pages 3/71 to 3/126.

Switching devices – Contactors and contactor assemblies – for switching motors

Power contactors for switching motors

General data

3RT2.2 contactors · Size S0 with mountable accessories

The figure shows the version with screw terminals

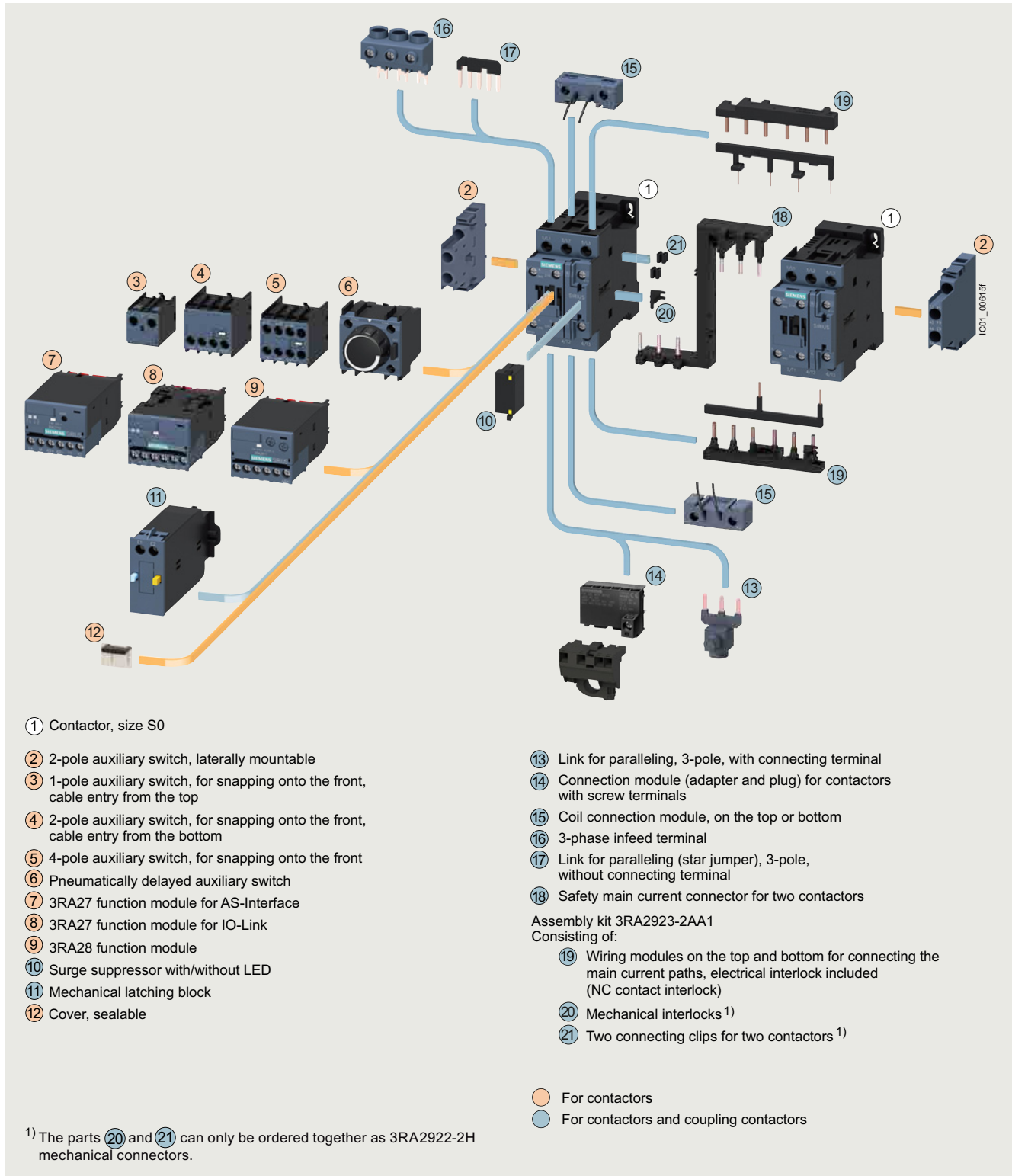

Accessories and spare parts, see pages 3/71 to 3/126.

Switching devices – Contactors and contactor assemblies – for switching motors

Power contactors for switching motors

General data

3RT2.3 contactors · Size S2 with mountable accessories

The figure shows the version with screw terminals

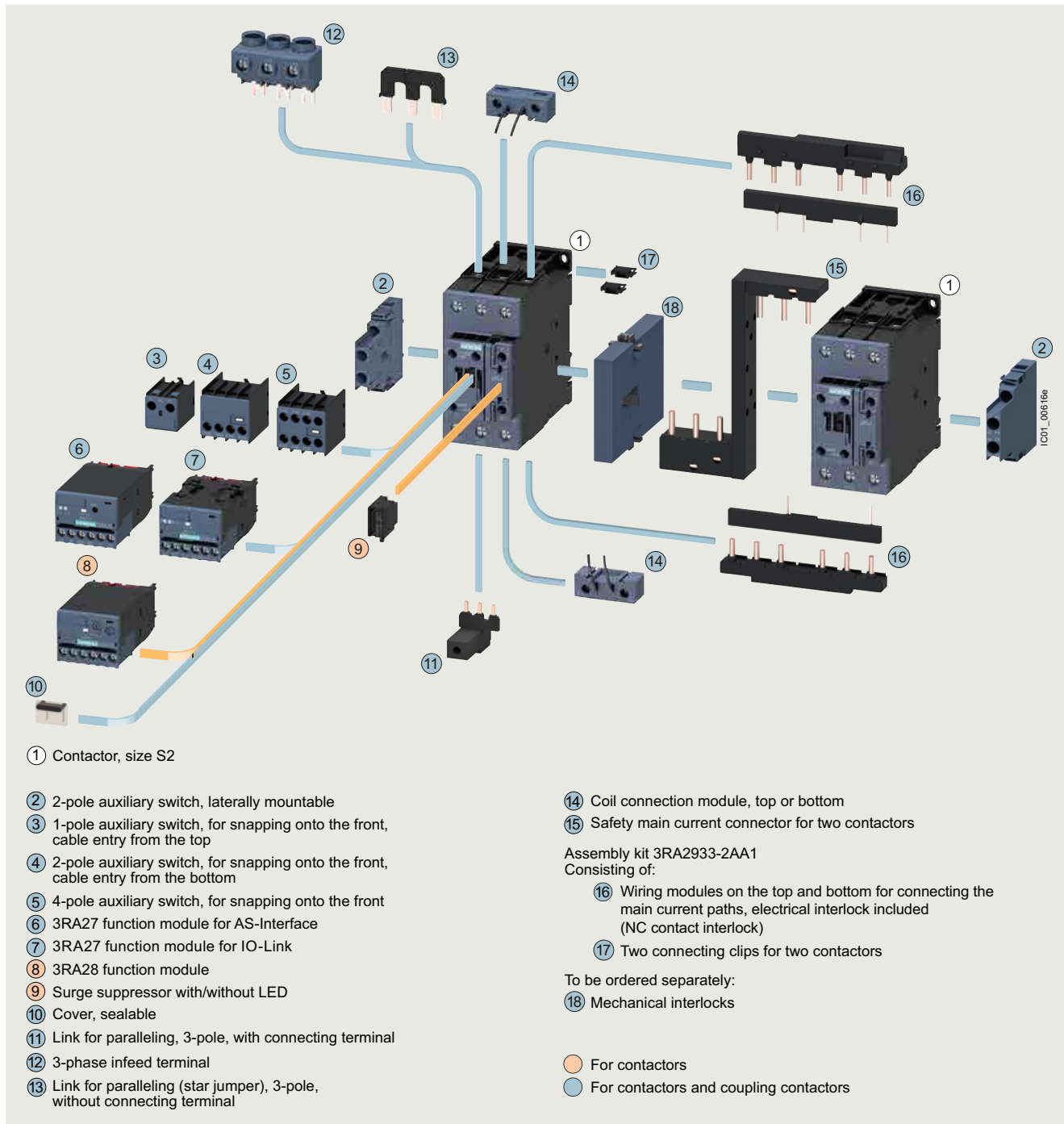

Accessories and spare parts, see pages 3/71 to 3/126.

Switching devices – Contactors and contactor assemblies – for switching motors

Power contactors for switching motors

General data

3RT2.4 contactors · Size S3 with mountable accessories

The figure shows the version with screw terminals

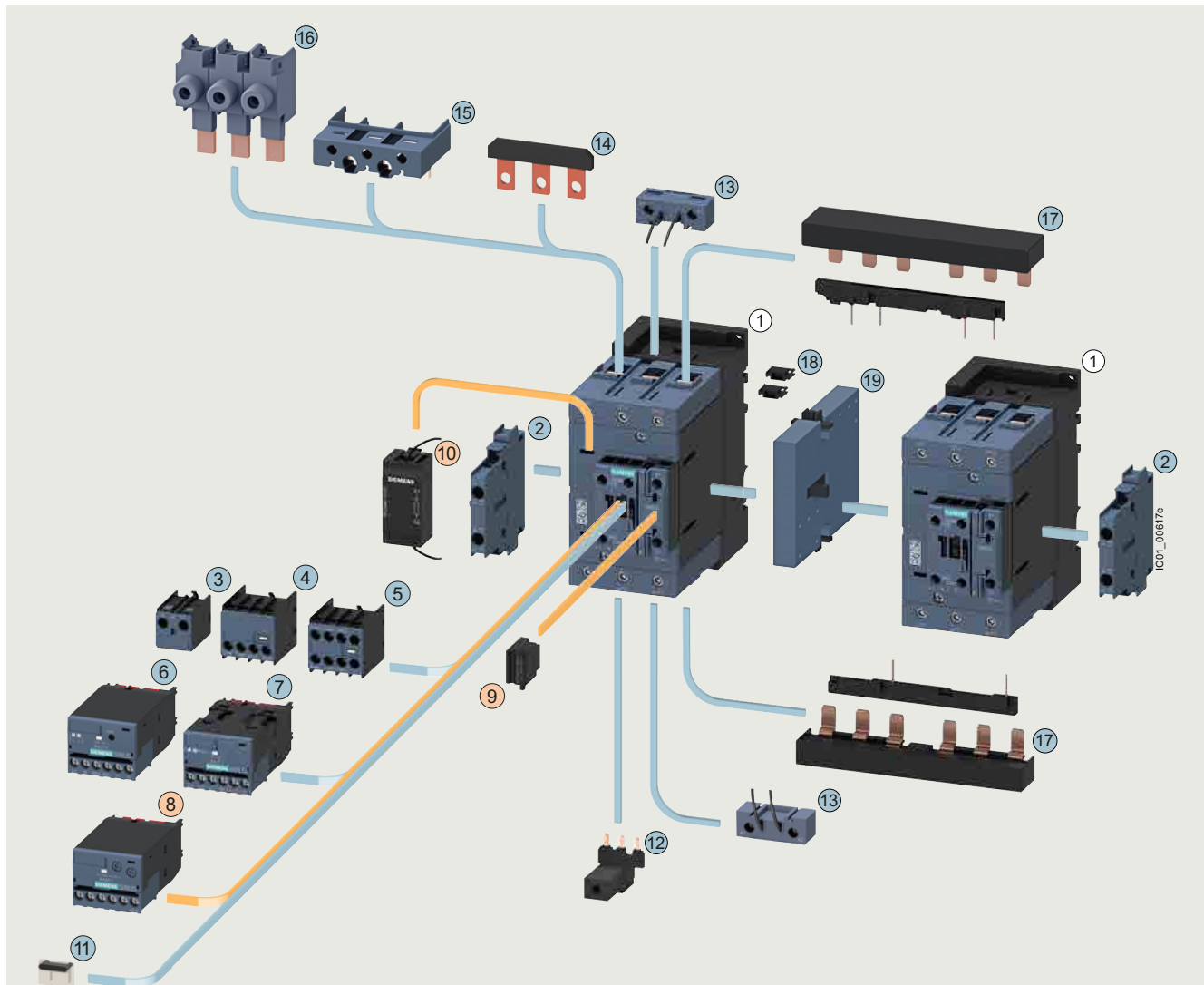

① Contactor, size S3

② 2-pole auxiliary switch, laterally mountable

③ 1-pole auxiliary switch, for snapping onto the front, cable entry from the top

④ 2-pole auxiliary switch, for snapping onto the front, cable entry from the bottom

⑤ 4-pole auxiliary switch, for snapping onto the front

⑥ 3RA27 function module for AS-Interface

⑦ 3RA27 function module for IO-Link

⑧ 3RA28 function module

⑨ Surge suppressor with/without LED (Varistor, diode assembly), can be plugged in on the front

⑩ Surge suppressor without LED (RC element), can be plugged in on the front in the recesses on the left next to the connection block

⑪ Cover, sealable

⑫ Links for paralleling, 3-pole, with connecting terminal

⑬ Coil connection module, top or bottom

⑭ Links for paralleling (star jumper), 3-pole, without connecting terminal

⑮ Auxiliary conductor terminal, 3-pole

⑯ 1-phase infeed terminals (3 units)

Assembly kit 3RA2943-2AA1

Consisting of:

⑰ Wiring modules on the top and bottom for connecting the main, auxiliary and control current paths, electrical interlock¹⁾ included, interruptible (NC contact interlock)

⑱ Two connectors for two contactors

To be ordered separately:

⑲ Mechanical interlock

○ For contactors

○ For contactors and coupling contactors

¹⁾ 3RT201. contactors with one NC contact in the basic unit are required for the electrical interlock. An additional NO contact is required for momentary-contact operation.

Accessories and spare parts, see pages 3/71 to 3/126.

Switching devices – Contactors and contactor assemblies – for switching motors

Power contactors for switching motors

General data

3RT105 and 3RT145 contactors · Size S6 with mountable accessories

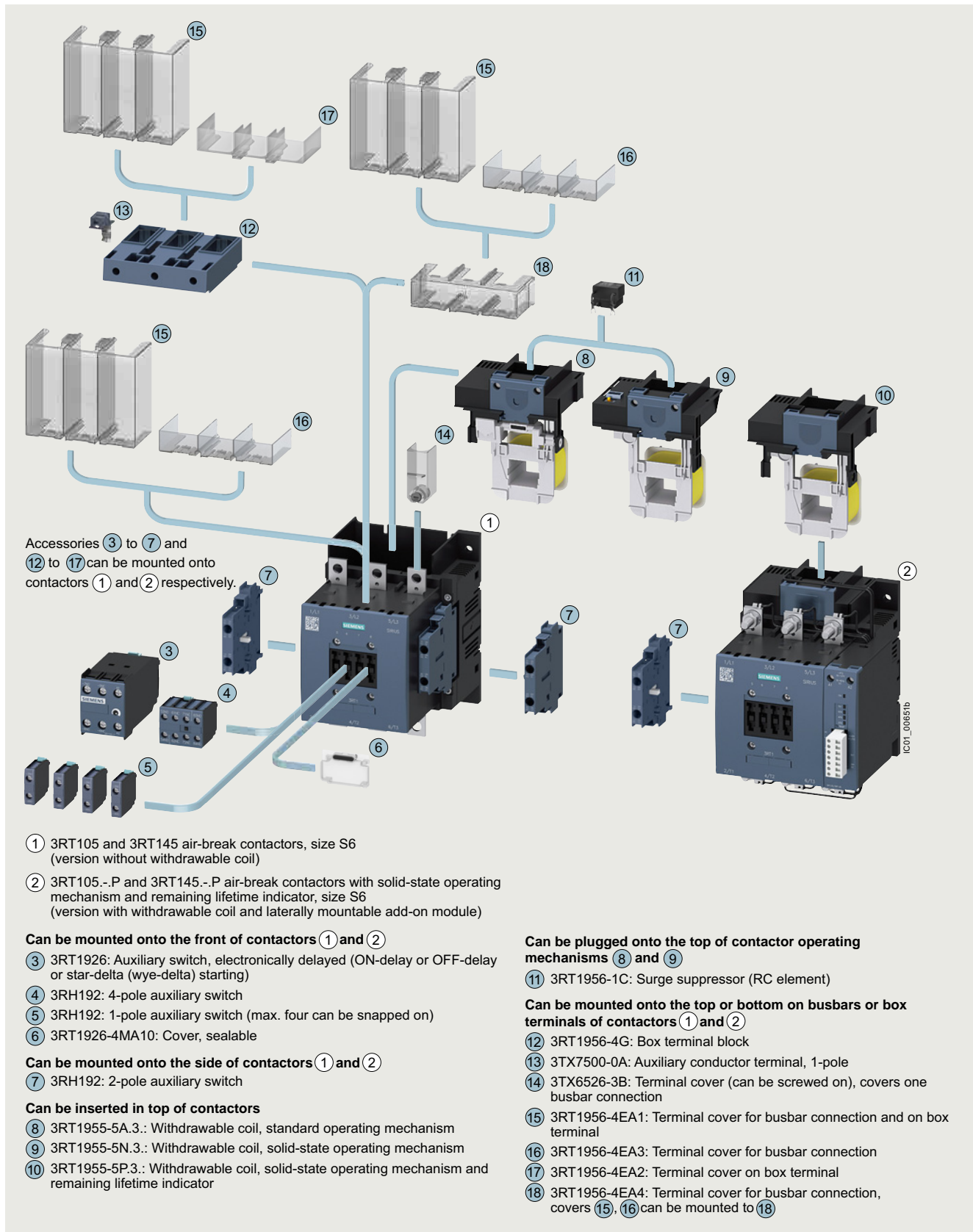

Accessories and spare parts, see pages 3/71 to 3/126.

Switching devices – Contactors and contactor assemblies – for switching motors

Power contactors for switching motors

General data

3RT106 and 3RT146 contactors · Size S10 with mountable accessories

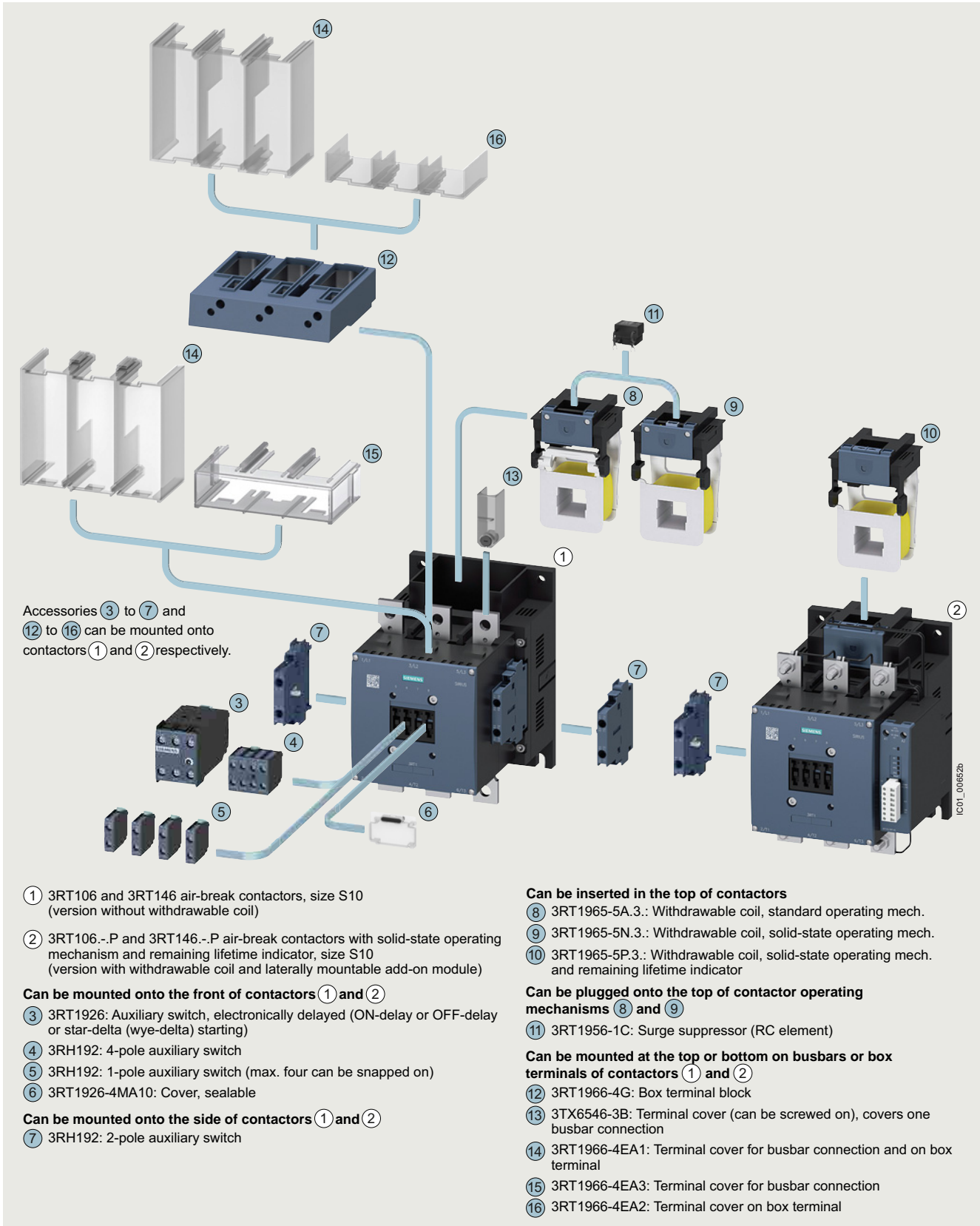

Accessories and spare parts, see pages 3/71 to 3/126.

Switching devices – Contactors and contactor assemblies – for switching motors

Power contactors for switching motors

General data

3RT126 vacuum contactors · Size S10 with mountable accessories

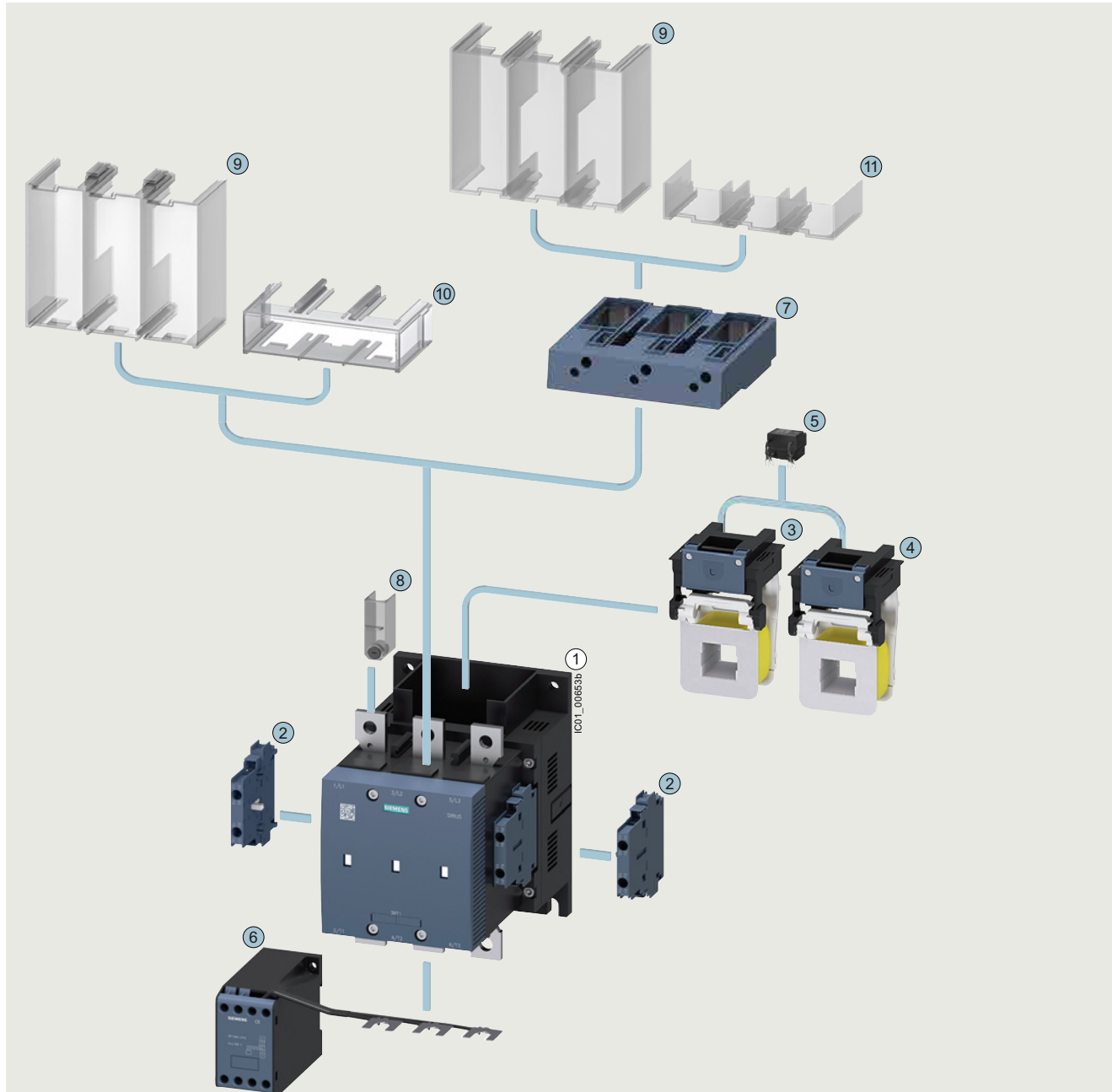

- ① 3RT126 vacuum contactor, size S10
(version without withdrawable coil)

Can be mounted onto side of contactor

- ② 3RH192: 2-pole auxiliary switch

Can be inserted in top of contactor

- ③ 3RT1966-5A.3.: Withdrawable coil, standard operating mechanism
④ 3RT1966-5N.3.: Withdrawable coil, solid-state operating mechanism

Can be plugged onto top of contactor operating mechanisms

- ⑤ 3RT1956-1C: Surge suppressor (RC element)

Can be mounted at bottom on busbars

- ⑥ 3RT1966-1PV.: Main current path surge suppression module

Can be mounted onto the top or bottom on busbars or box terminals

- ⑦ 3RT1966-4G: Box terminal block
⑧ 3TX6546-3B: Terminal cover (can be screwed on), covers one busbar connection
⑨ 3RT1966-4EA1: Terminal cover for busbar connection and on box terminal
⑩ 3RT1966-4EA3: Terminal cover for busbar connection
⑪ 3RT1966-4EA2: Terminal cover on box terminal

Accessories and spare parts, see pages 3/71 to 3/126 and 3/134 to 3/138.

Switching devices – Contactors and contactor assemblies – for switching motors

Power contactors for switching motors

General data

3RT107 and 3RT147 contactors · Size S12 with mountable accessories

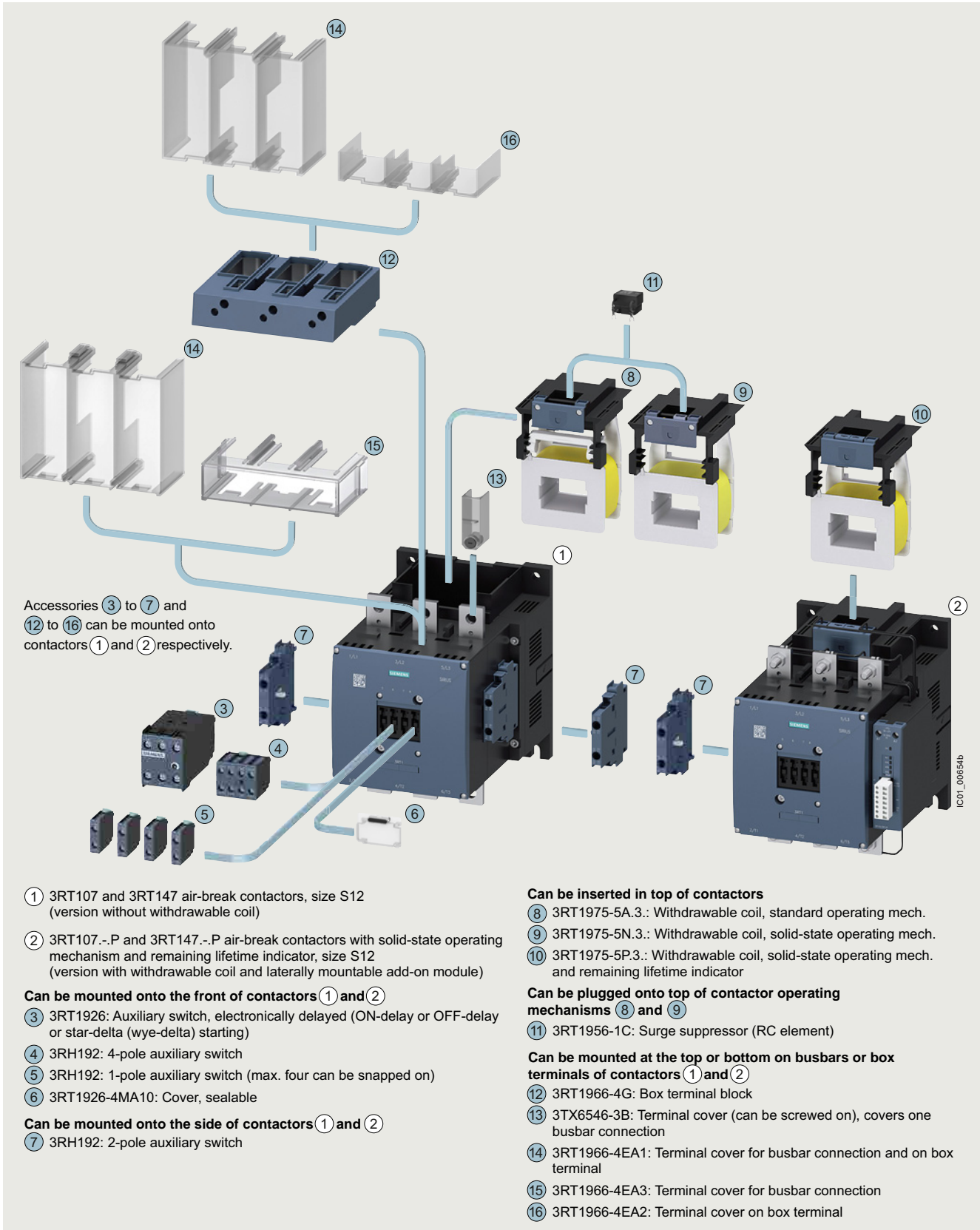

Accessories and spare parts, see pages 3/71 to 3/126.

Switching devices – Contactors and contactor assemblies – for switching motors

Power contactors for switching motors

General data

3RT127 vacuum contactors · Size S12 with mountable accessories

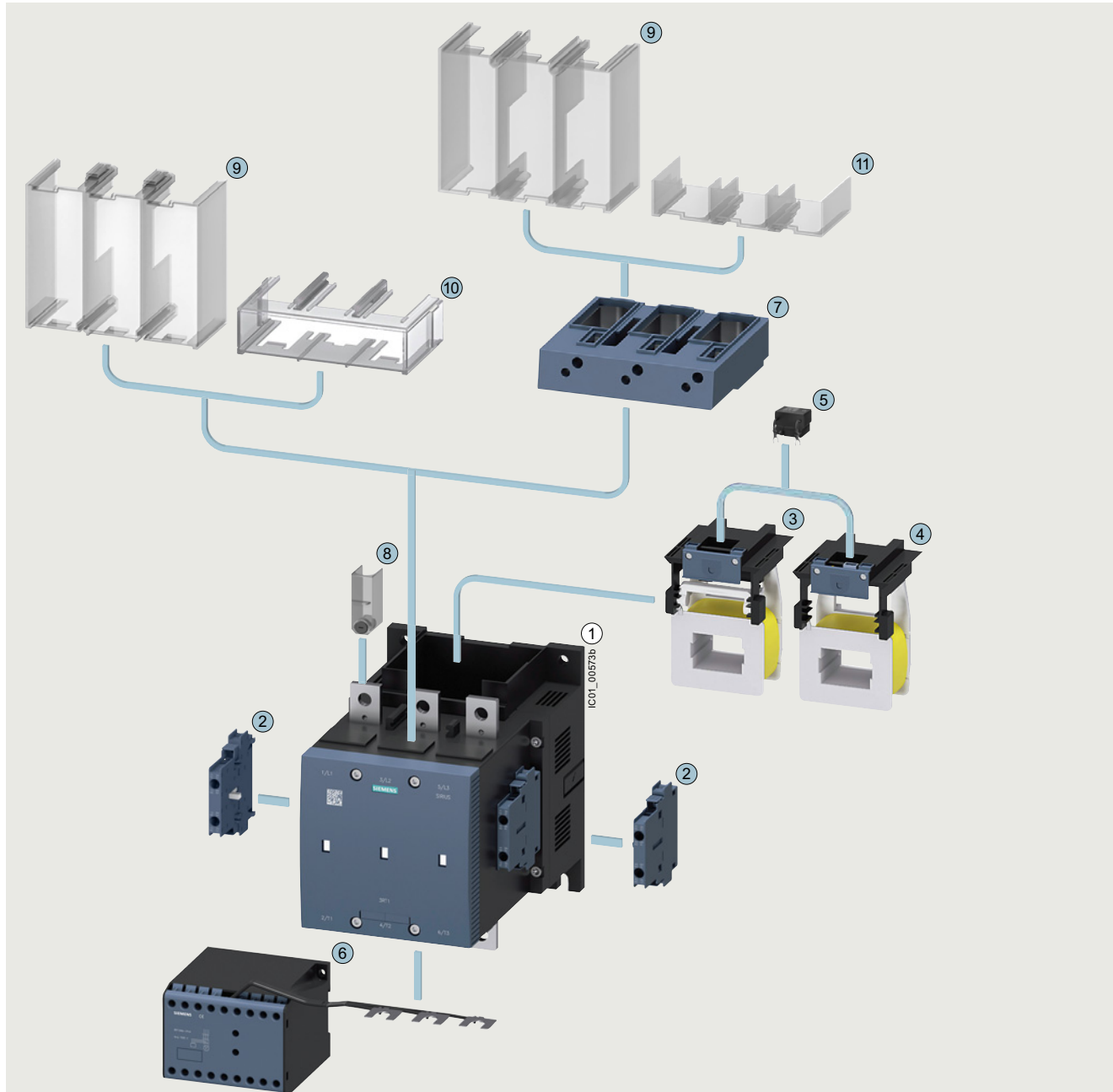

- ① 3RT127 vacuum contactor, size S12
(version without withdrawable coil)

Can be mounted onto the side of contactor

- ② 3RH192: 2-pole auxiliary switch

Can be inserted in top of contactors

- ③ 3RT1975-5A.3.: Withdrawable coil, standard operating mechanism
④ 3RT1975-5N.3.: Withdrawable coil, solid-state operating mechanism

Can be plugged onto the top of contactor operating mechanisms

- ⑤ 3RT1956-1C: Surge suppressor (RC element)

Can be mounted at bottom on busbars

- ⑥ 3RT1966-1PV.: Main current path surge suppression module

Can be mounted at the top or bottom on busbars or box terminals

- ⑦ 3RT1966-4G: Box terminal block

- ⑧ 3TX6546-3B: Terminal cover (can be screwed on), covers one busbar connection

- ⑨ 3RT1966-4EA1: Terminal cover for busbar connection and on box terminal

- ⑩ 3RT1966-4EA3: Terminal cover for busbar connection

- ⑪ 3RT1966-4EA2: Terminal cover on box terminal

Accessories and spare parts, see pages 3/71 to 3/126 and 3/134 to 3/138.

Switching devices – Contactors and contactor assemblies – for switching motors

Power contactors for switching motors

General data

3TF68 and 3TF69 vacuum contactors · Size 14 with mountable accessories

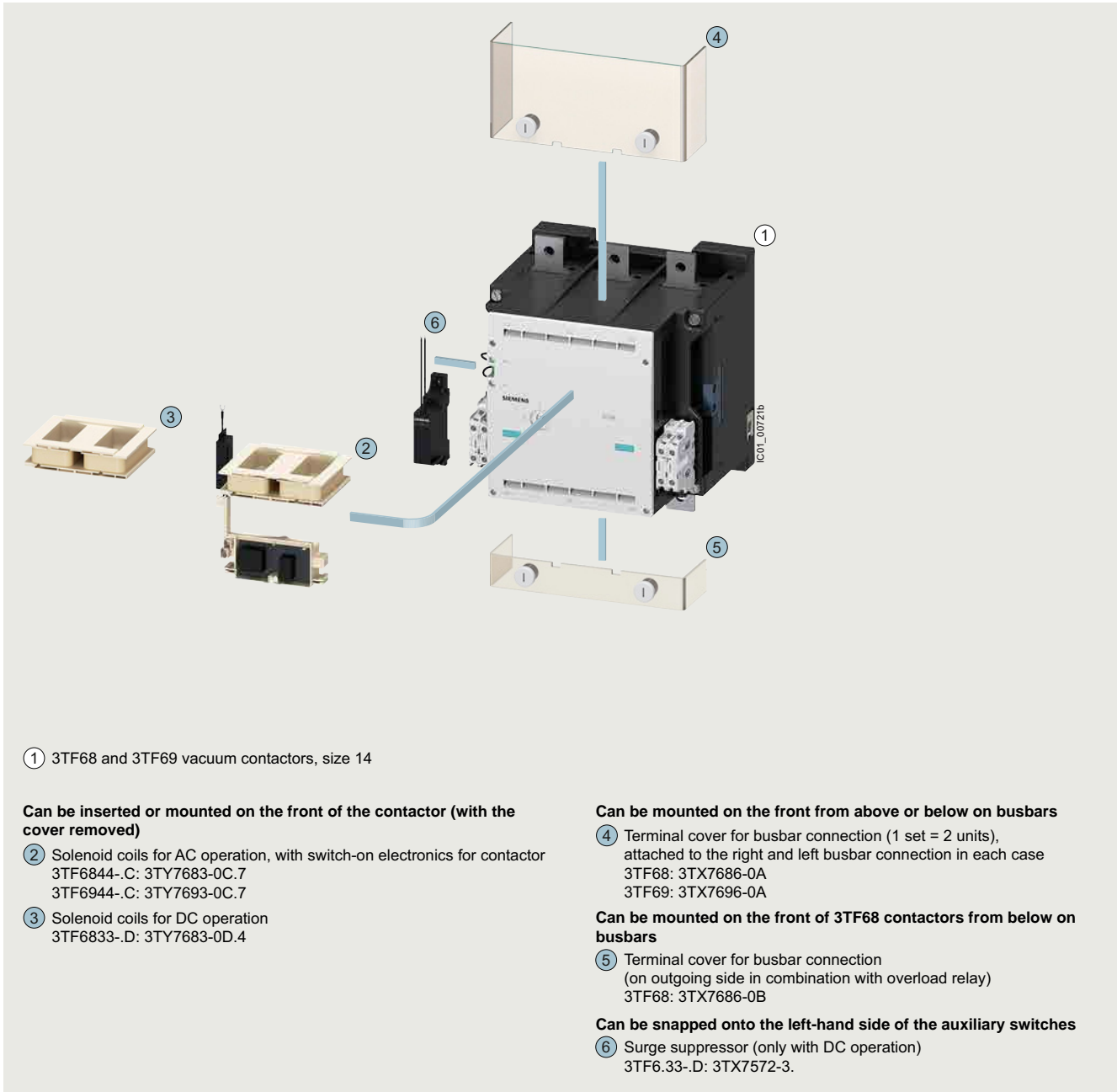

① 3TF68 and 3TF69 vacuum contactors, size 14

Can be inserted or mounted on the front of the contactor (with the cover removed)

- ② Solenoid coils for AC operation, with switch-on electronics for contactor
3TF6844-.C: 3TY7683-0C.7
3TF6944-.C: 3TY7693-0C.7
- ③ Solenoid coils for DC operation
3TF6833-.D: 3TY7683-0D.4

Can be mounted on the front from above or below on busbars

- ④ Terminal cover for busbar connection (1 set = 2 units), attached to the right and left busbar connection in each case
3TF68: 3TX7686-0A
3TF69: 3TX7696-0A

Can be mounted on the front of 3TF68 contactors from below on busbars

- ⑤ Terminal cover for busbar connection (on outgoing side in combination with overload relay)
3TF68: 3TX7686-0B

Can be snapped onto the left-hand side of the auxiliary switches

- ⑥ Surge suppressor (only with DC operation)
3TF6.33-.D: 3TX7572-3.

Accessories and spare parts, [see pages 3/134 to 3/138](#).

Switching devices – Contactors and contactor assemblies – for switching motors

Power contactors for switching motors

SIRIUS 3RT contactors, 3-pole up to 250 kW

Overview

Version	Size	Ratings of three-phase motors at 50 Hz and 400 V kW	Connection methods Screw terminals	Spring-loaded terminals	Type	Page
Power contactors for switching motors						
AC operation						
Basic units • With permanently mounted auxiliary switch • With permanently mounted auxiliary switch and varistor plugged into the front	S00	3 ... 7.5	✓	✓	3RT201.-.A.0. 3RT201.-.AP04-3MA0 3RT201.-.CP04-3MA0	3/47 3/47 3/47
Basic units • With removable auxiliary switch • With permanently mounted auxiliary switch and varistor plugged in	S0	4 ... 18.5	✓	✓	3RT202.-.A.0 3RT202.-.A.04 3RT202.-.CL24-3MA0	3/48, 3/49 3/50 3/50
Basic units • With removable auxiliary switch • With permanently mounted auxiliary switch and integrated coil circuit	S2	18.5 ... 37	✓	✓	3RT203.-.A.0 3RT203.-.1A.04 3RT203.-.CL24-3MA0	3/51, 3/53 3/51 3/51
Basic units • With removable auxiliary switch • With permanently mounted auxiliary switch and integrated coil circuit	S3	37 ... 55	✓	✓	3RT204.-.A.0 3RT204.-.1A.04 3RT204.-.1CL24-3MA0	3/52, 3/53 3/52 3/52
DC operation						
Basic units • With integrated coil circuit • With permanently mounted auxiliary switch • With permanently mounted auxiliary switch and integrated coil circuit • With voltage tap-off	S00	3 ... 7.5	✓	✓	3RT201.-.B.4. 3RT201.-..B4. 3RT201.-.BB44-3MA0 3RT201.-.FB44-3MA0	3/54 3/54 3/55 3/55
Basic units • With coil circuit plugged into the front • With removable auxiliary switch • With permanently mounted auxiliary switch and integrated coil circuit • With voltage tap-off	S0	4 ... 18.5	✓	✓	3RT202.-.B.40 3RT202.-..B40 3RT202.-.BB44 3RT202.-..B44-3MA0	3/58 3/58 3/58 3/59
DC operation for direct control by PLC (coupling contactors)						
Basic units	S00	3 ... 5.5	✓	✓	3RT201.-..B4.	3/56
Basic units with integrated coil circuit	S00	3 ... 5.5	✓	✓	3RT201.-..B4.	3/56, 3/57
	S0	4 ... 15	✓	✓	3RT202.-.KB40	3/60
	S2	18.5 ... 37	✓	✓	3RT203.-.KB40	3/61
	S3	37 and 45	✓	✓	3RT204.-.KB40	3/61
AC/DC operation (50/60 Hz AC or DC)						
Basic units with integrated coil circuit	S0	5.5 ... 18.5	✓	✓	3RT202.-.N.30	3/62
Basic units with integrated coil circuit • With removable auxiliary switch • With permanently mounted auxiliary switch • With voltage tap-off • With fail-safe 24 V DC control signal input for safety-related applications up to SIL 3	S2	18.5 ... 37	✓	✓	3RT203.-.N.30 3RT203.-.1N.34 3RT203.-.NB34-3MA0 3RT203.-.NB30-0CC0	3/63 3/63 3/63 3/63
Basic units with integrated coil circuit • With removable auxiliary switch • With permanently mounted auxiliary switch • With voltage tap-off • With fail-safe 24 V DC control signal input for safety-related applications up to SIL 3	S3	37 ... 55	✓	✓	3RT204.-.N.30 3RT204.-.1N.34 3RT204.-.NB34-3MA0 3RT204.-.NB30-0CC0	3/64 3/64 3/64 3/64
Basic units with integrated coil circuit • Standard operating mechanism for AC and DC operation • Solid-state operating mechanism with the option of control via a separate 24 V DC control signal input - Fail-safe control signal input for safety-related applications up to SIL 3 - Standard control signal input - Standard control signal input, with remaining lifetime indicator (RLT)	S6 ... S12	55 ... 250	✓ ¹⁾	✓	3RT10.-.A.36	3/66
	S6 ... S12	55 ... 250	✓ ¹⁾	--	3RT10.-.S.36	3/67
			✓ ¹⁾	✓	3RT10.-.N.36	3/68
			✓ ¹⁾	--	3RT10.-.P.35	3/68

-- Version not possible

✓ Version possible

¹⁾ Connection method:

- Main circuit: Busbar connection (optionally with box terminals),

- Auxiliary/control circuit: Screw terminals or spring-loaded terminals.

Switching devices – Contactors and contactor assemblies – for switching motors

Power contactors for switching motors

SIRIUS 3RT contactors, 3-pole up to 250 kW



Contactors with screw terminals: 3RT20 (sizes S00 to S3) and 3RT10 (sizes S6 to S12)

Our power range of contactors for switching IE2 motors and highly efficient IE3 and IE4 motors:

- Contactors, [see pages 3/47 to 3/68](#):
 - Size S00: 3RT201 to 7.5 kW
 - Size S0: 3RT202 to 18.5 kW
 - Size S2: 3RT203 to 37 kW
 - Size S3: 3RT204 to 55 kW
 - Sizes S6 to S12: 3RT10 up to 250 kW
- Vacuum contactors, [see page 3/127 onwards](#):
 - Sizes S10 and S12: 3RT12 to 250 kW
 - Size 14: 3TF6 to 450 kW

Standards

IEC 60947-1, IEC 60947-4-1, IEC 60947-5-1 (auxiliary switches)

Contactors with increased tamper protection

Increased tamper protection is ensured either by using our contactor versions with factory-installed, permanently mounted auxiliary switches protected against mechanical external actuation (e.g. 3RT20...-3MA0 or 3RT10...-3PA0 contactors), or by using the 3RT2916-4MA10 or 3RT1926-4MA10 sealable cover as an accessory ([see page 3/118](#)).

Switching devices – Contactors and contactor assemblies – for switching motors

Power contactors for switching motors

SIRIUS 3RT contactors, 3-pole up to 250 kW

Operating times

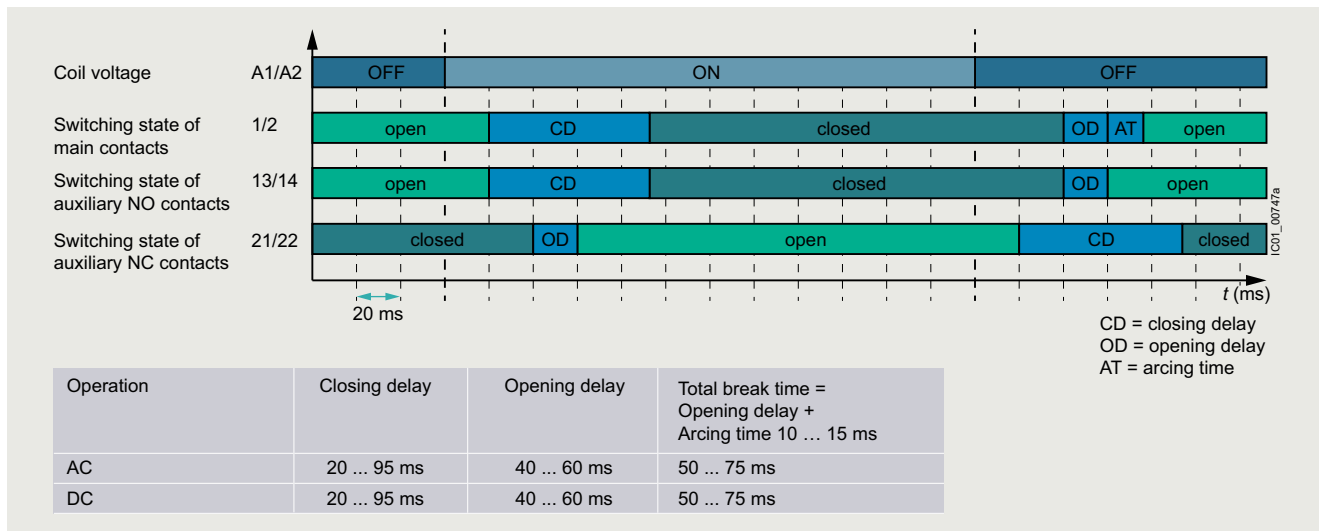

Operating times using the example of contactor 3RT1054-1AB36

Protection of the device connections from short circuit, overload and overvoltage

Appropriate steps must always be taken to protect device connections from overload and short circuit. There are different constraints depending on the type of connection:

Short-circuit and overload protection of main connections

For information about protection of a single contactor, see the [technical product data sheet](#).

For more information on device combinations such as contactor with overload relay or contactor with circuit breaker as motor feeder, refer to

- [Digital Configuration Manual for load feeders](#)
- [Configuration Manual for load feeders](#)

Short-circuit and overload protection of auxiliary connections

For information on the protection of auxiliary contacts, see the [technical product data sheet](#).

Short-circuit and overload protection of control supply voltage or supply voltage connections

First of all, the relevant standards and regulations for configuring control panels and the parts and components installed in them must be taken into account, for example for cable dimensioning.

One possible protection for these circuits could be the selection of a suitable power supply, i.e. one with a current-limiting function. In the selection of the source and the connecting cable, the load characteristics of the contactor must be considered (short-time inrush current peaks for solid-state contactor operating mechanisms, switch-on power, holding power). The same applies to the selection of suitable protection devices.

If there are further switching elements in the circuits, such as the auxiliary contact system of an overload relay that operates the contactor, the short-circuit protection necessary for this must also be considered.

For further recommendations, e.g. the use of miniature circuit breakers or circuit breakers for equipment in control circuits, see [Control panel tip – Selecting and dimensioning suitable power supplies quickly and reliably](#).

Short-circuit and overload protection of contactors with digital input

A typical rated current of 20 mA applies to these inputs according to the PLC input types according to IEC 60947-4-1. These inputs can be protected accordingly.

- Contactors with PLC and F-PLC inputs:
 - For 3RT10...-P marked with IN+/IN-
 - For 3RT10...-S, -.N and 3RT20...-S marked with +/-
- Supply voltage connections A1 - A2:
 - For 3RT10...-N, -.P and 3RT20...-S, protection should be provided on the basis of the load characteristics. For information about power consumption, see the [technical product data sheet](#).
 - For 3RT10...-S, protection is already integrated.

Short-circuit and overload protection of other connections

The contactor version 3RT10...-P with remaining lifetime indicator (RLT) has additional connections H1 - H2 and R1 - R2.

If A1 - A2 is already protected, further protection of H1 - H2 is not required.

For information on the protection of R1 - R2, see the [technical product data sheet](#).

Overvoltage protection at the control supply voltage connection

3RT20 contactors supplied without a coil circuit can be retrofitted with RC elements, varistors, diodes or diode assemblies (combination of diode and Zener diode for short break times) for damping switching overvoltages in the coil and can be ordered separately as accessories, see [page 3/102 onwards](#).

The 3RT10 contactors are already equipped with coil damping (varistor).

Note:

The break times of the contactor, the opening delay times of the NO contacts and the closing delay times of the NC contacts increase with damping.

For more detailed information about how damping affects the time response, see [Equipment Manual](#).

Switching devices – Contactors and contactor assemblies – for switching motors

Power contactors for switching motors

SIRIUS 3RT contactors, 3-pole up to 250 kW

Connection methods

Main circuit

- 3RT201 and 3RT202 contactors:
Screw terminals or spring-loaded terminals;
spring-loaded terminals with convenient plug-in design for device connectors
- 3RT203 and 3RT204 contactors:
Screw terminals with box terminal;
direct connection to the connecting bar is possible with cable lugs for 3RT204 when the box terminal is removed.
- 3RT10 contactors:
Screw terminals with connecting bars that the cables can be connected to using either cable lugs or flexible or rigid busbars. Alternatively, box terminals are available as accessories.

Auxiliary and control circuit

The 3RT contactors are available with screw terminals or spring-loaded terminals.

Electromagnetic compatibility

The contactors fulfill the requirements for environment category A.

Note:

When the contactors are used in an **environment with frequency converters**, the configuration notes must be observed, [see Equipment Manual](#).

Contact reliability of the auxiliary contacts

If voltages ≤ 110 V and currents ≤ 100 mA are to be switched, the auxiliary contacts of the 3RT contactors or 3RH contactor relays should be used as they guarantee a high level of contact reliability.

These auxiliary contacts are particularly suitable for solid-state circuits with currents ≥ 1 mA at a voltage ≥ 17 V.

Motor protection

3RT20 contactors

For protection against overload, 3RU2 thermal overload relays ([see page 7/86 onwards](#)) or 3RB3 electronic overload relays ([see pages 7/98, 7/100 and 7/102](#)) can be mounted on the 3RT20 contactors.

3RT10 contactors

For protection against overload, 3RB2 electronic overload relays ([see pages 7/99, 7/101 and 7/103](#)) can be mounted on the 3RT10 contactors.

Plant and application monitoring

For monitoring and measuring in the application, 3RR2 monitoring relays can be mounted on the 3RT20 contactors ([see page 10/47](#)).

Contactors with voltage tap

The 3RT20 contactors with voltage tap-off are special versions for mounting the SIRIUS 3RA27 function modules for connection to the control system via IO-Link or AS-Interface ([see page 3/75 onwards](#)).

Without a function module, these contactors can be used like the standard versions.

For more information on IO-Link and AS-Interface, [see "Industrial communication", page 2/1 onwards](#).

Operating mechanism types

3RT20 contactors

The standard versions are available with AC or DC operating mechanisms or as versions with a wide-range solid-state operating mechanism and a universal actuating voltage (AC or DC operation possible).

Versions with solid-state operating mechanisms for AC or DC operation with a fail-safe PLC input are also available for the 3RT203 and 3RT204 contactors.

Control takes place via the control supply voltage connection A1 - A2 with varying operating ranges ([see the technical product data sheet](#) for further details).

DC coupling contactors with reduced power consumption are also ideally suited for connection to the controller.

3RT10 contactors

The operating mechanisms are powered via a supply voltage with an operating range from 0.8 to $1.1 \times U_s$, optionally also controlled depending on the chosen mode of operation. Various rated voltage ranges are available for AC/DC control.

The following control or operating mechanism versions can be selected for contactors 3RT105 to 3RT107:

- 3RT10..-A contactors:
Standard operating mechanism for AC and DC operation (power consumption reduced from closing power to holding power)
- Solid-state operating mechanisms:
Overvoltage damping of the operating mechanism coil is already integrated in the electronics for contactors with solid-state operating mechanisms.
The following versions are available:
 - 3RT10..-N contactors:
With two operating modes: Direct control or via PLC input (24 V DC)
 - 3RT10..-P contactors:
Control via PLC input (24 V DC) only, but with additional remaining lifetime indicator (RLT)
 - 3RT10..-S contactors:
Control via fail-safe PLC input (24 V DC) only, for simplification of safety applications (without operating mode selection)

Switching devices – Contactors and contactor assemblies – for switching motors

Power contactors for switching motors

SIRIUS 3RT contactors, 3-pole up to 250 kW

Replacing solenoid coils, operating mechanisms or spare contacts

3RT20 contactors

Coil replacement is possible for contactors 3RT202 to 3RT204.

NOTICE:

Removal or changing of the operating mechanism or spare contacts is not permitted for 3RT20..-S contactors with fail-safe control.

3RT10 contactors

The operating mechanisms for 3RT10..-A/-N/-P contactors are removable and can be replaced simply by unlocking and pulling them out.

NOTICE:

Removal or changing of the operating mechanism is not permitted for 3RT10..-S contactors with fail-safe control.

Fitting auxiliary contacts and mounting additional auxiliary switches

Features in the delivery state

- 3RT20 contactors:
 - 3RT201 contactors:
 - An auxiliary contact is integrated in the basic unit.
 - Contactors 3RT202 to 3RT204:
 - The basic units contain two integrated auxiliary contacts (1 NO + 1 NC).
- 3RT10 contactors:
 - These contactors are supplied with two laterally mounted auxiliary switches. The fitting of auxiliary switches is possible on the front and on the side.

Expansion possibilities

All basic units (with the exception of coupling contactors in sizes S00 and S0) can be expanded using auxiliary switches. The permitted configuration must be taken into account.

Detailed information about the fitting of auxiliary switches for 3RT20 contactors, [see pages 3/83 to 3/90](#).

Switching devices – Contactors and contactor assemblies – for switching motors

Power contactors for switching motors

SIRIUS 3RT contactors, 3-pole up to 250 kW

Connection of contactors to fail-safe control modules

While contactors with smaller power ratings can be connected directly to the outputs of fail-safe controllers, implementing safety-related applications with standard contactors with higher power is much more complicated and elaborate because of the necessary coupling links.

Due to their fail-safe control input, special contactors provide a much simpler way of doing this:

- 3RT20...-S contactors in sizes S2 and S3
- 3RT10...-S contactors in sizes S6 to S12

For more information, see

- [Safety technology, page 11/1 onwards](#)
- [Guide of use for contactors in safety applications](#)

Example for SIL 2 and SIL 3/PL e application – previously:

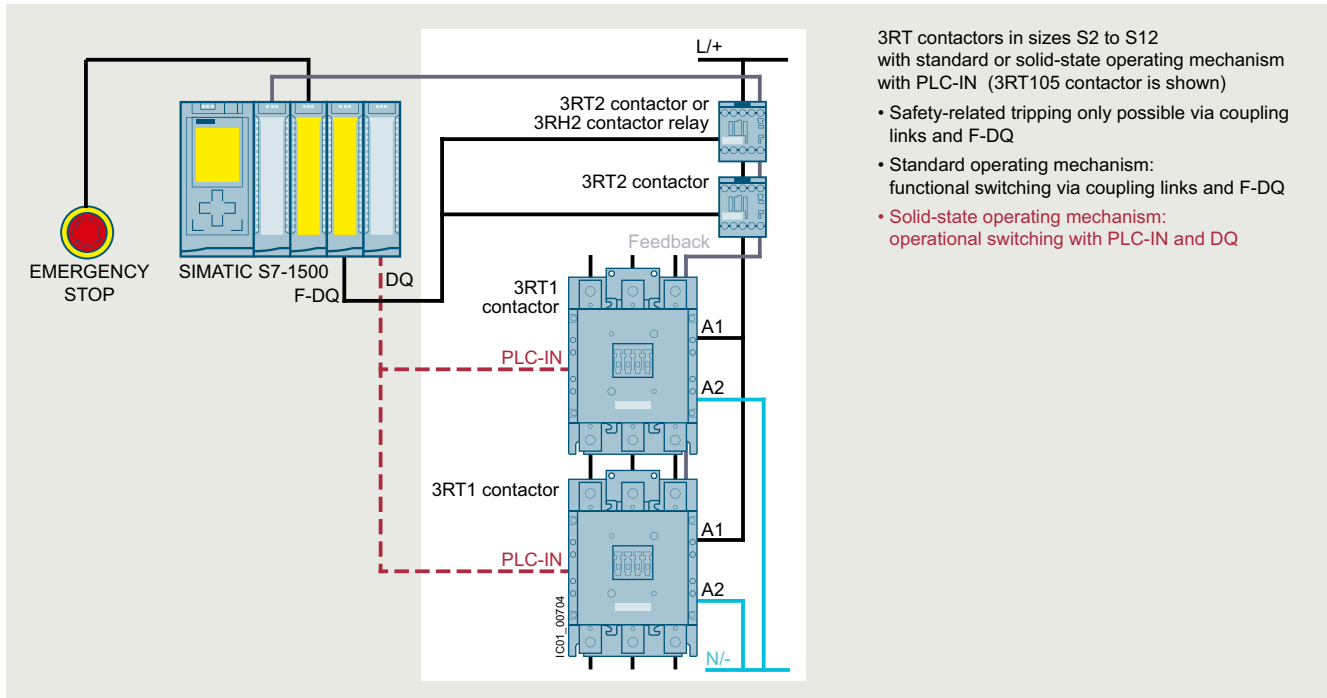

Application with safety-related tripping with standard contactors using the example of a 3RT105 contactor

Example for SIL 3/PL e (left-hand side) or SIL 2/PL c (right-hand side) application – new:

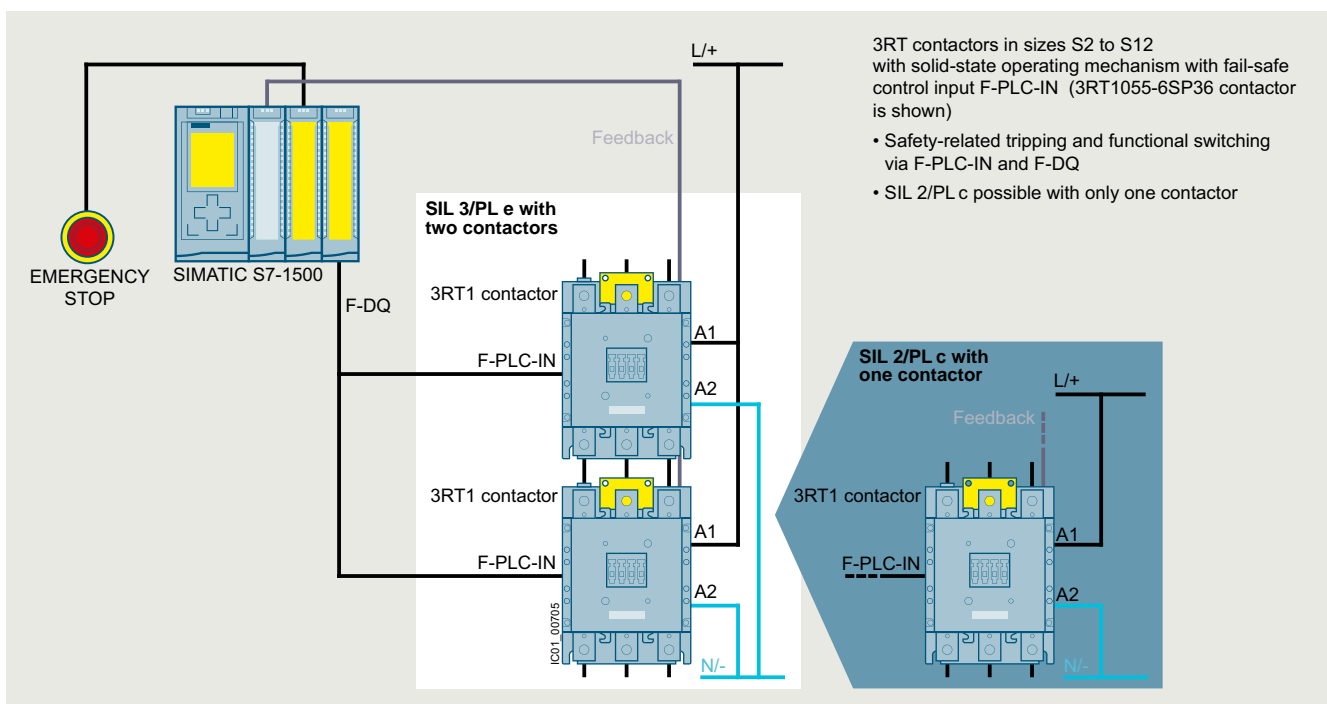

Application with safety-related tripping with contactors with fail-safe control using the example of a 3RT105 contactor

Switching devices – Contactors and contactor assemblies – for switching motors

Power contactors for switching motors

SIRIUS 3RT contactors, 3-pole up to 250 kW

Contactors for special applications

- SIRIUS 3RT.4 contactors for weak or non-inductive loads (AC-1), 3-pole, [see page 4/7 onwards](#)
- SIRIUS 3RT20 or 3RT10 contactors with an extended operating range, 3-pole (for railway applications), [see page 4/54 onwards](#)

Article number scheme

Product versions	Article number
SIRIUS power contactors	3RT2 □ □ □ - □ □ □ □ □ - □ □ □ □
Device type	e.g. 0 = 3-pole motor contactor
Size of the contactor	e.g. 4 = S3
Rating dependent on size	e.g. 5 = 37 kW for S3
Type of electrical connection	e.g. 1 = Screw terminals (main and auxiliary circuits)
Operating range/solenoid coil circuit	e.g. A = AC standard/without coil circuit
Rated control supply voltage	e.g. P0 = 230 V AC, 50 Hz
Auxiliary switches	e.g. 0 = for S3: 1 NO + 1 NC integrated
Special version	□ □ □ □
Example	3RT2 0 4 5 - 1 A P 0 0

Note:

The article number scheme shows an overview of product versions for better understanding of the logic behind the article numbers.

For your orders, please use the article numbers quoted in the selection and ordering data.

Switching devices – Contactors and contactor assemblies – for switching motors

Power contactors for switching motors

SIRIUS 3RT contactors, 3-pole up to 250 kW

Technical specifications

More information

Technical specifications, see
<https://support.industry.siemens.com/cs/ww/en/ps/16134/td>
 FAQs, see
<https://support.industry.siemens.com/cs/ww/en/ps/16134/faq>

System Manual for modular system, see
<https://support.industry.siemens.com/cs/ww/en/view/60311318>
 Equipment Manual, see
<https://support.industry.siemens.com/cs/ww/en/view/60306557>
 Application Manual - Switching devices with IE3 and IE4 motors, see
<https://support.industry.siemens.com/cs/ww/en/view/94770820>
 Digital Configuration Manual for load feeders, see
<https://imp.siemens.com/digital-engineering-manual/dem>
 Configuration Manual for load feeders, see
<https://support.industry.siemens.com/cs/ww/en/view/39714188>
 Configuration Manual for UL, see
<https://support.industry.siemens.com/cs/ww/en/view/53433538>
 Guide of use for contactors in safety applications, see
<https://support.industry.siemens.com/cs/ww/en/view/109807687>

Type	Contactors			
	3RT2		S3	3RT1
Size	S00 to S2		S3	S6 to S12
Rated data of the auxiliary contacts				
According to IEC 60947-5-1				
Data apply to integrated auxiliary contacts and conventional contacts in the auxiliary switches				
Rated insulation voltage U_i (pollution degree 3)	V	690	1 000 (3RT20...0CC0: 690)	--
• For laterally mountable auxiliary switches	V	690	690	500
• For front auxiliary switches	V	690	690	690
Conventional thermal current I_{th} = rated operational current $I_e/AC-12$	A	10		
AC load				
Rated operational current $I_e/AC-15/AC-14$				
• At rated operational voltage U_e	up to 230 V	A	10 ¹⁾	6
	400 V	A	3	3
	500 V	A	2	2
	690 V	A	1	1 ²⁾
DC load				
Rated operational current $I_e/DC-12$				
• At rated operational voltage U_e	24 V	A	10	10
	60 V	A	6	6
	110 V	A	3	3
	125 V	A	2	2
	220 V	A	1	1
	440 V	A	0.3	0.3
	600 V	A	0.15	0.15 ²⁾
Rated operational current $I_e/DC-13$				
• At rated operational voltage U_e	24 V	A	10 ¹⁾	10 ³⁾
	60 V	A	2	2
	110 V	A	1	1
	125 V	A	0.9	0.9
	220 V	A	0.3	0.3
	440 V	A	0.14	0.14
	600 V	A	0.1	0.15 ²⁾

Contact reliability at 17 V, 1 mA

According to IEC 60947-5-4

Frequency of contact faults < 10^{-8} i.e. < 1 fault per 100 million operating cycles

¹⁾ 3RH22, 3RH29, 3RT2...-...4, 3RT2...-...6: $I_e = 6$ A at AC-15/AC-14 and DC-13.

²⁾ With laterally mountable auxiliary switches, only the currents for rated operational voltages up to 500 V apply.

³⁾ For laterally mountable auxiliary switches, DC-13/at 24 V: Max. 6 A.

Switching devices – Contactors and contactor assemblies – for switching motors

Power contactors for switching motors

SIRIUS 3RT contactors, 3-pole up to 250 kW

Type

3RT contactors

Size

S00 to S12

Electrical endurance of auxiliary contacts

It is assumed that the operating mechanisms are switched randomly, i.e. not synchronized with the phase angle of the supply system.

The electrical endurance is mainly dependent on the breaking current.

Sizes S00 to S3

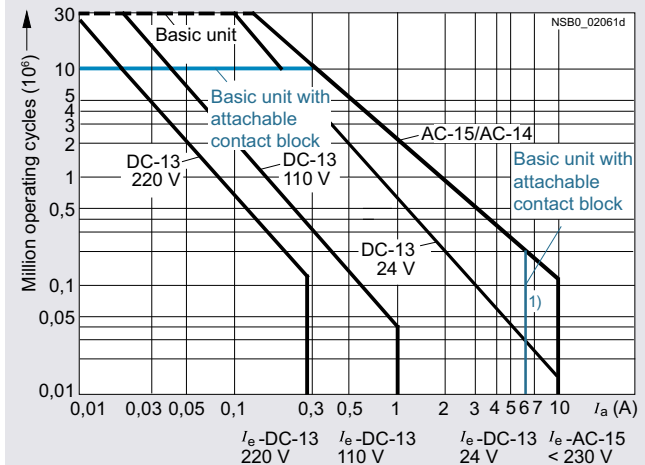

Sizes S6 to S12

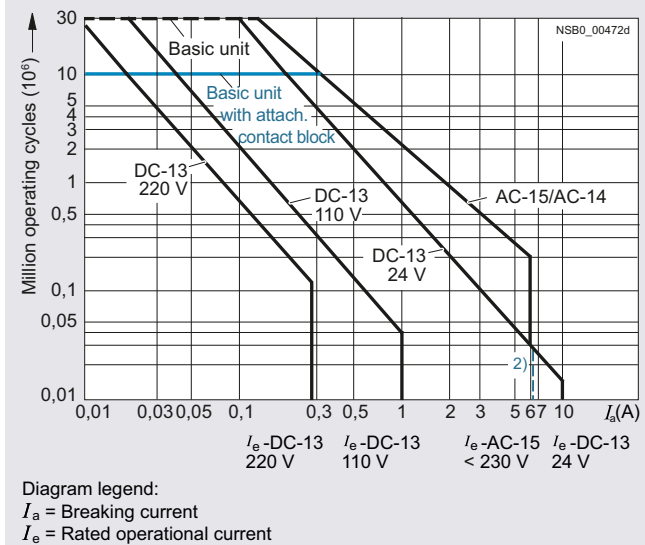

¹⁾ 3RH22, 3RH29, 3RT2...-...4, 3RT2...-...6: $I_e = 6$ A at AC-15/AC-14 and DC-13, 3RT2.4: $I_e = 6$ A at AC-15/AC-14.

²⁾ For laterally mountable auxiliary switches, DC-13/at 24 V: Max. 6 A.

³⁾ With laterally mountable auxiliary switches, the currents for rated operational voltages up to 500 V apply.

Switching devices – Contactors and contactor assemblies – for switching motors

Power contactors for switching motors

SIRIUS 3RT contactors, 3-pole up to 250 kW

Type	3RT2 contactors
Size	S00 and S0

Contact endurance of the main contacts

The characteristic curves show the contact endurance of the contactors when switching weak inductive or non-inductive AC loads (AC-1) and motor-driven loads (AC-3 and AC-3e) depending on the breaking current and rated operational voltage. It is assumed that the operating mechanisms are switched randomly, i.e. not synchronized with the phase angle of the supply system.

The rated operational current I_e complies with utilization category AC-4 (breaking 6 times the rated operational current) and is intended for a contact endurance of approximately 200 000 operating cycles.

If a shorter contact endurance is sufficient, the rated operational current $I_e/AC-4$ can be increased.

If the contacts are used for mixed operation, i.e. normal switching (breaking the rated operational current according to utilization category AC-3 and AC-3e) in combination with intermittent inching (breaking several times the rated operational current according to utilization category AC-4), the contact endurance can be calculated approximately from the following equation:

$$X = \frac{A}{1 + \frac{C}{100} \left(\frac{A}{B} - 1 \right)}$$

Characters in the equation:

- X Contact endurance for mixed operation in operating cycles
- A Contact endurance for normal operation ($I_a = I_e$) in operating cycles
- B Contact endurance for inching ($I_a = \text{multiple of } I_e$) in operating cycles
- C Inching operations as a percentage of total switching operations

Size S00

Operating cycles at

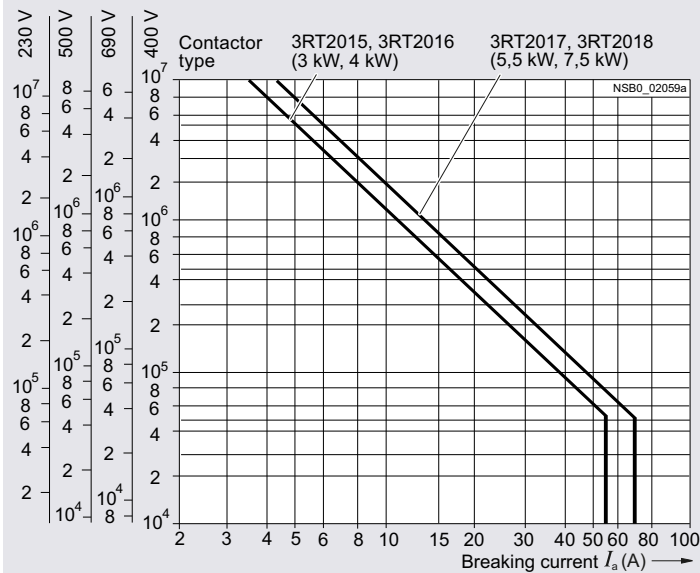

Size S0

Operating cycles at

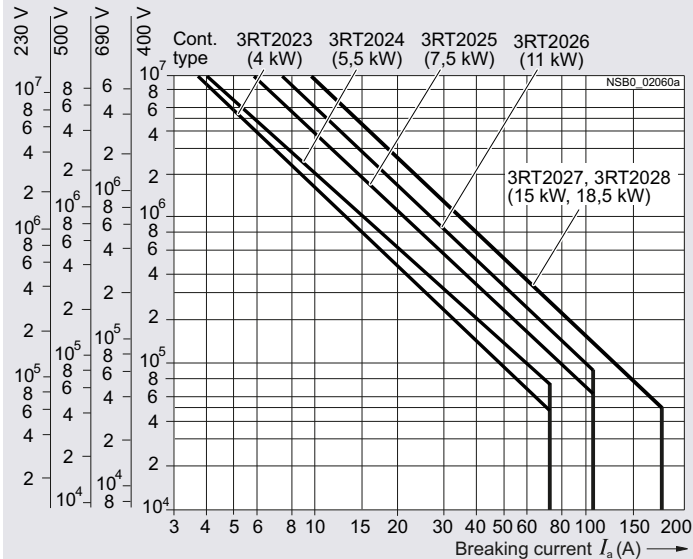

Switching devices – Contactors and contactor assemblies – for switching motors

Power contactors for switching motors

SIRIUS 3RT contactors, 3-pole up to 250 kW

Type **3RT contactors**
 Size **S2 to S12**

Contact endurance of main contacts (continued)

Size S2

Operating cycles at

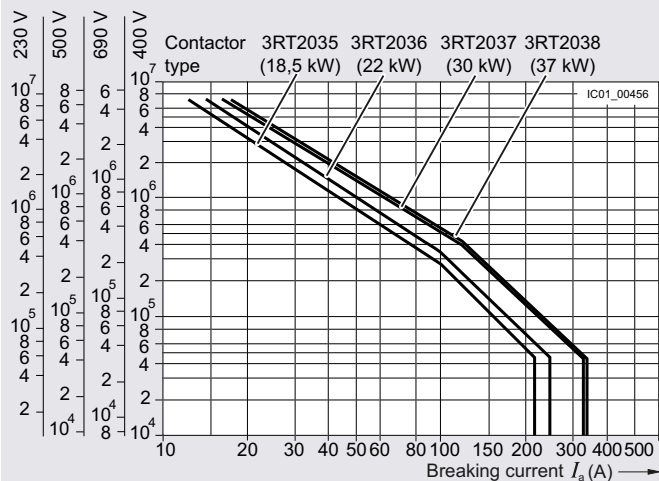

Size S3

Operating cycles at

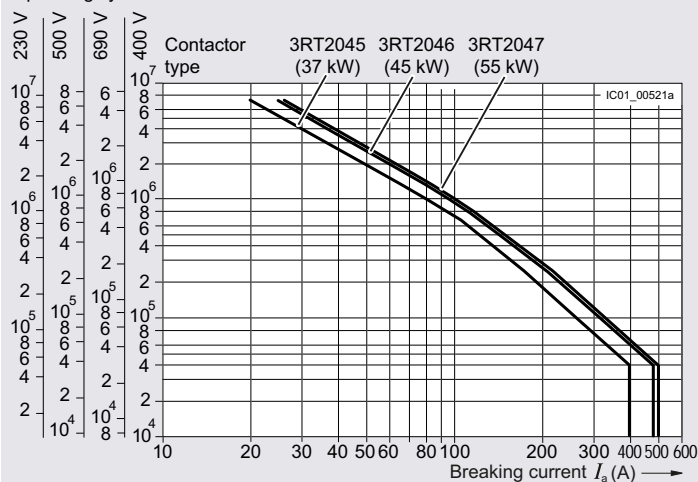

Sizes S6 to S12

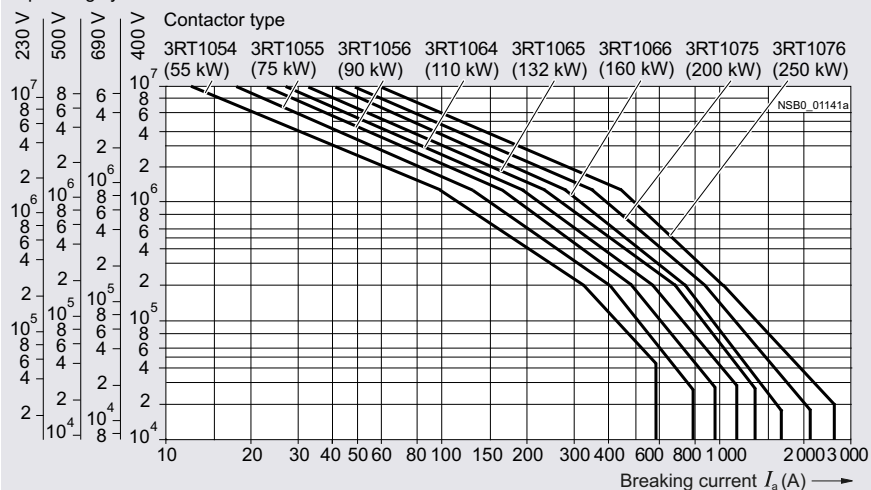

Operating cycles at



Switching devices – Contactors and contactor assemblies – for switching motors

Power contactors for switching motors

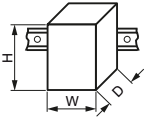
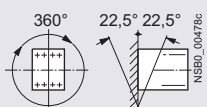
SIRIUS 3RT contactors, 3-pole up to 250 kW

Type	Contactors													
Size	3RT2015, 3RT2016	3RT2017, 3RT2018												
S00														
General data														
Dimensions (W x H x D)														
<ul style="list-style-type: none"> Basic unit <ul style="list-style-type: none"> Screw terminals Spring-loaded terminals Basic unit with mounted auxiliary switch <ul style="list-style-type: none"> Screw terminals Spring-loaded terminals Basic unit with mounted function module or solid-state time-delay auxiliary switch <ul style="list-style-type: none"> Screw terminals Spring-loaded terminals 		<table border="1"> <tr> <td>mm</td> <td>45 x 58 x 73</td> </tr> <tr> <td>mm</td> <td>45 x 70 x 73</td> </tr> <tr> <td>mm</td> <td>45 x 58 x 117</td> </tr> <tr> <td>mm</td> <td>45 x 70 x 121</td> </tr> <tr> <td>mm</td> <td>45 x 58 x 147</td> </tr> <tr> <td>mm</td> <td>45 x 70 x 147</td> </tr> </table>	mm	45 x 58 x 73	mm	45 x 70 x 73	mm	45 x 58 x 117	mm	45 x 70 x 121	mm	45 x 58 x 147	mm	45 x 70 x 147
mm	45 x 58 x 73													
mm	45 x 70 x 73													
mm	45 x 58 x 117													
mm	45 x 70 x 121													
mm	45 x 58 x 147													
mm	45 x 70 x 147													
Permissible mounting position														
The contactors are designed for operation on a vertical mounting surface.														
Upright mounting position		 Special version required												
Mechanical endurance														
<ul style="list-style-type: none"> Basic unit - With mounted auxiliary switch - With solid-state compatible auxiliary switch 	<table border="1"> <tr> <td>Operating cycles</td> <td>30 million</td> </tr> <tr> <td>Operating cycles</td> <td>10 million</td> </tr> <tr> <td>Operating cycles</td> <td>5 million</td> </tr> </table>	Operating cycles	30 million	Operating cycles	10 million	Operating cycles	5 million							
Operating cycles	30 million													
Operating cycles	10 million													
Operating cycles	5 million													
Electrical endurance														
Contact endurance of the main contacts, see page 3/27 .														
Rated insulation voltage U_i (pollution degree 3)	V	690												
Rated impulse withstand voltage U_{imp}														
<ul style="list-style-type: none"> Auxiliary circuit Main circuit 	<table border="1"> <tr> <td>kV</td> <td>6</td> </tr> <tr> <td>kV</td> <td>6</td> </tr> </table>	kV	6	kV	6									
kV	6													
kV	6													
Protective separation between the coil and the main contacts according to IEC 60947-1, Annex N	V	400												
Mirror contacts														
A mirror contact is an auxiliary NC contact that cannot be closed simultaneously with an NO main contact. <ul style="list-style-type: none"> 3RT2.1 (removable auxiliary switch) 3RH2919-.NF.. solid-state compatible auxiliary switches 		Yes, this applies to both the basic unit as well as to between the basic unit and the mounted auxiliary switch according to IEC 60947-4-1 Annex F No mirror contact for size S00												
Ambient temperature														
<ul style="list-style-type: none"> During operation During storage 	<table border="1"> <tr> <td>°C</td> <td>-25 ... +60</td> </tr> <tr> <td>°C</td> <td>-55 ... +80</td> </tr> </table>	°C	-25 ... +60	°C	-55 ... +80									
°C	-25 ... +60													
°C	-55 ... +80													

Switching devices – Contactors and contactor assemblies – for switching motors

Power contactors for switching motors

SIRIUS 3RT contactors, 3-pole up to 250 kW

Type Size	Contactors																																					
	3RT2015, 3RT2016 S00	3RT2017, 3RT2018																																				
Short-circuit protection																																						
Main circuit																																						
<ul style="list-style-type: none"> Fuse links, operational class gG: LV HRC, type 3NA; DIAZED, type 5SB; NEOZED, type 5SE according to IEC 60947-4-1 <ul style="list-style-type: none"> Type of coordination "1" A 35 50 Type of coordination "2" A 20 25 Weld-free (test conditions according to IEC 60947-4-1) A 10 Miniature circuit breaker (up to 230 V) with C characteristic Short-circuit current 1 kA, type of coordination "1" A 10 																																						
Auxiliary circuit																																						
Short-circuit test according to IEC 60947-5-1																																						
<ul style="list-style-type: none"> With fuse links, operational class gG: DIAZED, type 5SB; NEOZED, type 5SE with short-circuit current $I_k = 1$ kA A 10 With 230 V miniature circuit breaker, C characteristic with short-circuit current $I_k = 400$ A A 6 																																						
Short-circuit protection for contactors with overload relays																																						
see <ul style="list-style-type: none"> Digital Configuration Manual for load feeders Configuration Manual for load feeders 																																						
Short-circuit protection for fuseless load feeders																																						
See 3RA2 load feeders, page 8/5 onwards																																						
Control																																						
Solenoid coil operating range																																						
<ul style="list-style-type: none"> AC operation <table border="0"> <tr> <td>50 Hz</td> <td>0.8 ... 1.1 x U_s</td> </tr> <tr> <td>60 Hz</td> <td>0.85 ... 1.1 x U_s</td> </tr> </table> DC operation <table border="0"> <tr> <td>up to 50 °C</td> <td>0.8 ... 1.1 x U_s</td> </tr> <tr> <td>up to 60 °C</td> <td>0.85 ... 1.1 x U_s</td> </tr> </table> 	50 Hz	0.8 ... 1.1 x U_s	60 Hz	0.85 ... 1.1 x U_s	up to 50 °C	0.8 ... 1.1 x U_s	up to 60 °C	0.85 ... 1.1 x U_s																														
50 Hz	0.8 ... 1.1 x U_s																																					
60 Hz	0.85 ... 1.1 x U_s																																					
up to 50 °C	0.8 ... 1.1 x U_s																																					
up to 60 °C	0.85 ... 1.1 x U_s																																					
Power consumption of the solenoid coils (for cold coil and $1.0 \times U_s$)																																						
<ul style="list-style-type: none"> AC operation, 50/60 Hz, standard version <table border="0"> <tr> <td>- Closing power VA</td> <td>27/24.3</td> <td>37/33</td> </tr> <tr> <td>- P.f.</td> <td>0.8/0.75</td> <td></td> </tr> <tr> <td>- Holding power VA</td> <td>4.2/3.3</td> <td>5.7/4.4</td> </tr> <tr> <td>- P.f.</td> <td>0.25/0.25</td> <td></td> </tr> </table> AC operation, 50 Hz, for USA/Canada <table border="0"> <tr> <td>- Closing power VA</td> <td>26.4</td> <td>36</td> </tr> <tr> <td>- P.f. for closing power</td> <td>0.81</td> <td>0.8</td> </tr> <tr> <td>- Holding power VA</td> <td>4.4</td> <td>5.9</td> </tr> <tr> <td>- P.f. for holding power</td> <td>0.24</td> <td></td> </tr> </table> AC operation, 60 Hz, for USA/Canada <table border="0"> <tr> <td>- Closing power VA</td> <td>31.7</td> <td>43</td> </tr> <tr> <td>- P.f. for closing power</td> <td>0.81</td> <td>0.8</td> </tr> <tr> <td>- Holding power VA</td> <td>4.8</td> <td>6.5</td> </tr> <tr> <td>- P.f. for holding power</td> <td>0.25</td> <td></td> </tr> </table> DC operation (closing power = holding power) W 4 	- Closing power VA	27/24.3	37/33	- P.f.	0.8/0.75		- Holding power VA	4.2/3.3	5.7/4.4	- P.f.	0.25/0.25		- Closing power VA	26.4	36	- P.f. for closing power	0.81	0.8	- Holding power VA	4.4	5.9	- P.f. for holding power	0.24		- Closing power VA	31.7	43	- P.f. for closing power	0.81	0.8	- Holding power VA	4.8	6.5	- P.f. for holding power	0.25			
- Closing power VA	27/24.3	37/33																																				
- P.f.	0.8/0.75																																					
- Holding power VA	4.2/3.3	5.7/4.4																																				
- P.f.	0.25/0.25																																					
- Closing power VA	26.4	36																																				
- P.f. for closing power	0.81	0.8																																				
- Holding power VA	4.4	5.9																																				
- P.f. for holding power	0.24																																					
- Closing power VA	31.7	43																																				
- P.f. for closing power	0.81	0.8																																				
- Holding power VA	4.8	6.5																																				
- P.f. for holding power	0.25																																					
Permissible residual current of the electronics (with 0 signal)																																						
<ul style="list-style-type: none"> AC operation < 3 mA x (230 V/U_s)¹⁾ < 4 mA x (230 V/U_s)¹⁾ DC operation < 10 mA x (24 V/U_s)¹⁾ 																																						

¹⁾ The 3RT2916-1GA00 additional load module is recommended for higher residual currents, see page 3/120.

Type Size	Coupling contactors										
	3RT201.-HB4.	3RT201.-JB4.	3RT201.-KB4.	3RT201.-MB4.-0KT0	3RT201.-VB4.	3RT201.-SB4.					
Control											
Solenoid coil operating range											
0.7 ... 1.25 x U_s 0.85 ... 1.85 x U_s											
Power consumption of the solenoid coils (for cold coil) Switch-on power = holding power											
at U_s 24 V DC W 2.8 1.6											
Permissible residual current of the electronics (with 0 signal)											
< 6 mA x (24 V/ U_s) On request											
Upright mounting position											
On request											
Overvoltage configuration of the solenoid coil											
No overvoltage damping		Integrated diode		Integrated suppressor diode		No overvoltage damping		Integrated diode		Integrated suppressor diode	



Switching devices – Contactors and contactor assemblies – for switching motors

Power contactors for switching motors

SIRIUS 3RT contactors, 3-pole up to 250 kW

Type	Contactors				
Size	3RT2015	3RT2016	3RT2017	3RT2018	
Rated data of the main contacts					
Load rating with AC					
Utilization category AC-3 and AC-3e					
• Rated operational currents I_e	up to 400 V A	7	9	12	16
	440 V A	7	9	11	14
	500 V A	6	7.7	9.2	12.4
	690 V A	4.9	6.7		8.9
• Rated power for slip-ring or squirrel-cage motors at 50 and 60 Hz	at 230 V kW	1.5	2.2	3	4
	400 V kW	3	4	5.5	7.5
	690 V kW	4	5.5		7.5
Thermal load capacity	10 s current A	56	72	96	128
Power loss per main conducting path	at $I_e/AC-3/AC-3e/400 V$ W	0.2	0.3	0.5	1
Utilization category AC-4 (at $I_a = 6 \times I_e$)¹⁾					
• Maximum values					
- Rated operational current I_e	up to 400 V A	6.5	8.5		11.5
- Rated power for squirrel-cage motors at 50 Hz and 60 Hz	up to 400 V kW	3	4		5.5
• The following applies to a contact endurance of about 200 000 operating cycles:					
- Rated operational currents I_e	up to 400 V A	2.6	4.1		5.5
	690 V A	1.8	3.3		4.4
- Rated power for squirrel-cage motors at 50 Hz and 60 Hz	at 230 V kW	0.67	1.1		1.5
	400 V kW	1.15	2		2.5
	690 V kW	1.15	2.5		3.5

¹⁾ The data applies to 3RT2516 and 3RT2517 contactors (2 NO + 2 NC) up to a rated operational voltage of 400 V only.

Type	Contactors	
Size	3RT2015 to 3RT2018	
Conductor cross-sections		
Main conductors, auxiliary conductors and coil terminals (1 or 2 conductors can be connected)		
		 Screw terminals
• Solid or stranded	mm ²	2 x (0.5 ... 1.5) ¹⁾ ; 2 x (0.75 ... 2.5) ¹⁾ ; max. 2 x 4
• Finely stranded with end sleeve (DIN 46228)	mm ²	2 x (0.5 ... 1.5) ¹⁾ ; 2 x (0.75 ... 2.5) ¹⁾
• AWG cables, solid or stranded	AWG	2 x (20 ... 16) ¹⁾ ; 2 x (18 ... 14) ¹⁾ ; 2 x 12
• Terminal screw		M3 (for Pozidriv size 2; Ø 5 ... 6 mm)
• Tightening torque	Nm	0.8 ... 1.2 (7 ... 10.3 lb.in)
Main conductors, auxiliary conductors and coil terminals²⁾ (1 or 2 conductors can be connected)		
		 Spring-loaded terminals
• Operating devices	mm	3.0 x 0.5
• Solid or stranded	mm ²	2 x (0.5 ... 4)
• Finely stranded with end sleeve (DIN 46228)	mm ²	2 x (0.5 ... 2.5)
• Finely stranded without end sleeve	mm ²	2 x (0.5 ... 2.5)
• AWG cables, solid or stranded	AWG	2 x (20 ... 12)
Auxiliary conductors for front and laterally mounted auxiliary switches²⁾ (1 or 2 conductors can be connected)		
• Operating devices	mm	3.0 x 0.5
• Solid or stranded	mm ²	2 x (0.5 ... 2.5)
• Finely stranded with end sleeve (DIN 46228)	mm ²	2 x (0.5 ... 1.5)
• Finely stranded without end sleeve	mm ²	2 x (0.5 ... 2.5)
• AWG cables, solid or stranded	AWG	2 x (20 ... 14)



¹⁾ If two different conductor cross-sections are connected to one clamping point, both cross-sections must lie in one of the ranges specified.

²⁾ Max. outer diameter of the conductor insulation: 3.6 mm. On spring-loaded terminals with conductor cross-sections $\leq 1 \text{ mm}^2$ an insulation stop is recommended, see page 3/121.

Switching devices – Contactors and contactor assemblies – for switching motors

Power contactors for switching motors

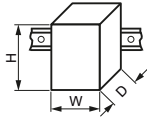
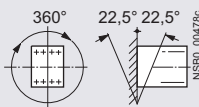
SIRIUS 3RT contactors, 3-pole up to 250 kW

		Contactors	
		3RT2023 to 3RT2025	3RT2026 to 3RT2028
Type		S0	
Size			
General data			
Dimensions (W x H x D)			
<u>AC operation</u>			
• Basic unit		mm	45 x 85 x 97
- Screw terminals		mm	45 x 102 x 97
- Spring-loaded terminals			
• Basic unit with mounted auxiliary switch		mm	45 x 85 x 141
- Screw terminals		mm	45 x 102 x 145
- Spring-loaded terminals			
• Basic unit with mounted function module or solid-state time-delay auxiliary switch		mm	45 x 85 x 171
- Screw terminals		mm	45 x 102 x 171
- Spring-loaded terminals			
<u>DC operation</u>			
• Basic unit		mm	45 x 85 x 107
- Screw terminals		mm	45 x 102 x 107
- Spring-loaded terminals			
• Basic unit with mounted auxiliary switch		mm	45 x 85 x 151
- Screw terminals		mm	45 x 102 x 155
- Spring-loaded terminals			
• Basic unit with mounted function module or solid-state time-delay auxiliary switch		mm	45 x 85 x 181
- Screw terminals		mm	45 x 102 x 181
- Spring-loaded terminals			
Permissible mounting position			
The contactors are designed for operation on a vertical mounting surface.			
Upright mounting position		 NSB0_00477a	
		Special version required, also applies for 3RT202.-.K.40 coupling contactors	
Mechanical endurance			
• Basic unit and basic unit with mounted auxiliary switch	Operating cycles	10 million	
• Basic unit with solid-state compatible auxiliary switch	Operating cycles	5 million	
Electrical endurance			
		Contact endurance of the main contacts, see page 3/27 .	
Rated insulation voltage U_i (pollution degree 3)		V	690
Rated impulse withstand voltage U_{imp}			
• Auxiliary circuit	kV	6	
• Main circuit	kV	6	
Protective separation between the coil and the main contacts (according to IEC 60947-1, Annex N)		V	400
Mirror contacts			
A mirror contact is an auxiliary NC contact that cannot be closed simultaneously with an NO main contact.			
• Integrated auxiliary switches		Yes, according to IEC 60947-4-1, Annex F	
• 3RT2.2. (removable auxiliary switch)		Yes, according to IEC 60947-4-1, Annex F	
Permissible ambient temperature			
• During operation	°C	-25 ... +60	
• During storage	°C	-55 ... +80	

Switching devices – Contactors and contactor assemblies – for switching motors

Power contactors for switching motors

SIRIUS 3RT contactors, 3-pole up to 250 kW

Type	Contactors			
Size	3RT2023 to 3RT2025	3RT2026	3RT2027, 3RT2028	
S0				
Short-circuit protection				
Main circuit				
• Fuse links, operational class gG: LV HRC, type 3NA; DIAZED, type 5SB; NEOZED, type 5SE according to IEC 60947-4-1	A	63	100	125
- Type of coordination "1"	A	25	35	50
- Type of coordination "2"	A	10	16	
- Weld-free (test conditions according to IEC 60947-4-1)	A	25	32	40
• Miniature circuit breaker with C characteristic (short-circuit current 3 kA, type of coordination "1")	A	25		
Auxiliary circuit				
• Fuse links, operational class gG: DIAZED, type 5SB; NEOZED, type 5SE (weld-free protection at $I_k \leq 1$ kA)	A	10		
• 230 V miniature circuit breaker, C characteristic (short-circuit current $I_k < 400$ A)	A	10		
Short-circuit protection for contactors with overload relays	see			
	• Digital Configuration Manual for load feeders			
	• Configuration Manual for load feeders			
Short-circuit protection for fuseless load feeders	See 3RA2 load feeders, page 8/5 onwards			

Type	Contactors				
Size	3RT2023 to 3RT2025	3RT2026 to 3RT2028	3RT202.-.NB3	3RT202.-.NF3	3RT202.-.NP3
S0					
Control					
Type of operating mechanism		AC or DC		AC/DC	
Solenoid coil operating range		AC/DC		0.8 ... 1.1 x U_s ¹⁾	
Power consumption of the solenoid coils (for cold coil and 1.0 x U_s)					
• AC operation, 50 Hz, standard version					
- Closing power	VA	65	77	6.6	11.9
- P.f.		0.82		0.98	
- Holding power	VA	7.6	9.8	1.9	3.9
- P.f.		0.25		0.86	0.51
• AC operation, 50/60 Hz, standard version					
- Closing power	VA	68/67	81/79	6.6/6.7	11.9/12.0
- P.f.		0.72/0.74		0.98/0.98	
- Holding power	VA	7.9/6.5	10.5/8.5	1.9/2.0	3.9/4.3
- P.f.		0.25/0.28		0.86/0.82	0.51/0.56
• AC operation, 50 Hz, for USA/Canada					
- Closing power	VA	65	77	--	
- P.f.		0.82	0.82	--	
- Holding power	VA	7 ³⁾ /7.6	9.8	--	
- P.f.		0.25	0.28	--	
• AC operation, 60 Hz, for USA/Canada					
- Closing power	VA	73	87	--	
- P.f.		0.76		--	
- Holding power	VA	7.2	9.4	--	
- P.f.		0.28		--	
• DC operation (closing power = holding power)	W	5.9/5.9		5.9/1.4	10.2/1.3
Permissible residual current of the electronics (with 0 signal)					
• AC operation	mA	< 6 mA x (230 V/ U_s)		< 7 mA x (230 V/ U_s)	
• DC operation	mA	< 16 mA x (24 V/ U_s)			
1) Coil operating range		2) The following applies to $U_{s \max} = 280$ V: upper limit = 1.1 x $U_{s \max}$.			
- at 50 Hz: 0.8 to 1.1 x U_s ,		3) Value applies to 3RT2023 contactor 50 Hz AC.			
- at 60 Hz: 0.85 to 1.1 x U_s .					

Type	Coupling contactors	
Size	3RT202.-.KB4.	S0
Control		
Solenoid coil operating range	0.7 ... 1.25 x U_s	
Power consumption of the solenoid coils (for cold coil) Switch-on power = holding power	at U_s 24 V DC W 4.5	
Permissible residual current of the electronics (with 0 signal)	< 10 mA x (24 V/ U_s)	
Overvoltage configuration of the solenoid coil	Integrated varistor	
		

Switching devices – Contactors and contactor assemblies – for switching motors

Power contactors for switching motors

SIRIUS 3RT contactors, 3-pole up to 250 kW

Type Size	Contactors						
	3RT2023	3RT2024	3RT2025	3RT2026	3RT2027	3RT2028	
Rated data of the main contacts							
Load rating with AC							
Utilization category AC-3 and AC-3e							
• Rated operational currents I_e	up to 400 V A	9	12	17	25	32	38
	440 V A	9	12	17	22	32	35
	500 V A	9	12	17	18	32	
	690 V A	9		13		21	
• Rated power for slip-ring or squirrel-cage motors at 50 and 60 Hz	at 230 V kW	2.2	3	4	5.5	7.5	11
	400 V kW	4	5.5	7.5	11	15	18.5
	690 V kW	7.5		11		18.5	
Thermal load capacity	10 s current A	80	110	150	200	260	304
Power loss per main conducting path	at $I_e/AC-3/AC-3e/400 V$ W	0.2	0.3	0.6	1.9	2.3	3.2
Utilization category AC-4 (at $I_a = 6 \times I_e$)							
• Maximum values:							
- Rated operational current I_e	up to 400 V A	8.5	12.5	15.5		22	
- Rated power for squirrel-cage motors at 50 Hz and 60 Hz	at 400 V kW	4	5.5	7.5		11	
• The following applies to a contact endurance of about 200 000 operating cycles:							
- Rated operational currents I_e	up to 400 V A	4.1	5.5	7.7	9	12	
	690 V A	3.3	5.5	7.7	9	12	
- Rated power for squirrel-cage motors at 50 Hz and 60 Hz	at 110 V kW	0.5	0.73	1	1.2	1.6	
	230 V kW	1.1	1.5	2	2.5	3.4	
	400 V kW	2	2.6	3.5	4.4	6	
	690 V kW	2.5	4.6	6	7.7	10.3	

Type Size	Contactors	
	3RT2023 to 3RT2028	S0
Conductor cross-sections		
Main conductors (1 or 2 conductors can be connected)		
• Solid or stranded	mm ²	2 x (1 ... 2.5) ¹ ; 2 x (2.5 ... 10) ¹
• Finely stranded with end sleeve (DIN 46228)	mm ²	2 x (1 ... 2.5) ¹ ; 2 x (2.5 ... 6) ¹ ; 1 x 10
• AWG cables, solid or stranded	AWG	2 x (16 ... 12) ¹ ; 2 x (14 ... 8) ¹
• Terminal screws - Tightening torque	Nm	M4 (for Pozidriv size 2; Ø 5 ... 6 mm) 2 ... 2.5 (18 ... 22 lb.in)
Auxiliary conductors (1 or 2 conductors can be connected)		
• Solid or stranded	mm ²	2 x (0.5 ... 1.5) ¹ ; 2 x (0.75 ... 2.5) ¹
• Finely stranded with end sleeve (DIN 46228)	mm ²	2 x (0.5 ... 1.5) ¹ ; 2 x (0.75 ... 2.5) ¹
• AWG cables, solid or stranded	AWG	2 x (20 ... 16) ¹ ; 2 x (18 ... 14) ¹
• Terminal screws - Tightening torque	Nm	M3 (for Pozidriv size 2; Ø 5 ... 6 mm) 0.8 ... 1.2 (7 ... 10.3 lb.in)
Main conductors²⁾ (1 or 2 conductors can be connected)		
• Operating devices	mm	3.0 x 0.5
• Solid or stranded	mm ²	2 x (1 ... 10)
• Finely stranded with end sleeve (DIN 46228)	mm ²	2 x (1 ... 6)
• Finely stranded without end sleeve	mm ²	2 x (1 ... 6)
• AWG cables, solid or stranded	AWG	2 x (18 ... 8)
Auxiliary conductors²⁾ (1 or 2 conductors can be connected)		
• Operating devices		3.0 x 0.5
• Solid or stranded	mm ²	2 x (0.5 ... 2.5)
• Finely stranded with end sleeve (DIN 46228)	mm ²	2 x (0.5 ... 1.5)
• Finely stranded without end sleeve	mm ²	2 x (0.5 ... 2.5)
• AWG cables, solid or stranded	AWG	2 x (20 ... 14)

¹⁾ If two different conductor cross-sections are connected to one clamping point, both cross-sections must lie in one of the ranges specified.

²⁾ Max. outer diameter of the conductor insulation: 6.4 mm. On spring-loaded terminals with conductor cross-sections ≤ 1 mm² an insulation stop is recommended, see page 3/121.

Switching devices – Contactors and contactor assemblies – for switching motors

Power contactors for switching motors

SIRIUS 3RT contactors, 3-pole up to 250 kW

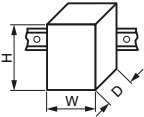
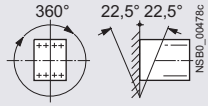
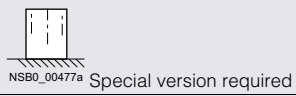
Type Size	Contactors				
	3RT2035	3RT2036	3RT2037	3RT2038	
General data					
Dimensions (W x H x D)					
<ul style="list-style-type: none"> Basic unit <ul style="list-style-type: none"> Screw/spring-loaded terminals Basic unit with mounted auxiliary switch <ul style="list-style-type: none"> Screw terminals Spring-loaded terminals Basic unit with mounted function module or solid-state time-delay auxiliary switch <ul style="list-style-type: none"> Screw/spring-loaded terminals 		mm	55 x 114 x 130		
		mm	55 x 114 x 174		
		mm	55 x 114 x 178		
		mm	55 x 114 x 204		
Permissible mounting position					
The contactors are designed for operation on a vertical mounting surface.					
Upright mounting position					
Mechanical endurance					
<ul style="list-style-type: none"> Basic units and basic units with mounted auxiliary switch 	Operating cycles	10 million (3RT203.-S.30: 5 million)			
<ul style="list-style-type: none"> Basic units with solid-state compatible auxiliary switch 	Operating cycles	5 million			
Electrical endurance					
Contact endurance of the main contacts, see page 3/28 .					
Rated insulation voltage U_i (pollution degree 3)		V	690		
Rated impulse withstand voltage U_{imp}					
<ul style="list-style-type: none"> Auxiliary circuit 	kV	6			
<ul style="list-style-type: none"> Main circuit 	kV	6			
Protective separation between the coil and the main contacts (according to IEC 60947-1, Annex N)		V	400		
Mirror contacts					
A mirror contact is an auxiliary NC contact that cannot be closed simultaneously with an NO main contact.					
<ul style="list-style-type: none"> Integrated auxiliary switches 3RT2.3. (removable auxiliary switch) 	Yes, according to IEC 60947-4-1, Annex F Yes, according to IEC 60947-4-1, Annex F				
Permissible ambient temperature					
<ul style="list-style-type: none"> During operation 	°C	-25 ... +60			
<ul style="list-style-type: none"> During storage 	°C	-55 ... +80			
Short-circuit protection					
Main circuit					
<ul style="list-style-type: none"> Fuse links, operational class gG: LV HRC, type 3NA; DIAZED, type 5SB; NEOZED, type 5SE according to IEC 60947-4-1 <ul style="list-style-type: none"> Type of coordination "1" Type of coordination "2" Weld-free (test conditions according to IEC 60947-4-1) 					
	A	160		250	
	A	80		125	
	A	16	25	50	
Auxiliary circuit					
<ul style="list-style-type: none"> Fuse links, operational class gG: DIAZED, type 5SB; NEOZED, type 5SE (weld-free protection at $I_k \leq 1$ kA) 	A	10			
<ul style="list-style-type: none"> 230 V miniature circuit breaker, C characteristic (short-circuit current $I_k < 400$ A) 	A	10			
Short-circuit protection for contactors with overload relays		see			
		<ul style="list-style-type: none"> Digital Configuration Manual for load feeders Configuration Manual for load feeders 			
Short-circuit protection for fuseless load feeders		See 3RA2 load feeders, page 8/5 onwards			

Switching devices – Contactors and contactor assemblies – for switching motors

Power contactors for switching motors

SIRIUS 3RT contactors, 3-pole up to 250 kW

Type	Contactors			Coupling contactors
	3RT203.-A..., 3RT203.-C...	3RT203.-N.3.	3RT203.-S.3.	3RT203.-KB4.
Size	S2			
Control				
Type of operating mechanism	AC	AC/DC	DC	
Solenoid coil operating range				
• AC operation ¹⁾	0.8 ... 1.1 x U_s	--		
• AC/DC operation ¹⁾	--	0.8 ... 1.1 x U_s		
• DC operation	--	--	0.8 ... 1.2 x U_s	
Power consumption of the solenoid coils (for cold coil and 1.0 x U_s)				
• AC operation, 50 Hz, standard version				
- Closing power	VA	190	--	--
- P.f.		0.72	--	--
- Holding power	VA	16	--	--
- P.f.		0.37	--	--
• AC operation, 50/60 Hz, standard version				
- Closing power	VA	210/188	--	--
- P.f.		0.69/0.65	--	--
- Holding power	VA	17.2/16.5	--	--
- P.f.		0.36/0.39	--	--
• AC operation, 60 Hz, for USA/Canada				
- Closing power	VA	212	--	--
- P.f.		0.67	--	--
- Holding power	VA	18.5	--	--
- P.f.		0.37	--	--
• AC/DC operation				
- Closing power for AC operation	VA	--	40	--
- P.f.		--	0.95	--
- Holding power for AC operation	VA	--	2	--
- P.f.		--	0.95	--
- Closing power for DC operation	VA	--	23 ²⁾	0.7
- Holding power for DC operation	VA	--	1	40
• DC operation				
- Closing power for DC operation	W	--	--	21.5 ³⁾
- Holding power for DC operation	W	--	--	1
Permissible residual current of the electronics (with 0 signal)				
• AC/DC operation	mA	--	< 20	--
• DC operation	mA	--	--	< 20
Overvoltage configuration of the solenoid coil	--	Integrated varistor 		
PLC control input according to IEC 60947-1				
• Solid-state operating mechanism		--	Type 1	--
• Rated voltage	V DC	--	24	--
• Operating range	V DC	--	17 ... 30	--
• Power consumption	mA	--	≤ 30	--
• Recovery time after power failure, typical	s	--	2	--

¹⁾ Coil operating range
 - at 50 Hz: 0.8 to 1.1 x U_s ,
 - at 60 Hz: 0.85 to 1.1 x U_s .

²⁾ In the case of AC/DC coils, increased pickup currents (2.6 A on average) arise during the first 230 ms. For direct control by PLC, we therefore recommend special coupling contactors with reduced power consumption. The connection of one 3RT203.-KB4. coupling contactor is possible per PLC output port with an output current of 2 A, see page 3/61.

³⁾ In the case of DC coils, increased pickup currents (2.1 A on average) arise during the first 230 ms.

Switching devices – Contactors and contactor assemblies – for switching motors

Power contactors for switching motors

SIRIUS 3RT contactors, 3-pole up to 250 kW

Type	Contactors					
Size	3RT2035	3RT2036	3RT2037	3RT2038		
S2						
Rated data of the main contacts						
Load rating with AC						
Utilization category AC-3 and AC-3e						
• Rated operational currents I_e	up to 400 V	A	41	51	65	80
	440 V	A	41	51	65	80
	500 V	A	41	51	65	80
	690 V	A	24		47	58
• Rated power for slip-ring or squirrel-cage motors at 50 Hz and 60 Hz	at 230 V	kW	11	15	18.5	22
	400 V	kW	18.5	22	30	37
	690 V	kW	22		37	45
Thermal load capacity	10 s current	A	400	420	520	640
Power loss per main conducting path	at I_e /AC-3/ AC-3e/400 V	W	2.2	4	3.8	5.7
Utilization category AC-4 (at $I_a = 6 \times I_e$)						
• Maximum values						
- Rated operational current I_e	up to 400 V	A	35	41	55	
- Rated power for squirrel-cage motors at 50 Hz and 60 Hz	at 400 V	kW	18.5	22	30	
• The following applies to a contact endurance of about 200 000 operating cycles:						
- Rated operational currents I_e	up to 400 V	A	22	24	28	30
	690 V	A	18.5	20	22	24
- Rated power for squirrel-cage motors at 50 Hz and 60 Hz	at 110 V	kW	3.2	3.5	4.1	4.3
	230 V	kW	6.7	7.3	8.5	9.1
	400 V	kW	11.6	12.6	14.7	15.8
	690 V	kW	16.8	18.2	20	21.8

Type	Contactors	
Size	3RT2035 to 3RT2038	
S2		
Conductor cross-sections		
Main conductors (1 or 2 conductors can be connected)		
• Solid or stranded	mm ²	2 x (1 ... 35) ¹⁾ ; 1 x (1 ... 50) ¹⁾
• Finely stranded with end sleeve (DIN 46228)	mm ²	2 x (1 ... 25) ¹⁾ ; 1 x (1 ... 35) ¹⁾
• AWG cables, solid or stranded	AWG	2 x (18 ... 2) ¹⁾ ; 1 x (18 ... 1) ¹⁾
• Terminal screws		Pozidriv size 2; Ø 5 ... 6 mm
- Tightening torque	Nm	3 ... 4.5 (27 ... 40 lb.in)
Auxiliary conductors and control conductors (1 or 2 conductors can be connected)		
• Solid or stranded	mm ²	2 x (0.5 ... 1.5) ¹⁾ ; 2 x (0.75 ... 2.5) ¹⁾
• Finely stranded with end sleeve (DIN 46228)	mm ²	2 x (0.5 ... 1.5) ¹⁾ ; 2 x (0.75 ... 2.5) ¹⁾
• AWG cables, solid or stranded	AWG	2 x (20 ... 16) ¹⁾ ; 2 x (18 ... 14) ¹⁾
• Terminal screws		M3 (for Pozidriv size 2; Ø 5 ... 6 mm)
- Tightening torque	Nm	0.8 ... 1.2 (7 ... 10.3 lb.in)
Auxiliary and control conductors²⁾ (1 or 2 conductors can be connected)		
• Operating devices	mm	3.0 x 0.5
• Solid or stranded	mm ²	2 x (0.5 ... 2.5)
• Finely stranded with end sleeve (DIN 46228)	mm ²	2 x (0.5 ... 1.5)
• Finely stranded without end sleeve	mm ²	2 x (0.5 ... 2.5)
• AWG cables, solid or stranded	AWG	2 x (20 ... 14)



¹⁾ If two different conductor cross-sections are connected to one clamping point, both cross-sections must lie in one of the ranges specified.

²⁾ Max. outer diameter of the conductor insulation: 3.6 mm.
On spring-loaded terminals with conductor cross-sections ≤ 1 mm² an insulation stop is recommended, see page 3/121.

Switching devices – Contactors and contactor assemblies – for switching motors

Power contactors for switching motors

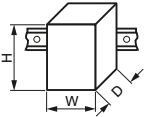
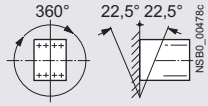
SIRIUS 3RT contactors, 3-pole up to 250 kW

Type Size	Contactors		
	3RT2045 S3	3RT2046	3RT2047
General data			
Dimensions (W x H x D)			
<ul style="list-style-type: none"> Basic unit - Screw/spring-loaded terminals 		mm	70 x 140 x 152
<ul style="list-style-type: none"> Basic unit with mounted auxiliary switch - Screw terminals - Spring-loaded terminals 		mm mm	70 x 140 x 196 70 x 140 x 200
<ul style="list-style-type: none"> Basic unit with mounted function module or solid-state time-delay auxiliary switch - Screw/spring-loaded terminals 		mm	70 x 140 x 226
Permissible mounting position			
The contactors are designed for operation on a vertical mounting surface.			
Upright mounting position		 NSB0_00477a Special version required	
Mechanical endurance			
<ul style="list-style-type: none"> Basic units and basic units with mounted auxiliary switch 	Operating cycles	10 million	
<ul style="list-style-type: none"> Basic units with solid-state compatible auxiliary switch 	Operating cycles	5 million	
Electrical endurance			
Contact endurance of the main contacts, see page 3/28 .			
Rated insulation voltage U_i (pollution degree 3)	V	1 000 (3RT20...-.....-OCC0: 690)	
Rated impulse withstand voltage U_{imp}			
<ul style="list-style-type: none"> Auxiliary circuit 	kV	6	
<ul style="list-style-type: none"> Main circuit 	kV	8	
Protective separation between the coil and the main contacts (according to IEC 60947-1, Annex N)	V	690	
Mirror contacts			
A mirror contact is an auxiliary NC contact that cannot be closed simultaneously with an NO main contact.			
<ul style="list-style-type: none"> Integrated auxiliary switches 3RT2.4. (removable auxiliary switch) 	Yes, according to IEC 60947-4-1, Annex F Yes, according to IEC 60947-4-1, Annex F		
Permissible ambient temperature			
<ul style="list-style-type: none"> During operation 	°C	-25 ... +60	
<ul style="list-style-type: none"> During storage 	°C	-55 ... +80	
Short-circuit protection			
Main circuit			
<ul style="list-style-type: none"> Fuse links, operational class gG: LV HRC, type 3NA; DIAZED, type 5SB; NEOZED, type 5SE according to IEC 60947-4-1 			
<ul style="list-style-type: none"> - Type of coordination "1" 	A	250	
<ul style="list-style-type: none"> - Type of coordination "2" 	A	160	160
<ul style="list-style-type: none"> - Weld-free (test conditions according to IEC 60947-4-1) 	A	80	100
Auxiliary circuit			
<ul style="list-style-type: none"> Fuse links, operational class gG: DIAZED, type 5SB; NEOZED, type 5SE (weld-free protection at $I_k \leq 1$ kA) 	A	10	
<ul style="list-style-type: none"> 230 V miniature circuit breaker, C characteristic (short-circuit current $I_k < 400$ A) 	A	10	
Short-circuit protection for contactors with overload relays	see		
	<ul style="list-style-type: none"> Digital Configuration Manual for load feeders Configuration Manual for load feeders 		
Short-circuit protection for fuseless load feeders	See 3RA2 load feeders, page 8/5 onwards		

Switching devices – Contactors and contactor assemblies – for switching motors

Power contactors for switching motors

SIRIUS 3RT contactors, 3-pole up to 250 kW

Type	Contactors			Coupling contactors
	3RT204.-.A..., 3RT204.-.C...	3RT204.-.N.3.	3RT204.-.S.3.	3RT204.-.KB4.
Size	S3			
Control				
Type of operating mechanism	AC	AC/DC	DC	
Solenoid coil operating range				
• AC operation ¹⁾	0.8 ... 1.1 x U _s	--		
• AC/DC operation ¹⁾	--	0.8 ... 1.1 x U _s		
• DC operation	--	--	0.8 ... 1.2 x U _s	
Power consumption of the solenoid coils (for cold coil and 1.0 x U _s)				
• AC operation, 50 Hz, standard version				
- Closing power	VA	296	--	--
- P.f.		0.61	--	--
- Holding power	VA	19	--	--
- P.f.		0.38	--	--
• AC operation, 50/60 Hz, standard version				
- Closing power	VA	348/296	--	--
- P.f.		0.62/0.55	--	--
- Holding power	VA	25/18	--	--
- P.f.		0.35/0.41	--	--
• AC operation, 60 Hz, for USA/Canada				
- Closing power	VA	326	--	--
- P.f.		0.62	--	--
- Holding power	VA	22	--	--
- P.f.		0.38	--	--
• AC/DC operation				
- Closing power for AC operation	VA	--	163	130
- P.f.		--	0.95	--
- Holding power for AC operation	VA	--	3.1	2.4
- P.f.		--	0.95	0.7
- Closing power for DC operation	VA	--	76 ²⁾	130
- Holding power for DC operation	VA	--	1.8	--
• DC operation				
- Closing power for DC operation	W	--	--	25 ³⁾
- Holding power for DC operation	W	--	--	0.9
Permissible residual current of the electronics (with 0 signal)				
• AC/DC operation	mA	--	< 20	--
• DC operation	mA	--	--	< 20
Overvoltage configuration of the solenoid coil	--	Integrated varistor 		
PLC control input according to IEC 60947-1				
• Solid-state operating mechanism	--	--	Type 1	--
• Rated voltage	V DC	--	24	--
• Operating range	V DC	--	17 ... 30	--
• Power consumption	mA	--	≤ 30	--
• Recovery time after power failure, typical	s	--	2	--

¹⁾ Coil operating range
 - at 50 Hz: 0.8 to 1.1 x U_s,
 - at 60 Hz: 0.85 to 1.1 x U_s.

²⁾ In the case of AC/DC coils, increased pickup currents (6.5 A on average) arise during the first 150 ms. For direct control by PLC, we therefore recommend special coupling contactors with reduced power consumption. The connection of one 3RT204.-.KB4. coupling contactor is possible per PLC output port with an output current of 2 A, see page 3/61.

³⁾ In the case of DC coils, increased pickup currents (2.1 A on average) arise during the first 150 ms.

Switching devices – Contactors and contactor assemblies – for switching motors

Power contactors for switching motors

SIRIUS 3RT contactors, 3-pole up to 250 kW

Type	Contactors			
Size	3RT2045	3RT2046	3RT2047	
Rated data of the main contacts				
Load rating with AC				
Utilization category AC-3 and AC-3e				
• Rated operational currents I_e	up to 400 V A	80	95	110
	500 V A	80	95	110
	690 V A	58	78	98
	1 000 V A	30		
• Rated power for slip-ring or squirrel-cage motors at 50 and 60 Hz	at 230 V kW	22	22	30
	400 V kW	37	45	55
	690 V kW	55	75	90
	1 000 V kW	37		
Thermal load capacity	10 s current A	760		880
Power loss per main conducting path	at $I_e/AC-3/AC-3e/400 V$	5.3	6.6	7.9
Utilization category AC-4 (at $I_a = 6 \times I_e$)				
• Maximum values				
- Rated operational current I_e	up to 400 V A	66	80	97
- Rated power for squirrel-cage motors at 50 Hz and 60 Hz	at 400 V kW	37	45	55
• The following applies to a contact endurance of about 200 000 operating cycles:				
- Rated operational currents I_e	up to 400 V A	34	42	46
	690 V A	24	30	36
- Rated power for squirrel-cage motors at 50 Hz and 60 Hz	at 110 V kW	4.9	6.1	6.7
	230 V kW	10.4	12	14
	400 V kW	17.9	22	24.3
	690 V kW	21.8	27.4	32.9

Type	Contactors	
Size	3RT2045 to 3RT2047	
Conductor cross-sections		
Main conductors (1 or 2 conductors can be connected)		
• Solid	mm ²	2 x (2.5 ... 16) ¹⁾
• Stranded	mm ²	2 x (6 ... 16) ¹⁾ ; 2 x (10 ... 50) ¹⁾ ; 1 x (10 ... 70) ¹⁾
• Finely stranded with end sleeve (DIN 46228)	mm ²	2 x (2.5 ... 35) ¹⁾ ; 1 x (2.5 ... 50) ¹⁾
• AWG cables, solid or stranded	AWG	2 x (10 ... 1/0) ¹⁾ ; 1 x (10 ... 2/0) ¹⁾
• Terminal screws		Hexagon socket, A/F 4
- Tightening torque	Nm	4.5 ... 6 (40 ... 53 lb.in)
Auxiliary conductors and control conductors (1 or 2 conductors can be connected)		
• Solid or stranded	mm ²	2 x (0.5 ... 1.5) ¹⁾ ; 2 x (0.75 ... 2.5) ¹⁾
• Finely stranded with end sleeve (DIN 46228)	mm ²	2 x (0.5 ... 1.5) ¹⁾ ; 2 x (0.75 ... 2.5) ¹⁾
• AWG cables, solid or stranded	AWG	2 x (20 ... 16) ¹⁾ ; 2 x (18 ... 14) ¹⁾
• Terminal screws		M3 (for Pozidriv size 2; \varnothing 5 ... 6 mm)
- Tightening torque	Nm	0.8 ... 1.2 (7 ... 10.3 lb.in)
Auxiliary and control conductors²⁾ (1 or 2 conductors can be connected)		
• Operating devices	mm	3.0 x 0.5
• Solid or stranded	mm ²	2 x (0.5 ... 2.5)
• Finely stranded with end sleeve (DIN 46228)	mm ²	2 x (0.5 ... 1.5)
• Finely stranded without end sleeve	mm ²	2 x (0.5 ... 2.5)
• AWG cables, solid or stranded	AWG	2 x (20 ... 16)

¹⁾ If two different conductor cross-sections are connected to one clamping point, both cross-sections must lie in one of the ranges specified.

²⁾ Max. outer diameter of the conductor insulation: 3.6 mm.
On spring-loaded terminals with conductor cross-sections $\leq 1 \text{ mm}^2$ an insulation stop is recommended, see page 3/121.

Switching devices – Contactors and contactor assemblies – for switching motors

Power contactors for switching motors

SIRIUS 3RT contactors, 3-pole up to 250 kW

Type	Contactors					
	3RT1054	3RT1055, 3RT1056	3RT1064 to 3RT1066	3RT1075	3RT1076	
Size	S6		S10	S12		
General data						
Dimensions (W x H x D)						
<ul style="list-style-type: none"> Basic unit Basic unit with mounted auxiliary switch 			mm	120 x 172 x 170	145 x 210 x 202	160 x 214 x 225
			mm	120 x 172 x 217	145 x 210 x 251	160 x 214 x 271
Permissible mounting position						
The contactors are designed for operation on a vertical mounting surface.						
Mechanical endurance						
	Operating cycles	10 million				
Electrical endurance						
Contact endurance of the main contacts, see page 3/28 .						
Rated insulation voltage U_i (pollution degree 3)						
	V	1 000				
Rated impulse withstand voltage U_{imp}						
<ul style="list-style-type: none"> Auxiliary circuit Main circuit 	kV	6				
	kV	8				
Protective separation between the coil and the main contacts according to IEC 60947-1, Annex N						
	V	690				
Mirror contacts						
A mirror contact is an auxiliary NC contact that cannot be closed simultaneously with an NO main contact.			Yes, according to IEC 60947-4-1, Annex F			
Permissible ambient temperature						
<ul style="list-style-type: none"> During operation During storage 	°C	-25 ... +60				
	°C	-55 ... +80				
Electromagnetic compatibility (EMC)						
see page 3/21						
Short-circuit protection						
Main circuit						
Fuse links, operational class gG: LV HRC, type 3NA; DIAZED, type 5SB; NEOZED, type 5SE according to IEC 60947-4-1						
<ul style="list-style-type: none"> Type of coordination "1" Type of coordination "2" Weld-free 	A	355		500	630	
	A	250	315	400	500	
	A	80	160	250		315
Auxiliary circuit						
Short-circuit test						
<ul style="list-style-type: none"> With fuse links of operational class gG: DIAZED, type 5SB; NEOZED, type 5SE with short-circuit current $I_k = 1$ kA according to IEC 60947-5-1 With miniature circuit breakers with C characteristic with short-circuit current $I_k = 400$ A 	A	10				
	A	10				
Short-circuit protection for contactors with overload relays						
see <ul style="list-style-type: none"> Digital Configuration Manual for load feeders Configuration Manual for load feeders 						

Switching devices – Contactors and contactor assemblies – for switching motors

Power contactors for switching motors

SIRIUS 3RT contactors, 3-pole up to 250 kW

Type Size	Contactors				
	3RT105. S6	3RT106. S10	3RT107. S12		
Control					
Operating range of the solenoid operating mechanism	AC/DC	0.8 x $U_{s \text{ min}}$... 1.1 x $U_{s \text{ max}}$			
Power consumption of the solenoid operating mechanism (with cold coil and rated range $U_{s \text{ min}}$... $U_{s \text{ max}}$)					
• Standard operating mechanism (3RT10...-A)					
- AC operation	Switch-on power at $U_{s \text{ min}}$ Switch-on power at $U_{s \text{ max}}$ Holding power at $U_{s \text{ min}}$ Holding power at $U_{s \text{ max}}$	VA/p.f. VA/p.f. VA/p.f. VA/p.f.	250/0.9 300/0.9 4.8/0.8 5.8/0.8	490/0.9 590/0.9 5.6/0.9 6.7/0.9	700/0.9 830/0.9 7.6/0.9 9.2/0.9
- DC operation	Switch-on power at $U_{s \text{ min}}$ Switch-on power at $U_{s \text{ max}}$ Holding power at $U_{s \text{ min}}$ Holding power at $U_{s \text{ max}}$	W W W W	300 360 4.3 5.2	540 650 6.1 7.4	770 920 8.5 10
• Solid-state operating mechanism (3RT10...-N/-P/-S)					
- AC operation	Switch-on power at $U_{s \text{ min}}$ Switch-on power at $U_{s \text{ max}}$ Holding power at $U_{s \text{ min}}$ Holding power at $U_{s \text{ max}}$	VA/p.f. VA/p.f. VA/p.f. VA/p.f.	190/0.8 280/0.8 3.5/0.6 4.8/0.6	400/0.8 530/0.8 5.5/0.5 8.5/0.4	560/0.8 750/0.8 5.6/0.5 9/0.4
- DC operation	Switch-on power at $U_{s \text{ min}}$ Switch-on power at $U_{s \text{ max}}$ Holding power at $U_{s \text{ min}}$ Holding power at $U_{s \text{ max}}$	W W W W	250 320 2.1 2.8	440 580 2.8 3.4	600 800 3 3.6
PLC control input according to IEC 60947-1					
• Solid-state operating mechanism	3RT10...-N/-P 3RT10...-S		Type 2 Type 1		
• Rated voltage		V DC	24		
• Operating range		V DC	17 ... 30		
• Power consumption		mA	≤ 30		
• Recovery time after power failure, typical (applicable only for fail-safe version 3RT10...-S)		s	2		

Switching devices – Contactors and contactor assemblies – for switching motors

Power contactors for switching motors





SIRIUS 3RT contactors, 3-pole up to 250 kW

Type Size	Contactors									
	3RT1054 S6	3RT1055	3RT1056	3RT1064 S10	3RT1065	3RT1066	3RT1075 S12	3RT1076		
Rated data of the main contacts										
Load rating with AC										
Utilization category AC-3 and AC-3e										
• Rated operational currents I_e	up to 500 V	A	115	150	185	225	265	300	400	500
	at 690 V	A	115	150	170	225	265	280	400	450
	at 1 000 V	A	53	65	65	68	95	95	180	180
• Rated power for slip-ring or squirrel-cage motors at 50 Hz and 60 Hz	at 230 V	kW	37	45	55	55	75	90	132	160
	at 400 V	kW	55	75	90	110	132	160	200	250
	at 500 V	kW	75	90	132	160	160	200	250	315
	at 690 V	kW	110	132	160	200	250	250	400	400
	at 1 000 V	kW	75	90	160	200	132	132	250	250
Thermal load capacity	10 s current	A	1 100	1 300	1 480	1 800	2 400		3 200	4 000
Power loss per main conducting path	at $I_e/AC-3/AC-3e/400 V$	W	7	9	13	17	18	22	35	55
Utilization category AC-4 (at $I_a = 6 \times I_e$)										
• Maximum values										
- Rated operational current I_e	up to 400 V	A	97	132	160	195	230	280	350	430
- Rated power for squirrel-cage motors at 50 Hz and 60 Hz	at 400 V	kW	55	75	90	110	132	160	200	250
• The following applies to a contact endurance of about 200 000 operating cycles:										
- Rated operational current I_e	up to 500 V	A	54	68	81	96	117	125	150	175
	up to 690 V	A	48	57	65	85	105	115	135	150
- Rated power for squirrel-cage motors at 50 Hz and 60 Hz	at 230 V	kW	16	20	25	30	37	40	48	56
	at 400 V	kW	29	38	45	54	66	71	85	98
	at 500 V	kW	37	47	57	67	82	87	105	123
	at 690 V	kW	48	55	65	82	102	112	133	148

Switching devices – Contactors and contactor assemblies – for switching motors

Power contactors for switching motors

SIRIUS 3RT contactors, 3-pole up to 250 kW

Type	Contactors			
Size	3RT105. S6	3RT106. S10	3RT107. S12	
Conductor cross-sections				
Main conductors (1 or 2 conductors can be connected)				
 Screw terminals				
With mounted box terminals				
Type	3RT1955-4G (55 kW)	3RT1956-4G	3RT1966-4G	
Terminal screws	M10 (hexagon socket, A/F 4)		M12 (hexagon socket, A/F 5)	
- Tightening torque	Nm 10 ... 12 lb.in 90 ... 110		Nm 20 ... 22 lb.in 180 ... 195	
Front clamping point connected				
	• Finely stranded with end sleeve (DIN 46228)	mm ² 16 ... 70	16 ... 120	
	• Finely stranded without end sleeve	mm ² 16 ... 70	16 ... 120	
	• Stranded	mm ² 16 ... 70	16 ... 120	
	• AWG cables, solid or stranded	AWG 6 ... 2/0	6 ... 250 kcmil	3/0 ... 600 kcmil
	• Ribbon cable conductors (number x width x thickness)	mm Min. 3 x 9 x 0,8, max. 6 x 15,5 x 0,8	Min. 3 x 9 x 0,8, max. 10 x 15,5 x 0,8	Min. 6 x 9 x 0,8, max. 20 x 24 x 0,5
Rear clamping point connected				
	• Finely stranded with end sleeve (DIN 46228)	mm ² 16 ... 70	16 ... 120	
	• Finely stranded without end sleeve	mm ² 16 ... 70	16 ... 120	
	• Stranded	mm ² 16 ... 70	16 ... 120	
	• AWG cables, solid or stranded	AWG 6 ... 2/0	6 ... 250 kcmil	250 ... 500 kcmil
	• Ribbon cable conductors (number x width x thickness)	mm Min. 3 x 9 x 0,8, max. 6 x 15,5 x 0,8	Min. 3 x 9 x 0,8, max. 10 x 15,5 x 0,8	Min. 6 x 9 x 0,8, max. 20 x 24 x 0,5
Both clamping points connected (minimum cross-section 16 mm²)				
	• Finely stranded with end sleeve (DIN 46228)	mm ² Max. 1 x 50, 1 x 70	Max. 1 x 95, 1 x 120	
	• Finely stranded without end sleeve	mm ² Max. 1 x 50, 1 x 70	Max. 1 x 95, 1 x 120	
	• Stranded	mm ² Max. 1 x 50, 1 x 70	Max. 1 x 95, 1 x 120	
	• AWG cables, solid or stranded	AWG Max. 2 x 1/0	Max. 2 x 3/0	Min. 2 x 2/0, max. 2 x 500 kcmil
	• Ribbon cable conductors (number x width x thickness)	mm Max. 2 x (6 x 15,5 x 0,8)	Max. 2 x (10 x 15,5 x 0,8)	Max. 2 x (20 x 24 x 0,5)
Busbar connections				
Connecting bar (max. width)	mm 17		25	
Cable lug connection				
• Finely stranded with cable lug ¹⁾²⁾	mm ² 16 ... 95		50 ... 240	
• Stranded with cable lug ¹⁾²⁾	mm ² 25 ... 120		70 ... 240	
• AWG cables, solid or stranded	AWG 4 ... 250 kcmil		2/0 ... 500 kcmil	
• Terminal screws	M8 x 25 (A/F 13)		M10 x 30 (A/F 17)	
- Tightening torque	Nm 10 ... 14 lb.in 90 ... 124		14 ... 24 124 ... 210	
Auxiliary conductors (1 or 2 conductors can be connected)				
• Solid	mm ² 2 x (0,5 ... 1,5) ³⁾ ; 2 x (0,75 ... 2,5) ³⁾ ; max. 2 x (0,75 ... 4) ³⁾			
• Finely stranded with end sleeve (DIN 46228)	mm ² 2 x (0,5 ... 1,5) ³⁾ ; 2 x (0,75 ... 2,5) ³⁾			
• AWG cables, solid or stranded	AWG 2 x (18 ... 14)			
• Terminal screws	M3 (Poizidriv size 2)			
- Tightening torque	Nm 0,8 ... 1,2 lb.in 7 ... 10,3			
Auxiliary conductors⁴⁾ (1 or 2 conductors can be connected)				
 Spring-loaded terminals				
• Operating devices		3,0 x 0,5; 3,5 x 0,5		
• Solid	mm ² 2 x (0,25 ... 2,5)			
• Finely stranded with end sleeve (DIN 46228)	mm ² 2 x (0,25 ... 1,5)			
• Finely stranded without end sleeve	mm ² 2 x (0,25 ... 2,5)			
• AWG cables, solid or stranded	AWG 2 x (24 ... 14)			

¹⁾ 3RT105.: When using cable lugs according to DIN 46235, use the 3RT1956-4EA1 terminal cover for conductor cross-sections from 95 mm² to maintain the phase clearance, see page 3/118.

²⁾ 3RT106. and 3RT107.: When connecting cable lugs according to DIN 46234 for conductor cross-sections larger than 240 mm² and according to DIN 46235 for conductor cross-sections larger than 185 mm², the 3RT1966-4EA1 terminal cover is required to maintain the phase clearance, see page 3/118.

³⁾ If two different conductor cross-sections are connected to one clamping point, both cross-sections must lie in one of the ranges specified.

⁴⁾ Max. outer diameter of the conductor insulation: 3.6 mm. On spring-loaded terminals with conductor cross-sections ≤ 1 mm² an insulation stop is recommended, see page 3/121.

Switching devices – Contactors and contactor assemblies – for switching motors

Power contactors for switching motors

SIRIUS 3RT contactors, 3-pole up to 250 kW

Data for North America

Type Size	Contactors				
	3RT2015 S00	3RT2016	3RT2017	3RT2018	
Ⓢ and Ⓛ rated data					
Rated operational voltage	V AC	600			
Uninterrupted current , at 40 °C, open and enclosed	A	20			
Maximum horsepower ratings (from Ⓢ and Ⓛ approved values)					
• Rated power for three-phase motors at 60 Hz	at 200 V hp	1.5	2	3	
	230 V hp	2	3		5
	460 V hp	3	5	7.5	10
	575 V hp	5	7.5	10	
Short-circuit protection (contactor)					
• Class J fuse (values for RK5 fuses available on request)	A	60			
• Circuit breakers according to UL 489 ("Inverse Time Breakers")	A	50			
• Combination Motor Controllers (Type E) according to UL 508 or UL 60947-4-1		3RV2.1 or 3RV2.2			

Type Size	Contactors							
	3RT2023 S0	3RT2024	3RT2025	3RT2026	3RT2326-.....-4AA0	3RT2027	3RT2028	
Ⓢ and Ⓛ rated data								
Rated operational voltage	V AC	600						
Uninterrupted current , at 40 °C, open and enclosed	A	30						42
Maximum horsepower ratings (from Ⓢ and Ⓛ approved values)								
• Rated power for three-phase motors at 60 Hz	at 200 V hp	2	3	5	5	3	10	
	230 V hp	3			7.5	5	10	
	460 V hp	5	7.5	10	15	10	20	
	575 V hp	7.5	10	15	20	15	25	
Short-circuit protection (contactor)								
• Class J fuse (values for RK5 fuses available on request)	A	125						150
• Circuit breakers according to UL 489 ("Inverse Time Breakers")	A	70						100
• Combination Motor Controllers (Type E) according to UL 508 or UL 60947-4-1	at 480 V Type	3RV202						
	at 600 V Type	3RV202						

Type Size	Contactors							
	3RT2035 S2	3RT2036, 3RT2336-.....-4AA0	3RT2037	3RT2038	3RT2045	3RT2046	3RT2047 S3	
Ⓢ and Ⓛ rated data								
Rated operational voltage	V AC	600						
Uninterrupted current , at 40 °C, open and enclosed	A	55	60	80	90	62	77	99
Maximum horsepower ratings (from Ⓢ and Ⓛ approved values)								
• Rated power for three-phase motors at 60 Hz	at 200/208 V hp	10	15	20		25	30	
	230/240 V hp	15		20	25	30		40
	460/480 V hp	30	40	50		60	75	
	575/600 V hp	40	50		60	60	75	100
Short-circuit protection (contactor)								
• RK5 fuse	A	150	200	250		300	350	
• Combination Motor Controllers (Type E) according to UL 508 or UL 60947-4-1	Type	3RV203				3RV204		

Switching devices – Contactors and contactor assemblies – for switching motors

Power contactors for switching motors

SIRIUS 3RT contactors, 3-pole up to 250 kW

Type Size	Contactors							
	3RT1054 S6	3RT1055	3RT1056	3RT1064 S10	3RT1065	3RT1066	3RT1075 S12	3RT1076
Ⓢ and Ⓜ rated data								
Rated operational voltage	V AC	600						
Uninterrupted current , at 40 °C, open and enclosed	A	140	195	250	330	400	540	
Maximum horsepower ratings (from Ⓢ and Ⓜ approved values)								
<ul style="list-style-type: none"> Rated power for three-phase motors 	at 200 V hp	40	50	60	75	100	125	150
	230 V hp	50	60	75	100	125	150	200
	460 V hp	100	125	150	200	250	300	400
	at 60 Hz 575 V hp	125	150	200	250	300	400	500
Short-circuit protection	For more information, see Certificate of Compliance for the individual devices . For the dimensioning of load feeders, see Configuration Manual .							

Type Size	Contactors			
	3RT201 S00	3RT202 to 3RT204 S0 to S3	Mountable auxiliary switch	3RT105 to 3RT107 S6 to S12
	Integrated or mountable auxiliary switch	Integrated	Mountable auxiliary switch	Mountable auxiliary switch
Ⓢ and Ⓜ rated data of the auxiliary contacts				
Rated voltage	V AC	600		
Switching capacity		A 600, Q 600	A 600, P 600	A 600, Q 600
<ul style="list-style-type: none"> Uninterrupted current at 240 V AC 	A	10		

Switching devices – Contactors and contactor assemblies – for switching motors

Power contactors for switching motors

AC-3e

IE3/IE4 ready

SIRIUS 3RT contactors, 3-pole up to 250 kW

Selection and ordering data

AC operation

PU (UNIT, SET, M) = 1
 PS* = 1 unit
 PG = 41B



3RT201.-1A...







3RT201.-2A...



3RT201.-1AP04-3MA0



3RT201.-2AP04-3MA0

Rated data		Auxiliary contacts	Rated control supply voltage U_s	Screw terminals 	Spring-loaded terminals 
AC-3 and AC-3e, t_u : 60 °C	AC-1, t_u : 40 °C	Ident. No.	50/60 Hz AC	Article No.	Article No.
Operational current I_e up to 400 V	Operational current I_e up to 690 V	Version		Price per PU	Price per PU
Ratings of three-phase motors at 50 Hz and 400 V		 			
A	A	NO NC V			

For screw fixing and snap-on mounting on TH 35 DIN rail

Size S00

7	3	18	10	1	--	24 110 230	3RT2015-1AB01 3RT2015-1AF01 3RT2015-1AP01	3RT2015-2AB01 3RT2015-2AF01 3RT2015-2AP01	
			01	--	1	24 110 230	3RT2015-1AB02 3RT2015-1AF02 3RT2015-1AP02	3RT2015-2AB02 3RT2015-2AF02 3RT2015-2AP02	
9	4	22	10	1	--	24 110 230	3RT2016-1AB01 3RT2016-1AF01 3RT2016-1AP01	3RT2016-2AB01 3RT2016-2AF01 3RT2016-2AP01	
			01	--	1	24 110 230	3RT2016-1AB02 3RT2016-1AF02 3RT2016-1AP02	3RT2016-2AB02 3RT2016-2AF02 3RT2016-2AP02	
12	5.5	22	10	1	--	24 110 230	3RT2017-1AB01 3RT2017-1AF01 3RT2017-1AP01	3RT2017-2AB01 3RT2017-2AF01 3RT2017-2AP01	
			01	--	1	24 110 230	3RT2017-1AB02 3RT2017-1AF02 3RT2017-1AP02	3RT2017-2AB02 3RT2017-2AF02 3RT2017-2AP02	
16	7.5	22	10	1	--	24 110 230	3RT2018-1AB01 3RT2018-1AF01 3RT2018-1AP01	3RT2018-2AB01 3RT2018-2AF01 3RT2018-2AP01	
			01	--	1	24 110 230	3RT2018-1AB02 3RT2018-1AF02 3RT2018-1AP02	3RT2018-2AB02 3RT2018-2AF02 3RT2018-2AP02	
With permanently mounted auxiliary switch									
7	3	18	22	2	2	230	3RT2015-1AP04-3MA0	3RT2015-2AP04-3MA0	
9	4	22	22	2	2	230	3RT2016-1AP04-3MA0	3RT2016-2AP04-3MA0	
12	5.5	22	22	2	2	230	3RT2017-1AP04-3MA0	3RT2017-2AP04-3MA0	
16	7.5	22	22	2	2	230	3RT2018-1AP04-3MA0	3RT2018-2AP04-3MA0	
With permanently mounted auxiliary switch and varistor plugged into the front									
7	3	18	22	2	2	230	3RT2015-1CP04-3MA0	3RT2015-2CP04-3MA0	
9	4	22	22	2	2	230	3RT2016-1CP04-3MA0	3RT2016-2CP04-3MA0	
12	5.5	22	22	2	2	230	3RT2017-1CP04-3MA0	3RT2017-2CP04-3MA0	
16	7.5	22	22	2	2	230	3RT2018-1CP04-3MA0	3RT2018-2CP04-3MA0	

Other voltages according to page 3/69 on request.

Accessories and spare parts, see pages 3/71 to 3/126.

Switching devices – Contactors and contactor assemblies – for switching motors

Power contactors for switching motors

SIRIUS 3RT contactors, 3-pole up to 250 kW **IE3/IE4 ready** **AC-3e**

AC operation





PU (UNIT, SET, M) = 1
 PS* = 1 unit
 PG = 41B



3RT202-1A.00



3RT202-2A.00

Rated data		Auxiliary contacts		Rated control supply voltage U_s	Screw terminals 	Spring-loaded terminals 
AC-3 and AC-3e, t_u : 60 °C	AC-1, t_u : 40 °C	Ident. No.	Version	50 Hz AC	Article No.	Article No.
Operational current I_e up to 400 V	Operational current I_e up to 690 V		 		Price per PU	Price per PU
400 V			NO NC V			
A	A					
	kW					

For screw fixing and snap-on mounting on TH 35 DIN rail

Size S0

Size	kW	I_e (A)	Ident. No.	Version	Terminal	Article No.	Article No.
9	4	40	11	1	24	3RT2023-1AB00	3RT2023-2AB00
					110	3RT2023-1AF00	3RT2023-2AF00
					230	3RT2023-1AP00	3RT2023-2AP00
12	5.5	40	11	1	24	3RT2024-1AB00	3RT2024-2AB00
					110	3RT2024-1AF00	3RT2024-2AF00
					230	3RT2024-1AP00	3RT2024-2AP00
17	7.5	40	11	1	24	3RT2025-1AB00	3RT2025-2AB00
					110	3RT2025-1AF00	3RT2025-2AF00
					230	3RT2025-1AP00	3RT2025-2AP00
25	11	40	11	1	24	3RT2026-1AB00	3RT2026-2AB00
					110	3RT2026-1AF00	3RT2026-2AF00
					230	3RT2026-1AP00	3RT2026-2AP00
32	15	50	11	1	24	3RT2027-1AB00	3RT2027-2AB00
					110	3RT2027-1AF00	3RT2027-2AF00
					230	3RT2027-1AP00	3RT2027-2AP00
38	18.5	50	11	1	24	3RT2028-1AB00	3RT2028-2AB00
					110	3RT2028-1AF00	3RT2028-2AF00
					230	3RT2028-1AP00	3RT2028-2AP00

Other voltages according to page 3/69 on request.

Accessories and spare parts, see pages 3/71 to 3/126.

Switching devices – Contactors and contactor assemblies – for switching motors

Power contactors for switching motors

AC-3e

IE3/IE4 ready

SIRIUS 3RT contactors, 3-pole up to 250 kW

AC operation 





PU (UNIT, SET, M) = 1
 PS* = 1 unit
 PG = 41B



3RT202-1A.20



3RT202-2A.20

Rated data		Auxiliary contacts	Rated control supply voltage U_s	Screw terminals 	Spring-loaded terminals 
AC-3 and AC-3e, t_u : 60 °C	AC-1, t_u : 40 °C	Ident. No.	50/60 Hz AC	Article No.	Article No.
Operational current I_e up to 400 V	Ratings of three-phase motors at 50 Hz and 690 V	Version		Price per PU	Price per PU
400 V		 			
A	kW	NO NC V			

For screw fixing and snap-on mounting on TH 35 DIN rail

Size S0

Size	Rated current I_e (A)	Rated power (kW)	Ident. No.	Version	Control voltage U_s (V)	3RT202-1A.20	3RT202-2A.20
9	4	40	11	1 1	24 110 230	3RT2023-1AC20 3RT2023-1AG20 3RT2023-1AL20	3RT2023-2AC20 3RT2023-2AG20 3RT2023-2AL20
12	5.5	40	11	1 1	24 110 230	3RT2024-1AC20 3RT2024-1AG20 3RT2024-1AL20	3RT2024-2AC20 3RT2024-2AG20 3RT2024-2AL20
17	7.5	40	11	1 1	24 110 230	3RT2025-1AC20 3RT2025-1AG20 3RT2025-1AL20	3RT2025-2AC20 3RT2025-2AG20 3RT2025-2AL20
25	11	40	11	1 1	24 110 230	3RT2026-1AC20 3RT2026-1AG20 3RT2026-1AL20	3RT2026-2AC20 3RT2026-2AG20 3RT2026-2AL20
32	15	50	11	1 1	24 110 230	3RT2027-1AC20 3RT2027-1AG20 3RT2027-1AL20	3RT2027-2AC20 3RT2027-2AG20 3RT2027-2AL20
38	18.5	50	11	1 1	24 110 230	3RT2028-1AC20 3RT2028-1AG20 3RT2028-1AL20	3RT2028-2AC20 3RT2028-2AG20 3RT2028-2AL20

Other voltages according to page 3/69 on request.

Accessories and spare parts, see pages 3/71 to 3/126.

Switching devices – Contactors and contactor assemblies – for switching motors

Power contactors for switching motors

SIRIUS 3RT contactors, 3-pole up to 250 kW **IE3/IE4 ready** **AC-3e**

AC operation

PU (UNIT, SET, M) = 1
 PS* = 1 unit
 PG = 41B



3RT202.-1A.04





3RT202.-2A.04

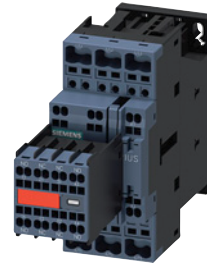

3RT202.-1CL24-3MA0

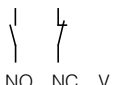

3RT202.-2CL24-3MA0

Rated data		Auxiliary contacts		Rated control supply voltage U_s	Screw terminals 	Spring-loaded terminals 
AC-3 and AC-3e, t_{ij} : 60 °C	AC-1, t_{ij} : 40 °C	Ident. No.	Version	50 Hz AC	Article No.	Article No.
Operational current I_e up to 400 V	Operational current I_e up to 690 V				Price per PU	Price per PU
400 V	690 V					
A	A					

For screw fixing and snap-on mounting on TH 35 DIN rail

Size S0

With removable auxiliary switch								
9	4	40	22	2	2	24 230	3RT2023-1AB04 3RT2023-1AP04	3RT2023-2AB04 3RT2023-2AP04
12	5.5	40	22	2	2	24 110 230	3RT2024-1AB04 3RT2024-1AF04 3RT2024-1AP04	3RT2024-2AB04 3RT2024-2AF04 3RT2024-2AP04
17	7.5	40	22	2	2	24 110 230	3RT2025-1AB04 3RT2025-1AF04 3RT2025-1AP04	3RT2025-2AB04 3RT2025-2AF04 3RT2025-2AP04
25	11	40	22	2	2	24 110 230	3RT2026-1AB04 3RT2026-1AF04 3RT2026-1AP04	3RT2026-2AB04 3RT2026-2AF04 3RT2026-2AP04
32	15	50	22	2	2	24 110 230	3RT2027-1AB04 3RT2027-1AF04 3RT2027-1AP04	3RT2027-2AB04 3RT2027-2AF04 3RT2027-2AP04
38	18.5	50	22	2	2	24 110 230	3RT2028-1AB04 3RT2028-1AF04 3RT2028-1AP04	3RT2028-2AB04 3RT2028-2AF04 3RT2028-2AP04
With permanently mounted auxiliary switch and varistor plugged in								
9	4	40	22	2	2	230	3RT2023-1CL24-3MA0	3RT2023-2CL24-3MA0
12	5.5	40	22	2	2	230	3RT2024-1CL24-3MA0	3RT2024-2CL24-3MA0
17	7.5	40	22	2	2	230	3RT2025-1CL24-3MA0	3RT2025-2CL24-3MA0
25	11	40	22	2	2	230	3RT2026-1CL24-3MA0	3RT2026-2CL24-3MA0
32	15	50	22	2	2	230	3RT2027-1CL24-3MA0	3RT2027-2CL24-3MA0
38	18.5	50	22	2	2	230	3RT2028-1CL24-3MA0	3RT2028-2CL24-3MA0

Other voltages according to page 3/69 on request.

Accessories and spare parts, see pages 3/71 to 3/126.

Switching devices – Contactors and contactor assemblies – for switching motors

Power contactors for switching motors

AC-3e

IE3/IE4 ready

SIRIUS 3RT contactors, 3-pole up to 250 kW

AC operation

PU (UNIT, SET, M) = 1
 PS* = 1 unit
 PG = 41B



3RT203.-1A.00



3RT203.-3A.00





3RT203.-1A.04



3RT203.-3CL24-3MA0



3RT203.-1CL24-3MA0

Rated data		Auxiliary contacts		Rated control supply voltage		Screw terminals 		Spring-loaded terminals 	
AC-3 and AC-3e, t_u : 60 °C		AC-1, t_u : 40 °C		50 Hz AC		Article No.		Article No.	
Operational current I_e up to 400 V	Ratings of three-phase motors at 50 Hz and 400 V	Operational current I_e up to 690 V	Ident. No.	Version		Price per PU	Price per PU		
A	kW	A	NO	NC	V				

For screw fixing and snap-on mounting on TH 35 DIN rail

Size S2

41	18.5	60	11	1	1	24 110 230	3RT2035-1AB00 3RT2035-1AF00 3RT2035-1AP00	3RT2035-3AB00 3RT2035-3AF00 3RT2035-3AP00	
51	22	70	11	1	1	24 110 230	3RT2036-1AB00 3RT2036-1AF00 3RT2036-1AP00	3RT2036-3AB00 3RT2036-3AF00 3RT2036-3AP00	
65	30	80	11	1	1	24 110 230	3RT2037-1AB00 3RT2037-1AF00 3RT2037-1AP00	3RT2037-3AB00 3RT2037-3AF00 3RT2037-3AP00	
80	37	90	11	1	1	24 110 230	3RT2038-1AB00 3RT2038-1AF00 3RT2038-1AP00	3RT2038-3AB00 3RT2038-3AF00 3RT2038-3AP00	
With removable auxiliary switch									
41	18.5	60	22	2	2	24 110 230	3RT2035-1AB04 3RT2035-1AF04 3RT2035-1AP04	-- -- --	
51	22	70	22	2	2	24 110 230	3RT2036-1AB04 3RT2036-1AF04 3RT2036-1AP04	-- -- --	
65	30	80	22	2	2	24 110 230	3RT2037-1AB04 3RT2037-1AF04 3RT2037-1AP04	-- -- --	
80	37	90	22	2	2	24 110 230	3RT2038-1AB04 3RT2038-1AF04 3RT2038-1AP04	-- -- --	
With permanently mounted auxiliary switch and integrated coil circuit (varistor plugged in at the factory)									
41	18.5	60	22	2	2	230	3RT2035-1CL24-3MA0	3RT2035-3CL24-3MA0	
51	22	70	22	2	2	230	3RT2036-1CL24-3MA0	3RT2036-3CL24-3MA0	
65	30	80	22	2	2	230	3RT2037-1CL24-3MA0	3RT2037-3CL24-3MA0	
80	37	90	22	2	2	230	3RT2038-1CL24-3MA0	3RT2038-3CL24-3MA0	

Other voltages [according to page 3/69](#) on request.

Accessories and spare parts, [see pages 3/71 to 3/126](#).

Switching devices – Contactors and contactor assemblies – for switching motors

Power contactors for switching motors

SIRIUS 3RT contactors, 3-pole up to 250 kW **IE3/IE4 ready** **AC-3e**

AC operation

PU (UNIT, SET, M) = 1
PS* = 1 unit
PG = 41B



3RT204.-1A.00





3RT204.-1A.04



3RT204.-1CL24-3MA0



3RT204.-3A.00

Rated data		Auxiliary contacts	Rated control supply voltage U_s	Screw terminals 	Spring-loaded terminals 
AC-3 and AC-3e, t_u : 60 °C		Ident. No.	50 Hz AC	Article No.	Article No.
Operational current I_e up to 400 V	Ratings of three-phase motors at 50 Hz and 400 V	Version		Price per PU	Price per PU
A	A	NO NC V			

For screw fixing and snap-on mounting on TH 35-15 and TH 75-15 DIN rails

Size S3

80	37	125	11	1	1	24 110 230	3RT2045-1AB00 3RT2045-1AF00 3RT2045-1AP00	3RT2045-3AB00 3RT2045-3AF00 3RT2045-3AP00
95	45	130	11	1	1	24 110 230	3RT2046-1AB00 3RT2046-1AF00 3RT2046-1AP00	3RT2046-3AB00 3RT2046-3AF00 3RT2046-3AP00
110	55	130	11	1	1	24 110 230	3RT2047-1AB00 3RT2047-1AF00 3RT2047-1AP00	3RT2047-3AB00 3RT2047-3AF00 3RT2047-3AP00
With removable auxiliary switch								
80	37	125	22	2	2	24 110 230	3RT2045-1AB04 3RT2045-1AF04 3RT2045-1AP04	-- -- --
95	45	130	22	2	2	24 110 230	3RT2046-1AB04 3RT2046-1AF04 3RT2046-1AP04	-- -- --
110	55	130	22	2	2	24 110 230	3RT2047-1AB04 3RT2047-1AF04 3RT2047-1AP04	-- -- --
With permanently mounted auxiliary switch and integrated coil circuit (varistor plugged in at the factory)								
80	37	125	22	2	2	230	3RT2045-1CL24-3MA0	--
95	45	130	22	2	2	230	3RT2046-1CL24-3MA0	--
110	55	130	22	2	2	230	3RT2047-1CL24-3MA0	--

Other voltages [according to page 3/69](#) on request.

Accessories and spare parts, [see pages 3/71 to 3/126](#).

Switching devices – Contactors and contactor assemblies – for switching motors

Power contactors for switching motors

AC-3e

IE3/IE4 ready

SIRIUS 3RT contactors, 3-pole up to 250 kW

AC operation 

PU (UNIT, SET, M) = 1
 PS* = 1 unit
 PG = 41B



3RT203.-1A.20



3RT203.-3A.20





3RT204.-1A.20



3RT204.-3A.20

Rated data		Auxiliary contacts	Rated control supply voltage
AC-3 and AC-3e, t_u : 60 °C		Ident. No. Version	50/60 Hz AC
Operational current I_e up to 400 V	Ratings of three-phase motors at 50 Hz and 400 V		
A	400 V kW	NO NC V	

Screw terminals 	
Article No.	Price per PU

Spring-loaded terminals 	
Article No.	Price per PU

For screw fixing and snap-on mounting on TH 35 DIN rail**Size S2**

41	18.5	60	11	1	1	24 110 230	3RT2035-1AC20 3RT2035-1AG20 3RT2035-1AL20	3RT2035-3AC20 3RT2035-3AG20 3RT2035-3AL20
51	22	70	11	1	1	24 110 230	3RT2036-1AC20 3RT2036-1AG20 3RT2036-1AL20	3RT2036-3AC20 3RT2036-3AG20 3RT2036-3AL20
65	30	80	11	1	1	24 110 230	3RT2037-1AC20 3RT2037-1AG20 3RT2037-1AL20	3RT2037-3AC20 3RT2037-3AG20 3RT2037-3AL20
80	37	90	11	1	1	24 110 230	3RT2038-1AC20 3RT2038-1AG20 3RT2038-1AL20	3RT2038-3AC20 3RT2038-3AG20 3RT2038-3AL20

For screw fixing and snap-on mounting on TH 35-15 and TH 75-15 DIN rails**Size S3**

80	37	125	11	1	1	24 110 230	3RT2045-1AC20 3RT2045-1AG20 3RT2045-1AL20	3RT2045-3AC20 3RT2045-3AG20 3RT2045-3AL20
95	45	130	11	1	1	24 110 230	3RT2046-1AC20 3RT2046-1AG20 3RT2046-1AL20	3RT2046-3AC20 3RT2046-3AG20 3RT2046-3AL20
110	55	130	11	1	1	24 110 230	3RT2047-1AC20 3RT2047-1AG20 3RT2047-1AL20	-- -- 3RT2047-3AL20

Other voltages [according to page 3/69](#) on request.Accessories and spare parts, see [pages 3/71 to 3/126](#).

Switching devices – Contactors and contactor assemblies – for switching motors

Power contactors for switching motors

SIRIUS 3RT contactors, 3-pole up to 250 kW **IE3/IE4 ready** **AC-3e**

DC operation





PU (UNIT, SET, M) = 1
 PS* = 1 unit
 PG = 41B



3RT201.-1B...



3RT201.-2B...

Rated data		Auxiliary contacts	Rated control supply voltage U_s		Screw terminals 	Spring-loaded terminals 
AC-3 and AC-3e, t_U : 60 °C	AC-1, t_U : 40 °C	Ident. No.	Version	DC	Article No.	Price per PU
Operational current I_e up to 400 V	Operational current I_e up to 690 V			V		
400 V						
A	kW					

For screw fixing and snap-on mounting on TH 35 DIN rail

Size S00

7	3	18	10	1	--	24	3RT2015-1BB41	3RT2015-2BB41
			01	--	1	24	3RT2015-1BM41	3RT2015-2BM41
						220	3RT2015-1BB42	3RT2015-2BB42
						220	3RT2015-1BM42	3RT2015-2BM42
9	4	22	10	1	--	24	3RT2016-1BB41	3RT2016-2BB41
			01	--	1	24	3RT2016-1BM41	3RT2016-2BM41
						220	3RT2016-1BB42	3RT2016-2BB42
						220	3RT2016-1BM42	3RT2016-2BM42
12	5.5	22	10	1	--	24	3RT2017-1BB41	3RT2017-2BB41
			01	--	1	24	3RT2017-1BM41	3RT2017-2BM41
						220	3RT2017-1BB42	3RT2017-2BB42
						220	3RT2017-1BM42	3RT2017-2BM42
16	7.5	22	10	1	--	24	3RT2018-1BB41	3RT2018-2BB41
			01	--	1	24	3RT2018-1BM41	3RT2018-2BM41
						220	3RT2018-1BB42	3RT2018-2BB42
						220	3RT2018-1BM42	3RT2018-2BM42
With integrated coil circuit (varistor integrated at the factory)								
7	3	18	10	1	--	24	3RT2015-1UB41	3RT2015-2UB41
			01	--	1	24	3RT2015-1UB42	3RT2015-2UB42
9	4	22	10	1	--	24	3RT2016-1UB41	3RT2016-2UB41
			01	--	1	24	3RT2016-1UB42	3RT2016-2UB42
12	5.5	22	10	1	--	24	3RT2017-1UB41	3RT2017-2UB41
			01	--	1	24	3RT2017-1UB42	3RT2017-2UB42
16	7.5	22	10	1	--	24	3RT2018-1UB41	3RT2018-2UB41
			01	--	1	24	3RT2018-1UB42	3RT2018-2UB42
With integrated coil circuit (diode integrated at the factory)								
7	3	18	10	1	--	24	3RT2015-1FB41	3RT2015-2FB41
			01	--	1	24	3RT2015-1FB42	3RT2015-2FB42
9	4	22	10	1	--	24	3RT2016-1FB41	3RT2016-2FB41
			01	--	1	24	3RT2016-1FB42	3RT2016-2FB42
12	5.5	22	10	1	--	24	3RT2017-1FB41	3RT2017-2FB41
			01	--	1	24	3RT2017-1FB42	3RT2017-2FB42
16	7.5	22	10	1	--	24	3RT2018-1FB41	3RT2018-2FB41
			01	--	1	24	3RT2018-1FB42	3RT2018-2FB42

Other voltages [according to page 3/69](#) on request.

Accessories and spare parts, [see pages 3/71 to 3/126](#).

Switching devices – Contactors and contactor assemblies – for switching motors

Power contactors for switching motors

AC-3e

IE3/IE4 ready

SIRIUS 3RT contactors, 3-pole up to 250 kW

DC operation 

PU (UNIT, SET, M) = 1
 PS* = 1 unit
 PG = 41B



3RT201.-1BB44-3MA0



3RT201.-2BB44-3MA0



3RT201.-1BB4.-0CC0



3RT201.-2BB4.-0CC0

Rated data

AC-3 and AC-3e,
 t_u : 60 °COperational current I_e
up to
400 V

A

Ratings of
three-phase
motors at
50 Hz and**400 V**

A

AC-1,
 t_u : 40 °COperational
current I_e
up to
690 V

A

Auxiliary contacts

Ident. No.

Version

Rated control
supply voltage
 U_s

DC

Ident. No.

Version

NO

NC

V

Screw terminals 

Article No.

Price
per PUSpring-loaded terminals 

Article No.

Price
per PU**For screw fixing and snap-on mounting on TH 35 DIN rail****Size S00****With permanently mounted auxiliary switch**

7	3	18	22	2	2	24
9	4	22	22	2	2	24
12	5.5	22	22	2	2	24
16	7.5	22	22	2	2	24

3RT2015-1BB44-3MA0

3RT2015-2BB44-3MA0

3RT2016-1BB44-3MA0

3RT2016-2BB44-3MA0

3RT2017-1BB44-3MA0

3RT2017-2BB44-3MA0

3RT2018-1BB44-3MA0

3RT2018-2BB44-3MA0

**With permanently mounted auxiliary switch and integrated coil circuit
(diode integrated at the factory)**

7	3	18	22	2	2	24
9	4	22	22	2	2	24
12	5.5	22	22	2	2	24
16	7.5	22	22	2	2	24

3RT2015-1FB44-3MA0

3RT2015-2FB44-3MA0

3RT2016-1FB44-3MA0

3RT2016-2FB44-3MA0

3RT2017-1FB44-3MA0

3RT2017-2FB44-3MA0

3RT2018-1FB44-3MA0

3RT2018-2FB44-3MA0

With voltage tap-off (only available with 24 V DC coils)

7	3	18	10	1	--	24
			01	--	1	24
9	4	22	10	1	--	24
			01	--	1	24
12	5.5	22	10	1	--	24
			01	--	1	24
16	7.5	22	10	1	--	24
			01	--	1	24

3RT2015-1BB41-0CC0

3RT2015-2BB41-0CC0

3RT2015-1BB42-0CC0

3RT2015-2BB42-0CC0

3RT2016-1BB41-0CC0

3RT2016-2BB41-0CC0

3RT2016-1BB42-0CC0

3RT2016-2BB42-0CC0

3RT2017-1BB41-0CC0

3RT2017-2BB41-0CC0

3RT2017-1BB42-0CC0

3RT2017-2BB42-0CC0

3RT2018-1BB41-0CC0

3RT2018-2BB41-0CC0

3RT2018-1BB42-0CC0

3RT2018-2BB42-0CC0

Other voltages [according to page 3/69](#) on request.Accessories and spare parts, [see pages 3/71 to 3/126](#).

Switching devices – Contactors and contactor assemblies – for switching motors

Power contactors for switching motors

SIRIUS 3RT contactors, 3-pole up to 250 kW **IE3/IE4 ready** **AC-3e**

DC operation for direct control by PLC

- Coupling contactors with adapted power consumption
- Suitable for solid-state PLC/F-PLC outputs
- Cannot be expanded with auxiliary switches



PU (UNIT, SET, M) = 1
PS* = 1 unit
PG = 41B



3RT201.-1.B4.



3RT201.-2.B4.

Rated data		Auxiliary contacts		Rated control supply voltage	Screw terminals 	Spring-loaded terminals 
AC-3 and AC-3e, t_{ij} : 60 °C		AC-1, t_{ij} : 40 °C		U_s	Article No.	Article No.
Operational current I_e up to 400 V	Ratings of three-phase motors at 50 Hz and 400 V	Operational current I_e up to 690 V	Ident. No.	Version		
A	kW	A	NO	NC		
			V			

For screw fixing and snap-on mounting on TH 35 DIN rail

Size S00

(cannot be expanded with auxiliary switches)

Operating range **0.7 ... 1.25 x U_s** ,

power consumption of the solenoid coils **2.8 W** at 24 V

7	3	18	10	1	--	24	3RT2015-1HB41 3RT2015-1HB42	3RT2015-2HB41 3RT2015-2HB42
			01	--	1	24		
9	4	22	10	1	--	24	3RT2016-1HB41 3RT2016-1HB42	3RT2016-2HB41 3RT2016-2HB42
			01	--	1	24		
12	5.5	22	10	1	--	24	3RT2017-1HB41 3RT2017-1HB42	3RT2017-2HB41 3RT2017-2HB42
			01	--	1	24		

Operating range **0.85 ... 1.85 x U_s** ,

power consumption of the solenoid coils **1.6 W** at 24 V

7	3	18	10	1	--	24	3RT2015-1MB41-0KT0 3RT2015-1MB42-0KT0	3RT2015-2MB41-0KT0 3RT2015-2MB42-0KT0
			01	--	1	24		
9	4	22	10	1	--	24	3RT2016-1MB41-0KT0 3RT2016-1MB42-0KT0	3RT2016-2MB41-0KT0 3RT2016-2MB42-0KT0
			01	--	1	24		
12	5.5	22	10	1	--	24	3RT2017-1MB41-0KT0 3RT2017-1MB42-0KT0	3RT2017-2MB41-0KT0 3RT2017-2MB42-0KT0
			01	--	1	24		

With integrated coil circuit (diode integrated at the factory)

(cannot be expanded with auxiliary switches)

Operating range **0.7 ... 1.25 x U_s** ,

power consumption of the solenoid coils **2.8 W** at 24 V

7	3	18	10	1	--	24	3RT2015-1JB41 3RT2015-1JB42	3RT2015-2JB41 3RT2015-2JB42
			01	--	1	24		
9	4	22	10	1	--	24	3RT2016-1JB41 3RT2016-1JB42	3RT2016-2JB41 3RT2016-2JB42
			01	--	1	24		
12	5.5	22	10	1	--	24	3RT2017-1JB41 3RT2017-1JB42	3RT2017-2JB41 3RT2017-2JB42
			01	--	1	24		

Operating range **0.85 ... 1.85 x U_s** ,

power consumption of the solenoid coils **1.6 W** at 24 V

7	3	18	10	1	--	24	3RT2015-1VB41 3RT2015-1VB42	3RT2015-2VB41 3RT2015-2VB42
			01	--	1	24		
9	4	22	10	1	--	24	3RT2016-1VB41 3RT2016-1VB42	3RT2016-2VB41 3RT2016-2VB42
			01	--	1	24		
12	5.5	22	10	1	--	24	3RT2017-1VB41 3RT2017-1VB42	3RT2017-2VB41 3RT2017-2VB42
			01	--	1	24		

Other voltages [according to page 3/69](#) on request.

Accessories and spare parts, [see pages 3/71 to 3/126](#).

Switching devices – Contactors and contactor assemblies – for switching motors

Power contactors for switching motors

AC-3e

IE3/IE4 ready

SIRIUS 3RT contactors, 3-pole up to 250 kW

DC operation for direct control by PLC

- Coupling contactors with adapted power consumption
- Suitable for solid-state PLC/F-PLC outputs
- Cannot be expanded with auxiliary switches



PU (UNIT, SET, M) = 1
 PS* = 1 unit
 PG = 41B



3RT201.-1.B4.



3RT201.-2.B4.

Rated data		Auxiliary contacts	Rated control supply voltage U_s	
AC-3 and AC-3e, t_i : 60 °C		Ident. No.	Version	DC
Operational current I_e up to	Ratings of three-phase motors at 50 Hz and			
400 V	400 V			
A	kW	A		V
			NO	NC

Screw terminals Spring-loaded terminals 

Article No.

Price per PU

Article No.

Price per PU

For screw fixing and snap-on mounting on TH 35 DIN rail

Size S00

With integrated coil circuit (suppressor diode integrated at the factory)

(cannot be expanded with auxiliary switches)

Operating range **0.7 ... 1.25 x U_s** ,power consumption of the solenoid coils **2.8 W** at 24 V

7	3	18	10	1	--	24
			01	--	1	24
9	4	22	10	1	--	24
			01	--	1	24
12	5.5	22	10	1	--	24
			01	--	1	24

Operating range **0.85 ... 1.85 x U_s** ,power consumption of the solenoid coils **1.6 W** at 24 V

7	3	18	10	1	--	24
			01	--	1	24
9	4	22	10	1	--	24
			01	--	1	24
12	5.5	22	10	1	--	24
			01	--	1	24

3RT2015-1KB41
3RT2015-1KB423RT2015-2KB41
3RT2015-2KB423RT2016-1KB41
3RT2016-1KB423RT2016-2KB41
3RT2016-2KB423RT2017-1KB41
3RT2017-1KB423RT2017-2KB41
3RT2017-2KB423RT2015-1SB41
3RT2015-1SB423RT2015-2SB41
3RT2015-2SB423RT2016-1SB41
3RT2016-1SB423RT2016-2SB41
3RT2016-2SB423RT2017-1SB41
3RT2017-1SB423RT2017-2SB41
3RT2017-2SB42Other voltages [according to page 3/69](#) on request.Accessories and spare parts, [see pages 3/71 to 3/126](#).

Switching devices – Contactors and contactor assemblies – for switching motors

Power contactors for switching motors

SIRIUS 3RT contactors, 3-pole up to 250 kW **IE3/IE4 ready** **AC-3e**

DC operation

PU (UNIT, SET, M) = 1
 PS* = 1 unit
 PG = 41B



3RT202.-1B.40





3RT202.-2B.40

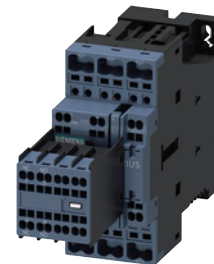

3RT202.-1B.44



3RT202.-2B.44

Rated data		Auxiliary contacts	Rated control supply voltage U_s	Screw terminals 	Spring-loaded terminals 
AC-3 and AC-3e, t_u : 60 °C		AC-1, t_u : 40 °C	DC	Article No.	Article No.
Operational current I_e up to 400 V	Ratings of three-phase motors at 50 Hz and 400 V	Operational current I_e up to 690 V		Price per PU	Price per PU
A	kW	A			
			NO NC V		

For screw fixing and snap-on mounting on TH 35 DIN rail

Size S0

9	4	40	11	1	1	24	3RT2023-1BB40	3RT2023-2BB40
12	5.5	40	11	1	1	24 220	3RT2024-1BB40 3RT2024-1BM40	3RT2024-2BB40 3RT2024-2BM40
17	7.5	40	11	1	1	24 220	3RT2025-1BB40 3RT2025-1BM40	3RT2025-2BB40 3RT2025-2BM40
25	11	40	11	1	1	24 220	3RT2026-1BB40 3RT2026-1BM40	3RT2026-2BB40 3RT2026-2BM40
32	15	50	11	1	1	24 220	3RT2027-1BB40 3RT2027-1BM40	3RT2027-2BB40 3RT2027-2BM40
38	18.5	50	11	1	1	24 220	3RT2028-1BB40 3RT2028-1BM40	3RT2028-2BB40 3RT2028-2BM40
With coil circuit plugged into the front (varistor plugged in at the factory)								
9	4	40	11	1	1	24	3RT2023-1DB40	3RT2023-2DB40
12	5.5	40	11	1	1	24	3RT2024-1DB40	3RT2024-2DB40
17	7.5	40	11	1	1	24	3RT2025-1DB40	3RT2025-2DB40
25	11	40	11	1	1	24	3RT2026-1DB40	3RT2026-2DB40
32	15	50	11	1	1	24	3RT2027-1DB40	3RT2027-2DB40
38	18.5	50	11	1	1	24	3RT2028-1DB40	3RT2028-2DB40
With coil circuit plugged into the front (diode assembly plugged in at the factory)								
9	4	40	11	1	1	24	3RT2023-1FB40	3RT2023-2FB40
12	5.5	40	11	1	1	24	3RT2024-1FB40	3RT2024-2FB40
17	7.5	40	11	1	1	24	3RT2025-1FB40	3RT2025-2FB40
25	11	40	11	1	1	24	3RT2026-1FB40	3RT2026-2FB40
32	15	50	11	1	1	24	3RT2027-1FB40	3RT2027-2FB40
38	18.5	50	11	1	1	24	3RT2028-1FB40	3RT2028-2FB40
With removable auxiliary switch								
9	4	40	22	2	2	24	3RT2023-1BB44	3RT2023-2BB44
12	5.5	40	22	2	2	24	3RT2024-1BB44	3RT2024-2BB44
17	7.5	40	22	2	2	24	3RT2025-1BB44	3RT2025-2BB44
25	11	40	22	2	2	24	3RT2026-1BB44	3RT2026-2BB44
32	15	50	22	2	2	24	3RT2027-1BB44	3RT2027-2BB44
38	18.5	50	22	2	2	24	3RT2028-1BB44	3RT2028-2BB44

Other voltages according to page 3/69 on request.

Accessories and spare parts, see pages 3/71 to 3/126.

Switching devices – Contactors and contactor assemblies – for switching motors

Power contactors for switching motors

AC-3e

IE3/IE4 ready

SIRIUS 3RT contactors, 3-pole up to 250 kW

DC operation

PU (UNIT, SET, M) = 1
 PS* = 1 unit
 PG = 41B



3RT202.-1.B44-3MA0







3RT202.-2.B44-3MA0



3RT202.-1BB40-0CC0



3RT202.-2BB40-0CC0

Rated data		Auxiliary contacts	Rated control supply voltage U_s	Screw terminals 	Spring-loaded terminals 
AC-3 and AC-3e, t_u : 60 °C	AC-1, t_u : 40 °C	Ident. No.	DC	Article No.	Article No.
Operational current I_e up to 400 V	Operational current I_e up to 690 V	Version		Price per PU	Price per PU
Ratings of three-phase motors at 50 Hz and 400 V		 			
400 V	A	NO NC V			

For screw fixing and snap-on mounting on TH 35 DIN rail

Size S0

With permanently mounted auxiliary switch and integrated coil circuit (varistor integrated at the factory)

12	5.5	40	22	2	2	24
17	7.5	40	22	2	2	24
25	11	40	22	2	2	24
32	15	50	22	2	2	24

3RT2024-1DB44-3MA0
3RT2025-1DB44-3MA0
3RT2026-1DB44-3MA0
3RT2027-1DB44-3MA0

3RT2024-2DB44-3MA0
3RT2025-2DB44-3MA0
3RT2026-2DB44-3MA0
3RT2027-2DB44-3MA0

With permanently mounted auxiliary switch and integrated coil circuit (diode assembly plugged in at the factory)

9	4	40	22	2	2	24
12	5.5	40	22	2	2	24
17	7.5	40	22	2	2	24
25	11	40	22	2	2	24
32	15	50	22	2	2	24
38	18.5	50	22	2	2	24

3RT2023-1FB44-3MA0
3RT2024-1FB44-3MA0
3RT2025-1FB44-3MA0
3RT2026-1FB44-3MA0
3RT2027-1FB44-3MA0
3RT2028-1FB44-3MA0

3RT2023-2FB44-3MA0
3RT2024-2FB44-3MA0
3RT2025-2FB44-3MA0
3RT2026-2FB44-3MA0
3RT2027-2FB44-3MA0
3RT2028-2FB44-3MA0

With voltage tap-off

9	4	40	11	1	1	24
12	5.5	40	11	1	1	24
17	7.5	40	11	1	1	24
25	11	40	11	1	1	24
32	15	50	11	1	1	24
38	18.5	50	11	1	1	24

3RT2023-1BB40-0CC0
3RT2024-1BB40-0CC0
3RT2025-1BB40-0CC0
3RT2026-1BB40-0CC0
3RT2027-1BB40-0CC0
3RT2028-1BB40-0CC0

3RT2023-2BB40-0CC0
3RT2024-2BB40-0CC0
3RT2025-2BB40-0CC0
3RT2026-2BB40-0CC0
3RT2027-2BB40-0CC0
3RT2028-2BB40-0CC0

Other voltages according to page 3/69 on request.

Accessories and spare parts, see pages 3/71 to 3/126.

Switching devices – Contactors and contactor assemblies – for switching motors

Power contactors for switching motors

SIRIUS 3RT contactors, 3-pole up to 250 kW **IE3/IE4 ready** **AC-3e**

DC operation for direct control by PLC

- Coupling contactors with adapted power consumption
- Suitable for solid-state PLC/F-PLC outputs
- Cannot be expanded with auxiliary switches





PU (UNIT, SET, M) = 1
 PS* = 1 unit
 PG = 41B



3RT202.-1KB40



3RT202.-2KB40

Rated data		Auxiliary contacts	Rated control supply voltage U_s	Screw terminals 	Spring-loaded terminals 
AC-3 and AC-3e, t_u : 60 °C		Ident. No.	DC	Article No.	Article No.
Operational current I_e up to 400 V	Ratings of three-phase motors at 50 Hz and 400 V	Version		Price per PU	Price per PU
A	400 V	 			
	A	NO NC V			

For screw fixing and snap-on mounting on TH 35 DIN rail

Size S0

With integrated coil circuit (varistor integrated in electronics at the factory)

(cannot be expanded with auxiliary switches)

Operating range **0.7 ... 1.25 x U_s**

power consumption of the solenoid coils **4.5 W** at 24 V

9	4	40	11	1	1	24
12	5.5	40	11	1	1	24
17	7.5	40	11	1	1	24
25	11	40	11	1	1	24
32	15	50	11	1	1	24

3RT2023-1KB40

3RT2023-2KB40

3RT2024-1KB40

3RT2024-2KB40

3RT2025-1KB40

3RT2025-2KB40

3RT2026-1KB40

3RT2026-2KB40

3RT2027-1KB40

3RT2027-2KB40

Other voltages [according to page 3/69](#) on request.

Accessories and spare parts, [see pages 3/71 to 3/126](#).

Switching devices – Contactors and contactor assemblies – for switching motors

Power contactors for switching motors

AC-3e

IE3/IE4 ready

SIRIUS 3RT contactors, 3-pole up to 250 kW

DC operation for direct control by PLC

- Coupling contactors with adapted power consumption
- Suitable for solid-state PLC/F-PLC outputs with 2 A
- Can be expanded using front or lateral auxiliary switch (1 x left and 1 x right)

PU (UNIT, SET, M) = 1
 PS* = 1 unit
 PG = 41B



3RT203.-1KB40





3RT203.-3KB40



3RT204.-1KB40



3RT204.-3KB40

Rated data		Auxiliary contacts	Rated control supply voltage U_s	Screw terminals 		Spring-loaded terminals 	
AC-3 and AC-3e, t_j : 60 °C		Ident. No.	DC	Article No.	Price per PU	Article No.	Price per PU
Operational current I_e up to 400 V	Ratings of three-phase motors at 50 Hz and 400 V	Version					
		NO					
		NC					
		V					

For screw fixing and snap-on mounting on TH 35 DIN rail

Size S2

With integrated coil circuit (varistor integrated in electronics at the factory)

Operating range $0.8 \dots 1.2 \times U_s$,
 closing power of the solenoid coils **21.5 W** at 24 V

41	18.5	60	11	1	1	24	3RT2035-1KB40	3RT2035-3KB40
51	22	70	11	1	1	24	3RT2036-1KB40	3RT2036-3KB40
65	30	80	11	1	1	24	3RT2037-1KB40	3RT2037-3KB40
80	37	90	11	1	1	24	3RT2038-1KB40	3RT2038-3KB40

For screw fixing and snap-on mounting on TH 35-15 and TH 75-15 DIN rails

Size S3

With integrated coil circuit (varistor integrated in electronics at the factory)

Operating range $0.8 \dots 1.2 \times U_s$,
 closing power of the solenoid coils **25 W** at 24 V

80	37	125	11	1	1	24	3RT2045-1KB40	3RT2045-3KB40
95	45	130	11	1	1	24	3RT2046-1KB40	3RT2046-3KB40

Other voltages according to page 3/69 on request.

Accessories and spare parts, see pages 3/71 to 3/126.

Switching devices – Contactors and contactor assemblies – for switching motors

Power contactors for switching motors

SIRIUS 3RT contactors, 3-pole up to 250 kW **IE3/IE4 ready** **AC-3e**

AC/DC operation

- Extended operating range of the solenoid coil 0.7 to 1.3 x U_s
- Power consumption reduced from closing power to holding power



PU (UNIT, SET, M) = 1
 PS* = 1 unit
 PG = 41B



3RT202.-1N.30



3RT202.-2N.30

Rated data		Auxiliary contacts	Rated control supply voltage U_s	Screw terminals 	Spring-loaded terminals 
AC-3 and AC-3e, t_u : 60 °C		Ident. No.	50/60 Hz AC or DC	Article No.	Article No.
Operational current I_e up to 400 V	Ratings of three-phase motors at 50 Hz and 400 V	Version		Price per PU	Price per PU
A	A	NO NC V			

For screw fixing and snap-on mounting on TH 35 DIN rail

Size S0

With integrated coil circuit (varistor integrated in electronics at the factory)

12	5.5	40	11	1	1	21 ... 28 95 ... 130 200 ... 280	3RT2024-1NB30 3RT2024-1NF30 3RT2024-1NP30	3RT2024-2NB30 3RT2024-2NF30 3RT2024-2NP30
17	7.5	40	11	1	1	21 ... 28 95 ... 130 200 ... 280	3RT2025-1NB30 3RT2025-1NF30 3RT2025-1NP30	3RT2025-2NB30 3RT2025-2NF30 3RT2025-2NP30
25	11	40	11	1	1	21 ... 28 95 ... 130 200 ... 280	3RT2026-1NB30 3RT2026-1NF30 3RT2026-1NP30	3RT2026-2NB30 3RT2026-2NF30 3RT2026-2NP30
32	15	50	11	1	1	21 ... 28 95 ... 130 200 ... 280	3RT2027-1NB30 3RT2027-1NF30 3RT2027-1NP30	3RT2027-2NB30 3RT2027-2NF30 3RT2027-2NP30
38	18.5	50	11	1	1	21 ... 28 95 ... 130 200 ... 280	3RT2028-1NB30 3RT2028-1NF30 3RT2028-1NP30	3RT2028-2NB30 3RT2028-2NF30 3RT2028-2NP30

Other voltages according to page 3/69 on request.

Accessories and spare parts, see pages 3/71 to 3/126.

Switching devices – Contactors and contactor assemblies – for switching motors

Power contactors for switching motors

AC-3e**IE3/IE4 ready****SIRIUS 3RT contactors, 3-pole up to 250 kW****AC/DC operation** 

- Extended operating range of the solenoid coil 0.8 to 1.1 x U_s
- Power consumption reduced from closing power to holding power

PU (UNIT, SET, M) = 1
 PS* = 1 unit
 PG = 41B



3RT203.-1N.30



3RT203.-3N.30



3RT203.-1N.34



3RT203.-1NB34-3MA0



3RT203.-3NB34-3MA0

Rated dataAC-3 and AC-3e,
 t_c : 60 °COperational current I_e
up to
400 V
ARatings of
three-phase
motors at
50 Hz and
400 V
kWAC-1,
 t_c : 40 °COperational
current I_e
up to
690 V
A**Auxiliary contacts**Ident.
No.

Version

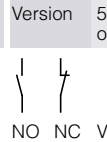
Rated control
supply voltage
 U_s
50/60 Hz AC
or DC**Screw terminals** 

Article No.

Price
per PU**Spring-loaded terminals** 

Article No.

Price
per PU**For screw fixing and snap-on mounting on TH 35 DIN rail****Size S2****With integrated coil circuit (varistor integrated in electronics at the factory)**

Operational current I_e (A)	Power (kW)	Rated voltage (V)	Ident. No.	Version	Rated control supply voltage U_s	Article No.	Article No.
41	18.5	60	11	1 1	20 ... 33 83 ... 155 175 ... 280	3RT2035-1NB30 3RT2035-1NF30 3RT2035-1NP30	3RT2035-3NB30 3RT2035-3NF30 3RT2035-3NP30
51	22	70	11	1 1	20 ... 33 83 ... 155 175 ... 280	3RT2036-1NB30 3RT2036-1NF30 3RT2036-1NP30	3RT2036-3NB30 3RT2036-3NF30 3RT2036-3NP30
65	30	80	11	1 1	20 ... 33 83 ... 155 175 ... 280	3RT2037-1NB30 3RT2037-1NF30 3RT2037-1NP30	3RT2037-3NB30 3RT2037-3NF30 3RT2037-3NP30
80	37	90	11	1 1	20 ... 33 83 ... 155 175 ... 280	3RT2038-1NB30 3RT2038-1NF30 3RT2038-1NP30	3RT2038-3NB30 3RT2038-3NF30 3RT2038-3NP30

With removable auxiliary switch and integrated coil circuit (varistor integrated in electronics at the factory)

Operational current I_e (A)	Power (kW)	Rated voltage (V)	Ident. No.	Version	Rated control supply voltage U_s	Article No.	Article No.
41	18.5	60	22	2 2	20 ... 33 83 ... 155 175 ... 280	3RT2035-1NB34 3RT2035-1NF34 3RT2035-1NP34	-- -- --
51	22	70	22	2 2	20 ... 33 83 ... 155 175 ... 280	3RT2036-1NB34 3RT2036-1NF34 3RT2036-1NP34	-- -- --
65	30	80	22	2 2	20 ... 33 83 ... 155 175 ... 280	3RT2037-1NB34 3RT2037-1NF34 3RT2037-1NP34	-- -- --
80	37	90	22	2 2	20 ... 33 83 ... 155 175 ... 280	3RT2038-1NB34 3RT2038-1NF34 3RT2038-1NP34	-- -- --

With permanently mounted auxiliary switch and integrated coil circuit (varistor integrated in electronics at the factory)

Operational current I_e (A)	Power (kW)	Rated voltage (V)	Ident. No.	Version	Rated control supply voltage U_s	Article No.	Article No.
41	18.5	60	22	2 2	20 ... 33	3RT2035-1NB34-3MA0	3RT2035-3NB34-3MA0
51	22	70	22	2 2	20 ... 33	3RT2036-1NB34-3MA0	3RT2036-3NB34-3MA0
65	30	80	22	2 2	20 ... 33	3RT2037-1NB34-3MA0	3RT2037-3NB34-3MA0
80	37	90	22	2 2	20 ... 33	3RT2038-1NB34-3MA0	3RT2038-3NB34-3MA0

With voltage tap-off and integrated coil circuit (varistor integrated in electronics at the factory)

Operational current I_e (A)	Power (kW)	Rated voltage (V)	Ident. No.	Version	Rated control supply voltage U_s	Article No.	Article No.
41	18.5	60	11	1 1	20 ... 33	3RT2035-1NB30-0CC0	3RT2035-3NB30-0CC0
51	22	70	11	1 1	20 ... 33	3RT2036-1NB30-0CC0	3RT2036-3NB30-0CC0
65	30	80	11	1 1	20 ... 33	3RT2037-1NB30-0CC0	3RT2037-3NB30-0CC0
80	37	90	11	1 1	20 ... 33	3RT2038-1NB30-0CC0	3RT2038-3NB30-0CC0

Other voltages according to page 3/69 on request.

Accessories and spare parts, see pages 3/71 to 3/126.

Switching devices – Contactors and contactor assemblies – for switching motors

Power contactors for switching motors



SIRIUS 3RT contactors, 3-pole up to 250 kW **IE3/IE4 ready** **AC-3e**

AC/DC operation

- Extended operating range of the solenoid coil 0.8 to 1.1 x U_s
- Power consumption reduced from closing power to holding power

PU (UNIT, SET, M) = 1
 PS* = 1 unit
 PG = 41B



Rated data		Auxiliary contacts		Rated control supply voltage U_s		Screw terminals 		Spring-loaded terminals 		
AC-3 and AC-3e, t_u : 60 °C	Operational current I_e up to 400 V	AC-1, t_u : 40 °C	Operational current I_e up to 690 V	Ident. No.	Version	50/60 Hz AC or DC	Article No.	Price per PU	Article No.	Price per PU
Ratings of three-phase motors at 50 Hz and 400 V	400 V	Ratings of three-phase motors at 50 Hz and 690 V								
A	kW	A								

For screw fixing and snap-on mounting on TH 35-15 and TH 75-15 DIN rails

Size S3

With integrated coil circuit (varistor integrated in electronics at the factory)

80	37	125	11	1	1	20 ... 33 83 ... 155 175 ... 280	3RT2045-1NB30 3RT2045-1NF30 3RT2045-1NP30	3RT2045-3NB30 3RT2045-3NF30 3RT2045-3NP30	
95	45	130	11	1	1	20 ... 33 83 ... 155 175 ... 280	3RT2046-1NB30 3RT2046-1NF30 3RT2046-1NP30	3RT2046-3NB30 3RT2046-3NF30 3RT2046-3NP30	
110	55	130	11	1	1	20 ... 33 83 ... 155 175 ... 280	3RT2047-1NB30 3RT2047-1NF30 3RT2047-1NP30	3RT2047-3NB30 3RT2047-3NF30 3RT2047-3NP30	
With removable auxiliary switch and integrated coil circuit (varistor integrated in electronics at the factory)									
80	37	125	22	2	2	20 ... 33 83 ... 155 175 ... 280	3RT2045-1NB34 3RT2045-1NF34 3RT2045-1NP34	-- -- --	
95	45	130	22	2	2	20 ... 33 83 ... 155 175 ... 280	3RT2046-1NB34 3RT2046-1NF34 3RT2046-1NP34	-- -- --	
110	55	130	22	2	2	20 ... 33 83 ... 155 175 ... 280	3RT2047-1NB34 3RT2047-1NF34 3RT2047-1NP34	-- -- --	
With permanently mounted auxiliary switch and integrated coil circuit (varistor integrated in electronics at the factory)									
80	37	125	22	2	2	20 ... 33	3RT2045-1NB34-3MA0	3RT2045-3NB34-3MA0	
95	45	130	22	2	2	20 ... 33	3RT2046-1NB34-3MA0	3RT2046-3NB34-3MA0	
110	55	130	22	2	2	20 ... 33	3RT2047-1NB34-3MA0	3RT2047-3NB34-3MA0	
With voltage tap-off and integrated coil circuit (varistor integrated in electronics at the factory)									
80	37	125	11	1	1	20 ... 33	3RT2045-1NB30-0CC0	3RT2045-3NB30-0CC0	
95	45	130	11	1	1	20 ... 33	3RT2046-1NB30-0CC0	3RT2046-3NB30-0CC0	
110	55	130	11	1	1	20 ... 33	3RT2047-1NB30-0CC0	3RT2047-3NB30-0CC0	

Other voltages according to page 3/69 on request.

Accessories and spare parts, see pages 3/71 to 3/126.

Switching devices – Contactors and contactor assemblies – for switching motors

Power contactors for switching motors

AC-3e

IE3/IE4 ready

SIRIUS 3RT contactors, 3-pole up to 250 kW

AC/DC operation

- Certified and fail-safe 24 V DC control input with max. 20 mA, e.g. for control via the fail-safe output module of a controller (F-PLC) or safety relay
- Achievable Safety Integrity Level (SIL) according to IEC 62061 and Performance Level (PL) according to ISO 13849-1 with corresponding fault diagnostics:
 - With one contactor: SIL 2 or PL c
 - With two contactors in series: SIL 3 or PL e
 - Fail-safe applications can be implemented using this contactor.
- Extended operating range of the solenoid coil 0.8 to 1.1 x U_s
- Power consumption reduced from closing power to holding power

For more information, see

- [Safety technology, page 11/1 onwards](#)
- [Guide of use for contactors in safety applications](#)

PU (UNIT, SET, M) = 1
 PS* = 1 unit
 PG = 41B



3RT203.-1S.30



3RT203.-3S.30



3RT204.-1S.30



3RT204.-3S.30

Rated data

AC-3 and AC-3e,
 t_u : 60 °COperational current I_e up to 400 V

A

Ratings of three-phase motors at 50 Hz and 400 V

kW

AC-1,
 t_u : 40 °COperational current I_e up to 690 V

A

Auxiliary contacts

Ident. No.

Version

NO

NC

V

Rated control supply voltage U_s

50/60 Hz AC or DC



Screw terminals

Article No.

Price per PU

Spring-loaded terminals

Article No.

Price per PU

For screw fixing and snap-on mounting on TH 35 DIN rail

Size S2

With integrated coil circuit (varistor integrated in electronics at the factory)

Operational current I_e (A)	Rated power (kW)	Rated voltage (V)	Ident. No.	Version	PU	Control supply voltage U_s (V)
41	18.5	60	01	--	1	21 ... 33 83 ... 150 175 ... 280
51	22	70	01	--	1	21 ... 33 83 ... 150 175 ... 280
65	30	80	01	--	1	21 ... 33 83 ... 150 175 ... 280
80	37	90	01	--	1	21 ... 33 83 ... 150 175 ... 280

3RT2035-1SB30
 3RT2035-1SF30
 3RT2035-1SP30

3RT2035-3SB30
 3RT2035-3SF30
 3RT2035-3SP30

3RT2036-1SB30
 3RT2036-1SF30
 3RT2036-1SP30

3RT2036-3SB30
 3RT2036-3SF30
 3RT2036-3SP30

3RT2037-1SB30
 3RT2037-1SF30
 3RT2037-1SP30

3RT2037-3SB30
 3RT2037-3SF30
 3RT2037-3SP30

3RT2038-1SB30
 3RT2038-1SF30
 3RT2038-1SP30

3RT2038-3SB30
 3RT2038-3SF30
 3RT2038-3SP30

For screw fixing and snap-on mounting on TH 35-15 and TH 75-15 DIN rails

Size S3

With integrated coil circuit (varistor integrated in electronics at the factory)

Operational current I_e (A)	Rated power (kW)	Rated voltage (V)	Ident. No.	Version	PU	Control supply voltage U_s (V)
80	37	125	01	--	1	21 ... 33 83 ... 150 175 ... 280
95	45	130	01	--	1	21 ... 33 83 ... 150 175 ... 280
110	55	130	01	--	1	21 ... 33 83 ... 150 175 ... 280

3RT2045-1SB30
 3RT2045-1SF30
 3RT2045-1SP30

3RT2045-3SB30
 3RT2045-3SF30
 3RT2045-3SP30

3RT2046-1SB30
 3RT2046-1SF30
 3RT2046-1SP30

3RT2046-3SB30
 3RT2046-3SF30
 3RT2046-3SP30

3RT2047-1SB30
 3RT2047-1SF30
 3RT2047-1SP30

3RT2047-3SB30
 3RT2047-3SF30
 3RT2047-3SP30

Accessories and spare parts, see pages 3/71 to 3/126.

Switching devices – Contactors and contactor assemblies – for switching motors

Power contactors for switching motors

SIRIUS 3RT contactors, 3-pole up to 250 kW **IE3/IE4 ready** **AC-3e**

AC/DC operation

- Standard operating mechanism 3RT10...-A
- For screw fixing
- Auxiliary and control conductors: Screw terminals or spring-loaded terminals
- Main conductors: Busbar connections; a connection kit with screws, spring washers and nuts is enclosed.

PU (UNIT, SET, M) = 1
PS* = 1 unit
PG = 41B



3RT105.-6A.36





3RT106.-6A.36



3RT107.-6A.36



3RT107.-2A.36

Size	Rated data			AC-1, t_{ij} : 40 °C	Operational current I_{oe} up to	Auxiliary contacts, lateral	Rated control supply voltage U_s	Screw terminals 		Spring-loaded terminals 	
	AC-3 and AC-3e, t_{ij} : 60 °C	Ratings of three-phase motors at 50 Hz and up to						Version	50/60 Hz AC or DC	Article No.	Price per PU
	500 V	400 V	500 V 690 V	690 V							
	A	kW	kW kW	A		NO NC V					

Standard operating mechanism for AC and DC operation (power consumption reduced from closing power to holding power)

With integrated coil circuit (varistor integrated at the factory)

	S6										
	115	55	75 110	160	2 2	110 ... 127 220 ... 240	3RT1054-6AF36 3RT1054-6AP36	3RT1054-2AF36 3RT1054-2AP36			
	150	75	90 132	185	2 2	110 ... 127 220 ... 240	3RT1055-6AF36 3RT1055-6AP36	3RT1055-2AF36 3RT1055-2AP36			
	185	90	132 160	215	2 2	110 ... 127 220 ... 240	3RT1056-6AF36 3RT1056-6AP36	3RT1056-2AF36 3RT1056-2AP36			
	S10	110	160 200	275	2 2	110 ... 127 220 ... 240	3RT1064-6AF36 3RT1064-6AP36	3RT1064-2AF36 3RT1064-2AP36			
	265	132	160 250	330	2 2	110 ... 127 220 ... 240	3RT1065-6AF36 3RT1065-6AP36	3RT1065-2AF36 3RT1065-2AP36			
	300	160	200 250	330	2 2	110 ... 127 220 ... 240	3RT1066-6AF36 3RT1066-6AP36	3RT1066-2AF36 3RT1066-2AP36			
	S12	200	250 400	430	2 2	110 ... 127 220 ... 240	3RT1075-6AF36 3RT1075-6AP36	3RT1075-2AF36 3RT1075-2AP36			
	500	250	315 400	610	2 2	110 ... 127 220 ... 240	3RT1076-6AF36 3RT1076-6AP36	3RT1076-2AF36 3RT1076-2AP36			

Other voltages [according to page 3/70](#) on request.

Accessories and spare parts, [see pages 3/71 to 3/126](#).

Switching devices – Contactors and contactor assemblies – for switching motors

Power contactors for switching motors

AC-3e

IE3/IE4 ready

SIRIUS 3RT contactors, 3-pole up to 250 kW

AC/DC operation

- Certified and fail-safe 24 V DC control input with max. 20 mA, e.g. for control via the fail-safe output module of a controller (F-PLC) or safety relay
- Achievable Safety Integrity Level (SIL) according to IEC 62061 and Performance Level (PL) according to ISO 13849-1 with corresponding fault diagnostics:
 - With one contactor: SIL 2 or PL c
 - With two contactors in series: SIL 3 or PL e
 - Fail-safe applications can be implemented using this contactor.
- Version with removable lateral auxiliary switches or permanently mounted auxiliary switches
- For screw fixing
- Auxiliary and control conductors: Screw terminals
- Main conductors: Busbar connections; a connection kit with screws, spring washers and nuts is enclosed.

For more information, see

- [Safety technology, page 11/1 onwards](#)
- [Guide of use for contactors in safety applications](#)





3RT105.-6S.36

3RT106.-6S.36

3RT107.-6S.36

3RT105.-6S.36-3PA0

3RT107.-6S.36-3PA0

Size	Rated data according to IEC 60947-4-1 AC-3 and AC-3e, t_i : 60 °C	Auxiliary contacts, lateral	Rated control supply voltage U_s	Screw terminals 	PU (UNIT, SET, M)	PS*	PG
	Operational current I_e up to	Version	50/60 Hz AC or DC	Article No.	Price per PU		
	500 V	  V					
	A						
	400 V						
	kW						

Solid-state operating mechanism

With two removable laterally mounted auxiliary switches

With integrated coil circuit (varistor integrated in electronics at the factory)

S6	115	55	2	2	96 ... 127 200 ... 277	3RT1054-6SF36 3RT1054-6SP36	1	1 unit	41B
	150	75	2	2	96 ... 127 200 ... 277	3RT1055-6SF36 3RT1055-6SP36	1	1 unit	41B
	185	90	2	2	96 ... 127 200 ... 277	3RT1056-6SF36 3RT1056-6SP36	1	1 unit	41B
S10	225	110	2	2	96 ... 127 200 ... 277	3RT1064-6SF36 3RT1064-6SP36	1	1 unit	41B
	265	132	2	2	96 ... 127 200 ... 277	3RT1065-6SF36 3RT1065-6SP36	1	1 unit	41B
	300	160	2	2	96 ... 127 200 ... 277	3RT1066-6SF36 3RT1066-6SP36	1	1 unit	41B
S12	400	200	2	2	96 ... 127 200 ... 277	3RT1075-6SF36 3RT1075-6SP36	1	1 unit	41B
	500	250	2	2	96 ... 127 200 ... 277	3RT1076-6SF36 3RT1076-6SP36	1	1 unit	41B

With two permanently laterally mounted auxiliary switches

With integrated coil circuit (varistor integrated in electronics at the factory)

S6	115	55	2	2	96 ... 127 200 ... 277	3RT1054-6SF36-3PA0 3RT1054-6SP36-3PA0	1	1 unit	41B
	150	75	2	2	96 ... 127 200 ... 277	3RT1055-6SF36-3PA0 3RT1055-6SP36-3PA0	1	1 unit	41B
	185	90	2	2	96 ... 127 200 ... 277	3RT1056-6SF36-3PA0 3RT1056-6SP36-3PA0	1	1 unit	41B
S10	225	110	2	2	96 ... 127 200 ... 277	3RT1064-6SF36-3PA0 3RT1064-6SP36-3PA0	1	1 unit	41B
	265	132	2	2	96 ... 127 200 ... 277	3RT1065-6SF36-3PA0 3RT1065-6SP36-3PA0	1	1 unit	41B
	300	160	2	2	96 ... 127 200 ... 277	3RT1066-6SF36-3PA0 3RT1066-6SP36-3PA0	1	1 unit	41B
S12	400	200	2	2	96 ... 127 200 ... 277	3RT1075-6SF36-3PA0 3RT1075-6SP36-3PA0	1	1 unit	41B
	500	250	2	2	96 ... 127 200 ... 277	3RT1076-6SF36-3PA0 3RT1076-6SP36-3PA0	1	1 unit	41B

Accessories and spare parts, see pages 3/71 to 3/126.

Switching devices – Contactors and contactor assemblies – for switching motors

Power contactors for switching motors

SIRIUS 3RT contactors, 3-pole up to 250 kW **IE3/IE4 ready** **AC-3e**

AC/DC operation

- Solid-state operating mechanism
 - 3RT10...-N with 24 V DC control signal input
 - 3RT10...-P with 24 V DC control signal input and with remaining lifetime indicator (RLT)
- For screw fixing
- Auxiliary and control conductors: Screw terminals or spring-loaded terminals
- Main conductors: Busbar connections; a connection kit with screws, spring washers and nuts is enclosed.

PU (UNIT, SET, M) = 1
 PS* = 1 unit
 PG = 41B

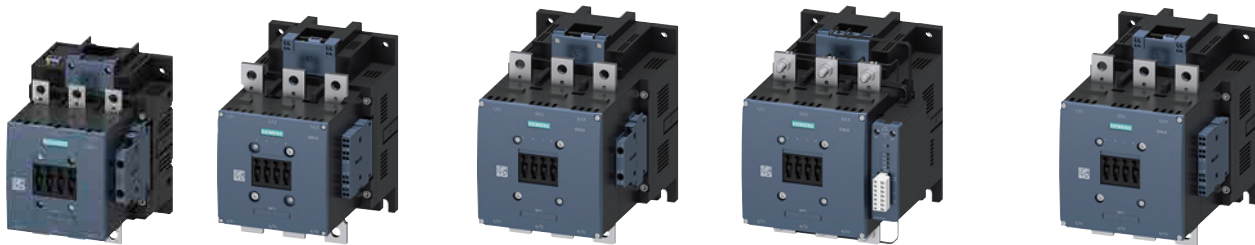



3RT105.-6N.36

3RT106.-2N.36

3RT107.-6N.36

3RT107.-6P.35

3RT107.-2N.36

Size	Rated data	AC-1, t_{ij} : 40 °C	Auxiliary contacts, lateral	Rated control supply voltage U_s	Screw terminals 	Spring-loaded terminals 
	AC-3 and AC-3e, t_{ij} : 60 °C	Operational current I_e up to	Version	50/60 Hz AC or DC	Article No.	Article No.
	Operational current I_e up to	Operational current I_e up to	NO NC V		Price per PU	Price per PU
	500 V A	400 V kW				
	500 V kW	690 V kW				

Solid-state operating mechanism

With 24 V DC control signal input
 e.g. for control by PLC

With integrated coil circuit (varistor integrated in electronics at the factory)

	S6	115	55	75	110	160	2	2	96 ... 127 200 ... 277	3RT1054-6NF36 3RT1054-6NP36	3RT1054-2NF36 3RT1054-2NP36
		150	75	90	132	185	2	2	96 ... 127 200 ... 277	3RT1055-6NF36 3RT1055-6NP36	3RT1055-2NF36 3RT1055-2NP36
		185	90	132	160	215	2	2	96 ... 127 200 ... 277	3RT1056-6NF36 3RT1056-6NP36	3RT1056-2NF36 3RT1056-2NP36
	S10	225	110	160	200	275	2	2	96 ... 127 200 ... 277	3RT1064-6NF36 3RT1064-6NP36	3RT1064-2NF36 3RT1064-2NP36
		265	132	160	250	330	2	2	96 ... 127 200 ... 277	3RT1065-6NF36 3RT1065-6NP36	3RT1065-2NF36 3RT1065-2NP36
		300	160	200	250	330	2	2	96 ... 127 200 ... 277	3RT1066-6NF36 3RT1066-6NP36	3RT1066-2NF36 3RT1066-2NP36
	S12	400	200	250	400	430	2	2	96 ... 127 200 ... 277	3RT1075-6NF36 3RT1075-6NP36	3RT1075-2NF36 3RT1075-2NP36
		500	250	315	400	610	2	2	96 ... 127 200 ... 277	3RT1076-6NF36 3RT1076-6NP36	3RT1076-2NF36 3RT1076-2NP36

For 24 V DC control signal input · with remaining lifetime indicator (RLT)
 e.g. for control by PLC

With integrated coil circuit (varistor integrated in electronics at the factory)

	S6	115	55	75	110	160	1	1	96 ... 127 200 ... 277	3RT1054-6PF35 3RT1054-6PP35	---
		150	75	90	132	185	1	1	96 ... 127 200 ... 277	3RT1055-6PF35 3RT1055-6PP35	---
		185	90	132	160	215	1	1	96 ... 127 200 ... 277	3RT1056-6PF35 3RT1056-6PP35	---
	S10	225	110	160	200	275	1	1	96 ... 127 200 ... 277	3RT1064-6PF35 3RT1064-6PP35	---
		265	132	160	250	330	1	1	96 ... 127 200 ... 277	3RT1065-6PF35 3RT1065-6PP35	---
		300	160	200	250	330	1	1	96 ... 127 200 ... 277	3RT1066-6PF35 3RT1066-6PP35	---
	S12	400	200	250	400	430	1	1	96 ... 127 200 ... 277	3RT1075-6PF35 3RT1075-6PP35	---
		500	250	315	400	610	1	1	96 ... 127 200 ... 277	3RT1076-6PF35 3RT1076-6PP35	---

Other voltages according to page 3/70 on request.

Accessories and spare parts, see pages 3/71 to 3/126.

Switching devices – Contactors and contactor assemblies – for switching motors

Power contactors for switching motors

SIRIUS 3RT contactors, 3-pole up to 250 kW

Options

Rated control supply voltages for 3RT20 contactors, possible on request (change of the 10th and 11th digits of the article number)

Delivery time on request

Rated control supply voltage U_s	Contactor type Size	3RT201, 3RH2 S00	3RT202 S0	3RT203 S2	3RT204 S3
Sizes S00 to S3					
AC operation¹⁾					
Solenoid coils for 50 Hz (exception: Size S00: 50 and 60 Hz ²⁾)					
24 V AC		B0	B0	B0	B0
42 V AC		D0	D0	D0	D0
48 V AC		H0	H0	H0	H0
110 V AC		F0	F0	F0	F0
230 V AC		P0	P0	P0	P0
240 V AC		U0	U0	U0	U0
400 V AC		V0	V0	V0	V0
Solenoid coils for 50 and 60 Hz²⁾					
24 V AC		B0	C2	C2	C2
42 V AC		D0	D2	D2	D2
48 V AC		H0	H2	H2	H2
110 V AC		F0	G2	G2	G2
220 V AC		N2	N2	N2	N2
230 V AC		P0	L2	L2	L2
Solenoid coils (for USA and Canada³⁾)					
50 Hz					
60 Hz					
110 V AC	120 V AC	K6	K6	K6	K6
220 V AC	240 V AC	P6	P6	P6	P6
Solenoid coils (for Japan)					
50/60 Hz⁴⁾					
60 Hz⁵⁾					
100 V AC	110 V AC	G6	G6	G6	G6
200 V AC	220 V AC	N6	N6	N6	N6
400 V AC	440 V AC	R6	R6	R6	R6
DC operation¹⁾					
12 V DC		A4	A4	--	--
24 V DC		B4	B4	--	--
42 V DC		D4	D4	--	--
48 V DC		W4	W4	--	--
60 V DC		E4	E4	--	--
110 V DC		F4	F4	--	--
125 V DC		G4	G4	--	--
220 V DC		M4	M4	--	--
230 V DC		P4	P4	--	--

Examples

AC operation	3RT2023-1AP00	Contactor with screw terminals; with solenoid coil for 50 Hz for rated control supply voltage of 230 V AC
	3RT2023-1AG20	Contactor with screw terminals; with solenoid coil for 50/60 Hz for rated control supply voltage of 110 V AC
DC operation	3RT2025-2BB40	Contactor with spring-loaded terminals; for rated control supply voltage 24 V DC
	3RT2025-2BG40	Contactor with spring-loaded terminals; for rated control supply voltage 125 V DC

¹⁾ For deviating coil voltages and operating ranges of sizes S00 and S0, a SITOP 24 V DC power supply with wide-range input can be used for the coil control, see page 15/1 or Catalog KT 10.1.

²⁾ Coil operating range
- at 50 Hz: 0.8 to $1.1 \times U_s$,
- at 60 Hz: 0.85 to $1.1 \times U_s$.

³⁾ Coil operating range
- Size S00:
at 50 Hz: 0.85 to $1.1 \times U_s$,
at 60 Hz: 0.8 to $1.1 \times U_s$,
- Sizes S0 to S3: at 50 Hz and 60 Hz: 0.8 to $1.1 \times U_s$.

⁴⁾ Coil operating range
- Size S00:
at 50/60 Hz: 0.85 to $1.1 \times U_s$,
- Size S0:
at 50 Hz: 0.8 to $1.1 \times U_s$,
at 60 Hz: 0.85 to $1.1 \times U_s$.

⁵⁾ Coil operating range at 60 Hz: 0.8 to $1.1 \times U_s$.

Rated control supply voltage $U_{s \min}$ to $U_{s \max}$ ¹⁾	Contactor type Size	3RT202.-N S0	Rated control supply voltage $U_{s \min}$ to $U_{s \max}$ ¹⁾	Contactor type Size	3RT203.-N S2	3RT204.-N S3
Sizes S00 to S3						
AC/DC operation (50/60 Hz AC or DC)						
21 ... 28 V AC/DC		B3	20 ... 33 V AC/DC		B3	B3
95 ... 130 V AC/DC		F3	48 ... 80 V AC/DC		E3	E3
200 ... 280 V AC/DC ²⁾		P3	83 ... 155 V AC/DC		F3	F3
			175 ... 280 V AC/DC		P3	P3

¹⁾ Coil operating range

- Size S0: $0.7 \times U_{s \min}$ to $1.3 \times U_{s \max}$.

- Sizes S2 and S3: $0.8 \times U_{s \min}$ to $1.1 \times U_{s \max}$.

²⁾ The following applies to S0 and $U_{s \max} = 280$ V: upper limit = $1.1 \times U_{s \max}$.

Switching devices – Contactors and contactor assemblies – for switching motors

Power contactors for switching motors

SIRIUS 3RT contactors, 3-pole up to 250 kW

Rated control supply voltages for 3RT10 contactors, possible on request (change of the 10th and 11th digits of the article number)

Delivery time on request

Rated control supply voltage	Contactor type 3RT105.-A, 3RT106.-A, 3RT107.-A	Rated control supply voltage	Contactor type 3RT105.-N, 3RT106.-N, 3RT107.-N	3RT105.-P, 3RT105.-S, 3RT106.-P, 3RT106.-S, 3RT107.-P, 3RT107.-S
$U_{s \min}$ to $U_{s \max}$	Sizes S6 to S12	$U_{s \min}$ to $U_{s \max}$	Sizes S6 to S12	
Sizes S6 to S12				

AC/DC operation (50/60 Hz AC or DC) and operating range $0.8 \times U_{s \min}$ to $1.1 \times U_{s \max}$

Standard operating mechanism

23 ... 26 V AC/DC	B3
42 ... 48 V AC/DC	D3
110 ... 127 V AC/DC	F3
200 ... 220 V AC/DC	M3
220 ... 240 V AC/DC	P3
240 ... 277 V AC/DC	U3
380 ... 420 V AC/DC	V3
440 ... 480 V AC/DC	R3
500 ... 550 V AC/DC	S3
575 ... 600 V AC/DC	T3

Solid-state operating mechanism

21 ... 27.3 V AC/DC	B3	--
96 ... 127 V AC/DC	F3	F3
200 ... 277 V AC/DC	P3	P3

Switching devices – Contactors and contactor assemblies – for switching motors

Power contactors for switching motors

Accessories for SIRIUS 3RT contactors and SIRIUS 3RH2 contactor relays > General data

Overview

Extensive accessories and spare parts are available for SIRIUS 3RT power contactors and SIRIUS 3RH2 contactor relays.

These components are easily fitted to the contactors without the use of any tools according to requirements.

Overview graphics with mountable accessories:

- 3RT2 contactors, see pages 3/8 to 3/11
- 3RT10, 3RT12 and 3RT14 contactors, see pages 3/12 to 3/16
- 3RH2 contactor relays, see page 5/5

More information

TIA Selection Tool Cloud (TST Cloud), see www.siemens.com/tstcloud/?node=Contactor

Version	For contactors 3RT2, sizes S00 to S3; 3RH2, size S00	3RT105 to 3RT107, 3RT126 and 3RT127, 3RT145 to 3RT147; sizes S6 to S12	Selection and ordering data Page
Accessories for 3RT contactors and 3RH2 contactor relays			
Auxiliary switches			
Instantaneous	3RH29.1	3RH19.1	3/83 ... 3/99
Delayed			
• Pneumatic time-delay auxiliary switches	3RT2927-2P..1	--	3/100
• Solid-state time-delay auxiliary switches	3RA2813, 3RA2814, 3RA2815	3RT1926-2E/-2F/-2G	3/100, 3/101
Surge suppressors			
• Without LED	3RT29.6-1B/-1C/-1D/-1E	3RT1956-1C	3/102, 3/103
• With LED	3RT29.6-1J/-1L/-1M	--	3/103
Modules for contactor control			
Coupling links for control by PLC	3RH29.4-.GP11	--	3/104
3RA28 function modules			
• For direct on-line starting: ON-delay or OFF-delay	3RA2811, 3RA2812, 3RA2831, 3RA2832	--	3/105
• For star-delta (wye-delta) starting	3RA2816	--	3/105
3RA27 function modules for IO-Link or AS-Interface			
• For direct-on-line, reversing or star-delta (wye-delta) starting	3RA271.-A/-B/-C	--	3/106, 3/107
Mechanical latching blocks	3RT2926-3A.31	--	3/108
OFF-delay devices for contactors with AC/DC and DC operation	3RT2916-2B.01	--	3/108
Link modules			
Link modules from motor starter protector to contactor	3RA.9.1	--	7/61
Safety main current connectors for two contactors	3RA29.6-1A	--	3/109
Assembly kits			
• For reversing contactor assemblies	3RA29.3-2AA.	3RA19.3-2A	3/109
• For contactor assemblies for star-delta (wye-delta) starting	3RA29.-2BB., 3RA29.3-2C	3RA1953-3G, 3RA19.3-2/-3.	3/110 ... 3/112
Single wiring modules	3RA.9.3-3.A.	3RA19.3-3.	3/113
Star jumpers (links for paralleling), 3-pole	3RT.9.6-4BA3.	3RT19.6-4BA31	3/113
Mechanical interlock kits for two contactors	3RA29.2-2H	--	3/114
Mechanical interlocks for contactor assemblies	3RA2934-2B	3RA1954-2.	3/114
Mechanical connectors for contactor assemblies	3RA29.2-2.	3RA1932-2D	3/114
Connection modules/adapters			
Links for paralleling for main conducting paths	3RT.9.6-4BB.1	--	3/115
1-phase infeed terminals	3RA2943-3L	--	3/116
3-phase infeed terminals	3RA2913-3K, 3RV29.5-5A.	--	3/116
• With increased clearances and creepage distances	3RV2935-5E	--	3/116
3-phase busbars	3RV1915-1AB	--	3/116
Terminal blocks for connecting auxiliary conductors to main terminals			
• Box terminal blocks	3RT2946-4G	3RT19.-4G	3/116
• Box terminal for auxiliary conductor connection, 1-pole	--	3TX7500-0A	3/116
• Auxiliary conductor terminals, 3-pole	3RT2946-4F	--	3/116
Solder pin adapters for mounting contactors on printed circuit boards	3RT1916-4KA.	--	3/117
Coil connection modules for connections from top or from bottom	3RT2926-4R.1.	--	3/117
Connection module (adapter and motor feeder connector) for contactors with screw terminals			
• Adapters	3RT19.6-4RD01	--	3/117
• Motor feeder connector	3RT1900-4RE01	--	3/117

Switching devices – Contactors and contactor assemblies – for switching motors

Power contactors for switching motors

Accessories for SIRIUS 3RT contactors and SIRIUS 3RH2 contactor relays > General data

Version	For contactors 3RT2, sizes S00 to S3; 3RH2, size S00	3RT105 to 3RT107, 3RT126 and 3RT127, 3RT145 to 3RT147; sizes S6 to S12	Selection and ordering data Page
Accessories for 3RT contactors and 3RH2 contactor relays (continued)			
Covers			
Terminal covers	3RT1946-4EA1, 3RT29.6-4EA.	3RT1956-4EA., 3RT1966-4EA., 3TX65.6-3B	3/118
Sealable covers	3RT2916-4MA10	3RT1926-4MA10	3/118
Miscellaneous accessories			
Base plates			
• For reversing contactor assemblies	--	3RT19.2-2A	3/119
• For contactor assemblies for star-delta (wye-delta) starting	3RA29.2-2F	3RA19.2-2.	3/119
Adapters for screw fixing	3RT1926-4P	--	3/119
Connection kit for one complete contactor	--	3RT19...4PA00	3/119
EMC suppression modules	3RT2916-1P . .	--	3/119
Additional load modules	3RT2916-1GA00	--	3/120
LED modules for displaying contactor operation	3RT2926-1QT00	3RT1926-1QT00	3/120
Control kit	3RT29.6-4MC00	--	3/120
Insulation stop for securely holding back the conductor insulation for conductors up to 1 mm²	3RT2916-4JA02	3RT1916-4JA02	3/121
Tools for opening spring-loaded terminals	3RA2908-1A	3RA2908-1A	3/121
Blank labels	3RT2900-1SB.0	3RT2900-1SB.0	3/121
Spare parts for 3RT2 contactors			
Solenoid coils	3RT29...5...1	--	3/122, 3/123
Withdrawable coils	--	3RT19...5....	3/124
Connection plugs for solid-state operating mechanisms	--	3RT1955-4NQ02	3/125
Contacts with fixing parts	3RT29...-6.	3RT19...-6.	3/125
Arc chutes	--	3RT19...-7.	3/126

Switching devices – Contactors and contactor assemblies – for switching motors

Power contactors for switching motors

Accessories for SIRIUS 3RT contactors and SIRIUS 3RH2 contactor relays > General data

Auxiliary switches

The auxiliary switches can be designed as force-guided contacts in 3RH contactor relays or also as mirror contacts in the case of 3RT power contactors.

For more information on force-guided operation and mirror contacts, see [Manuals](#) → "More information", page 3/78, and in the [selection and ordering data](#), page 3/83 onwards.

Solid-state time-delay auxiliary switches for mounting on 3RT2 contactors and 3RH2 contactor relays

See pages 3/78 and 3/100

The 3RA28 solid-state time-delay auxiliary switches which can be mounted on the contactor are designed for applications in the range from 24 to 240 V AC/DC (wide voltage range). Both the electrical and mechanical connection are made by simple snapping on and locking.

The time-delay auxiliary switch is supplied with power directly by two plug-in contacts through the coil terminals of the contactor, in parallel with A./A2.

A protection circuit (varistor) is integrated in each module.

A sealable cover is available to protect against careless adjustment of the set times.

Note:

Mounting more auxiliary switches on the contactor is not permitted.

Surge suppressors

- Without LED (also for spring-loaded terminals)
Sizes S00 to S3, see [page 3/102](#)
- With LED (also for spring-loaded terminals)
Sizes S00 to S3, see [page 3/103](#)

All 3RT2 contactors and 3RH2 contactor relays can be retrofitted with RC elements or varistors for damping switching overvoltages in the coil. Diodes or diode assemblies (combination of interference suppression diode and Zener diode for short break times) can also be used.

The surge suppressors are plugged onto the front of size S00 contactors. Space is provided for them next to a snap-on auxiliary switch.

Varistors, RC elements or diode assemblies can be plugged onto the front of size S0 to S3 contactors. Exception: For size S3, the RC element is inserted on the front into the recesses to the left of the connection block.

Coupling contactors are supplied either unconnected or with a suppressor diode, varistor or diode connected as standard, according to the version.

Note:

The break times of the contactor, the opening delay times of the NO contacts and the closing delay times of the NC contacts increase with damping.

For more detailed information about how damping affects the time response, see [Equipment Manual](#).

Coupling links for control by PLC

See pages 3/80 and 3/104

- Operation with 24 V DC
- Operating range 17 to 30 V
- Low power consumption of 0.5 W
- An LED indicates the switching state.

The 3RH2924-1GP11 coupling link has an integrated surge suppressor (varistor) for the contactor coil being switched and is mounted on the size S0 contactor coil via a coil connection module.

Switching devices – Contactors and contactor assemblies – for switching motors

Power contactors for switching motors

Accessories for SIRIUS 3RT contactors and SIRIUS 3RH2 contactor relays > General data

3RA28 function modules for mounting on 3RT2 contactors and 3RH2 contactor relays

See pages 3/81 and 3/105

Simply by being plugged in place, the SIRIUS function modules enable different functionalities required for the assembly of starters to be realized in the feeder. The function modules and wiring kits thus help to reduce the wiring work within the feeder practically to zero.

Protection of the device connections

The specifications for short-circuit protection (fuses, motor starter protectors/circuit breakers, or miniature circuit breakers) are available for the device connections of the main circuit and the auxiliary circuit.

In order to ensure a holistic view for the protection of the device connections, the manufacturer is obliged to provide all relevant information for short-circuit protection and overcurrent protection.

For more information, for example if device connections for the control supply voltage, the supply voltage, or digital inputs/digital outputs are not connected to self-limiting current sources or energy sources, see [Equipment Manual or the technical product data sheet](#).

SIRIUS function modules for direct-on-line starting

The electronic timing relays which can be mounted on the contactor are available in these versions:

- Sizes S00 and S0 for applications in the range from 24 to 240 V AC/DC (wide voltage range)
- Sizes S2 and S3 for applications in either the range from 24 to 90 V AC/DC or 90 to 240 V AC/DC

Both the electrical and mechanical connection are made by simple snapping on and locking.

A protection circuit (varistor) is integrated in each module.

The electronic timing relay with semiconductor output uses two contact legs to actuate the contactor underneath by means of a semiconductor after the set time t has elapsed.

The switching state feedback is performed by a mechanical switching state indicator (plunger). In addition, the auxiliary switches in the contactors are freely accessible and can be used for feedbacks to the control system or for signal lamps.

A sealable cover is available to protect against careless adjustment of the set times.

The snap-on function modules for direct-on-line starting are used above all for realizing time functions independently of the control system.

With the OFF-delay variant of the timing relay it is possible for example for the fan motor for cooling a main drive to be switched off with a delay so that sufficient cooling after operation is guaranteed; the programmer of the control system does not need to worry about such technical details of the plant.

The ON-delay timing relays enable for example the time-delayed starting of several drives so that the summation starting current does not rise too high, which could result in voltage failure.

The use of snap-on function modules for direct-on-line starting results in the following advantages:

- Reduction of control current wiring
- Prevention of wiring errors
- Reduction of testing costs
- Implementation of time functions independently of the control system
- Less space required in the control cabinet compared to a separate timing relay
- No additive protection circuit required (varistor integrated)

Assembly of reversing starters

We offer ready-made wiring kits for the assembly of reversing starters. Use of these wiring kits offers further advantages, see [page 3/149](#).

SIRIUS function modules for star-delta (wye-delta) starting

Both interlocking and time functions are required for the assembly of star-delta (wye-delta) starters. With the function modules for star-delta (wye-delta) starting and the matching link modules for the main circuit, these starters can be assembled easily and with absolutely no errors.

The entire sequence in the control circuit is integrated in the snap-on modules. This covers:

- An adjustable star time t from 0.5 to 60 s
- A non-adjustable dead interval of 50 ms
- Electrical contacting of the contactors by means of coil pick-off (contact legs)
- Feedback of the switching state at the contactor using a mechanical switch position indicator (plunger)
- Electrical interlocking between the contactors

These modules do not require their own terminals and can therefore be used for contactors with both screw and spring-loaded terminals in all the sizes S00 to S3. To start the star-delta (wye-delta) starter, only the first of the three contactors (line contactor) is actuated, like in the case of a direct-on-line starter. All other functions then take place inside the individual modules.

This also offers advantages if the time function was previously implemented in a controller, as it again results in a significant reduction in the number of PLC outputs, the programming work and the wiring outlay.

The kits for the main circuit include the mechanical interlock, the star jumper, the wiring modules at the top and at the bottom, and the required connectors or connecting clips.

A protection circuit (varistor) is integrated in the basic module.

The function modules for star-delta (wye-delta) starting are mostly used where current-limiting measures for starting a drive are required and a high level of availability is essential at the same time. This technology has been used with success for several decades and has the additional advantage of requiring relatively little know-how. Through the use of function modules, the assembly work with simple standard components is even easier and absolutely error-free.

The use of function modules for star-delta (wye-delta) starting results in the following advantages:

- Operation solely through the line contactor A1/A2 – no further control current wiring needed
- Prevention of wiring errors
- Reduction of testing costs
- Integrated electrical interlocking saves costs and prevents errors
- Less space needed in the control cabinet compared to using a separate timing relay
- Adjustable starting in star mode from 0.5 to 60 s
- Independent of the contactor's control supply voltage (24 to 240 V AC/DC)
- Varistor integrated – no additive protection circuit required
- Mechanically coded assembly enables easy configuration and reliable wiring
- Fewer versions – one module kit for screw and spring-loaded connection and for all the contactor sizes S00 to S3
- Mechanical interlocking (with wiring kit for the main circuit)

Switching devices – Contactors and contactor assemblies – for switching motors

Power contactors for switching motors

Accessories for SIRIUS 3RT contactors and SIRIUS 3RH2 contactor relays > General data

SIRIUS 3RA27 function modules for IO-Link or AS-Interface for mounting on 3RT2 contactors

See pages 3/82 and 3/106

The SIRIUS 3RA27 function modules enable the assembly of starters and contactor assemblies for direct-on-line, reversing and star-delta (wye-delta) starting without any additional, complicated wiring of the individual components. They include the key control functions, e.g. timing and interlocking, required for the particular feeder and can be connected to the control system via either IO-Link or AS-Interface.

The electrical and mechanical connection to the contactor is established by snapping on and locking the respective modules. An additive protection circuit for the individual contactors can be dispensed with completely because a varistor is integrated in the modules. Feedback from the contactor contacts is performed with Hall sensors which provide reliable feedback on the switching state even under extremely dusty conditions.

The starters are connected to the higher-level control system through IO-Link, with the possibility of connecting up to four starters as a group to one port of the IO-Link master.

Optionally, the connection can be made via AS-Interface (specification V2.1 or higher, in A/B technology). As a result, up to 62 starters can be connected to one master and the address is entered in the normal manner with an addressing unit.

Through this type of connection to the control system, a maximum of wiring is saved. In the case of AS-Interface, the wiring amounts to the supply voltage and the two individual wires for AS-Interface.

The following essential signals are thus transmitted:

- Availability of the feeder in response to an indirect inquiry from the motor starter protector/circuit breaker
- Starter control
- Feedback on switching state of the starter

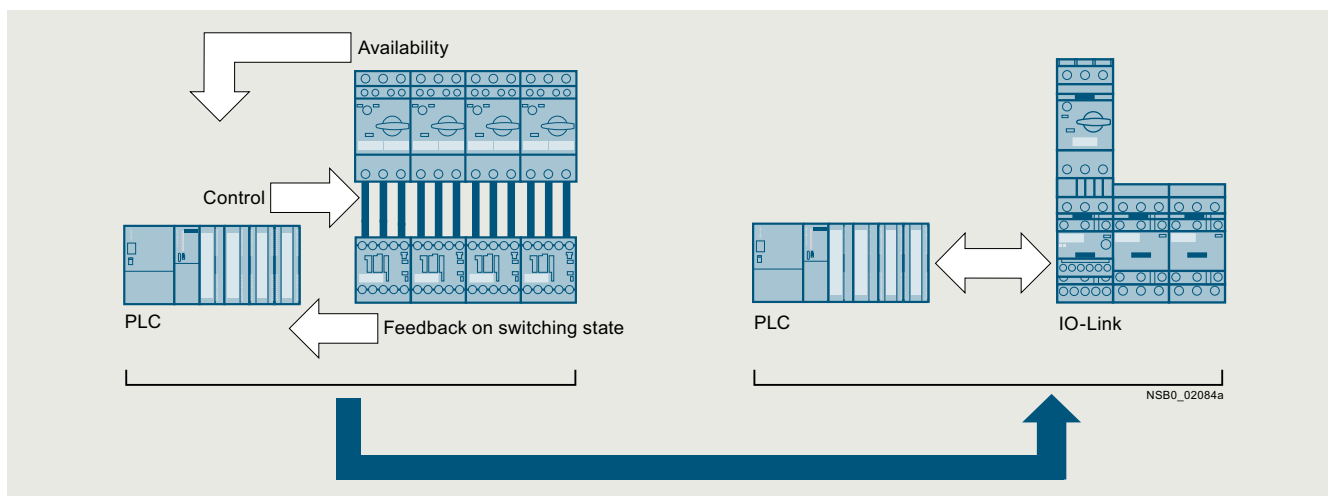

Signal transmission through IO-Link

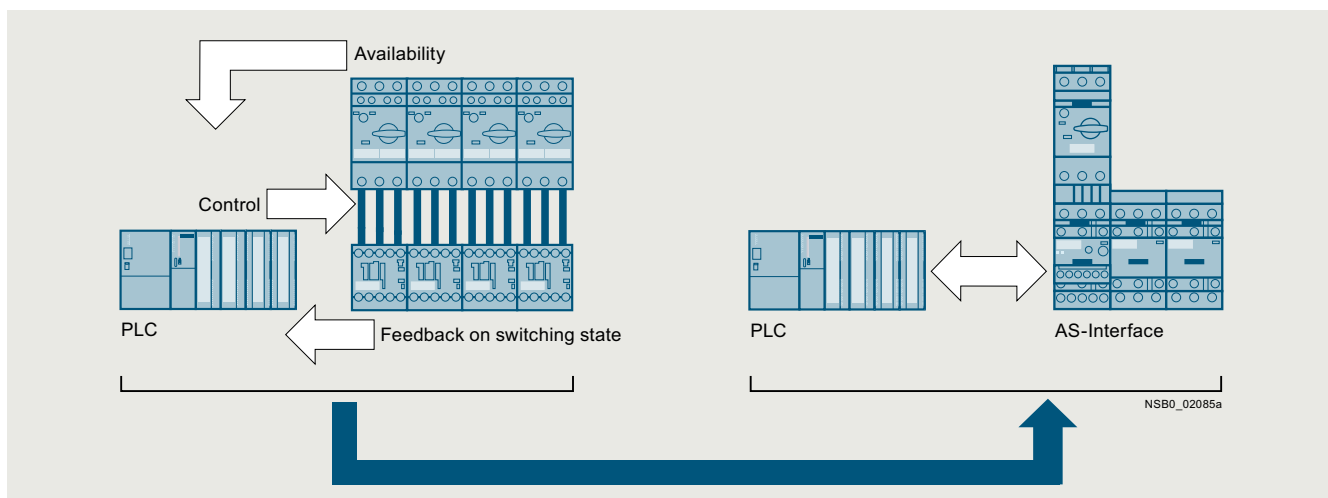

Signal transmission through AS-Interface

Switching devices – Contactors and contactor assemblies – for switching motors

Power contactors for switching motors

Accessories for SIRIUS 3RT contactors and SIRIUS 3RH2 contactor relays > General data

The inquiry from the motor starter protector/circuit breaker does not take place through additive wiring between the auxiliary switch and the module but by means of a voltage inquiry at the contactor input.

This requires special versions of the 3RT20...-...-0CC0 contactors with voltage tap-off (see pages 3/55, 3/59, 3/63 and 3/64).

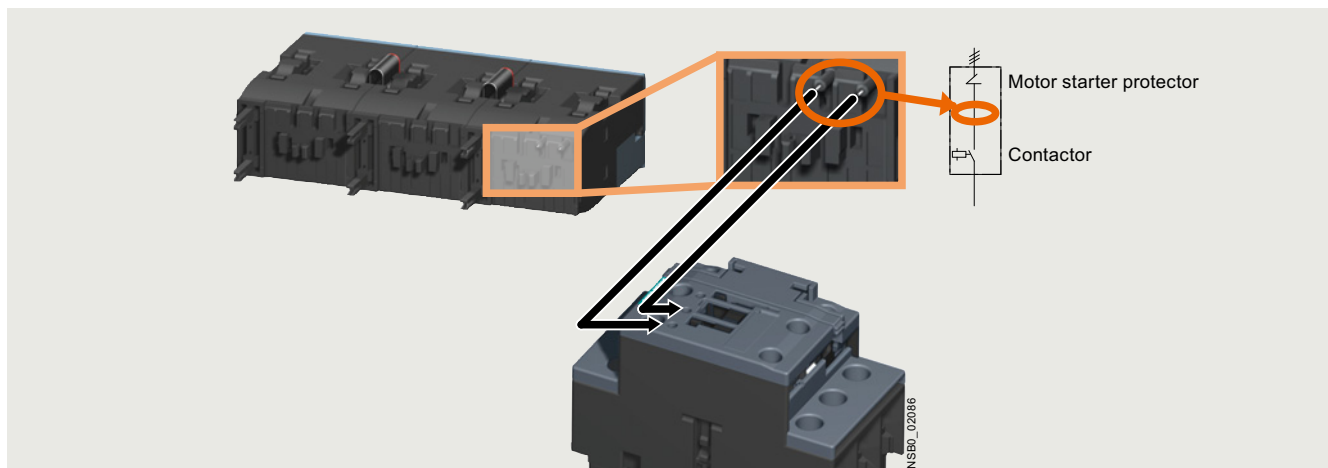

Availability signal through voltage tap-off

The following benefits result from the use of SIRIUS 3RA27 function modules:

- Reduction of control current wiring. In the case of IO-Link to no more than three cables for four feeders.
- Elimination of testing costs and wiring errors
- Reduction of configuration work
- Parameter server functionality
- Integration in TIA means unambiguous IO-Link diagnostics if a fault occurs
- Dispensing with IO modules saves space in the control cabinet
- All essential timing and interlocking functions for reversing duty and star-delta (wye-delta) starting are integrated
- No additive protection circuit required

For more information on IO-Link and AS-Interface, see "Industrial communication", page 2/1 onwards.

SIRIUS 3RA2711 function modules for IO-Link for mounting on 3RT2 contactors

By grouping up to four starters, it is possible to connect up to 16 starters to one master of the ET 200SP or S7-1200. In this case all the signals of the individual controls are made available directly in the process image of the input through only three individual wires per starter group. If the same potential is present

Protection of the device connections

The specifications for short-circuit protection (fuses, motor starter protectors/circuit breakers, or miniature circuit breakers) are available for the device connections of the main circuit and the auxiliary circuit.

In order to ensure a holistic view for the protection of the device connections, the manufacturer is obliged to provide all relevant information for short-circuit protection and overcurrent protection.

For more information, for example if device connections for the control supply voltage, the supply voltage, or digital inputs/digital outputs are not connected to self-limiting current sources or energy sources, see [Equipment Manual](#) or the [technical product data sheet](#).

at the ET 200SP or S7-1200 master and at the switching devices, the wiring can be further reduced by connecting the supply voltage of the contactor coils to the communication wires via jumpers.

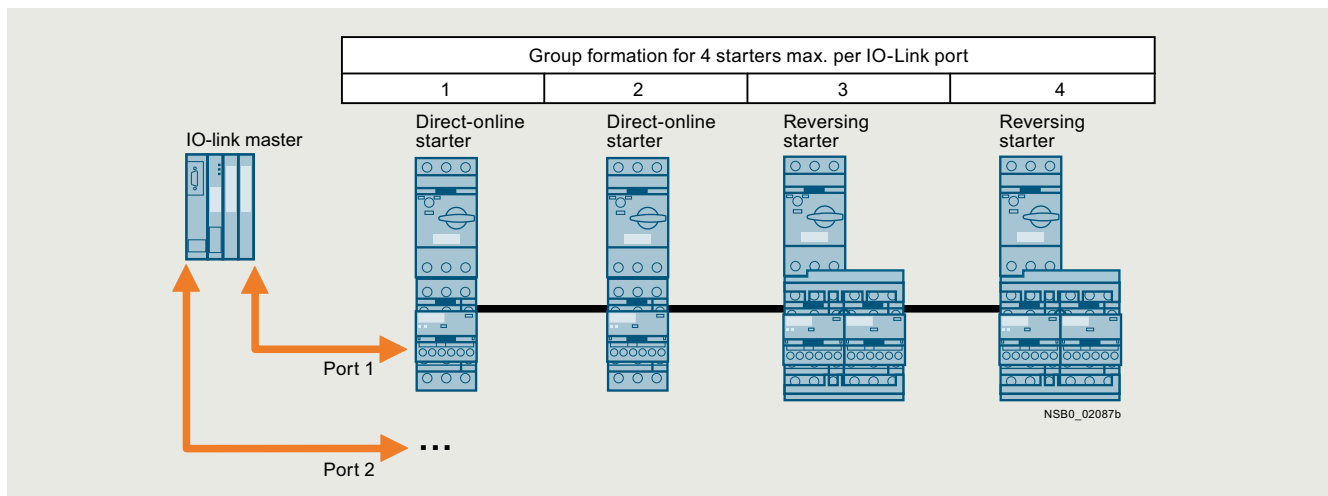

Group formation with IO-Link

Switching devices – Contactors and contactor assemblies – for switching motors

Power contactors for switching motors

Accessories for SIRIUS 3RT contactors and SIRIUS 3RH2 contactor relays > General data

In case of a malfunction, the corresponding error signals are also sent directly to the PLC in acyclic mode. This is in addition to transmission of the switching signals and status signals.

Possible error signals:

- Switching element defective
- No main voltage (motor starter protectors/circuit breakers tripped)
- No control supply voltage
- Limit position on the right/on the left
- Manual mode
- Process mapping error

This easy integration of the starters in the TIA world does not limit the flexibility in the field in the least. For example, all function modules have special terminals in order to enable direct local disconnection. These terminals can be connected for example to a position switch. The input interrupts the voltage supply to the

contactor coil directly, i.e. without going through the PLC. These terminals are jumpered in the delivery state.

Local manual operation of the complete starter group is also straightforward using a handheld device. The latter is easily connected to the last starter and can be built into the front panel of the control cabinet if required. This offers significant advantages particularly for commissioning.

SIRIUS function modules with IO-Link are used above all in machines and plants in which there are several motor feeders in one control cabinet. Using IO-Link, the connection of these feeders to the automation level is easy, quick and error-free. And with IO modules no longer needed, the width of the PLC is far smaller.

SIRIUS 3RA2712 function modules for AS-Interface for mounting on 3RT2 contactors

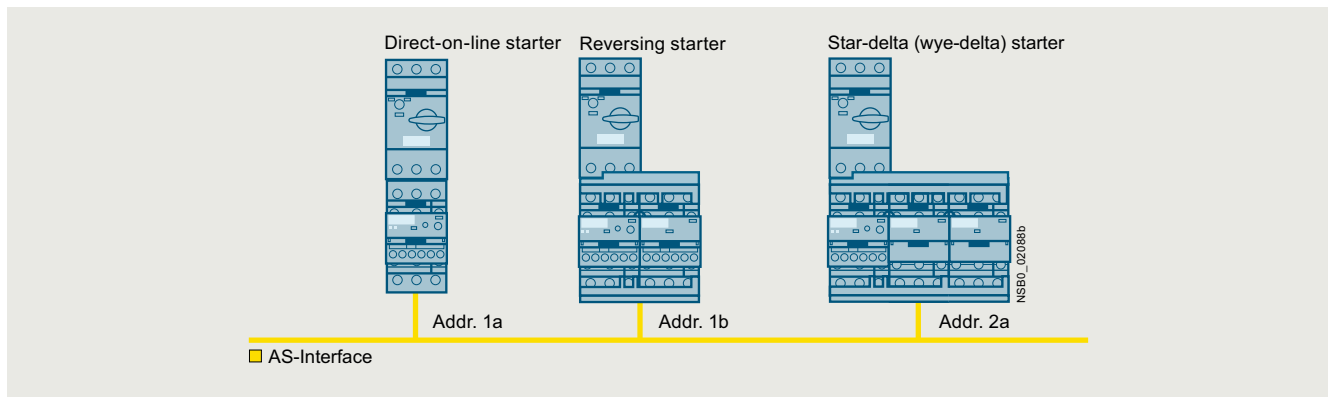

Topology with AS-Interface

This easy integration of the starters in the TIA world does not limit the flexibility in the field in the least. For example, all function modules have special terminals in order to enable direct local disconnection. These terminals can be connected for example to a position switch. The input interrupts the voltage supply to the contactor coil directly, i.e. without going through the PLC. These terminals are jumpered in the delivery state.

SIRIUS function modules with AS-Interface are recommended above all in machines and plants requiring easy connection of several different sensors and actuators both inside and outside the control cabinet to the higher-level control system. And with IO modules no longer needed, the width of the PLC is far smaller.

Switching devices – Contactors and contactor assemblies – for switching motors

Power contactors for switching motors

Accessories for SIRIUS 3RT contactors and SIRIUS 3RH2 contactor relays > General data

Technical specifications

More information

TIA Selection Tool Cloud (TST Cloud), see
www.siemens.com/tstcloud/?node=Contactor

Technical specifications

- SIRIUS 3RT2 contactors and SIRIUS 3RH2 contactor relays, see
<https://support.industry.siemens.com/cs/ww/en/ps/16208/td>
- SIRIUS 3RT1 contactors, see
<https://support.industry.siemens.com/cs/ww/en/ps/16209/td>

FAQs

- SIRIUS 3RT2 contactors and SIRIUS 3RH2 contactor relays, see
<https://support.industry.siemens.com/cs/ww/en/ps/16208/faq>
 - SIRIUS 3RT1 contactors, see
<https://support.industry.siemens.com/cs/ww/en/ps/16209/faq>
- System Manual for modular system, see
<https://support.industry.siemens.com/cs/ww/en/view/60311318>
- Equipment Manual, see
<https://support.industry.siemens.com/cs/ww/en/view/60306557>



Solid-state time-delay auxiliary switches for mounting on 3RT201 to 3RT204 (sizes S00 to S3) and 3RH2 contactor relays (size S00)

Type		3RA2813	3RA2814	3RA2815
Function		ON-delay	OFF-delay with control signal	OFF-delay without control signal
General data				
Dimensions (basic unit with mounted solid-state time-delay auxiliary switch)		See 3RT2 contactors (pages 3/29, 3/32, 3/35, 3/38) and 3RH2 contactor relays (page 5/8)		
Rated insulation voltage U_i Pollution degree 3, overvoltage category III	V AC	300		
Rated impulse withstand voltage U_{imp}	kV AC	4		
Permissible ambient temperature				
• During operation	°C	-25 ... +60		
• During storage	°C	-40 ... +80		
Electromagnetic compatibility (EMC)		IEC 61000-6-2, IEC 61000-6-4, IEC 61812-1, IEC 60947-4-1		
Overvoltage protection		Varistor integrated		
Control				
Operating range of excitation		0.85 ... 1.1 x U_s , 0.95 ... 1.05 times the rated frequency		
Rated power	W	1		
• Power consumption at 230 V AC, 50 Hz	VA	2		
Recovery time	ms	150		
Minimum ON duration	ms	--	35	200
Setting accuracy , typ., with reference to upper limit of scale		± 15%		
Repeat accuracy , max.		± 1%		
Load side				
Rated operational currents I_e				
• AC-15 at 24 ... 250 V, 50 Hz	A	3		
• DC-13				
	- at 24 V	A		
	- at 125 V	A		
	- at 250 V	A		
Mechanical endurance	Operating cycles	10 x 10 ⁶		
Electrical endurance at AC-15, 250 V, 3 A	Operating cycles	100 000		
Residual current , max.	mA	--		
Voltage drop , max., with conducting output	VA	--		
Short-circuit protection				
• Fuse link, operational class gG: DIAZED, type 5SB	A	4		

Switching devices – Contactors and contactor assemblies – for switching motors

Power contactors for switching motors

Accessories for SIRIUS 3RT contactors and SIRIUS 3RH2 contactor relays > General data

Type	3RA2813 ON-delay	3RA2814 OFF-delay with control signal	3RA2815 OFF-delay without control signal
Function			
Conductor cross-sections			
Connection type (1 or 2 conductors can be connected)		 Screw terminals	
• Solid	mm ²	1 x (0.5 ... 4), 2 x (0.5 ... 2.5)	
• Finely stranded with end sleeve (DIN 46228)	mm ²	1 x (0.5 ... 2.5), 2 x (0.5 ... 1.5)	
• AWG cables, solid or stranded	AWG	2 x (20 ... 14)	
• Terminal screws		M3 (for standard screwdriver size 2 or Pozidriv 2)	
• Tightening torque	Nm	0.8 ... 1.2	
Connection type (1 or 2 conductors can be connected)		 Spring-loaded terminals	
• Solid	mm ²	2 x (0.25 ... 1.5)	
• Finely stranded with end sleeve (DIN 46228)	mm ²	2 x (0.25 ... 1.5)	
• Finely stranded without end sleeve	mm ²	2 x (0.25 ... 1.5)	
• AWG cables, solid or stranded	AWG	2 x (24 ... 16)	
• Operating devices	mm	3.0 x 0.5	

Solid-state time-delay auxiliary switches, for snapping onto 3RT1 contactors

Type	3RT1926-2E, 3RT1926-2F, 3RT1926-2G	
Sizes	S6 to S12	
General data		
Dimensions (W x H x D)	mm	33 x 46 x 73
Rated insulation voltage U_i	V AC	300
Pollution degree 3, overvoltage category III according to IEC 60664-1		
Permissible ambient temperature		
• During operation	°C	-25 ... +60
• During storage	°C	-40 ... +85
Electromagnetic compatibility (EMC)	IEC 61812-1	
Control		
Operating range of excitation	0.85 ... 1.1 x U_s , 0.95 ... 1.05 times the rated frequency	
Rated power	W	2
Power consumption at 230 V AC, 50 Hz	VA	4
Recovery time	ms	150
Minimum ON duration	ms	200 (with OFF-delay)
Setting accuracy, typ., with reference to upper limit of scale	%	± 15
Repeat accuracy, max.	%	± 1



Type	3RT1926-2E, 3RT1926-2F, 3RT1926-2G	
Sizes	S6 to S12	
Load side		
Rated operational currents I_e		
• AC-15, 230 V, 50 Hz	A	3
• DC-13, 24 V	A	1
• DC-13, 110 V	A	0.2
• DC-13, 230 V	A	0.1
Short-circuit protection		
Fuse link, operational class gG: DIAZED, type 5SB	A	4
Mechanical endurance	Operat- ing cycles	10 x 10 ⁶
Conductor cross-sections		
Connection type (1 or 2 conductors can be connected)		 Screw terminals
• Solid	mm ²	2 x (0.5 ... 1.5), 2 x (0.75 ... 4)
• Finely stranded with end sleeve	mm ²	2 x (0.5 ... 2.5)
• AWG cables, solid or stranded	AWG	2 x (18 ... 14)
• Terminal screws		M3
• Tightening torque	Nm	0.8 ... 1.2

Switching devices – Contactors and contactor assemblies – for switching motors

Power contactors for switching motors

Accessories for SIRIUS 3RT contactors and SIRIUS 3RH2 contactor relays > General data

Coupling links for control by PLC



Type		3RH2924-1GP11	3RH2914-.GP11
Mounting on contactors of size		S0	S00 to S3
General data			
Standards		IEC 60947	
Rated insulation voltage U_i (pollution degree 3)	V	300	
Protective separation between coil and contacts according to IEC 60947-1, Annex N	V AC	Up to 300	
Permissible ambient temperature			
• During operation	°C	-25 ... +60	
• During storage	°C	-40 ... +80	
Control side			
Rated control supply voltage U_s	V DC	24	
Operating range	V DC	17 ... 30	
Power consumption at U_s	W	0.5	
Nominal current input	mA	20	
Release voltage	V	≥ 4	
Function display		Yellow LED	
Protection circuit		Varistor	
Load side			
Mechanical endurance	Operating cycles	20 million	10 million
Electrical endurance at I_e	Operating cycles	0.1 million	
Switching frequency	1/h	5 000	
Make-time	ms	Approx. 7	
Break-time	ms	Approx. 4	
Bounce time	ms	Approx. 2	
Contact material		AgSnO ₂	
Switching voltage	V AC/DC	24 ... 250	
Rated operational current I_e			
• AC-15/AC-14 at 230 V	A	3	
• DC-13 at 230 V	A	0.1	
Permissible residual current of the electronics (with 0 signal)	mA	2.5	
Conductor cross-sections			
Connection type (1 or 2 conductors can be connected)		 Screw terminals	
• Solid	mm ²	2 x (0.5 ... 2.5)	
• Finely stranded with end sleeve (DIN 46228)	mm ²	2 x (0.5 ... 1.5)	
• Terminal screws		M3	
Connection type (1 or 2 conductors can be connected)		 Spring-loaded terminals	
• Solid	mm ²	--	2 x (0.25 ... 1.5)
• Finely stranded with end sleeve (DIN 46228)	mm ²	--	2 x (0.25 ... 1.5)
• Finely stranded without end sleeve	mm ²	--	2 x (0.25 ... 1.5)
• AWG cables, solid or stranded	AWG	--	2 x (24 ... 16)
• Operating devices	mm	--	3.0 x 0.5

Switching devices – Contactors and contactor assemblies – for switching motors

Power contactors for switching motors

Accessories for SIRIUS 3RT contactors and SIRIUS 3RH2 contactor relays > General data

3RA28 function modules for mounting on 3RT2 contactors and 3RH2 contactor relays



Type	3RA2811	3RA2831	3RA2812	3RA2832	3RA2816
Mounting on contactors of size	S00, S0	S2, S3	S00, S0	S2, S3	S00 to S3
Function	For direct-on-line starting			For star-delta (wye-delta) starting	
	ON-delay		OFF-delay with control signal		
General data					
Dimensions (basic unit with mounted function module)					
See 3RT2 contactors (pages 3/29, 3/32, 3/35, 3/38) and 3RH2 contactor relays (page 5/8)					
Rated insulation voltage U_i Pollution degree 3, overvoltage category III	V AC	300			
Rated impulse withstand voltage U_{imp}	kV AC	4			
Overvoltage protection	Varistor integrated				
Recovery time	ms	50			150
Minimum ON duration	ms	--	35	--	
Setting accuracy, typ. , with reference to upper limit of scale	± 15%				
Repeat accuracy, max.	± 1%				
Permissible ambient temperature					
• During operation	°C	-25 ... +60			
• During storage	°C	-40 ... +80			
Electromagnetic compatibility (EMC)	IEC 61000-6-2, IEC 61000-6-4, IEC 61812-1, IEC 60947-4-1				
Control side					
Operating range of excitation					
0.85 ... 1.1 × U_N , 0.95 ... 1.05 times the rated frequency					
Rated power	W	1			
• Power consumption at 230 V AC, 50 Hz	VA	1			2
Load side					
Mechanical endurance	Operating cycles	100 × 10 ⁶			10 × 10 ⁶
Electrical endurance					
• With 3RT2028 contactor	Operating cycles	100 000			--
• At AC-15, 250 V, 3 A	Operating cycles	--			100 000
Residual current, max.	mA	5	--		
Voltage drop, max. with conducting output	VA	3.5	--		
Short-circuit protection					
Version of the fuse link required for short-circuit protection of the auxiliary switch	A	--			Fuse gL/gG: 4
Conductor cross-sections					
Connection type (1 or 2 conductors can be connected)					
 Screw terminals					
• Solid	mm ²	1 × (0.5 ... 4), 2 × (0.5 ... 2.5)			--
• Finely stranded with end sleeve (DIN 46228)	mm ²	1 × (0.5 ... 2.5), 2 × (0.5 ... 1.5)			--
• AWG cables, solid or stranded	AWG	2 × (20 ... 14)			--
• Terminal screws		M3 (for standard screwdriver size 2 or Pozidriv 2)			--
• Tightening torque	Nm	0.8 ... 1.2			--
Connection type (1 or 2 conductors can be connected)					
 Spring-loaded terminals					
• Operating devices	mm	3.0 × 0.5			--
• Solid	mm ²	2 × (0.25 ... 1.5)			--
• Finely stranded with end sleeve (DIN 46228)	mm ²	2 × (0.25 ... 1.5)			--
• Finely stranded without end sleeve	mm ²	2 × (0.25 ... 1.5)			--
• AWG cables, solid or stranded	AWG	2 × (24 ... 16)			--

Switching devices – Contactors and contactor assemblies – for switching motors



Power contactors for switching motors

Accessories for SIRIUS 3RT contactors and SIRIUS 3RH2 contactor relays > General data

3RA27 function modules for IO-Link for mounting on 3RT2 contactors

Type	3RA2711		
General data			
Dimensions	See 3RT2 contactors: pages 3/29, 3/32, 3/35 and 3/38		
Suitable for IO-Link masters according to specification	1.1		
Permissible ambient temperature			
• During operation	According to IEC 60947-1	°C	-25 ... +60
• During storage	According to IEC 60721-3-1	°C	-40 ... +80
• During transport	According to IEC 60721-3-2	°C	-40 ... +80
Operational voltage U_{Hi}	V DC		24 ± 20%
Max. length of the cables for the input Y1-Y2	m		30
Electromagnetic compatibility (EMC)	IEC 61000-6-2, IEC 61000-6-4, IEC 60947-4-1		
Conductor cross-sections			
Connection type (1 or 2 conductors can be connected)	 Screw terminals		
• Solid	mm ²		1 x (0.5 ... 4), 2 x (0.5 ... 2.5)
• Finely stranded with end sleeve (DIN 46228)	mm ²		1 x (0.5 ... 2.5), 2 x (0.5 ... 1.5)
• AWG cables, solid or stranded	AWG		2 x (20 ... 14)
• Terminal screws			M3 (for standard screwdriver Ø 6 mm or Pozidriv 2)
• Tightening torque of the terminal screws	Nm		0.8 ... 1.2
Connection type (1 or 2 conductors can be connected)	 Spring-loaded terminals		
• Operating devices	mm		3.0 x 0.5
• Solid	mm ²		2 x (0.25 ... 1.5)
• Finely stranded with end sleeve (DIN 46228)	mm ²		2 x (0.25 ... 1.5)
• Finely stranded without end sleeve	mm ²		2 x (0.25 ... 1.5)
• AWG cables, solid or stranded	AWG		2 x (24 ... 16)

3RA27 function modules for AS-Interface for mounting on 3RT2 contactors

Type	3RA2712		
General data			
Dimensions	See 3RT2 contactors: pages 3/29, 3/32, 3/35 and 3/38		
Slave type	A/B slave		
Suitable for AS-i masters according to specification	2.1 or higher		
AS-i slave profile IO.ID.ID2	7.A.E		
ID1 code (factory setting)	7		
Permissible ambient temperature			
• During operation	According to IEC 60947-1	°C	-25 ... +60
• During storage	According to IEC 60721-3-1	°C	-40 ... +80
• During transport	According to IEC 60721-3-2	°C	-40 ... +80
Operational voltage			
• AS-Interface	V		26.5 ... 31.6
• AUX PWR 24 V DC	V		24 ± 20%
Current consumption, max.			
• AS-Interface	mA		30
• AUX PWR			
- Maximum pickup/hold current	Size S00	mA	200/200
	Size S0	mA	300/300
	Size S2	mA	1 300/50
	Size S3	mA	4 000/70
Max. length of the cables for the input Y1-Y2	m		30
Electromagnetic compatibility (EMC)	IEC 61000-6-2, IEC 61000-6-4, IEC 60947-4-1		
Conductor cross-sections			
Connection type (1 or 2 conductors can be connected)	 Screw terminals		
• Solid	mm ²		1 x (0.5 ... 4), 2 x (0.5 ... 2.5)
• Finely stranded with end sleeve (DIN 46228)	mm ²		1 x (0.5 ... 2.5), 2 x (0.5 ... 1.5)
• AWG cables, solid or stranded	AWG		2 x (20 ... 14)
• Terminal screws			M3 (for standard screwdriver Ø 6 mm or Pozidriv 2)
• Tightening torque of the terminal screws	Nm		0.8 ... 1.2
Connection type (1 or 2 conductors can be connected)	 Spring-loaded terminals		
• Operating devices	mm		3.0 x 0.5
• Solid	mm ²		2 x (0.25 ... 1.5)
• Finely stranded with end sleeve (DIN 46228)	mm ²		2 x (0.25 ... 1.5)
• Finely stranded without end sleeve	mm ²		2 x (0.25 ... 1.5)
• AWG cables, solid or stranded	AWG		2 x (24 ... 16)

Switching devices – Contactors and contactor assemblies – for switching motors

Power contactors for switching motors

Accessories for SIRIUS 3RT contactors and SIRIUS 3RH2 contactor relays > Auxiliary switches, instantaneous

Overview

Auxiliary switch: Terminal designations and identification numbers for auxiliary contacts

Terminal designations

The terminal designations are 2-digit, e.g. 13, 14, 21, 22:

- Tens digit: Sequence digit
 - Related terminals have the same sequence digit
- Units digit: Function digit
 - 1-2 for normally closed contacts (NC)
 - 3-4 for normally open contacts (NO)

Identification numbers

The identification number indicates the number and type of the auxiliary contacts, e.g. 40, 31, 22, 13:

- 1st digit: number of normally open contacts (NO)
- 2nd digit: number of normally closed contacts (NC)

Examples:









- 31 = 3 NO + 1 NC
- 40 = 4 NO





Selection aid for mountable auxiliary switches for power contactors and contactor relays

The auxiliary switches of the 3RH29 series for mounting on the front and side can be used for 3RT2 power contactors as well as for 3RH2 contactor relays.

The possible combinations of basic unit and mounted auxiliary switch can be found in the tables, [see the following pages](#).

Where the columns and lines intersect (blue or green in the example) you will find the identification number for the combination of basic unit (column) and auxiliary switch (line).

Additional auxiliary switch		3-pole contactors		
Article number	Auxiliary contacts	3RT201	3RT201	3RT202 to 3RT204
	Version	S00	S00	S0 to S3
	NO NC	10	01	11
				
				
		2. 3. 4. 5.	5. 6. 7. 8.	3. 4. 5. 6.
		According to EN 50012 ¹⁾		

Auxiliary switches without NO contact				
3RH2911-□HA01	-- 1 	11	02	12
3RH2911-□HA02	-- 2 	12	03	13
3RH2911-□HA03	-- 3 	13	04	14
3RH2911-□FA04	-- 4 	14	--	--
IC01_00716				
Auxiliary switch with 1 NO contact				
3RH2911-□HA10	1 -- 	20	11	21

- 1 For screw terminals
- 2 For spring-loaded terminals

¹⁾ Combinations according to EN 50012, EN 50011 and IEC 60947-5-1 are in **bold print**. All combinations comply with EN 50005.

Example 1

Basic unit: 3-pole 3RT2017 motor contactor with 1 NO
 Required: 1 NO + 4 NC (Ident. No. 14)
 Result: 3RH2911-.FA04 auxiliary switch

Example 2

Basic unit: 3-pole 3RT2023 motor contactor with 1 NO + 1 NC
 Required: 1 NO + 4 NC (Ident. No. 14)
 Result: 3RH2911-.HA03 auxiliary switch

	Example 1	Example 2
Type	3RT20 motor contactor, S00 with 1 NO	3RT20 motor contactor, S0 with 1 NO + 1 NC
Sequence digit	2. 3. 4. 5.	3. 4. 5. 6.
Type	Auxiliary switch with 4 NC, 3RH2911-.FA04	Auxiliary switch with 3 NC, 3RH2911-.HA03
Function digit	1. 1. 1. 1. 2. 2. 2. 2.	1. 1. 1. 2. 2. 2.
Combination	3RT20 motor contactor, S00 with aux. switch	3RT20 motor contactor, S0 with aux. switch
Terminal designation Result	13 21 31 41 51 14 22 32 42 52 Ident. No. 14	13 21 31 41 51 14 22 32 42 52 Ident. No. 14

Switching devices – Contactors and contactor assemblies – for switching motors

Power contactors for switching motors

Accessories for SIRIUS 3RT contactors and SIRIUS 3RH2 contactor relays > Auxiliary switches, instantaneous

Additional auxiliary switches		3-pole contactors			4-pole contactors				Contactor relays		
Article number	Auxiliary contacts Version	S00 3RT201	S0 to S3 3RT202, 3RT203, 3RT204, 3RT244	S00 3RT231	3RT251	S0 to S3 3RT232, 3RT233, 3RT234	3RT252, 3RT253, 3RT254	S00 3RH21, 3RH24			
	NO NC	10	01 11	--	--	11	11	40E	31E	22E	
		2, 3, 4, 5, 6	2, 3, 4, 5, 6	1, 2, 3, 4	1, 2, 3, 4	3, 4, 5, 6	3, 4, 5, 6	5, 6, 7, 8	5, 6, 7, 8	5, 6, 7, 8	
		According to EN 50012 ¹⁾			According to EN 50012 ¹⁾				According to EN 50011 ¹⁾		

Auxiliary switches, front

Without NO contact

3RH2911-□HA01	--	1		11	02	12	01	01	12	12	41X	32X	23X
3RH2911-□HA02	--	2		12	03	13	02	02	13	--	42E	33X	24
3RH2911-□HA03	--	3		13	04	14	03	--	--	--	43	34	--
3RH2911-□FA04	--	4		14	--	--	--	--	--	--	44E	--	--

With 1 NO contact

3RH2911-□HA10	1	--		20	11	21	10	10	21	21	50E	41E	32E
3RH2911-□HA11	1	1		21	12	22	11	11	22	22	51X	42X	33X
3RH2911-□HA12	1	2		22	13	23	12	12	23	--	52	43	34
3RH2911-□HA13	1	3		23	14	24	13	--	--	--	53X	44X	--

With 2 NO contacts

3RH2911-□HA20	2	--		30	21	31	20	20	31	31	60E	51X	42X
3RH2911-□HA21	2	1		31	22	32	21	21	32	32	61	52	43
3RH2911-□HA22	2	2		32	23	33	22	22	33	--	62X	53	44X
3RH2911-□FA22	2	2		32	23	33	22	22	33	--	62X	53	44X

With 3 NO contacts

3RH2911-□HA30	3	--		40	31	41	30	30	41	41	70	61	52
3RH2911-□HA31	3	1		41	32	42	31	31	42	42	71X	62X	53X

With 4 NO contacts











3RH2911-□FA40	4	--		50	41	51	40	40	51	51	80E	71X	62X
---------------	---	----	--	----	----	----	----	----	----	----	-----	-----	-----

¹⁾ Combinations according to EN 50012, EN 50011 or IEC 60947-5-1 are in **bold** print. All combinations comply with EN 50005.

Switching devices – Contactors and contactor assemblies – for switching motors

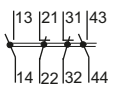

Power contactors for switching motors

Accessories for SIRIUS 3RT contactors and SIRIUS 3RH2 contactor relays > Auxiliary switches, instantaneous









Additional auxiliary switches		3-pole contactors			4-pole contactors				Contactor relays			
Article number	Auxiliary contacts Version	S00 3RT201	S0 to S3 3RT202, 3RT203, 3RT204, 3RT244	S00	S0 to S3 3RT231	3RT251	S0 to S3 3RT232, 3RT233, 3RT234	3RT252, 3RT253, 3RT254	S00 3RH21, 3RH24			
	NO NC	S00	S0 to S3	S00	S0 to S3	S00	S0 to S3	S0 to S3	40E	31E	22E	
												
		2. 3. 4. 5.	5. 6. 7. 8.	3. 4. 5. 6.	1. 2. 3. 4.	1. 2. 3. 4.	3. 4. 5. 6.	3. 4. 5. 6.	5. 6. 7. 8.	5. 6. 7. 8.	5. 6. 7. 8.	5. 6. 7. 8.
		According to EN 50005			According to EN 50005				According to EN 50005			

Auxiliary switches, front (continued)

With make-before-break¹⁾

3RH2911-□FB11	1	1		21	12	22	11	11	22	22	51	42	33
3RH2911-□FB22	2	2		32	23	33	22	22	33	--	62	53	44
3RH2911-□FC22	2	2		32	23	33	22	22	33	--	62	53	44

Complete inscription with terminals from top or bottom

3RH2911-1AA10	1	--		20	11	21	10	10	21	21	50	41	32
3RH2911-1BA10	1	--		20	11	21	10	10	21	21	50	41	32
3RH2911-1AA01	--	1		11	02	12	01	01	12	12	41	32	23
3RH2911-1BA01	--	1		11	02	12	01	01	12	12	41	32	23
3RH2911-1LA11	1	1		21	12	22	11	11	22	22	51	42	33
3RH2911-1MA11	1	1		21	12	22	11	11	22	22	51	42	33
3RH2911-1LA20	2	--		30	21	31	20	20	31	31	60	51	42
3RH2911-1MA20	2	--		30	21	31	20	20	31	31	60	51	42

¹⁾ Make-before-break contacts have no mirror contact function.

Switching devices – Contactors and contactor assemblies – for switching motors

Power contactors for switching motors

Accessories for SIRIUS 3RT contactors and SIRIUS 3RH2 contactor relays > Auxiliary switches, instantaneous

Additional auxiliary switches		3-pole contactors			4-pole contactors				Contactor relays		
Article number	Auxiliary contacts Version	S00 3RT201	S0 to S3 3RT202, 3RT203, 3RT204, 3RT244	S00 3RT231	3RT251	S0 to S3 3RT232, 3RT233, 3RT234	3RT252, 3RT253, 3RT254	S00 3RH21, 3RH24			
	NO NC	10	01	11	--	--	11	11	40E	31E	22E
		2. 3. 4. 5.	5. 6. 7. 8.	3. 4. 5. 6.	1. 2. 3. 4.	1. 2. 3. 4.	3. 4. 5. 6.	3. 4. 5. 6.	5. 6. 7. 8.	5. 6. 7. 8.	5. 6. 7. 8.
		According to EN 50005			According to EN 50005				According to EN 50011 ¹⁾		

Auxiliary switches, front (continued)

With complete inscription (for contactor relays²⁾)

3RH2911-□GA40	4	--		--	--	--	--	--	--	80E	--	--
3RH2911-□GA31	3	1		--	--	--	--	--	--	71E	--	--
3RH2911-□GA22	2	2		--	--	--	--	--	--	62E	--	--
3RH2911-□GA13	1	3		--	--	--	--	--	--	53E	--	--
3RH2911-□GA04	--	4		--	--	--	--	--	--	44E	--	--

Complete inscription

3RH2911-□XA40-0MA0	4	--		50	41	51	40	40	51	51	80E	71X	62X
3RH2911-□XA31-0MA0	3	1		41	32	42	31	31	42	42	71E	62X	53
3RH2911-□XA22-0MA0	2	2		32	23	33	22	22	33	--	62E	53	44X
3RH2911-□XA04-0MA0	--	4		14	--	--	--	--	--	--	44E	--	--

¹⁾ Combinations according to EN 50011 or IEC 60947-5-1 are in **bold** print. All combinations comply with EN 50005.

²⁾ For selection and ordering data, see page 3/93.

Switching devices – Contactors and contactor assemblies – for switching motors

Power contactors for switching motors

Accessories for SIRIUS 3RT contactors and SIRIUS 3RH2 contactor relays > Auxiliary switches, instantaneous

Additional auxiliary switches				3-pole contactors			4-pole contactors				Contactor relays				
Article number	Auxiliary contacts			S00	S0 to S3		S00	S0 to S3		S00					
	Version		Solid-state compatible	3RT201	3RT202, 3RT203, 3RT204, 3RT244		3RT231	3RT251	3RT232, 3RT233, 3RT234		3RT252, 3RT253, 3RT254		3RH21, 3RH24		
	Conventional	NO	NC	10	01	11	--	--	11	11	40E	31E	22E		
	NO	NC	NO	NO	NC										
				13	21	13 21			13 21	13 21	13 23 33 43	13 21 33 43	13 21 31 43		
				14	22	14 22			14 22	14 22	14 24 34 44	14 22 34 44	14 22 32 44		
				2. 3. 4. 5.	5. 6. 7. 8.	3. 4. 5. 6.	1. 2. 3. 4.	1. 2. 3. 4.	3. 4. 5. 6.	3. 4. 5. 6.	5. 6. 7. 8.	5. 6. 7. 8.	5. 6. 7. 8.		
				According to EN 50005			According to EN 50005				According to EN 50011¹⁾				

Auxiliary switches, front (continued)

Solid-state compatible

3RH2911-2NE21²⁾	1	--	1	1		31	22	32	21	21	32	32	61	52	43
3RH2911-1NE22²⁾	1	1	1	1		32	23	33	22	22	33	--	62	53	44
3RH2911-□NF02²⁾	--	--	--	2		12	03	13	02	02	13	--	42	33	24
3RH2911-□NF11²⁾	--	--	1	1		21	12	22	11	11	22	22	51	42	33
3RH2911-□NF20	--	--	2	--		30	21	31	20	20	31	31	60	51	42
3RH2911-2NF22²⁾	2	--	--	2		32	23	33	22	22	33	--	62	53	44
3RH2911-2NL22³⁾	1	2	1	--		32	23	33	22	22	33	--	--	--	--
3RH2911-2NL40	3	--	1	--		50	41	51	40	40	51	51	--	--	--
3RH2911-2NM31³⁾	2	1	1	--		41	32	42	31	31	42	42	--	--	--

¹⁾ Combinations according to EN 50011 or IEC 60947-5-1 are in **bold** print.

All combinations comply with EN 50005.

²⁾ The internal circuit diagrams shown apply to sizes S0 to S3 (incl. mirror contacts). If size S00 is used, the mirror contact function is not needed.

³⁾ Sizes S00 to S3: No mirror contact function.

Switching devices – Contactors and contactor assemblies – for switching motors

Power contactors for switching motors

Accessories for SIRIUS 3RT contactors and SIRIUS 3RH2 contactor relays > Auxiliary switches, instantaneous

Additional auxiliary switches		3-pole contactors			4-pole contactors				Contactor relays		
Article number	Auxiliary contacts Version	S00	S0 to S3		S00	S0 to S3			S00		
	NO NC	3RT201	3RT202, 3RT203, 3RT204, 3RT244		3RT231	3RT251	3RT232, 3RT233, 3RT234	3RT252, 3RT253, 3RT254	3RH21		
		10	01	11	--	--	11	11	40E	31E	22E
		2. 3. 4. 5.	5. 6. 7. 8.	3. 4. 5. 6.	1. 2. 3. 4.	1. 2. 3. 4.	3. 4. 5. 6.	3. 4. 5. 6.	5. 6. 7. 8.	5. 6. 7. 8.	5. 6. 7. 8.
		According to EN 50012 ¹⁾			According to EN 50012 ¹⁾				According to EN 50011 ¹⁾		

Lateral auxiliary switches

For size S00		Left	Right										
3RH2911-□DA02	-- 2 --			12	--	--	02	02	--	--	--	--	--
3RH2911-□DA02 + 3RH2911-□DA02	-- 2			14	--	--	--	--	--	--	--	--	--
3RH2911-□DA11	1 1 --			21	--	--	11	11	--	--	--	--	--
3RH2911-□DA11 + 3RH2911-□DA11	1 1			32	--	--	22	22	--	--	--	--	--
3RH2911-□DA20	2 -- --			30	--	--	20	20	--	--	--	--	--
3RH2911-□DA20 + 3RH2911-□DA20	2 --			50	--	--	40	40	--	--	--	--	--
3RH2911-□DA20 + 3RH2911-□DA11	2 --			41	--	--	31	31	--	--	--	--	--
3RH2911-□DA20 + 3RH2911-□DA02	2 --			32	--	--	22	22	--	--	--	--	--
3RH2911-□DA11 + 3RH2911-□DA02	1 1 -- 2			23	--	--	13	--	--	--	--	--	--

For sizes S0 to S3		Left	Right										
3RH2921-□DA02	-- 2 --			12	03	13	02	02	13	--	--	--	--
3RH2921-□DA02 + 3RH2921-□DA02	-- 2			14	--	--	--	--	--	--	--	--	--
3RH2921-□DA11	1 1 --			21	12	22	11	11	22	22	--	--	--
3RH2921-□DA11 + 3RH2921-□DA11	1 1			32	23	33	22	22	--	--	--	--	--
3RH2921-□DA20	2 -- --			30	21	31	20	20	31	31	--	--	--
3RH2921-□DA20 + 3RH2921-□DA20	2 --			50	41	51	40	40	--	--	--	--	--

¹⁾ Combinations according to EN 50012, EN 50011 or IEC 60947-5-1 are in **bold** print. All combinations comply with EN 50005.

Switching devices – Contactors and contactor assemblies – for switching motors

Power contactors for switching motors

Accessories for SIRIUS 3RT contactors and SIRIUS 3RH2 contactor relays > Auxiliary switches, instantaneous

Additional auxiliary switches		3-pole contactors			4-pole contactors				Contactor relays		
Article number	Auxiliary contacts Version	S00 3RT201	S0 to S3 3RT202, 3RT203, 3RT204, 3RT244	S00 3RT231	3RT251	S0 to S3 3RT232, 3RT233, 3RT234	3RT252, 3RT253, 3RT254	S00 3RH21			
	NO NC	10	01	11	--	--	11	11	40E	31E	22E
		2. 3. 4. 5.	5. 6. 7. 8.	3. 4. 5. 6.	1. 2. 3. 4.	1. 2. 3. 4.	3. 4. 5. 6.	3. 4. 5. 6.	5. 6. 7. 8.	5. 6. 7. 8.	5. 6. 7. 8.
		According to EN 50012¹⁾			According to EN 50012¹⁾				According to EN 50011¹⁾		

Lateral auxiliary switches (continued)

For sizes S00 to S3		Left	Right	3-pole contactors			4-pole contactors		Contactor relays			
3RH2921-□DA20 + 3RH2921-□DA11	2 -- 1 1			41	32	42	31	31	--	--	--	--
3RH2921-□DA20 + 3RH2921-□DA02	2 -- -- 2			32	23	33	22	22	--	--	--	--
3RH2921-□DA11 + 3RH2921-□DA02	1 1 -- 2			23	14	24	13	--	--	--	--	--

For contactor relays ²⁾		Left	3-pole contactors			4-pole contactors		Contactor relays				
3RH2921-□DA02	-- 2		--	--	--	--	--	--	--	42Z	33X	24
3RH2921-□DA11	1 1		--	--	--	--	--	--	--	51X	42X	33X
3RH2921-□DA20	2 --		--	--	--	--	--	--	--	60Z	51X	42X

¹⁾ Combinations according to EN 50012, EN 50011 or IEC 60947-5-1 are in **bold** print. All combinations comply with EN 50005.

²⁾ Without force-guided operation.



Switching devices – Contactors and contactor assemblies – for switching motors

Power contactors for switching motors

Accessories for SIRIUS 3RT contactors and SIRIUS 3RH2 contactor relays > Auxiliary switches, instantaneous

Additional auxiliary switches		3-pole contactors			4-pole contactors				Contactor relays		
Article number	Auxiliary contacts	S00	S0 to S3	S00	S0 to S3	S00	S0 to S3	S00	S00		
	Version	3RT201	3RT202, 3RT203, 3RT204, 3RT244	3RT231	3RT251	3RT232, 3RT233, 3RT234	3RT252, 3RT253, 3RT254	3RH21			
	Solid-state compatible										
	NO NC	10 01	11	-- --	11 11	11 11	11 11	40E 31E 22E			
		2. 3. 4. 5.	5. 6. 7. 8.	3. 4. 5. 6.	1. 2. 3. 4.	1. 2. 3. 4.	3. 4. 5. 6.	3. 4. 5. 6.	5. 6. 7. 8.	5. 6. 7. 8.	5. 6. 7. 8.
		According to EN 50012¹⁾			According to EN 50012¹⁾				According to EN 50011¹⁾		

Lateral auxiliary switches (continued)

Solid-state compatible

For size S00		Left	Right										
3RH2911-2DE11	1 1 --			21	--	--	11	11	--	--	--	--	--
	1 1			32	--	--	22	22	--	--	--	--	--
3RH2911-2DE11 + 3RH2911-2DE11	1 1												
For sizes S00 to S3		Left	Right										
3RH2921-2DE11	1 1 --			21	12	22	11	11	22	22	--	--	--
	1 1			32	23	33	22	22	--	--	--	--	--
3RH2921-2DE11 + 3RH2921-2DE11	1 1												
For contactor relays ²⁾		Left											
3RH2921-2DE11	1 1		--	--	--	--	--	--	--	--	51X	42X	33X

¹⁾ Combinations according to EN 50012, EN 50011 or IEC 60947-5-1 are in **bold** print. All combinations comply with EN 50005.

²⁾ Without force-guided operation.

Switching devices – Contactors and contactor assemblies – for switching motors

Power contactors for switching motors

Accessories for SIRIUS 3RT contactors and SIRIUS 3RH2 contactor relays > Auxiliary switches, instantaneous

Selection and ordering data



PU (UNIT, SET, M) = 1
 PS* = 1 unit
 PG = 41B



3RH2911-1HA22















3RH2911-2HA22

For contactors/ contactor relays ¹⁾	Auxiliary contacts Version	Screw terminals		Spring-loaded terminals	
		Article No.	Price per PU	Article No.	Price per PU
Type	 NO  NC				

Auxiliary switches for snapping onto the front

Sizes S00 to S3

3RT2.1, 3RT2.2, 3RT2.3, 3RT2.4, 3RH21, 3RH24	--	1	
	--	2	
	--	3	
	1	--	
	1	1	
	1	2	
	1	3	
	2	--	
	2	1	
	2	2	
	3	--	
	3	1	

3RH2911-1HA01	3RH2911-2HA01
3RH2911-1HA02	3RH2911-2HA02
3RH2911-1HA03	3RH2911-2HA03
3RH2911-1HA10	3RH2911-2HA10
3RH2911-1HA11	3RH2911-2HA11
3RH2911-1HA12	3RH2911-2HA12
3RH2911-1HA13	3RH2911-2HA13
3RH2911-1HA20	3RH2911-2HA20
3RH2911-1HA21	3RH2911-2HA21
3RH2911-1HA22	3RH2911-2HA22
3RH2911-1HA30	3RH2911-2HA30
3RH2911-1HA31	3RH2911-2HA31

¹⁾ For detailed information on use, see page 3/84.

Switching devices – Contactors and contactor assemblies – for switching motors

Power contactors for switching motors

Accessories for SIRIUS 3RT contactors and SIRIUS 3RH2 contactor relays > Auxiliary switches, instantaneous

PU (UNIT, SET, M) = 1
 PS* = 1 unit
 PG = 41B



3RH2911-1FC22



3RH2911-2FC22



3RH2911-1AA01



3RH2911-1BA01



3RH2911-1LA11



3RH2911-1MA11

For contactors/ contactor relays ¹⁾	Connections Position	Auxiliary contacts Version	Screw terminals		Spring-loaded terminals	
			Article No.	Price per PU	Article No.	Price per PU
Type		 NO NC NO NC				

Auxiliary switches for snapping onto the front

Sizes S00 to S3

3RT2.1, 3RT2.2, 3RT2.3, 3RT2.4, 3RH21, 3RH24	--	4	--	--	--	 .3 .3 .3 .3 .4 .4 .4 .4	3RH2911-1FA40	3RH2911-2FA40
	--	2	2	--	--	 .3 .1 .1 .3 .4 .2 .2 .4	3RH2911-1FA22	3RH2911-2FA22
	--	--	4	--	--	 .1 .1 .1 .1 .2 .2 .2 .2	3RH2911-1FA04	3RH2911-2FA04
	--	--	--	1	1	 .7 .5 .8 .6	3RH2911-1FB11	3RH2911-2FB11
	--	1	1	1	1	 .3 .1 .5 .7 .4 .2 .6 .8	3RH2911-1FB22	3RH2911-2FB22
	--	--	--	2	2	 .7 .7 .5 .5 .8 .8 .6 .6	3RH2911-1FC22	3RH2911-2FC22
1-pole and 2-pole auxiliary switches, cable entry from top or bottom								
3RT2.1, 3RT2.2, 3RT2.3, 3RT2.4, 3RH21, 3RH24	Top	1	--	--	--	 73	3RH2911-1AA10	--
	Bottom	1	--	--	--	 74	3RH2911-1BA10	--
	Top	--	1	--	--	 71	3RH2911-1AA01	--
	Bottom	--	1	--	--	 72	3RH2911-1BA01	--
	Top	1	1	--	--	 73 81	3RH2911-1LA11	--
	Bottom	1	1	--	--	 74 82	3RH2911-1MA11	--
	Top	2	--	--	--	 73 83	3RH2911-1LA20	--
	Bottom	2	--	--	--	 74 84	3RH2911-1MA20	--

¹⁾ For detailed information on use, see pages 3/84 and 3/85.

Switching devices – Contactors and contactor assemblies – for switching motors

Power contactors for switching motors

Accessories for SIRIUS 3RT contactors and SIRIUS 3RH2 contactor relays > Auxiliary switches, instantaneous

PU (UNIT, SET, M) = 1
 PS* = 1 unit
 PG = 41B



3RH2911-1GA22



3RH2911-2GA22

For contactor relays ¹⁾	Contactor relay with auxiliary switch	Auxiliary contacts
	Ident. No.	Version

Type



Screw terminals

Spring-loaded terminals

Article No. Price per PU

Article No. Price per PU

Auxiliary switches for snapping onto the front

Size S00

Blocks for the assembly of contactor relays with 8 contacts

3RH2140, 3RH2440, Ident. No. 40E	80E	4	--	
	71E	3	1	
	62E	2	2	
	53E	1	3	
	44E	--	4	

3RH2911-1GA40
3RH2911-1GA31
3RH2911-1GA22
3RH2911-1GA13
3RH2911-1GA04

3RH2911-2GA40
3RH2911-2GA31
3RH2911-2GA22
3RH2911-2GA13
3RH2911-2GA04

¹⁾ For detailed information on use, see page 3/86.

PU (UNIT, SET, M) = 1
 PS* = 1 unit
 PG = 41B



3RH2911-1XA22-0MA0



3RH2911-2XA22-0MA0

For contactors/ contactor relays ¹⁾	Auxiliary contacts	Version

Type

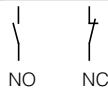

Screw terminals

Spring-loaded terminals

Article No. Price per PU

Article No. Price per PU

Auxiliary switches for snapping onto the front

Sizes S00 to S3

3RT2.1, 3RT2.2, 3RT2.3, 3RT2.4, 3RH21 ²⁾ , 3RH24 ²⁾	4	--	S00		S0 ... S3	
	3	1				
	2	2				
	--	4				

3RH2911-1XA40-0MA0
3RH2911-1XA31-0MA0
3RH2911-1XA22-0MA0
3RH2911-1XA04-0MA0

3RH2911-2XA40-0MA0
3RH2911-2XA31-0MA0
3RH2911-2XA22-0MA0
3RH2911-2XA04-0MA0

¹⁾ For detailed information on use, see page 3/86.

²⁾ For size S00, force-guided operation only applies for the 3RH contactor relay, and there is no force-guided operation for 3RT2 power contactors.

Switching devices – Contactors and contactor assemblies – for switching motors

Power contactors for switching motors

Accessories for SIRIUS 3RT contactors and SIRIUS 3RH2 contactor relays > Auxiliary switches, instantaneous

PU (UNIT, SET, M) = 1
 PS* = 1 unit
 PG = 41B



3RH1921-1XA22-0MA0

3RH1921-2XA22-0MA0

3RH1921-1CA10 3RH1921-1CD10

3RH1921-2CA10 3RH1921-2CA01

For contactors	Auxiliary contacts	
	Ident. No.	Version

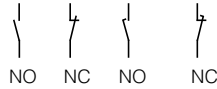

Type

NO NC NO NC

Screw terminals	
-----------------	--

Article No.	Price per PU
-------------	--------------

Spring-loaded terminals	
-------------------------	--

Article No.	Price per PU
-------------	--------------

Auxiliary switches for snapping onto the front

Sizes S6 to S12

4-pole auxiliary switches

• According to EN 50012

3RT1.5 ... 3RT1.7	22	2	2	--	--

3RH1921-1XA22-0MA0

3RH1921-2XA22-0MA0

1-pole auxiliary switches

• According to EN 50005 and EN 50012

3RT1.5 ... 3RT1.7	10	1	--	--	--
01	--	1	--	--	
10	--	--	1	--	
			(lead- ing)		
01	--	--	--	1	
				(lag- ging)	

3RH1921-1CA10
3RH1921-1CA01
3RH1921-1CD10
3RH1921-1CD01

3RH1921-2CA10
3RH1921-2CA01
--
--

Switching devices – Contactors and contactor assemblies – for switching motors

Power contactors for switching motors

Accessories for SIRIUS 3RT contactors and SIRIUS 3RH2 contactor relays > Auxiliary switches, instantaneous





PU (UNIT, SET, M) = 1
 PS* = 1 unit
 PG = 41B



3RH2911-1DA02











3RH2911-2DA02

For contactors/ contactor relays ¹⁾	Auxiliary contacts	Screw terminals 		Spring-loaded terminals 	
	Version	Article No.	Price per PU	Article No.	Price per PU
Type	 NO  NC				







Laterally mountable auxiliary switches, mounting on the right and/or the left, 2-pole

Size S00

			Left	Right		
3RT2.1	--	2			3RH2911-1DA02	3RH2911-2DA02
	1	1			3RH2911-1DA11	3RH2911-2DA11
	2	--			3RH2911-1DA20	3RH2911-2DA20

3RH21, 3RH24	--	2		--	3RH2921-1DA02	3RH2921-2DA02
	1	1		--	3RH2921-1DA11	3RH2921-2DA11
	2	--		--	3RH2921-1DA20	3RH2921-2DA20

Sizes S0 to S3

			Left	Right		
3RT2.2 ²⁾ , 3RT2.3 ³⁾ , 3RT2.4 ³⁾	--	2			3RH2921-1DA02	3RH2921-2DA02
	1	1			3RH2921-1DA11	3RH2921-2DA11
	2	--			3RH2921-1DA20	3RH2921-2DA20

¹⁾ For detailed information on use, see pages 3/88 and 3/90.

²⁾ With 3RT232. and 3RT252. contactors, mountable only on the right.

³⁾ 3RH2921-1DA.. lateral auxiliary switches can only be mounted on 3RT26 capacitor contactors of sizes S2 and S3.

Switching devices – Contactors and contactor assemblies – for switching motors

Power contactors for switching motors

Accessories for SIRIUS 3RT contactors and SIRIUS 3RH2 contactor relays > Auxiliary switches, instantaneous

PU (UNIT, SET, M) = 1
 PS* = 1 unit
 PG = 41B

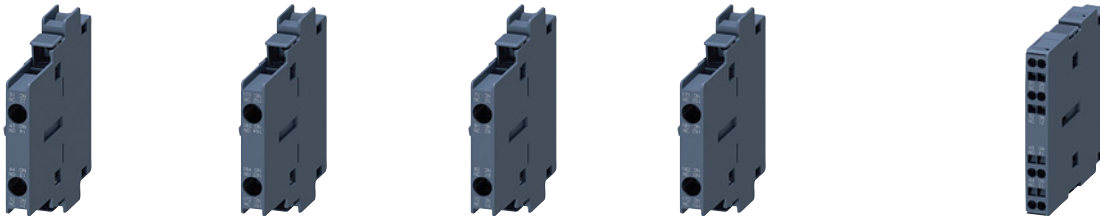

For contactors Auxiliary contacts Version		Screw terminals		Spring-loaded terminals	
Type	NO NC	Article No.	Price per PU	Article No.	Price per PU

Lateral auxiliary switches, mounting on the right or left, 2-pole

Sizes S6 to S12

		Left	Right		
First auxiliary switch					
• According to EN 50012					
3RT1.5 ... 3RT1.7	1 1			3RH1921-1DA11	3RH1921-2DA11
• According to EN 50005					
3RT1.5 ... 3RT1.7	2 --			3RH1921-1EA20	3RH1921-2EA20
	1 1			3RH1921-1EA11	--
	-- 2			3RH1921-1EA02	3RH1921-2EA02
Second auxiliary switch					
• According to EN 50012					
3RT1.5 ... 3RT1.7	1 1			3RH1921-1JA11	3RH1921-2JA11
• According to EN 50005					
3RT1.5 ... 3RT1.7	2 --			3RH1921-1KA20	3RH1921-2KA20
	1 1			3RH1921-1KA11	--
	-- 2			3RH1921-1KA02	3RH1921-2KA02

Switching devices – Contactors and contactor assemblies – for switching motors

Power contactors for switching motors

Accessories for SIRIUS 3RT contactors and SIRIUS 3RH2 contactor relays > Auxiliary switches, instantaneous

PU (UNIT, SET, M) = 1
 PS* = 1 unit
 PG = 41B



3RH2911-1NF.



3RH2911-2NF.

For contactors ¹⁾	Contacts Version		Screw terminals		Spring-loaded terminals	
	Conventional	Solid-state compatible	Article No.	Price per PU	Article No.	Price per PU
Type	NO	NC	NO	NC	NO	NC

Auxiliary switches for snapping onto the front

Solid-state compatible (encapsulated) auxiliary switches

- Rated operational currents I_e /AC-14 and DC-13 from 1 to 300 mA at 3 to 60 V
- Hard gold-plated contacts for increased contact reliability
- Auxiliary switches for snapping onto the front for 3RT2.2 to 3RT2.4 contactors are designed as mirror contacts according to IEC 60947-4-1, Annex F.

Sizes S00 to S3				S00	S0 ... S3			
3RT2.1, 3RT2.2, 3RT2.3, 3RT2.4	1	--	1	1			--	3RH2911-2NE21
	1	1	1	1			3RH2911-1NE22	--
	--	--	--	2			3RH2911-1NF02	3RH2911-2NF02
	--	--	1	1			3RH2911-1NF11	3RH2911-2NF11
	--	--	2	--			3RH2911-1NF20	3RH2911-2NF20
	2	--	--	2			NEW	3RH2911-2NF22
	1	2 ²⁾	1	--			NEW	3RH2911-2NL22
	3	--	1	--			NEW	3RH2911-2NL40
	2	1 ²⁾	1	--			NEW	3RH2911-2NM31

¹⁾ For detailed information on use, see page 3/86.

²⁾ The NC contacts have no mirror contact function.

Switching devices – Contactors and contactor assemblies – for switching motors

Power contactors for switching motors

Accessories for SIRIUS 3RT contactors and SIRIUS 3RH2 contactor relays > Auxiliary switches, instantaneous



PU (UNIT, SET, M) = 1
 PS* = 1 unit
 PG = 41B



3RH2911-1NF11



3RH2911-2NF11

For contactor relays ¹⁾	Contacts		Version		Screw terminals 	Spring-loaded terminals 
	Conventional	Solid-state compatible	NO	NC		
Type	NO	NC	NO	NC	Article No.	Price per PU

Auxiliary switches for snapping onto the front

Solid-state compatible (encapsulated) auxiliary switches

- Rated operational currents I_e /AC-14 and DC-13 from 1 to 300 mA at 3 to 60 V
- Hard gold-plated contacts for increased contact reliability

Size S00

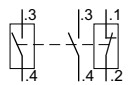
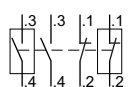
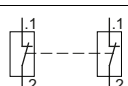
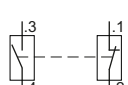
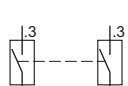
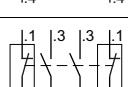
3RH21, 3RH24	1	--	1	1		--	3RH2911-2NE21
	1	1	1	1		3RH2911-1NE22	--
	--	--	--	2		3RH2911-1NF02	3RH2911-2NF02
	--	--	1	1		3RH2911-1NF11	3RH2911-2NF11
	--	--	2	--		3RH2911-1NF20	3RH2911-2NF20
	2	--	--	2		NEW	3RH2911-2NF22

¹⁾ For detailed information on use, see page 3/86.

Switching devices – Contactors and contactor assemblies – for switching motors

Power contactors for switching motors

Accessories for SIRIUS 3RT contactors and SIRIUS 3RH2 contactor relays > Auxiliary switches, instantaneous

PU (UNIT, SET, M) = 1
 PS* = 1 unit
 PG = 41B



3RH2911-2DE11



3RH1921-2JE11

For contactors/ contactor relays ¹⁾	Size	Contacts Version Solid-state compatible	Screw terminals	Spring-loaded terminals
			Article No.	Article No.
Type		NO NC	Price per PU	Price per PU

Lateral auxiliary switches, mounting on the right and/or the left, according to EN 50012

Solid-state compatible (encapsulated) auxiliary switches

- Rated operational currents I_e /AC-14 and DC-13 from 1 to 300 mA at 3 to 60 V
- Hard gold-plated contacts for increased contact reliability
- Laterally mountable auxiliary switches for 3RT2.1 to 3RT2.4 and 3RT1.5 to 3RT1.7 contactors are designed as mirror contacts according to IEC 60947-4-1, Annex F.

Sizes S00 to S3

				Left	Right		
Auxiliary switches							
3RT2.1	S00	1	1			--	3RH2911-2DE11
3RH21, 3RH24	S00	1	1		--	--	3RH2921-2DE11
3RT2.2, 3RT2.3, 3RT2.4	S0 ... S3	1	1			--	3RH2921-2DE11

Sizes S6 to S12

				Left	Right		
First auxiliary switch							
3RT1.5 ... 3RT1.7	S6 ... S12	1	1			--	3RH1921-2DE11
Second auxiliary switch							
3RT1.5 ... 3RT1.7	S6 ... S12	1	1			--	3RH1921-2JE11

¹⁾ Applies for 3RT2 contactors and 3RH2 contactor relays: For detailed information on use, see page 3/90.

Switching devices – Contactors and contactor assemblies – for switching motors

Power contactors for switching motors

Accessories for SIRIUS 3RT contactors and SIRIUS 3RH2 contactor relays > Auxiliary switches, delayed

Selection and ordering data

For contactors	Time range t	Screw terminals	⊕	PU (UNIT, SET, M)	PS*	PG
Type	s	Article No.		Price per PU		

Pneumatic time-delay auxiliary switches for mounting on 3RT2 contactors

Size S0

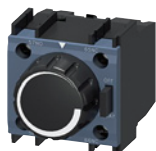

3RT2927-2P..1

Auxiliary contacts 1 NO and 1 NC¹⁾

ON-delay

3RT202 ²⁾	1 ... 30	3RT2927-2PA01	1	1 unit	41B
	10 ... 180	3RT2927-2PA11	1	1 unit	41B

OFF-delay

3RT202 ²⁾	1 ... 30	3RT2927-2PR01	1	1 unit	41B
	10 ... 180	3RT2927-2PR11	1	1 unit	41B

¹⁾ In addition to these, no other auxiliary contacts are permitted.

²⁾ Cannot be fitted onto coupling contactors and coupling contactor relays.

PU (UNIT, SET, M) = 1
PS* = 1 unit
PG = 41B



3RA2813-1FW10



3RA2813-2AW10

For contactors	Rated control supply voltage U_s ¹⁾	Time range t	Output/ auxiliary contacts	Screw terminals	⊕	Spring-loaded terminals	⊕
Type	V	s		Article No.	Price per PU	Article No.	Price per PU

Solid-state time-delay auxiliary switches²⁾ for mounting on 3RT2 contactors and 3RH2 contactor relays

Sizes S00 to S3

The electrical connection between the solid-state time-delay auxiliary switch and the contactor or contactor relay underneath is established automatically when it is snapped on and locked.

ON-delay

(varistor integrated)

3RT2 ³⁾⁴⁾ , 3RH21 ³⁾ , 3RH24	24 ... 240 AC/DC	0.05 ... 100 (1, 10, 100; selectable)	1 CO 1 NO + 1 NC	3RA2813-1AW10 3RA2813-1FW10		3RA2813-2AW10 3RA2813-2FW10	
--	------------------	---	---------------------	--	--	--	--

OFF-delay with control signal

(varistor integrated)

3RT2 ³⁾⁴⁾ , 3RH21 ³⁾ , 3RH24	24 ... 240 AC/DC	0.05 ... 100 (1, 10, 100; selectable)	1 CO 1 NO + 1 NC	3RA2814-1AW10 3RA2814-1FW10		3RA2814-2AW10 3RA2814-2FW10	
--	------------------	---	---------------------	--	--	--	--

OFF-delay without control signal⁵⁾

(varistor integrated)

3RT2 ³⁾⁴⁾ , 3RH21 ³⁾ , 3RH24	24 ... 240 AC/DC	0.05 ... 100 (1, 10, 100; selectable)	1 CO 1 NO + 1 NC	3RA2815-1AW10 3RA2815-1FW10		3RA2815-2AW10 3RA2815-2FW10	
--	------------------	---	---------------------	--	--	--	--

¹⁾ AC voltage values apply for 50 Hz and 60 Hz.

²⁾ The solid-state time-delay auxiliary switches are also available as 3RA28 function modules for mounting on 3RT2 contactors and 3RH2 contactor relays, see page 3/105.

³⁾ Cannot be fitted onto coupling contactors and coupling contactor relays.

⁴⁾ From product version E04 onwards, 3RA281. solid-state time-delay auxiliary switches can be used for 3RT2.4 contactors.



⁵⁾ Setting of output contacts in as-supplied state not defined (bistable relay). Application of the control supply voltage once results in contact changeover to the correct setting.

Technical specifications, see page 3/78.

Switching devices – Contactors and contactor assemblies – for switching motors

Power contactors for switching motors

Accessories for SIRIUS 3RT contactors and SIRIUS 3RH2 contactor relays > Auxiliary switches, delayed

For contactors	Auxiliary contacts	Rated control supply voltage U_s ¹⁾	Time range t	Screw terminals	PU (UNIT, SET, M)	PS*	PG			
Type	V	s	Article No.	Price per PU						
Solid-state time-delay auxiliary switches for mounting on 3RT1 contactors										
Sizes S6 to S12										
	3RT10, 3RT14	ON-delay²⁾ 1 NO + 1 NC	24 AC/DC	0.05 ... 1 0.5 ... 10 5 ... 100	3RT1926-2EJ11 3RT1926-2EJ21 3RT1926-2EJ31	1	1 unit	41H		
			100 ... 127 AC	0.05 ... 1 0.5 ... 10 5 ... 100	3RT1926-2EC11 3RT1926-2EC21 3RT1926-2EC31	1	1 unit	41H		
			200 ... 240 AC	0.05 ... 1 0.5 ... 10 5 ... 100	3RT1926-2ED11 3RT1926-2ED21 3RT1926-2ED31	1	1 unit	41H		
			OFF-delay without control signal²⁾³⁾							
			24 AC/DC	0.05 ... 1 0.5 ... 10 5 ... 100	3RT1926-2FJ11 3RT1926-2FJ21 3RT1926-2FJ31	1	1 unit	41H		
			100 ... 127 AC/DC	0.05 ... 1 0.5 ... 10 5 ... 100	3RT1926-2FK11 3RT1926-2FK21 3RT1926-2FK31	1	1 unit	41H		
		200 ... 240 AC/DC	0.05 ... 1 0.5 ... 10 5 ... 100	3RT1926-2FL11 3RT1926-2FL21 3RT1926-2FL31	1	1 unit	41H			
		Star-delta (wye-delta) starting (varistor integrated)²⁾								
			3RT10, 3RT14	1 NO delayed + 1 NO instantaneous, dead time 50 ms	24 AC/DC	1.5 ... 30	3RT1926-2GJ51	1	1 unit	41H
					100 ... 127 AC	1.5 ... 30	3RT1926-2GC51	1	1 unit	41H
					200 ... 240 AC	1.5 ... 30	3RT1926-2GD51	1	1 unit	41H

3RT1926-2G.51

1) AC voltage values apply for 50 and 60 Hz.

2) Connecting terminals A1 and A2 for the control supply voltage of the solid-state time-delay auxiliary switch must be connected to the associated contactor by means of cables.





3) Setting of output contacts in as-supplied state not defined (bistable relay). Application of the control supply voltage once results in contact changeover to the correct setting.

Switching devices – Contactors and contactor assemblies – for switching motors

Power contactors for switching motors

Accessories for SIRIUS 3RT contactors and SIRIUS 3RH2 contactor relays > Surge suppressors

Selection and ordering data

For contactors	Version	Rated control supply voltage $U_s^{1)}$		Article No.	Price per PU	PU (UNIT, SET, M)	PS*	PG	
		AC operation	DC operation						
Type		V AC	V DC						
Surge suppressors without LED (also for spring-loaded terminals)									
Size S00									
For plugging onto the front of the contactors (with or without auxiliary switches)									
 3RT2916-1B.00	3RT2.1, 3RH2	Varistors	24 ... 48	24 ... 70	3RT2916-1BB00	1	1 unit	41B	
			48 ... 127	70 ... 150	3RT2916-1BC00	1	1 unit	41B	
			127 ... 240	150 ... 250	3RT2916-1BD00	1	1 unit	41B	
			240 ... 400	--	3RT2916-1BE00	1	1 unit	41B	
			400 ... 600	--	3RT2916-1BF00	1	1 unit	41B	
			400 ... 600	--	3RT2916-1BF00	1	1 unit	41B	
	3RT2.1, 3RH2	RC elements	24 ... 48	24 ... 70	3RT2916-1CB00	1	1 unit	41B	
			48 ... 127	70 ... 150	3RT2916-1CC00	1	1 unit	41B	
			127 ... 240	150 ... 250	3RT2916-1CD00	1	1 unit	41B	
			240 ... 400	--	3RT2916-1CE00	1	1 unit	41B	
			400 ... 600	--	3RT2916-1CF00	1	1 unit	41B	
			400 ... 600	--	3RT2916-1CF00	1	1 unit	41B	
3RT2.1, 3RH2	Interference suppression diode	--	12 ... 250	3RT2916-1DG00	1	1 unit	41B		
3RT2.1, 3RH2	Diode assembly (diode and Zener diode) for DC operation	--	12 ... 250	3RT2916-1EH00	1	1 unit	41B		
Size S0									
For plugging into the front of the contactors (before mounting the auxiliary switch)									
 3RT2926-1E.00	3RT2.2	Varistors²⁾	24 ... 48	24 ... 70	3RT2926-1BB00	1	1 unit	41B	
			48 ... 127	70 ... 150	3RT2926-1BC00	1	1 unit	41B	
			127 ... 240	150 ... 250	3RT2926-1BD00	1	1 unit	41B	
			240 ... 400	--	3RT2926-1BE00	1	1 unit	41B	
			400 ... 600	--	3RT2926-1BF00	1	1 unit	41B	
			400 ... 600	--	3RT2926-1BF00	1	1 unit	41B	
	3RT2.2	RC elements	24 ... 48	24 ... 70	3RT2926-1CB00	1	1 unit	41B	
			48 ... 127	70 ... 150	3RT2926-1CC00	1	1 unit	41B	
			127 ... 240	150 ... 250	3RT2926-1CD00	1	1 unit	41B	
			240 ... 400	--	3RT2926-1CE00	1	1 unit	41B	
			400 ... 600	--	3RT2926-1CF00	1	1 unit	41B	
			400 ... 600	--	3RT2926-1CF00	1	1 unit	41B	
3RT2.2	Diode assemblies for DC operation	--	24	3RT2926-1ER00	1	1 unit	41B		
		--	30 ... 250	3RT2926-1ES00	1	1 unit	41B		
Size S2									
For plugging into the front of the contactors (before mounting the auxiliary switch)									
 3RT2936-1BF00	3RT2.3	Varistors²⁾	24 ... 48	24 ... 70	3RT2936-1BB00	1	1 unit	41B	
			48 ... 127	70 ... 150	3RT2936-1BC00	1	1 unit	41B	
			127 ... 240	150 ... 250	3RT2936-1BD00	1	1 unit	41B	
			240 ... 400	--	3RT2936-1BE00	1	1 unit	41B	
			400 ... 600	--	3RT2936-1BF00	1	1 unit	41B	
			400 ... 600	--	3RT2936-1BF00	1	1 unit	41B	
	3RT2.3	RC elements	24 ... 48	24 ... 70	3RT2936-1CB00	1	1 unit	41B	
			48 ... 127	70 ... 150	3RT2936-1CC00	1	1 unit	41B	
			127 ... 240	150 ... 250	3RT2936-1CD00	1	1 unit	41B	
			240 ... 400	--	3RT2936-1CE00	1	1 unit	41B	
			400 ... 600	--	3RT2936-1CF00	1	1 unit	41B	
			400 ... 600	--	3RT2936-1CF00	1	1 unit	41B	
3RT2.3	Diode assemblies for DC operation	--	24	3RT2936-1ER00	1	1 unit	41B		
		--	30 ... 250	3RT2936-1ES00	1	1 unit	41B		
Size S3									
For plugging into the front of the contactors (before mounting the auxiliary switch)									
 3RT2936-1ER00	3RT2.4	Varistors²⁾	24 ... 48	24 ... 70	3RT2936-1BB00	1	1 unit	41B	
			48 ... 127	70 ... 150	3RT2936-1BC00	1	1 unit	41B	
			127 ... 240	150 ... 250	3RT2936-1BD00	1	1 unit	41B	
			240 ... 400	--	3RT2936-1BE00	1	1 unit	41B	
			400 ... 600	--	3RT2936-1BF00	1	1 unit	41B	
			400 ... 600	--	3RT2936-1BF00	1	1 unit	41B	
	3RT2.4	Diode assemblies for DC operation	--	24	3RT2936-1ER00	1	1 unit	41B	
			--	30 ... 250	3RT2936-1ES00	1	1 unit	41B	
	For plugging into the two recesses on the left next to the connection block for auxiliary switches and coils A1 and A2, the connecting cables are wired to A1 and A2, (see also overview graphic on page 3/11)								
	 3RT2946-1C.00	3RT2.4	RC elements	24 ... 48	24 ... 70	3RT2946-1CB00	1	1 unit	41B
				48 ... 127	70 ... 150	3RT2946-1CC00	1	1 unit	41B
				127 ... 240	150 ... 250	3RT2946-1CD00	1	1 unit	41B
240 ... 400				--	3RT2946-1CE00	1	1 unit	41B	
400 ... 600				--	3RT2946-1CF00	1	1 unit	41B	
400 ... 600				--	3RT2946-1CF00	1	1 unit	41B	

¹⁾ Can be used for AC operation for 50/60 Hz. Other voltages on request.

²⁾ The varistor is already integrated on the DC and AC/DC contactors.

Switching devices – Contactors and contactor assemblies – for switching motors

Power contactors for switching motors

Accessories for SIRIUS 3RT contactors and SIRIUS 3RH2 contactor relays > Surge suppressors

For contactors	Version	Rated control supply voltage $U_s^{1)}$		Article No.	Price per PU	PU (UNIT, SET, M)	PS*	PG
		AC operation	DC operation					
Type		V AC	V DC					

Surge suppressors without LED

Sizes S6 to S12



3RT1956-1C.00

For connecting to withdrawable coil for contactors with

- Standard operating mechanisms 3RT1...-A...
- Solid-state operating mechanisms 3RT1...-N...

3RT1.5 ... 3RT1.7	RC elements	24 ... 48 48 ... 127 127 ... 240 240 ... 400 400 ... 600	24 ... 70 70 ... 150 150 ... 250 -- --

Screw terminals



3RT1956-1CB00	1	1 unit	41B
3RT1956-1CC00	1	1 unit	41B
3RT1956-1CD00	1	1 unit	41B
3RT1956-1CE00	1	1 unit	41B
3RT1956-1CF00	1	1 unit	41B



3RT1956-1C.02

3RT1.5 ... 3RT1.7	RC elements	24 ... 48 48 ... 127 127 ... 240 240 ... 400 400 ... 600	24 ... 70 70 ... 150 150 ... 250 -- --

Spring-loaded terminals



3RT1956-1CB02	1	1 unit	41B
3RT1956-1CC02	1	1 unit	41B
3RT1956-1CD02	1	1 unit	41B
3RT1956-1CE02	1	1 unit	41B
3RT1956-1CF02	1	1 unit	41B

1) Can be used for AC operation for 50/60 Hz. Other voltages on request.

For contactors	Version	Rated control supply voltage $U_s^{1)}$		Power consumption P of LED at U_s	Article No.	Price per PU	PU (UNIT, SET, M)	PS*	PG
		AC operation	DC operation						
Type		V AC	V DC	mW					

Surge suppressors with LED (also for spring-loaded terminals)

Size S00



3RT2916-1J.00

For plugging onto the front of the contactors (with or without auxiliary switches)

3RT2.1, 3RH2	Varistors	24 ... 48 48 ... 127 127 ... 240 --	12 ... 24 24 ... 70 70 ... 150 150 ... 250	10 ... 120 20 ... 470 50 ... 700 160 ... 950

3RT2916-1JJ00	1	1 unit	41B
3RT2916-1JK00	1	1 unit	41B
3RT2916-1JL00	1	1 unit	41B
3RT2916-1JP00	1	1 unit	41B
3RT2916-1LM00	1	1 unit	41B
3RT2916-1LN00	1	1 unit	41B
3RT2916-1LP00	1	1 unit	41B

Size S0



3RT2926-1MR.00

For plugging into the front of the contactors (before mounting the auxiliary switch)

3RT2.2	Varistors	24 ... 48 48 ... 127 127 ... 240	12 ... 24 24 ... 70 70 ... 150	10 ... 120 20 ... 470 50 ... 700

3RT2926-1JJ00	1	1 unit	41B
3RT2926-1JK00	1	1 unit	41B
3RT2926-1JL00	1	1 unit	41B
3RT2926-1MR00	1	1 unit	41B

Sizes S2 and S3



3RT2936-1JJ.00

For plugging into the front of the contactors (before mounting the auxiliary switch)

3RT2.3, 3RT2.4	Varistors ²⁾	24 ... 48 48 ... 127 127 ... 240	12 ... 24 24 ... 70 70 ... 150	10 ... 120 20 ... 470 50 ... 700

3RT2936-1JJ00	1	1 unit	41B
3RT2936-1JK00	1	1 unit	41B
3RT2936-1JL00	1	1 unit	41B

1) Can be used for AC operation for 50/60 Hz. Other voltages on request.

2) The varistor without LED is already integrated on the DC and AC/DC contactors.

Switching devices – Contactors and contactor assemblies – for switching motors

Power contactors for switching motors

Accessories for SIRIUS 3RT contactors and SIRIUS 3RH2 contactor relays > Modules for contactor control

Selection and ordering data

For contactors	Version	Article No.	Price per PU	PU (UNIT, SET, M)	PS*	PG
----------------	---------	-------------	--------------	-------------------	-----	----

Type

Coupling links for control by PLC

Screw terminals

Size S0



3RH2924-1GP11

For mounting on the coil terminals of the contactors (for contactors with screw terminals only)

With LED for the switching state and with integrated varistor for damping switching overvoltages

- 24 V DC control, 17 ... 30 V DC operating range

3RH2924-1GP11

1

1 unit

41B

Sizes S00 to S3



3RH2914-1GP11

For mounting on the front of contactors with AC, DC or AC/DC operation

- 24 V DC control, 17 ... 30 V DC operating range

3RT2.1,
3RT2.2,
3RT2.3,
3RT2.4
3RH2

3RH2914-1GP11

1

1 unit

41B



3RH2914-2GP11

- 24 V DC control, 17 ... 30 V DC operating range

3RT2.1,
3RT2.2,
3RT2.3,
3RT2.4
3RH2

Spring-loaded terminals

3RH2914-2GP11

1

1 unit

41B

Technical specifications, [see page 3/80](#).

Switching devices – Contactors and contactor assemblies – for switching motors

Power contactors for switching motors

Accessories for SIRIUS 3RT contactors and SIRIUS 3RH2 contactor relays > Modules for contactor control

PU (UNIT, SET, M) = 1
 PS* = 1 unit
 PG = 41B

More information

Equipment Manual for 3RA28 function modules, see
<https://support.industry.siemens.com/cs/ww/en/view/60279150>





3RA2811-2CW10



3RA2812-1DW10



3RA2816-0EW20

For contactors	Size	Version	Rated control supply voltage U_s ¹⁾	Time range t	Screw terminals 	Spring-loaded terminals 
Type			V AC/DC	s	Article No.	Price per PU

3RA28 function modules for mounting on 3RT2 contactors and 3RH2 contactor relays

For direct-on-line starting

3RT2.1 ²⁾ , 3RT2.2 ²⁾ , 3RH21 ²⁾ , 3RH24	S00, S0	ON-delay two-wire design, varistor integrated The electrical connection between the function module and the contactor underneath is established automatically when it is snapped on and locked.	24 ... 240	0.05 ... 100 (1, 10, 100; selectable)	3RA2811-1CW10	3RA2811-2CW10
3RT2.3 ²⁾ , 3RT2.4 ²⁾³⁾	S2, S3	The electrical connection between the function module and the contactor underneath is established automatically when it is snapped on and locked.	24 ... 90 90 ... 240	0.05 ... 100 (1, 10, 100; selectable)	3RA2831-1DG10 3RA2831-1DH10	3RA2831-2DG10 3RA2831-2DH10
3RT2.1 ²⁾ , 3RT2.2 ²⁾ , 3RH21 ²⁾ , 3RH24	S00, S0	OFF-delay with control signal, varistor integrated The electrical connection between the function module and the contactor underneath is established automatically when it is snapped on and locked.	24 ... 240	0.05 ... 100 (1, 10, 100; selectable)	3RA2812-1DW10	3RA2812-2DW10
3RT2.3 ²⁾ , 3RT2.4 ²⁾³⁾	S2, S3	The electrical connection between the function module and the contactor underneath is established automatically when it is snapped on and locked.	24 ... 90 90 ... 240	0.05 ... 100 (1, 10, 100; selectable)	3RA2832-1DG10 3RA2832-1DH10	3RA2832-2DG10 3RA2832-2DH10

For star-delta (wye-delta) starting

3RT2.1, 3RT2.2, 3RT2.3 ²⁾ , 3RT2.4 ²⁾⁴⁾	S00 ... S3	Varistor integrated Comprising one basic module and two coupling modules The electrical connection between the function module and the contactor assembly is established automatically by snapping on and plugging in the connecting cables.	24 ... 240	0.5 ... 60 (10, 30, 60; selectable)	3RA2816-0EW20	3RA2816-0EW20
--	------------	---	------------	--	----------------------	----------------------

Accessories

3RA28	S00 ... S3	Cover, sealable			3RA2910-0	3RA2910-0
-------	------------	------------------------	--	--	------------------	------------------

- 1) AC voltage values apply for 50 and 60 Hz.
- 2) Cannot be fitted onto coupling contactors and coupling contactor relays.
- 3) From product version E03 onwards, 3RA283... function modules can be used for 3RT2.4 contactors.
- 4) From product version E04 onwards, 3RA2816 function modules can be used for 3RT2.4 contactors.

Technical specifications, see page 3/81.

Assembly of reversing starters

We offer ready-made wiring kits for the assembly of reversing starters. Use of these wiring kits offers further advantages, see page 3/149.

Switching devices – Contactors and contactor assemblies – for switching motors

Power contactors for switching motors

Accessories for SIRIUS 3RT contactors and SIRIUS 3RH2 contactor relays > Modules for contactor control

PU (UNIT, SET, M) = 1
 PS* = 1 unit
 PG = 41B

More information

Equipment Manual for 3RA2711 function modules for IO-Link, see <https://support.industry.siemens.com/cs/ww/en/view/39319600>

Equipment Manual for 3RA2712 function modules for AS-Interface, see <https://support.industry.siemens.com/cs/ww/en/view/39318922>





3RA2711-1AA00 3RA2711-2AA00 3RA2711-1BA00

3RA2712-1CA00

3RA2711-2BA00

3RA2711-2CA00

For con- tactors	Size	Version	Screw terminals 	Spring-loaded terminals 
Type			Article No.	Price per PU
Type			Article No.	Price per PU
SIRIUS 3RA27 function modules for direct-on-line starting				
3RT201	S00	IO-Link connection	3RA2711-1AA00	3RA2711-2AA00
...	...	Includes one module connector for creating an IO-Link group		
3RT204 ¹⁾	S3	AS-Interface connection	3RA2712-1AA00	3RA2712-2AA00
SIRIUS 3RA27 function modules for reversing starting²⁾				
3RT201	S00	IO-Link connection	3RA2711-1BA00	3RA2711-2BA00
...	...	Comprising one basic and one coupling module and an additional module connector ³⁾ for creating an IO-Link group		
3RT204 ¹⁾	S3	AS-Interface connection	3RA2712-1BA00	3RA2712-2BA00
Comprising one basic and one coupling module				
Assembly kits for making 3-pole contactor assemblies				
see page 3/109				
SIRIUS 3RA27 function modules for star-delta (wye-delta) starting⁴⁾				
3RT201	S00	IO-Link connection	3RA2711-1CA00	3RA2711-2CA00
...	...	Comprising one basic and two coupling modules and an additional module connector ³⁾ for creating an IO-Link group		
3RT204 ¹⁾	S3	AS-Interface connection	3RA2712-1CA00	3RA2712-2CA00
Comprising one basic and two coupling modules				
Assembly kits for making 3-pole contactor assemblies				
see page 3/110 onwards				

¹⁾ From product version E06 onwards, 3RA271. function modules can be used for 3RT2.4 contactors.

²⁾ For prewired reversing contactor assemblies with voltage tap-off, see pages 3/150 to 3/153. When these contactor assemblies are used, the assembly kit for the wiring is already integrated.

³⁾ 3RA2711-0EE17 module connectors for size S3 must be ordered separately, see page 3/107.

⁴⁾ For complete contactor assemblies for star-delta (wye-delta) starting including function modules, see pages 3/168 to 3/171.

Technical specifications for 3RA27 function modules, see page 3/82.

For contactors with voltage tap-off, see pages 3/55, 3/59, 3/63 and 3/64.

For IO-Link masters and AS-Interface masters, routers and power supply units, see "Industrial communication", page 2/1 onwards.

Switching devices – Contactors and contactor assemblies – for switching motors

Power contactors for switching motors

Accessories for SIRIUS 3RT contactors and SIRIUS 3RH2 contactor relays > Modules for contactor control



3RA2711-0EE10



3RA2711-0EE06

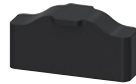

3RA2711-0EE15



3RA2910-0



3RA2711-0EE11



3RA6935-0A

For function modules	Version	Article No.	Price per PU	PU (UNIT, SET, M)	PS*	PG
Type						
Accessories for 3RA27 function modules						
3RA2711-...A00	Module connector set Comprising: • Two module connectors (14-pole, short) • Two interface covers	3RA2711-0EE10		1	1 unit	41B
3RA2711-...A00	Module connectors • 14-pole - 6 cm - 9 cm - 13 cm - 26 cm - 33.5 cm • 10-pole, 9 cm for the additional auxiliary voltage infeed <u>Note:</u> Selection of module connectors, see Equipment Manual for 3RA2711 function modules for IO-Link .	3RA2711-0EE17 3RA2711-0EE06 3RA2711-0EE18 3RA2711-0EE07 3RA2711-0EE08 3RA2711-0EE16		1 1 1 1 1 1	1 unit 1 unit 1 unit 1 unit 1 unit 1 unit	41B 41B 41B 41B 41B 41B
3RA2711-...A00	Interface covers (Set of 5)	3RA2711-0EE15		1	1 unit	41B
3RA2711-...A00	Covers, sealable	3RA2910-0		1	5 units	41B
Operator panels for communication via IO-Link						
3RA2711-...A00	Operator panel (set) Comprising: • 1 x operator panel • 1 x enabling module • 1 x interface cover • 1 x fixing terminal	3RA6935-0A		1	1 unit	42F
3RA2711-...A00	Connecting cable For connecting the operator panel to the coupling module Length 2 m, 10- to 14-pole	3RA2711-0EE11		1	1 unit	41B
3RA2711-...A00	Enabling module (replacement)	3RA6936-0A		1	1 unit	42F
3RA2711-...A00	Interface covers (replacement)	3RA6936-0B		1	5 units	42F

Switching devices – Contactors and contactor assemblies – for switching motors

Power contactors for switching motors

Accessories for SIRIUS 3RT contactors and SIRIUS 3RH2 contactor relays > Modules for contactor control

For contactors	Rated control supply voltage U_s	Time range t	Screw terminals	⊕	PU (UNIT, SET, M)	PS*	PG
Type	V	s	Article No.	Price per PU			

Mechanical latching blocks (no switching state change in the event of voltage drop)

Size S0

For snapping onto the front of contactors

The contactor remains in the energized state in the event of voltage drop.



3RT2926-3A.31

3RT202,	24 AC/DC	--	3RT2926-3AB31	1	1 unit	41B
3RT232,	110 AC/DC	--	3RT2926-3AF31	1	1 unit	41B
3RT252	230 AC/DC	--	3RT2926-3AP31	1	1 unit	41B

OFF-delay devices for contactors with AC/DC and DC operation

Sizes S00 to S3

Non-adjustable delay time



3RT2916-2B.01

3RT201.-1BF4., 3RT202.-1BF4., 3RT203.-1NF3., 3RH2...-1BF40	110 AC/DC	S00: > 0.1 S0: > 0.08 S2: > 0.25	3RT2916-2BK01	1	1 unit	41B
3RT201.-1BM4./-1BP4., 3RT202.-1BM4./-1BP4., 3RT203.-1NP3., 3RH2...-1BM40/-1BP40	220/230 AC/DC	S00: > 0.5 S0: > 0.3 S2: > 0.8	3RT2916-2BL01	1	1 unit	41B
3RT201.-1BB4., 3RT202.-1BB4., 3RT203.-1NB3., 3RT204.-1NB3., 3RT244.-1NB3., 3RH2...-1BB40	24 DC	S00: > 0.2 S0: > 0.1 S2: > 0.1 S3: > 0.05	3RT2916-2BE01	1	1 unit	41B

Switching devices – Contactors and contactor assemblies – for switching motors

Power contactors for switching motors

Accessories for SIRIUS 3RT contactors and SIRIUS 3RH2 contactor relays > Link modules

Selection and ordering data

For contactors	Size	Version	Screw terminals 	PU (UNIT, SET, M)	PS*	PG
Type			Article No.	Price per PU		

Safety main circuit connectors for two contactors



3RA2926-1A

3RT2.1	S00	For series connection of two contactors	3RA2916-1A	1	1 unit	41B
3RT2.2	S0		3RA2926-1A	1	1 unit	41B
3RT2.3	S2		3RA2936-1A	1	1 unit	41B

PU (UNIT, SET, M) = 1
 PS* = 1 unit (unless otherwise specified)
 PG = 41B

For contactors	Size	Version	Article No.	Price per PU	Article No.	Price per PU
Type						

Assembly kits for reversing contactor assemblies for making 3-pole contactor assemblies



3RA2913-2AA1



3RA2923-2AA1



3RA2933-2AA1



3RA2943-2AA1



3RA1953-2A



3RA1963-2A



3RA1973-2A

3RT201	S00-S00	The assembly kit contains: Mechanical interlock, two connecting clips for two contactors, wiring modules on the top and bottom <ul style="list-style-type: none"> For main, auxiliary and control circuits 	3RA2913-2AA1	3RA2913-2AA2
3RT202	S0-S0	The assembly kit contains: Mechanical interlock, two connecting clips for two contactors, wiring modules on the top and bottom <ul style="list-style-type: none"> For main, auxiliary and control circuits¹⁾ Only for main circuit²⁾ 	3RA2923-2AA1 --	-- 3RA2923-2AA2
3RT203	S2-S2	The assembly kit contains: Two connectors for two contactors, wiring modules on the top and bottom (3RA2934-2B mechanical interlock must be ordered separately, see page 3/114) <ul style="list-style-type: none"> For main and auxiliary circuits Only for main circuit³⁾ 	3RA2933-2AA1 --	-- 3RA2933-2AA2
3RT204	S3-S3	The assembly kit contains: Two connectors for two contactors, wiring modules on the top and bottom (3RA2934-2B mechanical interlock must be ordered separately, see page 3/114) <ul style="list-style-type: none"> For main and auxiliary circuits Only for main circuit³⁾ 	3RA2943-2AA1 --	-- 3RA2943-2AA2
3RT1.5	S6-S6	The assembly kit contains: Wiring modules on the top and bottom	3RA1953-2A	3RA1953-2A
3RT1.6	S10-S10		3RA1963-2A	3RA1963-2A
3RT1.7	S12-S12		3RA1973-2A	3RA1973-2A

Screw terminals

Spring-loaded terminals

¹⁾ Use of the 3RA2923-2AA1 assembly kit in conjunction with 3RT202-.....-3MA0 contactors is limited because the auxiliary switches in the basic unit are not allowed to be used on account of the permanently mounted auxiliary switch.

²⁾ Version in size S0 with spring-loaded terminals: Only the wiring modules for the main circuit are included. No connecting clips are included for the auxiliary and control circuit.





³⁾ Version in sizes S2 and S3 with spring-loaded terminals in the auxiliary and control circuits: Only the wiring modules for the main circuit are included. A cable set is included for the auxiliary circuit.

Switching devices – Contactors and contactor assemblies – for switching motors

Power contactors for switching motors

Accessories for SIRIUS 3RT contactors and SIRIUS 3RH2 contactor relays > Link modules

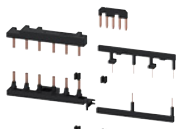
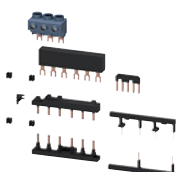
PU (UNIT, SET, M) = 1
 PS* = 1 unit (unless otherwise specified)
 PG = 41B

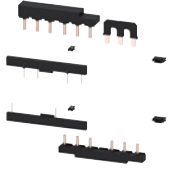
For contactors Type	Size	Version	Article No.	Price per PU	Article No.	Price per PU
Assembly kits¹⁾ for contactor assemblies for star-delta (wye-delta) starting for making 3-pole contactor assemblies						
	3RT201	S00-S00-S00	The assembly kit contains: Mechanical interlock, four connecting clips for three contactors, a star jumper, wiring modules on the top and bottom	Screw terminals 	Spring-loaded terminals 	
3RA2913-2BB1			<ul style="list-style-type: none"> For main, auxiliary and control circuits 	3RA2913-2BB1	3RA2913-2BB2	
	3RT202	S0-S0-S0	The assembly kit contains: Mechanical interlock, four connecting clips for three contactors, a star jumper, wiring modules on the top and bottom	3RA2923-2BB1	--	
3RA2923-2BB1			<ul style="list-style-type: none"> For main, auxiliary and control circuits Only for main circuit 	--	3RA2923-2BB2	
	3RT202	S0-S0-S0	The assembly kit contains: Mechanical interlock, four connecting clips for three contactors, a star jumper, wiring modules on the top and bottom, 3-phase infeed terminal	3RA2924-2BB1	--	
3RA2924-2BB1			<ul style="list-style-type: none"> For main, auxiliary and control circuits 			
	3RT203	S2-S2-S0	The assembly kit ²⁾ contains: Two connectors for three contactors, an S0 star jumper, a spacer, wiring modules on the top and bottom (S2-S0) for the main circuit, a cable set for the auxiliary circuit, a cable for connecting the A2 coil contact of the line contactor to the A2 coil contact of the delta contactor	3RA2933-2C	3RA2933-2C	
3RA2933-2C						
	3RT203	S2-S2-S2	The assembly kit ²⁾ contains: Four connectors for three contactors, an S2 star jumper, a cable for connecting the A2 coil contact of the line contactor to the A2 coil contact of the delta contactor and	3RA2933-2BB1	--	
3RA2933-2BB1			<ul style="list-style-type: none"> Wiring modules on the top and bottom for the main circuit and the auxiliary circuit Wiring modules on the top and bottom for the main circuit, a cable set for the auxiliary circuit 	--	3RA2933-2BB2	

¹⁾ When using the function modules for contactor assemblies for star-delta (wye-delta) starting, the wiring modules for the auxiliary current are not required.



²⁾ The 3RA2934-2B mechanical interlock for sizes S2 and S3 must be ordered separately, see page 3/114.

Switching devices – Contactors and contactor assemblies – for switching motors

Power contactors for switching motors

Accessories for SIRIUS 3RT contactors and SIRIUS 3RH2 contactor relays > Link modules

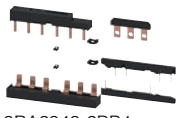
PU (UNIT, SET, M) = 1
 PS* = 1 unit (unless otherwise specified)
 PG = 41B

For contactors Type	Size	Version	Article No.	Price per PU	Article No.	Price per PU
Assembly kits¹⁾ for contactor assemblies for star-delta (wye-delta) starting for making 3-pole contactor assemblies (continued)						
 3RA2943-2C	3RT204	S3-S3-S2	The assembly kit ²⁾ contains: Two connectors for three contactors, an S2 star jumper, a spacer, wiring modules on the top and bottom (S3-S2) for the main circuit, a cable set for the auxiliary circuit, a cable for connecting the A2 coil contact of the line contactor to the A2 coil contact of the delta contactor	3RA2943-2C		3RA2943-2C
 3RA2943-2BB1	3RT204	S3-S3-S3	The assembly kit ²⁾ contains: Four connectors for three contactors, an S3 star jumper, a cable for connecting the A2 coil contact of the line contactor to the A2 coil contact of the delta contactor and <ul style="list-style-type: none"> Wiring modules on the top and bottom for the main circuit and the auxiliary circuit Wiring modules on the top and bottom for the main circuit, a cable set for the auxiliary circuit 	Screw terminals 		Spring-loaded terminals 
				3RA2943-2BB1		--
				--		3RA2943-2BB2

¹⁾ When using the function modules for contactor assemblies for star-delta (wye-delta) starting, the wiring modules for the auxiliary current are not required.

²⁾ The 3RA2934-2B mechanical interlock for sizes S2 and S3 must be ordered separately, see page 3/114.

Switching devices – Contactors and contactor assemblies – for switching motors

Power contactors for switching motors

Accessories for SIRIUS 3RT contactors and SIRIUS 3RH2 contactor relays > Link modules

For contactors	Size	Version	Article No.	Price per PU	PU (UNIT, SET, M)	PS*	PG
----------------	------	---------	-------------	--------------	-------------------	-----	----

Type

Assembly kits for contactor assemblies for star-delta (wye-delta) starting for making 3-pole contactor assemblies















			The assembly kit contains: link rails at bottom (a double infeed between the line contactor and the delta contactor is recommended.)				
 3RA1953-3G	3RT1.5, 3RT204	S6-S6-S3 For connection with box terminal only	The S3 star jumper must be ordered separately, see page 3/113.	3RA1953-3G	1	1 unit	41B
	3RT1.5	S6-S6-S6 For connection with box terminal only	--	3RA1953-2B	1	1 unit	41B
 3RA1953-2B	3RT1.5	S6-S6-S6 For connection without box terminal	--	3RA1953-2N	1	1 unit	41B
	3RT1.6, 3RT1.5	S10-S10-S6 For connection with box terminal only	The S6 star jumper must be ordered separately, see page 3/113.	3RA1963-3E	1	1 unit	41B
 3RA1963-3E	3RT1.6	S10-S10-S10 For connection without box terminal	--	3RA1963-2B	1	1 unit	41B
	3RT1.7, 3RT1.6	S12-S12-S10 For connection with box terminal only	The S10 star jumper must be ordered separately, see page 3/113.	3RA1973-3E	1	1 unit	41B
 3RA1973-3E	3RT1.7	S12-S12-S12 For connection without box terminal	--	3RA1973-2B	1	1 unit	41B
	3RA1973-2B						

Switching devices – Contactors and contactor assemblies – for switching motors

Power contactors for switching motors

Accessories for SIRIUS 3RT contactors and SIRIUS 3RH2 contactor relays > Link modules

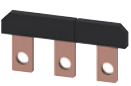
PU (UNIT, SET, M) = 1
 PS* = 1 unit (unless otherwise specified)
 PG = 41B

For con- tactors Type	Size	Version	Article No.	Price per PU	Article No.	Price per PU
Single wiring modules for making 3-pole contactor assemblies			Screw terminals 		Spring-loaded terminals 	
 3RA2913-3DA1	3RT201	S00-S00 • Top (in-phase) • Bottom (with phase reversal)	PS = 5 units PS = 5 units	3RA2913-3DA1 3RA2913-3EA1	3RA2913-3DA2 3RA2913-3EA2	
 3RA2923-3DA1	3RT202	S0-S0 • Top (in-phase) • Bottom (with phase reversal)	PS = 5 units PS = 5 units	3RA2923-3DA1 3RA2923-3EA1	3RA2923-3DA2 3RA2923-3EA2	
 3RA1933-3D	3RT203	S2-S2 • Top (in-phase), contactor clearance 10 mm • Bottom (with phase reversal), contactor clearance 10 mm		3RA1933-3D 3RA1933-3E	3RA1933-3D 3RA1933-3E	
 3RA1943-3E	3RT204	S3-S3 • Top (in-phase), contactor clearance 10 mm • Bottom (with phase reversal), contactor clearance 10 mm		3RA1943-3D 3RA1943-3E	3RA1943-3D 3RA1943-3E	
 3RA1953-3D	3RT1.5	S6-S6 • Top (in-phase, for connection with box terminal), contactor clearance 10 mm • Top (with phase reversal, for connection without box terminal), contactor clearance 10 mm		3RA1953-3D 3RA1953-3P	3RA1953-3D 3RA1953-3P	
Star jumpers (links for paralleling), 3-pole			Screw terminals 		Spring-loaded terminals 	
 3RT1916-4BA31	3RT201	S00 With through-hole The links for paralleling can be reduced by one pole.		3RT1916-4BA31	3RT2916-4BA32	
 3RT2926-4BA32	3RT202	S0 Without connecting terminal		3RT1926-4BA31	3RT2926-4BA32	
 3RT1936-4BA31	3RT203	S2		3RT1936-4BA31	3RT1936-4BA31	
 3RT1946-4BA31	3RT204	S3		3RT1946-4BA31	3RT1946-4BA31	
 3RT1956-4BA31	3RT1.5	S6		3RT1956-4BA31	3RT1956-4BA31	
 3RT1966-4BA31	3RT1.6, 3RT1.7	S10, S12		3RT1966-4BA31	3RT1966-4BA31	

Switching devices – Contactors and contactor assemblies – for switching motors

Power contactors for switching motors

Accessories for SIRIUS 3RT contactors and SIRIUS 3RH2 contactor relays > Link modules

For contactors	Size	Version	Article No.	Price per PU	PU (UNIT, SET, M)	PS*	PG
----------------	------	---------	-------------	--------------	-------------------	-----	----

Type

Mechanical interlock assembly kits for two contactors for making 3- and 4-pole contactor assemblies

	3RT201, 3RT231	S00-S00	The interlocking assembly kits can be used without a contactor clearance. One assembly kit consists of a mechanical interlock and two connecting clips.	3RA2912-2H	1	10 units	41B
---	----------------	----------------	---	-------------------	---	----------	-----



3RA2912-2H



3RA2922-2H

For contactors	Size	Version	Article No.	Price per PU	PU (UNIT, SET, M)	PS*	PG
----------------	------	---------	-------------	--------------	-------------------	-----	----

Type

Mechanical interlocks for contactor assemblies

A contactor clearance of 10 mm must be considered when using the following mechanical interlocks.



3RA2934-2B

3RT202, 3RT203	S2-S2, S3-S3	Mechanical interlock Note:	3RA2934-2B	1	1 unit	41B
3RT202, 3RT203, 3RT204	S2-S2-S0, S2-S2-S2, S3-S3-S2, S3-S3-S3	The mechanical interlock for sizes S2 and S3 must be ordered separately.				

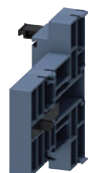

3RA1954-2G

3RT1.5 with 3RT204 ¹⁾	S6 (3RT1)-S6 (3RT1)-S3 (3RT2)¹⁾	Adapter in addition to the mechanical interlock The mechanical interlock is only possible together with this 3RA1954-2G adapter and the 3RA1954-2A mechanical interlock. Two connectors are included with the adapter, the interlock must be ordered separately.	3RA1954-2G	1	1 unit	41B
----------------------------------	---	--	-------------------	---	--------	-----



3RA1954-2A

3RT1.5, 3RT1.6, 3RT1.7	S6, S10, S12	Mechanical interlock Without auxiliary contacts; contactors in sizes S6, S10 and S12 can be interlocked with each other as required. No adaption of mounting depth is necessary.	3RA1954-2A	1	1 unit	41B
------------------------	---------------------	--	-------------------	---	--------	-----

Mechanical connectors for contactor assemblies

Two connectors are required for each assembly. The contactor clearance must be considered when selecting the connectors.



3RA1932-2D

3RT203, 3RT204	S2-S2, S3-S3	3-pole version	3RA2932-2C	1	10 units	41B
		• Without contactor clearance	3RA2932-2D	1	10 units	41B
	S6-S6	• With 10 mm contactor clearance	3RA1932-2D	1	10 units	41B

• With 10 mm contactor clearance (1 unit corresponds to 2 parts for 1 assembly)



3RA2932-2G

3RT233, 3RT234	S2-S2, S3-S3	4-pole version	3RA2932-2G	1	10 units	41B
		• With 20 mm contactor clearance	3RA2942-2G	1	10 units	41B

• With 10 mm contactor clearance



3RA2942-2G





¹⁾ The 3RA1954-2G adapter cannot be used in conjunction with 3RT204.-KB coupling contactors, size S3.

Switching devices – Contactors and contactor assemblies – for switching motors

Power contactors for switching motors

Accessories for SIRIUS 3RT contactors and SIRIUS 3RH2 contactor relays > Connection modules/adapters









Selection and ordering data

For contactors	Size	Version	Screw terminals	⊕	PU (UNIT, SET, M)	PS*	PG	
Type			Article No.	Price per PU				
Links for paralleling for main conducting paths			The links for paralleling (insulated) can be reduced by one pole. With connecting terminal					
3-pole								
	3RT201	S00	• Max. conductor cross-section: 25 mm ² , stranded	3RT1916-4BB31	1	1 unit	41B	
3RT1916-4BB31								
	3RT202	S0	• Max. conductor cross-section: 50 mm ² , stranded	3RT2926-4BB31	1	1 unit	41B	
3RT2926-4BB31								
	3RT203	S2	• Max. conductor cross-section: 120 mm ² , stranded	3RT1936-4BB31	1	1 unit	41B	
3RT1936-4BB31								
	3RT204, 3RT244	S3	• Max. conductor cross-section: 185 mm ² , stranded A cover is included for touch protection (can only be used when box terminal is removed).	3RT1946-4BB31	1	1 unit	41B	
3RT1946-4BB31								
4-pole								
	3RT231, 3RT251	S00	• Max. conductor cross-section: 25 mm ² , stranded	3RT1916-4BB41	1	1 unit	41B	
3RT1916-4BB41								

Switching devices – Contactors and contactor assemblies – for switching motors

Power contactors for switching motors

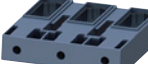
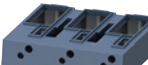
Accessories for SIRIUS 3RT contactors and SIRIUS 3RH2 contactor relays > Connection modules/adapters

Type	For con- tactors	Size	Version	Article No.	Price per PU	PU (UNIT, SET, M)	PS*	PG
1-phase infeed terminals								
	3RT204, 3RT244, 3RT264	S3	Conductor cross-section: 95 mm ²	3RA2943-3L		1	1 unit	41B
3RA2943-3L								
3-phase infeed terminals								
	3RT201	S00	Max. conductor cross-section: Up to 10 mm ² , AWG 12 ... 8	3RA2913-3K		1	10 units	41B
3RA2913-3K								
	3RT202, 3RT262	S0	Max. conductor cross-section: Up to 25 mm ² , AWG 10 ... 2/0	3RV2925-5AB		1	1 unit	41E
3RV2925-5AB								
	3RT203, 3RT263	S2	Max. conductor cross-section: Up to 70 mm ² , AWG 10 ... 2/0	3RV2935-5A		1	1 unit	41E
3RV2935-5A								
3-phase infeed terminals with increased clearances and creepage distances								
	3RT203	S2	Max. conductor cross-section: Up to 70 mm ² , AWG 10 ... 2/0	3RV2935-5E		1	1 unit	41E
3RV2935-5E								
3-phase busbars								
	3RT202	S0	Bridging phase-by-phase of all input terminals of the line contactor (Q11) and delta contactor (Q13)	3RV1915-1AB		1	1 unit	41E
3RV1915-1AB								
Terminal blocks for connecting auxiliary conductors to main terminals								
Box terminal blocks								
For round and ribbon cables (Connectable cross-sections of the contactors for size S3, see page 3/40 and for sizes 6 to S12, see page 3/44)								
	3RT204	S3	• 3-pole, for connection of main contacts, 2.5 to 70 mm ²	3RT2946-4G		1	1 unit	41B
3RT2946-4G								
	3RT1.5	S6	• Up to 70 mm ² , as standard on 3RT1054-1 contactor (55 kW)	3RT1955-4G		1	1 unit	41B
3RT1956-4G								
	3RT1.6, 3RT1.7	S10, S12	• Up to 240 mm ² , with auxiliary conductor connection up to 2.5 mm ²	3RT1966-4G		1	1 unit	41B
3RT1966-4G								
	3RT1.5	S6	Box terminal for auxiliary conductor connection, 1-pole For connection of auxiliary and control cables (0.5 ... 2.5 mm ²) to the main conductor terminals	3TX7500-0A		1	1 unit	41B
3TX7500-0A								
	3RT204	S3	Auxiliary conductor terminal, 3-pole For connection of auxiliary and control cables (0.5 ... 2.5 mm ²) to the main conductor terminals	3RT2946-4F		1	1 unit	41B
3RT2946-4F								

Switching devices – Contactors and contactor assemblies – for switching motors

Power contactors for switching motors

Accessories for SIRIUS 3RT contactors and SIRIUS 3RH2 contactor relays > Connection modules/adapters















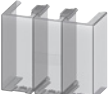

For contactors	Size	Version	Article No.	Price per PU	PU (UNIT, SET, M)	PS*	PG
Solder pin adapters for mounting contactors on printed circuit boards up to 5.5 kW/12 A							
	3RT2.1, 3RH21	S00	Assembly kit for soldering contactors with an integrated auxiliary contact onto a printed circuit board <u>Note:</u> One kit is required for one contactor.	Screw terminals 			
				3RT1916-4KA1	1	4 units	41B
	3RT2.1, 3RH21	S00	Assembly kit for soldering contactors with 4-pole mounted auxiliary switch onto a printed circuit board <u>Note:</u> One kit is required for one contactor.				
				3RT1916-4KA2	1	4 units	41B
							
							
3RT1916-4KA2							
Coil connection modules for connections from top or from bottom							
	3RT2.2, 3RT2.3, 3RT2.4	S0 to S3	<ul style="list-style-type: none"> • Connection from top • Connection from below • Connection diagonally 				
3RT2926-4RA11				3RT2926-4RA11	1	1 unit	41B
				3RT2926-4RB11	1	1 unit	41B
				3RT2926-4RC11	1	1 unit	41B
	3RT2.2	S0	<ul style="list-style-type: none"> • Connection from top • Connection from below 	Spring-loaded terminals 			
3RT2926-4RA12				3RT2926-4RA12	1	1 unit	41B
				3RT2926-4RB12	1	1 unit	41B
Connection modules (adapter and motor feeder connector) for contactors with screw terminals							
	3RT201, 3RH2	S00	The connection module comprises an adapter and a motor feeder connector. Adapters Ambient temperature $t_{u, max.} = 60\text{ °C}$ <ul style="list-style-type: none"> • Rated operational current I_{θ} at AC-3/AC-3e/400 V: 20 A 	Screw terminals 			
3RT1926-4RD01	3RT202	S0	<ul style="list-style-type: none"> • Rated operational current I_{θ} at AC-3/AC-3e/400 V: 25 A 				
	3RT201, 3RT202, 3RH2	S00, S0	Motor feeder connector				
3RT1900-4RE01				3RT1916-4RD01	1	1 unit	41B
				3RT1926-4RD01	1	1 unit	41B
				3RT1900-4RE01	1	1 unit	41B

Switching devices – Contactors and contactor assemblies – for switching motors

Power contactors for switching motors

Accessories for SIRIUS 3RT contactors and SIRIUS 3RH2 contactor relays > Covers

Selection and ordering data

For contactors	Size	Version	Article No.	Price per PU	PU (UNIT, SET, M)	PS*	PG
Terminal covers							
Covers for contactors with screw terminals (box terminals) (2 units required per contactor)							
		3RT203 3RT204, 3RT244	S2 S3	• For 3-pole contactors	3RT2936-4EA2 3RT2946-4EA2	1 1	1 unit 1 unit 41B 41B
		3RT1.5 3RT1.6, 3RT1.7	S6¹⁾ S10¹⁾, S12¹⁾		3RT1956-4EA2 3RT1966-4EA2	1 1	1 unit 1 unit 41B 41B
		3RT233, 3RT253 3RT234, 3RT254	S2 S3	• For 4-pole contactors (Scope of supply: one 3-pole and two 1-pole terminal covers are supplied)	3RT2936-4EA4 3RT2946-4EA4	1 1	1 unit 1 unit 41B 41B
Covers for contactors with cable lugs and busbar connections							
		3RT2.4	S3	• For complying with the phase clearances and as touch protection if box terminal is removed (2 units required per contactor)	3RT1946-4EA1	1	1 unit 41B
		3RT1.5 3RT1.6, 3RT1.7	S6¹⁾ S10¹⁾, S12¹⁾	- Length: 100 mm - Length: 100 mm - Length: 120 mm	3RT1956-4EA1 3RT1966-4EA1	1 1	1 unit 1 unit 41B 41B
		3RT1.5	S6	• For the assembly kits for 3RA1953-... contactor assemblies for star-delta (wye-delta) starting (see page 3/112) or for the 3RA1953-3, single wiring modules. (see page 3/113)	3RT1956-4EA4	1	1 unit 41B
		3RT1.6, 3RT1.7	S10, S12	• For the assembly kits for reversing contactor assemblies and contactor assemblies for star-delta (wye-delta) starting	3RT1966-4EA3	1	1 unit 41B
Terminal covers for busbar connections							
		3RT1.5 3RT1.6, 3RT1.7	S6 S10, S12	• Cover the three busbar connections, between the contactor and 3RB2 overload relay	3RT1956-4EA3 3RT1966-4EA3	1 1	1 unit 1 unit 41B 41B
		3RT1.5 3RT1.6, 3RT1.7	S6 S10, S12	• Can be screwed on free screw end; covers one busbar connection (1 set = 6 units)	3TX6526-3B 3TX6546-3B	1 1	1 unit 1 unit 41B 41B
Sealable covers							
		3RT2.1, 3RT2.2, 3RT2.3, 3RT2.4, 3RH2 ²⁾	S00 ... S3	For preventing manual operation (Not suitable for coupling contactors of size S00/S0)	3RT2916-4MA10	1	5 units 41B
		3RT1.5 ... 3RT1.7 ²⁾	S6 ... S12		3RT1926-4MA10	1	5 units 41B

¹⁾ Also fits on contactors of sizes S6 to S12 with box terminals.











²⁾ Exception: Contactors and contactor relays with auxiliary switch mounted on the front.

Switching devices – Contactors and contactor assemblies – for switching motors

Power contactors for switching motors

Accessories for SIRIUS 3RT contactors and SIRIUS 3RH2 contactor relays > Miscellaneous accessories



Selection and ordering data

For contactors	Size	Version	Article No.	Price per PU	PU (UNIT, SET, M)	PS*	PG
Base plates							
For reversing contactor assemblies							
	3RT1.5	S6	For customer assembly of reversing contactor assemblies	3RA1952-2A	1	1 unit	41B
	3RT1.6	S10		3RA1962-2A	1	1 unit	41B
	3RT1.7	S12		3RA1972-2A	1	1 unit	41B
For contactor assemblies for star-delta (wye-delta) starting							
	3RT2/ 3RT2/ 3RT2	S2-S2-S0, S2-S2-S2, S3-S3-S2, S3-S3-S3	For configuring contactor assemblies for star-delta (wye-delta) starting	3RA2932-2F	1	1 unit	41B
				3RA2942-2F	1	1 unit	41B
							
	3RT1/ 3RT1/ 3RT2	S6-S6-S3	For customer assembly of contactor assemblies for star-delta (wye-delta) starting with a laterally mounted timing relay 10 mm clearance between the contactors	3RA1952-2E	1	1 unit	41B
	3RT1/ 3RT1/ 3RT1	S6-S6-S6 S10-S10-S6 S10-S10-S10 S12-S12-S10 S12-S12-S12		3RA1952-2F	1	1 unit	41B
				3RA1962-2E	1	1 unit	41B
				3RA1962-2F	1	1 unit	41B
				3RA1972-2E	1	1 unit	41B
				3RA1972-2F	1	1 unit	41B
Adapters for screw fixing							
	3RT2.2	S0	Screw adapters for securing the contactors, two units required per contactor (1 pack = 10 sets for 10 contactors)	3RT1926-4P	1	10 units	41B
Connection kit for one complete contactor							
	3RT105	S6	Each set includes 6 screws, spring washers and nuts.	3RT1955-4PA00	1	1 unit	41B
	3RT106, 3RT107	S10, S12		M 8 x 25 M 10 x 30	3RT1966-4PA00	1	1 unit
							
EMC suppression modules; 3-phase, up to 7.5 kW							
For contactors with AC or DC operation							
	3RT201	S00	RC elements (3 x 220 Ω/0.22 μF) • Up to 400 V • Up to 575 V • Up to 690 V	Screw terminals 			
				3RT2916-1PA1	1	1 unit	41B
				3RT2916-1PA2 3RT2916-1PA3	1	1 unit	41B
	3RT201	S00	Varistors • Up to 400 V • Up to 575 V • Up to 690 V	3RT2916-1PB1	1	1 unit	41B
		3RT2916-1PB2		1	1 unit	41B	
		3RT2916-1PB3		1	1 unit	41B	

Switching devices – Contactors and contactor assemblies – for switching motors

Power contactors for switching motors





Accessories for SIRIUS 3RT contactors and SIRIUS 3RH2 contactor relays > Miscellaneous accessories

For contactors	Size	Version	Article No.	Price per PU	PU (UNIT, SET, M)	PS*	PG	
Type								
Additional load modules								
 3RT2916-1GA00	3RT2.1, 3RH2	S00	<p>For plugging onto the front of the contactors with or without auxiliary switches</p> <p>For increasing the permissible residual current and for limiting the residual voltage, it ensures the safe opening of contactors with direct control via 230 V AC semiconductor outputs of SIMATIC controllers, simultaneously provides overvoltage damping</p> <p>Rated voltage: 50/60 Hz AC, 180 ... 255 V Operating range: 0.8 ... 1.1 x U_s</p>	3RT2916-1GA00		1	1 unit	41B
LED modules for displaying contactor operation								
 3RT2926-1QT00	3RT2, 3RT1, 3RH2	S00 ... S12	<p>For snapping into the location hole of an inscription label on the front of a contactor either directly on the contactor or on the front auxiliary switch</p> <p>The LED module is connected to coil terminals A1 and A2 of the contactor and indicates its energized state with a yellow LED. Connecting wires need to be extended as required.</p> <p>Rated voltage: 24 ... 240 V AC/DC with reverse polarity protection</p>	3RT2926-1QT00		1	5 units	41B
Control kit								
 3RT2916-4MC00	3RT2.1, 3RH2	S00	For manual operation of contactor contacts, for startup and service	3RT2916-4MC00		1	5 units	41B
	3RT2.2	S0		3RT2926-4MC00		1	5 units	41B
	3RT2.3, 3RT2.4	S2, S3		3RT2936-4MC00		1	5 units	41B

Switching devices – Contactors and contactor assemblies – for switching motors

Power contactors for switching motors

Accessories for SIRIUS 3RT contactors and SIRIUS 3RH2 contactor relays > Miscellaneous accessories

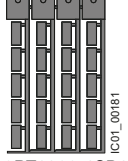
For contactors	Size	Version	Article No.	Price per PU	PU (UNIT, SET, M)	PS*	PG	
Insulation stops for securely holding back the conductor insulation for conductors up to 1 mm²								
 <p>3RT2916-4JA02</p>  <p>3RT1916-4JA02</p>			<p>Insulation stop strips Can be inserted in cable entry of the spring-loaded terminal (two strips per contactor required)</p> <ul style="list-style-type: none"> • For basic units, removable individually • For auxiliary and control current on basic units and for mountable 3RH29 auxiliary switches, removable in pairs 	<p>Spring-loaded terminals </p>				
3RT2.1, 3RH2	S00		3RT2916-4JA02		1	20 units	41B	
3RT2.2 ... 3RT2.4, 3RT1, 3RH29	S0 ... S12		3RT1916-4JA02		1	20 units	41B	
Tools for opening spring-loaded terminals								
 <p>3RT, 3RH</p> <p>3RA2908-1A</p>			<p>Screwdriver For all SIRIUS devices with spring-loaded terminals Length: approx. 200 mm, 3.0 mm x 0.5 mm, titanium gray/black, partially insulated</p>	<p>3RA2908-1A</p>		1	1 unit	41B
Blank labels								
 <p>3RT2900-1SB20</p>			<p>Unit labeling plates¹⁾ For SIRIUS devices</p> <ul style="list-style-type: none"> • 10 mm x 7 mm, titanium gray • 20 mm x 7 mm, titanium gray 	<p>3RT2900-1SB10</p> <p>3RT2900-1SB20</p>		100	816 units	41B
3RT	S00 ... S12		3RT2900-1SB60		100	3060 units	41B	
			<p>Adhesive labels For SIRIUS devices</p> <ul style="list-style-type: none"> • 19 mm x 6 mm, titanium gray 					

¹⁾ PC labeling system for individual inscription of unit labeling plates available from: murrplastik Systemtechnik GmbH (see page 16/18).

Switching devices – Contactors and contactor assemblies – for switching motors

Power contactors for switching motors

Spare parts for SIRIUS 3RT contactors and SIRIUS 3RH2 contactor relays > Solenoid coils

Selection and ordering data

Screw terminals and spring-loaded terminals

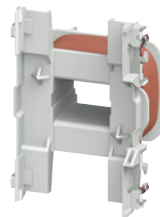

3RT2924-5A.01

For contactors	Rated control supply voltage U_s			Article No.	Price per PU	PU (UNIT, SET, M)	PS*	PG
	50 Hz	50/60 Hz	60 Hz					
Type	V	V	V					
Solenoid coils · AC operation								
Size S0								
3RT2023-A,	24	--	--	3RT2924-5AB01		1	1 unit	41B
3RT2024-A,	42	--	--	3RT2924-5AD01		1	1 unit	41B
3RT2025-A	48	--	--	3RT2924-5AH01		1	1 unit	41B
	110	--	--	3RT2924-5AF01		1	1 unit	41B
	230	--	--	3RT2924-5AP01		1	1 unit	41B
	400	--	--	3RT2924-5AV01		1	1 unit	41B
	--	24	--	3RT2924-5AC21		1	1 unit	41B
	--	42	--	3RT2924-5AD21		1	1 unit	41B
	--	48	--	3RT2924-5AH21		1	1 unit	41B
	--	110	--	3RT2924-5AG21		1	1 unit	41B
	--	220	--	3RT2924-5AN21		1	1 unit	41B
	--	230	--	3RT2924-5AL21		1	1 unit	41B
	--	--	24	3RT2924-5AC11		1	1 unit	41B
	110	--	120	3RT2924-5AK61		1	1 unit	41B
	220	--	240	3RT2924-5AP61		1	1 unit	41B
	--	100	110	3RT2924-5AG61		1	1 unit	41B
	--	200	220	3RT2924-5AN61		1	1 unit	41B
	--	400	440	3RT2924-5AR61		1	1 unit	41B
3RT2026-A,	24	--	--	3RT2926-5AB01		1	1 unit	41B
3RT2027-A,	42	--	--	3RT2926-5AD01		1	1 unit	41B
3RT2028-A	48	--	--	3RT2926-5AH01		1	1 unit	41B
3RT2325-A,	110	--	--	3RT2926-5AF01		1	1 unit	41B
3RT2326-A,	230	--	--	3RT2926-5AP01		1	1 unit	41B
3RT2327-A	400	--	--	3RT2926-5AV01		1	1 unit	41B
3RT2526-A	--	24	--	3RT2926-5AC21		1	1 unit	41B
	--	42	--	3RT2926-5AD21		1	1 unit	41B
	--	48	--	3RT2926-5AH21		1	1 unit	41B
	--	110	--	3RT2926-5AG21		1	1 unit	41B
	--	220	--	3RT2926-5AN21		1	1 unit	41B
	--	230	--	3RT2926-5AL21		1	1 unit	41B
	--	--	24	3RT2926-5AC11		1	1 unit	41B
	110	--	120	3RT2926-5AK61		1	1 unit	41B
	220	--	240	3RT2926-5AP61		1	1 unit	41B
	--	100	110	3RT2926-5AG61		1	1 unit	41B
	--	200	220	3RT2926-5AN61		1	1 unit	41B
	--	400	440	3RT2926-5AR61		1	1 unit	41B

Note:

Contactors with AC and AC/DC coils have different depths. It is only possible to replace the coils on AC contactors with AC coils. It is not possible to replace the coils on DC contactors.

Switching devices – Contactors and contactor assemblies – for switching motors

Power contactors for switching motors

Spare parts for SIRIUS 3RT contactors and SIRIUS 3RH2 contactor relays > Solenoid coils

Screw terminals and spring-loaded terminals

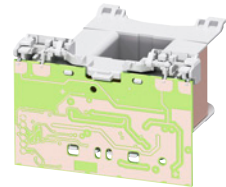
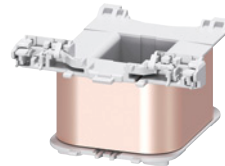
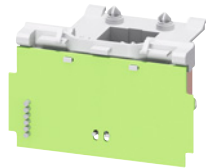

3RT2934-5A.01

3RT2934-5N.31

3RT2944-5A..1

3RT2944-5N.31

For contactors	Rated control supply voltage U_s				Article No.	Price per PU	PU (UNIT, SET, M)	PS*	PG
	50 Hz	50/60 Hz	60 Hz	DC					
Type	V	V	V	V					

Solenoid coils · AC operation

Size S2

3RT203.-A,	24	--	--	--	3RT2934-5AB01		1	1 unit	41B
3RT233.-A,	42	--	--	--	3RT2934-5AD01		1	1 unit	41B
3RT243.-A,	48	--	--	--	3RT2934-5AH01		1	1 unit	41B
3RT253.-A	110	--	--	--	3RT2934-5AF01		1	1 unit	41B
	230	--	--	--	3RT2934-5AP01		1	1 unit	41B
	400	--	--	--	3RT2934-5AV01		1	1 unit	41B
	--	24	--	--	3RT2934-5AC21		1	1 unit	41B
	--	42	--	--	3RT2934-5AD21		1	1 unit	41B
	--	48	--	--	3RT2934-5AH21		1	1 unit	41B
	--	110	--	--	3RT2934-5AG21		1	1 unit	41B
	--	208	--	--	3RT2934-5AM21		1	1 unit	41B
	--	220	--	--	3RT2934-5AN21		1	1 unit	41B
	--	230	--	--	3RT2934-5AL21		1	1 unit	41B
	110	--	120	--	3RT2934-5AK61		1	1 unit	41B
	220	--	240	--	3RT2934-5AP61		1	1 unit	41B
	--	--	480	--	3RT2934-5AV61		1	1 unit	41B
	--	--	600	--	3RT2934-5AT61		1	1 unit	41B
	--	100	110	--	3RT2934-5AG61		1	1 unit	41B
	--	200	220	--	3RT2934-5AN61		1	1 unit	41B
	--	--	277	--	3RT2934-5AU61		1	1 unit	41B
	--	400	440	--	3RT2934-5AR61		1	1 unit	41B

Size S3

3RT204.-A,	24	--	--	--	3RT2944-5AB01		1	1 unit	41B
3RT234.-A,	42	--	--	--	3RT2944-5AD01		1	1 unit	41B
3RT244.-A,	48	--	--	--	3RT2944-5AH01		1	1 unit	41B
3RT254.-A	110	--	--	--	3RT2944-5AF01		1	1 unit	41B
	230	--	--	--	3RT2944-5AP01		1	1 unit	41B
	400	--	--	--	3RT2944-5AV01		1	1 unit	41B
	--	24	--	--	3RT2944-5AC21		1	1 unit	41B
	--	42	--	--	3RT2944-5AD21		1	1 unit	41B
	--	48	--	--	3RT2944-5AH21		1	1 unit	41B
	--	110	--	--	3RT2944-5AG21		1	1 unit	41B
	--	220	--	--	3RT2944-5AN21		1	1 unit	41B
	--	230	--	--	3RT2944-5AL21		1	1 unit	41B
	110	--	120	--	3RT2944-5AK61		1	1 unit	41B
	220	--	240	--	3RT2944-5AP61		1	1 unit	41B
	--	--	480	--	3RT2944-5AV61		1	1 unit	41B
	--	--	600	--	3RT2944-5AT61		1	1 unit	41B
	--	100	110	--	3RT2944-5AG61		1	1 unit	41B
	--	200	220	--	3RT2944-5AN61		1	1 unit	41B
	--	400	440	--	3RT2944-5AR61		1	1 unit	41B

Solenoid coils · AC/DC operation, with varistor

Size S2

3RT203.-N,	--	20 ... 33	--	20 ... 33	3RT2934-5NB31		1	1 unit	41B
3RT233.-N	--	30 ... 42	--	30 ... 42	3RT2934-5ND31		1	1 unit	41B
	--	48 ... 80	--	48 ... 80	3RT2934-5NE31		1	1 unit	41B
	--	83 ... 155	--	83 ... 155	3RT2934-5NF31		1	1 unit	41B
	--	175 ... 280	--	175 ... 280	3RT2934-5NP31		1	1 unit	41B

Size S3

3RT204.-N,	--	20 ... 33	--	20 ... 33	3RT2944-5NB31		1	1 unit	41B
3RT234.-N,	--	30 ... 42	--	30 ... 42	3RT2944-5ND31		1	1 unit	41B
3RT244.-N,	--	48 ... 80	--	48 ... 80	3RT2944-5NE31		1	1 unit	41B
3RT254.-N	--	83 ... 155	--	83 ... 155	3RT2944-5NF31		1	1 unit	41B
	--	175 ... 280	--	175 ... 280	3RT2944-5NP31		1	1 unit	41B

Notes:

It is only possible to replace the coils on AC contactors with AC coils, and on AC/DC contactors with AC/DC coils.

Coil replacement is not permitted for 3RT20...-S contactors with fail-safe control.

Switching devices – Contactors and contactor assemblies – for switching motors

Power contactors for switching motors



Spare parts for SIRIUS 3RT contactors and SIRIUS 3RH2 contactor relays > Solenoid coils

PU (UNIT, SET, M) = 1
 PS* = 1 unit
 PG = 41B

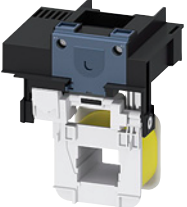

For contactors		Rated control supply voltage U_s	Screw terminals	Spring-loaded terminals
Size	Type	V	Article No.	Article No.
			Price per PU	Price per PU

Withdrawable coils

Standard operating mechanism for AC/DC

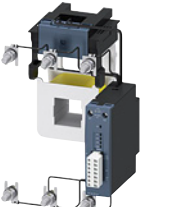

	S6	3RT105, 3RT145	23 ... 26 AC/DC	3RT1955-5AB31	3RT1955-5AB32
			42 ... 48 AC/DC	3RT1955-5AD31	3RT1955-5AD32
			110 ... 127 AC/DC	3RT1955-5AF31	3RT1955-5AF32
			200 ... 220 AC/DC	3RT1955-5AM31	3RT1955-5AM32
			220 ... 240 AC/DC	3RT1955-5AP31	3RT1955-5AP32
			240 ... 277 AC/DC	3RT1955-5AU31	3RT1955-5AU32
			380 ... 420 AC/DC	3RT1955-5AV31	3RT1955-5AV32
			440 ... 480 AC/DC	3RT1955-5AR31	3RT1955-5AR32
			500 ... 550 AC/DC	3RT1955-5AS31	3RT1955-5AS32
			575 ... 600 AC/DC	3RT1955-5AT31	3RT1955-5AT32
	S10	3RT106, 3RT146	23 ... 26 AC/DC	3RT1965-5AB31	3RT1965-5AB32
			42 ... 48 AC/DC	3RT1965-5AD31	3RT1965-5AD32
			110 ... 127 AC/DC	3RT1965-5AF31	3RT1965-5AF32
			200 ... 220 AC/DC	3RT1965-5AM31	3RT1965-5AM32
			220 ... 240 AC/DC	3RT1965-5AP31	3RT1965-5AP32
			240 ... 277 AC/DC	3RT1965-5AU31	3RT1965-5AU32
			380 ... 420 AC/DC	3RT1965-5AV31	3RT1965-5AV32
			440 ... 480 AC/DC	3RT1965-5AR31	3RT1965-5AR32
			500 ... 550 AC/DC	3RT1965-5AS31	3RT1965-5AS32
			575 ... 600 AC/DC	3RT1965-5AT31	3RT1965-5AT32
	S12	3RT107, 3RT147	23 ... 26 AC/DC	3RT1975-5AB31	3RT1975-5AB32
			42 ... 48 AC/DC	3RT1975-5AD31	3RT1975-5AD32
			110 ... 127 AC/DC	3RT1975-5AF31	3RT1975-5AF32
			200 ... 220 AC/DC	3RT1975-5AM31	3RT1975-5AM32
			220 ... 240 AC/DC	3RT1975-5AP31	3RT1975-5AP32
			240 ... 277 AC/DC	3RT1975-5AU31	3RT1975-5AU32
			380 ... 420 AC/DC	3RT1975-5AV31	3RT1975-5AV32
			440 ... 480 AC/DC	3RT1975-5AR31	3RT1975-5AR32
			500 ... 550 AC/DC	3RT1975-5AS31	3RT1975-5AS32
			575 ... 600 AC/DC	3RT1975-5AT31	3RT1975-5AT32

Solid-state operating mechanism for AC/DC with 24 V DC control signal input e.g. for control by PLC

	S6	3RT105, 3RT145	21 ... 27.3 AC/DC	3RT1955-5NB31	3RT1955-5NB32
			96 ... 127 AC/DC	3RT1955-5NF31	3RT1955-5NF32
			200 ... 277 AC/DC	3RT1955-5NP31	3RT1955-5NP32
	S10	3RT106, 3RT146	21 ... 27.3 AC/DC	3RT1965-5NB31	3RT1965-5NB32
			96 ... 127 AC/DC	3RT1965-5NF31	3RT1965-5NF32
			200 ... 277 AC/DC	3RT1965-5NP31	3RT1965-5NP32
	S12	3RT107, 3RT147	21 ... 27.3 AC/DC	3RT1975-5NB31	3RT1975-5NB32
			96 ... 127 AC/DC	3RT1975-5NF31	3RT1975-5NF32
			200 ... 277 AC/DC	3RT1975-5NP31	3RT1975-5NP32

• Additionally with PLC relay output and remaining lifetime indicator (RLT)

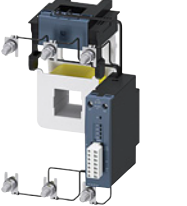
(withdrawable coil with lateral solid-state module)

	S6	3RT105, 3RT145	96 ... 127 AC/DC	3RT1955-5PP31	--
			200 ... 277 AC/DC	3RT1955-5PP31	--
	S10	3RT106, 3RT146	96 ... 127 AC/DC	3RT1965-5PP31	--
			200 ... 277 AC/DC	3RT1965-5PP31	--
	S12	3RT107, 3RT147	96 ... 127 AC/DC	3RT1975-5PP31	--
			200 ... 277 AC/DC	3RT1975-5PP31	--

Solid-state operating mechanism for DC with 24 ... 110 V DC control signal input e.g. for control by PLC with extended operating range

(see also contactors for railway applications, page 4/61 onwards)

	S6	3RT105...-X...-0LA2	24 DC	--	3RT1955-5XB42
			72 DC	--	3RT1955-5XJ42
			110 DC	--	3RT1955-5XF42
	S10	3RT106...-X...-0LA2	24 DC	--	3RT1965-5XB42
			72 DC	--	3RT1965-5XJ42
			110 DC	--	3RT1965-5XF42
	S12	3RT107...-X...-0LA2	24 DC	--	3RT1975-5XB42
			72 DC	--	3RT1975-5XJ42
			110 DC	--	3RT1975-5XF42

Note:

In the case of 3RT10...-S contactors with fail-safe control inputs, removing and replacing the operating mechanism are not permitted.

Switching devices – Contactors and contactor assemblies – for switching motors

Power contactors for switching motors

Spare parts for SIRIUS 3RT contactors and SIRIUS 3RH2 contactor relays > Solenoid coils

Operating mechanisms		Version	Article No.	Price per PU	PU (UNIT, SET, M)	PS*	PG
Size	Type						
Connection plugs for solid-state operating mechanisms							
 3RT1955-4NQ02	S6 ... S12	3RT1.5-.N, -.S, -.X ...	2-pole	3RT1955-4NQ02	1	1 unit	41B
		3RT1.7-.N, -.S, -.X					











Switching devices – Contactors and contactor assemblies – for switching motors

Power contactors for switching motors

Spare parts for SIRIUS 3RT contactors and SIRIUS 3RH2 contactor relays > Contacts and arc chutes

Selection and ordering data

For contactors	Version	Article No.	Price per PU	PU (UNIT, SET, M)	PS*	PG			
Size	Type								
Contacts with fixing parts									
For contactors with 3 main contacts									
	S2¹⁾	3RT2035 3RT2036 3RT2037 3RT2038	Main contacts (3 NO contacts) for utilization category AC-3 and AC-3e (1 set = 3 movable and 6 fixed contacts with fixing parts)	3RT2935-6A 3RT2936-6A 3RT2937-6A 3RT2938-6A	1 1 1 1	1 unit 1 unit 1 unit 1 unit	41B 41B 41B 41B		
	S3¹⁾	3RT2045 3RT2046 3RT2047		3RT2945-6A 3RT2946-6A 3RT2947-6A	1 1 1	1 unit 1 unit 1 unit	41B 41B 41B		
	S6	3RT1054 3RT1055 3RT1056		3RT1954-6A 3RT1955-6A 3RT1956-6A	1 1 1	1 unit 1 unit 1 unit	41B 41B 41B		
	S10	3RT1064 3RT1065 3RT1066		3RT1964-6A 3RT1965-6A 3RT1966-6A	1 1 1	1 unit 1 unit 1 unit	41B 41B 41B		
	S12	3RT1075 3RT1076		3RT1975-6A 3RT1976-6A	1 1	1 unit 1 unit	41B 41B		
	S3	3RT2446 3RT2448	Main contacts (3 NO contacts) for utilization category AC-1	3RT2946-6D 3RT2948-6D	1 1	1 unit 1 unit	41B 41B		
	S6	3RT1456	(1 set = 3 movable and 6 fixed contacts with fixing parts)	3RT1956-6D	1	1 unit	41B		
	S10	3RT1466 3RT1467		3RT1966-6D 3RT1967-6D	1 1	1 unit 1 unit	41B 41B		
	S12	3RT1476		3RT1976-6D	1	1 unit	41B		
									
For contactors with 4 main contacts									
	S2	3RT2336 3RT2337	Main contacts (4 NO contacts) for utilization category AC-1 (1 set = 3 movable and 6 fixed contacts and replacement pole with fixing parts)	3RT2936-6E 3RT2937-6E	1 1	1 unit 1 unit	41B 41B		
Arc chutes									
For contactors with 3 main contacts									
	S6	3RT1054 3RT1055 3RT1056 3RT1456	Only for contactors with AC/DC coil	3RT1954-7A 3RT1955-7A 3RT1956-7A 3RT1956-7B	1 1 1 1	1 unit 1 unit 1 unit 1 unit	41B 41B 41B 41B		
		S10	3RT1064 3RT1065 3RT1066 3RT1466		3RT1964-7A 3RT1965-7A 3RT1966-7A 3RT1966-7B	1 1 1 1	1 unit 1 unit 1 unit 1 unit	41B 41B 41B 41B	
			S12	3RT1075 3RT1076 3RT1476		3RT1975-7A 3RT1976-7A 3RT1976-7B	1 1 1	1 unit 1 unit 1 unit	41B 41B 41B

¹⁾ Replacement of the spare contact is not permitted for 3RT20...-S contactors with fail-safe control.

Switching devices – Contactors and contactor assemblies – for switching motors

Power contactors for switching motors

SIRIUS 3RT12 and 3TF6 vacuum contactors

Overview



3RT12 and 3TF6 vacuum contactors

Our power range of vacuum contactors for switching IE2 motors and highly efficient IE3 and IE4 motors:

- Sizes S10 and S12: 3RT12 to 250 kW
- Size 14: 3TF6 to 450 kW

See page 3/131 onwards

Standards

IEC 60947-1, IEC 60947-4-1, IEC 60947-5-1 (auxiliary switches)

Terminal covers may have to be fitted onto the connecting bars, depending on the configuration with other devices (see pages 3/118 and 3/135).

Operating conditions

Vacuum contactors are basically unsuitable for switching DC voltage. Vacuum contactors are approved for use exclusively **for applications in the 45 to 60 Hz frequency range**. Help with applications > 60 Hz is available from our Technical Support, www.siemens.com/support-request.

Protection of the device connections from short circuit, overload and overvoltage

Appropriate steps must always be taken to protect device connections from overload and short circuit. There are different constraints depending on the type of connection:

Short-circuit and overload protection of main connections

For information about protection of a single contactor, see the [technical product data sheet](#).

For more information on device combinations such as contactor with overload relay or contactor with motor starter protector/circuit breaker as motor feeder, refer to

- [Digital Configuration Manual for load feeders](#)
- [Configuration Manual for load feeders](#)

Short-circuit and overload protection of auxiliary connections

For information on the protection of auxiliary contacts, see the [technical product data sheet](#).

Short-circuit and overload protection of control supply voltage or supply voltage connections

First of all, the relevant standards and regulations for configuring control panels and the parts and components installed in them must be taken into account, for example for cable dimensioning.

One possible protection for these circuits could be the selection of a suitable power supply, i.e. one with a current-limiting function. In the selection of the source and the connecting cable, the load characteristics of the contactor must be considered (short-time inrush current peaks for solid-state contactor operating mechanisms, switch-on power, holding power). The same applies to the selection of suitable protection devices.

If there are further switching elements in the circuit, such as the auxiliary contact system of an overload relay that operates the contactor, the short-circuit protection necessary for this must also be considered.

For further recommendations, e.g. the use of miniature circuit breakers or circuit breakers for equipment in control circuits, see [Control panel tip – Selecting and dimensioning suitable power supplies quickly and reliably](#).

Short-circuit and overload protection of contactors with digital input

A typical rated current of 20 mA applies to these inputs according to the PLC input types according to IEC 60947-4-1.

These inputs can be protected accordingly (for 3RT12...N contactors marked with IN+/IN-).

The supply voltage connections A1 - A2 must be protected according to the load characteristics.

For information about power consumption, see the [technical product data sheet](#).

Overvoltage protection at the control supply voltage connection

The 3RT12 contactors are already equipped with coil damping (varistor).

Note:

The break times of the contactor, the opening delay times of the NO contacts and the closing delay times of the NC contacts increase with damping.

For more detailed information about how damping affects the time response see [Equipment Manual](#).

Protection from overvoltage in the main circuit

The 3RT12 and 3TF6 vacuum contactors can be retrofitted with varistors for damping switching overvoltages in the motor.

The 3TF6 contactors have integrated damping depending on the version.

Note:

When 3TF6 contactors are used **in an environment with frequency converters**, the overvoltage damping (if available) must be removed. For more information, see [Equipment Manual](#).

Connection methods

Main circuit

3RT12 vacuum contactors are available with busbar connections. Box terminal blocks can be ordered separately as accessories for versions with screw terminals, see page 3/135.

The 3TF6 vacuum contactors are available with busbar connections.

Auxiliary and control circuit

The 3RT12 and 3TF6 contactors are available with screw terminals.

Switching devices – Contactors and contactor assemblies – for switching motors

Power contactors for switching motors

SIRIUS 3RT12 and 3TF6 vacuum contactors

Motor protection

3RB2 electronic overload relays (see pages 7/99, 7/101 and 7/103) can be mounted on the 3RT12 vacuum contactors for protection against overload.

Electromagnetic compatibility (EMC)

The contactors satisfy the conditions for environment A according to IEC 60947-1.

Contact reliability of the auxiliary contacts

If voltages ≤ 110 V and currents ≤ 100 mA are to be switched, the auxiliary contacts of the vacuum contactors or 3RH contactor relays should be used as they guarantee a high level of contact reliability.

These auxiliary contacts are particularly suitable for solid-state circuits with currents ≥ 1 mA at a voltage ≥ 17 V.

Vacuum interrupters

3RT12 vacuum contactors

The contact gaps of the vacuum contactors are contained in hermetically enclosed vacuum interrupters unlike the 3RT10 contactors – the main contacts operate in air under atmospheric conditions. The particular benefit of vacuum contactors, however, is that their electrical endurance is significantly higher.

They are especially suited to frequent switching in inching-/mixed operation, e.g. in crane control systems.

3TF6 vacuum contactors

The switching contacts of the vacuum contactors are contained in hermetically enclosed vacuum interrupters.

With these contactors, the contact erosion of the vacuum interrupters can be checked in the energized state with the help of three white double slides below the connecting bars on the outgoing side.

Operating mechanism types

3RT12 vacuum contactors

The contactors can be operated with AC (50 to 60 Hz) as well as with DC. Two types of solenoid operation are available:

- Standard operating mechanism for AC and DC operation (power consumption reduced from closing power to holding power), version 3RT12..-A
- Solid-state operating mechanism, version 3RT12..-N

3TF6 vacuum contactors

- Standard version 3TF6.44-.C.7 with AC operation
- 3TF6.33-.D.4 contactors with DC control are supplied with a 3TC4417-4A.. reversing contactor and a series resistor.

Replacing operating mechanisms

3RT12 vacuum contactors

The operating mechanisms of the vacuum contactors are removable and can be replaced simply by unlocking and pulling them out.

3TF6 vacuum contactors

It is also possible to replace the operating mechanism components of the vacuum contactor.

Fitting auxiliary contacts and mounting additional auxiliary switches

Features in the delivery state

- 3RT12 vacuum contactors:
These contactors are supplied with two laterally mounted auxiliary switches with two contacts each (2 NO + 2 NC)
- 3TF6 vacuum contactors:
These contactors are supplied with four laterally mounted auxiliary switches with two contacts each (4 NO + 4 NC). For operating mechanism versions with 3TC series contactor, two auxiliary contacts are already defined (3 NO + 3 NC).

Expansion possibilities

- 3RT12 vacuum contactors:
All basic devices can be expanded via auxiliary switches. The permitted configuration must be taken into account.
- Vacuum contactor 3TF6:
These devices are already fully equipped and no expansion is possible.

Switching devices – Contactors and contactor assemblies – for switching motors

Power contactors for switching motors

SIRIUS 3RT12 and 3TF6 vacuum contactors

Technical specifications

Technical specifications of SIRIUS 3RT12 and 3TF6 vacuum contactors, [see](#)

- [Technical product data sheet](#)
- [Equipment Manual](#)

More information

Technical specifications, [see](https://support.industry.siemens.com/cs/ww/en/ps/16137/td)
<https://support.industry.siemens.com/cs/ww/en/ps/16137/td>
 FAQs, [see](https://support.industry.siemens.com/cs/ww/en/ps/16137/faq)
<https://support.industry.siemens.com/cs/ww/en/ps/16137/faq>
 System Manual for modular system, [see](https://support.industry.siemens.com/cs/ww/en/view/60311318)
<https://support.industry.siemens.com/cs/ww/en/view/60311318>
 Equipment Manual, [see](https://support.industry.siemens.com/cs/ww/en/view/60306557)
<https://support.industry.siemens.com/cs/ww/en/view/60306557>
 Application Manual - Switching devices with IE3 and IE4 motors, [see](https://support.industry.siemens.com/cs/ww/en/view/94770820)
<https://support.industry.siemens.com/cs/ww/en/view/94770820>
 Digital Configuration Manual for load feeders, [see](https://imp.siemens.com/digital-engineering-manual/dem)
<https://imp.siemens.com/digital-engineering-manual/dem>
 Configuration Manual for load feeders, [see](https://support.industry.siemens.com/cs/ww/en/view/39714188)
<https://support.industry.siemens.com/cs/ww/en/view/39714188>
 Configuration Manual for UL, [see](https://support.industry.siemens.com/cs/ww/en/view/53433538)
<https://support.industry.siemens.com/cs/ww/en/view/53433538>
 Guide of use for contactors in safety applications, [see](https://support.industry.siemens.com/cs/ww/en/view/109807687)
<https://support.industry.siemens.com/cs/ww/en/view/109807687>

Type

Size

SIRIUS vacuum contactors

3RT12

S10 and S12

Contact endurance of the main contacts

The characteristic curves show the contact endurance of the contactors when switching weak inductive or non-inductive AC loads (AC-1) and motor-driven loads (AC-3 and AC-3e) depending on the breaking current and rated operational voltage. It is assumed that the operating mechanisms are switched randomly, i.e. not synchronized with the phase angle of the supply system.

The rated operational current I_e complies with utilization category AC-4 (breaking 6 times the rated operational current) and is intended for a contact endurance of approximately 200 000 operating cycles.

If a shorter contact endurance is sufficient, the rated operational current $I_e/AC-4$ can be increased.

If the contacts are used for mixed operation, i.e. normal switching (breaking the rated operational current according to utilization category AC-3 and AC-3e) in combination with intermittent inching (breaking several times the rated operational current according to utilization category AC-4), the contact endurance can be calculated approximately from the following equation:

$$X = \frac{A}{1 + \frac{C}{100} \left(\frac{A}{B} - 1 \right)}$$

Characters in the equation:

X Contact endurance for mixed operation in operating cycles

A Contact endurance for normal operation

($I_a = I_e$) in operating cycles

B Contact endurance for inching

($I_a = \text{multiple of } I_e$) in operating cycles

C Inching operations as a percentage of total switching operations

Operating cycles at

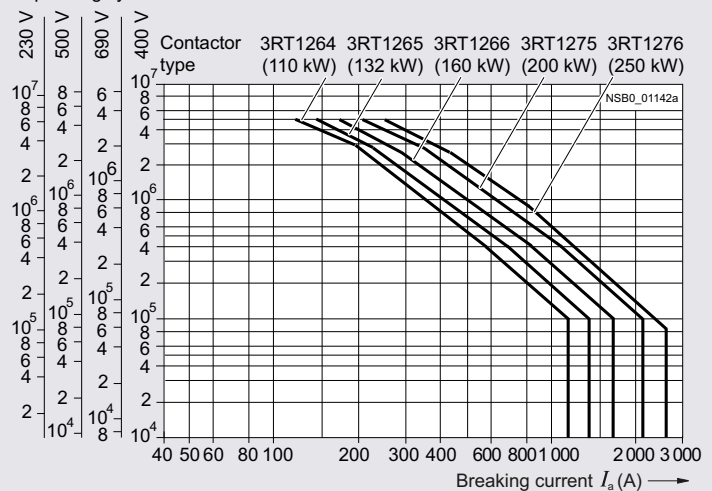

Switching devices – Contactors and contactor assemblies – for switching motors

Power contactors for switching motors

SIRIUS 3RT12 and 3TF6 vacuum contactors

Type
Size

Vacuum contactors
3TF6
14

Electrical endurance of auxiliary contacts

The electrical endurance for utilization category AC-12 or AC-15/AC-14 depends mainly on the breaking current. It is assumed that the operating mechanisms are switched randomly, i.e. not synchronized with the phase angle of the supply system.

The characteristic curves apply to 230 V AC.

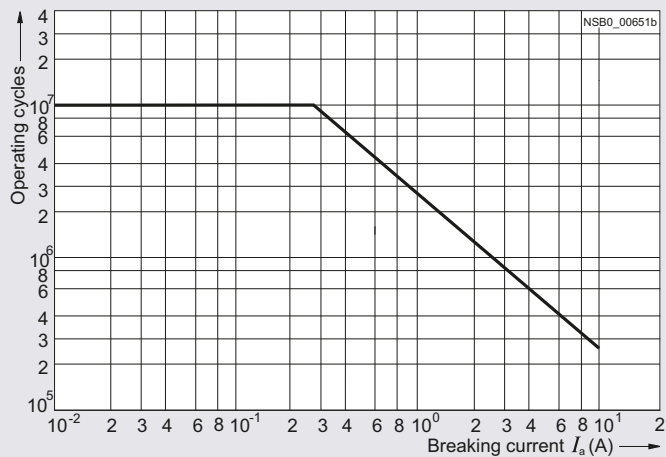

Contact endurance of the main contacts

The characteristic curves show the contact endurance of the contactors when switching weak inductive or non-inductive AC loads (AC-1) and motor-driven loads (AC-3 and AC-3e) depending on the breaking current and rated operational voltage. It is assumed that the operating mechanisms are switched randomly, i.e. not synchronized with the phase angle of the supply system.

The rated operational current I_e complies with utilization category AC-4 (breaking 6 times the rated operational current) and is intended for a contact endurance of approximately 200 000 operating cycles.

If a shorter contact endurance is sufficient, the rated operational current $I_e/AC-4$ can be increased.

If the contacts are used for mixed operation, i.e. normal switching (breaking the rated operational current according to utilization category AC-3 and AC-3e) in combination with intermittent inching (breaking several times the rated operational current according to utilization category AC-4), the contact endurance can be calculated approximately from the following equation:

$$X = \frac{A}{1 + \frac{C}{100} \left(\frac{A}{B} - 1 \right)}$$

Characters in the equation:

- X Contact endurance for mixed operation in operating cycles
- A Contact endurance for normal operation ($I_a = I_e$) in operating cycles
- B Contact endurance for inching ($I_a = \text{multiple of } I_e$) in operating cycles
- C Inching operations as a percentage of total switching operations

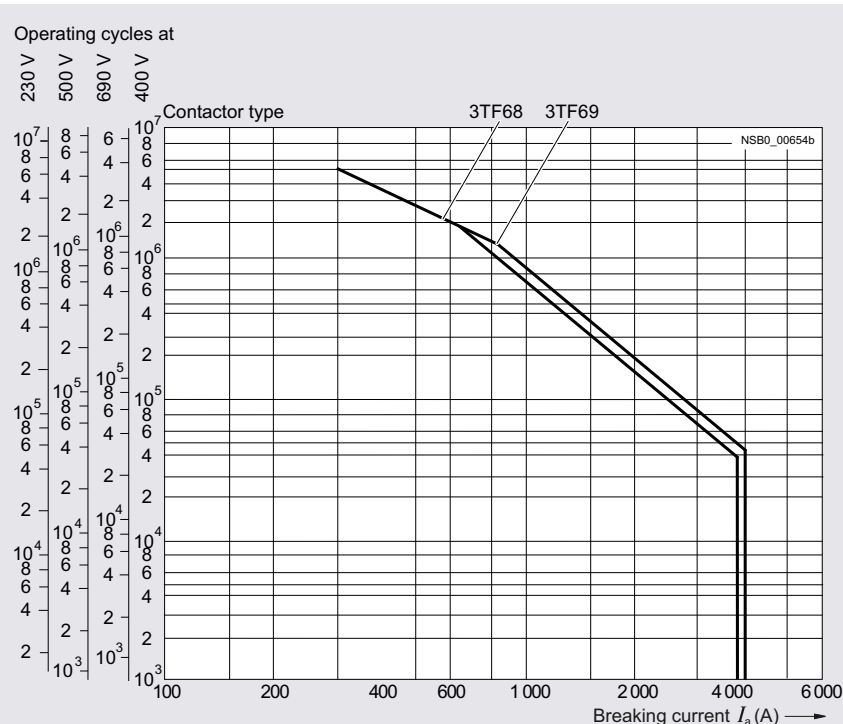

Switching devices – Contactors and contactor assemblies – for switching motors

Power contactors for switching motors

AC-3e

IE3/IE4 ready

SIRIUS 3RT12 and 3TF6 vacuum contactors

Selection and ordering data

SIRIUS 3RT12 vacuum contactors, 3-pole, 110 to 250 kW

AC/DC operation

- Standard operating mechanism 3RT12...-A
- 3RT12...-N solid-state operating mechanism with 24 V DC control signal input
- For screw fixing
- Auxiliary and control conductors: Screw terminals
- Main conductors: Busbar connections; a connection kit with screws, spring washers and nuts is enclosed.



3RT1264-6AF36



3RT127...-6N.36

Size	Rated data					AC-1, t_{ij} : 40 °C	Auxiliary contacts, lateral		Rated control supply voltage U_s 50/60 Hz AC or DC	Screw terminals 	PU (UNIT, SET, M)	PS*	PG
	AC-3 and AC-3e, t_{ij} : up to 60 °C	Rating of three-phase motors at 50 Hz and					Operational current I_e up to	NO					
	Operational current I_e up to	Rating of three-phase motors at 50 Hz and				Operational current I_e up to			NO	NC	V	Article No.	Price per PU
	1 000 V	230 V	400 V	500 V	690 V		1 000 V						
	A	kW	kW	kW	kW	A							

Standard operating mechanism for AC and DC operation (power consumption reduced from closing power to holding power)

With integrated coil circuit (varistor integrated at the factory)

S10	225	55	110	160	200	330	2	2	110 ... 127 220 ... 240	3RT1264-6AF36 3RT1264-6AP36	1	1 unit	41B
	265	75	132	160	250	330	2	2	110 ... 127 220 ... 240	3RT1265-6AF36 3RT1265-6AP36	1	1 unit	41B
	300	90	160	200	250	330	2	2	110 ... 127 220 ... 240	3RT1266-6AF36 3RT1266-6AP36	1	1 unit	41B
S12	400	132	200	250	400	610	2	2	110 ... 127 220 ... 240	3RT1275-6AF36 3RT1275-6AP36	1	1 unit	41B
	500	160	250	355	500	610	2	2	110 ... 127 220 ... 240	3RT1276-6AF36 3RT1276-6AP36	1	1 unit	41B

Solid-state operating mechanism

With 24 V DC control signal input e.g. for control by PLC

With integrated coil circuit (varistor integrated in electronics at the factory)

S10	225	55	110	160	200	330	2	2	96 ... 127 200 ... 277	3RT1264-6NF36 3RT1264-6NP36	1	1 unit	41B
	265	75	132	160	250	330	2	2	96 ... 127 200 ... 277	3RT1265-6NF36 3RT1265-6NP36	1	1 unit	41B
	300	90	160	200	250	330	2	2	96 ... 127 200 ... 277	3RT1266-6NF36 3RT1266-6NP36	1	1 unit	41B
S12	400	132	200	250	400	610	2	2	96 ... 127 200 ... 277	3RT1275-6NF36 3RT1275-6NP36	1	1 unit	41B
	500	160	250	355	500	610	2	2	96 ... 127 200 ... 277	3RT1276-6NF36 3RT1276-6NP36	1	1 unit	41B

Other voltages [according to page 3/70](#) on request.

For an overview of the 3RT12 vacuum contactors with mountable accessories, [see pages 3/14 and 3/16](#).

The accessories for the 3RT1 vacuum contactors correspond to those for the basic units of the 3RT1 contactors, [see page 3/71 onwards](#).

For spare parts, [see page 3/137 onwards](#).

Switching devices – Contactors and contactor assemblies – for switching motors

Power contactors for switching motors

SIRIUS 3RT12 and 3TF6 vacuum contactors **IE3/IE4 ready** **AC-3e**

3TF6 vacuum contactors, 3-pole, 335 to 450 kW

AC operation 

- For screw fixing
- Main conductors: Busbar connections
- Auxiliary and control conductors: Screw terminals
- With overvoltage protection of the coil (varistor)



3TF68



3TF69

Size	Rated data					AC-1, t _J : 40 °C	Auxiliary contacts, lateral		Rated control supply voltage U _s 50/60 Hz AC	Screw terminals 		PU (UNIT, SET, M)	PS*	PG
	Operational current I _e up to	Rating of three-phase motors at 50 Hz and					Operational current I _e up to	NO		NC	Article No.			
690 V	230 V	400 V	690 V	1 000 V	690 V	A			kW			kW	kW	kW
AC operation, 50/60 Hz¹⁾														
14	630 (552) ²⁾	200 (160) ²⁾	355 (315) ²⁾	600 (560) ²⁾	--	700	4	4	110 ... 132 200 ... 240	3TF6844-OCF7 3TF6844-OCM7	1 1	1 unit 1 unit	41B 41B	
						600	700	4	4	110 ... 132 200 ... 240	3TF6844-8CF7 3TF6844-8CM7	1 1	1 unit 1 unit	41B 41B
14	820 (630) ²⁾	260 (200) ²⁾	450 (355) ²⁾	800 (600) ²⁾	--	910	4	4	110 ... 132 200 ... 240	3TF6944-OCF7 3TF6944-OCM7	1 1	1 unit 1 unit	41B 41B	
						800	910	4	4	110 ... 132 200 ... 240	3TF6944-8CF7 3TF6944-8CM7	1 1	1 unit 1 unit	41B 41B

¹⁾ Please observe the information regarding the use of 3TF6 vacuum contactors in the environment of frequency converters, see page 3/127.

²⁾ Value applies for utilization category AC-3e.

For an overview of the 3TF6 vacuum contactors with mountable accessories, see page 3/17.

Accessories and spare parts, see pages 3/134 to 3/138.

Rated control supply voltages, possible on request (change of the 10th and 11th digits of the article number)

Delivery time on request

Rated control supply voltage U _s	Contactor type	3TF6844-C..., 3TF6944-C...
	Size	14

AC operation

Solenoid coils for 50/60 Hz

110 ... 132 V AC	F7
200 ... 240 V AC	M7
230 ... 277 V AC	P7
380 ... 460 V AC	Q7

Switching devices – Contactors and contactor assemblies – for switching motors

Power contactors for switching motors

AC-3e

IE3/IE4 ready

SIRIUS 3RT12 and 3TF6 vacuum contactors

DC operation

- Main conductors: Busbar connections
- Auxiliary and control conductors: Screw terminals
- Power consumption reduced from closing power to holding power



3TF6833-1D.4
with reversing contactor 3TC4417-0A

Size	Rated data					AC-1, t_i : 40 °C	Auxiliary contacts, lateral			Rated control supply voltage U_s DC	Screw terminals 		PU (UNIT, SET, M)	PS*	PG
	AC-3 and AC-3e, t_i : Up to 55 °C	Rating of three-phase motors at 50 Hz and					Operational current I_e up to	NO	NC		V	Article No.			
Operational current I_e up to	230 V	400 V	690 V	1 000 V	690 V	A				kW			kW	kW	A
14	630 (552) ²⁾	200 (160) ²⁾	355 (315) ²⁾	600 (560) ²⁾	-- 600	700 700	3	3	24						
14	820 (630) ²⁾	260 (200) ²⁾	450 (355) ²⁾	800 (600) ²⁾	-- 800	910 910	3	3	24						

DC operation¹⁾

14	630 (552) ²⁾	200 (160) ²⁾	355 (315) ²⁾	600 (560) ²⁾	-- 600	700 700	3	3	24						
14	820 (630) ²⁾	260 (200) ²⁾	450 (355) ²⁾	800 (600) ²⁾	-- 800	910 910	3	3	24						

¹⁾ Please observe the information regarding the use of 3TF6 vacuum contactors in the environment of frequency converters, see page 3/127.

²⁾ Value applies for utilization category AC-3e.

For an overview of the 3TF6 vacuum contactors with mountable accessories, see page 3/17.

Accessories and spare parts, see pages 3/134 to 3/138.

Rated control supply voltages, possible on request (change of the 10th and 11th digits of the article number)

Delivery time on request

Rated control supply voltage U_s	Contactor type	3TF6833-D.., 3TF6933-D..
	Size	14

DC operation

Solenoid coils

24 V DC	B4
110 V DC	F4
125 V DC	G4
220 V DC	M4
230 V DC	P4

Switching devices – Contactors and contactor assemblies – for switching motors

Power contactors for switching motors

Accessories and spare parts for SIRIUS 3RT12 and 3TF6 vacuum contactors









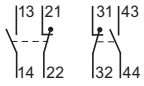

Selection and ordering data

Accessories

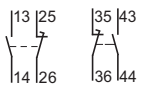
For further accessories for the SIRIUS 3RT12 vacuum contactors, see 3RT10 basic units, page 3/71 onwards.

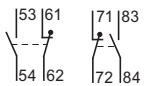
Overview graphics with mountable accessories:



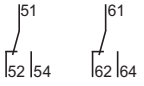



- 3RT12 contactors, see pages 3/14 and 3/16
- 3TF68 and 3TF69 contactors, see page 3/17

For contactors	Auxiliary contacts				Connections		Screw terminals 	PU (UNIT, SET, M)	PS*	PG
	Version	NO	NC	NC	Left	Right				
Size	Type	NO	NC	NC	Left	Right	Article No.	Price per PU		
Auxiliary switches, instantaneous										
For lateral mounting										
	14	3TF68, 3TF69	1	1	--		3TY7561-1AA00	1	1 unit	41B
		3TF68, 3TF69	1	--	1		3TY7561-1EA00	1	1 unit	41B
		3TF68, 3TF69	1	1	--		3TY7561-1KA00	1	1 unit	41B
	14	3TF68, 3TF69	--	--	1		3TY7681-1G	1	1 unit	41B
Solid-state compatible auxiliary switches										
For lateral mounting										
	14	3TF68, 3TF69	1	CO contact			3TY7561-1UA00	1	1 unit	41B

Switching devices – Contactors and contactor assemblies – for switching motors

Power contactors for switching motors

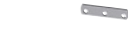
Accessories and spare parts for SIRIUS 3RT12 and 3TF6 vacuum contactors

For contactors	Version	Article No.	Price per PU	PU (UNIT, SET, M)	PS*	PG
Size	Type					
Locking devices for mechanical interlock						
	14 3TF68-3TF68	For two contactors of the same size, for mounting on base plate	3TX7686-1A	1	1 unit	41B
Base plates						
For reversing contactor assemblies						
	14 3TF68-3TF68	For customer assembly of reversing contactor assemblies	3TX7681-1A	1	1 unit	41B
For contactor assemblies for star-delta (wye-delta) starting						
	14 3TF68-3TF68-3RT1.7	For configuring contactor assemblies for star-delta (wye-delta) starting	3TX7681-1B	1	1 unit	41B
Assembly kits for contactor assemblies						
For reversing contactor assemblies						
	14 3TF68-3TF68	The assembly kit contains: wiring modules on the top and bottom	3TX7680-1A	1	1 unit	41B
						
For contactor assemblies for star-delta (wye-delta) starting						
	14 3TF68-3TF68-3RT1.7	The assembly kit contains: Wiring modules on the top and bottom, Star jumper S12	3TX7680-1B	1	1 unit	41B
						

Switching devices – Contactors and contactor assemblies – for switching motors

Power contactors for switching motors

Accessories and spare parts for SIRIUS 3RT12 and 3TF6 vacuum contactors

Spare parts





PU (UNIT, SET, M) = 1
 PS* = 1 unit
 PG = 41B

For contactors		Rated control supply voltage $U_{s \text{ min}}$ to $U_{s \text{ max}}$		Screw terminals 		Spring-loaded terminals 		
Size	Type	V AC/DC	Article No.	Price per PU	Article No.	Price per PU		
Withdrawable coils								
Standard operating mechanism for AC/DC								
	S10	3RT126	23 ... 26	3RT1966-5AB31	--			
			42 ... 48	3RT1966-5AD31	--			
			110 ... 127	3RT1966-5AF31	--			
			200 ... 220	3RT1966-5AM31	--			
			220 ... 240	3RT1966-5AP31	--			
			240 ... 277	3RT1966-5AU31	--			
			380 ... 420	3RT1966-5AV31	--			
			440 ... 480	3RT1966-5AR31	--			
			500 ... 550	3RT1966-5AS31	--			
			575 ... 600	3RT1966-5AT31	--			
	S12	3RT127	23 ... 26	3RT1975-5AB31	3RT1975-5AB32			
			42 ... 48	3RT1975-5AD31	3RT1975-5AD32			
			110 ... 127	3RT1975-5AF31	3RT1975-5AF32			
			200 ... 220	3RT1975-5AM31	3RT1975-5AM32			
			220 ... 240	3RT1975-5AP31	3RT1975-5AP32			
			240 ... 277	3RT1975-5AU31	3RT1975-5AU32			
			380 ... 420	3RT1975-5AV31	3RT1975-5AV32			
			440 ... 480	3RT1975-5AR31	3RT1975-5AR32			
			500 ... 550	3RT1975-5AS31	3RT1975-5AS32			
			575 ... 600	3RT1975-5AT31	3RT1975-5AT32			
	S10	3RT126	21 ... 27.3	3RT1966-5NB31	--			
			96 ... 127	3RT1966-5NF31	--			
			200 ... 277	3RT1966-5NP31	--			
			S12	3RT127	21 ... 27.3	3RT1975-5NB31	3RT1975-5NB32	
					96 ... 127	3RT1975-5NF31	3RT1975-5NF32	
					200 ... 277	3RT1975-5NP31	3RT1975-5NP32	
Solid-state operating mechanism for AC/DC with 24 V DC control signal input e.g. for control by PLC								
Operating mechanisms		Version	Article No.	Price per PU	PU (UNIT, SET, M)	PS*	PG	
Size	Type							
Connection plugs for solid-state operating mechanisms								
	S10,	3RT126.-5N...	2-pole	3RT1955-4NQ02	1	1 unit	41B	
	S12	3RT127.-5N...						

Switching devices – Contactors and contactor assemblies – for switching motors

Power contactors for switching motors

Accessories and spare parts for SIRIUS 3RT12 and 3TF6 vacuum contactors

For contactors		Version	Rated control supply voltage U_s	Article No.	Price per PU	PU (UNIT, SET, M)	PS*	PG				
Size	Type		V									
Solenoid coils												
 3TY76.3-0C..	14	3TF68	AC operation	50/60 Hz AC								
			The solenoid coils are fitted as standard with varistors against overvoltage; the coil is supplied with switch-on electronics.	110 ... 132					3TY7683-0CF7	1	1 unit	41B
				200 ... 240					3TY7683-0CM7	1	1 unit	41B
				230 ... 277					3TY7683-0CP7	1	1 unit	41B
				380 ... 460	3TY7683-0CQ7	1	1 unit	41B				
	3TF69			110 ... 132	3TY7693-0CF7	1	1 unit	41B				
				200 ... 240	3TY7693-0CM7	1	1 unit	41B				
				230 ... 277	3TY7693-0CP7	1	1 unit	41B				
			380 ... 460	3TY7693-0CQ7	1	1 unit	41B					
 3TY7683-0D..	14	3TF68	DC operation	24 DC								
			The solenoid coils are supplied without reversing contactor.	110 DC					3TY7683-0DB4	1	1 unit	41B
				125 DC					3TY7683-0DF4	1	1 unit	41B
				220 DC					3TY7683-0DG4	1	1 unit	41B
				230 DC					3TY7683-0DM4	1	1 unit	41B
									3TY7683-0DP4	1	1 unit	41B
Vacuum interrupters												
 3RT197.-6V	S10	3RT1264	Set with three vacuum interrupters with fixing parts	--								
		3RT1265		--					3RT1964-6V	1	1 unit	41B
		3RT1266		--					3RT1965-6V	1	1 unit	41B
S12	3RT1275	--	3RT1966-6V	1	1 unit	41B						
	3RT1276	--	3RT1975-6V	1	1 unit	41B						
 3TY7690-0B	14	3TF68	Set with three vacuum interrupters with components	--								
		3TF69		--					3TY7680-0B	1	1 unit	41B
			Note:									
			In order to ensure reliable operation of the contactors, only original replacement interrupters should be used.									
								3TY7690-0B				
								1				
								1				
								1 unit				
								41B				
								1 unit				
								41B				
AC solenoid operating mechanisms with coil												
 3TY7685-0C.7	14	3TF6844-.C	Solenoid operating mechanism with coil	50/60 Hz AC								
				200 ... 240					3TY7685-0CM7	1	1 unit	41B
				230 ... 276				3TY7685-0CP7				
								1				
								1				
								1 unit				
								41B				

Switching devices – Contactors and contactor assemblies – for switching motors

Power contactors for switching motors

3TG10 power relays/miniature contactors

Overview

Standards

IEC 60947-1, IEC 60947-4-1, IEC 60947-5-1

Version

The 3TG10 power relays/miniature contactors are available with screw terminals or 6.3 mm x 0.8 mm flat connectors.

The 3TG10 miniature contactors are characterized by their width of just 36 mm.

Protection of the device connections from overvoltage

The 3TG10 power relays/miniature contactors have an integrated protective circuit against switching overvoltages.

Application

Because they are hum-free they are suitable for use in household appliances and distribution boards in office and residential areas.

They can also be used for applications where there is little space, such as air conditioners, heating systems, pumps and fans, i.e. for simple electrical controls.

Technical specifications

More information

Technical specifications, see <https://support.industry.siemens.com/cs/ww/en/ps/16186/td>

Reference Manual for switching devices, see <https://support.industry.siemens.com/cs/ww/en/view/35554359>
FAQs, see <https://support.industry.siemens.com/cs/ww/en/ps/16186/faq>

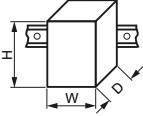
Type	3TG10	
General data		
Dimensions (W x H x D)		mm 36 x 56 x 56
Endurance		
• Mechanical	Operating cycles	3 million
• Electrical		
- AC-1 at I_e	Operating cycles	0.1 million
- AC-3/AC-3e at I_e	Operating cycles	0.4 million
Rated insulation voltage U_i (pollution degree 3)	V	400
Rated impulse withstand voltage U_{imp}	kV	4
Protective separation between the coil and the contacts according to IEC 60947-1, Annex N	V	Up to 300
Permissible ambient temperature		
• During operation ¹⁾	°C	-25 ... + 55
• During storage	°C	-50 ... + 80
Short-circuit protection		
Fuse links , operational class gG: LV HRC, type 3NA; DIAZED, type 5SB; NEOZED, type 5SE according to IEC 60947-4-1		
• Type of coordination "1"	A	25
• Type of coordination "2"	A	10
Miniature circuit breakers , C characteristic	A	10
Control		
Solenoid coil operating range		0.85 ... 1.1 x U_s
Power consumption of the solenoid coils (for cold coil and 1.0 x U_s)		
• AC operation, 45 ... 450 Hz	VA	4.4
- P.f.		0.9 (hum-free)
• DC operation	W	4
Rated data of the main contacts		
Load rating with AC		
Utilization category AC-1		
• Rated operational current I_e up to 400 V at 55 °C ¹⁾	A	20 for screw terminals, 16 for flat connectors
• Rated power U_e for AC loads with p.f. = 1, 230/220 V		
- For screw terminals	kW	7.5 (13 at 400 V)
- For flat connectors	kW	6 (10 at 400 V)
• Minimum conductor cross-section for loads with I_e	mm ²	2.5

¹⁾ If the three main conducting paths carry a load of 20 A, the following applies if $I > 10$ A in the fourth conducting path: Permissible ambient temperature 40 °C.

Switching devices – Contactors and contactor assemblies – for switching motors

Power contactors for switching motors



3TG10 power relays/miniature contactors

Type				3TG10
Rated data of the main contacts (continued)				
Load rating with AC				
Utilization category AC-3 and AC-3e				
• Operational current for AC-3/AC-3e at $U_e \leq 400$ V rated value			A	8.4/6.4
• Rated power for slip-ring or squirrel-cage motors for AC-3/AC-3e, at 50 and 60 Hz and at $U_e \leq 400$ V			kW	4/3
Utilization category AC-5a (permissible grid impedance: $\geq 0.5 \Omega$)				
Switching of gas discharge lamps				
per main conducting path at 230 V, 50 Hz				
	Rated power per lamp	Rated operational current per lamp		
• Uncompensated	18 W	0.37 A	Unit(s)	43
	36 W	0.43 A	Unit(s)	37
	58 W	0.67 A	Unit(s)	24
• DUO switching	18 W	2 x 0.11 A	Unit(s)	2 x 81
	36 W	2 x 0.21 A	Unit(s)	2 x 42
	58 W	2 x 0.32 A	Unit(s)	2 x 28
Switching of gas discharge lamps with compensation or ECG				
per main conducting path 230 V, 50 Hz				
Connection	Rated power per lamp	Capacitor capacitance	Rated operational current per lamp	
• Shunt compensation	L18 W	4.5 μ F	0.11 A	Unit(s) 15
	L36 W	4.5 μ F	0.21 A	Unit(s) 15
	L58 W	7 μ F	0.32 A	Unit(s) 10
• With ECG (single lamp)	L18 W	6.8 μ F	0.10 A	Unit(s) 39
	L36 W	6.8 μ F	0.18 A	Unit(s) 39
	L58 W	10 μ F	0.27 A	Unit(s) 26
• With ECG (two lamps)	L18 W	10 μ F	0.18 A	Unit(s) 2 x 26
	L36 W	10 μ F	0.35 A	Unit(s) 2 x 26
	L58 W	22 μ F	0.52 A	Unit(s) 2 x 12
Utilization category AC-5b, switching incandescent lamps				kW 1.6
per main conducting path at 230 V, 50 Hz				
Load rating with DC				
Utilization category DC-1, ($L/R \leq 15$ ms)				
• Rated operational currents I_e				
- 1 conducting path			up to 24 V A	16
			60 V A	6
			110 V A	2
			220 V/240 V A	0.8
- 2 conducting paths in series			up to 24 V A	16
			60 V A	16
			110 V A	6
			220 V/240 V A	1.6
- 3 conducting paths in series			up to 24 V A	18
			60 V A	18
			110 V A	16
			220 V/240 V A	6
Utilization category DC-3 and DC-5				
Shunt-wound and series-wound motors ($L/R \leq 15$ ms)				
• Rated operational currents I_e				
- 1 conducting path			up to 24 V A	10
			60 V A	0.5
			110 V A	0.15
			220 V/240 V A	0
- 2 conducting paths in series			up to 24 V A	16
			60 V A	5
			110 V A	0.35
			220 V/240 V A	0
- 3 conducting paths in series			up to 24 V A	16
			60 V A	16
			110 V A	10
			220 V/240 V A	1.75

Switching devices – Contactors and contactor assemblies – for switching motors

Power contactors for switching motors

3TG10 power relays/miniature contactors

Type	3TG10	
Conductor cross-sections		
<ul style="list-style-type: none"> Terminal screws Finely stranded with end sleeve (DIN 46228 Form A/D/C) Solid Permissible opening tool (screwdriver) 	mm ²	 Screw terminals M3 2 x (0.75 ... 2.5) 2 x (1 ... 2.5), 1 x 4 3.0 mm x 0.5 mm (3RA2908-1A) or Pozidriv 2
<ul style="list-style-type: none"> Finely stranded 6.3 mm plug-in sleeve according to DIN 46245/DIN 46247 - 6.3 ... 1 - 6.3 ... 2.5 	mm ² mm ²	 Flat connectors 0.5 ... 1 1 ... 2.5
Ⓢ and Ⓣ rating (screw terminals)		
Rated insulation voltage	V AC	600
Uninterrupted current Open and enclosed	A	20
Maximum horsepower ratings (from Ⓢ and Ⓣ approved values)		
<ul style="list-style-type: none"> Rated power for three-phase motors at 60 Hz 	at 115 V hp 200 V hp 230 V hp 460 ... 600 V hp	0.5/-- 1/3 1.5/3 0/5

Switching devices – Contactors and contactor assemblies – for switching motors

Power contactors for switching motors

3TG10 power relays/miniature contactors **IE3/IE4 ready** **AC-3e**

Selection and ordering data

AC operation  **or DC operation** 

For screw fixing and snap-on mounting on TH 35 DIN rail

Rated data		Utilization category		Auxiliary contacts		Rated control supply voltage U_s	Article No.	Price per PU	PU (UNIT, SET, M)	PS*	PG
AC-1 at 55 °C	AC-3/AC-3e	Operational current I_e up to 400 V	Power of AC loads at 50 Hz and 400 V	Operational current I_e up to 400 V ¹⁾	Power of AC loads at 50 Hz and 400 V						
A	kW	A	kW	NO	NC	V					

Hum-free · with screw terminals



3TG10...0...

AC operation, 45 ... 450 Hz

Operational current I_e up to 400 V	Power of AC loads at 50 Hz and 400 V	Operational current I_e up to 400 V ¹⁾	Power of AC loads at 50 Hz and 400 V	Auxiliary contacts	Rated control supply voltage U_s	Article No.	Price per PU	PU (UNIT, SET, M)	PS*	PG
20	13	8.4/6.4	4/3	1 --	24 AC 110 AC 230 AC	3TG1010-0AC2 3TG1010-0AG2 3TG1010-0AL2		1	1 unit	41H
				-- 1	24 AC 110 AC 230 AC	3TG1001-0AC2 3TG1001-0AG2 3TG1001-0AL2		1	1 unit	41H

DC operation

Operational current I_e up to 400 V	Power of AC loads at 50 Hz and 400 V	Operational current I_e up to 400 V ¹⁾	Power of AC loads at 50 Hz and 400 V	Auxiliary contacts	Rated control supply voltage U_s	Article No.	Price per PU	PU (UNIT, SET, M)	PS*	PG
20	13	8.4/6.4	4/3	1 --	24 DC	3TG1010-0BB4		1	1 unit	41H
				-- 1	24 DC	3TG1001-0BB4		1	1 unit	41H

Hum-free · with 6.3 mm x 0.8 mm flat connectors



3TG10...1...

AC operation, 45 ... 450 Hz

Operational current I_e up to 400 V	Power of AC loads at 50 Hz and 400 V	Operational current I_e up to 400 V ¹⁾	Power of AC loads at 50 Hz and 400 V	Auxiliary contacts	Rated control supply voltage U_s	Article No.	Price per PU	PU (UNIT, SET, M)	PS*	PG
16	10	8.4/6.4	4/3	1 --	24 AC 110 AC 230 AC	3TG1010-1AC2 3TG1010-1AG2 3TG1010-1AL2		1	1 unit	41H
				-- 1	24 AC 110 AC 230 AC	3TG1001-1AC2 3TG1001-1AG2 3TG1001-1AL2		1	1 unit	41H

DC operation

Operational current I_e up to 400 V	Power of AC loads at 50 Hz and 400 V	Operational current I_e up to 400 V ¹⁾	Power of AC loads at 50 Hz and 400 V	Auxiliary contacts	Rated control supply voltage U_s	Article No.	Price per PU	PU (UNIT, SET, M)	PS*	PG
16	10	8.4/6.4	4/3	1 --	24 DC	3TG1010-1BB4		1	1 unit	41H
				-- 1	24 DC	3TG1001-1BB4		1	1 unit	41H

¹⁾ The rated operational currents apply to each pole.

Accessories

Version	Max. rated operational currents I_e /AC-1 (at 55 °C) of the contactors	Max. conductor cross-sections	Screw terminals	PU (UNIT, SET, M)	PS*	PG
	A	mm ²	Article No.	Price per PU		

Links for paralleling (insulated star jumpers)¹⁾



3RT1916-4BB31

Version	Max. rated operational currents I_e /AC-1 (at 55 °C) of the contactors	Max. conductor cross-sections	Screw terminals	PU (UNIT, SET, M)	PS*	PG
3-pole						
• Without connecting terminal	16	--	3RT1916-4BA31	1	1 unit	41B
• With connecting terminal	40	25	3RT1916-4BB31	1	1 unit	41B
4-pole						
• With connecting terminal	40	25	3RT1916-4BB41	1	1 unit	41B

¹⁾ The links for paralleling can be reduced by one pole. The rated operational currents apply to each pole.

Switching devices – Contactors and contactor assemblies – for switching motors

Reversing contactor assemblies

SIRIUS 3RA23 reversing contactor assemblies, up to 55 kW

Overview

More information

Homepage, see www.siemens.com/sirius

SiePortal, see www.siemens.com/product?3RA23_3RT1

Conversion tool, see www.siemens.com/conversion-tool

TIA Selection Tool Cloud (TST Cloud), see www.siemens.com/tstcloud/?node=LoadFeeder

Guide of use for contactors in safety applications, see <https://support.industry.siemens.com/cs/ww/en/view/109807687>

The 3RA23 reversing contactor assemblies in sizes S00 to S3 can be ordered as follows:

- Fully wired and tested, with mechanical and electrical interlock, see [page 3/150 onwards](#).
- For all individual parts for customer assembly, see [page 3/71 onwards](#).

The 3RA23 reversing contactor assemblies have screw terminals or spring-loaded terminals (main and control circuits) and are suitable for screw fixing and snap-on mounting on TH 35 DIN rails.

Complete 3RA23 reversing contactor assemblies

The 3RA23 reversing contactor assemblies of sizes S00 to S3 each consist of two contactors with the same power, with one NC contact (S00) or one NO contact and one NC contact (S0 to S3) in the basic unit. The contactors are mechanically and electrically interlocked (NC contact interlock).

3RU2 overload relays (see [page 7/86 onwards](#)) or 3RB3 overload relays (see [pages 7/98, 7/100 and 7/102](#)) for contactor mounting or stand-alone installation, SIMOCODE pro 3UF7 motor management and control devices (see [page 10/12 onwards](#)) or 3RN2 thermistor motor protection relays ([page 10/138 onwards](#)) can be used for motor protection.

3RA23 reversing contactor assemblies with voltage tap-off

The reversing contactor assemblies with voltage tap-off (see [pages 3/150 to 3/153](#)) are required for mounting the function modules for connection to the controller via the IO-Link or AS-Interface communications systems. The 3RA27 function modules must be ordered separately, see [page 3/106](#).



For more information on IO-Link and AS-Interface, see "Industrial communication", [page 2/1 onwards](#).

Switching devices – Contactors and contactor assemblies – for switching motors

Reversing contactor assemblies

SIRIUS 3RA23 reversing contactor assemblies, up to 55 kW

Sizes S00 to S3

Rated data for AC-3/AC-3e at AC 50 Hz 400 V		Size	Type	Contactor (see page 3/47 onwards)	Assembly kit (see page 3/109)	Fully wired and tested reversing contactor assemblies
Rating P kW	Operational current I _e A					
 Screw terminals						
3	7	S00-S00		3RT2015-1...2	3RA2913-2AA1	3RA2315-8XB30-1...
4	9			3RT2016-1...2	3RA2913-2AA1	3RA2316-8XB30-1...
5.5	12			3RT2017-1...2	3RA2913-2AA1	3RA2317-8XB30-1...
7.5	16			3RT2018-1...2	3RA2913-2AA1	3RA2318-8XB30-1...
5.5	12	S0-S0		3RT2024-1...0	3RA2923-2AA1	3RA2324-8XB30-1...
7.5	17			3RT2025-1...0	3RA2923-2AA1	3RA2325-8XB30-1...
11	25			3RT2026-1...0	3RA2923-2AA1	3RA2326-8XB30-1...
15	32			3RT2027-1...0	3RA2923-2AA1	3RA2327-8XB30-1...
18.5	38			3RT2028-1...0	3RA2923-2AA1	3RA2328-8XB30-1...
18.5	41	S2-S2		3RT2035-1...0	3RA2933-2AA1	3RA2335-8XB30-1...
22	51			3RT2036-1...0	3RA2933-2AA1	3RA2336-8XB30-1...
30	65			3RT2037-1...0	3RA2933-2AA1	3RA2337-8XB30-1...
37	80			3RT2038-1...0	3RA2933-2AA1	3RA2338-8XB30-1...
37	80	S3-S3		3RT2045-1...0	3RA2943-2AA1	3RA2345-8XB30-1...
45	95			3RT2046-1...0	3RA2943-2AA1	3RA2346-8XB30-1...
55	110			3RT2047-1...0	3RA2943-2AA1	3RA2347-8XB30-1...
 Spring-loaded terminals						
3	7	S00-S00		3RT2015-2...2	3RA2913-2AA2	3RA2315-8XB30-2...
4	9			3RT2016-2...2	3RA2913-2AA2	3RA2316-8XB30-2...
5.5	12			3RT2017-2...2	3RA2913-2AA2	3RA2317-8XB30-2...
7.5	16			3RT2018-2...2	3RA2913-2AA2	3RA2318-8XB30-2...
5.5	12	S0-S0		3RT2024-2...0	3RA2923-2AA2	3RA2324-8XB30-2...
7.5	17			3RT2025-2...0	3RA2923-2AA2	3RA2325-8XB30-2...
11	25			3RT2026-2...0	3RA2923-2AA2	3RA2326-8XB30-2...
15	32			3RT2027-2...0	3RA2923-2AA2	3RA2327-8XB30-2...
18.5	38			3RT2028-2...0	3RA2923-2AA2	3RA2328-8XB30-2...

Article number scheme

Product versions	Article number
SIRIUS reversing contactor assembly	3RA23 <input type="checkbox"/> <input type="checkbox"/> - <input type="checkbox"/> <input type="checkbox"/> <input type="checkbox"/> <input type="checkbox"/> - <input type="checkbox"/> <input type="checkbox"/> <input type="checkbox"/> <input type="checkbox"/>
Size of the contactor	e.g. 4 = S3 <input type="checkbox"/>
Rating dependent on size	e.g. 5 = 37 kW for size S3 <input type="checkbox"/>
Type of overload relay	e.g. 8X = Without <input type="checkbox"/> <input type="checkbox"/>
Assembly	e.g. E = Communication-capable installation <input type="checkbox"/>
Interlock	e.g. 3 = Mechanical and electrical <input type="checkbox"/>
Free auxiliary switches	e.g. 0 = S3: 2 NO total <input type="checkbox"/>
Type of electrical connection	e.g. 1 = Screw terminals (main and auxiliary circuits) <input type="checkbox"/>
Operating range/solenoid coil circuit	e.g. A = AC standard/without coil circuit <input type="checkbox"/>
Rated control supply voltage	e.g. L2 = 230 V AC, 50/60 Hz <input type="checkbox"/> <input type="checkbox"/>
Example	3RA23 4 5 - 8 X E 3 0 - 1 A L 2

Note:

The article number scheme shows an overview of product versions for better understanding of the logic behind the article numbers.

For your orders, please use the article numbers quoted in the selection and ordering data.

Switching devices – Contactors and contactor assemblies – for switching motors

Reversing contactor assemblies

SIRIUS 3RA23 reversing contactor assemblies, up to 55 kW

Fully wired and tested reversing contactor assemblies · Size S00-S00 · Up to 7.5 kW

The figure shows the version with screw terminals

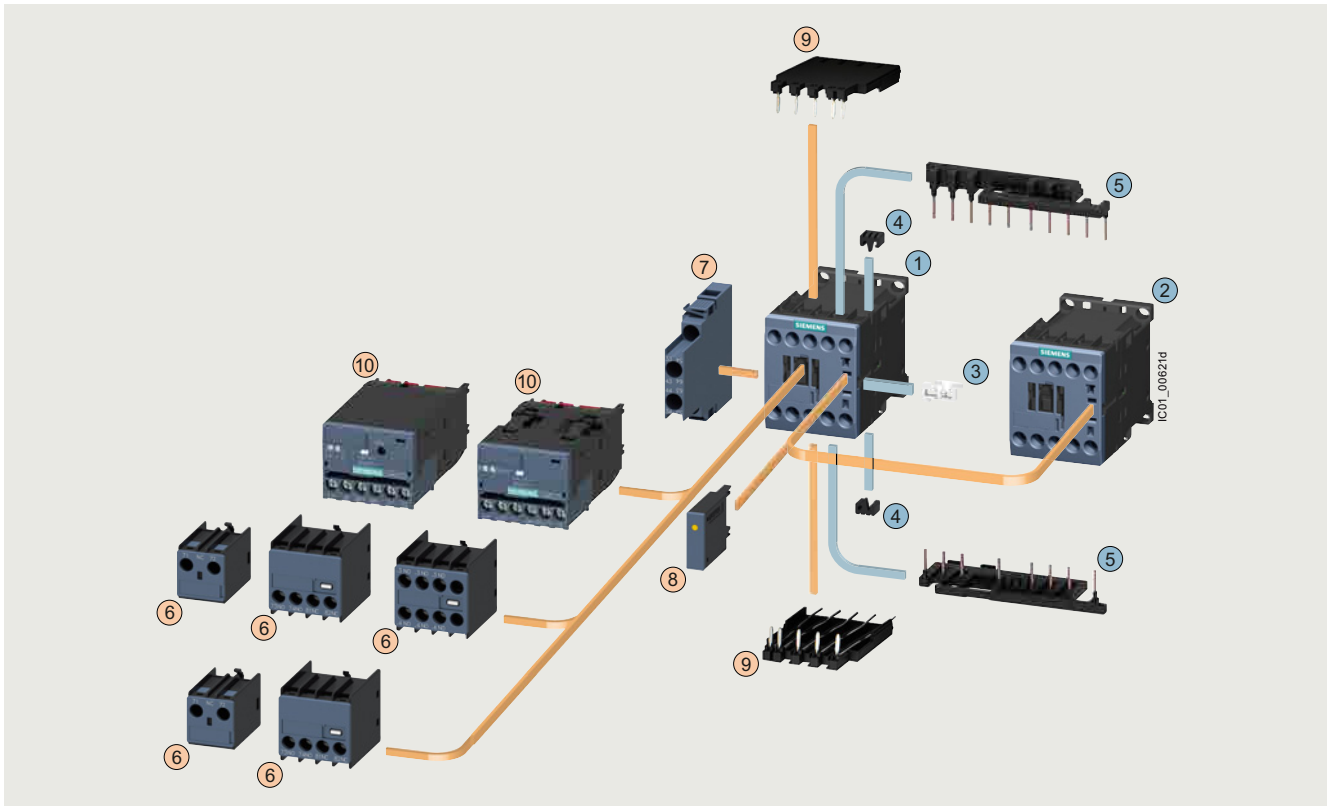

Mountable accessories (optional)

To be ordered separately	Type	Page
⑥ Auxiliary switch, front ¹⁾	3RH2911	3/91 ... 3/93, 3/97
⑦ Auxiliary switch, lateral	3RH2911	3/95, 3/99
⑧ Surge suppressor	3RT2916	3/102, 3/103
⑨ Solder pin adapter	3RT1916-4KA1	3/117
⑩ Function module for connection to the control system	3RA271.-1BA00	3/106

Complete reversing contactor assembly

Individual parts	Type		Page
	Q11	Q12	
① ② Contactors, 3 kW	3RT2015	3RT2015	3/47, 3/54, 3/55
① ② Contactors, 4 kW	3RT2016	3RT2016	3/47, 3/54, 3/55
① ② Contactors, 5.5 kW	3RT2017	3RT2017	3/47, 3/54, 3/55
① ② Contactors, 7.5 kW	3RT2018	3RT2018	3/47, 3/54, 3/55
③ ... ⑤ Assembly kit comprising:	3RA2913-2AA1		3/109
	③ Mechanical interlock ²⁾		
	④ Two connecting clips for two contactors ²⁾		
	⑤ Wiring modules on the top and bottom for connecting the main current paths, electrical interlock included ³⁾ , interruptible (NC contact interlock)		

¹⁾ Auxiliary switch according to EN 50005 must be used.

²⁾ The parts ③ and ④ can only be ordered together as 3RA2912-2H mechanical connectors.

³⁾ 3RT201. contactors with one NC contact in the basic unit are required for the electrical interlock. An additional NO contact is required for momentary-contact operation.

For complete reversing contactor assemblies, see page 3/150.

Switching devices – Contactors and contactor assemblies – for switching motors

Reversing contactor assemblies

SIRIUS 3RA23 reversing contactor assemblies, up to 55 kW

Fully wired and tested reversing contactor assemblies · Size S0-S0 · Up to 18.5 kW

The figure shows the version with screw terminals

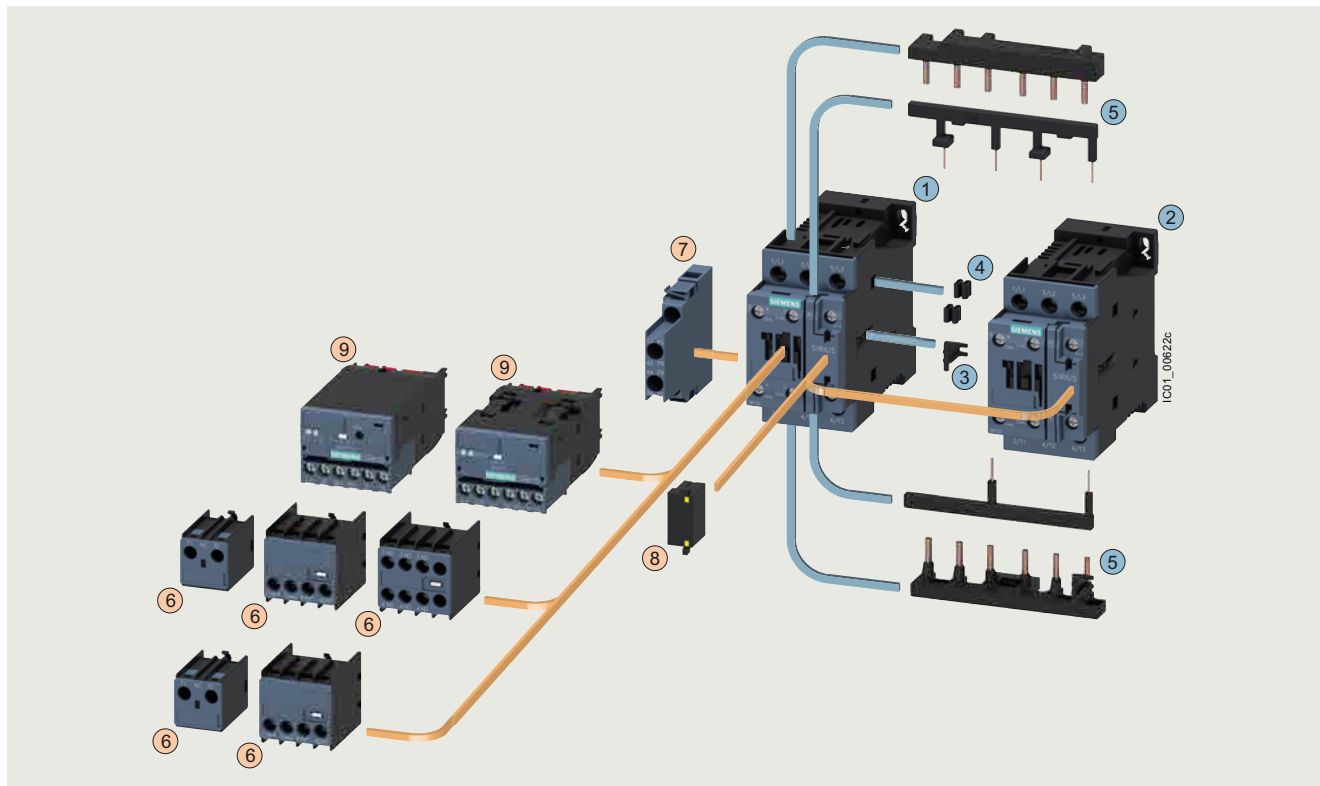

Mountable accessories (optional)

To be ordered separately	Type	Page
⑥ Auxiliary switch, front	3RH2911	3/91 ... 3/93, 3/97
⑦ Auxiliary switch, lateral	3RH2921	3/95, 3/99
⑧ Surge suppressor	3RT2926	3/102, 3/103
⑨ Function module for connection to the control system	3RA271.-1BA00	3/106

Complete reversing contactor assembly

Individual parts	Type		Page
	Q11	Q12	
① ② Contactors, 5.5 kW	3RT2024	3RT2024	3/49, 3/58, 3/59
① ② Contactors, 7.5 kW	3RT2025	3RT2025	3/49, 3/58, 3/59
① ② Contactors, 11 kW	3RT2026	3RT2026	3/49, 3/58, 3/59
① ② Contactors, 15 kW	3RT2027	3RT2027	3/49, 3/58, 3/59
① ② Contactors, 18.5 kW	3RT2028	3RT2028	3/49, 3/58, 3/59
③ ... ⑤ Assembly kit comprising:	3RA2923-2AA1		3/109
	③ Mechanical interlock ¹⁾		
	④ Two connecting clips for two contactors ¹⁾		
	⑤ Wiring modules on the top and bottom for connecting the main current paths, electrical interlock included (NC contact interlock)		

¹⁾ The parts ③ and ④ can only be ordered together as 3RA2922-2H mechanical connectors.

For complete reversing contactor assemblies, see page 3/151.

Switching devices – Contactors and contactor assemblies – for switching motors

Reversing contactor assemblies

SIRIUS 3RA23 reversing contactor assemblies, up to 55 kW

Fully wired and tested reversing contactor assemblies · Size S2-S2 · Up to 37 kW

The figure shows the version with screw terminals

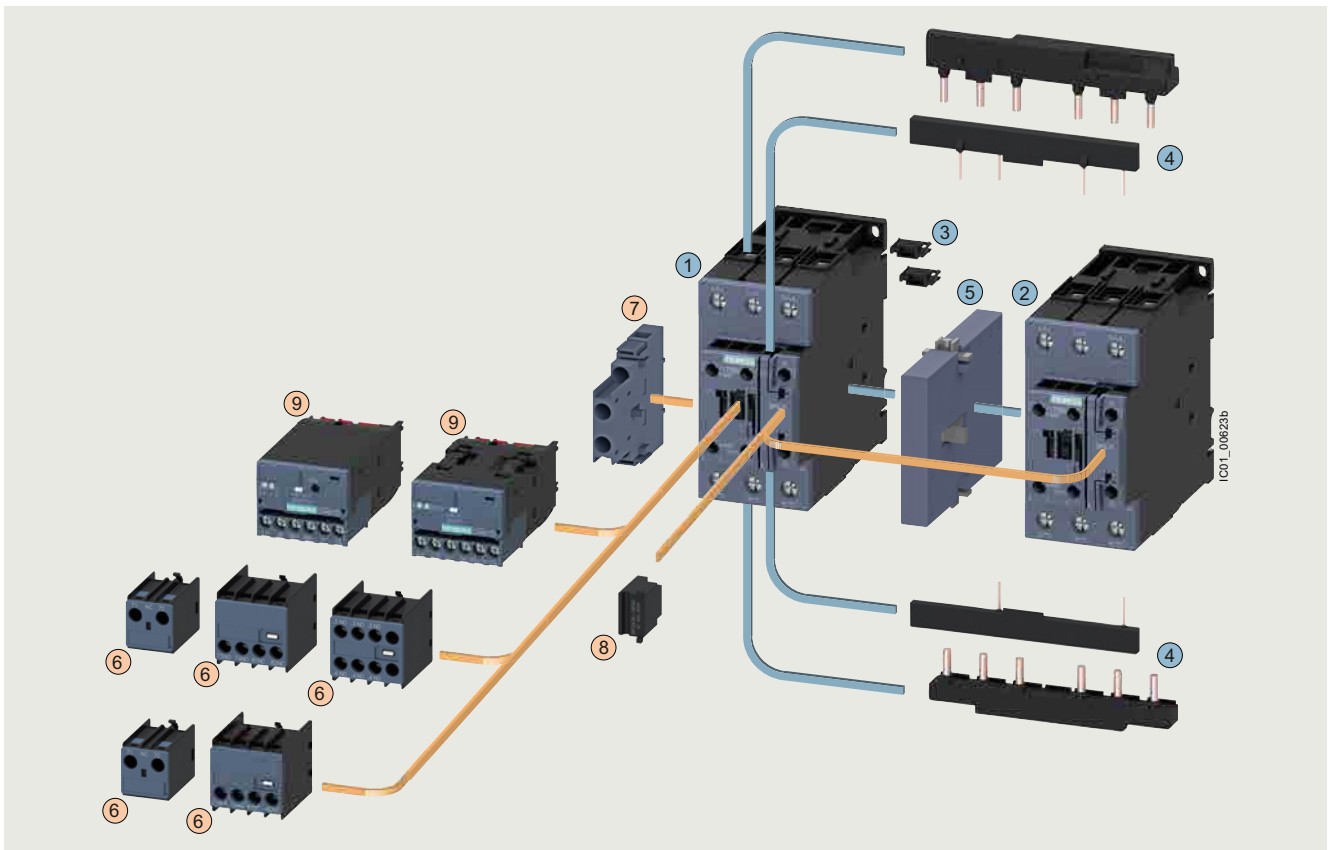

Mountable accessories (optional)

To be ordered separately	Type	Page
⑥ Auxiliary switch, front	3RH2911	3/91 ... 3/93, 3/97
⑦ Auxiliary switch, lateral	3RH2921	3/95, 3/99
⑧ Surge suppressors	3RT2936	3/102, 3/103
⑨ Function module for connection to the control system	3RA271.-1BA00	3/106

Complete reversing contactor assembly

Individual parts	Type		Page
	Q11	Q12	
① ② Contactors, 18.5 kW	3RT2035	3RT2035	3/53, 3/63
① ② Contactors, 22 kW	3RT2036	3RT2036	3/53, 3/63
① ② Contactors, 30 kW	3RT2037	3RT2037	3/53, 3/63
① ② Contactors, 37 kW	3RT2038	3RT2038	3/53, 3/63
③ ④ Assembly kit comprising:	3RA2933-2AA1		3/109
③	Two connectors for two contactors		
④	Wiring modules on the top and bottom for connecting the main and auxiliary circuits, electrical interlock included (NC contact interlock)		
⑤	Mechanical interlock	3RA2934-2B	3/114

For complete reversing contactor assemblies, see page 3/152.

Switching devices – Contactors and contactor assemblies – for switching motors

Reversing contactor assemblies

SIRIUS 3RA23 reversing contactor assemblies, up to 55 kW

Fully wired and tested reversing contactor assemblies · Size S3-S3 · Up to 55 kW

The figure shows the version with screw terminals

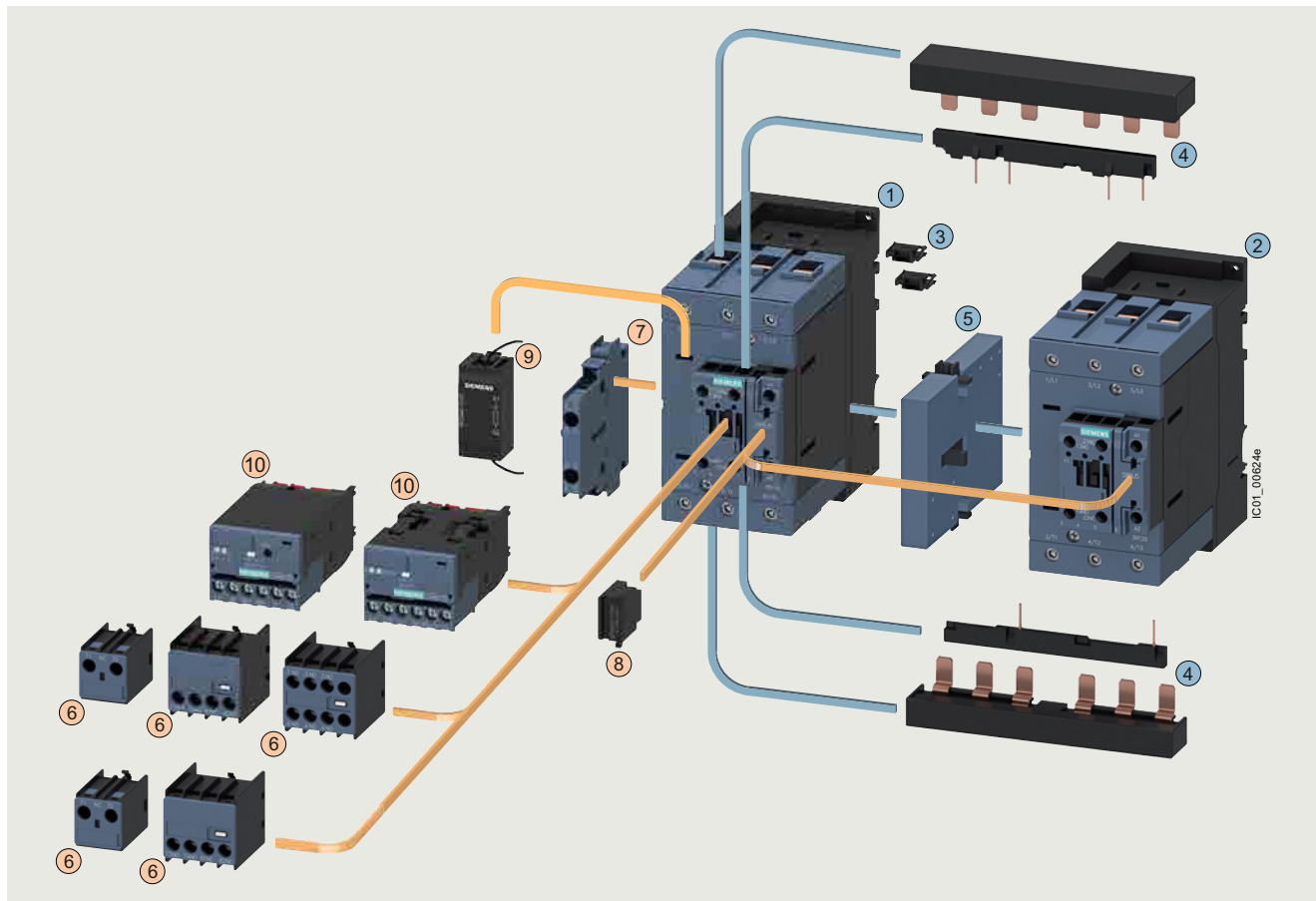

Mountable accessories (optional)

To be ordered separately	Type	Page
⑥ Auxiliary switch, front	3RH2911	3/91 ... 3/93, 3/97
⑦ Auxiliary switch, lateral	3RH2921	3/95, 3/99
⑧ Surge suppressor (varistor, diode assembly)	3RT2936	3/102, 3/103
⑨ Surge suppressor (RC element)	3RT2946	3/102
⑩ Function module for connection to the control system (the associated module connectors 3RA2711-0EE17 must be ordered separately, see page 3/107)	3RA2711-1BA00	3/106

Complete reversing contactor assembly

Individual parts	Type		Page
	Q11	Q12	
①② Contactors, 37 kW	3RT2045	3RT2045	3/53, 3/64
①② Contactors, 45 kW	3RT2046	3RT2046	3/53, 3/64
①② Contactors, 55 kW	3RT2047	3RT2047	3/53, 3/64
③④ Assembly kit comprising:	3RA2943-2AA1		3/109
③ Two connectors for two contactors			
④ Wiring modules on the top and bottom for connecting the main and auxiliary circuits, electrical interlock included (NC contact interlock)			
⑤ Mechanical interlock	3RA2934-2B		3/114

For complete reversing contactor assemblies, see page 3/153.

Switching devices – Contactors and contactor assemblies – for switching motors

Reversing contactor assemblies

SIRIUS 3RA23 reversing contactor assemblies, up to 55 kW

Benefits

Using wiring kits for reversing contactor assemblies has the following advantages:

- Notable reduction of wiring in the control circuit
- Integrated mechanical interlock for sizes S00 to S3
- Prevention of wiring errors in the main circuit

Connecting combs for screw terminals also result in:

- Prevention of wiring errors in the control circuit
- Reduction of testing costs
- Ready-jumpered actuation of the auxiliary switches and the frame (A2)
- Integrated electrical interlocking

Accessories

Selecting the auxiliary switches

The following points should be noted:

Size S00

- For maintained-contact operation:
Use contactors with an NC contact in the basic unit for the electrical interlock.
- For momentary-contact operation:
Use contactors with an NC contact in the basic unit for the electrical interlock; in addition, an auxiliary switch with at least one NO contact for self-locking is required per contactor.

Sizes S0 to S3

- For maintained-contact operation:
The contactors have two integrated auxiliary contacts (1 NO contact + 1 NC contact); the NC contact can be used for electrical interlocking.
- For momentary-contact operation:
Electrical interlock as for maintained-contact operation; the NO contact in the basic unit can be used for the self-locking.

Surge suppression

Sizes S00 to S3

All reversing contactor assemblies can be fitted with RC elements or varistors for damping switching overvoltages in the coil.

As with the individual contactors, the surge suppressors can either be plugged onto the top of the contactors (S00) or be plugged into the front of the contactors (S0 to S3).

Technical specifications

More information

Technical specifications, see <https://support.industry.siemens.com/cs/ww/en/ps/16146/td>
FAQs, see <https://support.industry.siemens.com/cs/ww/en/ps/16146/faq>

System Manual for modular system, see <https://support.industry.siemens.com/cs/ww/en/view/60311318>
Equipment Manual, see <https://support.industry.siemens.com/cs/ww/en/view/60306557>
Application Manual - Switching devices with IE3 and IE4 motors, see <https://support.industry.siemens.com/cs/ww/en/view/94770820>
Guide of use for contactors in safety applications, see <https://support.industry.siemens.com/cs/ww/en/view/109807687>

The technical specifications are the same as for the individual contactors (see page 3/25 onwards).

Switching devices – Contactors and contactor assemblies – for switching motors

Reversing contactor assemblies

SIRIUS 3RA23 reversing contactor assemblies, up to 55 kW **IE3/IE4 ready** **AC-3e**

Selection and ordering data

Fully wired and tested reversing contactor assemblies¹⁾ · Size S00-S00 · Up to 7.5 kW
AC operation  or DC operation 

PU (UNIT, SET, M) = 1
PS* = 1 unit
PG = 41B





3RA231.-8XB30-1A.0



3RA231.-8XE30-1BB4



3RA231.-8XB30-2A.0

Rated data AC-3 and AC-3e					Rated control supply voltage U_s	Screw terminals 		Spring-loaded terminals 				
Operational current I_e up to 400 V	Ratings of three-phase motors at 50 Hz and 60 Hz and			Article No.		Price per PU	Article No.	Price per PU				
	A	230 V	400 V		690 V				kW	kW	kW	V
AC operation, 50/60 Hz												
7	2.2	3	4	24 AC	3RA2315-8XB30-1AB0	3RA2315-8XB30-2AB0	3RA2315-8XB30-2AF0	3RA2315-8XB30-2AP0				
				110 AC	3RA2315-8XB30-1AF0							
				230 AC	3RA2315-8XB30-1AP0							
9	3	4	5.5	24 AC	3RA2316-8XB30-1AB0	3RA2316-8XB30-2AB0	3RA2316-8XB30-2AF0	3RA2316-8XB30-2AP0				
				110 AC	3RA2316-8XB30-1AF0							
				230 AC	3RA2316-8XB30-1AP0							
12	3	5.5	5.5	24 AC	3RA2317-8XB30-1AB0	3RA2317-8XB30-2AB0	3RA2317-8XB30-2AF0	3RA2317-8XB30-2AP0				
				110 AC	3RA2317-8XB30-1AF0							
				230 AC	3RA2317-8XB30-1AP0							
16	4	7.5	7.5	24 AC	3RA2318-8XB30-1AB0	3RA2318-8XB30-2AB0	3RA2318-8XB30-2AF0	3RA2318-8XB30-2AP0				
				110 AC	3RA2318-8XB30-1AF0							
				230 AC	3RA2318-8XB30-1AP0							
DC operation												
7	2.2	3	4	24 DC	3RA2315-8XB30-1BB4	3RA2315-8XB30-2BB4	3RA2315-8XB30-2BB4	3RA2315-8XB30-2BB4				
9	3	4	5.5	24 DC	3RA2316-8XB30-1BB4							
12	3	5.5	5.5	24 DC	3RA2317-8XB30-1BB4							
16	4	7.5	7.5	24 DC	3RA2318-8XB30-1BB4	3RA2318-8XB30-2BB4	3RA2318-8XB30-2BB4	3RA2318-8XB30-2BB4				
With voltage tap-off												
7	2.2	3	4	24 DC	3RA2315-8XE30-1BB4				3RA2315-8XE30-2BB4	3RA2315-8XE30-2BB4	3RA2315-8XE30-2BB4	
9	3	4	5.5	24 DC	3RA2316-8XE30-1BB4							
12	3	5.5	5.5	24 DC	3RA2317-8XE30-1BB4							
16	4	7.5	7.5	24 DC	3RA2318-8XE30-1BB4	3RA2318-8XE30-2BB4	3RA2318-8XE30-2BB4	3RA2318-8XE30-2BB4				

¹⁾ The contactors integrated in the reversing contactor assemblies of size S00 each have one integrated auxiliary contact (1 NC per contactor). The NC contacts are necessary for electrical interlocking of the contactors.
Exception:

If a reversing contactor assembly with voltage tap-off is used together with a function module, electrical interlocking is realised through the function module and the available auxiliary contact (1 NC per contactor) can be used freely.

Representation of the complete reversing contactor assemblies with optionally mountable accessories, see page 3/145.

Switching devices – Contactors and contactor assemblies – for switching motors

Reversing contactor assemblies

AC-3e IE3/IE4 ready SIRIUS 3RA23 reversing contactor assemblies, up to 55 kW

Fully wired and tested reversing contactor assemblies¹⁾ · Size S0-S0 · Up to 18.5 kW
AC operation  **or DC operation** 

 PU (UNIT, SET, M) = 1
 PS* = 1 unit
 PG = 41B



3RA232-8XB30-1A.2

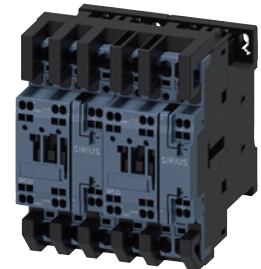

3RA2324-8XE30-1BB4



3RA232-8XB30-2A.2

Rated data AC-3 and AC-3e					Rated control supply voltage U_s	Screw terminals 		Spring-loaded terminals 	
Operational current I_e up to 400 V	Ratings of three-phase motors at 50 Hz and 60 Hz			Article No.		Price per PU	Article No.	Price per PU	
	230 V	400 V	690 V		A				kW
AC operation, 50/60 Hz									
12	3	5.5	7.5	24 AC	3RA2324-8XB30-1AC2	3RA2324-8XB30-2AC2			
				110 AC	3RA2324-8XB30-1AG2	3RA2324-8XB30-2AG2			
				230 AC	3RA2324-8XB30-1AL2	3RA2324-8XB30-2AL2			
17	4	7.5	11	24 AC	3RA2325-8XB30-1AC2	3RA2325-8XB30-2AC2			
				110 AC	3RA2325-8XB30-1AG2	3RA2325-8XB30-2AG2			
				230 AC	3RA2325-8XB30-1AL2	3RA2325-8XB30-2AL2			
25	5.5	11	11	24 AC	3RA2326-8XB30-1AC2	3RA2326-8XB30-2AC2			
				110 AC	3RA2326-8XB30-1AG2	3RA2326-8XB30-2AG2			
				230 AC	3RA2326-8XB30-1AL2	3RA2326-8XB30-2AL2			
32	7.5	15	18.5	24 AC	3RA2327-8XB30-1AC2	3RA2327-8XB30-2AC2			
				110 AC	3RA2327-8XB30-1AG2	3RA2327-8XB30-2AG2			
				230 AC	3RA2327-8XB30-1AL2	3RA2327-8XB30-2AL2			
38	11	18.5	18.5	24 AC	3RA2328-8XB30-1AC2	3RA2328-8XB30-2AC2			
				110 AC	3RA2328-8XB30-1AG2	3RA2328-8XB30-2AG2			
				230 AC	3RA2328-8XB30-1AL2	3RA2328-8XB30-2AL2			
DC operation									
12	3	5.5	7.5	24 DC	3RA2324-8XB30-1BB4	3RA2324-8XB30-2BB4			
17	4	7.5	11	24 DC	3RA2325-8XB30-1BB4	3RA2325-8XB30-2BB4			
25	5.5	11	11	24 DC	3RA2326-8XB30-1BB4	3RA2326-8XB30-2BB4			
32	7.5	15	18.5	24 DC	3RA2327-8XB30-1BB4	3RA2327-8XB30-2BB4			
38	11	18.5	18.5	24 DC	3RA2328-8XB30-1BB4	3RA2328-8XB30-2BB4			
With voltage tap-off									
12	3	5.5	7.5	24 DC	3RA2324-8XE30-1BB4	3RA2324-8XE30-2BB4			
17	4	7.5	11	24 DC	3RA2325-8XE30-1BB4	3RA2325-8XE30-2BB4			
25	5.5	11	11	24 DC	3RA2326-8XE30-1BB4	3RA2326-8XE30-2BB4			
32	7.5	15	18.5	24 DC	3RA2327-8XE30-1BB4	3RA2327-8XE30-2BB4			
38	11	18.5	18.5	24 DC	3RA2328-8XE30-1BB4	3RA2328-8XE30-2BB4			

¹⁾ The contactors integrated in the reversing contactor assemblies of sizes S0 to S3 each have two integrated auxiliary contacts (1 NC and 1 NO per contactor). The NC contacts are necessary for electrical interlocking of the contactors. The NO contacts are unassigned.

Exception:

If a reversing contactor assembly with voltage tap-off is used together with a function module, electrical interlocking is realised through the function module and the available auxiliary contacts (1 NC and 1 NO per contactor) can be used freely.

Representation of the complete reversing contactor assemblies with optionally mountable accessories, [see page 3/146](#).

Switching devices – Contactors and contactor assemblies – for switching motors

Reversing contactor assemblies

SIRIUS 3RA23 reversing contactor assemblies, up to 55 kW **IE3/IE4 ready** **AC-3e**

Fully wired and tested reversing contactor assemblies¹⁾ · Size S2-S2 · Up to 37 kW
AC operation  **or AC/DC operation** 

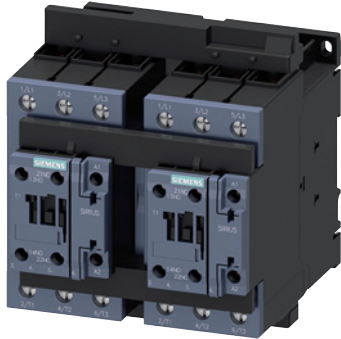

PU (UNIT, SET, M) = 1
 PS* = 1 unit
 PG = 41B



3RA233.-8XB30-1A.2



3RA233.-8XE30-1NB3

Rated data AC-3 and AC-3e					Screw terminals 		Spring-loaded terminals 	
Operational current I_e up to 400 V	Ratings of three-phase motors at 50 Hz and 60 Hz			Rated control supply voltage U_s	Article No.	Price per PU	Article No.	Price per PU
	230 V	400 V	690 V					
A	kW	kW	kW	V				
AC operation, 50/60 Hz								
41	11	18.5	22	110 AC	3RA2335-8XB30-1AG2		--	
				230 AC	3RA2335-8XB30-1AL2		--	
51	15	22	22	110 AC	3RA2336-8XB30-1AG2		--	
				230 AC	3RA2336-8XB30-1AL2		--	
65	18.5	30	37	110 AC	3RA2337-8XB30-1AG2		--	
				230 AC	3RA2337-8XB30-1AL2		--	
80	22	37	45	110 AC	3RA2338-8XB30-1AG2		--	
				230 AC	3RA2338-8XB30-1AL2		--	
AC/DC operation								
With integrated coil circuit (varistor integrated in electronics at the factory)								
41	11	18.5	22	20 ... 33 AC/DC	3RA2335-8XB30-1NB3		--	
51	15	22	22	20 ... 33 AC/DC	3RA2336-8XB30-1NB3		--	
65	18.5	30	37	20 ... 33 AC/DC	3RA2337-8XB30-1NB3		--	
80	22	37	45	20 ... 33 AC/DC	3RA2338-8XB30-1NB3		--	
With voltage tap-off								
41	11	18.5	22	20 ... 33 AC/DC	3RA2335-8XE30-1NB3		--	
51	15	22	22	20 ... 33 AC/DC	3RA2336-8XE30-1NB3		--	
65	18.5	30	37	20 ... 33 AC/DC	3RA2337-8XE30-1NB3		--	
80	22	37	45	20 ... 33 AC/DC	3RA2338-8XE30-1NB3		--	

¹⁾ The contactors integrated in the reversing contactor assemblies of sizes S0 to S3 each have two integrated auxiliary contacts (1 NC and 1 NO per contactor). The NC contacts are necessary for electrical interlocking of the contactors. The NO contacts are unassigned.



Exception:

If a reversing contactor assembly with voltage tap-off is used together with a function module, electrical interlocking is realised through the function module and the available auxiliary contacts (1 NC and 1 NO per contactor) can be used freely.

Representation of the complete reversing contactor assemblies with optionally mountable accessories, see page 3/146.

Switching devices – Contactors and contactor assemblies – for switching motors

Reversing contactor assemblies

AC-3e IE3/IE4 ready SIRIUS 3RA23 reversing contactor assemblies, up to 55 kW
Fully wired and tested reversing contactor assemblies¹⁾ · Size S3-S3 · Up to 55 kW
AC operation  or AC/DC operation 



PU (UNIT, SET, M) = 1
 PS* = 1 unit
 PG = 41B



3RA234.-8XB30-1A.2



3RA234.-8XE30-1NB3

Rated data AC-3 and AC-3e					Rated control supply voltage U_s ²⁾	Screw terminals 		Spring-loaded terminals 	
Operational current I_e up to 400 V	Ratings of three-phase motors at 50 Hz and 60 Hz			Article No.		Price per PU	Article No.	Price per PU	
	A	kW	kW		kW				V
AC operation, 50/60 Hz									
80	22	37	55	110 AC	3RA2345-8XB30-1AG2	--			
				230 AC	3RA2345-8XB30-1AL2	--			
95	22	45	75	110 AC	3RA2346-8XB30-1AG2	--			
				230 AC	3RA2346-8XB30-1AL2	--			
110	30	55	75	110 AC	3RA2347-8XB30-1AG2	--			
				230 AC	3RA2347-8XB30-1AL2	--			
AC/DC operation									
With integrated coil circuit (varistor integrated in electronics at the factory)									
80	22	37	55	20 ... 33 AC/DC	3RA2345-8XB30-1NB3	--			
95	22	45	75	20 ... 33 AC/DC	3RA2346-8XB30-1NB3	--			
110	30	55	75	20 ... 33 AC/DC	3RA2347-8XB30-1NB3	--			
With voltage tap-off²⁾									
80	22	37	55	20 ... 33 AC/DC	3RA2345-8XE30-1NB3	--			
95	22	45	75	20 ... 33 AC/DC	3RA2346-8XE30-1NB3	--			
110	30	55	75	20 ... 33 AC/DC	3RA2347-8XE30-1NB3	--			

¹⁾ The contactors integrated in the reversing contactor assemblies of sizes S0 to S3 each have two integrated auxiliary contacts (1 NC and 1 NO per contactor). The NC contacts are necessary for electrical interlocking of the contactors. The NO contacts are unassigned.

Exception:

If a reversing contactor assembly with voltage tap-off is used together with a function module, electrical interlocking is realised through the function module and the available auxiliary contacts (1 NC and 1 NO per contactor) can be used freely.

²⁾ The associated module connectors 3RA2711-0EE17 for the 3RA271. function modules must be ordered separately, see page 3/107.

Representation of the complete reversing contactor assemblies with optionally mountable accessories, see page 3/148.

Switching devices – Contactors and contactor assemblies – for switching motors

Reversing contactor assemblies

Reversing contactor assemblies consisting of SIRIUS 3RT1 and 3TF6 contactors, up to 335 kW

Overview

The individual parts for the reversing contactor assemblies for customer assembly must be ordered separately.

- 3RT1 contactors (see page 3/66 onwards) and 3RT12 and 3TF6 vacuum contactors (see page 3/131 onwards):

The operating times of the individual contactors are rated in such a way that no overlapping of the contact connection and the arcing time between two contactors can occur on reversing, provided they are interlocked by way of their auxiliary switches (NC contact interlock) and the mechanical interlock.

For assemblies with AC operation and 50/60 Hz, a dead interval of 50 ms must be provided when used with voltages over 500 V; a dead interval of 30 ms is recommended for use with voltages up to and including 400 V. These dead times do not apply to assemblies with DC operation.

The operating times of the individual contactors are not affected by the mechanical interlock.

- Mechanical interlocks
 - 3RT1 contactors: see page 3/114
 - 3TF68 vacuum contactors: locking device for mechanical interlock, see page 3/136.
- Wiring kits consisting of wiring modules on the top and bottom
 - 3RT1 contactors: see page 3/109
 - 3TF68 vacuum contactors: see page 3/136
- Base plates
 - 3RT1 contactors: see page 3/119
 - 3TF68 vacuum contactors: see page 3/136

Additional components

- For momentary-contact operation: auxiliary switch (NO contact) for self-locking
- 3RB2 overload relays (see pages 7/99, 7/101 and 7/103), SIMOCODE pro 3UF7 motor management and control devices (see page 10/12 onwards) or 3RN2 thermistor motor protection relays (see page 10/138 onwards) can be used for overload protection.

More information

Homepage, see www.siemens.com/sirius

SiePortal, see www.siemens.com/product?3RA23_3RT1

Guide of use for contactors in safety applications, see <https://support.industry.siemens.com/cs/ww/en/view/109807687>

Switching devices – Contactors and contactor assemblies – for switching motors

Reversing contactor assemblies

Reversing contactor assemblies consisting of SIRIUS 3RT1 and 3TF6 contactors, up to 335 kW

Reversing contactor assemblies for customer assembly · Size S6-S6 · Up to 90 kW

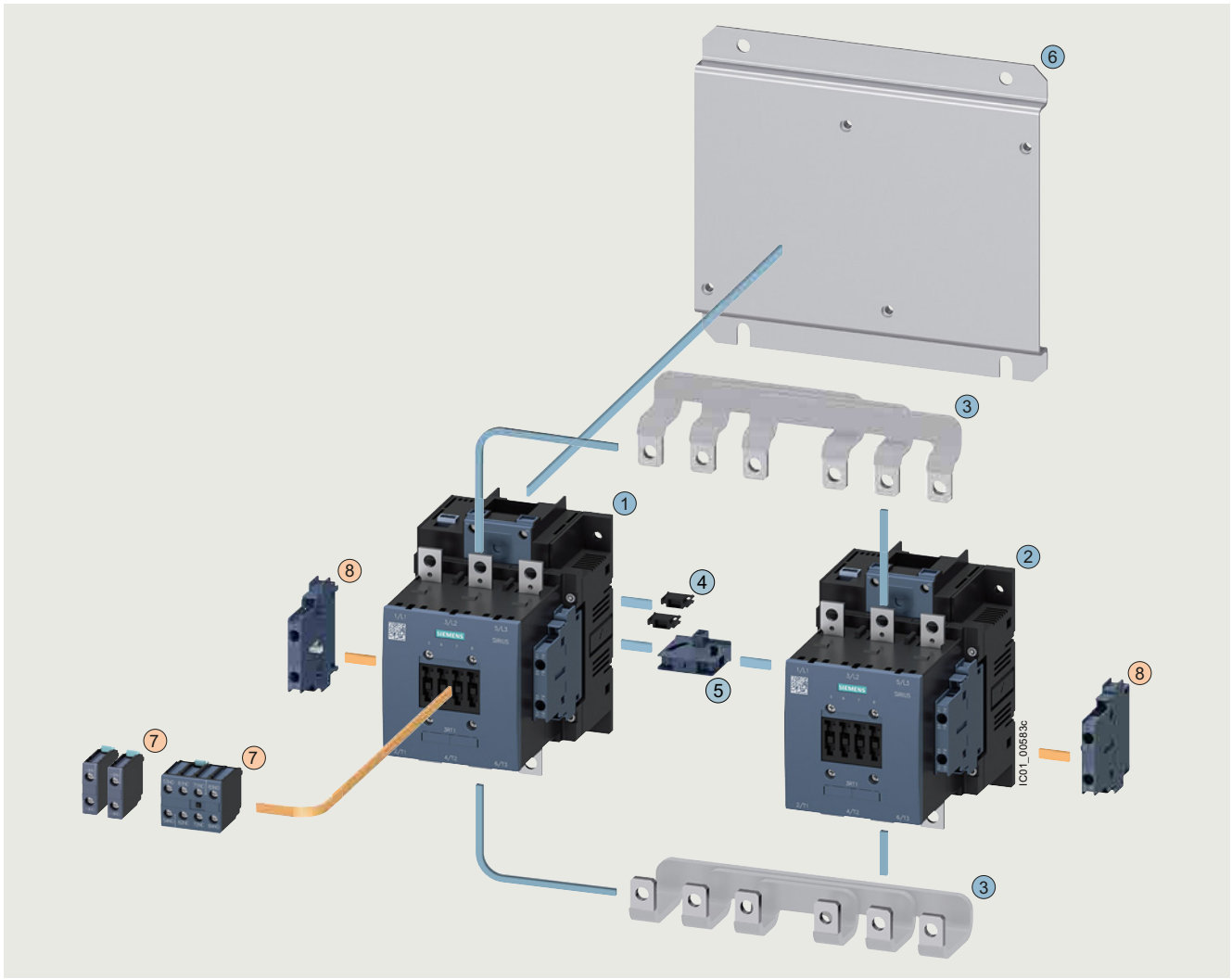

Mountable accessories (optional)

To be ordered separately	Type	Page
⑦ Auxiliary switch, front	3RH1921	3/94
⑧ Auxiliary switch, lateral	3RH1921	3/96

Reversing contactor assembly for customer assembly

Individual parts	Type		Page
	Q11	Q12	
①② Contactors, 55 kW	3RT1054	3RT1054	3/66 ... 3/68
①② Contactors, 75 kW	3RT1055	3RT1055	3/66 ... 3/68
①② Contactors, 90 kW	3RT1056	3RT1056	3/66 ... 3/68
③ Assembly kit consisting of: Wiring modules on the top and bottom for contactors without box terminals for connecting the main and auxiliary circuits, electrical interlock included (NC contact interlock)	3RA1953-2A		3/109
④ Two connectors for two contactors	3RA1932-2D		3/114
⑤ Mechanical interlock	3RA1954-2A		3/114
⑥ Base plate for reversing contactor assemblies	3RA1952-2A		3/119

Switching devices – Contactors and contactor assemblies – for switching motors

Reversing contactor assemblies

Reversing contactor assemblies consisting of SIRIUS 3RT1 and 3TF6 contactors, up to 335 kW

Reversing contactor assemblies for customer assembly · Size S10-S10 · Up to 160 kW

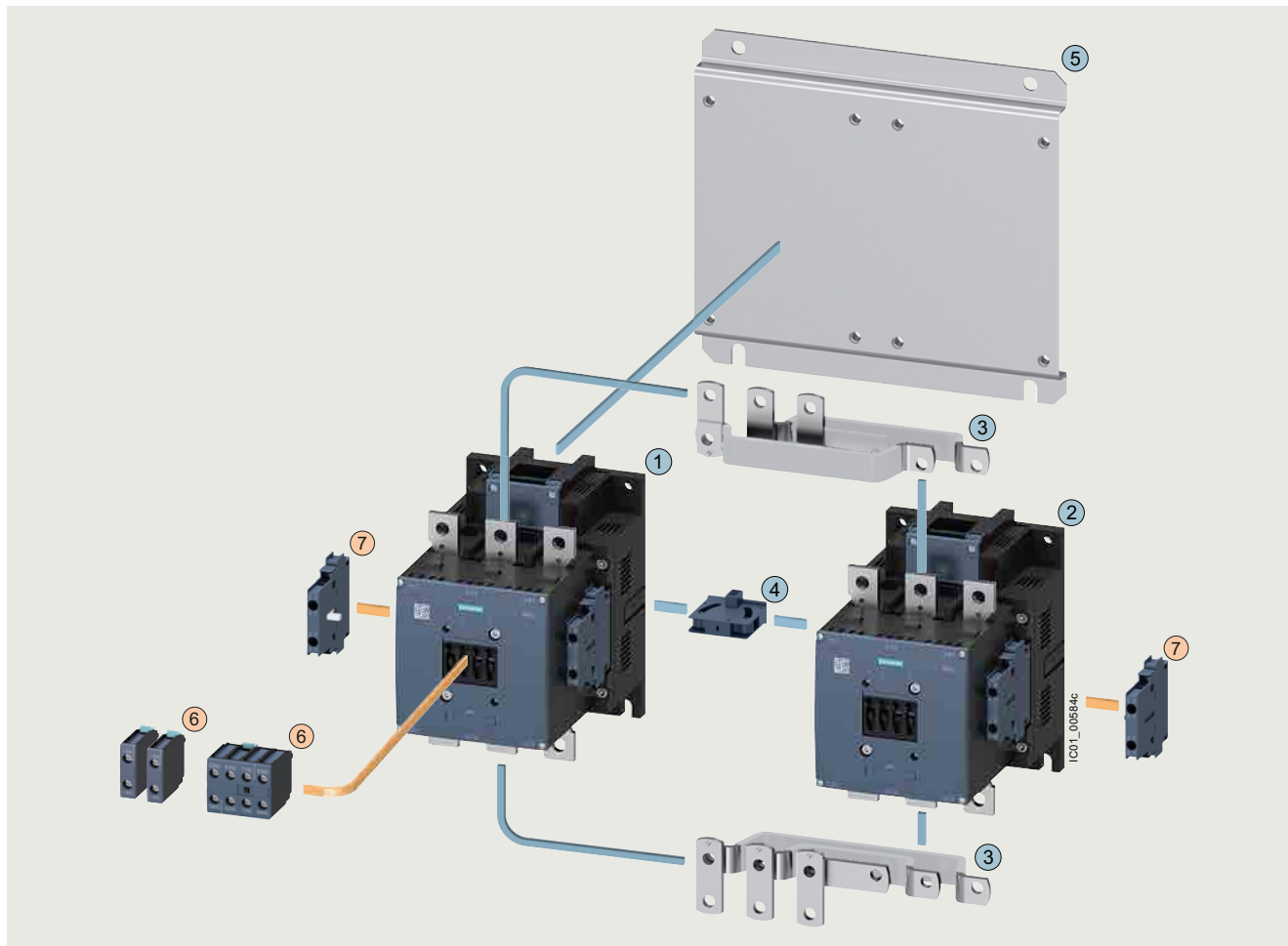

Mountable accessories (optional)

To be ordered separately	Type	Page
⑥ Auxiliary switch, front	3RH1921	3/94
⑦ Auxiliary switch, lateral	3RH1921	3/96

Reversing contactor assembly for customer assembly

Individual parts	Type	Type	Page
	Q11	Q12	
①② Contactors, 110 kW	3RT1.64	3RT1.64	3/66 ... 3/68, 3/131
①② Contactors, 132 kW	3RT1.65	3RT1.65	3/66 ... 3/68, 3/131
①② Contactors, 160 kW	3RT1.66	3RT1.66	3/66 ... 3/68, 3/131
③ Assembly kit consisting of: Wiring modules on the top and bottom for contactors without box terminals for connecting the main and auxiliary circuits, electrical interlock included (NC contact interlock)	3RA1963-2A		3/109
④ Mechanical interlock	3RA1954-2A		3/114
⑤ Base plate for reversing contactor assemblies	3RA1962-2A		3/119

Switching devices – Contactors and contactor assemblies – for switching motors

Reversing contactor assemblies

Reversing contactor assemblies consisting of SIRIUS 3RT1 and 3TF6 contactors, up to 335 kW

Reversing contactor assemblies for customer assembly · Size S12-S12 · Up to 250 kW

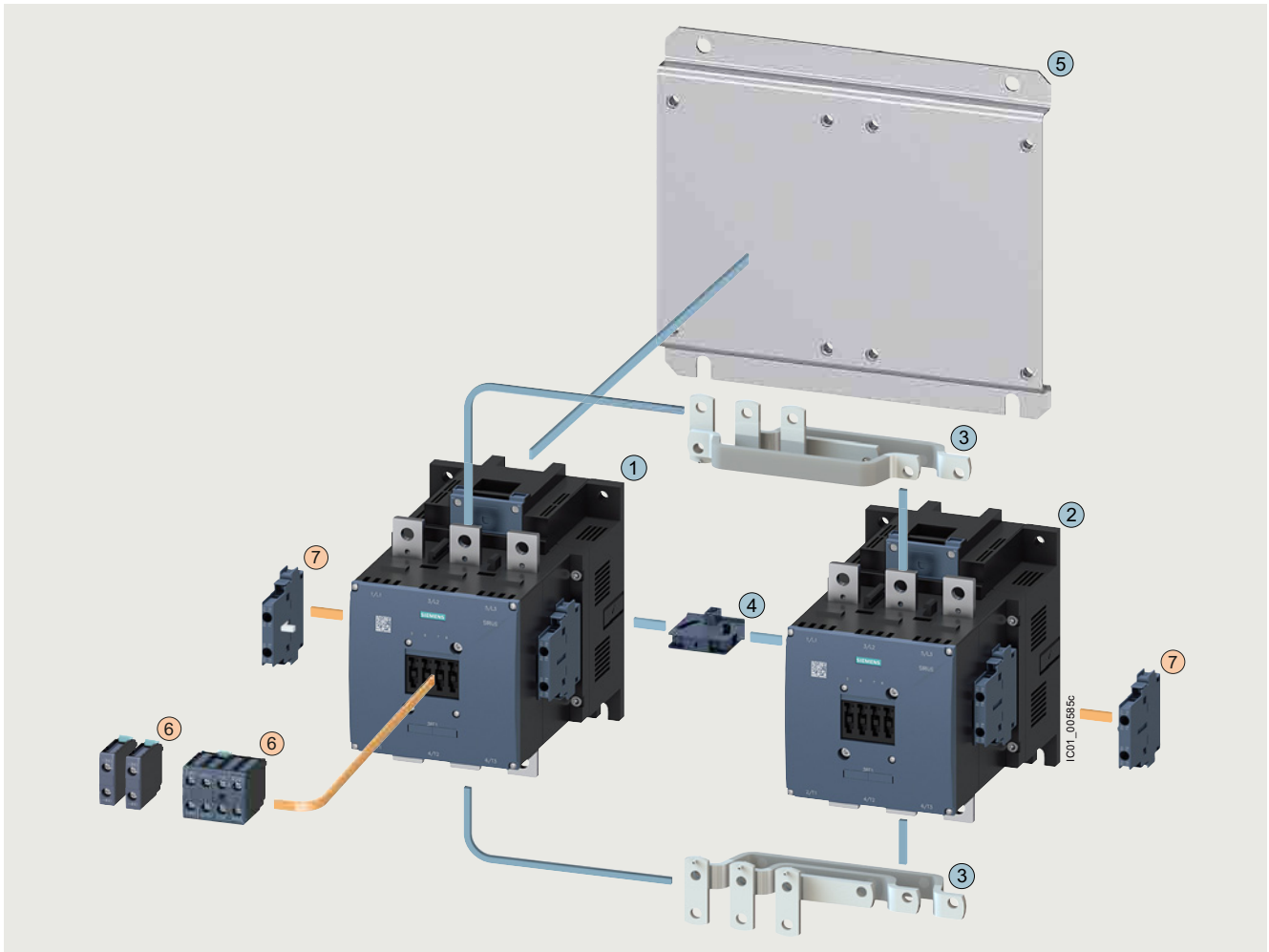

Mountable accessories (optional)

To be ordered separately	Type	Page
⑥ Auxiliary switch, front	3RH1921	3/94
⑦ Auxiliary switch, lateral	3RH1921	3/96

Reversing contactor assembly for customer assembly

Individual parts	Type		Page
	Q11	Q12	
①② Contactors, 200 kW	3RT1.75	3RT1.75	3/66 ... 3/68, 3/131
①② Contactors, 250 kW	3RT1.76	3RT1.76	3/66 ... 3/68, 3/131
③ Assembly kit consisting of: Wiring modules on the top and bottom for contactors without box terminals for connecting the main and auxiliary circuits, electrical interlock included (NC contact interlock)	3RA1973-2A		3/109
④ Mechanical interlock	3RA1954-2A		3/114
⑤ Base plate for reversing contactor assemblies	3RA1972-2A		3/119

Switching devices – Contactors and contactor assemblies – for switching motors

Reversing contactor assemblies

Reversing contactor assemblies consisting of SIRIUS 3RT1 and 3TF6 contactors, up to 335 kW

Reversing contactor assemblies for customer assembly · Size 14-14 · Up to 335 kW

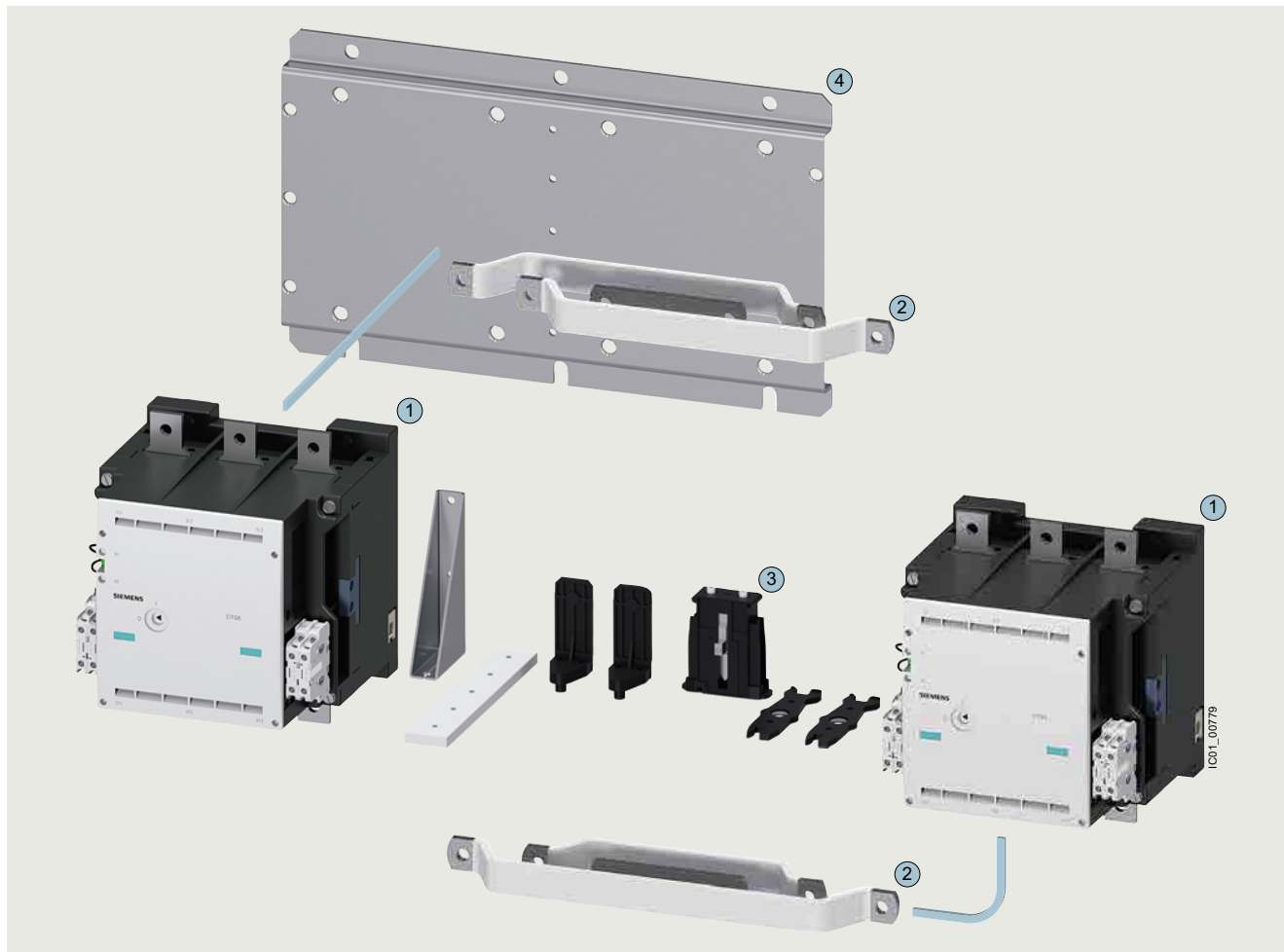

Reversing contactor assembly for customer assembly

Individual parts	Type	Q11	Q12	Page
① Vacuum contactors, 335 kW	3TF68		3TF68	3/132, 3/133
② Assembly kit consisting of: Wiring modules on the top and bottom for connecting the main and auxiliary circuits, electrical interlock included (NC contact interlock)	3TX7680-1A			3/136
③ Locking device for mechanical interlock	3TX7686-1A			3/136
④ Base plate for reversing contactor assemblies	3TX7681-1A			3/136

Switching devices – Contactors and contactor assemblies – for switching motors

Contactor assemblies for star-delta (wye-delta) starting

SIRIUS 3RA24 contactor assemblies for star-delta (wye-delta) starting, up to 90 kW

Overview

More information

Homepage, see www.siemens.com/sirius

SiePortal, see www.siemens.com/product?3RA24_3RT

Conversion tool, see www.siemens.com/conversion-tool

TIA Selection Tool Cloud (TST Cloud), see www.siemens.com/tstcloud/?node=LoadFeeder

Guide of use for contactors in safety applications, see <https://support.industry.siemens.com/cs/ww/en/view/109807687>

The 3RA24 contactor assemblies for star-delta (wye-delta) starting in sizes S00 to S3 can be ordered as follows:

- Fully wired and tested, with electrical and mechanical interlock, see [page 3/168 onwards](#).
- For all individual parts for customer assembly, see [page 3/71 onwards](#).

The 3RA24 contactor assemblies for star-delta (wye-delta) starting have screw terminals or spring-loaded terminals and are suitable for screw fixing and snap-on mounting on TH 35 DIN rails.

A base plate is also available for the size S2 and S3 assemblies.

A dead interval of 50 ms on reversing is already integrated in the 3RA28 function module for star-delta (wye-delta) starting.

With the fully wired and tested 3RA24 contactor assemblies for star-delta (wye-delta) starting, the auxiliary contacts included in the basic units are unassigned.

The 3RA24 contactor assemblies for star-delta (wye-delta) starting are designed for standard applications.

Note:

Contactor assemblies for star-delta (wye-delta) starting in special applications such as very heavy starting¹⁾ or star-delta (wye-delta) starting of special motors must be customized. Help with designing such special applications is available from our Technical Support, www.siemens.com/support-request.

¹⁾ For effective assistance from Technical Support, you must provide the following details:

- Rated motor voltage,
- Rated motor current,
- Service factor, operating values,
- Motor starting current factor,
- Starting time,
- Ambient temperature.

Surge suppression

Surge suppression (varistor) is included in the 3RA28 function modules for star-delta (wye-delta) starting.

Motor protection

3RU2 overload relays (see [page 7/86 onwards](#)) or 3RB3 overload relays (see [pages 7/98, 7/100 and 7/102](#)) for contactor mounting or stand-alone installation, SIMOCODE pro 3UF7 motor management and control devices (see [page 10/12 onwards](#)) or 3RN2 thermistor motor protection relays ([page 10/138 onwards](#)) can be used for motor protection.

The overload relay can either be mounted on the line contactor or fitted separately. It must be set to 0.58 times the rated motor current.

SIRIUS 3RA28 function module for star-delta (wye-delta) starting

The 3RA2816-0EW20 star-delta (wye-delta) function module (see [page 3/105](#)) replaces the complete wiring in the control circuit and can be used in the voltage range from 24 to 240 V AC/DC. It is snapped onto the front of the contactor assembly for star-delta (wye-delta) starting size S00, S0, S2 or S3.

One function module comprises a complete module kit:

- Basic module with integrated control logic and time setting
- Two coupling modules with corresponding connecting cables

The scope of supply thus comprises a complete module kit for one contactor assembly for star-delta (wye-delta) starting in size S00, S0, S2 or S3, regardless of the connection method.

Data of the control circuit:

- Wide voltage range 24 to 240 V AC/DC
- Time range 0.5 to 60 s (3 selectable settings)
- Dead interval of 50 ms, non-adjustable

Switching devices – Contactors and contactor assemblies – for switching motors



Contactors assemblies for star-delta (wye-delta) starting

SIRIUS 3RA24 contactor assemblies for star-delta (wye-delta) starting, up to 90 kW

Complete device combinations

Note:

The selection of contactor types refers to fused designs.

Rated data at 50 Hz 400 V AC			Size	Type		Fully wired and tested contactor assemblies for star-delta (wye-delta) starting
Rating <i>P</i> kW	Operational current <i>I_e</i> A	Motor current A		Line/delta contactor	Star contactor	
 Screw terminals						
5.5	12	9.5 ... 13.8	S00-S00-S00	3RT2015-1...	3RT2015-1...	3RA2415-8XF31-1...
7.5	16	12.1 ... 17		3RT2017-1...	3RT2015-1...	3RA2416-8XF31-1...
11	25	19 ... 25		3RT2018-1...	3RT2016-1...	3RA2417-8XF31-1...
11	25	19 ... 25	S0-S0-S0	3RT2024-1...0	3RT2024-1...0	3RA2423-8XF32-1...
15	32	24.1 ... 34		3RT2026-1...0	3RT2024-1...0	3RA2425-8XF32-1...
18.5	40	34.5 ... 40		3RT2026-1...0	3RT2024-1...0	3RA2425-8XF32-1...
22	50	31 ... 43		3RT2027-1...0	3RT2026-1...0	3RA2426-8XF32-1...
22/30	50	31 ... 43	S2-S2-S0	3RT2035-1...0	3RT2026-1...0	3RA2434-8XF32-1...
37	80	62.1 ... 77.8		3RT2035-1...0	3RT2027-1...0	3RA2435-8XF32-1...
45	86	69 ... 86		3RT2036-1...0	3RT2028-1...0	3RA2436-8XF32-1...
55	115	77.6 ... 108.6	S2-S2-S2	3RT2037-1...0	3RT2035-1...0	3RA2437-8XF32-1...
55	115	77.6 ... 108.6	S3-S3-S2	3RT2045-1...0	3RT2035-1...0	3RA2444-8XF32-1...
75	150	120.7 ... 150		3RT2045-1...0	3RT2036-1...0	3RA2445-8XF32-1...
90	160	86 ... 160		3RT2046-1...0	3RT2037-1...0	3RA2446-8XF32-1...
 Spring-loaded terminals						
5.5	12	9.5 ... 13.8	S00-S00-S00	3RT2015-2...	3RT2015-2...	3RA2415-8XF31-2...
7.5	16	12.1 ... 17		3RT2017-2...	3RT2015-2...	3RA2416-8XF31-2...
11	25	19 ... 25		3RT2018-2...	3RT2016-2...	3RA2417-8XF31-2...
11	25	19 ... 25	S0-S0-S0	3RT2024-2...0	3RT2024-2...0	3RA2423-8XF32-2...
15	32	24.1 ... 34		3RT2026-2...0	3RT2024-2...0	3RA2425-8XF32-2...
18.5	40	34.5 ... 40		3RT2026-2...0	3RT2024-2...0	3RA2425-8XF32-2...
22	50	31 ... 43		3RT2027-2...0	3RT2026-2...0	3RA2426-8XF32-2...

Article number scheme

Product versions	Article number
SIRIUS contactor assembly for star-delta (wye-delta) starting	3RA24 <input type="checkbox"/> <input type="checkbox"/> - <input type="checkbox"/> <input type="checkbox"/> <input type="checkbox"/> <input type="checkbox"/> - <input type="checkbox"/> <input type="checkbox"/> <input type="checkbox"/> <input type="checkbox"/>
Size of the contactor	e.g. 4 = S3 <input type="checkbox"/>
Rating dependent on size	e.g. 5 = 75 kW for size S3 <input type="checkbox"/>
Type of overload relay	e.g. 8X = Without <input type="checkbox"/> <input type="checkbox"/>
Assembly	e.g. F = Ready-assembled with function modules <input type="checkbox"/>
Interlock	e.g. 3 = Mechanical and electrical <input type="checkbox"/>
Free auxiliary switches	e.g. 2 = S3: 3 NO + 3 NC total <input type="checkbox"/>
Type of electrical connection	e.g. 1 = Screw terminals (main and auxiliary circuits) <input type="checkbox"/>
Operating range/solenoid coil circuit	e.g. A = AC standard/without coil circuit <input type="checkbox"/>
Rated control supply voltage	e.g. L2 = 230 V AC, 50/60 Hz <input type="checkbox"/> <input type="checkbox"/>
Example	3RA24 4 5 - 8 X F 3 2 - 1 A L 2

Note:

The article number scheme shows an overview of product versions for better understanding of the logic behind the article numbers.

For your orders, please use the article numbers quoted in the selection and ordering data.

Switching devices – Contactors and contactor assemblies – for switching motors

Contactor assemblies for star-delta (wye-delta) starting

SIRIUS 3RA24 contactor assemblies for star-delta (wye-delta) starting, up to 90 kW

Fully wired and tested contactor assemblies for star-delta (wye-delta) starting · Size S00-S00-S00 · Up to 11 kW

The figure shows the version with screw terminals

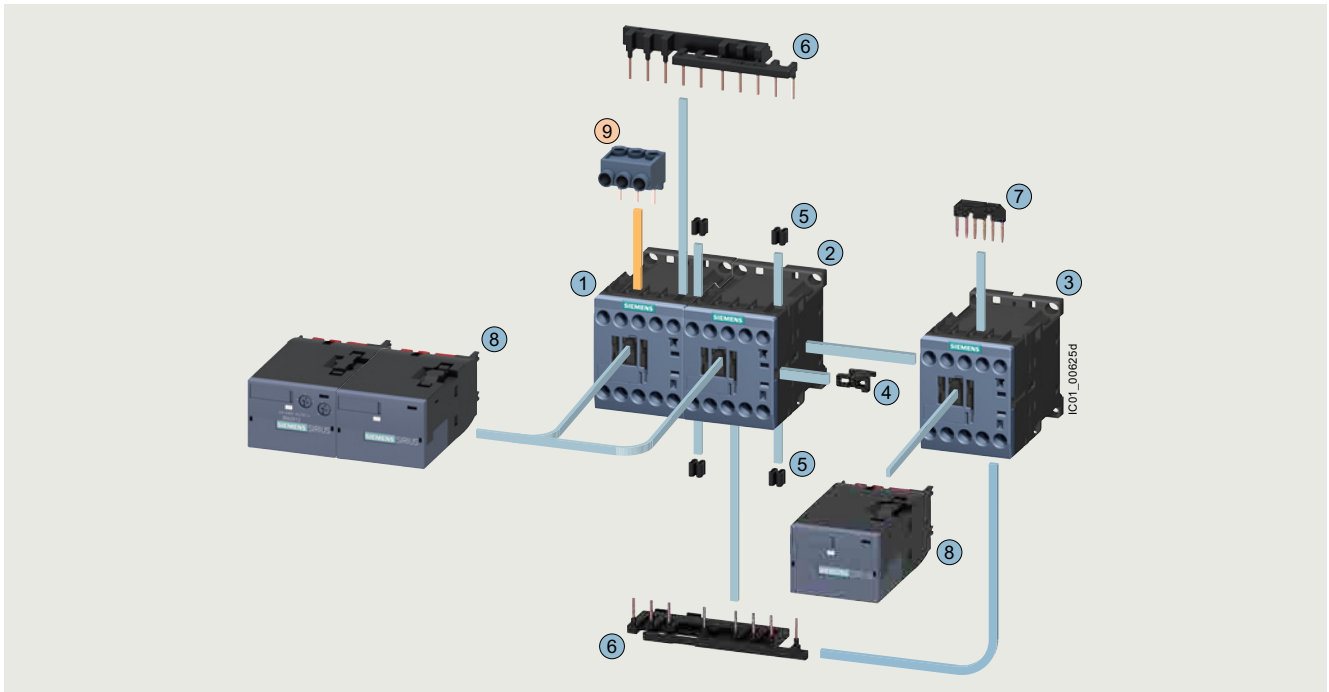

Mountable accessories (optional)

To be ordered separately	Type	Page
⑨ 3-phase infeed terminal ¹⁾	3RA2913-3K	3/116

Complete contactor assembly for star-delta (wye-delta) starting

Individual parts	Type			Page
	Q11 ²⁾	Q13	Q12	
①②③ Contactors, 5.5 kW	3RT2015	3RT2015	3RT2015	3/47, 3/54
①②③ Contactors, 7.5 kW	3RT2017	3RT2017	3RT2015	3/47, 3/54
①②③ Contactors, 11 kW	3RT2018	3RT2018	3RT2016	3/47, 3/54
④ ... ⑦ Assembly kit S00-S00-S00 comprising:	3RA2913-2BB1			3/110
④ Mechanical interlock				
⑤ Four connecting clips for three contactors				
⑥ Wiring modules on top and bottom for connecting the main and auxiliary circuits				
⑦ Star jumper				
⑧ Function modules for star-delta (wye-delta) starting	3RA2816-0EW20			3/105

¹⁾ Part ⑨ can only be mounted for contactors with screw terminals.

²⁾ The version with 1 NO is required for momentary-contact operation.

Complete contactor assemblies for star-delta (wye-delta) starting, see [page 3/168](#).

Switching devices – Contactors and contactor assemblies – for switching motors

Contactor assemblies for star-delta (wye-delta) starting

SIRIUS 3RA24 contactor assemblies for star-delta (wye-delta) starting, up to 90 kW

Fully wired and tested contactor assemblies for star-delta (wye-delta) starting · Size S0-S0-S0 · Up to 22 kW

The figure shows the version with screw terminals

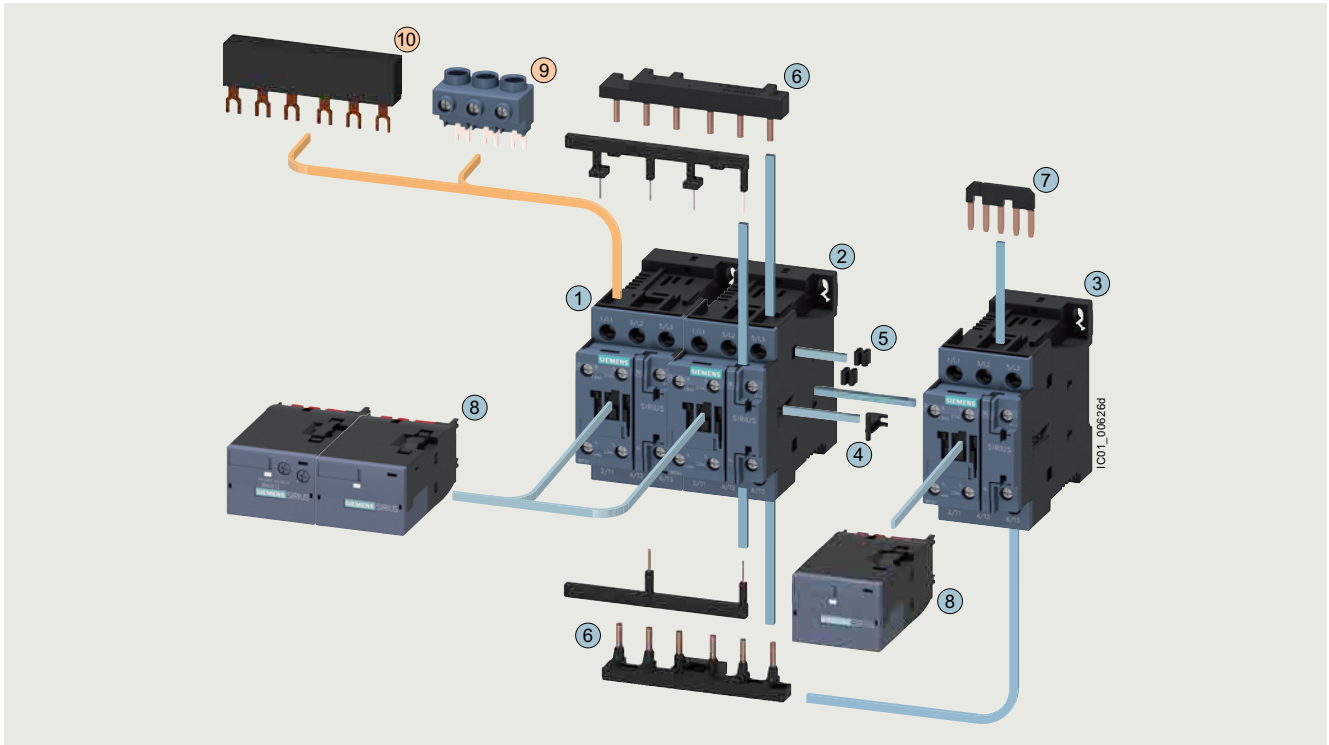

Mountable accessories (optional)

To be ordered separately	Type	Page
⑨ 3-phase infeed terminal ¹⁾	3RV2925-5AB	3/116
⑩ 3-phase busbar ¹⁾	3RV1915-1AB	3/116

Complete contactor assembly for star-delta (wye-delta) starting

Individual parts	Type			Page
	Q11	Q13	Q12	
①②③ Contactors, 11 kW	3RT2024	3RT2024	3RT2024	3/49, 3/58
①②③ Contactors, 15/18.5 kW	3RT2026	3RT2026	3RT2024	3/49, 3/58
①②③ Contactors, 22 kW	3RT2027	3RT2027	3RT2026	3/49, 3/58
④ ... ⑦ Assembly kit S0-S0-S0 comprising:	3RA2923-2BB1			3/110
④ Mechanical interlock				
⑤ Four connecting clips for three contactors				
⑥ Wiring modules on top and bottom for connecting the main and auxiliary circuits				
⑦ Star jumper				
⑧ Function modules for star-delta (wye-delta) starting	3RA2816-0EW20			3/105

¹⁾ The parts ⑨ and ⑩ can only be mounted for contactors with screw terminals, the wiring modules ⑥ must be removed beforehand.

Complete contactor assemblies for star-delta (wye-delta) starting, see page 3/169.

Switching devices – Contactors and contactor assemblies – for switching motors

Contactor assemblies for star-delta (wye-delta) starting

SIRIUS 3RA24 contactor assemblies for star-delta (wye-delta) starting, up to 90 kW

Fully wired and tested contactor assemblies for star-delta (wye-delta) starting · Size S2-S2-S0¹⁾ · Up to 45 kW or S2-S2-S2 · 55 kW

The figure shows the version with screw terminals in S2-S2-S2

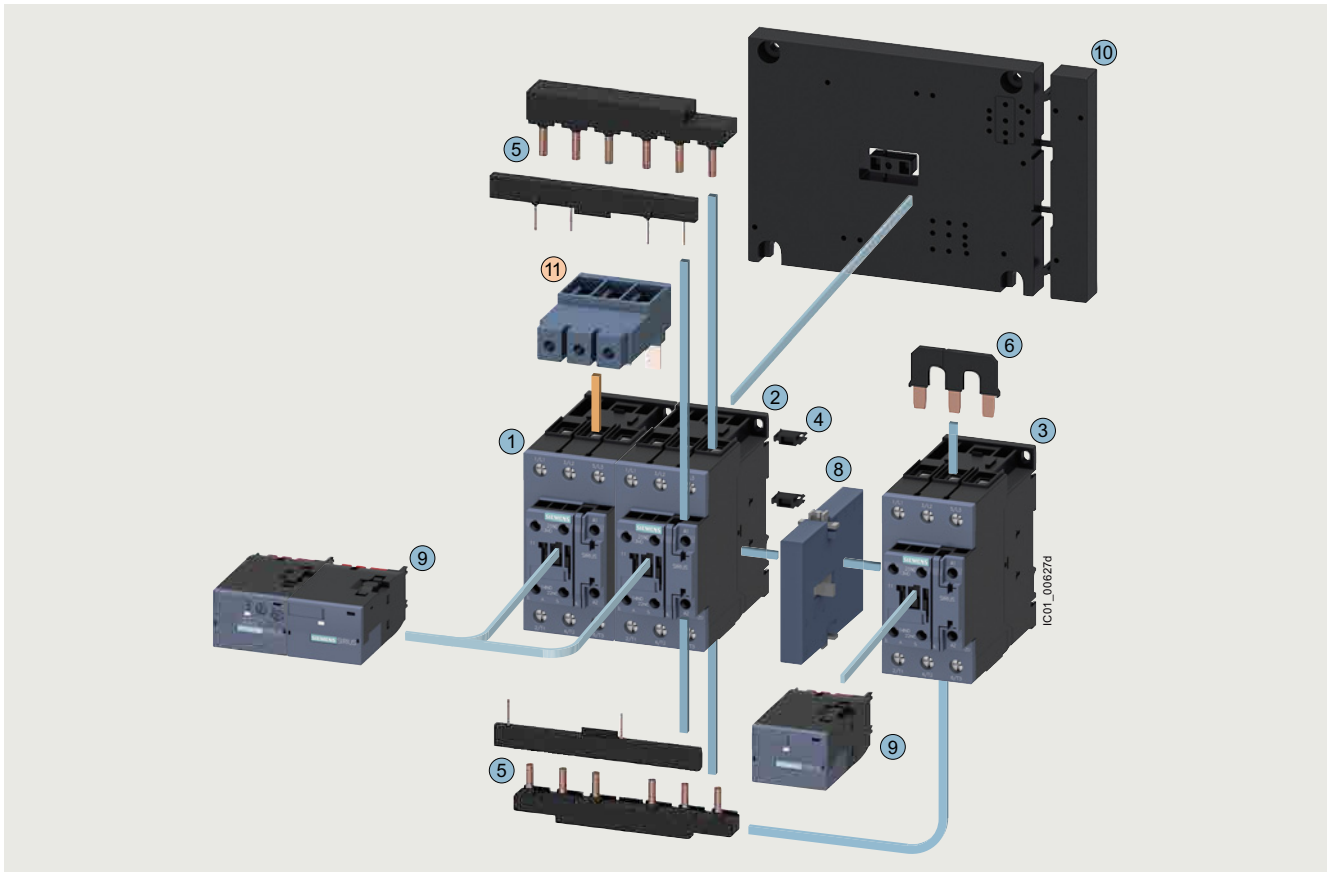

Mountable accessories (optional)

To be ordered separately	Type	Page
⑪ 3-phase infeed terminal	3RV2935-5A	3/116

Complete contactor assembly for star-delta (wye-delta) starting

Individual parts	Type			Page
	Q11	Q13	Q12	
①②③ Contactors, 22/30 kW	3RT2035	3RT2035	3RT2026	3/49, 3/53, 3/62, 3/63
①②③ Contactors, 37 kW	3RT2035	3RT2035	3RT2027	3/49, 3/53, 3/62, 3/63
①②③ Contactors, 45 kW	3RT2036	3RT2036	3RT2028	3/49, 3/53, 3/62, 3/63
①②③ Contactors, 55 kW	3RT2037	3RT2037	3RT2035	3/49, 3/53, 3/63
④ ... ⑦ Assembly kit S2-S2-S2 comprising:	3RA2933-2BB1			3/110
④ Four connectors for three contactors (not required for fully pre-wired contactor assemblies for star-delta (wye-delta) starting)				
⑤ Wiring modules on top and bottom for connecting the main and auxiliary circuits				
⑥ Star jumper S2				
⑦ Cable for connecting the A2 coil contact of the line contactor with the A2 coil contact of the delta contactor (not shown in the drawing)				
⑧ Mechanical interlock	3RA2934-2B			3/114
⑨ Function modules for star-delta (wye-delta) starting	3RA2816-0EW20			3/105
⑩ Base plate star-delta (wye-delta)	3RA2932-2F			3/119

¹⁾ Complete contactor assembly for star-delta (wye-delta) starting in size S2-S2-S0 (not shown): The 3RA2933-2C assembly kit is to be used here, see page 3/110.

Complete contactor assemblies for star-delta (wye-delta) starting, see page 3/170.

Switching devices – Contactors and contactor assemblies – for switching motors

Contactors assemblies for star-delta (wye-delta) starting

SIRIUS 3RA24 contactor assemblies for star-delta (wye-delta) starting, up to 90 kW

Fully wired and tested contactor assemblies for star-delta (wye-delta) starting · Size S3-S3-S2¹⁾ · Up to 90 kW

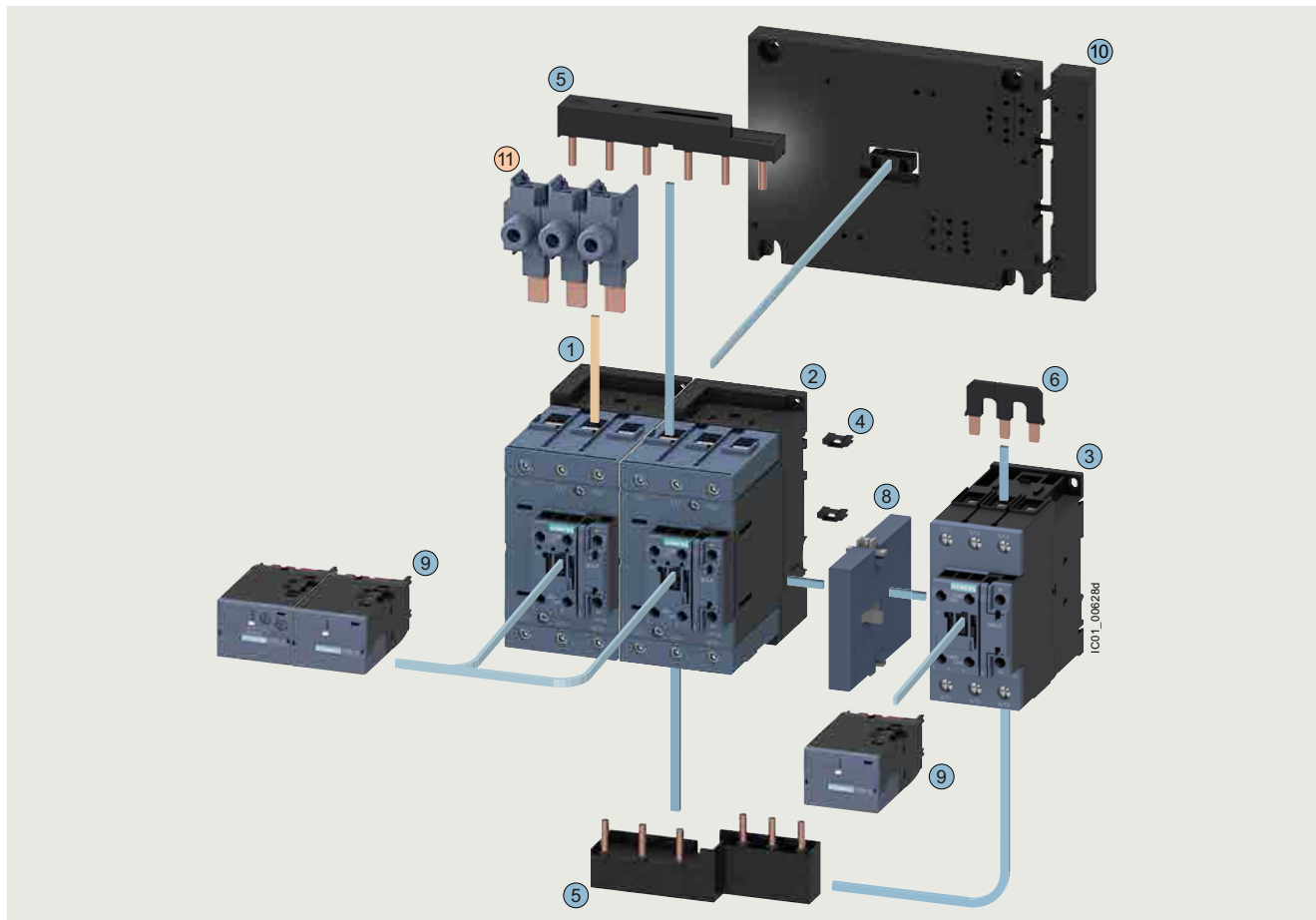

Mountable accessories (optional)

To be ordered separately	Type	Page
⑪ 1-phase infeed terminal (three units are required)	3RA2943-3L	3/116

Complete contactor assembly for star-delta (wye-delta) starting

Individual parts	Type			Page
	Q11	Q13	Q12	
①②③ Contactors, 55 kW	3RT2045	3RT2045	3RT2035	3/53, 3/63, 3/64
①②③ Contactors, 75 kW	3RT2045	3RT2045	3RT2036	3/53, 3/63, 3/64
①②③ Contactors, 90 kW	3RT2046	3RT2046	3RT2037	3/53, 3/63, 3/64
④ ... ⑦ Assembly kit S3-S3-S2 comprising:	3RA2943-2C			3/111
④ Two connectors for three contactors (not required for fully pre-wired contactor assemblies for star-delta (wye-delta) starting)				
⑤ Wiring modules on top and bottom (S3-S2) for connecting the main and auxiliary circuits and a cable set for the auxiliary circuit				
⑥ Star jumper S2				
⑦ Cable for connecting the A2 coil contact of the line contactor with the A2 coil contact of the delta contactor (not shown in the drawing)				
⑧ Mechanical interlock	3RA2934-2B			3/114
⑨ Function modules for star-delta (wye-delta) starting	3RA2816-0EW20			3/105
⑩ Base plate star-delta (wye-delta)	3RA2942-2F			3/119

¹⁾ Contactor assembly for star-delta (wye-delta) starting for customer assembly in size S3-S3-S3 (not shown): The 3RA2943-2BB assembly kit is to be used here, see page 3/111.

Complete contactor assemblies for star-delta (wye-delta) starting, see page 3/171.

Switching devices – Contactors and contactor assemblies – for switching motors

Contactor assemblies for star-delta (wye-delta) starting

SIRIUS 3RA24 contactor assemblies for star-delta (wye-delta) starting, up to 90 kW

Technical specifications

More information

Technical specifications, see <https://support.industry.siemens.com/cs/ww/en/ps/16150/td>
 FAQs, see <https://support.industry.siemens.com/cs/ww/en/ps/16150/faq>
 System Manual for modular system, see <https://support.industry.siemens.com/cs/ww/en/view/60311318>

Equipment Manual, see <https://support.industry.siemens.com/cs/ww/en/view/60306557>
 Application Manual - Switching devices with IE3 and IE4 motors, see <https://support.industry.siemens.com/cs/ww/en/view/94770820>
 Guide of use for contactors in safety applications, see <https://support.industry.siemens.com/cs/ww/en/view/109807687>

Unless otherwise indicated below, the technical specifications correspond to those of the 3RT individual contactors (see page 3/25 onwards) and 3RU2 overload relays (see page 7/82 onwards).

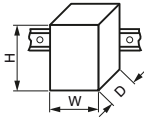
Type		3RA2415	3RA2416	3RA2417	3RA2423	3RA2425	3RA2426
Sizes		S00-S00-S00	S00-S00-S00	S00-S00-S00	S0-S0-S0	S0-S0-S0	S0-S0-S0
General data							
Dimensions (W x H x D) with function module							
• AC operation							
- Screw terminals		mm	135 x 68 x 145		135 x 101 x 171		
- Spring-loaded terminals		mm	135 x 84 x 145		135 x 114 x 171		
• DC operation							
- Screw terminals		mm	135 x 68 x 145		135 x 101 x 181		
- Spring-loaded terminals		mm	135 x 84 x 145		135 x 114 x 181		
Individual contactors							
• Q11 line contactor	Type	3RT2015	3RT2017	3RT2018	3RT2024	3RT2026	3RT2027
• Q13 delta contactor	Type	3RT2015	3RT2017	3RT2018	3RT2024	3RT2026	3RT2027
• Q12 star contactor	Type	3RT2015	3RT2015	3RT2016	3RT2024	3RT2024	3RT2026
Mechanical endurance							
	Operating cycles	3 million					
Unassigned auxiliary contacts of the individual contactors							
For circuit diagrams of the control circuit, see Equipment Manual for contactors/contacter assemblies							
Short-circuit protection							
Main circuit without overload relays							
Fuse links, operational class gG: LV HRC, type 3NA; DIAZED, type 5SB; NEOZED, type 5SE with single or double infeed							
• Highest rated current of the fuse according to IEC 60947-4-1							
- Type of coordination "1"	A	35		63		100	125
- Type of coordination "2"	A	20		25		35	63
Auxiliary circuit							
Short-circuit test							
• With fuse links, operational class gG: DIAZED, type 5SB; NEOZED, type 5SE with short-circuit current $I_k = 1$ kA according to IEC 60947-5-1	A A	10 6	6 (up to $I_k < 0.5$ kA; ≤ 260 V), if the auxiliary contact of the overload relay is connected in the contactor coil circuit				
• With miniature circuit breaker, C characteristic with short-circuit current $I_k = 400$ A	A A	10 6	6 (up to $I_k < 0.5$ kA; ≤ 260 V), if the auxiliary contact of the overload relay is connected in the contactor coil circuit				
Short-circuit protection with overload relay							
see							
<ul style="list-style-type: none"> Digital Configuration Manual for load feeders Configuration Manual for load feeders 							

Switching devices – Contactors and contactor assemblies – for switching motors

Contactor assemblies for star-delta (wye-delta) starting

SIRIUS 3RA24 contactor assemblies for star-delta (wye-delta) starting, up to 90 kW

Type		3RA2415	3RA2416	3RA2417	3RA2423	3RA2425	3RA2426
Sizes		S00-S00-S00	S00-S00-S00	S00-S00-S00	S0-S0-S0	S0-S0-S0	S0-S0-S0
Rated data of the main contacts							
Current-carrying capacity with reversing time up to 10 s							
• Rated operational current I_e	at 400 V	A	12	17	25	40	55
	690 V	A	6.9	9	20.8	22.5	35
• Rated power for three-phase motors at 50 Hz and 60 Hz	at 230 V	kW	3.3	4.7	7.2	12	16.6
	400 V	kW	5.8	8.2	12.5	21	30.1
	690 V	kW	5.8	7.5	18	20.4	33
• Switching frequency with overload relay		1/h	15				
Current-carrying capacity with reversing time up to 15 s							
• Rated operational current I_e	at 400 V	A	12	17	25	31	44
	690 V	A	6.9	9	20.8	22.5	35
• Rated power for three-phase motors at 50 Hz and 60 Hz	at 230 V	kW	3.3	4.7	7.2	9.4	13.8
	400 V	kW	5.8	8.2	12.5	16.3	24
	690 V	kW	5.8	7.5	18	20.4	33
• Switching frequency with overload relay		1/h	15				
Current-carrying capacity with reversing time up to 20 s							
• Rated operational current I_e	at 400 V	A	12	17	25	28	39
	690 V	A	6.9	9	20.8	22.5	35
• Rated power for three-phase motors at 50 Hz and 60 Hz	at 230 V	kW	3.3	4.7	7.2	8.5	12.2
	400 V	kW	5.8	8.2	12.5	14.7	21.3
	690 V	kW	5.8	7.5	18	20.4	33
• Switching frequency with overload relay		1/h	15				

Switching devices – Contactors and contactor assemblies – for switching motors

Contactor assemblies for star-delta (wye-delta) starting

SIRIUS 3RA24 contactor assemblies for star-delta (wye-delta) starting, up to 90 kW

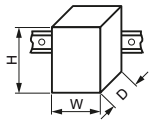
Type		3RA2434	3RA2435	3RA2436	3RA2437	3RA2444	3RA2445	3RA2446
Sizes		S2-S2-S0	S2-S2-S0	S2-S2-S0	S2-S2-S2	S3-S3-S2	S3-S3-S2	S3-S3-S2
General data								
Dimensions (W x H x D) with function module			mm			220 x 180 x 244		
<ul style="list-style-type: none"> AC and DC operation Screw terminals 			177.5 x 142 x 223					
Individual contactors								
• Q11 line contactor	Type	3RT2035	3RT2035	3RT2036	3RT2037	3RT2045	3RT2045	3RT2046
• Q13 delta contactor	Type	3RT2035	3RT2035	3RT2036	3RT2037	3RT2045	3RT2045	3RT2046
• Q12 star contactor	Type	3RT2026	3RT2027	3RT2028	3RT2035	3RT2035	3RT2036	3RT2037
Mechanical endurance		Operating cycles	1 million					
Unassigned auxiliary contacts of the individual contactors		For circuit diagrams of the control circuit, see Equipment Manual .						
Short-circuit protection								
Main circuit without overload relays								
Fuse links, operational class gG: LV HRC, type 3NA; DIAZED, type 5SB; NEOZED, type 5SE with single or double infeed								
<ul style="list-style-type: none"> Highest rated current of the fuse according to IEC 60947-4-1 								
- Type of coordination "1"	A	160			250			
- Type of coordination "2"	A	80			125	160		
Auxiliary circuit								
Short-circuit test								
<ul style="list-style-type: none"> With fuse links, operational class gG: DIAZED, type 5SB; NEOZED, type 5SE with short-circuit current $I_k = 1$ kA according to IEC 60947-5-1 								
	A	10						
	A	6 (up to $I_k < 0.5$ kA; ≤ 260 V), if the auxiliary contact of the overload relay is connected in the contactor coil circuit						
<ul style="list-style-type: none"> With miniature circuit breaker, C characteristic with short-circuit current $I_k = 400$ A 								
	A	10						
	A	6 (up to $I_k < 0.5$ kA; ≤ 260 V), if the auxiliary contact of the overload relay is connected in the contactor coil circuit						
Short-circuit protection with overload relay		see				On request		
		<ul style="list-style-type: none"> Digital Configuration Manual for load feeders Configuration Manual for load feeders 						
Rated data of the main contacts								
Current-carrying capacity with reversing time up to 10 s								
• Rated operational current I_e		at 400 V	A	On request				
		690 V	A	On request				
• Rated power for three-phase motors at 50 Hz and 60 Hz		at 230 V	kW	On request				
		400 V	kW	On request				
		690 V	kW	On request				
• Switching frequency with overload relay		1/h		15				
Current-carrying capacity with reversing time up to 15 s								
• Rated operational current I_e		at 400 V	A	On request				
		690 V	A	On request				
• Rated power for three-phase motors at 50 Hz and 60 Hz		at 230 V	kW	On request				
		400 V	kW	On request				
		690 V	kW	On request				
• Switching frequency with overload relay		1/h		15				
Current-carrying capacity with reversing time up to 20 s								
• Rated operational current I_e		at 400 V	A	On request				
		690 V	A	On request				
• Rated power for three-phase motors at 50 Hz and 60 Hz		at 230 V	kW	On request				
		400 V	kW	On request				
		690 V	kW	On request				
• Switching frequency with overload relay		1/h		15				

Switching devices – Contactors and contactor assemblies – for switching motors

Contactor assemblies for star-delta (wye-delta) starting

SIRIUS 3RA24 contactor assemblies for star-delta (wye-delta) starting, up to 90 kW

IE3/IE4 ready

Selection and ordering data

Fully wired and tested contactor assemblies for star-delta (wye-delta) starting · Size S00-S00-S00 · Up to 11 kW
AC operation  or DC operation 



PU (UNIT, SET, M) = 1
PS* = 1 unit
PG = 41B



3RA241.-8XF31-1A.0

3RA241.-8XF31-2A.0

3RA241.-8XE31-2BB4

Rated data AC-3					Rated control supply voltage U_s	Screw terminals 		Spring-loaded terminals 	
Operational current I_e up to		Ratings of three-phase motors at 50 Hz and 60 Hz at				Article No.	Price per PU	Article No.	Price per PU
400 V	230 V	400 V	690 V	V					
A	kW	kW	kW						
AC operation, 50/60 Hz									
12	3.3	5.5	9.2	24 AC	3RA2415-8XF31-1AB0		3RA2415-8XF31-2AB0		
				110 AC	3RA2415-8XF31-1AF0		3RA2415-8XF31-2AF0		
				230 AC	3RA2415-8XF31-1AP0		3RA2415-8XF31-2AP0		
16	4.7	7.5	9.2	24 AC	3RA2416-8XF31-1AB0		3RA2416-8XF31-2AB0		
				110 AC	3RA2416-8XF31-1AF0		3RA2416-8XF31-2AF0		
				230 AC	3RA2416-8XF31-1AP0		3RA2416-8XF31-2AP0		
25	5.5	11	11	24 AC	3RA2417-8XF31-1AB0		3RA2417-8XF31-2AB0		
				110 AC	3RA2417-8XF31-1AF0		3RA2417-8XF31-2AF0		
				230 AC	3RA2417-8XF31-1AP0		3RA2417-8XF31-2AP0		
DC operation									
12	3.3	5.5	9.2	24 DC	3RA2415-8XF31-1BB4		3RA2415-8XF31-2BB4		
16	4.7	7.5	9.2	24 DC	3RA2416-8XF31-1BB4		3RA2416-8XF31-2BB4		
25	5.5	11	11	24 DC	3RA2417-8XF31-1BB4		3RA2417-8XF31-2BB4		
For IO-Link connection									
12	3.3	5.5	9.2	24 DC	3RA2415-8XE31-1BB4		3RA2415-8XE31-2BB4		
16	4.7	7.5	9.2	24 DC	3RA2416-8XE31-1BB4		3RA2416-8XE31-2BB4		
25	5.5	11	11	24 DC	3RA2417-8XE31-1BB4		3RA2417-8XE31-2BB4		
For AS-Interface connection									
12	3.3	5.5	9.2	24 DC	3RA2415-8XH31-1BB4		3RA2415-8XH31-2BB4		
16	4.7	7.5	9.2	24 DC	3RA2416-8XH31-1BB4		3RA2416-8XH31-2BB4		
25	5.5	11	11	24 DC	3RA2417-8XH31-1BB4		3RA2417-8XH31-2BB4		



Representation of the complete contactor assemblies for star-delta (wye-delta) starting with optionally mountable accessories, see page 3/161.

Switching devices – Contactors and contactor assemblies – for switching motors

Contactor assemblies for star-delta (wye-delta) starting

IE3/IE4 ready SIRIUS 3RA24 contactor assemblies for star-delta (wye-delta) starting, up to 90 kW

Fully wired and tested contactor assemblies for star-delta (wye-delta) starting · Size S0-S0-S0 · Up to 22 kW

AC operation  or DC operation 



PU (UNIT, SET, M) = 1
PS* = 1 unit
PG = 41B



3RA242.-8XF32-1A.2

3RA242.-8XE32-1BB4

3RA242.-8XF32-2A.2

Rated data AC-3				Rated control supply voltage U_s	Screw terminals 		Spring-loaded terminals 		
Operational current I_e up to	Ratings of three-phase motors at 50 Hz and 60 Hz at				Article No.	Price per PU	Article No.	Price per PU	
400 V	230 V	400 V	690 V	V					
A	kW	kW	kW						
AC operation, 50/60 Hz									
25	7.1	11	19	24 AC	3RA2423-8XF32-1AC2		3RA2423-8XF32-2AC2		
				110 AC	3RA2423-8XF32-1AG2		3RA2423-8XF32-2AG2		
				230 AC	3RA2423-8XF32-1AL2		3RA2423-8XF32-2AL2		
32/40	11.4	15/18.5	19	24 AC	3RA2425-8XF32-1AC2		3RA2425-8XF32-2AC2		
				110 AC	3RA2425-8XF32-1AG2		3RA2425-8XF32-2AG2		
				230 AC	3RA2425-8XF32-1AL2		3RA2425-8XF32-2AL2		
50	--	22	19	24 AC	3RA2426-8XF32-1AC2		3RA2426-8XF32-2AC2		
				110 AC	3RA2426-8XF32-1AG2		3RA2426-8XF32-2AG2		
				230 AC	3RA2426-8XF32-1AL2		3RA2426-8XF32-2AL2		
DC operation									
25	7.1	11	19	24 DC	3RA2423-8XF32-1BB4		3RA2423-8XF32-2BB4		
32/40	11.4	15/18.5	19	24 DC	3RA2425-8XF32-1BB4		3RA2425-8XF32-2BB4		
50	--	22	19	24 DC	3RA2426-8XF32-1BB4		3RA2426-8XF32-2BB4		
For IO-Link connection									
25	7.1	11	19	24 DC	3RA2423-8XE32-1BB4		3RA2423-8XE32-2BB4		
32/40	11.4	15/18.5	19	24 DC	3RA2425-8XE32-1BB4		3RA2425-8XE32-2BB4		
50	--	22	19	24 DC	3RA2426-8XE32-1BB4		3RA2426-8XE32-2BB4		
For AS-Interface connection									
25	7.1	11	19	24 DC	3RA2423-8XH32-1BB4		3RA2423-8XH32-2BB4		
32/40	11.4	15/18.5	19	24 DC	3RA2425-8XH32-1BB4		3RA2425-8XH32-2BB4		
50	--	22	19	24 DC	3RA2426-8XH32-1BB4		3RA2426-8XH32-2BB4		

Representation of the complete contactor assemblies for star-delta (wye-delta) starting with optionally mountable accessories, see page 3/162.

Switching devices – Contactors and contactor assemblies – for switching motors

Contactor assemblies for star-delta (wye-delta) starting

SIRIUS 3RA24 contactor assemblies for star-delta (wye-delta) starting, up to 90 kW

IE3/IE4 ready

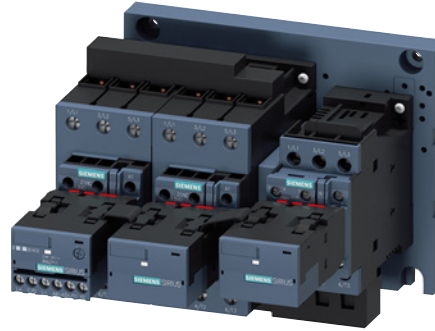
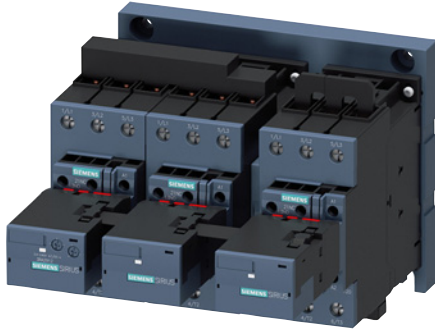

Fully wired and tested contactor assemblies for star-delta (wye-delta) starting · Size S2-S2-S0 · Up to 45 kW or S2-S2-S2 · 55 kW
AC operation  **or AC/DC operation** 

PU (UNIT, SET, M) = 1
 PS* = 1 unit
 PG = 41B



3RA2437-8XF32-1A.2

3RA2434-8XE32-1NB3

Rated data AC-3					Rated control supply voltage U_s	Screw terminals 		Spring-loaded terminals 	
Operational current I_e up to		Ratings of three-phase motors at 50 Hz and 60 Hz at				Article No.	Price per PU	Article No.	Price per PU
400 V	230 V	400 V	690 V						
A	kW	kW	kW	V					
AC operation, 50/60 Hz									
50/65	19.6	22/30	34	24 AC	3RA2434-8XF32-1AC2	--	--	--	--
				110 AC	3RA2434-8XF32-1AG2	--	--	--	--
				230 AC	3RA2434-8XF32-1AL2	--	--	--	--
80	25	37	63	24 AC	3RA2435-8XF32-1AC2	--	--	--	--
				110 AC	3RA2435-8XF32-1AG2	--	--	--	--
				230 AC	3RA2435-8XF32-1AL2	--	--	--	--
86	27	45	63	24 AC	3RA2436-8XF32-1AC2	--	--	--	--
				110 AC	3RA2436-8XF32-1AG2	--	--	--	--
				230 AC	3RA2436-8XF32-1AL2	--	--	--	--
115	37	55	93	24 AC	3RA2437-8XF32-1AC2	--	--	--	--
				110 AC	3RA2437-8XF32-1AG2	--	--	--	--
				230 AC	3RA2437-8XF32-1AL2	--	--	--	--
AC/DC operation, 50/60 Hz AC or DC									
With integrated coil circuit									
(varistor integrated in electronics at the factory)									
50/65	19.6	22/30	34	20 ... 33 AC/DC	3RA2434-8XF32-1NB3	--	--	--	--
80	25	37	63	20 ... 33 AC/DC	3RA2435-8XF32-1NB3	--	--	--	--
86	27	45	63	20 ... 33 AC/DC	3RA2436-8XF32-1NB3	--	--	--	--
115	37	55	93	20 ... 33 AC/DC	3RA2437-8XF32-1NB3	--	--	--	--
For IO-Link connection									
50/65	19.6	22/30	34	20 ... 33 AC/DC	3RA2434-8XE32-1NB3	--	--	--	--
80	25	37	63	20 ... 33 AC/DC	3RA2435-8XE32-1NB3	--	--	--	--
86	27	45	63	20 ... 33 AC/DC	3RA2436-8XE32-1NB3	--	--	--	--
115	37	55	93	20 ... 33 AC/DC	3RA2437-8XE32-1NB3	--	--	--	--
For AS-Interface connection									
50/65	19.6	22/30	34	20 ... 33 AC/DC	3RA2434-8XH32-1NB3	--	--	--	--
80	25	37	63	20 ... 33 AC/DC	3RA2435-8XH32-1NB3	--	--	--	--
86	27	45	63	20 ... 33 AC/DC	3RA2436-8XH32-1NB3	--	--	--	--
115	37	55	93	20 ... 33 AC/DC	3RA2437-8XH32-1NB3	--	--	--	--

Representation of the complete contactor assemblies for star-delta (wye-delta) starting in size S2-S2-S2 with optionally mountable accessories, see page 3/163.

Switching devices – Contactors and contactor assemblies – for switching motors

Contactor assemblies for star-delta (wye-delta) starting

IE3/IE4 ready SIRIUS 3RA24 contactor assemblies for star-delta (wye-delta) starting, up to 90 kW

Fully wired and tested contactor assemblies for star-delta (wye-delta) starting · Size S3-S3-S2 · Up to 90 kW
AC operation  or **AC/DC operation** 

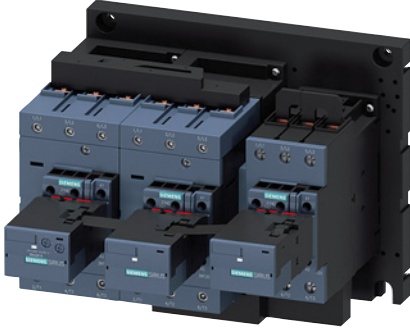

PU (UNIT, SET, M) = 1
 PS* = 1 unit
 PG = 41B



3RA244.-8XF32-1A.2

3RA244.-8XE32-1NB3

3RA244.-8XH32-1NB3

Rated data AC-3					Rated control supply voltage U_s	Screw terminals 		Spring-loaded terminals 	
Operational current I_e up to		Ratings of three-phase motors at 50 Hz and 60 Hz at				Article No.	Price per PU	Article No.	Price per PU
400 V	230 V	400 V	690 V						
A	kW	kW	kW	V					
AC operation, 50/60 Hz									
115	30	55	90	24 AC	3RA2444-8XF32-1AC2	--			
				110 AC	3RA2444-8XF32-1AG2	--			
				230 AC	3RA2444-8XF32-1AL2	--			
150	37	75	110	24 AC	3RA2445-8XF32-1AC2	--			
				110 AC	3RA2445-8XF32-1AG2	--			
				230 AC	3RA2445-8XF32-1AL2	--			
160	45	90	132	24 AC	3RA2446-8XF32-1AC2	--			
				110 AC	3RA2446-8XF32-1AG2	--			
				230 AC	3RA2446-8XF32-1AL2	--			
AC/DC operation, 50/60 Hz AC or DC									
With integrated coil circuit (varistor integrated in electronics at the factory)									
115	30	55	90	20 ... 33 AC/DC	3RA2444-8XF32-1NB3	--			
150	37	75	110	20 ... 33 AC/DC	3RA2445-8XF32-1NB3	--			
160	45	90	132	20 ... 33 AC/DC	3RA2446-8XF32-1NB3	--			
For IO-Link connection									
115	30	55	90	20 ... 33 AC/DC	3RA2444-8XE32-1NB3	--			
150	37	75	110	20 ... 33 AC/DC	3RA2445-8XE32-1NB3	--			
160	45	90	132	20 ... 33 AC/DC	3RA2446-8XE32-1NB3	--			
For AS-Interface connection									
115	30	55	90	20 ... 33 AC/DC	3RA2444-8XH32-1NB3	--			
150	37	75	110	20 ... 33 AC/DC	3RA2445-8XH32-1NB3	--			
160	45	90	132	20 ... 33 AC/DC	3RA2446-8XH32-1NB3	--			

Representation of the complete contactor assemblies for star-delta (wye-delta) starting with optionally mountable accessories, see page 3/164.

Switching devices – Contactors and contactor assemblies – for switching motors

Contactor assemblies for star-delta (wye-delta) starting

Contactor assemblies for star-delta (wye-delta) starting consisting of SIRIUS 3RT and 3TF6 contactors, up to 710 kW

Overview

The individual parts for the contactor assemblies for star-delta (wye-delta) starting for customer assembly must be ordered separately.

- 3RT contactors (see page 3/66 onwards) and 3RT12 and 3TF6 vacuum contactors (see page 3/136 onwards):
The operating times of the individual contactors are rated in such a way that no overlapping of the contact connection and the arcing time between two contactors can occur on reversing, provided they are interlocked by way of their auxiliary switches (NC contact interlock) and the mechanical interlock.
For assemblies with AC operation and 50/60 Hz, a dead interval of 50 ms must be provided when used with voltages over 500 V; a dead interval of 30 ms is recommended for use with voltages up to and including 400 V. These dead times do not apply to assemblies with DC operation.
The operating times of the individual contactors are not affected by the mechanical interlock.
- Mechanical interlocks
 - 3RT contactors and 3RT12 vacuum contactors: Adapter and mechanical interlock to interlock S6 and S3, see page 3/114.
 - 3TF68 vacuum contactors: locking device for mechanical interlock, see page 3/136.
- Wiring kits consisting of wiring modules or link rails and star jumpers
 - 3RT contactors and 3RT12 vacuum contactors: see page 3/112 onwards
 - 3TF68 vacuum contactors: see page 3/136
- Base plates
 - 3RT contactors and 3RT12 vacuum contactors: see page 3/119
 - 3TF68 vacuum contactors: see page 3/136

Additional components

- For momentary-contact operation: auxiliary switch (NO contact) for self-locking
- 3RB2 overload relays (see pages 7/99, 7/101 and 7/103), SIMOCODE pro 3UF7 motor management and control devices (see page 10/12 onwards) or 3RN2 thermistor motor protection relays (see page 10/138 onwards) can be used for overload protection.
The overload relay can either be mounted on the line contactor or separately fitted. It must be set to 0.58 times the rated motor current.
- Optional surge suppression for the S3 contactors; the contactors in sizes S6 to S12 are wired as standard with varistors.

The contactor assemblies for star-delta (wye-delta) starting for customer assembly are designed for standard applications.

Note:

Contactor assemblies for star-delta (wye-delta) starting in special applications such as very heavy starting¹⁾ or star-delta (wye-delta) starting of special motors must be customized. Help with designing such special applications is available from our Technical Support, www.siemens.com/support-request.



Video: SIRIUS contactor assembly for star-delta (wye-delta) starting – configuration example with 75 kW contactors

More information

Homepage, see www.siemens.com/sirius

SiePortal, see www.siemens.com/product?3RA24_3RT

Guide of use for contactors in safety applications, see <https://support.industry.siemens.com/cs/ww/en/view/109807687>

¹⁾ For effective assistance from Technical Support, you must provide the following details:

- Rated motor voltage,
- Rated motor current,
- Service factor, operating values,
- Motor starting current factor,
- Starting time,
- Ambient temperature.

Switching devices – Contactors and contactor assemblies – for switching motors

Contactor assemblies for star-delta (wye-delta) starting

Contactor assemblies for star-delta (wye-delta) starting consisting of SIRIUS 3RT and 3TF6 contactors, up to 710 kW

Contactor assemblies for star-delta (wye-delta) starting for customer assembly · Size S6-S6-S3 · Up to 160 kW

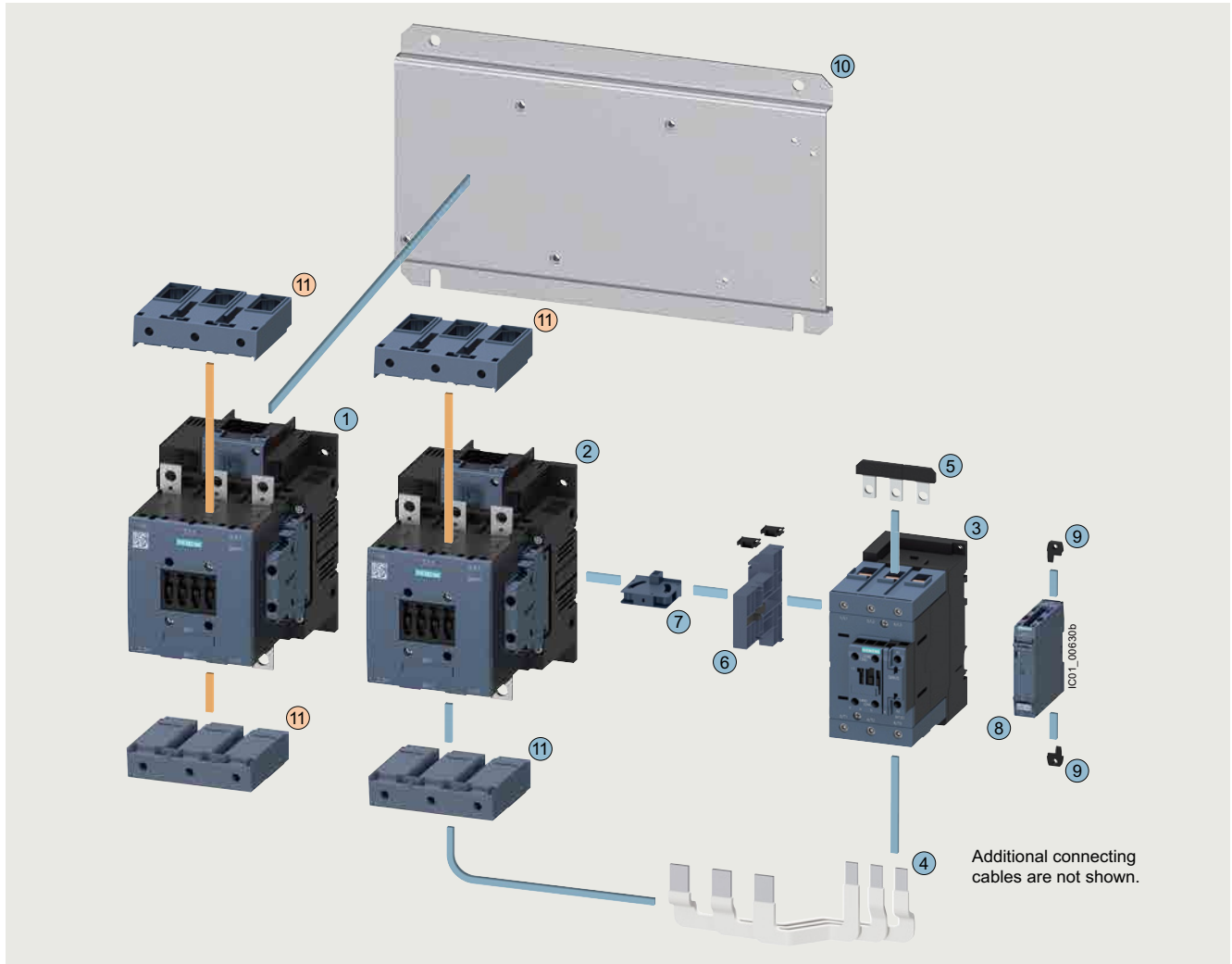

Mountable accessories (optional)

To be ordered separately	Type	Page
① Box terminal blocks	3RT1955-4G	3/116

Contactor assemblies for star-delta (wye-delta) starting for customer assembly

Individual parts	Type			Page
	Q11	Q13	Q12	
①②③ Contactors, 110 kW	3RT1054	3RT1054	3RT2045	3/52, 3/61, 3/64 ... 3/68
①②③ Contactors, 132 kW	3RT1055	3RT1055	3RT2046	3/52, 3/61, 3/64 ... 3/68
①②③ Contactors, 160 kW	3RT1056	3RT1056	3RT2047	3/52, 3/61, 3/64 ... 3/68
④ <u>Assembly kit S6-S6-S3 for contactors with box terminals</u> consisting of: Wiring modules, bottom	3RA1953-3G			3/112
⑤ Star jumper S3	3RT1946-4BA31			3/113
⑥ Adapter for the mechanical interlock between S6 and S3 (including two connectors)	3RA1954-2G ¹⁾			3/114
⑦ Mechanical interlock between S6 and S3	3RA1954-2A			3/114
⑧ Timing relay with star-delta (wye-delta) function	3RP257.			10/34
⑨ Push-in lugs for star-delta (wye-delta) timing relays	3ZY1311-0AA00			10/35
⑩ Base plate star-delta (wye-delta)	3RA1952-2E			3/119
⑪ Box terminal block	3RT1955-4G			3/116

¹⁾ The 3RA1954-2G adapter cannot be used in conjunction with 3RT204...-KB coupling contactors, size S3.

Switching devices – Contactors and contactor assemblies – for switching motors

Contactor assemblies for star-delta (wye-delta) starting

Contactor assemblies for star-delta (wye-delta) starting consisting of SIRIUS 3RT and 3TF6 contactors, up to 710 kW

Contactor assemblies for star-delta (wye-delta) starting for customer assembly · Size S6-S6-S6 · Up to 160 kW

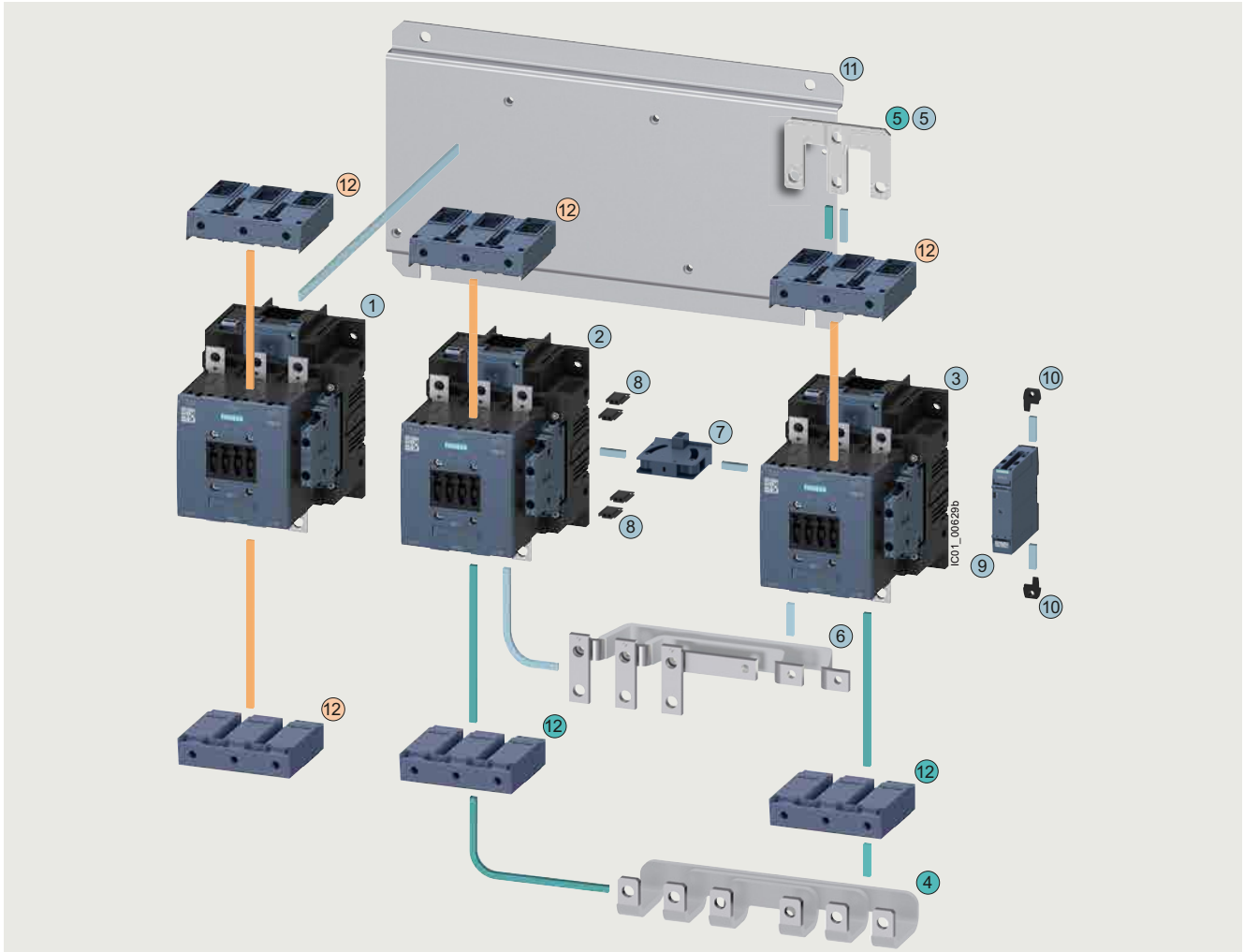

Mountable accessories (optional)

To be ordered separately	Type	Page
12	Box terminal blocks 3RT1955-4G	3/116

Contactor assemblies for star-delta (wye-delta) starting for customer assembly

Individual parts	Type			Page
	Q11	Q13	Q12	
1 2 3	3RT1054	3RT1054	3RT1054	3/66 ... 3/68
1 2 3	3RT1055	3RT1055	3RT1055	3/66 ... 3/68
1 2 3	3RT1056	3RT1056	3RT1056	3/66 ... 3/68
4 5	3RA1953-2B			3/112
Assembly kit S6-S6-S6 for contactors with box terminals consisting of:				
4				Link rails, bottom
5				Star jumper S6
5 6	3RA1953-2N			3/112
Assembly kit S6-S6-S6 for contactors without box terminals consisting of:				
6				Link rails, bottom
5				Star jumper S6
7	3RA1954-2A			3/114
8	3RA1932-2D			3/114
9	3RP257			10/34
10	3ZY1311-0AA00			10/35
timing relays				
11	3RA1952-2F			3/119
12	3RT1955-4G			3/116
Box terminal block				



Video: SIRIUS contactor assembly for star-delta (wye-delta) starting – configuration example with 75 kW contactors

Switching devices – Contactors and contactor assemblies – for switching motors

Contactor assemblies for star-delta (wye-delta) starting

Contactor assemblies for star-delta (wye-delta) starting consisting of SIRIUS 3RT and 3TF6 contactors, up to 710 kW

Contactor assemblies for star-delta (wye-delta) starting for customer assembly · Size S10-S10-S6 · Up to 250 kW

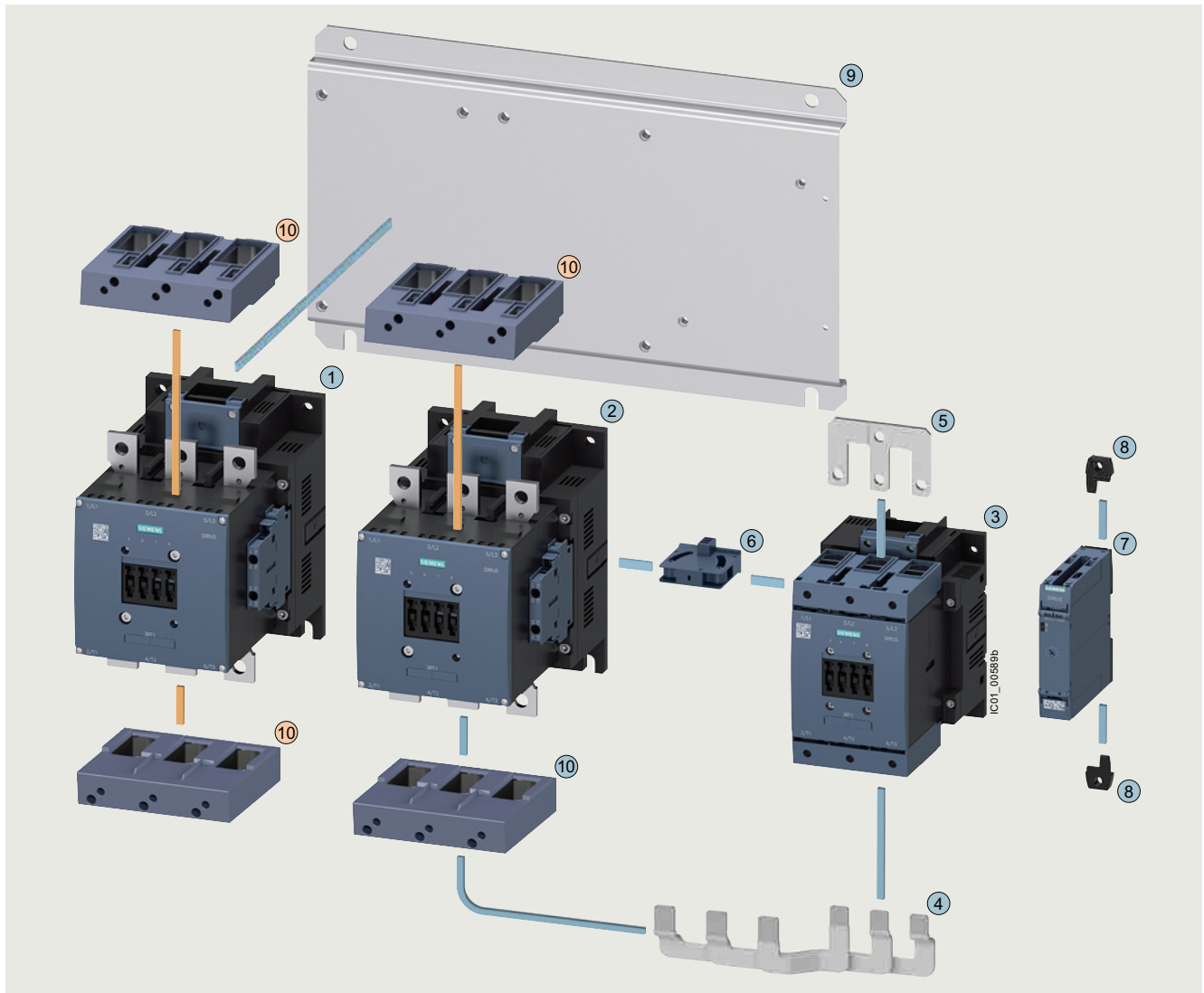

Mountable accessories (optional)

To be ordered separately	Type	Page
⑩ Box terminal blocks	3RT1966-4G	3/116

Contactor assemblies for star-delta (wye-delta) starting for customer assembly

Individual parts	Type			Page
	Q11	Q13	Q12	
①②③ Contactors, 200 kW	3RT1.64	3RT1.64	3RT1054	3/66 ... 3/68, 3/131
①②③ Contactors, 250 kW	3RT1.65	3RT1.65	3RT1055	3/66 ... 3/68, 3/131
④ Assembly kit S10-S10-S6 for contactors with box terminals consisting of: Wiring modules, bottom	3RA1963-3E			3/112
⑤ Star jumper S6	3RT1956-4BA31			3/113
⑥ Mechanical interlock between S10 and S6	3RA1954-2A			3/114
⑦ Timing relay with star-delta (wye-delta) function	3RP257.			10/34
⑧ Push-in lugs for star-delta (wye-delta) timing relays	3ZY1311-0AA00			10/35
⑨ Base plate star-delta (wye-delta)	3RA1962-2E			3/119
⑩ Box terminal block	3RT1966-4G			3/116



Video: SIRIUS contactor assembly for star-delta (wye-delta) starting – configuration example with 75 kW contactors

Switching devices – Contactors and contactor assemblies – for switching motors

Contactor assemblies for star-delta (wye-delta) starting

Contactor assemblies for star-delta (wye-delta) starting consisting of SIRIUS 3RT and 3TF6 contactors, up to 710 kW

Contactor assemblies for star-delta (wye-delta) starting for customer assembly · Size S10-S10-S10 · Up to 250 kW

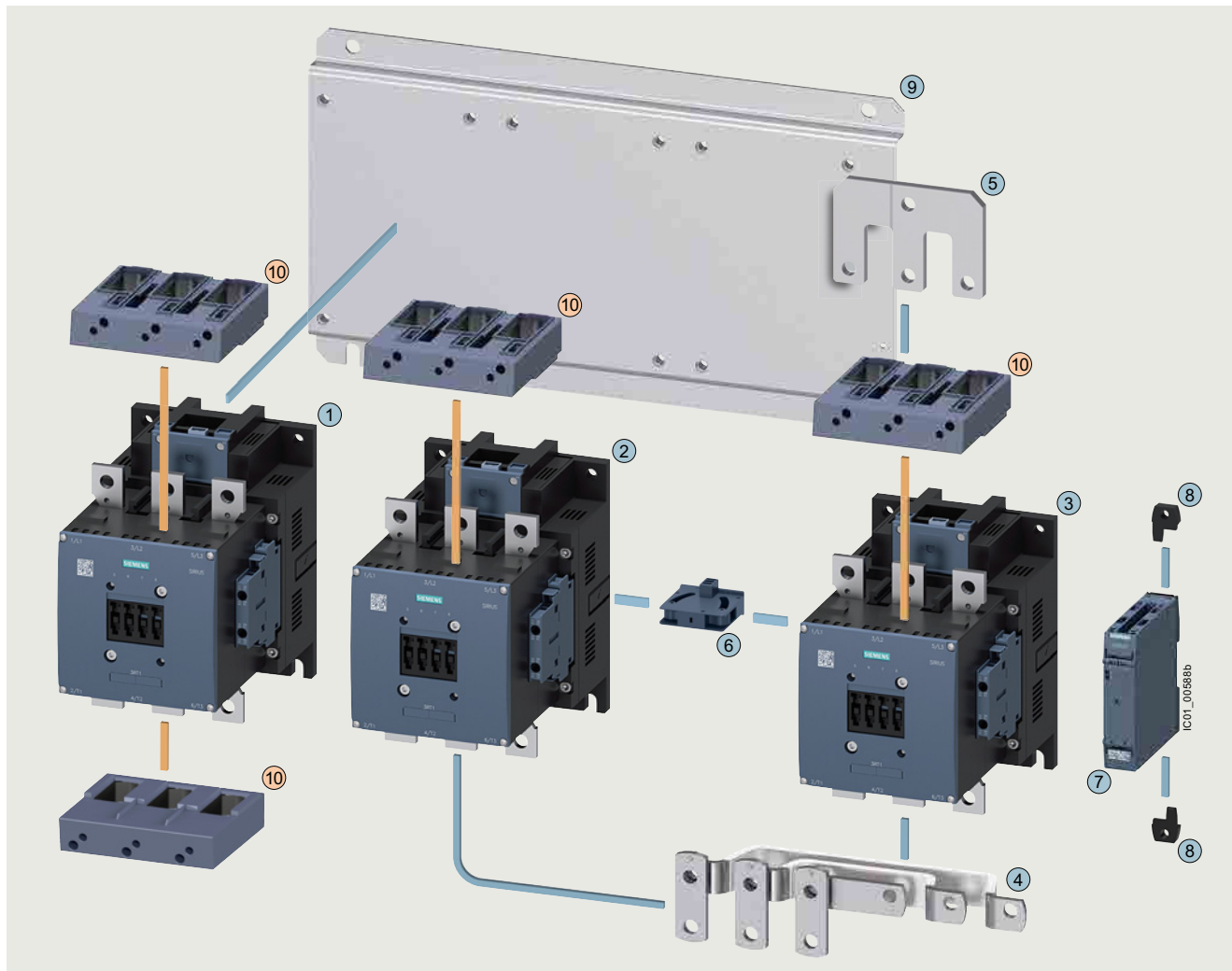

Mountable accessories (optional)

To be ordered separately	Type	Page
⑩ Box terminal blocks	3RT1966-4G	3/116

Contactor assemblies for star-delta (wye-delta) starting for customer assembly

Individual parts	Type			Page
	Q11	Q13	Q12	
①②③ Contactors, 200 kW	3RT1.64	3RT1.64	3RT1.64	3/66 ... 3/68, 3/131
①②③ Contactors, 250 kW	3RT1.65	3RT1.65	3RT1.65	3/66 ... 3/68, 3/131
④⑤ Assembly kit S10-S10-S10 for contactors without box terminals consisting of:	3RA1963-2B			3/112
④ Link rails, bottom				
⑤ Star jumper S10				
⑥ Mechanical interlock	3RA1954-2A			3/114
⑦ Timing relay with star-delta (wye-delta) function	3RP257.			10/34
⑧ Push-in lugs for star-delta (wye-delta) timing relays	3ZY1311-0AA00			10/35
⑨ Base plate star-delta (wye-delta)	3RA1962-2F			3/119



Video: SIRIUS contactor assembly for star-delta (wye-delta) starting – configuration example with 75 kW contactors

Switching devices – Contactors and contactor assemblies – for switching motors

Contactor assemblies for star-delta (wye-delta) starting

Contactor assemblies for star-delta (wye-delta) starting consisting of SIRIUS 3RT and 3TF6 contactors, up to 710 kW

Contactor assemblies for star-delta (wye-delta) starting for customer assembly · Size S12-S12-S10 · Up to 500 kW

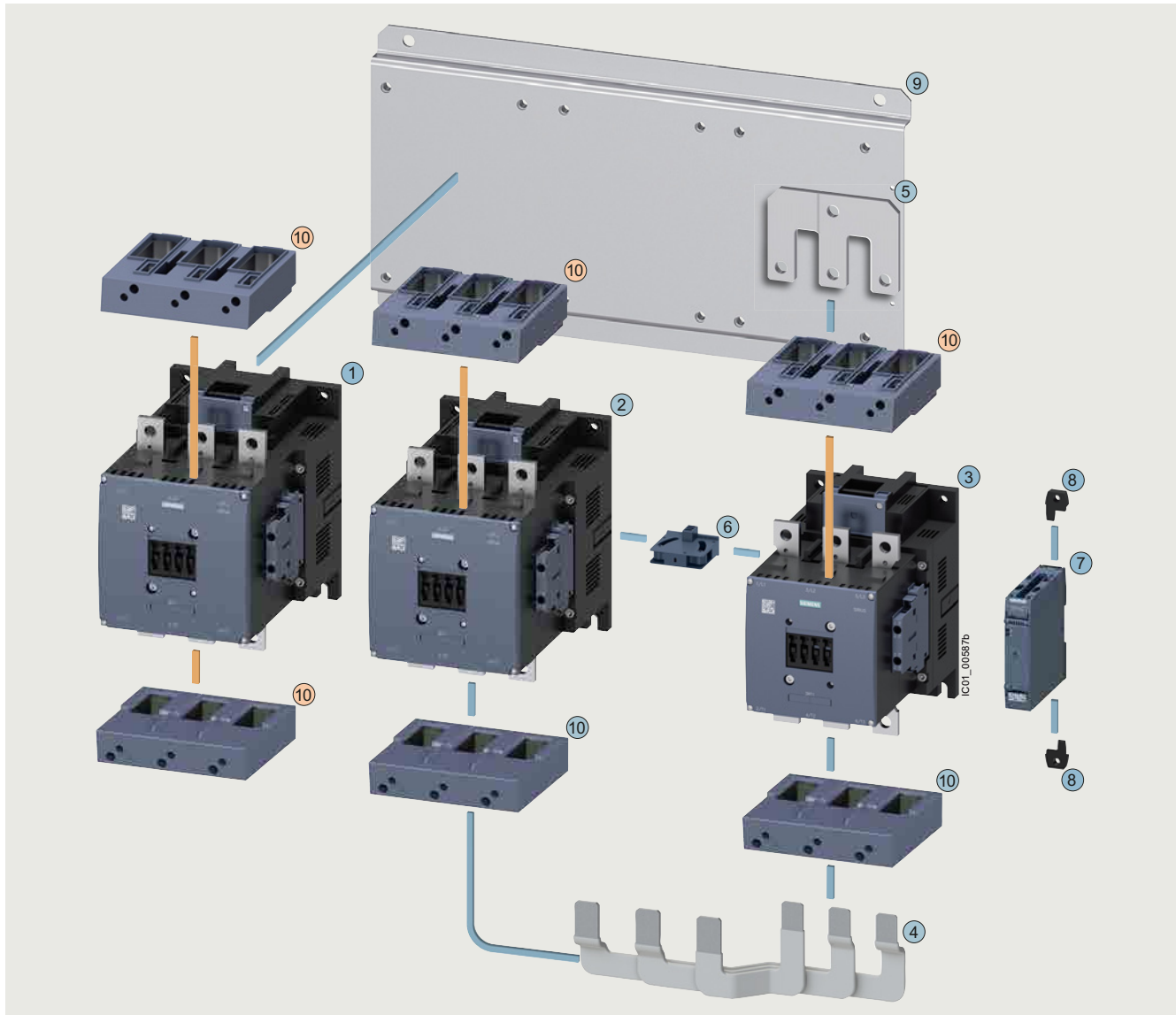

Mountable accessories (optional)

To be ordered separately Type Page

⑩ Box terminal blocks 3RT1966-4G 3/116

Contactor assemblies for star-delta (wye-delta) starting for customer assembly

Individual parts

①②③ Contactors, 355 kW
 ①②③ Contactors, 400 kW
 ①②③ Contactors, 500 kW
 ④ Assembly kit S12-S12-S10
 for contactors with box terminals
 consisting of:
 Wiring modules, bottom

⑤ Star jumper S10 3RT1966-4BA31 3/113
 ⑥ Mechanical interlock between S12 and S10 3RA1954-2A 3/114
 ⑦ Timing relay with star-delta (wye-delta) function 3RP257. 10/34
 ⑧ Push-in lugs for star-delta (wye-delta) timing relays 3ZY1311-0AA00 10/35
 ⑨ Base plate star-delta (wye-delta) 3RA1972-2E 3/119
 ⑩ Box terminal blocks 3RT1966-4G 3/116

Type

Q11

Q13

Q12

Page

3RT1.75 3RT1.75 3RT1.64 3/66 ... 3/68, 3/131

3RT1.75 3RT1.75 3RT1.65 3/66 ... 3/68, 3/131

3RT1.76 3RT1.76 3RT1.66 3/66 ... 3/68, 3/131

3RA1973-3E 3/112



Video: SIRIUS contactor assembly for star-delta (wye-delta) starting – configuration example with 75 kW contactors

Switching devices – Contactors and contactor assemblies – for switching motors

Contactor assemblies for star-delta (wye-delta) starting

Contactor assemblies for star-delta (wye-delta) starting consisting of SIRIUS 3RT and 3TF6 contactors, up to 710 kW

Contactor assemblies for star-delta (wye-delta) starting for customer assembly · Size S12-S12-S12 · Up to 500 kW

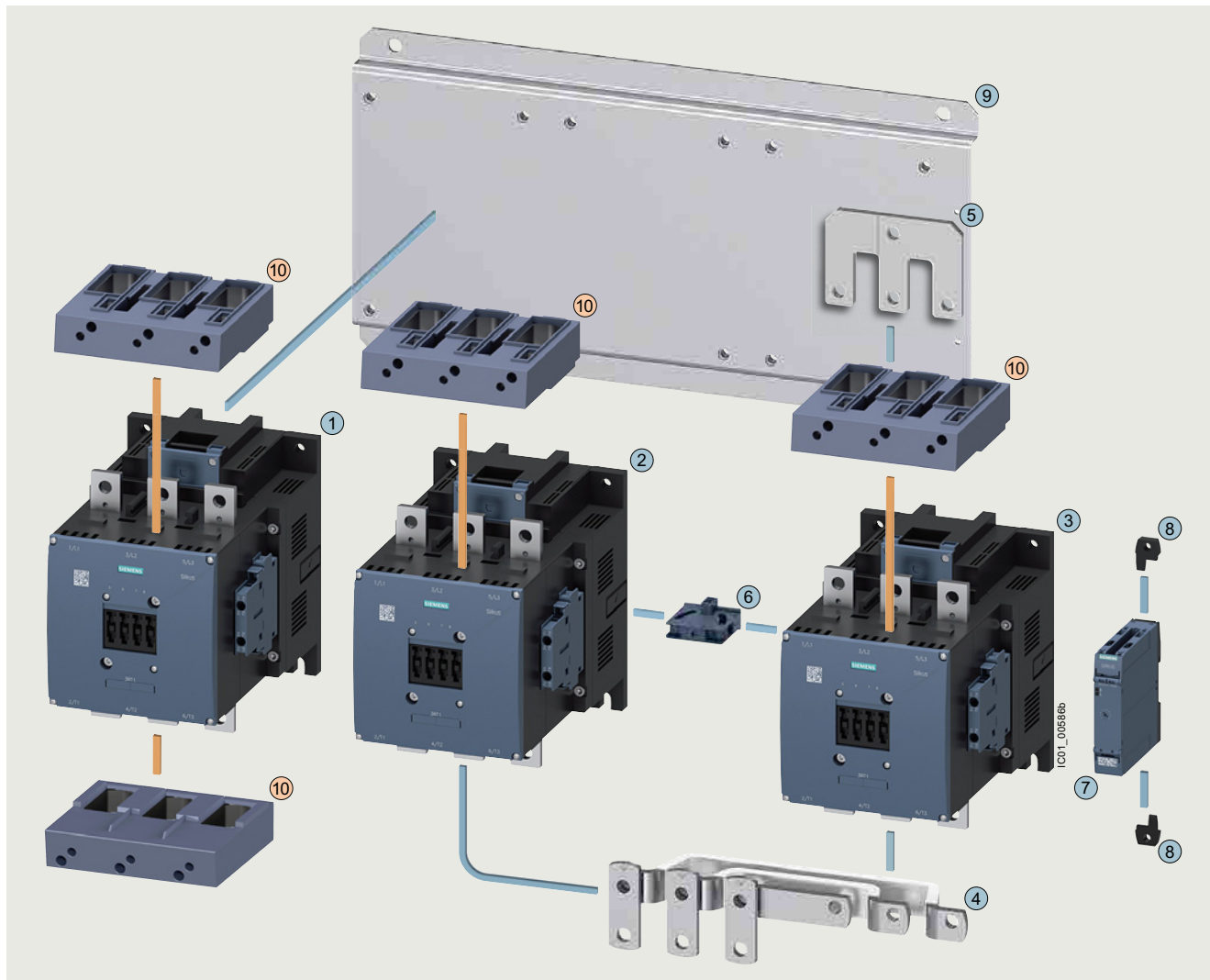

Mountable accessories (optional)

To be ordered separately	Type	Page
⑩	Box terminal blocks	3/116

Contactor assemblies for star-delta (wye-delta) starting for customer assembly

Individual parts	Type			Page
	Q11	Q13	Q12	
①②③	3RT1.75	3RT1.75	3RT1.75	3/66 ... 3/68, 3/131
①②③	3RT1.76	3RT1.76	3RT1.76	3/66 ... 3/68, 3/131
④⑤	3RA1973-2B			3/112
Assembly kit S12-S12-S12 for contactors without box terminals consisting of:				
④	Link rails, bottom			
⑤	Star jumper S12			
⑥	Mechanical interlock	3RA1954-2A		3/114
⑦	Timing relay with star-delta (wye-delta) function	3RP257.		10/34
⑧	Push-in lugs for star-delta (wye-delta) timing relays	3ZY1311-0AA00		10/35
⑨	Base plate star-delta (wye-delta)	3RA1972-2F		3/119



Video: SIRIUS contactor assembly for star-delta (wye-delta) starting – configuration example with 75 kW contactors

Switching devices – Contactors and contactor assemblies – for switching motors

Contactor assemblies for star-delta (wye-delta) starting

Contactor assemblies for star-delta (wye-delta) starting consisting of SIRIUS 3RT and 3TF6 contactors, up to 710 kW

Contactor assemblies for star-delta (wye-delta) starting for customer assembly · Sizes 14-14-S12 · Up to 710 kW

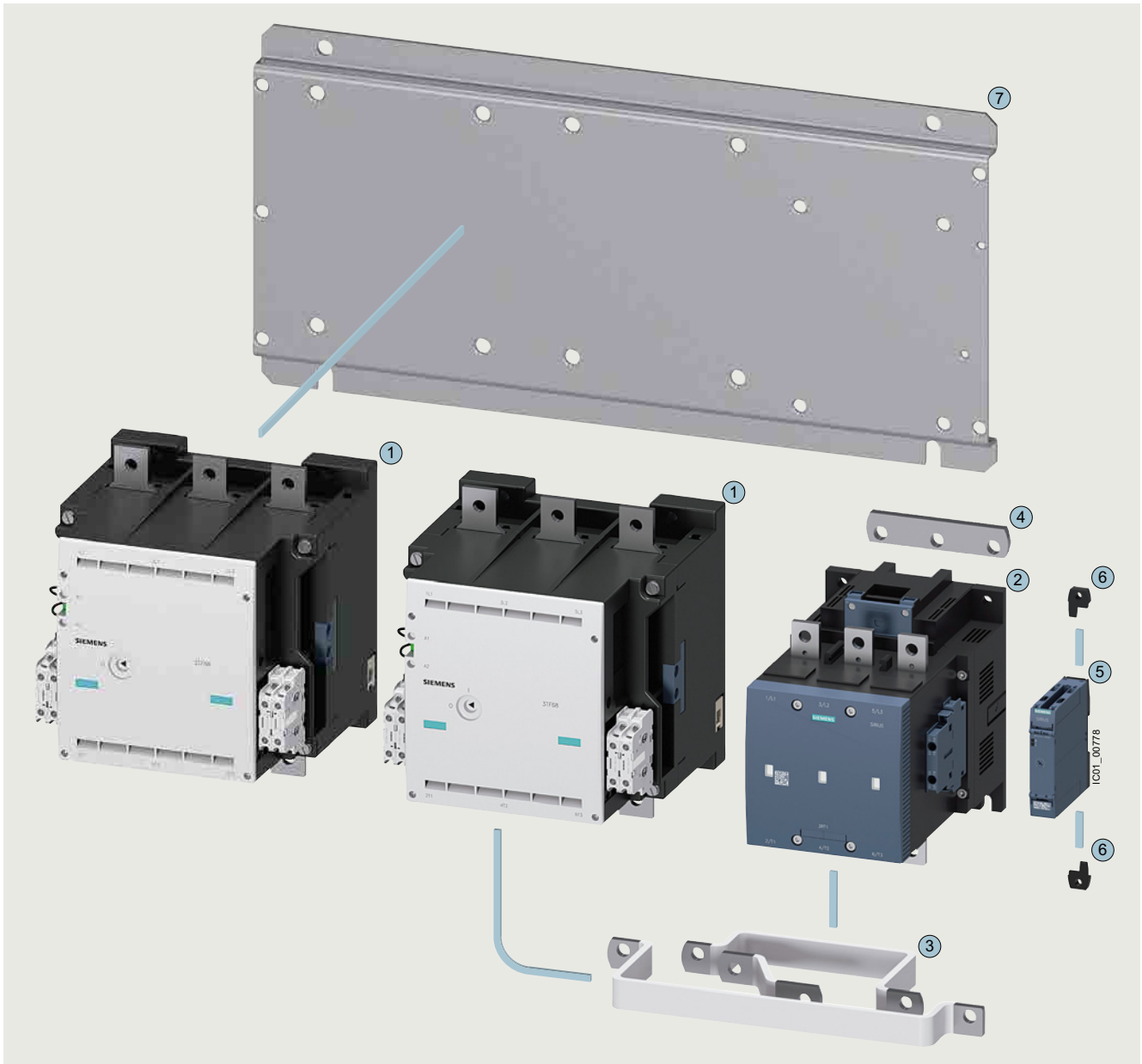

Contactor assemblies for star-delta (wye-delta) starting for customer assembly

Individual parts

	Type	Q11	Q13	Q12	Page
①②	Contactors, 710 kW	3TF68	3TF68	3RT127.	3/131 ... 3/133
③④	Assembly kit 14-14-S12 for contactors without box terminals consisting of:	3TX7680-1B			3/136
③	Wiring modules on the top and bottom				
④	Star jumper S12				
⑤	Timing relay with star-delta (wye-delta) function	3RP257.			10/34
⑥	Push-in lugs for star-delta (wye-delta) timing relays	3ZY1311-0AA00			10/35
⑦	Base plate star-delta (wye-delta)	3TX7681-1B			3/136

Switching devices – Contactors and contactor assemblies – for switching motors

Notes

3