

# E-Class™ Mark III

Operator's Manual ■ ■ ■

*Professional and Professional+ Models*



*Professional+*



*Professional*

right by our customers. ■ ■ ■



datamax·oneil

## Copyright Information

CG Triumvirate is a trademark of Agfa Corporation.

CG Times based upon Times New Roman under license from the Monotype Corporation.

Windows is a registered trademark of the Microsoft Corporation.

All other brand and product names are trademarks, service marks, registered trademarks, or registered service marks of their respective companies.

## Limitation of Liability

In no event shall Datamax-O'Neil be liable to the purchaser for any indirect, special or consequential damages or lost profits arising out of or relating to Datamax-O'Neil's products, or the performance or a breach thereof, even if Datamax-O'Neil has been advised of the possibility thereof. Datamax-O'Neil's liability, if any, to the purchaser or to the customer of the purchaser hereunder shall in no event exceed the total amounts paid to Datamax-O'Neil hereunder by the purchaser for a defective product.

In no event shall Datamax-O'Neil be liable to the purchaser for any damages resulting from or related to any failure or delay of Datamax-O'Neil in the delivery or installation of the computer hardware, supplies or software or in the performance of any services.

Some states do not permit the exclusion of incidental or consequential damages, and in those states the foregoing limitations may not apply. The warranties here give you specific legal rights, and you may have other legal rights which vary from state to state.

## Firmware (Software) Agreement

The enclosed Firmware (Software) resident in the Printer is owned by Licensor or its suppliers and is licensed for used only on a single printer in the user's Trade or Business. **The User agrees not to, and not to authorize or permit any other person or party to, duplicate or copy the Firmware or the information contained in the non-volatile or programmable memory.** The firmware (Software) is protected by applicable copyright laws and Licensor retains all rights not expressly granted. In no event will Licensor or its suppliers be liable for any damages or loss, including direct, incidental, economic, special, or consequential damages, arising out of the use or inability to use the Firmware (Software).

Information in this document is subject to change without notice and does not represent a commitment on the part of Datamax-O'Neil Corporation. No part of this manual may be reproduced or transmitted in any form or by any means, for any purpose other than the purchaser's personal use, without the expressed written permission of Datamax-O'Neil Corporation.

## Important Safety Instructions

This printer has been carefully designed to provide years of safe reliable performance. As with all types of electrical equipment, however, there are a few basic precautions that should be taken to avoid personal injury or damage to the device:

- Carefully read the installation and operating instructions provided with the printer.
- Read and follow all warning and instruction labels on the printer.
- Place the printer on a flat, stable surface.
- Do not insert anything into the ventilation slots or openings on the printer.
- Do not place the printer on or near a heat source.
- Do not use the printer near water. Never spill liquid into the printer.
- Be certain the power source is within the voltage rating and frequency listed for the printer. If you are unsure, check with your dealer, an electrician, or local power company.
- Do not place the power cord where it can be stepped on. If the power cord becomes damaged or frayed, replace it immediately.
- Only qualified, trained service technicians should attempt to repair the printer.

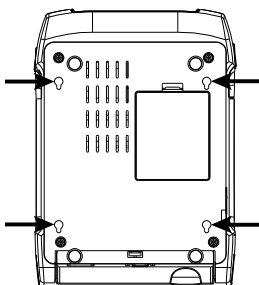

---

Cut-outs are not intended for wall-mount use.

---

## Agency Compliance and Approvals



UL60950-1, Second Edition, 2007-03-27, Information Technology Equipment  
CSA C22.2 No. 60950-1-07, Second Edition, 2007-03



The manufacturer declares under sole responsibility that this product conforms to the following standards or other normative documents:

EMC: EN 55022 (2008) Class A  
EN 50024 (1998)  
IEC 60950-1 : 2001, Second Edition



Safety: This product complies with the requirements of IEC 60950-1:2001, Second Edition

Customs Union – Russia, Kazakhstan, Belarus



GB4943-2001, GB9254-2008, GB17625.1-2012

**FCC:** This device complies with FCC CFR 47 Part 15 Class A.

**Note:** This equipment has been tested and found to comply with the limits for a Class A digital device, pursuant to Part 15 of the FCC Rules. These limits are designed to provide reasonable protection against harmful interference when the equipment is operated in a commercial environment. This equipment generates, uses, and can radiate radio frequency energy, and if not installed and used in accordance with the instructions in this manual, it may cause harmful interference to radio communications. Operation of this equipment in a residential area is likely to cause harmful interference in which case the user will be required to correct the interference at his own expense.

All rights reserved  
Copyright © 2014, Datamax-O'Neil  
Part Number: 88-2358-01, Rev C

# Contents

<b>1 Getting Started</b>	<b>1</b>
1.1 Introduction	1
1.2 Unpacking the Printer	1
1.3 Kensington Security Slot	2
<b>2 Printer Setup</b>	<b>3</b>
2.1 Introduction	3
2.2 Connecting the Printer	3
2.2.1 Power Connections	3
2.2.2 Interface Connections	4
2.3 Loading Media	5
2.3.1 Loading Roll Media	5
2.3.2 Loading - External Media	7
2.3.3 Loading Media with the Peel and Present Option	9
2.3.4 Loading Media with the Cutter Option	10
2.3.5 Adjustable Media Core Hangers (Pro+ models only)	11
2.4 Loading Ribbon	12
2.4.1 Using the Ribbon Core Adapters	15
<b>3 Printer Operation</b>	<b>17</b>
3.1 Introduction	17
3.2 LED Indicators	17
3.3 User Interface	18
3.3.1 Feed/Pause Mode	18
3.3.2 Test Mode	18
3.3.3 Menu Mode	19
3.4 Printer Configuration Tools	20
3.5 Printer Configuration Utility (NETira CT)	21
3.6 Windows Driver	24
3.7 Media Calibration	26
3.7.1 Quick Calibration	26
3.7.2 Manual Calibration	27
3.7.3 Advanced Entry Calibration	28

<b>4</b>	<b>Menu System .....</b>	<b>35</b>
4.1	Menu System Overview .....	35
4.2	The User Menu.....	35
4.3	The Advanced Menu.....	36
4.4	Menu Details .....	37
<b>5</b>	<b>Maintenance &amp; Adjustments .....</b>	<b>51</b>
5.1	Introduction .....	51
5.2	Cleaning the Printhead .....	52
5.3	Ribbon Tension Adjustment .....	54
5.4	Adjustable Media Sensor .....	55
5.5	Printhead Replacement .....	56
5.6	Platen Roller Replacement .....	58
5.7	Updating Firmware .....	59
5.7.1	Boot 1 and Boot 2 Boot Loaders.....	59
<b>6</b>	<b>Troubleshooting .....</b>	<b>61</b>
6.1	Introduction .....	61
6.2	Troubleshooting Tips.....	61
6.3	Hex Dump Mode .....	63
<b>A</b>	<b>Specifications .....</b>	<b>65</b>
<b>B</b>	<b>Wireless and Wired LAN Setup .....</b>	<b>69</b>
B.1	Network Card Setup .....	69
B.2	Wireless Setup.....	70
B.2.1	Wireless Setup – Infrastructure .....	71
B.2.1	Wireless Setup – Ad-Hoc .....	72
B.3	Installing the Printer Driver.....	74
<b>C</b>	<b>Bluetooth Setup.....</b>	<b>77</b>
C.1	Bluetooth Setup .....	77
<b>D</b>	<b>Menu Language .....</b>	<b>79</b>
D.1	Changing the Menu Language .....	79
D.2	Advanced File Handling Information .....	82

# 1 Getting Started

## 1.1 Introduction

---

The E-Class Mark III printer (hereafter referred to as “the printer”) is user-friendly thermal printing device that blends quality and durability in an affordable package to meet all of your labeling needs. This manual provides the information necessary to operate and maintain the printer.

To begin printing labels or tags, refer to the instructions included with your software labeling program. For your convenience, a Windows printer driver can be found on the Accessories CD-ROM, or it can be downloaded from our website at <http://www.datamax-oneil.com>. (If you wish to write custom programs or label formats, a copy of the *Programmer's Manual* also is included for your reference, or the manual can be downloaded.)

## 1.2 Unpacking the Printer

---

After removing the printer from the packaging material, check the contents of the box. In addition to the printer, the following items should be present:

- Power Supply
- Accessories CD-ROM
- Any special or additionally ordered items

### ***Additional Requirements***

The following items are necessary to generate labels:

- Parallel, Serial, USB, or Ethernet cable, see Section 2.2.2 for details.
- Applicable media; see Appendix A for details.

Contact customer support or your sales representative for advice on the media and software that may best be suited for your application.



It is a good idea to save all packaging material for future use.

---

## 1.3 Kensington Security Slot

---



Professional + modules equipped with the Key Lock Option also include a built-in Kensington Security Slot with a metal backing plate. The Kensington slot allows you to physically secure the printer from being stolen by tethering it to a larger object like a desk or counter. There are many security solutions offered by Kensington that are compatible with the slot.

Visit <http://www.kensington.com> for a full line of locking options and accessories.

The Kensington Security Slot has been the industry standard since 1990, giving customers the best option for physical security of computer and electronic equipment.



1 Kensington Security Slot

# 2 Printer Setup

## 2.1 Introduction

This section explains how to connect your printer and load media (including ribbon, if equipped for thermal transfer operation).

## 2.2 Connecting the Printer

### 2.2.1 Power Connections

The printer is powered by an external auto-ranging power supply, which connects between the printer and an electrical outlet. Ensure that the operating ranges of the power supply are compatible with your electrical service, (see Appendix A for details) then connect power as follows:



Before connecting power to the printer, ensure that the Power Switch is in the OFF (O) position.

- 1) Connect the Power Supply to Power Jack of the printer.
- 2) Connect the AC Power Cord to the Power Supply.
- 3) Connect the AC Power Cord to an Electrical Outlet.





## 2.2.2 Interface Connections



Before connecting interface cables to the printer, ensure that the Power Switch is in the OFF (O) position.



1	Ethernet Port
2	USB Port
3	Serial Port
4	USB Host Port
5	Parallel Port

### Cable Requirements

Choose the correct cable when interfacing the printer to the host:

- The Parallel Port** (optional) supports parallel communications via a 36-pin male mini-Centronics connector. Bi-directional communications (forward and reverse channels) is supported when an IEEE 1284 compliant cable and supporting host software is used.
- The Ethernet Port** supports Wired LAN communications (see Appendix B for information).
- The Serial Port** supports RS-232C communications via a DB-9 connector with specific pin-outs (interface cable part numbers and pin-outs are given below; contact your reseller to order). Serial port settings are menu-selectable and must match the host settings.

Host DB-9S	Printer DB-9P	Host DB-25S	Printer DB-9P
TX 3	2 RX	TX 2	2 RX
RX 2	3 TX	RX 3	3 TX
CTS 8	7 RTS	CTS 5	7 RTS
DSR 6	4 DTR	DSR 6	4 DTR
GND 5	8 CTS	GND 7	8 CTS
DTR 4	5 GND	DTR20	5 GND
Shield	Shield	Shield	Shield
Part # 32-2483-01		Part # 32-2301-01	

- The USB Port** supports high-speed serial communications and requires a standard USB interface cable.
- The USB Host Port** (optional). The USB Host Port allows the printer to accept external USB memory devices for storing graphics, label formats, fonts, and firmware. The port can also accept a USB keyboard for standalone, direct data (Line mode) input applications; see the Programmer's Manual for more information on how to utilize the port.



The printer automatically establishes communications with the first port through which valid data is received. Afterward, a timeout period must be exceeded (or power must be cycled OFF and ON) to change the established communications port.

## 2.3 Loading Media



The printer is equipped with an Adjustable Media Sensor and may require adjustment to match your media choice, refer to Section 4.4.

### 2.3.1 Loading Roll Media

Load media as follows:

- 1) Pull forward on the Cover Latches and lift up on the cover. Pro+ models have Key Lock option that must be unlocked before the cover can be opened.



- 2) Slide the Media Guides outward.



Pro+ model Media Guides are equipped with Adjustable Media Core Hangers, see section 2.3.5.

- 3) Slide the Media Hangers outward and insert the Roll Media as shown. Allow the Media Hangers to retract and grasp the media roll.



- 4) Pull out enough media to exit the front of the printer. Adjust the Media Guides so they are lightly touching the edge of the media.

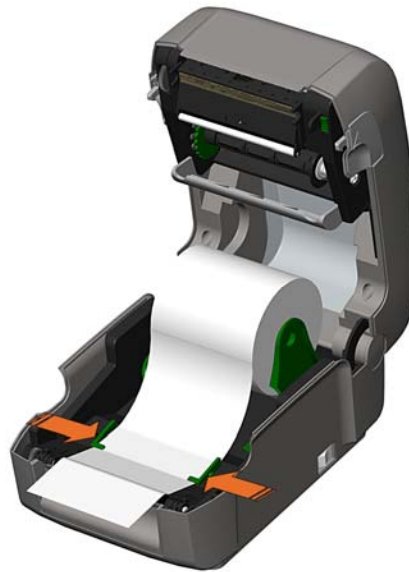

- 5) If using thermal transfer media (ribbon) proceed to Section 2.4 Loading Ribbon. Otherwise close the printer's Cover and press downward until latched. Pro



Pro+ models are equipped with a Cover Release Latch. Press outward on the latch to release cover.



- 6) Press the  button to advance the media (if the Fault Light is lit, see Section 3.7.)



The printer is factory set to use gap media. If using another media type (for example, continuous media), printer setup must be reconfigured; see Section 3.4.

### 2.3.2 Loading - External Media

Using Internal Media Chute Guides Accessory (Professional model only)

Load media as follows:

- 1) Slide the Media Guides outward.
- 2) Slide the Media Hangers outward and install the two Media Chute Guides into the Media Hangers.

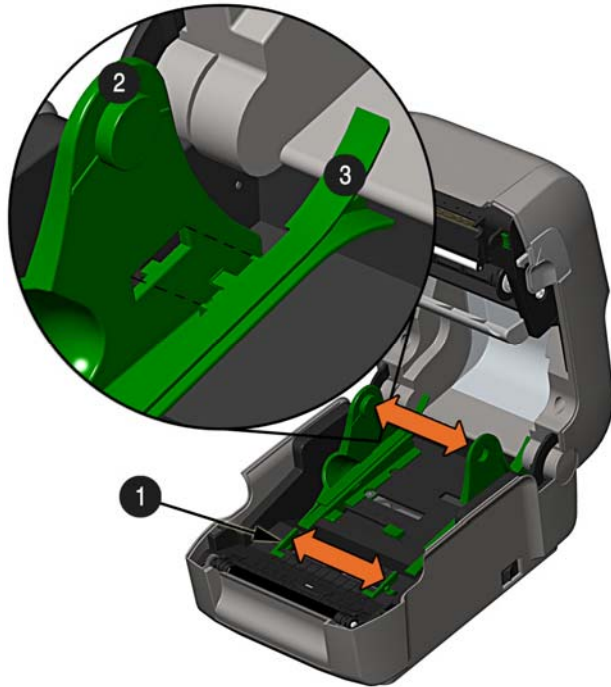

- ❶ Media Chute Guides
- ❷ Media Hangers
- ❸ External Media Guide

- 3) Position the Media Hangers to match the width of the media being used. Slide the Hanger Lock against the Media Hanger to hold this position.

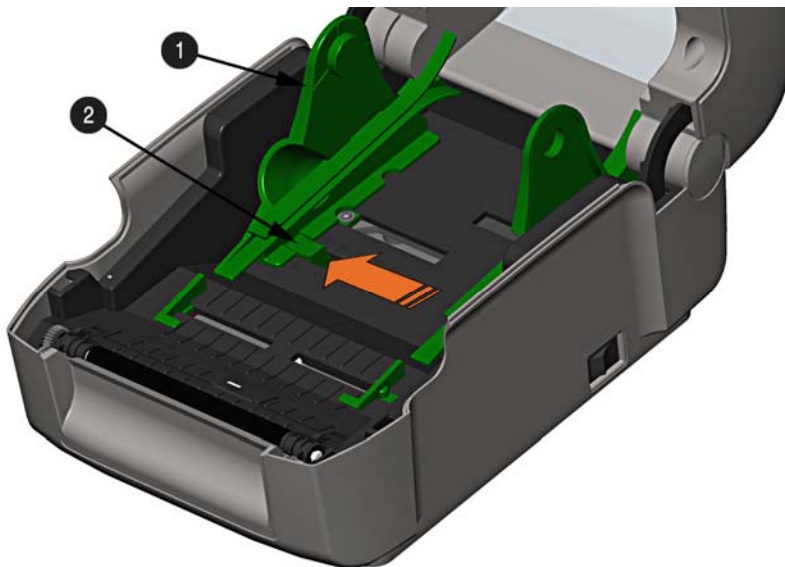

- ❶ Media Hangers
- ❷ Hanger Lock

- 4) Route the media through the External Media Slot in the rear of the printer. Pull out enough media to exit the front of the printer. Adjust the Media Guides so they are lightly touching the edge of the media.

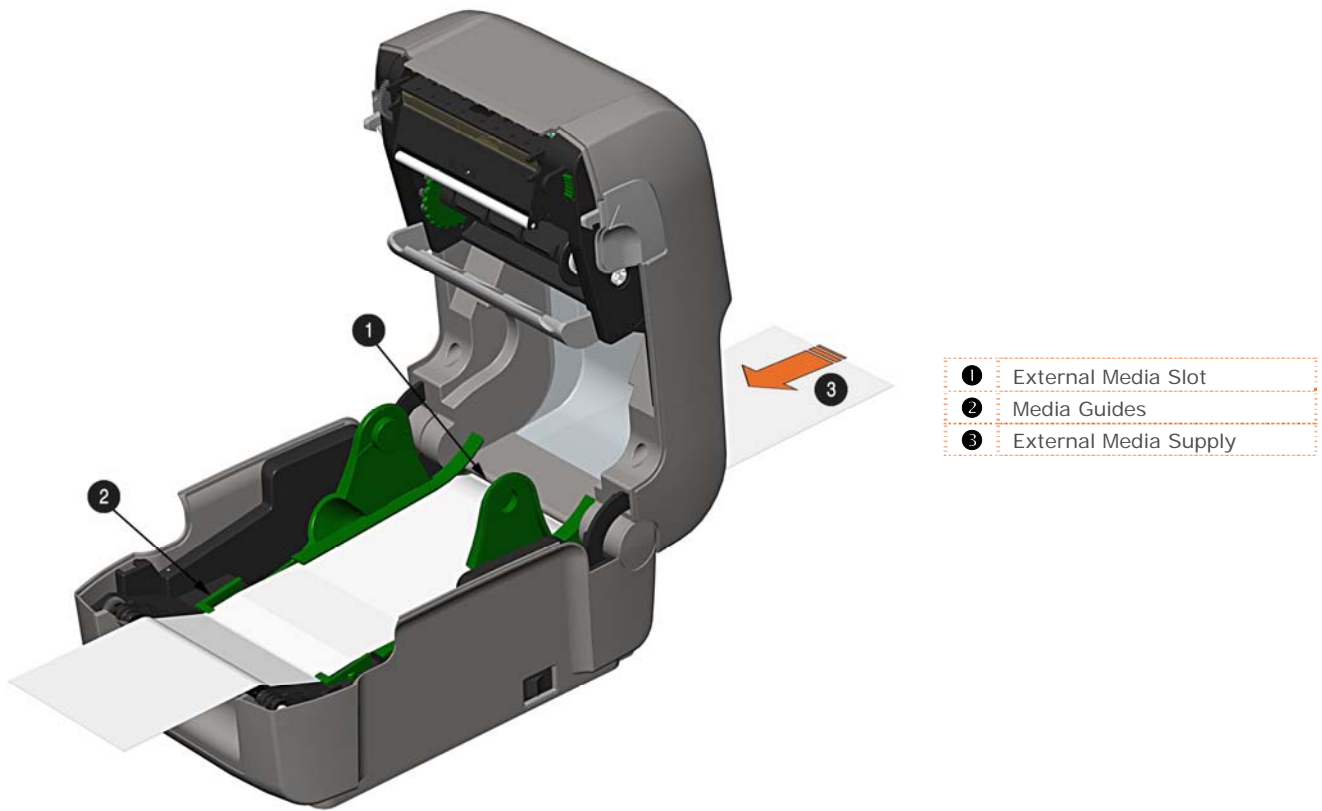

- 5) If using Thermal Transfer media (ribbon) proceed to Section 2.4 Loading Ribbon. Otherwise close the printer's Cover and press downward until latched.
- 6) Press the  button to advance the media (if the Fault Light is lit, see Section 3.7.)



The printer is factory set to use gap media. If using another media type (for example, continuous media), printer setup must be reconfigured; see Section 3.4.

### 2.3.3 Loading Media with the Peel and Present Option

Load media for peeling (if the printer is equipped with the option) as follows:

- 
- ✓ When using the Peel Mechanism do not exceed a print speed of 4 IPS.
- 
- ✓ To utilize "Tear mode" with Peel and Present Option installed; move the Peeler Door to its open position.
- 

- 1) Load media as described in Section 2.3, (steps 1-3).
- 2) Remove about 8 inches (200mm) of labels from the Media Backing.
- 3) Open the Peeler Door. Route the Media Backing over the Platen Roller and Peel Bar, and then behind the Peel Roller and Peeler Door, as shown below.

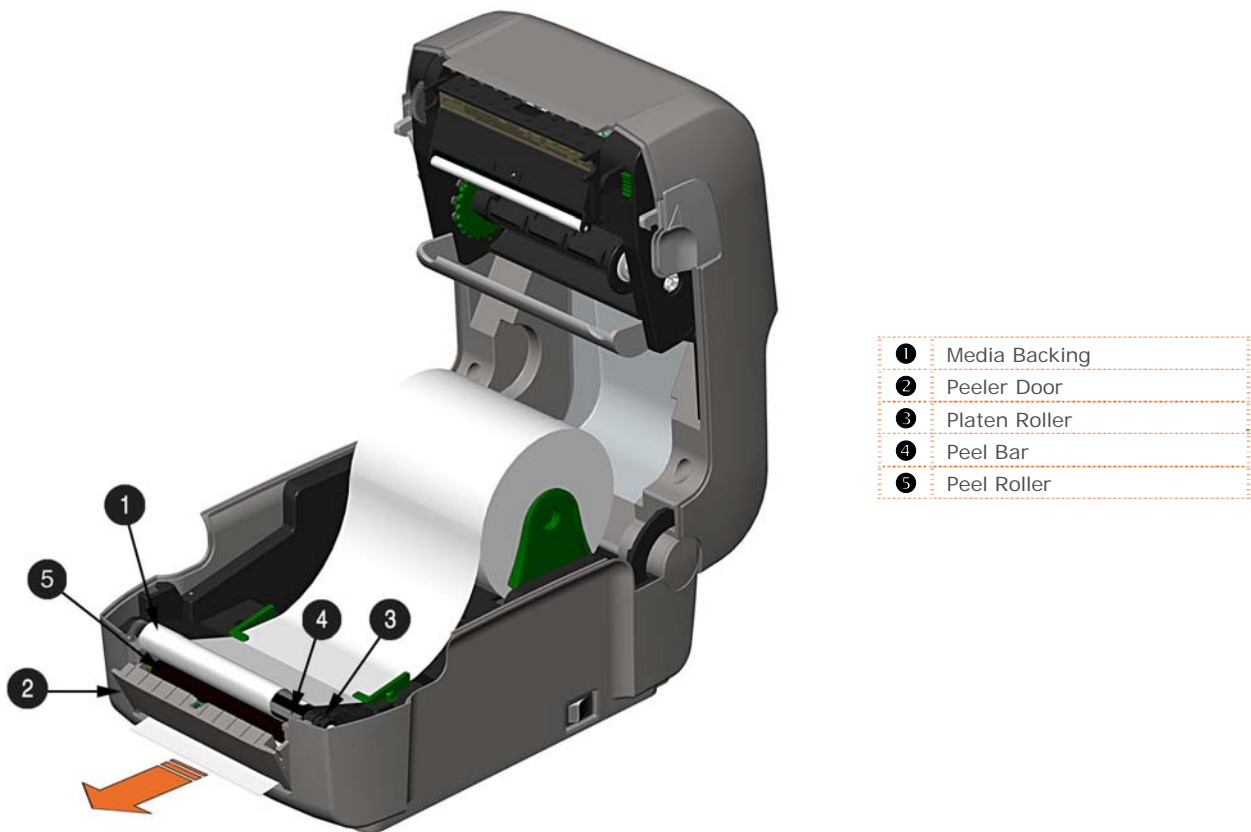

- 4) Close the Peeler Door.
- 5) If using Thermal Transfer media (ribbon) proceed to Section 2.4 Loading Ribbon. Otherwise close the printer's Cover and press downward until latched.
- 6) Press the  button to advance the media (if the Fault Light is lit, see Section 3.7.)
- 7) The printer will now peel each label and present it to the operator for removal. The indicator light will flash orange and the next label will not feed/print until the previous label is removed.

- 
- ✓ The printer is factory set to use gap media. If using another media type (for example, continuous media), printer setup must be reconfigured; see Section 3.4.
-



### 2.3.4 Loading Media with the Cutter Option

Load media for cutting (if the printer is equipped with the option) as follows:

- 1) Load media as described in Section 2.3, (steps 1-3).
- 2) Route the media through the opening in the Cutter.



- |   |        |
|---|--------|
| 1 | Cutter |
| 2 | Media  |

- 3) If using Thermal Transfer media (ribbon) proceed to Section 2.4 Loading Ribbon. Otherwise close the printer's Cover and press downward until latched.
- 4) Press the  button to advance the media (if the Fault Light is lit, see Section 3.7.). The printer will now cut each label as it exits from the printer.
- 7) The printer will now peel each label and present it to the operator for removal.



If the printer is equipped with the Present Sensor Option, the indicator light will flash orange and the next label will not feed/print until the previous label is removed.



The printer is factory set to use gap media. If using another media type (for example, continuous media), printer setup must be reconfigured; see Section 3.4.

### 2.3.5 Adjustable Media Core Hangers (Pro+ models only)

The Adjustable Media Core Hangers allow for support of media rolls with 3", 1.5", or 1" cores.

To adjust:

- 1) Pull outward in on the Core Hanger and slide the Core Hanger up or down to the desired setting. Be sure both core hangers are set to the same position.

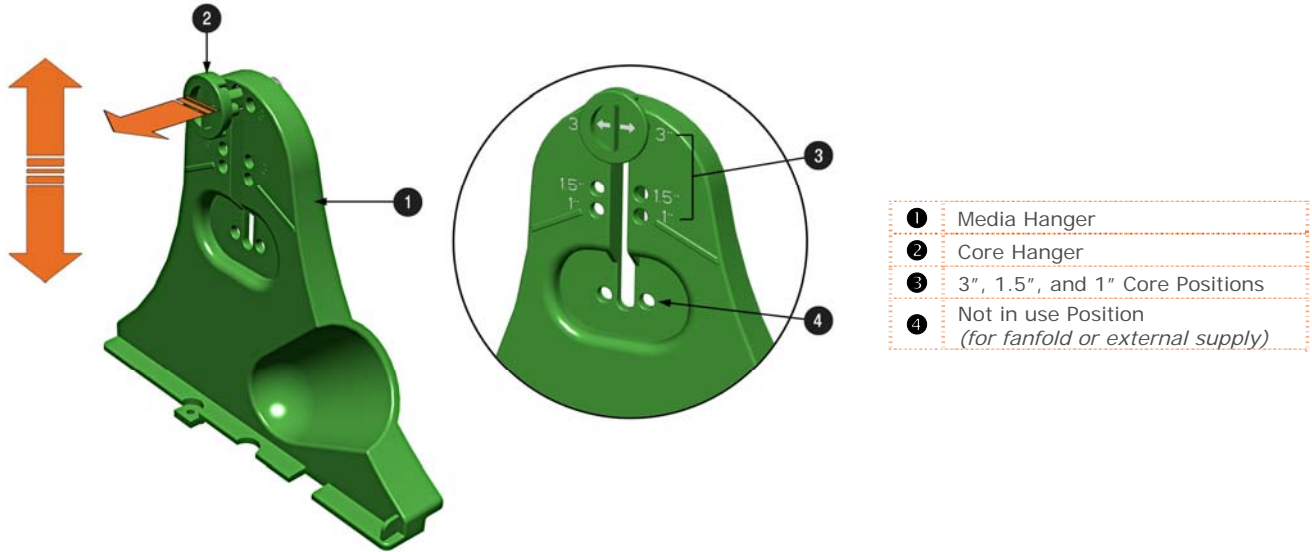



## 2.4 Loading Ribbon

The printer is capable of using C.S.I (Coated Side In) and C.S.O (Coated Side Out) ribbons in the following configurations:

### *½" Core Ribbons*

**Ribbon Core Width:** 4.3 inches (110mm)  
**Ribbon Width:** 1.0 - 4.3 inches (25 - 110mm); Centered on core

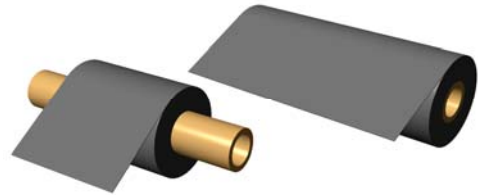

### *1" Core Ribbons (with Ribbon Core Adapters, see section 2.4.1.)*

**Ribbon Core Width:** 1.0 - 4.3 inches (25 - 110mm); Centered on Ribbon Core Adapters  
**Ribbon Width:** 1.0 - 4.3 inches (25 - 110mm); Centered on core

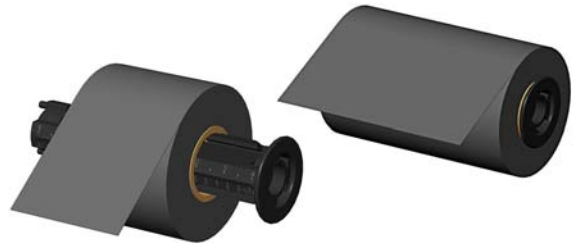

Load ribbon as follows:



If equipped with the thermal transfer option, the printer is factory set to use ribbon; see Section 3.4 to change this setting if using direct thermal media.

- 1) Determine the type of ribbon (C.S.I or C.S.O) you are using.

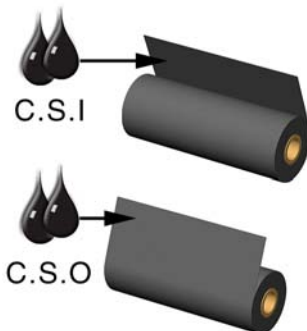

<b>C.S.I</b>	Coated Side In Ribbon
<b>C.S.O</b>	Coated Side Out Ribbon



Ensure the inked side of the ribbon faces toward the label media, not the printhead.

- 2) Push out the Supply Hub and load the Supply Roll into the printer as shown. Depending on the size of the Supply Roll, the Media Bouncer may need to be pushed out of the way.
- 3) Once the Supply Roll is loaded, slide the Ribbon Handler Latch downward to unlatch the Ribbon Handler Assembly.

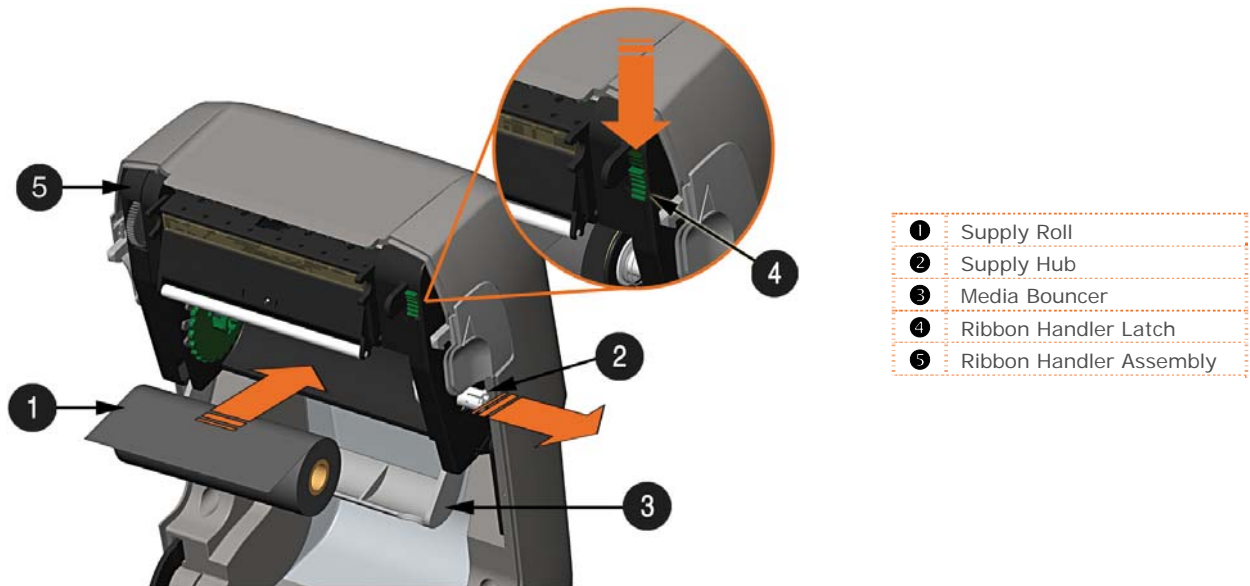

- 4) Push out the Take-up Hub and load an empty Ribbon Core into the printer as shown.

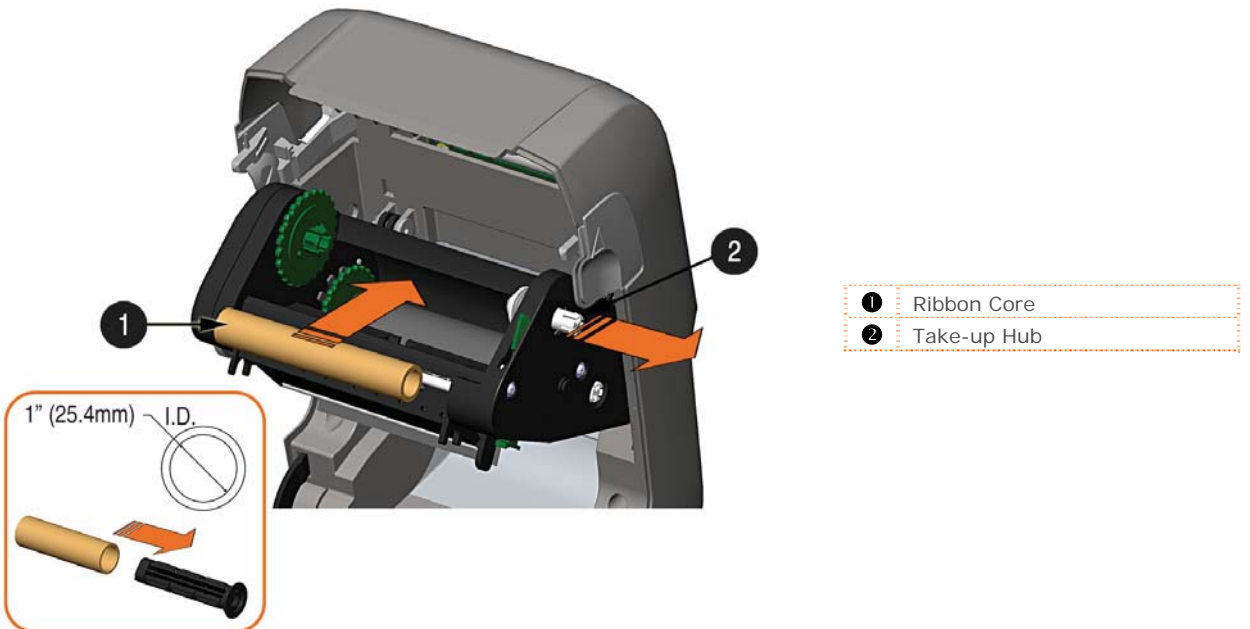

- 5) Route the ribbon from the supply roll to the Ribbon Core, as shown below.
- 6) If not already attached, affix the leader of the ribbon to the Ribbon Core using Tape. Rotate the Take-up Hub Wheel several times to secure the ribbon.

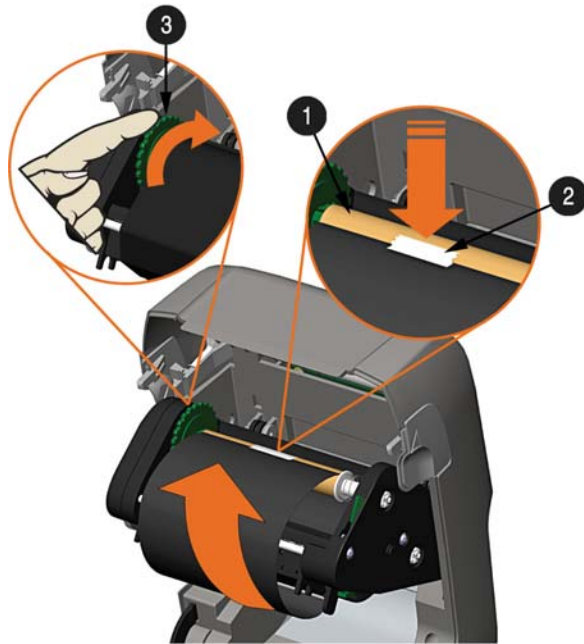

- |   |                   |
|---|-------------------|
| 1 | Ribbon Core       |
| 2 | Tape              |
| 3 | Take-up Hub Wheel |

- 7) Raise and latch the Ribbon Handler Assembly. Close the cover and press the  button to advance the media (if the Fault Light is lit, see Section 3.7.)

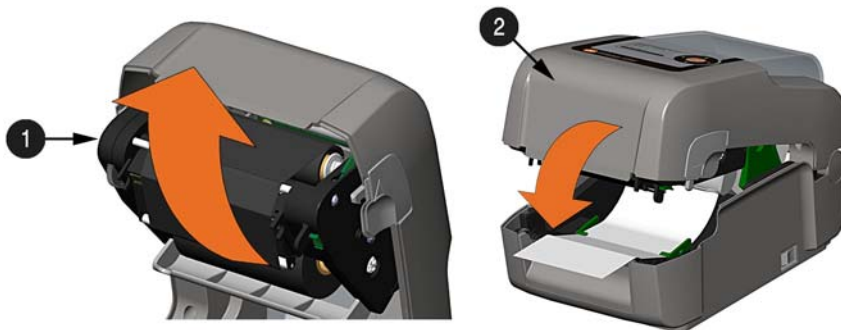

- |   |                         |
|---|-------------------------|
| 1 | Ribbon Handler Assembly |
| 2 | Cover                   |

## 2.4.1 Using the Ribbon Core Adapters

When using ribbons with a 1" (25.4mm) I.D. core, a Core Adapter must be used.

- 1) Slide the Ribbon Roll (with the leader positioned as shown above) onto a Core Adapter. Slide an empty Ribbon Core onto the remaining Core Adapter.

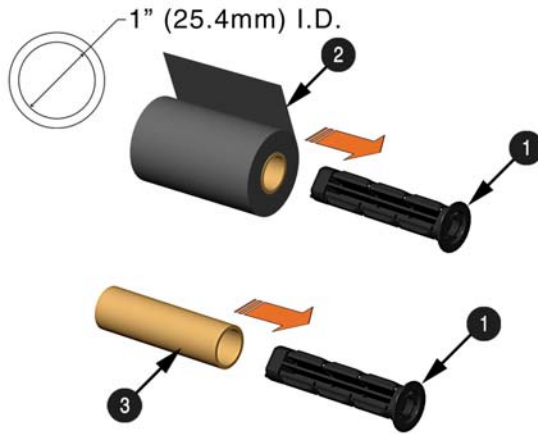

1	Core Adapter
2	Ribbon Roll
3	Ribbon Core

- 2) If using a narrow ribbon, position the Ribbon Roll so that it is centered on the Core Adapter. The Core Adapters are marked in both inches and centimeters to aid in proper positioning.

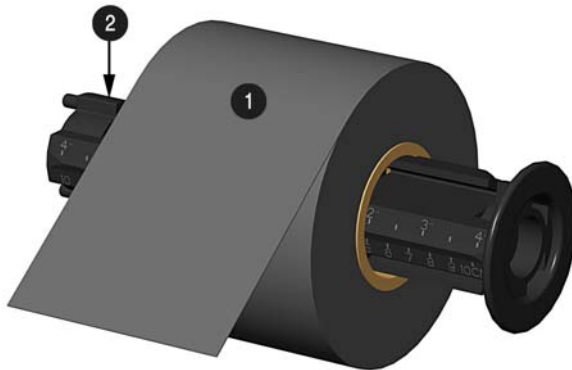

1	Core Adapter
2	Ribbon Roll



# 3 Printer Operation

## 3.1 Introduction

The Front Panel consists of a graphic display, two indicator lights, four directional arrow buttons and one multi-function button, as detailed in the following sections.

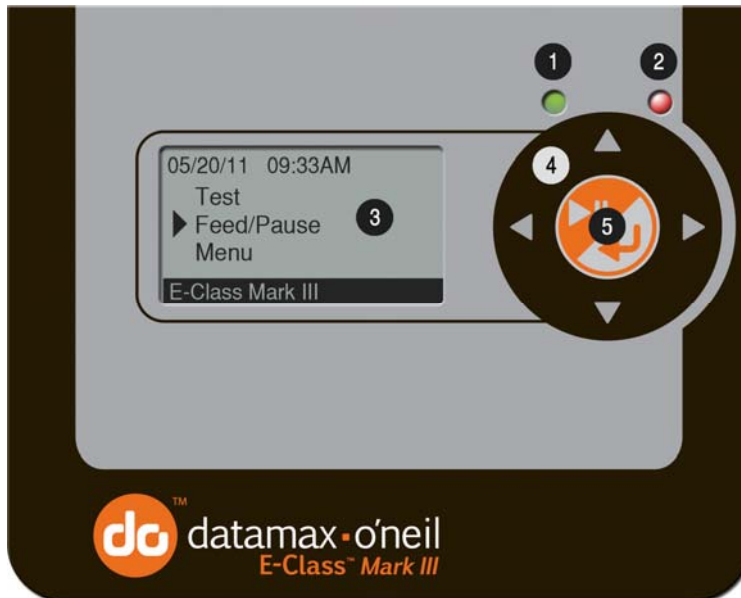

- ① Green/Orange Status LED
- ② Red Error LED
- ③ Graphic Display
- ④ Directional Arrow Buttons
- ⑤ Multi-function Button

## 3.2 LED Indicators

Two LED indicator lights provide a quick visual reference of printer operations and conditions, as defined below:

Color	LED 1		LED 2
	Green	Orange	Red
Solid	Ready to print	Paused or Present Sensor is blocked.	TOF sensing error. Next TOF not Found.
Flashing	Processing/busy	Paused/busy	Out of stock\labels or printer jam..
Off	No power		No Error

Both indicators will be ON during power-up initialization and following a reset.

### 3.3 User Interface

The User Interface is divided in three sections, Feed/Pause, Test, and Menu. Button functions are dependent on the mode currently in use.

Use the Up and Down arrow buttons to scroll to the item and then press the center button to enter that menu mode.



- ① Time/Date
- ② Printer Mode
- ③ Programmable Marquee  
(See Programmer's Manual for displaying a custom message)

#### 3.3.1 Feed/Pause Mode

	At idle: Feeds the media to the next label. When printing: Pauses current print job; prompts user to resume or cancel
	Scrolls upward to the next menu item
	Scrolls downward to the next menu item
	N/A
	N/A

#### 3.3.2 Test Mode

The Test Mode contains test and informational label selections:





- Print Quality Label
- Print Configuration
- Ribbon Test Label
- Test Label
- Validation Label
- Print Last Label
- Network Report

Internally generated, these labels are printed at pre-selected media type, speed, and heat settings. Changes to these print settings can be made via the Menu System or through host commands. When printing, use full width media to capture the entire format; otherwise, adjust the printer and set the Label Width menu setting.







(1) Press the CANCEL KEY to stop printing.

(2) A printing delay can be set; see Print Test Rate in the Diagnostics menu branch.

	Enters the Test mode menu/sub-menu items. Prints the chosen test label.
	Scrolls upward to the next menu item. Increments the Count value.
	Scrolls downward to the next menu item. Decrements the Count value.
	Exits the Test menu mode
	Displays the 'Count' screen.

### 3.3.3 Menu Mode

The menu mode is covered in detail in Chapter 4.

	Enters the Menu mode menu/sub-menu items. Enter/Accepts current prompt.
	Scrolls upward to the next menu item. Increments the current value.
	Scrolls downward to the next menu item. Decrements the current value.
	Exits to the previous menus level
	Enters the next menu/sub-menu item.



## 3.4 Printer Configuration Tools

The printer contains many user adjustable parameters. These parameters are configurable using a few methods. The table below lists the most popular ways of configuring the printer and the advantages of each. Choose the method that best addresses your application.

Method	Description	Pros	Cons	For More Info
NETira CT Program*	NETira CT (located on the Accessories CD-ROM) is a Windows based configuration utility that allows the user to make changes to the existing printer setup via a direct connection to the host computer's serial, USB, Ethernet, or parallel connection.	Easy to use, gives the user the most control of the printer.	Software must be installed on a Windows based host computer.	See Section 3.5
Internal Web Pages*	Internal web pages are simple HTML pages that can be accessed with any web browser via the optional Ethernet port.	Easy to use. Printer can be configured from any host connected to the network regardless of physical location or host operating system.  No additional software required.	Printer must be equipped with an Ethernet or Wi-Fi option.  Depending on the complexity of the network, initial connection may not be possible until network parameters are set via another method.	See Appendix B
Windows Driver	The Windows printer driver (located on the Accessories CD-ROM).	Many applications require use of driver for printing from 3 <sup>rd</sup> party applications. This can be an all in one solution for some users that do not require advanced setups.	Requires installation of a driver on a Windows based host.  Only basics parameters can be configured.	See Section 3.6
DPL Programming Commands	DPL Programming Language commands can be built into custom label formats or sent individually to the printer.	DPL commands can be built directly into label formats which can configure the printer on the fly.	DPL programming knowledge needed.	See the <i>Programmer's Manual</i>

\* Recommended methods

## 3.5 Printer Configuration Utility (NETira CT)

NETira CT (located on the Accessories CD-ROM) is a Windows-based configuration utility that allows the user to make changes to the existing printer setup via a direct connection to the host computer's serial, USB, Ethernet, or parallel ports.

NETira Features:

- Allows Real-Time Control/Query of Printer Configuration
- Define and Save Optimal Configurations for Applications
- Saved Configurations can be Shared with other Printers and Sent via Email
- Download Files, Formats and Fonts
- Query Memory Modules



Be sure to use the NETira utility located on the Accessories CD-ROM that is included with your printer. Older versions might not operate correctly with some printers. For the latest version please visit our web site at <http://www.datamax-oneil.com>



Be sure your printer's firmware version is **9.03\_0016B or greater**. Firmware is available from our website, for the latest version please visit our web site at <http://www.datamax-oneil.com>

## USB and Parallel Port Connection Requirements

Using Netira CT with an USB or parallel port connection requires a Windows driver to be installed and the driver to be set to "Print directly to the printer". Install the Windows driver as described in section 3.6. Then follow the steps below to set the driver setting:

1) Open the list of installed printers on your PC.

*Windows XP*

Open Printer and Faxes by clicking the Start button, and then Settings, and then click on Printer and Faxes.

*Windows 7*

Open Devices and Printers by clicking the Start button, and then click on Devices and Printers.

2) Right click on the printer and select Properties from the drop down menu.

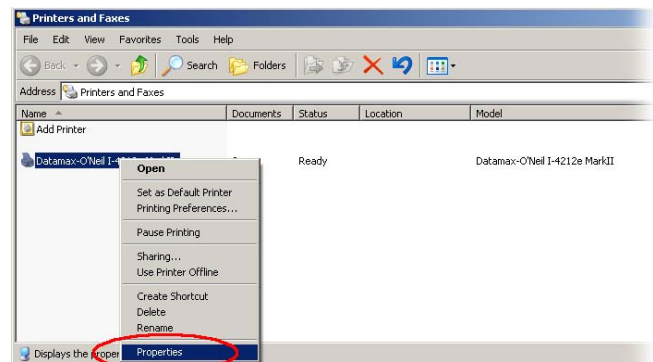

3) In the Driver Properties window, click on the Advanced tab.

4) Click the "Print directly to the printer" radio button. Then click OK.

*USB and parallel port connections will now be available for use with Netira CT.*

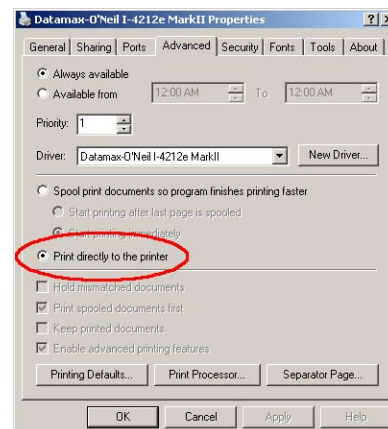

## NETira CT Usage

- 1) Once installed launch the NETira CT configuration utility:
- 2) Be sure the printer is 'ON'. Connect the host to the printer (see Section 2.2.2 Interface Connections).

### For Serial Connections:

- a) Query the printer by using the 'Auto Detect' button. This will connect to the printer and retrieve the setting currently stored in the printer.

### For USB and Parallel Connections:

Close the 'Open a configuration file...' dialogue box.

- a) In the toolbar, from the drop down menu box, select the appropriate port Then click on the Query Printer Icon .

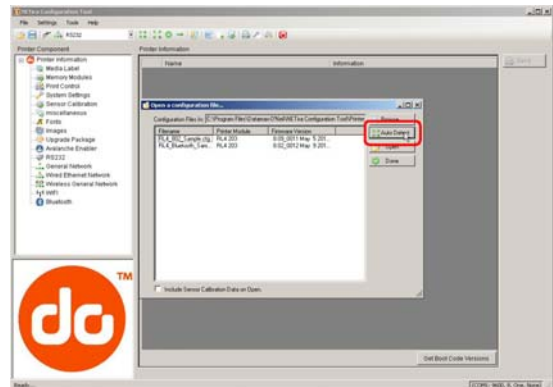

### For Ethernet Connections:

Close the 'Open a configuration file...' dialogue box.

- a) In the toolbar, Click on the 'TCP/IP Configuration' Icon .
- b) In the 'TCP/IP Configuration' dialogue box enter the IP address of the printer, Port: 9100 and click 'OK'. (The IP address is displayed on the printer's Network Report and Configuration Labels).

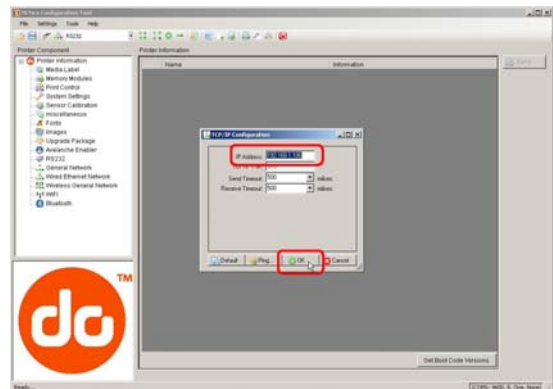

- c) In the toolbar, from the drop down menu box, select "TCP\_IP". Then click on the Query Printer Icon .

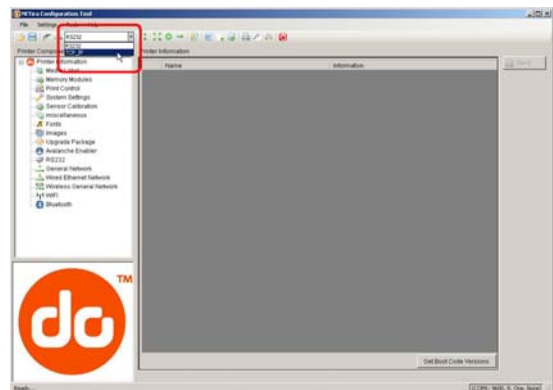

- 3) At this point you may browse the Printer Component categories and make any changes necessary to the printer configuration.

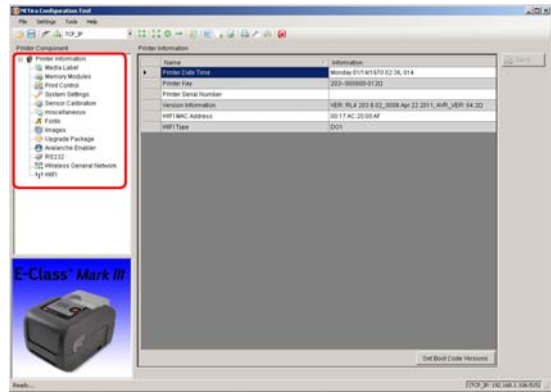

- 4) Once complete, send the new settings to the printer using the 'Send' button.

Note: When sending the changes to the printer, only the changes displayed on the current page will be sent. You must click the 'Send' button for each page that has been modified.

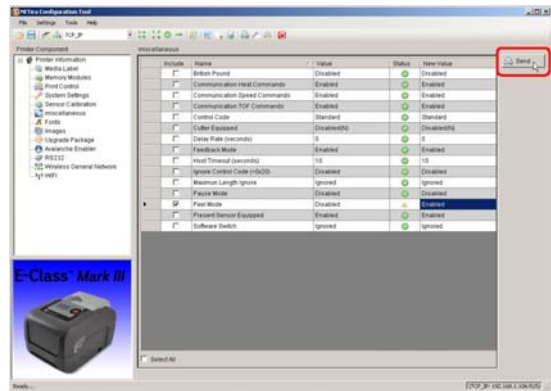

## 3.6 Windows Driver

The Windows driver is located on the Accessories CD-ROM included with your printer. For the latest version please visit our web site at <http://www.datamax-oneil.com>

- 
- Be sure your printer's firmware version is **9.03\_0016B or greater**. Firmware is available from our website, for the latest version please visit our web site at <http://www.datamax-oneil.com>
- 

- Be sure your printer's USB Mode is set to "Printer". This mode can be viewed/changed via the printer's front panel menu under: Communications> USB Port> USB Device Class.
- 

Installing the Windows Driver:

- 1) Place the Accessories CD-ROM included with your printer into your computers CD-ROM drive.
- 2) Once the CD-ROM starts select your printer model then "Install Driver" from the menu and follow the instructions on the screen to install.



- 3) When prompted, select your printer from the list, (i.e. Datamax-O'Neil E-4xxx Mark III). Continue to follow the on-screen instructions to install the driver.

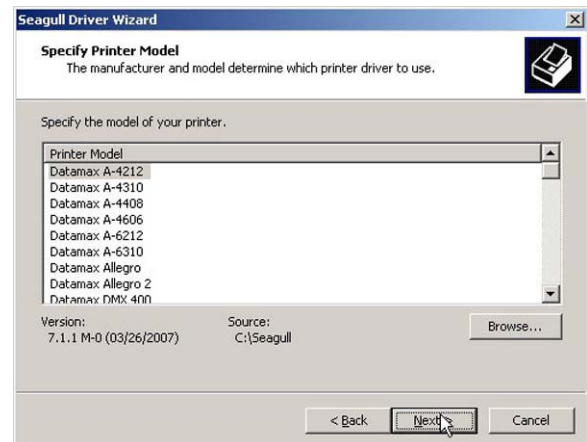

## Important Notes:

The Windows driver functions the same as any other Windows printer. While built-in help files provide information on all settings, there are some important setting parameters that should be observed for trouble free printing:

### Page Setup Tab: Stock

It is important that the Stock setting matches the size of the label you are using. If you cannot find a match for your label click New and enter the dimensions of your label.

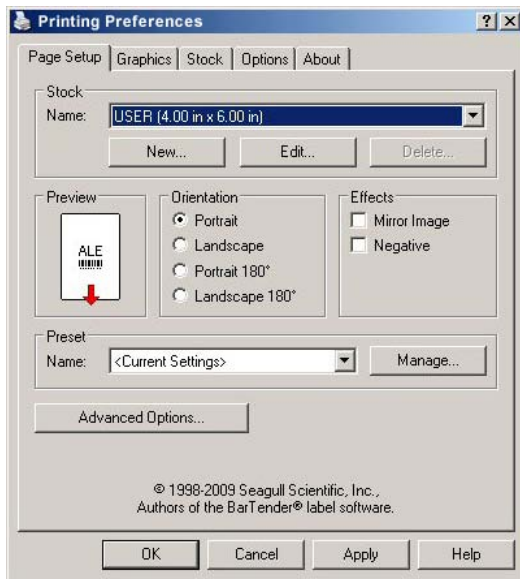

### Options Tab: Print Speed & Printhead Temperature

These two settings will have the greatest effect on print quality. Some label stocks will require more heat and slower print speeds to generate a quality image.

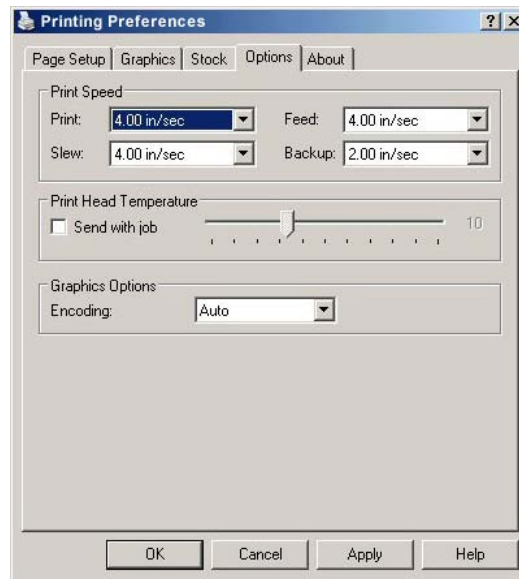

The Windows application software used to create the label format will likely have a "Page Setup" screen. This will also need to match the size of the label you are using.

## 3.7 Media Calibration

### 3.7.1 Quick Calibration

Ensure the printer is properly loaded with media, proceed with calibration as follows:



- This calibration is not necessary when using continuous stock.
- Media containing large gaps may require a change in the Paper Out Distance before proceeding.

Calibrate the printer as follows:

Step	Action	Displayed Message	Comment
A	Turn ON the printer.		Wait briefly for initialization to complete.
B	Using the  button scroll to MENU and press the  button.  Make sure MEDIA SETTINGS is highlighted and press the  button.  Then using the  button, scroll to SENSOR CALIBRATION.	(Printer Menu)	
C	Press the  button to access SENSOR CALIBRATION.  Make sure QUICK CALIBRATION is highlighted and press the  button.  Using the  button, scroll to YES and then press the  button to proceed.	Quick Calibration  No >Yes	Select NO to abort this procedure.
D	With the media installed and the cover closed, press and hold the  button until at least 2 full labels have been fed from the printer and then release.	Press/Hold Enter Key	

There are two possible outcomes:

CALIBRATION COMPLETE - will be displayed, and the media will be advanced to the next top of form if calibration was successful; or,

CALIBRATION FAILED will be displayed if calibration was not successful. In this case, check the hints listed below to help resolve the problem:

#### Calibration Hints:

WARNING LOW BACKING is a normal message when calibrating die-cut media mounted on a highly translucent liner or notched tag stocks.













If the initial attempt fails, perform the Manual Calibration routine, see Section 3.7.2.

### 3.7.2 Manual Calibration

The Manual Calibration can be performed using the NETira CT Utility (see Section 3.5) or using the front panel buttons via the printer's menu, see Section 4.4.

Manual Calibration provides dynamic readings, which can be helpful when using media with small position-critical notches or marks.

Calibrate the Media Sensor using the steps below:

Step	Action	Displayed Message	Comment
A	Turn ON the printer.		Wait briefly for initialization to complete.
B	Using the  button scroll to MENU and press the  button.  Make sure MEDIA SETTINGS is highlighted and press the  button.  Then using the  button, scroll to SENSOR CALIBRATION.	(Printer Menu)	
C	Press the  button to access SENSOR CALIBRATION.  Make sure MANUAL CALIBRATION is highlighted and press the  button.  Using the  button, scroll to YES and then press the  button to proceed.	Manual Calibration  No >Yes	Select NO to abort this procedure.
D	With no media installed and the cover closed, press the  button.	Remove Label Stock  Press Enter  Yyy	This sets the empty value, where "yyy" represents the current sensor reading.
E	Load the media. Be sure the Media Sensor is positioned correctly.  With the media installed and the cover closed, press and hold the  button until at least 2 full labels have been fed from the printer and then release.	Please Reload Media Press/Hold Enter Key  yyy	<i>Unless otherwise noted, do not move the Media Sensor after this step.</i>
F	Observe the calibration result.	Calibration Complete	Calibration was successful.   <i>If WARNING LOW BACKING is displayed, calibration was still successful.</i>
G	Press the  repeatedly to exit the menu, select YES at the SAVE CHANGES prompt and then press the  button.		The printer is now ready for use.











### 3.7.3 Advanced Entry Calibration

Advanced Entry is an alternate calibration method for special-case media types, where sensor readings are taken using different sampling algorithms and from a list of these readings the best algorithm is selected for manual entry into the database.

Advanced Entry Calibration should be used only when Manual Calibration proves unsuccessful.

Calibrate the Media Sensor using the steps below:

The Sensor Calibration menu item is only accessible in the Advanced Menu mode.

Step	Action	Displayed Message	Comment
A	Turn ON the printer.		Wait briefly for initialization to complete.
B	Using the  button scroll to MENU and press the  button.  Make sure MEDIA SETTINGS is highlighted and press the  button.  Then using the  button, scroll to SENSOR CALIBRATION.	(Printer Menu)	
C	Press the  button to access SENSOR CALIBRATION.  Make sure ADVANCED ENTRY is highlighted and press the  button.	ADVANCED ENTRY	
D	Scroll to TRAN SENSOR GAIN (or REFL SENSOR GAIN, if using reflective media) then press the  button.	TRAN SENSOR GAIN 17  (0 - 31)	The following examples detail die-cut media calibration; however, unless otherwise noted, the reflective media procedure is the same.
E	Install media. Position the Media in the Media Sensor and close the cover.	TRAN SENSOR GAIN 17  (0 - 31)	<input checked="" type="checkbox"/> <i>Do not position the Media Sensor under a perforation; and if using preprinted media, ensure the label area placed over the sensor is free of text, graphics, lines, etc.</i>

**Advanced Entry Calibration (continued)**

Step	Action	Displayed Message	Comment
F	<p>Using the ▼ or ▲ button, set the Gain Number to 0.</p> <p>Record the sensor reading as a Label Value for Gain Number 00 in a table (32 rows by four columns, with headings similar to those shown below.)</p>	<p>TRAN SENSOR GAIN</p> <p>0</p> <p>253</p> <p>(0 - 31)</p>	<p>This is the Label Value for a gain setting of 0.</p>

Gain Number	Label Value	TOF Value	Difference Value
00	253		
01			
02			
...			
31			

Step	Action	Displayed Message	Comment
G	<p>Using the ▲ button, increment the Gain Number by one and then Record the Label Value.</p> <p>Repeat this process for each Gain Number.</p>	<p>TRAN SENSOR GAIN</p> <p>1</p> <p>250</p> <p>(0 - 31)</p>	<p>This is the Label Value for a gain setting of 1.</p>

Gain Number	Label Value	TOF Value	Difference Value
00	252		
01	250		
02	248		
...	...		
31	09		

**Advanced Entry Calibration (continued)**

Step	Action	Displayed Message	Comment
H	<p>Raise the cover assembly then proceed according to the media type:</p> <p>Die-cut – Remove a label or two from the liner then position the liner in the Media Sensor.</p> <p>Notched – Position the Media in the Media Sensor under the notch.</p> <p>Reflective – Position the Media in the Media Sensor under the black mark.</p>	<p>TRAN SENSOR GAIN</p> <p>31</p> <p>09 (0 - 31)</p>	<p>(1) Do not position the Media Sensor under a perforation; and if using preprinted media, ensure the label area placed over the sensor is free of text, graphics, lines, etc.</p> <p>(2) Do not move the Media Sensor after this step.</p>
I	<p>Lower and latch the Cover Assembly.</p> <p>Using the ▼ or ▲ button, set the Gain Number to 0.</p> <p>Record the reading as a TOF Value for Gain Number 0 in the table.</p>	<p>TRAN SENSOR GAIN</p> <p>0</p> <p>248 (0 - 31)</p>	<p>This is the TOF Value for a gain setting of 0, where “248” represents the current sensor reading.</p>

*Sample Calibration Table*

Gain Number	Label Value	TOF Value	Difference Value
00	252	248	
01	250		
02	248		
...	...		
31	09		

**Advanced Entry Calibration (continued)**

Step	Action	Displayed Message	Comment
J	Using the ▲ button, increment the Gain Number by one. Record the TOF Value. Repeat this process for each Gain Number.	TRAN SENSOR GAIN 1 245 (0 - 31)	These are TOF Values, where "245" represents the current sensor reading.

*Sample Calibration Table*







Gain Number	Label Value	TOF Value	Difference Value
00	252	248	
01	250	245	
02	248	234	
...	...	...	
31	09	14	

Step	Action	Displayed Message	Comment
K	<p>In your sample calibration table, where both the Label Value and TOF Value are at least 20, subtract the amounts and record the result as a Difference Value (see below).</p> <p>Identify the largest Difference Value and the corresponding Gain Number. This Gain Number will be used to resample the media.</p>	TRAN SENSOR GAIN 31 14 (0 - 31)	In the example below, Gain Number 18 is chosen because; both values are at least twenty and it has the highest Difference Value.

*Sample Calibration Table*

















Gain Number	Label Value	TOF Value	Difference Value
00	252	248	4
01	250	245	5
02	248	234	14
...	...	...	...
15	188	63	125
16	184	51	133
17	179	38	141
18	174	25	149
19	170	19	N/A
...	...	...	...
31	132	14	N/A

**Advanced Entry Calibration (continued)**

Step	Action	Displayed Message	Comment
L	Using the  or  button, set the Gain Number determined in the previous step. Press the  button to enable the setting.		This example uses Gain Number 18.
M	<p>Press the  button again to re-enter the TRAN SENSOR GAIN (or REFL SENSOR GAIN, if using reflective media) menu item.</p> <p>Complete a table (see example below) using new measurements, as follows:</p> <p>(A) Raise the Cover Assembly. Place the label over the Media Sensor then lower and latch the Cover Assembly. Record the sensor reading as "<i>Paper</i>".</p> <p>(B) Raise the Cover Assembly. Place the liner, notch, or mark over the Media Sensor then lower and latch the Cover Assembly. Record the sensor reading as "<i>Gap (or Mark)</i>".</p> <p>(C) Raise the Cover Assembly. Remove all media from the Media Sensor then lower and latch the Cover Assembly. Record the sensor reading as "<i>Empty</i>".</p>	<p>TRAN SENSOR GAIN</p> <p>18</p>  (0 - 31)	<p>Where "yyy" is a numerical value representing the current sensor reading.</p> <p><input checked="" type="checkbox"/> <i>The re-sampled values may differ from those previously noted. This is normal; do not readjust the Media Sensor.</i></p>

<i>Gain Number</i>	<i>Paper</i>	<i>Gap (or Mark)</i>	<i>Empty</i>
18	174	42	9

**Advanced Entry Calibration (continued)**

Step	Action	Displayed Message	Comment
N	<p>Press the  button to exit the current menu level.</p> <p>Using the  button, scroll to PAPER SENSOR LEVEL (or if using reflective media, REFL PAPER LEVEL) and then press the  button.</p> <p>Using the  or  button, set the Paper value determined in Step M and then press the  button.</p>	<p>PAPER SENSOR LEVEL</p> <p>174 (0 - 255)</p>	This is the Paper value.
O	<p>Using the  button, scroll to GAP SENSOR LEVEL (or, if using reflective media, MARK SENSOR LEVEL) and then press the  button.</p> <p>Using the  or  button, Set the Gap (or Mark) value determined in Step M and then press the  button.</p>	<p>GAP SENSOR LEVEL</p> <p>042 (0 - 255)</p>	This is the Gap (or Mark) value.
P	<p>Using the  button, scroll to EMPTY SENSOR LEVEL and then press the  button.</p> <p>Set the Empty value determined in Step M and then press the  button.</p>	<p>EMPTY SENSOR LEVEL</p> <p>9 (0 - 255)</p>	This is the Empty value.
Q	<p>Press the  repeatedly to exit the menu, select YES at the SAVE CHANGES prompt and then press the  button.</p>	<p>Save Changes?</p> <p>No &gt;Yes</p>	Save Changes. The printer is ready for use.

If the calibration attempt fails, try desensitizing the sensor as follows:

- Go to MEDIA SETTINGS / SENSOR CALIBRATION / ADVANCED ENTRY / TRAN (or REFL) SENSOR GAIN and lower the corresponding GAIN SETTING by one.
- Exit the menu and save your changes. Test your media at the new setting. If necessary, repeat until a usable Gain Setting is obtained.



# 4 Menu System

## 4.1 Menu System Overview

---

The Menu System contains two modes, each with a differing level of access to secondary menus or functions:

- The User Menu accesses basic printer settings and functions
- The Advanced Menu accesses all operational settings, functions, and diagnostics

---

 Prompts may appear before menu access is granted and before changes are enacted; see Security for details.

---

## 4.2 The User Menu

---

The User Menu contains basic selections in these menus:

- Media Settings
- Print Control
- Printer Options
- System Settings

---

(1) Some setting changes will only become effective (and saved) after selecting YES at the Save Changes prompt.



(2) Labeling software may, in some cases, override the printer menu settings; see Advanced Menu for details.

---









## 4.3 The Advanced Menu

---

The Advanced Menu contains all setting, control, and functional selections in these menus:

- Media Settings
- Print Control
- Printer Options
- System Settings
- Communications
- Diagnostics

After selecting the Advanced Menu, it will be shown whenever the **MENU** branch is accessed. To enable the Advanced Menu, proceed as follows:

1. Press the  button to scroll to MENU and then press the  button.
2. Using the  button, scroll to SYSTEM SETTINGS then press the  button.
3. Be sure the cursor is next to MENU MODE then press the  button.
4. Using the  button, scroll to ADVANCED MENU then press the  button. (Upon completion, OK will be displayed and the printer will exit the menu system.)

---

(1) Some setting changes will only become effective (and saved) after selecting YES at the Save Changes prompt.



(2) Labeling software may, in some cases, override the printer menu settings; see Advanced Menu / Communications / Host Settings to avoid potential conflicts.

(3) To return to the User Menu, re-select it or restore the factory defaults.

---

## 4.4 Menu Details

### Media Settings

The Media Settings menu contains label and ribbon sensing and sizing functions, as well as printhead cleaning selections:

- Media Type
- Media Index Type
- Auto Calibration\*
- Label Length
- Maximum Label Length\*
- Paper Empty Distance\*
- Label Width
- Ribbon Low Options\*
- Sensor Calibration\*
- Printhead Cleaning\*

 Items denoted with an asterisk (\*) are only accessible through the Advanced Menu.

The menu selections are defined as follows:

DISPLAYED ITEM	ITEM DESCRIPTION
MEDIA TYPE	Selects the method used to print labels and should be set according to the type of media being used, where:
DIRECT THERMAL	Sets use for media that is heat reactive to produce an image.
THERMAL TRANSFER	Sets use for media that requires a ribbon to produce an image.
MEDIA INDEX TYPE	Selects the top-of-form (TOF) sensing method used to determine the leading edge of the label, where:
GAP	TOF will be recognized by sensing the gaps in the media. (Default Setting)
NOTCH	TOF will be recognized by sensing the notches on the edge of the media.
HOLE	TOF will be recognized by sensing the holes in the field of the media.
BLACK MARK	TOF will be recognized by sensing the reflective (black) marks on the underside of the media.
CONTINUOUS	No TOF sensing will be used; instead, LABEL LENGTH (in Media Settings) is used.
AUTO CALIBRATION	The printer will sense each label as it exits the printer and continually make sensor adjustments to ensure the best possible calibration.
ENABLE	(Default Setting)
DISABLE	Printer will use the stored calibration values
LABEL LENGTH	Determines the length of the label (0 - 99.99 inches) when the SENSOR TYPE is set to CONTINUOUS, where:
4.00	Is the default setting.
MAXIMUM LABEL LENGTH	Sets the distance (0 - 99.99 inches) that the printer will feed media to find TOF (when the Sensor Type is set to GAP or REFLECTIVE) before a TOF Fault is declared, where:
8.00	Is the default setting.

 Maximum Label Length should typically be 2.5 to 3 times the physical length of the label.

PAPER EMPTY DISTANCE	Sets the distance (0 - 99.99 inches) the printer will attempt to feed before an Out Of Stock Fault is declared, where:
0.25	Is the default setting.

 When using clear or translucent media, this setting should be longer than the actual label size.

LABEL WIDTH	Sets the maximum printable width. Objects extending beyond this setting will NOT print, where:
4.00	Is the default setting.

DISPLAYED ITEM	ITEM DESCRIPTION
RIBBON LOW OPTIONS	Defines the printer response when THERMAL TRANSFER mode is selected and the ribbon supply begins to diminish.
RIBBON LOW DIAMETER	Sets the ribbon supply threshold diameter (1.00 - 2.00 inches) that will trigger a Low Ribbon Warning prompt, where:
0.50	Is the default setting.
PAUSE ON RIBBON LOW	Allows the printer to enter a paused condition when Ribbon Low Diameter is met, where:
ENABLE	Pauses when a Ribbon Low Diameter condition is detected; the PAUSE Key must be pressed to proceed with the print job.
DISABLE	No action is required by the operator; printing can continue until a Ribbon Fault is declared. (Default Setting)
SENSOR CALIBRATION	Selects the media sensor calibration method, where:
QUICK CALIBRATION	Sets the values via internal printer calculations by feeding blank labels through the printer.
MANUAL CALIBRATION	Manual calibration that scans media and backing and out of stock condition to calculate the proper calibration.
ADVANCED ENTRY	Sets the values via manual entry (typically for hard to calibrate label stocks), as described in the ADVANCED ENTRY CALIBRATION where:
PAPER SENSOR LEVEL	Establishes the threshold for the paper value (0 - 255), where 170 is the default setting.
REFL PAPER LEVEL	Establishes the threshold for the reflective value (0 - 255), where 170 is the default setting.
GAP SENSOR LEVEL	Establishes the threshold for the gap value (0 - 255), where 040 is the default setting.
MARK SENSOR LEVEL	Establishes the threshold for the mark value (0 - 255), where 040 is the default setting.
EMPTY SENSOR LEVEL	Establishes the threshold for the empty value (0 - 255), where 000 is the default setting.
TRAN SENSOR GAIN	Establishes the sensitivity of the transmissive sensor (0 - 31), where 15 is the default setting.
REFL SENSOR GAIN	Establishes the sensitivity of the reflective sensor (0 - 31), where 15 is the default setting.
PRINTHEAD CLEANING	Controls the automatic cleaning alert and function, where:
CLEAN HEAD SCHEDULE	Specifies the inch (or centimeter) count at which to clean the printhead, and if exceeded three times, declare a Head Cleaning Fault. (Note that the specified count [0 - 200 inches] will be multiplied by one thousand, and that zero [the default setting] will disable the function.)
CLEAN HEAD COUNTER	Indicates the number of inches (or centimeters) since a cleaning was last initiated.
RESET COUNTER	Resets the Clean Head Counter to zero to restart the Clean Head Schedule.
CLEAN HEAD NOW	Initiates the cleaning process and resets the Clean Head Counter.

## Print Control

The Print Control menu contains printing throughput, offset and custom setup functions:

- Heat
- Print Speed
- Feed Speed
- Reverse Speed\*
- Slew Speed\*
- Row Offset
- Column Offset
- Present Distance
- TOF Precedence\*
- Custom Adjustments\*



Items denoted with an asterisk (\*) are only accessible through the Advanced Menu.

The menu selections are defined as follows:

DISPLAYED ITEM	ITEM DESCRIPTION
HEAT	Controls the burn time (0 - 30) of the printhead (and is equivalent to the Heat setting in many software labeling programs), where:
10	Is the default setting.
PRINT SPEED	Controls the rate of label movement during printing, where:
x.x in/sec	Default setting is dependant on printer model.
FEED SPEED	Controls the rate of label movement between printing areas, where:
x.x in/sec	Default setting is dependant on printer model.
REVERSE SPEED	Controls the rate of label movement (2.0 - 5.0 inches per second) during backup positioning, where:
2.0 in/sec	Is the default setting.
SLEW SPEED	Controls the rate of label movement (2.0 - 16.0 inches per second) between printing areas when using the GPIO function, where:
x.x in/sec	Default setting is dependant on printer model.
ROW OFFSET	Shifts the vertical start of print position (0 - 99.99 inches) on the label, where:
0.00 in.	Is the default setting.
COLUMN OFFSET	Shifts the HORIZONTAL, left-justified start of print position to the right (0-99.99 inches), without shifting the LABEL WIDTH termination point to the right, where:
0.00 in.	Is the default setting.
PRESENT DISTANCE	Sets the label stop position (0 - 4.00 inches) past the start of print position upon output. When subsequent label formats are received, the printer will automatically back up the label to position it at the start of print position, where:
0.00 in.	Is the default setting.



When set to 0.01 in., NONE is assumed and a zero (0) positioning value will be used.

TOF PRECEDENCE	Allows an override of label format data when the form length is exceeded, where:
DISABLE	Prints labels formats without TOF truncating. (Default Setting)
ENABLE	Ends the label at the next TOF, truncating any print data that extends past this mark.
CUSTOM ADJUSTMENTS	Changes the factory adjustment parameters to finely and independently compensate for slight mechanical differences sometimes evident when multiple printers share label formats. These settings are also available to make special label formatting adjustments, where:
DARKNESS	Controls the strobe time (1 - 64) to establish the nominal HEAT setting for printhead-specific thermal characteristics, where:
32	Is the default setting.
CONTRAST	Allows fine-tuning (1 - 64) of the gray adjustment for print quality, where:
32	Is the default setting.
ROW ADJUST	Shifts the vertical start of print position (in xxx dots) to fine-tune the ROW OFFSET setting, where:
+0 (-100 – 2030 DOTS)	If shifting Row Adjust in the negative direction, modify the PRESENT ADJUST setting (see below) by that same amount.
COLUMN ADJUST	Shifts both the horizontal start of print position and the LABEL WIDTH termination point to the right (in xxx dots) to fine-tune the COLUMN OFFSET setting, where:
+000 (-100 – 100 DOTS)	Is the setting.
PRESENT ADJUST	Adjusts the label stopping position (in xxx dots) to fine-tune the PRESENT DISTANCE setting, where:
+000 (-100 – 100 DOTS)	Is the setting.

## Printer Options

The Printer Options menu contains file-handling, module, and optional equipment settings:

- Modules
- Present Sensor
- Cutter

The menu selections are defined as follows:

DISPLAYED ITEM	ITEM DESCRIPTION																								
MODULES	Controls memory handling functions, where:																								
DIRECTORY	Allows viewing and printing of the available space and file types (including plug-in files) present on a module. Only detected modules will be listed, and selecting ALL will display all results. (See the <i>Programmer's Manual</i> for memory allocation information.)																								
PRINT FILE	Prints selections from stored file types: <table border="1" data-bbox="435 600 1383 890"> <thead> <tr> <th>File Extension</th> <th>Printed Result</th> </tr> </thead> <tbody> <tr> <td>DBM</td> <td>A font sample.</td> </tr> <tr> <td>DCM</td> <td>The configuration commands contained in the file.</td> </tr> <tr> <td>DIM</td> <td>The image.</td> </tr> <tr> <td>DLB</td> <td>The stored label.</td> </tr> <tr> <td>DLN</td> <td>The name of the language.</td> </tr> <tr> <td>DMS</td> <td>The database contained in the file for RFID.</td> </tr> <tr> <td>DPL</td> <td>A label format, if detected.</td> </tr> <tr> <td>DTT</td> <td>A font sample.</td> </tr> <tr> <td>PLU</td> <td>The names of the files contained in the plug-in directory.</td> </tr> <tr> <td>PRN</td> <td>Is processed as a DPL file.</td> </tr> <tr> <td>TXT</td> <td>Is processed as a DPL file.</td> </tr> </tbody> </table>	File Extension	Printed Result	DBM	A font sample.	DCM	The configuration commands contained in the file.	DIM	The image.	DLB	The stored label.	DLN	The name of the language.	DMS	The database contained in the file for RFID.	DPL	A label format, if detected.	DTT	A font sample.	PLU	The names of the files contained in the plug-in directory.	PRN	Is processed as a DPL file.	TXT	Is processed as a DPL file.
File Extension	Printed Result																								
DBM	A font sample.																								
DCM	The configuration commands contained in the file.																								
DIM	The image.																								
DLB	The stored label.																								
DLN	The name of the language.																								
DMS	The database contained in the file for RFID.																								
DPL	A label format, if detected.																								
DTT	A font sample.																								
PLU	The names of the files contained in the plug-in directory.																								
PRN	Is processed as a DPL file.																								
TXT	Is processed as a DPL file.																								
PROCESS FILE	Processes a selected file for use by the printer.																								
FORMAT MODULE	Selects from a list of modules available for formatting by the printer. Choosing FORMAT MODULE will erase existing data in the selected module																								
DELETE FILE	Selects from the list of available files for deleting.																								
COPY FILE	Selects from the list of available files for copying, prompting you for the destination module before execution.																								
UNPROTECT MODULE	Selects from the list of available modules to unprotect, and then prompting you regarding the outcome of the attempt.																								
PRESENT SENSOR	Controls the "on-demand" dispensing of labels , where:																								
MODE	Sets the detection method and response of the printer:																								
ENABLED	Enables the Present Sensor (or Peel and Present mechanism) and sets the label stop location; if not detected, a fault will be generated.																								
DISABLED	Disables the option.																								
RETRACT DELAY	Programs a time delay for the retraction of the next label in the print process, where:																								
(1 - 255 x 10 mS) 070	Is the range, times 10 milliseconds; and Seventy (times ten) is the default setting.																								
CUTTER	Controls the Cutter operation, where:																								
MODE	Sets the detection method and response of the printer:																								
DISABLED	Disables the cutter.																								
AUTO	Is the default setting, where the presence of the cutter option is automatically sensed. If detected, the cutter is enabled; otherwise, it will be ignored.																								
ENABLED	Enables the cutter. If the cutter is not detected, a fault will be generated.																								

## System Settings

The System Settings menu contains label formatting, operation, and control functions:

- Menu Mode
- Configuration File
- Internal Module\*
- Default Module\*
- Scaleable Font Cache\*
- Single Byte Symbols\*
- Double Byte Symbols\*
- Time And Date
- Media Counters\*
- Print Configuration\*
- Configuration Level\*
- Set Factory Defaults\*
- Format Attributes\*
- Label Rotation
- Imaging Mode\*
- Pause Mode\*
- Peel Mode\*
- Security\*
- Units Of Measure\*
- Input Mode\*
- User Label Mode\*
- DPL Emulation\*
- Column Emulation\*
- Row Emulation\*
- SOP Emulation\*
- Back After Print\*
- Font Emulation\*
- Label Store\*
- Menu Language
- Display Settings\*
- Fault Handling\*
- Buzzer\*
- SCL Font Bold Factor\*



Items denoted with an asterisk (\*) are only accessible through the Advanced Menu.

The menu selections are defined as follows:

DISPLAYED ITEM	ITEM DESCRIPTION
MENU MODE	Sets the menu access level, where:
USER MENU	Accesses limited basic menu items.
ADVANCED MENU	Accesses all menu items.
CONFIGURATION FILE	Controls the creation, storage, and recall of printer configuration files, where:
RESTORE AS CURRENT	Returns the printer to a previously saved configuration.
SAVE SETTING AS	Creates a file based on the current printer configuration, as described here.
DELETE FILE	Removes a selected configuration file from memory. (An active file cannot be deleted.)
FACTORY SETTING FILE	Provides a list of available configuration files used to restore the printer's configuration following a Level One Reset or when YES is selected in the SET FACTORY DEFAULTS menu. (NONE is the default file setting.)
INTERNAL MODULE	Sets the number of 1KB blocks (100 - 5120) allocated for the internal DRAM 'D' module, where:
1024	Is the Default Setting.
DEFAULT MODULE	Designates the memory module to be used for file storage when not specified, where:
D	Is the Default Setting (DRAM module).
G	Flash module.



The available modules may vary depending upon printer model and options.

DISPLAYED ITEM	ITEM DESCRIPTION
SCALEABLE FONT CACHE	Configures the number of 1KB blocks (128 - 512) allocated for the scaleable font engine, where:
384 KBytes	Is the Default Setting.
SINGLE BYTE SYMBOLS	Selects the code page used to print single byte fonts, including:

ARABIC-8	ISO 15: ITALIAN	ISO 17: SPANISH
CYRILLIC	LEGAL	ISO 11: SWEDISH
ISO 60: DAN/NOR	HP4000 ZAPF DINGBAT	SYMBOL
DESKTOP	MATH-8	TURKISH-8
ITC ZAPF DINGBAT/100	MACINTOSH	PS TEXT
ITC ZAPF DINGBAT/200	PS-MATH	UTF-8
ITC ZAPF DINGBAT/300	PC-858 MULTILINGUAL	ISO 4: UK
PS ITC ZAPF DINGBAT	MICROSOFT PUBLISHING	ISO 6: ASCII
ISO 8859/1 LATIN 1	PC-8 CODE PAGE 437	VENTURA INTERNATIONAL
ISO 8859/2 LATIN 2	PC-8 D/N, CP 437N	VENTURA US
ISO 8859/5 LATIN 5	PC-852 LATIN 2	VENTURA MATH
ISO 8859/10 LATIN 6	PC-851 LATIN/GREEK	WINDOWS 3.1 LATIN 1
ISO 8859/7 LT/GK E7	PC-862 LATIN/ARABIC	WINDOWS LATIN/ARABIC
ISO 8859/15 LATIN 9	PI FONT	AGFA TIDBITS
ISO 8859/7 LT/GK EG	PC-850 MULTILINGUAL (Default Setting)	WINDOWS 3.1 LATIN 2
ISO 8859/8 LATIN/HBR	PC-864 LATIN/ARABIC	WINDOWS LATIN/GREEK
ISO 8859/8 LATIN/CYR	PC-8 TK, CP 437T	WINDOWS 3.1 LATIN 5
ISO 69: FRENCH	PC-1004	WINDOWS
GREEK-8	PC-775 BALTIC	WINDOWS 3.0 LATIN 1
PC-8 GREEK	PTXT3000	WINDOWS LATIN/CYRIC
ISO 21: GERMAN	NON-UGL, PI FONT	WINDOWS 3.0 LATIN 5
HEBREW-7	ROMAN-8	
HEBREW-8	ROMAN-9	



Reference the *Programmer's Manual* for code page symbol set details.

DOUBLE BYTE SYMBOLS	Selects the optional ILPC code page used to print double byte fonts, where:
JIS	Japanese Industry Standard
SHIFT JIS	Shift Japanese Industry Standard
EUC	Extended UNIX Code
UNICODE	Unicode (including Korean). (Default setting)
GB	Government Bureau Industry Standard; Chinese (PRC)
BIG 5	Taiwan encoded





Reference the *Programmer's Manual* for the code page symbol set details.

TIME AND DATE	Sets the printer's time and date.
MEDIA COUNTERS	Displays and controls various internal counters, where:
ABSOLUTE COUNTER	Shows the total number of inches printed and the date the counter was set (non-resettable).
RESETTABLE COUNTER	Shows the number of inches printed since the last reset (user-resettable).
RESET COUNTER	Returns the Resettable Counter to zero.
PRINT CONFIGURATION	Produces a Configuration Label using the printer's current database information.

(1) The information varies with the model, firmware version, and installed options.



(2) To capture all the data, use media that is at least 2 inches (51 mm) wide and set the Label Width (in Media Settings) according to the width of your labels.

DISPLAYED ITEM	ITEM DESCRIPTION
CONFIGURATION LEVEL	Displays the hardware and software levels of the printer, where:  <input checked="" type="checkbox"/> This information is also provided on the Configuration Label.
PRINTER KEY	Identifies the unique key number of the printer, in the form: vvvv-cwxx-yyyyyy-zzz, where:  vvvv - Represents the printer model number. cwxx - Represents the hardware/software feature level, where: c - Represents the printer class. w - Represents hardware feature level of the main board. xx - Represents the software feature level (10 = standard DPL, and 20 = Internal CG Times Font). Features are accepted up to this value, but increases beyond the range will require an authorization code. yyyyyy - Is the manufacturing date code. zzz - Is a unique time stamp.
APPLICATION VERSION	Displays the level, version number, and date of the application firmware.
BOOT LOADER	Displays the version level of the boot loaders.
UPGRADE PRINTER CODE	Upgrades the software feature level of the printer.
UNLOCK FEATURE	Unlocks additional optional features within the printer. (An authorization code is required.)
SET FACTORY DEFAULTS	Returns the printer settings to the factory-programmed values (except CUSTOM ADJUSTMENTS and calibrations); or, if selected, to the Factory Setting File, where selecting YES at the prompt causes the configuration to be restored.
FORMAT ATTRIBUTES	Defines the manner in which overlapping text and graphics appear when printed, where:
TRANSPARENT	Intersecting text, images, and bar codes will be printed, for example: 
XOR	Intersecting text, images, and bar codes will not be printed, for example:  (Default Setting)
OPAQUE	Intersecting text, images, and bar codes will be printed by obliterating those formatted first, for example: 
LABEL ROTATION	Allows the label format to be rotated 180 degrees before printing, where:
ENABLED	Flips the format.
DISABLED	Does not flip the format. (Default Setting)
IMAGING MODE	Determines the process used to format labels, where:
MULTIPLE LABEL	Images multiple labels as memory permits to achieve the fastest throughput. If time-stamping labels, however, the indicated time will reflect the moment of imaging rather than the actual print time. (Default Setting)
SINGLE LABEL	Images the next label only after the previous label has been printed, providing the most accurate time-stamps but at a slower throughput rate.
PAUSE MODE	Allows for controlled interactive printing, where:
ENABLED	Requires you to press the PAUSE Key to print each label.
DISABLED	Labels are printed without pausing. (Default Setting)
PEEL MODE	Allows the printer to wait until the Start of Print signal is received (via the optional GPIO Port) to feed a label, where:
ENABLED	Inhibits the feed function until the Start of Print signal is received.
DISABLED	Feeds the label regardless of the Start of Print signal. (Default Setting)
SECURITY	Allows all or part of the User Interface to be password-protected and for that password to be modified:
SELECT SECURITY	Allows password to be set for specific User Interface areas, where:
DISABLED	No password is required for menu access. (Default Setting)
SECURE MENU	Sets a password requirement for User and Advanced menu entry.
MENU AND TEST	Sets a password requirement for all menu entries.
ADVANCED MENU	Sets a password requirement for Advanced menu entry. (After enabling this selection, make it effective by returning the Menu Mode to the User setting; see above.)
MODIFY PASSWORD	Modifies the four-digit password required when security is enabled. For modification, the code must be reentered when prompted to confirm.

To be activated, the password must initially be set to a value other than the default setting (0000).



DISPLAYED ITEM	ITEM DESCRIPTION
UNITS OF MEASURE	Sets the measurement standard used, where:
IMPERIAL	Uses inches. (Default Setting)
METRIC	Uses millimeters and centimeters.
INPUT MODE	Defines the type of processing that will occur when data is received, where:
DPL	Processes data for standard DPL printing.
LINE	Processes data for Line Mode (template) printing.
PL-Z	Alternative programming language processing will be used, with the exception of the following DPL specific-parameters: DPL Emulation; SOP Emulation; and Label Store.
PL-I	Processes data for PL-I printing.
PL-B	Processes data for PL-B printing.
AUTO	Identifies then activates the appropriate emulation parser for the data.
USER LABEL MODE	Sets the printer to power-up as default, where:
ENABLED	Functions in standalone mode for quick access to user defined formats.  <input checked="" type="checkbox"/> This mode will remain active until disabled.
↔DISABLED	Functions in normal mode, awaiting commands from a host. (Default Setting)
DPL EMULATION	Allows the printer to reproduce, for backward compatibility, label formats with the same characteristics as those produced by legacy models, where:
STANDARD	Standard DPL processing will be used for printing. (Default Setting)
ALLEGRO	Processes DPL data as an Allegro®, including row position calculations based on 194 dots per inch and the exceptions noted below.
PRODIGY PLUS	Processes DPL data as a Prodigy Plus®, including column calculations based on 200 dots per inch and the exceptions noted below.
PRODIGY	Processes DPL data as a Prodigy®, including column calculations based on 200 dots per inch and the exceptions noted below.

---

Exceptions:

- Data Terminator processing – When printing 1 2 of 5 bar codes D, J, and L, the first non-numeric character processed will terminate the bar code data field.
- Bar Size exception – When printing 1 2 of 5 bar code L, if the bar size specified is greater than P (25) it is automatically decreased to 10.
- Human Readable Fonts fixed size – When printing EAN and UPC bar codes B, C, F, G, M, and N, a fixed font size is produced.
- Line and box vertical sizing anomaly – When printing rotations 2 and 4, lines and boxes are affected by the vertical multiplication factor defined in the DPL Dxx command.
- Column position defaults – Column positions greater than the printhead width are adjusted back to the printable area then printed.
- Bar codes in rotation 3 - (upside down / right to left) default sizing – When row position in rotation 3 is less than bar code height, bar codes falling off the label's leading edge are pushed back onto the label.
- <STX>L command – When no printable fields reside in the format, it results in no label movement.

---

DISPLAYED ITEM	ITEM DESCRIPTION
COLUMN EMULATION	Allows the column dots per inch to be adjusted (153 - 253 dots), so that numbers smaller than the printhead resolution reduce the printed output from right to left, where:
XXX Dots	Default setting is dependant on printer model.
ROW EMULATION	Allows the row dots per inch to be adjusted (103 - 303), so that numbers smaller than the printhead resolution enlarge the height of the printed output and numbers larger reduce it, where:
XXX Dots	Default setting is dependant on printer model.
SOP EMULATION	Allows label positioning commands to function with backward compatibility when printing label formats designed for legacy models, where:
DISABLED	Produces the natural start of print position. (Default Setting)
110 (PRODPLUS)	Emulates the Prodigy Plus® start of print position.
220 (ALLEGRO)	Emulates the Allegro® start of print position.
250 (PRODIGY)	Emulates the Prodigy™ start of print position.
BACK AFTER PRINT	Determines media movement when a cutter, present sensor, peel and present, or GPIO is enabled, where:
MODE	Repositions media, where:
DISABLED	Movement occurs only when the next label is ready to print, minimizing edge curling. (Default Setting)
ENABLED	Movement occurs according to BACKUP DELAY timing after a cut, cleared sensor, or SOP to allow fastest throughput.
BACKUP DELAY (1/50s)	Instructs the printer to retract a presented label after a specified time elapses (0 – 255, in one-fiftieth of a second increments), where:
000	Retraction occurs when the next label is received and processed. (Default Setting)
FONT EMULATION	Allows font substitution for all internal fonts where:
STANDARD FONTS	Prints using a standard (internal) font. (Default Setting)
CG TIMES	Prints using the CG Times font.
USER ID S50	Prints using a downloaded font.
LABEL STORE	Determines the command recall level used when retrieving stored label formats, where:
STATE & FIELDS	Recalls the printer state (i.e., heat, speed settings, etc.) and the label-formatting commands for the stored label. (Default Setting)
FIELDS ONLY	Recalls the label-formatting commands for the stored label.
MENU LANGUAGE	Selects the menu and configuration label language. Only languages that are resident will be displayed (see Appendix D), where:
ENGLISH	Enables English (Default Setting)
DISPLAY SETTINGS	Determines the appearance of the items in the display, where:
GRAPHIC DISPLAY MODE	Determines the magnification of the displayed items, where:
STANDARD	Is the normal setting.
ENHANCED	Is the enlarged setting.
DISPLAY UNITS	Determines the displayed type of distance information, where:
STANDARD	Displays the information according to the UNITS OF MEASURE setting (see above).
IMPERIAL	Displays the information in inches.
METRIC	Displays the information in millimeters and centimeters.
DISPLAY BACKLIGHT	Controls the mode and "ON" time of the display's backlight
BACKLIGHT MODE	Sets the mode in which the backlight is activated. Choices are Always On, Always Off, or Auto.
AUTO ON TIME	Set the amount of time the backlight will remain on. BACKLIGHT MODE (see above) must be set to auto.
DISPLAY CONTRAST	Adjusts the displays contrast (0-100), where:
50	Is the default setting
FAULT HANDLING	Determines the intervention required and the disposition of the label in process when a fault occurs, where:
LEVEL	Selects the user action and the reprint status upon declaration of a fault, where:
NO REPRINT	Printing stops and a fault message is displayed. Following correction of the problem, the FEED Key must be pressed to clear the fault, but the label in process is not reprinted.
STANDARD	Printing stops and a fault message is displayed. Following correction of the problem, the FEED Key must be pressed to clear the fault then the label in process is reprinted. (Default Setting.)
BUZZER	Sets a scalable font boldfacing amount, where:
ENABLED	Enables the printers buzzer. (Default Setting)
DISABLED	Disables the printers buzzer.
SCL FONT BOLD FACTOR	Sets a scalable font boldfacing amount, where:
08 (1 – 36)	Is the setting, based on an incrementing scale, where eight (08) is nominal.

## Communications

The Communications menu contains interface and host control functions:

- Serial Port A\*
- Parallel Port A\*
- USB Port\*
- Network/Bluetooth\*
- Host Settings\*



Items denoted with an asterisk (\*) are only accessible through the Advanced Menu.

The menu selections are defined as follows:

DISPLAYED ITEM	ITEM DESCRIPTION
SERIAL PORT A	Controls the RS-232 communications settings for Serial Port A, where:
BAUD RATE	Sets the serial communication rate, where:
(1200 – 115KBPS)	Is the range, in Bits Per Second; and,
9600 BPS	is the Default Setting.
PROTOCOL	Sets the data flow control (handshaking) method, where:
BOTH	XON/XOFF and CTS/DTR are used. (Default Setting)
SOFTWARE	XON/XOFF is used.
HARDWARE	CTS/DTR is used.
NONE	Flow control is not used.
PARITY	Sets word parity, where:
NONE	Parity is not used. (Default Setting)
ODD	Odd parity is used.
EVEN	Even parity is used.
DATA BITS	Sets word length, where:
(7 - 8)	A seven or eight bit word is selectable; and,
8	is the Default Setting.
STOP BITS	Sets the number of stop bits, where:
(1 - 2)	One stop or two stop bits are selectable; and,
1	is the Default Setting.
PARALLEL PORT A	Controls the communication setting for the parallel port, where:
PORT DIRECTION	Determines if data is returned from the printer, where:
UNI-DIRECTIONAL	No data is returned; communication is one-way.
BI-DIRECTIONAL	Data is returned in compliance with IEEE 1284 back-channel operation. (Default Setting)
	 An IEEE 1284 bidirectional cable is required.
USB PORT	Controls the communication setting for the USB port
USB DEVICE CLASS	Defines the USB port type
PRINTER	Sets the printer for use as a typical Windows printer
CDC	Sets the printer for use with handled PC's and similar devices
COMPOSITE	Combines both Printer and CDC classes. (Default Setting)

DISPLAYED ITEM	ITEM DESCRIPTION
NETWORK/BLUETOOTH	Controls the communications settings for the network and Bluetooth interfaces, where:
ACTIVE INTERFACE	Selects the network interface currently in use by the printer, where:
NONE	Disables all interfaces
WIRED ETHERNET	Selects the Wired Ethernet interface
WIRELESS ETHERNET	Selects the Wireless Ethernet interface (if installed)
BLUETOOTH	Selects the Bluetooth interface (if installed)
WIRED ETHERNET	Controls the communications settings for the wired Ethernet network interface
IP DISCOVERY	Sets the address discovery method, where:
USE STATIC ADDRESSES	The stored static IP, Subnet Mask, and / or Gateway Address will be used.
USE DHCP	The card broadcasts over the network using DHCP protocol to receive addresses from the responsible server at startup. Manual modifications to IP Address, Subnet Mask, or Gateway Address are not allowed; and, if no server is found, the specified static value will be used. (Default Setting)  <input checked="" type="checkbox"/> A server assigned IP address takes precedence over any static IP address stored in the interface.
USE BOOTP	The card broadcasts over the network using BOOTP protocol to receive addresses from the responsible server at startup. Manual modifications to IP Address, Subnet Mask, or Gateway Address are not allowed; and, if no server is found, the specified static value will be used. (Default Setting)  <input checked="" type="checkbox"/> A server assigned IP address takes precedence over any static IP address stored in the interface.
STATIC IP ADDRESS	Specifies the static IP Address of the interface in the standard octet format.
STATIC SUBNET MASK	Specifies the static Subnet assigned to the interface, for example: 255.255.255.000.
STATIC GATEWAY	Specifies the Gateway Address the interface will use, for example: 192.168.10.1
DUPLEX CAPABILITY	Specifies the transmission and speed of the wired Ethernet connection: <ul style="list-style-type: none"> <li>• Auto-Negotiate (default);</li> <li>• 10 BaseT Half Duplex</li> <li>• 10 BaseT Full Duplex</li> <li>• 100 BaseT Half Duplex</li> <li>• 100 BaseT Full Duplex</li> </ul>
PRIMARY WINS SERVER	The IP address of the primary WINS Server.
SECONDARY WINS SERVER	The IP address of the secondary WINS Server.
PRIMARY DNS SERVER	The IP address of the primary DNS Server.
SECONDARY DNS SERVER	The IP address of the secondary DNS Server.
SNMP TRAP ADDRESS	Is the address in standard octet format where SNMP traps will be sent when SNMP service is installed on your receiver. When zeroed, no traps are sent.
SNMP SERVER ADDRESS	Is the server address in standard octet format for SNMP services.
NETBIOS ENABLE	Enables or disables the NET BIOS SERVICES
NO	(Default Setting)
YES	
TCP PRINT PORT	Selects the Port to use for all TCP network communications; Default is 9100
INACTIVITY TIME	Set the amount of time ( <i>in seconds</i> ) in which the current port will remain open when no activity is present.
LPD PRINT PORT	Selects the Port to use for all LPD network communications; Default is 515

DISPLAYED ITEM	ITEM DESCRIPTION
WIRELESS ETHERNET	Controls the communications settings for the wireless Ethernet network interface, where:
IP DISCOVERY	Sets the address discovery method, where:
USE STATIC ADDRESSES	The stored static IP, Subnet Mask, and / or Gateway Address will be used.
USE DHCP	The card broadcasts over the network using DHCP protocol to receive addresses from the responsible server at startup. Manual modifications to IP Address, Subnet Mask, or Gateway Address are not allowed; and, if no server is found, the specified static value will be used. (Default Setting)
	<input checked="" type="checkbox"/> A server assigned IP address takes precedence over any static IP address stored in the interface.
USE BOOTP	The card broadcasts over the network using BOOTP protocol to receive addresses from the responsible server at startup. Manual modifications to IP Address, Subnet Mask, or Gateway Address are not allowed; and, if no server is found, the specified static value will be used. (Default Setting)
	<input checked="" type="checkbox"/> A server assigned IP address takes precedence over any static IP address stored in the interface.
STATIC IP ADDRESS	Specifies the static IP Address of the interface in the standard octet format.
STATIC SUBNET MASK	Specifies the static Subnet assigned to the interface, for example:255.255.255.000.
STATIC GATEWAY	Specifies the Gateway Address the interface will use, for example:192.168.10.1
BLUETOOTH	Controls the communications settings for the Bluetooth network interface, where:
DISCOVERABLE	Yes/No; Determines whether other Bluetooth devices in range can detect the printer.
CONNECTABLE	Yes/No; Determines whether other Bluetooth devices in range can connect to the printer.
BONDABLE	Yes/No; Determines whether other Bluetooth devices in range can create a "bondable" connection with the printer
AUTHENTICATION REQUIRED	Yes/No; Determines whether passkey is required to the printer.
ENCRYPTION	Yes/No; Determines whether encryption is used during data transfer to the printer.
INACTIVE DISCONNECT TIME	(0-65535 in seconds); Default: 60 Set the amount of time ( <i>in seconds</i> ) in which the current connection will remain open when no activity is present.
POWER DOWN TIME	(0-65535 in seconds); Default: 60 Set the amount of time ( <i>in seconds</i> ) in which the Bluetooth module will remain on when no activity is present.
GENERAL NETWORK	Controls general communication parameters, where:
SNMP ENABLE	Sets SNMP
NO	(Default Setting)
YES	
TELNET ENABLE	Enable/Disable Telnet protocol
NO	(Default Setting)
YES	
FTP SERVER ENABLE	Enable/Disable FTP protocol
NO	(Default Setting)
YES	
HTTP SERVER ENABLE	Enable/Disable FTP protocol
NO	
YES	(Default Setting)
LPD PRINT ENABLE	Enable/Disable LPD protocol
NO	
YES	(Default Setting)
TCP PRINT ENABLE	Enable/Disable TCP protocol
NO	
YES	(Default Setting)
NETCENTER ENABLE	Enable/Disable Netcenter compatibility
NO	(Default Setting)
YES	
GRATUITOUS ARP	Sets time interval for ARP transmission packets, where: (0-100 minutes); Default is 0
NETWORK REPORT	Print or view on screen the printers network information.

DISPLAYED ITEM	ITEM DESCRIPTION
HOST SETTINGS	Controls the communications with a host device, where:  <input checked="" type="checkbox"/> The "ignore host" settings for ESC SEQUENCES, HEAT, SPEED, TOF SENSING, SYMBOL SET, CNTRL-CODES, STX-V SW SETTINGS, and MAX LENGTH will be unaffected when PL-Z Mode is selected (see Input Mode for details).
HOST TIMEOUT	Sets the number of seconds (1 - 60) that an established communications port must be idle before data can be received through an alternate port, where:  <input checked="" type="checkbox"/> If the time-out period is exceeded before all data is received, the data will be ignored.
10	Is the Default Setting.
CONTROL CODES	Allows changes to the prefix of the software commands interpreted by the printer, where:
STANDARD CODES	Use these characters: Hex 01 = SOH command; Hex 02 = STX command; count-by = ^; Hex 1B = ESC; Hex 0x0D = Carriage Return. (Default Setting)
ALTERNATE CODES	Use these characters: Hex 5E = SOH command; Hex 7E = STX command; count-by = @; Hex 1B = ESC; Hex 0x0D = Carriage Return.
ALTERNATE CODES 2	Use these characters: Hex 5E = SOH command; Hex 7E = STX command; count-by = @; Hex 1B = ESC; Hex 0x7C = Carriage Return.
CUSTOM CODES	Each DPL command (SOH, STX, CR, and count-by) may be selected by entering the desired Hex code.
FEEDBACK CHARACTERS	Allows the printer to return a Hex 1E (RS) after each label successfully prints, and a Hex 1F (US) after each label batch successfully prints, where:
ENABLED	Sends feedback characters to the host.
DISABLED	Does not send feedback characters to the host. (Default Setting)
ESC SEQUENCES	Allows data containing invalid ESC control code sequences to be processed, where:
ENABLED	Processes commands normally. (Default Setting)
DISABLED	Ignores ESC sequences during processing (since some systems send a "banner" to the printer). Bitmapped font downloads are disabled in this mode.
HEAT COMMAND	Determines the way the DPL Heat command is handled, where:
ENABLED	Processes commands normally. (Default Setting)
DISABLED	Ignores DPL Heat commands; instead, the heat value is controlled via the menu setting.
SPEED COMMANDS	Determines the way DPL Print, Feed, Slew, and Reverse commands are handled, where:
ENABLED	Processes commands normally. (Default Setting)
DISABLED	Ignores DPL speed commands; instead, the speeds are controlled via the menu setting.
TOF SENSING COMMANDS	Determines the way in which DPL Gap, Continuous, and Reflective commands are handled, where:
ENABLED	Processes commands normally. (Default Setting)
DISABLED	Ignores DPL TOF commands; instead, TOF is controlled via the menu setting.
SYMBOL SET COMMAND	Determines the way in which DPL Single and Double Symbol Set commands are handled, where:
ENABLED	Processes commands normally. (Default Setting)
DISABLED	Ignores DPL Symbol Set commands; instead, the Symbol Set selection is controlled via the menu setting.
CNTRL-CODES (DATA)	Determines the way in which DPL SOH, STX, CR, ESC, and ^ codes are handled, where:
ENABLED	Processes commands normally. (Default Setting)
DISABLED	Ignores DPL Control Codes; instead, the control code functions are established via the menu setting.
STX-V SW SETTINGS	Determines the way in which the DPL <STX>V command is handled, where:
ENABLED	Processes commands normally. (Default Setting)
DISABLED	Ignores the option-enable command; instead, the option selections are controlled via menu settings.
MAX LENGTH COMMAND	Determines the way in which the DPL <STX>M command is handled, where:
ENABLED	Processes commands normally. (Default Setting)
DISABLED	Ignores the maximum label length command; instead, Maximum Label Length is controlled via the menu setting.
PROCESS SOH (DATA)	Determines the way the printer responds to an Immediate Command (e.g., Get Status, Module Storage, etc.), where:
ENABLED	Operations are interrupted upon receipt to process the command.
DISABLED	Processes commands normally. (Default Setting)

## Diagnostics

The Diagnostics menu contains testing functions and printhead reporting selections:

- Hex Dump Mode\*
- Options Testing\*
- Print Test Rate (min)\*
- Sensor Readings\*
- Ribbon Sensor Limits\*
- Flash Module Report\*



Items denoted with an asterisk (\*) are only accessible through the Advanced Menu.

The menu selections are defined as follows:

DISPLAYED ITEM	ITEM DESCRIPTION																				
HEX DUMP MODE	Determines how the printer handles the data received from a host, where:																				
ENABLE	The printer outputs the raw ASCII data it receives without interpretation; no processing occurs.																				
DISABLE	Processes data normally. (Default Setting)																				
FILE CAPTURE	Saves the incoming data to Module H (USB thumbdrive) if present; otherwise, the file is stored on Module G. The file name, in the form [dmx_xxx_yyy.dpl], where the count is automatically incremented for every capture and a unique printer time stamp (xxx), is assigned.																				
OPTIONS TESTING	Performs printer option diagnostics or monitors and outputs test results, where:																				
TEST PRESENT SENSOR	Performs a functional test of the Present Sensor by indicating LABEL PRESENTED (when a label blocks the sensor) and LABEL NOT PRESENTED (when no label blocks the sensor). (Note that this test can also be used to check the sensor function of the Peel & Present option.)																				
TEST CUTTER	Performs a functional test of the Cutter, where:																				
PERFORM TEST 001 TIMES	Cycles the cutter blade a selected number of times (0 - 999), with PASS / FAIL results given for each cycling attempt.																				
PRINT TEST RATE (MIN)	Sets a label-to-label delay interval (0 - 120 minutes) when Test label batch printing, where:																				
000	Is the Default Setting.																				
SENSOR READINGS	Displays the values (0 – 255) from the printer sensors, where: <table style="margin-left: auto; margin-right: auto; border-collapse: collapse;"> <tr> <td style="padding: 0 10px;">THR</td> <td style="padding: 0 10px;">TRAN</td> <td style="padding: 0 10px;">RIBM</td> <td style="padding: 0 10px;">24V</td> </tr> <tr> <td style="padding: 0 10px;">103</td> <td style="padding: 0 10px;">091</td> <td style="padding: 0 10px;">009</td> <td style="padding: 0 10px;">171</td> </tr> <tr> <td colspan="4"> </td> </tr> <tr> <td style="padding: 0 10px;">PS</td> <td style="padding: 0 10px;">HD</td> <td style="padding: 0 10px;">RANK</td> <td></td> </tr> <tr> <td style="padding: 0 10px;">003</td> <td style="padding: 0 10px;">255</td> <td style="padding: 0 10px;">050</td> <td></td> </tr> </table> <p>THR = Printhead thermistor sensor;            TRAN = Gap media sensor (REFL when set to reflective);            RIBM = Ribbon sensor;            24V = 24 volt power supply sensor;            PS = Present sensor;            HD = Printhead position sensor; and,            RANK = Printhead ranking resistor.</p>	THR	TRAN	RIBM	24V	103	091	009	171					PS	HD	RANK		003	255	050	
THR	TRAN	RIBM	24V																		
103	091	009	171																		
PS	HD	RANK																			
003	255	050																			
RIBBON SENSOR LIMITS	Displays the values from the ribbon sensor readings (see example below) for printers equipped with the thermal transfer option, where: <table style="margin-left: auto; margin-right: auto; border-collapse: collapse;"> <tr> <td style="padding: 0 10px;">RIBBON ADC LOW</td> </tr> <tr> <td style="padding: 0 10px;">111</td> </tr> <tr> <td colspan="2"> </td> </tr> <tr> <td style="padding: 0 10px;">RIBBON ADC HIGH</td> </tr> <tr> <td style="padding: 0 10px;">249</td> </tr> </table>	RIBBON ADC LOW	111			RIBBON ADC HIGH	249														
RIBBON ADC LOW																					
111																					
RIBBON ADC HIGH																					
249																					
FLASH MODULE REPORT	Displays the module report data, where:																				
VIEW	Displays the data.																				
PRINT	Prints a reference label: <div style="border: 1px solid black; padding: 10px; margin-left: auto; margin-right: auto; width: fit-content;"> <p><b>FLASH MODULE REPORT</b>              SUN 12:44PM 23MAY2011              Module G Mount Fail: 0              Module G Reformatted: 0</p> </div>																				

# 5 Maintenance & Adjustments

## 5.1 Introduction

This section details the cleaning, adjusting, and troubleshooting tips for the printer. The following table outlines the recommended maintenance schedule for the various printer parts.

Area	Method	Interval
Printhead	Turn OFF the printer before cleaning the printhead. Use solvent* applied with a cotton swab to clean the printhead from end to end.	After every roll of media.
Platen Roller	Turn OFF the printer. Rotate the platen roller and clean it thoroughly with solvent* applied with a cotton swab.	After every roll of media.
Peel-Off Roller	Rotate the peel-off roller and clean it thoroughly with solvent* applied with a cotton swab.	After every roll of media.
Media Path	Solvent*	After every roll of media.
Peel/Tear Bar	Solvent*	As needed
Media Sensor	Blown air or brush	Monthly
Exterior	Mild detergent or desktop cleaner.	As needed
Interior	Brush or vacuum cleaner	As needed.

\* A solvent containing isopropyl alcohol is recommended for use.



Isopropyl alcohol is a flammable solvent; always take the proper precautions when in use.



## 5.2 Cleaning the Printhead



Never use a sharp, hard, or abrasive object on the printhead.

If print quality declines (symptoms can include unreadable bar codes or streaks through text and graphics), the typical cause is debris buildup on the printhead which, left unattended, can lead to premature dot failure. Depending upon the supplies and printing parameters used, different cleaning methods are recommended.



Streaks can indicate a dirty or a faulty printhead.

Proper cleaning is critical. To maintain peak performance of the printer, Datamax-O'Neil offers a complete line of cleaning products including pens, cards, films and swabs. To learn more visit our [website](#).

### *Cotton Swab Procedure*

If printing with direct thermal media or thermal transfer media with wax ribbon, clean the printhead as follows:

- 1) Turn OFF the power switch and unplug the printer. Open the printer. **Wait briefly for the printhead to cool.**
- 2) Remove any installed media and ribbon. Using a Cotton Swab moistened (not soaked) with isopropyl alcohol, thoroughly clean the Printhead.

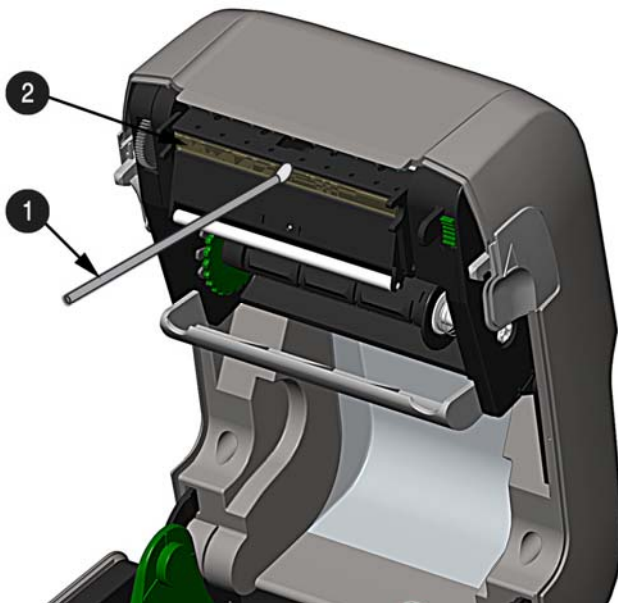

- 1 Cotton Swab with Solvent
- 2 Printhead

## ***Cleaning Card Procedure***

If printing with direct thermal media, thermal transfer media with wax/resin ribbon combinations, or if the Cotton Swab technique was not successful, clean the printhead as follows:

- 1) Open the printer. **Wait briefly for the Printhead to cool.**
- 2) Remove media and ribbon then place a Cleaning Card under the Printhead (part number 70-2013-01).
- 3) Close the cover then press the  button to initiate cleaning.
- 4) After the cleaning card has been run through the printer, reinstall media (and ribbon, if needed). Plug in and turn ON the printer. Run a few sample labels and examine them. If streaking is still present, use the Cleaning Film Procedure, below; otherwise, this completes cleaning.

## ***Cleaning Film Procedure***

If printing with thermal transfer media and resin ribbon, when printing with a Heat Value of 22 or higher, or when other methods prove unsuccessful, clean the printhead as follows:

- 1) Open the printer. **Wait briefly for the Printhead to cool..**
- 2) Remove media and ribbon then place a sheet of Cleaning Film under the Printhead (part number 70-2087-01).
- 3) Close the cover then press  button to initiate cleaning.
- 4) After the cleaning film has been run through the printer, turn OFF the Power Switch and unplug the printer. Open the cover and **wait briefly for the Printhead to cool.** Using a cotton swab moistened (not soaked) with isopropyl alcohol, clean the Printhead then allow it to dry.
- 5) Reinstall media (and ribbon, if needed). Plug in and turn ON the printer. Run a few sample labels and examine them. If streaking is still present, the Printhead may need to be replaced; see Section 5.5

## 5.3 Ribbon Tension Adjustment

The adjustable ribbon handler feature, found on printers equipped with the thermal transfer option, allows the optimum amount tension to be supplied by the ribbon supply hub. Adjust the ribbon tension as follows:

- 1) Turn 'off' the printer.
- 2) Hold the ribbon/ribbon hub to prevent it from turning. Then push in and rotate the Ribbon Tension Adjustment Knob to the position that matches the core size of the ribbon in use.

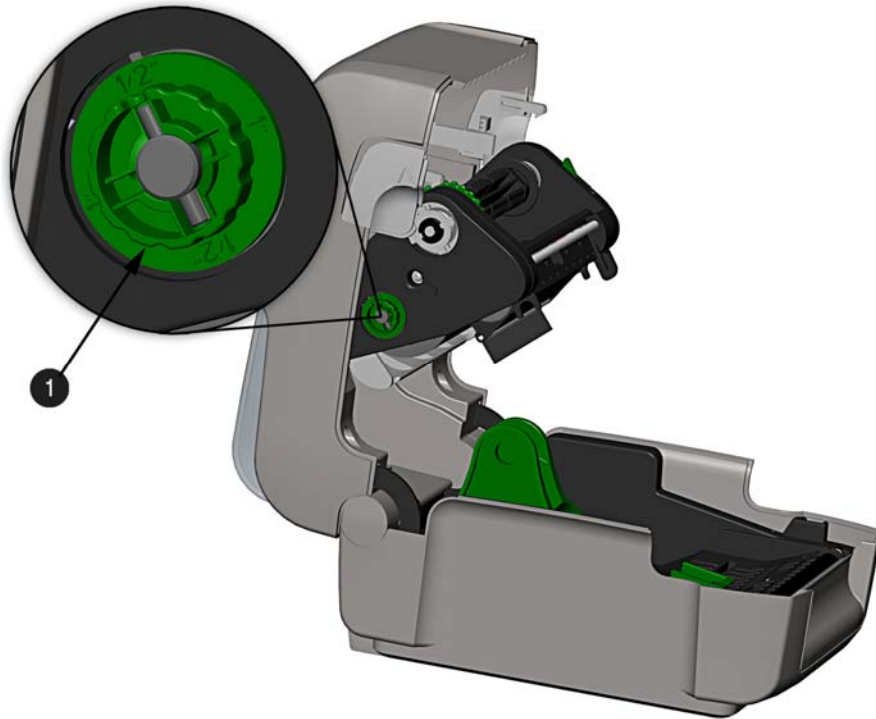

- ❶ Ribbon Handler
- ❷ Ribbon Tension Adjustment Knob

## 5.4 Adjustable Media Sensor

The optional Adjustable Media Sensor (AMS) allows the printer to accept a wider variety of media configurations. The table below defines general AMS positions for various media and Top of Form (TOF) types.

AMS Positioning		
Media Type	Sensor Location	TOF Sensing Method
Continuous	Any location in the media path with both sensors aligned.	Continuous (Only detects out of media)
Die-Cut	Any location within the media path where the gap between the labels crosses the sensors. (top and bottom sensors must be aligned)	Separate Die Cut and Notched. Use this for the Notched or Hole Media
Notched/Hole	Center of the Notch or Hole	Gap (primary) Reflective (secondary)
Black Bar	Center of the Black Mark	Reflective

Position the AMS as follows:

- 1) On the Bottom AMS Sensor, identify the proper Indicator for use with your media.

❶	Gap or Notch Indicator
❷	Reflective (Mark) Indicator
❸	Lock Release

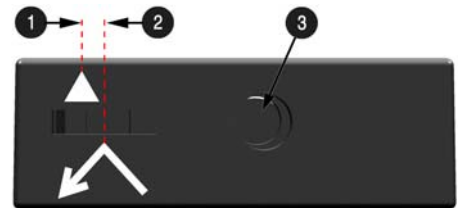

- 2) Depress the Lock Release and slide the Bottom AMS sensor so the Indicator is in line with the center of the notch, gap, or reflective (mark) of the installed media.
- 3) Depress the Lock Release and slide the Top AMS Sensor over to the same setting as the Bottom AMS Sensor, (this is not necessary if using reflective media).

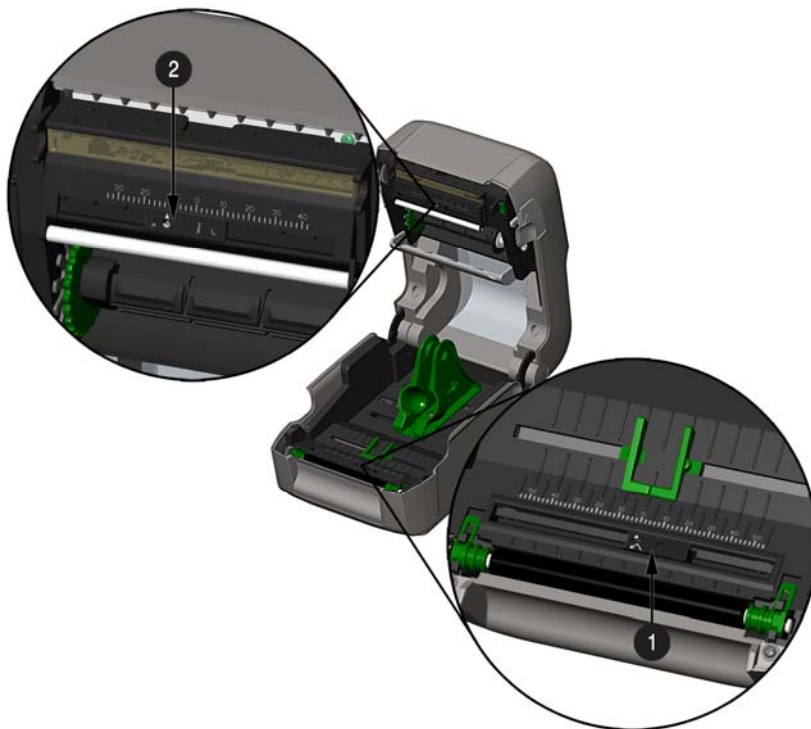

❶	Bottom AMS Sensor
❷	Top AMS Sensor

- 4) Load media, see Section 2.3.

## 5.5 Printhead Replacement

If the Printhead becomes damaged or worn, replace it as follows:



Always follow proper Electro Static Discharge procedures when replacing the printhead.

- 1) Turn OFF the printer and remove the ribbon if installed.
- 2) Lower the Ribbon Handler Assembly.
- 3) Press outward on the two Printhead Carrier Tabs and rotate the Printhead Carrier down.

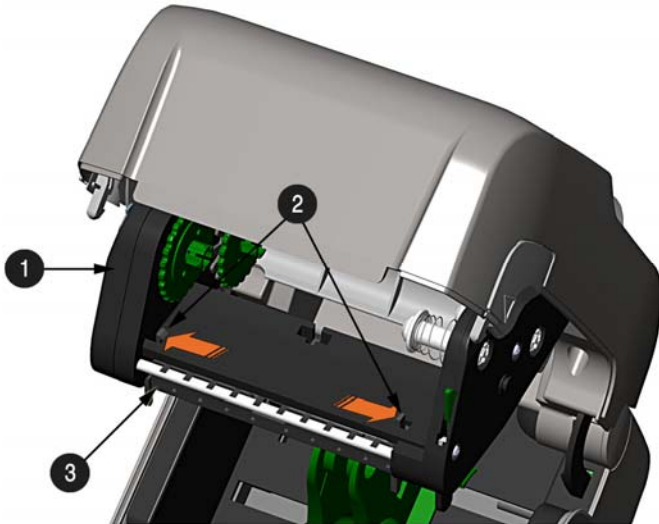

- 1 Ribbon Handler
- 2 Printhead Assembly Tabs
- 3 Printhead Carrier

- 4) Press inward on the two Printhead Shield Tabs and rotate the Printhead Shield down.

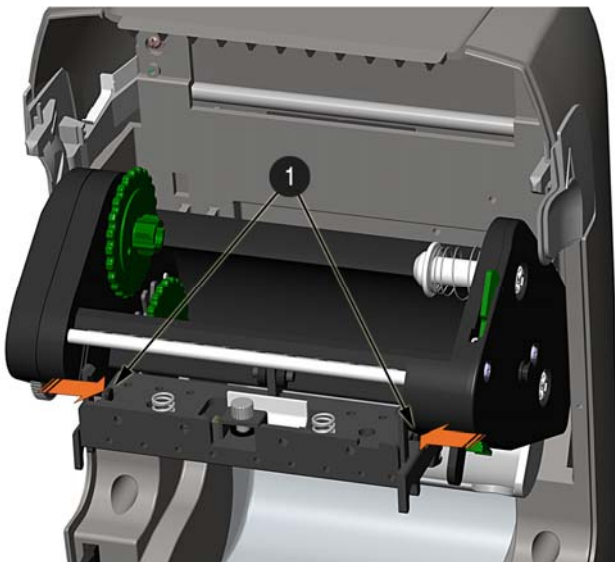

- 1 Printhead Shield Tabs

- 5) Loosen the Printhead Screw and allow the Printhead to fall free.
- 6) Remove the Printhead Cable.

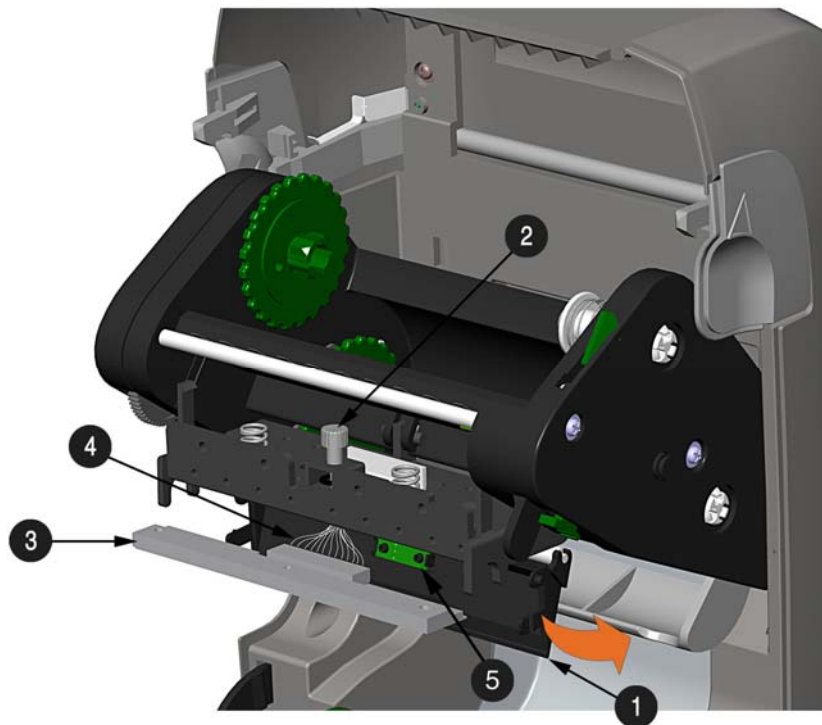

❶	Printhead Shield
❷	Printhead Screw
❸	Printhead
❹	Printhead Cable
❺	Sensor

**Installation:**

- 1) Carefully connect the Printhead Cable to the new Printhead.
- 2) Position the Printhead in the Printhead Carrier and tighten the Printhead Screw.
- 3) Ensure the Sensor properly seated and rotate the Printhead Shield upward until it snaps into place.
- 4) Rotate the Printhead Carrier upward until it snaps into place.

## 5.6 Platen Roller Replacement

The Platen Roller can be easily removed for cleaning, replacement, or clearing media jams.

- 1) Turn OFF the printer and remove the media if installed.
- 2) Lift up on the two Platen Roller Tabs.

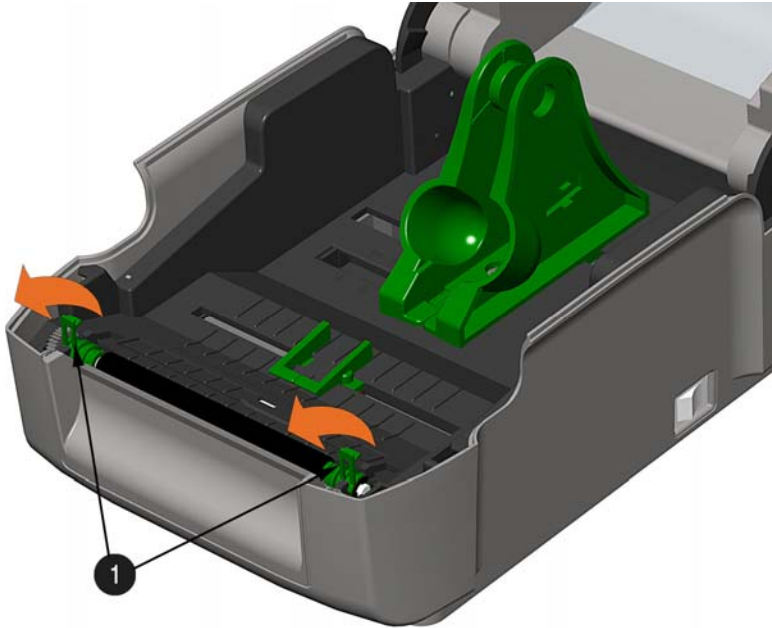

1 Platen Roller Tabs

- 3) Remove the Platen Roller Assembly from the printer.

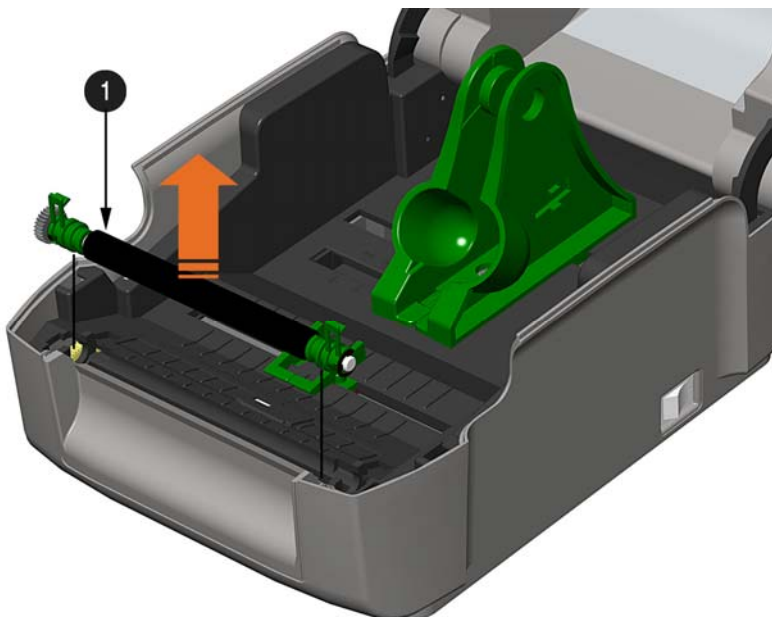

1 Platen Roller Assembly

### Installation:

- 1) Position the Platen Roller Assembly into the printer.
- 2) Rotate the two Platen Roller Tabs downward until they snap into place.



## 5.7 Updating Firmware

When program updates and/or new features are added, they can be downloaded to the printer as follows:

- 1) Identify the new version for your model of printer from the Datamax-O'Neil Web site at [www.datamax-oneil.com](http://www.datamax-oneil.com) and download it onto your computer's hard drive.
- 2) Launch the NETira CT configuration utility, and query (connect) to the printer, (see section 3.5 for more information on NETira CT).



It is recommended that the configuration be saved before downloading firmware, and restored when finished. Be sure to check the box labeled "Include Sensor Calibration Data on Open" when restoring the configuration.

- 3) Go to the Tools>Upgrade>Firmware. Select the binary file (BIN file).
- 4) Click the 'Send' button to start the firmware update.

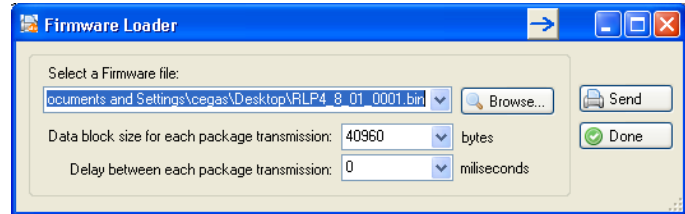

### 5.7.1 Boot 1 and Boot 2 Boot Loaders

- 1) Connect the printer to your PC using a serial cable
- 2) Launch the NETira CT configuration utility, and query (connect) to the printer, (see section 3.5 for more information on NETira CT).



It is recommended that the configuration be saved before downloading firmware, and restored when finished. Be sure to check the box labeled "Include Sensor Calibration Data on Open" when restoring the configuration.

- 3) Go to the Tools>Upgrade>Firmware. Select the binary files (BIN files) for each of the Boot files.
- 4) Check the "Select and Download Boot 1 file:", "Select and Download Boot 2 file:" and "Erase System and/or User Area" boxes and click send to initiate the download.



Always Check "Erase System and/or User Area" box unless otherwise instructed..

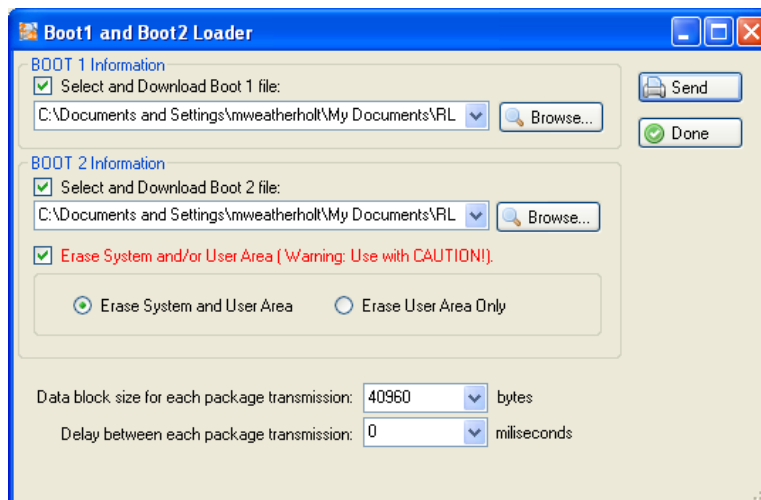

- 5) Once the Boot Loader files have been loaded, the firmware version can now be updated using the procedure outlined in section 5.7.





# 6 Troubleshooting

## 6.1 Introduction

---

Occasionally, situations arise that require troubleshooting. Possible problem situations and potential solutions are listed below. Contact a qualified technician for problems that persist or problems not covered in this section.

## 6.2 Troubleshooting Tips

---

The following section lists the symptoms and the associated page numbers of the topics covered. While not every situation is addressed, you may find some tips helpful. After a correction action is taken press the FEED Button to clear the alarm.

### **Unacceptable print quality:**

- Dirty printhead: Clean the printhead (see Section 5.2).
- The temperature setting may be incorrect for the media being used: Use the software program or DPL commands adjust the Heat Setting and Print Speed.
- A mismatched incorrect ribbon/media combination is being used: Check the types being used.
- Faulty printhead: Replace it (see Section 5.5) or call for service.

### **The printer does not print or prints several labels at once:**

- The labels are incorrectly loaded: See the loading instructions on the inside cover of the printer, or in Section 2.3.
- The media is not calibrated: Calibrate it (see Section 3.7).
- The media sensor or sensor circuitry may be defective: Call for service.

### **The ribbon does not advance (the paper advances, but ribbon does not):**

- The ribbon may be installed incorrectly: Ensure that the inked side of the ribbon faces the labels. With most ribbons this can be verified by rubbing paper against the ribbon; the ink should smudge the paper. Or, if using label stock, the sticky side of a label will pull off the ink.
- A mismatched ribbon/paper combination is resulting in an insufficient amount of friction between paper and ribbon: Ensure that the correct type of ribbon is being used with the media.

**Skips every other label** (print quality is good, but every other label is skipped):

- The label is formatted too close to the top edge of the label: Leave white space equal to 8-dot rows (about .02 inch [.5mm]) at the top of the label.
- The media is not calibrated: Calibrate it (see Section 3.7).
- The media sensor or media sensor circuitry may be defective: Call for service.

**Unable to print rotations:**

- The characters are formatted outside the dimensions of the label: Check that the row/column values provide enough room for the height of the image being printed.

**Light print on the right side of the label:**

- The printer's cover is not latched down: Latch it.
- The printhead is not properly aligned: Call for service.

**Printer fails to power ON:**

- The AC wall outlet may be faulty: Try another outlet.
- The power supply may be faulty: Replace it.
- Possible defective power switch: Call for service.

**Label advances 1-2 inches before a fault indication:**

- The ribbon may be incorrectly installed. Ensure that the inked side of the ribbon faces the labels. With most ribbons this can be verified by rubbing paper against the ribbon; the ink should smudge the paper. Or, if using label stock, the sticky side of a label will pull off the ink.
- A mismatched ribbon/paper combination is resulting in an insufficient amount of friction between paper and ribbon: Ensure that the correct type of ribbon is being used with the media.

**Label advances 12 inches before a fault indication:**

- The media may not be properly loaded: Reload it (see Section 2.3). When loading media ensure that the media hangers and media guides are against the media and that gaps or marks in the labels are in line with the media sensor.
- The media sensor or media sensor circuitry may be defective: Call for service.

**Labels move excessively from side to side during printing:**

- The media may not be properly loaded: Reload it (see Section 2.3). When loading media ensure that the media hangers and media guides are against the media and that gaps or marks in the labels are in line with the media sensor.

## 6.3 Hex Dump Mode

The Hex Dump Mode is a useful tool for diagnosing problems, including communication and DPL syntax errors, allowing a comparison of input strings (sent by host) to output data (received by printer). To decode this information, the *Programmer's Manual* is an essential reference. This output can be used for debugging the label format. In addition, by repeatedly sending a format, this mode can uncover handshaking problems (if they exist). Handshaking problems are identified by sections of missing data in the character string.

### To print the Hex Dump Label:

To begin, go to the Diagnostics menu and enable Hex Dump Mode; see Section 4.4. Exit the menu and save the changes. Now, 'HEX DUMP MODE' will be indicated by the display and all data sent to the printer will now be output in hexadecimal code, along with the printable ASCII equivalents, as shown below. To exit Hex Dump Mode, re-enter the Diagnostics Menu and disable the Hex Dump Mode, exit the menu, then save the changes.

The figure below is a sample Hex Dump Label. After sending a label format to the printer, the hex code output will be immediate. As a final note, many software programs use bit mapping to construct the label, making diagnosis difficult. Contact Datamax-O'Neil Technical Support with any questions.

```
0000 02 4C 00 44 31 31 00 31 ^L.D11.1
0008 36 31 31 30 30 30 30 33 61100003
0010 32 30 30 30 31 30 46 4F 200010F0
0018 4E 54 20 36 3A 20 41 4C NT 6: AL
0020 4C 20 56 41 4C 49 44 20 L VALID
0028 20 20 20 20 20 20 20 20
0030 20 20 20 00 31 36 31 31 1611
0038 30 30 30 30 32 38 30 30 00002800
0040 30 31 30 20 20 20 20 20 010
0048 20 20 20 43 48 41 52 41 CHARA
0050 43 54 45 52 53 3A 00 31 CTERS: 1
0058 36 31 31 30 30 30 30 32 61100002
0060 34 30 30 30 31 30 23 24 400010#$
0068 25 26 28 29 2A 2B 2E 20 %&()*+.-
```



# A Specifications

## *Mechanical*

Width	Pro Models: 8.01 inches (20.4 cm) Pro+ Models: 8.54 inches (21.7 cm)
Depth	Pro Models: 11.10 inches (28.2 cm) Pro+ Models: 14.17 inches (36.0 cm)
Height	Pro Models: 7.36 inches (18.7 cm) Pro+ Models: 9.45 inches (24.0 cm)
Weight	Pro Models: 5.25 pounds (2.4 kg) Pro+ Models: 7.75 pounds (3.5 kg)
Operating Temperature	40 to 95 F (4 to 35 C)
AC Input Voltage	Power Supply: 105 VAC to 250 VAC / 50-60 Hz

## *Printing*

Print Method	Direct Thermal; Thermal Transfer (optional)
Print Speed	203 DPI Models: 2 - 6 IPS (50.8 – 152.4mm/s) 300 DPI Models: 2 - 5 IPS (50.8 – 127mm/s)
Resolution	203 DPI Models: 203 DPI (8 dots/mm) 300 DPI Models: 300 DPI (11.8 dots/mm)
Tear Bar	Tear up
DRAM Memory	16MB
FLASH Memory	64MB

## **Media / Ribbon**

Media Types	Roll-Fed, Die-Cut, Continuous, Fan-Fold
Max. Media Width	4.4 inches (110mm)
Min. Media Width	0.75 inches (19mm)
Max. Print Width	203 DPI Models: 4.25 inches (108mm) 300 DPI Models: 4.12 inches (106mm)
Print Length Range	.236 – 99 inches (6 - 2514mm)
Minimum Label Height	Tear: 0.5 inches (12mm) Peel: 1.0 inches (25mm) Cut: 1.18 inches (30mm)
Media Thickness Range	.0025 - .01 inches (.064 - .254mm); <i>up to .005 inches (.127mm) with optional Cutter</i>
Media Supply Roll Capacity	Pro Models: 5 inches (127mm) O.D. on a 1 inch (25.4mm) core Pro+ Models: 7.2 inches (182.9mm) O.D. on 3 inch (76.2mm), 1.5 inch (38.1mm), or 1 inch (25.4mm) cores  ½" Core Ribbons Ribbon Core Width: 4.3 inches (110mm) Ribbon Width: 1.0 - 4.3 inches (25 - 110mm); Centered on core
Ribbon Width Range	1" Core Ribbons (with Ribbon Core Adapters, see section 2.4.1.) Ribbon Core Width: 1.0 - 4.3 inches (25 - 110mm); Centered on Ribbon Core Adapters Ribbon Width: 1.0 - 4.3 inches (25 - 110mm); Centered on core
Ribbon Roll Capacity	0.5" (13mm) core with 361' (110m) long ribbon or 1" (25mm) core with 984' (300m) long ribbon

## **Communications**

Interface Ports (standard)	USB, RS-232 (DB-9), IEEE 1284 Type C compliant mini-Centronics parallel, and 10/100 Wired LAN
Baud Speed	600 to 38,400 bits per second (BPS)
Handshaking	Xon/Xoff, CTS, DTR
Parity	Even, Odd, or None
Stop Bits	1 or 2
Data Bits	7 or 8

## **Fonts**

9 Bit Mapped Fonts rotated 0, 90, 180, and 270 degrees.

## **Embedded Bar Codes**

32 embedded barcodes (see the *Programmer's Manual* for a detailed listing).

## Approved Media

To achieve optimum print quality and maximum printhead life, Datamax-O'Neil specifies the use of Datamax-O'Neil brand media and ribbons. These supplies are specially formulated for use in our printers; use of other supplies may affect the print quality, performance, and life of the printer or its components. For a current list of approved media and ribbons for use in direct thermal and thermal transfer applications, please contact a Media Representative at (407) 523-5650.

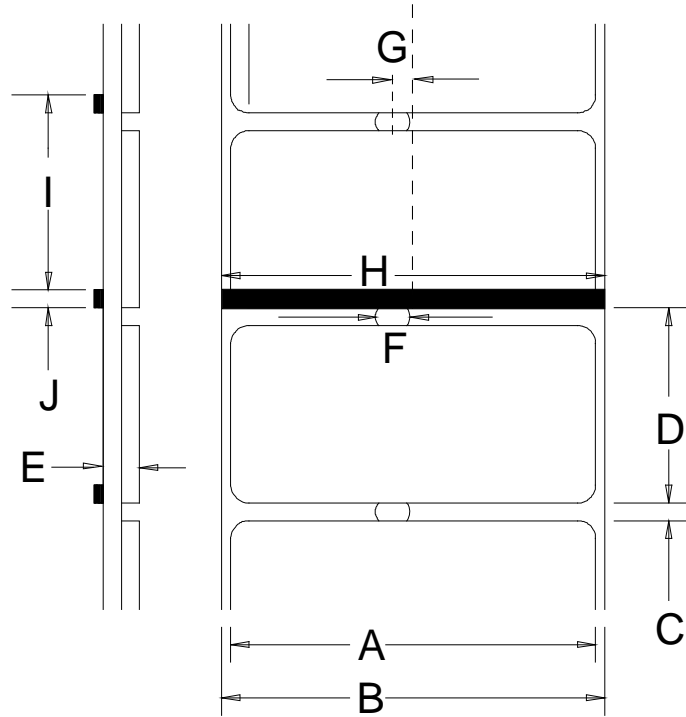

	Description	Max <sup>[1]</sup>	Min <sup>[1]</sup>
A	Label width	203 DPI: 4.25 300 DPI: 4.12	.75
B	Backing width	4.4	.75
C	Gap between labels	.25	.10
D	Label length	24 <sup>[3]</sup>	.25 <sup>[4]</sup>
E	Total thickness	.010 <sup>[6]</sup>	.0025
F	Notch opening width	--	.20
G	Distance from the center of the media to the center of media sensor aperture. The distances differ for "right of center" and "left of center" and are dependant on whether transmissive or reflective media is being used.	Transmissive (Gap/Hole/Notch): 42mm to left and 34mm to right  Reflective (Bar/Hole/Notch): 58mm to left and 38mm to right	
H	Reflective mark width <sup>[2]</sup>	4.4	.50
I	Distance between reflective marks	24 <sup>[3]</sup>	.25 <sup>[5]</sup>
J	Reflective mark length	.25	.10

<sup>[1]</sup> Units of measure are in inches.

<sup>[2]</sup> The reflective (black) mark must be carbon based, placed on the backside of the stock, and the reflectance shall be less than 10% at wavelengths of 950 and 640 nm.

<sup>[3]</sup> The label length may vary up to 99 inches with printable area not exceeding the maximum label length.

<sup>[4]</sup> This distance is inclusive of the minimum gap between labels. Min length of 1.25 inches (31.8mm) with optional Cutter installed.

<sup>[5]</sup> This distance is inclusive of the minimum reflective mark.

<sup>[6]</sup> .007 inches (.117mm) w/Standard Cutter.





# B Wireless and Wired LAN Setup



## B.1 Network Card Setup



Whether a wired or wireless connection is intended, it is recommended to establish a wired connection to the printer first. This will allow access to the printer's internal web pages to configure the settings necessary for a typical wireless connection. If a wired connection is not or cannot be achieved, all connection parameters can also be set using the NETira CT configuration utility, see section 3.5.

The printer makes IP requests at power-up, so before making a network connection to the printer consider how your IP addressing needs to be assigned. The IP addressing of the printer can be configured in one of two ways: Using a static IP Address or Using IP Discovery (DHCP, BootP, or RARP). **At factory default settings IP DISCOVERY is ENABLED (DHCP).**

1. With Printer Off, connect the network cable then turn on Printer.
2. The printer will now search for a DHCP server. Allow up to 90 seconds for the printer to retrieve an IP address.

3. At this point it is recommended to print a Network Report. This Network Report is generated by the printer and lists important default information such as the IP and MAC Addresses as well as SSID for wireless equipped cards. To print the 'Network Report':

Press the  button to highlight the 'TEST' menu branch and then press the  button.

Using the  button, scroll to Network Report, and then press the  button.

When prompted choose either "View" (to view the information on the display) or "Print" (to print the information).

4. Verify the printer has obtained a valid IP address for your network. If a valid IP address was not obtained or you wish to use a different static address this can be set via the printer's front panel.

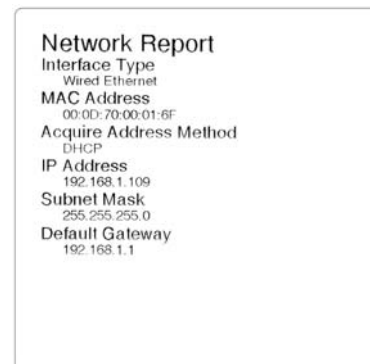

*The information on this label will vary depending on your configuration and firmware version.*

Enter the printer's menu and navigate to the Communications>Network/Bluetooth>Wired Ethernet menu branch.

- Set the "IP Discovery" menu item to "Use Static Addresses".
- Set the "IP Address" menu item to desired value, continue the same procedure with "Subnet Mask" and "Default Gateway" menu items if necessary. Exit the printer's menu. Cycle power to the printer, upon start-up the printer will connect to the network using the new parameters you provided.

Once the previous steps have been successfully completed you may now use the IP Address to:

- If your printer is equipped with wireless capabilities, browse to the printer's internal web pages for wireless/advanced configuration. **See section B.2, Wireless Setup.**

-or-

- Install a printer driver, and start printing from your Windows applications. **See section B.3, Installing the Printer Driver.**

## B.2 Wireless Setup

1. Open your web browser. Type in the IP Address assigned to the printer. The printers default IP address is: 192.168.10.26.



If a different IP Address has been assigned to the printer, make sure to enter the correct IP address.

The following page will appear:

The printer's internal web pages are divided into 10 pages that are accessible via the navigation bar on the left-hand side.

Most of the items on these pages mimic the printer's internal menu. For more information on the function of these settings see the corresponding function in Chapter 4.

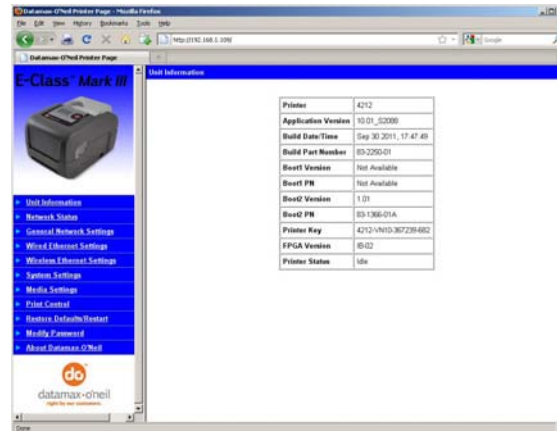

You must provide a password to change any settings, the default password is "sysadm".



If any address parameters were changed such as IP address, subnet or gateway, the printer might not be viewable from the current host if they are no longer on the same subnet.

## B.2.1 Wireless Setup – Infrastructure

After a successful setup is made via a wired connection, the Wireless connection (if equipped) can now be configured in infrastructure mode using a static or DHCP issued IP address.

1. Open your web browser. Type in the IP Address of the printer. The Default IP is: 192.168.10.26.



If a different IP Address has been assigned to the printer, make sure to enter the correct IP address.

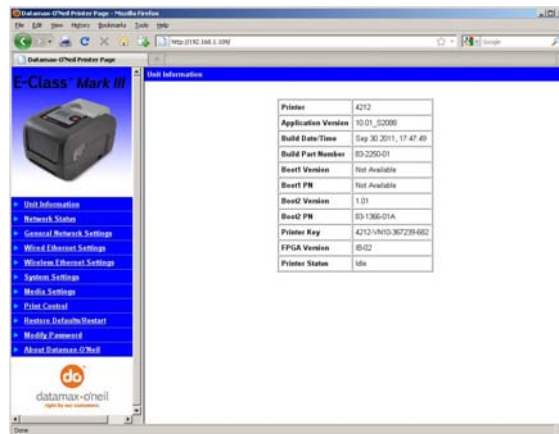

A page similar to the right will appear:



2. Click on the “Wireless Ethernet Settings” menu item on the left side of the screen. Locate and set the following items:
  - In the “Acquire Address Method” section, select the “Use DHCP” radio button.



*For static IP setup:*

  - In the “Acquire Address Method” section, select the “Use Static Addresses” radio button.
  - In the “Static IP Addresses” section, enter valid static IP addresses for Printer IP Address, Printer Subnet Mask, and Printer Gateway.
3. Scroll down the page to “Network Type”, select “infrastructure” from the drop down box.
4. In the SSID field type the name of the SSID of your access point.
5. Under the “WIFI Security and Authentication”, set any security/authentication settings necessary for your network.
6. Scroll down to the bottom of the page, enter the password (default is “sysadm”) and click Apply.
7. Click on the “General Network Settings” menu item on the left side of the screen. Locate and set the following items:
8. In the “Network Interface”, select the “Wireless Ethernet” radio button
9. Scroll down to the bottom of the page, enter the password (default is “sysadm”) and click Apply.
10. Click on the “Restore Defaults/Restart” menu item on the left side of the screen. Be sure that Restart Printer is displayed in the “Action to Execute:” drop down box. Enter the password at the top of the page (default is “sysadm”) and click Execute to restart the printer.

The printer will now search for a server. Allow up to 90 seconds for the printer to retrieve an IP address.

At this point it is recommended to print a Network Report. This Network Report is generated by the printer and lists important default information such as the IP and MAC Addresses as well as SSID for wireless equipped cards. To print the 'Network Report':

Press the  button to highlight the 'TEST' menu branch and then press the  button.

Using the  button, scroll to Network Report, and then press the  button.

When prompted choose either "View" (to view the information on the display) or "Print" (to print the information).

Once the previous steps have been successfully completed you may now use the IP Address to install a printer driver, and start printing from your Windows applications. See section B.3, Installing the Printer Driver.



The information on this label will vary depending on your configuration and firmware version.

### B.2.1 Wireless Setup – Ad-Hoc

After a successful setup is made via a wired connection, the Wireless connection (if equipped) can now be configured in ad-hoc mode using a static IP address. To configure the wireless card in Ad-hoc mode, you must configure your host computer to match the IP settings of the printer. Refer to your operating system's or your wireless network card documentation for information on how to configure your computer.

1. Open your web browser. Type in the IP Address of the printer. The Default IP is: 192.168.10.26.



If a different IP Address has been assigned to the printer, make sure to enter the correct IP address.

A page similar to the right will appear:

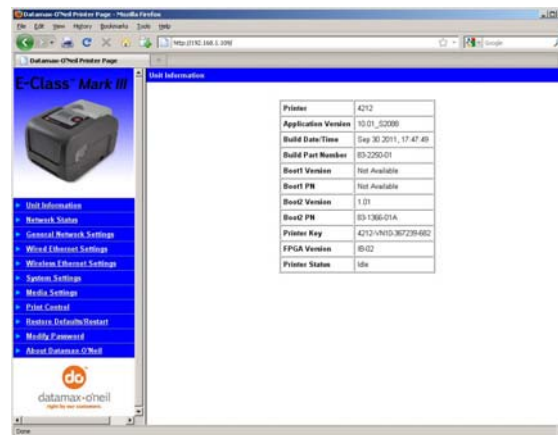

2. Click on the "Wireless Ethernet Settings" menu item on the left side of the screen. Locate and set the following items:
  - In the "Acquire Address Method" section, select the "Use Static Addresses" radio button.
  - In the "Static IP Addresses" section, enter valid static IP addresses for Printer IP Address, Printer Subnet Mask, and Printer Gateway.
3. Scroll down the page to "Network Type", select "Ad-hoc" from the drop down box.
4. In the SSID field type the name of the SSID you wish to assign to the printer.

5. Under the “WIFI Security and Authentication”, set any security/authentication settings necessary for your network.
6. Scroll down to the bottom of the page, enter the password (default is “sysadm”) and click Apply.
7. Click on the “General Network Settings” menu item on the left side of the screen. Locate and set the following items:
8. In the “Network Interface”, select the “Wireless Ethernet” radio button
9. Scroll down to the bottom of the page, enter the password (default is “sysadm”) and click Apply.
10. Click on the “Restore Defaults/Restart” menu item on the left side of the screen. Be sure that Restart Printer is displayed in the “Action to Execute:” drop down box. Enter the password at the top of the page (default is “sysadm”) and click Execute to restart the printer.
11. The printer will now search for a server. Allow up to 90 seconds for the printer to retrieve an IP address.

12. From Windows, you may now “View Wireless Networks”. From the list of available wireless networks select the printer that you wish to connect to and then click on the Connect button.

If you do not see your printer listed be sure you have the host computer configured for Ad-hoc wireless networks.

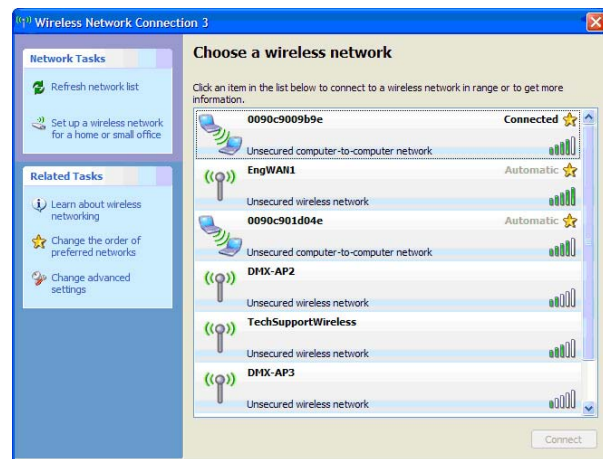

*This process will vary depending on your wireless device installed in your host computer and your operating system version.*

Once the previous steps have been successfully completed you may now use the IP Address assigned to the printer to install a printer driver, and start printing from your Windows applications. See section B.3, Installing the Printer Driver.

## B.3 Installing the Printer Driver

Install the Printer Driver as follows (screen shots below are samples taken using Windows 2000; other versions will be similar):

<p>1</p> <p>Start the Windows Add Printer Wizard. The following screen should appear, and then click Next &gt; .</p>	<p>2</p> <p>Make sure that Local Printer is selected and then click Next &gt; .</p>
<p>3</p> <p>Select Create a new port: and then select Standard TCP/IP Port from the drop down menu. Click Next &gt; .</p>	<p>4</p> <p>Click Next &gt; .</p>
<p>5</p> <p>In the Printer Name or IP Address: field, enter the IP address of your printer. The Port Name field <u>does not</u> need to be changed. When finished click Next &gt; .</p>	<p>6</p> <p>Make sure Standard is selected and then click Next &gt; .</p>
<p>7</p> <p>Confirm your settings and then click Finish.</p>	<p>8</p> <p>Click Have Disk.</p>



9

Insert the Accessories CD-ROM and click Browse.

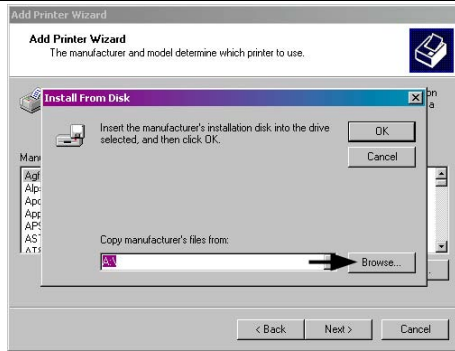

10

Browse to the \DRIVERS\ folder on the CD-ROM. Ensure the file "Datamax-O'Neil.inf" is selected then click OK.

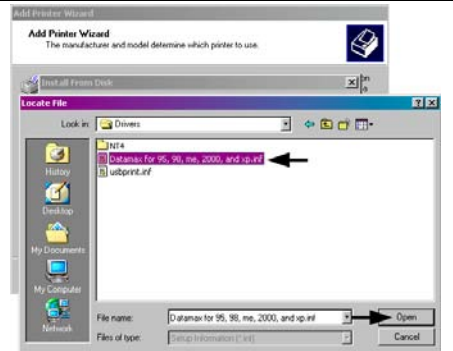

11

Click OK.

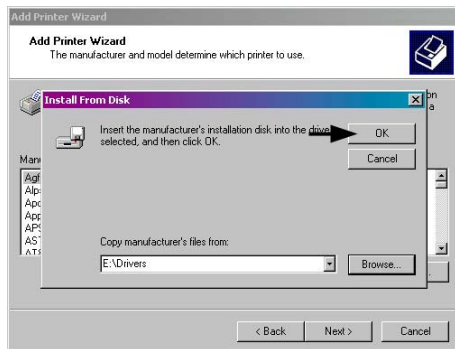

12

Choose your printer from the list and then click Next>.

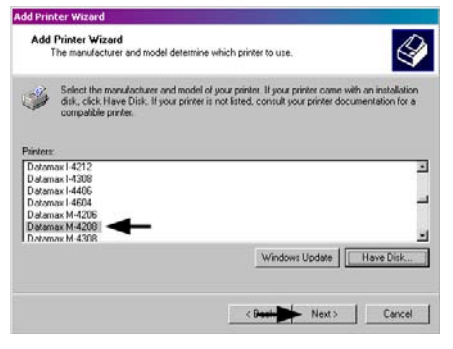

13

Assign a name in the Printer name field and select whether or not it is to be your default printer then click Next>.

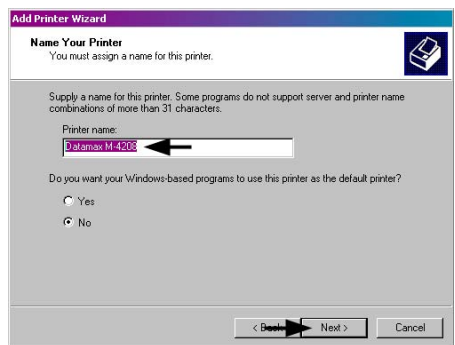

14

Select whether or not to share this printer on your network. Then click Next>.

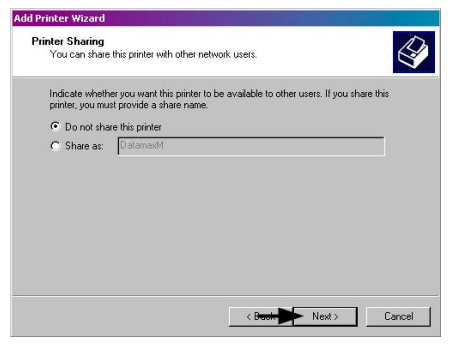

15

Select No then Click Next>.

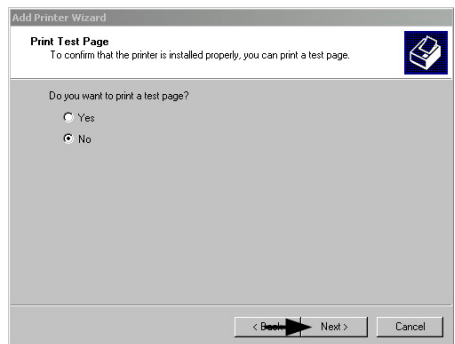

16

Confirm your settings and then click Finish.

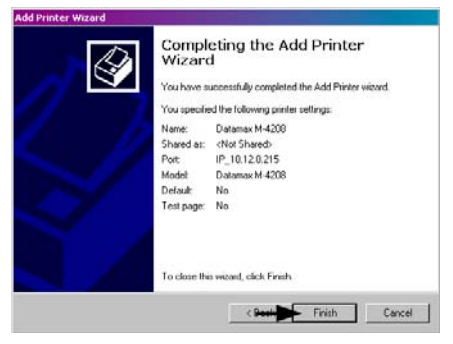

17

If prompted with the Digital Signature Not Found window, click Yes to continue installation.

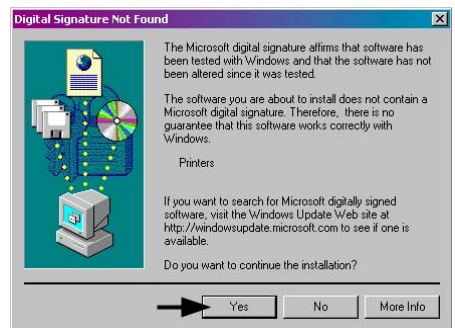

18

Your computer will now copy the necessary files from the CD-ROM.



The driver and port installation is now complete. The printer can be selected through any Windows application.





# C Bluetooth Setup

## C.1 Bluetooth Setup

Bluetooth connection parameters can be set using the NETira CT configuration utility, via an established serial or wired LAN connection.

Launch the NETira CT configuration utility, and query (connect) to the printer, (see section 3.3 for more information on NETira CT).

- 1) Click on the General Network menu branch under the Printer Component section of the configuration utility.
- 2) In the Primary Interface setting; from the drop down box, select Bluetooth. Send the new setting to the printer using the 'Send' button. Allow 30 seconds for the printer to reset.

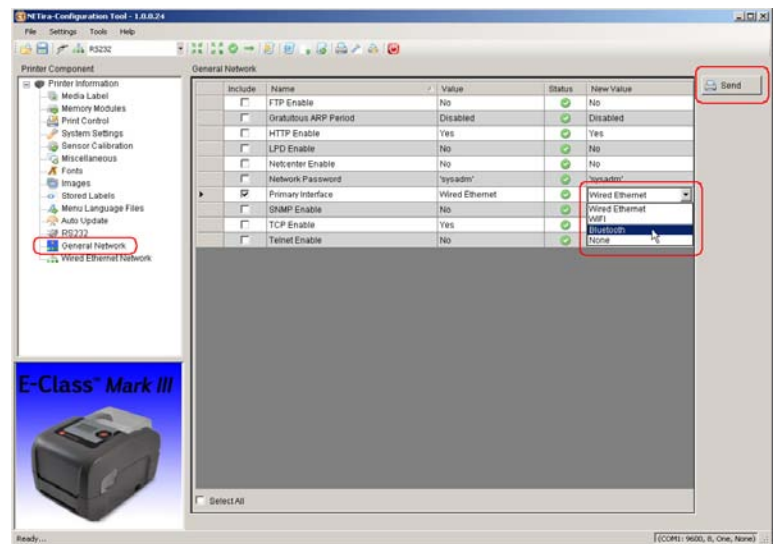

- 3) Click the Bluetooth menu under the Printer Component section of the configuration utility.

- 4) To set up the printer for Bluetooth, change (or confirm) the following parameter settings:

- Bondable:** Yes
- Connectable:** Yes
- Discoverable:** Yes
- PassKey:** Default '0000' (must match entry used on host computer)

- 5) Send the new settings to the printer using the 'Send' button. Allow 30 seconds for the printer to reset.

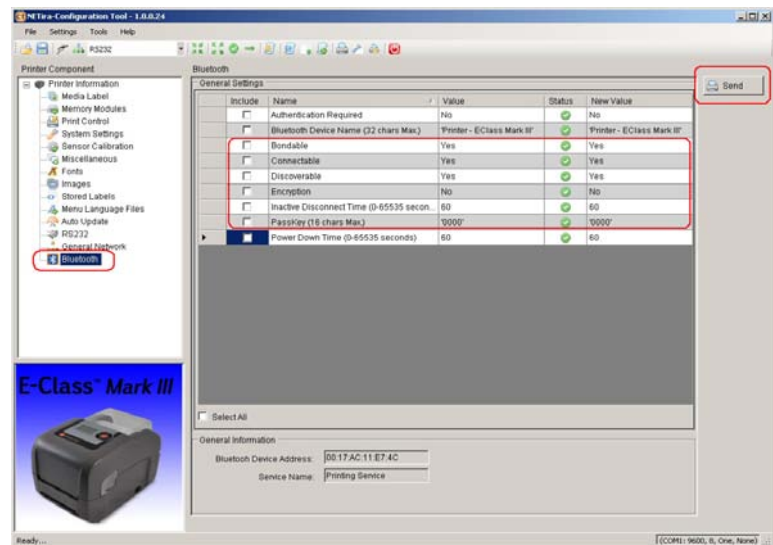

For connection to the printer please refer to the instructions included with your Bluetooth adapter or host computer/handheld.



# D Menu Language

## D.1 Changing the Menu Language

---

Different languages and / or Datamax-O'Neil-provided translations can be downloaded to replace the standard (English) menu of the printer by changing the spreadsheet that defines the system dictionary. To change the language you will add a new language column (or modify the existing column) in the spreadsheet, click on the "Generate DPL file(s)" radio button, and then send that file(s) to the printer.

Software requirements for modifying the menu language are as follows:

- Microsoft® Excel must be purchased by user;
- Img2dl.exe (provided at ftp://ftp.datamax-oneil.com/Printer%20Firmware/EFIGS-A.I.M.W.Class/) is a program used during the process to create the DPL file; and,
- Common.xls (also provided at the web site above) is the Menu Dictionary.



Place *Img2dl.exe* and *Common.xls* in the same directory.

Create a Menu Language by following these steps:

- A. Invoke Excel and open the Common.xls file. *After the file opens, the following screen appears:*

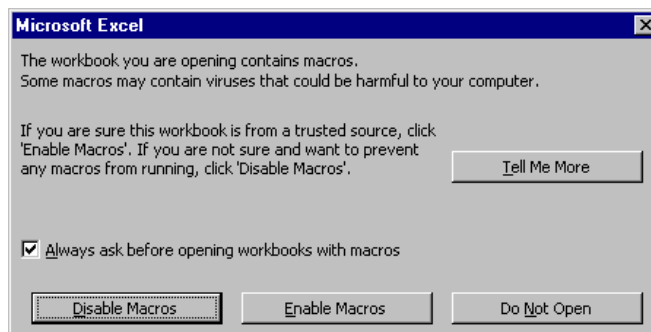

B. Click the “Enable Macro” box. *The following screen appears:*

	A	B	C	D	E	F	G
1				Generate Source Files	Generate DPL File(s)		
2	<b>NID</b>	<b>COMMENTS</b>	<b>MAX</b>	<b>MESSAGE ID</b>	<b>ENGLISH</b>	<b>FRANCAIS</b>	<b>ITALIANO</b>
3	0000	System Messages	20	MID_READY	READY	PRÊT	PRONTO
4	0001		20	MID_PRINTING	PRINTING		
5	0002		20	MID_PAUSED	PAUSED	PAUSE	IN FAUSA
6	0003	1Aa	20	MID_CANCEL_PRINT_JOB	CANCEL PRINT JOB?		
7	0004		20	MID_CLEARING_FAULTS	CLEARING FAULTS		CANCELLA ERRORI
8	0005		10	MID_OF	OF	DE	DI
9	0006		20	MID_DOTCHECK_IN_PROGRESS	DOTCHECK IN PROGRESS		
10	0007	Faults	20	MID_SYSTEM_FAULT	SYSTEM FAULT	DEFAILLANCE SYSTEME	ANOMALIA SISTEMA
11	0008		20	MID_ADC_FAULT	ADC FAULT	DEFAILLANCE ADC	ANOMALIA ADC
12	0009		20	MID_HEAD_UP_FAULT	HEAD UP FAULT	TETE NON VEROUILLEE	ANOM. TESTINA ALTA
13	0010		20	MID_RIBBON_FAULT	RIBBON FAULT	DEFAILLANCE RUBAN	ANOMALIA NASTRO
14	0011		20	MID_TOP_OF_FORM_FAULT	TOP OF FORM FAULT	DEFAIL. DEBUT D'IMP.	ANOMALIA BORDO SUP
15	0012		20	MID_OUT_OF_STOCK	OUT OF STOCK	RUPTURE PAPIER	ESAUIRITO
16	0013		20	MID_CUTTER_FAULT	CUTTER FAULT	DEFAILLANCE COUPEAU	ANOMALIA TAGLIERIN
17	0014		20	MID_VERIFIER_FAULT	VERIFIER FAULT	DEFAILLANCE VERIFIC.	ANOMALIA VERIFICAT
18	0015		20	MID_RIBBONSAVER_FAULT	RIBBONSAVER FAULT	DEFAIL. ECONOM. RUBAN	ANOM. SALVA-NASTRO
19	0016		20	MID_POSITION_FAULT	POSITION FAULT	DEFAILLANCE POSITION	ANOM. POSIZIONAMEN
20	0017		20	MID_TEMPERATURE_FAULT	TEMPERATURE FAULT		
21	0018		20	MID_DMA_FAULT	DMA FAULT	DEFAILLANCE DMA	ANOMALIA DMS
22	0019		20	MID_PRINT_ENGINE_FAULT	PRINT ENGINE FAULT	DEFAILLANCE MOTEUR	
23	0020		20	MID_24V_OUT_OF_TOLERANCE	24V OUT OF TOLERANCE	DEPASS. TOLERANCE 24V	24V FUORI TOLLERAN
24	0021		20	MID_STROBE_TIMING_FAULT	STROBE TIMING FAULT	DEFAIL. DUREE D'IMP	ANOM. FASAT. STROB
25	0022	Warnings	20	MID_WARNING_RESOLVED	WARNING RESOLVED	AVERTISSEMENT RESOLU	AVVERTENZA RISOLTA
26	0023		20	MID_RIBBON_LOW	RIBBON LOW	RUBAN FAIBLE	NASTRO BASSO
27	0024		20	MID_GAP_MISSED	GAP MISSED	INTERVALLE MANQUANT	INTERVALLO SALTATO
28	0025		20	MID_DOT_FAILURE	DOT FAILURE	DEFAUT IMPRESSION	ANOMALIA PUNTO
29	0026		20	MID_BAD_SENSOR_DELTA	BAD SENSOR DELTA		
30	0027		20	MID_HOST_CHANGES_PENDING	HOST CHANGES PENDING		MOD. HOST IN ATTES
31	0028		20	MID_LOW_VOLTAGE	LOW VOLTAGE		
32	0029		20	MID_GOODBYE	GOODBYE		
33	0030	Conditions	20	MID_REMOVE_LABEL	REMOVE LABEL	ENLEVER ETIQUETTE	RIMUOVI ETICHETTA
34	0031		20	MID_TEMPERATURE_PAUSE	TEMPERATURE PAUSE		

C. Click on Column J and enter the new language, or modify an existing one. Some tips on this process:

- Message Size – When entering new messages, reference the “MAX” column: this is the maximum number of characters allowed for this field. (Warnings are displayed when the number of characters is exceeded, or when trying to modify the MAX value; however, if “cutting and pasting” fields, this warning system may be defeated.)
- Two Line Messages – Some of the message are displayed as two lines. These are indicated in the comment fields.
- Comments – This field can be modified with no effect.

D. After editing is complete, highlight all of the columns to be created by pressing the letter above the column (more than one column can be selected).

E. Press the Generate DPL File(s) radio button. *A file will be generated for each of the selected columns and Excel will provide confirmation (for example, as shown below, small.ls).*

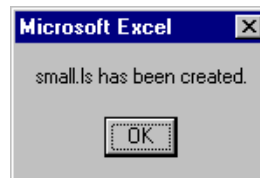

- F. Download the generated files to the printer – one method is the DOS copy command:

copy small.ls lpt1: /b

- G. Reset the printer by pressing and holding the CANCEL Key for approximately four seconds.
- H. After resetting, verify operation by printing a Configuration Label (see Section 4.4). *New language information will be printed under SYSTEM INFORMATION / OPTIONAL LANGUAGES. (Also, the new language will appear on the display as a menu item in SYSTEM SETTINGS / MENU LANGUAGE. These are the only methods to determine a successful download.)*

Enable the new language. Enter the menu system and go to SYSTEM SETTINGS / MENU LANGUAGE and select the new language. Next select the desired font for the language. Save the changes when prompted. *(A reset will occur as font validation is performed.)*

*An error has occurred if the printer displays the new language selection, but all messages remain in English. In this case, re-check your process or contact Datamax-O'Neil Technical Support (be ready to provide the Common.xls and DPL download files created). Other error messages are also possible:*

Menu Language Error Message	Description
Please select the entire column(s) or the desired language(s), by clicking on the column letter(s)	After pressing the Generate DPL File(s) radio button, the languages to convert were not correctly selected.
Message text may not exceed MAX = xx designated characters for this MID	The entered message exceeds the number of characters specified in column C. You may not modify this number.

- I. Repeat Steps A – H using the filename misc.xls to translate printer option items. This will output small20.ls.



## D.2 Advanced File Handling Information

---

- The standard printer leaves the factory with EFIGS loaded into Module Y. At this point, Module Y is LOCKED and will only accept additional language downloads.
- After downloading a language update, Module Y is left UNLOCKED until the printer is reset or power is cycled. In this state, Module Y will accept font, image and label format downloads. The module will also honor the Clear Module request. Therefore, following an update it is recommended that a reset be performed to lock the module; otherwise, a software package may “Clear All Modules” thus destroying the new menu language(s).
- Module Y can be UNLOCKED by sending this DPL string: <STX>KpY0
- To restore the factory generated EFIGS image, download the file \*832296.01A to the printer. This file is located on the Datamax-O’Neil FTP site. The letter at the end of the file name (e.g., A) specifies the revision. The latest revision will be available on the FTP site.
- Downloading the same language twice will automatically delete the first occurrence, but will not free the memory space.
- Deletion of the selected language will reset the printer to English. The total number of languages that the printer can now accept is limited to 10, but this number is dependent upon the size of each language translation. The translation size will vary with the number of messages that are translated for that particular language. Current complete language files are about 7,000 bytes each; but with product growth, the total number of languages is expected to drop to five.

The screen shot below is an example of Unicode defined languages, Chinese & Russian. Note the only additional information required is the “double” in row 1.

	I	J	K	L	M
1				Double	Double
2	<b>ESPAÑOL</b>	<b>small</b>	<b>TREK</b>	<b>Chinese</b>	<b>RUSSIAN</b>
3	LISTO	ready	AWAITING ORDERS	准备	ГОТОВ
4	IMPRIMIENDO	printing	WARP DRIVE ENGAGED	打印中	ПЕЧАТЬ
5	EN PAUSA	paused	ALL STOP	暂停	ПАУЗА
6	CANCELAR IMPRESIÓN	cancel batch?	ABORT MISSION?	取消	ОТМЕНИТЬ ЗАДАНИЕ?
7	BORRAR ERRORES	clearing faults	RE-INITIALIZING	清除错误	СБРОС ОШИБОК
8	DE	of	FACTOR	OF	ОФ
9		advanced menu	KNOWLEDGE BASE	高级菜单	МЕНЮ
10	ERROR DE SISTEMA	system fault	DIRECT HIT SUSTAINED	系统错误	СИСТЕМНАЯ ОШИБКА
11	ERROR DE ADC	adc fault	HULL BREACH DECK TEN	ADC错误	ОШИБКА ADC
12	CABEZAL LEVANTADO	head up fault	ENGINES OFFLINE	打印头抬起错误	ТЕРМОГОЛОВКА ПОДНЯ
13	ERROR DE CINTA	ribbon fault	PHASORS OFFLINE	破带错误	ОШИБКА РИБОНА
14	ERROR INICIO ETIQ.	top of form fault	UNABLE TO GO TO WARP	TOF错误	ОШИБКА ГРАНИЦ ЭТИК
15	SIN PAPEL	out of stock	TORPEDO TUBES EMPTY	标签用完	ОТСУТСТВУЕТ ЭТИКЕТ
16	ERROR DE CORTADOR	cutter fault	CASCADE FAILURE	切刀错误	ОШИБКА РЕЗАКА
17	ERROR DE VERIFICADOR	verifier fault	TRACTOR BEAM FAILURE	检测器出错	ОШИБКА ВЕРИФИКАЕРА
18	ERROR ECONOM. CINTA	ribbonsaver fault	METAPHASIC FAILURE	破带节约装置错误	ОШИБКА РИБОНСЕЙВЕР
19	ERROR DE POSICION	position fault	UNKNOWN COORDINATES	位置错误	ОШИБКА ПОЛОЖЕНИЯ
20	FALLO DE TEMPERATURA	temperature fault	CORE TEMP. CRITICAL	温度错误	ОШИБКА ТЕМПЕРАТУРЫ
21	ERROR DMA	dma fault	COMPUTER MALFUNCTION	DMA错误	ОШИБКА DMA
22	ERROR MOTOR IMPRES.	print engine fault	PORT NACELL OFFLINE	打印引擎错误	ОШИБКА ДВИГАТЕЛЯ
23	24V FUERA TOLERANCIA	24v out of tolerance	SAFETY LIMT EXCEEDED	电压越界	ОШИБКА ВОЛЬТАЖА
24		present sensor fault	INERT. DAMP. OFFLINE	出纸检测器错误	ОШИБКА ДАТЧИКА НАП
25	ADVERTEN. CORREGIDA	warning resolved	ALL CLEAR	警告	ПРОБЛЕМА УСТРАНЕНА
26	CINTA BAJA	ribbon low	TORPEDO TUBES LOW	破带不多	КОНЧАЕТСЯ РИБОН
27		head/cover up fault	LANDING FAULT	打印头抬起错误	ПОДНЯТА КРЫШКА
28	FALLO PUNTO CABEZAL	dot failure	SHIELDS COMPROMISED		ОШИБКА ТЕРМОГОЛОВК
29		label rotation	SYMMETRY INVERSION	标签旋转	ЭТИКЕТКА ПОВЕРНУТА
30	CAMBIOS PENDIENTES	host changes pending	HOSTILE APPROACHING	主机更改评估中	ОБНОВЛЕНИЕ ХОСТА



