

OUR COPY

# THE KITEFLIER



## THE KITE SOCIETY NEWSLETTER

with

MIDLAND KITEFLIERS NEWS

BRIGHTON KITEFLYERS AERODYNE

APRIL

ISSUE 27

## CONTENTS

Editorial .....	3
Kite Fly For Peace .....	4
Here and There .....	5
Japanese Kite Restoration .....	6
Events Update .....	7
Kite Design .....	13
Local Groups .....	14
Shropshire Holdfast .....	15
Midland Kitefliers News .....	18
Brighton Kiteflyers Aerodyne .....	20
Events List .....	22
Subscription Form and Sweatshirt .....	23

The front cover shows a small model of the Yokaichi kite being restored hopefully to fly at Sunderlands Festival of the Air in September.

## THE SMALLEST POSSIBLE HOT AIR BALLOON

Only 18 inches in diameter and powered by birthday cake candles. Made from ultra light weight high density polythene, will not flare up like tissue paper absolutely safe. Designed to fly indoors or outside in really calm weather. Ideal for parties children as young as six can launch them. Many flights possible.



PRICE inclusive of 24 candles + holder postage directions. £4.50 or with 2 balloons £7.50. Green and white or blue and white. six gores.

All other sizes, hot air 'or gas up to 14 ft diam. Send SAE to:- Charles Saffery 1 Lansdown Terrace Lansdown Rd, Bath. or Tel: 24 hrs (0225) 311165.

# MALVERN KITES

We stock a large range of quality kites, materials, books and miscellanea.

**MAKERS INCLUDE** Wycombe Kite Co., Prof. Waldof, Vertical Visuals, Trlby, Flexifoil, Peter Powell, Windy Kites, Fennemore, Dan Leigh, Monday Lunch, Propius, Peter Lynn, Stratton, Gunter, Zammo.

**MATERIALS** Our 1985 range of materials includes many new fittings: rings, swivels, fibreglass rod, dowell, ripstop tape, ripstop, tyvek etc.

**MISCELLANEA** Books, Model Hot Air Balloons, Boomerangs, Frisbees—all weights, greetings and post cards, clocks, earrings, brooches.

**KITELINE** Braided kiteline from 23lb. — 1500lb., Twisted line from 20lb — 80lb, in bulk or short lengths. Kevlar (to order).

**MAIL ORDER VISITORS** Send a stamp for a free copy of our illustrated mail order catalogue.

Very welcome — see our impressive display of kites, photographs and accessories. We are open at weekends and bank holidays too — See catalogue for full details.

WE HAVE MOVED  
TO SPLENDID NEW PREMISES

THE WAREHOUSE, ST. ANN'S ROAD, GREAT MALVERN, WORCESTERSHIRE.  
TELEPHONE: MALVERN (06845) 65504

# THE KITE SOCIETY

31, Grange Road, Ilford, Essex IG1 1EU



**KITE SOCIETY**

Dear Reader,

We have been holding discussions with Ron Moulton of the British Kite Fliers Association with regard to entry into the bi-annual Old Warden Festival. Both he and the manager of the Shuttleworth collection have agreed to Kite Society members having free entry to the aerodrome. This is extremely good news as a lot of you have said that the cost of entry means that you have not attended. This is no longer a problem. Just present your membership card at the entrance and you will be able to enter the field.

Do not forget the festival this year is on 5th May. See Events Update for how to get there.

Remember though, you **MUST** show your membership card. Both the old Blue card and the new Gold card are acceptable.

We would like to thank both Ron Moulton and the Shuttleworth collection for this concession - let us make use of it!

For those of you who do not know the British Kite Fliers Association, which was formed nearly ten years ago, has recently decided not to enrol any more members and passes all interested people on to the Kite Society.

We are organising a trip to visit the Dieppe festival being held on 13th and 14th September. The trip will depart lunch time on the 12th of September and return early evening on Sunday 14th September.

If you are interested in joining our trip then we require a £10.00 deposit per person showing your interest. The deposit must be with us by 9th May 1986.

Gill and Jon Bloom

(Editors)

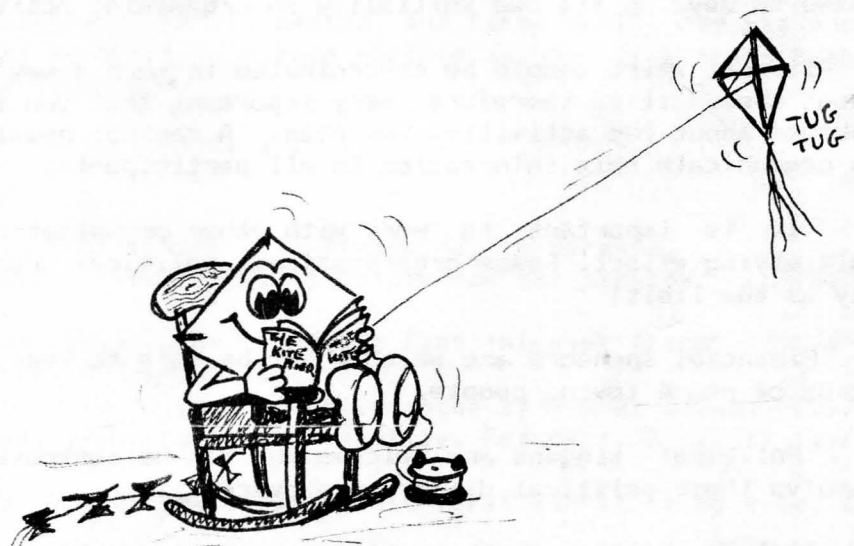

## KITE FLY FOR PEACE

We have recently received some details of the International Kite Fly for Peace - "One Sky - One World".

The idea was initiated by American Jane Parker Ambrose. Jane who owns Sky Scrapers kites conceived and designed a peace kite she planned to fly in Moscow, and then donate to the Soviets as a token of friendship between the two superpowers.

Since kites are a "universal symbol of mankind's relationship to nature and earth", Jane said, "What better way to express Global co-operation than through their magical quality".

In mid-October 1985 Jane travelled to Moscow where she presented her kites to Valentina Tereshkova, the first woman in space. Tereshkova, President of the Soviet Women's Peace Committee praised Jane's efforts and the gift as a sign of friendship. Jane also had the support of the American Kitefliers Association and the Kite Trade Association of the U.S.A. About 200 members signed a letter extending best wishes to the Soviet people and expressing hopes for a future of peace and friendship between the two countries. From this gesture developed the idea of an international kite fly for peace.

Further to the above news the following letter containing more details was received from Michael Steltzer.

At present there is no organisation to co-ordinate the various activities in different countries. Jane Parker Ambrose is in the process of founding a non-profit corporation for the purpose of channelling funds and support into this initiative. The idea is to found a basis upon which this initiative can carry on for a few years and not go into the red.

Details of activities are very general at the moment. Jane has asked me to inform all those people and organisations I know of the following information.

1. For 1986 the International Kite Fly for Peace will be world-wide on October 12 1986. This day has been chosen independent of other commemorative days for the purpose of showing a positive direction. We do not want to orientate ourselves with past burdens. A Sunday has been chosen so as to make it possible for as many people as possible to participate in this event.
2. Each Kite Association, Kite Newsletter and related organisation is being asked to develop its own initiative in organising activities for this day.
3. All activities should be co-ordinated in such a way so that others can know about them. It is therefore very important that you inform us or Jane Parker Ambrose about the activities you plan. A central newsletter will then be able to communicate this information to all participants.
4. It is important to work with other organisations in order to get a multiplying effect. Peace organisations, political organisations etc. Only the sky is the limit!
5. Financial sponsors are welcome but be sure to keep this initiative in the hands of peace loving people.
6. Political slogans are welcome and can be controversial. The people can resolve their political differences peacefully.
7. Include children in the activities. What do children think if people all

## KITE FLY FOR PEACE

over the world fly kites for peace on one day.

8. Organise Kite festivals, fly symbolic kites, fly kite banners, organise kite workshops, do leaflet lifting, it's your world so do your part.

9. Think of a symbol for this event and let us know - it would be nice to have a world wide symbol of our activities.

If you wish to know more, or have any ideas, then write to Michael Steltzer, Eisenacher Strasse 81, 1000 Berlin 62, West Germany.

---

## HERE AND THERE

We have received an offer from America regarding patents relating to kites.

670 Patents have been compiled into volumes the same size as the original documents. The two volumes consist of the abstract page of each patent issued from 1866 to 1985. The set is arranged numerically according to patent number and has indices for Patent Number, Inventors Name and Classification. The cost of each set is \$80.00.

We have to order a minimum of 6 sets which have to be ordered by 30th April. If you are interested please contact the editorial office as soon as possible.

---

Cambridge City Council would like one or two people to run a one week course of kite making in August or early September. There are two sessions a day 10.00 to 12.00 with 7 - 9 year olds and 2.00 to 4.00 with 10 - 14 year olds.

Basically starting on sled kites and working up to more complicated forms. Pay is approximately £86.00 for the leader and £65.00 for an assistant. You have to provide the materials but get the money back.

If you are interested contact:-

Colin Jackson  
2 Drake Road  
Eaton Socon  
St. Neots  
Cambs. PE19 3HS.

---

From Holland we have received the first catalogue for VACUUM kites. The illustrated catalogue contains many new and novel designs including the Dreimaster featured on the cover of issue 25, three dimensional castles and cars.

Another feature of the catalogue is a computer aided design software package to help you develop your own kite forms. The software will run on a Commodore 64.

For further details write to VACUUM, P.O.Box 820, 3500 AV Utrecht, Holland.  
TEL: 03402 48186.



# JAPANESE KITE RESTORATION PROJECT

On the 25th October 1981 on the Kite Hill at Parliament Hill Fields, London, NW3 members of the British Kite Flying Association and several members of the Japan Kite Association got together in order to fly kites, including a 'large' kite from the Yokaichi region of Japan.

The 'large' kite weighing something like 1,000 pounds and measuring approximately 40 feet by 30 feet had been flown over from Japan by British Airways as part of their involvement in the Great Japan Exhibition which was held at the Royal Academy of Arts (24th October 1981 - 21st February 1982.) The members of the Japan Kite Association had arranged their visit to England to coincide with the start of the 'Great Japan Exhibition' and also to show a display of kites from the Japanese Kite Museum at 'Mitsukoshi', Dorland House, 14-20 Regent Street, London W1.

The day itself was a grey disappointing day for such an inviting spectacle. The kite, rolled and covered in a large blue tarpauline was ceremoniously carried to the top of the Kite Hill, unrolled, spars adjusted and then .....the skies opened ..... the kite never flew it was thoroughly soaked and then rather unceremoniously packed away. It was eventually placed in storage at the Science Museum's Depot at Wroughton.

However as the title suggests there are plans afoot to hopefully repair and restore this imposing kite back to its original glory, maybe even fly it.

A small group of enthusiasts has visited Wroughton twice to ascertain the nature of the task to be undertaken. It appears after brief investigation that although the kite never flew and was totally drenched, the damage is 'not too bad'. The paper covering needs re-gluing, split bamboo needs replacing, etc.,.Plans are now progressing for a major working weekend in order to make a full survey of the kite and its current condition. After the survey it is hoped that a full restoration can take place.....

More news as the project progresses.

## EVENTS UPDATE

### Old Warden Aerodrome

As mentioned in the editorial Kite Society Members can now (on production of their membership cards) attend the Old Warden Kite Festival without paying an entrance fee. This represents a saving of £1.50 per person.

Of late the Old Warden Festival has been sparsely attended, but it is a superb site and this year with a group of French Kitefliers showing off their kites (see the Anglo French news below) it would be nice for as many British Kitefliers to attend as possible.

There is plenty to see and do. The Aerodrome houses the unique Shuttleworth Collection - consisting of 30 flyable aeroplanes, half of which are the sole surviving examples of their kind. There are many exhibits and aircraft restoration schemes to be seen - Plus restaurant/cafeteria facilities. A great day out even for non-kitefliers.

This time we will be having a drink to meet the French and fellow kitefliers in the local Inn after the event has finished, The Hare and Hounds in Old Warden Village.

To reach Old Warden - it is two miles due west of the A1 where the A1 bypasses Biggleswade. From East Anglia take the A603 from Cambridge to the roundabout west of Sandy town centre then the B658 signposted to Shefford or the A1. From the A1 the collection is signboarded from the roundabout Northwest of Biggleswade town centre along a minor road that crosses the B658. From the M1 exit at junction 12 and take the A5120, or at junction 13 the B557 and A418 towards Ampthill. From the Southwest take the A40 from Oxford and the A418 towards Ampthill. From Ampthill take the A507 via the roundabout at Clophill to Shefford and then the B658 signposted to Sandy.

---

### York Festival of Kites

The following comes from Jim Rowlands:-

The York Festival is progressing well and is on course to be one of the most varied and interesting being presented this year.

Pride of place is being given to Eiji Ohashi and Takishi Nishibayashi who are in England for three months by invitation of The Borough of Sunderland's Japanese Festival. They will be presenting displays on each of the two days.

Dave Green gets a chance to show off the power of his Stratoscoops with a display of manlifting, while on the Saturday Bill Souten and his colleagues will be making an attempt to establish a record for Britain's longest kite. The 'Jorvik Serpent' sponsored by the Jorvik Viking Centre, York, will have a head approximately 3 m square and a 500 m tail.

Other notable kitefliers attending the Festival are Martin Lester, Gill & Jon Bloom, Greg Locke and the Bearly-Made-It-Skydiving Squad, Peter Waldron and Fred Waterhouse with his Hyperkites.

Teams will also be coming from France, Germany and Holland.

As well as the two days event, kitefliers in the area in late May and early June might care to pop in to the Guildhall on Coney Steet, York, where there

## EVENTS UPDATE

will be an exhibition of the work of British Kitemakers.

During Whit Week we are also presenting a number of kite workshops. Vercel Pinnock will be describing West Indian Kites, Bill Souten will be taking an adult group making large kites in rip stop while I will be leading a number of groups making a range of kites for children.

Entries are especially invited for the competitions for which prizes have been donated by Bass North Ltd. Rules and entry forms may be obtained from Ann Hoskins, 2 Dewsbury Terrace, York YO1 1HA.

One final plea - I should like to ask kitefliers attending the festival please DO NOT use KEVLAR flying line unless coated or sleeved. That stuff is lethal near crowds of people.

See you at York!

---

### International Kite Fliers Meeting, Fano, Denmark.

From Wolfgang Schimmelpfennig:-

Since the 1st International Kites Fliers Meeting at Fano has been very successful, I am glad to announce the 2nd Kite Fliers Meeting at Fano. It is scheduled from 20th June 1986 to 23rd June 1986.

Fano is a small island on the west coast of Denmark. The beach is an outstanding place for kite fliers, 300 m wide and 11 Km long. The constant wind there makes it easy for us to fly kites. The beach can be reached by cars and strong pulling kites can be connected to them.

We will stay in a group of blockhouses which are located on a camping place. There is a three night package available for 57,- DM.

Of course the stay at the island of Fano can be extended if so desired. Travelers with a camping car or tent are welcome to this camp as well.

Barbecue and Video/slide shows are scheduled for the nights.

The ferry to Fano takes about 20 min and costs 30,- DM. Reservations are not necessary.

The Drachen Club Deutschland will participate on this kite fliers meeting.

There is no sponsor for the kite fliers meeting at Fano.

For reservations and more information write or call to:-

Wolfgang Schimmelpfennig  
Timmermannsredder 11  
2000 Hamburg 71  
West Germany.

Tel: 040/6405199.



## EVENTS UPDATE

Foker International Kite Festival, Scheveningen, Holland.

A further update on the prices for the hotel and conference package has been received.

Staying at the Badhotel the prices are 198.- DFL for a small single room, 273.- DFL for a single room, a double room is 160.50 DFL per person and a triple room 133.00 DFL per person. In addition 60.- DFL will give you lunch, coffee and a buffet-dinner on the Friday as part of the symposium.

The cost is for bed and breakfast including service and VAT for 3 nights.

If you are interested in taking advantage of this offer contact:-

Vlioger Op  
Weteringkade 5a  
2515 AK Den Haag  
Holland  
Tel: 070-85.85.86

---

### European Kite Tour

For those of you who may be interested in attending the events at Holland, Fano and, additionally Cervia the following details supplied by Michael Steltzer may be of interest.

It's a whirlwind tour of some of the most famous kite festivals in Europe including a visit of the only standing kite exhibition in Europe. We have transport capacity for 21 Kiteflyers.

The Itinerary is as follows:-

12/06/86 7.00 am Depart Berlin and arrive Scheveningen 16.00. Stay for the Scheveningen Festival.

16/06/86 Depart Scheveningen for Fano and arrive at 16.00. Stay at Fano including the kitefliers meeting.

23/06/86 Depart Fano and drive to Munich arriving at 18.00. 24/06/86 Visit the museum, some free time in Munich and have dinner in a German Monastery.

25/06/86 Depart Munich for Cervia in Italy arrive at 19.00. Stay for the festival and depart Cervia on 30/06/86 driving back to Munich. Stay overnight and drive to Berlin/Amsterdam on the 1st July.

Three VW vans have been rented. All vans are with turbo-charged diesel engines. Each van will have a maximum of 7 people. The vans will have tubes for kite transport on the roof - 4 tubes per van - each tube 2.5 m long and 30 cm diameter.

Rooms for Scheveningen can be obtained through Vlioger Op as above. Rooms for Fano must be booked through Michael. The cost will be 105.- DM per person. In addition a 12.- DM fee will be charged for organising costs. In Cervia room and board are being supplied by Cervia Volante.

The cost of transportation as outlined above is 500.- DM per person. A 50%

## EVENTS UPDATE

deposit is required to reserve a seat.

If you are interested then phone Michael Steltzer on 030/784 7769 or 030/795 4700. He must know as soon as possible and before the end of April.

If you want some more details of the trip itself get in touch with the editorial office.

---

### Nuneham Park Festival

We have received an invitation to the third Nuneham Park Festival, near Oxford being held on the 6th and 7th September. Last year we gave a demonstration and did some night flying. If anyone is interested in giving a demonstration for this event they should write directly to the organiser.

The person to contact is E.M.Reily Collins, c/o Hallidays, The Old College, Dorchester on Thames, Oxford, OX9 8HL.

---

### Wooburn, High Wycombe.

The following notice was received from Peter Metcalf.

I am organising a Kite Festival at Wooburn near High Wycombe, Bucks on 21st/22nd June. The idea is for an informal get together similar to the Malvern Kiting Weekend.

Over the weekend, and together with two other friends we will be holding a 24 hour sponsored kitefly, the proceeds being divided equally between my daughters school and our local hospital radio. Any contribution would be appreciated.

Anyone interested in attending should contact me on High Wycombe 28133 for details. If you prefer to write the address is Peter Metcalf, 9 Bowden Lane, High Wycombe, Bucks HP11 1DL.

---

### Japanese Festival, Washington, Tyne and Wear.

The festival will be launched on 14th September with a spectacular "Festival of the Air", probably the largest outdoor arts event to be seen in England in 1986. It will include mass kite flying by local groups resulting from three months of workshops by Japan's leading kite makers, Eiji Ohashi and Takeshi Nishibayashi. Demonstrations of kite fighting and of man-lifting kites. The flying of a giant 20 foot kite by a 30 person team.

There will also be some kite trains and an attempt to fly both huge and tiny kites flown by professional Japanese kite makers.

There will also be an exhibition of Japanese kites at the Sunderland Civic Centre during the period of the Festival 14th September to 18th October.

The Exhibition will include the world's smallest kite, the size of a postage stamp, and Europes largest Japanese kite, 20 feet wide and requiring 30 men to

## EVENTS UPDATE

fly it. A rich variety of traditional Kabuki Style kites and modern fighting kites backed up with woodblock prints and other supporting information illustrating the rich social history of Japanese Kites.

---

### Anglo French Kite Days.

Bill Souten of the Midland Kite Fliers has organised a group of about 12 French Kitefliers to come to Britain for the weekend of 3rd/4th/5th May. Events have been organised as follows:-

3rd May - Cofton Park, Longbridge, Birmingham. The park is situated to the south of Birmingham, next to the British Leyland Longbridge Factory. It can be reached by travelling south from the city on the A38 or by taking the A38 from junction 4 on the M5.

4th May - Old Warden Aerodrome, Biggleswade, Bedfordshire. See page 7 for how to get there. After the event we will be meeting in The Hare and Hounds Inn in Old Warden Village.

5th May - Blackheath, London. Situated very close to Greenwich Park and the National Maritime Museum. It can be reached by taking the Blackwall Tunnel A102(M) and the Shooters Hill Road.

All are welcome to come to all events to meet new friends and fly your kite.

---

### Bournemouth

The following item has been sent to us, if anyone knows anymore about this can they let us know.

Hundreds of entries are expected for a mass "Kite Fly" over Dorset in June.

The Kite Fly, part of Dorset's participation in Industry Year, is being organised by the Bournemouth and Poole College of Art and Design, and could involve all Dorset schools and colleges.

Mr John Andrew, head of the department of graphic design and technical illustration at the college, said all kites would be welcome, from the simplest to the most complex and technologically advanced - from the small diamond shaped creation of a primary school pupil to a multi-sailed monster from a college student.

Mr Andrew said that each entry - and there could be as many as 900 short listed - had to carry the name or logo of the sponsor.

Judging will take place on the Great Kite Fly Day, at a venue to be announced and all the short listed entries will be on display at the Dorset Industry Fair at Hurn Airport on June 11 to 15.

The four categories are 5 to 8 years, 9 to 13 years, 14 to 16 years and over 16.

Schools and colleges will carry out the initial judging and they will send the winner in each category to the Great Kite Fly Day.

# RUFFORD PARK

# KITE DAY

SUNDAY 17<sup>TH</sup> AUGUST 1986

Once again there will be a kite fly-in at Rufford Park in Nottinghamshire. The meeting is being organised by Dennis England. Dennis writes " Enthusiasts who have yet to acquaint themselves with this park will see from the plan of its layout below that there are large areas of kite eating woodland, but compensations exist in that there are a lot of nice woodland walks, wildlife on the lake and unusual sculpture and artwork exhibits within the gardens and inside the Craft Centre. Where there is also a nice cafe supplying snacks and light cooked meals. Throughout the season a wide range of special exhibitions are provided in the hall above. CAA clearance to 2000' is in the process of application, a range of lower priced kites will be on sale by the M.K.F. and other attractions are being sought. Last years meeting seemed to be well enjoyed, I hope everyone will come again and have fun. I look forward to seeing you at Rufford on the 17th August." Dennis England.

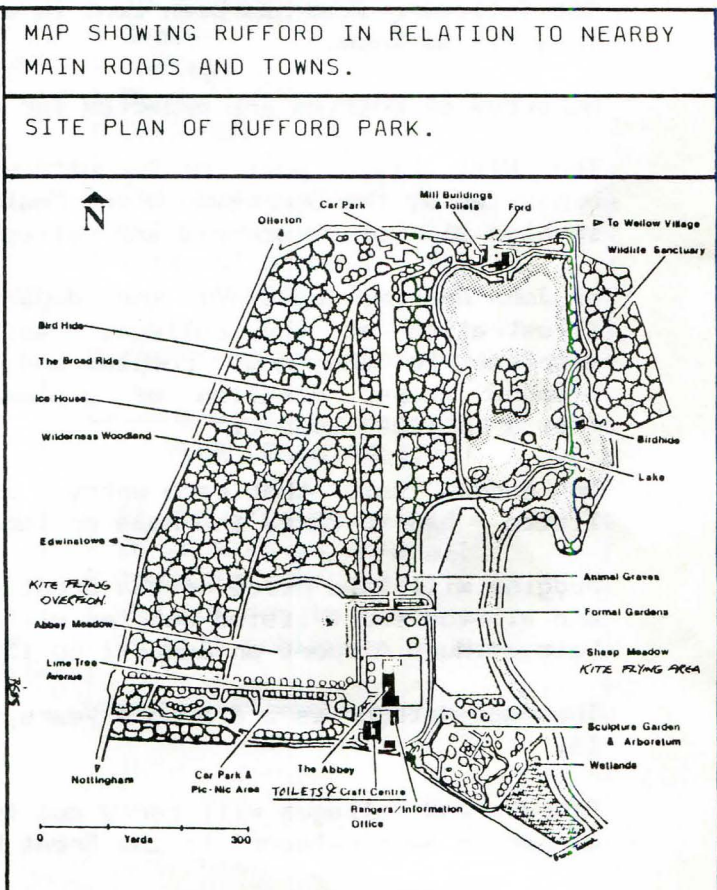
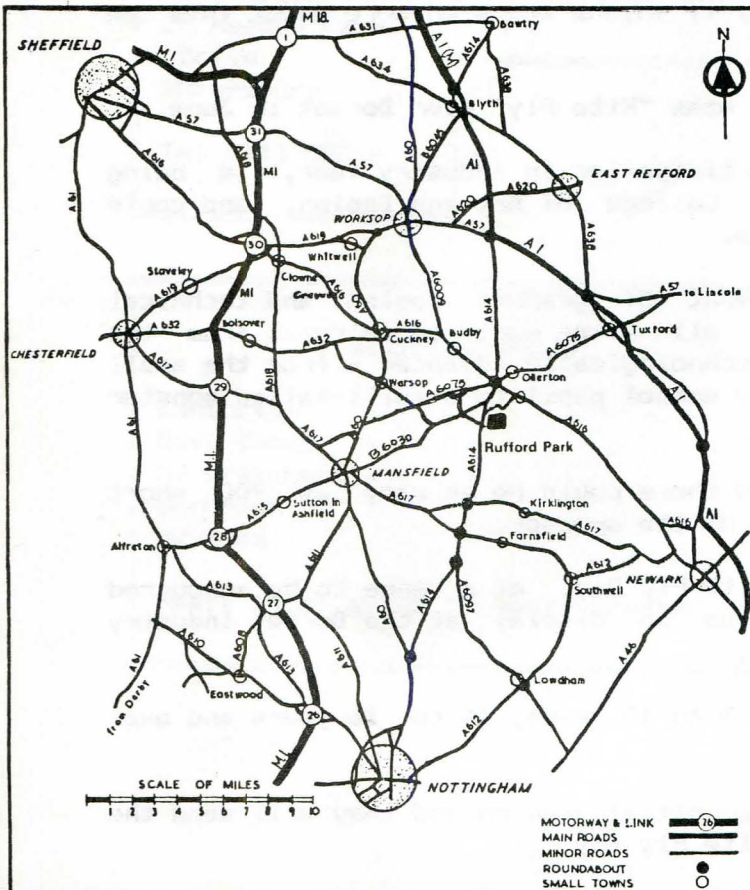

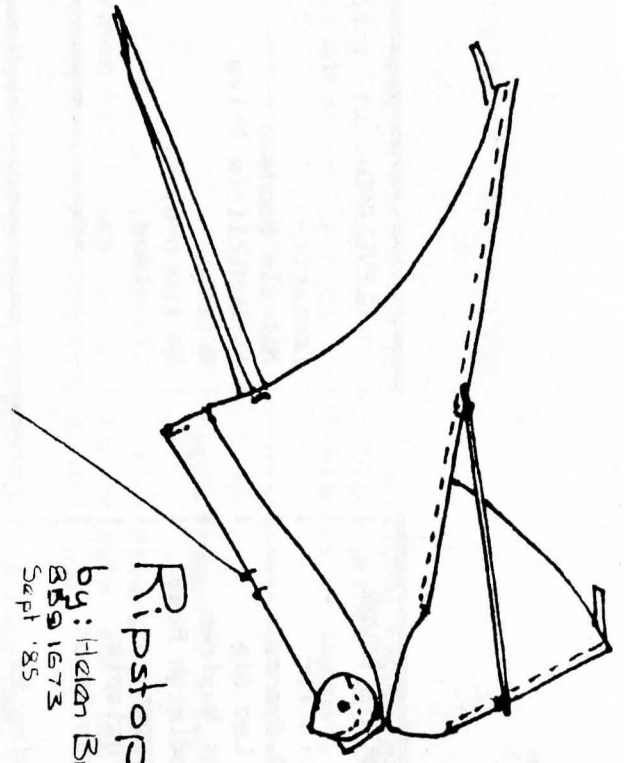

56cm. Cross-bar  
 fixed to rings with  
 rubber band stoppers  
 or plastic sleeves

## Ripstop Bird

by: Helen Bushell 10 Elm Gue E Kaw  
 859 1673 3102 Vic Australia  
 Sept '85

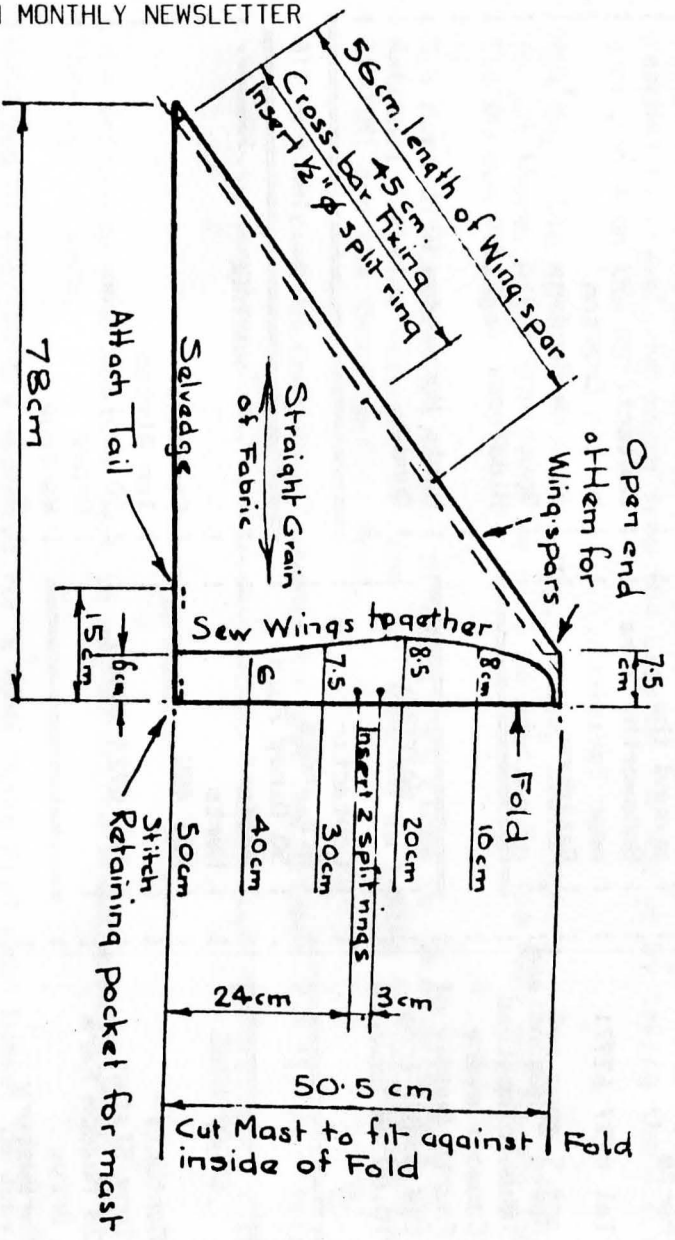

Body - Cut Double

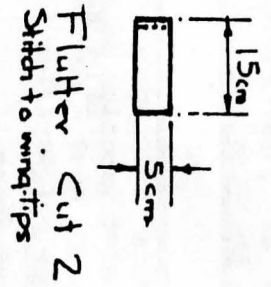
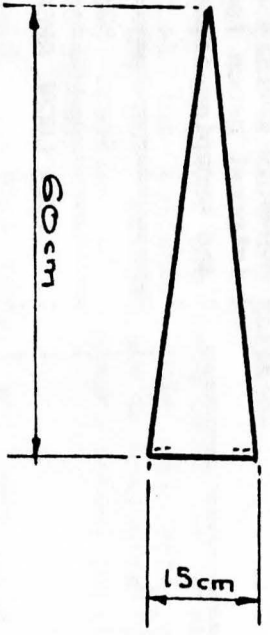

**Materials:** Ripstop Nylon  
 6mm Dowel or equivalent  
 3mm Fibreglass may be used for mast and wings but not for the cross-bar.

14mm Black  
 Stickers for  
 eyes

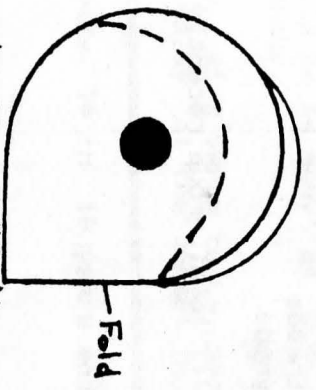

Head: Fold 1/4  
 or card and cut  
 3/4 of a circle 7cm dia  
 Machine stitch to head of kite

## LOCAL GROUPS

### ST. ALBANS

Contact:-  
Geoff Adams  
6 Pembridge Close  
Bovingdon  
Herts  
Tel 0442 833736

Carole and Alan  
Peacock  
61 Windmill Avenue  
St Albans  
Herts

Tel 0727 62971

Meets - Nomansland  
(Wheathampstead  
Common) every  
Fourth Sunday of  
the month from  
10.00 am onwards.

### SHROPSHIRE

Contact:-  
Tony Slater  
28 Meadow Farm  
Drive  
Shrewsbury

Tel 0743 55016

### NORTH DEVON

Contact:-  
L.J.Symons  
Ju Les Gla  
East Waytown  
Goodleigh Road  
Snapper  
Barnstaple  
North Devon

Trying to  
organise fly-ins  
around the  
Godsworthy area  
near Tavistock,  
Dartmoor

### WATFORD

Contact:-  
A.J.Jones  
50 Oxhey Road  
Watford  
Herts  
WD1 4QQ

Tel 0923 29400

### CLEVELAND

Contact:-  
Malcolm Goodman  
44 Huntcliffe Drive  
Brotton  
Saltburn-by-sea  
Cleveland

### GREENFORD

Contact:-  
Martin Croxton  
66 Drew Gardens  
Greenford  
Middlesex

Meets Horsenden Hill on  
Sunday

### WANTAGE

Contact:-  
Ian Alston  
10 Wayland Road  
Grove  
Wantage  
Oxon.  
OX12 0BQ

Tel Wantage 4942  
Hopes to start a local  
interest group for fly-ins  
and swapping ideas

### BETHESDA WALES

Contact:-  
Davi Jones  
57 Braichmelyn  
Bethesda  
Gwynedd

Small local group recently created.

### YOUR LOCAL AREA?

If you are interested  
in forming an informal  
group in your area.  
Why not get in touch and  
we will publicise it for you

## THE SHROPSHIRE HOLDFAST

---

KITES AWAY! ..... We hope not, but it can happen as we know only too well.

The usual way to anchor large, heavy pulling kites is to belt a stout stake or angle iron into the ground with a lump hammer.

Now all this heavy tackle is at an end with the Shropshire Holdfast.

Confessions first; this is a miniature dead crib, or adaptation shall we say, of the Royal Engineer's Ordnance Holdfast Picket used during the war and later, to provide a very strong anchor point for such jobs as bridge building, holding down aircraft, timber and steel erection, in fact any job requiring a restraining force of several tons.

Now for the details of the Shropshire Holdfast. It is simply made out of a 12" length of 1/16" thick steel angle section (1"x1") ,with a 3/8" diameter hole drilled through the apex of the angle near one end, and then several 1/4" diameter holes drilled on alternate sides through the web of the angle.

Take a set of 10 round tent pegs from the local camping shop and if you have the tackle, braze a close fitting washer to the peg near its top hook. (This is not absolutely essential, but it does stop the angle lifting up the pin).

When ready to set up the holdfast, lay it on the ground in line with the direction of pull, and push the pins through the 1/4" holes into the ground at 90 degrees to each other, rather like cross nailing a carpented junction. You need 5 or 6 pins minimum with the first two close to the 3/8" main hole.

In the 3/8" hole, either fit a strong circular ring or a climbers karabiner. The cheapest and most effective ring I have found is a screw link from a local ironmonger, but please check that the working load stamped on the side is adequate.

If you put your line through the ring, attach the kite, and walk downwind, with your reel unrolling in one hand, and your kite in the other, you can then launch the kite and tow it up by walking away from the anchor until a good altitude is gained and finally making several turns around a pin in front of the anchor. If the load is excessive go on again to another pin beyond it.

Dont be tempted to insert a pulley instead of a ring, you WANT FRICTION to lessen the load on the front securing pins.

The holdfast has been used very successfully to hold a seven foot high Sanjo Rokkaku with soft ground and as you know those can really pull.

If you feel that the upward pull of the kite will pull the front pins out of the ground, remember that the resultant direction of pull lies somewhere midway between the kite line and the line running forwards to the front securing pins.

The Shropshire Group have carried out tests on the Holdfast and it is now standard equipment for handling all our seven foot Rokkakus, about six of them, (all of them made by Paul Morgan of Morgan Kites). We have found that the Holdfast could stay put even when loaded with a 300 pound pull as indicated on a 400 pound spring balance.

Note:- Have you any idea of how strong a 100 pound pull feels? It took two of us to apply that 300 pound load and believe me that was some pull, neither

# THE SHROPSHIRE HOLDFAST

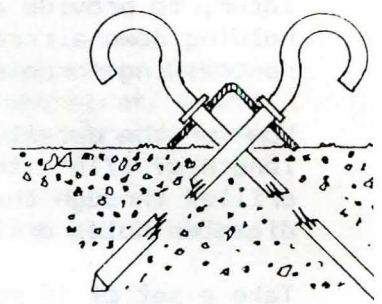
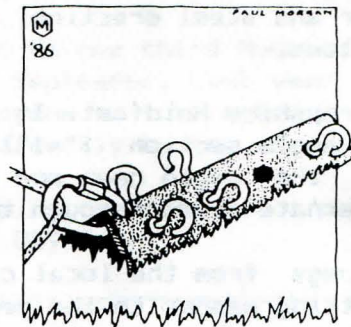
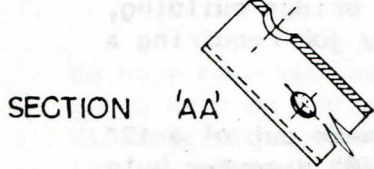
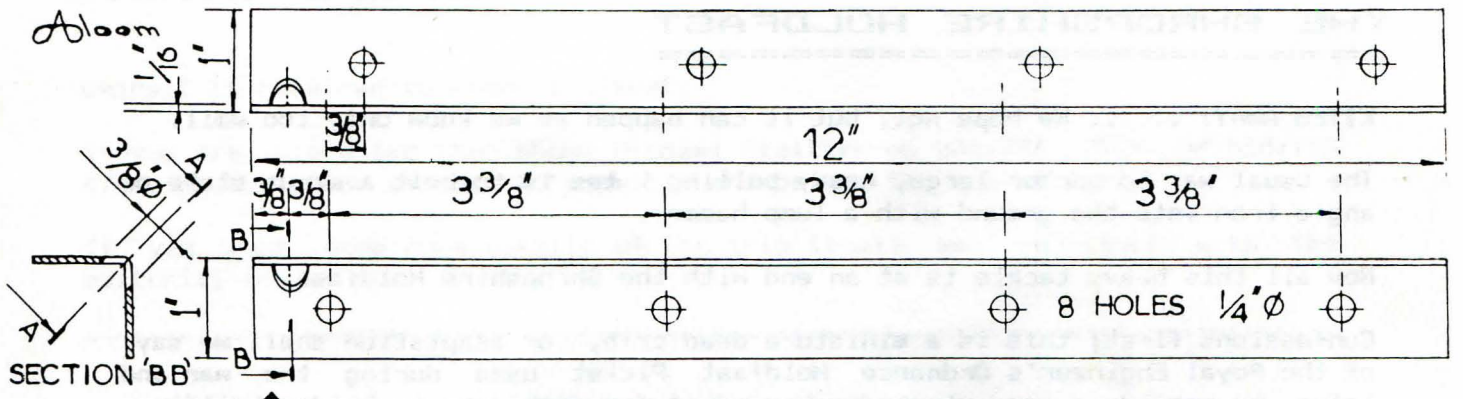

Illustrations by Paul Morgan and David Bl...

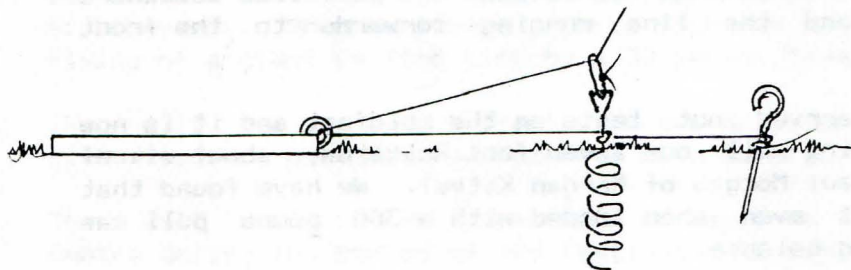
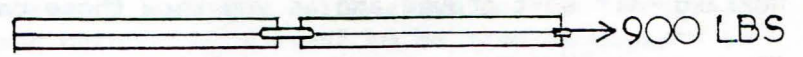
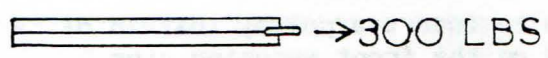
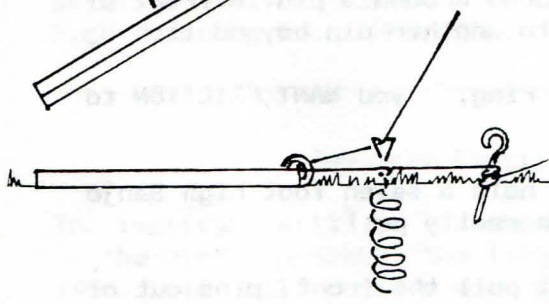
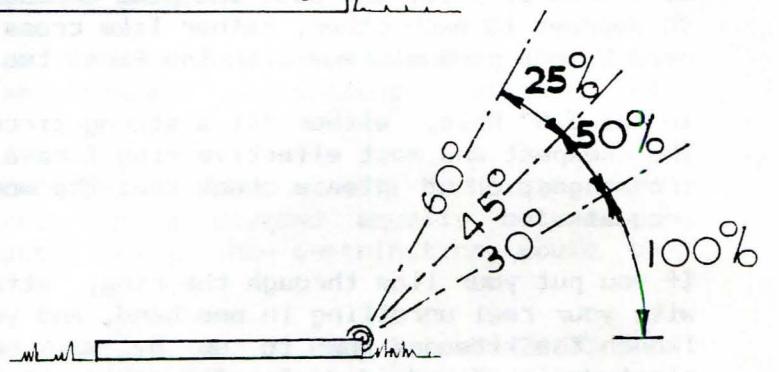
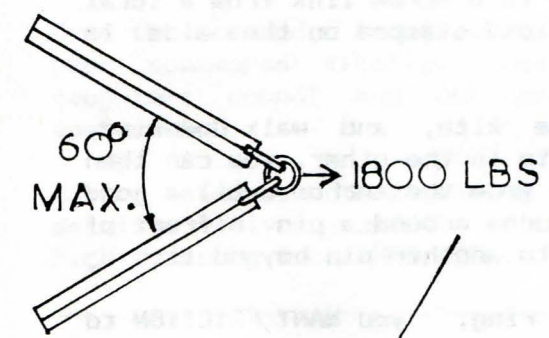
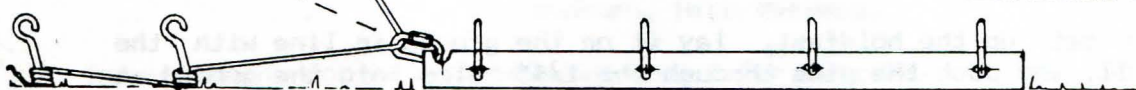

SUGGESTED LOADINGS FOR SHROPSHIRE  
HOLDFAST



# THE SHROPSHIRE HOLDFAST

---

---

of us being exactly lightweight weaklings.

As a foot note to the origins of the Shropshire Holdfast, The Royal Engineers Ordnance Holdfast uses an angle iron about a yard long with spikes of forged steel, 1/2" diameter and 3 feet long. When used in good ground, it will take a 2 ton load from zero degrees to thirty degrees upwards, three times this when used in tandem (One behind the other, linked.) and an amazing six times, when used in a sixty degree vee formation with a common shackle or linked shackles at a junction of the holdfasts.

This means that the Shropshire Holdfast will certainly take a 300 pounds straight load, 900 pounds in tandem, and 1800 pounds in a vee formation!

These load figures are true for all pulls applied from an angle of zero degrees (i.e horizontal) up to thirty degree elevation, but they should be diminished by fifty percent between thirty and forty five degrees, and by seventy five percent between forty five and sixty degrees.

Dont forget the previous hint that actual pull is somewhere between the main kite line angle and the angle of the final anchoring line. (i.e the resultant as shown by the dotted angle on the side view)

Further tests may show that the figures are too conservative anyway, but in any case an increase in diameter of pins from 3/16" to 1/4" and length from 9" to 12" will certainly yield benefits, but where does one stop?

Another useful field of investigation is the use of a "doggy spike". Some pet shops sell dog anchors, something like a giant corkscrew which can be screwed into the ground in front of the Shropshire Holdfast, either to pass the main kite line through, before going to the Holdfast, or used as a securing pin, to carry a strap or loop over the main line which drags it nearer the ground, and reduces the angle of the line going to the Holdfast. More work is going on into the virtues of this new system and further developments will be shown on these pages as they occur.

From the Shropshire Kite Group.

David Bloom.

~~~~~  
If anyone is interested in contacting the Shropshire Kite Group the address to write to is:-

Shropshire Kite Group  
Tony Slater  
28 Meadow Farm Drive  
Shrewsbury

Tel: 0743 55016

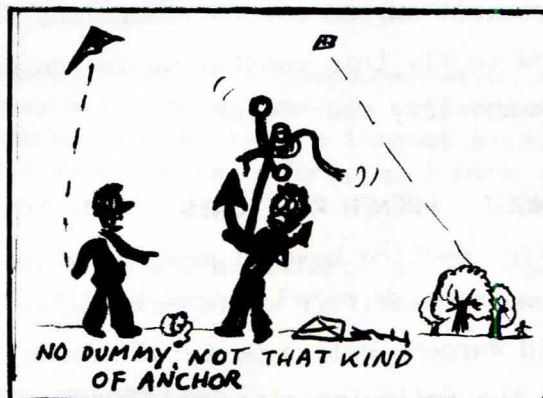



# MKEXTRA

## MIDLANDS KITE FLIERS NEWS

76 OXHILL ROAD, HANDSWORTH, BIRMINGHAM, B21 9RH.



MARCH 1986.

### JACK HALE.

It is with deep regret that I have to inform members of the death of Jack Hale. Jack, father of Mike and Nick Hale was one of our earliest members who always gave an air of authority to any of the activities in which he was involved.

### ACKNOWLEDGEMENT.

Mary, Michael and Nicholas Hale wish to express their sincere thanks to members of the M.K.F. for their kind messages of sympathy and floral tribute in their sad loss of Jack in January.

### BOOKS FOR SALE.

Brian Waters of Derby wrote recently to advise of a book sale in Sussex.

LECORNU, J. LES CERFS-VOLANTS. Paris. Librairie Nony & Cie. 1902. £175.00

(POCOCK, George, ) A TREATISE ON THE AEROPLEUSTIC ART. Second edition, 1852

Any offers ?? £325.00

### JORVIK VIKING CENTRE SERPENT KITE

Plans are a foot to build a 500 metre serpent kite for the Jorvik Viking Centre in York. This kite will hopefully be flown at the York Festival 31st May - 1st June. Members who are interested in helping with this project should contact Bill Souten a,s,a,p.

The kite is to be made from ripstop and fibreglass but using tyvek for the 500 metre tail. It will be bright red in colour and have the official 'Erik' logo at the head. If anyone out there has any stunning ideas on how to fly this monster would you please let us know in the very near future.



### ANGLO - FRENCH KITE DAYS 3rd, 4th and 5th MAY 1986.

After meeting several members of the Cerf-Volant Club de France last year in Italy I was asked if it would be possible for them to come to Britain mainly to visit Old Warden. Well a party of around a dozen are coming this spring and will be flying at the following sites ; Saturday 3rd May - Cofton Park, Longbridge, Birmingham. Sunday 4th May - Old Warden Aerodrome, Bedfordshire. Monday 5th May **MAY DAY.** Blackheath Common, South London. **COME ALONG AND JOIN US AT ANY OR ALL THE SITES.**

SHREWSBURY KITE & MODEL FESTIVAL  
 SUNDAY 6<sup>th</sup> JULY 1986  
 2pm at Sundorne Recreation Ground



ATTRACTIONS INCLUDE—  
 BEER LIFTING COMPETITION  
 KITE, BOOMERANG AND MODEL AIRCRAFT DEMONSTRATIONS  
 JAPANESE KITES,  
 REFRESHMENTS, TRADE STANDS.

**ADMISSION FREE**  
 CIVIL AVIATION AUTHORITY CLEARANCE TO FLY TO 2000ft.

**Sponsored by:**

**THE SHREWSBURY MODEL SHOP  
 ALBREW MALTSTERS LTD**

For more details phone Carol Moffatt - Shrewsbury 107431 61411

DERBY'S  
 BIENNIAL  
 KITE  
 FESTIVAL  
 1986  
 SUNDAY  
 20<sup>th</sup> JULY  
 ON THE RACECOURSE  
 in association with the  
 MIDLANDS  
 KITE FLIERS

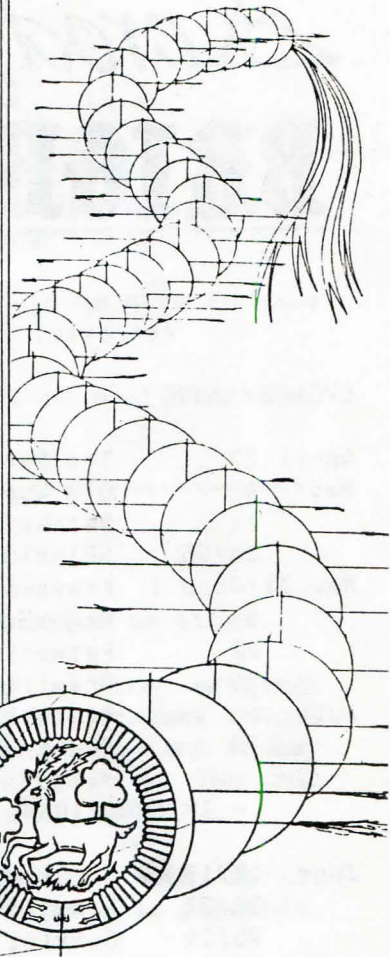

Details: 76 Oxhill Road, Birmingham, B21 9RH.

# ANGLO-FRENCH KITE DAYS

CERF-VOLANT CLUB DE FRANCE  
 THE MIDLANDS KITE FLIERS  
 BLACKHEATH KITE ASSOCIATION  
 BRITISH KITE FLYING ASSOCIATION

## FLYING VENUES

Saturday 3rd May :

Cotton Park, Longbridge, Birmingham.

Sunday 4th May :

Old Warden Aerodrome, Bedfordshire.

Monday 5th May :

Blackheath Common, South London.

# STAFFORD'S FESTIVAL OF KITES

SUNDAY 22<sup>nd</sup> JUNE 1986

ORGANISED BY  
 STAFFORD DISTRICT ARTS COUNCIL  
 IN ASSOCIATION WITH THE  
 MIDLANDS KITE FLIERS



# Aerodyne

## BRIGHTON KITE FLYERS

April 1986

Aerodyne, Stephen Smedley, 86B Centurion Road, Brighton BN1 3LN

### EVENTS- HOME

|               |                                    |           |               |               |      |
|---------------|------------------------------------|-----------|---------------|---------------|------|
| April 27      | The Rake, Petersfield              | 1000 feet | Fly-in        | 197/SU 785265 |      |
| May 4         | Old Warden, Beds.                  |           | Festival      | 153/TL 150448 | BKFA |
| 11            | Beachy Head                        | 1000 feet | Fly-in        | 199/TV 592963 |      |
| 24/25         | BRIGHTON KITE FESTIVAL             | See below | Festival      | 198/TQ 342055 | BKF  |
| May 31/June 1 | Knavesmire Racecourse, York        |           | Festival      |               | YKF  |
| 8             | High Salvington                    | 1000 feet | Fly-in        | 198/TQ 103058 |      |
| 22            | Petworth Kite Festival             |           | Festival      | 197/SU 968217 |      |
| 29            | Grayling Well Hospital, Chichester |           | Demonstration |               |      |
| July 6        | Red Hill                           | 1500 feet | Fly-in        | 198/TQ 284084 |      |
| 20            | Beachy Head                        | 1000 feet | Fly-in        | 199/TV 592963 |      |

### - INTERNATIONAL

|            |                |                                          |  |      |
|------------|----------------|------------------------------------------|--|------|
| June 13/15 | Scheveningen   | 9th Fokker Festival                      |  |      |
| 20/23      | Fanø, Denmark  | 2nd International Kiteflyers Meeting     |  | DCD  |
| 25/29      | Cervia, Italy  | International Cervia Kite Festival       |  |      |
| Sept 13/14 | Dieppe, France | International Festival                   |  | CVCF |
| Oct 4/5    | Wanne, Belgium | International Festival, Chateau de Wanne |  | NCB  |

\* \* \*

I have recently received a catalogue from the American kite retailers "Into The Wind". Although kites in the USA are generally much more expensive than in the UK there are one or two interesting items that I haven't seen over here. Apart from a wide range of stunt kites the catalogue includes a full range of Stratton Engineering airplane kites, a variety of types of Kevlar line, and some pretty impressive "tumbling star box kites". There are also some useful bits and pieces for terminating and joining GRP tube. If you want to have a look see me at fly-ins.

\* \* \*

Membership fees for 1986-87 are due by 1st May, please. A year's annual subscription is £3.95; insurance cover (£250,000 liability for one year) is £1.55. Fill out the form below and send it to Greg, with your money.

\*\*\*\*\*  
To: Brighton Kite Flyers, Gregor N Locke, 53 New Road, Shoreham-by-Sea, BN4 6RB.

NAME: .....  
ADDRESS: .....  
.....

|               |       |
|---------------|-------|
| * MEMBERSHIP  | £3.95 |
| * INSURANCE   | £1.55 |
| * PLAIN BADGE | £1.25 |
| * SWEATSHIRT  | £8.75 |
| TOTAL         | £     |

\* Please delete unrequired items

OFFICE USE ONLY

## BRIGHTON KITE FESTIVAL PREVIEW

This year's event looks like being one of the best ever, being accompanied this time by a kite exhibition in Brighton at the Corn Exchange (see below).

For those of you wanting to stay overnight at the flying site, accommodation is available for self-contained units, limited on the basis of first come, first served. If you intend to take advantage of this, please inform Greg by 1st May.

As always, CAA clearance has been obtained for the duration of the Festival. During daylight hours the limit is 3500 feet above sea level, and additional clearance has been given for night flying at 1500 feet above mean ground level. Remember that perspicuity markers will still need to be carried above 200 feet (60 metres).

To recap: during daylight hours red and white banners or tube streamers must be fixed on the kite line at intervals depending on the type of marker used (see *Aerodyne*, October 1985). When flying at night an arrangement of red and white lights must be carried on the kite line and also placed on the ground at the mooring point (Air Traffic Control Regulations, 1981, Rule 14).

Of course, there's nothing to stop you dressing your kite up to look like a Christmas tree or the Blackpool illuminations if the fancy takes you. So why not participate in a competition that is being organised over Saturday evening (24th May) for "The Most Spectacular Night Kite"? No rules for this one, but I think that safety precludes hooking your delta up to the National Grid! I don't have any information on prizes, but I am sure that there will be some incentive, probably in the form of liquid refreshment.

As well as kites this year the Brighton Kite Festival also plays host to the first National Model Rocket Championships.

## BRIGHTON KITE EXHIBITION

As many of you will already know, the Brighton Kite Flyers have been asked to assist in an exhibition of kites to be held in the Brighton Museum, Corn Exchange, Church Street, Brighton. Entitled "Earth, Waves, Wind and Fire", the exhibition is part of the Brighton Festival whose theme this year is "The Four Elements". The exhibition will include a wide variety of kites (approximately 30) loaned by BKF members. Most of the exhibits will remain on show for the entire duration of the exhibition, which runs from May 2nd to June 29th. Open every day apart from Mondays, an added bonus is that admission is FREE!

\* \* \*

BRIGHTON KITE FESTIVAL '86 commemorative T-shirts and badges are now available from *Aerodyne*. Featuring the festival logo, in blue and red, the T-shirts (white) are £4.85 (incl. p+p), and available in small, medium, and large sizes. The pin badges are 30p - if ordering badges separately, please enclose an SAE. Of course, both items will also be on sale at the Festival.

\* \* \*

## KITING ANNIVERSARIES

|       |    |                                                                                                                                                 |
|-------|----|-------------------------------------------------------------------------------------------------------------------------------------------------|
| March | 28 | Good Friday, traditional kite flying day in Bermuda.                                                                                            |
| April | 11 | Dodds Meddock flies a 4-cell parafoil for six minutes - at the North Pole, 1980.                                                                |
| May   | 5  | Ten Eddy Bow kites flown to 23,385 feet (highest flight in the US), Mount Weather, Virginia, 1910.                                              |
|       | 11 | Rhomboid box-kite released from Brighton by S.H.R. Salmon, attached to drag rope, 1900. Lands at Vierville, France (103 miles) four days later. |
| June  | 27 | Capt. B.F.S. Baden-Powell builds his first man-carrying kite, 36 feet tall, 1894.                                                               |
| July  | 18 | Two-masted boat pulled by kite across the Mersey from Liverpool to Birkenhead, 1828.                                                            |

## EVENTS LIST

=====

- 26th April Spring Kite Festival, Berlin. V.V.W. Festival.  
 27th April Spring Kite Festival, Berlin. V.V.W. Festival.  
 3rd May Festival Hall, London. Demonstration. K.S.  
 Anglo French Kite Day. Cofton Park, Longbridge, Birmingham. M.K.F.  
 4th May Old Warden Aerodrome, Biggleswade, Beds. B.K.F.A. Festival.  
 5th May Anglo French Kite Day. Blackheath Common, London. M.K.F.  
 11th May Grafham Water, Cambs. G.O.K.F. Fly-in.  
 24th May Brighton Festival, North Sheepcote Valley. B.K.F. Festival  
 25th May Brighton Festival, North Sheepcote Valley. B.K.F. Festival.  
 31st May York Kite Festival, Knavesmire, York. Y.K.F. Festival.  
 Ferry Meadows, Peterborough. G.O.K.F. Festival  
 1st June York Kite Festival, Knavesmire, York. Y.K.F. Festival  
 Ferry Meadows, Peterborough. G.O.K.F. Festival.  
 Bath Festival of the Air. Bath. Festival.  
 13th June Scheveningen Kite Festival, Holland. V.O. Festival  
 to  
 15th June Scheveningen Kite Festival, Holland. V.O. Festival.  
 20th June International Kitefliers Meeting of Fano, Denmark.  
 21st June Wooburn Festival, High Wycombe, Bucks. Festival  
 International Kitefliers Meeting of Fano, Denmark  
 22nd June Petworth Kite Day, Petworth, Sussex. P.F. Festival  
 Wooburn Festival, High Wycombe, Bucks. Festival.  
 Stafford Festival of Kites. Festival. M.K.F.  
 International Kitefliers Meeting of Fano, Denmark.  
 25th June Cervia Kite Festival, Cervia, Italy. C.V. Festival  
 to  
 29th June Cervia Kite Festival, Cervia, Italy. C.V. Festival.  
 29th June Blackheath Summer Rally, Blackheath, London. B.K.A. Festival.  
 6th July Shrewsbury Kite festival. M.K.F. Festival.  
 13th July Riverside Park, St. Neots, Cambs. G.O.K.F. Fly-in.  
 20th July Derby Kite Festival, Derby Racecourse. M.K.F. Festival.  
 26th July Wessex Kite Festival, Netley, Southampton. W.K.G. Festival  
 27th July Wessex Kite Festival, Netley, Southampton. W.K.G. Festival.  
 10th August Grafham Water, Cambs. G.O.K.F. Fly-in.  
 17th August Rufford Park Kite Day, Nottinghamshire. Festival.  
 24th August Bournemouth Kite Festival, Hengistbury Head. W.K.G. Festival.  
 6th September Aldham Kite Day, Marks Tey, Colchester, Essex. E.K.G. Festival  
 Malvern Kite Weekend, Malvern, Worcs. M.K. Festival  
 Nuneham Park Festival, Oxford. Demonstration.  
 7th September Malvern Kite Weekend, Malvern, Worcs. M.K. Festival.  
 Nuneham Festival, Oxford. Demonstration.  
 13th September Dieppe International Kite Festival, Dieppe, France. Festival.  
 Festival of the Air, Newcastle upon Tyne. W.A.C. Festival.  
 14th September Dieppe International Kite Festival, Dieppe, France. Festival.  
 Festival of the Air, Newcastle upon Tyne. W.A.C. Festival.  
 Ferry Meadows, Peterborough. G.O.K.F. Fly-in  
 19th September Berlin International Kite Festival, Berlin. V.V.W. Festival.  
 to  
 21st September Berlin International Kite Festival, Berlin. V.V.W. Festival.  
 5th October Old Warden Aerodrome, Biggleswade. B.K.F.A. Festival.  
 18th October Copenhagen Kite Festival, Denmark. Festival.

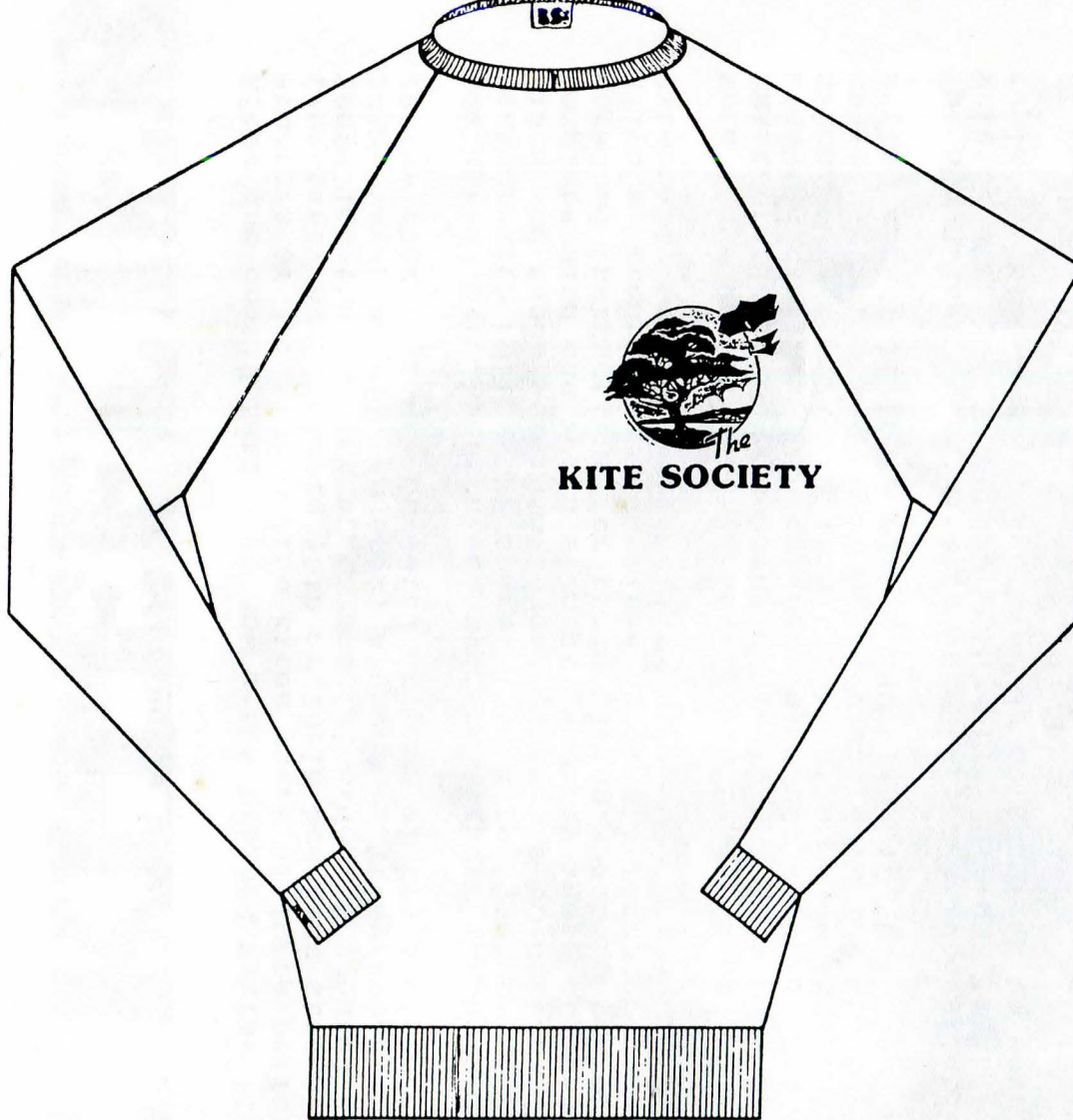

## THE KITE SOCIETY SWEATSHIRTS

High quality, 50% Polyester 50% Cotton mix, crew neck, fleece lined sweatshirts.

Available in either White or Grey Marl with a black logo on the left breast.

SIZES: 36" (S), 38" (M), 40/42" (L), 44" (XL), 46" (XXL).

The Kite Society logo is approximately 90mm by 130mm in size.

PRICE £10.00 each plus £1.00 for post and packaging.

Delivery will take about 28 days. Cash with orders please.....

# THE KITE SOCIETY

31, Grange Road, Ilford, Essex IG1 1EU

## INTERESTED IN KITES?

Are you wondering if there are any groups or organisations you can join?

THE KITE SOCIETY could be the answer. The KITE SOCIETY was created to encourage communication between kitefliers, both the novice and the expert.

The benefits of membership include :-

A quarterly publication of a newsletter to which members are encouraged to communicate. Plus kite plans, kite news and details of events around the country, both national and local.

Free admission to the bi-annual kite festival held at Old Warden, Bedfordshire.

Discount at kite shops throughout the U.K. and Europe.

Organised trips to international kite festivals.

### MEMBERSHIP FEE:

£4.00 per year for the U.K. £6.00 per year for the rest of Europe. All other countries £6.00 Land Mail or £8.00 Air Mail.

For this members will receive four issues of The Kiteflier and the benefits as listed above.

Supplementary membership for a member living at the same address £2.00. For this low cost fee a membership card will be issued for discount and the entry into Old Warden.

### METHODS OF PAYMENT.

All cheques, postal orders or money orders should be made payable to the KITE SOCIETY.

\*\*\*\*\*  
 I WISH TO JOIN THE KITE SOCIETY AND ENCLOSE A CHEQUE / POSTAL ORDER / MONEY ORDER / CASH FOR  
 \_\_\_\_\_ MADE PAYABLE TO THE KITE SOCIETY.

Name .....

Supplementary members :-

Address .....

.....

.....

.....

.....

.....

.....

POST CODE ..... TELEPHONE NO.....

PLEASE SEND THIS FORM WITH PAYMENT TO THE ABOVE ADDRESS.

Badges are also available. These 4" x 2" badges with the words "The Kite Society" (no logo) embroidered on them cost £1.80. Background colour can be black or white. Thread colour can be one of Red, White, Blue, Yellow, Green, Black or Orange. If you are interested send us details of colour choice and cheque or P.O. made payable to The Kite Society.



31, Grange Road, Ilford, Essex IG1 1EU

advertisement

Spring is here

After due consideration we now stock braided Kevlar flying line for stunters or for single line kites where ultimate performance is important. Available in 50lb or 200lb breaking strain it is wound in 200ft lengths, or longer to special order. Suggested uses are for the 50lb- Peter Powell, Phoenix, Avenger or Trlby/Ace/Blazer. For the 200lb- Flexifoil 6ft or 10ft, Griphon or train of Peter Powells.

New kites- from America we have the Avenger which is a chevron shaped stunter with hollow GRP spars. This kite flies best in light/medium winds and needs very small hand movements to control it. Also comes complete with the world's worst assembly instructions- but very detailed instructions for train flying. Soon to be here from Italy, Alivole kites- range comprises about six modern style box kites (ie externally braced, multi celled etc).

More line- we now stock tandem braided polyester (a sort of hybrid twist/braid) in 650m lengths of 110lb and 350m lengths of 200lb breaking strains. Much cheaper than pure 16 or 32 plait braided nylon/polyester flying line this line has low stretch and good wear characteristics making it equally suitable for stunters or single string kites. 110lb is £9.95, 200lb is £10.50.

The Sky Blazer stunt kite is very very nearly available (at time of writing). Basically square with a flexible GRP frame the Sky Blazer replaces the old Trlby/Ace kite as our easiest to stack stunter.

On the book and magazine front Kites-the science and the wonder is now available again. Kites by Carpentier and Bachelet has gone up to 2.95. Another issue of KiteLines should be here real soon now (well, soonish nowish sort of). We have another book on boomerangs written by Herb Smith, a well known Australian boomerang person ( well, it does say he's well known in the book).

Still Air Toy- the Aerobie (a sort of flying ring thing) should be available from the beginning of April. Flies further than nearly any other hand flung object, Aerobies are good for the unsocialable frisbee flinger who wishes to remove himself from the vicinity of others ( 100yd throws are easy).

So far this year, new items; Space Shuttle kite, Icarus kite, Kevlar flying line, Tandem braid, Avenger stunter, Herb Smith Boomerang book, 8 & 10mm GRP rod (only in shop).

Kite Society Gold Card welcome here.  
Never leave the flying field without it!  
It says more about you than .....?

**The Kite Store Ltd, 69 Neal Street, London WC2H 9PJ.**