

Bliainiris Thiobraid Árann

# TIPPERARY

G.A.A. Yearbook 2004

*Inside:*  
**Crystal Quiz**

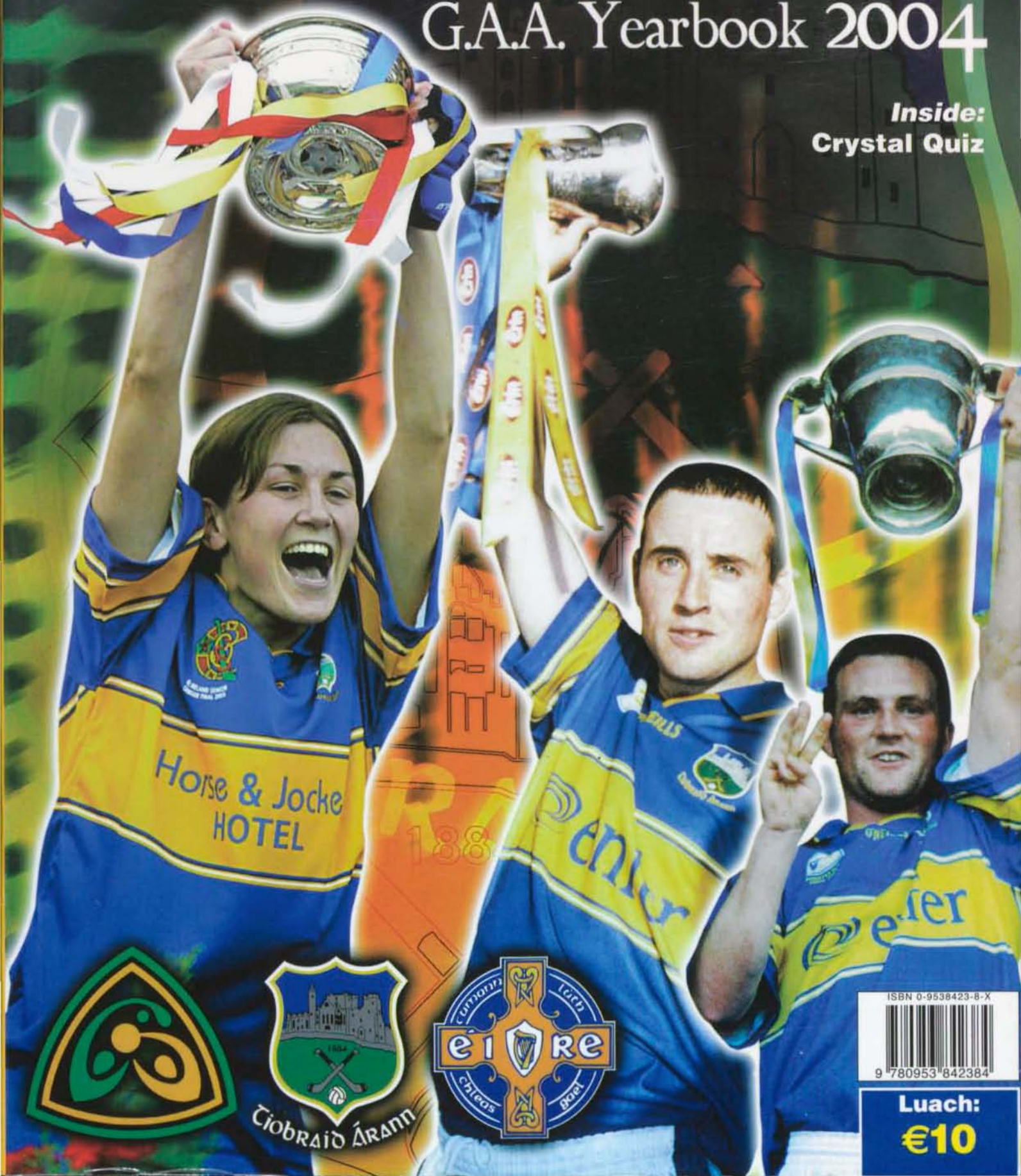

Horse & Jockey  
HOTEL



Tiobraid Árann



ISBN 0-9536423-8-X



9 780953 842384

**Luach:**  
**€10**

# Tiobraid Árann



Front row (from left): Alan O'Neill, Joe Ryan, Hugh Moloney, Martin Maher, Eoin Kelly, Roman O'Brien, Eamon Ryan, Michael Phelan, John O'Brien, David Kennedy, Conor O'Mahony  
Back row (from left): Evan Hanley, Timmy Minogue, Joe Caesar, John Devane, Francis Devanney, Pat Buckley, Tony Scroope, Vincent Doheny, Eamon Buckley, Diarmuid Fitzgerald, Michael Farrell, Lee Shanahan, Nicky Ryan, Derek Bourke, Shane Sweeney, David Maher.

## MUNSTER U-21 HURLING CHAMPIONS 2003



# Tipperary G.A.A. Yearbook



## 2004

C  
O  
N  
T  
E  
N  
T  
S

Focal ón gCathaoirleach	3	Tipperary Camogie Players Dominate All-Star Awards	95
Blame the vicar!	5	Tipperary Junior County Camogie Team	96
Bad start and worse finish	9	Tipperary Camogie Supporters Club	97
Tipperary Intermediate Team 2003	13	Tipperary Camogie 2003	99
Under-21 Hurling Championship review 2003	15	South Tipperary review	105
Tipperary County Minors 2003	17	Tipperary Ladies Football 2003	117
Tipperary win Masters All-Ireland	19	Mid Tipperary Review	125
Senior Hurling Championship	21	New Crest for Mid Board	138
Tipperary Football 2003	27	West Tipperary Review	143
The Ballad Section	29	2003 Historic Year for Tipperary Institute	150
Inter-County Football Review	31	Hosting of Ryan Cup/Fitzgibbon Cup	151
A profile of Andy Shortall	33	Tipperary Handball Report	153
County Senior Football Championship	35	Semple Stadium	157
Cahir's Historic first	37	Coiste Scór Thiobraid Árann	158
Declan's Australian Diary	39	Tipperary team of 1958-1965 honoured	160
Dinny Cahill	40	Cumann na Sean Ghael	162
Donie Nealon	41	Golden-Kilfeacle reunion	164
Tipperary Supporters Club	43	Tipperary Top 2003 All-Star Charts	170
Tales of Tipperary's troubles with three	45	County Champions 2002	171
Tipperary Hurling Club, New York	47	Munster Council Awards	172
Tipperary Hurling at the crossroads	49	Vodafone Awards	173
Recent GAA publications	51	Mid Tipperary GAA Convention	174
The Blue and Gold Ultras	55	Tipperary Primary Schools' GAA Quiz	166
Paper Chase	57	Presentation, Celebrations and other Social Events	175
Adanced School of Hurling	61	County Bord na nÓg 2003	177
Mick Burns	63	Mick Prior Memorial Tournament	179
How many have we won?	65	North Tipperary Bord na nÓg 2003	183
Which way will the HDC jump?	67	Mid Tipperary Bord na nÓg 2003	185
National Athletics Champions	69	South Tipperary Bord na nÓg 2003	189
John Costigan	71	West Tipperary Bord na nÓg 2003	193
Medal presentation 51 years on	73	Summer Camps in the West 2003	197
The Life of a PRO	75	Cumann na mBunscoil	198
Emily club honours players of the past	77	Post Primary Schools Reports 2003	203
Roscrea Sports Awards	78	The Tipperary Year Book Awards	206
North Board review	79	Scoreboard	207
Ballina Under-21's enjoy great year	87	Football Highlights	212
The Sweetest Victory of all	91	Friends we lost in 2003	213
Raymie Ryan Interview	93	Launch of Camogie Book	224

### COVER PHOTOGRAPHS:

David Morrissey, Tipperary Minor Hurling Captain with the Munster Championship Trophy.  
 Una O'Dwyer, Senior Camogie Captain with the All-Ireland Trophy (The O'Duffy Cup).  
 Eoin Kelly, Tipperary Under-21 Hurling Captain with the Munster Championship Trophy.

**Liam Ó Donnchú, Tipperary Yearbook Secretary, Ballymoreen, Littleton, Dúrlas Éile, Co. Thiobraid Árann**

# Tipperary G.A.A. Merchandise Shop

For all your Christmas gift ideas call to Tipperary GAA Merchandise Shop at Lár Na Pairce, Slievenamon Road, Thurles

## On-Line Shopping

You can buy Tipperary GAA Merchandise from anywhere in the world

Log on to: [tipperary.gaa.ie](http://tipperary.gaa.ie)



Open 10am-5.30pm Mon-Sat all year round  
Phone: 0504-22702 Fax: 0504-24333  
Email: [tipperary@gaa.ie](mailto:tipperary@gaa.ie)  
or shop on-line at our web site:  
[tipperary.gaa.ie](http://tipperary.gaa.ie)

Selection of Club Histories, Hurleys, Sliotars, Footballs, as well as League Leader Hurling Board Game also on sale



Visit **Lár na Páirc**

Offers a wide range of Tipperary Supporters' wear including:

- Jerseys
- Shorts
- Socks
- Tracksuits
- Geat Bags
- Polo Shirts
- T-Shirts

We meet the needs of all Tipperary supporters from scarves, jerseys, shorts, tracksuits & socks

**Gift Vouchers available**

**i** Tourist Information Point Open all Year



Call in, phone, fax, e-mail or check out our web site

**Free T-Shirt with ever €40.00 of goods purchased**

# Focal ón gCathaoirleach

(Donal Ó Seanacháin)

**B**a mhaith liom fáilte a chur roimh bliainirs Thiobraid Árann 2004. Teastaíonn uaim ard moladh a thabhairt arís don choiste foilseachain agus tá súil agam go mbainfidh lucht a teite ard taitheamh.

It is my pleasure to welcome once more the annual Tipperary Yearbook on to the shelves of our newsagents. This publication has been ongoing for in excess of thirty years and it is to the credit of the publication committee that it's a sell out each year. My sincere thanks to the committee for a job well done.

A year that initially promised quite a lot on the playing front ended in disappointment. Our senior hurling team participated in a marvellous league final that we looked like winning for much of the game only to have it snatched from us in the dying minutes. It also proved costly for us in terms of injuries. The championship, having started badly with defeat by Clare, saw us bounce back and we had good wins over Laois, Offaly and Galway. On August 17th, we travelled to Croke Park in optimistic mood for showdown with Kilkenny. Despite an excellent first half display, which saw us, lead by two points the break, Kilkenny proved much the stronger in the second half and in the end we were well beaten.

The success of our minor and under-21 hurlers at provincial level augurs well for the future. My sincere congratulations and thanks to the players and their respective management teams.

On the football scene, the year started impressively when our senior foot-



ball team captured the McGrath Cup. The league campaign that followed was less rewarding. We got back on track in the championship and although beaten by Kerry we came through the qualifiers only to be beaten by Donegal in Croke Park in what I believe was a good day for Tipperary football. If we can continue proper coaching at underage level and with greater commitment from the players and full support of our development programmes, all of us could look forward to future with a certain amount of optimism. My thanks to all who work so hard in the promotion of football and I assure them of my total support.

I want to express my appreciation to the many sub-committees who undertake so much work on behalf of the board. Much of their work goes unnoticed but without them Gaelic games in

the county would not function.

I want to congratulate the achievements of our camogie team in winning the Munster and All-Ireland titles. Their success and the progress of ladies football in the county have highlighted the important role that ladies can play in our association. In a year that saw Tipperary selected as one of the pioneering counties for the integration of GAA, ladies football and camogie it gives me great pleasure to congratulate the camogie team on an outstanding success and the ladies football team who won provincial honours. My thanks to everyone who helped and co-operated during the year.

Tipperary handballers did well this year with a number of provincial and All-Ireland titles coming back to the premier county. The success of Ger Coonan (Ballina) in the All-Ireland 60 x 30 minor singles final was a highlight of the year, as was the world title for Fergal Collins in the boys under-13 doubles competition. Well done to all concerned in and out of the handball court.

As an association we have a duty of care to Scór and our culture, which Scór promotes. I would ask clubs to become pro-active in the effort to help Scór survive and thrive. Tipperary can compete with the best as evidenced by the All-Ireland success of the Shannon Rovers, Ballad Group, this year.

Chun deireadh a chur ba mhaith liom mo mhíle buíochas ghabhail le gach éinne as ucht an sar obair atá a dhéanamh acu ar son Chumann Lúthcleas Gael sa chontae agus mar buille scór guim Nollaig fé shean is faoi mhaise oraibh go léir.

## Tipperary GAA Yearbook Committee 2004 *Coiste Cumsarsáide Thiobraid Árann*

**Cathaoirleach:** Seamus J King  
**Rúnaí:** Liam Ó Donnchú

**North Tipperary**  
Ed Donnelly, County Board PRO  
Seamus O'Doherty  
Liam Hogan

**Mid Tipperary**  
John O'Grady  
John Costigan

**South Tipperary**  
Con Hogan  
James Holohan  
Mícheál Ó Meara.

**West Tipperary**  
Jerry Ring  
JJ Kennedy

**Thanks to our photographers:**  
Brendan O'Connor, Jerry Ring, Bridget Delaney, John Kelly, Breeda Mulally, John Moloughney.

# The Tipperary Supporters Affinity Credit Card

Tipperary



An Exclusive Credit Card for the Tipperary Supporter

In 2000 the Tipperary GAA, in association with Bank of Ireland, launched the Tipperary Affinity Credit Card. Since then, funds generated from this card have benefited hurling in Tipperary. Strengthen your ties with the Tipperary Hurling Team while supporting the continuing activities of the Tipperary GAA and take advantage of having your own unique Credit Card featuring the majestic Rock of Cashel.

## Features of the card :

- Up to 56 Days Interest-Free (provided you pay by the payment due date)
- Interest Rate :
  - On purchases - 16.9%
  - On Cash Advances - 17.2%
- Worldwide acceptability
- 24 hour access to cash
- Balance transfer option

## Benefits to Tipperary GAA

Bank of Ireland donates €13 per new account and a percentage of the annual spend to the Tipperary GAA Supporters Club - all at no extra cost to you.

Support Tipperary and get a great deal . . .

Bank of Ireland

To apply for your Tipperary Supporters Affinity Card, call Bank of Ireland at

**1890 365 100**

For further details visit the Tipperary GAA Supporters Club website @ [www.tippsupportersclub.com](http://www.tippsupportersclub.com)

Tipperary

Bank of Ireland



Lending criteria and terms and conditions apply. Rate quoted effective as at 1st March 2003 and subject to change. Bank of Ireland is licensed by the Central Bank of Ireland

# Blame the Vicar!



By Archbishop Clifford

**“When things go wrong and it's rather tame, To find we are ourselves to blame, It gets trouble over quicker To go and blame things on the Vicar.”**

For “Vicar” read “Manager” in John Betjeman’s amusing poem and you have an explanation of the recrimination, which followed Tipp’s heavy defeat by Kilkenny in the All-Ireland semi-final in August.

I had set my video recorder before leaving home that day. I anticipated a classic, “emotion recollected in tranquility” if not pure poetry. I played it after my return that evening only to find that the tape ran out at half-time with Tipp two points up! Indeed, the tape recorder was wiser than some Tipperary supporters who reacted to this defeat with more emotion than tranquility! It is regrettable that some so-called supporters resorted to cowardly abuse of the manager and even of his family, with anonymous letters and telephone calls. This was one of the reasons why Michael Doyle resigned and his co-selectors with him.

In my experience, anonymous letters are never about the issue presented, they usually date back to some past injury, real or imaginary. Too long waiting in the long grass cause such writers to forget their names! Rather than take John Betjeman’s solution, we might recall Oscar Wilde’s story of his visit to a miners club in a wild part of North America or Canada. When one miner, who didn’t regard the music up to standard, raised his gun and pointed it towards the pianist, another shouted, “Don’t shoot the piano player - he is doing his best”. Both the management and the team did their best in 2003. They got within an ace of winning the league. Only the loss of ace full-back,

Philip Maher, deprived them of victory in a game which was played with championship passion.

Going out barely two weeks later without Philip Maher, Eamon Corcoran and Paul Ormond, we were given tickets for the scenic route by Clare, who were waiting for three years to recover lost ground. The team got to Salthill but it was no stroll on the promenade! A one-point win, after a Galway do or die last minute surge, gave us new confidence.

Offaly were the next opponents and they were no match for us. And so to the semi-final against Kilkenny. Even though I was not able to see the video recording, I will never forget Brendan Cummins’ “out of body saves”, half way through the second half. Three times he did the impossible, blocking and sending out. The crowd stood in awe and admiration. The only problem was that the Tipperary backs were also stuck to the ground watching the ping-pong exchanges. A goal on the fourth try. And then the deluge! A twelve point defeat. Then the post-mortem and the fall-out.

It fell to the ladies to bring home the only All-Ireland title in 2003. And they did it in style! They found themselves back in the final with Cork, who had robbed them of their crown twelve months before. Cork were favourites to take the O’Duffy Cup for the second time but they did not reckon with the Tipp girls’ determination to prove that last year’s final with the four Cork goals did not do them justice. So they played with pure passion and with all their well-honed skills to win their fourth All-Ireland in five years.. There was only one goal this time - Jovita Delaney saw to that! It was a magnificent team effort and the inspirational captain, Una O’Dwyer, held up the O’Duffy Cup while Raymie Ryan looked on with pride, a worthy successor to Michael Cleary.

The senior footballers had another unhappy visit to Tralee, but they had a much better game against Carlow where they won their way to a Croke Park appearance against Donegal. While they did not win, they played first class football. They were unlucky not to avail of two goal opportunities. Had they been taken the result might have been different. Two players impressed that day and indeed throughout the season, man of the match, Declan Browne and Eamon Hanrahan. But full credit to the team and management on an overall satisfactory year.

The under-21 hurlers gave us four great games. They defeated Clare and Cork in extra time to take the Munster

Crown. They drew with Galway and lost in extra time.

Indeed, there was controversy here too because the referee announced two minutes of time added on at the end of normal time. He played almost four and Galway got the goal in the dying seconds which got them into extra time. The Galway men won by four points — yet another semi-final disappointment for Tipp players and supporters.

The Spring heralded a new disease called SARS, which threatened to call off the Special Olympics. Luckily, the crisis passed and the event proved to be a marvellous success, which involved communities all over Ireland, including Co. Tipperary. The special athletes reminded us forcibly that we should look at their abilities rather than their disabilities and not patronise them. So, I won’t tell them that they were just fantastic!

The Sars of Thurles came very close yet again to winning the Dan Breen Cup. They defeated reigning champions Mullinahone in a very exciting game and faced Toomevara once again in the county final. They had a poor first half but they put in an almighty effort in the second and had us on the edge of our seats as they bombarded the Toomevara goal in the final minutes. But the Greyhounds had the experience and the stamina to stave them off for at least another year!

County Final Day at Semple Stadium saw forty-six of the hurling greats from 1958-65, winners of five All-Irelands came on to the pitch to take the salute. They looked fit and well, probably much fitter and healthier than their erstwhile opponents! It was timely and fitting for the Tipperary County Board and the “Tipperary Star” and the Anner Hotel to honour these men and their families. They gave Tipperary Gaels huge pride and enjoyment in their day. The spontaneous applause for one man among the forty-six - Jimmy Doyle — was a mark of the very special, enduring affection in which he is held

Like Knocknagoshel of old, Tipperary Institute arose up and took its place among the nations of the earth this

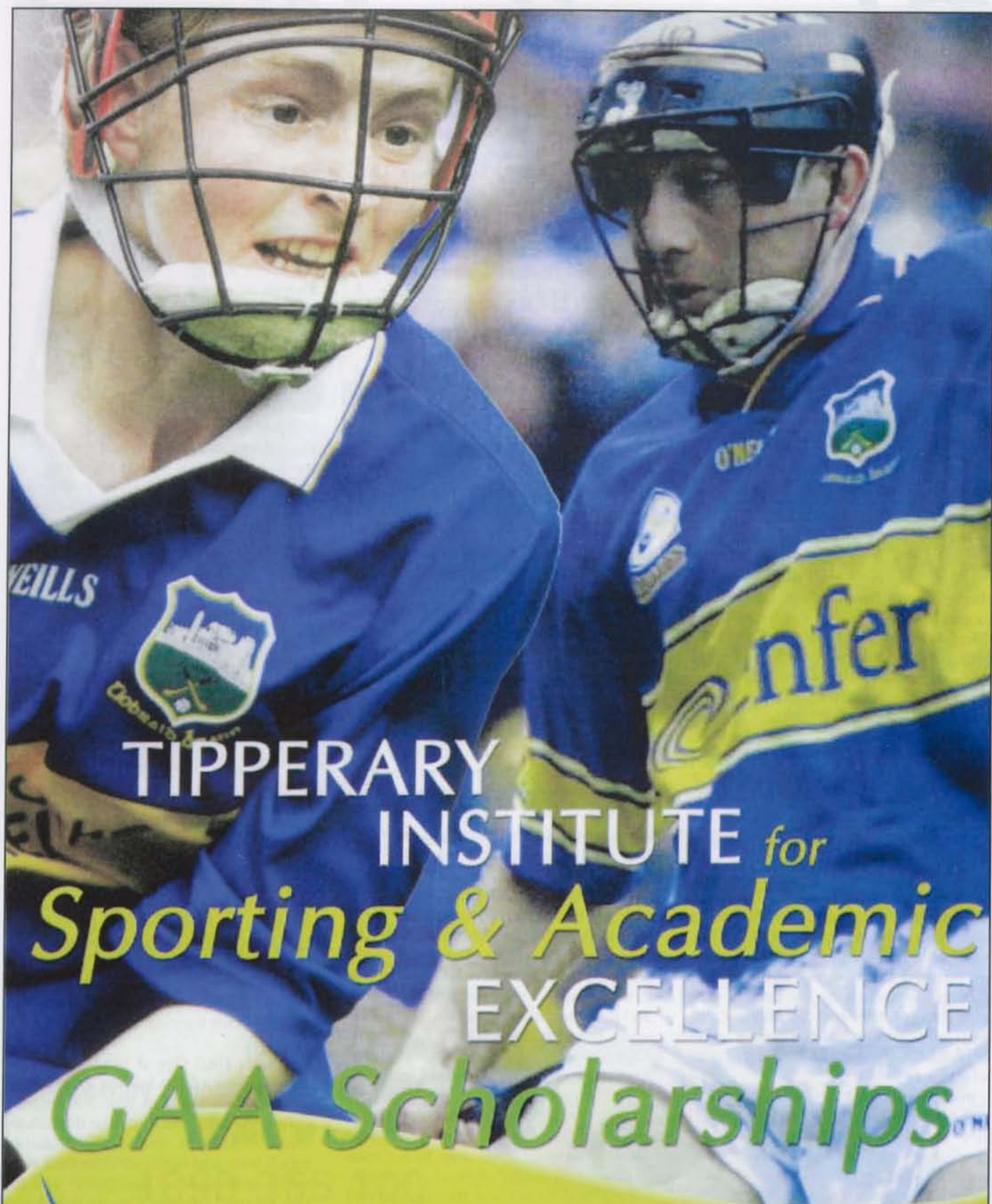

TIPPERARY  
INSTITUTE *for*  
*Sporting & Academic*  
EXCELLENCE  
GAA Scholarships



Instiitiúid Thioðraid Árann

Nenagh Road, Thurles, Co. Tipperary.  
Cashel Court, Clonmel, Co. Tipperary.

Tel: +353 504 28000

Fax: +353 504 28011

Email: [info@TippInst.ie](mailto:info@TippInst.ie)

Web: [www.TippInst.ie](http://www.TippInst.ie)





Spring. It hosted the Fitzgibbon and Ryan Cups. At the reception in the dining hall, the warmth, the welcome and the hospitality that characterised the "Homes of Tipperary" in Kichham's day was palpable. The competitions were sponsored by an I.T. company, Datapac, a healthy change from the regular drink sponsorships of so many sports and festivals.

To top it all, the Tipperary Institute hurlers won the Ryan Cup for the first time — beating all comers in their grade, including Athlone IT in the final. Mark O'Leary was their star in a very skilful fifteen. Fitzgibbon Cup next stop!

Despite the disappointment of the senior hurlers, it was not a bad year overall. The weather was the best in years. It lasted almost until the end of October. We got the Cathedral

restored to its original splendour and Semple Stadium also extended the "Kinane Stand". I wish to thank the county board for postponing the county finals to facilitate us for the official opening on October 5th. As it happened, we were in the Cathedral from the rain that Sunday, and the sun shone at the county finals on the following Sunday. Fair exchange!

I have some experience of anonymous letters in my job. I always look for the signature before I read any letter. If there is no signature it goes in the shredder! To quote Sam Goldwyn, author of such statements as "a verbal contract isn't worth the paper it is written on; include me out. Anonymous letters! I wouldn't put my name to one of them!" I am sorry for what happened to Michael Doyle. I still cherish the memory of his two goals in Killarney in 1987.

We may have lost to Kilkenny twice in the one year but we must not lose our sense of humour. Actually, I once caught out the writer of many anonymous letters. She sent me a Christmas Card! You would have to laugh at it. Such people should not be taken too seriously.

Which now brings me to wish all the readers of this comprehensive chronicle of the ups and downs of 2003 a very peaceful and Holy Christmas. As they say today, Enjoy! And don't forget to share your pleasure by sending a copy to your friends outside the county. It will be appreciated.

Nollaig fé shéan is fé mhaise dibh a léitheóirí uasail. Go mbeidh a t'adh libh san Ath Bhlhian!

✦ **Most Rev. Dermot Clifford, DD,**  
**Archbishop of Cashel & Emlý,**  
**Patron G.A.A.**

## A day of happiness for the young captains



Upperchurch N.S. captain Peter Ryan receives the Roinn 'B' hurling shield from Tipperary hurler Ger O'Grady, Cumann na mBunscoil secretary, Donal McCarthy (centre).



Inch N.S. camogie captain Aoife O'Meara receives the Roinn 'B' Shield from Cumann na mBunscoil chairman Christy Clancy, with school principal Paudie Butler (centre).



Boherlahan captain Sharon Hayes receives the camogie Roinn 'C' shield from Tipperary hurler Denis Byrne with Cumann na mBunscoil secretary Donal McCarthy (left).



Loughmore N.S. captain Denis Leahy receives the Roinn 'A' hurling shield from Cumann na mBunscoil chairman Christy Clancy, with school principal Stephen Maher and Tipperary hurler Eoin Kelly present.

# TIPPERARY G.A.A. DRAW

Winners  
from

ROSCREA

to

CORK

to

KILSHEELAN

to

THE  
PHILIPPINES



*Roscrea's Lily Bourke won Star Prize in August*



*Young Robert O'Doherty, Mitchelstown won a Toyota Yaris in September with Skeheenarinky.*



*Kilsheelan's Peg Lonergan won 2nd prize in June*



*Moyne Templetuohy's Philippino friends in Lisheen Mines won 1st prize in June*



## CAR WINNERS IN 2003

- Jan 03 Roisin O'Keeffe (Solohead)
- Feb 03 Doran Family (Moycarkey)
- Mar 03 O'Shea Family (St. Patrick's)
- Apr 03 Patricia Kelly (Nenagh Éire Óg)
- May 03 Thomas J. Semple (Sarsfields)
- May 03 Bob Keane (Clonmel Óg)
- June 03 Alexei L Gabrillo (Moyne-T.)
- June 03 Peg Lonergan (Kilsheelan)
- July 03 Eileen Griffin (Moyle Rovers)
- July 03 Patrick Kennedy (Templederry)
- Aug 03 Lily Bourke (Roscrea)
- Aug 03 Walter Byrne (Clonakenny)
- Sept 03 Martin Burke (Fethard)
- Sept 03 Robert O'Doherty (Skeheenarinky)
- Oct 03 Breda Larkin White (Kilsheelan)
- Oct 03 Nick Bailey (Skeheenarinky)
- Nov 03 Ger O'Leary (Portroe)
- Nov 03 Cora Ryan (Moycarkey-Borris)

## PRIZE WINNERS IN 2003

# Bad start and worse finish

By John O'Grady



Tipperary Senior Hurling Panel 2003, in qualifier against Galway. Front l to r: Diarmuid Fitzgerald, Eamon Ryan, Justin Cottrell, Benny Dunne, Martin Maher, Paul Curran, Lar Corbett, Eoin Kelly, Paul Kelly, Denis Byrne, Tommy Dunne, David Kennedy, John Carroll, Paddy O'Brien. Back l to r: Michael Ryan, Aidan Butler, John Devane, Thomas Costelloe, Eamon Corcoran, Mark O'Leary, Eddie Enright, Brendan Cummins, Brian O'Meara, Conor Gleeson, Brian Horgan, Richie Flannery, Colin Morrissey, Redser O'Grady, Liam Cahill, Eoin Brislane.

BY JOHN O'GRADY (CULBAIRE)

**T**he new Tipp triumvirate of Michael Doyle, Kevin Fox and Liam Sheehy fielded its first team for competitive purposes at Nenagh on Feb 23rd. Before a sliotar was struck, there was a little episode, which in retrospect has its amusing side - the team declined to pose for a photograph. The gesture had to do with a Gaelic Players Association stance on rights to reproduction. It was not to be the last time the players were heard from. That league campaign - a five-game group which Tipp headed -

was a very creditable showing for team and mentors. Tipp were unlucky not to win the title. In retrospect, the intensity of the series over a brief period was blamed for the shock and the margin of the defeat by Clare on May 18th. Also, and more so, the league left us without Eamon Corcoran and Philip Maher, adding to the existing absence of Paul Ormonde. Half the defence that won the 2001 All Ireland - no one could accuse the mentors of undue luck.

For the record, and in sequence, that league series had the following results:

v Offaly, 4-14 to 1-8, v Limerick 1-17 to 1-8, v Wexford 3-21 to 1-11, v Derry 4-19 to 2-14, v Cork 4-11 to 4-15. Second phase v Kilkenny 2-19 to 2-16, v Galway 3-15 to 2-18, v Clare 0-22 to 0-14, v Kilkenny 5-13 to 5-14.

Six victories, one draw, two losses, the first loss to Cork at the stadium.

One draw with Galway at the same venue, the second loss in the final to Kilkenny all had the common factor of a backwards finish from a strong position. The year was to end with the most drastic of declines in the All-Ireland semi-final.



What has Nicky said to Mickie?



Tipperary Senior Hurling Selectors (from left) Kevin Fox, Michael Doyle and Liam Sheehy.

## LEAGUE FEATURES

**I**n brief summary, those league matches had features worth recall. The opener at Nenagh saw Lar Corbett score 3-3 against a Birr-less Offaly. Fellow Sars man Ger (Redser,) O'Grady played full-forward in the second round against Limerick. Martin Maher and John Devane got runs in the corner back berths, which were the object of attention. Corbett was back in free flow and he does flow swiftly - against Wexford, in Nenagh, with 2-2. The Derry game gave scope for further experiments Justin Cottrell played in goal in the expected victory.

The course of affairs so smooth so far, got its first jolt when Cork came to Thurles. Two late goals by the tall and slender substitute Setanta O' hAlpin undermined Tipp. Browne and Deane had goaled pre-interval and Eoin Kelly had a pair for the home team. Cummins had to depart with injury, before Setanta struck to spoil our record, the losing side were: Cummins, Devane, Maher, Benny Dunne, Flannery, Butler, Horgan, Tommy Dunne, Morrissey, O'Meara, Gleeson, O'Leary, Kelly, O'Grady, Corbett. Reserves called in Kennedy, Carroll, Cahill, Cottrell. At this stage the quest for a centre back centred on Aidan Butler, Noel Morris wasn't available until the Nowlan Park game. Eddie Enright's position had been uncertain from the start of the new regime. Paul Curran was another out of the frame until circumstances intervened. Paul Kelly's fitness had been a problem since the last stage of the county championship won by Mullinahone. Finding a settled fifteen was another and larger problem. Come one of our best days of a chequered year. The next phase set the leaders of the two groups against each other at Nowlan Park. No doubting the individual headline grabber on the Monday media Redser, had scored 1-6 off Noel Hickey in the three-point victory of the visitors. How ironic that Aug 17th at Croke Park did not include the Sarsfields forward at all and that the All-Ireland Man of the Match, was full-back Hickey. Four of his points came in seven minutes. He kicked in the goal that put Tipp seven ahead. The battling return of Noel Morris helped considerably in keeping Kilkenny under control. A late Charlie Carter goal was survived by stout resistance, in which Martin Maher added to his claims. To win at that grounds was very pleasing but it was to have no lasting benefit.

## CORCORANS EXIT

**N**ext it was Galway at the Stadium and a draw that felt like a defeat, even without the extra hurt of Corcoran's dismissal. Six up going into added time after three early goals including a Corbett contribution, we got caught by an David Tierney goal for the unsatisfactory share of the spoils.

The day had an interesting aspect in

Denis Byrne's first appearance since crossing the border from Kilkenny - he was thrown into the hectic and troubled finishing spell of Galway recovery. We went to Ennis. What might have been a Banner effort at a pre-championship gesture turned out to be no crusading Clare onslaught at all. Tame, was the word for the phoney war. We won readily by 8 points, with Byrne again playing a role. The league final was a different matter altogether and a doubly galling one in its flag strewn, spectacular way. An early knock or twist for Philip Maher seemed to be minor for a few minutes but soon the commanding figure of the Borris, backman was limping off and out of the year's picture for good. Worse still, Noel Morris made it a double deficit with a thigh injury. Yet, when John Carroll goaled on 68 minutes Tipp seemed sure winners. We'd been eight up with ten left. Corbett had got our fourth goal earlier. Against a ruffled Tipp defence Kilkenny called in Carter. Charlie's impact was instant two goals, added to Brennan's - three in six minutes.

The Cats were surging and probing. Shefflin got the winning point the odd one in fifty seven, in a game to redeem the oft downgraded league. Tipp were the most luckless of losers but again our fabric seemed to loosen in the home stretch. Tipp's starting line out Cummins, Maher, P. Maher, Dunne, Horgan, Kennedy, Kelly, Dunne, Morris, Carroll, Gleeson, Cahill, Kelly, O'Grady, Corbett. Subs used were Brislane, Devane and O'Neill.

## TIPP V CLARE AGAIN

**S**uspended, like Corcoran, was the law of averages in the provincial championship draw. The repeated Tipp v Clare tie made it ten meetings since 1995. Tipp had shaken off Banner dominance to take the last three. Absent, of course, was Philip Maher. The call had gone out to Paul Curran, whose examination obligations had led to his absence from the start of the league. A general impression that Lyons Clare were now below the Loughnane level was prevalent even acknowledging

how marginally we,d got away with victory in recent years. A crowd of about 20,000 was way down on peak years of the rivalry, with the fall off more attributable to Clare's dubious following them to ours. Gaps on the terraces, though soon had on field parallels of stunning and Tipp silencing extent.

We lined out, Cummins, Maher, Corcurran, Dunne, Horgan, Kennedy, Kelly, Dunne, Morris, O Meara, Gleeson, Cahill, Kelly, Carroll, Corbett. Shock waves were soon felt, minor tremours from points by O Connor, Gilligan and Lynch, major ones from O Connor and Quinn goals. A massive 2-8 to 0-2 became 2-10 to 0-5 at the welcome break. It had been a tough baptism for Curran, with the formation shattered all round by the eager Clare attack. Roars, surprised, and all the louder for that, rose in glee from the Banner support. Our attempts to respond - points by Kelly, Carroll, Dunne and Gleeson after reasoning were met firmly by a relaxed but still purposeful Clare. We got it to minus eight through O'Meara and Kelly, still deep in distress and with Cummins averting worse. A move of Tommy Dunne to full forward had him stranded in ample space and little traffic in the dying moments. The winning side then suffered a blow that was to have serious consequences. Renowned centreback Sean McMahon was sent off for an episode involving Gleeson. The afters, of that affair saw Carroll follow him.

A thoroughly bad day and a considerable let down for Tipp reversing the trend in favour of Lyons, men. In the hour plus of need with called in Costelo, Brislane, Enright and O'Leary. The long walk back the Marina echoed the Banner joy the rest of us with little to say. Who at that moment, would have foreseen Tipp, lasting longer in the All Ireland race? We weren't going to take an ideal, unbeaten All Ireland the other sort would not be very acceptable.

The drubbing in Cork made it clear that re-thinking on choices and places would be required. Half back, minus Corcoran was one zone to examine,



Tipperary's John Carroll scoring a goal in the top corner against Offaly.

while form in some forward positions was quite questionable. Curran had done respectably as full back, if without the stature and colour of Maher. Cummins in goal was getting too much business from the opposing attacks.

The Corcoran case kept getting irritated debate, now that McMahon was being assessed at a one-month suspension. But Eamon was out unseen till the Galway game in Salthill.

## LAOIS NO PROBLEM

**T**he qualifier draw gave us Laois, We'd feared a higher hurdle. On a June Saturday in Portlaoise a pushover of limited value left twenty four points between us and Paudie Butler's selection. Costello was again a first choice with Benny Dunne taking wing back beside brother Tommy - the most radical option. Enright and Brislane were a new midfield with Morris unfit. Denis Byrne was full forward in a championship debut.

Neither Corbett nor O'Grady started - quite a revision of league form. Subs galore including the Thurles pair, got a run as the outcome was settled. Tommy at number six - it had been a training camp exercise - got most attention. Would he be missed further up the field? Laois would hardly prove much. It was the Kilkenny recruit who caught the eye, having easily his best day for us mainly from wing forward. He set up Eoin Kelly for a quick goal and Eoin followed with another in the one way win. For a time David Cuddy gave trouble to Paul Curran. A tougher test followed. Galway now had the high prestige of going to Ennis and shading it over Clare. Logically, the Connacht team ought now defeat those who'd lost to Clare especially in unfamiliar Pearse Park. This was some assignment. It proved to be our best day of the season and a fine uplift going into the quarter-finals. The margin was the utter minimum with seven up shrinking to just one point in hectic added time. Ironically, Corcoran was back against the team he'd last played. The mobile Benny Dunne now teamed with Enright at midfield. One down at half time, we appreciated Corbett's three points nearing the break and as many from O'Leary. Galway missed several good openings, with Rory Gantley, bothering Paul Kelly considerably in that half. John Carroll's impact, when called in, was immense. He went to the forty, as Byrne was replaced. A wonderful long score by Ollie Canning was Galway's last for twenty five minutes. A Benny Dunne goal off a ball kept in play by Carroll was the day's lethal strike.

The visitors were on a roll with four successive white flags - Carroll with two plus Benny Dunne and O'Meara. For better measure Redser, came on and hit another point. All over? The roller

coaster still had another turn to it. A Hayes goal, after Cloonan had come on, brought late agitation, and a looseness that hadn't been there in a sturdy defence till now, left the possibility of catching Tipp on the line. Kerins had a goal chance but took an unavailing point. One of the year's finest games left Tipp still alive, and with credit restored.

## OFFALYS LATE GOALS

**T**he quarters placed Offaly in our path. Confidence was strong after the Salthill success. It proved to be justified though at again we suffered late tremors. Hanniffy and Coughlan goals reduced the advantage to five points at the finish. We came up with an initial novelty in Gleeson at full forward, when Corbett had been named. Tipp did not instantly take control, or anything like it.

Cummins had to save from Hanniffy quite early. A kicked goal by O'Meara near the break relaxed the side, and Dunne's accurate 65s were valuable. Carroll's goal within minutes of the restart ended the contest at eleven ahead, but that late Offaly flourish put a less cheerful end to it. An ankle knock for Tommy Dunne and an injury for Cummins were worrying. Kennedy (for Dunne), O'Grady (for Corbett), Byrne (for O'Leary) and Morrissey (for Carroll) were tokens of presumed victory. Nothing could be bigger than a Tipp v Kilkenny semi-final in towering Croke Park, with all the new fangled introductory routine over the PA to get the fans shouting - special noises for such as Tommy Dunne and DJ Carey. We felt we were in with a challenging chance, happy not to be favourites. A win would compensate for the negative days with the Cats in the league final and Clare in the championship. A loss had to be considered too but it should be of no wounding magnitude. Nothing between them, was a common view.

## A DRASTIC DRIPPING

**A** lot, a whole lot, was Tipp's lot. Twelve! Kilkenny once having got the break of a Brennan goal ten minutes after the resumption and



Tipperary Captain Brian O'Meara in action against Offaly in Corke Park.

the lead went into overdrive as Tipp lost shape. They scored 2-7 against 0-2 in the final half hour. We did not want to hear of added time and were grateful to the heroic Cummins for escaping more severe punishment.

The shock was the greater for the sadness of the fall from a lead of two at the break. What happened then?, was the query. No such thoughts occurred as we saw Tipp line out Cummins, Costello, Curran, Maher, Corcoran, Dunne, Kelly, Benny Dunne, Enright, O'Leary, Carroll, O'Meara, Kelly, Gleeson, Corbett. Kilkenny raised eyebrows at once when Shefflin took right wing instead of facing Tommy Dunne. Hoyne got that mission. The interval had us in quite optimistic mood. We'd taken them on and emerged with credit after a half of seven level scoreboards - the feared D.J. hadn't yet shown menace. Shefflin's frees weren't very accurate. He and Eoin Kelly matched a five points half to each from play. Paul Kelly's point was a tremendous effort, seeming a signal of defiance. Corcoran and Benny Dunne particularly shone. D.J. Carey move from full to corner, as their inside attack achieved little. Tipp had the illusion of a goal, from Kelly off a quick Cummins ball to Corcoran. Too quick, according to referee O'Connor. Hoyne placed Brennan for the influential first goal Cummins had already halted a pile driver. Carey's two 65's were on the mark. Lyng had a point to endorse the Brennan goal, Kavanagh, Delaney and Barry were winning the battles back the field. Peter catching at will. Cummins did a triple stop but Walsh drove home for number two. Shefflin iced the cake with the third.

Between points by O'Meara and Paddy O'Brien, Tipp had a long barren spell. So the process continued, with Tipp unable to find leadership or gain or use possession against the rampant Cats. The chorus of approval swelled for them. The closeness for forty minutes was a fading memory. Noel Morris (for Corbett), Paddy O'Brien (for O'Leary), Brian Horgan (for Enright), David Kennedy (for Costello), Eoin Brislane (for Tommy Dunne) were the reserves who saw out the catastrophe. The sight of Dunne coming off seemed to intensify the gloom and symbolise the depth of disappointment. Criticism of management was inevitable, if going to extremes in some quarters. Quite soon, discontent in the camp had Doyle considering his position and finding it hard in visualise continuing.

The episode was far from pleasant but is now history. We hope Ken Hogan, Jack Bergin and Colm Bonnar can find and coach and train the best we have. Better still if that best is good enough in 2004.



# Tipperary North County Enterprise Board Ltd.

**Promoting & Supporting Local Enterprises**

**Our help – Your success**

Tipperary North County Enterprise Board assists the establishment and expansion of micro-enterprise in North Tipperary by providing the following support services:

- ◆ **Advice**
- ◆ **Mentoring**
- ◆ **Finance**
- ◆ **Training**
- ◆ **Management Development**
- ◆ **Networking**
- ◆ **Workshops**
- ◆ **Schools' Programmes**

**For further information on these programmes and other on-going activities please contact us at:**

**Tipperary North County Enterprise Board Ltd.,  
Summerhill, Nenagh,  
Co. Tipperary  
Tel.: 067-33086, Fax.: 067-33605,  
e-mail: [tncceb@eircom.net](mailto:tncceb@eircom.net)**



The Board is funded by the Irish Government and the EU Structural Funds under the National Development Plan 2000 – 2006



# Tipperary Intermediate Team 2003



Tipperary Intermediate Hurling Champions . . . Back row (l. to r.): Pat Cosgrave, Evan Hanley, James Moran, Hugh Flannery, Tom Moylan (capt.), Brian Hogan, Tony Scroope, Kevin Nealon, Shane Maher, Pat Buckley, Ger griffin, Daragh Egan, Liam O'Connor, Shane McGrath. Front row (l. to r.): Brian Gaynor, Simon Everard, Colm Everard, Dermot Hogan, Tadhg Slevin, Ronan O'Brien, Michael Phelan, Hugh Moloney, Eamon Ryan, Ronan Stanley, Tommy Connors.



*Brothers in Arms . . .*

Brothers on opposing sides, Cathal Egan Captain on the Clare Intermediate Hurling Team has a handshake for his brother Daragh, who was sub goalkeeper on the Tipperary Intermediate Hurling Team.

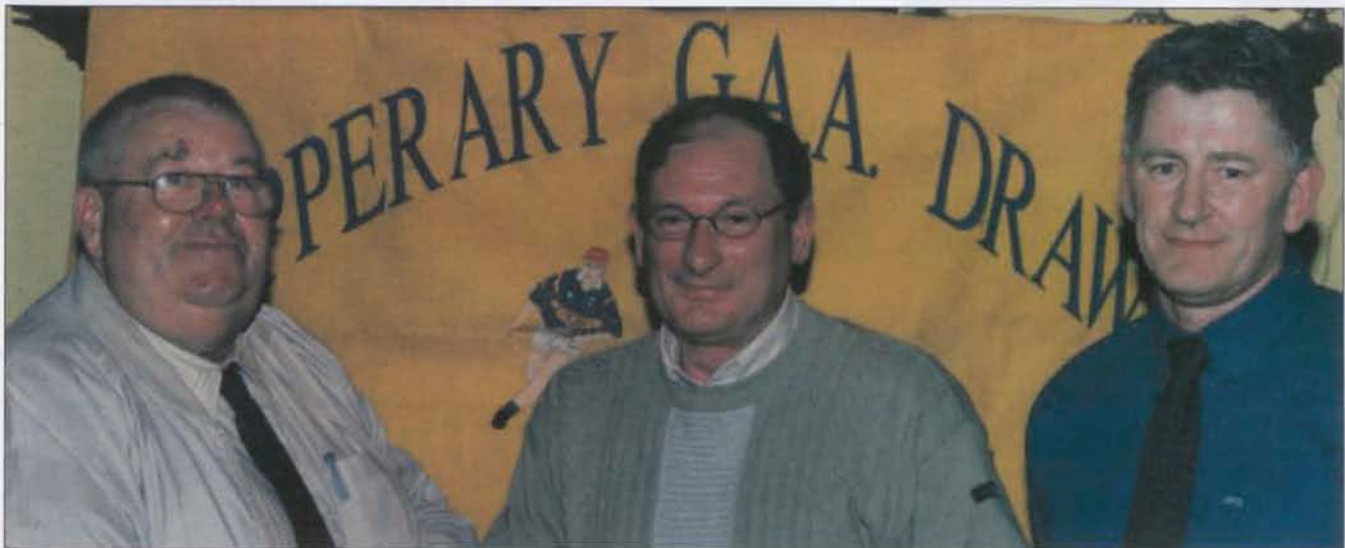

The county draw committee made a presentation to Brendan O'Connor (centre) for his services over fifteen years - on left is draw chairman Gus Fitzgerald, on right is Tim Floyd draw co-ordinator.



Munster Council presentation of cheques to post primary schools for development. L to r: Seán Fogarty, vice-chairman, Munster Council, Gerard O'Brien, Principal Roscrea CC, Mary Finnegan-Burke, Principal, Cashel CS, Donie Nealon, Runai, Munster council, Donie Shanahan, chariman, Co Board, John Ryan, Muster council.

# Ryan & Burns Car Sales Ltd.

Dublin Road,  
Nenagh

Tel: 067-33290.

Fax: 067-33972



**mazda**



**SUZUKI.**



*Main Dealer for*



*&*



**mazda**

**CAR OF THE YEAR**

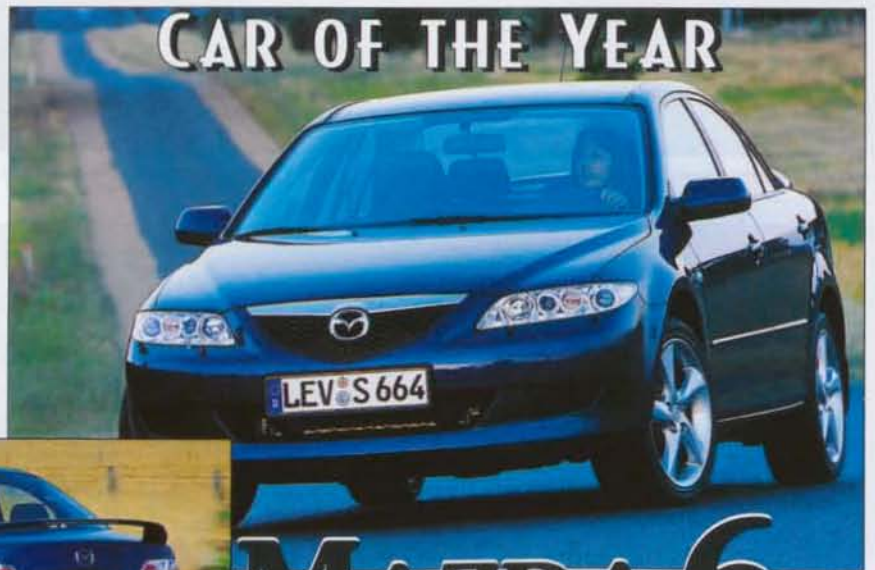

**MAZDA 6**

*Contact: Tony Burns or John Ryan*



# Glorious Campaign Could Have Yielded More

By Noel Dundon (Tipperary Star)

It was a championship that gave much pleasure and pain for supporters of the blue and gold. There were some fantastic moments on this odyssey, particularly in the journey through the provincial championship which culminated with a Premier win after extra time on the banks of the Lee.

Tipperary's u-21 charges had matured right before our eyes. Manager, Seamus Power, and his selectors, Eugene Ryan and Jackie Bolger, got Tipperary to the starting line in time for the semi-final clash against Clare in Cusack Park, Ennis despite the fact that so many players were tied up with other teams. It's always been a difficulty with the u-21 grade and it certainly doesn't help the management team in terms of trying to get the players to gel successfully. However, they ground out a significant victory over Clare on a scoreline of 1-11 to 0-11 thanks to a golden second half ten-minute patch from senior star and captain, Eoin Kelly. The players themselves were the first to admit that this was far from a polished display, but they were delighted to have come out on top in what was always a close clash with plenty of tension and edge of the seat hurling. They showed no small measure of guts and character in the remaining minutes when their backs were to the wall and the Bannermen were in search of an equalising goal. It wasn't to come as the Tipperary rear-guard stood tall and strong led by the excellent John Devane and Martin Maher.

The Tipp lads had shown tremendous spirit and fight in this game and it was something which was to stand to them hugely throughout their campaign. They had to rely on all their strength of character in the Munster final in Semple Stadium when the Rebels came on a evening raid with the aim of taking home the silverware at the end of the day, it was the Munster Council secretary, who took it home as the game ended in a draw 1-18 (Tipperary) to 3-12 (Cork) despite the fact that Tipp had led by 1-10 to 0-5 at the break.

Tipperary were sublime in the first half. They were hurling with real flair and precision and the backs in particular, with Hugh Moloney and Martin Maher very prominent, were leading from the front. John O'Brien had bagged the goal in the 17th minute and Tipp's play was very impressive with Eamon Ryan, Pat Buckley and Diarmuid Fitzgerald being very prominent indeed. Tipp had hit the ground running and were completely dominant. The half back line was exceptional and the midfield and forwards linked very well indeed. But, Cork fought back - a goal from Diarmuid O'Riordan after just two minutes upon resumption brought them back into contention. Then Kieran Murphy flicked another ball to the net and panic began to set in. Tipp lost their shape and Cork began to found space where tightness was the order of the day heretofore. Substitute, Michael Naughton, goaled again for Cork to level the game and when they went into the lead, there was a palpable sense of disbelief amongst the home supporters. It was nip and tuck thereafter and Cork came from behind to level the game and send the decider to a replay.

Tipp were disappointed to have let the game slip. They had played some fine hurling but failed to put Cork away when the chance arose. It took another eighty minutes to separate the sides and what a classic the replay was. Tipp won it by 2-14 to 0-17 when a magnificent display of courage, determination and guts coupled with speed, skill and stamina saw them gun down The Rebels in their own backyard. This was what hurling is all about. The exchanges were tough and frequent; the ball



Tipperary U21 Hurling Selectors, left to right: Seamus Power, Eugene Ryan and Jackie Bolger.

lashing off the firm sod; the defensive displays breathtaking and some of the scores wonderful.

In short this was a fabulous spectacle of the game of hurling and another one of those epic Munster final clashes associated with Tipperary and Cork legend and lore. It finished 0-13 each at the end of normal time and as aching and bruised limbs were massaged to get the last ounces of energy out of them during the interval, Eoin Kelly rallied his troops and laid it on the line for them - they were not going home without the silverware. They didn't.

Kelly made his own personal statement within 15 seconds of the restart. A long ball in from Eamon Ryan was plucked from the sky and he buried the sliothar in the net to give Tipp the advantage. Cork responded to level at the break, but the decisive score came from substitute, Conor O'Mahoney, in the 4th minute of the last period when he buried an Evan Hanly centre to send the cup back to Slievenamon.

It was a glorious victory and one which made the supporters delirious. This was as plucky a display from a Tipperary side as you are likely to see and the Tipp supporters who made the trip were privileged indeed to have witnessed such an epic and titanic battle. One had to feel for Cork - they had given so much over the course of the two games, but true to form they were the first on their feet to congratulate Tipperary.

Another day; another game; another bout of extra time; and this time disappointment. Tipp travelled to Ennis again for the All-Ireland semi-final against Galway and the lead-losing epidemic which spread through Premier County teams like wildfire in 03 touched the u-21's again. A late goal from Galway in the 63rd minute, after Tipp had overturned a 1-9 to 1-5 interval deficit, sent the game into extra time. Tipperary were justifiably angry over the 3 minutes of additional time played and Offaly referee, Pat Horan, received a lot of 'advice' about his timekeeping as a result. And, while Tipp might have been displeased with the outcome they certainly rued some slack play which allowed substitute, Donnellan, to force extra time. Another twenty minutes was just a bridge too far for Tipp. The legs were weary from a long campaign and they suffered as a result. Galway won out by four in the end 2-20 to 2-16.

Team: Vincent Doherty (Mullinahone), Eamon Buckley (Drom-Inch), John Devane (Clonoulty-Rossmore), Michael Phelan (Ballybacon-Grange), Martin Maher (Borrisoleigh), Diarmuid Fitzgerald (Roscrea), Hugh Moloney (Nenagh Eire Og), Eamon Ryan (Moycarkey-Borris), Joe Ceasar (Killenaule), David Kennedy

(Clonoulty-Rossmore), Francis Devanney (Toomevara), Pat Buckley (Emly), Eoin Kelly (Mullinahone), capt., John O'Brien (Toomevara), Tony Scroope (Burgess). Subs: Evan Hanley (Lattin-Cullen) for Pat Buckley, Conor O'Mahoney (Newport) for Ceasar, Alan O'Neill (Cappawhite) for Kennedy, T Minogue (Templederry) for O'Neill. Other subs: Joseph Ryan (Boherlahan-Dualla), Michael Farrell (Killenaule), Nicky Ryan (Portroe), Ronan O'Brien (Eire-Og, Annacarty), Derek Bourke (Loughmore-Castleiney), David Maher (Boherlahan-Dualla).

And so another u-21 campaign came to a close. Looking back the players and the management team gave supporters plenty to cheer about. They worked very hard and were unlucky not to have reached the All-Ireland final. Quite a number of players came to notice during the campaign as they played forceful hurling and gave of their all throughout. No doubt many of them will be involved in the senior set up in the coming months.

Seamus Power, in his first foray into inter county management, endured many scary moments throughout the season. There was a lot of tension and edge of the seat action at times and he and his selectors Jackie Bolger and Eugene Ryan made the appropriate changes when necessary. It was a glorious campaign which could have yielded much more. Sadly, it didn't, but there are some great memories nonetheless.

**Roll on '04.**



Eoin Kelly

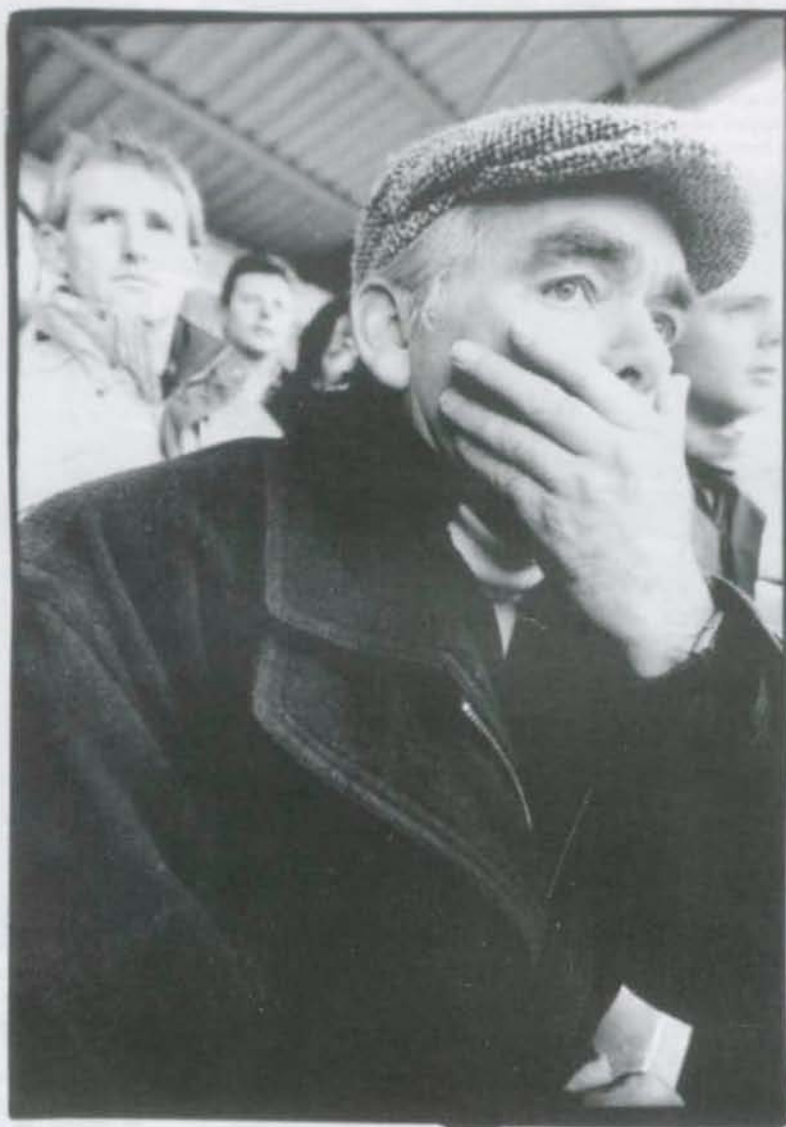

Score and they'll remember you for 20 years.

Miss and they'll remember you forever.

The AIB Club Championships. Proudly sponsored by AIB Bank



# Tipperary County Minors 2003

By JOHN GUITON (Tipperary Star)

**T**he sensational championship collapse of our senior team at All-Ireland semi-final stage in 2003, catapulted Tipperary into the public spotlight for all the wrong reasons.

However, when the disappointment had subsided the Blue and Gold followers looked through the year for crumbs of success and found some in the capture of a provincial double of the minor and under-21 successes in Munster.

My colleague Noel Dundon chronicles the memorable year for the U/21 side at provincial level and with equal pleasure this scribe reflects on the marvellous three in a row clinched with great gusto at Semple Stadium on Sunday June 28th. How Tipperary supporters cherished the moment and showed their gratitude for a very special achievement in the modern era. With captain David Morrissey, the only player from the previous two-in-a-row eligible for this year's squad, this was quite an accomplishment for the team and their management Paddy McCormack (Thurles Sarsfields) manager, and selectors Philip Ryan (Sean Treacy's), Vincent McKenna (Borrisokane), Jamesie Ivors (Ballingarry) and all associated with the preparation of the side.

The victory was all the sweeter in that Tipp had pulled off a rare coup by defeating the rebels on all three occasions. What really pleased Tipp was the fact that they won the final the hard way having suffered a big blow in the early stages with the loss of full back Sean Ryan through injury. His replacement David McGrath did well when finding himself in the thick of the action so quickly. Tipp faced into the decider knowing well that they would have to produce a top class performance if they were to win having had less than convincing victories over Waterford and Limerick. Manager Paddy McCormack had taken the view that Tipp would have to step up a gear. He was confident that his charges would do just that, and as things turned out he was spot on. "We had worked hard since the Munster semi-final and once the players examinations were completed, we focused totally on the Munster final," Paddy told the Tipperary Star.

Without any shade of doubt Tipp had improved considerably having limped over Waterford in the first round and struggled to overcome Limerick. They still faced an arduous test against Cork and while in a rather undistinguished final the rebels seemed well positioned entering the closing stages to crush the Tipp dream, the Premier County

showed tremendous courage and spirit to take a two point win (2-12 to 0-16).

Having led by two points at the interval (0-8 to 1-3) Cork pushed four ahead (0-14 to 1-7) with eleven minutes remaining. The game suddenly sprung to life. For the first time Tipp showed their real capabilities and Shane Long, having run onto a pass from David Young, whipped home in style his second goal (48th minute) to leave only a point in arrears (0-14 to 2-7). With their supporters roaring them on, their confidence soared after Richie Ruth struck the equaliser (one of only six frees Tipperary received over the game). The real sign that Tipp were going to take stopping came when sub Shane O'Brien on his first touch of the ball fired over a point to give his side the lead for the first time since the 11th minute of the match (2-9 to 0-14). A spine-tingling finish ensued, Tipp defended stoutly, but, the course of the game was to change momentarily. Cork were back in the driving seat, scores from Brendan Barry and Barry Coleman edging them in front again (0-16 to 2-9). Signs looked ominous for Tipp on the call of full time, but, they really proved their character taking the game by the scruff of the neck when other teams might have buckled. In one last throw of the dice they had two match-winning points from Shane Long and Richie McGrath to clinch a victory adorned by a 2-10 tally from play. As players and mentors celebrated wildly the achievement was all the more commendable when it is considered that virtually the entire side were playing in their first ever Munster final. And great credit to Paddy McCormack and his mentors for putting in a massive effort with the team that was duly rewarded.

Unfortunately for all concerned the dream of the elusive All-Ireland ended with defeat at All-Ireland semi-final stage against a slicker Galway. However, Tipp had nothing to be ashamed of in that they fell just short of depriving the fancied Galwegians their place in a second All-Ireland decider in three years. In a hard fought game most noteworthy for its huge turnover of superb scores Tipperary having trailed a point at the interval (1-9 to 1-8) looked well poised to take the scalp of the Westerners as they led by three points with eleven minutes of the match remaining. Corner forward, Richie Ruth, gave them a massive boost in 49th minute when he got before the advancing Galway goalie Aidan Ryan to flash a dropping ball centred by David Young to the net. The

goal came at the end of a most impressive spell for Tipp during which they chalked up 1-5 and conceded only a single point. However, they failed to hammer home the well-seized initiative and Galway, ably led by their captain and score-getter supreme Niall Healy, pulled the game away from their grasp with a solid finish to deservedly win by three points (2-19 to 2-16).

While Tipp faltered in the closing stages it could be argued that their performance was worthy of a draw. However, all concerned were able to take more than a dollop of consolation from the fact that the side in its first championship season fared out pretty well against a quality Galway outfit. The team will be a year more experienced next season as they set out on the championship trail once again. Imagine the scenes should they win a Munster four in a row and go on to All-Ireland victory! A tall order, indeed, but the achievements are not beyond their capabilities. Good luck to all concerned.

Tipperary: D. Egan (Kildangan) 0-1, B. O'Sullivan (Thurles Sarsfields), S. Ryan (Moneygall), P. Stapleton (Borrisoleigh), B. Hanly (Lattin-Cullen), N. Teehan (Gortnahoe-Glengoole), C. Hayes (Kildangan), K. Bergin (Killenaule), R. McGrath (Carrick Davins), S. Long (Gortnahoe-Glengoole), D. Shepherd (Moycarkey-Borris), D. Morrissey (Galtee Rovers), R. Ruth (Thurles Sarsfields), S. O'Brien (Ballina), D. Hickey (Boherlahan-Dualla). Subs: D. Young (Toomevara) for Morrissey, I. Delaney (J. K. Brackens) for O'Sullivan, S. Cleary (Borrisokane) for Teehan, P. Ryan (Sean Treacy) for S. O'Brien, C. O'Brien (Eire Og, Annacarty) for Hickey.



Toomevara captain, Michael Bevans visited loyal Toomevara fan Kitty Kennedy at Walshe Rest Home, Nenagh with the Dan Breen Cup. Kitty was unable to attend the County Final.

# Templemore Arms Hotel

*Wedding Receptions Our Speciality*  
*Our Newly Refurbished Belville Suite*  
*Overlooking our Beautiful Garden*  
*"The Ideal Setting For Your Special Day"*



***Belville Banqueting Suite***

*The Templemore Arms Hotel Renowned for its  
Personal Service and Attention to Detail*

*"A Little Difference Makes All The Difference"*

*Contact Dan or Julie on (0504) 31423*

# Tipperary Win Masters All Ireland

Only four teams participated in the Masters competition in 2003, Dublin, Kerry, Limerick and Tipperary. Tipp beat Kerry in the first round. Limerick beat Tipp in the second round and beat Dublin in last of group matches. Kerry, Limerick and Tipp ended up on equal points and had to play off. Tipp got a bye to the final and played Kerry, who came through against Limerick.

The final was played at Bruff on October 11. Kerry tried hard in the first quarter, giving Tipperary as good as they got, but a Ken Hogan goal at the twelfth minute put an end to this.

Tipp led at the break by 2-9 to 0-5, the second goal coming from Liam Maher. In the second half Kerry, who

included Cormac Bonnar at centre-forward, kept plugging away but didn't make great headway. In the end Tipperary won handily by 3-19 to 1-10.

*Tipperary:* John Sheedy (Portroe), Andy O'Neill (Cappawhite), Liam Keogh (Silvermines), Ger Ryan (Silvermines), Pat McGrath (Loughmore - Castleiney), Jackie Bolger (Mullinahone), Sam Walsh (Carrick Swans), Kevin Fox (Éire Óg), Jimmy Dunne (Toomevara) (0-1), Pa O'Neill (Cappawhite) (1-3), Pat Fox (captain) (Éire Óg) (0-2), Phil Hennessy (Nenagh Éire Óg) (0-2), Pat Looby (Drom-Inch) (0-6), Ken Hogan (Lorrha) (1-0), Liam Maher (Boherlahan) (1-4). *Substitutes:* Pat Ivors (Ballingarry) for S. Walsh; Vincent McKenna (Borrisokane), for J. Dunne, Tom McGrath (Loughmore-Castleiney) for Pat McGrath.



Tipperary Masters Captain Pat Fox lifts The All Ireland Trophy



Pat Fox is challenged by Kerry's Christy Walsh in the Masters All Ireland Final.



Tipperary Master All Ireland Hurling Champions . . . Back row: Frankie McGrath, Liam Maher, Pat O'Neill, John Sheedy, John Sherlock, Martin Bourke, Jimmy Dunne, Conor O'Donovan, Liam Keogh, Ger Ryan, Vincent McKenna, Pat Kelly, Liam Sheedy, Sam Walsh, Pat Dunlea (sel.), Larry Mackey (manager). Front (l. to r.): Ken Hogan, Pat Looby, Anthony O'Neill, Phil Hennessy, Jackie Bolger, Pat Ivors, Pat McGrath, Pat Fox (captain), Kevin Fox, Jimmy Dunne, Tom McGrath.



# Credit Union



## Products & Services



Highly Competitive Insurance

Loans for Virtually Everything

Very Competitive Interest Rates

Comprehensive Foreign Exchange Service

Members Car Draw (Some Credit Unions)

Attractive Yearly Dividends

Loan/Savings Protection

VHI / Bupa Group Schemes

Website Facility (Some Credit Unions)

Much Much More.....

Credit Unions of Tipperary  
Proud Sponsors of the  
Tipperary County Championships 2003

# SENIOR HURLING

# CHAMPIONSHIP 2003

By: SEAMUS J. KING

## 2003 Results at a Glance

### CREDIT UNIONS TIPPERARY COUNTY SENIOR HURLING CHAMPIONSHIP

WINNER	SCORE	RUNNER-UP	SCORE	VENUE	DATE	REFEREE
<b>[DAN BREEN CUP]</b>						
<b>Round 1 [Eight defeated Divisional semi-finalists]</b>						
Killenaule	0-18	Cashel	0-13	Fethard	on 31/8/03	Ref. W. Clohessy (Drom-Inch)
Cappawhite	5-16	Carrick Swans	1-8	Clonmel	on 6/9/03	Ref. J. Ryan (Cashel K.C.)
Boherlahan	4-18	Newport	0-10	Dolla	on 7/9/03	Ref. W. Barrett (Ardfinnan)
Moneygall	1-15	Upperchurch/D	0-12	Templemore	on 7/9/03	Ref. R. Barry (Cappawhite)
<b>Round 2 [Divisional runners-up v Round 1 winners]</b>						
Moneygall	4-12	Ballingarry	0-8	Templemore	on 13/9/03	Ref. J. Ryan (Cashel)
Th. Sarsfields	3-12	Killenaule	1-14	Boherlahan	on 14/9/03	Ref. J. McDonnell (Roscrea)
Kickhams	3-9	Boherlahan	2-10	Cashel	on 14/9/03	Ref. J. Sweeney (Thurles)
Nenagh E. Og	6-15	Cappawhite	0-10	Newport	on 14/9/03	Ref. W. Clohessy (Drom-Inch)
<b>Quarter-finals [Divisional winners v Round 2 winners]</b>						
Moneygall	1-13	Loughmore C	1-11	Templemore	on 20/9/03	Ref. R. Barry (Cappawhite)
Nenagh E. Og	2-15	Galtee Rovers	2-10	Templemore	on 20/9/03	Ref. J. Ryan [Boherlahan]
Th. Sarsfields	2-19	Mullinahone	2-11	Cashel	on 20/9/03	Ref. J. McDonnell ((Roscrea)
Toomevara	2-21	Kickhams	1-11	Templemore	on 21/9/03	Ref. S. Roche (Kilsheelan)
<b>Semi-finals</b>						
Toomevara	2-19	Moneygall	0-16	S. Stadium	on 27/9/03	Ref. W. Clohessy (Drom-Inch)
Th. Sarsfields	3-17	Nenagh E.Og	2-18	S. Stadium	on 27/9/03	Ref. N. Cosgrove (Marlfield)
<b>Final</b>						
Toomevara	3-19	Th. Sarsfields	3-16	S. Stadium	on 12/10/03	Ref. S. Roche (Kilsheelan)

### SENIOR HURLING RELEGATION

#### Preliminary Round

Drom/Inch	1-15	Borrisoleigh	2-11	Templemore	on 25/08/03	Ref. W. Barrett (Ardfinnan)
Roscrea	0-21	Silvermines	0-13	Toomevara	on 27/08/03	Ref. M. Cahill (Kilruane MacD)

#### Round 1 [Semi-finals]

[1] Borrisoleigh	0-21	Silvermines	0-9	Nenagh	on 04/09/03	Ref. J. Sweeney (Thurles)
[2] J.K. Brackens	1-14	Portroe	2-7	Dolla	on 24/08/03	Ref. E. Browne (Kickhams)
[1] Holycross	1-16	Moycarkey	1-14	Boherlahan	on 25/08/03	Ref. R. Barry (Cappawhite)
[2] Templederry	2-15	Clonoulty	2-11	Borrisoleigh	on 30/08/03	Ref. D. Curtis (Thurles)

#### Finals

[1] Portroe	5-17	Silvermines	6-11	Nenagh	on 10/09/03	Ref. J. Ryan [Boherlahan]
[2] Clonoulty/R	1-15	Moycarkey/B	1-13	Holycross	on 21/09/03	Ref. W. Barrett (Ardfinnan)

### Senior Hurling League - Finals

#### Premier Division:

Toomevara	0-23	Thurles Sarsfields	0-13	Templemore	28/06/03	W.Barrett (Ardfinan)
-----------	------	--------------------	------	------------	----------	----------------------

#### Division 1:

Moneygall	2-12	Borrisoleigh	1-14	Templemore	08/06/03	N. Cosgrave (Marlfield)
-----------	------	--------------	------	------------	----------	-------------------------

#### Division 2:

Portroe	3-14	Boherlahan/Dualla	1-12	Dolla	15/06/03	R. Barry (Cappawhite)
---------	------	-------------------	------	-------	----------	-----------------------

#### Division 3:

Templederry	1-14	Drom-Inch	1-11	Borrisoleigh	06-/09/03	A. Moloney (Cahir)
-------------	------	-----------	------	--------------	-----------	--------------------

### Intermediate Hurling League

Gortnahoe/Glengoele	3-12	Moyne-Templetuohy	0-17	Morris Park	04/09/03	P. Shelly (Killenaule)
---------------------	------	-------------------	------	-------------	----------	------------------------

There was much speculation leading up to the county senior hurling final on October 12, the earliest date for the final to be played since 1994. Would the worm turn for Thurles Sarsfields and bring them their first victory at this level since 1974, also the last year they defeated Toomevara in the senior hurling championship, or would the Greyhounds, stung by their one-point defeat by Mullinahone in the 2002 semi-final, which deprived them of a chance of five-in-a-row, bounce back?

The sides followed impressive paths to the final. The North representatives came through unscathed with an impressive tally of twelve goals and ninety-six points to their credit. They did have two close encounters, surviving by the minimum of margins in their early round clashes against Templederry and Borrisoleigh. They found their rhythm after that and scored impressive victories, conceding only three goals and seventy-five points in their six games.

At first sight Thurles Sarsfields' path was even more impres-

sive. They scored fifteen goals and ninety-three points along the way. It wasn't plain sailing, however. They lost to Loughmore-Castleiney by four points in the Mid final, and they conceded ten goals and eighty-five points in their six games. In fact, after their defeat at the hands of the Mid champions, they weren't expected to be in the final shake-up, but an impressive victory over Mullinahone in the county quarter-final silenced their critics.

#### QUALIFIERS AND RELEGATION

It was the second year of the new championship format, with a series of qualifiers for defeated divisional semi-finalists, and relegation for first-round losers. The South were not involved in the latter, having only four teams, the minimum regarded as necessary for divisional viability. In the other divisions the North supplied five teams, the Mid four, and Clonoulty-Rossmore from the West, for the relegation pot. After two preliminary rounds, four semi-finals and two finals, Silvermines and Moycarkey-Borris lost out to Portroe and Clonoulty-Rossmore respectively, and will play intermediate hurling next year. This year's intermediate champions will be promoted to senior ranks, thus reducing the number of senior teams to twenty-five.

The final game between Clonoulty-Rossmore and Moycarkey-Borris at Holycross was one of the games of the year, attracting a bumper crowd. It provided an outstanding performance from veteran, Declan Ryan, who was mostly responsible for his side's survival in senior ranks. One of his admirers said after the match: 'They should erect a monument to him.'

#### QUALIFIERS, ROUND 1

In this round the eight divisional semi-final losers played off to provide four teams to play the losers of the divisional finals. The result was even enough with one team from each division, Killenaule, Cappawhite, Boherlahan-Dualla and Moneygall, coming through.

Meanwhile the divisional finals were played, which didn't impinge too much on the progress of the county championship. In the Mid an early Loughmore-Castleiney blast floored Thurles Sarsfields, giving the winners their ninth title since their first in 1983. Played at Templemore on August 24, the final score was 3-14 to 2-13. In the South Mullinahone defeated Ballingarry by 3-14 to 1-10 in a stormy final, which erupted into ugly scenes early in the second half. Played at Clonmel on August 31, the winners led by 2-6 to 0-7 at the interval and sent out a clear signal that they were on course for a county double. Toomevara did sufficient to win the North final at Cloughjordan on September 7, defeating a defence-frail Nenagh Eire Og by 3-12 to 0-16 on a day of per-



The Dunnes from Toomevara celebrate the County Final win, from left: Ken (with man of the match award), Benny, Terry, Barry and Tommy.



One of the many colourful banners that children from Toomevara parish had on display on County final day.



Nenagh Eire Og team - North finalists and County semi-finalists. Back row left to right: John Flannery, Richie Flannery, Noel Moloney, Michael Hackett, Eddie Tucker, Declan O'Meara, Hugh Moloney, John Slattery. Seated: Michael Cleary, Brian Darcy, Kevin Tucker, Michael McNamara, Robbie Tomlinson, Eoin Fitzgibbon, John Kennedy.



The Tipperary Credit Unions, once again sponsored the County Tipperary Hurling and Football Championships for 2003. Photographed at the presentation of the cheque from the Tipperary Credit Unions to the Tipperary GAA County Board (from left): Tim Floyd, Donal Shanahan, Brendan Wright (Chairman of Tipperary Credit Unions County Committee), Kathleen Halpin (Treasurer of the Sponsorship Committee), Michael O'Brien.





Thurles Sarsfields - County Senior finalists. Back row left to right: Tommy Maher (captain), Ger O'Grady, Ciaran Carroll, Brendan Carroll, Johnny Enright, Gerry Spain, Matthew O'Dowd, Jamie Murphy, Barry O'Dwyer, Jonathan Connors, John Lillis, Eddie Enright, Eamonn Walshe, Seamus O'Shea, Eoin Costello, Aidan Dundon, Tony Connolly, Conor Stapleton. Front: Tommy Callanan, Colm O'Rourke, Richie Ruth, Tommy Connors, David O'Dwyer, Tony Ruth, Shane Ryan, Stephen Mason, Patrick McCormack, Lar Corbett, Wayne Cully, Lee Shanahan, Brendan O'Sullivan, Brian O'Grady, Eamonn Tuohy. Mascot: Colin Maher.



Credit Union Launch - "For the Credit of the Little Village". Pictured left to right: Brian O'Meara (Tipperary Captain 2002), Tommy O'Sullivan (Chairman) Jackie Bolger (Secretary, Mullinahone GAA Club), Ky Vaughan (Captain, Mullinahone 2002), Donal Shanahan (County Chairman), Rickie Sheehan (Treasurer Mullinahone GAA Club & Mullinahone Credit Union).



Eoin Brislane's hurley is held by a Kilnoyley player, but he still manages to part with the ball, during the Munster club championship.

sistent rain. On the same day at Sean Treacy Park, Tipperary, it took a pointed free by Galtee Rovers' Pa Morrissey, deep into added time, to keep their hopes of a first title alive against Kickhams. The latter made a great revival in the second half. Behind by 0-7 to 0-2 at the interval, and having Vincent Kelly sent off early in the second half, their chances looked slim, but they put together a great performance after that, and almost snatched victory. The replay was held at Golden the following week and the men from Bansha reversed the pattern of the drawn game. Behind by 0-7 to 0-5 at the interval, they produced a second-half display that left Kickhams floundering. In the end they thoroughly deserved their 2-15 to 1-11 victory and their first senior hurling title.

## QUALIFIERS - ROUND 2

In this round the first-round winners were pitted against the divisional runners-up. The four winners were Moneygall, Thurles Sarsfields, Kickhams and Nenagh Eire Og. Ballingarry were the only divisional runner-up to be beaten, losing out badly to Moneygall. In the local derby between Kickhams and Boherlahan, the West men came through.

## QUARTER FINALS

The field had narrowed to eight teams by this stage, and the results brought two surprises. Moneygall came through against Mid champions, Loughmore-Castleiney, having two points to spare on a scoreline of 1-13 to 1-11. Thurles Sarsfields surprised many with their defeat of Mullinahone, who were being set up as likely opponents for Toomevara in the final. The latter sent out a clear signal of their intentions in their defeat of Kickhams.

# FOR ALL YOUR NETTING REQUIREMENTS

*Ring the specialists*

SPORTS WORLD NETTING

*Aughrim, Scarriff, Co. Clare*

*We Supply and fit our own*

## Manual and Electrical Systems

*Also available:*

Full Range of  
Quality  
Goal Nets.

**PADRAIG GIBLIN**

Aughrim,  
Scarriff,  
Co. Clare

Tel: 061-921851

086-2520663

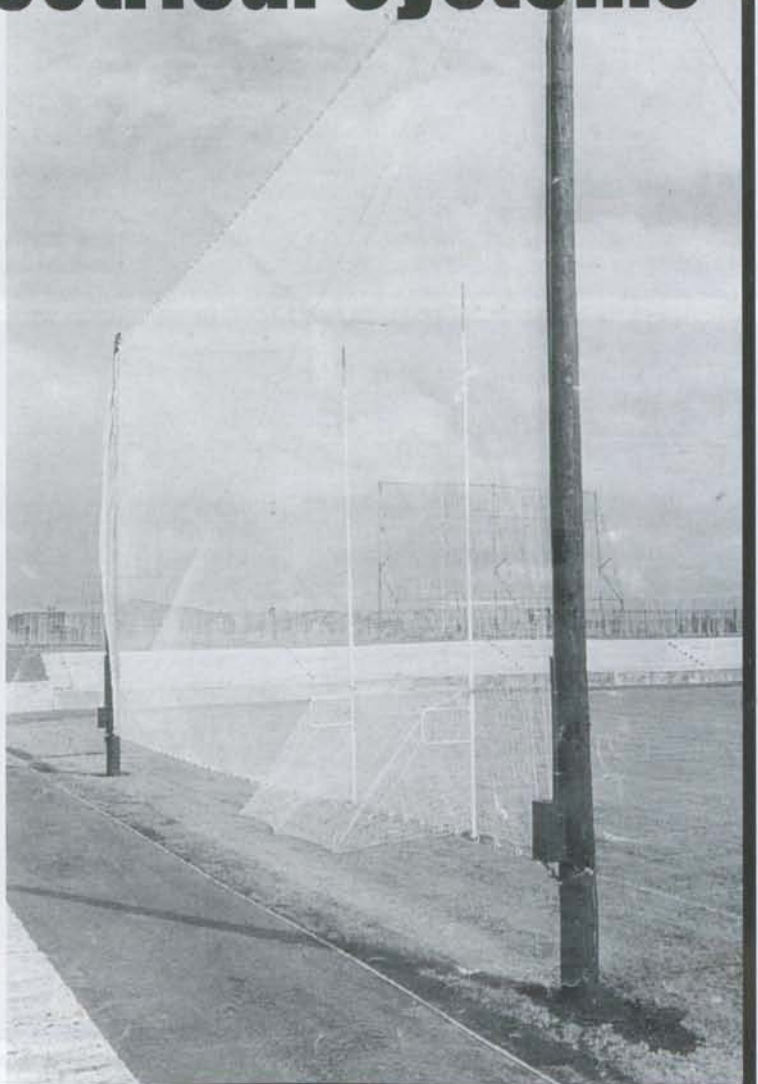

## SEMI-FINALS

Three North teams, plus Thurles Sarsfields, made up the semi-final pairings at Semple Stadium on Saturday, September 27. The Toomevara-Moneygall clash was a close one until the final ten minutes, when an Eoin Brislane goal for Toomevara put some distance between the sides. Toomevara led by 1-8 to 0-9 at the interval, the goal coming from Ken Dunne just before the break, when he raced through from forty yards and sent an unstoppable shot past Sean McCormack in the Moneygall goals. At times during the game it looked as if Toomevara would pull away, but Moneygall kept coming back, and it was only in the final ten minutes that the winners eventually put light between them and their dogged opponents. It was Toomevara's 13th county semi-final since 1989, and their ninth victory.

In the second semi-final Thurles Sarsfields had to survive a late Nenagh Eire Og rally. Sarsfields started off lively and were ahead by 1-4 to 0-1 after eight minutes. Nenagh came into the game, helped by Michael Cleary's accurate free-taking, and the score was 1-11 to 0-9 in favour of Sarsfields at the interval. Nenagh's best patch was after the resumption and by the fortieth minute they had taken the lead, 0-15 to 1-11, for the first time. The game remained level until the final quarter when Sarsfields gradually pulled ahead with a substantial lead. However, there was a final kick in Nenagh and, in the closing minutes, they scored two goals to leave only two points between the sides on a scoreline of 3-17 to 2-18.

## THE FINAL

And so to Semple Stadium two weeks and a day later for the final, played in unprecedented dry conditions. Toomevara were the bookie's favourites but there was a sneaking hope that Sarsfields wouldn't lose out for the fourth year in a row. There was a parallel with the 1960 final, when Sarsfields, after winning five in a row, were dethroned by Toomevara. Was it possible that Sarsfields might do the dethroning on this occasion?

The story of the game is easily told. Toomevara came on to the field like a team inspired. They showed hunger, pace, combination and determination in contrast to a Sarsfields outfit that was strangely lethargic. Their new look side, which should have exuded the confidence gained at minor and under-21 level, was inexplicably subdued. Toomevara commanded the field, led by 2-10 to 0-5 at the interval and, with five minutes of normal time remaining, had nine points to spare, 3-17 to 1-14. Only at this stage did Sarsfields erupt with an effort worthy of a county final. In the final minutes they scored 2-2 to 0-2, and nearly created a huge shock. The final score was 3-19 to 3-16 in favour of Toom.

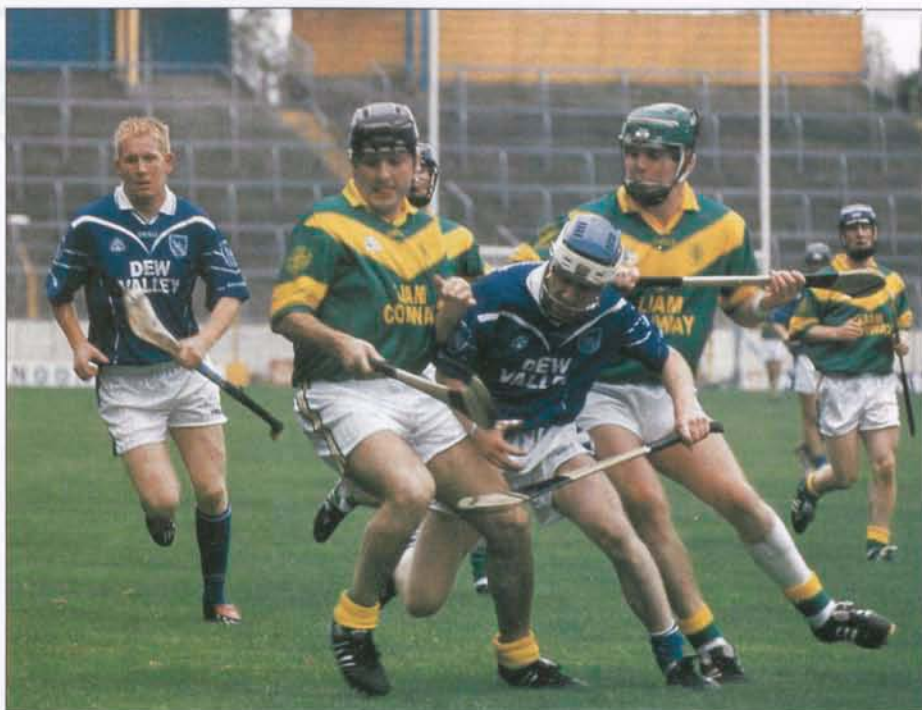

Action from the County Senior final - Ger "Redser" O'Grady (Thurles Sarsfields), Tony Delaney (Toomevara), Johnny Enright (Thurles Sarsfields), and Eoin Brislane (Toomevara).



County Board Secretary Michael O'Brien presents the County League Cup to Toomevara captain Michael Bevens.

In the aftermath there were many questions to be asked, even if few were answered. Did Toom take their collective foot off the pedal when they enjoyed a nine point lead? Was Sarsfields' last eight minutes their 'true' form, or was it allowed by Toom's relaxation? What would have happened had Redser's 20 metre free not whizzed wide of the post? What had Sarsfields not conceded an easy, early goal?

The answers don't really matter because they won't change the result. Toomevara are champions for the fifth time in six years and they possess a team of enormous talent. Their achievement now has to be an All-Ire-

land club championship, otherwise they will never be regarded as a great team. The only consolation for Thurles Sarsfields has to be their final ten minutes. In that period they revealed what they are capable of doing, and they have the consolation of knowing that they almost snatched a draw from a team that appeared to have all the answers. However, they will have also to face up to the question of why they played so poorly for so long in their most important encounter of the year.

**Teams: Toomevara** - Justin Cottrell, Benny Dunne, George Frend, Philip Shanahan, Brian Duff, Tony Delaney, David Young, Terry Dunne (0-3), Ken Dunne (0-6), Paddy O'Brien (1-1), Eoin Brislane (0-3), John O'Brien (0-2), Michael Bevans (capt.), Thomas Dunne (1-0), Willie Ryan (0-1). **Sub:** John Boland for Duff. **Other subs:** Tomás O'Meara, Francis Devaney, Pdraig Hackett, John Kinirons, Kevin Cummins, Barry Dunne, Denis Kelly, Andrew Ryan, David Kennedy, Tommy Carroll, Ken Hall, Brian McGrath Ronan Tynan, Ciaran Fitzpatrick, Patrick Tuohy.

**Thurles Sarsfields** - Patrick McCormack, Brian O'Grady, Tommy Maher (capt.), Tony Connolly, Brendan O'Sullivan, Stephen Mason, Lee Shanahan, Eddie Enright 0-1, Wayne Cully (0-3), Johnny Enright (0-6), Ger O'Grady (0-2), Tony Ruth (0-3), Lar Corbett (2-1), Eoin Costello, Shane Ryan. **Subs:** Brendan Carroll for Mason, Seamus O'Shea for Connolly, Richie Ruth (1-0) for Ryan, Eamon Walshe for Costello.

**Other subs:** Ciaran Carroll, Tommy Collins, John Connors, Barry Dwyer, Aidan Dundon, John Lillis, Jamie Murphy, David O'Dwyer, Matthew O'Dowd, Gerry Spain, Conor Stapleton, Eamon Tuohy.

**Referee:** Seamus Roche (Kilsheelan).

# Bank of Ireland



CAN ARRANGE



**£120,000 Buildings Cover  
&  
£20,000 Contents Cover**

**FOR AS LITTLE AS**

**€5**

**PER WEEK**

**Burglar & Smoke Alarm Discounts applied**

**“Whatever type of home you live in why not make it more secure with  
Bank of Ireland’s new competitive Home Insurance Cover.  
To us at Bank of Ireland competitive also means comprehensive.”**

*Don't wait any longer*

**Contact your local branch or call 1850 604 604**

# Tipperary Football 2003

By Hugh Kennedy (P. R. O.)

The year 2003 began for Tipperary senior football in January when we played Waterford in the McGrath Cup semi-final at Clonmel. We won on the score Tipperary 1-08 Waterford 2-04.

The team was: Brian Enright (Cahir); Benny Hahessy (Swan); Niall Kelly (Kildangan); Damien Byrne (Fethard); Shane Maher (Burgess); Declan Fanning (Killenaule); Niall Fitzgerald (Moyle Rovers); Liam England (Inane Rovers); Aidan Fitzgerald (Fethard); Tony Doyle (Killenaule); Eamon Hanrahan (Commercials) Captain; Patrick Halley (Rockwell Rovers); John Paul Looby (Fethard); Benny Hickey (Cahir); David Byrne (Emly); Subs: Niall Sheehan (Arravale Rovers) for Liam England; Fergal O'Callaghan (Commercials) for John Paul Looby; Peter Lambert (Ardfinnan) for Patrick Halley.

The win qualified us for the McGrath Cup final in which we met Clare at Milltown-Malbay on Sunday 26th January and we were again successful after extra time on the score Tipperary 1-09 Clare 1-08.

The team was: Brian Enright (Cahir); Benny Hahessy (Swan); Niall Kelly (Kildangan); Damien Byrne (Fethard); Shane Maher (Burgess); Declan Fanning (Killenaule); Niall Fitzgerald (Moyle Rovers); Kevin Mulryan (J. K. Brackens); Fergal O'Callaghan (Commercials) Captain; Tony Doyle (Killenaule); Aidan Fitzgerald (Fethard); Patrick Halley (Rockwell Rovers); Benny Hickey (Cahir); Eamon Hanrahan (Commercials); David Byrne (Emly). Subs: Declan Browne (Moyle Rovers) for Patrick Halley; John Paul Looby (Fethard) for David Byrne; Patrick Halley (Rockwell Rovers) for Shane Maher.

A week later, 2nd February, our National League campaign opened with a game against Clare in Ardfinnan. It was a major upset that Clare won and reversed the McGrath Cup result on the score Clare 1-12, Tipperary 1-06.

The team was: Brian Enright (Cahir); Benny Hahessy (Swan); Niall Kelly (Kildangan); Damien Byrne (Fethard); Shane Maher (Burgess); Declan Fanning (Killenaule); Patrick Halley (Rockwell Rovers); Eamon Hanrahan (Commercials); Fergal O'Callaghan (Commercials) Captain; David Byrne (Emly); Aidan Fitzgerald (Fethard); Benny Hickey (Cahir); Tony Doyle (Killenaule); Declan Browne (Moyle Rovers); Niall Fitzgerald (Moyle Rovers); Subs: Paul Cahill (Grangemockler) for David Byrne; Kevin Mulryan (J. K. Brackens) for Benny Hahessy; Peter Lambert (Ardfinnan) for Eamon Hanrahan; John Paul Looby (Fethard) for Benny Hickey.

On the 9th February we lost to Waterford at Dungarvan on the score Waterford 1-11 Tipperary 1-07.

The team was: Philly Ryan (Commer-

cial) captain; Shane Maher (Burgess); Niall Kelly (Kildangan); Damien Byrne (Fethard); Niall Fitzgerald (Moyle Rovers); Declan Fanning (Killenaule); Patrick Halley (Rockwell Rovers); Aidan Fitzgerald (Fethard); Fergal O'Callaghan (Commercials); Benny Hahessy (Swan); Kevin Mulryan (J. K. Brackens); John Paul Looby (Fethard); Tony Doyle (Killenaule); Eamon Hanrahan (Commercials); Peter Lambert (Ardfinnan); Subs: Niall Sheehan (Arravale Rovers) for Niall Fitzgerald; Micheal Webster (Loughmore/Castleiney) for Eamon Hanrahan; David Byrne (Emly) for Peter Lambert; Benny Hickey (Cahir) for Kevin Mulryan.

Our National League game against Derry in Derry on 16th February was the best result of that competition when we drew on the score Tipperary 2-10, Derry 1-13.

The team was: Philly Ryan (Commercials) captain; Shane Maher (Burgess); Niall Kelly (Kildangan); Liam Cronin (Moyle Rovers); Declan Fanning (Killenaule); Niall Fitzgerald (Moyle Rovers); Patrick Halley (Rockwell Rovers); Kevin Mulryan (J. K. Brackens); Fergal O'Callaghan (Commercials); Aidan Fitzgerald (Fethard); Eamon Hanrahan (Commercials); Benny Hickey (Cahir); Tony Doyle (Killenaule); Peter Lambert (Ardfinnan); David Byrne (Emly). Subs: Niall Sheehan (Arravale Rovers) for Declan Fanning.

Many would consider Derry the best team in our group and it is difficult to reconcile with the other performances in the group. On March 2nd in our fourth league game we were beaten by Carlow in Ardfinnan on the score Carlow 1-14 Tipperary 1-08.

The team was: Philly Ryan (Commercials) captain; Shane Maher (Burgess); Niall Kelly (Kildangan); Liam Cronin (Moyle Rovers); Damien Byrne (Fethard); Niall Fitzgerald (Moyle Rovers); Patrick Halley (Rockwell Rovers); Aidan Fitzgerald (Fethard); Fergal O'Callaghan (Commercials); Kevin Mulryan (J. K. Brackens); Eamon Hanrahan (Commercials); Benny Hickey (Cahir); Tony Doyle (Killenaule); Peter Lambert (Ardfinnan); Declan Browne (Moyle Rovers); Subs: Paul Cahill (Grangemockler) for Kevin Mulryan; Liam England (Inane Rovers) for Peter Lambert; John Paul Looby (Fethard) for Patrick Halley; Micheal Webster (Loughmore / Castleiney) for Aidan Fitzgerald.

On March 9th we were beaten by Wexford in Wexford on the score Wexford 2-14, Tipperary 0-07.

The team was: Paul Fitzgerald (Fethard); Sean Collum (J. K. Brackens); Niall Kelly (Kildangan); Liam Cronin (Moyle Rovers); Liam England (Inane Rovers); Niall Fitzgerald (Moyle Rovers); Shane Maher (Burgess); Kevin Mulryan (J. K. Brackens);

Eamon Hanrahan (Commercials); Aidan Fitzgerald (Fethard); Fergal O'Callaghan (Commercials) Captain; Benny Hahessy (Swan); Eddie O'Brien (Killenaule); Tony Doyle (Killenaule); Declan Browne (Moyle Rovers). Subs: Paul Cahill (Grangemockler) for Aidan Fitzgerald; Declan Fanning (Killenaule) for Liam England; Micheal Webster (Loughmore/Castleiney) for Eamon Hanrahan; John Paul Looby (Fethard) for Niall Kelly.

On March 23rd we were at home to Longford in Nenagh but were beaten on the score Longford 4-18, Tipperary 2-11.

The team was: Philly Ryan (Commercials) captain; Shane Maher (Burgess); Niall Kelly (Kildangan); Robbie Costigan (Cahir); Niall Fitzgerald (Moyle Rovers); Sean Collum (J. K. Brackens); Declan Fanning (Killenaule); Kevin Mulryan (J. K. Brackens); Aidan Fitzgerald (Fethard); Benny Hahessy (Swan); Fergal O'Callaghan (Commercials); Liam England (Inane Rovers); Eddie O'Brien (Killenaule); Declan Browne (Moyle Rovers); Benny Hickey (Cahir). Subs: Patrick Halley for Niall Kelly; Paul Cahill (Grangemockler) for Benny Hickey; Eamon Hanrahan (Commercials) for Aidan Fitzgerald; John Paul Looby (Fethard) for Paul Cahill.

On April 6th we were away to Monaghan and lost on the score Monaghan 1-12, Tipperary 1-08.

The team was: Brian Enright (Cahir); Shane Maher (Burgess); Liam Cronin (Moyle Rovers); Robbie Costigan (Cahir); Benny Hahessy (Swan); Sean Collum (J. K. Brackens); Declan Fanning (Killenaule); Fergal O'Callaghan (Commercials) Captain; Eamon Hanrahan (Commercials); Liam England (Inane Rovers); Niall Fitzgerald (Moyle Rovers); John Paul Looby (Fethard); Peter Lambert (Ardfinnan); Declan Browne (Moyle Rovers); Paul Cahill (Grangemockler). Subs: Eddie O'Brien (Killenaule) for Peter Lambert; Aidan Fitzgerald (Fethard) for Liam England; Kevin Mulryan (J. K. Brackens) for Liam Cronin; Benny Hickey (Cahir) for Eddie O'Brien.

On 25th May we met Waterford in the senior football championship at Waterford and won on the score Tipperary 0-18 Waterford 1-12.

The team was: Philly Ryan (Commercials) (captain); Niall Kelly (Kildangan); Damien Byrne (Fethard); Liam Cronin (Moyle Rovers); Declan Fanning (Killenaule); Sean Collum (J. K. Brackens); Robbie Costigan (Cahir); Eamon Hanrahan (Commercials); Fergal O'Callaghan (Commercials); Liam England (Inane Rovers); Niall Fitzgerald (Moyle Rovers); Aidan Fitzgerald (Fethard); Peter Lambert (Ardfinnan); Declan Browne (Moyle Rovers); Damian O'Brien (Eire Og-Anacarty). Subs: Tony Doyle (Killenaule) for Peter Lambert; Benny Hahessy (Swan) for Liam

Cronin; Paul Cahill (Grangemockler) for Damian O'Brien; Patrick Halley (Rockwell Rovers) for Niall Fitzgerald; Shane Maher (Burgess) for Damien Byrne.

Our success over Waterford qualified us for the semi-final against Kerry at Tralee on June 15th. Kerry won on the score Kerry 0-25 Tipperary 1-10.

The team was: Philly Ryan (Commercials) (captain); Sean Collum (J. K. Brackens); Niall Kelly (Kildangan); Damien Byrne (Fethard); Benny Hahessy (Swan); Declan Fanning (Killenaule); Robbie Costigan (Cahir); Eamon Hanrahan (Commercials); Fergal O'Callaghan (Commercials) Niall Fitzgerald (Moyle Rovers); Liam England (Inane Rovers); Aidan Fitzgerald (Fethard); Tony Doyle (Killenaule); Declan Browne (Moyle Rovers); Patrick Halley (Rockwell Rovers). Subs: Damian O'Brien (Eire Og-Anacarty) for Benny Hahessy; Liam Cronin (Moyle Rovers) for Niall Kelly; Paul Cahill (Grangemockler) for Sean Collum; Benny Hickey (Cahir) for Damian O'Brien; Shane Maher for Niall Fitzgerald.

In the qualifier draw we met Carlow in the first round at Semple Stadium and won on the score Tipperary 1-14 Carlow 0-13.

The team was: Philly Ryan (Commercials) (captain); Damien Byrne (Fethard); Sean Collum (J. K. Brackens); Robbie Costigan (Cahir); Liam England (Inane Rovers); Declan Fanning (Killenaule); Niall Fitzgerald (Moyle Rovers); Eamon Hanrahan (Commercials); Fergal O'Callaghan (Commercials); Aidan Fitzgerald (Fethard); Paul Cahill (Grangemockler); Kevin Mulryan (J. K. Brackens); Tony Doyle (Killenaule); Declan Browne (Moyle Rovers); Benny Hickey (Cahir). Subs: Benny Hahessy (Swan) for Damien Byrne; Niall Kelly (Kildangan) for Robbie Costigan; Damian O'Brien (Eire Og-Anacarty) for Tony Doyle; Liam Cronin (Moyle Rovers) for Paul Cahill.

In the second round we met Donegal at Croke Park on 5th July and played well although the final score does not do justice to Tipperary's performance. The final score Donegal 2-19, Tipperary 0-15. This defeat ended Tipperary's participation in senior football in 2003.

The team was: Philly Ryan (Commercials) (captain); Robbie Costigan (Cahir); Sean Collum (J. K. Brackens); Liam Cronin (Moyle Rovers); Patrick Halley (Rockwell Rovers); Declan Fanning (Killenaule); Niall Fitzgerald (Moyle Rovers); Eamon Hanrahan (Commercials); Fergal O'Callaghan (Commercials); Aidan Fitzgerald (Fethard); Kevin Mulryan (J. K. Brackens); Paul Cahill (Grangemockler); Damien O'Brien (Eire Og-Anacarty); Declan Browne (Moyle Rovers); Benny Hickey (Cahir). Subs: John Shanahan (Moyle Rovers) for Benny Hickey; James Williams (Moyle Rovers) for John Shanahan; Benny Hahessy (Swan) for Niall Fitzgerald; Brian Enright (Cahir); Niall Sheehan (Arravale Rovers); Shane Maher (Burgess); Tony Doyle (Killenaule); Fergus O'Callaghan (Commercials); Damien Byrne (Fethard); Niall Kelly (Kildangan); Peter Lambert (Ardfinnan).

## JUNIOR FOOTBALL

Our junior football campaign began on 25th May with a win over Waterford and this win on the score Tipperary 2-08, Waterford 0-13 qualified us for a semi-final place against Kerry.

The team was: Donnacha Horan (Eire Og-Anacarty); Peter King (Ballina); Alan J. Lonergan (Ardfinnan); Willie Ryan (Kilsheelan/Kilcash); Robbie Boland (Moyle Rovers); Mark O'Brien (Aherlow); Dermot Gleeson (Ballinahinch); Mark Peters (Galtee Rovers); Michael Tarrant (Cahir); James Williams (Moyle Rovers); Albert Keating (Ardfinnan); Paul Breen (Knockavilla Donaskeigh Kickhams) Captain; Des Lyons (Grangemockler); Declan Laffan (Loughmore/Castleiney); John Roche (Kilsheelan/Kilcash). Subs: Pa Morrissey (Galtee Rovers) for Willie Ryan; John Shanahan (Moyle Rovers) for Albert Keating.

In the semi-final Kerry defeated us 0-15 to 0-07 at Tralee.

The team was: Donnacha Horan (Eire Og-Anacarty); Paul Tobin (Arravale Rovers); Alan J. Lonergan (Ardfinnan); Peter King (Ballina); Pa Morrissey (Galtee Rovers); Mark O'Brien (Aherlow); Dermot Gleeson (Ballinahinch); Michael Tarrant (Cahir); Robbie Boland (Moyle Rovers); James Williams (Moyle Rovers); Albert Keating (Ardfinnan); Paul Breen (Knockavilla Donaskeigh Kickhams) Captain; John Shanahan (Moyle Rovers); Des Lyons (Grangemockler); John Roche (Kilsheelan/Kilcash). Subs: Declan Laffan (Loughmore/Castleiney) for Paul Breen; Gary Morrison (Cahir) for John Roche; Paul McCarthy (Galtee Rovers) for Michael Tarrant; William Ryan (Kilsheelan/Kilcash) for Dermot Gleeson; Jerry Ryan (Upperchurch/Drombane) for Robbie Boland; Derek Breen (Knockavilla Donaskeigh Kickhams); Paddy O'Flaherty (Cahir); Damien O'Brien (Burgess); Tommy Connors (Kildangan).

## UNDER-21 FOOTBALL

In under-21 football we met Kerry in the semi-final at Kilmallock and were heavily defeated on the score Kerry 4-17, Tipperary 2-05.

The team was: Brian Enright (Cahir); Niall Sheehan (Arravale Rovers); Peter King (Ballina); Paddy O'Flaherty (Cahir); Patrick Halley (Rockwell Rovers); Robbie Costigan (Cahir); John Hassett (Moyle/Templetuohy); Damien O'Brien (Burgess); David Byron (Galtee Rovers); David Hickey (Ballina); Paul McCarthy (Galtee Rovers); Domhnaill McKeogh (Ballina); Tony Doyle (Killenaule); Brian Coen (Fethard); Sean McKeogh (Ballina). Subs: James McGrath (Cahir) for David Byron; Thomas Maher (Ardfinnan) for David Hickey; Declan Peters (Galtee Rovers) for Domhnaill McKeogh; Paul O'Mahoney (Commercials) for Paul McCarthy; John Dunne (J. K. Brackens) for John Hassett; Keith Madigan (Clonmel Og); Brian Fitzgerald (Ballylooby/Castlegrace); Padraig Whelan (Cahir); Aaron Ryan (Inane Rovers); Daragh Duggan (Holycross/Ballycahill).

## MINOR FOOTBALL

In minor football the championship

was run on the Round Robin system. In the first round Kerry defeated Tipperary at Kilmallock 2-13 to 1-07 on 1st March.

The team was: Martin McKeogh (Ballina); Paddy Troy (Inane Rovers); Kevin Quinlan (Kilruane McDonagh); Jerry O'Brien (Ballina); Neville Melbourne (Moyle Rovers); David Morrissey (Galtee Rovers); Sean Horan (St. Patricks); Alan Curran (Mullinahone); Brian McCormack (St. Patricks); Mark McKenna (Eire Og-Nenagh); Shane O'Brien (Ballina); Paul Halley (Rockwell Rovers); James Egan (Loughmore/Castleiney); Robbie Cremin (Burgess) (Captain); Stephen Murphy (Kilruane McDonagh). Subs: Kevin Quinlan (Moyle/Templetuohy) for Paddy Troy; Timmy Byrnes (Lattin-Cullen) for Mark McKenna; Ciaran McGrath (Loughmore/Castleiney) for James Egan; Lorcan Bannon (Ardfinnan) for Shane O'Brien; Ciaran Ryan (Cappawhite) for Alan Curran.

On round 2 on March 8 Tipperary defeated Cork at Ballyagran 2-9 to 1-9.

The team was: Martin McKeogh (Ballina); Danny Madigan (Commercials); Kevin Quinlan (Kilruane McDonagh); Jerry O'Brien (Ballina); Shane O'Brien (Ballina); David Morrissey (Galtee Rovers); Sean Horan (St. Patricks); Neville Melbourne (Moyle Rovers); Kevin Quinlan (Moyle/Templetuohy); Peter Hally (Ardfinnan); Robbie Cremin (Burgess) Captain; Brian McCormack (St. Patricks); Stephen Murphy (Kilruane McDonagh); Timmy Byrnes (Lattin-Cullen); Brian Mulvihill (Moyle Rovers). Subs: Kenneth Kiely (Commercials) for Brian McCormack.

In round 3 Tipperary beat Limerick at Fermoy 2-06 to 2-05 on 15th March.

The team was: Martin McKeogh (Ballina); Danny Madigan (Commercials); Robbie Cremin (Burgess) Captain; Jerry O'Brien (Ballina); Brian McCormack (St. Patricks); David Morrissey (Galtee Rovers); Sean Horan (St. Patricks); Neville Melbourne (Moyle Rovers); Kevin Quinlan (Moyle/Templetuohy); Stephen Murphy (Kilruane McDonagh); Peter Hally (Ardfinnan); Mark McKenna (Eire Og-Nenagh); Ian Barnes (Commercials); Timmy Byrnes (Lattin-Cullen); Brian Mulvihill (Moyle Rovers). Subs: Kieran Lyons (Moyle Rovers) for Mark McKenna; Alan Rockett (Swan) for Kevin Quinlan; Paul Halley (Rockwell Rovers) for Peter Hally.

In round 4 on 29th March Clare beat Tipperary 4-10 to 1-09 at Cloughaun.

The team was: Martin McKeogh (Ballina); Danny Madigan (Commercials); Kevin Quinlan (Kilruane McDonagh); Jerry O'Brien (Ballina); Brian Carroll (Commercials); David Morrissey (Galtee Rovers); Sean Horan (St. Patricks); Neville Melbourne (Moyle Rovers); Kenneth Kiely (Commercials); Kevin Quinlan (Moyle/Templetuohy); Robbie Cremin (Burgess) Captain; Alan Rockett (Swan); Peter Hally (Ardfinnan); Brian McCormack (St. Patricks); Brian Mulvihill (Moyle Rovers). Subs: Paul Halley (Rockwell Rovers) for Brian Carroll; Cormac Moore for Danny Madigan; Ciaran Ryan (Cappawhite) for Brian McCormack.

In round 5 on 16th April Tipperary

beat Waterford 2-15 to 1-03 at Fermoy.

The team was: Ian Browne (Moyle Rovers); Cormac Moore (Arravale Rovers); Kevin Quinlan (Kilruane McDonagh); Jerry O'Brien (Ballina); Sean Horan St. Patricks; Shane O'Brien (Ballina); David Morrissey (Galtee Rovers); Neville Melbourne (Moyle Rovers); Kenneth Kiely (Commercials); Kieran Lyons (Moyle Rovers); Kevin Quinlan (Moyle/Templetuohy); Peter Hally (Ardfinnan); Ian Barnes (Commercials); Robbie Cremin (Burgess) (Captain); Brian Mulvihill (Moyle Rovers). Subs: Ciaran McGrath (Loughmore / Castleiney) for Peter Hally; Michael McHugh (Kilsheelan/Kilcash) for Robbie Cremin; Alan Cur-

ran (Mullinahone) for Ian Barnes; Alan Rockett (Swan) for Neville Melbourne.

Thus we qualified for the Munster semi-final against Cork at Kilmallock on 3rd July and Cork won 2-18 to 0-08.

The team was: Martin McKeogh (Ballina); Danny Madigan (Commercials); Kevin Quinlan (Kilruane McDonagh); Jerry O'Brien (Ballina); Robbie Cremin (Burgess) (Captain); Shane O'Brien (Ballina); Sean Horan (St. Patricks); Neville Melbourne (Moyle Rovers); Kenneth Kiely (Commercials); Peter Hally (Ardfinnan); Darragh Egan (Kildangan); Kevin Quinlan

(Moyle/Templetuohy); Stephen Murphy (Kilruane McDonagh); Timmy Byrnes (Latin-Cullen); Brian Mulvihill (Moyle Rovers). Subs: David Morrissey (Galtee Rovers) for Jerry O'Brien; Ian Barnes (Commercials) for Peter Hally; Shane Long (Gortnahoe/Glen-goole) for Darragh Egan; Ian Browne (Moyle Rovers) for Martin McKeogh; Alan Curran (Mullinahone) for Timmy Byrnes; Pat Marnane (Galtee Rovers); Cormac Moore (Arravale Rovers); Brian McCormack (St. Patricks); Paul Halley (Rockwell Rovers); Ciaran McGrath (Loughmore-/Castleiney); Alan Rockett (Swan); Michael McHugh (Kilsheelan/Kilcash); Kieran Lyons (Moyle Rovers)

## The Ballad Section

### TOOMEVARA'S 18th COUNTY HURLING CROWN 2003

'Twas the 12th day of October  
The year 2003,  
The Greyhounds beat the Thurles blues  
And won another victory.

The Sean Treacy band again looked grand  
As in many a day of old;  
The Sarsfields wore the Blue and White  
And Toomevara, the Green and Gold.

At half-time famed Toom had surged ahead  
2-10, 0-5 to the fore;  
But Sarsfields came with power in the second half-hour  
And only lost by a score.

3-19 3-16 was the final score;  
Great Toom have won renown;  
They now can boast and truly toast  
Their 18th hurling crown.

Goal man Justin Cottrell  
Toomevara's pride and joy,  
Benny Dunne, George Frend, Phil Shanahan,  
Ever ready to do or die.

Duff, Hackett, Delaney, David Young,  
Terry, and man-of-the-match Ken Dunne,  
Paddy O'Brien, (Eoin) Brislane and John O'Brien,  
Like real greyhounds can they run!

Captain Bevans (Tommy) Dunne and Willie Ryan,  
Their illustrious deeds we know;  
They reminded us of the men who played  
Forty years ago!

Here's to manager, Michael Conneely;  
Selectors: Rory, Matt and Pat;  
Physio: E. Murphy and John Tuohy,  
And each hurling aristocrat.

I'll remember you, brave hurlers true,  
Like Wedger's men, of old;  
May your daughters fair, and your sons e'er wear  
The famous Green and Gold.

### MOYCARKEY/BORRIS MINORS – 2003

The final was played in the Stadium,  
The finest, that we ever saw  
Between the Swans and Moycarkey/Borris  
When the final whistle blew 'twas a draw.

The replay was in Johnny Leahy's Park,  
On November 9th 2003  
When Moycarkey/Borris won the Sean Treacy Cup  
For a splendid and great victory.

We now will sing this 'Victory' song,  
About each and every fellow,  
For this gallant side, who wore with pride,  
The historic red and yellow.

Barry O'Brien, Shortall, Quinn,  
Healy, Kevin Moran and Power,  
Dixon, Carey, Kelly, Brian Moran and Coote,  
'Twas Kirby, Hogan and Clohessy's (great) hour.

Capt David Sheppard got the cup  
Which Ml. McKenna got before,  
The winning score was 2 gls 8 pts  
Brave Carrick Swans 2-4.

They came from Graigue and Ballyerk,  
Ballinamona, Curraheen,  
Ballydavid, Newhill, Coolkip, Clonleigh,  
And Moycarkey, Borris so green.

Noard, Turtulla, Leigh, Kevinsfort,  
Skehana and fair Gaile,  
With Ballytarsna's patriot sons  
Who were never known to fail.

Here's to manager/coach, Jack Bergin,  
Jim Flanagan – we recall John's fame,  
And Knockanuss is known to us  
For Nicky Hogan's name.

Here's to Shortall, Bourke and Flanagan,  
McGuire, Healy, Cantwell, Ryan,  
Kinanes, Fanning, Keatings, Kennedy  
And Joe Moran, leader, lion

For those teachers, mentors, parents,  
And all who help we pray  
For the work being done in Littleton  
Three cheers hip hip ! hurrah



# Amárach Technologies Ltd.

Business centre, Connolly street, Nenagh

## IT Consultancy



- Home P.C.s and printers
- Business computers and servers
- Computer networks
- Repairs and support
- Accountancy software and training
- Customised software development



**Finance available**

**For further details contact us at**

Phone 067 43871 Fax 067 43872 Email [info@amarach.ie](mailto:info@amarach.ie)

Or call in Monday to Friday 9am to 5pm





# Inter County Football Review



Tipperary U-21 Football Selectors . . . (l. to r.): Tom Kirwan, Mick Keally, John Cummins, Sean McManus.



Tipperary Minor Football Team 2003 . . . Back row (l. to r.): Jerry O'Brien, David Morrissey, Alan Rocket, Michael McHugh, Brian McCormack, Kevin Quinlan, Darragh Egan, Shane O'Brien, Neville Melbourne, Robbie Cremins, Stephen Murphy, Peter Hally, Alan Curran, Ciaran Lyons. Front (l. to r.): Shane Long, Timmy Byrnes, Sean Horan, Kenneth Kiely, Danny Madigan, Martin McGeogh, Kevin Quinlan, Brian Mulvihill, Pat Murnane, Paul Hally, Kieran McGrath, Cormac Moore.



Tipperary Junior Football Selectors . . . (l. to r.): Conor O'Dwyer, Seamus McCarthy, Martin Healy, Pete Savage, (in front Conor's son Jack).



Tipperary Junior Football Panel 2003 . . . Back row (l. to r.): Mark Sheehan, John Shanahan, Michael Tarrant, Paul McCarthy, John Roche, Alan J. Lonergan, Peter King, James Williams, Paul Breen, Mark O'Brien, Dessie Lyons, Dermot Gleeson, Derek Breen, Gary Morrison. Front (l. to r.): Tommy Connors, Paddy Flaherty, Pa Morrissey, Declan Laifan, Willie Ryan, Donncha Horan, Robbie Boland, Mark Peters, Albert Keating, Gerry Ryan.



Tipperary Minor Football Selectors . . . (l. to r.): Liam Molloy, Jim Healy, Tom O'Connor, manager, Tom McCullogh, Sean Hennessy.



Tipperary U-21 Football Panel 2003 . . . Back row (l. to r.): Dara Duggan, Keith Madigan, Thomas Maher, Sean McKeogh, John Hasset, Robbie Costigan, Paul McCarthy, David Byron, Damien O'Brien, Donal McKeogh, Paul O'Mahony, Aaron Ryan, John Dunne, Brian Fitzgerald. Front (l. to r.): Declan Peters, Peter King, David Hickey, Paddy Flaherty, Brian Coen, Brian Enright, Tony Doyle, Pat Hally, Niall Sheehan, James McGrath, Padraig Whelan.



Tipperary GAA Board received a cheque from Bank of Ireland at the Nenagh branch for participating in the Football Championship. Front (l. to r.): Donal Shanahan, (Co. Board Chairman), Benny Dunne (Tipp. Hurler and Bank of Ireland), Michael Nolan (Co. Board Treasurer), Michael Frawley (Football Board Chairman), Dympna Harty (Bank of Ireland), Michael O'Brien (Co Board Secretary), John Daly (Bank of Ireland).



Tipperary Senior Football Panel 2003 . . . Back row (l. to r.): Paul Cahill, Benny Hickey, Brian Enright, Fergus O'Callaghan, Liam England, Robbie Costigan, Aidan Fitzgerald, Niall Fitzgerald, Eamon Hanrahan, Peter Lambert, Niall Kelly, Declan Fanning, Fergal O'Callaghan, Kevin Mulryan. Front (l. to r.): Benny Hahessy, David Byrnes, Patrick Hally, Tony Doyle, Niall Sheehan, Declan Browne, Philly Ryan, Damien O'Brien, Damien Byrne, Sean Collum, Liam Cronin, Shane Maher.



Tipperary Football Supporters Club . . . Back (l. to r.): Donal Shanahan, John Doyle, Barry O'Brien, Michael Power. Front (l. to r.): Tom McGlinchy, Con Ryan, J.J. Crowley, Tom Collum, Mick Frawley.

**TIPPERARY'S CAMOGIE ALL IRELAND  
2003**

Four championships in the last five years,  
From '99 to 2003  
Those fair maids from Kickhams Knocknagow  
Have won camogie history.

'Twas Michael Cleary led the way  
With a historic three in a row  
Now Raymie reigns as trainer great;  
The Duffy Cup we now can show.

Jovita manned the Bearnna Baoil;  
Una O'Dwyer was our captain bold;  
With Suzanne and Claire Madden  
Were the pride of the Blue and Gold.

Sinead Nealon and Ciara Gaynor  
And Therese Brophy from Burgess  
With (E) Hayden and (A) McDermott  
Brought us glory and success.

Noelle Kennedy, Claire Grogan,  
Philly Fogarty, Deirdre Hughes,  
Joanne Ryan and Eimear McDonnell  
With Tris O Halloran could not lose.

Bourke, Howard, Young and Michelle Shortt  
Mulcahy, Tris and Paula Ryan,  
Bulfin, Breen, O'Connell, Connolly, Corcoran,  
Were all, ready, on the line.

From Cashel, Burgess, Drom/Inch  
Anacorthy, Templemore,  
Kilruane, Portroe, Moycarkey/Borris  
And Toomevara, famed of yore.

Raymie Ryan from Cashel was trainer  
Marion (Graham) and Conor Ryan,  
And all who helped those camogie stars  
Since 1999.

Great gallant Gaels of Knocknagow  
So gentle, yet, so strong  
With hearts of steel who knew no fear  
The bravest of the throng.

The Golden Years of our camogie teams  
Shines out for all to see.  
With hurleys in hand, youth, take your stand,  
For the honour of Tipperary.

**UPPERCHURCH/DROMBANES  
FIRST FOOTBALL FINAL**

'Twas the 25th of January  
The year 2003  
When Upperchurch/Drombane won fame  
And football history.

To the Ragg they went, and two hours were spent  
In overcoming Ballina  
In the final game, they wrote their name  
In the annals of the GAA

A draw first day, 3-5 , 2-8  
In the replay, they were all alive,  
To sweep aside the Shannon side  
By 1-12 to just 0-5.

In goals was David Carey,  
And Donal was full back;  
Ml. O Dwyer and Alan Tierney  
No courage did they lack.

Pat Short, L.T. and Kinane's Andy  
Never an inch did yield;  
Capt. Gerry Ryan and Paddy Brennan did shine  
And mastered the centre field.

Conor O Dwyer, Mike Ryan and lively Eoin Shortt  
Brian Whelan, Padraig Hayes, Padraig Bourke,  
Niall Ryan, Pad Hayes, Jody Brennan  
Were also keen for work.

Timmy Ryan, Seamus Griffin, John Carey,  
Colm Kennedy, Sean Purcell, John Quinn,  
John Ryan of the line, Joe Brennan,  
All helped in this historic win.

Mike Frawley presented the Dick Power Cup,  
To Gerry Ryan from Knockmaroe;  
Walter Moloney and physio (Ml) McCormack  
Kept ye fit the whole year through.

Rody Lowry and Pakie Whelan  
And Patsy Ralph picked the team  
That won the county final;  
They fulfilled their greatest dream.

The bon-fires blazed round many a hill  
The black and amber flags did soar  
Upperchurch/Drombane had won the first football cup  
Which we'll remember – for ever more.

J. Perkins



A crowd scene at Croke Park on All-Ireland camogie final day.



Jovita Delaney with Tipperary chairperson Margaret Skehan.

# A profile of Andy Shortall

By Mick Frawley

**A**t a recent meeting of the county committee Andy Shortall was ratified as coach manager of the Tipperary S.F. team for a period of two years. Many times since his appointment I have been asked who this man is together with queries as regards his football background, and previous experience in both coaching and management at various levels.

Andy Shortall is a Laois man bred, born and reared. In his new roll he follows in the footsteps of Colm Browne who had a very successful period as team manager of the Tipperary team during the years 1998 and 1999. Incidentally they are both former players of a very good Laois S.F. team in the early and mid eighties.

The task which he has taken on is one for which he is eminently qualified, which I will expand on later. In former years the person in charge was always referred to as the team trainer, but in today's more sophisticated and demanding world the expectations are much greater and the position now described as team manager is a much more onerous and demanding task. Current trends and demands in relation to the preparation and treatment of teams have in a very significant way increased the workload of the team manager.

No longer are the pre-requisites for the job confined to being a good judge of a player or a good reader of a game. He must also ensure that the physical and mental preparation of the team reaches the highest standards attainable. Likewise, he must be experienced and knowledgeable in all other aspects and facts of the game such as skills, teamwork, planning etc. In short the team manager must be a person of many talents. With the appointment of Andy Shortall as the person in charge of the Tipperary senior football team, we believe that we have a person of that calibre.

Andy's professional history is second to none. He qualified as a P.E. teacher from Thomond College, now known as U. L., in 1975, having earlier studied at Strawberry Hill College in London. He followed up on this qualification in 1983 when he graduated from U. C. D. with a B. A. in Maths and Economics. As a teacher he taught in Colaiste Dhulaigh in Coolock and in St. Aidan's C. B. S. in Whitehall during the years 1975 to 1989. He was appointed vice-principal of Rathangan post primary school, a



*Munster Council secretary Donie nealon presents the McGrath Cup to Tipperary Senior Football Captain Fergal O'Callaghan.*

position he occupied up until 1991. Later that year he was appointed to the post of Principal, St. Fergal's College, Rathdowney, where he served for the following eleven years until 2002.

He has an impressive playing career at club, college and county level. At underage he played both hurling and football at all levels for his club Annanough. From 1970 up until 1987 he played at under-21 and senior level for the club culminating in an U21 county title in 1970. His club were senior county finalists 1982 and semi-finalists 1985 and 1987. Also, county league champions 1982.

At county level he played both minor hurling and football for Laois and, as referred to earlier, was a member of the Laois senior county team for a number of years. His college career is both impressive and varied. He played with Thomond College, Limerick from 1973 to 1975 and helped them in their victories in the Higher Education League competitions of 1974 and 1975. Again he had a distinguished playing career with the U.C.D. College team from 1980 to 1983.

His impact and subsequent successes at managerial level are numerous. While still a player with Thomond College he managed the College's Freshers team. He coached the Gaelic football team in Colaiste Dhulaigh, that won the Dublin Vocational Schools championship on two occasions. Similar success came his way with the St. Aidan's C.B.S. team when they were crowned All-Ireland Colleges A champions under-14 in 1987. Incidentally 3 years earlier St. Aidan's, whom he was coach-

ing at the time, supplied six players to the Dublin All-Ireland minor team who beat Tipperary in the Centenary final of that year.

The senior football team U.C.D. was also managed by Andy Shortall. This team reached the Higher Education league final in 1984, and won the Sigerson Cup competition in 1985. During this period he was also manager of the Combined Universities team, which competed in a national competition between the Universities, the Colleges, the Garda and the Army.

At county level he was assistant manager to Richie O'Connor of Offaly to the Laois senior football team. Presently he is coaching the Laois under-16 development squad, which is the supply line to the Laois team that won this year's All-Ireland championship.

In his role as manager and coach to the Tipperary senior football team for the next two years, he will have as his selectors Mick Byrnes of Lattin-Cullen and Jim Cahill of Moyle Rovers. Both Mick and Jim are well known as a result of their great contribution to both their clubs and county as players and administrators.

There is a huge challenge in which all of us without exception have got a part to play, no matter how big or small that part might appear to be. At every conceivable opportunity either by word or deed we must at all times be both unselfish and unsparing in our efforts in helping Andy, Mick & Jim in their endeavours to restore Tipperary football to its former place in the sun.



*Declan Browne in action against Donegal.*



# Rockwell College

Cashel, Co. Tipperary



## SECONDARY SCHOOL:

Tel: 062-61444, Fax: 062-61661, E-mail: rockwell@iol.ie  
Web Site: www.rockwell-college.ie

### CO-EDUCATIONAL:

- Full Lunch, Tea and Supervised Study provided for all students.
- Open Day for all Prospective New Students on Saturday 14th February, 2004.
- Scholarship Examination takes place on Saturday 14th February, 2004.
- Places in 5th Year limited.
- Repeat Leaving Certificate Class with proven excellent results.
- Wide range of subjects. Excellent Recreational Facilities, many playing fields, golf course, gymnasium, swimming pool, tennis courts etc.

■ **BOARDING:** Full Boarding Facilities for boys  
Limited Host family accommodation available for girls

■ **DAY BOARDING:** 8.40a.m. - 8.15p.m.  
Monday to Friday.

**INFORMATION:** School Secretary



## CAMP ROCKWELL 2004

Tel: 062-61444, Fax: 062-61661, E-mail: camprockwell@ireland.com  
Web Site: www.rockwell-college.ie



### For Boys & Girls 5-14 Years

- |                 |               |                       |                       |               |              |
|-----------------|---------------|-----------------------|-----------------------|---------------|--------------|
| ■ Arts & Crafts | ■ Scooters    | ■ Orienteering        | ■ Assault Course      | ■ Mini-golf   | ■ Tennis     |
| ■ Basketball    | ■ Leatherwork | ■ Unihoc              | ■ Boating             | ■ Canoeing    | ■ Swimming   |
| ■ Soccer        | ■ Computers   | ■ Pedal Boats on Lake | ■ Overseas Programmes | ■ Pogo Sticks | ■ BMX (U-12) |

**2004 Camp runs on a weekly basis commencing:**

**July 3rd, 10th, 17th & 24th (Residential Camp) ■ July 5th, 12th, 19th & 26th (Day Camp)**

**For brochure contact The Camp Office**



# County Senior Football Championship

By Eamonn Wynne, Clonmel Nationalist

**I**t won't have gone down as a classic. On the contrary, this year's county senior football final must rank as one of the poorest in years. But the standard of football didn't cost anyone in Cahir a thought when Clonmel referee Brian Tyrell's final whistle unleashed wild celebrations among their players, supporters and mentors, as their hard-earned 3-points victory over Ardfinnan secured Cahir's first county senior football championship.

Loud cheers rang out around Clonmel Sportsfield when captain, Michael Tarrant, became the first man wearing the white and green jersey of the Suir-side club to raise the O'Dwyer Cup aloft. It represented a fairytale ending to the season for Cahir and, as the only team to go through both the South and county championships undefeated, it was a success that was thoroughly deserved.

Remarkably, Cahir were also appearing in their first final, having only turned senior in 1998, statistics which added even more lustre to their historic achievement. The final had thrown up a novel pairing, and the odds on a Cahir/Ardfinnan clash in the decider would surely have been generous at the beginning of the year.

The stage was set for a memorable

game between the neighbouring clubs, and the weather gods even obliged by providing a dry, albeit cool, day. But both teams appeared stifled by the importance of the occasion, as a dour final boiled down to the survival of the fittest.

Ardfinnan had a converted free from top scorer Michael Phelan to open the scoring in the first minute. Amazingly, though, they were forced to endure a wait of 36 minutes for their next score, as Cahir's midfield pairing of Michael Tarrant and James Hyland began to exert its dominance. Man-of-the-match, Benny Hickey, tapped over two points from frees, the hardworking James McGrath also added a brace of points, and with corner-forward Pdraig Whelan also getting in on the scoring act they led at half-time by 0-5 to 0-1.

However with Sean Maher, Michael English, Kieran O'Brien, Tristan Browne and substitute Shane Sweeney all growing in prominence, Ardfinnan finally woke up in the second-half. Scores from the outstanding Michael Phelan – the only player among Ardfinnan's starting fifteen to score -- hauled them back into contention, and when substitute Paul Kennedy also found the target they were just a point adrift.

Ardfinnan's rejuvenation presented a

severe test of Cahir's character. But it was one that they passed with flying colours. A free from Benny Hickey, which struck the inside of the upright before dropping over the bar, steadied the Cahir ship, before substitute Liam Kiely made the game safe. The solid second-half performance that wrapped up the 0-7 to 0-4 victory owed as much to the defensive doggedness of Damien Lonergan, David O'Gorman, Paddy O'Flaherty, Robbie Costigan, Pdraig Hyland and Paul Frazer as it did to the three points kicked on the turnover.

So dominant was the defence that goalkeeper Anthony Burke, who deputised for the injured Brian Enright, was hardly tested, as Cahir reached the Holy Grail with a success that was masterminded with some aplomb by manager Pat O'Brien, coach Colm Flaherty and selectors Alan O'Connor and Jerry Tarrant. Given their rags to riches rise through the ranks, nobody would begrudge Cahir their day in the sun. But Ardfinnan would have been popular winners too. The proud wearers of those distinctive maroon jerseys have captured the championship seven times, and from 1961 to 1974 the club contested 11 out of 13 Finals, five of which were won, including a three-in-a-row from 1962 to 1964.

However their last success was way back in 1974, as this narrow, heart-breaking defeat consigned them to the wilderness for at least another year.

Despite the relative poverty of the fare, the final was witnessed by one of the largest attendances in some time. And the thousands were comfortably accommodated at Clonmel's spacious Sportsfield, underlining the wisdom of playing the football final in the southern footballing stronghold of the county instead of Semple Stadium, where some recent finals haven't quite caught the imagination of the paying public.

The Cahir team that made history in Clonmel on Sunday, October 19th was Anthony Burke, Damien Lonergan, David O'Gorman, Pdraig Hyland, Robbie Costigan, Paul Frazer, Paddy O'Flaherty, Michael Tarrant (captain), James Hyland, Robbie Hally, Gary Morrison, James Mc.Grath, Pdraig Whelan, Benny Hickey and Ger Leahy.

Substitutes who played were Ger O'Gorman, Daniel Maguire and Liam Kiely.

The defeated Ardfinnan line-up was Eamonn Ryan, Thomas Maher, Alan John Lonergan, Nigel Carrigan, Michael



Alan O'Gorman (Ardfinnan) and Pdraig Hyland (Cahir)

English, Gerry Ryan, Kieran O'Brien, Sean Maher, Albert Keating, Michael Phelan, Tristan Browne, Pa Norton, Alan O'Gorman, Trevor O'Leary and Johnny English.

Substitutes who appeared were Brian Lonergan, Shane Sweeney, Paul Kennedy and Peter Halley.

It could be claimed that the first steps on Cahir's road to glory were taken in 2001, when a team captained by Paul Frazer won the South senior championship. And when they regained the divisional crown on the last Sunday in August, again at the expense of Moyle Rovers, people began to sit up and take notice of the team.

They showed they meant business when they beat a fancied Fethard outfit by 0-8 to 0-5 in the semi-final, having led from start to finish in a contest in which county star, Benny Hickey, was their main source of inspiration.

The other semi-final saw Ardfinnan hold off a spirited challenge from Galtee Rovers to emerge winners by 1-8 to 0-7, when they were grateful to a goal from Michael Phelan 11 minutes from the end.

Title holders Clonmel Commercials



*Celebrating (left to right): Daniel Maguire, Padraig Whelan, Paddy O'Flaherty, Brian Enright, Sarath Divakaran.*

bowled out of the championship at the quarter-final stage on a wet September evening in Kilsheelan, when Fethard beat them by 0-13 to 0-9. Commercials lived to regret the many chances for

points that they missed, and they were unable to cope with a strong Fethard finish spearheaded by the experienced Willie Morrissey.

A Loughmore/Castleiney side weakened by the absence of the injured trio of Noel Morris, David Kennedy and Paul Ormonde, went down to Ardfinnan by 2-8 to 0-6 at the same stage of the competition; and in the other quarter-final Galtee Rovers proved too powerful for an under-strength Carrick Swans team when they won by 1-17 to 1-4.

Cahir by-passed the quarter-final stage, with their South final victory and their qualification through the open draw system securing their berth in the last four.

Far removed from the excitement of county final day was business to be sorted out at the less glamorous end of the championship, as Kickhams surrendered their senior status when they were beaten by Mullinahone in the relegation play-off.

But the year belonged to Cahir. As that remarkable unbeaten run was stretched, they added another string to their bow when they beat Ennistymon by 3-13 to 1-6 in Caherconlish in the Munster Club Second Division league final, before embarking on their Munster club championship campaign with a home game against more Clare opposition, county champions, St. Senan's.

Cahir's county championship success represented something of a watershed in the county. 2003 was the first year since Loughmore took the title in 1992, that a club outside of the big three of Clonmel Commercials, Fethard and Moyle Rovers, had lifted the O'Dwyer Cup, as the curtain came down on Another eventful championship.



*Paddy O'Flaherty (Cahir) and Michael Phelan (Ardfinnan).*

# Cahir's Historic First South and County Senior Football Championship Victories



Michael Tarrant lifts the O'Dwyer Cup

**T**he year 2003, will long be remembered by Cahir's GAA followers, as the year that the club finally won its first county S.F. title. Two clubs were registered with the GAA in 1887, one around the town, known as the "Faugh-a-Bal-lagh" and another known as the "Wild Rovers" around Poulmucka. For 116 years Cahir had continued to play football, without the ultimate prize of a senior title.

Munster Senior Football League, Division Two.

The club decided to enter this competition and it proved very worthwhile in that it provided early matches for many players in January, February and March against teams from outside the county. The teams in Cahir's group were Ennistymon, Co Clare, Clashmore, Co Waterford, St. Michael's, Co Cork, Mungret, Co Limerick and Aherlow Co Tipperary. However, the semi-final, in which Cahir defeated Clashmore by 1-11 to 0-8, was not played until after the county final. The final against Ennistymon, was played in Caherconlish on Saturday, November 1st and Cahir ran out easy winners 3-13

to 1-6. This victory now gives Cahir the opportunity to play in Division One next year.

## THE CHAMPIONSHIPS.

Amazingly, Cahir only played their first championship game on the 29th June, when they comprehensively defeated Carrick Swans 3-13 to 0-8. This victory gave Cahir a place in the South semi-final. Two weeks later, Cahir defeated Knockavilla Donaskeigh Kickhams at New Inn, on a score of 2-12 to 0-5 in the second round of the county championship. Cahir's next championship game was on the 24th August, in Fethard, against Carrick Swans, who had now reached the South semi-final through the losers group. Cahir were well on top in the first half and led 0-7 to 0-2. However, a late flourish from the Swan gave the score-board a respectable appearance. This victory now set up a repeat of the 2001 South final with Moyle Rovers.

This game was played in Clonmel on Sunday, 31st August. For Moyle Rovers this was a "do or die" game, as they needed to win to stay in the county championship. After twenty minutes it looked ominous for Cahir with Rovers leading 0-6 to 0-1 and Declan Browne showing why he is one of the best forwards in the country. However, Cahir fought back and at half-time were level 0-6 each. Cahir began the second-half excellently and went in front by 0-10 to 0-6. Both teams fought out the final quarter with great enthusiasm and in the end Cahir deserved their one point victory 1-12 to 0-14. With a scoring return of 1-6 Benny Hickey's was voted "Man of the Match". After the game Michael Tarrant became only the third Cahir man to lift the South senior trophy. This victory also put Cahir directly into the county semi-final.

On Sunday, 21st September Cahir took on championship favourites, Fethard. By half-time Fethard led 1-6 to 1-4 and continued to hold the lead until Benny Hickey's two late points left the score 1-11 to 1-11. The replay took place on Sunday October the 5th. The game was a tense affair and the heavy rain made conditions difficult for both teams. Fethard were reduced to 14 men in the first half and Cahir used the extra-man very clever-

ly. In the end Cahir were well worth their 0-8 to 0-5 victory and were now in their first ever county senior football final.

This was played at Clonmel on the 29th of October against local rivals, Ardfinnan. Prior to the game the town of Cahir was decked out in green and white and this generated great support for the team. In a very tense game both teams played below their capability. At half-time Cahir, having played some great football against the wind, had a lead of 0-5 to 0-1. However, in the second half Ardfinnan really took the game to Cahir and scored three unanswered points. Cahir's backs and mid-field worked really hard to contain the opposition. Then in the final minutes points from Benny Hickey and Liam Kiely earned Cahir its first county senior football title on a score of 0-7 to 0-4.

In winning the championship Cahir scored 6-75 and conceded 2-52, with 9 different players scoring. The historic winning team was:

Anthony Burke, Damien Lonergan, Davy O'Gorman, Pdraig Hyland, Robbie Costigan, Paul Frazer, Paddy O'Flaherty, Michael Tarrant (Capt.) James Hyland, Robbie Hally, Gary Morrison, James MC Grath, Pdraig Whelan, Benny Hickey, Ger Leahy.

Subs. Liam Kiely for Leahy, Ger O'Gorman for Hally, Daniel McGuire for Whelan. Other panel members: Brian Enright (injured for final) Gavin Berry, Diarmuid Tarrant, Ciaran O'Flaherty, Colm Lonergan, Eamon Hally, Noel O'Gorman, Tom O'Gorman, Liam O'Gorman, John Devereaux, Paul Lonergan, Edgar McGrath, Sean Carroll, and Mark Costigan (who unfortunately could not play in the final because of suspension).

Manager:	Pat O'Brien
Coach:	Colm O'Flaherty
Selector:	Gerry Tarrant.
Selector:	Alan O'Connor
Physio:	Sarath Divakaran, Ciara O'Malley.

Throughout the year the panel received great support from the club officers and members. A special word of thanks to Hughie O'Donoghue who provided a meal to all players each night after training.

# Templemore Jewellers

20 MAIN STREET, TEMPLEMORE

Tel: 0504-31830

*Trophies,  
Medals &  
Presentation  
Pieces for  
all G.A.A.  
Sporting  
Occasions*

Bronze Figures, Clocks,  
Medals, Trophies, Cups  
and Plaques



ENGRAVING  
OUR SPECIALITY



Diamond Engagement rings 30% off  
Giftware includes Tipperary, Water-  
ford, Galway and Heritage Crystal &  
Rynhart Collection and our very own  
Tipperary Design bronze sculptures  
*We can arrange an appointment for you  
with our Diamond manufacturer in Dublin*

*We appreciate the huge support  
we receive from the G.A.A. and  
wish all our friends in the  
G.A.A. continued success.*



# Declan's Australian Diary

by James Holohan



Declan Browne

Since he burst on the scene at underage level, Moyle Rovers' Declan Browne has represented his county in all grades of football. His arrival signified an exciting time for his club, when they won their first ever county senior football title. He received a well-deserved All Star Award in 1998 and over the last few years he has received a host of best player awards within the county. All G.A.A. followers were delighted when he got the call to travel to Australia to take on the home side in the International Rules Series.



James Holohan

On his return the following interview took place:

**James:** When you were asked to take part in trials — Did you think you could adapt to the challenge?

**Declan:** When I got the call up I wondered if I would be able to cope with the physical aspect but after three sessions I got used to it and felt confident of being selected.

**James:** How did you feel after the journey and how soon did the team have a workout?

**Declan:** After the long journey out it took about 36 hours to get acclimatised and on the following day we had the warm-up match.

**James:** In the warm up game how did you get injured?

**Declan:** In the second quarter I was called into action. After four minutes, I was watching the flight of the ball, which was thirty yards away, when an opponent came from behind and I got a knee in the right thigh. After receiving medical attention, my worse fears were realised and I knew that I had little chance of being fit to participate any further. In fact, resulting from this injury I will not be able to take part in any football activity until after Christmas. This was a major disappointment for me as I felt it would be the ultimate honour to play for my country.

**James:** What did you think of the first test in Perth?

**Declan:** With a large number of inexperienced players on the team it was vital to get off to a good start. The opening half went according to plan as our side adapted well to the task. We lost our way after the break and the superior fitness of the Australians told in the end. In the second match in Melbourne we started well using new tactics which we tried out in training. These proved fruitful as we were leading at half time. The Aussies again dominated the third quarter. Our lads stuck to their task and it was a credit to them to win by a three-point margin. Everyone was gutted when we lost the series as a lot of effort had gone in.

**James:** What was the training regime like?

**Declan:** We trained everyday concentrating on a wide range of skills and indeed if any players thought that this was just a holiday they got a rude awakening. There was great camaraderie within the squad, in fact, we gelled so well it was just like a club team back home.

**James:** Did the Australian media generate much hype before the games, like what happens here at home?

**Declan:** Being the No 1 sport in Melbourne, it was well marketed and it captured the imagination of the public. Despite the Rugby World Cup (Ireland V Australia) being played on the same weekend the International Rules game had the greater crowd attracting 63,000 spectators. As a matter of interest the cost of a match ticket was \$20 approx.

**James:** Do you think there is anything in the Australian game that you would like to see tried here?

**Declan:** I think that picking the ball off the ground would speed up the game. It might also reduce the amount of fouling as a player would be able to get away quicker and avoid being held by an opponent. There are arguments for and against the mark but I personally would prefer not to see it introduced in our game. The system of interchanging players is something the G.A.A. might have a look at.

**James:** Finally Declan, we hear various rumours that Mick O'Dwyer wanted you in Kildare and now in Laois — Do you want to comment?

**Declan:** Despite the speculation in the media and elsewhere I can state categorically that neither Mick O'Dwyer, or anyone else, ever approached me to play outside my county. I am happy to represent my club and county and my first allegiance will always be to them. Looking forward, my aim is to regain full fitness and get back again to the playing fields

# Dinny Cahill

ANTRIM HURLING MANAGER

I first met Dinny Cahill when he came to Antrim in October 2001. Dinny met with the county chairman, J O'Boyle, that night and took on the job as manager of Antrim for three years. When talking to Dinny you could see his passion and enthusiasm for the game of hurling. From that night on, the wheels were set in motion with myself and the other selector Ger Rogan.

The first thing we had to do was set up trials. The first three weekends in November were the dates decided on which 97 players would attend. Dinny wanted to see all potential talent and was delighted that 97 players were interested in playing for Antrim.

Dinny makes the journey from Cloughjordan every weekend, arriving for training on a Friday evening at 7pm and not leaving till Sunday afternoon. In the Summer season, he makes the journey on a Tuesday night also. We train in Belfast on a Tuesday night with many players driving the 60 miles from the Glens. Feeling tired after a long journey, Dinny jumps out of the jeep full of energy, raring to go.

The change he has made in Antrim hurling in two years is incredible. He has cut out bad habits, upped the pace of the game and has them playing to a plan. The players, selectors, backroom team, county board and supporters think highly of Dinny. They realise the sacrifices he has made to improve the standard of hurling in Antrim, which is clear to be seen. Dinny always treats the players with great respect making sure they always 'enjoy the field' (as Dinny puts it). This year before our All-Ireland quarter-final we travelled south to play a few challenge games. When we were down we took time to visit Cloughjordan and the Kilruane MacDonaghs club.

On a personal point of view Dinny has really done wonders for Antrim hurling, but myself, wife Christine and daughter Julie Ann, have made friends with a wonderful family. We have been down to Cloughjordan a few times and met his wife Marian and sons, who are all hurling mad, and not to forget the most talented hurling dog I've ever seen, Max.

A dark cloud will fall over Antrim whatever time this great man decides to call it a day in Antrim. We all hope not for sometime yet.

**Tom McLean** (Antrim selector)

Over the years I have played for several quality managers both northern and southern and now have been fortunate to experience playing under the watchful eye of Dinny Cahill.

Dinny came to Antrim and took on the job of county manager at a time when few others would have accepted the challenge that existed. Dinny has a vision of where Antrim hurling should be and more importantly has an infectious belief that massive improvements can be made. As a player, I have seen evidence of this and see how his enthusiasm and knowledge of the game together with his continued commitment has rubbed off on the players and has transformed the county, fortunes over the last two seasons. Dinny is taking the talents within Antrim, developing them with patience and instilling a style of hurling, which he knows is capable of matching that of anywhere in the country.

All the players continue to learn from every training session and from what I know and have seen, I believe that in his third year this genuine hurling man will get just reward for the work he is doing. We hope he continues to enjoy his experience with our county.

**Colm McGuckian** (Antrim captain)

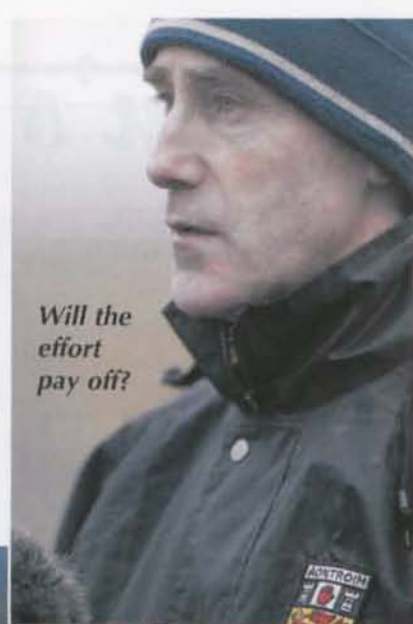

*Will the effort pay off?*

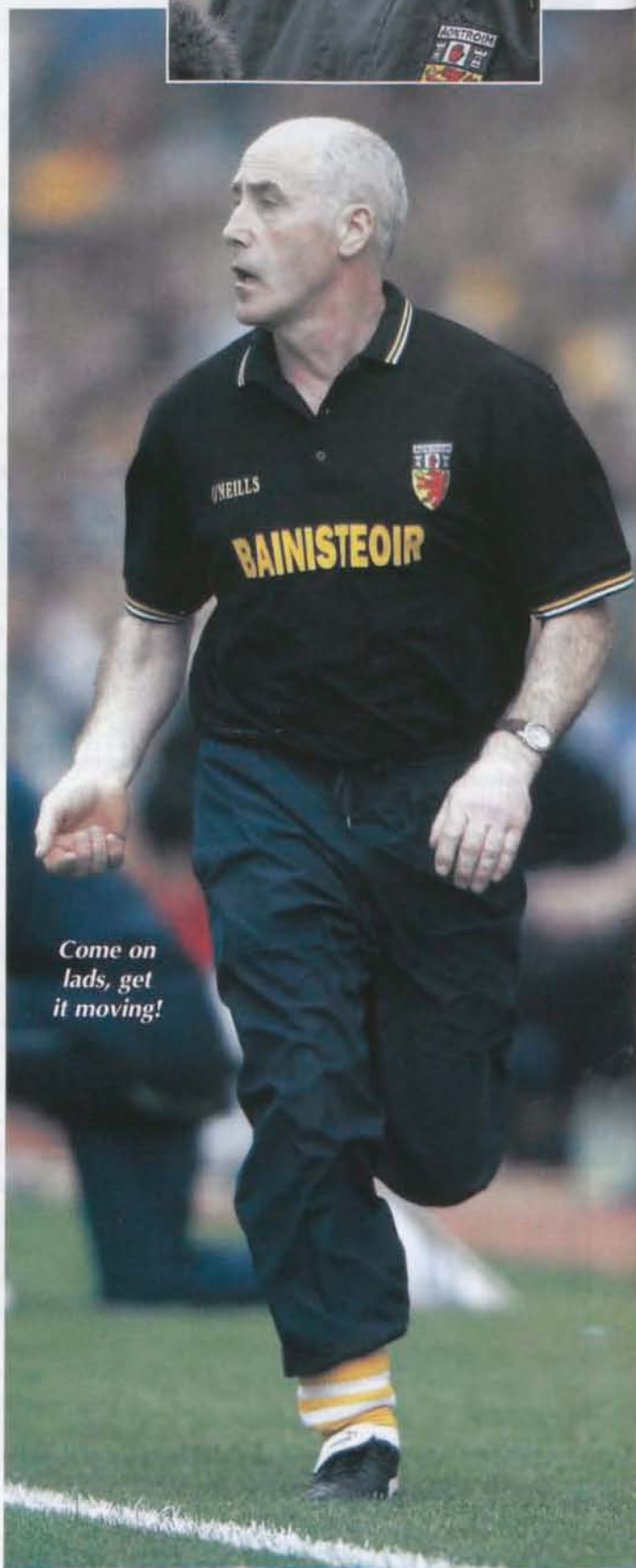

*Come on lads, get it moving!*

# DONIE NEALON

(Runai, Comhairle na Mumhan 1977-2003)

SEAMUS GAIKNEAR, P.R.O.

**M**y acquaintance and friendship with Donie Nealon began in St. Flannan's College where we were members of the same class. I renewed that relationship when I became a member of Comhairle na Mumhan and worked with him as an officer on that body.

GAA officials, especially those on higher councils, are often depicted as bureaucratic, over-conscious of the Treoir Oifigiúil - in a word, far removed from the true base of all GAA activity-the games. In no way does Donie fit into this stereotyped image of the GAA official. An outstanding player himself witnessed by a huge haul of medals, an inter-county referee, a hugely successful coach and selector with successful Tipperary teams and last, but not least, he is still to be seen prowling the sideline when his native Burgess are playing.

He brought all these experiences with him to the post of Runai Comhairle na Mumhan when he was elected to that post in 1977 to succeed Sean Mac Carthaigh R.I.P. He now retires from the position having given 26 years of outstanding leadership and service.

## ADMINISTRATOR

As an administrator, nothing was too small for his attention. In latter years the huge increase in the number of all-ticket games has placed enormous extra work on the Runai. Organising a big game with attendance of 40/50,000 is a massive undertaking often taken for granted. Printing and distribution of tickets, pre-game meetings with local venue committees, Gardaí, Medical personnel, Safety Officer, Stewards, Stilesmen; correspondence to



St. Flannan's, Ennis, 1954 Harty Cup Winners . . . Back row (left to right): Donal Houlihan, Willie O'Donovan, Kevin Gaynor, Paddy O'Malley, Jackie Roughan, Seamus Gardiner, Jim Donlon, Michael Donellan, Tom Hanly, Jackie McNamara, Edmund Cahill, Jack Collison. Front row (left to right): Conleth Conroy, Michael Gilmartin, J.J. O'Keefe, Donie Nealon, Gerard McCarthy, Seamus Ryan (capt.), Jim Hassett, Rory McInerney, Jim McGrath, Michael Gilmartin.

match officials, special guests, requests for tickets, car passes, local Radio, RTE, journalists. To do this - sometimes two Sundays in succession - imposes a huge volume of work on the Runai. With the Cisteoir, the day began usually before 11.00 a.m. and finished some time after the match. Most of the time they never get to see the game. As well as the big days all other games at all grades - minor, under 21, junior, intermediate, club at different venues around the province- are always under the supervision of the Runai or Cisteoir.

## AVAILABILITY TO CLUB/COUNTIES

His knowledge of the rules was constantly in demand - clubs all over the province will remember with gratitude his knowledge and help in their efforts to buy property, develop fields, replace trustees. The massive increase in the income/expenditure figures of the Council in his time is some indicator of the huge increase in the Runai's work

1977	Income	€176,053
	Expenditure	€109,255
2002	Income	€5,761,132
	Expenditure	€5,723,799

## CROKE PARK

At national level Donie's knowledge and experience were keenly appreciated and he was a member of numerous committees at that level. His views on hurling stretch back not just to his own playing days but to the very popular coaching seminars in Gormanstown in the sixties, which could be said to have begun the coaching programmes in the Association.

## PERSONAL QUALITIES

Donie brought many personal qualities to his post as Runai. A man of huge integrity he was meticulous in his collecting of gates. A brilliant hurler himself he had no time at all for what could be considered unfair, dirty or dangerous play. He had the same consistent approach to any such incident wherever it occurred. When it was announced some time ago at the Tipperary County Board that the Munster Council would have a new secretary and that the Council had purchased a premises for an office in Limerick the question was asked "Will this now be a nine to five job"? This maybe in one way shows the common acceptance of Donie's approach to the job. In the week before big games his house and office was often besieged to the huge inconvenience of his family.

## FOCAL SCOIR

Of course Donie will be missed. His wealth of knowledge and experience are not easily replaced. Simon Moroney, his successor begins a new chapter. In fact Simon will be only the fifth Runai in just over 100 years of the existence of the Munster Council. All of gaeldom wish Donie a relaxing retirement. He can now sit back and enjoy all the games and he will not have to worry about anything going wrong on the big day. Kitty and the family who shared a lot of the work before big games will now have their house back to themselves. Donie's work and legacy to Comhairle na Mumhan will not be forgotten.



Munster Council Officers 2003 . . . Left to right: Christy Cooney (chairman Munster Council), Sean Kelly (GAA President), Donie Nealon, Dan Hoare (treasurer Munster Council).

# The Royal Hotel

BRIDGE STREET, TIPPERARY TOWN

*"Under New Management"*

Situated In Tipperary Town, a familiar meeting place serving excellent food from 8 am to 9pm daily using finest quality local produce, tastefully decorated rooms with all amenities.

All Rooms en-suite with T.V. and Direct Dial Telephone  
Special packages for Golfers and Hill walkers (and all sporting groups). Commercial rates available.

Meeting rooms available, Function rooms for parties large and small



Nicky English brings back McCarthy Cup to Tipperary in 1991.  
Seen here with his parents Donie and Maura and Fr Derry Quirke

**Telephone: 062-33244 Fax: 062-33596**

E-mail: [info@royalhotel.com](mailto:info@royalhotel.com) Website: [www.royalhoteltipperary.ie](http://www.royalhoteltipperary.ie)

# Tipperary Supporters Club

By Gerry Ryan PRO



Jimmy Hennessy, middle, Co. Senior selector 1971 with All Star goalkeepers Pat Moloughney on left and Tony Reddan on right.



Tipperary goalkeepers spanning the last fifty years who attended a function in Thurles on County Final Day. Left to right Terry Moloney, Peter O'Sullivan, Donal O'Brien, John O'Donoghue, Roger Mounsey and John O'Grady.

**O**ur 16th annual general meeting was held on March 26th. The financial summary presented as part of the auditor's report showed that since inception in October 1986 that €1,119,015 had been expended on Tipperary hurling through the Supporters Club.

This figure is a marvellous testament to the wonderful hurling supporters of Tipperary.

The function of the officers & committee of the Tipperary Supporters Club is to continually harness this goodwill and to organise attractive fundraising events.

We had our Annual 'Night at the Dogs' which was held at Harold's Cross Greyhound Stadium on Friday May 2nd. It was a wonderful night of hospitality and entertainment for our sponsors & guests.

The event was another financial success generating a surplus of in excess of €23,000. Then the concentration was on a new venture a Table Quiz excellently organised by John Coman it attracted a huge following. The venue was 'Rody Bolands' of Rathmines, which is owned by Nenagh native, Kieran O'Meara, a committee member since the inception of the club.

The Annual Golf Classic returned for its 4th consecutive year to the excellent Tipperary Golf & Country Club at Dundrum on May 18th.

We had 60 teams participating with a further 38 tee & green sponsors as well as the main sponsors Enfer Scientific. This event is now established as a special date in the diary of participants over the year. It's a day when friendships are renewed it is one of our principal events and this year raised over €30,000.

The popular winning team this year

comprised Andy Lacey, his two nephews Declan Keaty, James Nolan and none other than Pat Fox.

Andy of course was proprietor of the Royal Hotel in Tipperary Town for many years and has done trojan work on the committee of the Supporters Club.

On an ongoing basis throughout the year we are promoting club membership @ €25 and the Tipperary Supporters exclusive credit card.

Our final fundraiser was the corporate lunch in the Hogan Mezzanine at Croke Park on Sunday, August 17th. This event was in association with Tipperary county board and the Croke Park facilities made it a truly splendid setting. The guest after dinner speaker was Micheal O Muircheartaigh who ensured it was a memorable occasion.

When you look at the amount of activity and the level of fundraising involved it is amazing to see in the financial summary that since the inception of the club administration expenses have only averaged €4,800 per annum in 16 years.

## HOW CAN YOU HELP?

We have two ongoing ventures that every Tipperary person can support and be involved in promoting and that is annual membership and applying for a Tipperary Credit Card.

You can support Tipperary and still get a great deal by having your own unique Credit Card featuring the majestic Rock of Cashel. The card is available through any Bank of Ireland branch and you do not have to be a customer to apply. You can alternatively call 1890 365 100 and for each new account Bank of Ireland donates €13 and a percentage of the annual spend to the Tipperary Supporters Club. This is at no extra cost to you, so if you have an existing credit card why not switch and

support our hurlers. Our membership costs €25, so we are continually trying to increase our membership and this year we asked current members to sell at least 1 extra membership. You can purchase your membership on line at [www.tipp supportersclub.com](http://www.tipp supportersclub.com) or forward a cheque to me Gerry Ryan, 8 Kinchora Close, Cullenagh, Ballina, Co Tipperary. My contact number is 087 2569412 and we would love to hear from people who would like to get involved helping in fundraising activities for our hurlers.

## WHAT NEXT?

Our sponsorship of the under-17 Advanced School of Hurling (ASH) continues. This venture in association with the Tipperary Coaching & Games Development Committee and the county minor hurling selectors was launched in October 2001. The aim of this project is that young hurlers will develop their sporting and life skills in a structured environment and be prepared to go on to compete for places at minor, under-21 and ultimately senior level. We are looking at a number of new initiatives for 2004 including:

- establishing a sub-committee in the USA
- holding a Race Day at the Punchestown festival.

Our golf classic will be in Dundrum again in May 2004 and we are holding another Table Quiz in Rody Bolands on December 2nd in conjunction with the Tipperary Association, Dublin.

If you are interested in participating in any of these events please contact Gerry Ryan at 087-2569412.

Thanks to everyone for the support of Tipperary hurling in the past and we would welcome it to continue so as to keep our great county to the forefront in hurling.

**Visit Thurles's Newest Food Experience**

# PARK AVENUE HOUSE

## THURLES

and

# DERELS RESTAURANT

*New extensive menus specialising in steaks, seafood, pasta and many house specialities from around the world.*

-----  
OPEN NIGHTLY TUESDAY - SATURDAY (LAST ORDERS 9.45 p.m.)

LUNCHES 7 DAYS A WEEK  
-----

MEETING ROOMS AND FUNCTION ROOM AVAILABLE FOR ALL OCCASIONS

*"Where Quality Lives Up To Reputation"*

CONTACT: Louise or Derek O'Connell at (0504) 21144

## **D & S TARMAC CONTRACTORS**

Tarmacadam, Kerby

Laying & Tar



Spraying Specialists

**ROADS • DRIVEWAYS  
CAR PARKS • TENNIS  
COURTS • ETC.**

EXPERIENCED PROFESSIONAL SERVICE

**Denis Moore - 0504-22845**

**Stephen Brolan - 0504-22901**

**Mobile: 087-2639943**

**56 MOYNE ROAD, THURLES**

## ***J. Fitzgibbon & Sons***

### **ENGINEERING WORKS**

*~ Farm Buildings*

*~ Beef Units etc.*

*~ Sheeted Doors & All Farm  
Equipment*

*~ Fire Escapes*

*~ Entrance Gates & Ornamental  
Iron Works*

**Mitchell Street, Thurles,  
Co. Tipperary.**

**Telephone: (0504) 22161**

**Fax: (0504) 23277**

# TALES OF TIPPERARY'S TROUBLES WITH THREE

**John O'Grady**

**T**ipperary's failure in 2003 was perhaps inevitable. Not for plain practical hurling reasons but for the power or curse of the final digit in the number of the year. A glance at the record of our senior All-Irelands will reveal everything else from 0 to 9. Three? Not a sign of it.

So, let's do a morbid postmortem on the sequence of losses on a figure that's generally regarded as lucky and even as having all sorts of mystical significance – trinities, triads and third-time lucky, etc.

We'll work our way up from 1893. In that early year, when clubs competed on behalf of counties, Tipperary missed out by not competing at all. No defeat, anyway! In 1903 the Lahorna de Wets – named for the Boer general – lost to a Cork selection from Blackrock, St. Finbarr's and Dungourney. So 'outside' help was availed of by the leading club.

The jinx, if such it be, began in 1913. A dispute was ongoing over the funds for the Croke Memorial – most of the money was diverted towards the purchase of Croke Park, against Tipperary wishes. The Toomevara selection led by 'Wedger Meagher' was asked not to play Kilkenny but did so, losing 2-4 to 1-2, Hugh Shelly and Paddy Brolan of Thurles were on the team as were Jimmy Murphy and Bob Mockler of Horse and Jockey.

The 1923 side went under to Limerick – the game, in those disturbed times, wasn't played till March of 1924. Curiously, of the team that had beaten Clare, eight – including captain Johnny Leahy – were missing on the day of defeat. Arthur O'Donnell, Stephen Hackett, Joe Fitzpatrick, Phil Cahill, Tom Dwan, Steve Kenny, Jack Darcy – all absent. An ill-timed epidemic – or non-medical reasons?

A replay with Waterford in 1933 was held in Carrick-on-Suir. The team contained three, who were later to captain All-Ireland teams – Jim Lanigan (1937), Mick Daniels (Dublin captain in 1938), John Maher (1945). The two great Phils, Purcell and Cahill, were still there, with goalkeeper Tom O'Meara, the classic full-forward Martin Kennedy and the great Killea man, Tommy Treacy. But for all that array of ability. Waterford took it, 5-5 to 2-2.

War-time 1943, third year of Cork's four in a row, saw no Tipperary challenge to that supremacy because we couldn't get past Waterford in Dungarvan. Little Jimmy Maher of Boherlahan was between the sticks – he lasted till Reddin's arrival for the 1949 campaign – and he had future title-winning companions of 1945 in Ger Connolly at full-back, John Maher at centre and Tommy

Doyle on the wing. Willie Wall of the 1937 side was left corner-back, but one sees no mention of Johnny Ryan's absence on that occasion. I note that Tom Mason, grandfather of Sarsfields' Stephen, was wing forward. Sonny Maher, brought back six years later to good effect, was full-forward. The 1943 side got a sound beating in 'sweet Dungarvan town,' 4-5 to a meagre 1-2.

Ten years later, circumstances were fairly similar, with Cork in the middle year of their three-in-a-row that followed Tipperary's trio. The team – Reddin: Byrne, Brennan, Doyle; Keane, Finn, T. Doyle; Stakelum, Hough; Ned Ryan, Shanahan, Bannon; Tim Ryan, Kenny, Philip Maher. They'd beaten Waterford readily. John Doyle had been controversially sent off but was back for the final. Cork prevailed, 3-10 to 1-11, with forward flaws our main ailment – and Christy Ring another.

It's painful to mention 1963! The odd one of five, that loss to Waterford in Limerick. We'd won the two before and were to win the two after. So the gap in 1963 sticks out like the missing volume of an encyclopaedia. Not that the Decies came from nowhere – they'd beaten us in a tight league final at Nowlan Park. Tipperary opened the championship by defeating Cork and lined out in Limerick as follows – Mounsey, Doyle, Maher, Carey, Burns, Wall, Pat Ryan, English, Nealon, Doyle, Kiely. Tom Ryan, McKenna, Devaney, McLoughlin, Waterford scored three points from play and won by that many in a goal less game. McLoughlin had a goal disallowed. The attack, naturally, bore the brunt of critical reaction. The strange thing was that in the All-Ireland with Kilkenny, Waterford scored half a dozen goals and lost.

Pain returns, acutely, when we fast forward to 1973. Richie Bennis and that last puck '70' Some argued it had drifted wide. Len Gaynor put his case forcefully to the umpires! Some said that goalkeeper Tadhg Murphy hadn't touched the ball till it was over the line. Murphy hadn't been available against Waterford so Jimmy Doyle reverted to where he'd been as minor in 1954. In the semi-final against Cork Roscrea's Roger Ryan was a prolific scorer on a day of five Tipperary goals. On a hot Thurles day in the final Tipperary scored twenty times, Limerick thirteen. Six of theirs were of green colour. Ned Rea got in repeatedly on goalkeeper Murphy as referee Slattery adopted a tolerant view. John Flanagan appeared to have earned us another day with a point towards Killinan. Came the fatal '70'. Our team Murphy; Fogarty, Kelly, Gleeson, Crampton, O Connor, Gaynor, Hogan, P.J. Ryan, Loughnane, Roche, O Dwyer, Flanagan, Ryan, Keating,

On to 1983. We'd not passed the first round in a decade but a win over Clare finally broke that sad series. Success ended with that. In a semi-final at Pairc Uí Chaoimh we got ousted by Waterford for whom Pat McGrath and Mossie Walsh were relentless leaders. The score 4-13 to 2-15. John Sheedy was in goal. Peter Brennan was flanked by a pair of Hogans, Eddie and Enda. 'Pa' Fitzelle, McIntyre and Bobby Ryan were outside. Liam Bergin was captain and had Ralph Callaghan as partner at midfield. The attack – Doyle, Maher, Dooley; Waters, Grogan, English.

Fresher – too fresh, maybe in memory is 1993. The ease and fluency of the win over Clare – Gaynor's Clare – had the superlatives flying, though the Banner's 2-12 was a decent total against our defence. But 3-17 obscured the blemish. John Leahy was 'the man' that day in Limerick.

Centre-back was a queried position – what's new? Toomevara's Michael O'Meara was in possession. In a North game at Nenagh, with Babs Keating casting an observant eye vis a vis Galway, Eire Og's Tomlinson gave O'Meara such trouble on the 40 as to cause a switch by the Toome mentors. What might Joe Cooney do? Babs wasn't confident of a positive answer from the Tipperary captain and the side for Croke Park had Bobby Ryan restored to No.6.

It was no fortunate day. Hopper McGrath got one past Ken Hogan from a fair distance for an early shaker. We lost Declan Ryan with a knee knock, Ryamie Ryan and Paul Delaney collided heavily, the Cashel player having to depart. When Declan went off, we made it a twosome of exits by also removing Colm Bonner, a piece of strategy loudly disapproved of in the wake of the fall. Fox and Conor Stakelum were the incoming duo. Pat weaved through for a late goal but time and Galway got the better of us 1-16 to 1-14, even without Finnerty and Keady. Their driving force was Gerry McInerney from centre back, coming powerfully away with rousing deliveries. For the record our selection Hogan, Delaney, Sheedy, Ryan, R. Ryan, O'Meara, Conal Bonnar, Colm Bonnar, Carr, Cleary, Declan Ryan, Leahy, Aidan Ryan, Crosse, English. Ironically enough, the last quarter saw Michael O'Meara brought on at centre back. A defender who had an outstanding game in defeat was Michael Ryan at left back.

The story of 2003 is recounted in my sequential review of the season. Not 'till 2013 will there be a choice of a happier one. The best of luck to whoever plays, manages – or writes – in that era.



*Abbey Court Hotel*  
*Nenagh*



*"Casual Country Elegance"*

- 82 elegantly appointed bedrooms
- Luxurious New Leisure club
- Award Winning Cloister Restaurant & Abbots Bar
- Extensive conference & Banqueting Facilities
- Ideal Wedding Venue

Dublin Road, Nenagh, Co. Tipperary  
Ph: 067-41111 Fax: 067-41022  
E-mail: [info@abbeycourt.ie](mailto:info@abbeycourt.ie)  
Web: [www.abbeycourt.ie](http://www.abbeycourt.ie)

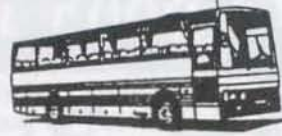

Best of Luck to all  
Tipperary teams

Bertie Fitzpatrick

# BUS HIRE

Roscrea

Tel.: (0505) 21922  
Mobile No. (086) 2435793

# ROSCREA OIL

THE OIL PROFESSIONALS

Telephone: (0505) 21433/21909

Fax: (0505) 22494

ROSCREA OIL

**ESTUARY**

**A CUSTOMER FOCUSED COMPANY COMMITTED TO SERVE**

**SUPPLIERS OF - HOME HEATING - KEROSENE  
AGRICULTURAL OIL - AUTO DIESEL - PETROL**

(premium/unleaded)

Let the oil professionals work for you

**AN OLA IS FEARR**



# A Successful 2003 Campaign

by Michael Ryan

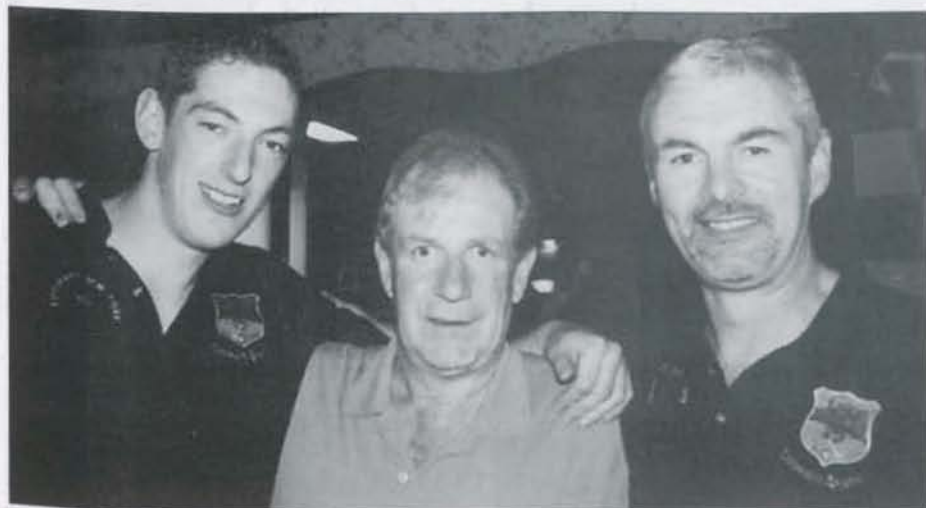

Pictured left to right: Sean Quirke Captain, Brendan Maher Manager and Michael Ryan President.

The advent of 2003 saw Tipperary Hurling Club focus on a repeat of its 2002 championship success. The A.G.M. in January, held in The Heritage Bar on McLean Ave. showed no signs of leftover celebrations from the previous year, rather an anxiousness by the management and club officers on the work that lay ahead and a restlessness by players eager to shed the confines of winter weather and test the spring in the caman once again.

Early games against New Jersey and Westmeath, and full points gained, steadied the team and eased the pressure on manager, Brendan Maher, for the time being at least. Brendan was looking to win his third title as manager and looked to veterans Eoin Cummins, Michael Kennedy, John Madden, Jim Lyons and Kevin Kennedy to backbone his team.

Further victories against Kilkenny and Limerick were to follow. In all these games the free-taking by Trevor Fletcher

was a delight and the introduction of Liam England added depth to our defence. Our only loss in the regular season was to Connecticut State, but enough points were already in the bag to secure a semi-final berth.

Offaly were our opponent in the semi-final and proved to be strong opposition. Robbie Ryan was showing the form that earned him our Player of the Year award, and with captain, Sean Quirke, and Eoin Cummins playing tight in defence we scraped out a one point victory thanks to last minute heroics by visitor, John Carroll. We were aided also by the presence of Eamon Corcoran who was steadfast throughout.

The final against Connecticut State turned into a marathon of sorts, taking two games and extra time to find a winner. Paul Curran and Eddie Brennan were our extra help and they played their parts with distinction, but every credit must also go to all our regular

## TIPPERARY HURLING CLUB NEW YORK - OFFICERS

### President

Michael Ryan,  
Upperchurch, Drombane.

### Vice President

Therese Crowe, Thurles.

### Secretary

Kevin Kennedy, Toomevara.

### Treasurer

Helena Campion, Gortnahoe.

### Custodian

Michael Kennedy, Toomevara.

### Trustees

Pat Costigan, Templetuohy  
Donal Morrissey, Knockavilla  
Sean ODwyer, Golden

### Senior Manager

Brendan Maher, Roscrea.

### Junior Manager

Declan O'Meara, Toomevara.

### Dance Co-chairs

Shane Quinlan, Upperchurch.  
Siobhan Kennedy, Upperchurch.

### Journal Chair

Helena Campion, Gortnahoe.

panel members, who showed tremendous heart and skill to retain the Michael Flannery Memorial Cup. Robbie Ryan deserved his Man of the Match award, hats off to Tim Cullen in goal, John Treacy, John Byrne, Dennis Ryan, Gary Quinlan, Tomas Keane, Alan Slattery and Mike Maher, along with players already mentioned through this report. Our 25th title was finally achieved with a 13 point victory.

The victory dance held at the Polish Centre on December 6th honoured all these players and also special honoree Seamus Collison, Moneygall native. It was a pleasure to have Jimmy Doyle with us and also Angela McDermott, Claire Madden and Marion Graham of camogie fame.

## Tipperary Senior Hurling Panel Champions New York 2003



Back row, left to right: Liam England, Mike Ryan (president), Steven Carty(selector), Alan Slattery, Kevin Kennedy, John Byrne, Owen Cummins, Sean Quirke(captain), John Madden, Mike Kennedy, Jim Lyons, Phil Bennett and Brendan Maher (manager). Front row, left to right: Gary Quinlan, Willie Hackett, Tomas Keane, Dennis Ryan, John Treacy, Mike Maher, Paul Curran, Trevor Fletcher, Eddie Brennan, Robbie Ryan, Tim Cullen and Declan O'Meara (selector).

Style  
Man

MEN'S  
AND BOYS'  
WEAR



*The Ultimate Men's Shop with all Leading Brands*

Prop: PAT O'DWYER

**NO. 2 WESTGATE, THURLES  
& PATRICK'S ST, TEMPLEMORE**

**Tel: 0504-24209**



**Gleeson Quarries**



● CONCRETE BLOCKS

● READY-MIX CONCRETE

● CLAUSE 804

● CRUSHED STONE

● WASHED GRAVEL

● WASHED SAND

● GROWLIME

● WET MIX MACADAM

**Laffansbridge, Thurles**

**Phone: 052-56117**

# Tipperary hurling at the crossroads

by Martin Ryan

While the golden girls of Tipperary stand atop the camogie world, their hurling counterparts must look back on the past year as a disappointing one, despite minor and under 21 provincial success. Such years have become the common experience for Tipperary hurling these days. Much has been said and written about the so-called 'famine' years, but the anticipated renaissance of Tipperary has been less than complete. While one can argue about the county's potential, it is surely beyond debate to say that this potential is far from being maximised.

The signs are ambiguous in some ways, as the county is the dominant force in Munster at minor level these days, yet at all grades we seem to have descended to the point of providing defeated opponents for teams in All-Ireland semi-finals. The level of achievement at All-Ireland level – the only measure in the final analysis – is certainly not commensurate with the perceived level of talent available. Without trying to be alarmist, many of us consider that while the county displays all the trappings of hurling wealth, in achievement terms its status as a real hurling power is under serious threat. Our competitiveness at the business end of the championships across the grades has diminished greatly. What is the explanation for this decline? Would it be fair to say that much of the problem is self-inflicted? And what can be done to address these problems? This situation urgently needs to be tackled, as in the current social climate, sustained success is needed in order for the game to maintain its primary position in the county. It is not over-stating things to say that Tipperary hurling is at a crossroads, and requires some serious thought and decision-making, concerning the direction it will take in the immediate future.

An examination of the minor and under 21 grades demonstrates beyond doubt that Tipperary hurling is seriously underachieving. While the county is the provincial leader in these grades, the statistics at national level paint a far less flattering picture. We have won just one All-Ireland minor title since 1982, despite winning ten Munster minor titles. In six of those years of failure at national level we have lost to Galway,



Dylan Maher, Moneygall and Barry Hogan, Portroe, get in hurling practice during half-time of a game in Cloughjordan.

The same county has beaten our under-21s in the last two All-Ireland semi-finals in which we met. Why can we not compete with Galway, yet Limerick beat Galway with little difficulty in the years they won their under-21 titles, as did Kilkenny this year at under 21 and minor? Our under-21 record is hardly inspiring either, with just two titles since 1981. When you consider the paucity of achievement at All-Ireland level in these grades, and the conventional view of their importance, it makes the fact that we have won three All-Ireland senior titles in the last fifteen years all the more remarkable. Our inability to win All-Ireland titles in these under-age grades is odd when you consider the healthy record of success we have had at the inter-county under-14 (eight wins in twenty years) and under-16 (six wins in fifteen years) tournaments. Clearly we are not satisfactorily bridging the chasm between the younger grades and minor/under 21.

It can be strongly argued that Tipperary is doing little to enhance its prospects by the way in which it organises its internal competitions and structures. Other counties can pluck a player straight off a club team and put him on a county team based on his performance at club level. In Tipperary one could not be confident about the reliability of club performance as a measure of a player's potential at a higher level. Club hurling in the county has been predictable and uninspiring over the

past number of years, and many clubs seem to be drifting along in the wrong grade. Despite a systematic relegation system over the past five years, twenty-four clubs – many who struggle – are still plying their trades at senior level. This is in a county where the last fifteen county senior finals have featured just eight different clubs. The damage this is doing is manifest in the inability of the county champions to progress in the provincial championship, and in county players who look the part at club level, yet don't 'cut the mustard' in the Blue and Gold. It is reflected also in poor attendances, with the massive enthusiasm displayed around Liberty Square in September 2001, not apparent on big club occasions at the Stadium or elsewhere.

Looking around other counties and at the general standard of clubs in Tipp, one must conclude that only about fourteen teams could reasonably be considered as capable of competing at senior level. A county championship such as this with only genuine senior teams, would be far more competitive and played off far more efficiently than the current version. Fourteen teams organised into two groups of seven, would ensure a minimum of six championship games, against strong and different opposition. An automatic relegation play-off system should keep any meaningless games to a minimum. It would also get rid of the incredibly unwieldy senior championship system we cur-

rently have. Under the present system, the divisional championships commence in early summer, yet by September, three months later, we still have sixteen of the twenty-four teams left in the county championship. That means that the four divisional championships manage to knockout only eight teams over a four-month period, yet the county series eliminates sixteen in an almost blitz-like fashion.

The explanation for this roundabout system is that the county championship is held up by the divisional competitions, and by other grades. If you get any group of people from different clubs together it will not be long before they are swapping stories of huge time gaps between matches during the best playing months. The upshot of this is that county finals in various grades are being played in November and December. There were 26 weekends between the start of April and the end of September in 2003. Even allowing for Tipperary playing, surely that is long enough to run off virtually all competitions, hurling and football, without having teams going through drudgery in the height of winter in the most important games?

The divisional system as currently constituted masks, and arguably causes huge inequities among the grades. Whatever emotional attachments people may now have to their divisional set-up, they are hardly an ideal way of efficiently organising all competitions. Proposed new divisions have been mooted in some quarters, among them one that involves amalgamating the Mid/North, and South/West, to create two divisions. This would be a dangerously unequal split, with the former combination being a significantly stronger division. Lest there be any umbrage taken at this, let us consider the facts, as this is demonstrably true. Take the last four years - 2000 to 2003. Forty teams competed in the five major county finals, that is Senior, Intermediate, Junior A, Under 21 A, and Minor A. Of these forty teams, thirty-one came from Mid/North, and only nine from South/West. Only two of these twenty county titles available in these grades during this time went to the South/West, with both going to the South. It is also telling that since the 'back-door' system was introduced in the county intermediate championship in 1999, only one of the five finals played has not featured an all North Tipperary line-up. All things considered, there can be little argument about this analysis, and there is a mountain of further evidence to support this conclusion if space permitted. Splitting the divisions in this convenient, pre-cast fashion would be a serious mistake.

The creation of area teams incorporating intermediate and junior clubs would also give a great injection to the championship. If organised properly

and given the requisite commitment, these outfits, as they do in Cork, would enhance the championship. The knee-jerk response is to say that it wouldn't work, and inter-parish rivalries would rule them out. My answer is that such teams in Cork, namely Imokilly and Avondhu, won three county titles in the late '90s, so it can work. If there was proper effort, and a good, committed mentorial set-up, there is no reason why these combination teams should not work. All that would be needed is for one of them to make an impact, and you would see the enthusiasm this would generate. It would give many very good young hurlers in smaller clubs a chance to play at senior level. On the subject of boosting the county championships, would it be outlandish to invite the Garda College or the Tipperary Institute to play in the county championship? The Intermediate and Junior championship could be rationalised in a similar manner, and players would be delighted to have up to eight or nine matches guaranteed over a twenty-week period between April and August in optimum weather conditions. The reduction in the number of senior teams would increase the quality of this championship dramatically, and would also have the effect of boosting the county intermediate team's strength, with a large group of new players available to it.

This is not a charter to jettison the divisions. There are many issues to which divisional boards, or at least bodies subordinate to the county board - whatever form they take - could turn their attention, without having to bother themselves with administrative functions such as fixtures and discipline. There is no reason why divisions could not retain their own championships, but there would be the added problem that grading would have to be decided at county championship level, so the weaker divisions could conceivably find themselves without a senior team. Divisional boards could examine why are large urban areas throughout the county not achieving a lot more? They could also run under-age competitions, as it is hardly feasible to haul juveniles large distances to play games. Recruitment of referees is another important function for such a body. I would see the divisional boards having a more pro-active, and hands-on advisory role, rather than operating in a purely administrative capacity.

It is not just the structures that are inhibiting progress. One has to question the lack of contribution from many former Tipp players in the preparation of county teams. We heard a lot of names bandied about in relation the senior manager's job recently, but why do such names not cut their teeth at other grades first? In Kilkenny, no less a figure

than Joe Hennessy is a mere selector on the county minor team. The late Ollie Walsh, and Noel Skehan both managed the county junior team. In Cork, the manager of the county under 14s was Bertie Og Murphy! People of such profile don't seem to retain an involvement in Tipperary. While realising that an inter-county career is far from a guarantee that somebody has management potential, it is a shame if the golf course lays claim to the experience, and respect these people could command in a dressing-room, especially from young impressionable players.

Not all indicators for Tipperary hurling are negative. We do seem to produce more good young hurlers than virtually any other county. The recent under-age success suggests that. We regularly contribute significant players to the top teams in the Fitzgibbon Cup. Our teams in the Harty cup always acquit themselves well, even if inevitably coming up against 'packed' teams. There are a lot of people doing great work in the county. My comments are not meant as an implicit criticism of such people. The point is that with the resources at the county's disposal, All-Ireland titles should be arriving regularly, but a variety of factors are preventing this happening. People who think that this is unconnected to the way we organise our club competitions are in denial. The changes required are fundamental and fly in the face of tradition, but are necessary. Some ideas mooted here such as clubs dropping down a grade will make some people uncomfortable, but wouldn't a tournament to identify these clubs provide great interest? The one thing we cannot do is opt for some soft-focus solution, which designed to keep people happy rather than change things, otherwise our status as a hurling county will continue its downward spiral. Radical thinking is required to maximise the county's potential. Radical action is even more necessary.



Darragh Egan, Puckane, from Kildangan club, North Tipperary, played on the Irish Junior team in International Rules football v Australia at Easter 2003. The Irish team won the series this year.

# RECENT GAA PUBLICATIONS

Seamus J. King

**T**he number of G.A.A. publications for review in this article is small in comparison with other years, but they make up in quality what they lack in quantity. *Pride of place must go to Kickhams: Gaelic Games in Knockavilla and Donaskeigh* by J.J. Kennedy, P.R.O. of the West division since 1982 and contributor of a G.A.A. commentary column to the *Nationalist*, under the penname "Westside" for a good number of years.

The history of Gaelic games in the parish of Knockavilla and Donaskeigh is a high quality work of over 400 pages. One of the many things in the book that caught my attention is to be found under the heading of 1935. The big story in that year was one of unity at last, as the existing teams of Knockavilla, Donaskeigh and Dundrum coalesced into the one club that would represent the entire parish for the future.

And what was that club called! Yes, you've guessed: Kickhams! Not Knockavilla Kickhams, or Knockavilla-Donaskeigh Kickhams, but Kickhams. I have been preaching this for some time, but newspapers, program makers and a varied assortment of people have been calling the club by other names for many years. So, maybe people will start calling the club by the right name now that the authority on the history of the club has spoken.

According to the author, the famous meeting that heralded the arrival of Kickhams is said to have taken place in the newly built chaplain's house at the Convent Cross, an appropriate place within striking distance of Dundrum, Knockavilla and Donaskeigh.

The event wasn't reported and no minutes of the meeting remain in existence, but, according to the author, anecdotal evidence suggests that the list of those who attended included, Sean O'Dwyer, later West chairman, Jerry O'Dwyer, later West secretary, Willie O'Dwyer, Mick Ryan (B), Gerard O'Dwyer (Managh), Paddy Cleary, Con McCarthy, Paddy Morrissey. An impressive line-up indeed.

As the three teams that coalesced in 1935 indicates, there was a G.A.A. life in the parish before that date. The book contains two chapters, which cover the history of the games in Knockavilla-Donaskeigh, from the foundation of the G.A.A. up to 1930, when the West board was formed. The interesting thing is that the first chapter is called, "The Time of the Football", and it reflects the fact that football was the first game of the parish in the early days of the G.A.A., an era that subsequently became known in the parish as the time of the football. So, as the author points out, when the Kickham club was promoted to senior football for the first time ever in 1997 following the county intermediate win in 1996 it was in fact returning to its roots. The first official championship won by any team from the parish was a Mid junior football title, won by Dundrum in 1927.

In the course of time Kickhams became a hurling club predominantly and had a most successful period between the mid-forties and 1960. During this period twelve divisional championships were won and, on the night of the launch – and what a great night it was with the hugely impressive past-president of Cumann Lúthchleas Gael, Peter Quinn, doing the honours – the players who brought such honour to the club during that period were honoured. *Pride of place* in the distinguished company went to John Farrell,

the only player to win all twelve, plus five divisional minor titles in the preceding years.

Following that golden age the club declined and, even though juvenile success started to come in the eighties, it took a long time to be translated into senior success. This happened in 1997, when the club captured their first senior divisional championship in the space of thirty-seven years.

All of this is recorded by J. J. Kennedy in this book. The publication must be a model for all other writers of club histories. It is comprehensive and concise, containing all the information required without long-winded or boring accounts of matches long gone. J.J. has incorporated short excerpts from contemporary newspaper accounts to add flavour to his narrative. The appendices include a list of all divisional winning teams plus the club's roll of honour. If a fault is to be found in this excellent publication it might be the shortage of pictures. There is a good scattering of them through the text but in a visual age more would have been desirable. I can understand that the author was constrained by those at his disposal, especially in the earlier part of the book.

Overall, though, J. J. Kennedy has done his club an enormous service. He has produced a work of quality that is a delight to read, even for one from outside the parish. He has brought to the work a thorough knowledge of Gaelic games in the area plus a wonderful facility with language, which has allowed him to give us a most readable account of the history of the games in the parish of Knockavilla and Donaskeigh.

The book is worth much more than the €20 asking price.



At the launch of *Kickhams Club History*, left to right: Tom Hayes, Secretary; Seamus O'Dwyer, Chairman; Peter Quinn, who launched the book; J.J. Kennedy, Author; Donal Shanahan, Co. Chairman; Sean Fogarty, Vice Chairman, Munster Council and James O'Donnell, West Board Chairman.

# NOEL BROWNE BANSHA

*Mini Bus Hire*

- *Weddings*
- *Parties*
  - *School Tours*
  - *Matches*

CALL US

*for a quotation at*

**062-54244**

# FITZPATRICK PRINTERS

FULL COLOUR PRINTING

DESIGN

TYPESETTING

Magazines, Brochures,  
Booklets, Posters, Postcards

ALL Business Stationery  
& Forms printed.

**DAVIS ST., TIPPERARY.  
TEL: 062 - 51113**

Fax: 062-51113

*Nellie's Bar*



*Soup • Snacks Daily*

45 CARD DRIVE

*Best of luck to Galtee Rovers in 2002  
and continuous success to all  
Tipperary G.A.A. Teams*

**BANSHA,  
CO. TIPPERARY**

**Tel: 062-54218**



*Your  
Community  
Radio Station*

St. Michael Street, Tipperary Town  
Tel: 062-52555. Fax: 062-52671

Cashel Studio: Halla na Féile, Cashel  
Tel: 062-62022

Now broadcasting from 7 a.m. until 12 midnight  
each week day

Tune in to Saturday Sports from 11 a.m. - 1 p.m.  
each Saturday for your complete guide to  
weekend fixtures.

Full Results Service with Reports on Saturdays  
and Sundays from 6.30 p.m. - 7.00 p.m. and  
Tuesday Sports from 7 p.m. - 8 p.m. previews  
and reviews all major fixtures.

**T.M.W.R. - "The Smile on Your Dial"**

## Celtic Times

The publication of a facsimile edition of Celtic Times, Michael Cusack's Gaelic Games Newspaper, by the Clasp Press, Ennis in conjunction with Comhairle na Mumhan, CLG, is an historical event.

Cusack published the paper during 1887 and it was revolutionary at the period, devoted as it was to sport. It was mostly produced by Cusack himself, with reports of athletic events and G.A.A. matches fed from a wide range of correspondents around the country. Events in County Tipperary are well covered in the paper, and in great detail as well. Cusack also used to paper to pronounce on whatever was bugging him at the time in the sporting area. Remember, he had severed his links with officialdom in the G.A.A. at this stage, but he used the paper to support and encourage the playing of Ireland's native pastimes and athletics.

At any rate the paper was "lost". For years it was believed that no copy of the paper existed. In 1969, Clare man, Brendan MacLua, who founded the "Irish Post", in London in that year, was given a file of Celtic Times, by Tommy Moore, a legendary G.A.A. figure, who ran a pub in Cathedral Street, Dublin. MacLua took the file to London and forgot, about it as he got his new paper off the ground.

Years later he told a few people about it and Marcus de Búrca used it when writing the biography of Cusack, which appeared in 1989. When the National Library heard of the file they asked MacLua to donate it. So also did the Clare County Library. Eventually MacLua donated it to Cusack's, and his own, native county with a microfilm copy going to the National Library.

How Tommy Moore got the only surviving copy of the paper remains a mystery. It appears it may have been the publisher's own copy, as the file is bound and hard-covered. Whereas it will remain a mystery for some time to come, it is now possible for anyone to have a hard-bound

copy of the file. What Clasp Press have done is to produce an extraordinary fine facsimile with the front cover carrying the masthead of the Celtic Times, plus the familiar picture of the bearded Cusack.

The facsimile includes numbers 8-53 of the paper, running from February-December 1887. It is missing the first seven numbers and the final two. The paper disappeared in mid-January 1888, simply because it was no longer able to pay its way. Cusack himself admitted that the circulation had fallen from 20,000 a week in May to 10,000 in December.

The paper sold for 1d for the benefit of the younger there were 240 of them in a pound. If you wish to purchase the 42 issues in this facsimile they will cost you €75. Dear indeed, but for an insight into the mind of Cusack, as well as information on the progress of the G.A.A. in the year 1887, as well as a wonderful historical curiosity, well worth the expenditure.

## All About Hurling

On a totally different scale is a 32 page publication from O'Brien Press entitled simply All About Hurling. Written by Irene Barber, and supported by Cumann na mBunscoil, it's a delightful publication for primary school students. The table of contents gives us the flavour: 1) the history of hurling, 2) the hurley, 3) the sliotar, 4) the Gaelic Athletic Association, 5) the trophies 6) Croke Park, 7) camogie, 8) Mick Mackey, 9) Christy Ring, 10) D. J. Carey, etc in all twenty-three chapters, imaginatively illustrated. A lovely contrast may be seen in two chapters entitled: Then, Now, showing the changes that have taken place in the games over the years.

For sale: €7.95.

A quick look at three programmes that appeared during the year. The first has to be the county hurling final program, which contained a 12-page insert on the celebrations for the 1958-65 All-Ireland players. This was a wonderful production which was collated by county P.R.O. Ed Donnelly. Sadly not enough copies of the program were produced. Four thousand

were printed on the expectation of a crowd of 8,000 but over 10,000 turned up. Some people were left short.

Tipperary Institute hosted the Fitzgibbon and Ryan finals this year, and, incidentally, won the Ryan. They produced a bumper program for the event, and some are still available from the college for €3.

Liam Hogan and Ed Donnelly produced an all-colour program for the Kilruane-MacDonaghs-Burgess county intermediate final, and the junior hurling A final replay between Burgess and Fennellys on the weekend of November 22/23. A beautiful production, and a credit to the Nenagh Guardian, who did the print work, it will become a trophy for the Kilruane MacDonaghs, as it saw them return to senior ranks, as well as for the Fennellys, who achieved a rare victory at this level.

Too late for review the 'History of Camogie in Tipperary' by Martin Bourke and Seamus J. King was launched by Meadhbh Stokes, the first player to captain a Tipperary senior camogie team to All-Ireland honours, at the Templemore Arms on December 3.

Containing almost 700 pages and over 300 photographs, the book traces the history of camogie in the county from the foundation of An Cumann Camóguideachta in 1904 to the end of 2003. It deals particularly with the history from 1932 onwards, when the first county championship was played.

As well as giving a detailed account of the story of the game, the book also includes an extensive statistical section devoted to results, winning teams etc. There are also chapters on the game in primary and secondary schools, profiles of clubs, poems and ballads, obituaries.

Selling for €25 it should prove excellent value and be a handy present for Christmas. It is the second county history to be produced - Cork published theirs in 2000 - and just in time for the Centenary of the Camogie Association in 2004.



### Launch of History of Camogie:

Front row (from left): Maeve Stokes, Marion Graham, Miriam O'Callaghan, President Camogie Association, Mairín Ní Chearnaigh, Munster President; Anne Newe, Tipperary Leader. Back row (from left): Seán Fogarty, Vice-Chairman Munster Council; Donal Shanahan, Co. Chairman, G.A.A., Seamus King and Martin Bourke, authors, Stephen Fitzgerald, Chairman, Camogie Board.

# BARLO MOTORS



**MAIN FORD DEALERS**



**CLOMEL**

**Tel. 052-25300**

**THURLES**

**Tel. 0504-22622**



*New and Used Car Sales*

*Parts and Service*



GIVE US A CALL – YOU WON'T BE DISAPPOINTED

*Specialising in Sports Trophies and Medals*

Bronze Hurling and Football Figures available • Family and County Crests, Clocks, etc.

**JOHN  
QUIRKE**

*Jeweller*

CASTLE STREET, CAHIR  
Tel: 052-41774



*Benny Hickey receives the "Man of the Match" award from sponsor and fellow Cabirman, John Quirke.*

Tipperary Crystal a Speciality

Rynhart Lamps and Figures  
and Fast Computerised Engraving Service



# The Blue and Gold Ultras

Over the past twelve months, the Premierview website has, courtesy of its discussion board, become perhaps the most active forum available for discussing matters of Tipperary GAA. The board now has 860 members and continues to grow apace. During 2003 a small group of board members decided that the atmosphere at Tipperary matches needed an injection.

Three members, Willie Dunne from Gortnahoe, Brian Corrigan from Newport, and Eamon McCormaic from Killenaule, founded a terrace-based supporters group to be called the Blue and Gold Ultras. The 'Ultras' is a concept, which has its origins among Italian sporting teams, such as Milan and Lazio of Rome. These 'Ultras' have a history of giving colourful and fanatical support to their teams, and the hope is that this level of support can be replicated on the terraces of Tipperary matches. The Blue and Gold Ultras currently has thirty-five members and the hope is that these numbers can be increased significantly. The one caveat is that members are expected to be regular attendees at Tipp matches.

The most spectacular impact made by the Ultras to date was the acquisition of a large flag measuring fifty feet by twenty-five, which was made by MS flags in Tullamore. This made its inaugural appearance at the Munster championship game against Clare in Pairc Uí Chaoimh, and appeared at all of Tipp's subsequent games, including under-21 games. The large flag attracted a lot of attention and much favourable comment, with the Irish Times, and Irish Examiner newspapers giving the Ultras front page attention prior to the All-Ireland semi-final last August.

A highlight for the supporters group was meeting GAA President Sean Kelly at Croke Park, when he enthusiastically endorsed the efforts of the group. The Ultras are currently planning a range of activities for 2004, and are hoping to attract many new members to help enjoy and add to the big-match atmosphere when the Blue and Gold is in town. The Ultras website can be visited at [www.ultras.pro.ie](http://www.ultras.pro.ie), or by email at [bluegoldultras@o2.ie](mailto:bluegoldultras@o2.ie).



G.A.A. President, Seán Kelly, with Ultras flag at Semple Stadium.



Having a walk about in Croke Park prior to the All-Ireland Senior Football Final. Left to right: Tommy Lonergan, Willie Robinson, Denis Lonergan, Brian White and John Maher.

# HANAFIN'S

*Furniture Store*

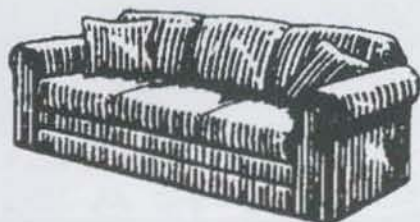

Carpets • Furniture • Curtains  
Beds • Household Needs

-----  
*Free Measuring & Estimating  
Expert Fitting*

*Come and view at your leisure*  
-----

**ROSSA STREET, THURLES**

Tel: 0504-21195. Fax: 0504-21352

# Panasonic

TV - Video - Hi-fi and Digital Sky

Computer systems by



**SIEMENS**

Fitted, set-up  
and serviced  
in your home

## Larry Bourke

Templemore

(0504) 31254/31658



TOHER GRASSCARE LTD.

**TOHER GRASSCARE  
LTD.**

MOUNTRATH ROAD, ABBEYLEIX, CO. LAOIS

Telephone: (0502) 31054. Fax: (0502) 31064.

Mobile: (087) 2588331

*For all your pitch maintenance  
requirements - gang mowers,  
ride-on gangmowers, spikers,  
aerators, etc.*

**SALES, SERVICE AND HIRE**

## GERALD STAKELUM LTD

Visit Our 10,000sq ft Retail Premises

One of the Largest Complete Office  
Suppliers in The Midlands

- Copiers • Fax Machines • Furniture
- Stationery • Computer Peripherals
- Full Range of Primary, Secondary  
School Books

**FREEFAX 1800 303 606**

All Services Provided  
Plan & Drawing Copying,  
Faxing, laminating,  
Shredding & Binding

**Specialists  
in Furniture  
Contracts  
Fit-Out**

**Tel: 0504-21888**

Parnell St., Thurles  
Co. Tipperary



# Paper Chase

By Seamus O'Doherty

All followers of Gaelic games owe much to the journalists and commentators who not only whet our appetites for the matches by their previews and build up, but also give us the details in their reports and analysis of the action.

In recent years the number of games played during a season not only of Sundays – but on several other days as well has increased apace and deadlines have as a consequence tightened for the media hacks!

It is surprising that so much of their work is produced to such high standards of accuracy and readability. We take it so much for granted that perhaps the work of the GAA media is not fully appreciated.

Our local correspondents are always reliable and up to date with Tipperary happenings, while the national media have a much wider brief which requires a huge grasp of the games and networking with local contacts formally and informally. Their job isn't always easy with the increasing reluctance of inter county teams to offer much, even on All-Ireland press nights!

During 2003, I kept an eye on the writing – some of which deviated from the usual impeccable standards and actually erred! There were other amusing and some reflective pieces which I share with you here. 'What it said in the papers' it might be, but don't believe everything that is written.

## Some fairly recent cases to start with

Ken Hogan's appointment as senior hurling manager:

This was a relatively simply story. On Friday 17th October many people

around the county knew that Ken Hogan, Jack Bergin and Colm Bonnar would be the trio 'for clearance' early the following week. So what happened?

The 'Irish Independent' and 'Evening Herald' of 22/10/03 told us that Ken had been appointed and 'will be joined by Jack Bergin (Moycarkey Borris) and Conal Bonnar (Dunhill, Waterford and formerly of Cashel King Cormac's) who were both part of English's management team, which steered Tipperary to the 2001 All Ireland title' Could it get worse?

'The Tipperary Star' 25/10/03 front page told us that Ken 'won minor and under-21 All-Ireland medals in 1980 and 1981 respectively! (Ken did not win an under-21 All-Ireland)

'The Guardian' front page of the same date told us he won an under-21 All-Ireland medal in 1984. (Kilkenny beat Tipp in the final!). A week later the same error was repeated in the Lorrha notes of the same newspaper.

'The Star Sunday' 26/10/03 topped it all. They carried a photograph of Conal Bonnar, with the caption 'Playing days: Tipperary's Colm Bonnar'

Colm's experience with Waterford in two Munster championship games with Limerick was captured by Jamie O'Keefe in his 'Studsip' column in the "Munster Express" 25/9/03. In the drawn match a €600 fine was handed out for the selectors being on the line with the manager for five minutes at the start of the second half' (and a selector spotted behind the Limerick goal, making switches at 5.35pm and also on the line at 5.45pm.

The replay proved even more expensive with Waterford fined a total of €2,000 for contravention of regulations, including €1,000 for three forays

onto the field by Justin McCarthy during the game and also the fact that Colm Bonnar and Seamie Hannon were 'kneeling on line' for most of game and occasionally seen 'moving along the line with the manager'. The total fine came of €3,300.

## A Trio

'The Star' 1/11/03 advised us that Birr are on the chase for a three in a row of All-Ireland club titles, a feat never before achieved. 'Only themselves and Athenry have won back to back titles'. (Better not mention Sarsfields (Galway) the first club to do it in 1993/94)

## What's another year?

According to 'Gaelic Jottings by 'TM' in the 'Dungarvan Observer' 5/11/03, Waterford players will finally get their 2001 Munster medals on Friday week the 14th November at the Granville Hotel. It should be a gala occasion'. These are the 2002 medals, but after waiting 39 years to win them what bother is another year's wait to get them?

## Roman Holiday

'The Sunday Independent' 9/11/03 carried a match report from the Inter provincial hurling decider in Rome, where Leinster beat Connacht. The reporter told us the crowd of about 1000 turned up 'to see the first GAA final staged on foreign soil since the 1947 All-Ireland football decider in New York's Polo Grounds'. Sorry for mentioning all these NHL and NFL finals played in New York up to as recently as 1990 (Kilkenny won the hurling). Is New York's Gaelic Park not foreign soil or is it that the pitch in Rome is used primarily for rugby?

## Centre of Excellence

'The Irish Examiner's' 'Arena' publication of 23/4/03 looked at 'some of the greatest teams which have graced the sporting world.' The hurling choice was Tipperary in the 1960's - among the words of praise were 'the deduction that a lot of their most famous victories came from being tough is simply not true'. They had everything, water tight defence, creative forwards, who could score and a solid midfield. In John Doyle . . . and Jimmy Doyle orchestrating everything from the centre (??) and as skipper they set a standard Tipp teams have been trying to reach since. Now if we knew what the centre was we could move on!

## Mix Up

'The Sunday World' 3/08/03 had Con Houlihan no less mix up his years with Antrim beating Offaly in the All-Ireland semi final of 1991! (Tipp beat Galway and Kilkenny beat Antrim in those semi finals. How could you forget 1989?) The article was headed 'Hurling in Crisis Again'



Nenagh Guardian editor Gerry Slevin was honoured by the Munster council for his in depth coverage of GAA affairs. He is pictured with his wife Lily, son Brian and daughter-in-law Barbara and Managing Director of Nenagh Guardian Pat Ryan.

## **Cliches of 2003 –**

'Man Management', 'Chasing the Game', 'It ran away from us', 'He spilled the ball', 'The game plan', 'A shoo in', 'Kick start', 'Closed them down', 'A big ask', 'A no brainer', 'Gutted', 'Waiting in the long grass for them' fresh from (surely 'exhausted from' is more accurate?) 'Lost the dressingroom'

## **Who?**

'The Irish Examiner' 1/3/03 explained how a Munster Council investment deal cost the province 25% of the investment last year. 'It is understood that then treasurer, Brendan Moylan of Tipperary, presented 'attractive' proposals to Council officers at a time three years ago when cash reserves were 'healthy'. Two investments were involved, one in shares. The investment made a small €14,000 loss in 2001, but took a serious hit last year, losing over €244,000.'

Despite that, official figures underline the relatively healthy state of Munster coffers, with €1.15m still on deposit with the banks.'

## **Don't mention the war**

'The Star' 26/7/03 (P26) told us that Antrim's only appearance in an All-Ireland S.H. final was in 1989. Not a mention of their poor performance during the war (1943) against Cork (5-16 to 0-4). Maybe it's just as well!

## **Short a few**

'The Sunday World' GAA man, Sean McGoldrick, fell about 12,000 short in his Wexford population in the 10/8/03 All-Ireland semi-final preview v Cork. He was working from the 1996 census. Maybe he thinks Wexford are still wishing they were there! The correct population is 116,596

## **The Kilkenny view of Ken Hogan**

D. J. Carey told 'The Star', Sunday 26/10/03 "Ken Hogan seems to be a very popular choice as new manager of Tipperary. Tipp are on the back foot after a bad beating by Kilkenny but I don't see this as a problem for Ken. After losing badly to Clare and Kilkenny this year Tipp have to go back and see where it went wrong and build up again and I think Ken will work well".

## **Not a chance!**

'The Irish Examiner' "weekend" of 29/3/03 advised in the TV section that there would be 'highlights of the GAA national hurling league quarter finals @ 7.30pm on Sunday 30/3/03. (We didn't have semi finals this year let alone quarter finals!)

## **Not So long**

When Lar Corbett scored three goals in the NHL game v Offaly in Nenagh last February, one Tipperary GAA writer

reckoned it hadn't happened since the late 1960's when John Flanagan was on target. (It happened on 31/9/1997 when Michael Cleary obliged against Kilkenny in a NHL game at Semple Stadium! Eoin Kelly joined the list by bagging three against Cork last March again in Thurles).

## **Not So**

Let's shatter a myth which has grown over the past 30 years – Ned Rea, Limerick did not score any goals in the 1973 Munster final against Tipperary.

## **New and newer**

Why do GAA correspondents keep writing about the 'new manager' months after the appointment has been made. Confusion now around Semple Stadium over which is the 'new stand' following the impressive upgrading of Ardán Uí Chinneáin, which dates from c 1967/68, compared to Ardan Uí Riain (1980)

## **Across the Border**

Denis Byrne's transfer to Mullinahone and Tipperary provided many headlines and stories. Alas, many correspondents got mixed up in his years of Kilkenny captaincy. He was not Kilkenny captain when they won the All-Ireland in 2000. Dermot Crowe wrote as follows in 'the Sunday Independent' on February 2nd:

'From Denis Byrne's home place in Kilkenny, one notices a looming mountain backdrop it is Slievenamon, located across the border in Tipperary. They're that close. Mullinahone sits ten miles away and the border itself less than two. But in hurling terms the divide is gargantuan; there's no blurring of the line separating the two tribes. You're one or the other. In that light, Denis Byrne's transfer to Mullinahone and Tipperary is the stuff of wild fantasy. Being overlooked by a team which meant the world to him has brought a decision he would surely have thought only a couple of years ago to be unthinkable.'

The Mullinahone notes in the 'Kilkenny People' of 20/6/03 were more effusive in the aftermath of Tipperary's qualifier win over Laois: 'Furthermore local people had seen Tipp win with five of their clubmen on the team, and a Mullinahone captain. The players involved were Brian O'Meara, Paul Kelly, Eoin Kelly, Paul Curran, Denis Byrne with Brian the captain. The lads were in good scoring form with the all Mullinahone full-forward line, scoring 3-15 out of 3-28. Paul Kelly's three points from wing back brought the lads' total to 3-18. Paul Curran who played full back was the odd one out, as he didn't get around to scoring. Saturday was Denis Byrne's first championship game with Tipperary, in his first season with the club, and all agreed that Denis played very well at full-forward, taking and making scores.'

'The Irish Independent 16/6/03' view was ever more laudatory:

Man of the Match, Denis Byrne (Tipperary) 'Eoin Kelly and Tommy Dunne both made claims that were hard to ignore, but Denis Byrne just about nicks it. His vision and distribution brought a new dimension to the Tipperary attack and he was no slouch in front of the posts either. He finished with 0-4 to his name, but created two of the goals and a host of other points.

## **Release Him**

The 'Sunday Independent' article from 10/8/03 written by John Drennan, will strike a chord with many GAA supporters: 'For those of us who believe sport is far more important than politics, one of the chief irritations are journalists, who describe GAA matches with the sort of elevated language which would be more appropriate for events like the Battle of Flanders. It's not just the eternal prattle or the way that Ger Canning squawks out nicknames like 'Sparrow!' as though this proves he possesses a superior knowledge of the sport. It's not even the clichés – our stats suggest 60 per match – to the point where he recently managed a hat-trick in one sentence. It is not his difficulty with GAA terms – in hurling the sliotar isn't battered, Ger, it is pulled or doubled on – or the way his doleful moans make a dull game worse. One would think sometimes poor Fermanagh were spoiling Ger's day on purpose. You see, Ger Canning just doesn't have the GAA equivalent of soul in the way Michael O'Muircheartaigh does. Flanders belongs to the golf playing, Alan Partridge wing of Sky Sports. So please, RTE, release Ger Canning to his true vocation of yapping about 'the drama' of Crewe vs Walsall, and spare us from any more of the 'has the composure/hit with authority' nonsense we have to endure very Sunday.'

## **Standards**

'The Sunday Tribune' 24/8/03

Enda McEvoy on the difference between Tipp and Wexford after big defeats in the All-Ireland semi-finals:

'Two counties suffered humiliation last weekend. Tipperary will glare into the cannon's mouth and strike off on the journey to a better place. Wexford, the ostriches of the hurling world, will not. Because Tipperary have standards. Because Wexford do not. Just one of the reasons why, we'll see a Tippman lifting the McCarthy Cup again far sooner than we'll see a Wexford mant.'

And some helpful advice – 'Cummins and Philip Maher excepted, they've an entire new spine to locate and install, not to mention the identification of a half-back line that fulfils the primary duty of half-back lines – which is defending.'

## Why Páirc Úi Chaoimh?

For several weeks throughout the championship season 'The Irish Times' carried a one column 'Championship 2003 at a glance' table with all the hurling and football results. They were obsessed with Páirc Úi Chaoimh as the venue for the Munster hurling final and carried the 'June 29th Páirc Úi Chaoimh message until the final was played in Semple Stadium! Páirc Úi Chaoimh is poorly regarded according to an early season survey of players by 'The Sunday Independent'

## The What?

'The Star 18/1/2003'

The start of a new season and they attribute the following quote to Tom McGlinchey, former Tipp football manager 'The Walsh Cup first of all, and then promotion in the league. They would be two high priorities. (Congrats then on the McGrath Cup success!)

## Another List!

Comebacks - The top 10 hurling comebacks 'The Sunday Times' 16/3/03  
Tipperary featured in five of the games listed: 1. 1968 All Ireland final v Wexford 3. 1991 Munster final replay v Cork 8. 1996 Munster final draw v Limerick. 9 1956 NHL Final v Wexford, 10 1992 NHL final v Limerick.

I would have to protest that a 15 point comeback by Wexford in 1956 was more impressive than an eight point comeback in 1968. There was a four-point winning margin in 1956, while only two points separated the teams in 1968. That's what lists do!!

## Clones or Thurles for a Journalist's pleasure?

Tom Humphries 'The Irish Times' 30/6/03

'Clones and Thurles in the same weekend. We thought we'd died and gone to traffic hell.

Clones has easier access but it's the greater challenge. If you are old enough to remember the classic BBC series Colditz, when the chaps used to feel duty bound to put one over on the Hun by escaping from the Huns' top prison, well you know a little of the feeling that comes over a hack approaching Clones.

Car park passes, press box passes, match tickets. They scrutinise everything in the same dour manner. You feel at any time they'll just take you from the car and shoot you. On Saturday, with the mass of old Dubs washing about, the mood of the local bib-wearing brigade had declined sharply. It was a surprise to see the teams gaining admission.

Thurles yesterday was more fraught and the traffic was congealed to the road all the way in. There was a sort of strained desperation on the faces of the

Waterford people making their way to Semple Stadium. Cork haven't won an All Ireland since 1999 and can convince themselves that a crisis is afoot. In Waterford, though, the wait has been an eternity longer and there was a sense that the chances to go all the way are very few and far between.

Another one went past yesterday. They shoehorned us into the old press box and we wondered what perversity of modern fire regulations meant the new press box could be unsafe while the sardine tin we sweated the afternoon out in could be deemed fine?

It's a TV thing, apparently. The TV pretty boys must not be endangered. No value on ugly print hacks' lives at all!

## Youthful

The 'Irish Times' 3/6/03

'A Youthful Cork Player', (together with a picture of him striking a sliotar with a hurley).

'Ireland outhalf, Ronan O' Gara, demonstrates obvious traces of his Cork heritage at the Ireland's squad training session in Australia yesterday.'

## Quote of the season

'It's difficult to visualise Tipperary rebounding from this reverse to carry off the McCarthy Cup. Correction. It's borderline impossible!'

Enda McEvoy 'The Sunday Tribune' 25.5.03 - a week after Clare had a nine-point victory.

## Double Safety standards.

'Sideline Cut', 'The Sunday Tribune' 8.6.03

Two questions arising from events at Semple Stadium last Sunday. One, for how long more are throw-ins to be put back in order to cater for supporters who can't be bothered to leave the pub on time? Both sets of players, keyed up for a 4.15 start, were outraged at being required to wait. They'd every right to be.

And secondly, if the new TV area in the old stand was condemned as a fire hazard, then how come the media gantry at Páirc Úi Chaoimh is so safe? We'd love to know what the Tipperary safety officer would make of it.

## The Club

Keith Duggan in the 'Irish Times' 13/3/03, explained why the All-Ireland club finals can be exclusive:

'It is the club finals that have become the central, unchanging feature of St. Patrick's Day. In the pubs, they are as regularly and widely anticipated as the Saturday of the English FA cup final or a good All-Ireland championship Sunday. But, although we watch with interest, it is impossible to become as engaged as might be the case watching an inter-county championship game.

'Irish people can form life-long

attachments to soccer clubs in English cities they have never visited and develop an intense like or hatred for the football fortunes of counties other than their own.

'But the club final scene is different. Although celebrated in the big stadium with the bands playing and the dignitaries in attendance, it is an intensely confined and almost private occasion. At least, that is the sense I have got attending All-Ireland club finals in the past few years. Unless your own town is out there - or at the very least a place you know intimately - fully understanding the various dynamics and characters that have elevated the club from the mediocre swell to the threshold of All Ireland grandeur is beyond your grasp.

'Of course, the obvious reason for any club making it as far as St. Patrick's Day is that it possesses a player of national renown, such as Brian Whelan of Birr or Kieran McDonald of Crossmolina. But one swallow does not a summer make.

'Gaelic clubs are complex entities. I am endlessly fascinated about the difference between a player from a provincial town that does well at Gaelic games and his city counterpart. In Irish cities, it is possible to have the potential for greatness and somehow slip through the net or walk away with nobody shouting stop.

'In small towns, it is possible to show fleeting signs of talent - to have a God-given month - and to be lauded as a genius for the rest of your hours on this planet.

'Local clubs are a phenomenon in that they are virtually the only concept - besides the St. Patrick's Day parade - that still coaxes people outdoors to meet and be together on as a community. Community is becoming a tougher and tougher notion to sell.

'It must be a great feeling to see your club colours in Croke Park. It is a sight that most clubs, most towns, will never even get close to. And that's the abiding impression that the club finals leave.

'You can look, but you can't touch.'

## Take your pick

'The Irish Times' 28/3/93 P22, listed the Div 2 Freshers final (hurling) as a fixture for the day, it was surprising then to see the result and scorers of the game nearby in the same edition!

## Not Our Sam

'The Star' of 14/6/03 mentioned that Tipp had won the Sam Maguire Cup on four occasions ....nice thought but the county has not been champions since the cup was presented in 1928.

## Programmes

Some match programmes were especially poor and inaccurate and the Wexford Co. Board had their PRO write to DBA (who produce the All Ireland

championship programmes) to ensure that errors were not repeated and relevant facts were not overlooked.

The DBA programme for the All-Ireland hurling quarter-finals on 27/7/03 told us that Dinny Cahill had won 5 Co. SHC medals. His club only won 4! Some man eh? Another effort to forget was the Cork v Kilkenny NHL offering at Pairc Ui Chaoimh on 20/4/03.

### **Take A Tip**

'Babs', the tipster in The Sunday Times 1/6/03 – Limerick won't hold Waterford. They did, it was a draw!! – 10/8/03 Cork to beat Wexford by 8 points – it was a draw!! I'm not going to mention his column of 25/5/03, which reckoned Tipp's performance against Clare was the worst in 50 years!

### **It's how you say it!**

On the evening of the Offaly Co. Hurling final an RTE sportscaster made an unconvincing attempt at pronouncing "Ballyskenagh" (who lost to Birr in their first final appearance). The result was correct but she could have got advice on the pronunciation from Bill Lalor (Sunday Game) who is from that area, in the parish of Roscrea.

### **Wide again**

The Irish Times Magazine p. 33 7/12/2002

GAA Munster club football final, Sunday, TG4 1.45pm

'Live coverage from Killarney as Limerick champions, Monaleen, take on the might of Cork champions, Nemo Rangers. Though Monaleen are contesting their first ever Munster final, and Nemo have the powerful scoring boot of Colin Corkery, it shouldn't be a one sided affair as Limerick football has improved significantly in recent seasons.'

Two points here: 1) the game was not shown live as promised and 2) Nemo won by 4-15 to 0-6. Just as well then!

### **Under what?**

Why do media men/women sometimes refer to a player as "underrated?" After all they are the ones who do the rating!!

### **Are you listening?**

A few howlers by Tipp FM as well, when they should have known better. One example, 26/03/03 8.35am a sports report advised that if Tipp won or drew against Cork on the following Sunday they would qualify for the NHL semi-finals. Tipp lost but it didn't matter because there were no semi finals in the competition this year!

Then we had a Tipp hurling selector on air 14/4/03 8.32am speaking about John Carroll's goal when the particular score had been notched by "Redser". A bit of amusement is often got on the way home from games by flicking to the

various local radio stations as they secure the full time results from around the country. The trick is to listen to RTE 1 first so you will know the correct full times!!

### **What's his name?**

The Antrim hurling manager according to "The Irish Examiner" 14/4/03 P24 is Dinny Ryan! That paper produced an excellent pre-championship Arena special on 7/5/03 but spoiled an excellent photo of Benny Dunne by calling him Martin Maher!

### **It was Kerry**

For those who still think Nicky English' championship debut as Tipp senior manager was against Clare on 6/6/1999, let us remind them that it was v Kerry on 22.5.1999 ("The Irish Independent" 17/5/03).

### **Kicks or pucks?**

'The Sunday Times' is excellent but not infallible as their report on the Fitzgibbon Cup final 2/3/03 showed with references to "free kicks". by a writer more associated with rugby! For anyone who doesn't know it, the Fitzgibbon Cup is the third level hurling competition. Waterford IT were captained to victory this year by Paul Curran, Mullinahone.

### **How many?**

Why is it not possible for the press to get details of all attendances at major games? The Tipp v Kilkenny NHL game in Nowlan Park on 13/4/03 received estimates of 8,000 to 10,000 depending on which paper you read. Interestingly the "Kilkenny People" and "Tipperary Star" both gave a 10,000 figure and who would know better than John Knox and John Guiton?

### **GAA website**

The Allianz NHL phase two draw 7/4/03 had a busy day pencilled in for Clare on April 20th. They were scheduled to play Wexford and Tipperary both at away venues, but luckily Galway stepped into the fray and played Tipp in Thurles! Maybe it wasn't so lucky -wasn't that the day Pat Ahearn, Carlow, made his big entrance for the season?

### **Mirror Mirror on the Wall**

The story of last winter was the strike by Cork hurlers. The "Irish Daily Mirror" dated 10/12/02 carried a photo with the caption 'Peace hopes. Cork chairman, Jim Forbes (centre) meeting players.' (The man in the centre was Frank Murphy). Mind you the headline "Rebels" will come back a stronger team for this experience" proved prophetic!

### **His name is . . .!**

We wrote last year about incorrect

identification of players in photographs, there were still some beauties this year!

The "Wexford Echo" 12/3/03 report of the NFL game at Wexford Park has a lovely photo and caption 'Paul Carley has his shot covered by Tipperary defender, Sean Collum at Wexford Park etc' – the Tipp player is Liam Cronin. They don't know their bangers from their mash!

The Irish Independent 24/2/03 has a photo and caption from the Tipp v Offaly NHL game at Nenagh 'Tipperary Philip Maher clears despite the attentions of Offaly's Brian Carroll during yesterday's Allianz NHL clash at Nenagh.' Alas it was neither of them! Try John Devane and S. Weir!!

Photos from the Tipp v Cork league game in March appeared in the papers on the following two days. The Mark Prendergast tackle on Eoin Kelly was correctly captioned in "The Sunday Tribune", "The Irish Times" but it was John Gardiner in "The Sunday Independent" and "The Star". Surprising that as the players name was visible on his hurley. No mention of Paddy Power either!

"The Waterford News and Star" 30/3/03 didn't recognise the Tipp captain, Brian O'Meara and called him Conor Gleeson. It just goes on and on.

"The Sunday Tribune" 19/6/03 P7 achieved the impossible. They had Enda McEvoy reporting from Semple Stadium on the Clare v Galway hurling qualifier the previous day. There was another edition of the same paper which had him reporting from Cusack Park. The notion of a mixed up Kilkenny hurling man is hard to swallow, so I blame the sports editor!

"The Daily Star" produced a colourful 48 page GAA championship 2003 magazine but should have been more careful with two of their statistics on page 11. The old Hogan Stand was moved to Limerick in 1959 not 1966, while Cork in 1984 not Tipp in 1937 were the last team to win an All-Ireland hurling title outside Croke Park.

### **And finally.....**

On 12/6/03 a piece was written in The Irish Examiner which I didn't see but an edited version was sent to me via e-mail, by a friend. It read:

'Two things jump out at you on first meeting Seamus O'Doherty. First off, the shiny shaven pate atop a jolly countenance, second, well he's sort of round and robust, he is one of the six fattest men in Ireland.'

On 13/6/03 apologies appeared in the same paper "to Limerick football keeper Seamus O'Donnell inadvertently referred to as Seamus O'Doherty in yesterday's paper". Is that OK then?

# Advanced School of Hurling

The ASH (Advanced School of Hurling) program concluded recently after an intensive few weeks development for forty-eight county minor hurlers. This programme, now in its third year, is an initiative of Tipperary county board, and is sponsored by the Tipperary Supporters Club. The following assisted in delivering the programme: Declan Ryan, Michael Cleary, Ken Hogan, Michael Ryan, Pat

McLoughney, Liam Cahill, Willie Barrett, Kay Finn (dietician), Paddy McCormack, Dinny Maher, John Cummins, Sandra Molloy. The programme was co-ordinated by Michael Bourke on behalf of the Games development Committee, and sessions were held in Morris Park and in the Sarsfields centre. The following players attended: Kevin Bolger (Mullinahone), Ian Murphy (Kilenaule), Patrick Ivors (Golden-Kilfeacle), Ryan O'Dwyer (Cashel), Liam Devane (Clonoulty-Rossmore), Michael Harding (Golden-Kilfeacle), Barry Grogan (Aherlow), Martin McKeogh (Ballina), Shane Carroll (Shannon Rovers), Grahah Gohery (Knockshegowna), David O'Connor (Borrisoleigh), Eoin Russell (Sarsfields), L. J. Ryan (Upperchurch-Drombane), Padraig Murphy (J. K. Brackens), William Moloughney (Clonakenny), Philip Austin (Borrisokane), Mark O'Meara (Roscrea), Timmy Breen (Roscrea), Owen Ryan

(Moneygall), David Kearns (Sarsfields), Shane Scully (J. K. Brackens), Martin Butler, (Drom-Inch), Stephen Lillis, (Sarsfields), John Coleman (Gortnahoe), Joe Dixon, (Moycarkey-Borris), Michael Collins (Sarsfields), Martin Dunne, (Clonmel Og), Shane Walshe, (Fethard), Declan Mulqueen, (Silvermines), Brian Maher, (Boherlahan), James Keogh, (Kilruane), Kieran Shortall, (Moycarkey-Borris), Ross Dunne, (Cappawhite), Paul O'Dwyer, (Knockavilla), Pat Power, (Lattin-Cullen), Niall Quigley, (Burgess), Brian McCormack (St. Pats), Joe Gleeson, (Borrisokane), Stephen Murphy (Kilruane), Colm Campion (Loughmore), Barry O'Donovan (Sarsfields), Tony O'Brien (Galtee Rovers), Kieran Bergin (Galtee Rovers), Shane Kearney (Clonmel Og) Kieran McCarthy (Cappawhite), Colm Cooney (Ballingarry), Patrick Stakelum (Holycross), Tim Gleeson (Arravale Rovers).



At the launch of the ASH Programme - Andy Lacey (Tipp Supporters Club), Ger Ryan (Chairman Tipp Supporters Club), Michael Bourke (Tipp G.D.C.), Gerry Moynihan (Tipp Supporters Club), Michael O'Brien (Co. Secretary), Donal Shanahan (Co. Chairman); Ed. Donnelly (P.R.O.)

## ENFER SCIENTIFIC

*Com  
Kelly*



Tipperary  
Ace  
Forward

PROUD SPONSORS OF TIPPERARY TEAMS

# IVERS & CULLINAN LTD.

LIMERICK ROAD, NENAGH, CO. TIPPERARY

Telephone (067) 31323. Fax. 067-33600



FULL RANGE OF NEW TOYOTA CARS  
AND COMMERCIALS EX-STOCK



Complete After-Sales Service Guaranteed

*Tá an carr atá uait againne*

Before buying your New or used Car Contact:

PHILIP CULLINAN or JOHN IVERS  
– Two of the Best for Toyota –



# J.K.C.

25-28 PEARSE ST., NENAGH, CO. TIPPERARY. TEL: 067-34556 / 31391



*Newsagent and Restaurant*

OPEN:

7.30 a.m. to 9 p.m. – 7 days

*Specialists in:*

GREETING CARDS

TOYS

NEWS

STATIONERY

CONFECTIONERY

Largest Toy Department in  
North Munster

**Breakfasts • Dinners • Snacks**

*EVENING MEALS*

*and*

*BED & BREAKFAST*



# MICK BURNS NENAGH AND TIPPERARY

By Liam Hogan

**O**n county final day the Tipperary County Board honoured 46 players who won All-Ireland medals for Tipp senior teams between the years 1958 and 65. Tipp defeated Galway in 58, Dublin in 61 plus Wexford the following year.

Two years later Tipp defeated Kilkenny before accounting for Wexford in 1965 given them five All-Ireland wins in an eight year period. Many hurling followers past and present, and indeed followers of Tipperary past and present, have described this period as the golden era of Tipperary hurling.

One of the players that played in each of the five finals was Mick Burns of Nenagh. Recently I did an interview with him about the game and his involvement with it.

"The advice I would give to any young player is to practice. Stay practicing. Players play hurling only two nights a week. You have to play hurling seven days a week if you want to make it to the top. I don't know who thought of the idea that you train Tuesday and Thursdays, but I think players should make use of any spare time," says the Nenagh man who was elected at right wing-back on the North Tipperary, Team of the Century 1951-2001.

"It all starts in school, then it is up to the individual. They have all the facilities they want. Take Michael Cleary who won a Munster medal in 1991. The morning after that game, I made a delivery to his mother and he was batting a ball up against a wall, the morning after a Munster final.

Now that is what I call dedication." Mick Burns of Nenagh first came on the Tipp senior team in 1957. In eleven years he won five All-Ireland medals in 58, 61, 62, 64 and 65, six leagues, four Oireachtas and eight Munster medals. He was a hurler of great skill and his small frame was blessed with great speed. He knowledge and love for hurling is very evident as I spoke to him in his home. One could sense he could talk about hurling all day with little effort. "It is very hard to define what one could do with hurling. Better men than me cannot do that. The game is gone high powered now. The game is all about fitness and lasting seventy min-

utes. In my day it was about the skills of the game. There was a lot more physical work then, you worked on the land and buildings. We were all physically fit."

## CLUB HONOURS

Like all hurlers, the club was an important feature of their career. Mick played minor hurling with Nenagh or Eire Og -as it was known then- for five years winning three North medals in 51, 53 and 55. He captained the team to win the North final in 55 against Toomevara. He won his first of two North senior medals in 57 and seven years later he captained the team to win again in 64. But what was the feeling among both the players and supporters at the time with Eire Og up in senior grade for a decade with little success?

"We were always knocking in the door. If you persist in trying, eventually it will happen. We won the minor championship in 55. There were eight of that team on the senior team then, and the year we won the North senior in 57 there were ten. Winning is something that does not happen overnight.

"We always had a spot of bother with players in university in Dublin. Then they could not play until the first of June because they were bound to play with the university. We had many players who would play hurling day and night - Michael Hanrahan, Tony Tierney and Devere Reynolds - of course we lost him to America and he was a terrible loss. When we would lose one you might get another one but we would never have fifteen good players at any one time."

## LEAN TIMES

The late sixties and seventies were a lean period for the club? But the club persisted. "It was not for the want of trying. You will get a good run with guys. The nineties have been good to us because players have played minor and U-21. There was no U-21 in our day. With new grades the camaraderieship comes into it, along with playing challenge matches and that. In 1964 we played a lot of challenges games, which brought us on a lot. Players played a game



Mick Burns

on a Friday evening and later in the evening we went to a dance which brought them more together. The team got to know one another better and became more of a family. When a team became a family the spectators

became more of a family also."

There is no doubt it Mick Burns is proud of Nenagh at present - what with winning four North titles in the last ten years. "I think it is fantastic. Perhaps they have not got the acclaim they deserve for it. But like everything when you are winning it is 20 years after when people began to talk about it."

## MOST CHERISHED

Playing for Tipp for a decade should provide great memories with the winning of five All-Ireland senior medals. Which one did Mick cherish most?

"Probably the 1964 All-Ireland against Kilkenny. The 62 All-Ireland was good and they were all good. But it has to be the 1964 game, because I was marking Eddie Kehir that day and I held him scoreless. He had played the year before against Waterford and he scored 0-14 points. He was a very good hurler. The Tipp team of 64 and 65 team was probably the best I have seen. The teams then were all good but 64 and 65 were the best," he stressed.

Was Keher the most difficult player he marked? "I would say that Keher and Frankie Walsh of Waterford. They were two great hurlers but two different types of hurlers."

## THE COUNTY'S LEAN PERIOD

Following the golden era of the sixties Tipp's dominance went into decline. Could Mick put his finger on the reasons of Tipp's lean period?

"I don't know what the problem was. Everybody tells me that a lot of us stayed on too long. I played until I was 31 and with players like John Doyle, Theo and Mick Maher, everyone would tell you we stayed on too long. I remember Paddy Leahy - God be good to him - he would bring on one or two players every year. From the sixties on he introduced players like Tom

Ryan, Killenaule and Larry Kiely, Mich Roche and Babs, Mick Murphy and Len Gaynor. There was always somebody coming along all the time. It is very hard for me to put a finger on it.

"When Francis Loughnane played he was the best forward for Tipp at any stage, but the players around him were probably not strong enough for back up. Jim Keogh was a good full-back and we were short corner backs at the time. You can put the decline down to a lot of things. We had loads of good hurlers but we just had not the killer instinct so it was only in 87 before the county came to life again. Eighteen years is a long time in Tipperary hurling."

Having played in no less than nine Munster finals does he favours the new qualifying system for this year's All-Ireland? "I do! It is a thing that would never worry me. Games are what hurling is about. I know there is nothing like a Munster final and it would be terrible if it was done away with, because a Munster final is something special to everybody. It is nice to see the team putting in the effort to get to the Munster final getting a second chance. A Munster final is never easy won but the day a team loses one it provides a big void in your life. Losing is sacrilege really. I did not lose many Munster finals but I know what losing is all about.

With the present team, could you see another All-Ireland this year?

"I would rate the team very good. I have a theory, it is hard to win one All-Ireland but even harder to win two. Every team has become professional and they are all on a par as regards preparation. They all have the training camps, physios etc. Limerick came out of nowhere last year. Clare came from nowhere in 95. Cork were there so it has nearly done the rounds now.

"The present team seem keen to do it all again. Off course with the use of videos it is easy for the opposition to map out players. I would give them a good shot because I think Ken is very much into discipline.

Discipline is everything. Tipp did the double last year and it is a long time since that was done. People say a lot of things about the League. It is worth having the League to have a crack at it. You will find out your players very quick."

# GER GAVIN

15/16/17 MITCHEL STREET  
AND 18/19 SARSFIELD STREET

**NENAGH**

**Tel: 067-32177**

*Carpets – Furniture – Wood Floor Covering*

*Household & Giftware*

*Expert Measuring and Fitting Service*

*Kitchen and Present Centre*

- All types of furniture and floor coverings stocked

**GIFTS FOR EVERY OCCASION AT KEENEST PRICES**

Special discounts for clubs

Féiríní agus earraí tí

# MARTIN O'CONNOR

**Newsagent**

**64 Kenyon Street,  
Nenagh**

**Telephone: 067-31358.**

FAX 067-33466

- Fax & Photocopying Service
- Greeting Cards for All Occasions
- Parking Discs
- Lotto Agent



*More than a  
Newsagent*

# How many have we won?

By Seamus Leahy

It was the summer of 1943 when the Germans were being pushed back out of Russia and the Americans were beginning to push their way up through Italy and, more important altogether, Antrim were heading towards their first appearance in a hurling All-Ireland final, that I discovered a copy of a wonderful publication called *The Gaelic Echo*. Of what we now call tabloid size, it was a GAA publication, which, if memory serves me right, had been brought out at the time of the 1940 Munster final.

War restrictions had not fully begun to pinch and there were about eight pages of hurling news, with lots of photographs, a commodity, which, by the time it came into my hands, had become a very scarce feature of publications of any kind. By 1943 of newspapers was in short supply. The daily papers had been reduced to a meagre four pages so that between war news and advertisements, there was precious little space for photographs. To a hurling follower who had not yet reached his ninth birthday *The Gaelic Echo*, with photographs of Mick Mackey and Jack Lynch and John Quirke and Paddy Scanlan and so many other heroes, was an Aladdin's treasure house.

But there was one item which took the sunshine from my day every time I defected to the haybarn with the precious publication under my jersey. There in black and white, for all the world to see was the list of senior hurling All-Ireland winners - Tipperary 12, Kilkenny 12, Cork 11. So far, so good. The trouble was that this was the year of Our Lord 1943 and Cork had put two All-Irelands under their belt since then, leaving them one ahead of Tipp. And, horror of horrors, they seemed all set to take the 1943 title as well which, indeed, they did.

How I longed for the calendar to be turned back to that golden summer of 1940 when, though Hitler seemed set to rule all Europe and Mick Mackey's Limerick were winning all around them, Cork were trailing behind Tipp in their number of All-Ireland titles. Better still, turn it back to the summer of 1939 when Tipp were in their rightful place, ahead of the entire pack.

Cork went on to win the unprecedented four-in-a-row and by the time Tipp won what had come to be widely referred to as our unlucky 13th the bomb had fallen on Hiroshima and Cork now headed the list with 14 All-Irelands. Kilkenny were still at twelve but they no longer seemed to present a huge threat. Our young eyes were firmly fixed on the Red menace -- and this Red menace had its home, not in the Kremlin, but by the Lee.

The Reds struck again in 1946 but Terry Leahy, with his long-range point for Kilkenny in 1947, averted disaster for us all. And then, on a never-to-be-forgotten day in Limerick in 1949, Jimmy Kennedy's magic blade flushed again and again and Cork disappeared from the frame for another three years. For three golden years there was never a championship defeat for Tipp until we were neck and neck with Cork with 16 titles

each. Ringey and company were back with a new challenge the following year and over the next few years they might have got much farther ahead of us but for the appearance of Nickey Rackard and his men. By then, these things did not seem quite as important to me as they once had. They were still important but not quite the most important things in the world. But though I was in the heart of West African bush by the time Tipp grabbed another title in 1958 and heard the game through a crackly connection with Radio Brazzaville, I was keenly aware that it need only a couple of more Croke Park appearances to put us once again ahead of the rest.

And then there appeared in our firmament a group who brought to Tipp such a dazzling succession of victories as the county had not enjoyed since Tubberadora and Moycarkey and Two-Mile-Boris brought home a bag of All-Irelands at the end of what is now referred to as the century before last. Seven times between 1960 and 1968 the blue and gold horde made their way to Croke Park and four times within the space of five years the McCarthy Cup was circled in modest triumph from the station down through Liberty Square to the steps of the cathedral. The trip to Croke Park had become a thing of custom to Tipperary followers. 'I suppose you were in Thurles to welcome the team home last night. I wrote to a relative at home after Radio Brazzaville informed me that Tipp had done it again. 'No, it's easier to go when they lose you don't have to go so often,' he replied.

Sitting on the verandah watching the Southern Cross low in the sky, I was in the habit of making the count of All-Ireland winners and by now it was entirely satisfying. In the mid 60s I asked a veteran who had watched Tipperary teams since the early 1900s what was the best Tipp team he ever saw, and he had no hesitation: 'The team we had last Sunday'. When Tadgh O'Connor led the march to the cathedral in 1971 the count was Tipperary 22, Cork 21, Kilkenny 17. God was in His heaven, all was well on earth and life stretched before us like a great sunny meadow with young fellows forever sitting on the headland, adding to the growing pile of All-Ireland medals.

And then the sky fell in. The Famine was upon us. The spuds rotted in the ground, the hens wouldn't lay, the birds wouldn't sing and a generation of young lads from Lorrha to Carrick grew up without ever knowing the knot in the stomach that only came on the first Sunday in September to those whose county was in Croke Park on that day. And by the time Richard Stakelum's voice rose above the delirium in Killarney on that never-to-be-forgotten day in 1987 proclaiming, 'The Famine is over' we had lost count of the All-Irelands that were stacked against us. The mental exercise of starting at the first final in 1887 and working our way forward was no longer a pleasure. There are things we prefer not to look at. Counting the winners of All-Ireland titles had become a distasteful mental exercise. Gone was the glow of pleasure in reflecting on the end result of the tot.

Three times since that golden day in Killarney the McCarthy Cup has been brought along the well-trodden way to the cathedral. But there are times indeed many times when we yearn for the glow of the 60s. Gone is the inner satisfaction that comes of knowing that not alone have you just won the prime award attaching to the greatest game in the world but that you are still clearly ahead of all other rivals for the distinction of leading the field in the list of winners of that honour.

The men who marched behind Matt Hassett and Jimmy Doyle and Michael Murphy in the 60s there are those who will argue as to whether they were as good as they were thought to be at the time. But there are experts to be heard wherever such profound questions are discussed against background noise of clinking glasses, who have no doubt that they were.

## As we were then

### ALL-IRELAND CHAMPIONSHIPS, 1887-1940

#### Senior Hurling

Tipperary (12) - 1887, 1895-96-98-99, 1900-06-08, 1916, 1925, 1930, 1937.

Kilkenny (12) - 1904-05-07-09, 1911-12-13, 1922, 1932-33-35, 1939.

Cork (11) - 1890-92-93-94, 1902-03, 1919, 1926-28-29-31.

Dublin (6) - 1889, 1917, 1920-24-27, 1938.

Limerick (6) - 1897, 1918, 1921, 1934-36, 1940.

Clare - 1914; Galway - 1923; Kerry - 1891; Laoighis - 1915; London - 1901 (Home Champions - Cork); Wexford - 1910.

#### Junior Hurling

Tipperary (4) - 1924-26, 1930, 1933.

Dublin (2) - 1932, 1937.

Waterford (2) - 1931, 1934.

Offaly (2) - 1923, 1929.

Cork (2) - 1925, 1940.

Kilkenny - 1928; Limerick - 1935;

Meath - 1927; Westmeath - 1936;

London - 1938; Galway - 1939.

#### Minor Hurling

Tipperary (4) - 1930-32-33-34.

Kilkenny (3) - 1931-35-36.

Cork (4) - 1928, 1937-38-39.

Waterford - 1929

Limerick - 1940.



## Cumann Lúthchleas Gael

### Coiste Thiobraid Árann Thuaidh

North Tipperary G.A.A. Bórd wish to thank all the clubs, players, team mentors, sponsors, officers, grounds people and supporters who helped or supported the Bórd in any way this year.

We also wish to thank our referee's, Gate Checkers & programme sellers for their contribution.

Finally a peaceful Christmas & a happy New Year to all

# Patrick Sarsfield

## BAR & RESTAURANT

Pearse Street, Nenagh

Food  
7 Days  
a Week



A la Carte Bar and Grill

Phone (067) 41366

Fax (067) 41533

*Congratulations and Best Wishes for the Future*

# O'BRIEN'S

– Esso Filling Station –  
Borrisokane



*Shop &  
Coffee Doc*

All you need – when you need it!

**WINNERS OF 5 STAR AWARD 2002**

*Groceries and Cold Meats, Delicatessen.  
Fresh Rolls Daily*

FREE DELIVERIES

Open:  
7.30 a.m. – 10 p.m.  
(7 days a week)

**Tel. 067-27408**



# Which way will the HDC jump?

By Martin Ryan



Kilruane MacDonaghs intermediate panel: County champions. Back row (l. to r.): Eamonn O'Shea (trainer), Stephen O'Leary, David Slattery, Pat Williams, George O'Leary, Michael Cleary, Martin Grace (selector), Mark O'Leary, Brian England, Ray McLoughney, Kevin O'Brien, Alan Ryan, Kevin Quinlan, Denis Cahill, Liam O'Shea (management), Bill Dooley, Edmond Morkan, Stephen Murphy. Front: Enda Hogan (selector), Bonnie Hayes (masseur), Colm England, Enda McLoughney, David Lawlor, Diarmuis Cahill, Brian Gaynor, Willie Darcy, Sean Gaynor (captain), Ryan Casey, Shane Williams, Paddy Ryan, Dermot O'Leary, Martin Walsh.

One of the harsh realities informing the Hurling Development Committee (HDC) in its current deliberations is the simple fact that, despite talk of a 'golden era' in the '90s, there remains only ten counties who can compete to any degree at the top level. Even inside this group of ten, the number who can seriously aspire to winning the All-Ireland is lower than any diplomatic person would publicly admit. The early rumours suggest that the HDC may bring back a proposal to play the qualifiers on the basis of a round robin series, which will ensure that teams get at least four matches. That may be an unlikely option, as it would create quite a hiatus in the middle of the competition, leaving provincial winners killing time while these qualifiers are played off. Whether that happens or not, it seems certain that the plans will retain the Munster championship, and probably the Leinster and Ulster ones too, perhaps amalgamating these two with Galway, to form the so-called Eastern conference. The question of the Munster championship provides an emotional conundrum for all Munster people. A great institution indeed, but as Wilde put it, who wants to be in an institution? What does cold analysis tell us about this great annual Southern fiesta?

The Munster championship contains half of the ten counties I referred to at the beginning, yet despite the coverage and excitement, it fails to knock anybody out of the overall championship. Effectively it is now a stand-alone tournament with its own winner, which also acts as a seeding mechanism to decide

at what point teams will commence the All-Ireland series. The difficulty with the Munster championship is essentially two-fold. The first issue is that if a team gets into the long side of the draw, such as Tipperary got in 2002 and 2003, it renders ultimate All-Ireland success virtually impossible, at least by the direct route. This path necessitates five difficult matches, with all the physical and mental strain involved. The second issue is that retaining the Munster championship means that in effect the lop-sided nature of the championship as a whole is retained.

If the Munster championship is to be retained, the only fair option is to amalgamate the rest. Galway cannot be indulged as before, and should not be the only county in the country to have a veto on whether they play in a provincial championship or not. While there have been ill-judged objections to the inclusion of Galway in Leinster, amalgamating the provinces is not about trying to punish Galway or Kilkenny, the perennial provincial champions, but about trying to create a championship format that is fair. Surely the dedicated and objective hurling people of Kilkenny and Galway would support this? It is dead easy to sit down with the HDC, and come up with a plan to give players more matches. But this is not the same as creating a fair championship format. While the provincial system was adopted by the GAA purely for logistical convenience over one hundred years ago, unfortunately it still exerts undue influence on important decisions such as this. Perhaps the HDC should go for broke, and come up with fresh propos-

als, such as obliterating any link between the provincial championships and the All-Ireland series. If the provincial championships are as sacred as claimed, they will thrive in an autonomous state. The last thing that the HDC should do is come up with a bizarre, convoluted competition, which bends the knee to the provincial system, as the football equivalent did a few years ago. Of course, it has to be acknowledged that however logical and good a proposal might seem, getting it accepted by congress is another issue, and it may have to be tailored specifically for this purpose.

I am not too sure if the HDC's terms of reference stretch as far as all hurling competitions, but if they don't a golden chance will have been lost. The simple fact is that the format of many of the hurling competitions is not only inhibiting the quality of the competitions, but some of them are grossly unfair, and illogical. A classic example of this is the case of the Galway hurling champions of 2003. In order to reach an All-Ireland club final, they will not have to play any team in either Leinster or Munster! By comparison, Patrickswell would have to beat the champions of Clare, Waterford, and Cork, plus the Leinster champions, to reach the final. That is an absurdly lop-sided situation that occurs every few years, with just the beneficiaries and victims varying. The provincial championships are killing this competition, and depriving the hurling public of what could be a much-enhanced version. This competition is ideal for the open draw. It could also be run off far more quickly and efficiently. It is odd

that there is such an effort made to turn the final into a Saint Patrick's day show-piece, and yet the structure of the general competition falls so far short of adequacy. Can you imagine the potential of this competition if it was opened up?

The champions of Tipperary and Kilkenny - two neighbouring counties - have never met in the club championship. Neither have the Wexford and Waterford representatives. Kilkenny's champion team has met the Waterford winners just once in thirty-four campaigns, and hasn't met a Cork team since 1981! All these counties where hurling is a huge interest, are being deprived of much better competition by the provincial system. Why not have a club championship consisting of sixteen or twenty teams arranged in groups of four or five, thereby guaranteeing each team at least three outings, with the top team in each group reaching the All-Ireland semi-final? This would be run off more quickly than the current competition, especially if county championships were prevented over-running for the flimsiest of reasons. Can you imagine the public interest in the champions of all the great hurling counties taking each other on over consecutive Sundays? If that thought doesn't emphasise the bankruptcy of the current system, nothing can.

Why not play the under-21 hurling championship on the basis of an open draw as well? Talk of teams having to travel too far for Wednesday matches is not a reason to avoid change. Any system which forces Tipperary to play Galway three days after the provincial final as happened in four years ago, is unsustainable. Galway should not have a bye to the semi-final, nor should they alone own such a decision. If it had to be done, a twelve-county under-21 championship could be run off over four or five weeks. An open draw might also provide us with much better All-Ireland Final than we have had in recent years, when on a few occasions it was obvious that one of the teams in the final was even in the top four in the country.

Is there any good reason why the All-Ireland Colleges' hurling championship is not played on an open-draw basis. At the moment we have only one reasonably competitive province, three others that are seriously dysfunctional, yet produce teams that compete in All-Ireland semi-finals automatically every year. One school has won thirteen of the last seventeen Leinster titles! The 'Connacht' championship is effectively the Galway colleges championship. The Ulster colleges have to amalgamate to compete, yet this team has a place in the last four of the championship, for no good reason than it is from another province. Schools hurling will always be unsatisfactory in some regards. We have in Tipp for example, four schools,

Templemore, Thurles, Borrisoleigh, and Cashel within a fifteen mile radius, who compete with each other, while other teams have the pick of half a county, or even an entire county or province.

The HDC cannot influence parents' choice of school, but they certainly could freshen up this championship and make it far more interesting for the neutral observer, not to say the player. Is the Fitzgibbon Cup not all the better for not being straitjacketed by the provincial structure? The logistical arguments against change in colleges' hurling are obvious, such as when teams might have to cover a large distance on a school day. But even if the early stages of the competition had to be geographically skewed, there's no good reason why the last sixteen couldn't be opened up. It would also boost youngsters who are sick of losing to the same teams year in year out, and would open up new experiences and styles of hurling to them. Isn't it remarkable that the reason that the Railway Cup has been struggling so badly to attract even what could be described as a crowd, is probably fundamentally due to the inability of GAA people to relate to the province as an entity, yet we stick steadfastly to the provinces as a means of organising our competitions. Hurling will never realise its potential while this remains the basis for competition.

There are many other issues requiring the HDC's attention, many of them far from being insurmountable problems. For example, why are the National League final and the Munster championship first round dates so close every year? The difficulties and inequities this creates are obvious. Kilkenny were able to take a three-week break from training after the league final, while Tipp played just thirteen days later. It is disingenuous to say that Tipp shouldn't have reached the league final. There are few enough competitions, and teams should be entitled to play them on their merits without fear of damaging championship prospects.

Why does the championship draw take place as early as October? This creates a huge build-up to one match, as seen to a great degree in the Tipp-Clare games of recent years, which seems to be detrimental to further progress. It also creates a 'phoney war' situation in the late stages of the National League, if teams drawn together in the championship, meet in the latter stages of the league. Would it not be exciting to have a live television draw on the evening of the National League final? Championship dates vary little from year to year, so it's unlikely that anybody would get apoplexy when they discover when they are playing. Just the opposition would be a surprise. If teams can prepare for new opposition with just two weeks notice during the championship,

why do they need seven months notice for the first round? On the subject of championship dates, is it reasonable that the provinces seem to plan their fixtures in a vacuum, with no regard for what the other provinces are at. It was lunacy that Offaly-Wexford, and Cork-Clare were played on the same day in 2003. There are few enough hurling matches on live television, and to ensure that one of these didn't make it is unforgivable.

Why is it that any changes suggested for championship formats, such as Galway being invited into Leinster, are always deferred until the year after the next championship? If it is a good idea now, why not implement it now? If the current state of affairs is unsatisfactory enough to demand change, why delay this change?

Lastly and most importantly, people must acknowledge that however the HDC juggles around with competitions, it will not produce hurlers in Cavan, or Louth, or West Kerry, not to mention the large tracts of urban Ireland, which is a hurling wasteland. This requires a different approach, with proper under-age competitions and coaching structures set-up, with good quality full-time coaches. This needs to be followed up over a long period of time. It can be done, but needs resources and a proper commitment to achieve it. If the GAA can fund the redevelopment of Croke Park, it can fund the propagation of hurling. Doing so would be more beneficial to the GAA than dubious ventures as trying to resuscitate an ailing Railway Cup, however genuine the intention may be. If the GAA can crack this particular problem, perhaps then we anticipate a 'golden era' with real substance.



Kilruane MacDonagh's captain lifts the J.C. Ryan Cup after his side won the county intermediate final.

# National Athletics Champions

by J.M. Tobin

## 1885-1922

### I.A.A.A. Rules

In the 2003 Yearbook we presented a tentative list of Tipperary athletes who won Irish athletics championships under GAA rules between 1885 and 1922. The term 'Tipperary athlete' was taken to include both native-born competitors and also those from outside the county who represented Tipperary clubs. A notable example of the latter category was the Limerick RIC man, Thomas Ryan, who won a number of weight-throwing titles in the 1880s, as a member of the Clonmel GAA club.

During the months after the foundation meeting of November 1st 1884, the GAA spread rapidly throughout the country. However, there were those who viewed the new association with suspicion, arguing that it had a hidden political agenda. This minority group, based mainly in Dublin and with some prominent athletes in its ranks, proceeded to form a rival organisation in the spring of 1885, known as the Irish Amateur Athletic Association. The cross-country association of Ireland founded in 1881, affiliated to the IAAA some years later. Following a year of bitterness and hostility the two ruling bodies reached a compromise, whereby affiliated athletes, who wished to do so, were permitted to compete in each other championships. Although very few Tipperary men were members of

the IAAA they were joined by a number of GAA athletes who opted to contest the championships of the rival association. This combined group recorded the following victories under Irish Amateur Athletic Association rules between 1885 and 1922.

#### HIGH JUMP

1889 P. McGrath Aherlow  
 1890 P. McGrath Aherlow  
 1891 J.M. Ryan Ballyslateen, Golden  
 1892 J.M. Ryan Ballyslateen, Golden  
 1893 J.M. Ryan Ballyslateen, Golden  
 1895 J.M. Ryan Ballyslateen, Golden

#### LONG JUMP

1893 T.F. Kiely Ballyneale,  
 1895 T.F. Kierly Ballyneale

#### POLE JUMP

1894 T. Ryan ?  
 1897 M. Ryan Rockwell, Cashel  
 J. Blackburn Galbally

#### PUTTING 16 LBS SHOT

1887 J.S. Mitchel Bartoose, Emly  
 1903 J. Barrett Borrisokane  
 1906 J. Barrett Borrisokane  
 1907 J. Barrett Borrisokane  
 1908 J. Barrett Borrisokane  
 1910 J. Barrett Borrisokane  
 1911 J. Barrett Borrisokane

#### THROWING 16 LBS HAMMER

1886 T. Ryan Limerick/Clonmel  
 1887 T. Ryan Limerick/Clonmel  
 1895 T.F. Kiely Ballyneale  
 1897 T.F. Kiely Ballyneale  
 1898 T.F. Kiely Ballyneale  
 1899 T.F. Kiely Ballyneale

1900 T.F. Kiely Ballyneale  
 1901 T.F. Kiely Ballyneale  
 1902 T.F. Kiely Ballyneale  
 1903 T.F. Kiely Ballyneale  
 1908 T.F. Kiely Ballynealer

#### 56 LBS BETWEEN LEGS (no follow)

1895 T.F. Kiely Ballyneale  
 1903 T. Phelan Modeshill,  
 Mullinahone

#### 56LBS (with follow)

1886 J.C. Daly Limerick/Borrisokane

#### PUTTING 42 LBS

1885 J.C. Daly Limerick/Borrisokane  
 1886 J.C. Daly Limerick/Borrisokane  
 1887 J.C. Daly Limerick/Borrisokane

#### 3MILES WALK

1892 T. Carroll Aherlow  
 1893 T. Carroll Aherlow

#### CROSS COUNTRY

1920 T. Crowe Bishopswood,  
 Dundrum



Tim Crowe



GAA Yearbook Quiz Winners Presentation. Back (l. to r.) Chris Fahy, Liam O'Donnchú (secretary), Celia Walsh. Front Row (l. to r.) John Fahy, (Aherlow), Biddy Walsh (Cappawhite), winners, John Quirke, Margaret Quirke (Cahir). Missing from photo is winner Eamon Lonergan (Clonmel).



County Board Chairman Con Hogan hands over cup to Comhalatas-Coiste Chondae. In centre is Paddy Troy on right is Peter McAuley.



# TIPPERARY SPRING WATER

PALLAS, BORRISOLEIGH, CO. TIPPERARY

Tel: 0504-51113. Fax: 0504-51480.

15 CHERRY ORCHARD ESTATE, BALLYFERMOT, DUBLIN 10.

Tel: 01-6269787. Fax: 01-6260652

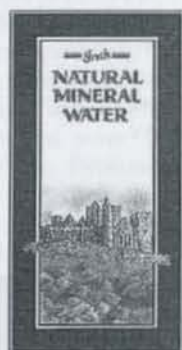

## *Uisce úr Thiobraid Árann*

*At Borrisoleigh in the rolling hills of Tipperary, the unique ecological conditions have combined to create this pure, crystal clear, natural mineral water as the perfect complement to good food and fine wines.*

Tel: 0504-51113

# Kellys of Fantane (Concrete Ltd)



Hugh McGrath, Sales Manager (Nenagh area) 087-2559323

Gus Maher (Thurles/Templemore area) 087-2307061

Timmy Stapleton - Farm Buildings 087-2570720



**Roger Kelly & Sons Ltd**  
**Fantane, Borrisoleigh, Thurles, Co Tipperary**  
**Tel: (0504) 52118 - 6 lines • Fax: (0504) 52200**





# John Costigan

by Liam Hogan

**W**hen Tipp and Kilkenny last met in a National Hurling League decider in 1968, it was Tipp who came out winners. Mick Roche was the captain, and after the glorious era of the early sixties when Tipp won the All-Ireland in 61, 62, 64 and 65, Tipp were in the process of rebuilding. The rebuilding process received a set back as Tipp lost the All-Ireland in 67 and, as it happens, it was to the same opposition.

Among the new faces that were added to the Tipp team were Noel O'Gorman and Jimmy Ryan from Carrick Davins, and there was also a young man from the little parish of Clonakenny. His name was John Costigan, who had seen his club win the county junior hurling championship for the first time in 1967. Representation on the minor, under-21 and intermediate county teams soon led to a call up to the seniors later on in the year.

"We were not expected to do that well in the league," said John. "For the league of 67/68 there were quite a number of new faces brought on to the team and I happened to be one. It was an experimental time and after Christmas we travelled to Wexford for a league game and we lost heavily by 3-12 to 0-10. At that stage there was no hope for us to win the league. But we bounced back in early March, and we drew with Kilkenny 0-12 to 2-6 at Thurles. This led us to a play off with Wexford, which took us to Croke Park when we won by 1-19 to 5-5," said John.

That victory meant a semi-final tilt with Cork in what was a very interesting prize for the winners. A trip to New York in fact, and for young country men that had never travelled too far away, the idea of travel-

ling to New York from Shannon was very enticing. So with that in mind Tipp were in the last four of the league, along with All-Ireland Champions in '66 (Cork) and '67 (Kilkenny) plus Clare. As it happens

Mick Roche, being captain brought home the trophy," added John.

Significantly Tipp faced Clare in the championship three weeks later followed by an easy win over Cork in the Munster final. The



John Costigan retired after 27 years as Secretary of the Post Primary Schools' Committee, photographed here with his wife Margie, James O'Donoghue, incoming Secretary of the Committee and County Board Chairman, Donie Shanahan.

Clare forced Kilkenny to a replay in one semi-final whereas Tipp had a 1-15 to 2-7 win over the Rebels in the other at Limerick.

And so the eagerly-awaited final was played on May 12th and there was a great build up to the game which attracted over 30,000 patrons. "After a tempestuous final Tipp emerged victors on the score of 3-9 to 1-13 much to the delight of some of the new players who had come on the team. It was a great victory for us, and those players like Donie Nealon, Mackey McKenna, Len Gaynor, Mick Roche, and John O'Donoghue who came from the remnants of the glory years in the early sixties."

That was only the home final as it was known then. The official final was played in New York was a two-leg affair. "It was late May and on the first Sunday the game was called off due to heavy rain. On the second Sunday the game was cancelled again due to the death of Robert Kennedy, who had been assassinated, so on the third weekend the final was played over two legs on Saturday and Sunday. Tipp emerged winners and

All-Ireland is a story on its own right. After a good first half, Tipp gave second best to Wexford, who finished winners with a two-point victory.

The league has received a fair amount of criticism for the past few years but in John's opinion the importance of the league - or lack of it - began to change about twenty years ago. He reflects on the 68 final: "At that time the National League was much more competitive than it is today. The emphasis is all championship now. It has become the be-all and end-all of hurling and I think it is media led. The introduction of the club championships in the seventies again took a little bit from the league," said John.

The playing of the full league in the one calendar year was the final straw for John. "The commencement of the league in February, and running it right up the start of the championship has taken the momentum out of the league. There is a lot to be said for the system, where the league began in October when two or three rounds were played pre-christmas and it gathered

momentum in the Spring and the final was played on a suitable time before the championship began. It is not suitable to play a league final in May while the championship starts two weeks later," he added.

"The league medals won by John Doyle, Mick Maher and Theo English were played for with the same feverishness as they played in the championship. They appreciate those league medals just as much as their All-Ireland medals," said John.

Reflecting on previous league finals John picks out the 1956 League final when as a young boy he listened to it on the radio. "Tipp led Wexford by 2-10 to 0-1 at half time. Wexford, with great players like the Rackards and the Kehoes, and company came back to win by a four point margin. I remember going to the final the following year when Tipp beat Kilkenny. The Hogan stand was being reconstructed at the time and the game marked the beginning of Jimmy Doyle's career. Many memories are still etched in my mind, and one of them is a twenty-one yard free by Paddy Kenny. There was the marvellous display by John Hough of Toomevara."

Clearly John is concerned as to where the league is going and how serious the league is taken by those who organise it in light of playing the final on a Bank Holiday Monday. "I have my doubts if the powers that be want the league to be played with the intensity that I would like to see. For me one of the great league games in recent times was between Tipp and Kilkenny at Nowlan Park. It was a game that enthralled the ten thousand who attended. It was the type of game that would bring the crowds back to the National League.

After retiring from the playing scene John entered the administration scene. As a secondary school teacher he held the post of secretary of the schools' committee, which organised competitions all over Tipp. He held the role of chairman with his adopted club J.K. Brackens since the club came into being in the early nineties.

In last year's county convention John Costigan was elected as the new vice-chairman. Part of the criteria of having the vice-chairman's job is chairman of the GAC which is a very important job, as that committee decide the fixtures for the year in both hurling and football. For the last few years the schedule has become very heavy because not alone are the various championships involved there is also the league in both codes to contend with.

Under his guidance he has steered the fixtures committee to a great year. All the competitions will be finished by the year's end. In his first meeting he made the proposal of playing the semi-finals and finals of the U-21 hurling and football competition on the one weekend. Those in attendance were too shocked to object and perhaps they did not take him seriously. They soon found out that this man is not for moving.

# DONNELLY WEB SOLUTIONS.....

Donnelly Web Solutions provide affordable Internet sites for business and sporting organisations in Ireland.

Designers of the Tipperary GAA page <http://tipperary.gaa.ie> and the Horse & Jockey Inn, sponsors of the Tipperary Camogie Team - <http://www.horseandjockeyinn.com>

We have also designed an extensive collection of our sites

If you are interest in seeing our work or getting a website for your organisation, please visit our website at <http://donnellyweb.net>

Donnelly Web Solutions Ireland - <http://donnellyweb.net>

E-mail - [info@donnellyweb.net](mailto:info@donnellyweb.net)

Call us - 087-2055642 or 087-2422774

## TAFFY'S

BAR & GROCERY  
LOUGHMORE

**FOR ALL YOUR  
DAILY REQUIREMENTS**

• **FUNCTION ROOM NOW AVAILABLE** •

Wish all LOUGHMORE CASTLEINEY  
teams the best of luck in 2002

*Many thanks to all our  
customers for their support.*



## Ulster Bank

70 O'Connell St., Clonmel

Ph. 052-22899

Kickham St., Nenagh

Ph. 067-32455

49 Liberty Sq., Thurles

Ph. 0504-24491

[www.ulsterbank.com](http://www.ulsterbank.com)

For all your banking needs

Ulster Bank Ireland Limited, Registered in Republic of Ireland, No. 25766.  
Registered Office: Ulster Bank Group Centre, Georges Quay, Dublin 2.  
Member of The Royal Bank of Scotland Group.



## Killenaule GAA Club

**K**illenaule GAA club has completed one of its most successful years ever, winning a South under-21 A football final and going on to be narrowly defeated by Ballina in the county final. The under-21 hurlers went one better, winning the county final for the first time in the grade

## Carrick Davins GAA Club

**A**t our AGM in January 2003, as we entered the 81st year of our club, and we decided to celebrate our 2002 county champions in minor B football with a very successful victory social in the Carraig Hotel. Well-known referee, and former South board chairman, Willie Barrett, presented medals to all our winning players. South board chairman, Barry O'Brien, and secretary, Sean Nugent, attended, as well as a large gathering of our supporters.

Our intermediate hurlers had a good year with victories over Cahir and Moyle Rovers and draws against Kilsheelan and St. Mary's, and with a small bit of luck we could have qualified for a semi final place. In minor A football we had victories over Moyle Rovers and Commercials. We narrowly lost the semi final to Ardfinnan. In minor A hurling we had victory's over St Mary's, Ballingary and Killenaule. We narrowly lost the semi-final replay to Killenaule. At time of writing we are still involved in junior B football championship. We were beaten in the under-21 football final.

The club would like to congratulate Richie McGrath on helping Tipperary win a third minor hurling Munster title in a row and although they lost to Galway in the semi

The juvenile club was also very successful during the year, winning South and county titles in under-16B football.

The club would like to thank everyone associated with this success, especially the managers, Jimmy Tobin, under-21 hurling – his selectors Dick Meagher, Davy Ahearne, Michael Gleeson and Liam Kelly, Tony Doyle, Sr. manager under-21 football, selectors, Pake Fennelly and Kenneth Cleary, Tony Doyle, Sr., manager under-16 football,

final he brought great honour to our club. Richie was a great inspiration to all our young players over the year. We wish him success in his future hurling career.

Overall it has been a good year for the Davins on the playing fields and gives us great promise for the future with the level of commitment shown by all our players.

We would like to thank all our sponsors and supporters for their assistance, and all our players, mentors and committee mem-

selectors Hugo Browne and Dick O Dwyer.

While they were not successful we would also like to express our deepest gratitude to players, managers and selectors of our minor, senior, junior and intermediate teams for their endeavours throughout the year.

The parish is deeply indebted to all those people. The club would also like to thank the officials and referees associated with our success.

bers for their efforts and their time during the past year.

At juvenile level four of our players, Lee Mackey, Jonathon Coady, Patrick Harris, and William O'Dwyer played on the South Tipperary under-15 hurling team, while A.J. Cronin, Michael Cronin and William O'Dwyer played on the South Tipperary under-16 football team. William O'Dwyer also played on the Tipperary under-16 hurling team.



*Presentation at Victory Social at Carraig Hotel 31st January 2003 . . . Chairman John O'Neill, Stephen Cronin (hurling captain), Willie Barrett and Paul Cody (football captain).*

# Medal Presentation 51 Years On



*Paddy Moloney receives his 1952 All-Ireland MHC medal after 51 years waiting from Co. Chairman Donie Shanahan at a function in Dundrum recently. On left is Veronica Moloney and on right is Michael O'Brien, Co. Secretary.*

**P**addy Moloney, Solohead (and later Arravale Rovers) was an outstanding minor hurler in the early fifties. He was on the county minor team that won the All-Ireland in 1952, contributing significantly to the progress of the team on the way to the final against Dublin.

However, he never played in the

final. The match took place on September 7 and, on the previous Wednesday, Paddy went into the seminary at St. Patrick's College, Kiltegan. Once in there was no way out for the final. Various efforts were made, including the offer of a taxi to bring him to Dublin for the final and despatch him back to the seminary immediately it was over..

Not only did he miss the final, but he didn't hear the result until the following Wednesday, and then only that they had won. Not for some time later did he get the score.

But the saga doesn't end there. He never got his All-Ireland medal. At that time there were the bare twenty medals and, in the absence of Paddy, Phil Hennessy of Nenagh was drafted into the panel. He played that day and scored the first point. When the medals were distributed Phil was included, as he had played in the final, and Paddy was excluded.

That was until December 2, just past. On that night at Dundrum House Hotel, Paddy Moloney was presented with his All-Ireland medal by chairman of county board, Donal Shanahan. His family were present on the occasion. There was a 'This is Your Life' presentation of Paddy by his brother, Fr. Bernie, a great speech by his older brother, Joe, and a witty, whimsical recollection of the whole episode by Paddy himself. To finish off the night Paddy's seventieth birthday was celebrated.

# Hayes' HOTEL

**Thurles, Co. Tipperary,  
Ireland.**

**Tel: 0504-22122/**

**Fax: 0504-24516**

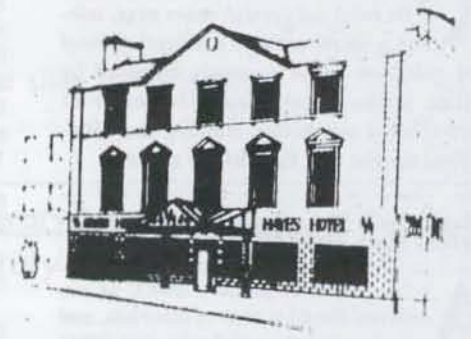

- Coffee Dock open daily from 8 a.m. - 11 p.m.
- Carvery Lunch served from 12.30 p.m. - 3 p.m.
- Grill Room open 6 p.m. - 9 p.m.
- Our restaurant offers an Extensive A La Carte & Dinner Menu - Open Daily
- Relax and meet friends in our comfortable and luxurious Bar.

---

BIRTHPLACE OF THE G.A.A.

*When in Thurles make sure to call in to Hayes' Hotel*

## Tipperary Star

*For the most complete coverage  
of G.A.A. affairs in Tipperary*

## The Nationalist

# The Life of a P.R.O.

By Ed Donnelly

**T**he role of Public Relations Officer in any organisation is an important one. The areas of public relations and communications are key to how any organisation is perceived by the general public. As the Gaelic Athletic Association is the largest sporting organisation in Ireland, then being the PRO of one of the 32 counties brings a lot of responsibility.

On the night of July 15th 2003, I was elected as Public Relations Officer for the Tipperary county board. Following in the footsteps of great gael's such as Seamus Ó Riain, John O'Grady, Gerry Long and Liz Howard is certainly a daunting task. All have been outstanding servants to the GAA in Tipperary in the past. My only commitment upon taking office was to try my best to live up to the standards expected of the position with a view to doing my best for the gael's of Tipperary.

So what does a County PRO do? I am not sure if there is a blueprint for the task. Everyone will bring their own ideas to the job and no two people will do the same thing. My main objective was to inform people of GAA activities which take place but which don't normally get headlines, and to do so in a positive manner. To aid with this vision, I needed the co-operation of the local newspapers and this was duly granted. So the weekly Tipperary GAA Scene column was born on August 7th, 2003.

The GAA in Tipperary is not just about senior hurling. Yes, it would be the most popular and most publicised sport. However, there is so much good work going on under the auspices of the GAA, both at home and abroad and through the forum of the column I have managed to highlight some of the less well-known achievements. I have spent many hours establishing communications with Tipperary people, both at



home and abroad. With the help of these contacts, I hope I have raised the awareness of all areas of the GAA in Tipperary through my column. Some of these areas would include handball, scór, refereeing, inter-firms, Tipperary teams overseas and Bord na nÓg to mention but a few.

Another initiative was to set up a Communications Committee with 2 members from each division. The remit of this committee is to discuss all forms of communications relating to Tipperary GAA activities with a view to continual improvements over time. The committee have met twice to date and will continue to discuss how the marketing of our association can be improved.

One of the most important aspects of the role is to work with the inter-county teams and management, with a view to ensuring the best possible media coverage for Tipperary. This requires setting

up a good relationship with the management teams in particular and also with the media, especially when teams are being announced and after matches. In the case of a team being announced, I tried to bring my computer background to the forefront as I set up an e-mail list of over 50 media personnel, from the world of radio, TV and the newspapers, both locally and nationally. The distribution of teams in this way cuts down a lot of time for me, the PRO, and also the media, who wish to spread the news quickly or meet deadlines.

Of course, the national media and in particular the newspapers, are interested in making a story. Before a match, journalists are looking for an angle, or a possible controversy that they could write about. Such stories are not always there but sometimes they are and it's the role of a PRO to consistently promote the positives in the team in question with the intention of allowing Tipperary the best chance possible of success. Another side of the media is talking on radio, both locally and nationally and once again, it's important to get your point across while at the same time, not being critical of anyone or anything to do with anyone involved with the Tipperary teams.

Once all of the inter-county teams are knocked out, the assumption many people make is that the life of a PRO gets easier. If anything, it gets much busier. When the inter-county season is in full flow, there are very few club matches (a discussion for another day!). However, when the inter-county scene ends, especially at senior level then the club scene ramps up very quickly. That brings its own pressures as team sheets and match programmes have to be compiled and that requires contacting a lot of clubs looking for teams and / or articles. Without hesitation, I can say that while this is time consuming, it is also very rewarding as I get to discuss GAA with people from all over the county and find out how their team are doing and if they think they will win the upcoming match. I also use this opportunity to see if there is any help I can give clubs or their committees.

One of the personally rewarding aspects of being PRO is that occasionally, the local papers have asked me to do a match report for them on certain weekends when they are over-stretched. Compiling match reports is something that has been a hobby of mine for a long time and to be asked to do this for the local papers is an honour.

As the GAA season winds down, a



Jim Flanagan, Ed. Donnelly, Harry Ryan and Donie Shanahan, County Chairman, following Ed's election as P.R.O.

**CHANNEL YOUR  
DRAINAGE  
PROBLEMS  
THROUGH RICHMOND**



*Hygienic stainless steel floor drains are ideal for the brewing, chemical and food processing industries, as well as hospitals, abattoirs, cold stores and anywhere a clinically clean environment is essential.*

*Richmond Trading is Ireland's leading supplier of gullies, grating and grease traps, and offers a comprehensive range of stainless steel piping and fitting. Also stockist of Polyconcrete, P.V.C. and cast iron drains.*

Contact:



**Richmond Trading Company**  
Stainless Steel and Drainage Specialists

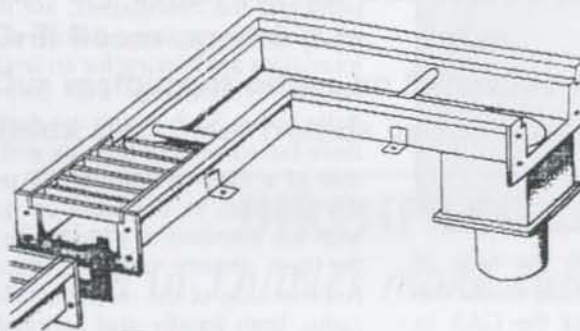

*Richmond Trading Co., Templemore, Co. Tipperary  
Tel: (0504) 31311 Fax: (0504) 31258  
Cork: (021) 4896320 / (086) 2563339  
Dublin (086) 2552071  
email: [escott@richmondtrading.ie](mailto:escott@richmondtrading.ie)*

*Continued success to the G.A.A.  
from Donal & Rose Young*

**The Ragg**  
**- BAR & LOUNGE -**

THE RAGG NITE CLUB  
ROSEWOOD SUITE

NEWLY REFURBISHED FUNCTION ROOM

IDEAL VENUE FOR AFTER-MATCH DRINKS & REFRESHMENTS

Weddings • Socials • Family Celebrations

\*\*\*\*\*

LUNCHES SERVED DAILY

\*\*\*\*\*

Contact Donal at:

**0504-51327/51376**

PRO has to attend meetings and functions. Often, the role of Master of Ceremonies falls to the County PRO and feeling comfortable at public speaking is a definite pre-requisite. One of the highlights this year included being called upon to announce the players who made up the 1958 to 1965 Tipperary teams. The 46 players who won five All-Ireland senior hurling finals for Tipperary in this period were present and it was a fantastic honour for me to meet so many of these legends. Also, being MC for a Corporate Lunch in Croke Park before the Tipperary and Kilkenny semi-final and meeting with Micheál Ó'Muircheartaigh, Sean Kelly, Liam Mulvihill and Seamus Ó Riain was an honour.

Helping out with the stewarding of the Ard Cómhairle section of the New Stand in Semple Stadium is also part of the job description. Again it's an honour to meet with so many famous people, both within the GAA and in business. Of course, the day-to-day business of a county board and dealing with issues when they arise is important. There were more than a fair share of issues since July 2003 but overall the experience has been a positive one and I have enjoyed it immensely.

What the future holds I do not know. I certainly hope for success on the playing fields for Tipperary in

2004 – at all levels. Off the field, I will continue in the role of PRO as long as people want me. After that, it will be back to my club Moycarkey-Borris who have been extremely supportive of me in the past few months.

Finally, one of the most talked about negatives in the GAA in the 21st century is the lack of young people who show an interest in getting involved in the GAA. As one of the youngest ever county board officers in Tipperary county board history, I can say to all aspiring GAA officials that being involved is both a rewarding and fulfilling experience and you won't know if you can do a job until you try.

## EMLY G.A.A. CLUB

*honours players of the past*



At Emlý Function to honour teams of 1959, 1960 and 1968. Left to right: Micheál Ó Muircheartaigh, Antoinette Cunningham, Chairperson, Seán Ó Ceallaigh, Uachtaráin C.L.G., Michael Burke, Treasurer, Tony Harnett, Secretary.



At Emlý Function to honour teams of 1959, 1960 and 1968. Left to right: Seán Kelly, Uachtaráin C.L.G., Paddy Clancy, captain West S.F. champions 1959; Mick Frawley, captain West S.F. champions 1960; Mick Dawson, captain County J.F. champions 1968 and Micheál Ó Muircheartaigh.

# Roscrea Sports Awards



At the Roscrea Sports awards night, the Kelly brothers from Mullinahone received the Tipperary Star joint Sports Personality of the Year Award (from left): Pat Caret (Tipperary Star), Paul Kelly, Eoin Kelly and Bishop Willie Walsh.

Special Merit Award winners at the Roscrea Sport awards night were the survivors of Roscrea's 1945 County S.H.C. final team (from left): Martin Loughnane RIP, Joseph Maher, Jack Ryan, Diarmuid Fitzgerald, Kevin O'Donoghue (representing his uncle Mick Ryan), Roddy Ryan (representing his father Dinny) with Bishop Willie Walsh.



# Burgess G.A.A. Club wins AIB Award



Burgess – AIB Club of the Year winners in both Tipperary and Munster (from left): Fergal McDonnell, Donie Nealon, Pat Carroll, Bobby O'Dwyer (AIB Manager, Nenagh), GAA President Sean McCague, J.A. McDonnell (Burgess Chairman), Timmy Maher, Bridget Delaney, Sean Kelly, G.A.A. President elect and Aidan O'Leary.

Burgess G.A.A. Secretary Aidan O'Leary and Chairman J.P. McDonnell hold the Munster AIB Club of the Year award.





# Coiste Thioðraid Arann Thuaidh

## Permanent T.S.B.Bank (Nenagh) Senior Hurling Championship

S-finals: Moneygall.....0 - 14  
Newport.....0 - 04  
(R): Moneygall.....2 - 11  
FINAL: NENAGH ÉIRE ÓG.....0 - 16

## Nenagh Guardian Intermediate Hurling Championship

S-finals: Kilruane Mac Donaghs.....2 - 12  
Burgess.....0 - 15  
FINAL: KILRUANE MAC DONAGHS.....2 - 09  
(R): KILRUANE MAC DONAGHS.....0 - 07

## Watch Centre Junior "A" Hurling Championship

S-finals: Toomevara.....1 - 12  
Roscrea.....1 - 07  
FINAL: BURGESS.....3 - 11

## Watch Centre Junior "B" Hurling Championship

S-finals: Newport.....2 - 12  
Lorrha/Dorrha.....3 - 11  
FINAL: BALLINA.....2 - 06

## Tom Walsh Under-21 "A" Hurling Championship

S-finals: Ballinahinch.....0 - 10  
Ballina.....3 - 12  
FINAL: BURGESS.....2 - 07

## Tom Walsh Under-21 "B" Hurling Championship

S-finals: Lorrha/Dorrha.....3 - 08  
Silvermines.....1 - 07  
(R): Lorrha/Dorrha.....1 - 08  
FINAL: MONEYGALL.....0 - 09

## Tom Walsh Under-21 "C" Hurling Championship

S-final: Portroe.....1 - 09  
FINAL: BALLINA (2).....3 - 05

## Ger Gavin Minor "A" Hurling Championship

S-finals: Kilruane Mac Donaghs.....2 - 14  
Toomevara.....7 - 02  
FINAL: KILRUANE MAC DONAGHS.....3 - 10

## Ger Gavin Minor "B" Hurling Championship

S-finals: Kildangan.....3 - 09  
Borris-Ileigh.....1 - 12  
FINAL: KILDANGAN.....2 - 14

## Ger Gavin Minor "C" Hurling Championship

FINAL 1ST LEG: BALLINAHINCH.....0 - 01  
FINAL 2ND LEG: PORTROE.....1 - 12

## Intermediate Football Championship

S-final: Newport.....W/O  
FINAL: KILDANGAN.....3 - 10

## Junior "A" Football Championship

S-finals: Ballina.....1 - 12  
Portroe.....0 - 08  
(R): Portroe.....3 - 07  
FINAL: BALLINA.....1 - 15

## Junior "B" Football Championship

S-finals: Newport.....W/O  
Inane Rovers.....2 - 06  
FINAL: NEWPORT.....0 - 04

## Under-21 "A" Football Championship

S-finals: Borris-Ileigh.....1 - 06  
Newport.....0 - 09  
FINAL: BURGESS.....0 - 04

## Under-21 "B" Football Championship

S-finals: Silvermines.....0 - 03  
Borrisokane.....1 - 06  
FINAL: KILRUANE MAC DONAGHS.....0 - 08

## Under-21 "C" Football Championship

FINAL: BALLINA (2) - ONLY TEAM IN CHAMPIONSHIP

## Minor "A" Football Championship

S-finals: Inane Rovers.....0 - 09  
Kilruane Mac Donaghs.....4 - 14  
FINAL: INANE ROVERS.....2 - 13

## Minor "B" Football Championship

S-finals: Kildangan.....0 - 09  
Ballinahinch.....0 - 09  
FINAL: KILDANGAN.....3 - 05

## Minor "C" Football Championship

FINAL: PORTROE.....0 - 07

## Intermediate Hurling League

S-finals: Burgess.....2 - 07  
Kildangan.....3 - 10  
FINAL: KILDANGAN.....3 - 13

## Junior "A" Hurling League

S-finals: Toomevara.....2 - 17  
Moneygall.....2 - 09  
FINAL: TOOMEVARA.....1 - 12

## Junior "B" Hurling League

S-finals: Kildangan.....2 - 14  
Newport.....0 - 13  
FINAL: KILDANGAN.....0 - 16

Nenagh Éire Óg.....0 - 14  
Toomevara.....3 - 14  
Nenagh Éire Óg.....3 - 21  
TOOMEVARA.....3 - 12

Kildangan.....3 - 08  
Borrisokane.....1 - 09  
BURGESS.....0 - 15  
BURGESS.....1 - 10

Burgess.....2 - 13  
Moneygall.....3 - 09  
MONEYGALL.....2 - 09

Ballina.....2 - 13  
Kildangan.....1 - 10  
LORRHA/DORRHA.....4 - 07

Burgess.....1 - 13  
Roscrea.....0 - 06  
BALLINA.....4 - 11

Moneygall.....3 - 08  
Newport.....1 - 11  
Moneygall.....3 - 10  
NEWPORT.....1 - 11

Ballina (2).....2 - 07  
SHANNON ROVERS.....2 - 12

Borrisokane.....2 - 10  
Roscrea.....4 - 17  
ROSCREA.....4 - 13

Silvermines.....0 - 08  
Ballina.....0 - 10  
BORRIS-ILEIGH.....0 - 13

PORTROE.....2 - 08  
BALLINAHINCH.....1 - 04

Inane Rovers.....Scr  
NEWPORT.....1 - 06

Borris-Ileigh.....1 - 03  
Borrisokane.....0 - 08  
Borrisokane.....0 - 13  
PORTROE.....1 - 06

Kildangan.....Scr  
Knockshegowna.....2 - 09  
KNOCKSHEGOWNA.....1 - 10

Burgess.....0 - 14  
Ballina.....2 - 10  
BALLINA.....2 - 07

Kilruane Mac Donaghs.....0 - 07  
Moneygall.....2 - 04  
MONEYGALL.....2 - 11

Burgess.....1 - 05  
Borris-Ileigh.....1 - 03  
KILRUANE MAC DONAGHS.....0 - 09

Silvermines.....1 - 05  
Borrisokane.....2 - 08  
BORRISOKANE.....5 - 08

LORRHA/DORRHA.....1 - 08

Ballina.....1 - 13  
Knockshegowna.....0 - 10  
BALLINA.....2 - 13

Templederry Kenyons.....2 - 07  
Burgess.....0 - 12  
MONEYGALL.....3 - 13

Ballina.....0 - 10  
Lorrha/Dorrha.....2 - 11  
LORRHA/DORRHA.....1 - 10

Cloughjordan Sun 24th Aug S. Roche  
Dolla Sun 24th Aug J. Ryan (Bob)  
Cloughjordan Sun 31st Aug N. Cosgrove  
CLOUGHJORDAN SUN 07TH SEP J. RYAN (BOB)

Nenagh Sat 13th Sep D. Curtiss  
Nenagh Sat 20th Sep F. Kearney  
NENAGH SUN 28TH SEP D. CURTISS  
NENAGH SUN 5TH OCT R. BARRY

Nenagh Mon 15th Sep M. Cahill  
Toomevara Sat 06th Sep D. Darcy  
NENAGH SAT 04TH OCT T. RYAN

Kilcolman Sat 27th Sep M. Griffin  
Borrisokane Sun 28th Sep D. Darcy  
NENAGH SUN 05TH OCT D. DARCY

(AET) Dolla Sat 05th Apr J. Stapleton  
Nenagh Mon 21st Apr M. Cahill  
NENAGH SUN 04TH MAY J. MC DONNELL

Ballygarry Sat 12th Apr J. Mc Donnell  
Ballina Sun 13th Apr J. Stapleton  
Ballygarry Fri 18th Apr D. Darcy  
TEMPLEDERRY SAT 26TH APR M. CAHILL

Kilcolman Sat 12th Apr M. Griffin  
PUCKANE TUE 22ND APR T. RYAN

Puckane Tue 26th Aug J. Stapleton  
Moneygall Tue 26th Aug T. Ryan  
MONEYGALL SUN 31ST AUG V. MC KENNA

Kilcolman Thu 21st Aug M. Cahill  
Dolla Fri 22nd Aug J. Collins  
CLOUGHJORDAN SUN 31ST AUG J. COLLINS

BALLINAHINCH THU 24TH JUL T.P. SULLIVAN  
PORTROE SAT 09TH AUG B. O'REILLY

Dolla Sat 4th Oct B. Darcy  
DOLLA SUN 19TH OCT J. KELLY

Dolla Mon 27th Oct T.P. Sullivan  
Puckane Sat 25th Oct M. Griffin  
Puckane Sat 01st Nov J. Lees  
DOLLA SAT 08TH NOV T.P. SULLIVAN

Moneygall Sat 01st Nov L. Hogan  
PUCKANE SAT 08TH NOV L. HOGAN

Templederry Mon 17th Mar T.P. Sullivan  
Ballinahinch Sat 22nd Mar L. Hogan  
NENAGH SUN 14TH APR M. HEALY

Nenagh Mon 17th Mar J. Kissane  
Roscrea Sat 22nd Mar D. Darcy  
NENAGH THU 10TH APR J. KISSANE

Toomevara Thu 07th Aug T. Ryan  
Dolla Sun 03rd Aug J. Kissane  
MONEYGALL THU 21ST AUG J. KISSANE

Nenagh Sun 03rd Aug B. O'Reilly  
Portroe Mon 01st Sep B. O'Reilly  
NENAGH SUN 14TH SEP D. DARCY

NENAGH WED 02ND JUL B. DARCY

Dolla Sun 08th Jun M. Cahill  
Nenagh Mon 02nd Jun J. Mc Donnell  
NENAGH FRI 13TH JUN J. MC DONNELL

Borrisoleigh Fri 30th May J. Stapleton  
Dolla Sun 25th May M. Griffin  
MONEYGALL FRI 06TH JUN J. STAPLETON

Kilcolman Sun 29th Jun D. Darcy  
Portroe Sun 29th Jun J. Collins  
DOLLA SUN 20TH JUL J. LEES

# SPORTSMANS DREAM

*Bí beo . . . bí beathach*

- \* Quotations given for Sets of Jerseys \*
- \* Racket Restringing on Premises \*
- \* Special Discounts given to Clubs and Schools \*



**11 KENYON STREET,  
NENAGH  
Tel: (067) 32205**

**The  
Watch  
Centre**

## NENAGH

Leading Suppliers of  
Cups, Medals, and  
Sporting Trophies.  
Watches, Jewellery,  
Waterford Crystal,  
Masons Ironstone  
and Aynsley

**25, Mitchel St.**

Phone: (067) 31913

# COOPER'S BAR

**Birdhill UP NEWPORT**

**PROP. DINNY & FIONA RYAN.  
TELEPHONE: 061-379114**

FOR THE BEST AFTER  
MATCH POST  
MORTEMS

*Athbhliain faoi shéan is faoi mhaise duit!*

## Moyles Garage



MAIN DEALER

SALES & SERVICES

**Old Birr Road,  
Nenagh,  
County Tipperary**

**Phone: 067-31385-31019**

**Mobile: 087-2631286**

**Fax: 067-31019**

*D.O.E. Testers for  
Heavy & Light Commercials*



Roscrea Minor Hurlers North 'A' Champions. . . Back row (l. to r.) Edward Leamy, Thomas Leamy, Sean Fitzgerald, Mark Ryan, Raymond Moloney (capt.), Ger Stone, Paul Stone, Paddy Troy, Eoin Delaney, Pat Fitzgerald, David Buckley. Front row (l. to r.) Enda Dooley, Timmy Breen, Mark O'Meara, Raymond Moloney, Colm McLeish, Eoin Shanahan, Jason Winters, Brian Franks, Trevor Byrne.



Moneygall U-21 Football 'B' North Champions. . . Back row (l. to r.) Ger Ryan, Brian Quinlan, Eoin Ryan, Bill Whyte, Michael Kirwan, Damien Martin, Derek O'Meara, Donal Doughan, Billy Hayes, Sean Ryan, Pajo Troy, Anton Doherty. Front row (l. to r.) Pdraig Doughan, Ger Kirwan, Philip Byrne, Michael Bergin, Paul Smith, Eamonn McCormack, Pauric Greene, Paddy Fanning (capt.), Ger Morten.



Kildangan Minor Hurlers North 'B' Champions. . . Back row (l. to r.) Andrew Murphy, Gearoid Connors, Patrick Coen, Darragh Egan, Thomas Seyour, Conor Hayes, Eoin Kelly (capt.), Colm Darcy. Front row (l. to r.) Brian McLoughlin, Kieran Madden, Sean Forde, Eoin Gleeson, Brian Freeman, John Martin and Martin Slattery.



Knockshewowna North Junior 'B' Champions. . . Back row (l. to r.) Ned Fogarty, Kieran Gohery Jack King, Brian Noonan, Darren Browne, Paul King, Keith Gohery, Joe Delahunty, Adrian Browne, Damien Bond, James Hodgins. Front row (l. to r.) Michael Dollery, Michael O'Brien, Brian Bond, Ger O'Brien, Michael Kennedy, Joe Cleary, Ray Killeen (capt.), Graham Gohery.



Ballina U-21 Football Panel North and County 'A' Champions, Also U21 Hurling 'A' Champions. . . Back row (l. to r.) Liam Sheehy (sel.), T.J. O'Connell, Christopher O'Meara, Gerry O'Brien, Stephen Strich, Sean McKeogh, Shane O'Brien, Patrick Cosgrave, Noel Moroney, Thomas Collins, Hughie Molloy, Eoin Kennedy, Liam Molloy (sel.), Front row (l. to r.) Robert Nolan, David Hickey, Martin McKeogh, Rody Kennedy, Peter King (capt.), Kevin Ryan, Domhnaill McKeogh, Gerard Sheehy, Seamus Larkin, Eoin Sheehy, Kevin Cosgrave.



Lorrha North Junior 'B' Hurling Champions 2003. Back row (l. to r.): Tony Hogan, John Carroll, John Sherlock, Richard Bourke, Ronan King, Donal Kennedy, Liam Carroll, Michael Cleary, Kevin Liffey, Ronan Harding, James O'Meara, Shane Brophy, Kevin Shewbridge, Eoin Gormally, Eamon Maher. Front row (l. to r.): Pádraig Deane, Martin Young, Michael Coen, Hubert Hogan (captain), Patrick Kennedy, Tadgh Nevin, Adrian Molloy, Patrick Hough (vice-captain), Dermot Power, David Sullivan, Kevin Hough.



Ballina U-21 Football Second team North 'C' Champions. . . Back row (l. to r.) Danny McKeogh (sel.), Pdraig Ryan, Diarmuid Healy, Wayne Calahane, Hughie Molloy, James Mooney, William Gleeson, Michael O'Sullivan, Patrick Kennedy, Pdraig McKeogh, Michael McKeogh, Liam Sheehy (sel.), Liam Molloy (sel.). Front row (l. to r.) Paul Hannon, T.J. O'Connell, Daniel Frawley, Brian McKeogh, Kevin Cosgrave, Eoin Sheehy, Michael Kennedy, James McKeogh, Pdraig McKeogh.



Newport U-21 Hurling Panel North and County 'B' Champions. . . Back row (l. to r.) Dinny Ryan (sel.), Diarmuid Sheridan, Philip O'Brien, Mike ahearne, Kevin McCabe, David O'Gorman, Eoin Shinnors, Richard Shinnors, Thomas Jones, Kevin O'Brien, Conor O'Mahony, Richard Ryan, Joe Powell, Shay O'Gorman, Vinny Moloney, Eddie Quigley (sel.). Front row (l. to r.) David Quinn, Kieran O'Sullivan, Donal Farrell, Richard Brennan (capt.) with mascot Conor Floyd, Mike Flannery, Michael Ryan (B), Christopher O'Connor, Andrew Hickey, Damien Coffey, Ger Bradley (manager).

# LANDTECH



Suppliers of:

Top Dressing Sand and Mixes

Specialised Sand Spreader

(Available for hire and contract work)

Amenity Grass, Seed & Fertilisers

TECHNICAL CONSULTANCY  
AND ADVICE ON PITCH MAINTENANCE  
AND CONSTRUCTION

Contact:

LANDTECH SOILS LTD.

20 Kenyon Street, Nenagh,  
Co. Tipperary

Tel: 067-32207. Fax: 067-33658

## Sports Field Construction Drainage & Maintenance

- Quality Turfgrass for pitch repairs
- Contract laying service
- Large Roll sod laying service also available
- Turf Tiles - 4" thick sod for emergency repairs



## Tipperary SportsTurf

20 Kenyon Street, Nenagh, Co. Tipperary  
Tel: 067-32207 Fax: 067-33658 Mobile: 086-2581191

### COMPLETE SPORTS FIELD DRAINAGE SERVICE

*Top Dressing Sand  
Supplied & Spread*

## Tipperary SportsTurf

# ALBANY HOME DECOR SPECIALISTS

## SUMMERHILL, NENAGH

Albany" – The Wallpaper and Paint Specialists

Top Brand Names in stock:

**Dulux, Berger, Fleetwood, Ronseal, Polycell**

Choose any colour you wish from the MacPherson  
Computerised colouring system – 5,000 colours in all!

HUGE RANGE OF WALLPAPERS AND BORDERS  
– LARGEST IN MUNSTER

Try a different look with Crown decorative effects or with our range of stencils

A visit to our picture gallery is a must

For all your D.I.Y. needs and expert advice contact: John Kennedy

**Telephone and Fax No. 067-31527**



Shannon Rovers U-21 Hurling Panel North 'C' Champions. . . Back row (l. to r.) Alan Byrnes, Bill O'Meara, Rob O'Halloran, Noel O'Donoghue, Roy Darcy, Derek Horan, Michael J. Quinlan, Edward Brophy, Rob O'Gorman, Shane Carroll. Front row (l. to r.) Daryl Darcy, George Hannigan, Michael Burke, Lee Darcy, Kevin Calahan, James Stack, Paul Ryan, Paddy Donnelan, Michael Dwyer.



Burgess Junior 'A' Hurling Panel North 'Champions. . . Back row (l. to r.) Michael Morrissey, Donal Nealon, Dave McAuliffe, Darrell Tucker, Thomas Hanrahan, Niall Quigley, Patrick Tucker, Jonathan Maher, Peter Carroll, Kevin Cooney, John Scroope, Paul Seymour, Brian Tucker, Tadhg Hogan, Joe Quigley, Johnny Flynn (sel.). Front row (l. to r.) Donie Nealon (sel.), Michael McDonnell, Frankie Hogan, David Kyne, John Darcy, David Ryan, Gerry Ryan, Keelan Howard, Pdraig McDonnell, Donal Hogan, Kieran Hogan (sel.), Patrick Hogan, Tony Gregan (sel.).



Portroe Senior Hurlers County League Division 2 Champions. . . Back row (l. to r.) Richard Clifford (trainer), Richard Freeman (sel.), Jimmy Creamer, Paudie Malone, Adrian Shinnars, Darren Gleeson, Joe Sexton, Coleman Shouldice, Nicky Ryan, Kenneth Kennedy, Finbar Ward, Noel O'Halloran, Charlie Willford, Anthony Freeman, John Hogan, James Sheedy (sel.). Front row (l. to r.) Nigal Kennedy, Fergal Hayes, James Seymour (man.), John Ryan, Anthony Kennedy (capt.), Denis Quinn, Liam Sheedy, Denis Hogan, Pat Sexton.



Toomevara Senior Hurling Panel County League Champions. . . Back row (l. to r.) Ken Hall, Ronan Tynan, Ciaran Fitzpatrick, Kevin Cummins, Tommy Carroll, Brian Duff, Francis Devaney, John Kinnirons, Pdraig Hackett, Tony Delaney, Ken Dunne, Andrew Ryan, Denis Kelly. Front row (l. to r.) Willie Ryan, John Boland, George Frend, Terry Dunne, Michael Bevans, Tomas O'Meara, John O'Brien, Philip Shanahan, Barry Dunne, David Kennedy, Paddy O'Brien.



Kildangan North Junior 'B' Hurling League Champions. . . Back row (l. to r.) John Harty, Martin Hogan, Conor Foley, Gary Corcoran, Niall Kelly, Colm Darcy, Eoin Kelly, Paul Hogan, John Slattery, Ger Quinn, Willie Seymour, Paul Gavin. Front row (l. to r.) Ollie Killeen (sel.), Paul Darcy, Andrew Murphy, Colm McGrath, Enda McGrath, Sean Gleeson, Seamus Gleeson, James Minihan, Eddie Fogarty, Michael Ryan.



Moneygall North Junior 'A' Hurling League Champions. . . Back row (l. to r.) Brian Gleeson, Thomas Harvey, Michael Dwyer, Damien Martin, Joe Smith, Ger Ryan, P.J. Hoolan, B. White, B. Fanning. Front row (l. to r.) Eamonn McCormack, Paul Smith, Michael Kirwan, Barry Ryan, Billy Hayes, Denis Dwyer (capt.), Tom Toohey, Billy McCormack, Paddy Fanning, Conor Ryan, Ger Moten, Paddy Guilfoyle.



Ballina North Junior 'A' Football Champions. . . Back row (l. to r.) Liam Sheehy, Kevin Cosgrave, Hughie Molloy, Michael Kennedy, James McKeogh, Stephen Stritch, Shane O'Brien, Aaron Devane (capt.), Peter King, Sean McKeogh, Domhnaill McKeogh, Liam Molloy. Front row (l. to r.) Christopher O'Meara, Kevin Ryan, Rody Kennedy, Martin McKeogh, Brendan McKeogh, Jerry O'Brien, David Hickey, Thomas Collins, Michéal Kennedy, Adrian Ring.



Kildangan North Intermediate Football Champions. . . Back row (l. to r.) Eoin Kelly, John Maher, Conor Hayes, Michael Ryan, Eddie Fogarty, Kevin Ryan, Darragh Egan, Ger Slattery, Liam Kyal Flannery, Denis Slattery, Brian Kelly, Dan Hackett, James Flannery, Liam Flannery (chairman). Front row (l. to r.) Liam Kelly (man.), Michael Slattery, Tommy Connors, Andrew Murphy, Karl Hogan, Liam Kelly, Brian Lawlor, Brendan Delaney (capt.), Patrick Lynch, Hugh Flannery, Sean Kelly.

# The Guardian

Est: 1838

*North Tipperary's leading newspaper*

**ABC** CERTIFIED



## **JOB PRINTING:**

*Ring us today for a competitive price for all your printing requirements.*

**Full Colour Printing**

*Specialising in Match Programmes for all Games*

13 SUMMERHILL, NENAGH, CO. TIPPERARY

Tel: (067) 31214 • Fax (067) 33401 • ISDN: (067) 50050

Email: [info@nenaghguardian.ie](mailto:info@nenaghguardian.ie) • [www.nenagh-guardian.ie](http://www.nenagh-guardian.ie)



Kildangan North Intermediate Hurling League Champions. . . Back row (l. to r.) Willie Seymour, Patrick Lynch, Karl Hogan, Darragh Egan, Liam Kelly, James Flannery (capt.), Brian Kelly, Tommy Connors. Front row (l. to r.) Hughie Flannery, Dermot Hogan, Brian McGrath, Eddie Fogarty.



Newport North Minor 'A' Football Champions. . . Back row (l. to r.) Nigal Ryan, Kieran McCabe, Noel Vaughan, Dermot Ryan, Mark Shinnors, Eoin Larkin, Conor O'Mahony, Leo Collins, Joe Powell, Christopher Connors, Eoin Shinnors, Shane Ryan, Vinnie Moloney, Philip O'Brien. Front row (l. to r.) Kieran O'Sullivan, Liam Ryan, David Quinn, Michael Ryan, Andrew Hickey, Christopher Doyle, Christopher Joyce, David Hayes, Martin Coffey, Daragh Ryan.



Burgess North Intermediate Hurling Champions. . . Back row (l. to r.) J.P. McDonnell (chairman), Paul Hogan, Darrell Tucker, Noel McDonnell, Robbie Cremin, David Ryan, John Scroope, Kevin Nealon, Brian Hogan, Tony Scroope, Damien O'Brien, Timmy Hogan, Kevin McDonnell, Shane Maher, Noel Gleeson, Peter Carroll, Liam Hogan, Patrick Tucker, Tony Gregan (sel.), Timmy Delaney (sel.), Johnny Flynn (sel.). Front row (l. to r.) Fergal McDonnell, Pdraig McDonnell, Garrett Howard, Shane Ryan, Colm O'Brien, David Maher, Eoin Hogan, Niall McGrath, Conor Quigley, Brian Duggan, Tommy Hanrahan, Jonathan Maher, Donal Hogan, Donie Nealon (sel.). Absent from photo John Flannery (sel.).



Newport North Intermediate Football Champions. . . Back row (l. to r.) David O'Gorman, Patrick Moroney, Richard Ryan, Eoin Larkin, Thomas Jones, Tom Moylan, Tom McGlinchey, Mick Coffey (capt.), Conor O' Mahony, Liam Jones, Vinnie Moloney, Eoin Shinnors, Michael, Ryan, Darren Quinlan, Eoin Bonfield, Jack Flannery (sel.). Front row (l. to r.) John Sheridan (sel.), Patrick Jones, Diarmuid Sheridan, Donnacha Houlihan, Martin McCabe, Andrew Hickey, David Hickey, Richard Brennan, Shane Ryan, Paddy Ryan, Dermot Boland, Kevin O'Brien, Timmy Floyd (sel.).



Templederry Sevens . . . Back row (l. to r.) Pio Kennedy, Tadhg McLoughlin, Eoghan Kinane, Paul Butler, Thomas McCutcheon. Front row (l. to r.) Aidan Ryan, Eanna Murray, Tom Ryan, Michael Russell, Brian Stapleton.



Templederry North U-12 Hurling Champions. . . . Back row (l. to r.) Dale Donnelly, Danelle Slattery, Leanne O'Dwyer, Simon Ryan, Paul Butler, Eanna Murray, Pio Kennedy, Aidan Ryan, Gerald Hogan, Brian Carey, Richard Walsh, Brian Stapleton. Front row (l. to r.) Patrick Griffin, David Butler, Donal Kennedy, Pdraig Gleeson, Joseph Shanahan, Eanna Ryan, Jamie Ryan, Matthew Hogan, Shane Kinane, Mark Grisewood, Edward Hynes.



Templederry North U-16 Hurling Champions. . . . Back row (l. to r.) Aidan Ryan, Dan Fahey, Pdraig O'Leary, Donal McGrath, Thomas Stapleton, Matthew Ryan, Alan Carey, Pat Ryan Gerard Kennedy, Gearoid Ryan, Eoghan Ryan. Front row (l. to r.): Denis Corcoran, Tadhg McLoughlin, Ronan Kinane, Tom Ryan, Christy Coughlan, Stephen Smith, John Fogarty, Paul Murray, Tommy Hogan



Templederry Senior 'C' Hurling League Champions. . . . Back row (l. to r.) Pdraig Ryan, P. Minogue, D. Madden, Ml. Ryan, D. Quinn, Ml. Ryan, T. Minogue, D. Bourke, M. Ryan, C. Ryan, G. Ryan, D. Kennedy,. Front row (l. to r.) P. Ryan, D. Collins, Paul Ryan, John Kennedy, Seamus Kennedy, P. Ryan, D. Corcoran, J. Hogan, D. Harkin, J.J. Daly.

*creating the perfect  
financial environment*



*one business contact  
worth hanging onto*



CONTACT DETAILS

Michael Ryan, ACCBank Thurles - 0504 21399

Mark Bourke, ACCBank Clonmel - 052 27331

Mairead Ryan, ACCBank Nenagh - 067 31177

ACC BANK plc is licensed by the Central Bank of Ireland



# Ballina under-21's enjoy great year



Ballina Under – 21 Hurling Team – North Tipperary Champions . . . Back Row (L to R): Willie Nolan (Selector), Peter King, Martin Mc Keogh, Shane O'Brien, Roddy Kennedy, Gerard Sheehy, Robert Nolan, Shamus Larkin, Noel Moroney, Jerry O'Brien, Stephen Stritch, Eoin Sheehy, T.J. O'Connell, Eoin Kennedy & Pat Sheehy (Selector). Front Row (L to R): Brian Mc Keogh, James Mc Keogh, Thomas Collins, Cathal O'Connell, Domhnall Mc Keogh, Sean Mc Keogh, Patrick Cosgrove, Kevin Ryan, David Hickey, Kevin Cosgrove, Patrick Kennedy & Brendan Mc Keogh (Selector). Mascot: Stephen O'Brien.

**B**allina under-21 footballers made history this year as they brought the first ever county under-21 title to the parish. On Sat 26th April, Ballina beat Killenaule in the final in the Ragg, The club's second team also played the county under-21 C final on the same day at the same venue, but had to give way to Aherlow.

This talented group also contested and won the North Tipp under-21 A hurling final as well as losing the divisional under-21 C hurling final. A sizeable number of these players were part of the club's winning junior A Football team, which won the divisional junior titles in 2002 & 2003.

Ballina began the year by playing in the 2002 county junior football final & replay against Upperchurch/Drombane. In the end Ballina had to give way to a stronger & more experienced Upperchurch side.

The North Tipp under-21 football & hurling campaigns also took place in March/April period. In the A Football championship Ballina scored easy wins over Ballinahinch & Newport. The North final was also against another neighbouring parish, Burgess, but again Ballina had a bit to spare thus reversing the final result of 12 months previous. The club's second team were the only team in the North Tipp Under-21 C football championship and represented the division in the county stages.

In the county semi-finals Ballina beat Moyne/Templetuoehy in the A semi-final & Clonakenny in the C semi-final to set up a historic day in The Ragg. The first game on the day was the C final against Aherlow. The boys from the west were far superior on the day and fully deserving of their victory as Ballina never produced the same type of football as they had against Clonakenny.

Our under-21 A side then took on Killenaule. These sides met in the county under-16 final of five years previously as well as meeting in the county under-21 B final of 2000. Ballina had won the under-16 & Killenaule had won the under-21.

Ballina played with the wind in the first half and struck for two vital goals to move into a commanding half-time lead. A big onslaught was expected from Killenaule in the second half & this duly came. However Ballina's rearguard held and with

our forwards tacking on some good scores Ballina won by four points.

#### PATH TO THE FINALS:

- A Football:** Beat Ballinahinch in North quarter-final 3-12 to 0-07 at Ballina on Mon 17th Mar  
Beat Newport in North semi-final by 2-11 to 0-10 at Ballinahinch on Sat 22nd Mar  
Beat Burgess in North final by 2-07 to 0-04 at Nenagh on Sun 13th Apr  
Beat Moyne/Templetuoehy in county semi-final by 3-07 to 2-06 at The Ragg on Apr 18  
Beat Killenaule in county final by 2-08 to 0-10 at The Ragg on Sat 26th Apr.
- C Football:** No Competition in North Tipp  
Beat Clonakenny in Co. S-final by 2-13 to 0-07 in Toomevara on Sat 19th Apr.  
Lost Aherlow in Co. Final by 0-02 to 2-11 at The Ragg on Sat 26th Apr.

During this time most of the players were also playing under-21 Hurling in either "A" or "C" championships. Ballina took on Toomevara in the quarter-final. This was a very competitive game in Nenagh with little or nothing between the sides at any stage. Ballina were the more balanced side and this was probably the telling factor in their win. Roscrea were next on the list in the North semi-final. Here Ballina set out their stall from the start and played with great commitment & discipline through out to win. The final was a repeat of last year's decider between Ballina & Burgess. Burgess had won the previous and Ballina were determined to succeed on this occasion, with nearly all players having been on the defeated side the previous year. Ballina played well on a wet evening in Nenagh to win their first ever North Tipp under-21 A hurling title and thus complete the hurling/football double.

Thurles Sarsfields were our opponents in Dolla in the county semi-final & how the Sars must love the second half of games in Dolla. Just like our neighbours Burgess in 2002, we entered our game as underdogs. Again like Burgess the previous year we proceeded to play some brilliant hurling in the

**Best Wishes to all Clubs and Teams in Tipp in 2004**

from

# **Clodagh Ironworks Ltd**

Pallas, Borrisoleigh

**Suppliers of  
Ornamental Gates  
and Railings,  
all types of  
Farm Buildings,  
Galvanised  
Cattle Crushes,  
Gates,  
and  
Cattle Grids**



**We also supply portable and permanent Goal Posts, Dug-Outs,  
Score Boards, and Galvanised Mesh Window Protectors  
suitable for all types of dressing rooms and pavilions**



**Galvanised and Powder Coated Security Fencing also available**

***Quality Work and Personal Attention Assured***

Contact Jonathan Cullen  
on 0504-51508 or 087-6579328  
E-mail: [clodaghironworks@eircom.net](mailto:clodaghironworks@eircom.net)

***You've tried the rest, now try the best***

first half and led by 12 points coming up to the interval and a real shock looked to be on the cards. Fifteen minutes into the second Ballina still seemed to be in command, but slowly Sarsfields clawed their way back into the game. As the game entered stoppage time the sides were level. However Sarsfields took the lead for the first time in the game in injury and ended up winning by 7 points. Heartbreak for Ballina, joy for Sarsfields after a great game.

Our second under-21 team also showed great courage & determination. They had a surprise win over Portroe in the North semi-final and advanced to meet Shannon Rovers in the final. On this occasion Shannon Rovers were a bit ahead of Ballina, but none the less the lads in Blue did themselves & the club proud.

#### PATH TO THE FINALS:

- A Hurling:** Beat Toomevara in North quarter -final 1-18 to 2-11 at Nenagh on Sat 5th Apr.  
 Beat Roscrea in North semi-final by 3-12 to 0-06 at Nenagh on Mon 21st Apr.  
 Beat Burgess in North Final by 4-11 to 2-07 at Nenagh on Sun 4th May.  
 Lost Thurles Sarsfields in Co. S-final by 3-12 to 4-16 at Dolla on Fri 20th Jun.
- C Hurling:** Beat Portroe in North S-final by 2-07 to 1-09 at Kilcolman on Sat 12th Apr.  
 Lost Shannon Rovers in North Final by 3-05 to 2-12 at Puckane on Tue 22nd Apr.

A number of players also received county recognition in Intermediate Hurling (Pat Cosgrove), Junior Football (Peter King), Under-21 Football (Peter King, David Hickey, Sean & Domhnall McKeogh), Minor Hurling (Shane O'Brien) & Minor Football (Shane & Jerry O'Brien & Martin Mc Keogh while Liam Molloy was a selector). Declan Gleeson won a Peadar Cummins Under-14 Hurling Medal with North Tipperary.

### Ballinahinch, Junior A Hurling, Junior B Football Co. Tipperary Champions 2002/03 and Munster Junior A Hurling Finalists 2003



Back Row, left to right; Ger Griffin (selector), Dermot Gleeson, Ger Griffin, Brendan Healy, Christopher Brennan, Donnacha Ryan, Des Kelly, Cathal Bourke, Michael Carroll, Michael Lenihan (selector). Front Row, left to right; Michael Healy (manager) Shane McGrath, Dermot Healy, Marcus Ryan, John Foley, Adrian Kelly, Alan Kelly, Philip Kelly, John Collins (Trainer).



North Tipp chairman 2002/03, Tom Slattery, John McGrath - chairman, Ballinahinch GAA Club, Cathal Bourke - secretary, John Carey - treasurer.

### Ballinahinch U-16 'C' Football Co. Champions 2003



Back Row, left to right: Cathal Bourke (sel.), Jamie Flynn, Lawrence Hogan, Donnacha McGrath, Tony Finn, Timmy Ryan, Sean Berkery, Liam Lynch, Ger Griffin (sel.). Front Row, left to right: James Younge, Thomas Grace, Mark Kelly, James Hickey, Cormac McGrath, Brian Mulcahy, Shane Healy, Thomas Moynihan, Ger O'Reilly (manager).



# The Horse & Jockey Inn

Standing at one of the traditional great crossroads of Ireland, halfway between Dublin and Cork, the Horse and Jockey Inn has always been the common social ground for those with a passion for equestrian or GAA sports.

Now, The Horse and Jockey Inn has changed and extended in layout and size.

Added to the existing spacious lounge, bar and high quality restaurant, are the 31 bedrooms and 2 suites with state of the art facilities throughout, along with the best a busy conference centre can offer.

For information Tel 0504 44192

Proud Sponsors  
of  
**Cipperary Camogie Team**

# The Sweetest Victory of all

September saw the All Ireland senior camogie title and the O'Duffy Cup regained by a superb Tipperary team, with victory over Cork. Their great southern rivals had deprived them of a four-in-a-row achievement twelve months earlier. The September 21st win left no doubt whatever as to Tipp's worthiness to be hailed as the queenpins of the modern camogie era.

To try to fully evaluate what winning the All Ireland senior title meant for Tipp, one has to cast the mind back one year previously to the same venue, the same occasion, but a very different result.

Tipp's four-in-a-row dream was ruthlessly snatched from them by a very determined Cork side that didn't stand on ceremony in the second half. There were no excuses, really, beyond the knowledge that Tipp had not played to their potential, each one well aware that as a team, they hadn't lived up to their pre-match favourites status.

Was it the end of an era?

Team manager Michael Cleary felt he had no more to offer and was anxious to hand over his role to another, his attention instead turning later towards leading the newly formed Supporters Club.

The players?

Yes, they were disappointed, none more so than full back Una O'Dwyer, who felt a personal pain in her inability to follow Cashel club mates Maedhbh Stokes, Jovita Delaney and Emily Hayden as victorious All Ireland captains.

But these girls were nothing if not resilient. Imbued with the conviction that Tipperary had much more to offer and that the camogie world deserved to see them display again the rich talents developed over the previous four years, there was unanimity that every effort be made to make 2003 a year of atonement.

Enter Raymie Ryan.

The Cashel man, himself a proud and effective wearer of the blue and gold and still giving excellent service in the red and green of the King Cormack's, was prevailed upon to assume the hot seat vacated by his former inter-county hurling colleague Michael Cleary. Not an easy decision to take, by any means, not only because of what the Nenagh man had brought in terms of leadership and guidance, but also because of the rapport Michael (with his selectors Bidy Phillips and Jim Madden) had built up with all the players.

It was to Raymie's credit that he was prepared to accept the position, his decision helped enormously, of course, by the spirit of the players and their determination to row in entirely with him and his selectors Marion Graham and Conor Ryan.

## PLOTTED AND TRAVERSED

It was in February that Raymie first met



the players officially and from there on, the road back to the top of the camogie ladder was plotted and traversed.

The national league was the initial step along the journey, a competition Tipp had won on only one occasion, the first year of its place on the camogie calendar, 1977.

Final day saw Tipp travel to Pairc Ui Rinn where a late rally saw Cork notch four precious points for a 3-13 to 2-12 win. Tipp were without Jovita Delaney, Claire Madden, Emily Hayden and Philly Fogarty, along with losing Therese Brophy early in the game through injury. Philly Fogarty entered as a sub and while defeat was somewhat disappointing, it was evident that Cork's fitness levels for the time of year were higher. No great worry then, the season was only now beginning to move in earnest and there would be other opportunities to reclaim lost ground.

There was never going to be any doubt that Tipp and Cork would compete for Munster's top prize but it surely was a unique occasion that it be played in another province, in Portlaoise AND as a curtain raiser to an All Ireland senior hurling qualifier between Tipp and Laois.

Things certainly looked bleak for Tipp at halftime when Cork led by 1-7 to 1-1 but what a second half transformation with Deirdre Hughes adding to her first half goal by blasting home a farther three in a 5-3 to 1-9 victory.

Injury kept team captain Una O'Dwyer out of action, Paula Bulfin an able replacement to lead the side and receive the trophy.

Later on, in the course of an interview with me prior to the All Ireland final, Raymie had no doubt that the Munster final had been won in the dressing room at halftime. He didn't care to elaborate other than to claim that something happened during the interval to turn around the lead and he stressed that team management had nothing to do with it. Win-

ning the game, said Raymie, was important in that it provided a title, but of far greater importance as he saw it, was the attitude of the players as demonstrated at half time in Portlaoise.

It was this attitude .. and one must read between the lines as to what actually transpired! that provided the conclusive evidence that in his charges, Raymie Ryan had a group that was laden with character, a group that would leave nothing undone to get their hands on the O'Duffy Cup once more.

## ALL IRELAND CHAMPIONSHIP

The All Ireland championship. A change in the method of its organisation from previous seasons in that eight teams were divided into two groups of four, and under a round robin system, four would emerge to the semi finals.

Tipp were there along with Wexford, Limerick and Dublin, the other group containing Cork, Kilkenny, Galway and Antrim. There was a certain perceived imbalance in the quality of the two groups, Tipp seen as having a relatively easy passage. However, an All Ireland championship is like no other and though Tipp might be confidently expected to emerge from their group, equally, the other teams could be expected to lift their game to challenging heights.

Over to Cashel came Wexford for Tipp's opening game and it proved to be the toughest of the group matches, Tipp conceding twice as many goals (4) than in the entire remainder of the season (2). Still, a 5-7 to 4-3 score line saw Tipp move on comfortably enough.

It was a very warm Saturday evening when we set out for Ballingarry in Limerick and a game against Limerick.

When the teams were ready and everyone else that might be expected to be there was there, honor of horrors, no referee. The appointee eventually made contact with Ballingarry to reveal having arrived in Ballingarry .. but not the match venue. Instead, it was Ballingarry in South Tipp!





A huddle between officials from both counties saw the whistle handed over to a Limerick official, Noel O'Connor, and a fair and efficient job he did too.

In a game which Tipp won by 3-12 to 1-9, advancement to the semi final was now secure, the last group game against Dublin, coupled with the meeting of Wexford and Limerick, merely to decide who would head the group and who would be runner-up. Jovita Delaney made a welcome return to her 'between the posts' position that evening in Ballingarry, after a long lay-off due to injuries received in a car accident. That game too saw Una O'Dwyer back in action after injury, being a second half mid field replacement. The road to the St Vincent club grounds in Dublin proved to be far rockier than might have been imagined in view of the Dubs defeats by both Wexford and Limerick. The score line of 5-16 to 0-2 clearly suggests a rout by the visitors but for all that, Dublin's physicality took much from the game as a spectacle. No doubt, intent on making their presence felt as effectively as possible, they ensured that some Tipp lassies returned home with some bruises to shows for their exertions!

No matter, there was now only one step separating them from a fifth All Ireland final appearance in a row. Limerick were also through from the group.

As Galway were runner-up to Cork in the other group, it was thought that the semi finals would see Tipp out against Galway and Cork against Limerick.

But no.

An open draw was decided upon, a decision that could well have backfired on the Association by bringing Tipp and Cork into semi final opposition, with Limerick and Galway in the other. With all due respects to the latter two, the prospects of a one-sided All Ireland final would have been there had the great Munster rivals been drawn as semi final opponents.

Luckily, Tipp and Cork avoided each other, the draw revealing another Tipp/Limerick clash and another Cork/Galway game, Cusack Park in Ennis was the venue for both, played as a curtain raiser to the Tipp and Galway All Ireland under 21 hurling semi final. Tipp and Limerick went into action first, and again with a change of referee! The appointed

lady and her officials, travelling all the way from Armagh got caught in traffic

in Ballinasloe. Fortunately, a deputy had been appointed and was present, Aine Derham, the Dublin official doing her usual efficient job.

Though Limerick had improved from the Ballingarry game, there was still no denying Tipp, a 4-16 to 0-10 margin telling its own tale.

Cork also scored 4-16 in their game against Galway, conceding but three points and the scene was again set for another Tipp/Cork final battle.

#### FINAL DAY

All Ireland final day coincided with the launch of a new camogie magazine "CO., Camogie Girls" and a glance through a section on the likes, the influences etc of the Tipp players, saw ballet (with horse riding) listed as one of Ciara Gaynor's hobbies! There would be no place for ballet that afternoon. The gauntlet had been thrown down, this would be a war of attrition as the country's two top teams set themselves up for glory in the presence of over 16,000 people, with hundreds of thousands more viewing the action on television.

The 2-11 to 1-11 score line might suggest a close game but it wasn't. Cork's goal came four minutes into added time and there had never been any real doubt as to the destination of the O'Duffy Cup because of Tipp's power packed play.

Mind you, several scores were missed in the first quarter, whereas in two attacks, Cork used them advantageously to send over two points.

The score that would set Tipp up came five minutes before the break. With Cork ahead, 0-4 to 0-2, Una O'Dwyer made a long clearance, Eimear McDonnell collected and set off goal wards, a goal very much in her mind. Leaving opponents in her wake she kicked the ball into the Cork net to the rapturous roars of the Tipp fans.

Though Cork came back to lead 0-7 to 1-3 at halftime, one sensed the corner had been turned by Tipp. That view was endorsed no fewer than forty seconds into the second half when a Therese Brophy clearance reached Deirdre Hughes who stunned the Cork defence with a blistering shot and with it Tipp's second goal.

This was a real tonic score and it deflated Cork considerably, so much so that an element of frustration began to creep into their game. This became all the more acute, when the Tipp defence solidly and defiantly put up the shutters, lifting their performance to a degree unimaginable and in heroic fashion. Cork forwards who brought impeccable credentials into the game found no way through. Farther out, the Tipp mid fielders and attack complemented the defence work with strong hurling and telling scores, the Cork mentors forced to ring the changes in order to make some impact on a game that was definitely oiling its way away from them.

In typical Cork manner, they didn't give in, thus ensuring a nail biting finish as they strove to hold on to their title, only to concede to an opposition that had no

notion whatever of allowing them snatch the game away.

It was Tipp's day. Lost ground had been reclaimed without a shadow of a doubt and Una O'Dwyer's face as she received the O'Duffy Cup from Camogie President Miriam O'Callaghan, coupled with her magnificent address, summed up more than adequately the feeling in the Tipp camp.

Out on the spacious Croke Park sod Raymie Ryan looked on, scarcely able to take it all in. His face radiated with joy, satisfaction and immense pride.

It had all worked out for him. His initial year on the camogie scene could not have had a more satisfactory result.

Four All Ireland titles in five years. Who would have believed it?

#### THE FUTURE

Does it all end there?

Keeping up the momentum can't be easy and exorcising the disappointment of 2002 has to be seen as something that has sent Tipp camogie back on a high pedestal, the highest in the land.

It is still a youthful team, with plenty to give to a game it has adorned with such distinction over the past half decade.

What motivation is required to keep it up?

Well, the first title was won in the year in which the complement of players was brought up from twelve to fifteen a side and the pitch extended to its full GAA size (1999). Tipp also had the distinction of winning the last final of the 20th century and they followed that up by becoming the first holders of the O'Duffy Cup of the 21st century. Next came three in a row (2001) and while the bid for four in a row failed (2002), they bounced back this year in their fifth successive All Ireland final appearance to reclaim the title.

Next year?

2004 sees the Camogie Association celebrate its centenary and Tipp go into that year as All Ireland champions. Surely seeking to retain the title in such an historic year is motivation enough to stay at it?



# Raymie Ryan Interview

By County PRO Ed Donnelly

**T**he Tipperary senior camogie team won the All-Ireland final in 2003. While most of the winning panel were involved in the three-in-a-row successes from 1999 to 2001, the team had a new manager in 2003. Faced with the task of replacing the very successful Michael Cleary, the new manager Raymie Ryan set about trying to retain the O'Duffy Cup. This was achieved along with success in the Munster final as the camogie team won their 4th All-Ireland title in 5 years. When the season ended, I caught up with Raymie Ryan for a chat. This is what transpired.

**ED** - Congratulations on your part in Tipperary's success in this year's camogie championship. What would you say has been the most memorable part of this year's campaign?

**RR** - The most memorable moment was when the final whistle went in the All-Ireland final. It was one of the best feelings you can possibly have when a Tipperary team wins an All-Ireland. It's a lot different when you are with the group of players since March, and you see them develop, improve themselves, get fit and mentally prepared for the final. The win in the All-Ireland brought the curtain down on a successful year.

**ED** - You had success with Cashel and Tipperary as a player in the past. How did the camogie victory compare when you were now involved as a manager?

**RR** - It's the same. Winning is what it's all about. There is no place for second place. You won't win as many games as you lose. If you are lucky, you might win one or two All-Irelands in your career but when you do win one, it's a great feeling.

**ED** - As a player, did you ever look to the future and think that you would like to get into team management?

**RR** - No. As a player, all you are thinking of is the next game. I remember saying once: "Who would be a manager or a selector?".

**ED** - Playing with Cashel and Tipperary at all levels, what managers impressed you and is there any 1 manager who you would say you learned the most from?

**RR** - Throughout a playing career, you will always have plenty of managers. If you take the Tipperary senior hurling manager, there have been six different managers in charge since 1994; Babs Keating, Fr. Tom Fogarty, Len Gaynor, Nicky English, Michael Doyle and now Ken Hogan.



Tipperary camogie manager Raymie Ryan gives instructions in the All-Ireland Final.

And then you have club managers as well. You try and pick up ideas from them all and then come up with what you think is the best approach. If I was to pick one, then Justin McCarthy would be the one I learned most from when he was manager of Cashel in the 1990's.

**ED** - Would you like to try your hand at team management in hurling in the future?

**RR** - I never really thought of it. I possibly would. Hurling is addictive. When you are not playing it, you want to be involved in it and I think of hurling as part of my social life - I just love hurling. I love skilful hurling. The best game in the last ten years would have been the All-Ireland semi-final in 2002. The quality in that game was fantastic and that is the type of hurling you are looking for.

**ED** - The present camogie team is recognised as being very skilful. Coming in to the job, did the level of skill among the players surprise you?

**RR** - I was told they were skilful. But after watching them for the year, there is nothing they can't do. They can be stubborn, they can be skilful, they can be tough and they can be resilient. Every night, someone will do something special in training, be it as back or a forward and it makes training something to look forward to.

**ED** - Going back to your playing career, at what level did you first play for Tipperary?

**RR** - I was probably late starting. In 1988, when I was 17, I made the Tipperary minor team. Funnily

enough, I could not make the panel earlier in the year but luckily was called in and made the championship team. The following year, I played minor again and was called in to the under-21 panel for the All-Ireland final in Portlaoise. At the time, things happened so fast that I probably didn't appreciate it but it's nice to look back at those times.

**ED** - How important is the Cashel King Cormacs club to you and your development as a hurler?

**RR** - Without a strong club behind you, a hurler won't develop. It's the players within that club that will develop you. I remember being 16 or 17 and playing under-21 and senior. You are playing on the same field as Colm Bonnar, Pa Fitzelle, Tony Slattery and Tommy Grogan and these types of players and you are learning all the time from them.

**ED** - In 1991, Cashel won the county final for the only time in their history. They then went on to win the Munster club title, before losing out to Kiltomer of Galway after three epic matches. What was the highlight of the 1991 season for you?

**RR** - The highlight was the final whistle in the county final in Thurles after beating Holycross. That was the Holy Grail. Everything after that was a bonus. The biggest disappointment of my career was when we lost to Kiltormer after three games. They were brilliant matches but it's a winners' game.

**ED** - When did you first break in to the Tipperary senior hurling panel?

**RR** - In April 1992, I played a

challenge game for Tipperary against Clare in Cahir. The next two games were then the league semi-final and final. I did not play well in the league final so I lost my place for the championship. There was no back door in those days so when Cork beat us, that was it.

**ED** - *Is it a regret that you never won an All-Ireland medal or even played in an All-Ireland senior hurling final with Tipperary?*

**RR** - It's the goal of every inter-county player to win an All-Ireland. If you don't do it then there is nothing you can do. There are a lot of players out there who have not won All-Ireland medals but still enjoy hurling. I would have liked to have won an All-Ireland but it just didn't happen.

**ED** - *As a native of Cashel, how familiar were you with the success of the local camogie team from the town in recent years?*

**RR** - I was aware of their success and would have attended a few of their games. I was asked on two occasions to train them, and through that I was familiar with their success and their ability.

**ED** - *Your first big match in charge was against your old rivals Cork in the Munster final at Portlaoise. How important was the Munster final victory in putting down a marker for the year to come?*

**RR** - It definitely was a marker. At that stage, Tipp had been beaten by Cork four times without a response. We were beaten in the league final earlier in the year but that would not have been a major loss because it was my first time seeing Cork. A few things did not go right on the day and that was a learning curve for me. If we had lost the Munster final, it would still have been a learning curve but as it turned out, it was the watershed for the year. At half-time that day, we really kick-started our year. We didn't play particularly well in the first half and our work-rate was not high enough, the girls would know that themselves. They were showing the Cork team too much respect.

**ED** - *Tipp qualified for the All-Ireland final with a number of good wins. With Cork in the final again and bearing in mind the 4 goals they had scored in the 2002 final, what tactics did you use to ensure that the defence improved this year?*

**RR** - The team conceded four goals in last year's All-Ireland and three goals in this year's league final. When you concede a goal at this level, it's very hard to get it back at the other end, especially when you are up against a good Cork back line. The key is to stop the supply going in to the

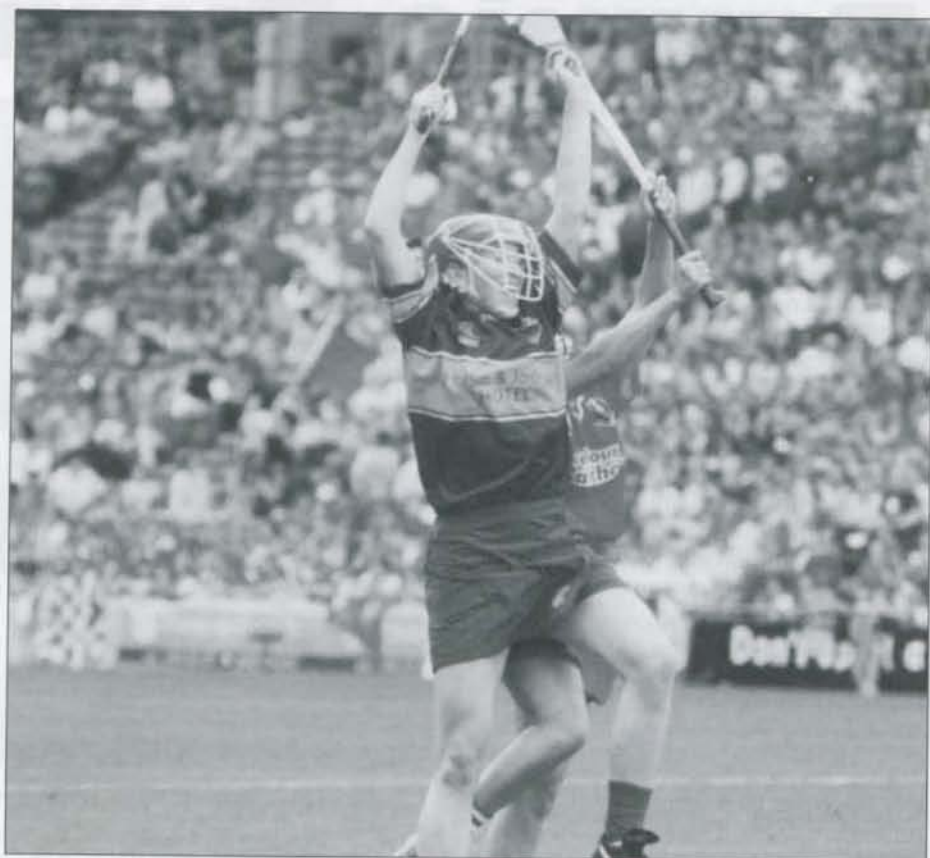

*Philly Fogarty goes high in the All-Ireland final.*

full-forward line. The key to defending is to start with your own corner-forward. In this year's final, Emer McDonnell and Deirdre Hughes both got in blocks on the Cork goalkeeper. They would not allow them the time and space to get in a long clearance. If the ball is not coming down fast, then as a backline you have time to organise yourself. Having said that, the Tipperary back line needed to keep control in the backline. They showed the required aggression to win the game.

**ED** - *What would you say is the main difference between camogie and hurling at the top level?*

**RR** - The only difference is the power and strength of the players, and the publicity.

**ED** - *It has been said that this Tipperary team is one of the best camogie teams of all time. Together with Cork, the standards in camogie have been raised. However, camogie at present is very much a two-county competition with everyone else behind Cork and Tipperary. Would you like to see the standards improving in other counties to ensure a better camogie championship in the future?*

**RR** - At certain times, you will get teams who will dominate certain championships for a few years. In the mid-70s in football it was Dublin and Kerry. It was Tipp and Cork in the late 80s and early 90s in Munster hurling. Tipp and Clare were hammer and tongs as it in the late-90s. Other

teams will always come on. You can't keep winning All-Irelands although we will always try. Another team will come, be it Galway, Kilkenny, Limerick or someone else. I do agree that Tipp and Cork have brought the game to a new level with their training methods and the amount of preparation they put in to it.

**ED** - *The Tipperary camogie team are at present planning a well-deserved holiday in Florida. What kind of fund-raising activities are planned to fund this holiday?*

**RR** - We have official team photographs and a calendar. There is also going to be a fund-raising game after Christmas between the All-Ireland winning masters team and the camogie team and hopefully we will get a good attendance. Those in attendance that day might be treated to something they may have never seen before. Men over forty wearing dresses should be interesting!

**ED** - *What would you say Tipp's chances are of winning the All-Ireland title in 2004?*

**RR** - It is totally in their hands. It's not in Cork's hands, or Clare's or anybody else's. It's totally in their own hands to win that All-Ireland. We just have to wait and see how they react. You are at your most vulnerable when you are champions but maybe this group will show beyond doubt what a great team they are.



# Tipperary Players

dominate

# All-Star Awards



**TIPPERARY CONTINGENT AT ALL-STARS AWARDS**

Seated (l-r): Finoala Grogan, Jean Hayden, Antoinette Delaney, Kathleen Hughes, Miriam Úi Cheallacháin (Uachtaran), Stephen Fitzgerald (Chairperson Tipperary Camogie Board), Marion Graham. Back: Jovita Delaney, Biddy Philips, Maria O'Dwyer, Deirdre Hughes, Therese Brophy, Martin O'Dwyer, Claire Grogan, Jovita Delaney, John Grogan, Eimear McDonnell, Eamonn Moloughney, Deirdre McDonnell, Ciara Gaynor, Mary Rose Ryan, Liz Howard.

**C**amogie's first ever All-Star team saw Tipperary dominate with no less than seven deserving players featuring.

Cork are represented by four players, while Limerick have three and Antrim have one, while noticeably there are no players from either Connacht or Leinster.

The All-Stars scheme is the latest step in camogie's marked modernisation in recent years and the inaugural team announcement on Tuesday last was also made in conjunction with the launch of the association's centenary year celebrations for the coming season.

The All-Star team is sponsored by Lynch Hotels, and the players are named the '2003 Lynchpins'.

The historic first selection comes at a time when camogie is at its strongest in Munster and particular in Tipperary. Would Deirdre Hughes have dreamed five years ago that she would have picked up four All-Ireland medals and become an All-Star as we celebrate the century of our association?

Tipperary goalkeeper Jovita Delaney, defender and captain Una O'Dwyer, who unfortunately is missing the celebrations as she explores greener pastures down under in 'Aussieland', Ciara Gaynor and Therese Brophy, and

in attack Deirdre Hughes, Claire Grogan and 'Texaco Award Winner' Eimear McDonnell.

The team of the century will be announced at the Centenary Banquet on February 28th and we look forward to a representation from Tipperary.

The All-Stars scheme will continue under the current sponsorship for the next two years. The 'Lynchpins' are also part of a 40-strong team of specially selected camogie 'ambassadors' who will be used to promote the game over the coming season. Tipperary's ambassador is non other than the the 1999 All-Ireland captain fantastic Meadhbh Stokes.



**TIPPERARY ALL-STARS**

From left: Maria O'Dwyer on behalf of Una, Jovita Delaney, Ciara Gaynor, Deirdre Hughes, Therese Brophy, Claire Grogan, Eimear McDonnell.

# Interprovincial Competition (Gael Linn)

## Tipperary Girls Give Superb Display

### SENIOR FINAL

MUNSTER 3-13 ULSTER 1-9

### JUNIOR FINAL

MUNSTER 4-7 ULSTER 0-5

**T**ipperary was well represented on Saturday last and gave a fine account of themselves in both the junior and senior gael linn competition. In the senior competition Munster took their 17th title and captured a three in a row by defeating Ulster 3-13 to 1-9 in the final, while in the opening game they had a comprehensive victory over Connaught.

In the final Munster had to line out with Ciara Gaynor who had picked up an injury in the opening game. Ulster lead at the break by 1-6 to 1-4 playing with a strong breeze, Munster's goal coming from Eileen O'Brien. However Vera Sheehan (Limerick) playing at centre forward and Joanne Ryan (Tipperary) and Eileen O'Brien (Limerick) playing on both wings dug deep with Joanne

By: MARION GRAHAM

securing two goals and Ulster failed to answer some fine Munster scores.

Tipperary were represented on the senior team by Sinead Nealon playing in her usual wing back position played some fine camogie and was instrumental in securing Munster's 17th title. Angie McDermott playing at mid-field covered miles in both games, while up front Joanne Ryan had her name on the scoreboard for both games scoring 2-1 in the final. Paula Ryan completed the Tipperary contingent as substitute goalie.

In the junior game Tipperary had a larger representation. Paula Ryan picked up her second medal of the afternoon in goals for Munster juniors and indeed had a star game between the posts in both the semi-final and final. Helen Breen at full back was stalwart while Meadhb Corcoran revealed

her experience at senior ranks with Tipperary. Lorraine Bourke at mid-field did trojan work while Trish O'Halloran, Michelle Shortt and Geraldine Kinnane in the forward line were a thorn in the sides of both Connaught and Ulster teams. Sharon Ralph and Deirdre McDonnell completed the Tipperary representation and when introduced in both games accounted well for themselves.

Three first half goals in the final from Val O'Keeffe (Cork) and Michelle Shortt set Munster up for a comfortable half-time lead of 3-1 to 0-5.

A superb Munster defence and mid-field display against a fierce wind kept Ulster forwards at bay in the second half to ensure a comfortable victory 4-7 to 0-5.

Well done to all the above mentioned Tipperary players and the management of both teams Marion Graham (Senior) and Martin Browne (Junior).

## TIPPERARY JUNIOR COUNTY TEAM

**O**n Saturday, March 15th Tipperary Junior Team had their first outing with a League game against Dublin in the County Grounds and Tipperary defeated Dublin by 2-4 to 0-6. This was a great start and gave them confidence for their next game which was to be against Antrim in Antrim the following Sunday but poor weather conditions would only allow one game to go ahead in the Loughale Pitch in Antrim and the Junior game was put back to another week end.

Unfortunately this was the only victory the Tipperary Junior experienced in the league campaign with defeats by Derry 3-7, Tipperary 2-9 and a further defeat by the eventual winners of their section Armagh had them out of the league by the time the re-fixtue against Antrim was finalised and Tipperary failed to field in this game.

However when the championship came about Tipperary made a gallant bid for the Munster title.

On Wednesday April 23rd Tipperary had a comprehensive 7-17 to 0-0 victory over

Limerick and so went on to play dare in the semi-final on Monday May 4th in the County Camogie Grounds.

Tipperary bowed out of the Munster Junior Championship when a strong and experienced Clare team defeated them by five points.

Tipperary set the pace and took the lead in the opening five minutes but this was shod lived and the only time Tipperary were in that position, because from here on Clare dominated and led at the break by 24 to 0-7.

The second half continued as the first with Clare securing four points before Tipperary put their first point over from Marie Harkin in the 43rd minute, two minutes later Marie Harkin had the ball in the Clare net with a brilliant finish from a melee in the goalmouth and left just a goal between the sides.

From here on it was tit for tat from both sides but in the end it was the most experienced Clare unit that held out in the end with a final score of 2-13 to 1-11.

Tipperary Team: Danielle O'Connell, Sam Hayes, Caroline Greed, Trish Ryan, Julie Kirwan (0-1), Helena Costigan, Linda Breen, Fiona Loughnane, Melissa Stapleton, Marie Harkin (0-3), Jacqueline O'Connor, Geraldine Kinnane (0-3), Eimear Ryan (0-2), Breda O'Neill, Michelle Shortt, Roseanna Kenneally, Theresa Maxwell, Una O'Rourke, Deirdre Quigley, Mairead Berkery, Mairead Byrne, Margruiite Ryan, Breda Cosgrove.



????

# TIPPERARY CAMOGIE SUPPORTERS CLUB



In September 1999, Tipperary senior camogie team won it's first ever All Ireland senior title. The euphoria that surrounded this win was evident right around the county and beyond, so much so that a feeling emerged from the sporting public that these ladies were entitled to a holiday, as a reward, just like their male counterparts, had been afforded for many years. With permission from the county board, all concerned set about fund raising through the sale of a team photograph. After a very successful fund raising effort the team were rewarded with a much deserved week away in the holiday resort of Linarite.

September 2001 Tipperary Senior camogie team completed a historic three in a row. Tipperary Supporters Club came about initially from the media coverage, which highlighted the fact that Tipperary senior All Ireland champions were going on a holiday to Cape Town, while their female counterparts who had reached the same heights in camogie could not raise enough funds "To take them to Ballyunion". It highlighted the different levels that existed within the G.A.A. circles and Cumann Camogaiochta Na nGael.

This was a major factor in the inaugural meeting of Tipperary Camogie Supporters Committee held in The Horse & Jockey in January 2002.

1. That they were entitled to a well deserved holiday.
2. That no player should be out of pocket i.e. provide players who had long journeys to travel to with expenses.
3. That their physio expenses be paid by the Supporters Committee.
4. That a meal be provided after training for the players who have to travel a long journey.
5. That a meal be provided for all players at the last training session prior to a game.

6. That Tipperary Supporters Committee provide all after match meals.

7. That when necessary a week end away be provided with meals included.

After a few lengthy and worthwhile meetings we decided on holding a Dog Nite in Thurles Greyhound Track in March. This proved to be a major success. By this time our Chairperson Michael had put the wheel in motion and had organised the holiday for the team and mentors. We had some finding to start the fundraising and the shortfall was met by the proceeds from the Dog Nite. It was a matter of great satisfaction to see this support and how people contributed to ensure our camogie players for their just reward with a holiday to remember in Gran Canaria.

At our next meeting our next task was to set up a monthly return sheet for the expenses incurred by the players. Meals were arranged after training sessions for the players who had to travel long journeys and other events were organised.

At this meeting decisions to extend the

committee was decided upon and the members were requested to ask individuals if they would have an interest in helping to formulate a committee in the name of Tipperary Camogie Supporters Club.

The first meeting was held on April 9th 2002 in the Horse & Jockey Hotel, in attendance at that meeting were Michael Cleary, Jean Hayden, Tom Egan, Martin Bourke and Marion Graham. A lot of thought was put into the members invited to attend the meeting of July 23 and to proved to be very successful with enthusiasm to the fore.

A number of other meetings were held and following committee were eventually elected and co-opted onto the Tipperary Camogie Supporters Club:- Chairperson Michael Cleary, Secretary Marion Graham, Joint Treasurer's Tom Egan and Jean Hayden,

**Committee:** Martin Bourke, Meadhb Stokes, Eileen Gaynor, Sean Fogarty, Eugene Ryan, Timmy Moloney, Stephen Fitzgerald, Martin O'Dwyer, Noel Hennessy, Eddie Moran, Kathleen Hughes and Noreen Kelly Ryan.

At a meeting on January 25 2003 it was decided that we draft a Constitution similar to the Tipperary G.A.A. Constitution and endorse it. Our second A.G.M. was held on November 5th in The Horse & Jockey Hotel here again enthusiasm was to the fore and all members were 100% behind the organisation of a holiday for the team after their tremendous victory over Cork on September 21.

The Committee elected were: Chairperson Michael Cleary, Vice-Chairperson Tom Egan, Secretary Marion Graham, Joint Treasurer's Jean Hayden and Tom Egan, P.R.O. Meadhb Stokes. Committee members, Martin O'Dwyer, Kathleen Hughes, Eileen Gaynor, Stephen Fitzgerald, Sean Fogarty, Eileen Butler (Tipperary/Dublin Association), Ann Moloney, Conor Ryan, Noreen Kelly Ryan, Martin Bourke and Timmy Moloney.



# Tipperary Minor Camogie

**W**e began training for the Munster Championship back in early March. A squad of twenty-four players were picked from trials that were held in February. The panel trained diligently twice and sometimes three times a week under the guidance of Sean Johnston, Tommy Ryan and Sheila Delaney.

We had a very skilful squad of players and that was realised when we easily disposed of a good Waterford side in a challenge match, winning that game by 3-15 to 1-5.

On Saturday 19th April, we faced a tough Clare side in the Munster semi-final. This game was played on a beautiful sunny day, the venue was Ogonnelloe. Again the girls played brilliantly and we had a very comprehensive win. The score line in that game was Tipperary 3-13, Clare 2-0.

The stage was now set for the Munster final. The opposition was our old rivals Cork, and the venue was Charleville. Cork came into that game as hot favourites, being All-Ireland champions from the previous year, also



*Tipperary Minor panel – Front row (l-r): Alison Lonergan, Mary Ryan, Ciara Heffernan, Ciara Johnston, Noreen Flanagan, Katie Kennedy, Michelle Dunne, Eileen Harty, Fiona Ryan, Marie Ryan, Elaine King. Back row: Máiread Luttrell, Deirdre Dunne, Cora Hennessy, Noreen Ryan, Joanne Nolan, Siobhán Bourke, Ciara O'Sullivan, Michelle Kirwan, Roseanna Kenneally, Therese Shortt, Patricia McGrath, Ailish Langton, Siobhán McGrath.*

they had home advantage.

Tipperary got off to a nervous start and soon found themselves trailing. The more experienced Cork side settled earlier and soon started to dominate. Tipperary showed some great fighting spirit in the second half as they went at cork and hit them with everything they had. They were rewarded with some hard earned scores. Unfortunately this wasn't to be Tipperary's day, but well

done to all the girls who trained hard and gave great commitment on the field, their day will come.

This was a young Tipperary side. Fifteen out of the twenty-four on the panel are young enough for next year. This augurs well for the future of camogie in Tipperary. Next year is another year and I'm sure many of these players will be back to seek a Munster title.

# Bournea Camogie Club

**B**ournea Camogie Club won their first every Junior 'B' Championship title this year by defeating a very strong Kildangan team in the final. Bournea's first opponents in capturing this title was away to the mighty Kiadangan team, Bournea ran out easy winners in this game.

Their next opponents were at home to Burgess and Tommevara, Bournea again being victorious in both encounters. Bournea's next game was away to Lorrha who always prove to be a tough challenge but once again Bournea were successful. This then put Bournea into the semi-final of the championship. Here Bournea encountered a very strong Slievenamon side in Ballycahill, after a very close encounter, the final whistle was greeted with the relief of a well-earned victory for the Bournea girls. Our next outing then was the county final, Bournea had never reached the county final previously, and normally getting knocked out at the semi-final stages. Great excitement was felt in the parish and on the day the girls were ready for the challenge, conditions were perfect on the day and Bournea went on to win the match by 2 points.

## JUNIOR 'B' LEAGUE

In this campaign Bournea were out to



*The Bournea Camogie Panel County Junior 'B' League and Championship winners 2003 – Back row (l-r): Máiread Byrne, Catherine Greed, Bernadette Byrne, Maria Costigan, Helena Costigan, Geraldine Byrne, Ann Murray, Sarah-Jane Cody, Caroline Ryan, Anne Marie Greed, Máiread Ryan, Bridget Costigan. Front: Cora Costigan, Shona Byrne, Caroline Greed, Ann Marie Nolan, Muireann O'Dwyer (captain), Máiread Costigan, Nicola Shanayhan, Siobhain Costigan.*

defend their title from last year and encountered such teams as Anacarthy and Clonalty/Rossmore and in each case were successful and received a walkover from Cashel. This put them in the semi-final against Slievenamon who Bournea had previously defeated in the championship semi-final. The girls knew that this would be a difficult encounter but were well prepared for the challenge and eventually ran out easy winners. Bournea were now in contention for doing the double in winning both the league and championship titles. Here they

encounter a strong Burgess team. This was a tightly contested match in windy conditions but once again victory was Bourneas. Bournea won on a scoreline of 2-5 to 1-4. Bournea can be very proud of themselves this year, playing 11 games and convincingly winning each one. Each player from one to twenty-five can be thanked for their efforts and be proud of their dedication to Bournea Camogie Club. A special word of thanks also to our trainers Dan and Pete for their effort throughout the year in making Bournea Camogie so successful.

TIPPERARY CAMOGIE 2003

THE FOLLOWING IS A LIST OF WINNERS AND RUNNERS-UP FOR CHAMPIONSHIP AND LEAGUES DURING THE 2003 CAMOGIE SEASON.

Competition	Winners	Runners-up
U-12 'A' Championship	Toomevara	Drom & Inch
U-12 'B' Championship	Burgess	Moneygall
U-12 'C' Championship	Kilruane	Portroe
U-12 'A' League	Toomevara	Burgess
U-12 'B' League	Moneygall	Clonoulty-Rossmore
U-12 'C' League	St. Cronan's	Cahir
U-14 'A' Championship	Drom & Inch	Toomevara
U-14 'B' Championship	Knockavilla-Donaskeigh	Clonoulty-Rossmore
U-14 'C' Championship	Kilruane	Moycarkey-Borris
U-14 'A' League	Drom & Inch	Toomevara
U-14 'B' League	Kilruane	Moneygall
U-14 'C' League	Moycarkey-Borris	Portroe
U-16 'A' Championship	Not complete	
U-16 'B' Championship	Not complete	
U-16 'C' Championship	Not complete	
U-18 'A' Championship	Not complete	
U-18 'B' Championship	Not complete	
Junior 'A' Championship	Drom & Inch	St. Cronan's Roscrea
Junior 'B' Championship	Bournea	Kildangan
Junior 'A' League (John Hogan Cup)	Drom & Inch	St. Cronan's Roscrea
Junior 'B' League (Terry Griffin/Geaney Cup)	Bournea	Burgess
Intermediate Championship	Burgess	Moneygall
Intermediate League (Jimmy Carroll Cup)	Not complete	
Senior Championship	Drom & Inch	Toomevara
Senior League (Ann Frazer)	Not complete	

Burgess U12 Camogie panel, County 'B' Championship winners and County 'A' League finalists - Back row (l-r): John Darcy (selector), Ruth Darcy, Emer Ryan, Sinead Ryan, Aine Murphy (captain), Laura Mahoney, Eadaoin Ryan, Bernie Scroope, Katie Ryan, Catherine Curtin, Laura Carroll, George Maloney (selector), Paudie Grace (selector). Front: Ruth Darcy, Mairead Murphy, Aine O'Halloran, Claire Maloney, Amy Kennedy, Aine O'Carroll, Ciara Holohan, Louise Hayes, Gemma Grace Aine Lucey.



CELEBRATING ALL-IRELAND FINAL

Jovita Delaney, Kathleen Hughes, Deirdre Hughes and John (Hotpoint) Hayes in a happy mood on the return journey from the All-Ireland final.



MEMBERS OF TIPPERARY CAMOGIE SUPPORTERS CLUB COMMITTEE Back row (l-r): Kathleen Hughes, Marion Graham (secretary), Stephen Fitzgerald, Martin Bourke, Martin O'Dwyer, Sean Fogarty. Seated: Michael Cleary (chairperson), Eileen Gaynor, Meadbh Stokes (PRO), Jean Hayden, Tom Egan (joint treasurers).

# Shannon Rovers Camogie Club

## UNDER 10 BLITZ

We were invited by Burgess to an U10 Blitz in Kilcolman. This was a very enjoyable day for all concerned. Our young players gained very valuable experience.

## UNDER 12

Our U12 age group gave us great enjoyment during 2003 with their trainers Rose Mannion and Caroline Prout. The girls vary in age with some as young as 5 years old. The future looks bright for the club with 36 girls in this age group on the panel. We have good parental input also with Margaret Fox and Timmie Carroll stepping in to train the girls on occasion.

## UNDER 12 BLITZ

We ran an U12 Blitz at the Ragg pitch due to our own pitch being renovated. It was a very successful day. Thanks to all the club who took part, to the parents who did the catering, to Carmel Prout for her calligraphy work on the certs, to the supporters and to everyone who helped to make the day a success. While our girls did not bring home silverware they did not come home empty handed either. Well done to all concerned.

## UNDER 14

We were unable to field a team for the U14 Championship but managed to get one together for the League who were trained by Rose Mannion. Our team consisted of four nine year olds, but they got through the group to the semi final. The girls fought hard but had to yield to a much stronger Portroe side. This year time was not on our side to host an U14 Blitz.

## UNDER 16

This U16 team have been training very hard all year under the eagle eyes of trainers Pat McLoughney, Gerry O'Rourke and Pat Stack. They came through their group to meet Annacorthy in the semi-final which they won. The girls meet Kilruane in the county final now, time and venue to be fixed.

## SHANNON ROVERS ON THE COUNTY SCENE

It has been a few years now since our club has had representatives at County level and we are very proud to have Aoife McLoughney and Marion Ryan on the U14 County team. They participated in Connaught, Limerick and Cork Blitz during the year. Sisters, Lorraine and Andrea Davis, represent us on the U18 County team. This is the first time the girls got to play at County level and we wish them good luck for the future.

All in all 2003 has been a busy but enjoyable year.



Shannon Rovers – U-16 county champions, 2003. Back row: G. O'Rourke (coach), L. Davis, M. Ryan, A. Davis, V. Austin, M. Ryan, S. Heenan, J. Stack, L. Tierney (c.), S. Cahalan, C. Prout, M. Austin, P. Stack (coach), A. McLoughney, P. McLoughney (coach). Front row: A. Cleary, G. Donoghue, A. Ryan, A. King, S. Donoghue, N. Carroll, E. McLoughney, A. Burke.



Burgess Intermediate camogie panel, county champions – Back row (l-r): Margaret Hogan, Denis Darcy, Eimear O'Connell, Breda Cosgrave, Joan McKeogh, Aoife Ryan, Ruth Barry, Aine Mulcahy, Ann Marie O'Brien, Elaine King, Kay Walsh, Sile Kyne, Niamh Hogan, Brian McDonnell (selector). Front: Donie Nealon (selector), Claire Kearns, Deirdre McDonnell, Maeve Moloney, Sarah Hayes, Sinead Nealon, Eimear McDonnell, Sheena Howard, Aine Hogan, Sinead Quinlan, Therese Brophy (captain), Tony Grogan (selector).



Shannon Rovers U-10 Burgess Blitz 2003 – Front row (l-r): Amy Lowry, Katie Walsh, Ruth Hogan, Sorcha Ridge, Grainne Fox, Megan Slattery, Mida McLoughney, Paula Hannigan, Alice Darcy. Back: Fiona Hyland, Peg Fox, Stacey O'Gorman, Marie Costello, Amanda Ryan, Aisling Carroll, Lucy Donoghue, Sarah Clarke.



Shannon Rovers U-12 Blitz – Front row (l-r): Grainne Fox, Amanda Ryan, Emma Cahalan, Katie Walsh, Sarah Kelly, Stacey O'Gorman, Marie Costello, Ruth Hogan. Middle: Michelle King, Jane Hannigan, Jessica Moran, Peg Fox, Nikki O'Gorman, Aisling Carroll, Grace Ryan. Back: Margaret Fox (coach), Jenny Hogan, Niamh Carroll, Julie Donnellan, Sarah Hall, Rose Mannion (coach).

## MUNSTER SCHOOLS COMPETITION

Our club was well represented at the Munster Schools competition for Borrisokane Community College, with A. Burke, J. Stack, M. Ryan, E. McLoughney, A. Davis, V. Austin, L. Davis and S. Heenan on the Junior 'A' team and N. Carroll, S. Donoghue, M. Ryan and S. Cahalan on Junior 'B' team. Congratulations to all.

## PLANS FOR 2004

The Shannon Rovers Club has been catering for the Juvenile members up to the age of 16 years so far. We are hoping to have a Junior team next year, please God. We have been coaching these girls for a number of years so we hope that all the hard work will now come to fruition. Our motto for the club has been: "Mol an oige agus tiocfaidh siad".



Toomevara U12 Camogie panel, County League and Championship winners – Back row (l-r): Aoife Grace, Aoife Murphy, Suzanne Kelly (manager), Nicola Whelan, Kate Duggan, Sandra Dunne, Niamh Gleeson, Aine Brislane (captain), Anne Marie Quigley, Orlaith Maher, Hazel Harty, Michelle Ryan, Eithne Canning, Elaine Martin, Donal Kelly, Paula Ryan (joint coach). Kneeling: Aisling Shanahan, Aoife Ryan, Nollie Hassett, Annie Ryan, Katie Larkin, Clare Murphy, Sile Ryan, Michelle Ryan, Niamh Kelly, Emer O'Brian, Moira Ryan, Marguarite Cleary.



## TIPPERARY INTERMEDIATE TEAM

Back row (l-r): Brendan Murphy (coach), Mary Rose Ryan, Siobhan Ryan, Helen Breen, Jacqueline O'Connor, Julie Kirwan, Mairead Morrissey, Joanne Nolan, Aine Mulcahy, Denise Fitzgerald, Moira Ryan, Noelette O'Dwyer, Martin Browne (manager). Middle: Niamh Connolly, Regina O'Meara, Lorraine Bourke, Deirdre McDonnell, Tisha O'Halloran, Jenney O'Halloran, Paula Ryan, Mary Looby, Jill Horan. Front: Sharon Ralph, Eimear Ryan, Trisha Ralph, Trish Ryan, Geraldine Kinnane, Claire Marie Fogarty, Meadhb Corcoran, Bernie O'Dowd (selector).



## TIPPERARY U18 MUNSTER FINALISTS

Back row (l-r): Deirdre Dunne, Ciara Heffernan, Mairead O'Donoghue, Meave Moloney, Sara Morrissey, Ciara O'Sullivan, Eimear Ryan, Julie Kirwan, Fiona O'Dwyer, Danielle O'Connell, Ailish Langton, Claire Grogan, Helena Costigan, Lizzie Woods, Catherine Greed, Claire Ryan, Joanne Nolan. Front: Fiona Fox, Tara Carey, Ciara Johnson, Andrea Davis, Mary Ryan, Lorraine Davis, Michelle Shortt (captain), Linda Breen, Noreen Flanagan, Alison Lonergan, Marie Jones, Trish Ralph, Marie Tynan, Roseanna Kenneally.

Agent for  
Lantz Wedding  
Stationery

Croke Street,  
Thurles.

Tel/Fax  
0504-21038

# MARY KENNEDY PRINTER

Opening Hours: Monday - Friday 9.30 a.m. - 5.30 p.m.

General &  
Commercial  
Printers

Laminating • Binding  
• Fax Service • Typing  
• Photocopying Service

## INCH HOUSE

COUNTRY HOUSE & RESTAURANT  
4-Star GUEST HOUSE

*Dining out at Christmas?*

For a special night out come to  
Inch House for  
good food, excellent wines  
in excellent surroundings

LISTED IN  
THE 100 BEST IN IRELAND

*Also in the Good Hotels Guide for  
Great Britain and Ireland*

For reservations, contact Nora at  
(0504) 51348

*Best of Luck to all Tipp Teams*

## TEMPLEMORE MOTOR WORKS LTD.

MAIN TOYOTA DEALERS



Tel: 0504-31222

087-2840940 / 086-2607587

Full range of Toyota models  
Selection of Quality Used Vehicles

**BOE Vehicle Testing ♦**  
**Tachograph and Speed Limiter**  
**Fitting ♦ Quality Servicing**  
- OPEN 6 DAYS -

## GLASHEENS

COACH SERVICES

HOLYCROSS &  
THURLES

*Outings - Weddings - Funerals  
School Tours  
&*

HACKNEY SERVICE

Telephone

Holycross 0504-43227/21838

Fax: 0504-43227

Thurles: 0504-43109



# DROM-INCH Camogie Review 2003

By Geraldine Kinane

Without doubt the year 2003 will be forever remembered as an extremely successful year in the history of Drom-Inch camogie club. In 2003 we had some great achievements at all age levels but most notably at senior level when on the 27th of August, captained by Julie Delaney, we captured the senior camogie title for the first time in 21 years. This great victory stemmed not only from a huge effort which was put into training this year but also down through the years as the majority of the panel can already boast numerous underage championship medals. Once again this year much training and preparation was put into our underage teams. As a result our U-12 side reached the county final losing out narrowly to Toomevara.

## U-14

Our U-14 team under the guidance of Helen Kiely, John Harkins and Niamh Harkins had a year to remember being crowned county and league champions. In the county final captained by Patricia McGrath they had a comfortable win over Toomevara and this result meant they then travelled to Mullingar to represent Tipperary in the Feile Na nGael championship. They did so with distinction, great displays and victories over Crookedwood and Lough Lene Gaels of Westmeath. They qualified to play St. Vincent's of Dublin in the semi-final but unfortunately after a thrilling encounter they were defeated by 3:5 to 2:2. The U-16 and U-18 championships have yet to be completed and we look forward to seeing how both our teams progress.

## SENIOR CAMPIGAIN

I think everyone involved in the club will agree that our achievements at senior level this year were quite remarkable and is testimony to the dedication commitment and talent of players and management within the club. Our path to glory began on January the 10th when training commenced and we set out to achieve our ultimate goal for the year, a

county championship that had eluded us for 21 years. On the 26th of April the team travelled to Kilkenny to participate in the Pan Celtic tournament. Wins over Fr. O'Neill's of Cork, Graigue Ballycallan of Kilkenny and Davitts of Galway saw us through to the final the following day. Our opposition was Freshford of Kilkenny and after an exciting and intense battle we were defeated. Nevertheless it was valuable preparation for the up and coming championship.

The championship started with a win over Templemore and a draw with Toomevara. We then faced old rivals Cashel and after an excellent all round performance we emerged winners by two points. Victory over Clonoulty saw us through to the county final against Toomevara on the 16th of August. After a tense hour of camogie we finished all square with Maria Harkin getting the all-important equalising goal from a free in the final minute.

A magnificent crowd turned out for the replay and they were treated to an enthralling and spirited game of camogie. In the end we succeeded, winning on a scoreline of 2:11 to 2:9. The victory was a combination of a tremendous performance of grit, determination and skill, and credit must go to all the girls and the management team of John Harkins, Timmy Delaney, Joan Harkins and Lar O'Brien. A week later we had another great win over Clare champions Newmarket-On-Fergus in the Munster semi-final. We then played Grannagh Ballingarry of Limerick in the Munster final. However, on the day their experience showed and we were defeated.

Looking back it was a most memorable year, when we finally made the breakthrough at senior level. It was also very encouraging to see the success and talent at underage level. Without question the club has a very prosperous future and we look forward to next year with great pride and confidence. Finally the club recognises and appreciates the great support it has received throughout the year. It also wishes to thank all the people who helped out in any way throughout the year, in training, fundraising, sponsorship and driving players etc.



Drom-Inch, Tipperary Senior Champions 2003 . . . Back row (left to right): Lar O'Brien (Chairman), Deirdre Delaney, Josephine Ryan, Eileen Harty, Joanne Ryan, Sinead Walsh, Amy O'Halloran, Mary Hassett, Jane Ryan, Norma Harrington, Jacqueline O'connor, Melissa Stapleton, Maria Harkin, John Harkin, Timmy Delaney, Noreen Delaney (secretary). Front row (left to right): Joan Harkin, Noelle Greene Aileen Kennedy, Siobhan Butler, Mary Looby, Michelle Shortt, Niamh Harkin, Julie Delaney, Teresa Maher, Helen Kiely, Linda Breen, Geraldine Kinnane, Triona Butler, Norah Kinnane, Roseanne Kinneally. Mascots (left to right): Jack Harkin, Gerry Kelly, Aoife O'Halloran.

# CLONMEL OIL COMPANY

*Waterford Road – CLONMEL*

Tel: 24177

Fax: 26747

Mobile: 088-259 5089



For your next order contact:

DECLAN BROWNE at 086-8311532 or LIAM STOKES at 086-2595089

*Quality Products  
Dependable Service*

**CHADWICKS**  
BUILDING MATERIALS

*YOUR FIRST  
CHOICE FOR  
BUILDING  
MATERIALS*

At Chadwicks you'll find the  
widest range of

**Timber, Building Materials and  
Plumbing & Heating Supplies,**  
all at genuinely competitive  
prices.

We also hire and sell  
**Scaffolding & Access  
Equipment.**

What's more, with a team of  
knowledgeable, experienced  
staff, our service is second  
to none!

**QUEEN STREET, CLONMEL**  
Tel: 052-21822. Fax: 052-21516

# South Tipperary Board

## SOUTH TIPPERARY BOARD ROLL OF HONOUR 2003

Date	Event	Venue	Referee	Date	Event	Venue	Referee
31/8/03	Glanbia Senior Hurling	Mullinahone 3-14	Ballingarry 1-10	Clonmel	J.Mc Donnell	13/4/03	U 21 Football B
31/8/03	Clonmel Oil Senior Football	Cahir 1-12	Moyle Rovers 0-14	Clonmel	G.O.Riordan	30/3/03	U 21 Football C
26/10/03	Martins Fruit and Veg Intermediate Hurling	Fethard 1-10	Ballybacon Grange 1-10	Clonmel	J.Ryan	29/8/03	Sureprint Minor Football A
Replay 30/11	Ballybacon Grange 3-8	Fethard 1-9				10/8/03	Minor Football B
26/10/03	Intermediate Football	Kilsheelan Kilcash 2-9	Killenaule 1-7	Clonmel	G.O. Riordan	10/8/03	Minor Football C
18/10/03	Garrabridge Lighting J.F.C.A	Fethard 2-11	Ballingarry 1-12	Kilsheelan	K. Delehunty	7/9/03	Chadwicks Minor Hurling A
5/10/03	John Quirke Jewellers J.H.C.A	Ballylooby Castlegrace 1-12	Ballyneale 1-7	Monroe	P.Shelley	13/9/03	M.K.Sports Minor Hurling B
10/5/03	Carew Investments Ltd U 21 Hurling A	Killenaule 0-14	Ballingarry 0-6	Fethard	N.Cosgrove	23/8/03	Minor Hurling C
27/4/03	Pat Cleere U 21 Hurling B	Carrick Swan 1-15	Moyle Rovers 1-5	Clonmel	A. Maloney	2/11/03	Europian Junior B Hurling
20/4/03	Pat Cleere U 21 Hurling C	Ballyneale 2-10	Skeheenarinka 1-9	Ned Hall Park	K.Delehunty	21/9/03	Junior Hurling League
6/4/03	Dick Cummins U 21 Football A	Killenaule 3-10	Fethard 0-8	Clonmel	D.Cahill		

## C.L.C.G. Coiste Chontae Thiobrad Árann Theas Oifigigh 2003

### UACHTARÁN

Risteárd Ó Cuimin  
Priomh Sraid Fíodh Árd 052-31167

### CATHAOIRLEACH

Barra Ó Briain  
Cnoc Anglesby, Cloichin an Mhargaidh 052-65357

### LEAS CATHAOIRLIGH

Míceal Mac Cormaic  
Sraid Ciarrai, Fíodh Árd 052-31534

Risteard Goldsboro  
Coalbrook Bail an Gharrai 052-54206

### RUNAI

Seán Ó Nuinseain 052-33958  
Baile Ghlaisin Cill Siolain Cluain Meala 087-2669304

### CISTOIR

Tomás Ó Ciosog  
19 Berkley Drive, Cluain Meala 052-23473

### IONTAOBHAI

Míceal Mac Aogain  
Bothair Baile An Phaoraigh, Cluain Meala 052-21206

### OIFIGEACH NA nÓg

Níoclas Ó Maolrunaig  
Dún Drongain 052-52126

## Nationalist Award Winners 2002

### HALL OF FAME HURLING

Michael Babs Keating [Ballybacon Grange]

### HURLER OF THE YEAR

Paul Kelly [Mullinahone]

### YOUNG HURLER OF THE YEAR

Trevor Ivors [Ballingarry]

### FOOTBALLER OF THE YEAR

Fergal O Callaghan [Commercials]

### YOUNG FOOTBALLER OF THE YEAR

Ian Barnes [Commercials]



*Ballyneale Win Under-21 Hurling . . . Ballyneale won their first ever county hurling title, under-21 hurling, when they defeated Clonakenny in the county final. Along the way they defeated St. Patrick's, Skeheenarinka by 2-10 to 1-9 in the South final and Aherlow by 1-12 to 2-6 in the county semi-final. The county final against Clonakenny at Cashel proved to be the club's finest hour. They trailed by a point at the break but put up a tremendous show in the second half. Behind by two points with ten minutes to go, they came back to level and then got the all-important winning point to give them victory by 0-11 to 0-10.*

# POWER & COMPANY

Wallpaper  
and Paint  
Specialists

Glass  
Brushes  
Oil Cloth

**18 O'CONNELL STREET,  
CLONMEL**

Telephone: (052) 22367

# Cahir House Hotel

The Square, Cahir, Co. Tipperary.  
Tel/Fax: 052-42727

Midweek Wedding Packages – Available  
Very Special deals on off-season Weddings  
November – March

Dinner dances and Socials – Look no further

**CAHIR HOUSE HOTEL**

3 star

Our 42 bedrooms can cater for visiting  
groups/teams at competitive rates

Please contact Liam Duffy for competitive rates

# THE CLONMEL ARMS HOTEL

*at the heart of Clonmel*

- **Cracking Good Bars**
- **Fabulous Banqueting Suites**
- **Great Food**
- **Sunday is family day**

*(Enjoy your lunch, let us look after the kids)*

*Come in and enjoy our hospitality • Large and Small Groups Welcome*

Website: [www.clonmelarmshotel.com](http://www.clonmelarmshotel.com) Email: [theclonmelarms@eircom.net](mailto:theclonmelarms@eircom.net)

Phone: 052-21233

## C.L.C.G. COISTE CHONTAE

### THIOBRAD ÁRANN THEAS OIFIGI 2003

**UACHTARÁN:** Ristéard Ó Cumin,  
Príomh Bord Fíodh Árd. 052-31167

**CATHAOIRLEACH:** Barra Ó Briain,  
Cnoc Anglesby,  
Cloichín an Mhargaidh. 052-65357

**LEAS CATHAOIRLIGH:** Miceál MacCormaic,  
Sráid Ciarrai, Fíodh Árd. 052-31534  
Ristéard Goldsboro  
Coalbrook,  
Baile na Gharrai 052-54206

**RUNAÍ:** Seán Ó Nuinseain,  
Baile Ghlaisin,  
Cill tSiolain, Cluain Meala. 052-33958  
Mobile: 087-2669304

**CISTÉOIR:** Tomás Ó Ciosóg,  
19, Berkley Drive, Cluain Meala  
052-23473

**IONTAOBHAÍ:** Miceal Mac Aogain,  
Bothar Baile An Phaoraigh,  
Cluain Meala 052-21206

**OIFIGEACH NA NÓG:** Nioclás Maolrunaigh  
Dun Drongain 052-52126

## NA COMORTAIS 2003

Senior Hurling  
**RYAN CUP**  
Sponsored by  
**GLANBIA**

Senior Football  
**O'SHEA CUP**  
Sponsored by  
**CLONMEL OIL**

Intermediate  
Hurling  
**O'DWYER CUP**  
Sponsored by  
**MARTIN'S  
FRUIT & VEG**

Intermediate  
Football  
**KEHOE CUP**  
Sponsorship  
available

Junior Hurling (A)  
**MAHER CUP**  
Sponsored by  
**JOHN QUIRKE  
JEWELLERS**

Junior Football (A)  
**EGAN CUP**  
Sponsored by  
**GARRABRIDGE  
LIGHTING**

Junior Hurling (B)  
**DOYLE CUP**  
Sponsored by  
**EUROPLAN**

Under 21 Hurling (A)  
**FLYNN CUP**  
Sponsored by  
**JOHN CAREW  
INVESTMENTS**

Under 21 Football (A)  
**JOHNNY CUMMINS  
CUP**  
Sponsored by  
**DICK CUMMINS  
BOARD  
PRESIDENT**

Under-21 Hurling (B)  
**FITZPATRICK CUP**  
Sponsored by  
**PAT CLEERE**

Under 21 Football (B)  
**SOUTH BOARD  
CUP**  
Sponsorship  
available

Under 21 Hurling (C)  
**SOUTH BOARD  
CUP**  
Sponsored by  
**PAT CLEERE**

Under 21 Football (C)  
**SOUTH BOARD  
CUP**  
Sponsorship  
available

Minor Hurling (A)  
**AHEARNE CUP**  
Sponsored by  
**CHADWICKS**

Minor Football A  
**LARKIN CUP**  
Sponsored by  
**SUREPOINT  
(CLONMEL) LTD**

Minor Hurling (B)  
**SOUTH BOARD  
CUP**  
Sponsored by  
**MK SPORTS**

Minor Football (B)  
**SOUTH BOARD  
CUP**  
Sponsorship  
available

Minor Hurling (C)  
**SOUTH BOARD  
CUP**  
Sponsorship  
available

Minor Football (C)  
**SOUTH BOARD  
CUP**  
Sponsorship  
available

**Players of Year  
Awards**  
Sponsored by  
**NATIONALIST  
NEWSPAPER PLC**

**Referee Awards**  
Sponsored by  
**SOUTH EAST  
SCAFFOLDING**

**Sponsorship  
enquiries**  
to any South Board  
Officer or to  
An Runai at  
087-2669304

*The Board  
is deeply  
grateful to  
all our  
sponsors  
for their  
outstanding  
support.*



Noel O'Grady, Killenaule Under-21 football captain, receives the South Tipperary Trophy from Barry O'Brien, South Tipperary Chairman, Dick Cummins, South Tipperary G.A.A. President is on the right.

## LAWNMOWERS

- Harry • Honda • Lawnflite • Twin-Cut
- Castlegarden • Electric
- Walk Behind & Ride-ons



DeWalt Pro Power Tools  
& Accessories



We're the Leaders in our Field

## **PAT CLEERE**

7 Dillon St, Clonmel  
Phone 052 24096

*Black & Decker, D.I.Y., Powertools  
& Garden Equipment*

**PARTNER, HUSQVARNA, STIHL  
CHAINSAWS**

## **Slievenamon Service Station**



**IRISHTOWN, CLONMEL  
CO. TIPPERARY**

Telephone: 052-21172

PETROL AND DIESEL SALES  
Puncture Repairs and Tyres  
Convenience Shop

**Open 7 Days, 7.30 to 11**



## **CAREW Investments Ltd.**

INVESTMENT & PENSION CONSULTANT  
MORTGAGES & SCHOOL FEES

*Loans arranged with all  
Leading Financial Institutions  
for Business – Farms – Pubs*

**Re-Mortgaging a Speciality**

## **JOHN CAREW**

*"St. Anne's", The Quay,  
Clonmel, Co. Tipperary.*

Tel. 052-27627.

(Home) 052-27486

## **Chawke's**



## **Bar**



CLONMEL,  
CO. TIPPERARY

*Call in for good craic in  
pleasant surroundings and  
friendly atmosphere.*

Good luck to Tipperary G.A.A. teams.

*Proprietor: GERARD CHAWKE*

Tel: (052) 21149



Newcastle South Tipperary Junior Hurling League Winners 2003 . . . Back row (l. to r.): Jim Burrowes (trainer), Niall Morrissey, Alan Sweeney, Daniel Kennedy, Brian Sweeney, Barry Hickey, Eanna O'Flynn, Denis Hackett, Fr. Sean Nugent. Front row (l. to r.): John Lonergan, John O'Halloran, David Lonergan, John McCarra, Barry Cullinan, Darren Goonan, Emmet Hallinan, Alan Cullinan.



Ballyneale County Tipperary U-21 Hurling Champions 2003 . . . Back row (l. to r.): Richard Downey, J.P. Wallace, Daniel Lambe, Michael Munnelly, Barry Hanrahan, Billy Lyons, Tomas Kennedy, John McAndrew, Robert Murphy, Darren O'Connor, Daniel Murray, Paul McAndrew. Front row (l. to r.): Peter Downey, Ted Lyons, Brian McCarthy (C), Robert Ryan, Darren Power, Theo English, Enda Fogarty.



St. Patricks Drangan/Cloneen South Tipperary Minor 'B' Hurling Champions 2003 . . . Back row (l. to r.): Tom McGrath, Liam Horan (capt.), Anthony Barry, Brian Hickey, Damian McCormack, Conor Barry, Dermot Molloy, Danny Gleeson, Patrick Moroney, Sam Morrissey. Front row (l. to r.): Aidan O'Brien, Colin Murphy, John Molloy, Sean Horan, Thomas Horan, Brian McCormack, Mark McCormack, C.J. O'Halloran, William Phelan, Tom Burke, Philip Britton, Simon O'Donovan.



Killenale South Tipperary U-21 'A' Football Champions 2003 . . . Back row (l. to r.): Joe Cesar, Barry Murphy, Niall Berry, Jonathan O'Dwyer, Johnny Grace, Richard Meagher, Ian Murphy, Jonathan Gleeson, Martin Shelly, David Shelly, Michael Farrell, Jonathan Berry, Mark Murphy. Front row (l. to r.): Tony Doyle, Patrick Kerwick, Vinny Hannigan, Noel O'Grady (capt.), Keith Kennedy, Daragh Blake, Stephen Brennan, David Maguire, Brendan Fanning, Simon McMenamin.



Killenale County Tipperary U-21 Hurling Champions 2003 . . . Back row (l. to r.): David Shelly, Jonathan Gleeson, Niall Bergin, Jonathan O'Dwyer, Michael O'Connor, Ian Murphy, Patrick Kerwick, Johnny Grace, Richard Meagher, Mark Murphy, Stephen Brennan, Barry Murphy, Martin Shelly, Brendan Fanning. Front row (l. to r.): Joseph Ceasar, Niall Berry, Noel O'Grady, Tony Doyle (capt.), Kieran Bergin, Gerry Kennedy, Vinny Hannigan, Keith Kennedy, Michael Farrell, Daragh Blake, Jonathan Berry, David Maguire. Missing from photo Matthew O'Donnell and Mark Bannon.



Moyle Rovers Panel Tipperary Minor Football 'A' Champions 2003 . . . Back row (l. to r.): Pdraig Kelly, Richard O'Donnell, Paul Johnson, Darragh Boland, Kevin Harte, Aidan Foley, Shane Dolan, Daniel Lynne, Aaron Kelly, Keith Fortune, Martin Dunne, Tommy Griffin, David Lyons. Front row (l. to r.): Philip Ryan, Tommy Barry, David Conway, Jim Ryan, Neville Melbourne, Brian Mulvill, Ian Browne, Michael Mulcahy, Stephen McGrath.



St. Patricks Drangan/Cloneen South Tipperary U-21 'C' Football Champions 2003 . . . Back row (l. to r.): C.J. O'Halloran (injured), Tom McGrath, Patrick Brett, Colin Murphy, John Paul Harrington, Adam Hickey, Brian McCormack, Liam Horan, William McCormack, Adrian Britton, Michael Britton. Front row (l. to r.): Philip Britton, John Molloy, Sean Horan, Stephen Kennedy, T.J. Noonan, Mark McCormack (capt.), Noel Lyons, Liam Brett.



William McGrath (first official treasurer of the Skeheenarinky Hurling Club), being presented with a memento during club presentations by club chairman Eddie Maher. Back (l. to r.): John McGrath (cousin) and Edmond Fox (vice-chairman)

# BRENDANS

CLOGHEEN

BAR AND LOUNGE

OFF LICENCE

*A friendly  
Welcome to all*

Tel. 052-65225, 65533

*Every success to the GAA in*

*Tipperary in 2000*

# M.K.

# SPORTS

CLONMEL

*Specialists in all Sports Gear  
Enquiries from clubs welcome*

**052-29195**



**We know the ground  
and we cover it well.**

As a farmer, your insurance requirements are unique and no company knows that better than FBD.

Because FBD was established by farmers, for farmers, we understand your needs and provide policies that are made to measure.

That understanding shows in the simplicity, choice of cover and competitive pricing of FBD's Farm Multiperil Policy - The Farmer's number one Insurance Package.

If you're looking for cover, put yourself on solid ground. Contact your local FBD office.

**FBD Insurance**

**CAHIR 052-41526.**

**CLONMEL 052-25637. Fax: 052-42298**

# NAGLES

## LOUNGE BAR & GUESTHOUSE

- Room en-suite
- Car Park
- T.V. Lounge
- Central Heating
- Pay Phone
- Evening Meals

Kilsheelan, Clonmel, Co. Tipperary

Tel: 052-33496

*Props: Tony & Lucy Gleeson*





Kilsheelan/Kilcass Intermediate Football . . . Back row (l. to r.): Aidan Slattery, Jimmy Ryan, William Larkin, Roger Doyle, Adrian Walsh, Pierce Larkin, Keith Robinson, Pakie Larkin, Michael Ryan, Edward Collum, Eddie O'Connell. Front row (l. to r.): Willie Ryan, Tom Sheil, Dan O'Connor, John Roche (capt.), Martin Larkin, David Power, Anthony Walsh, Edward Sweeney, Aidan Walsh. Missing from photo: Keith O'Brien, Liam Robinson, Noel Ryan, Michael McHugh and Sean Nugent.



Moyle Rover Minor 'C' Football Panel - South and County Champions 2003. Back row l to r: Richard O'Donnell, Philip Ryan, Stephen Kennedy, Damien Breen, Neill Doyle, Stephen McGrath, Niall O'Flynn, Darragh Boland, Michael Griffin. Front row l to r: Eoin Fogarty, Joseph Moore, David Harte, Ian McCormack, Daniel Lyne, David Lyons (capt), Alan McCormack, Shane Meade. Missing from photo: Sean Lonergan, Daniel Lyons, David Lorigan, Sean Keating, Barry Molloy, Brendan O'Connor, John Lynne, Michael Mulvihill jnr.



The Newcastle Team that won the Minor "C" Hurling final over Ballyneale at Kilsheelan. Front row L to R: Denis Hackett, Jason Ahearne, Paul Fennessy, David Freaney, Tom Kennedy, John Lonergan, Captain, John T. Egan, John Hallinan, Conor Grant. Back: Darren Goonan, Fr. Sean Nugent, Lorcan McCarra, Brian Sweeney, Jordan Corbett, Ger O'Donnell, Liam Kelly, Niall Kennedy, Shane Hickey, Alan O'Grady, and Michael Grant.



Fethard Junior A Football Team, South Champions 2003. Back L to R: Johnny Neville, Paul Kenrick, Michael 'Buddy' Fitzgerald, Chris Coen, Eoin Doyle, Shane Walsh, Diarmuid Bourke, Philly Blake, Tommy Sheehan, Jamie McCormack, John Noonan, Shay Coen, John Hurley. Front L to R: Philly Prout, Ian Kenrick, Kenneth O'Donnell, Brendan Brett, Shay Ryan (captain), Colm Coen, Paul Hackett, Ronan Maher, Shane Aylward, Martin Coen, Garreth Byrne, and Martin Ryan. Mascot in front is Luke Coen.



Kilsheelan-Kilcass South & county U-21 'B' Football Champions 2003. Back (l. to r.): John Doolan, Jim Healy, Tommy Ryan, Jimmy Ryan, Johnny Walsh, Stephen McGrath, Christy Ryan, Niall Walsh, Senan O'Halloran, Pierce Larkin, Eoin Ryan (K) and Thomas O'Dwyer. Front (l. to r.): Karl Gibbs, Anthony Walsh, David Power, Peter O'Connell, Eoin Ryan (B), Edmond Walsh, Oisín O'Cuinneagain, Michael McHugh, Pa Walsh and Shane Geoghan.

# THE CASTLE ARMS, CAHIR

BAR FOOD SERVED ALL DAY

*For drinks in a warm  
and friendly  
atmosphere*

**The place where all  
sportsmen meet**

Proprietor: Brian Costigan  
Phone: No. 052 42506

# Glen Electrical Contractors Ltd.

CLONMEL

Trading as Seamus Gubbins  
Installations / Maintenance  
to

**INDUSTRIAL  
COMMERCIAL  
DOMESTIC**

Tel. 052-23233  
Fax 052-23311  
glenelec@iol.ie

# BLACKTHORN SLIOTARS

CLONMEL ROAD, CAHIR,  
CO. TIPPERARY

Suppliers of  
Juvenile and Senior  
Handmade Leather Sliotars  
to

- CLUBS
- SCHOOLS
- CO. BOARDS ETC.

*Annual Winter Sale Now On*

**Telephone 052-42468**

# O'GORMAN CONSTRUCTION

(Ardfinnan) Ltd

Carrow, Ardfinnan, Co. Tipperary  
Tel: (052) 66108 Fax: (052) 66171  
087-2562049 086-8116361

**COMMERCIAL, INDUSTRIAL  
& RESIDENTIAL**



All types of construction work carried out,  
including conversion work for the  
DISABILITY GRANT ALLOWANCE

**THE "QUALITY" BUILDERS**

# Newcastle G.A.A. Club

The year 2003 will be remembered in Newcastle G.A.A. Club as the year in which our youth flourished. South titles at under-14, under-16, and minor grades, as well as winning the South Tipp junior hurling league, indicates the success the club has had over the past twelve months. Although many judge success by the titles won by adult teams, no one could argue the importance of underage victories.

The under-14s were very impressive in winning their South title against Fr. Sheehys in Ardfinnan. They went on to put up a brave effort against a bigger Newport team in the county semi-final.

The under-16s also won their South final in Ardfinnan – this time against Skeheenarinka. Their county semi-final opponents were Borrisokane in a game played in the Dúrlas Óg grounds in Thurles.

The minor 'C' hurlers and footballers both reached their respective South finals this year with the hurlers winning their final against Ballyneale in Kilsheelan, held during the Fleadh Cheoil weekend in August. This was one of the highest scoring games seen during the year with ten goals and fifteen points scored in total. Our third county semi-final of the year was played against Seán Treacys in Tipperary town. Unfortunately, after a great battle, it was Seán Treacys that progressed and went on to win the county final.

The junior hurlers had a very consistent league campaign progressing to the final of the competition against Mullinahone. After a great game of hurling Newcastle emerged victorious by three points and so take the title for the second time in three years. All the players and mentors involved in all of the club teams deserve great credit for their efforts at training and in competitions throughout the year. Hopefully the success for coming year on the field can be at least equaled and maybe even better.

Off the field, the club has also been very busy. The club participated in Scór competitions at all levels winning 3 south titles. However, a greater effort must be made in the coming year in a number of the Scór competitions.

Further development of the playing field has also been carried out during the past year, after the club received funding from the Department of Sport, Tourism and Recreation. It is hoped that the re-developed field will be well used for both training and matches over the next 12 months.

The club would like to thank everyone who has helped in the support and running of the club over the last number of years. It is only with the help of all of the community that the club can continue to develop in the future.



U-14 Team photo: Back: (l to r); John (O.J.) O'Grady, Andrew Fitzpatrick, Conor Devaney, David Ryan, Caoimhín McGrath, Liam Devaney, Cian Corbett, Karl Ryan, Will Kennedy, John Egan. Front L to R; Ciaran McCarra, Niall Hyland, Ann Marie McCarra, (James Fitzpatrick), Johnny Kelly (captain), Tommy Sweeney, Dylan Tobin, Thomas Lonergan, Brian Lonergan.



U-16 photo: Back: (l to r); Jason Ahearne, Andrew Fitzpatrick, Caoimhín McGrath, Lorcan McCarra, Alan O'Grady, Paul Fennessy, Conor Grant, Conor Devaney, Will Kennedy, Cian Corbett, Fr. Seán Nugent, Niall Kennedy. Front L to R; Karl Ryan, Johnny Kelly, Shane Hickey, Tom Kennedy, David Freaney (captain), Ger O'Donnell, Jordan Corbett, Liam Devaney.



Eoin Fogarty, Youghalarra N.S., gets his jersey signed by former Tipperary hurler and manager Nicky English.

# Moyle Rovers 2003

## MOYLE ROVERS U-16 'A' COUNTY FOOTBALL



Moyle Rovers Under 16 'A' Football Panel - South and County Champions 2003. Back row l to r: Stephen Melbourne, Darragh Boland, Thomas Duggan, Liam Redmond, David Lorrigan, David Harte, Ian McCormack, Barry Molloy, Sean Lonergan, Stephen Kennedy, Neil Doyle, Eoin Lennon, Robert Dower, Brian Melbourne. Front row l to r: Donal Lyne (Selector), Charlie Boland (Selector), Sean Keating, Brendan Boland, Daniel Lyons, Diarmuid Foley, Darren Nolan, Daniel Lyne, Richard Power, John Lyne, Tom Lorrigan (Selector). Missing from photo: Eoin Grace, Thomas O'Dea and Aidan Myers.

**I**t is never easy to win back-to-back championships at any level, but this is exactly what Moyle Rovers U16s managed to do in 2003. A convincing win over Clonmel Commercial in March in their first competitive outing set the tone for this determined panel and their dedicated selectors Donal Lyne, Tom Lorrigan and Charlie Boland. A slip-up against Carrick Swans in their second championship game removed any complacency in the squad and good wins followed over Cahir and Ardfinnan.

The South final on 22nd April involved a comfortable win over Clonmel Óg on a scoreline of 2-12 to 0-9. Following the now traditional break for exams, the county semi final beckoned on the 14th July. This turned out to be a close contest with Rovers edging out a gallant Inane Rovers on a scoreline of 1-8 to 1-6. The county final was arranged for the 21st July at a venue where all young footballers and hurlers dream of playing Semple Stadium. Arravale Rovers were the opposition, a great team that had proved to be too strong on occasions in the past. Following a tremendous game of football, however, it was the Moyle Rovers lads who came out on top. The final score, after an hour of highly entertaining football, read Moyle Rovers 3-8, Arravale Rovers 2-9. A notable feature of the game was the Rovers, selectors, effective use of their substitutes, with fresh legs at crucial times giving them that extra edge which assured victory in the end.

There were great celebrations following the final whistle when the u-16A cup was presented to Moyle Rovers captain, Daniel Lyne. In his speech Daniel paid tribute to the wonderful, sporting Arravale team, his own panel, the aforementioned selectors and hardworking secretary, Noreen Burke. The following panel represented Moyle Rovers under-16 this year:

Brendan Boland, David Harte, Diarmuid Foley, David Lorrigan, Daniel Lyons, Richard Power, Barry Molloy, Neil Doyle, Daniel Lyne, Darren Nolan, Thomas O'Dea, Stephen Kennedy, Aidan Myers, Sean Keating, Eoin Lennon, Sean Lonergan, John Lyne, Stephen Melbourne, Liam Redmond, Ian McCormack, Eoin Grace, Darragh Boland, Robert Dower, Brian Melbourne, Thomas Duggan.

### MINOR DOUBLE

**T**he year 2003 will be a one to remember for the Moyle Rovers minor footballers when they had the distinction of capturing the South and county minor football championships in both the 'A' and 'C' grades a feat never achieved by any club before. Our 'A' team were the first to start their championship campaign and they got off to a winning start when they defeated Clonmel Commercial by 1-10 to 0-7 in Ardfinnan on April 19th. This was followed by a comprehensive victory over Ardfinnan on April 23rd. We had to wait until July 19th before we played our next game against Carrick Davins which we lost by 2-10 to 1-10.

As the championship was played on a league system, we had already qualified for the semi-finals prior to this game, but a huge improvement was needed if we had any hope of progressing further. We drew our great rivals, Clonmel Commercial, in the South semi-final played in Kilsheelan on August 16th. This was a close and tense affair. The loss of our star forward, Brian Mulvihill, after a high challenge early in the game, was a huge blow to us, but our lads rolled up their sleeves and played outstanding football to run out convincing winners by 3-5 to 0-6 and had now qualified to meet Ardfinnan

in the final. The final was played in Ned Hall Park on August 29th. In a close and well contested game, we withstood a great Ardfinnan fight-back from 5 points down to capture our second South/minor 'A' football title by 0-15 to 1-11.

We comprehensively defeated Galtee Rovers in the county semi-final and met our great rivals Gortnahoe-Glengoose in the county final, which was played in Fethard on September 13th. This was indeed a memorable day as our lads played out of their skins to capture our first ever county minor 'A' football title. This was no more than what they deserved as every player on the panel put in a huge effort all year. There were scenes of great jubilation as captain Neville Melbourne, accepted the cup from Hugh Kennedy. In his acceptance speech, he thanked everyone who helped out during the year and dedicated this famous victory to our late club secretary, Jimmy McCarthy, who had contributed so much to these players during their juvenile careers.

Our minor C, footballers hoped to emulate the successes of their 'A' counterparts and began their year with a comprehensive victory over Newcastle which was followed by wins over Grangemockler and Marfield. They had now qualified for the South final. This game was played in Clonmel on August 10th against Newcastle. Our lads totally dominated from start to finish and ran out convincing winners by 6-7 to 3-2 to complete part 1 of an historic double. We defeated Lattin Cullen in the semi final played in Cashel on September 2nd by 5-9 to 2-9 and had now qualified to meet Lorrha in the county final. This game was played in Borrisoleigh on Saturday September 20th and we won by 5-8 to 1-6.

# Carrick Swan

Sean McDonnell P.R.O.

**T**he year 2003 will go down in history as one of the best ever in the history of Carrick Swan club with two county and five south championships collected along the way.

Our first success of the year came with our under-21 hurlers who captured the south (B) championship defeating Ballybacon-Grange in the final. A county semi-final success over Éire Óg Anacorthy qualified us for county final where Newport proved just too strong for our team. Our minor footballers had a great year defeating Ballyporeen to win the south (B) championship and beating Cappawhite in county semi-final. The final played in Clonmel as a curtain raiser to county senior final saw us face north champions Borrisokane and our team performed really well on the day to regain a championship we had won twice before. It was then the turn of our under 16 hurlers who defeated Ballingarry in south (A) final to win this championship for the third year in succes-

sion and went on to two great victories over Toomevara and Dúrlas Óg in county semi-final and final to win the county under 16 (A) hurling championship for the first time in our clubs history. Our junior (B) hurlers were crowned champions of South Tipperary after they defeated St. Marys going on to beat Cashel in county semi-final. Last, but by no means least, our minor hurlers reached the county (A) final before losing out in a replay. This team having captured the south (A) championship for the first time in 20 years defeating a gallant Killeenale team, played Galtee Rovers in county semi-final and had a clear cut win which qualified them for county final with mid champions Moycarkey. The first meeting of these teams was played as a curtain raiser to county senior final and resulted in a draw 1-12 each and the replay played in Cashel on Sunday, 9th November saw us lose out after a gallant display.

We hope the successful year our club has

enjoyed will have a galvanising effect on all our teams over the coming years and we sincerely thank not just our successful teams and their mentors, but all who donned the black and white this year showing tremendous dedication and commitment at all times. Our fantastic supporters deserve special mention and the colour and excitement they brought to many venues this year was great to witness and very much appreciated by our teams. We must also thank our many sponsors whose financial assistance helped us in no small way to succeed and indeed we thank anyone who was of help during the year 2003 and in the past.

Our club extends its sympathy to the families who have suffered bereavements during the year and we send get well wishes to any of our followers who are unwell at present.

Finally we extend seasons greeting to you all and hope that the year 2004 brings you all that you wish for.



Swans - South U-21 Hurling 'B' Champions & County Finalists . . . Back row (l. to r.): Derek Reade, Mark Walsh, Simon Butler, Shane Fitzpatrick, James Gibbs, Alan O'Sullivan, Pat Dooley, Pat Lanigan, John Walsh, Ross Cleary. Front row (l. to r.): Paul Diffily, Gerard Walsh, Alan Waters, Stephen Walsh, David Kelly, Noel O'Donnell, Anthony O'Donnell (capt.), John Walsh, Colin Regan, Darren Fahy, Matthew Power.



Swans - South & County U-16 Hurling 'A' Champions . . . Back row (l. to r.): Danny O'Hanlon, Stephen Kearns, Michael Ryan, Colin O'Sullivan, Mark Fogarty, Martin Russell, Wm. Lonergan, Stephen Hahessy, Kevin Lanigan, Dwane Fogarty, Wayne Cullen, Kieran Reade. Front row (l. to r.): Darryl Whitty, Shane Hogan, Dean Clery, Sean Barrett, Darren Waters, David Walsh, Damien Roche (capt.), Keith O'Dwyer, John Flynn, Paul Regan, Barry Walsh, Jimmy Duggan.



Swans - South Minor 'A' Hurling Champions & County Finalists . . . Back row (l. to r.) Kieran Reade, Danny O'Hanlon, Matthew Power, James Hawkins, Darren Fahy (capt.), Pat Lanigan, Wayne O'Neill, James Gibbs, David Smith, Wayne Murphy, Derek Reade, John White, Stephen Hahessy, Kevin Lanigan. Front row (l. to r.): Alan Walsh, Colin O'Sullivan, Stephen Walsh, Andrew Walsh, David Kelly, Alan Waters, Darryl Cavanagh, Shane Hogan, Paul Diffily, David Drohan.



Swans - South Junior Football 'B' Champions . . . Back row (l. to r. players only): John Walsh, Joe Walsh, Alan Casey, Wm. Loughman, Wm. Barrett, Gerard Walsh, Stephen Walsh, Noel Walsh, Tadgh Manning, Martin Walsh. Front row (l. to r.): Vincent Power, Mark Walsh, Willie Walsh, Gerry Walsh, Tony Robinson, Aaron Harrigan (C), Alan J. Ryan, Gerry Grace, Seamus Walsh.



Swans - South & County Minor Football 'B' Champions . . . Back row (l. to r. players only): Stephen Walsh, Danny O'Hanlon, Kieran Reade, Stephen Hahessy, Wayne Murphy, David Smith, John White, Pat Lanigan, Kevin Lanigan, Darren Fahy. Front row (l. to r.): Jimmy Dignam, Peter White, Alan Walsh, Derek Reade, Alan Rockett (capt.), Paul Diffily, David Drohan, David Walsh.



Swans - South U-10 'B' Plate winners . . . Back row (l. to r.) Thomas Power, Dale O'Meara, James Loughman, Dean Ryan, Dale O'Hanlon, Killian Keever, David Ryan (C), Alex Whitty, Eoin Nolan, Stefon Hitchins, Eric O'Dwyer, Colin Waters, Randal Barlow. Front row (l. to r.) Ian Roche, Martin Griffin, Jamie Torpey, Aidan Ryan, Paul Long, Shane Torpey, Liam Bates, Daniel Walsh, Michael Morrissey, Gavin O'Halloran, Adam Keyes, Bill Barrett, Kieran Lonergan.

*Best Wishes to Loughmore N. S.  
on their fund raising event*

## **DONAL CLARKE & SON**

**BUILDER'S PROVIDERS – TOOL HIRE  
YOUR COMPLETE BUILDING NEEDS**

Timber . Building Material . Plumbing,  
Heating & Electrical Supplies . D.I.Y.  
. Farm Supplies . Computerised Paint  
Mixing Scheme . Choice of 5000 colour  
from Dimensions System

OPEN 6 DAYS

*PERSONAL SERVICE*

**Priory Demesne, Templemore**

**Tel: 0504-31234**

**Fax: 0504-32547**

Key cutting service while-u-wait

**DELIVERY SERVICE AVAILABLE**

# **Bowe's Bar & Lounge**

**Friar Street, Thurles**

**Weekend – Irish Music  
and Sing-along**



Tel. 0504-23520

E-Mail: michael.bowe@bowetravel.ie

## **Kieran McNeill & Sons**

**Sports Stadia  
Equipment**

- Turnstiles • Crushbarriers
- Goalposts • Nets etc.

***Cullohill,  
Portlaoise.***

Phone 0502-37143/

Fax No. 0502-37316

Mobile: 088-2593980

## **GLEESON Steel & Engineering**

Stockists of All Types of Steel:

Angles, Channels, H.S. Mesh,  
Black/Balvanise, Tubing, Plating,  
Corrugated Box Profile Sheeting.

We supply:

Water Tanks, Feeding Troughs, Cubicles,  
Yardscrapers, Gates/Railings, Trailers, etc.

**WE DESIGN, FABRICATE, ERECT  
INDUSTRIAL AND FARM  
BUILDINGS**

**GORTNAHOE,  
THURLES**

Tel: 056-34110. Fax: 056-34237.

# Tipperary Ladies Football 2003

By Patreece Ryan

**2003** proved to be yet another great year for Tipperary Ladies football. While there were marvellous achievements by many clubs throughout the county during the year, without a doubt the highlights of the year were the county junior team being honoured with a prestigious Cidona Award from the Tipperary United Sports Panel at the end of January, and capturing the Munster junior title in Pairc Uí Rinn, Cork in August. At club level, Cahir succeeded in winning five county titles at various grades in 2003, which was a tremendous achievement, while Cappawhite reached the Munster intermediate club final in October. Further progress in 2003 saw Fethard and Kilruane finally establish ladies football clubs, while Mullinahone entered a team in the junior championship. Aherlow also had teams participating in the U-12 and U-14 championships.

## Suzuki National League Division 2A campaign 2002/2003

Tipperary, having won division 3 of the National League in 2002 were promoted to division 2 for the 2002/2003 campaign. This obviously meant that they would now be competing against much tougher oppositions but it was a challenge that Tipp looked forward to and would ensure they were well prepared when the championship commenced in June. The campaign began back on a beautiful Spring day in February with their first game at home to Louth, which the visitors won by 2-4 to 1-5. Tipp's second round game was played at a half-way venue in Durrow, near Tullamore, Co Offaly, and their opponents on this occasion were Cavan, who were somewhat of an unknown quantity. However, they proved too good for Tipperary and won by 3-8 to 2-6. Tipp returned to winning ways when they played Wexford in their third round game of the National League in Cahir at the end of February. Tipp gained the upper hand in this game from the throw-in and exerted pressure on Wexford for the entire hour. It was crunch time the following Sunday when Tipperary took on old rivals Sligo in Balinasloe. This was a make break game for Tipp with a win needed to secure their place in division 2A of the League. Tipp led by 3 points at the break but it was all to play for in the second half. In the end they won by two points.

Tipp's next outing was against the



Cappawhite Under 16 'B' Champions 2003. Front row: Mary Horan, Mary O'Meara, Anne O'Dwyer, Mary Claire Ryan, Emma Kennedy (Capt.), Claire Mullins, Valerie O'Neill, Jerri O'Dwyer, Sarah Ryan, Aisling Barry, Teresa Quinlan. Back row: Donna Quinlan, Anne Marie Ryan, Catherine Kelly, Mary Therese McCarthy, Laura Mullins, Bridget Barry, Mary O'Dwyer, Rebecca Cummins, Eibhlin Ryan, Ena Meagher, Denise O'Dwyer, Siobhan O'Neill.

Cork senior team at Cappawhite on St Patrick's weekend. Tipp knew they were going to be up against it in this game but two back to back victories over Wexford and Sligo gave them confidence going into the game. Tipp played well in the opening half and were just a goal down at the break. Cork scored a couple of goals early on in the second half and were in control from there on. Tipp on the other hand were finding it hard to score and in the end they were totally outclassed and defeated by 5-11 to 1-7.

Tipperary contested a three-way play-off for a place in the quarter-finals of the National League when they met Sligo in Ardrahan, Co Galway. Sligo missed several scoring chances in the first half, leaving the sides level on 5 points each at the break. Tipp performed badly in the second half and were well-beaten, 4-13 to 2-8, in the end. This finished their interest in the league.

The 2003/2004 Suzuki National League is already underway. Tipperary are grouped with Clare, Louth, Cavan, Sligo and Cork B in division 2 again. Tipp's first game is against Cavan at a halfway venue on 23rd November 2003. Tipp will once again be aiming to remain in division 2A of the National League but will certainly have great aspirations to retain their Munster title and hopefully go a step further in 2004.

## Munster U-14 Championship 2003

The Munster U14 championship saw Tipperary play Kerry, Clare, Limerick and finally Waterford all through the month of May, without success.

Having lost all of their games they were then able to play in the Munster Shield final against Clare on 28th June in Kilmallock. The first half was thoroughly entertaining, however in the second half Tipp allowed Clare more



Under 14 Girls at Feile na Peil. Holding the banner: Tina Mulcahy and Joe McGrath. Back row l to r: Amy Costin, Sinead Condon, Siobhan McGrath, Anne Marie McGrath, Nicola Lyons, Ciara O'Donoghue, Clare Clancy, Niamh Ryan, Kathleen Phelan, Fiona Keating, Kiara Maher, Fiona Dougliss, Emma Dolan, Maeve Scully. Front row l to r: Sarah Frisby, Tara Wall, Marie Kelly, Rita McGrath, Gillian O'Brien, Julie Irwin, Niamh Lonergan, Suin Smith, Eimear O'Donnell, Valerie Dromey. Mascot: Clare Moore.



*Cappawhite Under 14 'B' Co. Champions 2003. Front row: Marguerite Meagher, Amanda Beary, Dearbhla Ryan, Emma Kelly, Siobhan Ryan, Mary O'Meara, Catherine Kelly (Capt.), Denise O'Dwyer, Valerie O'Neill, Michelle Breheny, Katya Renehan, Clodagh Cummins. Back row: Cathy O'Neill (Trainers), Cecilia Walshe (Selector), Siobhan O'Neill, Donna Quinlan, Aisling Barry, Ena Meagher, Martina Buckley, Bridget Barry, Mary Kelly, Anita Barry, Sarah Ryan, Jerri O'Dwyer, Rebecca Cummins, Teresa Quinlan, John Minogue (Selector), Sinead Sheehan (Trainer).*



*Munster Junior Final, Pairc ni Rinn, Cork. Tipperary Munster Junior Champions 2003. Cappawhite girls, from left: Sheilagh Carew, Triona Hennessy, Helen Kennedy, Siobhan Costello, Mairead Crowe, Angela McDermott.*

into the game and they gradually increased their lead to secure a good win in the end. Tipp did not come away from this game empty handed as wing forward and Tipp captain, Cathriona Walsh, received the Player of the Match award. She was presented with her plaque from Dan O Mahoney, President of Munster Council for her efforts playing a captain's role in the Blue and Gold.

**Tipperary U-14 Panel 2003:-** Annette Meaney, Lisa Crotty, Siobhan Crotty (Ballyporeen), Nicola Gilmore (Brian Borus), Lisa Cleary, Roisin Quinlivan (Clonmel Commercials), Sinead O'Donnell, Emer Collins, Edith Carroll, Niamh Hearne, Elaine O'Gorman, Ann Marie O'Gorman (Cahir), Rebecca Cummins, Catherine Kelly, Sarah Ryan, (Cappawhite) Nicola Lyons, Emer O'Donnell, Niamh Lonergan, Gillian O'Brien, Rita McGrath (Moyle Rovers), Sinead O'Hara, Marie Purcell, Karen Mullins, Catherine Walsh, Lucy Brennan (Moycarkey/Borris), Ann Marie McCarra, Kate Hallinan, Lizzy O'Halloran (Newcastle), Denise Connolly, Sabrina Vance (St Ailbes).

### **Munster U-16 Championship 2003**

Tipperary put in a much bigger effort in the under-16 championship in 2003

than they had done the previous year. Their first round game was against Waterford in Bushy Park, Dungarvan, however, ended in defeat. A second round defeat by Limerick put an end to their involvement in the championship.

**Tipperary U-16 Panel 2003:-** Triona Burke (Cahir), Triona McGrath (Newcastle), Noreen O'Gorman (Cahir), Grainne Wade (Aherlow), Kate Slattery (Moycarkey/Borris), Orla Casey (Cahir), Ann O'Dwyer (Cappawhite), Stephanie Elliott (Cahir), Claire Carroll (Cahir), Gemma Maguire (Cahir), Margaret Doyle (Moycarkey/Borris), Niamh O'Mahoney (Ardfinnan), Alison Lonergan (Cahir), Mary Claire Ryan (Cappawhite), Mairead Hickey (Cahir), Ashling O'Donnell (Cahir), Emer Hally (Cahir), Valerie Dromey (Moyle Rovers), Ciara Heffernan (Moycarkey/Borris), Patricia Hickey (Brian Borús) Mary O'Doherty (Cappawhite), Jackie Clohessy (Moycarkey/Borris), Margaret Doyle (Moycarkey/Borris), Claire O'Brien (Moycarkey/Borris), Ann Marie Ryan (Cappawhite), Angela O'Connell (St Ailbes), Emma Russell (Ballyporeen), Elaine Meaney (Ballyporeen), Grainne Meaney (Ballyporeen), Ann Marie Fitzgerald (Ballyporeen), Maeve Scully (Moyle Rovers), Mairead Lutteral (Mullinahone)

### **Munster Minor Championship 2003**

Tipperary made a great start to their minor championship campaign when they defeated Limerick in their first round game in Clogheen on Wednesday 2nd July. Unfortunately for Tipp however, on the same evening Rebecca Walshe suffered an injury that was to see her take no further participation in the 2003 championship. Tipp travelled to Dromina, Co Cork to play Kerry in the Munster semi-final in August. Kerry had a very experienced side and dominated proceedings from the start. They were on top in all positions and although Tipp never gave up, the girls from the Kingdom were by far the better team on the night. Their forwards picked off some excellent scores and they had plenty to spare at the final whistle.

**Tipperary Minor Panel 2003:-** Catherine Doherty (Templemore), Lorraine Power (Moyle Rovers), Samantha Mullins (Brian Borus), Joanne O'Doherty (Cappawhite), Cait McCarra (Newcastle), Grainne O'Connor (Brian Borus), Katie Sweeney (Brian Borus), Sheila Carew (Cappawhite), Jaynie Clancy (Cappawhite), Patricia Hickey (Brian Borus), Amanda Grace (Ardfinnan), Cathy McGrath (Newcastle), Jennifer Grant (Brian Borus), Madeleine Hearne (Sliabh na mBan), Gemma Maguire (Cahir), Ashling Ryan (Ardfinnan), Rebecca Walshe (Aherlow)

### **Munster Junior Championship 2003**

Tipperary began their long awaited Munster championship campaign on Sunday, 29th June in Cahir. After a good display they were unfortunate to lose to Limerick by a point. Tipperary couldn't remain down for long however as they had just six days to regroup and focus on Cork in their next game. They bounced back with a good win by three points, having led by five at the interval. Tipp travelled to Doonbeg in Co Clare to play Kerry in their third round game. This was a game, which again Tipp had to win to keep alive their hopes of reaching a Munster final. Despite the fact that Tipp were playing against the breeze in the first half, they played some excellent football, picking off some terrific scores and securing a lead of 2-8 to 1-7 at half time. Further points and a goal for Tipp in the second half killed off any chance of a Kerry revival with the final score Tipp 3-12, Kerry 2-9. Tipp's final game in the round robin series of the championship was a meeting with Waterford in Cahir. They led by 2-7 to 0-5 at the interval and scored a comprehensive victory by 3-19 to 0-8.

Tipperary had to wait for over a week before they received confirmation that they had booked their place in the final



at Pairc Úi Rinn on August Bank Holiday Monday, as a couple of other games were still outstanding in the championship. When confirmation came through that Tipp had reached the final there was a sense of relief and excitement in the camp. Tipp, having won a couple of senior titles in the 1970s and again in 1980, had never contested a Munster junior final. The final, against Limerick, was a thrilling one with a somewhat nervous looking Tipp side trailing by 6 points at half time. The second half however was nail biting. The Tipp forwards scored some great points from play and with the supporters rallying behind the team they managed to claw their way right back into the game. Tipp went two points ahead with just minutes remaining on the clock. Some terrific defending by Tipp in the dying minutes saw them secure a historic victory in the end, by 0-11 to 0-9, and there were jubilant scenes when team captain, Denise Fitzgerald, was presented with the cup. The celebrations continued in Cahir and Ballylooby into the early hours of the morning.

Tipp's opponents in the All-Ireland semi-final on September 13 were Kildare. Kildare led by 2-10 to 0-4 at the break leaving Tipp with a mountain to climb in the second half. Tipperary were totally outclassed on the night by a much sharper and faster looking Kildare side.

**Tipperary Junior Panel 2003:-** Jennifer Grant (Brian Borús) Mairead Crowe (Cappawhite), Libby Grogan (Aherlow), Carmel Condon (Brian Borús), Maeve Corcoran (Moycarkey/Borris), Angela McDermott (Cappawhite), Mairead Morrissey (Brian Borús), Triona Hennessy (Cappawhite), Siobhan Costello (Cappawhite), Denise Fitzgerald (Brian Borús), Patreece Ryan (Ardfinnan), Edel Hanley (Aherlow), Mary Connolly (Sliabh na mBan), Helen Kennedy (Cappawhite), Moira Ryan (Aherlow), Claire Tobin (Ardfinnan), Barbara Moran (Ardfinnan), Orla Fahey (Brian Borús), Claire Lambert (Barbara Moran), Orla Fleming (Brian Borús), Rebecca Walsh (Aherlow), Claire Peters (Golden), Rosemarie Carew (Upperchurch/Drombane), Helen Norris (Brian Borús), Janet Rencontre (Ardfinnan), Nancy Ferris (Moyle Rovers), Louise Wade (Moyle Rovers), Sheila Carew (Cappawhite)

### **Cailíní Óige 2003**

While the Tipperary junior team were in action in Cahir on 29th May, the Cailíní Óige team were also in action in Ardfinnan in their competition. With conditions for football perfect and a strong panel of players to choose from Tipperary played some great football and defeated Limerick. Their next outing was played in much poorer weather conditions in Cahir. Their opponents in this game were Waterford who were



*Moyle Rovers U12B County Champions. Back row: Sarah Boland, Aisling Dwyer, Brid Coleman, Danielle Delahunty, Rebecca Ronan, Megan Kelly, Roisin Lorigan, Denise Ryan. Middle row: Niamh Whyte, Roisin Smyth, Paige Crotty, Aisling Dwyer, Kelly Walsh, Aisling Kenrick, Brigette O'Connor. Front row: Samantha Slattery, Fiona Ryan, Jessica Kenny, Aoife McGrath, Maura Kirby (capt.), Kelly Jones, Teresa McGrath, Niamh Foley, Aoife Hartnett.*

favorites to win. The team played very well despite the heavy rain and they overcame Waterford in the end earning a place in the Munster final of the competition. The final was played as the curtain raiser to both the Munster junior and senior finals at Pairc Úi Rinn in Cork on August Bank Holiday Monday. On the day they met a very strong Kerry side and despite their best efforts they were defeated in the end. It was a great achievement to reach the final of the competition and it was also a tremendous experience for such young players. They thoroughly enjoyed the day and also got to take home a medal.

**Cailíní Óige Panel 2003:-** Bridget Barry, Catriona Nagle, Valerie O'Neill, Samantha Lambert, Rebecca Meagher, Siobhan O'Neill, Michelle Ryan, Christine O'Gorman, Rebecca Cummins, Olivia McCarthy, Ailish Ryan, Bronagh Higgins, Ann Marie O'Gorman, Leanne Barrett, Cathriona Walsh, Hannah Gearon, Jean Marsh, Jacinta McCarthy, Sarah Fahey, Teresa Ryan, Julie Ann Maher, Breda Feeney, Emma Sisk, Julie O'Meara, Niamh Maher, Irene Leahy, Freda Casey, Megan English, Dawn Doolan, Saoirse O'Flynn, Edith Carroll, Marguerita Dawson, Gemma O'Brien, Ashling O'Brien, Maire Ring, Jane Kennedy, Ina Maher

### **U-12 Championship 2003**

The 2003 U-12 championship had a total of 11 teams taking part, namely, Aherlow, Ballyporeen, Moycarkey/Borris, Cappawhite, St Ailbes, Clonmel Commercials, Cahir, Brian Borus, Ardfinnan, Mullinahone and Moyle Rovers.

Kilsheelan was the venue for both the under-12A and replayed under-12B county final in 2003. Moyle Rovers and Mullinahone ended all square in the under-12B Final on the first occasion.



*Intermediate County Final (Football), left to right: Siobhan Costello, Cappawhite Captain; Richie O'Connor, Referee; Carmel Condon, Brian Borus captain.*

However, the second outing proved to be a much more one sided affair with Moyle Rovers proving much too strong for Mullinahone, and Rovers were crowned under-12B champions amid great celebrations.

The long awaited A final between Cahir and their near neighbours, Ardfinnan, looked set to be a very close encounter. Cahir exerted a lot of pressure on Ardfinnan in the first half and scored 1-2, while Ardfinnan failed to register a score. Ardfinnan got more into the game early on in the second half but Cahir responded well registering further scores on the board. In the end Cahir won easily with the score at full time reading Cahir 2-7, Ardfinnan 1-0.

### U-14 Championship 2003

The under-14 championship had 12 teams participating and they included; St Ailbes, Newcastle, Cappawhite, Brian Borus, Cahir, Aherlow, Upperchurch/Drombane, Moyle Rovers, Mullinahone, Ardfinnan, Ballyporeen and Moycarkey/Borris.

Cahir captured the under-14A county title defeating Moyle Rovers in the final on 28th May in Killenaule. This was a great game of football, between two evenly matched sides, who are no strangers to each other. It was close throughout, however, some good positional changes by Cahir saw them carve out a narrow victory in the end.

Cappawhite captured their third under-14 Plate title in a row when they overcame St Ailbe's (Emly) in the final, played at Tipperary town. Cappawhite

led by 1-3 to a goal at half time but at full time the score line was Cappawhite 1-6, St Ailbes 1-1.

### U-16 Championship 2003

The under-16 championship was made up of 10 teams including Mullinahone, Cahir, Brian Borus, Ballyporeen, Cappawhite, Moycarkey/Borris, Moyle Rovers, St Ailbes, Clonmel Commercials and Newcastle.

Cahir and Moycarkey/Borris went head to head in the under-16 A final on October Bank Holiday Monday in Cashel. Cahir gave a terrific first half display scoring 3-9 to Moycarkey's 3 points before the break. Moycarkey/Borris came out firing on all cylinders in the second half, scoring 4 goals and 5 points. Cahir, however, stood firm and managed to maintain their lead to secure a well-deserved vic-

tory in the end and in so doing captured their 5th title county of the year.

Cappawhite and St Ailbe's met in the under-16B (Plate final) with Cappawhite securing a victory in the end.

### Minor Championship 2003

The minor championship was divided into 3 sections in 2003. Section A included Cappawhite, Cahir and Brian Borus. Ardfinnan, Moyle Rovers and Moycarkey/Borris contested section B while St Ailbe's, Newcastle and Templemore made up Section C.

At time of print this championship has not concluded. Brian Borus and Cappawhite will play out the A final, while Moyle Rovers and Moycarkey/Borris will compete in the B final. These games are due to take place at the end of November.



Cailíní Óige – Tipperary v Limerick – Mary Horan (trainer), Hannah Gearon, Jean Marsh, Samantha Lambert, Michelle Ryan, Valerie O'Neill, Bridget Barry, Ailish Ryan, Siobhan O'Neill, Christine O'Gorman, Cathriona Nagle, Mary Ryan (trainer/selector). Front row (l. to r.): Cathriona Walshe, Leanne Barrett, Ann Marie O'Gorman, Edith Carroll, Sarah Fahey, Olivia McCarthy, Bronagh Higgins, Teresa Ryan, Rebecca Cummins.



Cailíní Óige – Tipperary v Waterford – back row (l. to r.): Mary Horan (trainer), Niamh Maher, Jemma O'Brien, Margarita Dawson, Saoirse O'Flynn, Cathriona Walshe, Jane Kennedy, Julie O'Meara, Emma Sisk, Breda Feeney, Niamh Maher, Ashling O'Brien, Biddy Ryan (selector). Front row (l. to r.) Megan English, Dawn Doolan, Freda Casey, Edith Carroll, Julie Ann Maher, Maire Ring. At rear of picture: Jean Marsh.

## Intermediate Championship 2003

The intermediate championship had been run for the first time in Tipperary in 2002. Again this year, two clubs from the county would have the opportunity of competing in the Munster club championship. Brian Borus, Cappawhite, Ardfinnan, Moyle Rovers and Aherlow were entered at intermediate level.

Aherlow, however, having lost several of their players from the previous year, found it difficult to field a team for the championship in 2003. The far superior Cappawhite and Brian Borus outclassed Ardfinnan and Moyle Rovers in their respective meetings and therefore it was to be a Brian Borus and Cappawhite intermediate final once again in 2003. Brian Borus were hoping to retain their intermediate title, while Cappawhite had gained vast experience in reaching the All Ireland junior club final in 2002.

The final was played on September 6th in Golden. The first half was highly entertaining with both sides giving their all. Brian Borus led by 1-3 to 1-1 at half time but it was all to play for. The second half was similar to the first and played with just as much intensity. Both teams exchanged scores and there was nothing between them in the dying minutes of the game. However, it was Angie McDermott and Triona Hennessy at midfield for Cappawhite who proved

to be the difference between the two sides and in the end Cappawhite narrowly edged out Brian Borus to capture the club's first ever intermediate title on a score line of 3-6 to 2-7.

Intermediate League

Cappawhite and Brian Borus are due to meet again in the final of the intermediate league, which is not yet fixed.

## Junior Championship 2003

### JUNIOR A

The eagerly awaited county junior A final between Ardfinnan and Moyle Rovers was played in Ned Hall Park, Clonmel on 25th August. Ardfinnan, having been defeated in the 2002 final by Cappawhite, and Moyle Rovers having captured the junior B title in 2002, both had points to prove. This game started at an intense pace and while Ardfinnan picked off a number of very good scores in the first half and led by seven points at the break, they were far from home and dry. Moyle Rovers threw everything at Ardfinnan and the game could have gone either way. Moyle Rovers had some poor shooting in the second half that was to prove detrimental for them in the end. Ardfinnan managed to hold on for dear life and secured a victory with just two points to spare at the final whistle. The win put them through to represent Tipperary in the Munster Junior Club Championship.

### JUNIOR B

Five teams made up the junior B

championship in 2003; Sliabh na mBan, Templemore, Moycarkey/Borris, Golden and Newport. The county semi-finals saw Templemore defeating Newport, while Sliabh na mBan overcame Moycarkey/Borris. The final between Templemore and Sliabh na mBan is due to take place on 30th November.

## Junior B League

The final of the junior B league between Sliabh na mBan and Moycarkey/Borris has not yet been played.

### JUNIOR C

The junior C championship had a total of 8 teams competing in 2003. They included Mullinahone, Upperchurch/Drombane, Cappawhite B, Newcastle, Kilruane, Cahir, Fethard and Moyne/Templetuohy.

In the final, which was played in Bancha, Cahir overcame Cappawhite B to capture the C title.

## Junior C League

Cahir and Upperchurch/Drombane contested the junior C league final, played in Dundrum in October. Cahir were by far the better team on the day with Upperchurch/Drombane proving to be no match for them. In defeating Upperchurch, Cahir completed a junior C league and junior C championship double in 2003.

## Munster Club Championship

Ardfinnan travelled to Clonakilty in



The Cappawhite ladies' football team that won the county intermediate football title by beating Brian Borus at Golden. Front: Ann Costello (sel.), Triona Hennessy, Tracy Maguire, Joanne O'Doherty, Siobhán Costello (captain), Deirdre Ryan, Jane Anne O'Neill, Ann O'Dwyer, Mairéad Crowe, Mary O'Dwyer, Faustina Renehan, Sinead Buckley, Seanie O'Neill (trainer). Back: Marion Fitzgerald, Sandra Barr, Elaine Renehan, Sheelagh Carew, Helen Kennedy, Marie O'Neill, Fiona Fox, Angela McDermott, Antoinette O'Doherty, Jayne Clancy, Mary Horan, Mary Claire Ryan, Cariona Fitzgerald, Sinead Sheehan, Noreen O'Doherty, Tony Breheny (Selector).  
Photo: B. Mullally.



Cahir ladies' football team who were victorious over Ardfinnan in the Under-12 'A' final at Kilsheelan. Front row: l. to r.: Áine Hickey, Orla McEniry, Aisling Higgins, Avril Hearn, Clíodhna Higgins, Aisling McCarthy, Shauna O'Donnell, Ruth Cummins and Aisling O'Connor. Middle row: Aoife O'Gorman, Molly Walshe, Bronagh Higgins, Geraldine O'Donnell, Jane O'Donnell, Anne Marie O'Gorman and Gillian O'Keefe. Back row: Kathryn Doverman, Claire Harris, Eimer Collins, Nicola Armitage, Sarah Harris, Freda Casey (capt.) Leanne Barrett, Aoife Casey, Aoife Burke. (Photo: B. Mullally)

October to play the much-fancied Gabriel Rangers for West Cork in the Munster junior club championship. Ardfinnan only really looked in contention for the first quarter of an hour in this game. The Cork side were in control in all positions and their passing and running off the ball was excellent with their forwards picking off some terrific scores with ease. Gabriel Rangers had built up a considerable lead by half time and their dominance continued in the second half with Ardfinnan being totally outclassed. At time of print Gabriel Rangers have qualified for the All-Ireland junior club final.

Cappawhite represented Tipp in the Munster intermediate club championship and after a somewhat shaky start, and having trailed by 3 points at the break, they secured a comprehensive victory over Dr Crokes of Kerry in the end. Cappawhite's next outing was in the Munster final on 18th October against Ballyvourney. Unfortunately, however Cappawhite met a very strong Cork side on the day that saw their Munster Club championship campaign come to an end.

### All Ireland Club

#### Seven-a-side Competition

Tipperary was well represented both at junior and intermediate level in the All-Ireland club seven-a-side competition in Portmarnock on Saturday, October 2003. Ardfinnan, Cahir, Cappawhite and Upperchurch/Drombane all took part. Despite the fact that we did not bring home any silverware in 2003, yet again all clubs had a thoroughly enjoyable and valuable weekend of football.

### U-1A Club

#### Blitz Competitions

Cahir Ladies Football Club hosted an under-14 blitz in beautiful conditions on Saturday, 18th October with teams from Cahir, Ballyporeen, Ardfinnan,

Moycarkey/Borris and Moyle Rovers taking part. Cahir and Moyle Rovers contested the A final with Moyle Rovers coming out winners in the end, while Ballyporeen overcame Ardfinnan in the B final.

At national level the Tipperary under-14 team travelled to St Oliver Plunkett's GAA club in Robinstown, Mullingar to participate in the All-Ireland under-14 Blitz competition in June. They were grouped with Leitrim, Carlow, Wexford and Dublin.

They had good wins over Leitrim and Carlow in their first two games but were defeated by Wexford and lost narrowly to Dublin in their last match. The under-14 panel proved that they can compete against many of their counterparts throughout the country and were unlucky not to have progressed further in this competition.

### Peil na nÓg

Moyle Rovers proudly represented Tipperary at Peil na nÓg, which was took place in Galway in July. Claregalway club, outside Galway city, were their hosts for the weekend. Although they did not bring home any silverware, they won the first two games in the competition and had a thoroughly enjoyable weekend.

Mullinahone also flew the flag for the county when they represented Tipperary at the Munster finals of the Community Games in the University of Limerick in July.

### Inter-Provincials

Edel Hanley from Aherlow was the sole representative from Tipperary on the Munster panel at the inter-provincials at Mullingar at the beginning of June. Edel has been a member of the Tipperary team for the past number of years and was the top scorer for Tipp in this year's championship, notching up a total of 3-25. Munster defeated Leinster, Connacht and Britain in their first three games. It was Munster and Ulster

who met in the final on Sunday with Munster capturing the title in the end. Edel contributed greatly to the Munster win scoring a couple of points over the weekend.

### Integration

At the end of February 2003 the GAA, the Ladies Football Association and the Camogie Association met in Croke Park. The meeting was in relation to the formal integration of the ladies games into the GAA. Since March a pilot scheme has been put in place. There are many benefits to all three organisations to forming an all-inclusive association and with everyone's co-operation from club level upwards the rewards will be great. Lets hope that everyone involved in Gaelic games in Tipperary will have the vision to move forward together.

Ladies Football in Tipperary has made great advances in the last number of years. At inter-county level Tipperary has now proven that they are a force to be reckoned with, while at club level Cappawhite have shown that they are among the best clubs in the country at present. If this momentum can be maintained who knows what the future will hold for the game in Tipperary. Congratulations to all clubs who participated in 2003 and especially to all those who captured titles. Well done to everyone who promoted and developed Ladies Football throughout the county and keep up the good work.

On behalf of the Tipperary Ladies Football county board I would like to congratulate anyone who celebrated happy occasions during the year and to extend sincere sympathy to those who suffered bereavements.

Anyone interested in setting up a new club or promoting ladies football in the county should contact Liam Shinnick, county chairperson at (052) 42195 or Biddy Ryan, county secretary at (052) 66146.



Cahir ladies U-16 A team who won the county final over Moycarkey, included are:  
 Front row: Ann Marie O'Gorman, Stephanie Elliott, Noreen O'Gorman, Loraine O'Donnell, Emer Hally (capt.) Edel Carroll, Leanne Barrett, Alison Lonergan, Claire Carroll. Middle row: Grainne Wade, Katie O'Reilly, Gemma Maguire, Orla Casey, Aisling O'Donnell, Elaine O'Gorman, Aoife Casey. Back row: Amy O'Donnell, Sinead O'Donnell, Mairead Hickey, Triona Burke, Niamh Hearn, Freda Casey, Caitriona Nagle.



The Cahir team that won the ladies football county junior 'C' title beating Cappawhite in the final at Bansha. Front row: (l. to r.): Alison Lonergan, Mairead Hickey, Stephanie Elliott, Carmel Kiely (captain), Gemma Maguire, Ann O'Brien, Thelma Lonergan, Claire Carroll. Middle row: Caoimhe Doherty, Noreen O'Gorman, Eimear Hally, Aisling O'Donnell, Alish Meehan, Eimear O'Loughlin. Back row: Miriam Hally, Michelle O'Donnell, Orla Casey, Triona Burke, Fiona Barrett and Lisa Halley. Absent from pic: Louise Carroll.



The Ardfinnan ladies football team that won the county Junior 'A' title beating Moyle Rovers at Clonmel. Back row (l. to r.): Grainne O'Leary (selector), Derek O'Mahoney (trainer), Libby Twomey, Claire Tobin, Suzanne Shine, Ashling Ryan, Deborah Doolan, Janet Rencontre, Niamh O'Mahoney, Brid Murphy, Jean Lonergan, Una Hally, Sandra Walsh. Front row (l. to r.): Biddy Ryan (selector), Noel Glavin (selector), Claire Lambert, Barbara Moran, Hannah Phelan, Patreece Ryan (captain), Lisa Grace, Amanda Grace, Ber Connolly, Suzanne Savage.



Cahir girls U-14 ladies football winners. Front row (l. to r.): Aisling Condon, Nicola Armitage, Amy Ryan, Leanne Barrett, Freda Casey, Elaine O'Gorman (captain), Anne-Marie O'Gorman, Geraldine O'Donnell, Bronagh Higgins, Eimear Collins, Clara Fahey. Back: Lisa Meaney, Jane O'Donnell, Catriona Nagle, Amy O'Donnell, Niamh Hearn, Sarah Harris, Ahelm Birem, Aoife Casey, Sinead O'Donnell, Lizzie Lonergan, Marie Brenna, Edith Carroll.



Tipperary junior ladies football Munster final winners: Front: Nancy Ferris (Moyle Rovers), Helen Norris (Brian Borus), Sheila Carew (Cappawhite), Jeanette Recontre (Ardfinnan), Claire Peters (Golden), Carmel Condon (Brian Borus), Siobhan Costelloe (Cappawhite), Denise Fitzgerald (captain) (Brian Borus), Orla Fahey (Brian Borus), Angela McDermott (Cappawhite), Barbara Moran (Ardfinnan), Mairead Crowe (Cappawhite), and Meave Corcoran (Moycarkey). Back row: Rosemary Carew (Upperchurch), Louise Wade (Moyle Rovers), Claire Tobin (Ardfinnan), Clare Lambert (Ardfinnan), Libby Grogan (Aherlow), Rebecca Walsh (Aherlow), Jennifer Grant (Brian Borus), Mairead Morrissey (vice-captain) (Brian Borus), Edel Hanly (Aherlow), Patreece Ryan (Ardfinnan), Triona Hennessey (Cappawhite), Mary Connolly (Mullinahone) and Helen Kennedy (Cappawhite).

## All-Ireland Camogie Final Action



Claire Maddan comes out with the ball

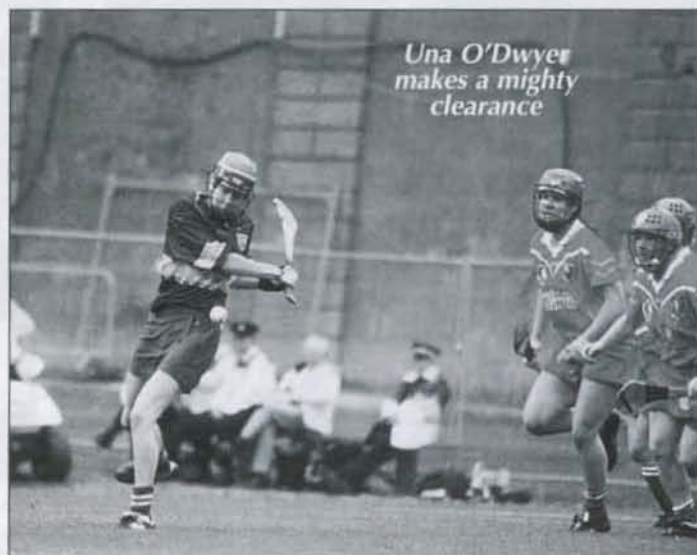

Una O'Dwyer makes a mighty clearance

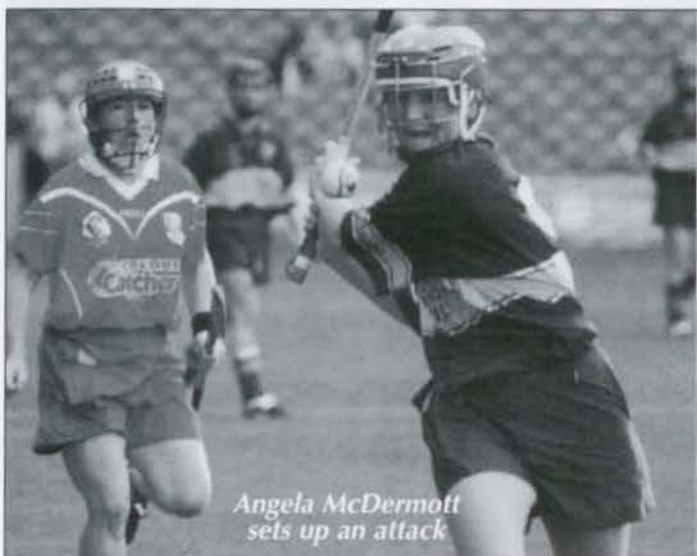

Angela McDermott sets up an attack



Joanne Ryan on the move

# Mid Tipperary Championship, League Winners and Runners-Up 2003

DATE	WINNERS	RUNNERS-UP	LOCATION	REFEREE
<b>YOUNGES THE RAGG SENIOR HURLING FINAL.</b>				
24/8	LOUGHMORE - C 3 - 14	THURLES SARS 2 - 13	TEMPLEMORE	W. BARRETT.
<b>MACLOCHLAINNS ROAD MARKINGS INTERMEDIATE HURLING FINAL.</b>				
30/8	CLONAKENNY 2 - 17	MOYNE - T 2 - 10	TEMPLEMORE	N. COSGRAVE
<b>MACKEY STAND JUNIOR A HURLING FINAL.</b>				
28/9	THURLES FENNELLYS 2 - 11	HOLYCROSS - B 3 - 8	THE RAGG	J. RYAN.
<b>MACKEY STAND JUNIOR A HURLING FINAL (REPLAY)</b>				
18/10	THURLES FENNELLYS 3 - 10	HOLYCROSS - B 2 - 12	THE RAGG	M. GOLDSBORO
<b>ROSKEEN CONSTRUCTION JUNIOR B HURLING FINAL.</b>				
20/9	DROM - INCH 4 - 14	KILLEA 1 - 8.	HOLYCROSS	P. J. LEAHY.
<b>NOEL RYAN PARNELL ST. U21 A HURLING FINAL.</b>				
20/4	THURLES SARS 3 - 17	LOUGHMORE - C 1 - 6	THE RAGG	W. CLOHESSY.
<b>NOEL RYAN PARNELL ST. U 21 B HURLING FINAL</b>				
13/4	MOYNE - TEMPLE 4 - 9	UPPERCHURCH - D 2 - 13.	THE RAGG	W. CLOHESSY.
<b>U 21 C HURLING</b>				
<b>ROADSTONE PROVINCES MINOR A HURLING FINAL</b>				
6/9	MOYCARKEY - B 4 - 11	GORTNAHOE - G3 - 11	HOLYCROSS	D. CURTIS.
<b>THURLES CREDIT UNION MINOR B HURLING FINAL.</b>				
27/8	DROM - INCH 3 - 9	J K BRACKENS 2 - 11	OUTSIDE FIELD.	M. TREACY.
<b>MINOR C HURLING CLONAKENNY W/O RAHEALTY - KSCR</b>				
<b>GLEESONS QUARRIES SENIOR FOOTBALL FINAL.</b>				
31/8	LOUGHMORE - C 3 - 8	J K BRACKEN 0 - 8	TEMPLEMORE	P. RUSSELL.
<b>GERRY CHAWKE INT. FOOTBALL FINAL</b>				
20/9	UPPERCHURCH - D 3 - 6	HOLYCROSS - B 3 - 6	THE RAGG	J. KELLY
<b>GERRY CHAWKE INT. FOOTBALL FINAL (REPLAY)</b>				
3 - 10 (REPLAY)	HOLYCROSS - B 2 - 8	UPPERCHURCH - D 2 - 5	THE RAGG	J. KISSANE
<b>EDDIE JOE JUNIOR A FOOTBALL FINAL</b>				
2/11	LOUGHMORE - C 0 - 10	DROM - INCH 0 - 5	HOLYCROSS	J. KELLY.
<b>ROSKEEN CONSTRUCTION JUNIOR B FOOTBALL FINAL</b>				
29/11	J K BRACKENS 1 - 10	THURLES FENNELLYS 0 - 9	CASTLEINEY	P. CULLEN
<b>U21 A FOOTBALL FINAL</b>				
30/3	MOYNE - T 2 - 11	LOUGHMORE - CASTLEINEY 0 - 13,	THE RAGG.	D. CURTIS.
<b>U21 B FOOTBALL FINAL</b>				
22/3	GORTNAHOE - G 3 - 5	BOHERLAHAN - D 0 - 4.	GORTNAHOE.	P. J. LEAHY
<b>U21 C FOOTBALL FINAL CLONAKENNY WINNERS</b>				
<b>BANK OF IRELAND THURLES MINOR A FOOTBALL FINAL</b>				
20/6	GORTNAHOE - G 0 - 20	LOUGHMORE - C 1 - 7.	HOLYCROSS	D. CURTIS
<b>1/5 MINOR B FOOTBALL FINAL.</b>				
	MOYCARKEY - B 1 - 5	DROM - INCH 0 - 7.	BALLYCAHILL.	M. TREACY
<b>MINOR C FOOTBALL FINAL.</b>				
	GORTNAHOE - G 2 - 12	CLONAKENNY 2 - 6.	KICKHAM PARK	K. BUTLER
<b>LEAGUES.</b>				
<b>CAHILL CUP FINAL.</b>				
2/11	THURLES SARS 2 - 15	MOYNE - T 1 - 14	HOLYCROSS.	M. TREACY.
<b>JUNIOR HURLING LEAGUES</b>				
<b>DIV 1 FINAL</b>				
22/6	THURLES FENNELLYS 2 - 15	HOLYCROSS - B 1 - 11	THE RAGG.	J. RYAN
<b>DIV 2 FINAL</b>				
13/6	THURLES SARS 1 - 11	LOUGHMORE - C 1 - 10	TEMPLEMORE.	W. CLOHESSY
<b>DIV 3 FINAL</b>				
28/6	J K BRACKENS 2 - 10	CLONAKENNY 1 - 8	THE RAGG.	K. BUTLER
<b>OUTSTANDING GAMES FROM 2002</b>				
<b>JUNIOR A FOOTBALL FINAL</b>				
22/12	UPPERCHURCH - D 0 - 11	DROM - INCH 1 - 5	THE RAGG	D. CURTIS
<b>JUNIOR B FOOTBALL FINAL</b>				
30 - 11	GORTNAHOE - G 2 - 8J.	K. BRACKENS 2 - 8	CASTLEINEY	P CULLEN
<b>REPLAY JUNIOR B FOOTBALL FINAL</b>				
7 - 12	GORTNAHOE - G 2 - 11	J. K. BRACKENS 2 - 3	TEMPLETUOHY	P. J. LEAHY
<b>U 21 B HURLING</b>				
26 - 12	J. K. BRACKENS 2 - 8	LOUGHMORE - C1 - 8	THE RAGG	J. RYAN

# THURLES GREYHOUND STADIUM

- *Magnificent New Grandstand* •
- *Racing Tuesday and Saturday* •
- *First Race 8 p.m. each night* •

**Track Available for all Functions  
Group Rates available on request**

**Parking and Bar Facilities  
Available for Match Days**

**THURLES GREYHOUND STADIUM,  
THURLES, CO. TIPPERARY.**

**TEL.: (0504) 21003**

**FAX: (0504) 26009**

# PRINTING

**Jim Fogarty  
Two-Mile-Borris  
Thurles**

Tel: (0504) 44181

**General, Social & Sports Printing**  
Dance, Social, Anniversary & 21st Invitation Tickets,  
Letterheads, Business Cards, Draw Cards, Club Lotto  
Tickets and Lotto Result Sheets, N.C.R., Invoice,  
Order, Delivery Books & Sets, Circulars,  
Printed Envelopes, Posters, Membership Cards,  
Menus, In Memoriam & Acknowledgement Cards,  
Raffle Tickets and much more ...

**PHONE: 0504-44181 FOR YOUR  
PRINTING REQUIREMENTS**

*Nollaig Shona dar mo gCustumeirí go leir*



## CUMANN LÚTHCHLEAS GAEL

Tiobraid Árann Mean



# *Mid Tipperary G.A.A. Board*

The Board wishes to thank all followers and sponsors of Gaelic Games in the division for their continued support and encouragement during the year.

RIOBARD Ó STAICLUIM  
Uachtarán

MAITIÚ Ó CONGHAILE  
Runaí

Michael de Búrca  
Cathaoirleach

Tomás Ó Meachair  
Cisteoir

MICHAEL Ó AOGAIN  
Runaí Cúnta



## MID TIPPERARY G.A.A. BOARD OFFICERS 2003

President	Bob Stakelum	Holycross - Ballycahill	Asst Treasurer	John O'Donovan	Rahealty - Kickhams
Chairman	John Doyle (Jnr)	Holycross - Ballycahill	Trustee	Pat Cullen	Loughmore - Castleiney
Secretary	Matty Connolly	Boherlahan - Dualla	Semple Stadium	Jim Max	Thurles Sarsfields
Treasurer	Tom Maher	Moyne - Templetuohy	P.R.O.	P.J. Leahy	Moyne - Templetuohy
V-Chairmen	Pat Gleeson	Loughmore - Castleiney	Gate Checkers	Dick Maher	Thurles Sarsfields
	P.J. Maher	Boherlahan - Dualla		Batt O' Dea	Loughmore - Castleiney
Asst. Secretary	Michael Egan	Gortnahoe - Glengoose			



*Thurles Fennellys Mid Tipperary Junior 'A' Hurling Champions. Back, l to r: Lar Barrett, Morgan Lanigan, John Callinan, Jim Mackey, Jim Woodlock, Pat Lalor, Alan Hughes, Joe Cleare, Gary Coppinger, Michael Kennedy, James O'Grady. Front, l to r: Sam Walsh, Philip Lalor, T.G. Gleeson, Kevin Jordan, Philip Butler (capt.), William Carroll, Lar Mackey, Thomas Jordan, Raymond Carew, Paul Shelly.*



*Mid U-21A Football Champions - Moyne-Templetuohy. Back, l to r: T. Bergin, M. Russell, C. Campion, M. Kelly, D. Bergin, M. Ely, R. Everard, D. Leahy, G. Maher, M. Costigan, E. Everard, N. Russell, T. Guilfoyle, D. Everard. Front, l to r: T. Hassett, J. Sweeney, K. Fogarty, K. Quinlan, J.P. Costigan, D. Kelly, capt, J. Hassett, E. Kelly, N. Walsh, N. Dunne, K. Walsh. Missing from photo: A. Leahy and O. Butler.*



*Gortnahoe-Glengoose Mid Tipperary Minor 'A' Football Champions. Back, l to r: Shane Hanrahan, David Mockler, Keith Holohan, Kevin Kenny, Jeff Brennan, Niall Teehan, Michael Heffernan, Paddy Phelan. Front, l to r: Shane Long, Mark O'Dwyer, Shane McCarthy, Patrick Skehan, Keith O'Dwyer, Stephen Bourke, Eddie Stokes.*



*Thurles Sarsfields Mid U-21 'A' Hurling Champions and County Finalists. Back, l to r: Aidan Dundon, Eoin Costello, Tony Connolly, Tony Ruth, Eamon Tuohy, Willie Collins, Barry Dwyer, capt. Front, l to r: David O'Dwyer, Peter Graydon, Wayne Cully, Lee Shanahan, Patrick McCormack, John Lillis, Brendan O'Sullivan, Richie Ruth.*



*The Drom-Inch Mid Tipperary Junior 'B' Hurling Champions. Back, l to r: Michael Kennedy, William Lowry, Michael Carr, Matthew Ryan, Pdraig Ryan, Seamus Cahill, Kevin Butler, Donnacha Kennedy, Ger Ryan, Sean Hayes, Andy Bourke. Front, l to r: Matty Shanahan, Noel McLoughlin, Declan Ryan, Trevor Hassett, John McGrath, Seamus Hassett, Kevin Nolan, John Egan, Joe Egan, Dick Kennedy, Des Hennessy.*



*Drom-Inch Mid Tipperary Minor 'B' Hurling Champions. Back, l to r: Diarmuid Long, Eric Woodlock, Michael Butler, Edward Costello, Michael Sheridan, Johnny Ryan, Kieran Young, James Woodlock, Jerome Ryan, Matthew Buckley, Gary Ryan. Front, l to r: Matthew McGrath, Daniel De Burca, Enda Walsh, Seamus Callanan, Martin Butler, James Ryan, Matthew Ryan, Cathal Flynn, Donnacha Kennedy, Paul Ryan, Martin McGrath.*



*The Moyne-Templetuohy U-21 'B' Hurling Champions. Front, l to r: Ricky Fogarty, John Paul Costigan, Niall Walsh, Kevin Fogarty, Gerry Maher, Niall Russell, John Sweeney, Martin Kelly. Back, l to r: William Maher, Jimmy Bergin, Raymond Everard, John Butler, Martin Costigan, John Hassett, Thomas Hassett, Ronan Ely, Damien Bergin, Edward Kelly, Sean Everard, Willie Fogarty.*



*Gortnahoe-Glengoose Mid Minor 'C' Football Champions. Back, l to r: Nicholas Guilfoyle, James Treacy, Dermot Ryan, Michael Clancy, Aidan Langton, Adrian Kilcourse, Kevin Maher, capt, Nigel O'Gorman, Shane McGarry, Michael McMonagle. Front, l to r: William Walsh, Michael Barnaville, Michael Phelan, Stephen Barnaville, Stephen Holohan, Kenneth Hickey, Sean Lahart, John Broderick.*



# Bowe Travel

Travel Agent for all Foreign Holidays in  
the Tipperary G.A.A. Members' Draw

FRIAR STREET, THURLES, CO. TIPPERARY

Telephone: 0504-22200. Fax: 0504-22121.

Telephone: 0504-23520. e-mail: michael.bowe@bowetravel.ie

"Fully Bonded Travel Agent"



Tiobraid Árann

- Togha Iománaithe

agus Peileadóirí



[www.bowetravel.ie](http://www.bowetravel.ie)

e-mail: [michael.bowe@bowetravel.ie](mailto:michael.bowe@bowetravel.ie)

BOOK ON-LINE  
CAR HIRE AND  
ACCOMMODATION



# INTOSPORT

KILKENNY ROAD, CASTLECOMER, CO. KILKENNY.

TEL. 056-41652. FAX 056-41588

*Sports and Leisurewear Manufacturers*

WHOLESALE PRICES TO CLUBS, SCHOOLS AND ASSOCIATIONS

*Jerseys • Shorts • Socks • Track Suits • Sweatshirts • Polo Shirts • Caps • Flags and Banners - Game Skirts for Camogie, Hockey, etc.*

*- Team Strips made to order - Kit Bags*

PRINTING OF CRESTS AND LOGOS, ETC.

Design and Printing of all types of Vinyl Signs. Evening appointments can be arranged.

TEL. 056-41652. FAX 056-41588

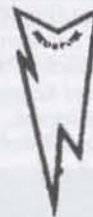

# Thurles Co-op

**THE COMPLETE SERVICE**

- Euro Spar Supermarket
- Dairy Products
- Topline Hardware
- Farm Supplies

FOR ALL THESE REQUIREMENTS:

**TELEPHONE: (0504) 21522**

*Plus your oil requirements from...*

# O'Meara Oil



**TELEPHONE: (0504) 21333**



Clonakenny Mid Tipperary Minor C Hurling Champions. Back, 1 to r: Pat Shelly, Alan Bulfin, John Costigan, Tomas Carroll, Gerard Smith, William Moloughney, Micheal Coonan, Eddie Byrne, Peadar Byrne, Peter Jennings. Front, 1 to r: Brendan Bulfin, James Cody, Niall Matthews, Donal Greed, Conor Ryan, Philip Crampton, Stephen Carroll.



Mid Tipp Minor B Football Champions, Moycarkey Borris. Front, 1 to r: P. O'Brien, D. Healy capt, P. Kelly, G. Carey, B. Lanphier, D. Maher, C. Bracken. Back, 1 to r: B. Moran, R. Coote, G. Ryall, J. Dixon, K. Shorthall, D. Kirby, S. Barry, D. Shepherd.



Loughmore Castleiney Mid Tipperary Senior Hurling Champions. Back, 1 to r: Declan Laffan, Derek Bourke, Brendan Healy, Michael Webster, Tom King, Garry Sweeney, David Kennedy, Alvy Stapleton. Front, 1 to r: Noel Morris, Paul Ormonde, Evan Sweeney, John Gleeson, Seamus Bohan, John Kennedy, Martin Gleeson.



Clonakenny Mid Tipperary Intermediate Hurling Champions. Back, 1 to r: Walter Byrne, Michail Murray, Gearoid Byrne, Michael Burke, Mark Ryan, Gerard Byrne, Joe Bourke, Bobby Martin, Declan O'Dwyer, Eoin Ryan, John Stapleton, Peter Jennings, Brian Bourke, David Crampton. Front row (l. to r.): Leo Crampton, Michael Leamy, William Moloughney, Seamus Nolan, Michael Smith, Allan Abbott, Mark Talbot, Martin Joe Murray, Johnny Madden, Donnacha Murray, Jim Costigan, Colm Murray, Thomas Carroll, Sean Madden (mascot).



Loughmore Castleiney Mid Tipperary Senior Football Champions. Back, 1 to r: Tommy Ormond, Declan Laffan, Mick McGrath, Michael Webster, Tom King, David Kennedy, Noel Kennedy. Front, 1 to r: Alvy Stapleton, Philip Kennedy, Evan Sweeney, Martin Gleeson, Noel Morris, Johnny Doran, Gary Sweeney, Barry Hennessy.



Holycross Ballycahill Mid Tipperary Intermediate Football Champions. Back, 1 to r: Declan Carr, Gary Byrne, William Ryan, Michael Lee, Liam McCullough, Robert Quinlan, Darragh Duggan, John Butler. Front, 1 to r: Donal Duggan, Denis McCullough, John Fogarty, John Ferncombe, Brendan Ryan, Stephan Flanagan.



Clonakenny Mid Tipperary U-21 'C' Hurling and Football Champions. Back, 1 to r: Walter Byrne, Gerard Smith, Peadar Byrne, Gearoid Byrne, Mark Ryan, Joe Shelly, William Moloughney, James Cody, Conor Ryan, John Costigan. Front, 1 to r: Michael Costigan, Damien Coonan, Niall Matthews, Martin Joe Murray, Michail Coonan, Tomas Carroll, David Crampton, Philip Crampton, Eddie Byrne.



Loughmore Castleiney Mid Tipperary Junior 'A' Football Champions. Back, 1 to r: Tom McGrath, John Scully, Aidan Webster, James Connolly, James Egan, Colm Campion, Domic Brennan, Olly Ryan (G), Seamus Bohan, Olly Ryan, Tom Maher, Jimmy McGrath, Brian Hennessy, Kevin Stapleton. Front, 1 to r: Diarmuid Brennan, John Paul Foy, Murtagh Brennan, Pat McGrath, Seamus Bohan, Kieran McGrath, Edward Connolly, Eoin McGrath, Tommy Larkin, Ronan Stapleton, Paul Brennan.

Wishing all our customers a "Smashing" Christmas

— from —



# BOURKES AUTOGLASS

Templemore 0504-31093 & Cahir 052-42444

ALL WINDSCREEN & WINDOW REPLACEMENT

• Cars • Vans • Trucks • Tractors • Plant • Machinery

We direct bill your insurance company

Mobile Service 086/087-2799835

Free Windscreen Check for NCT Test



J.K. Brackens panel that defeated Thurles Fennellys in the mid-Tipperary Junior 'B' football final 2003. Back row (l. to r.): Benny Fogarty, Jim Mullin, Owen O'Doherty, Michael Larkin, Sean Leahy, Brian Phelan, Tommy Deegan, Paul Guider, Michael Henderson, Padraic Murhy, Robert Bourke, Richard Grimes. Front row (l. to r.): Paddy Marnell, David Ryan (s.), Stephen Fennell, Aidan Doyle, Ronan Loughnane, Andrew Maher, P.J. Corcoran, Leo Dorrity, Ian Delaney, Tommy Kennedy, Shane Scully.

# Thurles Fennellys – County Junior 'A' hurling champions 2003



Back (l. to r.): Sean O'Dwyer, Declan Ryan, Michael O'Dwyer, James O'Grady, John Callanan, Paul Shelly, T.J. Gleeson, Pat Lawlor, Jim Mackey, Jim Woodlock, Lar Barrett, Alan Hughes, Kevin Jordan, Ray Molumby, Jimmy Donnelly, Joe Clare, Sam Walsh, William Carroll, P.J. Mackey. Front (l. to r.): Morgan Lanigan, Jamie Lennon, Kieran O'Dwyer, Mixie Mahony, Gary Coppinger, Raymond Carew, Thomas Jordan, Philip Lawlor, Philip Butler, Michael Kennedy, Lar Mackey, Paddy Mahony, Larry Mackey, Ger O'Grady, David Mahony, Tommy Woodlock, John Dooley. (Lying in front: John Jordan 'Swany').

**N**ovember 22nd, 2003, will be remembered as the day Thurles Fennellys created history by defeating Burgess after a replay to win their first Junior 'A' County Final. Having tasted the bitter pill of defeat on three previous occasions 1969, 1998 and 2000, this win was all the sweeter.

2003 saw Fennellys make their intentions known early in the year when going undefeated through the Junior League culminating with a very impressive win over Holycross-Ballycahill in the final.

Fennelly's commenced the championship in a confident mood under the

guidance of manager Michael Grogan with selectors Tommy Woodlock and Lar Mackey also joined in the latter stages by coach Eamon Kelly who proved a vital cog in the Fennellys wheel of success. Fennellys remained undefeated throughout the Mid Championship after some very impressive displays we again faced Holycross-Ballycahill in the Mid Final, however on this occasion they proved a much tougher nut to crack, following a thrilling 60 minutes a last minute point from Pat Lawlor clinched our first Mid title since 2000.

The county championship was looked forward to with great expecta-

tions that were realised with a fine quarter final win over Moneygall, in the semi-final we were victorious over a very impressive Ballylooby/Castlegrace in an exciting game played in New Inn.

In what many regarded as the best Junior County Final ever played and in front of a huge crowd in Templemore, Fennellys and Burgess finished level 1-17 each after a thrilling encounter. The replay in Dolla was equally as exciting with the sides level, a last minute point from Lar Barrett clinched victory for Fennellys amid scenes of jubilation from the massive crowd of Fennellys supporters.

## Turfgrass Advisory Services

Moate Road, Ballyragget, Co Kilkenny  
Phone: (056) 8830931 Mobile: (087) 6271811

Improve the performance and financial return of your sports pitch in 2004 without exceeding your budget.

Turfgrass Advisory services advises in all areas of sports ground maintenance, such as:

- Waterlogging / Compaction Problems
- Pitch Levelling
- Proper Turfgrass Seeding / Sodding and Fertilizer use
- Full On-Site Grounds and Machinery Maintenance Training

# Mackey's Bar



For Best  
Drinks  
and After  
Match  
Craic

Prop: LARRY & JOAN MACKEY

**BOHERNANAVE, THURLES**

**Tel: 0504-23481**

*Continued success to the Tipperary Masters*

**Paying too much for your  
Car Insurance ?**

**Why not contact us before  
renewing or for a quotation  
– FREE and without obligation.**

***We have special rates for :***

- Lady Drivers
- First time insurance for person with driving experience.
- Drivers over 25 earning 1 or more years No Claims Bonus.
- Home, Farm and Shop Insurance

## **Tim Maher & Son**

Insurance Brokers  
Croke Street,  
Thurles.  
0504-21444

## **Templetuohy Farm Machinery**

Templetuohy, Thurles Tel: 0504-45110

Powerstown, Clonmel Tel: 052-24060

*Main Dealers For:*

- John Deere Tractors
- John Deere Forage Harvesters
- Balers, Combines, Mowers
- Sulky Fertilizer Spreaders
- Kane Trailers & Dumpers
- Overum Ploughs
- Lely Equipment
- NC Equipment
- Ritchie Cattle Sheep Handling Equipment

*Branches also at:*

New Inn Cross, Portlaoise, Co. Laois 0502-26555

Old Dublin Rd., Enniscorthy, Co. Wexford 054-36601



**TEMPLETUOHY  
FARM  
MACHINERY**

## **LOUGHMORE INN**

*For a unique  
atmosphere and  
friendly service  
in pleasant  
surroundings*

**Phone: 0504-31444**

*Continued success to Tipp. G.A.A.*

# MOYCARKEY-BORRIS

## - COUNTY MINOR HURLING CHAMPIONS 2003 -

by Joe Moran (Moycarkey PRO)

**T**he Moycarkey-Borris minor hurlers completed a glorious eleven-match campaign on Sunday, November 9th with victory over Carrick Swans in the county minor final replay. It was a truly historic occasion as the club annexed its first county hurling title of the new millennium and its fourth county minor A title. The previous minor wins were in 1968, 1972 and 1983. Jack Bergin, whose distinguished lists of achievements for club and county began in the 1972 minor win, managed the 2003 champions. Jim Flanagan, another member of this year's management team began his many successes in the 1968 minor team. Nicky Hogan of a great hurling family in the Horse and Jockey was the third member of the management team.

The build up to the championship began in earnest after the June exams when all of the under-16 panel joined the minor panel. But there was a giggle of disbelief among the circle of players in response to Jim Flanagan's early season reference to being in the county final. In truth, expectations were modest as this was predominately a very young panel of players despite their talent and under-age achievements.

There were six evenly balanced teams in the Mid A championship, which was to prove one of the most exciting for many years. Moycarkey's first league round game to decide the semi-finalists was away to Sarsfields on Wednesday, July 2nd. Despite the absence of Joe Dixon the team began well and led by 0-6 to 0-5 at half time. However, with only ten minutes left, Sarsfields were 5 points ahead, 2-10 to 0-11. Moycarkey ate in to the lead point by point to draw the game 0-16 to 2-10.

The second league game was in Littleton versus Holycross-Ballycahill on Tuesday, July 8th. After a very even first half, Moycarkey scored freely after half time to win 1-19 to 1-8. Paudie Lanphier scored the first goal of the campaign. The third league round was versus Gortnahoe at Gortnahoe on Monday July 14th. Moycarkey began well and led 1-5 to 0-5 at half time. Gortnahoe seemed to have the game turned around in the second half and led 2-12 to 2-7 with four minutes remaining. Two late goals sealed a memorable victory on a scoreline of 4-7 to 2-12. Brian Moran scored three goals and Ciaran Clohessy scored his first goal at minor level. The early results had garnered five league points and boosted the team's morale. The defence was settling in to a solid unit while the forwards were improving with every game. David Sheppard was inspirational captain and Brian Moran was un-erring from frees.

The next three games were to provide a decisive test of character for the team. A casual performance away to Boherlahan on Wednesday, July 23rd resulted in a 0-7 to 2-6 defeat. Then on Tuesday August 12th at Littleton, the team dominated until near the end versus Loughmore-Castleiney only to concede two late goals on a scoreline of 0-16 to 2-12. Moycarkey were one of four teams on five points who had to play off for the remaining three semi-final places. Holycross were the play-off opponents in Boherlahan on a warm Saturday afternoon August 16th. The team had to field without Eddie Power, Daniel Kirby and Rory Cooe. Holycross led 3-5 to 0-10 at half time. A titanic struggle ensued with an injury time Joseph Dixon point securing a 0-21 to 4-8 win for Moycarkey. Eoin Cantwell played his first full minor championship game. Gerard Carey made a very successful transition to midfield. Despite being injured, David Sheppard scored six points from play while Brian Moran scored thirteen points (8 frees, 4 65's and 1 play). The team had finally reached the Mid semi-finals.

Moycarkey faced Sarsfields in the Mid semi-final on Friday, August 29th at the Ragg and led at half time by 1-9 to 0-10. The decisive scores were provided by Joseph Dixon's goal and two points from Gerard Carey. In the second half, Sarsfields were kept at bay by goalkeeper Shane Barry and the defence superbly marshalled by Kieran Shortall. Anthony Healy came on as a super-sub to score a very late winning point on a 1-13 to 0-15 scoreline.

Moycarkey faced a fancied Gortnahoe team in the Mid final on Saturday, September 6th in Holycross. The team recovered from a slow start to lead 2-7 to 1-8 at half time. Both goals came from close in frees by Brian Moran in response to Jack Bergin's thumbs down instructions. Ciaran Clohessy scored two further goals in the second half as Moycarkey took control of the game to win 4-11 to 3-11. David Sheppard received the Mid cup from his uncle, Mid chairman, Johnny Doyle.

The North champions Roscrea were Moycarkey's opponents in the county semi-final on Sunday, September 13th at Templemore. Despite playing with a strong wind, the concession of two goals left the half-time score only 1-8 to 2-3. Roscrea equalised early in the second half but goals from Brian Moran and a second from Ciaran Clohessy put Moycarkey in to a strong position. Shane Barry made an excellent save in injury time to ensure his sides victory on a scoreline of 3-12 to 3-10.

The county final versus Carrick Swans took place on Sunday, October 12th in

Temple Stadium. In the intervening period, many of the players were involved in the Mid under-16 hurling championship. In the early stages versus Swans, only the heroics of Peter O'Brien, Thomas Quinn, Kieran Shortall and Joseph Dixon kept Moycarkey in the game. As Phil Kelly began to dominate in midfield, the side recovered before half time to lead 0-7 to 0-6. It got better in the second half as a great Daniel Kirby goal contributed to a seven-point lead. But complacency and errors saw the lead disappear as the game ended in a draw, 1-12 to 1-12. David Sheppard received a harsh red card in the closing stages and it was a despondent dressing room after the game.

Football finals, under-16 hurling and players in Tunisia delayed the replay until Sunday, November 9th at Cashel. The month was well used as Jack Bergin increased the training tempo and experimented with challenge games versus Bishopstown and the Ballingarry school team. There was a firm resolve to win for the captain after all the efforts to make him available to play failed. The selectors insisted there would be no vice-captain and the team was to win so David could collect the cup after serving his match ban. Rory Cooe came in to the starting line-up for the replay. The team were under severe pressure in the early stages and trailed 1-3 to 0-1. But a Brian Hogan goal prompted a recovery as Moycarkey scored 1-3 without reply before half time to lead 1-4 to 1-3. The defence was again excellent with Eddie Power, Kevin Moran and Diarmuid Healy excelling in the half-back line. In the second half Moycarkey outscored Swans by 1-4 to 1-1 with great scores from Joseph Dixon, Ciaran Clohessy and Brian Moran. Victory was secured by the resolve and discipline of all fifteen players on a final scoreline of 2-8 to 2-4.

David Sheppard was carried shoulder high by his teammates as he collected the cup from county vice-chairman, John Costigan, amid scenes of great joy. All the players in the panel deserve great credit for the dedication, resolve, skill and discipline throughout the championship. The team management imbued the team with a real Moycarkey spirit. Great credit is also due to the coaches and mentors of the players since they began hurling. The great support for the team throughout the championship was greatly appreciated. Despite the vicissitudes of senior relegation, the minor success augurs well for the future of the great hurling parish of Moycarkey-Borris.

Best wishes to Tipperary teams in 2003

# Physiotherapy Clinic



22 CASTLE AVENUE,  
THURLES, CO. TIPPERARY.  
Telephone: 0504-23763

**Audrey M. Ryan** M.I.S.C.P.  
*Chartered Physiotherapist*

**By Appointment only**

## *Paints and Wallpapers*

– DECOR SPECIALIST SERVICE

**FRANK ROCHE & SONS LTD.**

57 Liberty Square, Thurles  
Tel. 0504-22313

*Latest High-Tec Computer Colour Guide Simulator*

Free Colour-matching Service on our  
Exclusive Colorgen Spectrometer  
Thousands of Colours to choose from . . . in  
Gloss, Matt, Silk and Eggshell Textures

- PERMOGLAZE • COLORTREND
- SIKKENS WOOD FINISHES
- DULUX • McPHERSONS • SANDEX

*Wallpapers specially chosen with Borders and Co-ordinates and Matching Curtains and Materials*

# Fogarty's Sports Bar

Liberty Sq, Thurles  
0504-24577



**"Where sports fans meet"**

Prop: Jim & Trish Fogarty

*Continued Success to the  
G.A.A. in Tipperary  
from John & Breda Kennedy*

# The County Bar

THURLES

*Enjoy your drink in cosy surroundings*

**FOOD SERVED DAILY**

**Tel: (0504) 21494**



# Moycarkey-Borris regain Minor Hurling title



Back (l to r): Nicky Hogan, Kevin Keating, Brian Keating, Kevin Moran, Rory Coote, Kieran Shortall, Shane Barry, Owen Cantwell, Eddie Power, Daniel Kirby, Brian Hogan, Joe Dixon, George Ryall, Conor Bourke, Peter O'Brien, Aidan Ryan, Jack Bergin, Jim Flanagan. Middle: Tony Flanagan, Paddy Shortall, Paudie Lamphier, Phil Kelly, Paul Kennedy, Brian Moran, David Kinane, David Sheppard (capt), Ger Carey, Diarmuid Healy, Thomas Quinn, Anthony Healy, Gerry McGuire, Kieran Clohosey. Front: Jamie Fanning.



David Sheppard receiving the Sean Treacy Cup from John Costigan and Rickie Sheehan (Credit Union) following Moycarkey-Borris's victory over Carrick Swan in the replayed Co Tipperary Minor A Hurling final.



Kevin Moran (Moycarkey-Borris) receiving the Man of the Match award after the replayed Co Tipperary Minor A Hurling final, pictured with John Costigan and Rickie Sheehan (Credit Union).

# EDDIE JOES

## Bar & Lounge

Thurles Road, Templemore  
(0504) 32272

*The Perfect after match stop*

**BIG SCREEN TV**

*Private room available for parties, functions, etc.*

*Best of Luck to  
All Tipperary GAA Teams and Clubs*



## Centenary Co-op

*Ballyduff, Thurles*

Tel 0504-45216

Fax 0504-45277 (Office)

Fax 0504-45327 (Store)

Electrical  
Hardware  
D.I.Y.  
Paints  
Building  
Fuel  
Fertiliser  
Animal Feeds  
Chemicals  
Seeds

Shops at:

Ballyduff 0504-45216

Cashel 062-61244

Littleton 0504-44323

Loran 0505-43226

Montore 0505-43210

Templemore 0504-31877

## MID TIPPERARY SCOR 2002/2003

**A**n Coiste Scór Thiobraid Árann Meanach had a very busy and enjoyable 2003/2003 season, starting with Scór na nÓg in December 2002 involving clubs, J.K. Brackens, Upperchurch/Drombane, Moyne/Templetuohy, Drom/Inch, Moycarkey/Borris, Loughmore/Castleiney and Dúrlas Óg, it was a great night's entertainment in a packed Loughmore Community hall. Drom/Inch went on to win Tráth na gCeist in county Scór, but were unlucky in Munster semi final. We held our Scór Sinsear final on 8th February in Clonmore with only four clubs. We are very disappointed with senior Scór in the division, but are grateful to our regular clubs who compete each year, if they have a win it is a bonus, but they are proud to represent their parish. Despite having no figure dancing team and no instrumental music, it was a most enjoyable night.

We commenced our Scór na bPáistí competitions with first semi final in Drom on 14th March, and second semi final in Clonmore on 21st March, with Mid final in Templetuohy on 4th April, 2003. This

## HOLYCROSS/ BALLYCAHILL GAA CLUB HONOURS JOHN RYAN GARRYNAMONA

**I**n the early evening of September 28th 2003, as the people of Tyrone began celebrating their historic All-Ireland success, clubmen and parishioners of Holycross/Ballycahill gathered in Ballycahill GAA grounds for their own piece of history. The occasion was the unveiling of a plaque in honour of the late John Ryan, Garrynamona, one of the unsung heroes of the club in previous decades.

As he unveiled the limestone plaque, Mid Board President, Bob Stakelum, recalled John's great contribution to the local GAA club for over 30 years in various roles including vice chairman, senior selector and committee member. But it was his utter dedication to the young hurlers of the parish, which stood out the most. John persuaded the youth to play



Pictured are the organising committee with Bob Stakelum who unveiled the plaque to John Ryan, Ballycahill. L. to r.: John Joe Dwyer, Larry Mackey, Bob Stakelum, J.P. Stakelum, Denny O'Dwyer.

Scór na nÓg	Scór Sinsear	Scór na bPáistí
Rince Foime J.K. Brackens	None	J.K. Brackens
Amhranaoicht Aonair	Upperchurch/D	J.K. Brackens
J.K. Brackens	Ceol Uirlise	J.K. Brackens
None	J.K.Brackens	Aithriseoireacht
Upperchurch/D	Loughmore C	Moycarkey/B
Bailead Ghrupa	Moyne/T-tuohy	J.K. Brackens
Upperchurch/D	Trath na gCeist	Drom/Inch
J.K. Brackens	Moyne/T-tuohy	Nuachleas
J.K. Brackens	J.K. Brackens	Upperchurch/D
Rince Seit Moycarkey/B	J.K. Brackens	Moycarkey/B

is a wonderful competition where it is a pleasure to work with primary school children, whose abundance of talent unfolds before the eyes of audience and captivates them. We had packed halls at the three stages of the competition. Ciara Ryan, J.K. Brackens won the county final in Our Lady's Secondary School, Templemore on 11th April where the standard was very high for young children. Coiste Scór Meanach would like to thank our host clubs during season for their help on competition nights and the hospitality of the ladies in the tearoom. A word of appreciation to Francey, at Scór Sinsear in Clonmore for his invaluable help. Also thanks to Mick and Noelle for keeping the flag flying on the last two nights of Scór na bPáistí whilst I was incapacitated.

Thanks to parents, teachers and tutors of all the competitions but especially Scór na bPáistí. We would like to thank our sponsors, Mid GAA Board, Donal Younge, The Ragg, Thurles Credit Union, Tivoli Cleaners, Lycon Auto Spares. We really appreciate their support. Thanks also to Michael Dundon and his staff at the Tipperary Star, for their help and courtesy during the year. Officers for 2003/2004 cathaoirleach, Noel Joyce, J.K. Brackens, leas-cathaoirleach, Paddy Cooney, Moycarkey/Borris, runai, Martina Fogarty, J.K. Brackens, assistant runai, Margaret O'Connell, Moycarkey/Borris, cisteoir and O.C.P, Nora Troy, Thurles Sarsfields, leas cisteoir, Mick Troy, Moyne/Templetuohy, delegates to county Scór, Paddy Cooney and Anne O'Meara, Drom/Inch.



Scoil Ailbhe Boys Primary School, Thurles, 2002 Winners of Mid Bord na nÓg Annual GAA Table Quiz which was held in the Park Avenue House, Thurles. Back row (l. to r.): John Lambe (representing the Lambe family) quiz sponsors, Mattie Connolly (scorechecker and Mid Senior Board secretary), Siobhan Power (Scoil Ailbhe), Fr. O'Rourke (scorechecker and President, Mid Bord na nÓg), John Devane (questionmaster). Front row (l. to r.): Team members Brian Stakelum, David Maher, Cian Treacy and Jamesy Morrissey.

the games of hurling and football. He encouraged them to continue playing and, along with his brother Paddy, he carried them to matches and training in large numbers all over the parish, divi-

sion and county. He was a leading light in the development of Ballycahill GAA field in the 1970s, encouraging and inspiring in his own quiet way as dressing-room facilities were planned and built.

To mark his dedication, John was made an Honorary Life Vice President of the club at the 1977 convention. A wonderful, friendly man John will long be remembered with affection in the parish of Holycross/Ballycahill. These memories of John Ryan, and many more, came flooding back in the late September sunshine, and all those present at the unveiling enjoyed a lovely occasion, embellished by refreshments afterwards in Ballycahill Hall. For as long as GAA clubs thrive in every parish in Ireland, they will depend on people with the generosity of time and spirit displayed for so many years by John Ryan, Garrynamona.

# NEW CREST FOR MID BOARD

At the first meeting of the Mid Tipperary GAA Board for 2003 which was held in Park Avenue House last January it was decided that it would be a good idea to design a new crest for the board and the division and as youth officer I was given the task of finding a good way to get a crest designed. I decided that seeing as the GAA is focused so much around the youth that I would launch a competition for boys and girls in our primary schools and let them design a new crest for the Mid Division. I knew that there was no way that I would be able to undertake a task like this on my own so I decided to call upon Aoife Maher, JK Brackens to give me a hand out and this she did very well.

It was decided that rather than having the competition open to all classes that we would limit the competition to students in fifth and sixth class, these young people we thought would have a good understanding of the GAA and its tradition amongst the clubs of Mid Tipperary.

Their were a number of guidelines given to the competitors such the main one being that the design had to represent the clubs in Mid Tipperary, The area of Mid Tipperary and the prominent land marks within the division. A letter was drafted and sent to all the primary schools in the division explaining all about the competition and asking all those to forward their entries by the closing date given.

We then decided that we would have to find people to sponsor prizes for the winning entries that we did and I would like to thank most sincerely



The new Mid Board crest.

Templemore Jewellers, The Tipperary GAA Shop and Dominic Leech of RKL Services Co. Wicklow who took the winning crest from its original form which was on A4 paper and with the aid of computer technology transferred it on to the flag.

By the time the closing date had arrived we had received over 100 entries from schools all around the division. Now came the hard part choosing the top ten designs and who better to do it than Aoife.

Within a few days Aoife had the entries down to the best ten and in her own words she said "its over to you now". Out of the ten top entries I had to choose the top three. This was never going to be easy as they were all so good but it had to be done so after

about a week of endless adjudicating I picked the top three and to my amazement the young girl who designed the winning entry was also involved with her friend in designing the third placed entry.

It was now decided to invite the three prizewinners, their friends, and families to a function in Park Avenue House This function was also attended by many well-known figures in GAA circles within the division. The prizewinners were announced and were as follows: 3rd place went to Kate English and Claire Dunne from Holycross NS. Second place went to a student of the Gael Scoil in Thurles, Leach Ní Coiribin or Leah Corbett was announced as the prizewinner. First place went to Claire Dunne From Holycross NS. who has obvious artistic talents and designed a lovely crest that will fly high over the playing fields of Mid Tipperary and will be displayed at many GAA functions in the division for a long time to come.

I would like to congratulate and thank each and every student who entered the competition, their teachers, Parents, and anyone else who contributed to making the competition such a success. Thanks also to the sponsors.

And finally a very special thanks to Aoife Maher for all her help and assistance.

**Jonathan Cullen**

Mid Tipperary Youth Officer



The new Mid Tipperary GAA Bord Crest being raised for the first time at the Mid Tipperary Senior Hurling Final in Templemore. Pictured l to r: P.J. Maher, Vice Chairman, Mid Tipp GAA Board; Bob Stakelum, President, Mid Board; Noel Morris, Captain, Loughmore, Castleiney; Jonathan Cullen, Mid Board Youth Officer; Tommy Maher, Captain, Thurles Sarsfields & Matty Connolly, Mid Board Secretary.



Winners of Competition to design a crest for the Mid Board organised by Youth Officer Jonathan Cullen. Pictured l to r: Kate English (Holycross), 3rd Prize; Claire Dunne (Holycross), 1st Prize and joint 3rd and Leah Corbett (Gael Scoil, Thurles), 2nd Prize. Also in picture John Doyle, Mid Board Chairman and Jonathan Cullen, Youth Officer.

# Mid Tipperary League Champions 2003



The Thurles Fennellys team that defeated Holycross-Ballycahill in the final of the Mid Tipperary Division 1 Junior Hurling League. Back row, l to r: P.J. Mackey, Willie Lalor, Joe Cleare, John Callinan, Lar Barrett, Pat Lalor, Philip Butler. Front, l to r: Garry Coppinger, Thomas Jordan, Ray Molumby, TJ Gleeson, Paul Shelly, Jim Mackey, Lar Mackey, Michael Kavanagh.



The Thurles Sarsfields team that defeated Loughmore-Castleiney in the Mid Tipperary Division 2 Junior hurling league final. Back, l to r: Jonathan Conors, Noel Skehan, Tony Coman, Colm Duggan, Shane Ryan, Paul Dwyer-Darcy, Gerry Spain, Jamie Barrett. Front, l to r: Mark Wade, Jim Corbett, Clive Hanrahan, Pat Treacy, Andy Rositer, Stiofan Ryan, Conor Stapleton.



Gortnahoe-Glengoole County Intermediate Hurling league champions v Moyne Templeuohy. Back, l to r: Mike Cleary, Johnny Guilfoyle, Paul Langton, Michael Cleary, Martin Goldsboro, Martin Gleeson, P.J. Gleeson, Joe Hogan. Front, l to r: Keith Corbett, Brendan Hogan, John Teehan (captain), Darren O'Donoghue, William Coleman, Ronan Stanley, P.J. McCormack.



The JK Brackens team, winners of the Mid Tipperary Division 3 Junior Hurling League. Back, l to r: P. Egan, J. Maher, P. Kirwan, A. Farrelly, F. Hennessy, C. Fitzgerald, C. Doyle, M. Larkin. Front, l to r: M. Bradish, B. Phelan, D. Maher, A. Maher, J. O'Shea, D. McBride, P. O'Brien. Mascot: Loma O'Shea.



Thurles Sarsfields, Cahill cup Winners 2003. Back, l to r: David Kearns, Barry Dwyer, Eamon Tuohy, Eoin Costello, Ger O'Grady (captain), Gerry Spain, John Connors, Shane Ryan, Eoin Russell, Michael Collins, Conor Stapleton, Barry McLoughlin. Front, l to r: Kieran O'Connor, Stephen Lillis, Tommy Collins, Ritchie Ruth, Patrick McCormack, David O'Dwyer, Lee Shanahan, Johnny Enright, Wayne Culley.

# Mid Tipperary GAA Board Presentations 2002

Mid Board Chairman John Doyle presenting the Junior Intermediate Club of the Year Award to Clonakenny Chairman John Moloughney.



Hugh Coughlan, Moyne Templeouhy after receiving the Mid Tipperary Young Footballer of the Year award (2002). (l to r): Tom Maher, Mid Board Treasurer, Hugh Coughlan, Matty Connolly, Mid Board Secretary and John Doyle, Mid Board Chairman.



Tom Collum receiving the Mid Tipperary Footballer of the Year Award (2002) on behalf of his son Sean, from Mid Board Chairman John Doyle. Also in photo: Tom Maher, Mid Board Treasurer and Matty Connolly, Mid Board Secretary.



John Doyle, Chairman Mid Tipperary GAA Board making a presentation to former Chairman Michael Bourke as a token of the Board's appreciation for his dedicated service as chairman. Also in photo: Tom Maher, Mid Board Treasurer and Matty Connolly, Mid Board Secretary.



Michael Maher, Holycross Ballycahill receiving the Mid Tipperary Hall of Fame Award (2002) from Mid Board Officers. Picture (l to r): Tom Maher, Mid Board Treasurer, Michael Maher, Matty Connolly, Mid Board Secretary, Bob Stakelum, Mid Board President and John Doyle, Mid Board Chairman.



Evan Sweeney, Loughmore Castleiney receiving the Mid Tipperary Young Hurler of the Year award (2002) from Mid Board Chairman John Doyle. Also in photo: Tom Maher, Mid Board Treasurer and Matty Connolly, Mid Board Secretary.



Mid Board Chairman John Doyle presenting the Senior Club of the Year Award to Loughmore Castleiney Chairman Jonathan Cullen. Also in picture John Treacy, Secretary Loughmore Castleiney (on left) and Sean Mockler, Loughmore Castleiney.



Noel Morris, Loughmore Castleiney receiving the Hurler of the Year award (2002) from Mid Board Chairman, John Doyle. Also in photo: Tom Maher, Mid Board Treasurer and Matty Connolly, Mid Board Secretary.



Andy O'Gorman, Gortnahoe Glengoose with Mid Board Officers after receiving a presentation for his service and dedication to the Mid Board and to mark his retirement as Mid Board Youth Officer. Picture (l to r): Tom Maher, Treasurer, Andy O'Gorman, Secretary and John Doyle, Chairman.



John Doyle, Chairman of Mid Tipperary GAA Board making a presentation to Brendan O'Connor, Tipperary Star, in recognition of his service to the Mid Board as photographer over many years. Also in photo: Tom Maher, Mid Board treasurer, and Matty Connolly, Mid Board Secretary.



# Upperchurch Drombane GAA unveil plaque

A plaque was officially unveiled on Sunday 19th October 2003 at the Upperchurch-Drombane GAA grounds at Drombane in honour of the original trustees of the club. The three original trustees were Jacksie Ryan RIP, Ballyboy; Jim O'Dwyer, Upperchurch and James Ryan, Drombane. The official unveiling was performed by the chairman of the club, Tom Carey in front of a large crowd, which included Mr Sean Fogarty, vice-chairman of the Munster Council, Family and friends of the three trustees and supporters of the Upperchurch-Drombane GAA Club attended the event, which began with Mass in the clubhouse. Those who attended on the autumn Sunday afternoon welcomed refreshments and were also treated to some memories of days gone by from Jimmy O'Dwyer and Packie Ryan.



Upperchurch-Drombane unveiled a plaque in honour of the three trustees who were instrumental in the purchase of the present field. The trustees were: James O'Dwyer (Upperchurch), Jacksie Ryan and James Ryan (Coolbawn). Pictured (l to r): Tom Carey (Chairman Upperchurch Drombane GAA Club), James O'Dwyer (Trustee), Helen Ryan (Wife of late Jacksie Ryan, Trustee), James Ryan (Trustee), Sean Fogarty, Munster Council Vice-Chairman.



Upperchurch-Drombane committee and guests at the unveiling of the plaque in honour of the three trustees who were instrumental in the purchase of the present field. Picture (l to r): Seamus Armstrong, Tom Kennedy, Michael Griffin, Paddy Bourke, Phil Lowry, Michael Bourke, Jim O'Dwyer, Tommy Tierney, Tom Carey, Owen Short, Tom Lowry, Fr. Brennan, Helen Ryan, James Ryan, Catriona Ryan, Tommy Ryan, Pakie Ryan.

# Club delegates to the Mid GAA Convention in Drombane



J.K. Brackens delegates at the Mid Senior Board's Annual Convention in Drombane Hall. Included are (l to r): Tom Collum, Aoife Maher, John Costigan and John Martin.



Photograph taken at the Mid Senior Board's Annual Convention shows Holycross-Ballycahill delegates photographed with clubman Johnny Doyle who was elected to the position of chairman at the Convention. Included are (seated l to r): Bob Stakelum, Mid Senior Board President; Johnny Doyle, Mid Senior Board Chairman. Standing: Paddy Byrne, Michael Ryan and Michael Hassett.



Drom-Inch delegates the Mid Senior Board's Annual Convention held in Drombane Hall (l to r): Willie Clohessy, Mattie Ryan, Kevin Bourke Donal Younge and Tommy Butler.



Thurles Fennelly's delegates at the Mid Senior Board's Annual Convention in Drombane Hall (l to r): Lar Mackey, Paddy O'Mahoney and Sean Russell.



Butter, Milk Powders,  
Emmental & Aherlow Cheese

Super Hardware Stores

O'Brien St., Tipperary, Goold's Cross, Borrisoleigh

Co-op Super Valu Supermarket, Kickiam Place, Tipperary

Tipperary Co-op Creamery Limited, Station Road, Tipperary

Tel: 062-33111 Fax: 062-51963



Willie Tarrant, captain of Galtee Rovers receives the West Senior Hurling Championship Cup for the first time in Galtee Rover's history from West Bord chairman James O'Donnell, also pictured on right Matt Quinlan, vice-chairman of Tipperary Co-op, sponsors of competition.

# Dundrum House Hotel

*A Gracious Country Manor*

Incorporating  
COUNTY TIPPERARY GOLF & COUNTRY CLUB

- 56 Rooms with Bathroom en suite, direct dial telephone, television and video channel.
- Excellent cuisine and wines served in the Rossmore Restaurant
- Entertainment most night in our Venue Bar
- Banqueting, Wedding & Conference Facilities.  
Galteemore Room 350  
Arch Room 100
- Banqueting, Wedding & Conference Facilities  
Galteemore Room 350  
Arch Room 100  
Irish Bar / Cellar 100
- 18 HOLE CHAMPIONSHIP GOLF COURSE

Visitors welcome. For "T" reservations phone Golf shop 062-71717

Stage of the Art Leisure Complex. For membership tel. 062-71222

Hotel - Tel: 062-71116. Fax: 062-71366



# West Tipperary Champions and Runners-up 2003

13/9/03	<u>Tipperary Co-Op Super Valu S.H.C.</u> Golden Rep.	Galtee Rovers	2.15	Kickhams	1.11	T.Ryan Kildangan
	<u>Gleeson Concrete -Crosco Cup-S.H.L.</u> Golden	Galtee Rovers	0.12	Arravale Rovers	0.4	
5/10/03	<u>Tipperary Credit Union -I.H.C.</u> Dundrum	Sean Treacys	1.14	Golden /K	1.1	S.Roche Kilsheelan
11/10/03	<u>Gleeson Concrete J.H.C.'A'</u> Golden Rep.	Emly	1.16	Clonoulty/Ross.	2.07	Eamon Browne Kickhams
11/10/03	<u>Tipperary Co-Op Super Valu J.H.C.'B'</u> Golden	Cashel K.C.	1.11	Rosegreen	0.08	Francis Kearney Clonoulty-Rossmore
26/4/03	<u>O'Dwyer Steel U21H.C.'A'</u> S.T.Park	Galtee Rovers	0.16	Kickhams	1.09	David Grogan Aherlow
10/4/03	<u>U21H.C.'B'</u> Cappawhite	Eire Og/Anacarty	2.11	Arravale Rovers	1.05	Richard Barry Cappawhite
6/4/03	<u>U21H.C.'C'</u> S.T.Park	Aherlow	2.08	Solohead	2.05	Sean Bradshaw Golden-Kilfeacle
20/8/03	<u>Dundrum House Hotel M.H.C.'A'</u> S.T.Park	Galtee Rovers	3.14	Clonoulty/Ross.	2.14	Phil Ryan Kickhams
13/8/03	<u>Matt Kavanagh Coaches M.H.C.'B'</u> Dundrum	Golden	2.12	Cappawhite	2.04	Sean Bradshaw Golden-Kilfeacle
27/8/03	<u>M.H.C.'C'</u> Anacarty	Sean Treacys	1.19	Aherlow	2.1	Richard Barry Cappawhite
31/8/03	<u>Ballinilard Transport S.F.C.</u> Dundrum	Galtee Rovers	2.12	Eire Og/Anacarty	1.06	B Tyrell Clonmel
	<u>Ballinilard Transport S.F.L.-O'Donoghue Cup</u> Aherlow	Aherlow	3.11	Eire Og/Anacarty	2.03	Michael Grace Galtee Rovers
13/9/03	<u>Mike O'Brien I.F.C.</u> S.T.Park	Lattin/Cullen	1.19	Emly	2.05	D Cahill Kilruane MacDonaghs
18/10/03	<u>C&amp;C Engineering J.F.C.'A'</u> Golden	Rosegreen	2.09	Rockwell Rovers	2.08	Paddy Russell Emly
27/9/03	<u>A.I.B J.F.C.'B'</u> Dundrum	Aherlow	1.14	Sean Treacys	1.09	Willie Kennedy Kickhams
29/3/03	<u>McGrath Oil U21F.C.'A'</u> Golden	Galtee Rovers	0.13	Cashel K.C.	1.06	Eamon Browne Kickhams
30/3/03	<u>McGrath Oil U21F.C.'B'</u> Golden	Lattin/Cullen	1.07	Eire Og/Anacarty	1.04	John RyanC Golden-Kilfeacle
22/3/03	<u>McGrath Oil U21F.C.'C'</u> S.T.Park	Aherlow	0.11	Solohead	0.03	R O Connor Arravale Rovers
16/8/03	<u>M.F.C.'A'</u> Golden	Galtee Rovers	1.17	Arravale Rovers	1.07	Ger Riordan Solohead
25/6/03	<u>Pa Sheehy M.F.C.'B'</u> Bansha	Cappawhite	2.1	Aherlow	2.08	R O Connor Arravale Rovers
16/7/03	<u>M.F.C.'C'</u> S.T.Park	Lattin/Cullen	2.07	Sean Treacys	1.05	Eamon Browne Kickhams



Sponsorship Presentation to West Tipperary Board from Tipperary Co-op SuperValu. Pictured from left to right: Nicky English, Noel Horgan, Chief Executive, Tipp Co-op, James O'Donnell, West Board Chairman, Sean Madden, Chairman Tipp Co-op and Niall Quinn.



Willie Tarrant, captain of Galtee Rovers receives the West Tipperary Senior Hurling Championship Cup for the first time in Galtee Rovers' history from West Bord chairman James O'Donnell, also pictured on right Matt Quinlan, vice-chairman of Tipperary Co-op, sponsors of competition.

## CUMANN LÚTHCHLEAS GAEL -COISTE THIOBRAID ÁRANN THJAR

*The Board wishes to thank the Clubs and Gaels of West Tipperary for their continuing support and encouragement in the promotion of Gaelic Games in the Division.*

*Congratulations to all the winners in 2003.*

*We also wish to acknowledge the generous sponsorship support received for our competitions, listed above.*

*We ask you to support all our sponsors.*

Chairman: James O'Donnell. Vice-Chairmen: Billy Ryan, Matty Finnerty.  
Secretary: Jerry Ring. Treasurer: Eamon Buckley. P.R.O.: J.J.Kennedy.

# SHREELAWN OIL CO. LTD.



**OIL  
DISTRIBUTORS**

*Branch Office and Depot:*

**BANSHA,  
CO. TIPPERARY**

**Tel: (062) 54018. Fax: (062) 54009**

*Branch Office and Depot:*

**GARRANROE,  
THURLES, CO. TIPPERARY**

**Tel: (086) 6486787**

*Branch Office and Depot:*

**ROSE GREEN,  
CO. TIPPERARY**

**Tel: (062) 62381 Fax: (062) 61381**

*Suppliers of:*

**Motor Diesel • Tractor Diesel • Heating Oils • Lubricating Oils  
• Oil Storage Tanks, etc.**

**DELIVERED TO YOU, OR AVAILABLE AT OUR DEPOT.**



# Gleeson Concrete



<b>• CONCRETE BLOCKS</b>		
		<b>• GROWLIME</b>
<b>• READY-MIX CONCRETE</b>		
		<b>• WASHED GRAVEL</b>
<b>• CRUSHED STONE</b>		
		<b>• WASHED SAND</b>

Donohill, Tipperary.

Phone: 062-76111



Left to right: Dinny Cahill (Antrim manager), with Ger O'Neill and Laois manager, Paudie Butler, at the Limerick v Offaly S.H. game in Thurles.



Sean Treacys West Tipperary and County Minor Hurling 'C' Champions 2003. . . Back row (l. to r.) Declan Hickey, Rory Ryan, Simon Kennedy, John Berkerry, Liam Ryan, Larry McLoughlin, Tom Ryan, Joe Ryan, Denis Stapleton, Paudie Carey. Front row (l. to r.) J.J. Ryan, Gerard Nolan, Tom Hickey, Paudie Ryan, Pat Stapleton, Eamonn Devitt, Derek Nolan, Eamon Wade, Jamie Ryan, Paul Hogan.



Golden/K West Tipperary Minor Hurling 'B' Champions 2003. . . Back row (l. to r.) Daithi Ivors, John Curriuan, Niall Kennedy, Damien Ryan, Ger Looby, Jamie Keaty, Owen Davern, Phillip Long, Paddy Hayes, James Hayes, Michael Harding, Charles Crosse, John English, Tom O'Donnell (trainer). Front row (l. to r.) Johnny Looby (sel.), Liam Byrnes, Kevin Griffin, Daithi Bargary, Jamie Curriuan, Diarmuid Ryan, Paddy Ivors, Jim Bob McCarthy, Michael Fitzgerald, Diarmuid Carr, Rhodie O'Dwyer, Jonathan Corcoran, Sean Walsh



Cappawhite West Tipperary Minor Football 'C' Champions 2003. . . Back row (l. to r.) Ciaran Ryan (P), John Fitzgerald, Tomás Crowe, Jerry Renehan, Ciarán McCarthy, Paul O'Dwyer, Eoin Ryan, Kevin Mullins (capt.), Colm O'Keefe, Tom Carr, Jim McGrath, Brendan Buckley. Front row (l. to r.) Michael P. Buckley, Damien Barry, Michael O'Neill, David Bourke, Ross Dunne, Joe Harding, Timmy Cranley, Declan O'Meara, Joe Clancy, Michael P. Buckley.



Paddy McLoughlin (Tipp & Munster interfirms) presenting the cup for the Munster Inter-Firms Senior Hurling final to the BOI Lifetime (Nenagh) captain, Ger Hegarty. Liam Sheedy (Portroe) and Benny Dunne (Toomevara) were among those playing.



Eire Óg West Tipperary U-21 Hurling 'B' Champions 2003. . . Back row (l. to r.) Pakie Crowe, Robert Hogan, Cathal Hayes, Daniel Hogan, Alan Shanahan, Wesley Ryan, Michael O'Dwyer, Shane Barry, Pat Ahearne, Conor O'Brien, Shane Slattery, Eoin O'Dwyer, Pdraig Ryan. Front row (l. to r.) Thomas Coughlan, Sean Hogan, John O'Dwyer, Raymond Barry, Phillip McGrath, Ronan, O'Brien, Michael O'Dwyer, Christy O'Dwyer, Jamie Hanley, Stephen Quinn.



Lattin/Cullen MFC 'B' Winners 2003 . . . Back row (l. to r.) Roger Kiely, Pat Power, Thomas Condon, Timmy Byrnes, Eamon Condon, Gary Power, Damien Morrissey, Thomas Burns, Larry O'Halloran, Tadhg hennessy, Ger Howe. Front row (l. to r.) Joe Buckley, Ailbe Burns, Michael Kenny, Joseph McCarthy, Donnacha O'Grady, Stephen Martin, Shane Kirby, Brendan Hanley.

# MOLONEY BROS. Cashel

**FRUIT AND  
VEGETABLE  
DISTRIBUTORS**

PHONE 062-62152

Wishing continued success  
to Cashel King Cormacs and  
Tipperary GAA

# OLLIE'S NEW INN

*For best drinks  
and  
tasty snacks  
in a  
pleasant  
environment*



**Proprietors:  
GERRY and PHIL RYAN**

# Barron's Lounge

NEW INN

Tel: 052-62252

For the best drinks  
in a good

G.A.A. atmosphere

CABARET EVERY WEEKEND



# CURRY HANLY

*Tyre & Battery Service*

Link Road, Tipperary Town

Telephone: 062-51066

Best of Luck to Tipperary  
Hurlers and Footballers

*Continued success to Tipperary G.A.A. Yearbook  
from*

T I P P E R A R Y  
p r i n t & d e s i g n

*Tipperary's  
No.1 Printers*

Call to our Stationery Shop at  
**Limerick Rd, Tipperary**

Telephone / Fax 062-51390

**FOR FAST & FRIENDLY  
SERVICE  
AT THE BEST PRICES!**



Lattin/Cullen West Tipperary U-21 Football 'B' Champions 2003. . . Back row (l. to r.) Daniel Connery, Pat Maguire, Michael Kenny, Joseph O'Dwyer, Tim Butler, Paul Ryan, Michael Byrnes, James Breen, Billy Condon, Brendan Condon. Front row (l. to r.) Tim Byrnes, Donncha O'Grady, James, Maguire, James O'Dwyer, Pat O'Grady, Damien Leahy, Ailbe Power, Evan Hanley, Thomas Condon.



Aherlow West Tipperary U-21 Hurling 'C' Champions 2003. . . Back row (l. to r.) Cathal O'Shea (manager), Gerard Peters, Billy Donovan, Kieran Nash, Brian Moroney (coach), Seamus Grogan, Paul Coughlan, Tadhg Donoghue, Paddy Hennessy, Mike B. O'Brien, Barry Grogan, Alan O'Neill. Front row (l. to r.) Brian Leonard, Laurence Coskeran, Danny Hennessy, Shane Leonard, John Ryan, Joe Fahy, Frankie Leonard, Vincent Hennessy.



Galtee Rovers West Tipperary Minor Hurling 'A' Champions 2003. . . Back row (l. to r.) Shane Egan, Kieran Marnane, Gerard Crowe, Tony O'Brien, Tony Egan, William Levingstone, Mark O'Brien, Niall O'Sullivan, Thomas Peters, James Keating. Front row (l. to r.) Kieran Bergin, David Morrissey, Pat Marnane, Donal Collins, Damien Ryan, Andrew O'Halloran, Adrian Grace.



Aherlow West Tipperary Junior Football 'B' Champions 2003. . . Back row (l. to r.) Kieran Moroney (manager), Noel Clifford, Richie Cleary, Tadhg O'Donoghue, Robert Hennessy, Laurence Coskeran, Seamus Grogan, Brian Moroney, Morgan O'Connell, Jackie Bourke, Luke Leonard, Declan Kiely, Lionel Leonard, Tom Leonard (chairman). Front row (l. to r.) Conor O'Shea, Brendan Carew, James Noonan (capt.) Shane Leonard, Denis Grogan, Frankie Leonard, Pat Frenen, Barry Leonard, George Kiely, Peter Leonard, Joe Fahy.



Galtee Rovers West Tipperary U-21 Hurling 'A' Champions 2003. . . Back row (l. to r.) Andrew O'Halloran, Kieran Bergin, Michael Byron, Mark O'Brien, Kieran Marnane, David Byron, Eamon O'Connell, Pat Marnane, Paul Marnane, Paul McCarthy, Raymond O'Dwyer. Front row (l. to r.) William Levingstone, Adrian Grace, David Morrissey, Brendan Murphy, Tony O'Brien, Tony Lonergan, Pat Marnane, Andrew Morrissey, Kevin Bergin, Anthony Boles.



Galtee Rovers West Tipperary U-21 Football 'A' Champions 2003. . . Back row (l. to r.) Michael Byron, Kieran Marnane, Eamon O'Connell, Declan Peters, Michael O'Connell, Denis Peters, Paul McCarthy, David Byron, Kieran Bergin, Mark O'Brien, Tony O'Brien, Michael Peters, David Morrissey. Front row (l. to r.) Andrew Morrissey, Brendan Murphy, Christopher Higgins, Anthony Boles, Pat Marnane, Kevin Bergin, Tony Lonergan, Adrian Grace, Owen Wade, Anthony Crowe.



Aherlow West Tipperary and County U-21 Football Champions 2003. . . Back row (l. to r.) Gerard Peters, Alan O'Neill, Joe Fahy, Brian Moroney, Paul Coughlan, Danny Hennessy, Tadhg Donoghue, Seamus Grogan, Patrick Hennessy, Brian Leonard. Front row (l. to r.) Vincent Hennessy, John Hennessy, Laurence Coskeran, Frank Leonard, Jos O'Brien, Shane Leonard, Kieran Nash, Barry Grogan.



Sean Treacys West Tipperary Inter Hurling Champions 2003. . . Back row (l. to r.) Declan Hickey, Tom Keane, Paudie Carr, Tom Ryan, Ger O'Toole, Paul Shanahan, Brendan Carr, Johnny Butler, Sean Kennedy, Kevin Ryan (M), Ollie Carr, Dermot Ryan, Francis Carr, Joe Ryan, Paul Quigley, Mick Hanley (trainer), Pat Carey. Front row (l. to r.) William Ryan, Paul Shiels, John Berkerry, Joe Ryan, Seamus Carey, Vincent Carr, Liam Nolan, Emmet Steed, Seanie O'Dwyer, Paudie Ryan, Eamon Ryan, Willie O'Dwyer.

# Arravale Rovers in New York

The Arravale Rovers juvenile club broke fresh ground in 2003 when in early July a group of under 16s and adults enjoyed the 'trip of a lifetime' to New York. The brainchild of the club's senior coach, James Hogan, the event was made possible by the hospitality of New York GAA, who hosted the group for some 10 days and ensured that their Tipperary visitors would have a memorable stay in the 'Big Apple'.

The group had the opportunity of playing games in Gaelic Park and Rockford, while in-between times there was a visit to Chelsea Pier for indoor soccer, golfing and ice skating. There was also time to visit Chinatown, Little Italy and Ground Zero. Calls to the Empire State Building and the Statue of Liberty were also on the menu while possibly the highlight of the visit was the visit to the harbour for the fireworks display on the 4th of July.

In truth it was just one feature of a hectic year which started in early February with the winning of West Tipperary honours in Peil na nOg. It was to be the start of a clean sweep of football titles as our lads went on to capture under-12, under-14 and under-16 grades, culminating with under 13 Garda Cup honours late in the year. We didn't manage a county title although

our under 16s will wonder how they lost their final to Moyle Rovers by the minimum. No hurling titles came our way even though all of our teams gave a good account of themselves and our under 15s have qualified for the final of the Garda Cup. The basis for such continued success can be viewed any weekend when a group of voluntary and willing coaches give so freely of their time to look after a myriad of juveniles ranging in ages from six to sixteen nurturing their young charges to the skills of hurling and football.

The summer camp, which has been

in existence for the past decade, never fails to attract and in late July Sean Treacy Park played host to well in excess of 100 lads and lassies all enjoying a variety of exercises in a friendly and well supervised atmosphere.

Trips are a highlight of every year and during 2003 we enjoyed trips to Moyle Rovers, Cahir, Thurles, Clonmel Og, Na Piarasigh and Mungret in Limerick.

As winter looms our younger juveniles go indoors at Canon Hayes Recreation Centre from November to March before resuming activity outdoors. And so the cycle continues. Roll on 2004.



West Tipperary G.A.A. Board officers with G.A.A. President Seán Kelly, (l. to r.) Jerry Ring, James O'Donnell, Seán Kelly, Eamonn Buckley.



Mickey Murphy (centre) receiving his 1931 West M.H.C. medal from West Board Chairman James O'Donnell. On the left is Mickey's daughter Mary Burgess. Back (l. to r.): John Ryan, Cashel K.C., treasurer, Matty Finnerty; secretary, Donal Ryan; and Cashel K.C. chairman, Ger Slattery

# GALTEE ROVERS – ST. PECAUNS 2003

## *A treble on the double*

**W**hen Galtee Rovers won the county junior hurling title in 1999, and followed this up with the county intermediate championship in 2001, few could have imagined that we would contest, let alone win our first West senior hurling title in 2003 and add five other adult titles to it in the course of what was, by any standards, a remarkable year.

Such is the spirit of the club that first round reversal against Cashel was to prove the turning point in our year and it motivated our outfit to lift themselves past West champions, Clonoulty and then past Cashel, to earn a tilt with Kickhams in the final. The draw in Sean Treacy Park, and particularly the replay in Golden, will surely go down in history as key moments for the club and they have been widely documented already but the sight of Willy Tarrant with his hands on the O'Dwyer Cup is one that will be treasured for ages. In the county quarter final we showed too much respect to Nenagh for too long before hauling their lead back to a single point in a memorable second half.

This year our senior footballers were chasing their 5th title in a row and the question was would our dual status prove a help or a hindrance. Certainly it proved no problem in the West when we opened our campaign with a win over Kickhams. Then it was on to the Old Firm type semi-final against neighbours, Arravale, where a succession of points proved to be the difference at the end. This year we met Éire Óg in the West final and we recalled the close encounter of 2002 at under 21 level when a late goal proved our salvation, however the margin this time was wider. As West champions we headed into the county championship and fell to Ardfinnan at the penultimate hurdle in what was our 7th game on the trot with injuries piling up all the time.

At under 21 level our footballers have regularly won West A titles but for the past 2 years we have been fortunate to record a double in this grade with wins for our hurlers over Kickhams and our footballers over Cashel in 2003. In this regard our present bunch are still out of luck outside of the division and it is essential that this is remedied soon before the well runs dry.

At minor level we again had a successful year with West A titles in both hurling and football for teams who have had an amount of success since under 12 level. A driving force in this team is David Morrissey, who captained Tipperary minor hurlers this year and won his third Munster minor medal in the

process. It is good to see a healthy sprinkling of minor and under 21 hurlers and footballers on our senior panels and this must surely be a positive sign of things to come for the club.

Over the years tireless work has been done at juvenile level in the club and it was great to see our under 12 footballers deservedly win a West title at Solohead, before giving a great account of themselves in Semple Stadium in June. Perhaps the unluckiest panel were our under-16 footballers who scored 3-11 against Arravale in an excellent West final, only to lose by a single point. Trojan work indoors and outdoors also in underage hurling and personally it was great to see a rural club field 30 under-12 and under 10 hurlers playing Cahir in April. As we look forward to further progress on and off the field we recall in Spring the dedication of the GAA Centre to the memory of John and Geraldine McGrath, a fitting tribute to their tireless efforts on behalf of the club. As the year draws to a close, Jim Byron, player, umpire, officer and supporter has been honoured as one of 40 Sean Ghaeil who have made a significant contribution to the Gaelic Athletic Association in their lifetime. Mar focal scór, a sincere Thank You to all our players, mentors, officials, sponsors and supporters for your fantastic efforts in 2003 and let us look forward to further success in the coming year.



*Galtee Rovers West Tipperary Senior Hurling Champions 2003. . . Back row (l. to r.) John Morrissey, Tony O'Brien, Jimmy Butler, Eamon O'Connell, Chris Byron, Vinny Murphy, Seamus Moloney, Michael Grace, Cahal Moloney, Mark Peters, David Byron, Pa Morrissey, Michael Scanlon, Denis Peters, Mark O'Brien, Larry Quinn. Front row (l. to r.) Kieran Bergin, Kevin Bergin, Tony Lonergan, Colin Morrissey, Willie Tarrant, Andrew Morrissey, Dallan Browne, Pat Marnane, David Morrissey, Anthony Boles, Michael White.*



*Galtee Rovers West Tipperary Minor Football 'A' Champions 2003. . . Back row (l. to r.) Larry Roche (sel.), Brian Hogg, Larry O'Brien, Thomas Peters, Kieran Marnane, Gerard Crowe, William Levingstone, Tony Egan, Raymond O'Dwyer, Michael O'Connell, Mark O'Brien, David Morrissey, Willie Tarrant (manager). Front row (l. to r.) Eamon Wade, Stephen McGrath, Kieran Bergin, Damien Ryan, Donal Collins, Pat Marnane, Adrian Grace, Owen Wade, Andrew O'Halloran, Tony O'Brien, Brendan Healy.*



*Galtee Rovers West Tipperary Senior Football Champions 2003. . . Back row (l. to r.) David Byron, Ed Fahy, Declan Peters, Michael Grace, Vinny Murphy, Cahal Moloney, Seamus Moloney, Paul McCarthy, Colin Morrissey, Denis Peters, Mark O'Brien, Pat Ryan, Pat Marnane. Front row (l. to r.) Jim Phelan, Andrew Morrissey, Christopher Higgins, Pa Morrissey, Eddie Grace, Anthony Boles, David Morrissey, Kieran Bergin, Willie Tarrant, Tony Lonergan.*

# 2003 Historic Year for TI

**T**HE year 2003 will go down as an historic year in Tipperary Institute. After only four years in existence, the Institute won the prestigious Ryan Cup, the All-Ireland Third Level Colleges Hurling B Championship, as well as reaching a league final (yet to be played at time of writing). To climb so high on the colleges hurling ladder, in such a short period of time must be put down to determination, heart, vision, sheer hard work and no little skill. At the AGM at the start of the college year, the club set a goal to qualify for the Ryan Cup semi-finals/finals weekend. It was some months before the Institute learned it had been given the honour of hosting the weekend, as well as the Fitzgibbon Cup final, the premier event of colleges hurling.

The fact that the TI were to host the weekend made the squad all the more focused and determined to be part of it and to compete in it. After an unbeaten run in the group stage of the division 2 league (defeating IT Tralee, Cork Colleges of FE, UCC, Waterford IT, Cork IT), TI overcame Athlone IT in a hard fought extra-time semi-final win, before facing St. Mary's Teacher Training College, Belfast in the Ryan Cup 1st round. A lack of match practice showed on the side of the northerners and Tipp Inst coasted to an easy 8-17 to 1-03 victory.

This put TI into a quarterfinal against IT Carlow at Dr. Morris Park, Thurles. After trailing for much of the first half, Tipp Inst dug deep to grind out a 1-09 to 0-10 win, Micheál Hassett getting the vital goal. In hindsight, this game proved to be a watershed, a day when questions were asked and firmly answered by the likes of Hassett, Mark O'Leary, Seamus Butler and goalkeeper Austin Cooney, captain. Many felt afterwards that having come through this encounter, TI would be in the running for major honours in '03.

So, the hosts were through to the semi-final. In a game ruined by atrocious weather conditions, TI came up against old rivals, Cork Colleges of FE in Littleton on February 28. After taking an early lead, the hosts remained on top and through the hard work of Michael Costello, Owen Shortt, Paul Ryan, Eamon Tuohy and Barry McLoughlin, qualified for the final on a scoreline of 2-17 to 0-10. Given the 'weekend' structure of the competition, the final was played the following day. Thankfully, the weather had eased somewhat overnight and the well-kept Ragg pitch wasn't in too bad a condition.



Larry Banville Datapak, sponsors of Fitzgibbon and Ryan competitions, presenting The Man Of The Match Award to Mark O'Leary

A lightning start from TI saw goals go in from Micheál Hassett (2), Mark O'Leary (2) and Seamus Butler to lead by 5-05 to 0-1 after 25 minutes. Even the most optimistic Tipp Inst supporter couldn't have foreseen such a whirlwind start, given the struggle between the two sides in the league quarter-final just 45 days previously. The midlanders started to get into their stride and tacked on some well-worked scores including a second-half goal. The sideline team of Paddy McCormack, Tommy Dunne, Fr. Jimmy O'Donnell, Tommy Butler and Philip Brady patrolled the sideline, ready to make the vital changes when necessary, as they had done all year. The host side tightened their grip in the second half winning by 5-13 to 1-11. Those early goals proved decisive in securing the young college's first ever piece of silverware. Scenes of jubilation among the

strong Ragg crowd greeted the final whistle, and a huge cheer went up as captain Austin Cooney, lifted the Ryan Cup and made a fine acceptance speech before Mark O'Leary was presented with the Man-of-the-Match award for the final.

It has been said over and over, but it really is hard to understate the achievement of TI in winning such a competition after a mere four years competing. Enormous credit has to go to each and every one of the players, not just the 'All-Stars' and county stars, all had a part to play. More than anything credit must go to Paddy McCormack, Tommy Dunne, Fr. Jimmy O'Donnell, Tommy Butler, Philip Brady for all their work on the training field over the last four years, laying a solid foundation for success, to Micheál Hassett and Seamus Butler who went above and beyond the call of duty as chairman and secretary respectively, and also to Maura Maher, whose selfless work and attitude towards the club was amazing- the true extent of her work for the club is known only to a few.

The club would also like to thank Thurles Sarsfields for the use of their pitch throughout the year and Philly Butler, who always had Morris Park in top-class condition. John Fogarty of Fogarty's Bar in Thurles deserves enormous credit for sponsoring both gearbags and polo shirts for the entire panel, as well as Coca-Cola (tracksuits) and Paddy Stakelum Menswear, Thurles (trousers and jumpers).

An historic year for one and all, and one which makes us look to the coming season with optimism....

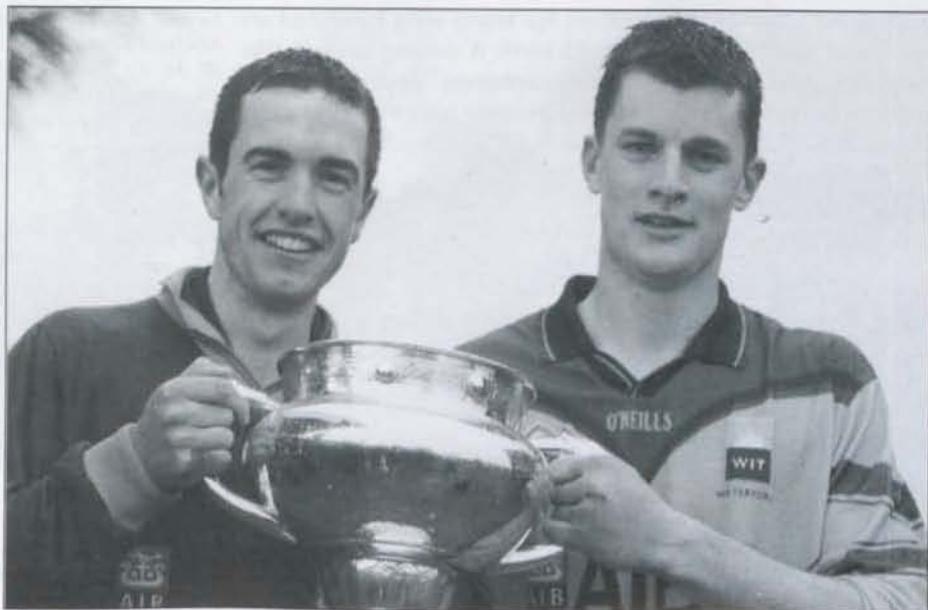

Influential players on the WIT team that won the Fitzgibbon Cup are Damien Young and Paul Curran (captain).



# Hosting of Ryan Cup/Fitzgibbon Cup

This past year was a great and historic one for Tipperary Institute GAA Club. While the obvious highlight of the campaign was the winning of the Datapac Ryan Cup, there were less heralded firsts on the football field and in the handball court, the Institute fielding for the first time in each code. Our camogie girls also caused a couple of people to eat their words, putting in some great performances.

But another major feather in the cap of Tipperary Institute is the fact the college this year hosted both the Ryan Cup Weekend (semi finals and final) and the Fitzgibbon Cup final, both sponsored by Datapac. It has been said in many quarters, including each of the participating colleges at the weekend, that this year's weekend was the best run and most enjoyable in many years, if not the best ever. In fact, Tipp Institute GAA Club has, at time of writing, been nominated by national colleges sports body CUSAI for the award of 'Best Inter-Varsity Event', the winner of which has yet to be announced.

In late 2002, at a meeting of 3rd level GAA clubs, a delegation from TI was asked if they would be interested in hosting the Datapac hurling finals. Without hesitation they jumped at the chance, knowing that, despite being the smallest and youngest college ever to host the finals, TI had the people to pull it off. And so, almost immediately, the work began. In between preparing to actually compete in the Ryan Cup, with training sessions and matches to be organised and played, a core group within the club threw themselves into the organising of the weekend, becoming immersed and apparently obsessed by the task. Many, many long days and late nights were spent behind the



Austin Cooney with Ryan Cup

scenes in the Institute, planning and plotting, scheming and dreaming. In order to finance such a huge undertaking, it was decided a big fundraiser was in order. On the 12th of February, TI GAA Club held a Greyhound benefit night. The proceeds of this hugely successful night went towards the expense of hosting the weekend, with a slice also going to St. Vincent de Paul and North Tipperary Hospice.

Like the overall weekend, the greyhound benefit night was an example of a small club doing the work of an army. And so it continued through the year. The constant liaising with past hosting colleges, the organising of other glamour nights such as the Launch Night for the Ryan/Fitzgibbon Weekend (attended by the top GAA names), the banquet night and meals for the competing college clubs at the weekend, the putting together of a top-class program for the weekend, the organising of pitches, sponsors, the list goes on and on and it is not an exaggeration to say that the work done by certain people in the club will never be fully known or appreciated. Everyone in the

club pulled their weight, but special recognition has to go to Maura Maher, Micheál Hassett, Paddy McCormack, Fr. Jimmy O'Donnell and Seamus Butler.

As the weekend in question grew nearer, the buzz around the college grew and grew. There was a real feeling that something big was about to happen, something important. As the final preparations were being made, the tension grew (there was even the odd argument during the decision-making process), as did the workload, but there was never any doubt that the club could and would pull off their goal.

And so it finally arrived. The final weekend in February 2003 is one that will be remembered in Tipperary hurling circles and in college hurling sections for quite a while. The fact that the Institute were competing in and, ultimately, winning the Ryan Cup put a wonderful gloss on an already magnificent weekend. It also meant that, as so many were involved in the preparation of the team, it again fell on the true pillars of the club. Here again some people have to take enormous credit for the thankless Trojan work they put in. After the hosts defeated Athlone IT in the Ryan final and Waterford IT beat Cork IT in the Fitzgibbon final, it was on to The Ragg for a fine meal for all before the business of celebrating got under way. Fair to say, I think, a most enjoyable weekend for all involved and concerned. A multitude of people helped during the year in ways that will never be known, and the club would especially like to express its appreciation and thanks to these people, too numerous to mention.

## Tipperary GAA gets connected

BY ED DONNELLY

Monday, April 14th was a significant day in GAA circles in Tipperary. On that date, for the first time ever, all club fixture notifications were sent to all clubs in Tipperary by e-mail only by the county secretary, Michael O'Brien. All four divisional secretaries followed suit soon afterwards, as Tipperary became only the 2nd county in Ireland (after Laois) to embrace the use of information technology in this way.

This initiative was announced at a county board meeting in February. To aid with this plan, a county IT committee was formed under the chairmanship of Ed Donnelly (Moycarkey-Borris). The first objective of this new committee (a sub-committee of the county development committee) was to organise training within each division for club and divisional officers to become accustomed to e-mail, the Internet and computers in general.

Training events were organised in Nenagh, Templemore, Tipperary Town and Cahir and were a big success.

Nearly seventy GAA officers were trained including the chairman, secretary & development officer of the county board, the county Bord na nÓg secretary & PRO and all four divisional secretaries. Over 60% of clubs took the opportunity to attend one of these courses.

To ensure consistency, all Tipperary clubs have been allocated their own GAA e-mail address, e.g. mullinahone@gaa.ie or clonmelcommercials@gaa.ie. It is through these GAA e-mail addresses that all correspondence from the county & divisional boards has been sent since April. The list of all club e-mails in Tipperary can be found on the Tipperary GAA web site at <http://tipperary.gaa.ie>

Adopting e-mail as the accepted form of notification for fixtures is a challenge

for clubs in Tipperary. However, this decision will in the long run increase efficiency, significantly lower costs and save hours of time, something which is valuable (and scarce) in the life of GAA officers throughout the county. If you have any questions concerning your club e-mail address, please contact Ed Donnelly at [eddonnelly@gaa.ie](mailto:eddonnelly@gaa.ie) or 087-2055642 or your representative on the county IT committee.

The members of the Tipperary county IT committee are as follows: - Ed Donnelly (Moycarkey-Borris), Ger McKeogh (Ballina - North board rep.), Aoife Maher (JK Brackens - Mid board rep.), Noel Byrne (Fethard - South board rep.), Eamonn Buckley (Lattin-Cullen - West board rep.), Michael O'Brien (Silvermines - county secretary), James O'Donnell (Golden-Kilfeacle - county development officer) and Jackie Maher (Toomevara).



Seamus Butler Tipperary Institute holds possession in the Ryan Cup Final Tipperary Institute Captain Austin Cooney receives the Ryan Cup



Ryan Cup All Ireland Champions 2003. Back row (l. to r.): Padraig Culbert (CEO, TI), Aidan Dalton, Neil Ryan, Mark O'Leary, Michael Costello, Eamon Tuohy, Seamus O'Keefe, Michael Hassett, Nicky Murphy, Jamie Murphy, John Joe Delaney, Kevin Butler, Eamon Ryan, Seamus Carey, Tommy Butler (sel.). Front row (l. to r.): Jimmy O'Donnell (sel.), Tommy Dunne, Shane Walsh, John McGrath, Eoin Shortt, Barry McLoughlin, William 'Boots' Carroll, Paul Ryan, Seamus Butler, Chris O'Flaherty, Edward Whelan, David Wall, Ritchie Crowe, Paddy McCormack (manager).



Pillars of the association . . . The place is the Archbishop's Palace, Thurles and the year 1960. The occasion was probably the assumption of the position of patron of the Association by Dr. Thomas Morris. Back row (l. to r.): Unidentified, Aodh O'Broin, Tull Dunne, Phil Purcell, Jim Regan or Jack Barrett, Johnny Leahy. Front row (l. to r.): Unidentified, Dr. Joe Stuart (President GAA), Dr. Morris, Pádraig Ó Caoimh, Pádraig de Búrca. Any information on the unidentified men in the photo to Liam Ó Donnchú, GAA Office, Thurles.

# Tipperary Handball Report

## 40 x 20 Championships

2003 was once again a busy and successful year for Tipperary handballers and our players achieved All-Ireland successes in both 40 x 20 and 60 x 30 during the year. Our players also took part in the World Championships held in October and Fergal Collins from Ballina partnered by Seamus O'Carroll from Limerick won the Boys 13 and Under 40 x 20 World Championship

Ger Coonan came through his Munster campaign with ease but lost the All-Ireland semi-final in Croke Park to old adversary Brian Carroll from Meath.

Jason Tobin from Carrick-on-Suir returned to handball after the absence of a few years and took the Munster junior B singles title after a very tough campaign. He then went on to defeat Mick Armstrong from Wexford in the All-Ireland semi-final played at Nenagh on a score line of 21-10, 21-12. The All-Ireland final against Niall McDermott from Roscommon was played in Crinkle, Co. Offaly and turned out to be a cliffhanger with Jason eventually winning 21-12, 16-21, 21-18.

Des Kelly and Michael O'Carroll

**W**e achieved success in 6 Munster championships in 40 x 20 and went on to achieve All-Ireland successes in 3 of these. Our Munster championship wins were as follows:

Grade	Winner
Minor Singles	Ger Coonan, Ballina
Junior B Singles	Jason Tobin, Carrick-on-Suir
Junior Doubles	Des Kelly/Michael Carroll, Ballinahinch
Master A Doubles	Tony Flaher/Pat Griffin, Youghalarra
Silvermaster B Doubles	Gerry Spillane, Clonmel & Michael Gleeson, Ballina
Ladies Junior B Singles	Cliona Collins, Ballina

from Ballinahinch played the best handball of their careers to date and took the Munster title in junior doubles. They met a very fancied pair from Kilkenny in Eddie Bourke and Canice Quigley but ran out winners at 21-19, 21-04. They then travelled to Ballymore Eustace in County Kildare to meet the Caddell Brothers from Antrim, Dominic and Tony, but won their All-Ireland title very convincingly on a score line 21-09, 21-12.

Tony Flaherty and Pat Griffin from Youghalarra travelled to O'Loughiins, Kilkenny to take on Martin Lawlor and Philly Parsons in the All-Ireland semi-final and after a tough game, came out second best to the All-Ireland holders 21-13, 19-21, 21-13.

Gerry Spillane from Clonmel and Michael Gleeson from Ballina teamed up to take part in the Silvermaster B Doubles and, having come through their Munster campaign, went on to play Jimmy Heffernan and Peter Larkin from Dublin in the All-Ireland semi-final. Gerry and Michael defeated the Dubliners in a tough game by 21-11, 21-20. They went on to defeat the Antrim pair of Seamus Collins and Tom Smith in the All-Ireland final played at Ballymore Eustace on a score line of 16-21, 21-07, 21-14.

Cliona Collins from Ballina won the Munster title in the ladies junior B singles but lost the All-Ireland final to Mary Murphy from Kilkenny, which was played at Nenagh.

## 60 x 30 Championships

**G**er Coonan continued on his winning ways and completed a double in Munster by winning minor singles and, partnered by Enda McKeogh, also took the minor doubles title. Ger and Enda lost at All-Ireland semi-final stage in the doubles to Richie Walsh and Jason Doyle from Wicklow. However, in the singles Ger went all the way and won the All-Ireland minor singles title by defeating Gerry Kane from Carlow in the semi-final, and then defeated a much fancied Damian Martin from Roscommon in the All-Ireland final played at Croke Park on the eve of the All-Ireland hurling final. Ger thus became only the second

Tipperary player to win the minor singles title, following in the footsteps of Tony Ryan who brought the All-Ireland title to the County in 1978.

We also achieved a double for the county in the junior with Adrian Johnson from Clonmel taking the Munster title in junior singles and John McQuaid and Martin McInerney from Ballina achieving success in junior doubles. John and Martin traveled to Talbot's Inch to take on the Offaly pair of Conor O'Brien and Noel Murphy, but were defeated by 21-06, 21-08.

**W**e enjoyed a very successful Munster campaign winning Munster titles in 12 grades as follows:

GRADE	WINNER
Minor Singles	Ger Coonan, Ballina
Minor Doubles	Ger Coonan/Enda McKeogh, Ballina
Junior Singles	Adrian Johnson, Clonmel
Junior Doubles	John McQuaid & Martin McInerney, Ballina
Intermediate Singles	Paul Mullins, Clonmel
Intermediate Doubles	Paul Mullins & Jimmy Mullins, Clonmel
Junior B Doubles	Jason Tobin, Carrick-on-Suir & Paul Coleman, Ballina
Masters A Singles	Pat Griffin, Youghalarra
Silvermasters A Doubles	Seamus Morrissey /Ger Spillane, Clonmel
Goldenmasters A Doubles	Pakie Mullins & Bill McCarth, Clonmel
Ladies Junior B Singles	Marian Coleman, Ballina
Ladies Junior B Doubles	Marian Coleman & Cliona Collins, Ballina

Adrian had reached the All-Ireland final of the junior B singles in 2002 but was defeated by Pat O'Donnell from Wicklow. Adrian however, gained revenge for this defeat and defeated Pat in the All-Ireland semi-final on a tight score of 21-15, 21-16. He then went on to defeat Conor Kerr from Tyrone in the All-Ireland final played in Croke Park, by 21-13, 21-08.

Jason Tobin from Carrick-on-Suir and Paul Coleman from Ballina teamed up for the junior B doubles and came through the Munster campaign. However, they lost out to the eventual All-Ireland winners of Michael Maher and Colm Love from Kilkenny in the All-Ireland semi-final played at Clough.

Paul Mullins from Clonmel achieved a double Munster success by winning the intermediate singles and doubles championship. He was partnered in the doubles by his cousin, Jimmy, also from Clonmel. However, Paul lost out in the All-Ireland semi-final to Michael Grogan from Wicklow and also the doubles semi-final to Michael Grogan and his partner Pat Quail. Michael Grogan went on to win the All-Ireland title in both singles and doubles.

Pat Griffin from Youghalarra traveled to Talbot's Inch to play his All-Ireland semi-final but lost to Billy Bourke from Kilkenny.

Seamus Morrissey and Gerry Spillane from Clonmel were also unsuccessful

against the Wexford opposition of Tony Breen and Jimmy Goggins in the All Ireland semi-final.

Pakie Mullins and Billy McCarthy travelled to Croke Park to defend their All-Ireland title but on this occasion were unsuccessful against their opponents of the previous year, Eugene

Kennedy and Billy Farrelly, and lost out in a very tight game.

Marian Coleman also enjoyed a double success in Munster winning the Ladies junior B singles and, in partnership with Cliona Collins also from Ballina, was successful in the junior B doubles. Marian defeated Mary Murphy

from Kilkenny in the All-Ireland semi-final and went on the defeat Emer Rafferty from Galway in the All-Ireland Final on a score line of 21-11, 21-20. Marian and Cliona also reached the doubles All-Ireland final against Kilkenny, but this game was postponed due to an injury to one of the Kilkenny players.

## Juvenile Handball

**E**va McKeogh and Ciara McCarthy had a very successful year winning Munster titles in both 40 x 20 and 60 x 30 in the girls under-15 doubles. In the 40 x 20, which was played early in the year, they defeated Mairead Whitmore and Sarah Hackett from Wexford in the All-Ireland semi-final, and went on the defeat Deirdre Donoghue and Kate Costelloe from Roscommon in the All-Ireland final, played in Roscommon on a score line of 01-21, 21-16, 11-05.

The girls then went on to achieve an All-Ireland double by coming through

**B**allina Handball Club again continued to be to the fore in the Munster campaign and were successful in four Munster championships as follows:-

### GRADE

Girls U.15 Doubles 40 x 20  
Girls U.15 Doubles 60 x 30  
Boys U.14 Singles 60 x 30  
Girls U.16 Doubles 60 x 30

### WINNER

Eva McKeogh & Ciara McCarthy  
Eva McKeogh & Ciara McCarthy  
Fergal Collins  
Karen Collins & Anne Marie Ryan

the 60 x 30 Munster campaign, and beat Eithne McHale and Leona Pryal of Mayo in the All-Ireland final.

Karen Collins and Anne Marie Ryan were defeated in the All-Ireland semi-final by the Kilkenny pair of Claire Love and Anne Marie Hawe.

Fergal Collins from Ballina although still under 13 years of age won the boys

under-14 singles title by defeating Colm O'Muirheartaigh from Kerry in the Munster final. He then went on to beat Cian Clancy from Carlow in the All-Ireland semi-final but gave way to Brian Doherty from Tyrone in a very exciting Final played in Ballina. Brian went on to take the title in a tie-breaker.

## Feile Na nGael

**Feile na nGael was hosted by Leinster and we were represented with a team from Ballina consisting of:**

Eoin Kent, Darragh Hardy, Donal Kent and Fergal Collins.

The team went on to win the 60 x 30 division 1 by defeating Garyhill (Carlow) in the final. This was due reward for the club as in the previous year they were beaten in the final by New Ross from Wexford. Fergal Collins went on to win the skills competition for the third year in a row and has now equalled Ger Coonan's record of three wins. Fergal is eligible to compete in Feile next year and is hoping to go one better than his clubmate, Ger, and we wish him every success.

## Inter Club

**T**he Ballina Club enjoyed a very successful inter-club campaign by winning the Munster title in junior 60 x 30.

They went on to beat Davidstown from Wexford in the All-Ireland semi-final, which was played in Talbot's Inch on a score line of 119-78, and then beat Williamstown from Galway in the All-Ireland final played in Crinkle. The Ballina team consisted of John McQuaid, John Lee, Martin McInerney, Michael Gleeson and Ger Coonan.

## Hardball

**A** number of our players took part in the All-Ireland Hardball championships. John Lee from Ballina took part in the junior singles.

He came through his first two rounds

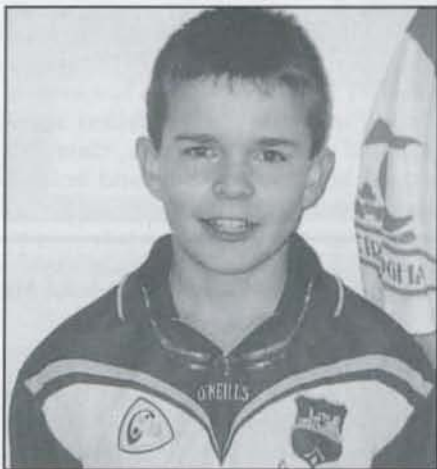

Fergal Collins, Runners-up 60x30 U14 All-Ireland Final.

against Anthony Bourke from Limerick and John Keyes from Limerick, but eventually lost out to James Doyle from Wexford on a score line 21-09, 21-07. John teamed up with John McQuaid for the junior doubles and again defeated the Limerick opposition of John Keyes and Anthony Bourke, but lost out to the overall winners Niall Kerr and Conor Kerr from Tyrone by 05-21, 21-19, 21-13. Jason Tobin from Carrick-on-Suir and Gerry Spillane from Clonmel also took part in the junior doubles. They were successful against Naill Morrisson and Ollie Deegan from Kildare but lost out to the Conway Brothers from Galway by 19-21, 21-17, 21-15.

## USHA Nationals

**T**he USHA Nationals took place in East Lansing, Michigan and Ger Coonan from Ballina enjoyed a

very successful campaign there.

He teamed up with Neil McDermott from Roscommon in the men's B doubles and defeated Joel Martin and Matt Krueger from Washington in the first round. They then defeated Kevin McGovern and John Early from Michigan in the quarter-final and were successful against the Mexican pair of Marique Escobar and Bald Memo Romero in the semi-final. However, they lost out in the final to a pair from Minnesota, of John Stefel and Mike Wells, by 21-05, 21-20.

Ger, however went all the way in the boys 17 & under singles, and defeated Ryan Bowler from Canada in the quarter-final, Tyler Weinzril from Washington in the semi-final, and Eric Hillgren from Nebraska in the final.

## Irish Nationals

**G**er Coonan took part in the Irish Nationals and was also the winner of boys under-17 singles.

Ger was successful against Damien Martin from St. Coman's, Roscommon in the semi-final (Damien retired injured). Ger then went on to beat Brian Carroll from Meath in the final in a very exciting game (15-21, 21-08, 11-07).

## Girls Inter Provincial

**T**ipperary were again represented in the Girls under-13 to 17, 60 x 30 inter-provincial team, when Karen Collins from Ballina represented the province in the inter-provincial final.

The Munster team were successful against Connaught by 135 points to 71.

The following is a complete list of the Tipperary Players who took part in the world championships:

#### PLAYERS

Fergal Collins, Ballina  
 Fergal Collins, Ballina & Seamus O'Carroll, Limerick  
 Ger Coonan, Ballina  
 Ger Coonan, Ballina / Brian Carroll, Meath  
 Karen Collins, Ballina  
 Karen Collins, Ballina & Sarah Flavin, Limerick  
 John Lee, Ballina  
 I Paul Coleman, Ballina  
 Aidan Supple, Ballyporeen  
 Jason Tobin, Carrick-on-Suir  
 David Forde, Silvermines  
 Michael Forde, Silvermines  
 Paul Coleman, Ballina/Jason Tobin, Carrick-on-Suir  
 David Forde/Michael Forde, Silvermines  
 Finbarr Ryan/Joseph Ryan, Silvermines  
 Michael Gleeson/Tom Quigley, Silvermines  
 John Kennedy, Silvermines  
 John Kennedy/Kevin Timmons, Silvermines  
 Des Kell /Michael Carroll, Ballinahinch  
 Tracey Coonan, Ballina & Sharon Daly, Kerry  
 Pat Griffin/Tony Flaherty, Youghalarra  
 Tony Flaherty, Youghalarra  
 Padd Collins, Ballina  
 And Purcell, Silvermines  
 Padd Collins/Jedd McKeogh, Ballina  
 And Purcell/Denis Gleeson, Silvermines  
 Jim Ryan, Silvermines  
 Jim Ryan, Silvermines/Morgan Darcy, Galway  
 Pat Maher, Clonmel

#### GRADE

Boys 13 & Under Singes  
 Boys 13 & Under Doubles  
 Boys 17 & Under Singles  
 Boys 17 & Under Doubles  
 Girls 17 & Under Singles  
 Girls 17 & Under Doubles  
 Mens C Singles  
 Mens C Singles  
 Mens C Singles  
 Mens C Singles  
 Mens C Singles  
 Mens C Doubles  
 Mens C Doubles  
 Mens C Doubles  
 Mens C Doubles  
 Mens B Singles  
 Mens B Doubles  
 Mens B Doubles  
 Ladies B Doubles  
 Master A Doubles  
 Silvermaster A Singles  
 Goldenmaster B Singles  
 Goldenmaster B Singles  
 Goldenmaster B Doubles  
 Goldenmaster B Doubles  
 Veteran Golden A Singles  
 Veteran Golden A Doubles  
 Diamondmaster B Singles



40x20 and 60x30 All-Ireland U15 Champions 2003 - Ciara McCarthy and Eva McKeogh.

ta Murphy from Kilkenny in the first round of the 17 & under-girls singles, but lost out to Sinead Devlin from Meath in the second round. Karen teamed up with Sarah Flavin from Limerick for the 17 & under doubles and they beat Claire O'Hagan and Claire McIvor in the first round but lost to the eventual winners Sinead Gallaghy and Emer Ni Fhaolain from Kildare in the second round.

We had six competitors in the men's C singles. Both John Lee and Paul Coleman from Ballina went out in the first round, John losing to Joel Smith from Dublin while Paul lost to Tom Connors from Wexford.

Aidan Supple from Ballyporeen defeated Brendan Redmond from Wexford in the first round but lost out in round two to Jason Tobin from Carrick-on-Suir. Jason in turn lost his next round to Noel Murphy from Offaly.

Both David Forde and Michael Forde from Silvermines won their first rounds. David defeated Matthew Marcil from Canada but lost out in round two to William Love from Kilkenny. Michael defeated Matthew Valdez from the USA in round one but lost to Mark McCartan in round two.

We had four pairings in the Men's C doubles - Michael Gleeson/Tom Quigley from Silvermines lost their first

### WORLD CHAMPIONSHIP 2003

Ireland hosted the World Championships for the first time since 1994 and over 1,000 competitors took part from various countries. There were 26 competitors from Tipperary, who took part in the championships and, as I mentioned earlier, Fergal Collins won the boys 13 & under doubles world title with his partner Seamus O'Carroll from Limerick.

Fergal Collins competed in the Boys 13 & Under Singles and had great wins over Keith Kavanagh, Wicklow, Gary Marshall, Kerry, Cian Coonehan, Kerry but eventually lost out in the semi-final

to the eventual winner and his partner Seamus O'Carroll from Limerick.

Fergal teamed up with Seamus O'Carroll from Limerick in the boys 13 & under doubles and achieved outright success. They defeated Daragh Cloake and Jason Murphy from Wexford in the first round and Conor Duff and Paul Connelly from Tyrone in the second round, Thomas Lennick and Ebin Brown from the USA in the semi-final and Conor Grogan and Caolan Daly from Tyrone in the final. This was indeed an outstanding achievement for Fergal and has brought honour and distinction to both his club and county.

Ger Coonan took part in the boys 17 & under singles and defeated Gareth Brown from Down in the first round. He then had wins over Lee Conlon from Monaghan, and Patrick Hogan from Kilkenny before finally losing out to the eventual winner, Robert McCarthy from Westmeath in the semi-final.

Ger teamed up with Brian Carroll from Meath to take part in the 17 & under doubles. They defeated Daniel O'Halloran and Paul Lynch from Clare in the first round and continued with wins over Ryan Bowler and Jason Roos from Canada in the second round. They went on to beat Gary McRory and Padraig McGlinchy from Tyrone in the semi-final, but lost out again to Robert McCarthy and John O'Shaughnessy from Westmeath in the final on a score line of 16-21, 21-19, 11-07.

Karen Collins from Ballina beat Loret-



Minor, Ger Coonan and Enda McKeogh.



World Championships Mens 'C' Runners-up, Paul Coleman and Jason Tobin.



Tom Aheane, Club President and Ger Coonan, Minor 60x30 2003

round match to Shane Grogan and Darren McRory from Tyrone.

David and Michael Forde from Silvermines won their first round against John Melody and Alan Pearson from Dublin but lost narrowly in their second round to Anthony Sheridan and James Greagan.

Finbarr and Joseph Ryan from Silvermines defeated Thomas Hughes and John Doyle in round one, Michel Gondalaz and Andre Martin of the Basque Country in round two, before eventually losing to Colm Love and Michael Maher (Kilkenny).

Paul Coleman and Jason Tobin were the most successful of the Tipperary players in the men's C doubles. They defeated Brian Kearns and Michael McGee in round one, Cohn McElone and Jim Cunningham in round two, Joe Goggins and Jimmy Shine in round three, Anthony Sheridan and James Greagan in the semi-final, before eventually losing out to Finbarr Rafferty and Alan O'Dwyer in the final.

John Kennedy from Silvermines took part in the men's B singles and defeated Daniel Marcil from Canada in the first round and although John suffered an ankle injury during that game, he took part in the second round but had to give second best to Bernie McDonagh from Galway. John teamed up with Kevin Timmons to take part in the men's B doubles but they were beaten by James Brady and Jan Griffin by 21-20,21-14.

Des Kelly and Michael Carroll from Balhinahinch also took part in the men's doubles and had a very successful cam-



Des Kelly and Michael Carroll.

paign. They defeated Rory Moore and Joe Tierney of the USA in round one, Xavier Uebera and Garikoitz Erroizenea from the Basque Country in round two, Darragh Ward and Trevor Winters from Kildare in the semi-final, before eventually losing to the Conway brothers from Galway, Oliver and Pat, in the final.

Tracey Coonan from Ballina joined forces with Sharon Daly from Kerry in the ladies B doubles but they were defeated by Eithne Mee from Roscommon who was partnered by Alexis Coulter from Canada.

Pat Griffin and Tony Flaherty lost their masters A doubles game against Thomas Maguire and Billy Silcock from Antrim, while Tony lost to Don Ryter from the USA in round one of his silver-masters A singles.

Both Paddy Collins, Ballina and Andy Purcell from Silvermines took part in the goldenmasters B singles. Andy lost his first round match to Steve Birell from USA and Paddy, while defeating Steve Leigh from the USA in his 1 round, lost narrowly to Chris Gildea also from the USA in round two.

Andy Purcell partnered Denis Gleeson to take part in the goldenmasters B doubles but lost out in their first round match against Doug Woods and Larry Brown from the USA. Paddy Collins teamed up with Jeddy McKeogh from Ballina and they defeated Steve Birell and Kevin Olson from the USA in round one (21-20-21-12). They then went on to defeat Seamus Duffy and Pat O'Sullivan from Sligo in round two before losing to Richard Downey and Neville Farrell from Dublin by 21-09,21-13 in the quarter-final..

Jim Ryan from Silvermines was our representative in the veteran golden A singles and defeated Burt Rapine in round one but lost to Ted Pritchard from Canada in round two. Jim joined up with Morgan Darcy from Galway for the veteran golden A doubles and defeated Reubin Ramirez and Bruce Lemon from the USA in round one but lost to Mike Kelly and Alan Sherill USA by 2 1-12,12-21,1 1-06 in the tie-breaker.

Patrick Maher from Clonmel was our oldest competitor taking part in the over-60 B singles and had a 1st round success against Tim Henman from the USA, played in Carrick-on-Suir, but lost



Michael Gleeson and Gerry Spillane.



Junior 'B' Singles winner 60x30, Marion Coleman.

to Jay Maxwell from the USA in his 2nd round match.

The hosting of the World Championships was very successful from an Irish point of view and full credit is extended to all the Tipperary players, who took part in the various venues throughout the country. The venues stretched from Kingscourt in Cavan to Carrick-on-Suir in Tipperary. Many thanks to the Carrick-on-Suir club for hosting part of the championships and to Pat McKenna, our chairman, for supervising at this venue.

## Finance

**A**gain I wish to thank the Tipperary GAA Board for their financial contribution to the Handball Board and again I urge all Clubs to take part in the monthly GAA Draw.

The County GAA Board also provided a number of Playing Shirts, which were then passed on to our handball players who were successful at Provincial level. Again this support is very much appreciated.

## Conclusion

**I**wish to thank our county chairman, Pat McKenna, North secretary, Paddy Collins, county PRO, Michael Hogan and all club secretaries, who promoted handball throughout the year. I also wish to thank the staff of Croke Park, especially Lorcan O'Ruairc, together with the officers of the Munster Council.



Tipperary Handball Chairman, Pat McKenna, enjoying the World Handball Championships.



Adrian Johnson, Clonmel, All-Ireland Junior Singles Champion 2003.



Ballina Junior Club winners – Martin McNerney, Michael Gleeson, John Nee, John McQuaid, Ger Coonan.



Ballina Feile team 2003 – Eoin Kent, Daragh Hardy, Donal Kent, Fergal Collins.



40x20 and 60x30 U15 Champions 2003 – Eva McKeogh, Ciara McCarthy with Coach Paddy Collins.

# Semple Stadium

Semple Stadium and Sarsfield Training pitch consist of eleven acres. It was once known as Molloy's field and was owned by a local merchant. It was sold to a Horse Show committee in 1901 and finally Canon M.K. Ryan secured 84 shareholders who bought and developed it as a hurling venue in 1910. It was then known as Thurles Gaelic Sportsfield and its first working committee included Tom Semple.

Its first major development took place in 1937. This included sideline seating, a new embankment and a small stand. The erection of the Kinnane Stand in 1967 was to replace this small stand. It was a huge undertaking with a capacity of 17,500. A major development took place in 1979 with the building of the New Stand (M.K. Ryan - Árd Riain) and both Terraces. It then became known as Semple Stadium. This latter development preceded the playing of the Centenary All-Ireland hurling final in 1984.

During the nineties, further development took place on re-aligning and improving terrace barriers, putting

down extra tarmac, improving exits, installing and modifying Dug-Outs, building toilets and cleaning and repairing steel girders in Árd Riain.

With higher standards for comfort and safety being demanded, it was then decided to improve and extend the Kinnane Stand. A steel and corrugated roof was placed on the full length of the building, giving weather coverage to 60% of its capacity and seats were installed in the full stand.

A Media Box was included for Press, Radio and Television. Many safety features were included. Entry/Exit stairs were improved, extra aisles were included and two new tunnels were built to facilitate easier entry to seats and safer exit. The fence between the Stand and the pitch was redesigned, lowered and made safer. A fire alarm system and a number of fire safety doors are now included in this Stand together with two additional exit doors. Provision has also been made for wheel-chairs.

Thurles Gaelic Sportsfield has been a Friendly Society since 1932. During the

1967 development, most of its shares were passed over in trust to the GAA. As a result, very substantial grants were paid to it by Central Council and Munster Council. During the past year, shareholding has been further realigned with one thousand shares in total now held by Central Council, Munster Council, Tipperary County Board, Mid Tipperary Board and Sarsfields GAA Club. A further 1053 are held by Trustees of the GAA from the provinces and Croke Park. Local shareholders hold 195 shares out of a total of 2248

The governing body comprised of seventeen of the above shareholders has appointed the present committee of management to look after the running of Semple Stadium, reporting to an annual general meeting of the governing body each year, or oftener if the latter so requires. It is highly desirable that county board be fully involved as officers and members of Semple Stadium Management Committee.

# COISTE SCÓR THIOBRAID ÁRANN

by Mary Murphy

Looking back on the year 2003, it was a very successful year for Scór competitors from Tipperary – having two All-Ireland titles come to the county. The two victorious clubs were **Borris-Ileigh** and **Shannon Rovers**.

The Borris-Ileigh club has been the most successful club in Tipperary over the past number of years and their All-Ireland title was just reward for the efforts of all involved with the Borris-Ileigh Scór committee. The Scór na nÓg Rince Seit group have been knocking at the door for the last few years, but 2003 was to provide ultimate success for this talented group of dancers. Congratulations to the dancers, musicians, committee and trainer, Philip Ryan, on their success.

Shannon Rovers won the first senior All-Ireland Scór title for the club and the North division last year when Siobhán Weafer won the Amhránaíocht Aonair competition in Scór Sinsear. This success provided the catalyst for their Ballad Group to try and

emulate Siobhán's achievement. From the first night of competition, the group impressed all who heard them and a second All-Ireland title was well on the way to the Shannon Rovers club. It is a great achievement for any club to win one All-Ireland, but to win two in a row in Scór Sinsear is an outstanding feat. Well done to all involved in their latest success.

The J.K. Brackens club had the honour of hosting the Munster finals of both Scór na nÓg and Scór Sinsear in Our Lady's Secondary School, Templemore. A lot of work and co-operation is required from the Scór Committee and the G.A.A. Committee and all who were involved are to be complimented on the very efficient manner in which they dealt with the large crowds who attended.

Many thanks, on behalf of Coiste Scór Thiobraid Árann, to all who helped in the promotion of Scór during the past year. Let's hope for more victories in the year ahead.

## Results of Tipperary Scór Competitions 2003

	Scór Sinsear	Scór na nÓg	Scór na bPáistí
Rince Fóirne	Borris-Ileigh	Borris-Ileigh	Silvermines
Amhránaíocht Aonair	Ann-Marie Kavanagh, Borris-Ileigh	Marie Sheary Silvermines	Clara Ryan J.K. Brackens
Ceol Uirlise	Borris-Ileigh	Borris-Ileigh	Templederry
Aithriseoireacht	Richard Brennan, Loughmore/Castleiney	Aoife O'Brien, Fr. Sheehys	Katie Larkin Toomevara
Baileád Ghrúpa	Shannon Rovers	Borris-Ileigh	Borris-Ileigh
Tráth na gCeist	J.K. Brackens	Drom/Inch	Seán Treacys
Nuachleas	J.K. Brackens	Borris-Ileigh	Ballylooby/Castlegrace
Rince Seit	Cappawhite	Borris-Ileigh	Templederry

At the recent Annual General Meeting, the officers elected for the coming year were as follows:

**Chairman:** Tom Gleeson (Silvermines)

**Vice-Chairman:** Seámus McGrath (Newcastle)

**Secretary:**

**Assistant Secretary:**

**Treasurer:** Dan Madden (Templederry)

**Assistant Treasurer:** Margaret O'Connell (Moycarkey-Borris)

**P.R.O.:** Mary Murphy (Newcastle)

**Munster Council Delegates:** Seámus McGrath & Dan Madden

**Divisional Representatives:**

**North:** Jack Fahey (Borris-Ileigh) & Nan Kelly (Portroe)

**South:** Pat O'Dwyer (Newcastle) & Paddy Kelly (Newcastle)

**Mid:** Anna O'Meara (Drom/Inch) & Paddy Cooney (Moycarkey/Borris).

**West:**

*If there are any clubs wishing to take part in Scór for the coming year, contact any of the above delegates for further information on the competitions.*



Ger "Redser" O'Grady of Thurles Sarsfields, won the 2003 Horse and Jockey Hurlball Tournament, defeating Eamonn Donnelly of Moycarkey-Borris in the final. The tournament proved a great success with over 40 taking part. Tipperary legend Mick Roche made the presentations after the final.



Tipperary Co. G.A.C. 2003. Front (l. to r.): James O'Donnell, West chairman; J.C. Ryan, Chairman Co. Board na nÓg, Donie Shanahan, Co. Chairman, John Costigan, Co. Vice-Chairman, Michael O'Brien, Co. Runáí, Willie Robinson, Referees Co-Ordinary, Matty Connolly, Mid Sec. Back row: (l. to r.) Seán Nugent, South Sec., Barry O'Brien, South Chairman, Pat Cullen, Mid Trustee, Eddie Lonergan, Sec. Football Board, Spike Nolan, Co. Treasurer, Ger McKeogh, North Sec., Catherine Gleeson, North Treasurer, Jerry Ring, West Sec.



# Scór 2003



*Borrisoleigh Music Group, Co. Winners Martin Maher, Toby Kavanagh, Mairead Maher and Mary Bradshaw.*



*Borrisoleigh Scór na Páistí Co. Final Winners, Ballad Group from left: Eimear Stapleton, Noreen Stapleton, Claire Kavanagh, Grace Prior and Rebecca Prior*



*Borrisoleigh Figure Dancers - Back row (l. to r.): Mick Fahy, Brendan Maher, Peter Ryan and Toby Kavanagh. Front row (l. to r.): Margaret Ryan, Brid Harty, Marie Ryan and Elaine Stapleton.*



*Borrisoleigh - Recitation, North Winner Maura Howard*



*Borrisoleigh Novelty Act, Co. Winners. From left: Mary Bradshaw, Ivan Kelly, Pauline O'Brien, Marie Ryan, Michael Corcoran and Katie Lyons*



*All Ireland Scór Sinsear Winners 2003 Bailéad Ghrúpa Shannon Rovers. From left: Siobhna Clarke, Conor Hyland, Carmel Cahalan, Martin Tierney and Siobhan Weafer.*



*Borrisoleigh Figure Dancers, Munster Finalists. Back row (l. to r.): Pauric Maher, Seamus Farrell, Thomas Walsh and Martin Maher. Front row (l. to r.): Carol Bradshaw, Ann Ryan, Jeanne Cowan and Deirdre Bradshaw.*



*Borrisoleigh Ballad Group, Co. Winners. From left: Katie Lyons, Elaine Stapleton, Derbhla O'Mahony, Marie Ryan and Mary Bradshaw.*



*Borrisoleigh - Solo Singer, Co. Winner Ann-Marie Kavanagh.*



*Borrisoleigh Question Time North Winners Rory Ryan, Gerry Treacy and Dean McCormack.*



*Borrisoleigh Set Dancers, North Winners. Back row (l. to r.): Pauric Maher, Thomas Walsh, Martin Treacy and Martin Maher. Front row (l. to r.): Deirdre Bradshaw, Carol Bradshaw, Ann Ryan and Michelle Maher.*



*Borrisoleigh Music Group, Co. Final Winners John Bradshaw, Noel Maher, Ann-Marie Kavanagh and Johnny Maher.*

# Tipperary Teams of 1958 to 1965 Honoured

**O**n this year's county senior hurling final day, the Tipperary Star and Anner Hotel in Association with the Tipperary county board sponsored a celebration of the success of the Tipperary senior hurling teams of 1958 - 1965. This era was arguably the best in Tipperary's illustrious history and the 46 players who won All-Ireland medals in this period. They had captured five 5 All-Irelands in 8 seasons were honoured.

The day began when the players convened for a pre-match reception in the Thurles Greyhound Stadium. This informal gathering allowed the players to catch up on old times before they took the short journey to Semple Stadium for the county final. After an exciting county minor final ended all square, it was the turn of the legends of 1958 to 1965 to adorn the famed Semple Stadium pitch. County PRO, Ed Donnelly, introduced the players to the crowd who responded with their generous applause to one and all.

After the senior final, the players were taken by bus to the Anner Hotel for a Gala Dinner in their honour. During the dinner, the players were treated to rare video footage of the 5 All-Irelands in question while the match reports of the time were posted at the side of the room. Each player received a presentation from the Patron of the GAA, Archbishop of Cashel and Emly, Dr. Dermot Clifford, before the captain of 1958, Tony Wall, addressed those present. The official proceedings were then wrapped up, but the conversations were still going strong some time later.

The committee in charge of this event included Seamus J. King (chairman), Martina Oakley (secretary), Liam O'Donnchú, Barry O'Brien, Ed Donnelly, Pat Carey (Tipperary Star) and Tommy Barrett.



Thurles Sarsfields group at the Tipperary Star and Anner Hotel function in conjunction with County Tipperary GAA Board to honour the Tipperary All-Ireland Winners 1958-1965. Back row from left to right: Michael Dundon, Editor Tipperary Star, Liam O'Donnchú, Peter Murphy, Michael Murphy, Tony Wall and Sean McLoughlin. Seated from left to right: Tommy Barrett, Larry Keane, Jimmy Doyle, Musha Maher, Fr. Ray Reidy, Paddy Doyle and Mickey Byrne.



Archbishop Clifford presents framed certificate to Mickey Byrne a member of the Tipperary Teams honoured on County Final Day.



Donie O'Brien, Frances O'Brien and their son Kieran at the pre-match reception on County Final Day when Tipperary All-Ireland winning teams (1958-1965) were honoured.



Tipperary Senior Hurling Captains with Liam McCarthy Cup - Their teams were honoured on County Final Day. Pictured from left to right: Pat Carey, Tipperary Star, Donal Shanahan, Co. Chairman, Tony Wall, Matt Hassett, Jimmy Doyle, Michael Murphy and Catherine Harrington, Anner Hotel.

# Laochra Thioðraid Árann 1958-1965

## Honoured on County Hurling Final Day



Tipperary Star and Anner Hotel in conjunction with the County Board honoured Tipperary All-Ireland Medal Winners 1958 to 1965, on County Final Day. Front row from left to right: Michael Keating Junior (representing Babs Keating), Seamus Mackey, Terry Moloney, John O'Grady, Donal O'Brien, John O'Donoghue, Peter O'Sullivan, Jimmy Doyle, Martin "Musha" Maher, Mrs O' Meara (representing John Hough), Mickey Byrne, John Doyle, Kieran Carey, Michael Maher, Billy McLoughney, Donie Nealon. Middle row from left to right: Tom McLoughney, Mackey McKenna, Larry Keane, Sean McLoughlin, Roger Mounsey, Liam Connolly, Matt Hassett, Willie Robinson (representing Tom Larkin), John Dillon, Mickey Lonergan, Noel O'Gorman, Mick Burns, Jimmy Finn, Michael Murphy, Fr. Ray Reidy, Roger Ryan (representing Late Tom Ryan)), Pat Ryan, Ronnie Slevin, Liam Devaney, Larry Kiely, Tom Ryan. Back row from left to right: Len Gaynor, Christy Hartigan, Peter Murphy (representing late Noel Murphy), Tony Wall, Theo English, John Roche (rep. Mick Roche) and Paddy Doyle.

# Cumann na Sean Ghael

Forty men who have dedicated their lives to the promotion of Gaelic games in County Tipperary, as players and administrators, were fittingly honoured at a function at Brú Boro on November 23. Cumann na Sean Ghael is a new group established during the year under the ambit of the county board to honour people over seventy years of age who, during their lifetime rendered significant service to the G.A.A. in the county. Headed by well-known inter-county referee, John Moloney of Bansha, and including Micheál Ó Meara, Clonmel, as secretary, John Costigan, Templemore, Noel Morris, Borrisokane, Seamus J. King, Cashel, Pat Moroney, Aherlow and Seamus McCarthy, Bansha, it selected ten representatives from each of the four divisions for their inaugural launch of the initiative, and each was made a fitting presentation to mark the occasion. The honoured were: *West:* Michael Murphy, Cashel, Jimmy Hennessy, Kickhams, Mgr. C. Lee, Aherlow, Willie Walsh, Cappawhite, Rev. Roger Kinane, Clonoulty-Rossmore, Val O'Dwyer, Rockwell Rovers, James O'Donoghue, Arravale Rovers, Jim Byron, Galtee Rovers, Jimmy Hannon, Lattin-Cullen, Tom O'Shea, Aherlow. *South:* Willie Wall, Carrick Swan, Tom Wall, do, Dick Allen, Fethard, Bunny Lambe, Old Bridge, George Pyke, Commercials, Dick Cummins, Fethard, Mick Gavin Commercials, John O'Donnell, Cahir, Paddy O'Keefe, St. Mary's, Paddy Browne, Killenaule. *Mid:* Liam O'Dwyer, Boherlahan, Bob Stakelum, Holy-cross-Ballycahill, Mickey Byrne, Thurles Sarsfields, Mick McGrath, Loughmore-Castleiney, Tom Everard, Drom, Mick Cahill, J.K. Brackens, Pakie Ryan, Upperchurch-Drombane, Mick Everard, Moyne-Templetuohy, Jim Leahy, Moycarkey-Borris, Jim Delaney, J.K. Brackens. *North:* Mick Ryan,



Jimmy Hannon ,centre,with his brother Jackie on left,and West Board Treasurer Eamon Buckley on right.



L/R;Liam O Dwyer,Boherlahan, Dick Cummins,Fethard and Very Rev. Monsignor Lee.



Back L/R;Jim O'Donoghue Arravale Rovers and Tom O'Donoghue Share a joke with Mickey Byrnes Sarsfields at front.



Recipients of Sean Ghael awards in Bru Boru Recently – Front (l-r): Seamus O Riain, Moneygall; Joe Mc Donagh, who presented the awards; Jimmy Butler Coffey, Newport; Son Kelly, Borrisokane; Michael Ryan, Burgess. Back (l-r): Noel Morris, Borrisokane; Tom Gleeson, Silvermines; Jim Bourke, Shannon Rovers; Jimmy Kennedy, Killadangan; Tony Reddin, Lorrha; Mick Ryan, Roscrea and Jimmy Finn, Borrisoleigh.



Some Award recipients at the Sean Ghael function in Bru Boru; Front (l-r): George Pyke, Commercials; Paddy O'Keeffe, St.Mary's; Paddy Browne, Killenaule; Joe Mc Donagh, Lar - Uachtaran; John O'Donnell, Cahir; Back: Jim O'Donoghue, Arravale Rovers; Dick Cummins, Fethard; Frank Power and Jimmy Hogan, who accepted awards on behalf of Tom and Willie Wall of Carrick Swans; Billy Lambe, on behalf of Bunny Lambe, Old Bridge.



From Fethard Jimmy Shea on left with Seanoiri Dick Cummins, Dick Allen and John Allen on right.



From left: Hurling greats Tony Reddin, Jimmy Finn, John Costigan and Editor of Nenagh Guardian, Gerry Slevin.



From left: Eamon Dwyer, Seamus McCarthy with Seanoiri Val Dwyer, Rockwell Rovers and Jim Byron Galtee Rovers and Chairman Of Seanoiri John Moloney.



Some of the Seanoiri who received schrolls at a ceremony in Bru Boru recently; Front (l-r): Willie Walsh, Cappawhite; Mickey Murphy, Cashel; Monsignor Lee, Aherlow; Jimmy Butler Coffey, Newport; Dick Allen, Fethard; Mich Gavin, Commercials. Back: John Moloney, Chairman, Sean Gael Committee; Val Dwyer, Rockwell Rovers; Jim Byron, Galtee Rovers; Joe Mc Donagh, Past President G.A.A.; Tom O'Shea Aherlow; Jimmy Hannon, Lattin; Jimmy Hennessy Kickhams.

Roscrea, Seamus Ó Riain, Moneygall, Son Kelly, Borrisokane, Mick Ryan, Burgess, Jimmy Butler-Coffey, Newport, Tom Gleeson, Silvermines, Tony Reddin, Lorrha, Jimmy Finn, Borrisoleigh, Jimmy Kennedy, Kildangan, Jim Burke, Shannon Rovers.

The presentations were made by Joe McDonagh, past president, CLG. The attendance included Donal Shanahan, chairman, Tipperary Co. Board, Mick Frawley, chairman, County Football Board, Sean Fogarty, vice-chairman, Munster Council and Art Bennett, chairman of Wexford Cumann na Sean Ghael. Unavoidably absent were recipients Bunny Lambe, Willie and Tony Wall, and Fr. Roger Kinane. After the presentations to the recipients, Seamus Ó Riain replied on their behalf.

A presentation was made to Joe McDonagh by John Moloney on behalf of Cumann na Sean Ghael, and the evening ended in appropriate fashion with Sean Nugent, secretary of South Board, leading the gathering in the singing of Slievenamon.

# Golden/Kilfeacle Reunion

## 1952, '53, '54 recalled



*Golden/Kilfeacle 1952 Co U15 Hurling Champions. Front (l to r): James O'Donnell, West Chair; Thos Moloney, Fr Joe Delaney, Liam O'Sullivan, club chair; Arthur Landers, Donie Shanahan, Eamonn Delaney, Babs Keating. Middle: Paddy Ryan (D), Michael O'Connor, John Dalton, John Joe Moloney, Seanie Morrissey, Willie Brennan, Donie Ryan. Back: Pat Duggan, Eddie Dalton, Seán O'Dwyer, Michael Ryan.*



*Golden/Kilfeacle 1953 Co U15 Hurling Champions. Front (l to r): James O'Donnell, West Chair; Thos Moloney, Alice Carroll, Liam O'Sullivan, club chair; Arthur Landers, Donie Shanahan, Eamonn Delaney, Babs Keating. Back: Larry Moloney, Simon Moloney, John Dalton, Packie Morrissey, Seanie Morrissey, Seamus Casey, Jackie McGrath, Willie Brennan, Sean O'Dwyer.*



*Golden/Kilfeacle 1954 Co U15 Hurling Champions. Front (l to r): James O'Donnell, West Chair; Thos Moloney, Fr Joe Delaney, Liam O'Sullivan, club chair; Arthur Landers, Donie Shanahan, co. chair; Gus Scott, Babs Keating, guest. Middle: Dave Hickey, Paddy Boles, Michael O'Connor, John Joe Moloney, Willie Brennan, Michael Ryan. Back: John Currivan, club sec; Billy Hickey, Pat Duggan, Eddie Dalton, Larry Ryan, Eddie Ryan, Thos Butler.*



*At presentation U15 Hurling County Champions three in a row Golden/ Kilfeacle 1952/1953/1954. Front (l to r): Donal Shanahan, Co. Chairman; John Dalton, capt. 1952; Arthur Landers, capt. 1953; Toss Moloney, capt. 1954. Back: James O'Donnell, West Chairman; DJ carr, club treasurer; Liam O'Sullivan, club chairman; John Currivan, club secretary.*

**F**riday 25th April 2003 will be a date that the surviving members of the history making 1952/'53/'54 under 15 Hurling County Champions will talk about for a long time. The players had returned from America, England and all over Ireland for the function which started with Mass in Golden Church followed by a celebration in Dundrum House Hotel. For many it was their first time meeting since their playing days. Many a story was told on the night of the heroic deeds of that era. The guest speaker on the night was Babs Keating. All players were presented with a memento of the night by club chairman Liam O'Sullivan.

# Cahir - Tipperary Senior Football Champions 2003



Back row (left to right): Damien Lonergan, Ger Leahy, Paul Frazer, John Devereaux, Paul Lonergan, James Hyland, Benny Hickey, Davy O'Gorman, Liam O'Gorman, Padraig Hyland, Colm Lonergan, Robbie Costigan, Diarmuid Tarrant, Mark Costigan, Edgar McGrath, Michael Quinn, Edgar McGrath Snr., James McGrath, Pat O'Brien, Patrick Hyland, Liam Shinnick, Jerry Tarrant, Denny Whelan. Front row (left to right): Gavin Berry, Alan O'Connor, Robbie Halley, Sean O'Carroll, Liam Kiely, Gerald O'Gorman, Eamon Hally, Noel O'Gorman, Brian Enright, Colm O'Flaherty, Sarah Divakaran, Michael Maguire, Padraig Whelan, Ciaran O'Flaherty, Gary Morrison, Paddy O'Flaherty, Rebecca Quinn.

# Tipperary Primary Schools G.A.A. Quiz



The Burgess N. S. team that finished in 4th place in the County Final of the Primary Schools GAA Table Quiz in the Park Avenue House, Thurles. Back row (l. to r.): J.C. Ryan, Chairman Co. Bord na nÓg, Liz Howard, Burgess Co. Bord PRO, Liam Hogan, North Bord Youth Officer, Nicholas Moroney, South Bord Youth Officer. Burgess NS team members Front row (l. to r.): Eoin Hogan, Bernadette Darcy, Paddy Looby and Damien Maher.



The Loughmore N. S. 'A' team that finished in 3rd place in the County Final of the Primary Schools GAA Table Quiz in the Park Avenue House, Thurles.

Back row (l. to r.): Andy O'Gorman, Mid Board Youth officer, Aoife Maher, Scorechecker, J.C. Ryan, Chairman Co. Bord na nÓg, Stephen maher, Loughmore NS, Liam Hogan, North Board Youth Officer, Nicholas Moroney, South Board Youth Officer. Loughmore N. S. 'A' team Front row (l. to r.): Cian Hennessy, Willie Eviston, Noel McGrath and Aidan McGrath.



Scoil Ailbhe, Thurles who finished in 5th place in the County Final of the Primary Schools GAA Table Quiz. Back row (l. to r.): Donal Ryan, Scoil Ailbhe, Aoife Maher, Scorechecker, J.C. Ryan, Chairman Co. Bord na nÓg, Liam Hogan, North Board Youth Officer, John Hally, South Board Youth Officer and Jimmy Coppinger, President Mid Bord na nÓg. Scoil Ailbhe, N. S. team Front row (l. to r.): James Morrissey, David Maher, Cian Treacy and Brian Stakelum.



The Knockavilla NS team who finished in 2nd place in the County Final of the Primary Schools GAA Table Quiz. Back row (l. to r.): Aoife Maher, Scorechecker, John Hally, South Board Youth Officer, J.C. Ryan, Chairman Co. Bord na nÓg, Liam Hogan, North Board Youth Officer, Nicholas Moroney, South Board Youth Officer. Knockavilla NS team Front row (l. to r.): Kevin Griffey, Kenneth Horgan, David Kennedy and Shane Heelan.



County Champions - The Moyne NS team who won the County Final of the Primary Schools GAA Table Quiz. Back row (l. to r.): Tom Maher, Scorechecker, John Hally, South Board Youth Officer, J.C. Ryan, Chairman Co. Bord na nÓg, Mairead Lloyd, Moyne, Scorechecker, Aoife Maher, Scorechecker. The Moyne NS team members Front row (l. to r.): Kevin Dunne, James Butler, Diarmuid Fogarty and Matthew Ryan.





# TOOMEVARA

## Tipperary Senior Hurling Champions 2003



*TOOMEVARA — County Senior Champions for the eighth time in twelve years.*

*Back row (l to r): Tommy Carroll, Thomas O'Meara, Cianan Fitzpatrick, Brian McGrath, Andrew Ryan, John Boland, Padraig Blackett, John Killohan, Kevin Cummins, Willie Ryan, Tony Delaney, Terry Dunne, Ken Dunne, Tommy Dunne, Brian Duff, David Kennedy, Eoin Brislane. Front: Paddy O'Brien, Patrick Tuohy, Denis Kelly, Barry Duggie, Benny Duggie, George Frend, Philip Shanshan, Justin Cottrell, Michael Bevans (capt), David Young, John O'Brien, Francis Devaney, Roman Ryan, Ken Hall.*

# Tipperary G.A.A. Convention

## ÁRUS na Sáirséalach, Dúrlas Éile, Nollaig '02



*County Board Officers Elected . . . Back row left to right: John Hally, Youth Officer, Concubhar Ó Riain, Oíficeach na Gaeilge, Con Hogan, Outgoing Chairman, Denis Floyd, Games Development, James O'Donnell, Club Development, John Ryan, Munster Council and Michael Power, Munster Council. Front row left to right: Liz Howard, P.R.O., Spike Nolan, Treasurer, Donal Shanahan, Chairman, Michael O'Brien, Secretary and John Costigan, Vice Chairman*



*County Board Convention . . . Con Hogan hands over to new County Chairman Donal Shanahan.*

# Munster Championship Draws 2004

## Comhairle na Mumhan

### SENIOR HURLING

**1st. Rd.** Clare v Waterford 16/5/04 Replay 22/5 Venue Thurles

**1st. Rd.** Cork v Kerry 16/5/04 Replay 22/5 Venue Cork/Killarney

**Semi-Final** - Limerick v Cork/Kerry 30/5/03 5/6 in Limerick

**Semi-Final** - Tipperary v Clare/Waterford 6/6/04 Replay 12/6 Venue: Pairc Uí Chaoimh/Limerick

**Final** - 27/6/04 **Replay** - 3/7

### SENIOR FOOTBALL

**First Round** - Clare v Kerry 23/5/04 **Replay** - 29/5 at Ennis

**First Round** - Tipperary v Limerick 16/5/04 22/5 Pairc Uí Chaoimh

**Semi-Final** - Cork v Clare/Kerry 13/6/04

20/6 at Killarney/Ennis

**Semi-Final** - Waterford v Tipperary/Limerick 13/6/04 **Replay** - 20/6 at Fermoy/Limerick

**Final** - 11/7/04 **Replay** - 17/7

### MUNSTER U-21 HURLING CHAMPIONSHIP

**First Round** - A. Tipperary Bye, B. Limerick v Kerry, C. Waterford Bye, P. Clare v Cork

**Semi-Finals** - A v B C v D

### MUNSTER U-21 FOOTBALL

**First Round** - A. Cork Bye, B. Tipperary v Limerick, C. Waterford Bye, D. Clare v Kerry

**Semi-Finals** - A v B C v D

### MINOR HURLING CHAMPIONSHIP

**First Round** - Clare v Tipperary, Kerry v Limerick, Cork v Waterford

3 Losers play knockout for 4th.Semi-Final spot. Open Draw for Semi-Finals.

### MINOR FOOTBALL CHAMPIONSHIP

**First Round** - Clare v Kerry, Tipperary v Limerick, Cork v Waterford

3 Losers play knockout for 4th.Semi-Final spot. Open Draw for Semi-Finals.

### McGRATH CUP.

**Semi-Finals** - Clare v Tipperary 18/01/04 extra time

Waterford v Limerick 18/01/04 extra time

**Final** - 25/01/04

*Le gach dea - ghuí agus chomhgháird-eachas do Choiste Chontae Thiobraid Árann ó Chomhairle na Mumhan.*

# Réiteoirí Thíobraid Árann



Noel Cosgrave receives his County Final Medal from County Board Secretary Michael O'Brien at The Referees Convention in Sarsfields Centre, Thurles. Also pictured is Michael Cahill, North Tipp, Referees Chairman and John Lonergan Tipperary Referees Secretary.

The Referees Convention at Sarsfields Centre, Thurles. Back row left to right: Willie Robinson, Seamus Mullins, John Bannon, Brian Tyrell, Willie Clohessy, Brian White. Front row left to right: Paddy Russell, Michael O'Brien, County Board Secretary, Dickie Murphy (Guest Speaker), Willie Barrett and John Lonergan, Referees Secretary.



Pictured at The Referees Convention in the Sarsfields Centre, Thurles are, back row from left to right: Noel Cosgrave, Christy Aylward, Padraig Ryan, John Bannon, special guest, Brian White, John Morrissey, Seamus Roche. Front row from left to right: Derek O'Mahony, Seamus Mullins, Steve McCormack, Donie Cahill, Dickie Murphy, guest and Willie Barrett.



Mid and North referees pictured at the GAA Convention in the Sarsfields Centre, Thurles where they received gear for the 2003 season. Back row from left to right: J.P. O' Sullivan, Richard O'Connor, Phil Ryan, Eamon Browne, John Bannon, guest referee, Brian O'Reilly, Billy Ryan and Stephen Egan. Front row from left to right: Tommy Ryan, Paddy Russell, John Ryan, P.J. Hewitt, Michael Cahill, Dickie Murphy, guest referee and P.J. Leahy.



John Ryan, Boherlahan is presented with Referees Gear by County Board Secretary Michael O'Brien and John Lonergan Tipperary Referees Secretary.

# Tipperary top 2003 All-Star Charts

All-Star awards were given out in 4 GAA sports in the last 2 weeks – Camogie, Gaelic Football, Hurling and Ladies Football.

Tipperary won 9 All-Star awards in total, more than any other county.

In Camogie, Tipperary topped the chart with 7 All-Stars.

Jovita Delaney, Una O'Dwyer, Ciara Gaynor, Therese Brophy, Claire Grogan, Emer McDonnell and Deirdre Hughes were the Camogie recipients. Goalkeeper Brendan Cummins won his 3rd Hurling All-Star in 4 years while Declan Browne won his 2nd Football All-Star award.

Congratulations to one and all.

In addition, Emer McDonnell of Burgess and Tipperary won the prestigious Texaco award for Camogie in 2003. This was the first such award for Camogie since the legendary Angela Downey of Kilkenny won back in the 1980s.

Another prestigious award went to Una O'Dwyer of Cashel and Tipperary who was awarded with the "Irish Tatler Sports Woman of the Year Award".



# County Champions 2002

*These finals were played too late for inclusion in last year's yearbook.*



*JK Brackens - Mid and County U21 'B' Hurling Champions 2002. Back row l to r: Mick Keely (selector), Michael Lynagh, Kevin Fitzgerald, Paul Guider, Pádraig Maher, Brendan Corcoran, Tommy Deegan, Lorcan Egan, Aidan Farrelly, John Bourke, Pat Egan, Michael Corcoran (selector), John Ivers (selector). Front row l to r: Philip Ryan, James Moore, Tommy Kennedy, Ian Delaney, Kevin Mulryan, Aidan Ivers, Paul O'Brien, Daniel Maher, Peter Maher, Peter Bourke.*



*Kickhams Co. I.F. Champions - 2002. Front l to r: Pat Ryan, Richard Hogan, Damien McGrath, Kevin Farrell, Johnny Butler, Brian Horgan, Aidan Butler, Vinny Kelly, Ger Butler, Aidan Murphy, Owen Morrissey. Back l to r: Willie Crowe, Gerry Cahill, Paul Morrissey, Declan Hogan, Fergal O'Brien, Noel O'Brien, Derek Breen, Alan Horgan, Paul Breen, Aidan Heney, John McCormack, Jimmy Farrell, Tony Farrell, Donie O'Brien.*



*Thurles Sarsfields - Mid and County U21 'A' Champions 2002. The Thurles Sarsfields panel that won the county under-21 'A' hurling championship title by defeating Burgess by the narrowest of margins at Dolla. Back row l to r: Richie Ruth, Tom King, Paul Dwyer-Darcy, Brian O'Loughlin, Philip Hayes, Wayne Culley, Eoin Costello, Barry O'Dwyer, Colm O'Rourke, Lar Corbett, Jamie Murphy, Eamonn Tuohy, Tony Connolly, Barry McLoughlin, Colm Duggan. Front row: Brian Graydon, Aidan Dundon, Stephen Mason, Brendan O'Sullivan, John Lillis, Lee Shanahan, Patrick McCormack, David O'Dwyer, Willie Collins, Tony Ruth (captain), Eamonn Gleeson, Kieran O'Connor.*



*Upperchurch, Drumbane Junior 'B' Football Panel - Mid and County Champions 2002. Back row l to r: Michael McCormack (Masseur), Pakie Phelan (Selector), L.T. Ryan, Alan Tierney, Rody Lowry (Selector), David Carey, Pádraig Bourke, Paddy Brennan, Michael Ryan, Tody Brennan, Timmy Ryan, Gerry Ryan, John Carey, Pádraig Hayes, Niall Ryan, John Ryan, John Quinn. Front: Michael O'Dwyer, Donal Carey, Conor O'Dwyer, Brian Phelan, Owen Shortt, Pat Shortt, Gerry Ryan (Captain), Andy Kinane, Colm Kennedy, Jerry Quinn, Seamus Griffin, Patsy Ralph (Selectors), Walter Moloney (Trainer).*

# COMHAIRLE NA MUMHAN



Munster Council Awards December 2002 . . . Presentation to Editors of Munster Council History, Updated. From left to right are Seamus King, Tipperary, Christy Cooney, Council Chairman, Jim Cronin, Cork and Fr. Seamus Gardiner, Tipperary.

Munster Council Grant Presentation to Moycarkey Pipe Band in Thurles. From left to right are Billy Sweeney, Ger Neville, Sean Fogarty, Vice Chairman Munster Council, Christy Cooney Chairman Munster Council, Billy Foley and Andrew Cooney.



Munster Council Presentations to Babs Keating (Football Hall of Fame), Michael Forrestial (Distinguished Service to Schools) and Gerry Slevin (Media Award).

Pictured at Presentation of Coaching Certificates by Munster Council were front row left to right: Paudie Butler, Muiris O'Suilleabhain, Christy Cooney, Pdraig Duffy and Sean Fogarty. Back row left to right: John Burns, Sandra Molloy and Pat McCormack.



# MUNSTER COUNCIL 2003



# Vodafone Awards

Above: Vodafone Director of Communications, Tara Delaney, presents the Vodafone GAA All Stars Players of the month for August to Brendan Cummins, centre, Tipperary hurling, and Tyrone football Mickey Harte, accepting the award on behalf of Brian Dooher, Westin Hotel, Dublin, September 2003.

Right: Tipperary hurler, Eoin Kelly, right, and Laois footballer Padraig Clancy have been named as Vodafone GAA All Stars Player of the Month for March, 2003.

Below: Christina Heffernan, Mayo football and Eimear McDonnell, right, Tipperary camogie, pictured after winning the Vodafone GAA Player of Year Awards, Westin Hotel, Dublin, November 2003.  
Photos: Sportsfile EDI



# Mid Tipperary G.A.A. Convention December 2002



Officers photographed following the Mid Senior GAA Board's Annual Convention held in Drombane Hall. Seated (l to r): Pat Gleeson, vice-chairman; Bob Stakelum, president; Michael Bourke, outgoing chairman; John Doyle, incoming chairman; Mattie Connolly, secretary; Tom Maher, treasurer; PJ Leahy, PRO. Standing: Pat Cullen Co Board trustee; Jim Max, Thurles Sportsfield rep; John McLoughney, mid referees co-ordinator; Michael Egan, assistant treasurer; PJ Maher, vice-chairman; Jonathan Cullen, youth officer; Batt O'Dea, gate checker; John O'Donovan, assistant secretary; Con Hogan, outgoing Co Board chairman.



Members of Upperchurch-Drombane GAA Club who organised the holding of the Mid Senior Board's Annual Convention in Drombane Hall, photographed with Johnny Doyle (front, third from right) who was elected to the position of chairman at the Convention.



Moyne-Templetoohy delegates in Drombane Hall for the Mid Board's Annual Convention. Seated (l to r): Aine Maher, Willie Fogarty, Lorna Leahy, Tom Maher. Standing: Con Costigan, PJ Leahy, Tom Flynn.

Rahealty-Kickhams delegates in Drombane Hall for the Annual Convention of the Mid Senior Board. Seated (l to r): Jimmy Breen, Larry Kavanagh, Paddy Campion. Standing: John O'Donovan, John Kelly, Denis Curtis, Kevin Bannon.



Michael Bourke, outgoing Mid Senior Board Chairman (left) making a presentation of a cheque to JC Ryan, chairman of Mid Bord na nÓg, at the Senior Board's Convention. The cheque was presented to help defray the costs involved in running Mid Bord na nÓg affairs. JC was subsequently elected as chairman of Co Bord na nÓg at its annual convention.



# Presentations, Celebrations and other Social Events

By Liz Howard

The trophy cupboards were not entirely bare in 2002, the minor and intermediate hurlers captured Munster honours and a number of players were recognised at various levels for outstanding individual display. I was pleased to be present at a number of such events, and involved in the organisation of some.

The minor and intermediate hurlers of 2002 were presented with their Munster and All-Ireland runner-up medals at a presentation dinner in the Templemore Arms in February. The minors had won the Munster championship for the second successive year but fell to Kilkenny in the All-Ireland final. The intermediate players had forced a draw against Galway in the final but lost out in the replay.

It was a lovely occasion as players and mentors relaxed and enjoyed the evening. Both teams had given great value during their respective championships. County Chairman Donal Shanahan presented the medals and I was honoured to introduce the players. Donal congratulated the hurlers on winning Munster titles and expressed his regret that All Ireland honours eluded both teams. He thanked them and the team management for their commitment and hard work during the year. He also presented both sets of selectors with a memento. Minor team manager Paddy McCormack spoke on behalf of his fellow selectors, Jamesie Ivors, Vincent McKenna and Philip Ryan. Liam Sheedy spoke on behalf of the Intermediate selectors, Toby Moran, Tom O'Donnell and Michael Grogan. While they were pleased to win the Munster championship he spoke of the disappointment in not winning All Ireland honours.

The achievements of the senior team management 1999-2002, Nicky English, Ken Hogan and Jack Bergin were honoured at a gala dinner in Dundrum House Hotel. Their respective wives, Ann, Joan and Bernie and members of their families accompanied them. A number of the senior hurlers attended. It was a relaxed sociable evening but tinged with regret in that it signalled the end of an era. The main sponsor of the event was Enfer Scientific, sponsors of Tipperary hurling and football teams. Enfer was represented by members of the Ronan family, Michael Murphy and Michael "Buddy"



Nicky is Magic . . . Donal Shanahan (Co. Chairman), presents Nicky English with his portrait in Dundrum House Hotel.



Tipperary Minor Selectors and Co. Board Selectors . . . Back row (l. to r.): John Costigan, Donal Shanahan, Michael O'Brien and Liz Howard. Front row (l. to r.): Vincent McKenna, Paddy McCormack (manager), Jamesie Ivors and Philip Ryan.

Fitzgerald (of football fame). The management and staff of Dundrum House Hotel pulled out all the stops to add to the evening. Brian Fox produced a lovely video tribute to Nicky, Ken and Jack, while Fran Curry and his band encouraged those who enjoy 'tripping the light fantastic' on to the dance floor.

Renowned Wexford based artist, Anne Farrell, was commissioned to paint portraits of Nicky, Jack and Ken. Anne, who is originally from England, has lived in Ireland for some years. She fell in love with the grace and beauty of hurling and has produced a number of portraits capturing hurling stars in action. Included among her works are Thomas Dunne, DJ Carey and Colm Bonnar. The portraits are a wonderful example of her work and all three recipients were delighted with them. Donal Shanahan paid tribute to the trio particularly in relation to 2001 when Tipperary senior hurlers swept the decks winning the Allianz National League, the Munster championship and the All-Ireland title. Thomas Dunne and Brian O'Meara made a presentation on behalf of the players and paid tribute to Nicky, Ken and Jack. Both were impressive showing again what great ambassadors they are for Tipperary and hurling.

Nicky, Ken and Jack spoke with humour, and a little nostalgia about their term, expressing how honoured they were to be entrusted with the job of managing Tipperary



Celebrating Victory. . . Donal Shanahan presents Jack Bergin with his portrait in Dundrum House Hotel.

senior hurling. They enjoyed working together. They paid tribute to the calibre of the players, both as people and hurlers. They deserved success, they thanked Jim Kilty, Dr. Peter Murchen, Dr. Gerry Sullivan, Pauline Fanning, John "Hotpoint" Hayes, Tom O'Donnell and Noel Ryan, the county board, Enfer Scientific, the Supporters Club and all who had supported them during their tenure. They acknowledged the supportive role paid by their wives, Ann English, Joan Hogan and Bernie Bergin who were presented with flowers. It would be remiss not to mention Ken and Jack, who with Colm Bonnar are now back at the helm of Tipperary senior hurling. Nicky too has a role, taking the Dublin based players for training once a week during the coming months. We wish them well.

The Credit Unions sponsorship of the Tipperary hurling and football championships was launched after a meeting of county board. All the Credit Unions were represented and the personable Brendan Wright spoke on their behalf. This is an excellent partnership and reflects the voluntary ethos of both the Credit Union movement and the GAA. Apart from the members of county committee a number of players attended, including Ky Vaughan, Brian O'Meara, Philly Ryan and Fergal O'Callaghan from the county hurling and football champions of 2002 senior team managers, Tom McGlinchey and



Donal Shanahan (Co. Chairman), presents Ken Hogan with his portrait in Dundrum House Hotel.

Michael Doyle also attended. The Tipperary Association honoured John Leahy as Tipperary Person of the Year 2002 a most popular choice, which reflected in the big attendance at the presentation dinner in the Red Cow Hotel in Dublin. One of the outstanding hurlers of his era John had managed Mullinahone to their first ever, senior Tipperary championship in 2002. His mother Stella, his siblings and extended family were present to see him presented with his award, a Jarlath Daly sculpture. The same Jarlath is President of the Tipps in Dublin. John was also supported on the night by the GAA in his club and Tipperary in general. The Tipperary Association had also hosted a dinner for the minor hurlers on All Ireland evening. Despite defeat players and mentors were gracious and enjoyed the evening. Footballer par excellence, Declan Browne, received the prestigious Canon Hayes County Award, a fitting tribute to this wonderful player. The Canon Hayes Awards night is always most enjoyable, beautifully presented and an eclectic mix of sports people from local to national level. Long may it continue!

Vodafone honoured three Tipperary players during the year, Eoin Kelly, Brendan Cummins and Eimear McDonnell. All three had produced outstanding displays to capture this much-valued award. Vodafone hosted lunch on each occasion in the elegant Westin Hotel, a nice opportunity to meet their families, friends and football counterparts, as well as Vodafone PR man, Enda Lynch from Kerry, and well-known journalist Donal Keenan.

The Tipperary Supporters Club hosted a Night at the dogs in Harolds Cross. No standing at the rails in freezing cold! Instead we dined in comfort as we watched proceedings overlooking the track. It was a fun night, good company and a few winners helped. Hurlers, Paul Ormonde, Paul Kelly and Thomas Dunne, county chairman, Donal Shanahan, and county secretary, Michael O'Brien, were guests. Some good tips were given by Micheal O'Muircheartaigh, other winning choices sheer inspiration! Another Supporters Club initiative was a Quiz Night in Rody Boland's. Well organised, a great crowd, lovely prizes and a super atmosphere made it most enjoyable. Matt Gleeson, John Coman, Danny O'Connell and Mick Hurlev organised the

Quiz. I have to mention Tipperary Institute's hosting of the Fitzgibbon and Ryan Cup and the pre-final dinner. Like everything they organise in TI, it was superb. Mark O'Leary was in flying form as TI won the Ryan Cup and Thomas Dunne was part of the back-room team. Mullinahone and Tipperary star, Paul Curran, led Waterford Institute to another Fitzgibbon cup victory. He too had a great game.

Two events, which I particularly enjoyed last year, were the North Tipperary juvenile presentation night in the Western Pass and the Primary Schools' County Quiz, in the Park Avenue. Ann McGrath, secretary North Tipperary Board, and John Hally, county youth officer, and the divisional youth officers were the organisers. It is always lovely to meet the younger brigade, full of life, opinions and chat. These occasions develop their life skills as well as being enjoyable.

I missed the AIB Club of the Year, was in Australia and New Zealand. Good to see my own club, Burgess, win county and Munster titles. The social side of the GAA is an important element as it gives people the opportunity to meet in a more relaxed atmosphere. The Galway county board hosted pre and post match receptions when Tipperary and Galway met in Pearse Park in Galway. The Galway and Tipperary players had the opportunity to get together after the game. There was great chat and both teams



*That's My Boy . . . Tipperary Person of the year 2002 John Leahy with his mother Stella.*

appreciated it. The Tipperary county board hosted a corporate lunch in Croke Park on All-Ireland semi-final day. For once I was able to relax and enjoy my lunch and leave the running around to others! Always look on the bright side!



*Tipperary Intermediate selectors 2002 . . . (l.to r.): Liam Sheedy (manager), Tony O'Donnell, Michael Grogan, Toby Moran at presentation function in Templemore Arms.*



*Presentation to outgoing Senior Hurling Selectors. . . Tommy Dunne, Nicky English, Paul Ormond, Jack Bergin, Brian O'Meara, Ken Hogan.*

# County Bord na nÓg 2003

**Garda Cup** - The Garda Cup U/16 inter-divisional hurling competition was commenced in early March to help divisions get ready for the Munster championship.

After the divisions played one another Mid and South qualified for the cup final, which was won by the Mid, 2-12 to 1-13. In the shield final North Tipp defeated the West by 2-11 to 0-14.

We are grateful to the Gardai of Tipperary for their sponsorship of this competition over the years.

**Peil na nÓg** - In the semi-finals played in Dr Morris Park, Thurles, Clonmel Commercial overcame Kilruane McDonaghs, 1-6 to 0-6, and Arravale Rovers defeated Dúrlas Óg, 2-3 to 2-1. Commercial defeated Arravale Rovers in the final at New Inn.

Clonmel Commercial went on to represent Tipperary in the national Feile finals at Galway

**Feile na nGael** - In the first semi-final played at Drombane, Dúrlas Óg defeated Kickams. In the second semi-final Nenagh Eire Óg defeated Moyle Rovers.

In the final Dúrlas Óg overcame Nenagh Eire Óg, and went on to represent Tipperary with distinction in the Feile finals, which were held this year in Kildare Meath and Westmeath.

**Feile Skills** - The Feile skills final was won by Kieran Lorrigan of the Moyle Rovers club. He also went on to represent Tipperary in the skills finals, which are held annually in conjunction with the Feile na nGael tournament. The finals were held in Cusack Park, Mullingar.

**Puck Fada** - The Puck Fada competition was won by: Cian Tucker (Nenagh Eire Óg).

**U/12 'A' Football** - In the first semi-final, played at New Inn, Arravale Rovers defeated Loughmore/Castleiney, while Cahir defeated Nenagh Eire Óg 1-10 to 1-0.

The final was played a week later at Semple Stadium. Cahir overcame Arravale Rovers by 2-12 to 0-2.

**U/12 'B' Football** - In the first semi-final Newport defeated Kilsheelan/Kilcash, while Galtee Rovers overcame Holycross after a close game.

In the final Newport defeated Galtee Rovers by 2-3 to 1-3.

**U/12 'C' Football** - In the first semi-final Clonakenny defeated Emly, while Borrisoleigh defeated St. Martin's, Marlfield in a replay. In the final played at Semple Stadium Borrisoleigh defeated Clonakenny.

**U/14 'A' Football** - In the first semi-final Nenagh Eire Óg beat Clonmel Commercial, while in the second semi-final Dúrlas Óg defeated Arravale Rovers.

In the final played in Semple Stadium Dúrlas Óg overcame Nenagh Eire Óg after a close game by 1-4 to 0-5.

**U/14 'B' Football** - In the semi-finals Cahir defeated Borrisoleigh and Upperchurch-Drombane defeated Clonoulty/Rossmore after a close game. In the final Cahir defeated Upperchurch/Drombane.

**U/14 'C' Football** - In the semi-finals Clonakenny overcame Sean Treacys, while Ballyporeen defeated Newport. In the final, played at Semple Stadium, Ballyporeen overcame Clonakenny by 3-11 to 2-8.

**U/16 'A' Football** - In the semi-finals Moyle Rovers overcame Inane Rovers after a close game, and Arravale Rovers overcame Moycarkey/Borris. In the final Moyle Rovers defeated Arravale Rovers on the score of 3-7 to 2-9

**U/16 'B' Football** - In the semi-finals Killenaule defeated Shannon Rovers while Cappawhite defeated Boherlahan/Dualla. In the final played at Semple Stadium, Killenaule defeated Cappawhite by 3-10 to 1-7.

**U/16 'C' Football** - In the semi-finals Clonakenny overcame Solohead while Ballinahinch overcame St Martins/Marlfield

after a close game. In the final played at Dolla, Ballinahinch beat Clonakenny.

**U/12 'A' Hurling** - In the semi-finals Nenagh Eire Óg defeated Clonmel Óg while Clonoulty/Rossmore defeated Loughmore/Castleiney. The final, which was played at Semple Stadium, was won impressively by Clonoulty/Rossmore, who defeated Nenagh Eire Óg by 4-4 to 1-3.

**U/12 'B' Hurling** - In the semi-finals Templederry defeated Ballybacon/Grange after extra time, and J. K. Brackens defeated Eire-Óg Annacarty. In the final, played at Semple Stadium, J K Brackens and Templederry drew, 4-7 to 5-4. In the replay, after a wonderful game, J K Brackens were victorious by the narrowest of margins, 1-6 to 1-5.

**U/12 'C' Hurling** - In the semi-finals St Patrick's (Drangan/Cloonen) defeated Shannon Rovers while Moycarkey Borris (B) defeated Solohead. The final, which was also played at Semple Stadium, was won by Moycarkey/Borris (B) by 4-2 to 2-5 for St. Patrick's.

When St. Patrick's questioned the legality of the Moycarkey team, Moycarkey withdrew from the competition, and St Patrick's and Solohead replayed the final, which was won by St. Patrick's 3-10 to 2-3.

**U/14 'A' Hurling** - In the semi-finals Nenagh Eire Óg defeated Ballingarry, while Dúrlas Óg defeated Kickhams. The final between old rivals Nenagh and Dúrlas Óg ended all square after a fine game. Nenagh won the replay by 3-7 to 1-6.

**U/14 'B' Hurling** - In the semi-finals Borrisoleigh defeated Kilsheelan/Kilcash and Boherlahan/Dualla overcame Cappawhite. In the final Borrisoleigh defeated Boherlahan/Dualla by 3-6 to 2-2.

**U/14 'C' Hurling** - In the semi-finals Dúrlas Óg B defeated Sean Treacys, while Newport defeated Newcastle. In the final Borrisoleigh beat Dúrlas Óg B by 7-10 to 1-3.

**U/16 'A' Hurling** - In the semi-finals Dúrlas Óg defeated Clonoulty/Rossmore 0-18 to 0-7, and Carrick Swans defeated Toomevara 0-13 to 0-3.

In the final, played at Leahy Park, Cashel Carrick Swan defeated Dúrlas Óg to win their first final in this grade, by 1-8 to 1-6.

**U/16 'B' Hurling** - In the semi-finals St. Patrick's (Drangan/Cloonen) defeated Templederry, while Moyne/Templetouhy defeated Aherlow. In the final St Patrick's defeated Moyne/Templetouhy by 4-18 to 3-7 to win their first final.

**U/16 'C' Hurling** - In the semi-finals Eire Óg/Anacarty defeated Clonakenny, while Borrisokane defeated Newcastle. In the final Borrisokane defeated Eire Óg/Anacarty by 1-12 to 1-7.

## TOURNAMENTS

**Jim Power Memorial U/14 Football** - This tournament is held annually in Waterford. The teams competing were Tipperary, Waterford, Limerick and Clare.

In the semi-finals Tipperary defeated Waterford 3-7 to 1-7, while Limerick defeated Clare. In the final Limerick defeated Tipperary by 2-3 to 0-6.

**U/15 Football** - Congratulations to all concerned in winning this tournament in Cork. The panel were as follows: Liam Ryan (Holycross/B), Shane Touhy, (Portroe), Paul Ryan (Arravale Rvs), Barry Molloy, (Moyle Rvs), Robert Harrington (Newport), Keith Quigley (Burgess), Thomas Stapleton (Templederry/K), Fergal Ryan (Boherlahan/D), Paul Fitzgerald (Cappawhite), Brian Jones (Arravale Rvs), Tony Dunne (Burgess), Thomas Grace (Ballinahinch), Mathew O'Donnell (Killanaule), Rody O'Dwyer (Golden/K), Joe Fletcher (Kildangan), Colum Gleeson (Portroe), Timmy Dalton (Arravale Rvs), Daniel Lyne (Moyle Rvs), Brian O'Sullivan (Newport), Jamie Flynn (Ballinahinch), Chris Aylward (Clonmel Óg), Cathal Dillon (Aher-

low), Seamie Ryan (Sean Treacys), Michael Doyle (Killenaule), Damian McCormack (St Patrick's/D), Justin Conroy (Portroe), Brendan Walsh, (Ardfinnan).

Mentors: Philip Kelly (North), Neil Ryan (Mid), Tom Fitzgerald (West), Tony Doyle (South).

**U/16 Football** - Congratulations to all concerned on a fine display in winning the Munster U/16 football shield, beating Waterford by 3-6 to 1-6 in the final. The panel was: Mark Tobin (Clonmel Commercials), Kevin Hearney (Clonmel Commercials), Andrew O'Halloran (Galtee Rvs), Tony Ryan (Ardfinnan), William O'Dwyer (Carrick Davins), Donal Lyne (Moyle Rvs), Connor Morrissey (Clonmel Óg), Cormac Molloy (Arravale Rvs), Kevin O'Callaghan (Clonmel Commercials), Timmy Dalton (Arravale Rvs), Kieran McGrath (Loughmore/C), George Hannigan (Shannon Rvs), David Maher (Moycarkey/B), Michael Hogan (Silvermines), Trevor Kennealey (Nenagh Eire Óg), Rory O'Connor (Boherlahan/D), John Hennessey (Aherlow), Evan Hunt (Boherlahan/D), Connor Quinlan (Moyn/T), Tom Hassett (Moyn-Templeouhy), Sean O'Donoghue (Clonmel Óg), Robert Ryan (Grangemockler), Tom O'Donnell (Cahir), David Lonergan (Ardfinnan), Rody O'Dwyer (Golden/K).

**Tony Forristal U/14 Hurling Tournament** - The Tipperary U/14 hurlers had no success when they contested the annual Tony Forristal inter-county hurling tournament, held at Waterford at the end of August.

They were defeated by Limerick and Galway

**Carrigadhaun U/15 Hurling Tournament** - Our U/15 hurlers suffered a similar fate in the Carrigadhaun Tournament, having been defeated by Limerick and Cork.

**Nenagh Co-op Inter Co U/16 Hurling Tournament** - Tipperary Bord na nÓg is grateful once more to Nenagh Co-op for their continued sponsorship of the U/16 Inter-County Hurling Tournament.

This year there was a change of format with two teams coming out of each group.

The winner of the group played in the A semi-final, and the second group team playing in the Plate semi-final

This year twelve teams entered, with Meath entering for the first time. The competition got under way on August 30.

**Round Robin Games** - Dr Morris Park. Galway 3-14 Waterford 1-3, Galway 2-10, Tipperary 1-7, Tipperary 2-19 Waterford 1-5.

Galway were group winners with Tipperary in runners-up spot.

**The Ragg** - Limerick 2-7 Cork 2-7, Limerick 3-9 Kilkenny 5-7, Cork 3-6 Kilkenny 1-6. Cork were group winners with Kilkenny in runners-up spot.

**Sarsfields Ground** - Wexford 2-19 Laois 3-12 after extra time, Meath failed to field a team. Wexford were winners of the group with Laois in runners-up spot

**Borrisoleigh** - Dublin 2-6 Offaly 2-4, Dublin 0-11 Clare 3-14, Clare 4-10 Offaly 2-4.

Clare emerged as group winners with Dublin in second spot.

The A semi-final resulted as follows: Wexford defeated Cork and Galway defeated Clare. The C semi-final Kilkenny defeated Laois and Tipperary defeated Dublin.

A final Galway V Wexford. B final Cork V Clare. C Final Tipperary V Kilkenny

A & B finals to be played in Nenagh on Sunday August 31st in the Shield final Cork defeated Clare 4-11 to 2-10.

In the Nenagh co-op final Galway and Wexford drew after extra time. The replay was played at Semple Stadium on Sunday October 5th. Another great game was served up, which Galway won 2-18 to Wexford 2-12.

The C final was not played until Saturday November 1st. Tipperary had a convincing victory over old rivals Kilkenny by 6-17 to 1-5.

We are indebted once more to Nenagh co-op for their sponsorship, to the management and staff of the Park Avenue Hotel, Thurles for providing most the catering on Saturday August 30th, and to the Patrick Sarsfield Restaurant, Nenagh a special thank you for providing the meal preceding the after-match presentations on the day of the drawn game.

**Buiochas** - I would like to thank my fellow officers and members of the board for their co-operation and dedication to their work during the year. I should also like to thank the divisional boards, the referees, the gate checkers, park committees and above all the supporters, who came along to the games. Sincere gratitude is also offered to the players who gave us so many fine games during the year.

A special word of thanks to the Tipperary Star, the Nenagh Guardian, the Nationalist, and also the local radio stations for their coverage of our games.

*Padraig De Nogla, Runai.*

## Co Bord na nÓg Results at a Glance 2003

GRADE	WINNER	RUNNER-UP	VENUE	REFEREE
U/12 A Football	Cahir 2-12	Arravale Rovers 0-2	Semple Stadium	Patsy Ralph.
U/12 B Football	Newport 2-3	Galtee Rovers 1-3	Semple Stadium	Micheal McCormack.
U/12 C Football	Borrisoleigh	6-6 Clonakenny 1-2	Semple Stadium	Philly Ryan.
U/14 A Football	Dúrlas Óg 1-4	Nenagh Eire Óg 0-5	Semple Stadium	Paddy Russell.
14 B Football	Cahir 5-12	Upperchurch/D 0-2	Semple Stadium	Sean Bradshaw.
U/14 C Football	Ballyporeen 3-11	Clonakenny 2-8	Semple Stadium	Tom Butler.
U/16 A Football	Moyle Rovers 3-7	Arravale Rovers 2-9	Semple Stadium	Collins
U/16 C Football	Ballinahinch 3-6	Clonakenny 0-7	Semple Stadium	Philly Ryan.
U/12 A Hurling	Clonoulty/R 4-4	Nenagh Eire Og 1-3	Semple Stadium	Ml Jordan.
U/12 B Hurling	J K Brackens 4-7	Templederry 5-4	Semple Stadium	Liam O Dwyer.
Replay	J.K.Brackens 1-6	Templederry 1-5	Semple Stadium	John Cahill
U/12 C Hurling	St Patrick's 3-10	Solohead 2-3	Semple Stadium	Patsy Ralph
U/14 A Hurling	Nenagh Eire Óg 2-9	Dúrlas Óg 3-6	Holycross	Noel Cosgrove
Replay	Nenagh Eire Óg 3-7	Dúrlas Óg 1-6	Holycross	B Tyrell
U 14 B Hurling	Borrisoleigh 3-6	Boherlahan 2-2	Holycross	W Kennedy
U/14 C Hurling	Newport 7-10	Dúrlas Óg 1-3	Holycross	Tommy Fitzgerald
U/16 A Hurling	Carrick Swan 1-8	Dúrlas Óg 1-6	Cashel	Paddy Russell
U/16 B Hurling	St Patricks /D 4-18	Moyn/T 3-7	Holycross	Tommy Fitzgerald.
U/16 C	Borrisokane 1-12	Eire Og/A 1-7	Holycross	Denis Curtis
Arrabawn Co-op final:	Galway 4-17	Wexford 4-17	Aet	R O Conner(Tipp)
Replay	Galway 2-18	Wexford 2-12		J Sweeney (Tipp)
Arrabawn co-op Shield	Cork 4-11	Clare 2-10		J Sweeney (Tipp)
Arrabawn Co-op Plate	Tipperary 6-19	Kilkenny 1-7		P Delaney (Laois)
Jim Power Memorial (Waterford)	Tipperary 0-6	Limerick 2-3		
Friends of Tipperary	U/16 Football Final	South Tipp 2-15	West Tipp 0-8	
	Shield Final	Mid Tipperary	bt	North Tipp

## Co. Bord na nÓg Officers 2003

Chairman:	J C. Ryan	(Upperchurch/Drombane)
Secretary:	Paddy Nagle	(Carrick-on -Suir)
Treasurer:	Frank Morris	(J. K. Brackens)
P.R.O. :	Richard Sheehan	(Mullinahone)
Rep to Senior Board:	Jim Lynch	(Cahir)

### Divisional Board Representatives on Co Board Na nOg 2003.

Mid:	Joe Moran, Neil Ryan, John Smith, Martin Tracey.
West :	Liaim O'Dwyer, Gerry Beary, Richard O'Connor, Tommy Fitzgerald.
South:	Michael Lonergan Liam Bolger, Christy Aylward. Martin Cody.
North:	Sean Creamer, Ann McGrath, Gerry O'Flynn, Sheila Delaney.

# MICK PRIOR Memorial Tournament

**T**his tournament is held annually to commemorate the late Mick Prior.

Mick had a great interest in the GAA and in everything Irish, and did trojan work promoting hurling, especially juvenile hurling in Borrisoligh and in County Tipperary generally. He also held various official positions in the club and at divisional board level.

This year the Prior family presented a new cup for this event (The Mick Prior Memorial Cup) and Paddy Prior brother of Mick, presented the cup to the victorious Loughmore-Castleiney team which defeated Moyne-Templetuohy in the final.



Mick Prior's Brother, Paddy, presents the cup to Loughmore-Castleiney captain - T. McGrath.



Loughmore-Castleiney team that won the Mick Prior Trophy 2003... Back l-r: Aoife McGrath, Trisha McGrath, Cian O'Riain Broin, Niamh Ryan, Joseph Nyland, Joseph Hennessy, Darragh Butler, Aaron Sweeney, Craig Cleary, Paul Morris, Lorcan Egan, Patrick Nolan, Padraic Hennessy, Andrew Cummins, Brian McGrath and Daniel Tormey. Front l-r: Edel Nyland, Rionn O'Rioin Broin, Kevin O'Connell, David Ryan, Richard Maher, John McGrath, Robert O'Connell, Liam McGrath, Dennis O'Brien, Mark Butler, Denis Brereton, Thomas Maher, Keith Marton, Peter Nyland, Joseph Hayden and John Connolly. Team managers: Jimmy Sweeney and Eamonn Sweeney.

## North Bord na nÓg Results (Football)

<b>U-12 'A'</b>	Toomevara	2-2	Burgess	1-1	<b>U-14 'B'</b>	Kildangan	1-2	Ballina	3-1
<b>Semi-finals</b>	Nenagh Éire Óg	5-12	Roscrea	1-1	<b>Semi-finals</b>	Lorrha	0-1	Borris-Ileigh	3-3
<b>Final</b>	Nenagh Éire Óg	3-9	Toomevara	4-2	<b>Final</b>	Borris-Ileigh	3-3	Ballina	0-1
<b>U-12 'A'</b>	Nenagh	3-3	Inane	1-3	<b>U-14 'C'</b>	Newport	4-6	Templederry	1-4
<b>Semi-finals</b>	Kilruane	3-1	Burgess	2-5	<b>Semi-finals</b>	Portroe	2-10	S/Rovers	1-4
<b>Final</b>	Nenagh	4-5	Burgess	0-3	<b>Final</b>	Newport	4-8	Portroe	1-4
<b>U-12 'B'</b>	Newport	4-3	Templederry	2-5	<b>U-16 'A'</b>	Kilruane	3-11	Borris-Ileigh	2-7
<b>Semi-finals</b>	Kildangan	1-4	Lorrha	2-1	<b>Semi-finals</b>	Inane	1-8	Nenagh	0-8
Replay	Kildangan	1-8	Lorrha	1-4	<b>Final</b>	Inane	3-4	Kilruane	1-8
<b>Final</b>	Newport	2-2	Kildangan	0-8	<b>U-16 'B'</b>	Silvermines	5-5	S/Rovers	5-9
Replay	Newport	2-4	Kildangan	1-3	<b>Semi-finals</b>	Newport	2-7	Burgess	1-16
<b>U-12 'C'</b>	Borris-Ileigh	3-4	Ballinahinch	0-1	<b>Final</b>	S/Rovers	2-5	Burgess	1-5
<b>Semi-finals</b>	S/Rovers	2-4	Borrisokane	1-2	<b>U-16 'C'</b>	Kildangan	4-9	Portroe	1-2
<b>Final</b>	Borris-Ileigh	1-5	S/Rovers	1-1	<b>Semi-finals</b>	Ballinahinch	2-7	Borrisokane	2-4
<b>U-14 'A'</b>	Kilruane	4-2	Inane	1-5	<b>Final</b>	Ballinahinch	1-5	Kildangan	1-4
<b>Semi-finals</b>	Nenagh	4-10	Burgess Gaels	0-0					
<b>Final</b>	Kilruane	1-4	Nenagh	1-4					
<b>Replay</b>	Nenagh	1-6	Kilruane	1-3					

## North Bord na nÓg Results (Hurling)

<b>U-12 'A'</b>	Toomevara	2-2	Burgess	1-1	<b>U-14 'C'</b>	Newport	4-10	Silvermines	0-1
<b>Semi-finals</b>	Nenagh Éire Óg	5-12	Roscrea	1-1	<b>Semi-finals</b>	S/Rovers	3-7	Ballina	0-5
<b>Final</b>	Nenagh Éire Óg	3-9	Toomevara	4-2	<b>Final</b>	Newport		S/Rovers	
<b>U-12 'B'</b>	Newport	0-9	Kilruane MacD	0-7	<b>U-16 'A'</b>	Kilruane MacD	3-14	Lorrha	1-6
<b>Semi-finals</b>	Lorrha	1-3	Templederry	3-3	<b>Semi-finals</b>	Toomevara	2-14	Roscrea	0-8
<b>Final</b>	Templederry	1-6	Newport	1-3	<b>Final</b>	Toomevara	2-9	Kilruane MacD	0-13
<b>U-12 'C'</b>	Silvermines	5-2	Portroe	3-4	<b>U-16 'B'</b>	S/Rovers	2-11	Borris-Ileigh	1-6
<b>Semi-finals</b>	S/Rovers	2-4	Borrisokane	2-1	<b>Semi-finals</b>	Templederry	6-9	Newport	1-9
<b>Final</b>	S/Rovers	7-7	Silvermines	3-2	<b>Final</b>	Templederry	1-12	S/Rovers	1-12
<b>U-14 'A'</b>	Nenagh Éire Óg	6-12	Toomevara	0-0	<b>Replay a.e.t.</b>	Templederry	3-11	S/Rovers	1-14
<b>Semi-finals</b>	Roscrea	2-7	Kilruane MacD	5-8					
<b>Final</b>	Nenagh Éire Óg	1-13	Kilruane MacD	2-7	<b>U-16 'C'</b>	Borrisokane	3-11	Ballinahinch	3-11
<b>U-14 'B'</b>	Kildangan	5-4	Burgess Gaels	1-3	<b>Semi-final</b>	Borrisokane	1-12	Ballinahinch	2-7
<b>Semi-finals</b>	Borris-Ileigh	3-8	Lorrha	1-1	<b>Replay</b>	Borrisokane	3-10	Kildangan	2-8
<b>Final</b>	Borris-Ileigh	3-4	Kildangan	0-2	<b>Final</b>	Borrisokane		Kildangan	

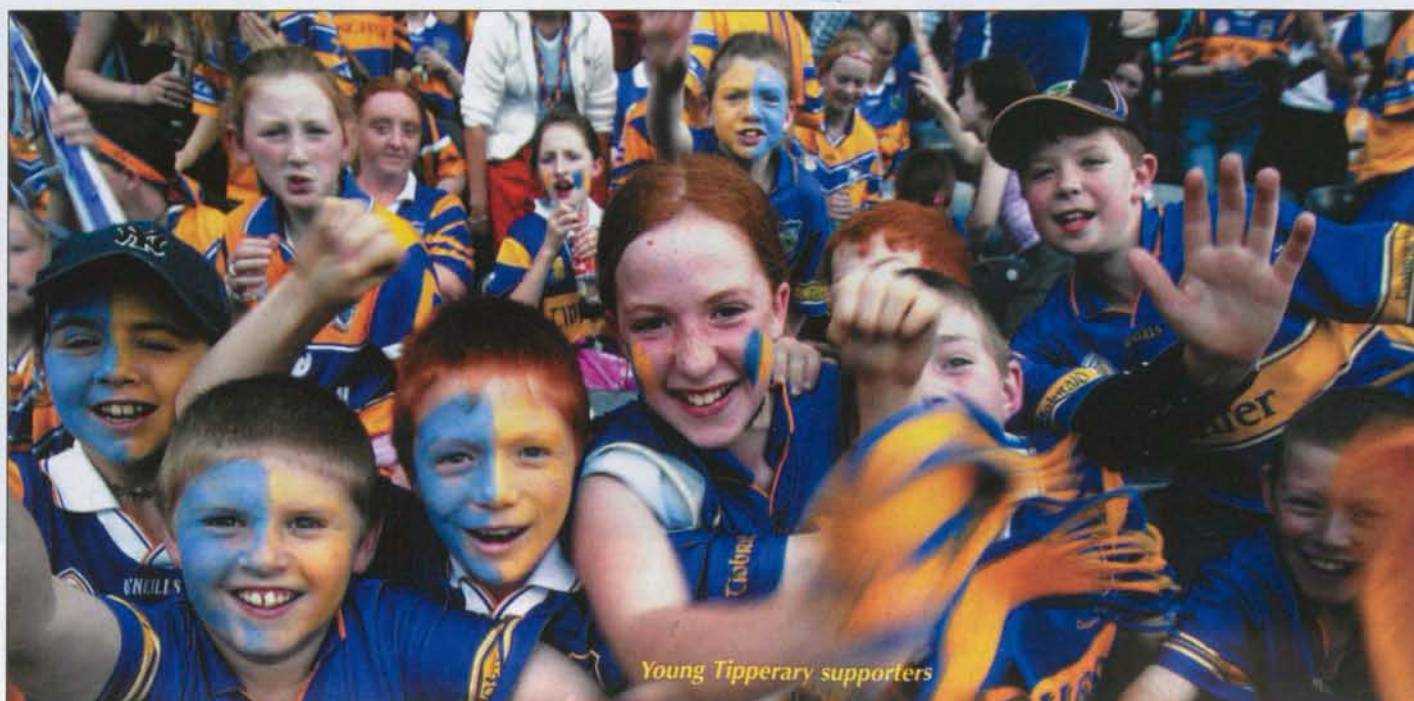

Young Tipperary supporters



The Cahir panel Tipperary County U-14 'B' Football Champions . . . Back row (l. to r.): John O'Donnell, Emmet Saunders, Neil Carey, Craig McGuire, Shane Casey, David Baker, Antonio Barbato, Ciaran O'Dwyer, Robbie Cunningham, Alan Power, Diarmuid Ryan. Front row (l. to r.): Cian Meehan, Neil Farrell, Eddie Kendrick, Ger Lonergan, Aaron Wall, Colm O'Donnell, Brian McEvoy, Ger Hally, Edmund Meehan, Shane Regan, John Ml. O'Donoghue, Paul McEvoy.



Presentation of gear to U-16 Hurling team for the Arrabawn Co-op Competition. (l. to r.): J.C. Ryan (Co. Bord na nÓg chairman), Shane Long (capt.) and Donie Shanahan (Co. Board chairman).



County Tipperary U-16 Hurling Panel . . . Back row (l. to r.): Eric Woodstock, Donal McGrath, Pdraig Hayes, Jody Ryan, Pauric Stapleton, Edward Costelloe, Brian White, Thomas Hassett, Matthew Ryan, Shane Long, Philip Ivors, Daniel Lynne, Dan O'Halloran, Michael Hoelan, Jack Maher, Ray McLoughney. Front row (l. to r.): Martin Walshe, James Dudley, Sean Cahill, James Heffernan, Kieran McGrath, Kevin Calahan, Brian Moran, Pdraig Hayes, Tony Ryan, Eoin Barrett, Kevin Reid, Kieran Murnane.



Launch of the Arrabawn Co-op U-16 Hurling tournament. Back row (l. to r.): Ricky Sheehan (PRO Co. Bord na nÓg), Frank Morris (treasurer Co. Bord na nÓg), Paddy Nagle (secretary Co. Bord na nÓg), Gerry Beary (Bord na nÓg delegate), Neil Ryan (Bord na nÓg delegate). Front row (l. to r.) David Coyne (Arrabawn Co-op sponsors), J.C. Ryan (Co. Bord na nÓg chairman), Tom Joyce (Arrabawn Co-op sponsors).



County Tipperary U-15 Football . . . Back row (l. to r.): Neil Ryan (mid sel.), Phil Kelly (north sel.), Brian O'Sullivan (Newport), Matthew O'Donnell (Killenaule), Thomas Stapleton (Templederry), Shane Tuohy (Portroe), Liam Ryan (Holycross), Tony Dunne (Burgess), Paul Fitzgerald Cappawhite, Brian Jones (Arravale Rovers), Barry Molloy (Moyle Rovers), Brendan Walsh (Ardfinnan), Joss Fletcher (Killadangan), Jamie Flynn, (Ballinahinch), Thomas Grace (Ballinahinch), Tony Doyle (south sel.), Tom Fitzgerald (west sel.). Front row (l. to r.): Robert Harrington (Newport), Seamie Ryan (Sean Treacys), Justin Conroy (Portroe), Rody O'Dwyer (Golden-Killeacle), Cathal Dillon (Aherlov), Chris Aylward (Clonmel Óg), Jimmy Dalton (Arravale Rovers), Damien McCormack (St. Patricks, Drangan), Daniel Lyons (Moyle Rovers), Paul Ryan (Arravale Rovers), Michael Doyle (Killenaule), Collum Gleeson (Portroe), Keith Quigley (Burgess), Fergal Ryan (Boherlahan Dulla)



Officers photographed after Co. Bord na nÓg Annual Convention at Park Avenue House, Thurles. Back row (l. to r.) Frank Morris (Treasurer), Rickie Sheehan (PRO), Jim Lynch (rep. to Co. Senior Board). Front row (l. to r.): Paddy Nagle (Secretary), J.C. Ryan (incoming chairman), Michael Lonergan (outgoing chairman).



Ballyporeen Panel Tipperary U-14 'C' Football County Final Champions 2003 . . . Back row (l. to r.): Danny Barrett, Cian Duggan, Kevin O'Brien, Gerry Clancy, Oliver Rath, Kenneth English, Danny Hannon, John English, Robert Duggan, Eanna Mooney, Paddy McCarthy. Front row (l. to r.): Dave Kennedy, John O'Brien, Simon Hickey, Kevin Crotty, Glen Walsh, Conor Sweeney, Larry Brophy, Siobhan Crotty, Christy McCarthy.



Newport Tipperary U-14 'C' Bord na nÓg Hurling County Champions . . . Back row (l. to r.): Michael McKeogh, Damien Moroney, Barry Doyle, Pdraic Hogan, Martin Homes, Aidan Ryan (B), Aoife Shinnors. Front row (l. to r.): Kieran Doherty, Nigel Jones, Patrick Hickey, Kevin O'Brien, Damien Burke, Sean O'Brien.



*Cahir Team Tipperary U-12 'A' Football County Champions . . . Back row (l. to r.): Joe McEnery, Frieda Casey, Michael Hickey, Evan Flynn, Eddie Kendrick, Eric Reece, Shane Tobin, Sean O'Connor, Matthew O'Sullivan, Shane Murphy, Barry McEvoy. Front row (l. to r.): Simon Williams, Anne Marie O'Gorman, Leanne Barrett, John O'Reilly, Eanna O'Gorman, Roger Peters, Aaron Wall, Alan Doolan, Michael Byrne, Eoin Farrell, Patrick Fitzgerald, Niall O'Donnell.*



*Borrisoleigh Panel Tipperary U-12 'C' Football County Final Champions 2003 . . . Back row (l. to r.): Paul Stapleton, Denis Ryan, Stephen Shanahan, Tommy Kavanagh, John Ryan, Pa Donnelly, Jason Fahey, Sean McCormack, Lorcan Ryan, Damien Dunne, Benny Harkin, Daniel Bergin, James Tynan. Front Row (l. to r.) Ben O'Donnell, Seamus Maher, Dylan Reid, Niall Cowan, Thomas Fahey, Barry Dwyer, Dan McCormack, Mossy Shanahan, Danny Ryan, Stephen Williams, Aidan Walsh, Chris Treacy.*



*Ballinahinch Team Tipperary U-16 'C' Football County Champions . . . Back row (l. to r.): Jamie Flynn, Timmy Ryan, Laurence Hogan, Tony Finn, Donnacha McGrath, Liam Lynch, Thomas Grace. Front row (l. to r.): Mark Kelly, Thomas Moynihan, Shane Healy, Brian Mulcahy, Sean Berkery, James Hickey, Cormac McGrath.*



*Borrisoleigh Tipperary Bord na nÓg U-14 'B' Hurling County Final Champions 2003 . . . Back row (l. to r.): Sean McCormack, William Donnelly, Joseph Buckley, Cathal Bourke, Cian O'Mahoney, Barry Donnelly, Gearoid Kent, Paul Maher. Front row (l. to r.): David O'Brien, Mossy Shanahan, Damien McCormack, Damien Dunne, Lorcan Ryan, Tommy Kavanagh, Damien Corcoran.*



*Carrick Swan Panel Tipperary U-16 'A' Bord na nÓg Hurling County Champions . . . Back row (l. to r.): Sean Barrett, Danny O'Hanlon, Kevin Lanigan, William Lonergan, Colin O'Sullivan, Martin Russell, Stephen Hahessy, Kieran Reade, Wayne Cullen, Michael Ryan, Stephen Kearns, Keith O'Dwyer. Front row (l. to r.): Dean Cleary, Barry Walshe, Dwayne Fogarty, Paul Regan, Andrew Diffily, David Walsh, Damien Roche, Daryl Whitty, Shane Hogan, Darren Murphy, John Flynn, Jimmy Dignam, Mark Fogarty.*



*Nenagh Eire Óg Panel Tipperary U-14 'A' Bord na nÓg Hurling County Champions . . . Back row (l. to r.): F. Savage, A. Kelly, M. Grace, D. Ely, P. Murphy, S. O'Carroll, J. Gallagher, M. Heffernan, C. Tucker, S. Maher, S. Healy, P. O'Connor, M. Hynes, M. Flannery, D. Cleary, E. Slattery, J. McGrath, E. Tucker. Front row (l. to r.): G. Tucker, A. Savage, P. Flynn, B. Heffernan, N. Madden, P. Carey, C. Moloney, P. Morris, W. O'Connor, W. Bolger, J. Reddan, T. O'Brien, M. Cleary.*



### Nenagh Eire Óg U-12 Panel Hurling North 'A' Champions



Back row (l to r) Karl Mackey, John Minogue, Willie O'Connor, Billy Heffernan, Pearse O'Brien, Shane Maher (captain), David Cleary, Kevin O'Gorman, Adrian Brennan. Middle row (l to r) John Byrne, Conor Geaney, Tommy Heffernan, Cliff Moloney, Kevin Flynn, Eddie Darcy, Sean Geaney, Conor Cleary, Paul Gleeson. Front row (l to r). David Hickey, Donnacha Heffernan, Cronan Gleeson, Darragh Quinn, Gary Power, Joseph Geaney, Adam Gratton, Conor Kennedy, Christopher Tinkler, Wesley Heenan.

### Nenagh Eire Óg U-12 Panel Football North 'A' Champions



Back row (l to r) Matthew Corrigan, Conor Cleary, Kieran McCann, Shane Maher, Alan Kevin, Joshua Bourke, David Cleary, William O'Connor, Pearse O'Brien, Kevin O'Gorman, John Minogue, Daire Quinn. Middle row (l to r) Paul Slattery, Eoin Chadwick, Oisín McGlynn, Eoin Byrne, Conor Geaney, Conor Cusack, Billy Heffernan (captain), Tommy Heffernan, Cliff Moloney, Eddie Darcy. Front row (l to r), Karl Mackey, Mark Higginsbottom, Darragh Walsh, Stephen Nagle, Sean Geaney, Robert O'Dwyer, David Hickey, Andrew Weinman.

### Newport U-12 Football North 'B' Champions



Back row (l to r) Carol Houlihan, Joseph Laffan, Odran Floyd, Noel Clifford, Patrick Floyd, Stephen O'Connor, Darren Moore, Michael O'Connor, Blaine Lenihan, Andrew Ryan, Billy Jones, Stephen Houlihan. Front row (l to r). Shane Lenihan, Brendan Ryan, Sammy Salem, Peter O'Sullivan, Joseph Cornaille, Martin Carey, Eamonn Farrell, Shane O'Brien, Anne-Marie Ryan.

### Nenagh Eire Óg U-14 Panel Football North Feile na nGael Winners



Back row (l to r) Thomas O'Brien, Alan Kelly, Kieran Duffy, Thomas Murphy, Shane O'Carroll, Cian Tucker, Mark Flannery, Sean Healy, Michael Heffernan, Jamie Gallagher, Mark Grace, Patrick Flynn, Michael Hynes. Front row (l to r). Willie Bolger, James Reddin, Niall Madden, Damien Ely, Shane Maher, Pierce Morris, Cliff Moloney, Eoin Slattery, Peter O'Connor, Billy Heffernan, Paul Carey.

**Templederry U-12 Hurling Team North 'B' Champions**



Back row (l to r) Dale Donnelly, Danielle Slattery, Leanne O'Dwyer, Simon Ryan, Paul Butler, Eanna Murray, Pío Kennedy, Aidan Ryan, Gerard Hogan, Brian Carey, Richard Walsh, Brian Stapleton. Front row (l to r) Patrick Griffin, David Butler, Donal Kennedy, Pdraig Gleeson, Joseph Shanahan, Eanna Ryan, Jamie Ryan, Mathew Hogan, Shane Kinane, Mark Grisewood, Edward Hynes.

**Templederry U-16 Hurling Panel North 'B' Champions**



Back row (l to r) Tommy Hogan, Pat Ryan, Alan Carey, Eoghan Ryan, Thomas Stapleton, Dan Fahy, Tadhg McLoughney, Pdraig O'Leary, Donal McGrath, Gearóid Ryan, Aidan Ryan. Front row (l to r) Denis Corcoran, Ronan Kinnane, John Fogarty, Ger Kennedy, Tom Ryan, Matthew Ryan (captain), Stephen Smith, Christy Coughlan, Paul Murray, Clíodhna and Moira Ryan (mascots).

**Shannon Rovers U-16 Panel Football North 'B' Winners**



Back row (l to r) Sean Darcy (selector), Jamie Bourke, George Hannigan, Philip Donnellan, Darren Carroll, Stephen Nevin, Paddy Cahalan (selector), Kevin Cahalan, David Hogan, Michael Harding, Timmy Carroll (selector). Front row (l to r) Michael O'Halloran (selector), Barry Cahalan, Sean Tiernan, Alan Hannigan, Danny O'Halloran (captain), Timmy Spellman, Brian Horrigan, Darragh Darcy, Cian McLoughney, Julian O'Halloran, Martin Cleary.

**Shannon Rovers U-12 Panel Hurling North 'C' Champions**



Back row (l to r) Patrick Burke, Pdraic O'Meara, Sean Donoghue, Paul Burke, Darragh Hough, Andrew Byrne, Ross Ryan, Niall Burke, John Costelloe, John Costelloe Snr. (selector). Middle row (l to r) Gerard Hogan (selector), Tom Shanahan (selector), Ronan Glynn, Stephen Stack, Paddy Keenan, John Starr, Peter Donoghue, Daniel Burke, Tom Burke (selector), George Ryan (selector). Front row (l to r) Emmett Dwyer, Cian Burke, Austin Tierney, Tom Hogan, Alan Hogan (captain), Sean Hogan, Eamon Costelloe, Jack Sullivan, Eanna McLoughney, Darragh McMahon, Eoin McMahon, David Shanahan.

# Mid Tipperary Bord na nÓg 2003



Launch of Campbell's sponsorship of Mid Bord na nÓg Championships 2003. Front (l to r): Jimmy Coppinger, President Mid Bord na nÓg; Neil Ryan, Secretary; Joe Moran, Chairman; John Smith, PRO; Martin Treacy, Vice-chairman. Back row: Liam McGrath, Representing sponsors; J.C. Ryan, Vice-chairman; Lar Devane, Representing sponsors; Liam Hayes, Bord delegate; Joe Kennedy, Bord Delegate; Frank O'Regan, Bord Treasurer.



Chairman of Mid Bord na nÓg, Joe Moran, making presentation to outgoing chairman J.C. Ryan at a recent function in Park Avenue House.



Chairman of Mid Bord na nÓg, Joe Moran making presentation to outgoing secretary, Martin Treacy at a recent function in Park Avenue House. Also in picture is Jimmy Coppinger, Bord President



Chairman of Mid Bord na nÓg, J.C. Ryan (left) presenting the 'Club of the Year' award to Durlás Óg delegates John Smith, chairman, and Jimmy Coppinger, secretary, at Mid Bord na nÓg's Annual Convention at the Park Avenue House, Thurles. Jimmy Coppinger was elected president of the board at the convention.



Mid Tipperary U-12 C Football Champions, Clonakenny. Back row (l to r): Philip Ryan, Paddy Murray, William Ryan, Paddy Murray, William Ryan, Siobhan Ryan, Laura Bourke, Emma Maher, Noel O'Meara, Michael John Carroll, Bobby Bergin. Front: Liam Mullally, Paul Bergin, Brendan Russell, Patrick Ryan, Stephen Russell, Padhraic Mullally, John Paul Hennessy, William Costigan, Padhraic Bourke.



Holycross-Ballycahill U-12 B Football Mid Champions. Back (l to r): Stephen Maguire, Jonathan Keady, Stephen Quirke, Eoin Stakelum, Timmy Ryan, Hugh Kennedy, Eoghan Moloney, Stephen McLoughlin, Daniel Murphy, Aidan Medley, Aidan Stakelum, Jamie Foley, Edward Moore. Front: Enda Kearney, Mark O'Donoghue, Cathal Barrett, Matthew Dean, Gerard Kennedy, Cathal Carroll (capt), Denis Ferncombe, Shane O'Dwyer, John Ryan, Tony Leahy, Jamie Byrne.



Mid and County Champions. The J.K. Brackens panel that defeated Templederry in the replay of the County Bord na nÓg U-12 B hurling final. Back row (l to r): Daniel Burke, Eoin Fitzpatrick, Jamie Hamill, Aidan Fogarty, Martin Lee, Austin Purcell, Keith Morris, Joseph Bergin, Michael Carroll, Eoin Bourke, Francis Kenneely, D. Fitzpatrick, F. Byrne, Francis Kenneely, D. Fitzpatrick, F. Byrne, Patrick Delaney. Front: Thomas Hamill, J. Newe, Padraic Bourke, Joe Coffey, Eoin Kennedy, Toby Morgan, Richard Buckley, Shane Cashman, David Murphy, Keith Kennedy, Patrick Brett, Damien Coffey.



Loughmore Castleiney panel that defeated Durlas Óg in the Mid Tipperary Bord na nÓg Centenary Co-op U-12 'A' Hurling Final. Back row (l to r): Liam Treacy, Darragh Butler, Richard Maher, Marty Ryan, Eamon Connolly, Thomas McGrath, John Meagher, Kevin Johnston, Patrick Nolan, Eamon McGrath, Padraic Egan, Michael Ryan, Padraic Hennessy, Craig Cleary, Paul Morris, Brian McGrath. Front: Joseph Nyland, Willie Eviston, Henry Maher, Aidan McGrath, Liam McGrath, Patrick Nolan, Aaron Sweeney, John McGrath, Denis Brereton, Kevin O'Connell, Joseph Hennessy, Corey O'Brien, Thomas Maher.



Loughmore Castleiney Mid Tipperary U-12 'A' Football Champions. Back row (l to r): John Maher, Brian McGrath, Liam Treacy, Craig Cleary, Patrick Nolan, Lorcan Egan, Thomas McGrath, Eamonn Connelly, Aidan McGrath, Kevin Johnson, Padraig Hennessy, Aaron Sweeney, Liam McGrath, Richard Maher. Front: Joseph Nyland, Joseph Hennessy, Tomas Maher, Martin Maher, Denis Brereton, Martin Ryan, Corey O'Brien, Henry Maher, Denis O'Brien, John McGrath, Willie Eviston, Patrick Nolan, Eamon McGrath, Padraig Egan, Paul Morris, Kevin O'Connell.



The Clonakenny Panel Mid Tipperary U-14 'C' Football Champions. Back (l to r): Thomas Ryan, Cora Costigan, Jonathan Cody, Aine Byrne, Brian Mullally, William Ryan, Luke Keehsan, Nicholas Ryan, Prionsios Matthews, David Cody, Siobhain Ryan, Mary Kiely. Front: Mairead Ryan, Jamie Maxwell, Stephen Russell, Philip Ryan, Michael John Carroll, Paddy Murray, Patrick Ryan, Bobby Bergin, Michael Crampton, John Paul Hennessy, Mark Mullally, Laura Burke, Bridget Higgins.



The Upperchurch Drombane team that defeated Boherlahann Dualla in the Mid Tipperary U-14 B Football final. Back (l to r): Miriam Ryan, Denise Armstrong, Therese Shortt, Joe Maguire, Thomas Keane, James Barry, Matthew Greene, Michael Kennedy, Aidan Brett, Padraig Shortt. Front: Philip Crowe, Peter Ryan, Sean Harty, Colm Ryan, Liam Clancy, Paul Ryan, Eugene Burke, Albie O'Donoghue, Padraig Greene, Gerard Fogarty.



Mid Tipp Under-14 'A' Football - Durlas Óg. Back (l to r): Brian Stakelum, Philip Cullen, Kevin O'Gordan, Shane Maher, Michael Cahill, Brian Callanan, John Joe Bourke, Stephen Dorney (captain), Laurence Burke, Patrick Leahy, Sean Moloney, Padraic Maher, Michael McGrath. Front: Killian McNally, Kieran Morris, Darragh Stakelum, Bobby Stakelum, Damien Grimes, Sean Smith, Jonathan Shannon, Ciaran O'Shea, Liam Cullen, Darren O'Neill, James Collins, Rodney Mason.



The Moycarkey-Borris 'B' panel that defeated Durlas Óg 'B' in the Park Avenue Mid Tipperary Bord na nÓg u-12 'C' Hurling final. Back (l to r): Eithne Moran, Padraic Fitzpatrick, Shane Byrne, Bridget O'Keefe, Timmy Ryan, Jeff Fallon, Michael Bracken, Daniel Woodlock, Michael Bryan. Front: Michael Moore, James Bourke, Niall Sullivan, Ciaran Quinn, Aidan Slattery, Frank Hayes.



Moycarkey Borris U-16 'B' Mid Football Champions 2003. Back (l to r): Patrick Shortall, Tony Flanagan, James Power, Noel Kinane, Tomas Quinn, Conor Burke, Kevin Moran, Eddie Power, Shane Barry, Eoin Cantwell, David Maher, Brian Moran. Front: Paul Kennedy, Jamie Fanning, Bobby Bracken, Aidan Ryan, Laurence Power, Ciarán Clohessy, Gerry McGuire, David Kinane, Phil Kelly (captain), Anthony Healy, Peter O'Brien, William Foley.



The Durlas Óg panel that defeated Moycarkey Borris in the Thurles Credit Union Mid Tipperary Bord na nÓg U-16 'A' Hurling final. Back (l to r): Conor Murphy, Kevin O'Halloran, Brian White, Ronan Walsh, Ian Maher, Patrick Skehan, David Morris, Garrett Foxton, Scott Grey. Front: Jody O'Grady, David Shannon, Adrian O'Mahoney, John Maher, Michael Gleeson, Patrick Bourke, Stephen Fewer.



JK Brackens – Mid and County U-12 'B' hurling champions 2003. Back row: (l. to r.) Seamus O'Dwyer (selector), Austin Purcell, Damien Coffey, Eoin Bourke, Eoin Fitzpatrick, Jamie Hamell, Francis Kennedy, Patrick Delaney, Martin Lee, Donal Fitzpatrick, Aidan Fogarty, Toby Morgan, Daniel Bourke, Michael Carroll, Joe Greed (selector). Front row (l. to r.): Joe Fitzpatrick (selector), Patrick Brett, David Murphy, Joe Coffey, Shane Cashman, Eoin Kennedy, James Newe, Joe Bergin (c.), Keith Morris, Richard Buckley, Pádraig Bourke, Keith Kennedy, Tomás Hammell, Pat Brett (selector).



The Durlas Óg 'B' team that defeated Clonakenny in the Mid Tipperary Bord na nÓg Under-14 'C' Hurling final sponsored by the Park Avenue. Back (l to r): James Collins, Bobby Stakelum, Sean Moloney, Brian Stakelum, Denis Maher, Philip Cullen, Brian Callanan, Conor Ryan, Rory O'Shea, Cillian McNally. Front: Stephen Maher, Barry McCormack, Sean Smith, Liam Cullen, Kieran Morris, Darragh Stakelum, Darragh O'Neill, Robert Murphy, Michael Russell.



The Boherlahan Dualla panel that defeated Loughmore Castleiney in the Mid Tipperary Bord na nÓg U-16 'B' Football final. Back (l to r): Eoin Sweeney, Fergal Ryan, Brendan Heaney, Christy Maher, Aidan Maher, Evan Hunt, James Ryan, David Patterson, Paul Murphy, Paddy Maher, Gerard O'Sullivan, Willie Murphy. Front: Mark Kavanagh, James Quinn, James Mulligan, Michael Murphy, David Ferncombe, Colin Bargary, Rory O'Connor, Fionn McCullagh, Philip Maher.



The Moyne Templeuohy panel that defeated Holycross Ballycahill in the Mid Tipperary Bord na nÓg U-16 'B' Hurling final sponsored by Kevin Darmody Ltd. Back (l to r): Tom Hassett, Tom Guilfoyle, Brian Kelly, Eoin Butler, P.J. O'Brien, Mark Stokes, David Costigan, Thomas Hassett, John Coughlan, Conor Quinlan, Joe O'Grady, Dermot Campion. Front: Eamon O'Dwyer, Paul Quinlan, Paul Carroll, Jack Fogarty, Tadgh Butler, Liam Butler, Geroid Leahy, Diarmuid Fogarty, David Bourke, Shane Everard, Thomas Lanigan.



Mid U-16 C Football and Hurling champions, Clonakenny. Back (l to r): Eddie Byrne, Anne Marie Nolan, Philip Crampton, John Costigan, Stephen Carroll, Aonghus Cody, Peadar Byrne, Brendan Bultin, Thomas Ryan, Prionsias Matthews, David Cody. Front: Aine Byrne, Brian Mullally, Jonathan Cody, Nicholas Ryan, Donal Greed, Cora Costigan, Mairead Ryan, Jamie Maxwell, Michael Crampton, Mark Mullally, Luke Keeshan.



Mid Feile na nGael, Durlas Óg. Back (l to r): Seam Moloney, Michael Cahill, Michael McGrath, Laurence Burke, Shane Maher, Conor Ryan, John Joe Bourke, Stephen Dorney, Pádraic Maher (capt), Bill McCormack, Rodney Mason, Kevin O'Gorman, Jonathan Shannon; Brian Callanan, Patrick Leahy, Brian Stakelum, Anthony O'Gorman, Barry McCormack.



Mid Peil na nÓg – Durlas Óg. Back (l to r): Pádraic Maher, Brian Stakelum, Kevin O'Gorman, Laurence Burke, Brian Callanan, Sean Moloney, John Joe Bourke, Michael Cahill, Stephen Dorney, Shane Maher, Rodney Mason, Darren O'Neill, Bobby Stakelum. Front: Jonathan Shannon (captain), Sean Smith, Michael McGrath, Ciaran O'Shea, Liam Cullen, Kieran Morris, John Shortt, Philip Cullen, Damien Grimes, Bill McCormack, Killian McNally.



Boherlahan Dualla – Mid U-14 B Hurling champions. Back (l to r): D. Hasset, E. Sweeney, M. Fogarty, D. Ryan, D. Fercombe, C. Heffernan, S. Ryan, B. Quin, Richard Ryan, Gerard O'Sullivan, S. Hayes, P.J. Stapleton, S. Leahy, C. Fitzgerald, R. Barret. Front: D. Devane, M. Murphy, E. Sheehy, P. Maher, F. MacCullagh, M. Kavanagh, I. Crosse, D. Kennedy, S. Tarrant, R. Clegg, S. Borgery, D. Cullen, T. Fitzpatrick.

# Mid Tipperary Bord Na nÓg Results 2003

GRADE	DATE	RESULT	VENUE	REFEREE
Morans U-12 'A' Football	27th May	Loughmore-Castleiney .2-7 J.K. Brackens .....2-4	Páirc na nÓg	Kevin Butler
Home Heat Providers U-12 'B' Football	2nd June	Holycross-Ballycahill ..1-4 Moyn-Templetuohy ...0-4	Littleton	Jimmy Sweeney
Park Avenue U-12 'C' Football	2nd June	Clonakenny .....2-6 Moycarkey-Borris 'B' ..1-0	Littleton	Martin Treacy
Denis Kinane Motors U-14 'A' Football	25th June	Dúrlas Óg .....1-5 Gortnahoe-Glengoole ..0-3	Templetuohy	P.J. Leahy
John J. Ronayne Ltd. U-14 'B' Football	26th June	Upperchurch-Drombane1-1 Boherlahan-Dualla ....0-1	Holycross	Michael Jordan
U-14 'C' Football Lisheen Mines	19th May	Clonakenny winners Moycarkey-Borris ....2-13	Holycross	Martin Treacy
U-16 'A' Football		Dúrlas Óg .....1-5		
A.I.B. (Thurles/Templemore)	30th June	Boherlahan-Dualla ....3-9 Loughmore-Castleiney .4-4	Holycross	Martin Goldsboro
U-16 'C' Football		Clonakenny winners		
Peil na nÓg (sponsor Jimmy Coppinger)	3rd May	Dúrlas Óg .....2-7 J.K. Brackens .....0-0	Sarsfields Pitch	Patsy Ralph
Centenary Co-Op U-12 'A' Hurling	21st Aug.	Loughmore-Castleiney .3-6 Dúrlas Óg .....0-4	Templemore	Kevin Butler
Pat Ryan (Senator) Windows U-12 'B' Hurling	21st Aug.	J.K. Brackens .....7-5 Moyn-Templetuohy ...2-5	Castleiney	Michael Jordan
Park Avenue U-12 'C' Hurling	25th Aug.	Moycarkey-Borris 'B' ..1-3 Dúrlas Óg 'B' .....0-2	Páirc na nÓg	P.J. Hewitt
U-14 'A' Hurling (sponsor Spain Family)	2nd Sept.	Dúrlas Óg .....4-13 Drom-Inch .....1-4	Drombane	Martin Treacy
Stakelums Hardware U-14 'B' Hurling (Replay)	6th Sept.	Boherlahan-Dualla ...6-6 Holycross-Ballycahill ..1-2	Drombane	Jimmy Sweeney
Park Avenue U-14 'C' Hurling	3rd Sept.	Dúrlas Óg 'B' .....2-5 Clonakenny .....1-7	Drom	Pat Lynch
Thurles Credit Union U-16 'A' Hurling	4th Oct.	Dúrlas Óg .....1-11 Moycarkey-Borris ....1-8	Semple Stadium	Martin Goldsboro
Kevin Darmody Ltd. U-16 'B' Hurling	28th Sept.	Moyn-Templetuohy ..2-11 Holycross-Ballycahill ..0-10	The Ragg	Kevin Butler
U-16 'C' Hurling		Clonakenny winners		
Feile na nGael (sponsor Jimmy Coppinger)	10th May	Dúrlas Óg .....2-15 J.K. Brackens .....1-0	Sarsfields Pitch	Pat Cullen



## Mid Tipperary Bord na nÓg Review 2003

Mid Tipperary Bord na nÓg once again enjoyed another successful and busy year. Almost 200 matches were played in the hurling and football championships starting with Peil na nÓg in early March and concluding with the under-16 'A' hurling final on 4th October. Every club in the division contested at least one Mid final with nine clubs sharing the titles.

Three county titles came to the Mid. Dúrlas Óg achieved a county double winning the under 14 'A' football and Feile na nGael. J.K. Brackens were successful at under 12 'B' hurling.

An under 10 indoor hurling blitz was organised early in the year at the Ursuline Sports Complex, Thurles with all clubs participating. The same under 10's ended the season with a blitz in Semple Stadium in October.

The Mid under 16 hurlers won the Garda Cup defeating the West in the semi final and the South in the final. This team was most unfortunate to lose to Imokilly in the Munster Inter-Divisional championship by one point after extra time. The other divisional teams enjoyed little success except the under 14's who defeated the North in the football shield final which was played under lights in Dr. Morris Park.

The Board is grateful to our loyal sponsors who sponsored our championships again this year and also Erin Foods who was the overall sponsor of Mid Bord na nÓg.

### OFFICERS 2003

- President:** Jimmy Coppinger (Dúrlas Óg)  
**Vice President:** Andy O'Gorman (Gortnahoe/Glengoole)  
**Chairman:** Joe Moran (Moycarkey/Borris)  
**Vice Chairmen:** Martin Treacy (Holycross/Ballycahill); J.C. Ryan (Upperchurch/Drombane)  
**Secretary:** Neil Ryan (Holycross/Ballycahill)  
**Treasurer:** Frank O'Regan (Moycarkey/Borris)  
**P.R.O.:** John Smith (Dúrlas Óg)  
**County Bord na nÓg Reps:** John Smith (Dúrlas Óg); Martin Treacy (Holycross/Ballycahill)  
**Rep. to Mid Senior Board:** Joe Moran (Moycarkey/Borris)



*JK Brackens - Mid and County U12B Hurling Champions 2003. Back Row: (l to r) Seamus O' Dwyer (selector), Austin Purcell, Damien Coffey, Eoin Bourke, Eoin Fitzpatrick, Jamie Hamell, Francis Kennedy, Patrick Delaney, Martin Lee, Donal Fitzpatrick, Aidan Fogarty, Toby Morgan, Daniel Bourke, Michael Carroll, Joe Greed (selector). Front Row: (l to r) Joe Fitzpatrick (selector), Patrick Brett, David Murphy, Joe Coffey, Shane Cashman, Eoin Kennedy, James Newe, Joe Bergin (c), Keith Morris, Richard Buckley, Pádraig Bourke, Keith Kennedy, Tomás Hamell, Pat Brett (selector)*

# Coiste Thioðraid Árann Theas

## South Tipperary Bord na nÓg

### Results 2003

Liam Bolger (Runaí)

FOOTBALL	WINNER	RUNNER-UP	VENUE	REFEREE	SPONSOR
Fé 12 'A'	Cahir	Ardfinnan	Sportsfield	K. Delahunty	J. Quirke Jewellers
Fé 12B	Kilsheelan	Killenaule	Sportsfield	P. Sweeney	Clancy Construction
Fé 12C	St. Martin's	Cahir B	Sportsfield	F. O'Brien	B. O'Brien Windows
Fé 14A	Commercials	Mullinahone	Cloneen	K. Delahunty	McCarthy Family
Fé 14B	Cahir	Ballingarry	Ballingarry	Ned Hall Park	P. Sweeney Clonmel Oil
Fé 14C	Ballyporeen	Newcastle	Ned Hall Park	P.J. Hassett	Big Sycamore Garage
Fé 16A	Moyle Rovers	Clonmel Óg	Ardfinnan	B. Tyrrell	M.C. Maher
Fé 16B	Killenaule	St. Patrick's	Fethard	B. Tyrrell	Liam Gahan Meats
Fé 16C	St. Martin's	Ballyporeen	Goatenbridge	P. Sweeney	Noel O'Keefe Car Sales

### Peil na nÓg

#### County Champions:

Cahir	12A
Cahir	14B
Ballyporeen	14C
Moyle Rovers	16A
Killenaule	16B

#### Peil na nÓg

### HURLING

	WINNER	RUNNER-UP	VENUE	REFEREE	
Fé 12 'A'	Clonmel Óg	St. Mary's	Ardfinnan	W. Barrett	Nightclub Security
Fé 12B	Ballybacon	Mullinahone	Monroe	K. Delahunty	Bourke Construction
Fé 12C	St. Patrick's	Ballylooby	Ned Hall Park	P. Sweeney	Mick O'Dwyer Fencing
Fé 14A	Ballingarry	Moyle Rovers	Fethard	V. Direen	Slieve na Mon Hurleys
Fé 14B	Kilsheelan	St. Patrick's	Fethard	C. Aylward	O'Gorman Construction
Fé 14C	Newcastle	Fr. Sheehy's	Goatenbridge	D. O'Mahoney	
Fé 16A	Carrick Swan	Ballingarry	Monroe	S. Roche	Clonmel Credit Union
Fé 16B	St. Patrick's	Ballybacon	Monroe	K. Delahunty	Mullinahone Oil
Fé 16C	Newcastle	Skeheenarinky	Ardfinnan	D. O'Mahoney	Star Fuels

### Feile na nGael

**Poc Fada:** James Logue, Ballingarry

**Skills:** Ciarán Lorigan, Moyle Rovers

#### County Champions:

St. Patrick's	12A
Carrick Swan	16A
St. Patrick's	16B
Ciarán Lorigan [Moyle Rovers]	Skills



Under 16 'B' Football South and County Champions 2003 . . . Back row (l. to r.): Anthony Doyle (manager), Kieran Murphy, Tom Kennedy, Stephen Browne, Padraig Kirby, Raymond O'Connor, Michael Hickey, Georgie Webster, Denis Healy Niall Bergin, Michael Kelly, Patrick Carroll, Edward Kelly, James Hickey, John Kelly, Hugo Browne (sel.), Front row (l. to r.): Matthew O'Donnell, Simon Kennedy, Michael Webster, James O'Connell, Matthew Ryan, Kevin Prendergast, Kevin Kennedy (capt.), Michael Doyle, Anthony Guinan, Noel Hayes, Paddy Codd, Brian Murphy.

## OFFICERS 2003

### Cathaoirleach:

Michael Ó Lonergáin

Fón: 052-38316

Mobile: 086-1026486

### Chairman:

Michael Lonergan [Ardfinnan]

### Secretary:

Liam Bolger [St. Mary's]

### Vice Chairmen [2]

Dick Egan [Mullinahone]

Declan McGrath [Moyle Rovers]

### Treasurer

Dick Egan [Mullinahone]

### Assistant Treasurer

Malachy Sheehan [Mullinahone]

### Runai:

Liam Ó Bolguidhir

53, Cnocán na Silíní

Cluain Meala

Fón/Fax: 052-29514

Mobile: 086-8294060

### Cistoir:

Risteard Mac Aodhagáin

Fón: 052-53293

Mobile: 087-2570430

### P.R.O.

P. A. Shelley [Killenaule]

### Registrar

Tony Hogan [Carrick Swan]

### Co. Bord na nÓg

Christy Aylward [Clonmel Óg]

### Reps [2]

Martin Cody [Mullinahone]

### South Senior Rep

John Harrington [St. Patrick's]

### Special Rep

Johnny O'Brien [Fr. Sheehy's]

## UP TO THE COUNTY FINAL

### FOOTBALL:

**U12A** Cahir easily defeated Eire Óg Nenagh in the semi-final and went on to defeat Arravale Rovers in the final.

**U12B** In the semi-final Kilsheelan Kilcash were beaten by Newport, the eventual County champions.

**U12C** St. Martin's lost to Borrisoleigh in a replayed semi-final. The first semi-final was a draw after extra time. Borrisoleigh went on to win the County final.

**U14A** Commercials were beaten by Eire Óg Nenagh in the County semi-final.

**U14B** Cahir beat Borrisoleigh in the county semi-final and went on to become County champion by beating Upperchurch-Drombane in the final.

**U14C** Ballyporeen beat Newport in the County semi-finals and became County champions by defeating Clonakenny in the final.

**U16A** Moyle Rovers defeated Innane Rovers in the semi-final and had a deserved one point victory to retain the trophy.

**U16B** Killenaule defeated Shannon Rovers in the semi-final and had a big margin to spare over Cappawhite in the final.

**U16C** St. Martin's were narrowly defeated by the eventual champions Ballinahinch in the semi-final.

**Peil na nÓg:** Commercials beat Kilruane McDonaghs in the semi-final and went on to represent the county in Galway by beating Arravale Rovers in the county final.

### HURLING:

**U12A** Clonmel Óg were defeated Eire Óg Nenagh in the county semi-final.

**U12B** Ballybacon Grange was defeated by Templederry after a replay.

**U12C** St. Patrick's defeated Shannon Rovers in the semi-final and lost to Moycarkey Borris in the final. However there was reason for investigation due to Moycarkey playing illegal players and they withdrew from the competition. The defeated semi-finalists were re-instated and played St. Patrick's in a rescheduled final which St. Patrick's won easily.

**U14A** Ballingarry were defeated by the eventual County champions, Eire Óg Nenagh in the county semi-final

**U14B** Kilsheelan Kilcash were also beaten by the eventual County champions Borrisoleigh in the county semi-final.

**U14C** Like in the other two U14 semi-finals Newcastle were beaten by Newport the eventual County champions.

**U16A** Carrick Swan easily beat Toomevara by ten points in the County semi-final and went on to narrowly defeat Dúrlas Óg in the County Final.

**U16B** St. Patrick's beat Templederry in the county semi-final and went on to a good victory in County final over Moyne Templetohy.

**U16C** Like in the U14C Newcastle went up to county and were beaten in the semi-final by the eventual winners Borrisokane.

## Well done to all our divisional champions but especially our County Champions

**FOOTBALL:** Cahir U12A & U14B, Ballyporeen U14C, Moyle Rovers U16A, Killenaule U16B and Commercials Peil na nÓg.

**HURLING:** St. Patrick's U12C & U16B and Carrick Swan U16A



U/10 Football South Tipperary B Shield. Final. Champions : St Patricks (Drangan & Cloneen) Back Row: James Rahilly (Capt), Thomas O'Brien, William O'Brien, Eamon Needham, Jonathan Hickey, Patrick Gorey, Jamie Moloney, James Phelan, Róbert Maher, James Phelan, Eamon Needham, James Buckley, Cathal O'Donovan, Robert Meagher, Cathal O'Donovan and Aodhan Maher. Front Row: Kieth Hickey, Aidan Buckley, James Buckley, Mark Mullaly, Mark Slattery, Cathal O'Mahoney and Brendan Gleeson.

U/10 South Tipperary C Shield. Final. Champions : St Patricks (Drangan & Cloneen) Back Row: Bernard Needham, Paddy Gorey, Tom O'Mahoney. Middle Row: Aodhan Meagher, William O'Brien, James O'Rahilly, Gerard Horan. Front Row: Aidan Buckley, Conor Gorey, Kieran O'Brien, Mark Mullally, Mark Slattery, Brendan Gleeson, Thomas O'Brien (capt.) Cathal O'Mahoney, Patrick Gorey.





South Tipperary and County U-16 'B' Hurling Champions : St Patricks (Drangan & Cloneen) Back row (left to right) : Eugene McCormack (sel.), Tom McGrath, Aaron Cronin, Damien McCormack, Anthony Barry, Edmond Phelan, Danny Gleeson, William Phelan, Enda Fogarty, Conor Barry, Sam Morrissey, Eoghán McCormack, Gerry Ryan (sel.). Front row (left to right): Robert Ryan, Jason Hayes, Darren O'Connell, Patrick Moroney, Brian Hickey, Tom Burke, Dermot Molloy (capt.), Robert McCormack, Sean O'Donovan, John McCormack (manager).



South Tipperary and County U-12 Hurling Champions : St Patricks (Drangan & Cloneen) Back row (left to right) : Raechel McCormack, Sarah Mockler, Neil Horan, Marcus O'Halloran, Tony O'Brien, Damian Barry, Neil Gleeson (capt.), Trevor Cunningham, Ciarán Maher, Gavin Strappe, Michelle Meagher, Roisin Horan, Keelan O'Neill. Front row (left to right): Mark Fitzgerald, Eamon Clancy, William O'Brien, Paul Tierney, Brendan Gleeson, Gerard Horan, Stephen Gleeson, Aodhan Maher, Fearghal Hayes, Alan Tobin.



Skeheenarinky U-10 Team Winners of their group in the South Tipperary Hurling Blitz Competition. Back row (left to right) : Eddie Maher (trainer), Eoin Morrissey, Ben Macken, Páidí O'Suilleabháin, Neil Barrett, Bobbie Breedy, John Carey, Sean O'Reilly, Mikey Sweeney, John Martin, Anthony Crotty, Seamus O'Callaghan, Lisa Carey, Shauna Maher, Patrick Cole. Middle row (left to right): Michael Slattery, Kieran Caplice, Noel Vaughan, Blaine Macken, Fionán O'Suilleabháin, Riain O'Callaghan, William English, Tommy Sweeney, Mikey Kearney, Jason Cahil, Adam King, Aaron Macken. Front row (left to right): Adam Finn, Ciarán Cahil, Eddie Barrett.



South Tipperary U-12 'B' Hurling Champions : Ballybacon/Grange. Back row (left to right) : David Condon, Colum Nugent, Daniel O'Regan, David Burke. Middle row (left to right) : Michelle Walsh, Carol Costigan, Michael O'Sullivan, John Bergin, Eoin Walsh, Jason Coffey, Philip Murphy, Jonathan Ryan, John Liston. Front row (left to right): James O'Mahony, William Hally, Aaron Cowan, Philip Walsh Jr., Oisín O'Flynn, Ciarán Nugent, Liam Walsh. Also pictured are selectors Laurence Walshe, Thomas Walshe, Philip Walsh and Liam O'Suilleabháin.



**Summer camp held by Carrick Davins Hurling /Football Club held in August 2003 in Davin Park, Carrick-on-Suir.**

Well done to all our Divisional Champions but especially our County Champions



Team captains Sean Maher (Ardfinnan) and Michael Tarrant (Cahir) with referee, Brian Tyrell before this years Tipperary Senior football final in Clonmel.



**Ballingarry - South Shield U-10 Hurling Champions** : Back row (left to right) : Coaches; Mary O'Shea, Noel Walsh, Georgie Ivors (manager), Tony Patchell. Middle row (left to right) Lee-Ann Walsh, Darren Jenkins, Eoin Jenkins, Eamonn Tuohy, Patrick Walsh, Paul Butler, Michelle Dunne, Shane Cleere, Sean Doherty, John pollard, Michael Tobin, Gerard Fennelly, John O'Connor. Front row (left to right): Niall Walsh, Shane Fitzgerald, Lorraine O'Shea, Conor Mangan, Sean Maher (capt.), Joseph Hanrahan, Jason Grace, William Corbett, Stephen Phelan, Anthony Patchell, Wayne Corbett, Conor Maher.



**Ballingarry - South Tipperary U-14 'A' Hurling Champions** : Back row (left to right) : Peter Logue, Adrian Croke, Ian Ivors, Brendan Ivors, Daniel Fitzgerald, James Logue, Ciaran Shelly, Tomas Fitzgerald, Kevin Fitzgerald, Kieran Fitzgerald, Daniel Fennelly (capt.), Matthew Treacy, Timmy Cleere, David Phelan, Carl Rotheram, Kevin Shelly (manager). Front row (left to right): Gerard Fitzgerald, Brian Kelly, Adrian Cleere, Billy Horan, Jonathan Ivors, Brendan Brennan, Michael (Blondie) Ivors, Jack Fennelly, Michael Power.



**Kilsheelan-Kilcass U-12 'B' South Football Champions** : Back row (left to right) : Shane Collumby, David Corcoran, Adrian McGuire, Stephen Ryan, William McGuire, Jason Earle, David Ryan, Donnacha Corcoran, Damien Dempsey, Yvonne Maher, Emma Corcoran, Joseph Brennan, Damien McCarthy, John Ormond and David Quinlan. Front row (left to right) : Bill Maher, Norman O'Shea, John Kehoe, Stephen Ahearne, Martin O'Dwyer, David Smyth, Rowlan Fitzpatrick, Conor Murphy, James Murphy (not on team), Declan Cashman, Alex Harte and Kevin Larkin.



**Kilsheelan-Kilcass U-14 'B' South Hurling Champions** : Back row (left to right) : William McGuire, Paul Kennedy, Darren McCarthy, David Ryan, Donnacha Lonergan, Danny Harte, Lorcan Ryan, Matthew Hantz, Paul Denn, Paraic Hickey, David Guiry and Lee Tobin. Front row (left to right) : Damien McCarthy, Shane Columby, David Ryan, Robert Hickey, Donnacha Corcoran, Graham Bysouth, Michael Geraghty, Miceal Corcoran, Naoise O'Cuinneagain, Rian O'Cuinneagain, Ciara Maher and Paul Fitzsimons.



### CIARAN LORIGAN

- 2000 - U12 'A' South Football
- 2001 - U12 'A' South & County Football
- 2002 - U12 'A' South Hurling & Football
- 2002 - South & County Peile na nÓg
- 2003 - South Feile na nÓg

### RITA MCGRATH

#### Boys Championship

- 2000 - U12 'A' South Football
- 2001 - U12 'A' South & County Football
- 2002 - South & County Peile na nÓg
- 2003 - South Feile na nÓg

#### Girls Championship

- 2001 - U12 'A' County Football
- 2003 - County Peile



A unique achievement by our Juvenile players Rita McGrath and Ciaran Lorigan who won the County under 14 Camogie and Hurling Skills Competition respectively this year.

# West Tipperary Bord na nÓg

**W**est Tipperary Bord na nÓg once again enjoyed another good year with plenty of good hurling and football games played. It was a year in which Clonoulty-Rossmore took county honours in under-12 A hurling, a title not won in the West for a number of years.

Arravale Rovers showed their true football skills when winning all A football competitions.

Divisional teams all prepared well, but without any silverware. The under-16 hurlers failed to Mid Tipp in the Garda Cup and to North Tipp in the Shield. A combo of South/East Limerick knocked us out of the Munster inter-divisional in under-16 football. Having overcome Mid Tipp in the semi final, we had to give way to South Tipp in the final of friends of Tipperary Football. At under-14 hurling in the Peadar Cummins tournament, we had no joy, losing both games to Mid and South Tipp.

It was a brilliant experience for the under-14 footballers having the games played under lights in Dr. Morris Park. We had a great comeback against Mid in the semi-final, but we had to give way to a good South team in the final.

We thank all our loyal sponsors for their continued support of our juvenile games.

**Officers for 2003;** Life President, James O Donoghue, Arravale Rovers, chairman, Richard O Connor, Arravale Rovers, vice-chairmen (2) John Hally, Rockwell Rovers, Phil Ryan, Kickhams, secretary, Gerry Beary, Cappawhite, assistant secretary, Liam O Dwyer, Eire Og, treasurer, Noel O'Brien, Arravale Rovers, PRO, Tommy Fitzgerald, Solohead, registrar, Roger Ryan, Cashel K.C., county Bord na nÓg reps., Richard O Connor, Gerry Beary, Tommy Fitzgerald, Liam O Dwyer, rep to senior board, D.J. Carr, Golden/Kilfeacle.

Championships started with U16 football. With the new proposals it meant more games in A & B competitions, also with Cashel KC and Arravale Rvs entering second teams at under 12s, 14s and 16s.

GRADE	DATE	WINNERS	RUNNERS-UP	GRADE	DATE	WINNERS	RUNNERS-UP
<b>Allied Irish Bank, Tipperary</b>				<b>Tipperary Co Op</b>			
U16 A football six teams 1 Group.				U12 B hurling 6 team 1 group			
S/F	12.5.03	Arravale Rvs 2-8	Clonoulty-Rossmore 1-11	S/F	14/8/03	Eire Og 7-6 Golden/K 2-1	Galtee Rvs 0-3 Lattin/C 0-4
Replay	19.5.03	Arravale Rvs 5-9	Clonoulty-Rossmore 1-7	Final	20/8/03	Eire Og 3-3	Goldfen/K 2-1
S/F	12.5.03	Galtee Rvs 5-9	Cashel KC 2-2	<b>Permanent TSB Tipperary</b>			
Final	26.5.03	Arravale Rvs 3-12	Galtee Rvs 3-11	U12 C hurling 5 teams			
<b>Quirke Jewellers, Cahir</b>				S/F 28/7/03 Solohead 2-1 Emly 1-2			
U16 B football six teams 1 group				16/8/03 Arravale Rvs 3-0 Sean Treacys 2-1			
S/F	12/5/03	Cappawhite 2-10 Aherlow 1-11	Kickhams 3-2 Sean Treacys 2-1	Final 27/8/03 Solohead 3-2 Arravale Rvs 1-1			
Final	19/5/03	Cappawhite 1-3	Aherlow 0-3	<b>Kelly Soft drinks</b>			
<b>Cashel Credit Union</b>				U14 A hurling 5 teams			
U16 C football 4 teams				S/F 3/9/03 Cashel Kc 0-11 Clonoulty/R 0-5			
Final	5/5/03	Solohead 2-8	Arravale Rvs 1-6	1/9/03 Kickhams 2-9 Arravale Rvs 1-5			
<b>Fitzpatrick Printers</b>				Final 6/9/03 Kickhams 10-8 Cashel KC 1-2			
U12 A football 5 teams 1 group				<b>Caulfields Super Value Tipperary</b>			
S/F	17/5/03	Arravale Rvs 4-12 Clonoulty Rvs 2-9	Aherlow 0-2 Kickhams 0-3	U14 B hurling 6 teams			
Final	26/5/03	Arravale Rvs 2-9	Clonoulty 2-6	S/F 1/9/03 Aherlow 5-4 Rockwell Rvs 2-5			
<b>O'Dwyer Hardware Dundrum</b>				Golden/K 1-4 Cappawhite 0-7 AET			
U12 B Football 5 teams				Replay 4/9/03 Cappawhite 4-5 Golden/K 1-8			
S/F	18/5/03	Galtee Rvs 3-9 Lattin/C 0-5	Golden/K 2-3 Rockwell Rvs 1-1	Final 6.9.03 Cappawhite 1-6 Aherlow 1-4			
Final	25/5/03	Galtee Rvs 2-7	Lattin/C 1-3	<b>Amber Oil Tipperary</b>			
<b>Noel Browne Bus Hire</b>				U14 C hurling 3 teams home and away			
U12 C football 6 teams 1 group				Final 4/9/03 Sean Treacys 2-6 Lattin/C 1-3			
S/F 1	7/5/03	Solohead 0-8 Emly 5-5	Sean Treacys 1-4 Rosegreen 0-5	<b>Tipperary Credit Union</b>			
Final	26/5/03	Emly 2-3	Solohead 0-5	U16 A hurling 6 teams			
<b>Hanly Tyre Centre Tipperary</b>				Play off 5/9/03 Cappawhite 1-8 Galtee Rvs 1-6			
U14 A football 6 teams 1 group				12/9/03 Cappawhite 1-12 Cashel KC 1-9			
Play off	5.6.03	Kickhams 4-5	Rockwell Rvs 2-5	S/F 20/9/03 Arravale Rvs 1-13 Cappawhite 1-6			
S/F	12/6/03	Arravale Rvs 3-10 Aherlow 3-5	Kickhams 3-8 Cashel KC 2-5	Final 28/9/03 Clonoulty/R 1-11 Kickhams 2-6			
Final	16./6/03	rravale Rvs 1-8	Aherlow 2-3	Final 28/9/03 Clonoulty/R 0-15 Arravale Rvs 0-8			
<b>Sergeant Peppers</b>				<b>Centenary Co-Op</b>			
U14 B football 5 teams				U16B hurling 5 teams			
S/F	12.6.03	Cappawhite 2-3 Clonoulty/R 1-7 Galtee Rvs 1-2	Golden/K 1-5	S/F 20/9/03 Rockwell Rvs 1-8 Golden/K 1-6			
Final	22/6/03	Clonoulty/R 3-9	Cappawhite 1-4	28/9/03 Aherlow 1-6 Sean Treacys 2-2			
<b>Kala Electrics</b>				Final 4/10/03 Aherlow 0-15 Rockwell Rvs 1-6			
U14 C football 4 teams				<b>P.J. Burns Plumbing Supplies</b>			
Play off	5/6/03	Lattin/C 2-5	Sean Treacys 0-2	U16 C hurling			
	9/6/03	Sean Treacys 5-9	Solohead 5-3	Final 8/9/03 Eire Og 1-7 Solohead 1-6			
Final	16/6/03	Sean Treacys 2-4	Lattin/C 0-5	<b>Coke Cola Feile na nGael U14 hurling</b>			
<b>Gleeson Concrete</b>				11/5/03 Kickhams 2-10 Eire Og 1-0			
U12 A hurling 5 teams				<b>Coke Cola Peile na nOg U14 football</b>			
S/F	14/8/03	Clonoulty/R 10-10	Rockwell Rvs 1-2	3/5/03 Arravale Rvs 1-3 Golden/K 0-0			
	16/8/03	Kickhams 1-6	Arravale Rvs 2-0	<b>Coke Cola Skillstar</b> – Gerry O'Neill Cappawhite			
Final	18/8/03	Clonoulty/R 4-13	Kickahms 0-4	<b>Coke Cola Poc Fada</b> Eoin McCarthy Arravale Rvs			

# West Tipperary Bord na nÓg Review 2003



At West Bord na nÓg Convention 2/12/02. Front (l to r): Officers – Gerry Beary, Secretary; Richard O'Connor, Chairman; James O'Donnell, West Chairman; Roger Ryan, Registrar; D.J. Carr, Joint Treasurer; Tom Fitzgerald, PRO; Noel O'Brien, Joint Treasurer.



Officers and sponsors at West Bord na nÓg Presentation night in Dundrum. Front (l to r): Phil Ryan, Vice-chairman; Gerry Beary, Sec; Billy Ryan WB Vice-chairman; Richard O'Connor, Chairman WB na nÓg; Denis Ryan, Eithne O'Dwyer. Back: Seamus Hanley, Maurice Ryan, Tom Fitzgerald, PRO; Declan Donnelly, Brendan Cummins, David Morrissey, Paul Madden, Noel O'Brien, Treasurer; John Quirke, Eamon O'Dwyer.



Clonoulty Rossmore U-12 A West and County Champions (hurling). Back row (l to r): Brema Horan, Margaret White, John Coffey, Paddy Heffernan, Liam Kearney, Fr Jim Fogarty, Donal Carroll, Helen Carroll. 3rd row: Martin Sadlier, Philip Kearney, Seamus Carew, Shane Ryan, Kieran Carroll, Cáit Devane, Aidan Ryan, Padraig Heffernan, Judy Ryan. 2nd row: Philip Quirke, Philip Ryan, Michael Quinn, Thomas Butler (capt), Darren Corcoran, Aaron Ryan, Conor Hammersley, Liam Maher, Brian Armstrong, Kevin Maher. Front row: Shane Fryday, Seán Hayes, Aidan White, James Coffey, Niall Shanahan, Jack Spillane, Richard Coffey, Paul Hayes, Kieran Ryan.



At West Tipperary Bord na nÓg medal presentation 2003 in Dundrum. Captains and official. Front (l to r): Brian Carroll, U-14BF, Clonoulty/R; J. Ryan, U-12AF, Arravale Rvs; Tomas Butler, U-12 AG, Clonoulty/R; Danny O'Connell, U-12BF, Galtee Rvs; Leonard Leahy, U-13F Garda Cup Shield; Joe Clancy U-16BF, Cappawhite; Sean Keogh, U-14AH, Kickhams; James O'Leary, U-16AF, Arravale Rvs. Middle row: Jason Forrestal U-16AH, Clonoulty/R; Eoin McCarthy, U-14 Peil na nÓg, Arravale Rvs; David Morrissey, Tipperary M.H. Captain; Brendan Cummins, Tipperary S.H. goalkeeper; J.C. Ryan, Co Chairman Bord na nÓg, Billy Ryan, Vice-Chairman, West Board; Liam O'Dwyer; Richard Ryan, U-16CV, Eire Óg. Back: James Fitzelle, U-12 H Shield, Cashel; Damien Ryan, U-12 CH, Solohead; Pat Maguire, U-14 BH, Cappawhite; Richard Doherty U-12 BH, Eire Óg; T.J. Quigley U-14 CH; Sean Treacys; Thomas Condon U-12 CF, Emly; Kevin Wallace U-16 CF, Solohead.



Galtee Rovers – West U-12 FB Champions, 2003. Front (l to r): Owen Lonergan, Conor O'Sullivan, Christopher O'Halloran, Niall Daly, Brendan McGrath, Padraig Lonergan. Back: Aidan Kennedy, James Smith, Liam Kavanagh, Billy Moloney, John Peters, Danny O'Connell, Ross McGrath, Emmett Ryan, Darren Dwyer.



Emly – West U-12 F 'C' Champions, 2003. Front (l to r): Adam Davern, Paul Breen, Shane Carroll, Leonard Vance, Robert McGrath, Thomas Condon, Jason Ryan, Declan Hennessy, Marie Byrne, Eddie O'Meara. Back: Larry Breen, James O'Meara, John Hennessy (selector), Aideen McAuley, Conor Quish, Christopher McGrath, Patrick McGrath, David Cleary, Con Ryan, Nicholas Alymer, Patrick Quinn, Declan McGrath, Adrian Dawson, David McGrath, Declan Moriarty, Colm Walsh, Christopher Hennessy, Irene Leahy, Patsy Walsh.



West Tipperary U-16 Hurling Team. Back (l to r): James O'Leary, Paul Fitzgerald, Seamus Grogan, Brian Fox, Tadhg Ryan, Jody Ryan, James Dudley, Kieran Marnane, Eoin Barrett, James Heffernan, Michael Heelan, Cathal Dillon, John Ryan (B), Diarmuid Cullen, Jason Forrestal, Daithi Ivors, Aidan Fogarty. Front (l to r): Tommy Quinn, Stephen Rhatigan, Niall Kennedy, Timmy Hammersley, Timmy Dalton, Tommy Comerford, Padraig Hayes, James Loughman, Stephen Spillane, Michael O'Neill, Michael Richard Buckley, Timmy Cranley.



Camp Arravale Rovers on vist of Redser O'Grady and david Morrissey . . . Back (l to r): Michael J. Ryan, Michael Ryan, Craig Quinlan, Sean O'Meara, Brian Kissane, Tom Hayes, Matthew O'Donoghue, Sean Compton, Gavin Hogan, John Crowe, Gerard Mulhaire, Mark Crowe, Brian Lowry, Michael cunningham. Standing athe the back David Morrissey and Redser O'Grady. Front (l to r): Sean McGrath, Kelvin O'Brien, Daniel Jones, Dara Fitzpatrick, Conor Duggan, Eddie O'Meara, Thomas Landers, Joseph O'Connor, Kieran Crowe, Ian Riordan.



Arravale Rvs – West U-12 F 'A' Champions, 2003. Front (l to r): Ian Riordan, Donough Leahy, Diarmuid O'Donnell, Barry Collins, Shane Leahy, Michael Ryan, Michael John Ryan, David Heffernan, Paddy Dalton, Brian Lowry, Gearard Mulhair. Back: Morgan O'Brien, Thomas Landers, Daniel Fowler, Daniel Jones, Niall Donovan, Sean O'Meara, John Brehony, Gerard O'Dwyer, Brian Kissane, Dara Fitzpatrick, Kieran Crowe.



Cappawhite West U-14 'B' H Champions, 2003. Front (l to r): Cathal McCarthy, Mark Buckley, Matthew Walsh, Cormac Heffernan, Jim Fitzgerald, Donagh Heffernan, Dean O'Dwyer, Jim Carr, Darragh Buckley, Jim Ryan (TH), Cian Marnane, Luke Ellis. Back: Niall Creedon (selector), Siobhan O'Neill, Sean O'Carroll (selector), Bridget Barry, Kelan Buckley, Patrick Maguire (capt), Jack Turner, Keith Ryan, Anthony Cummins, Jerry O'Neill, John Hourigan, Kevin White, Robert Ryan, Michael McCarthy (selector), John O'Neill, Patrick Barry.



Arravale Rovers – West U-14 F 'A' Champions. Front (l to r): Willie Gilenan, Sean Egan, Mikie O'Dwyer, Daniel Heffernan, Michael O'Sullivan, Conor McNamara, Alan Kiely, Darren Lowry, Michael J. Ryan. Back: Stephen Rediern, Ian Richardson, Sean Spillane, Fergal McNamara, Eoin McCarthy, Patrick Finnan, Declan Ryan, David Crowe, David McCormack, Tadhg Kinnane.



Clonoulty Rossmore U-14 'B' Football West Champions. Back (l to r): Donal Carroll, Francis Kearney, Padraig Kearney, Marty Ryan, David White, Christopher Morrissey, Donnacadh Ryan, Aaron Wright, Thomas Butler, Jamie Moloney, P.J. Ryan, Daniel O'Dwyer, Eddie Lyng, Andrew Quirke, Liam Maher. Front: Padraig Heffernan, Seán O'Connor, Aidan Ryan, Kieran Hammersley, Brian Carroll (capt), Aidan White, Jim Ryan, Shane Ryan, David Fitzpatrick, John O'Neill, Kieran Ryan, Niall Shanahan. Sitting: Aidan Carroll, James Ryan.



Aherlow – West U-16 H 'B' Champions, 2003. Front (l to r): Bernard O'Brien, William Hennessy, Anne Marie Fahy, Liam Richardson, Vincent Hennessy, Sean Dillon, William White, Thomas Hanley, Ciaran McDonald, Mark Grogan. Back: Brian Moroney (coach), Gordon Peters, Peter Knight, Seamus Grogan, William Óg O'Brien, Cathal Dillon, Dillon, John Hennessy, Tommy O'Neill, Thomas O'Neill, Thomas Fahy, Martin Peters, Gary Frewen, Sean Mullins, Liam McCormack, Cathal O'Shea (manager).



Cappawhite U-16 'B' F Co Finalists, 2003. Front (l to r): Ciarán Ryan (TH), John McGrath, Jerry O'Neill, Peter Buckley, Patrick Maguire, Matthew Ryan (W), David Buckley (Mascot), Jim Carr, Michael O'Neill, Timmy Cranley, Dessie Renehan. Back: Vinny Barry, Gerry Renehan, Jimmy Ryan (P), Paul Fitzgerald, Martin O'Connor, Michael Ryan (W), Michael R. Buckley, Michael P. Buckley, Mark Quinlann, Joe Clancy (capt), Brian Renehan, Colin Andrews, Shane Coughlan.



Arravale Rovers U-16 'A' F Co Finalists 2003. Front (l to r): Jason Sutton, Cormack Molloy, Brian Jones, Michael O'Sullivan, Ned Lowry, James O'Leary, Stephen Rhatigan, Timmy Dalton, Alan Kiely, Paul Ryan, Steven Rediern, David McCormack. Back: John O'Brien, Sean Walsh, Gerard Tuohy, Gavin Ryan, Michael Ellard, Stephen Spillane, Jonathan Ryan, Alan Kenny, Kevin Ryan, Damien Kiely, Sean Spillane, Paudie Noonan.



Clonoulty Rossmore U-16 'A' Hurling West Champions. Back (l to r): Joe Hammersley, Padraig Heffernan, Noreen Ryan, Padraig White, Diarmuid Cullen, Eamon Egan, James Heffernan, Tadhg Ryan, Patrick Ryan, Marty Ryan, Joey O'Keefe, James Manton, Rory Ryan, Thomas Quinn, Philip Ryan, John O'Neill, Séamus Manton, Michael Quinn. Front: James Hammersley, David Egan, Aidan Carroll, Anthony Kearney, David White, John O'Keefe, Jason Forrestal, Timothy Hammersley (capt), Donnacadh Ryan, Jim Ryan, Thomas Butler, Andrew Quirke, Kieran Hammersley, David Fitzpatrick, Aidan Ryan.



Budding Young Hurlers at the Arravale Rovers summer Camp. Back (included): Niall Fitzgerald Conal O'Brien, Maurice Mulhair, Gavin Holmes, Ethan McGrath, Shane Donovan, Gerard Halligan, John Cummins, Mark Tuohy, Dan Shanahan (Waterford), David McCahill, standing at back Redser O'Grady. Front (included): Frank Ryan, Paul Jones, Emmet Hayes, Sean Brennan, Sean Cunningham, Kieran Kearns, Liam Kinnane, Cahal Burns, Cian Ryan, Ronan Fogarty.



Budding Young Hurlers at the Arravale Rovers summer Camp. Back (included): Niall Fitzgerald Conal O'Brien, Maurice Mulhair, Gavin Holmes, Ethan McGrath, Shane Donovan, Gerard Halligan, John Cummins, Mark Tuohy, Dan Shanahan (Waterford), David McCahill, standing at back Redser O'Grady. Front (included): Frank Ryan, Paul Jones, Emmet Hayes, Sean Brennan, Sean Cunningham, Kieran Kearns, Liam Kinnane, Cahal Burns, Cian Ryan, Ronan Fogarty.



Kickhams West Tipperary & Féile U-14 Hurling Champions. Back (l to r): Patrick O'Brien, Gerry Horgan, Paddy Bourke, Gerry O'Brien, Mark Ryan, Sheena Ryan, Eamon Ryan (sel.), Beth Ryan, Jack Ryan, Patsy O'Brien (sel.), Shane Morrissey, Darrah Browne, John Slattery, Eddie McGrath. Front (l to r): Willie Barry, John Fryday, Sean Keogh (capt.), Kenneth Hogan, Shane Heelan, Sean Carroll, Jason Duncan, Niall O'Brien, Sean Hanly.



Golden/Kilfeacle West Tipperary Crosco Cup Winners 2003 . . . . Back (l to r): David Fogarty, Edward O'Donnell, Jason Collins, Stuart Beattie, Donncha Carr, Kevin McCarthy, Michael Carr, Gerard Fogarty, Damien Fogarty, Brian Fogarty, John Colohan, Charles Walsh, Phillip Long. (missing from photo is Daithi Fogarty.) Front (l to r): John Currihan, Diarmuid Carr, Richard Walsh, Michael Harding, Jim 'B' McCarthy, Shane Stapleton, Michael Stapleton, James Tierney, Aidan Fogarty, Paul Fogarty, Mark Bargary, Paddy Ivers, Billy Lonergan.



Arravale Rovers Medal Presentation from (l to r): Peter Gleeson (sel.), James O'Dwyer (capt. M.F.C. 'A'), Tom Richardson (sel.) R.I.P., Brian Glasheen (capt. Co. U-21 F.C. 'B'), Tommy Toomey (sel.).



Emly - West Junior Hurling 'A' Champions, 2003. Back (l to r): Fran Cunningham (manager), Sean Hennessy, Denis Heelan, Oliver Murphy, Owen Buckley, Donncha Breen, Michael O'Donnell, Michael Ring, Paudie Hefferenan, Kenneth Purcell, Eddie Hanley, Michael Ryan, Richie Byrnes, Kieran Lees, Adrian Hennessy, James Ryan, Karl Burke, Billy Hartigan, Joe Heelan. Front (l to r): Tony Hartnett, Meanie Condon, Michael Burke, Jimmy Lonergan, Paul Creamer, Ger Dawson, John Purcell, David Hennessy, P.J. Connolly and James Condon (kids with cup), Danny Cunningham, Pat Buckley, Donal Condon, David Byrnes, Roger English.



Rosegreen, West J.F.C. 'A' - Winners 2003. Front l to r: Tomas Manton, Stephen O'Brien, Frank Cullington, Seanie Cormack, Bobby Wade, Vinnie Downey, Michael Corcoran, Aidan Lonergan, Eddie Walsh, Tom Shelly, David Quirke, Robert O'Brien, Mark Hamett. Back l to r: Paki Hallissey, Pat Cormack, John 'Chalkie' Walsh (Captain), Fintan Ryan, Joe Hennessey, Ryan Hennessey, John Hennessey, Michael Golden, James 'Chalkie' Walsh, Vinnie Downey, T.J. Phelan, Cathal Ryan, David Brennan.



Cashel, West J.H.C. 'B' - 2003. Front l to r: John Simon O'Dwyer, Michael Ryan, Eamonn Morrissey, Gavin Manton, Tony Hewitt, Sean Kennedy (Captain), David Ryan, Michael O'Connor, P.J. Mooney, Aidan O'Dwyer, Brian Lowe, Michael Rendue, Gerard Slattery (Chairman), James Fitzelle Junior. Back l to r: Eugene Maguire (Coach), Seamus Morrissey, Matty Finnerty (Secretary), David Delahunty, Ross Doyle, Jonathan Kennedy, Ciaran Farrell, Robert Whyte, William Fitzelle, Sean Morrissey, John O'Dwyer, Eamonn Foley, John Paul Peters, Daniel Slattery, Edmond O'Dwyer, Mark Moloney, Michael Minogue (Selectors), Donal O'Donoghue (Selector), Noel Hall (Selectors), Pat O'Donoghue Snr.

# SUMMER CAMPS IN THE WEST 2003



Lattin Summer Camp – Front, 1 to r: Anthony Leahy, Robert Cole, Margareth Ryan, Sarah Dillon, Emma Heffernan, Jack Healy, Aideen Heffernan, Carol Leahy, Sophie Nelson, Michael Mulchrone, Mary Rose Hourigan. Middle, 1 to r: Conor Duffy, Liam Cunningham, Noelle Leahy, Aoife Howe, Mark Russell, Darren Neville, Ciaran Gannon, Lisa Buckley, David O’Henev, Niall Enright, Patrick O’Donoghue, Kevin O’Dwyer, Susan Daly. Standing at back, 1 to r: Anne Gill, Shane Kirby, Redser O’Grady, Morgan Healy, Damien O’Donnell, Thomas Leahy.

Lattin Summer Camp – Front, 1 to r: Eamon Cooney, Thomas Mulchrone, David Cooney, Karen Howe, Teresa Leahy, Sean Kiely, Caitriona Kenny, Graham Nelson, Annie Ryan, James Landers, Jason O’Brien, Jack Maher. Middle, 1 to r: Emma Buckley, Aoife Buckle, Ailish Cooney, Robert McGrath, Thomas O’Donoghue, Sean Cunningham, Michael Ryan, Gerry McCahill, Patrick O’Donoghue, Tom Healy, David Hayes, Martin Ryan, Aaron Kenny, Pdraig Finnan. Back, 1 to r: Jamesie Hogan, Redser O’Grady, Sean Ryan, Stephen Martin.



Lattin Summer Camp – Front, 1 to r: Shane Neville, John W. Ryan, Kevin Franks, Nicola Buckley, Cora Howe, Louise Howe, Kate O’Donoghue, Melissa Hayes. Middle, 1 to r: Sara Duffy, Josephine Ryan, Jenny Daly. Back, 1 to r: John W. Ryan, Rory Maher, Shane Ryan, Luke Ashmore, Sean Dillon, Jamie Franks, Seamus Hourigan. Standing at back, 1 to r: Ailbe Burns, Redser O’Grady, Timmy O’Donoghue.

Lattin Summer Camp – Front, 1 to r: Cathal Martin, Leonard Leahy, Maurice Leahy, Ciara O’Dwyer, Arthur Dunne, Timmy Heffernan, Michael Kirby, Martin Kirby, Billy Heffernan. Middle, 1 to r: Mickie Martin, T.J. Heffernan, James Hayes, Michael Hanley, Anne Marie Corcoran, Mairead O’Grady, David Enright, Shane Russell, John O’Henev, John Cooney, Shane Enright, Jason Ryan, John Breen, Edward Gill, Alan Hayes. Back, 1 to r: Redser O’Grady, Tadhg Hennessy.



Arravale Rovers Summer Camp – Front, 1 to r: Evelyn O’Meara, Jessica Hogan, Jenny O’Dwyer, Michelle Lowry, Danielle Nevin, Amy Brennan Cummins, Amy Nevin, Aoife Burns. Middle, 1 to r: Eimear Bennett, Aisling O’Connor, Katie Bennett, Karen Kissane, Sinead Ryan, Aisling Landers, Elaine McCahill, Jennifer McCahill, Aoife Lowry. Back, standing, 1 to r: Mairead Coughlan, Redser O’Grady, Claire O’Brien.



Nollaig Shona agus  
Ath Bhliain faoi mhaise  
dár léitheoirí uile.



# Cumann na mBunscol



*Ballagh NS Roinn 'E' Hurling Champions*



*Loughmore NS Roinn 'A' Hurling Champions*



*Loughmore NS Roinn 'B' Hurling Champions*



*Ladies Peil na mBan Football Primary Panel 2003 . . . Back row (l. to r.): Mary Ryan, Mary Horan, Maura Ring, Leanne Barrett, Jean Marsh, Freda Casey, Lucy Brennan, Saoirse O'Flynn, Samantha Lambert, Michelle Ryan. Front row (l. to r.): Ailish Ryan, Rebecca Cummins, Aine Brislane, Valerie O'Neill, Rebecca Meagher, Olivia McCarthy and Jacinta McCarthy.*



*St. Peters NS Clonmel U-11 'A' Hurling Champions*



*Tipperary Primary Hurling Panel 2003 . . . Back row (l. to r.): Viv Dooley, Tom Butler, John Kennedy, Shane Delaney, Daniel Fennessy, Finbar Horgan, John Sheedy, Noel McGrath, James Barry, Mark Power, Pat Conway, Michael Heffernan. Front row (l. to r.): Patrick Maher, Tom Ryan, James McLoughney, Ciarán Duggan, Pádraig Kelly, Sean McCormack, Anthony Grace, Pádraig Heffernan.*



*Upperchurch NS U-11 Indoor Hurling Champions*



*Clonulty NS U-11 Hurling Champions*



*Ballycahill NS Roinn 'E' Special Hurling Champions*





*Boherlahan NS Roinn 'C' Camogie Champions*



*Rathcabbin NS Roinn 'D' Hurling Champions*



*Inch NS Roinn 'B' Camogie Champions*



*Monastery Tipperary CBS Roinn 'C' Hurling Champions*



*Dunkerrin NS Roinn 'A' Camogie Champions*



*Upperchurch NS Roinn 'B' Hurling Champions*



*Upperchurch NS U-11 Indoor Camogie Champions*



*Grange NS U-11 Roinn 'C' Hurling Champions*



*Moneygall NS Camogie Mini-Sevens  
County Champions 2003*



*New Inn Roinn 'D' Camogie Champions*



Winners of the Schools GAA/McDonalds sponsored Girls Football Catch & Kick Skills Challenge. Pictured (l. to r.): Mary O'Shea (coach), Lorraine O'Shea (Mohober NS), Eoin Kelly (Mullinahone, (Roseanne Phelan (Mohober NS), Sandra Molloy (games development officer).



New Inn U-11 Panel Roinn 'B' County Camogie Champions



Loughmore National School, winners of the Mid Tipp GAA Primary Schools Quiz 2003. Back row (l-r): Jim Ryan (representing Lambe family, sponsor of trophy), Martin Ryan (Loughmore), Jonathan Cullen (Mid Board Youth Officer), John Doyle (Mid Board Chairman). Front: Marty Ryan, Patrick Healy Nolan, Willie Eviston, Tomás McGrath.



Upperchurch NS U-11 County Camogie Champions



Upperchurch NS U-11 County Football Champions



St. Peters & Paul captain, Brian Smyth, receives the U11 Roinn 'A' Hurling Shield.



Ardfinnan NS U-13 Roinn 'C' Football Champions



Rathcabbin N.S. captain Patrick Maher receives the Roinn 'D' Hurling Shield.

# Church and General Cumann na mBunscoil

**C**umann na mBunscoil has been kept busy over the past twelve months. A record number of children have participated in our competitions in 2003. The highlight of the year was undoubtedly the hurling and camogie county finals, which were held at Semple Stadium over two days. Seventeen finals were played in all, with over 600 children taking part. Our organisation is going from strength to strength with each passing year. Let's hope that 2004 will be another successful year for Cumann na mBunscoil, and many boys and girls around the country.

## HURLING:

The hurling championship was played in the glorious conditions of May and June this year. Instead of the usual rain gear, sun cream was packed into many a kit bag. The championship reached its height on the 12th and 13th of June, when 22 hopeful teams arrived at Semple Stadium looking for a county title. The finals threw up some epic encounters, especially the Roinn A final between Loughmore and Nenagh. The Roinn B final, contested between Upperchurch and St. Peter and Paul's, needed to go to extra time before a winner was found! Congratulations to all those, who reached the county finals of 2003 and contributed to two magnificent days of hurling. The winners were as follows:

### Roinn A:

Loughmore 0-13; Nenagh 0-7.

### Roinn B:

Upperchurch 7-3; St. Peter/Paul's: 2-14.

### Roinn C:

Monastery, Tipp Town 2-4; Portroe 1-4.

### Roinn D:

Rathcabbin 7-8; Gaelscoil Dúrlas 0-12.

### Roinn E:

Ballagh 5-7; Gurtagarry 1-0.

### Roinn E (2):

Ballycahill 7-4; Rossmore 3-2.

### Roinn F:

Ballinaclough 4-7; Slieveardagh 3-3.

### Under-11 A:

St. Peter & Paul's: 3-1; Scoil Ailbhe 1-3.

### Under-11 B:

Loughmore 3-10; Ardfinnan 0-5.

### Under-11 C:

Grange 0-11; Boherlahan 0-3.

### Under-11 D:

D: Clonoulty 2-5; New Inn 0-0.

## CAMOGIE

2003 has been the most successful year to date for camogie in our primary schools. When the championship started back in 1993 there was just one division. In 2003 the girls contested four senior divisions, and two U-11s. The standard of games in the finals this year was marvellous, especially the Roinn A final between St Mary's, Nenagh and Dunkerrin. The results were as follows:

### Roinn A:

Dunkerrin 3-0; St Mary's, Nenagh 0-0.

### Roinn B:

Inch 2-0; Moneygall 1-0.

### Roinn C:

Boherlahan 6-1; Kilsheelan 0-0.

### Roinn D:

New Inn 4-4; Cappawhite 1-0.

### U-11 A:

Upperchurch 3-2; Littleton 0-0.

### U-11 B:

New Inn 1-2; Ballylooby 0-1.

### I.N.T.O. Mini-7s.

The mini-7s proved very popular again this year. The hurling and camogie were played in April while the football, boys and girls, was moved to October to coincide with the football season. A special word of thanks to the many teachers, scattered throughout the county, who organised the blitz days. Your help is very much appreciated.

## CAMOGIE:

Moneygall - Cliona Ryan\*.

## HURLING:

Loughmore - Noel McGrath and Aidan McGrath\*

## PEIL NA MBAN:

Our Lady of Mercy Cahir.  
- Leanne Barrett\*

## FOOTBALL:

Loughmore - Dara Dwyer (Fethard)\*.

\*Played in Croke Park during All-Ireland Hurling & Football Semi Finals.

## FOOTBALL AND PEIL NA MBAN:

The football and peil na mban championship got under way in September, and has had unusually good weather throughout. Again the good

news is that the levels of participation are increasing, especially amongst the girls, and many new schools are carving out a name for themselves. Unlike hurling and camogie, the football has no finals' day due to the difficulty in getting any field in November willing to allow 12 games to be played on it. It is due to this, that at the time of writing, many divisions are not yet finalised, and results are not available.

## THE PRIMARY GAME:

Tipperary were represented by three fine Primary Game teams on the Munster stage in 2003. Tipperary took on Clare in the hurling, Waterford in peil na mban and Kerry in football. All those that were selected for a Primary Game panel were a credit to their families and schools. The turn out for the trials this year was astounding, illustrating the enthusiasm there is among children to play for Tipperary. It was often overwhelming for those given the onerous task of selecting a panel of just 17. The selectors deserve a special word of thanks for what is a difficult and time consuming job. Congratulations to all who donned the Tipperary Primary Game jersey in 2003!

### Hurling Primary Game vs. Clare:

John Kennedy - Inch.  
Shane Delaney - Drom.  
Daniel Fennessy - Holycross.  
Finbarr Horgan - St Peter & Paul's.  
John Sheedy - Portroe.  
Noel McGrath - Loughmore.  
James Barry - Upperchurch.  
Mark Power - St Mary's, Clonmel.  
Pat Conway - Kilruane.  
Patrick Maher - Rathcabbin.  
Tom Ryan - Templederry.  
James Moloughney - Carrig.  
Ciaran Duggan - Lorrha.  
Padraig Kelly - Puckane.  
Sean McCormack - Borrisoleigh.  
Anthony Grace - Carrick-on-Suir.  
Padraig Heffernan - Clonoulty.

Selectors: Tom Butler (Ballinure), Michael Heffernan (New Inn), Viv Doolley (Cloughjordan).

### Peil na mBan Primary Game vs. Waterford:

Valerie O' Neill - Ayle.  
Amy Johnson - St Oliver's.  
Rebecca Maher - Drangan.  
Jean Marsh - Ardfinnan.  
Freda Casey - Cahir.  
Lucy Brennan - Glengoole.

Jacinta McCarthy - Ballyporeen.  
 Leanne Barrett - Cahir.  
 Ailish Ryan - Upperchurch.  
 Aine Brislane - Gurtagarry.  
 Samantha Lambert - Grange.  
 Maire Ring - Emly.  
 Sinead Condon - Kilsheelan.  
 Rebecca Cummins - Ayle.  
 Catriona Walsh-Presentation  
 Thurles.

Saoirse O' Flynn - Ardfinnan.  
 Olivia McCarthy - Ballylooby.

*Selectors:* Mary Horan (Ballylooby),  
 Mary Ryan (Upperchurch), Michelle  
 Ryan (Kilsheelan).

*Football Primary Game vs. Kerry*

Brian Quinn - Boherlahan.  
 Gavin Ryan - Rosegreen.  
 Michael Creamer - Portroe.  
 Brian Smith - St Mary's, Clonmel.  
 Michael Fitzgerald - Thomastown.  
 Andrew Walsh - Cloneen.  
 Kevin O' Riordan - Templemore.  
 Paul Horan - Drangan.  
 Stuart Hanrahan - Glengoole.  
 Joseph O'Connor - Grange.  
 Eolan McCarthy - Littleton.  
 Sean Cleary - Rathcabbin.  
 Eoin O' Connell - Fethard.  
 John O' Brien - Gurtagarry.  
 Kieran Tobin - Ballysloe.  
 Shane Russell - Mt Bruis.  
 Alan Hannigan - Kilbarron.

*Selectors:* Liam O' Sullivan  
 (Ardfinnan), Aodhan Wren (Littleton),  
 Michelle Ryan (Kilsheelan).

*Officers:* Hon. President - Jerry Daly,  
 Monadreen, Thurles; Paul Brett, St Oliver's.  
 President - Sean Horan, Clonmel.  
 Chairman - Christie Clancy, Littleton.  
 Secretary - Donal MacCarthy, Ballylooby.  
 Treasurer - Jerry McDonnell, P.R.O. -  
 Michelle Ryan, Kilsheelan. Delegates to  
 Coiste na Mumhan: Christy Clancy,  
 Donal MacCarthy, Michelle Ryan. Dele-  
 gates to Coiste Naisiunta: Christy Clancy,

Donal MacCarthy, Jerry McDonnell.  
 Coiste na Mumhan - Runaí: Jerry  
 McDonnell. County Board Representa-  
 tive: Jerry McDonnell.

A sincere thank you to all those  
 who helped our competitions run so  
 smoothly this year; teachers, co-ordi-  
 nators, clubs, referees and the man-  
 agement and staff of Semple Stadium.  
 Thanks also to our local newspapers;  
*The Nationalist, Tipperary Star,*  
*Nenagh Guardian* and *South Tipp*  
*Today*, who give us tremendous sup-  
 port every year. *Go raibh mile maith*  
*agaibh go leir.*

### North Tipperary Primary Schools Hurling Championship 2003

*Section A:*

There was no section A, the three  
 schools in that section competing  
 directly in the county championship

*Section B & C:*

It was decided to amalgamate these  
 two sections, with the winners com-  
 peting in the county C championship.  
 After a series of first round games  
 Portroe, Puckane, Roscrea and Bor-  
 risoleigh qualified for the semi-finals.  
 Portroe and Borrisoleigh came through  
 to contest the final, which Portroe  
 won.

In the plate final Borrisokane defeat-  
 ed Ballina.

*Section D:*

This was one of the most competi-  
 tive competitions. Fourteen schools  
 participated with Rathcabbin and  
 Cloughjordan defeating Kilruane and  
 Kilbarron respectively in the semi-  
 finals. Rathcabbin won the final by  
 two points.

*Section E:*

Just four teams, Rearchcross, Ard-  
 croney, Silvermines and Gurtagarry,  
 took part. Gortagarry, who defeated

Silvermines, defeated Ardcroney, who  
 accounted for Rearchcross, in the final  
 after extra time.

In the plate final Silvermines defeat-  
 ed Rearchcross.

*Section F:*

This was a new competition for two-  
 teacher schools. Ten teams took part.  
 Ballinaclough and Kilkeary defeated  
 Kyle Park and Birdhill respectively in  
 the semi-finals. Ballinaclough won the  
 final.

Lissenhall defeated Fantane in the  
 plate final.

### North Tipperary Primary Schools Football Championship 2003

*Section B:*

Ten schools entered. Portroe defeat-  
 ed Roscrea, while Templederry  
 accounted for Borrisoleigh in the semi-  
 finals. Portroe won the final.

In the plate final Ballina overcame  
 Puckane.

*Section C:*

Eleven teams took part. Rathcabbin  
 defeated Kilruane, while Burgess  
 defeated Lorrha/Redwood in the semi-  
 finals. Rathcabbin won the final.

In the plate final Cloughjordan  
 defeated Ballinahinch.

*Section D:*

Nine schools entered. After wins  
 over Ardcroney and Kilkeary respec-  
 tively in the semi-finals, Ballinaclough  
 defeated Gurtagarry in the final. In the  
 plate final Lachamore defeated Lis-  
 senhall.

*Football Blitz:*

This was run off for the seven  
 schools too weak to take part in Sec-  
 tion D. After a series of round robin  
 games Birdhill and Fantane qualified  
 for the final, which Birdhill won.

# AWARDS 2002



South Board award winners 2002 - L. to r.: Ian Barnes - young footballer;  
 Fergal O'Callaghan - footballer; Mrs. Kelly representing her son Paul Kelly  
 - hurler; Michael 'Babs' Keating - hall of fame and Trevor Ivors - young  
 hurler.



Cidona Award winners 2002: L. to r.: Jimmy Butler-Coffey  
 (Knocknagow award); Una O'Dwyer - camogie; Declan Browne -  
 Gaelic football and Paul Kelly - hurling. Missing from photo: Gerard  
 Coonan - handball; Michael Cleary - sports executive and Tipperary  
 ladies junior football team representative.

# Tipperary Post Primary Schools Report 2003

## Sean Ó Costagain

It is my privilege once more to submit my report on the activities at Post Primary level on the GAA fields of Tipperary over the past twelve months in what was again a very busy but uneventful year. I wish on behalf of the schools of Tipperary to record our appreciation to Tom Colum, our Servicing Officer, for his marvellous work in ensuring our competitions were high profile, well organised and completed well in advance of our certificate examinations. Our thanks to local media, print and audio for their help and co-operation in publicising and reporting on our games. Without your assistance, our games would suffer. At the outset, I will proceed with results and highlights of our 15 championships.

### CANON FITZGERALD CUP U17 'A' HURLING CHAMPIONSHIP

Thurles C.B.S.	3-11	Nenagh CBS	1-6
Cashel C.S.	3-14	Roscrea CS	2-8

#### FINAL

Cashel CS	2-17	Thurles CBS	3-8
-----------	------	-------------	-----

This, our premier hurling competition at Post-Primary level, saw the return of the old traditional schools for final 2003. It was once again a very entertaining final, which saw a talented Cashel outfit emerge as worthy winners. With most of those players having won Dean Ryan Cup medals in 2001, there is definitely the nucleus of a team to challenge for Harty Cup honours in 2004.

### CANON FITZGERALD SHIELD U17 'B' HURLING CHAMPIONSHIP

#### Semi Finals

Presentation Ballingarry	4-17	Cistercian Roscrea	3-25
Clonmel CBS	5-20	Colaiste Dun Iascaigh	2-6

#### FINAL

Presentation Ballingarry	1-7	Clonmel CBS	0-5
--------------------------	-----	-------------	-----

The wonderful work being done by hurling enthusiasts Aidan O'Leary and Joe Moran in the hearth of Slieve Ardagh country is reaping its rewards and this victory by their school over a very highly thought-of Clonmel C.B.S. augers well for the schools chances in next year's Munster senior 'B' colleges championship. Keep up the great work.

### CROKE CUP U15 'A' HURLING CHAMPIONSHIP

#### Semi Finals

Nenagh CBS	3-14	Borrisokane C.C.	1-7
Thurles CBS	4-18	St. Joseph's Borrisoleigh	3-3

#### FINAL

Thurles CBS	2-8	Nenagh CBS	1-4
-------------	-----	------------	-----

The Croke Cup, which is one of the oldest Post-Primary competitions in the county commencing back in 1935, saw two very deserving teams emerge to contest the final. The overall balance of the Mid Tipp school proved decisive in the end of an excellent final. Subsequently Nenagh C.B.S. had some compensation when the same team captured the Munster U-15 Corn An Phiarsaigh later in the year. Thurles C.B.S. having proceeded to Munster U-15 'A' final v. St. Flannan's, Ennis and despite a gallant effort, had to give best to the Clare nursery.

### Hennessy Cup U15 'B' Hurling Championship:

Presentation Ballingarry	2-5	Clonmel CBS	0-4
Nenagh VS	5-7	Cistercian Roscrea	2-6



Canon Fitzgerald Cup Winners 2003, Cashel CS. Front l to r: William Fitzell, Paul O'Dwyer, James Keane, Tommy Comerford. Centre l to r: Fr. Bernie Moloney, James Dudley, James Heffernan, Darragh Hickey, vice-captain; Michael Heelan, John Dwyer, Pdraig Hayes, Mr. T.J. Quinn. Back l to r: James Hayes, Brian Maher, Eoin Shine, Kevin Griffin, Nigel Hayes, captain; James McCarthy, Paddy Ivers, Eoin Barrett, Tony Hewitt, Michael Harding, Daniel McCarthy. Missing from photograph: A.J. Maher.



CBS Thurles, Croke Cup Champions 2003. Back l to r - Noel Kinane (Moycarkey), Liam Ryan (Hollycross), Kevin Moran (Moycarkey), Aidan Ryan (Moycarkey), James Kennedy (Hollycross), John Joe Bourke (Durlas Og), Michael Cahill (Durlas Og), Patrick Bourke (Durlas Og), Micheal Gleeson (Durlas Og), Stephen Dorney (Durlas Og), Stephen Maher (Galmoy), Paul Connors (Durlas Og), Colm Stapleton (Upperchurch), Diarmuid Cullen - Captain (Clonoulty), Paul Kennedy (Moycarkey), Jamie Fanning (Moycarkey), Pdraig Maher (Durlas Og). Missing: Ciaran Clohessy (Moycarkey), Pierce Stakeelum (Hollycross), Michael Carr (Hollycross).



Roscrea C.S. All Ireland Junior 'A' Vocational Champions 2003. Front row l to r: Kevin King, Killenaule; Ger Moten, Moneygall; John King, Moneygall; James Doran, Camross; Enda Dooley, Roscrea; Eoin Doran, Camross; Philip Fanning, Moneygall; Sean Fitzgerald, Roscrea; Stephen McLoughney, Coolderry; Tadhg Keenan, Camross; David Buckley, Roscrea. Middle row l to r: Mr John Haugh, Deputy Principal; Owen Shanahan, Roscrea; Owen Moloney, Roscrea; Owen Delaney, Roscrea; Brian Franks, Roscrea; Declan Teehan, Coolderry; Kevin Dooley, Roscrea; Paul Stone, Roscrea; Declan Murray, Coolderry; Willie Smyth, Trainer; Mr Gerard O'Brien, Principal. Back row l-r: Mark O'Meara, Roscrea; Joseph Treacy, Moneygall; Conor Doran, Camross; Cathal Parlon, Coolderry; David O'Hara, Ballyskenagh; Keith Baggott, Roscrea; Thomas Devereux, Moneygall; Nigel Dooley, Coolderry; Mark Bevans, Shinrone; James Marigan, Roscrea; William McLoughney (captain), Clonakenny.



Scoil Ruain, Killenaule Panel Supermacs All Ireland Vocational Schools Finalists. Back l to r: Gerry Maguire, (Coach), Michael O'Connor, Sean Cahill, Michael Heffernan, Jamie McCormack, Nial Teehan, Kevin Kenny, Edward Stokes, Matthew Maher, Johathan O'Dwyer, Brendan Fanning, Shane Hanrahan, David McGuire, Francis Kearney (Selector). Front l to r: Gerry Kennedy, Keith Holohan, Mark O'Brien, Shane McCarthy, William Coleman, John Coleman, Shane Long, Jeff Brennan, No. 24 Mark McCormack, John Holohan.



Cistercian College Roscrea, Sciath UI Chathan. Front row l to r: A. Cody, Clonkenny; R. Shanahan, Sixmilebridge; J. Cody, Clonkenny; S. Hennessy, Captain, Kilruane McDonaghs; D. Shannon, Castlegar; T. Delaney, Clough/Ballacolla; L. Hyland, Clough/Ballacolla; K. Quinlan, Ballinamore/Durrow. Middle row l to r: P. Duggan, Moycarkey/Borris; T. Phelan, Camross; D. Flanagan, Tullamore; D. Cody, J.K. Brackens; E. Mullins, Naomh Brid; D. Cavanagh, Thurles; S. Hackett, Tullamore.



St Joseph's College, Borrisoleigh All Ireland Senior (B) Runners Up 2003. Back row (l.-r.): Donal Norton, Michael Harty, Brendan Duggan, Michael Ryan, Brian Graydon, Jonathon Maher, Eoin Russell, Denis O'Meara, Philip Bourke, Andy Kinane, Martin Butler, David Kearns, Eric Woodlock, Ciaran Brislane, Mark Cahill, Cathal Flynn, Grey Bowe. Front row (l.-r.): Brendan Maher, Willie Ryan, James Hogan, Daniel Shanahan, James Woodlock, David Young, Donnacha Kennedy, Paddy Stapleton, Edward Costello, Brendan O'Sullivan, Andy Fogarty, Justin Cleary, Shane Finnan.



Abbey CBS - Rice Shield Winners, Westcourt Cup 2003. Front l to r: Damien O'Brien, Dara Kennedy, Billy O'Meara, John Joe O'Brien, Peter O'Dwyer, Darren Lowry, Eoin O'Malley, Pat Ryan. Middle l to r: Declan Riordan, James Rhatigan, Bernard O'Brien, Michael O'Sullivan, Ciaran McDonald, Sean Spillane, William Óg O'Brien, Owen McCarthy, David Kennedy, Owen Fitzbiggon, Michael Ryan, Kevin Ryan. Back l to r: Denis O'Dwyer, Liam Horgan, Mark Fanning, Padraig Lyons, Tadgh O'Donnell, James Ryan, Padraig O'Dwyer, Robert Walsh, Shane Egan, Christopher Hadnett, Ian Richardson, Oisin O'Dwyer.



Tipperary Senior Vocational Panel - All Ireland Finalists. Back row l to r: Tom Kennedy, Patrick Mumane, Cathal Parlan, Paddy Troy, Keith Condon, Dan Hoctor, Michael Heffernan, Ray McLoughney, Darragh Egan, Niall Teehan, Niall Madden, Mark Ryan, Enda Forde, Willie Moloughney, Martin Ryan, Kevin Quinlan. Kneeling: Kieran O'Sullivan, Joey McLoughney, Paul Diffily, John Holohan, Ray Murray, Edward Bevans, Colm Larkin, Padraig Moriarty, Conor Hayes, Shane Long, Richie McGrath, Nicholas Kenny, Gerry Kennedy, Conor Foley.

## FINAL

Presentation Ballingarry 1-9 Nenagh VS 1-7

In what was a great year for Ballingarry on the domestic scene, they deservedly captured

U-15 'B' championship and Hennessy Cup with a narrow victory over Nenagh V.S.

Our congratulations again to all concerned.

## McGabhann Cup football 'A' championship - Under 1/6/84:

Coláiste Dun lascaigh 3-8 Cashel CS 0-11

Clonmel CBS 1-14 Our Lady's Templemore 1-7

## FINAL

Clonmel CBS 0-14 Colaiste Dun lascaigh 1-5

Clonmel High School added the Tipperary senior Post Primary championship to the Munster title (Corn an Uachtarán) with a very well fired up and focused outfit. It augers well for football in Tipperary to have such a powerful nursery as Clonmel come to the forefront. Our congratulations to all concerned and keep up the good work.

## SCIATH MHIC GABHANN FOOTBALL 'A' Under 1/6/84

### Semi Finals

Nenagh CBS 1-7 St. Joseph's Borrisoleigh 0-8

Killenaule VS W/O Carrick-on-Suir VS

### FINAL

Killenaule VS 1-16 Nenagh CBS 2-13(Draw)

Killenaule VS 1-10 Nenagh CBS 1-5

Despite the fact that we had a great final that went to a replay, there was a lot to be disappointed about concerning this competition in 2003. Despite nine teams affiliating, four failed to fulfil their fixtures, which needs to be addressed in order not to bring the competition into disrepute. Nenagh VS, Borrisokane VS Carrick-on-Suir VS and Presentation Ballingarry failed to fulfil fixtures. In that context, I would request schools not to affiliate if they are not going to participate as it gives rise to an organisational nightmare.

## Cusack Cup U15 'A' Football

### Semi Finals

Clonmel CBS 5-11 Colaiste Dun lascaigh 4-9

Tipperary CBS 1-18 Our Lady's Templemore 2-4

### FINAL

Tipperary CBS 2-10 Clonmel CBS 2-5

Having won the Munster U15 Corn na mBandon, Tipperary CBS were favourites to capture this trophy in 2003. They were deserving winners of an excellent competition and with a talented group like this at their disposal, the future looks bright for the Abbey in the immediate future. Well done again to all concerned. Keep up the good work.

## CARRICK SHIELD U15 'B' FOOTBALL

St. Joseph's Borrisoleigh 3-6 Nenagh CBS 1-9

Killenaule VS 1-13 Thurles CBS 1-4

### FINAL

St. Joseph's Borrisoleigh 3-8 Killenaule VS 3-10

Of the ten teams that affiliated, one school, Scoil Ailbe, Tipperary Town withdrew. The level of competition was excellent from the outset culminating in a tremendous final, which saw Killenaule V.S. capture their second county title. Spare a thought for Borrisoleigh who had an excellent year on the colleges scene being very active not alone in Tipperary but also in Munster competitions.

## Senior Hurling 'C' Champions 2002-2003

St. Joseph's Newport

## Senior Football 'C' Champions 2002-2003

P.P. Fethard

## Junior Football 'C' Champions 2002-2003

P.P. Fethard



Abbey CBS Captains 2003. From l to r: Ciaran Clifford with County U14F Cup; Timmy Dalton with Munster U15/F Cup and Peter O'Dwyer with Westcourt Cup U14 Hurling.

### Corn Ui Chathain 'A' First Year Championship Hurling

Clonmel CBS 7-8 Borrisokane CC 2-7

### Sciath Ui Chathain 'B' First Year Championship hurling

Cistercian College Roscrea 6-15 Carrick-on-Suir VS 0-4

### U14 'A' Football Championship – Blitz final

Tipperary CBS 2-5 Colaiste Dun Iascaigh 0-5

### U14 'B' Football Championship – Blitz final

Clonmel CBS 'B' 1-5 Thurles CBS 1-0

The past year, despite many distractions in the form of weather, mid term exams and industrial unrest, I am glad to report a quite successful year. We succeeded in getting all our competitions completed even though some went quite late.

Once again our thanks are due to county board for their unfailing assistance to the schools Post Primary Board. Our thanks to county chairman, Donal Shanahan, for invitation to schools that contested All-Ireland finals to a meal and presentation in May. It was an unqualified success and recognition of the great efforts by our schools to keep the flag flying at national level. You measure your standards by being able to compete at national level and therefore it is with pride I say a sincere well done to Roscrea C..S. and their most dedicated coach/trainer, William Smith, for bringing back the junior All-Ireland vocational schools title to the county. Our commiserations with St. Joseph's Borrisoleigh and Killenaule V.S. for falling at the final flight in their attempt to capture All-Ireland honours. A sincere well done to Tipperary C.B.S., St. Joseph's Borrisoleigh, Nenagh C.B.S. and Clonmel C.B.S. for capturing provincial titles in different competitions and hard luck to those who failed in a number of finals. It is great to be there and persistence always gets its reward.

The new format for running the Harty, while congesting an already congested programme, has its supporters and I must say not without good reason but just the same, we cannot keep adding extra games to the school calendar without eliminating certain competitions, which appear to be overlapping from an age point of view.

As it is my last year as secretary of the Tipperary Post Primary Schools Board, I wish to say a sincere thank you to all games masters, referees, groundsmen, and all others that I have been involved with during my term of office. It has been most fulfilling and I want to sincerely thank James O' Donoghue for taking up the position and I want to wish him every success in the future.



Abbey CBS, Under 15 Football County and Munster Champions 2003. Front row l to r: Damien Ryan, Danie Quirke, John O'Kelly, Timmy Dalton, Rhodie O'Dwyer, Ciaran McDonald, Noel Leahy. Middle row l to r: John O'Dwyer (Trainer), Sean Mullins, Alan Kiely, Ian Bourke, Sean Walsh, Brian Jones, David Enright, Bernard O'Brien. Back row l to r: Owen Fitzgibbon, Jamie O'Callaghan, Stephen Martin, Thomas O'Neill, Cathal Dillon, Seamus Grogan, Tadgh Hennessy, Paul Ryan, Noel Kilcoyne (Coach).



Presentation Secondary School, Ballingarry, winners of Under 17 Hurling Fitzgerald Shield and the Under 16 Hurling Hennessy Cup. Back row l to r: Phil Ivors, Ballingarry; Michael Phelan, Gortnahoe; Mark Dwyer, Gortnahoe; Matthew O'Donnell, Killenaule; Patrick Doheny, Emeralds; Tom Butler, Ballingarry; Sean Lahert, Gortnahoe. Middle row: Mr Aidan O'Leary, Robert McCormack, St. Patricks; Matthew Rotheram, Ballingarry; Tom McGrath, St. Patricks; Matthew Treacy, Ballingarry; Danny Gleeson, St. Patricks; John Murphy, Mullinahone. Front rows: William Barnaville, Gortnahoe; Michael Fogarty, Ballingarry; Keith Dwyer, Gortnahoe; Niall Bergin, U-16 Captain, Killenaule; Ned Tobin, Mullinahone; Ian Murphy, Killenaule; Kieran Bergin, U17 Captain, Killenaule; Brian McCormack, St Patricks; Thomas Maher, Ballingarry; Richard Butler, Ballingarry; Joey Doheny, Emeralds; Alan Cooney, Ballingarry; James Logue, Ballingarry.



Abbey CBS, County Under 14 Football Winners 2003. Front l to r: Denis Lawton, Anthony Ryan, John Joe O'Brien, Gordon Peters, Joseph O'Keefe, Kevin Ryan, Peter O'Dwyer. Back l to r: Declan Riordan, Dara Kennedy, James Rhaligan, Denis O'Dwyer, Robert Walsh, David McCormack, Ian Richardson, Oisín O'Dwyer, Michael Ryan.

# The Tipperary Year Book Awards

BY JAMES HOLOHAN

Last year the inaugural Yearbook Awards took place. There was general agreement that most of them went to those most deserving. However, some of the awards did not meet with universal approval and indeed it could be said that they were quite controversial and that there were others more worthy of them.

This year it was decided to discontinue the scheme due to the exorbitant cost. In response to public demand sponsorship was sought and an approach was made to Comhlucht Aer Te Na hEireann (The Irish Hot Air Company) to come on board. Having so many branches in the county they were delighted to accede to our request.

Following our appeal for nominations our office was inundated with names of potential worthy recipients and it left our adjudicating panel with a major headache. After many meetings and burning the midnight oil the panel's successful nominees are listed below.

## County Awards

### THE IF YOU DON'T SUCCEED AT FIRST - TRY TRY AGAIN AWARD:

Goes to the Killenaule U/21 Hurling team. After many attempts at minor and U/21 against Thurles Sarsfields they finally came good. The Hills are alive with the clash of the ash.

**THE KING OF SPADES AWARD:** Goes to the many volunteers who lend a hand to the re-sodding of goalmouths. Wouldn't it be great if it was possible to lay an artificial surface in this much trodden area?

**THE QUEEN OF CLUBS AWARD:** Goes to the ladies who never let us down when it comes to making teas, preparing sandwiches and washing jerseys. Advice to men - stay away from the kitchen.

**THE HURLER ON THE DITCH AWARD:** Goes to those supporters who showed their feelings in no uncertain manner to Michael Doyle following our defeat by Kilkenny. To those so-called fans - Did you apply for the job when the vacancy arose?

**THE OFF THE RAILS AWARD:** Goes to our camogie team who looked resplendent in their new attire on All-Ireland Final Day. More importantly was their brilliant victory fashioned over the rebels.

**THE TOP DOG AWARD:** Goes to the greyhounds from Toomevara. Unquestionably the best hurling team in the county. Against Thurles Sarsfields, despite leading all the way from trap to line they nearly got caught in a photo finish.

**THE LUCK OF THE DRAW AWARD:** Goes to the Kilsheelan Club. In recent months they won two cars and many valuable cash prizes in the County Draw. To the two lucky ladies we say - beware of those penalty points!!!

**THE ROLL BACK THE PAGES OF HISTORY AWARD:** Goes to the county camogie board whose mammoth 700-page production will make a great Christmas read. Come on girls - give us another three in a row.

**THE BOOKER PRIZE AWARD:** Goes to Knockavilla Kickhams as they were the only ones to publish their club history. Well done to J.J. & Co. This will provide interesting reading with moments of nostalgia out there in Westside.

**THE SOUND OF MUSIC AWARD:** Goes to everyone who participated in SCOR. Despite its dwindling popularity our advice is - Get out there and take part, remembering all the world's a stage.

## National Awards

**THE STEEL HURLEY AWARD:** Goes to Clare goalkeeper Davy Fitzgerald. It will come in handy for striking uprights, goalposts, advertising hoardings etc thus saving his own half door for its original purpose.

**THE MOST COLOURFUL PLAYER AWARD:** Goes to Anthony you know who. Unfortunately, for him there was no Sam at the end of the Rainbow.

**THE MISS OF THE YEAR AWARD:** Goes to Westmeath's Dessie Dolan. He failed to avail of easy chances on successive weeks - maybe a pair of Puma-sponsored boots would have done the trick.

**THE JOHNNY COME LATELY AWARD:** Goes to the large number of fans who arrive late for matches thus delaying the starting time and also live T.V. transmission. Next time leave home earlier or

take the train.

**THE BARE FACTS AWARD:** Goes to the Wexford supporter who did his party piece at the Leinster hurling final. Perhaps men of greater substance are needed if his county is to break the Kilkenny monopoly in Leinster.

**THE MOST VERSATILE PLAYER AWARD:** Goes to AN Other. A.N. has a wide range of skills, which means that he can be selected in any position. Unfortunately his talents have not yet been awarded with any honours.

**THE BEST ACTOR AWARD:** Goes to those who fail to stay on their feet when a soft free is in the offing. After retirement a career on the boards might be worth a try.

**THE FLOG A DEAD HORSE AWARD:** Goes to the G.A.A. authorities for keeping the ailing Railway Cup competitions alive. We, here in the office say, give it a one-way ticket to oblivion.

**THE TAIL WAGGING THE DOG AWARD:** Goes to the Cork county board as they always get their way when it comes to making fixtures. Frankly speaking they had no opposition.

**THE COUCH POTATO AWARD:** Shared jointly by the Kilkenny and Galway supporters for their absence in large numbers from the All-Ireland U/21 hurling final at Thurles. The Golden Wonders on the pitch deserve a wider audience.

Last year a decision was made to let Santa Claus do the honours, unfortunately due to his heavy schedule the awards failed to arrive on time. On this occasion Comhlucht Aer Te Na hEireann have generously agreed to hold an awards ceremony. At the time of going to press no date has been finalised. For further information Email us at [www.pieinthesky@hotmail.com](mailto:www.pieinthesky@hotmail.com).



Tipperary camogie stars Deirdre Hughes and Una O'Dwyer with recently formed camogie club members at Nenagh Éire Óg.



# SCOREBOARD 2003

Compiled by Seamus O'Doherty

## COUNTY FINALS - HURLING

### Senior:

Toomevara	3-19
Thurles Sarsfields	3-16

### Inter:

Kilruane MacDonaghs	2-17
Burgess	2-15

### Junior 'A':

Thurles Fennellys	1-17
Burgess	1-17
	(draw)

Thurles Fennellys

Burgess	0-14
	(replay)

### Junior 'B':

Lorrha	2-10
Carrick Swans	1-9

### Under-21 'A':

Killenaule	4-11
Thurles Sarsfields	1-10

### Under-21 'B':

Newport	2-9
Carrick Swans	0-8

### Under-21 'C':

Ballyneale	0-11
Clonakenny	0-10

### Minor 'A':

Moycarkey Borris	1-12
Carrick Swans	1-12
	(draw)

Moycarkey Borris	2-8
Carrick Swans	2-4
	(replay)

### Minor 'B':

Drom-Inch	7-8
St. Patrick's	2-7

### Minor 'C':

Seán Treacy's	6-9
Portroe	0-9
	(draw)

### Under-16 'A':

Carrick Swans	1-8
Durlás Óg	1-6

### Under-16 'B':

St. Patrick's	4-18
Moyne-Templetuohy	3-7

### Under-16 'C':

Borrisokane	1-12
Éire Óg, Annacarty	1-7

### Under-14 'A':

Dúrlas Óg	3-6
Nenagh Éire Óg	2-9
	(draw)

Nenagh Éire Óg	3-7
Dúrlas Óg	1-6
	(replay)

### Under-14 'B':

Borrisoleigh	3-6
Boherlahan-Dualla	2-2

### Under-14 'C':

Newport	7-10
Dúrlas Óg 'B'	1-3

### Under-12 'A':

Clonoulty-Rossmore	4-4
Nenagh Éire Óg	1-3

### Under-12 'B':

Templederry	5-4
J.K. Bracken's	4-7
	(draw)

J.K. Bracken's	1-6
Templederry	1-5
	(replay)

### Under-12 'C':

St. Patrick's	3-10
Solohead	2-3

## COUNTY FINALS - FOOTBALL

### Senior:

Cahir	0-7
Ardfinnan	0-4

### Inter:

Grangemockler	1-9
Kildangan	0-9

### Junior 'A':

Fethard	
Ballina	

### Junior 'B':

Clonmel C	
Knockshegowna or J.K. Brackens	

### Under-21 'A':

Ballina	2-8
Killenaule	0-10

### Under-21 'B':

Kilsheelan/Kilcash	1-12
Gortnahoe-Glengoole	0-8

### Under-21 'C':

Aherlow	2-11
Ballina 'B'	0-2

### Minor 'A':

Moyle Rovers	1-13
Gortnahoe-Glengoole	1-5

### Minor 'B':

Carrick Swans	2-13
Borrisokane	2-6

### Minor 'C':

Moyle Rovers (2)	5-8
Lorrha	1-6

### Under-16 'A':

Moyle Rovers	3-10
Arravale Rovers	2-9

### Under-16 'B':

Killenaule	3-10
Cappawhite	1-7

### Under-16 'C':

Ballinahinch	3-6
Clonakenny	0-7

### Under-14 'A':

Durlás Óg	1-4
Nenagh Éire Óg	0-5

### Under-14 'B':

Cahir	5-12
Upperchurch-Drombane	0-2

### Under-14 'C':

Ballyporeen	3-11
Clonakenny	2-8

### Under-12 'A':

Cahir	2-12
Arravale Rovers	0-2

### Under-12 'B':

Newport	2-3
Galtee Rovers	1-3

### Under-12 'C':

Borrisoleigh	6-6
Clonakenny	1-2

## INTER-COUNTY C/SHIPS - HURLING

### Senior:

May 18th at Páirc Uí Chaoimh:

Clare	2-17
Tipperary	0-14

June 14th at Portlaoise:

Tipperary	3-28
Laois	0-13
	(Qualifiers)

### July 13th at Pearse Stadium:

Tipperary	1-18
Galway	1-17
	(Qualifiers)

### July 27th at Croke Park:

Tipperary	2-16
Offaly	2-11
	(Q/F)

### August 17th at Croke Park:

Kilkenny	3-18
Tipperary	0-15
	(Semi-final)

### Intermediate:

May 18th at Páirc Uí Chaoimh:

Tipperary	3-19
Clare	1-6

June 8th at Semple Stadium:

Cork	3-16
Tipperary	1-14

### Under-21:

July 9th at Cusack Park, Ennis:

Tipperary	1-11
Clare	0-11

### July 31st at Semple Stadium:

Tipperary	1-18
Cork	3-12
	(Munster Final) (Draw)

*August 3rd at Páirc Uí Chaoimh:*

Tipperary .....	2-14
Cork .....	0-17
(replay - A.E.T.)	

*August 22nd at Cusack Park, Ennis:*

Galway .....	2-20
Tipperary .....	2-16
(semi-final - A.E.T.)	

**Minor:**

*April 9th at Semple Stadium:*

Tipperary .....	1-9
Waterford .....	0-10

*May 14th, at Semple Stadium:*

Tipperary .....	1-9
Limerick .....	2-1
(S. Final)	

*June 29th at Semple Stadium:*

Tipperary .....	2-12
Cork .....	0-16
(Munster Final)	

*August 10th, at Croke Park:*

Galway .....	2-19
Tipperary .....	2-16
(All-Ireland Semi-Final)	

**MASTERS (OVER-40):**

Tipperary beat Kerry.  
Limerick beat Tipperary  
Tipperary beat Dublin.

*October 11th at Bruif:*

Tipperary .....	3-19
Kerry .....	1-10
(All-Ireland Final)	

**Inter-County Championships (Football):**

**Senior:**

*May 25th at Walsh Park:*

Tipperary .....	0-18
Waterford .....	1-12
(1st round)	

*June 15th at Tralee:*

Kerry .....	0-25
Tipperary .....	1-10
(S/F)	

*June 21st at Semple Stadium:*

Tipperary .....	1-14
Carlow .....	0-13
(Qualifiers)	

*July 5th at Croke Park:*

Donegal .....	2-19
Tipperary .....	0-15
(Qualifiers)	

**Junior:**

*May 25th at Walsh Park:*

Tipperary .....	2-8
Waterford .....	0-13
(1st round)	

*June 15th at Tralee:*

Kerry .....	0-15
Tipperary .....	0-8
(S/F)	

**UNDER-21:**

*August 15th at Kilmallock:*

Kerry .....	4-17
Tipperary .....	2-5
(S/F)	

**MINOR: (Round Robin Games)**

*March 1st at Kilmallock:*

Kerry .....	2-13
Tipperary .....	1-7

*March 8th at Ballygran:*

Tipperary .....	2-9
Cork .....	1-9

*March 15th at Fermoy:*

Tipperary .....	2-6
Limerick .....	2-5

*March 29th at Cloughaun, Limerick:*

Clare .....	4-9
Tipperary .....	1-10

*April 16th at Fermoy:*

Tipperary .....	2-15
Waterford .....	1-3

*July 3rd at Kilmallock:*

Cork .....	2-18
Tipperary .....	0-8
(S/F)	

**"Masters":**

*August 9th at Claremorris:*

Tipperary .....	1-15
Mayo .....	1-15

*August 16th at Templemore:*

Tipperary .....	1-12
Cavan .....	1-4

*August 30th at Killeigh:*

Donegal .....	2-19
Tipperary .....	2-5

*September 13th at Gortletragh:*

Leitrim .....	1-14
Tipperary .....	1-8

(Tipperary did not qualify for the Quarter Final)

**ALLIANZ N.H.L. - DIV. 1 'B'**

*February 23rd at Nenagh:*

Tipperary .....	4-14
Offaly .....	1-8

*March 9th at Semple Stadium:*

Tipperary .....	1-17
Limerick .....	1-8

*March 16th at Nenagh:*

Tipperary .....	3-21
Wexford .....	1-11

*March 23rd at Dungiven:*

Tipperary .....	4-19
Derry .....	2-14

*March 29th at Semple Stadium:*

Cork .....	4-15
Tipperary .....	4-11

**SECOND PHASE:**

*April 13th at Nowlan Park:*

Tipperary .....	2-19
Kilkenny .....	2-16

*April 20th at Semple Stadium:*

Tipperary .....	3-15
Galway .....	2-18

*April 27th at Ennis:*

Tipperary .....	0-22
Clare .....	0-14

*May 5th at Croke Park:*

Kilkenny .....	5-14
Tipperary .....	5-13
(Final)	

**SENIOR HURLING CHALLENGE GAMES**

*January 12th at Dr. Morris Park:*

U.C.C. ....	1-17
Tipperary .....	0-16

*January 19th at Dr. Morris Park:*

Birr .....	2-15
Tipperary .....	1-13

*January 26th at Nenagh:*

Tipperary .....	1-25
Athenry .....	0-9

*February 1st at Clan na nGael, Dublin:*

Tipperary .....	2-28
Dublin .....	0-13

**McGRATH CUP SENIOR FOOTBALL**

*January 18th at Clonmel:*

Tipperary .....	1-8
Waterford .....	2-4
(Semi-Final)	

*January 26th at Miltown Malbay:*

Tipperary .....	1-9
Clare .....	1-8
(A.E.T. - Final)	

**ALLIANZ N.F.L. - DIVISION 2 'B'**

*February 2nd at Ardfinnan:*

Clare .....	1-12
Tipperary .....	1-6

*February 9th at Dungarvan:*

Waterford .....	1-11
Tipperary .....	1-7

*February 16th at Celtic Park:*

Tipperary .....	2-10
Derry .....	1-13

*March 2nd at Ardfinnan:*

Carlow .....	1-14
Tipperary .....	1-8

*March 9th at Wexford Park:*

Wexford .....	2-15
Tipperary .....	0-7

*March 23rd at Nenagh:*

Longford .....	4-18
Tipperary .....	2-11

*April 6th at Clones:*

Monaghan .....	1-12
Tipperary .....	1-8

**All-Ireland 7-a-side hurling (Kilmacud Crokes)**

*September 13th (Dublin area):*

Portroe .....	3-11
Midleton (Cork) .....	1-5

Portroe .....	5-6
St. Gabriel's (London) .....	0-4

Portroe .....	5-8
Newmarket-on-Fergus (Clare) .....	4-2

Portroe .....	5-7
Coolderry (Offaly) .....	3-6
(Quarter-Final)	

Portroe .....	1-10
Rathdowney (Laois) .....	1-8
(Semi-Final)	

Garryspillane (Limerick) .....	5-7
Portroe .....	3-10
	(Final)

#### All-Ireland 7-a-side (Junior) hurling – St. Jude's

<i>September 13th (Dublin):</i>	
Ballylooby .....	3-4
Ballinahinch .....	2-4
	(Shield Final)

#### INTER PROVINCIAL – HURLING

<i>October 18th at Limerick:</i>	
Connacht .....	1-20
Munster .....	1-16
	(Semi-Final)

#### INTER PROVINCIAL – FOOTBALL

<i>November 9th at Enniskillen:</i>	
Connacht .....	1-13
Munster .....	1-9
	(Semi-Final)

#### MUNSTER SENIOR LEAGUES – HURLING

Ballingarry .....	1-20
Ballybrown (Limerick) .....	3-9
	(Semi-Final)

#### MUNSTER SENIOR LEAGUES – FOOTBALL

Cahir .....	3-12
Ennistymon (Clare) .....	1-6
	(Div. 2 Final)

#### MUNSTER CLUB CHAMPIONSHIP – HURLING

<i>October 26th at Semple Stadium:</i>	
Toomevara .....	3-18
Kilmoyley (Kerry) .....	2-11
	(R.I.)

<i>November 9th at Semple Stadium:</i>	
Newtownshandrum (Cork) .....	0-15
Toomevara .....	1-9
	(S.F.)

#### MUNSTER CLUB CHAMPIONSHIP – Football

<i>November 16th at Cahir:</i>	
St. Senan's, Kilkee .....	0-14
Cahir .....	0-10
	(S.F.)

#### COUNTY LEAGUE FINALS – Hurling

##### Premier:

<i>June 28th at Templemore:</i>	
Toomevara .....	0-23
Thurles Sarsfields .....	0-13

##### Division 1:

<i>June 8th at Templemore:</i>	
Moneygall .....	2-12
Borrisoleigh .....	1-14

##### Division 2:

<i>15th June at Dolla:</i>	
Portroe .....	3-14
Boherlahan .....	1-12

##### Division 3:

<i>6th September at Borrisoleigh:</i>	
Templederry .....	1-14
Drom-Inch .....	1-11

##### Intermediate:

<i>4th September at Dr. Morris Park:</i>	
Gortnahoe/Glengoolie .....	3-12
Moyné-Templetuohy .....	0-17

#### COUNTY LEAGUE FINALS – Football

##### Minor:

<i>June 27th at Bansha:</i>	
Cahir .....	5-11
Rockwell Rovers .....	1-3

##### Division 4:

<i>August 15th at Killenaule:</i>	
Rosegreen .....	3-7
St. Patrick's .....	2-6

##### Division 3:

<i>August 27th at Cahir:</i>	
Clonmel Óg .....	0-10
Emly .....	1-7
	(draw)

##### *September 27th at Cahir:*

Clonmel Óg .....	2-10
Emly .....	1-8
	(replay)

##### Division 2:

<i>October 5th at New Hall Park:</i>	
Kilsheelan/Kilcash .....	3-8
Carrick Swans .....	1-7

##### Division 1:

<i>November 8th at New Inn:</i>	
Fethard .....	0-9
Aherlow .....	0-6

#### Tipperary Inter-Firm – Senior Hurling

<i>September 8th at Borrisokane:</i>	
Bank of Ireland/Lifeline Assur. ....	2-13
Proctor and Gamble .....	0-14

<i>November 15 at Ballina:</i>	
Bank of Ireland	
(Lifetime Assurance) .....	1-9
Molex (Shannon) .....	0-10
	(Munster Final)

<i>November 29 at Palmerstown:</i>	
Bank of Ireland	
(Lifetime Assurance) .....	0-12
Dunreidy (Kilkenny) .....	1-8
	(All-Ireland Semi Final)

#### Tipperary Inter-Firm – Junior Football

<i>September 15th at Kilsheelan:</i>	
Merck, Sharpe and Dohme .....	4-18
Guidant .....	2-8
	(Final)

#### Munster Junior Club Championship

##### Football:

<i>February 23rd at Claughaun, Limerick:</i>	
Upperchurch-Drombane .....	0-15
South Liberties (Limerick) .....	1-3

<i>March 2nd at Seán Treacy Park, Tipp:</i>	
Kiskeam (Cork) .....	4-18
Upperchurch-Drombane .....	1-6
	(Semi-Final)

##### Hurling:

<i>February 22rd at Dungarvan:</i>	
Ballinahinch .....	1-18
Geraldines (Waterford) .....	0-6
	(Semi-Final)

<i>March 15th at Ballyagran:</i>	
Ballinhassig (Cork) .....	6-8
Ballinahinch .....	2-8
	(Final)

Note: Ballinhassig subsequently beat Blacks and Whites (Kilkenny) in the All-Ireland Final.

#### GARDA CUP U-16 HURLING

<i>March 17th at Dr. Morris Park:</i>	
South Tipperary .....	
North Tipperary .....	
	(Semi-Final)

<i>March 17th at Golden:</i>	
Mid Tipperary .....	3-9
West Tipperary .....	2-7
	(Semi-Final)

<i>March 29th at Golden:</i>	
Mid Tipperary .....	2-12
South Tipperary .....	1-13
	(Final)

<i>March 29th at The Ragg:</i>	
North Tipperary .....	2-11
West Tipperary .....	0-14
	(Shield)

#### Munster U-16 Hurling Championship

##### (A):

<i>April 21st at Ardfinnan:</i>	
Imokilly (Cork) .....	6-12
Mid Tipperary .....	2-23
	(A.E.T. – first round)

<i>April 12th at Emly:</i>	
Limerick South-East .....	4-10
West Tipperary .....	1-5
	(Preliminary)

<i>April 21st at St. Patrick's (Limerick):</i>	
North Tipperary .....	0-14
East Clare .....	0-12
	(1st Round)

<i>April 30th at New Inn:</i>	
North Tipperary .....	3-11
Imokilly (Cork) .....	0-10
	(Semi-Final)

<i>May 6th at Bruff:</i>	
Limerick South-East .....	1-14
North Tipperary .....	1-8
	(Final)

##### (B):

<i>April 21st at Carrigtwohill:</i>	
South Tipperary .....	2-11
Carraigdhoun (Cork) .....	0-4

<i>April 21st at Carrigtwohill:</i>	
South Tipp .....	5-9
Muskerry, Cork .....	1-5
	(S/F)

<i>April 27th at Fermoy:</i>	
South Tipperary .....	5-9
Muskerry (Cork) .....	1-5
	(Semi-Final)

<i>May 3rd at Mitchelstown:</i>	
South Tipperary .....	1-11
Carberry (Cork) .....	0-9
	(Final)

#### Under-14 Hurling County Féile na nGael

<i>May 27th at Templemore:</i>	
Durlás Óg .....	2-7
Nenagh Éire Óg .....	1-4
	(Final)

**Under-14 Féile na nGael hurling****(Played at Kildare/Meath/Westmeath):**

June 12th:	
Dúrlas Óg .....	3-5
Glen Rovers (Cork) .....	1-5
June 13th:	
James Stephens (Kilkenny) .....	1-10
Dúrlas Óg .....	0-3
June 13th:	
Dúrlas Óg .....	3-15
Clonlara (Clare) .....	1-4
June 13th at Mullingar:	
Dúrlas Óg .....	2-6
St. Vincent's (Dublin) .....	2-4
	(Semi-Final)

**June 14th at Mullingar:**

James Stephens .....	3-7
Dúrlas Óg .....	1-3
	(Final)

**Cumann na mBunscoil Co. Finals****June 12/13 at Sempie Stadium:****Hurling:**

(A.)	
Loughmore .....	0-13
Nenagh .....	0-7
(B.)	
Upperchurch .....	7-3
SS. Peter and Paul's .....	2-14
	(A.E.T.)
(C.)	
Monastery, Tipp Town .....	2-4
Portroe .....	1-4
(D.)	
Rathcabbin .....	7-8
Gaelscoil Dúrlas Éile .....	0-2
(E.)	
Ballagh .....	5-7
Gurtagarry .....	1-0
(E.) (2)	
Ballycahill .....	7-4
Rossmore .....	3-2
(F.)	
Ballinaclough .....	4-7
Slievardagh .....	3-3

**Under-16 Inter Divisional****(Friends of Tipperary Football):****June 30th at Clonoulty:**

South Tipperary .....	2-15
West Tipperary .....	0-8
	(Final)

Mid Tipp beat North Tipp (Shield Final)

South Tipperary beat North Tipp.

West Tipperary .....	4-12
Mid Tipperary .....	4-9
	(Semi-Finals)

**Peadar Cummins Under-14 Hurling****July 5th at Borrisoleigh:**

North Tipperary .....	
South Tipperary .....	
	(Semi-Final)

**July 5th at The Ragg:**

Mid Tipperary .....	2-11
West Tipperary .....	1-6
	(Semi-Final)

North Tipp. beat Mid Tipp. (Final)

South Tipp .....	4-20
West Tipp .....	5-7
	(Shield)

**Tony Forristal Under-14 Hurling****August 30th at Waterford (Mount Zion):**

Tipperary .....	8-6
Wexford .....	6-3

Limerick .....	1-7
Tipperary .....	1-5
	(Tipp did not qualify for the semi-finals).

**Under-16 Football Munster Tournament****July 12th at Askeaton:**

South Kerry .....	1-19
Tipperary .....	1-4

**July 12th at Askeaton:**

Tipperary .....	1-16
Clare .....	1-8

**July 19th at Askeaton:**

Tipperary .....	3-6
Waterford .....	1-6
	(Shield Final)

**U-15 Football Bord na nÓg (Cork City)****July 5th at St. Finbarr's:**

Tipperary .....	0-6
Cork City .....	0-5

Tipperary .....	3-8
Clare .....	4-5

Limerick beat Tipperary

Tipperary .....	0-7
Limerick .....	0-5
	(Final)

**U-14 Jim Power Tournament (Football)****November 1st at Stradbally, Waterford:**

Tipperary .....	3-7
Waterford .....	1-7
	(Semi-Final)

**November 1st at Stradbally, Waterford:**

Limerick .....	2-3
Tipperary .....	0-6
	(Final)

**November 1st at Stradbally, Waterford:**

Clare .....	3-11
Waterford .....	1-2
	(Shield Final)

**U-14 Inter Divisional Football****October 14th at Dr. Morris Park:**

West Tipperary .....	3-17
Mid Tipperary .....	3-6
	(Semi-Final)

South Tipperary beat North Tipperary

(Replay – Semi-Final)

**October 16th at Dr. Morris Park:**

Mid Tipperary .....	3-1
North Tipperary .....	1-5
	(Shield)

**October 19th at Clonmel Óg:**

South Tipperary .....	3-10
West Tipperary .....	2-4
	(Final)

**Arrabawn Under-16 Hurling Shield Final****November 1st at Urlingford:**

Tipperary .....	6-19
Kilkenny .....	1-7

**Relegation Finals – Senior Hurling****September 10th at Nenagh:**

Portroe .....	5-17
Silvermines .....	6-11
	(A.E.T.)

**September 21st at Holycross:**

Clonoulty-Rossmore .....	1-15
Moycarkey-Borris .....	1-13

**Senior Football:****October 12th at Fethard:**

Mullinahone .....	2-15
Knockavilla D.K. ....	2-7

**FITZGIBBON CUP (Hurling)****January 18th: Dublin.**

Garda College .....	1-16
Trinity College (Dublin) .....	1-1
	(Preliminary Round)

**February 1st at Templemore:**

Garda College .....	4-9
M.I.C.L. (Limerick) .....	0-3
	(first round)

**February 8th at Templemore:**

Cork Inst. of Tech. ....	0-13
Garda College .....	1-9
	(second round)

**February 25th at The Mardyke:**

C.I.T. ....	3-6
U.C.C. ....	0-8
	(Semi-Final)

**February 25th at Ardfinnan**

W.I.T. ....	1-17
U.L. ....	1-13
	(S/F)

**March 1st at The Ragg:**

W.I.T. ....	0-13
Cork I.T. ....	1-13
	(Final)

**SIGERSON CUP (FOOTBALL)****February 5th at Templemore:**

W.I.T. ....	2-7
Garda College .....	1-6
	(Preliminary Round)

**March 7th at Ballincollig:**

U.C.D. ....	1-10
U.U.J. ....	2-6
	(Semi-Final)

**March 7th at The Mardyke:**

N.U.I., Galway .....	2-14
N.U.I., Maynooth .....	0-8
	(Semi-Final)

**March 8th at Páirc Uí Rinn:**

N.U.I., Galway .....	1-8
U.C.D. ....	0-9
	(Final)

**RYAN CUP (Hurling)****February 19th: At Dr. Morris Park.**

Tipperary Institute .....	1-9
Carlow I.T. ....	0-10
	(Quarter-Final)

February 28th: At Littleton.  
 Tipperary Institute ..... 2-10  
 Cork College of F. Ed. .... 0-7  
 (Semi-Final)

March 1st: At The Ragg.  
 Tipperary Institute ..... 5-13  
 Athlone I.T. .... 1-11  
 (Final)

### MUNSTER COLLEGES

#### Irish Examiner Dr. Harty Cup: (Senior Hurling)

January 29th: At Ardfinnan.  
 St. Colman's, Fermoy ..... 4-14  
 Thurles C.B.S. .... 0-13

January 29th: At Nenagh:  
 St. Flannan's, Ennis ..... 1-16  
 Our Lady's, Templemore ..... 0-8  
 (Quarter-Final)

January 29th: At Tipp Town:  
 St. Flannan's, Ennis ..... 1-15  
 Cashel C.S. .... 1-10  
 (Quarter-Final)

January 29th: At Clonmel:  
 D.L.S., Waterford ..... 2-8  
 Abbey C.B.S. .... 2-7  
 (Quarter-Final)

#### Senior Football 'B' Championship:

March 2nd : At Mitchelstown:  
 High School, Clonmel ..... 2-11  
 Hamilton H.S. (Bandon) ..... 2-9  
 (Munster Final)

April 6th : At Birr:  
 St. Michael's, Lurgan ..... 1-9  
 Clonmel H.S. .... 1-5  
 (All-Ireland Semi-Final)

### Senior Hurling 'B' Championship

#### Corn Phadráig:

March 7th: At Araglin:  
 High School, Clonmel bt. Douglas C.S.  
 (Semi-Final)

March 5th: At Limerick:  
 St. Joseph's, Borrisoleigh ..... 5-8  
 Col. na Spioráid Naomh (Cork) .... 3-9  
 (Semi-Final)

March 19th: At Boherlahan:  
 St. Joseph's ..... 1-16  
 High School, Clonmel ..... 1-11  
 (Final)

April 6th: At Mullingar:  
 St. Joseph's ..... 1-16  
 St. Mary's, Belfast ..... 1-8  
 (All-Ireland Semi-Final)

April 26th: At Clonmel:  
 Castlecomer C.S. .... 1-12  
 St. Joseph's ..... 1-8  
 (All-Ireland Final)

### Voc. Schools Cham. Junior Hurling

March 12th: At Goatenbridge:  
 Cóláiste Phobail Ros Cré ..... 5-10  
 Coachford (Cork) ..... 0-11  
 (Munster Semi-Final)

March 26th: At Mitchelstown:  
 Cóláiste Phobail Ros Cré beat  
 St. Brogan's (Bandon, Cork).

April 12th: At Portumna:  
 Cóláiste Phobail Ros Cré ..... 2-9  
 St. Rynagh's C.S. .... 2-7  
 (All-Ireland Semi-Final)

April 27th: At Birr:  
 Cóláiste Phobail Ros Cré ..... 2-10  
 St. Brigid's (Loughrea) ..... 2-8  
 (All-Ireland Final)

### All-Ireland Voc. Schools Championship

#### (Senior Hurling)

April 5th: At Feenagh:  
 Scoil Ruain, Killenaule ..... 2-8  
 Causeway Comp. (Kerry) ..... 1-10  
 (Semi-Final)

April 6th at Portumna:  
 St. Brigid's (Loughrea) ..... 0-16  
 Borrisokane ..... 0-11  
 (Semi-Final)

April 20 at Semple Stadium:  
 St. Brigid's (Loughrea) ..... 1-13  
 Scoil Ruain ..... 0-12  
 (Final)

### Munster V. S. U-16 Championships

March 5th at Ballygiblin:  
 St. Brogan's (Bandon) ..... 1-17  
 Borrisokane C.S. .... 3-7  
 (Semi-Final)

### All-Ireland Inter-County Voc. Schools

March 29th : At Nowlan Park:  
 Tipperary ..... 1-20  
 Kilkenny ..... 2-10  
 (Semi-Final)

May 3rd at Birr:  
 Galway ..... 1-16  
 Tipperary ..... 2-7  
 (Final)

### Munster Colleges Under-15 'B' H.C.

April 8th: At Dr. Morris Park:  
 Nenagh C.B.S. .... 3-11  
 Abbey C.B.S. .... 3-9  
 (S/F)

21st May at Cloughaun:  
 Nenagh C.B.S. beat Tulla  
 (Final)

### Rice Cup Under-14 Hurling:

May 29th: At Seán Treacy Park:  
 Charleville C.B.S. .... 3-14  
 Thurles C.B.S. .... 1-15  
 (A.E.T. - Final)

### Canon Fitzgerald U-17 'A' Hurling

May 9th: At Holycross.  
 Cashel C.S. .... 2-17  
 Thurles C.B.S. .... 3-8  
 (Final)

### Fitzgerald Shield U-17 Hurling:

15th May at New Inn:  
 Presentation, Ballingarry ..... 1-7  
 H.S., Clonmel ..... 0-6  
 (Final)

### White Cup U-15 'A' Hurling:

May 7th at Nenagh:  
 St. Flannan's (Ennis) ..... 3-7  
 Thurles C.B.S. .... 1-5  
 (Final)

## OUTSTANDING RESULTS 2002

### (County Finals - Hurling)

Inter:  
 Newport ..... 1-14  
 Kildangan ..... 0-9  
 Under-21 'A':  
 Thurles Sarsfields ..... 1-11  
 Burgess ..... 1-10  
 U-21 'B':

J.K. Brackens ..... 2-10  
 Ballinahinch ..... 1-13  
 (Draw)  
 J.K. Brackens ..... 1-12  
 Ballinahinch ..... 2-8  
 (Replay)

Minor 'A':  
 Loughmore-Castleiney ..... 1-12  
 Burgess ..... 1-9

### Football:

Inter:  
 Knockavilla-D. Kickhams ..... 0-5  
 Newport ..... 0-5  
 (Draw)  
 Knockavilla-D. Kickhams ..... 1-9  
 Newport ..... 0-2  
 (Replay)

Junior 'A':  
 Upperchurch-Drombane ..... 3-5  
 Ballina ..... 2-8  
 (Draw)  
 Upperchurch-Drombane ..... 1-12  
 Ballina ..... 0-5  
 (Replay)

Junior 'B':  
 Ballinahinch ..... 2-8  
 Gortnahoe-Glengoole ..... 0-3  
 Minor 'A':  
 Loughmore-Castleiney ..... 2-13  
 Newport ..... 0-9  
 Co. Senior Football Relegation Final:  
 Arravale Rovers ..... 3-7  
 Moyle-Templetuohy ..... 1-6

### Co. Adult Football League:

Div. 1 Final:  
 Ardfinnan ..... 1-11  
 Aherlow ..... 1-9

### Co. Adult Football League:

Div. 2 Final:  
 Killenaule ..... 3-7  
 Grangemockler ..... 0-8

### Co. Adult Football League:

Div. 4 Final:  
 Loughmore-C. .... 1-11  
 Mullinahone ..... 1-7

### Croke Cup (U-15) Colleges 2002/3 'A' Hurling Final:

Thurles CBS ..... 2-8  
 Nenagh C.B.S. .... 1-4

### Corn na Banndan (Under-15) 'B'

Football Final:  
 Abbey C.B.S. .... 1-5  
 De La Salle (Waterford) ..... 0-7.

## REMINDER

To everybody who submits a match report or summary for publication - please give the competition name, the date, and final score for the match.

# Football Highlights 2003



Damien O'Brien in action against Donegal



Nelly Frawley, middle with Mary and Anne in Croke Park at the Tipperary versus Donegal Game.



Tipperary supporters in Croke Park at Donegal Game.



Patrick Hally in action against Donegal.



Brian Sheehan and Peter Lambert in Croke Park after Donegal game.

# Friends we lost in 2003



**PHILIP BLAKE**  
1918 - 2003

It was with great sadness that we learnt of the death of Philip Blake, Mortlestown, Killenaule and formerly of Cloughaleigh, Golden. Topsey, as he was more popularly known to his wide circle of friends, was one of life's characters, who was always in good form and loved to talk about times past on the playing fields. Topsey was a keen hurler and played at all levels, the highlight of his career being a member of the victorious Golden Fontenoy junior hurling team that won the club's first ever West title in 1935. He went on to play senior hurling with the club, before moving to Killenaule where he lived until the time of his death. To his wife and family we extend our sincere sympathy.



**JIMMY BOHAN**  
1944-2003  
(J. K. Brackens)

Jimmy Bohan of Graffin, Clonmore passed away on September 12 after a short illness. Although he never played hurling or football he was devoted to Gaelic Games and gave a lifetime of service to Clonmore and J. K. Brackens. He was a selector

on the Clonmore junior hurling team that won divisional honours in 1970. He was involved with the Clonmore team that won the Mid under-17 football title in 1971. He was a selector on the 1974 and 1975 teams that began a new era for Clonmore, winning a junior divisional title in 1974 and an intermediate in 1975. For all of twenty-five years he was a pillar of support in the Clonmore club, as a selector and committee man. When the clubs in the parish amalgamated in 1992 he was totally for it, seeing it as best for the G.A.A. in the parish. He followed J. K. Brackens with the same vigour and enthusiasm, as he had Clonmore. He also enthusiastically followed the fortunes of Tipperary. His coffin was draped in the Clonmore colours and a guard of honour was provided by his G.A.A. and worker colleagues. To his wife, Noreen, daughter, Margaret, brothers and sisters, sincerest sympathy. I bhflaitheas Dé go raibh anam usual, Seamus.



**CHARLIE BOLAND**  
(Moyle Rovers)

On the 21st June 2003 the Moyle Rovers club suffered yet another bereavement within a few weeks, when its president, Charlie Boland, died. Having been involved with the Valley Rovers Club early in life the family moved to Moangarriff where he became involved with the Moyle Rovers. When he married Eileen O'Keefe, they fostered GAA and all things good in Irish culture in the

parish of Powerstown and Lisronagh. Together they were instrumental in the major successes of the club in recent times at both juvenile and adult level. He was one of the main motivations in purchasing our present field at Moyle Park. He also had a passion for motor rallying which was demonstrated at his removal when the Tipperary Stone Throwers assisted in the organizing of traffic control and parking. Charlie bore his long illness with dignity and great courage but this did not prevent him attending matches until it became impossible for him to travel. The club thanks all who assisted him when attending games and allowing Eileen to park in prime and convenient locations. Charlie was buried in Powerstown cemetery. Present in the very large attendance were representatives from all walks of life. Although he was a native of Co. Waterford he lived most of his married life in Lisnatubrid on the banks of the Anner and at the foot of Slievenamon. It was appropriate and moving that Charlie was laid to rest to the strains of Slievenamon sang by his near neighbour, Joe O'Connell.

The club offers its sincere sympathy to his wife Eileen and extended family. Go ndeana dia trocaire ar a anam.



**PHIL COLLINS**  
1921-2002  
(Ballinahinch)

The name of Phil Collins will always be remembered throughout the parish of Ballinahinch when

GAA affairs are discussed. He was born in 1921 and died on September 28th 2002.

In 1939 Phil played minor hurling for North Tipperary and succeeded in winning a county title. In 1939 he played fullback for the Tipperary minor hurling team that was well beaten by Limerick in the Munster final.

He had to wait until 1949 to win a North Tipperary junior hurling medal with Knockmeal Rangers, following a great win over Cloughjordan in the final.

In later years, he acted as chairman and secretary of the club on many different occasions and was, for many years, Ballinahinch's delegate to the North Tipperary Board. At the time of his death he held the position of joint president of Ballinahinch GAA Club, clearly a man who has given his all to his club and parish.

To his wife and family the club extends its deepest sympathy.



**MICK COLLISON**  
1920-2003  
(Moneygall)

Mick Collison gave a lifetime of service to Moneygall Club. In his playing days he was a member of the Moneygall intermediate team that won the North Tipp final in 1949 and went on to win the county final by defeating Newcastle by 7-4 to 2-2. He also played football with the club and was on the team that won the North Tipperary junior final three years in a row in 1949,

1950 and 1951. He acted as a senior hurling selector in the 70s when Moneygall won two county finals and he was an important member of the club committee for many years. Deepest sympathy to his wife Maura and his brother Jack.

**PADDY COONAN**  
(Ballina)

In February of this year, Paddy Coonan passed away after a number of months of illness. For a man as active as Paddy, his ill health was hard to bear as it meant he was unable to go to Ballina and Tipperary matches. He was an avid match-goer whether it was to an underage or a county game. He liked nothing better than to be on the sideline at a game and to be involved in whatever repartee went on between the rival supporters. A player himself in the sixties he represented Ballina for a number of years. His presence in the village is missed as he was always ready for a chat about the games he enjoyed so much.



**WILLIAM (Dollar) DAWSON**  
1940-2002

The Dollar, as he was affectionately known, was one of Emly's finest players at either football or hurling. In his juvenile days he was one of Fr. Mullally's outstanding Emly Atoms.

As a forward he had few equals, being fast, fearless and strong on the ball. Generally the name W.Dawson was top scorer for Emly due to his accuracy from play and frees.

His years spent as a student at De La Salle Brothers, Hospital and Salesian College, Pallaskenry gave him the opportunity to further develop his undoubted

skills.

In his playing career he won many medals but pride of place was the county junior football one he won in 1968.

When he retired he spent some time as a referee.

To his sister, brothers and relatives we extend our sympathy.

Ar dheas lamh Dé go raibh se.



**PAT EGAN**  
(J. K. Brackens)

There was deep regret and profound sorrow when the death of Pat Egan, Park Road, Templemore became known on April 17. His playing career as a hurler and footballer spanned three decades. His career commenced in 1957 playing junior hurling with Clonmore/Killea, and when the clubs went their separate ways the following year, he threw in his lot with Clonmore. His commitment to the club set an example for other players and success eventually came in 1970 when the club won a Mid junior hurling title, the first in thirty-two years. Two years later Pat was deprived of a second divisional title when Clonmore were defeated by Thurles Kickhams in the Mid final. Pat was possessed with enormous strength and, coupled with tremendous hurling ability, he was feared by defenders, who found him almost impossible to contain. At his funeral he was referred to as 'the gentle giant.' His coffin was draped in the Clonmore colours and his guard of honour was provided by his 1970 playing colleagues. Deepest sympathy to his brothers, Billy and Christy, sisters Hannah, Maggie, Mary and Nellie, nephews, nieces, relations and friends.

**EVAN FLYNN**  
(Cahir)  
1991-2003

Our clubs success at juvenile level for the current year was put into perspective when we received the news of the tragic death of Evan Flynn.

Evan was a very popular member of our successful U-12A football team of 2003. He joined the team 3 years ago and straight away we recognised a diligent, determined and skilful athlete. Evan was a very sociable, well-mannered player, who took training as seriously as it should be taken. Evan was always willing to learn new skills and tactics. When instructed from the sideline during matches he carried out those instructions to a tee. This year he wore the number 4 jersey with great distinction playing in all games in the championship and culminating in a county final success in Semple Stadium.

Evan will be a great loss to the club to his fellow players and to his parents Marie and Paddy and brother Neville.

On behalf of Cahir Juvenile G.A.A. we extend our sympathy to his family on their great loss. We are privileged to have known him and believe he enjoyed his time playing with our club.

Ar dheis Dé go raibh a anam.



**JOHNNY FOX**  
(Skeheenarinky)

It was with deep shock that the people of Skeheenarinky, and the surrounding parishes heard of the untimely death of Johnny Fox on Wednesday, April 9th. Johnny was out enjoying his favourite pastime with his gun dogs when he died suddenly.

He was a respected judge

at dog trials and a member of the local gun club. At the time of his death he was supervisor with South Tipperary Co. Council and was more than helpful on what could be done in the locality. In his playing days he was a prominent member of the Skeheenarinky and Ballyporeen hurling and football teams. He was treasurer of the Skeheenarinky hurling club for a number of years. Johnny lived life to the full and touched the lives of all who knew him. The crowds who came out to pay their last respects at his funeral in Ballyporeen was a fitting tribute to the popularity and esteem in which he was held. A guard of honour was provided on both days of the funeral by his work colleagues, the GAA clubs and gun club members from far and wide.

To his wife Josie, sons Noel and John, daughters Deirdre, Siobhan, Mairead and Michelle, brother and sisters and their families the club extends its deepest sympathy.

May he rest in peace.



**BILL GLEESON**  
1908-2002  
(Roscrea)

A link with Roscrea's first North title win in 1936 was severed when Bill Gleeson passed away on December 25, 2002.

Bill came on to the senior panel in 1934 and went on to win six divisional senior titles with the club. Sadly, like so many of the great Roscrea hurlers of that era, a county medal eluded him and Bill retired after losing the 1945 county final to Thurles Sarsfields in a replay.

After retiring Bill went on to coach camogie for a number of years in the town, and his efforts started a great peri-



od of success, which commenced with a county camogie title in 1946.

Bill also did Trojan work for St. Anne's and was chairman of the Friends of St. Anne's for sixteen years. At his time of passing Bill was vice-president of the hurling club. Guards of honour were provided by both the club and St. Anne's at his funeral.

Sympathy is extended to his family.

### **FRANK HALLEY 1913-2003**

#### **(Marfield & Cashel)**

**F**ranks Halley lived nearly all his life in the heart of Marfield Village, but was very proud of the fact that he was born and reared near the Rock in the City of Kings. Cashel's loss was certainly Marfield's gain. He was to play a leading and significant role in the Marfield Hurling Club, both as founder member and as an administrator for around forty years.

Frank was our first secretary in 1946, if only for a short time. To quote Wally Lynch, another founder member, Frank Halley did little talking, he was a doer and did Trojan work without much assistance in the early stages. The first annual general meeting was held in 1947. Frank exchanged roles with Wally Lynch to become treasurer, and he would continue this role for forty years. The plight of the treasurer during those early years was a difficult one, for money was scarce and it was very hard to organise functions to generate finance. I can truthfully say from research, that the treasurer and other committee members were out of pocket, in their efforts to keep the club intact in those early years. The club was fortunate to have a treasurer of Frank's calibre, very astute with finance and scrupulously honest in every dealing.

The Marfield club and its activities became almost an obsession with Frank. Seldom, if ever, did he ever miss a training session on the lawn. He was ever present at championship, tournament and challenge games, and was always available to buy a

drink for the players after matches, sometimes a trifle reluctantly if funds were scarce. He represented the club with distinction at South and county conventions and when Frank spoke, everyone listened. Frank helped out in every other area of club activities, such as, erecting goal posts in the lawn, keeping the grass well trimmed for training and challenge games. He was very proud to see the club develop like it did from simple beginnings, to the winning of the first South Junior title in 1954, culminating with the winning of that historical first senior title in 1960.

It was a source of immense pride to Frank to see Theo selected to play for Tipperary and to be ever-present at his homecoming celebrations, when he brought his first senior All-Ireland medal to Clonmel and to his beloved Marfield club. The clock had turned full cycle as far as Frank Halley was concerned. He handed down to Frank Ryan a strong, viable and resourceful club to his successors and hopefully they will continue the passion those men and their equals had for the club, namely to be successful and famous.

When the Marfield Village Association was founded in 1985 to develop the village and protect the wildlife, trees, and Marfield Lake, Frank was at the first meeting. He had found his second great love after the Marfield Hurling Club.

Frank loved the lake and all its wild birds and was a familiar figure to all who visited the lake. He knew the names and habits of all the birds and willingly shared this information to any who asked. His favourite spot was sitting at the top end of the lake watching people feed the birds and chatting with his friends. He declared war on litter and every day could be seen with his day's effort ready for the bin. At the Loughtally Cross is a line of beech trees Frank set on the high bank and watered and minded until they took root.

Later when the village committee undertook the renovation of St. Patrick's Chapel, Marfield, Frank

spent many a pleasant hour discussing and observing the work. It was also to be Frank's last resting place. In his later years Frank's health declined, but he remained active and in full possession of his faculties. On his way to his place of final rest Frank made one final trip down by Marfield Lake, which he loved so well. His clubmates and villagers formed a guard of honour at Frank's house as a tribute to a lifetime of service to club and village. He rests today in the peace and quiet of Marfield Church.



### **SEAMUS HAYES (Kiladangan)**

**T**he Kiladangan club suffered a major loss this year with the sudden death of Seamus Hayes on April 19th 2003. Seamus was dedicated to the development of GAA in the parish. His contribution was immense both as a player and as a coach.

As a juvenile Seamus was a member of the 1966 under-15 hurling team, which brought divisional and county honours to the club. Five years later he was on the intermediate hurling team, which won the Hewitt Cup for the first time and then went on to win the county final.

He was a member of the county intermediate panel, which won the All Ireland the following year. In 1980 he again helped the club win a north title. When his playing career came to an end, Seamus continued his involvement with the club and began to coach under age teams. His success with these teams is reflected in the many competitions won by the club at juvenile level. Most of our current intermediate team can thank Seamus's coaching skills/or their successes. His coaching

skills at club level were recognised by many outside the club and Seamus was asked to get involved with North and county teams. Here again he was very successful and many players have Munster medals thanks to his skill and dedication.

He was very popular in schools where he was employed to coach the skills of hurling. He had a remarkable ability to remember the names of the students and always had a word of encouragement for them when he might meet them, even years after they had left the school.

Seamus's passing is a great loss to the club and to the association but it is a much greater loss to his family.

To his wife Margaret, sons Cathal and Fergal, his father, brothers and sister, we extend our deepest sympathy.

Ar dheis Dé go raih a anam.



### **MARTIN HOGAN (Burgess)**

**A**ll who knew Martin Hogan, Castlecranna and formally of Gortmore, Carrigatoher, were shocked when news filtered through of his sudden passing on January 10th last. His funeral was one of the largest witnessed in North Tipperary. Martin was loved and respected by all who knew him. He came to prominence in the entertainment world, by displaying memorable performances with the Burgess Muintir na Tire Drama group. Recitations were part of Martin's party piece, the list included Caoch O'Laoire, Sam McGee, and Dangerous Dan McGrew. In later years, he relaxed by partaking in a game of draughts or cards, as well as attending race meetings. Martin always

had a passion for hurling and indeed won a North intermediate hurling medal in 1970. His brothers Liam, Pakie, Donie and John were more renowned for their feats on the hurling field, while another brother Mortimer is a long-standing administrator of Burgess GAA club. A void is created by Martin Hogan's absence, particularly by his wife Mena and seven children, Fatima, Martine, Vanessa, Sinead, Joseph, Martin David, and Juanita.



#### CON KENNEDY

(Upperchurch-Drombane)

Shock and disbelief were felt both Con's native Upperchurch-Drombane and his adopted parish, Rossmore on the 7th May this year at the sudden and untimely death of Con Kennedy due to a farm accident. Con had a very successful juvenile career with Upperchurch-Drombane winning under 15 and under 17 county titles in the 1960's. Con always took great interest in the fortunes of his native parish and rarely missed any of their games. He also had a great interest in handball and racquetball. Con served many roles in the local Gortahoola Handball & Racquetball Club for many years. We extend our sincere sympathy to his wife, son daughter, parents and family. Ar dheis Dé go raibh a anam.

#### MICHAEL KENNEDY (Upperchurch-Drombane)

Michael Kennedy passed to his eternal reward on the 17th November 2002 following an illness, which he bore with great courage. Mikie, as he was fondly known, was a member of the Upperchurch-Drombane GAA Club for many years. He served the club in many roles over the years.

216 - Tipperary G.A.A. Yearbook

He achieved his ultimate satisfaction while serving as a selector in the victorious intermediate hurling team which won the county final



in 1998, which led to the promotion of the club to senior ranks after a ten year lapse. His likeable personality and witty stories will be remembered and greatly missed by his many friends in the club. We extend our sincere sympathy to his wife Sheila, his daughter Mary, his sons, P.J., Seamas, Paul and Colm, his son-in-law, his relatives and many friends. Ar dheis Dé go raibh a anam.



#### TOM KEOGH

Tom Keogh, Ballinacloy, died on Feb 11th, 2003, aged 52. He played juvenile hurling with his beloved Silvermines in the sixties. He won a county title with Nenagh Vocational School in 1967. Tom left his native Ballinacloy for Dublin in 1969 where he spent most of his working life in the bar trade but he always remained a loyal supporter of the Blue and Gold of Tipperary and the Blue and White of Silvermines. In latter years, ill health curtailed his activities, but it seldom kept him from attending a Tipp match or 'Mines' match.

Our deepest sympathy is extended to his wife Collette, sons Declan, Derek and Martin, brothers, sister

and many friends. Go ndeana Dia trocaire ar a anam.

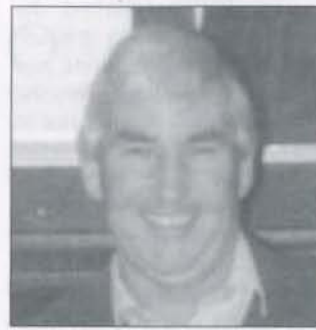

#### FRANK LAFFORD

1934-2003

(Clonmel Commercials)

The members of Clonmel Commercials were saddened on August 20th when news of the death of a former player, Frank Lafford, filtered through. Frank had played with Clonmel Commercials in all grades from juvenile right through to senior. Born in 1934 he donned the colours of the club first in the mid 40's and he wore the jersey with distinction for many years.

A member of the work force of Burke's Bacon in Clonmel, Frank graduated through the club ranks before arriving on the scene as a senior in the 50's. He won a county senior medal with Clonmel Commercials in 1956 when he lined out at left full back. He was a stylish and tough defender.

He had retired before the club's next county title but was a member of the team beaten by Loughmore/Castleiney in the county semi-final in 1958 and was on the losing side in the 1960 county final. His interest in the GAA extended beyond his playing days and he was a keen follower of the Blue and Gold. Frank's death was greeted with much sadness by those who remember his playing days but his memory will live with his team mates and opponents alike. Ar Dheis Dé go raibh a anam.

#### JACKIE LONERGAN

1931-2003

The year 2003 was in its infancy when Jackie Lonergan was called to his eternal reward. With his passing, the Emly GAA club lost a

life-long member. In his younger days, he was an accomplished hurler, being good enough to be called for trials for the county minor hurling team in 1949. He



spent many years playing for Emly, generally in the forward line.

He was an active committee member and served as secretary of the club for many years. However, it was as Emly correspondent to the Nationalist for more than 30 years that his services to the local club was most appreciated. Every club activity was faithfully reported and recorded in the Emly notes and these were valuable sources of information when the club history was written. We extend our sympathy to his wife, Esther, and family.

Ni bheidh a leitheid ann aris.



#### PHIL LOOBY

(Burgess)

On July 13th last, a former Burgess and Duharra hurler Phil Looby passed away peacefully in Blackpool, England, which was his home since the late 1940s. Phil played at corner-back on the Burgess 1941 team that brought the first North intermediate hurling title to the parish, when they defeated Toomevara in the North final.

His brothers Paddy and Denis (both deceased) were

also members of this successful team. The Dromin native played with the parish senior team Duharra, which lost to Kilruane MacDonaghs in the 1944 senior North final. Phil married his neighbour, Mary Ryan from Carrigal, and the couple spent many happy years in Blackpool with their son Kevin. He was an avid supporter of Manchester United, spending many a Saturday afternoon at Old Trafford, and he hoped that his grandchildren Eoin and Brendan would follow the same direction. Phil kept in touch with the activities of Burgess GAA Club and local news. He read *The Guardian*, from cover to cover on a weekly basis. He was a great man to tell a joke. He was honoured to be a special guest at the 1991 Burgess dinner dance, when the surviving members of the successful Burgess 1941 team and Youghalarra 1942 team were special guest.



**MARTIN LOUGHNANE**  
1917-2003  
(Roscrea)

**M**artin Loughnane died on October 17 after a short illness. Having started his hurling career in the Roscrea street leagues in the late 1920s, Martin went on to win North minor medals in 1934 and 1935. His ability was spotted by the county minor selectors and he progressed to the county, winning three Munster medals 1933-35, and two All-Irelands in 1933 and 1935.

In 1934, while still a minor, Martin made his Roscrea senior debut, playing in goal against Toomevara. In 1936 the great breakthrough came

when Roscrea won their first North senior title, giving Martin the first of nine senior medals. The others were won in 1937, 1939, 1941, 1942, 1945, 1949, 1954, and in 1967 as a goalie.

Martin was also part of the county senior panel, that won the All-Ireland in 1945. He played his last game for Roscrea in the 1967 county final loss to Carrick Davins.

He also enjoyed success in the inter-firm competition with Roscrea Bacon Factory, winning the league in 1966, alongside his son, Michael, and training them to an All-Ireland victory in 1972, with a team that included his nephew, Francis.

The late John Joe Maher included Martin in his all-time Roscrea Hurling Fifteen because he was a genius, that's the best word I can find to describe him. He had every qualification of a great forward, free-taker supreme, angles meant nothing to him, a foot was as good as the width of the goalmouth. Very fast, tricky, a great forward., A fine tribute indeed.

Martin continued to help out with Roscrea teams after his playing years. He also brought his skills to County Offaly, where he won two county titles with Coolderry in 1979 and 1980, and two titles with Kinnitty in 1984 and 1985.

At his time of passing Martin still had a huge interest in the game and was vice-president of the Roscrea club. He also maintained his other great passion in life, greyhounds and coursing, right up to his last days.

Sincere sympathy is extended to his family.

**JIMMY MCCARTHY**  
1950-2003  
(Moyle Rovers)

**I**t was with great shock and sadness with which the news spread of the sudden and untimely death of our club secretary, Jimmy McCarthy, last May at the early age of 53. Jimmy, fondly known as Coady, was the heartbeat of the Moyle Rovers Club. He served the club as a player, a top referee and as club secretary up until the time of his death.

He also served a term as South Bord na nÓg chairman, a position of which he was very proud of. Jimmy



had many friends both inside and outside the club. This was due to his jolly character and great sense of humour, which appealed to both young and old alike. The esteem in which Jimmy was held was reflected in the huge crowds that attended his funeral at which young and old wept openly as we mourned the death of a great club stalwart and dear, dear friend. We extend our deepest sympathy to his brothers, sisters, nephews, nieces and friends. Ar dheis Dé go raibh a anam.

**NICHOLAS McENIRY**  
(Cahir)

**D**uring the year Cahir G.A.A. club lost one of its stalwart members, Nicholas McEniry. He is sorely missed by his many friends in the club, many of whom remember him from his playing days with Wild Rovers in the 1950's and also for his role in the founding of the juvenile club in the late 60's and his sterling work for that club at a time when cars were scarce and two or three mentors would ferry an entire team to and from matches.

Nicholas managed the U-14 football team that won the county title in 1977. This team also won a South hurling title. He was chairman of the re-organised juvenile club in the 1970's and into the 1980's.

Nicholas was again a selector on the U-14 football team that won two county titles (Rural and Urba/Rural) in 1980.

Nicholas was also instrumental in organising the hugely successful parish

leagues, which were the foundation of much of the success Cahir had in the 1980's and into the 90's. He was on the club committee for many years and was an honorary life president up to the time of his passing. The sympathy of the entire club goes out to Nicholas' family and many friends. Ar dheis Dé ar a anam.



**STEPHEN McHUGH**  
1985-2003  
(Eire Óg/Annacarty)

**I**t was with deep sadness that the parish of Annacarty/Donohill learned of the death of Stephen McHugh at the tender age of eighteen years on July 10, 2003. Stephen had been ill for the previous twelve months, an illness he bore with dignity and courage for one so young. In fact it was while playing minor football with Eire Óg against Rosegreen that it became apparent to his fellow players and supporters that something was amiss, as he felt unable to finish the match.

Football was Stephen's game though while playing with the club's under-16s and under-18s in 1998, and again with the under-16s in 2000, success eluded him. During his time at school in Rockwell College, he played rugby but his real talent shone out in the athletics field with Dundrum Athletic Club, winning both individual and team events.

The club wishes to express sincere sympathy to his parents, Bernard and Maureen, and his sister, Marie.

**TOM McLOUGHNEY**  
1985-2003  
(Templederry)

**T**he parish of Templederry and beyond were deeply shocked and saddened on

February 3 last to hear of the untimely death of Tom McLoughney, Gortnagoona, at the young age of 18 years.



For many years he was a valued member of Bord na nÓg in the parish, representing his club in various championships from under-12 upwards in hurling and football. Later, he played minor.

He was on the successful Templederry under-16 team in 1999, which won divisional titles in hurling and football, and on the equally successful teams in 2000, to which was added a county hurling title in the grade.

He also took a keen interest in Scór, and represented his club in set dancing and the novelty act. He also represented his club in the Munster fleadh competition in set dancing.

As a person Tom was much loved. His outgoing personality and sense of fun led to many friendships. He was a popular member of the community and this was reflected in the huge crowds that turned out to the funeral.

To his father, Tom, mother, Bernie, sister, Sharon, and all his relatives, we extend our deepest sympathy.

Ar dheis Dé go raibh a anam.



**JOE MAHER**  
(Clonakenny)

Joe Maher died on November 6. He was part and parcel of everything positive in the little parish of Clonaken-

ny-Couragouneen for many years. He served as chairman of the hurling club from 1966-1971, and was at the helm when the club won back-to-back county junior football and number 1 junior hurling in 1967 and 1968. He was president of the club at the time of his death.

He was also an outstanding actor, and played every role imaginable with Clonakenny Dramatic Society. He also produced many plays with various groups in the parish. He was also a life long member of the Pioneer Total Abstinence Association.

To his brother, Ben, sisters, Nancy and Sr. Teresa, nephews and nieces, we extend our deepest sympathy.

Ar dheis Dé go raibh a anam dílis



**JOHN JOE NEVIN**  
(Ballina)

Ballina club president, John Joe Nevin, collapsed and died while watching his club's junior footballers in county final action against Upperchurch-Drombane in the Ragg on Sunday, January 12th 2003.

The Galway native who resided at 5 Grange Road, was at the final with his wife Patsy, and as Ballina secured the levelling point to draw the match, he collapsed and was taken to Nenagh hospital where he was pronounced dead. In his early seventies, John Joe spent some years in England where he was involved with St. Finbarr's club in Coventry and on making Ballina his home, he immersed himself in the promotion of juvenile activities being especially associated with the club's underage teams over the past 20/25 years. He attended every club match that Ballina played and his worth to the club in so many ways was recog-

nized at the conferring of the office of club president on him.

He was also an avid Galway fan and invariably indulged in much banter with fellow club mates, in the run up to Tipp-Galway confrontations. John Joe is survived by his wife Patsy, daughters Theresa, Frances, Bernadette, Caroline, sons John and Desmond, brothers, sisters, grandchildren and other relatives.



**TIM NYHAN**

There was widespread regret occasioned by the death of Tim Nyhan, Clongour, Thurles, in March of this year. Tim was a quiet and caring man who was held in high esteem by all who knew him. A most accomplished hurler in his youth, he was one of the brightest stars of Thurles C.B.S. teams in the late 'thirties. Tim, affectionately known as 'Dobby', went on to captain the successful Harty campaign of 1938, a team trained by Br. Ryan. Tipperary minor hurling selectors were quick to recognise his talent and for three years (1936-1938), he ably wore the Blue and Gold. During these years and later into the '40s, he lined out with Thurles Sarsfields. Tim's coffin was draped in Sarsfield's blue at his removal and a large attendance paid a fitting tribute to this quiet and pleasant man. Sincere sympathy is extended to the bereaved. Suaimhneas síoraí dá anam.

**DENIS O'BRIEN**  
(Burgess)

When news filtered through that Denis O'Brien of Dromin, Carrigatoher had passed away on April 30th last, it was greeted with sadness by all who knew him,

but particularly for his wife Anne, daughters Denise and Frances, sons Martin, Paul, Eugene, Donnan and Pierce.



Denis was a great character, very much on demand at a party or a celebration where he could dance a set or sing such ballads as Galtee Mountain Boy, and Scarlet Ribbon for her hair. An active member of Burgess Muintir na Tire drama group, he played leading roles with plays performed during Lent. Denis won North intermediate championship medals in 1951, 53, 59 and 63. He played one of his best games in the club colours, when Burgess lost to Toomevara in the 1955 North intermediate final, but missed out on the 1956 success as he had emigrated to America. While residing in Chicago, Denis won a championship medal with Harry Boland's club. This Dromin farmer loved his native place and never forgot his roots, neither did his family members including Teresa Ryan, Silver St. Nenagh.



**JIMMY O'BRIEN**  
(Burgess)

Jimmy O'Brien, Munroe, Newtown was a hurler of note. His first championship medal came in 1939, when Youghalarra had a resounding win over Boher

in the North minor hurling final, while the parish intermediate team lost to Shannon Rovers in the final on the same day. Jimmy was a regular member of the Duharra senior team in the late 1940s. North intermediate championship medals came this versatile player's way in 1953, 56 and 59, while he was also a member of the 1955 side that lost to Toomevara in the North final. Jimmy played with the Tipperary junior hurling team in 1956 that overwhelmed Cork in the opening round of the Munster championship. Tipperary were unexpectedly defeated by Kerry at the semi-final stage. When his playing days were over, Jimmy officiated as an umpire in club and inter county GAA games. He was an extensive farmer and had a keen interest in horse racing and loved his game of cards.



**PADDY O'BRIEN**  
(1923-2002)  
Kickhams

It was with great regret and sorrow that we learned of the death of Paddy O'Brien, Garrane, on November 16, 2002.

In his youth Paddy was a strong skilful hurler. He started at midfield for the Tipperary minors in an epic match against Cork at Semple Stadium in 1941. Cork had a narrow victory but such was Paddy's display on the day that many observers noted it was O'Brien against Cork. He also featured on the Kickhams teams that won West senior hurling titles in 1946 and 1949.

As a mark of respect to a true Gael, the Kickham club

provided a guard of honour at his funeral. To his wife, Maureen, and family we offer our condolences at their sad loss. Ar dheis Dé go raibh a anam uasal.



**REV. FR. JOSEPH A. O'BRIEN**  
1922-2002  
(Kiladangan)

The death of Fr. Joseph O'Brien in April 2002 came as a shock to all those who knew him. Although in failing health for a short time it was assumed that his strength and will be live would see him with us for many more years. Born in Tuamgraney, Co. Clare in 1922, Fr. Joe had a life long interest in the GAA and indeed in all sports. His skill with a caman was evident at an early age and he captained the St. Flannan's College team during his time there. He won a county hurling championship medal with his parish Bodyke.

Ordained in 1948 he served as curate in the parishes of Killanena and Kilmaley before coming to Toomevara in 1959. Fr. Joe was a tireless worker and his contribution to the parish of Toomevara was immense. He spent twenty-one years in Toomevara before moving to Bournea as parish priest in 1980. There he built a new school at Lismackin and a new church at Couraguneen. In 1985 he became parish priest of Monsea and Killodiernan, our parish.

As parish priest he led his flock with courage and dignity. He became involved in all aspects of parish life and was a staunch supporter of our GAA club. He was president of our club up to the time of his death. When he

retired as parish priest he remained in the parish as Assistant Priest. He continued his interest in all things local and was an honoured guest at our dinner dance just two months before his death.

To his family and friends we extend our deepest sympathy.

A dheis Dé go raibh an anam.



**EAMON (Eamy) O'CONNOR**

The people of Drangan and Cloneen were saddened to hear of the death of Eamy O'Connor RIP which took place in Dublin recently. Though not in the best of health for some time, his death still came as a great shock especially to his wife and family. Eamy gave great service to the St. Patrick's GAA club in a career that spanned more than three decades. He won a South Tipp championship with St. Patrick's school team in 1944, and a South minor football title with Fethard in 1951. He also won a south junior football championship with St. Patrick's Cloneen in 1951. He was a member of the St. Patrick's panel that won the south and county senior football championship in 1953. He captained St. Patrick's to win a South junior football title in 1963, and also no 2 junior hurling in 1963. His last successful year was when he played in goal for the junior football team that won south and county honours in 1967. He was one of the most dedicated and committed players ever to represent the club. He sleeps peacefully in Cloneen, at the foot of Slievenamon along with family, friends and a few of his former team mates. May he rest in peace.



**EUGENE O'DONNELL**  
1935-2003

(Clonmel Commercials)

The news of the sudden death of Eugene O'Donnell on April 3rd came as a great shock to all in the club. Eugene was a staunch supporter of the Commercials club and could always be called on to help out at fundraising and for transporting the players down the years.

Born in Kildorrery in Co. Cork in 1935 Eugene moved to Clonmel in 1968. He served as a sales Rep along with Mick Roche for John Player & Sons.

His involvement with our club came shortly after his arrival in the town. His son, David, was a prominent player with the club and it was with with great pride that Eugene recalled the many county titles that David and his team mates gathered during those years.

Commercials All-Ireland Peil Na nÓg victory of 1982 in Cavan was especially a source of great pride for the genial Cork man, Eugene was always available for a Church Gate collection or a flag day and with the salesman in him it was always rather difficult to pass him!!

Eugene retired in 1989 after 38 years service and was a regular user of the GAA Centre in Clonmel. He will be sadly missed by his wife Nancy, his sons and daughters and the rest of his family as well as his many friends in business and the GAA.

**JIMMY O'DONNELL**  
1920-2003  
(Eire Óg, Annacarty)

Jimmy O'Donnell passed to his eternal reward on October 23, 2003 in Tipperary Town, his adopted

home. He was born and reared in Rahyvira in the parish of Annacarty/Donohill some eighty-three years



earlier. His hurling career spanned nine years, from 1937-1945, with Eire Óg. He played minor with the county in 1937, when Tipperary lost to Cork, who has Christy Ring on the team. He won two West minor medals with Brian Borus, a combination of Eire Óg/Cappawhite. The foundation of these successes was laid in winning the schoolboys, league with Annacarty NS in 1934, 1935 and 1936, under the tutelage of Bill O'Donnell. Jimmy also played with Doon C.B.S.

The early forties saw Eire Óg win four West senior hurling titles, four league medals, and the county final in 1943. Minding the net in all these matches was Jimmy O'Donnell. Though small in stature, he was lion-hearted in minding his goalmouth. The team profile, prior to the county final, gave this description: a very determined little man, who usually manages to clear his lines. In 1945 Eire Óg were beaten by Cashel in the West final, and Jimmy moved on to pastures new, marrying his wife, Bridget, who predeceased him some years ago.

The Eire Óg club had a guard of honour at his funeral, headed by two of the surviving members of the 'forties, Fan O'Dwyer and Michael Ryan. We offer our sympathy to his sons and daughters.

**EILEEN O'GORMAN  
(Newcastle)**

**O**n the morning of Friday, December 20th 2002, the village of



Newcastle and surrounding areas were shocked to hear of the death of Eileen O'Gorman. Eileen, nee Walsh, came from a Ballymacarby family that was steeped in the G.A.A. After moving to Newcastle, she and her family became very involved with the local club. All of her family represented the club whether it was on the field of play, on the club committee or in the Scór competitions where they won a number of All-Ireland titles for Set Dancing. She was always a great supporter of the club and attended many games and Scór activities over many years. A guard of honour at the removal of her remains represented both the G.A.A. club and Céilí Club that she supported so well. The sympathy of both of these clubs are extended to Eileen's husband James, daughter Geraldine, sons Bernard, Anthony and Niall, son-in-law Ronnie, daughter-in-law Valerie, grandchildren, sisters, brothers, relatives and her many friends. Ar dheis Dé go raibh a hanam dhilís.



**FATHER PADDY  
O'GORMAN, AP  
(Knockavilla Donaskeigh)**

**A**lthough he had been ill for some time, Fr. O'Gorman was recovering and expected to be back

working in the parish, but he was taken suddenly to his eternal reward on May 19, 2003.

He was a Life President of the Kickham club since his arrival in the parish in 1991. Originally from Thurles, he had a great interest in and knowledge of Gaelic games, and was not afraid to put a point across. He had a particular interest in juvenile games, and took immense pride in the achievements of our young hurlers, footballers and camogie players.

He is a sad loss to the parish and club. We offer our condolences to his family and fellow religious. Ar dheis Dé go raibh a anam uasal.



**Kathleen (Kit) O'Hara,  
(Clonakenny)**

**T**he parish of Clonakenny-Couraguneen heard with shock on November 14 of the death of Kit O'Hara. She was very well-known locally, and was admired as a great friend and neighbour, who loved a chat and was never too busy to lend a hand to someone in need.

Kit became a great supporter of Clonakenny following a very successful playing career with Roscrea camogie club. She was a key player during the golden era of the club, when they won sixteen county titles in seventeen years. She also played camogie with Tipperary. In later years she took care of the Clonakenny G.A.A. playing gear. She had a great devotion to St. Martin and called on him many a time to intercede on Clonakenny's behalf.

To her family we offer our sincerest sympathies, especially her husband, Charlie, sons John and Jerry, daughters Kathleen, Mary, Aileen and Martina.

Leaba i measc na Naomh dí



**MARY (Minnie)  
O'NEILL  
(Newcastle)**

**I**n July 2003 Newcastle lost one of its senior citizens with the passing of Mary O'Neill. Minnie, as she was known to all, was in her late eighties. Her husband Tommy preceded her some years ago. She was a great supporter of Newcastle teams, juveniles and adults in hurling football and in Scór competitions. Minnie was a non-drinker, but she did enjoy her social life especially a game of cards and going to bingo. Her party piece was "The Laughing Policeman", which she performed at the local Christmas Party last December. She will be sadly missed by all in the area and in the Day Care Centre in Clogheen, where she made many friends. She will miss more so by her son Séamus and daughter May O'Meara and family, all who looked after her so well since she lost her husband. Our sincere sympathy to them all. Solas na bhFláitheas uirthi.



**JIMMY QUINLAN  
(Upperchurch-Drombane)**

**J**immy Quinlan, Ballyboy, Upperchurch died on All-Ireland hurling final day, on the 9th September 2001. Jimmy was a well-known figure in Upperchurch-Drombane and surrounding areas. A loyal supporter of the local club, his playing

days in the 1960s saw Jimmy give great service to the club. He was a member of the victorious junior No. 2 hurling team, which won a mid-final in 1968. Jimmy always took great interest in the activities of both parish and county teams and liked to debate the games in his shop at Ballyboy. The huge turnout at the removal of his remains from his residence bore testament to his popularity. We extend our sincere sympathy to his wife Anne, his sons Tom and Shane, his daughters Marie, Breda and Annette, his son-in-law, his grandchildren, his family and friends. Ar dheis Dé go raibh a anam.



**TOM RICHARDSON**  
(Arravale Rovers)

On the 26th of April, Arravale Rovers lost one of its most outstanding members in the person of Tom Richardson. When news filtered through late on that Saturday evening it was treated with shock and disbelief. Tom played for the club for a good number of years winning a junior football medal in 1980.

He won senior west football medals in 1981 and 1984. He won a senior county title in football in 1985 after a replay with Loughmore, which was the highlight of his playing career. He also won O'Donoghue cup medals in 1987 and 1992. When his playing days were over he trained teams and was in fact a selector at the time of his death. He was involved with every football team in the club from under age right up to the senior level. Tom served two periods as chairman 1995 to 1997 and 2001. He was also dele-

gate to the West board and the county board. He was a great man to fight the club's case when called upon to do so. Tom's funeral, which was the largest seen in Tipperary Town for years, showed his popularity in the club and outside. His coffin was draped in his beloved black and amber and his no 6 jersey of which he wore with distinction on many an occasion. The members of the club were profoundly saddened by Tom's untimely death, but nowhere will he be missed more than at Arravale Terrace by his wife Catherine, daughter Adrinne and sons Ian and Pierce. Ar dheis Dé do raibh a anam dilis.



**JACK RIORDAN**  
1923-2003  
(Solohead)

On July 24th Solohead and Tipperary lost one of its true supporters. Well known for song and craic, he followed the blue and gold where ever they played. In his younger days he played for Eire Og, Anacarty but when he married in 1953, he moved to Solohead.

He got involved with the local club and held various positions from selector to chairman. Indeed he was very proud to be chairman in centenary year 1984 and also played a part in the purchasing of the playing field. In his later years he was honoured as life president a position he held up until his death.

Jack will be sorely missed by all who knew him and sounds like 'Me Uncle in the Dail' will never be forgotten. To his wife Ciss, sons T.J. Nico, Seanie and Ger daughters Josie, Marie and Annette, brother George, and sister, Josie, we express

our deepest sympathy.

Ar dheis Dé go raibh a anam

**CON RYAN**  
(Toomevara)

The passing of Con Ryan during the year to his eternal reward removed another link with the Toomevara team that brought so much success to the parish during the late 'fifties and early sixties.

Con was a man of strong build and on the hurling field, and he used his strength to great effect when giving many powerful displays as the foundation was laid for many of Toom's victories. He gave many sterling performances for the club and his strong hurling ability was recognised by all his teammates.

He had a great love for our Irish culture with a special interest in Irish history and a wonderful appreciation of Irish music.

A skilled stonemason of the highest quality, much of his top class work can be seen in many parishes throughout North Tipperary.

*"Lives of good men all remind us*

*We can make our lives sublime,*

*And departing leave behind us*

*Footprints on the sands of time"*

To his wife Alice and family we tender our sincerest condolences on the loss of a devoted family man.

"Ar dheis Dé go raibh a anam"



**DONIE RYAN**  
(Upperchurch-Drombane)

It was with great shock and disbelief that we learned of the sudden death of Donie Ryan on the 22nd November 2002. Donie had a lifetime interest in both

club and inter-county hurling. He devoted his playing career to his beloved Black and Amber where he regularly commanded the number five shirt in the 1960s and 1970s. Donie was a loyal supporter of his local club and enjoyed attending all their matches. He loved to debate the finer points of the game and be the hurler on the ditch, with his many GAA friends in Patsy's pub. He was delighted to see his daughter, Catheriona, continue the family connection as secretary of his beloved club. We extend our sincere sympathy to his wife Bridie, his daughters Catheriona, Doreen and Joanne, his mother, his grandchild, his son-in-law, his brothers, sister, relatives and many friends, Ar dheis Dé go raibh a anam.



**JACK RYAN**  
(Kildangan)

It was with great sadness we learned of the death of Jack Ryan in September 2002. Jack grew up in Claree, Puckane, in the Kildangan parish. He was a fine hurler in his youth, played juvenile U15 in 1951-52, minor hurling in 1956, and played on the Kildangan-Burgess under 21 team, winners of North final in 1959. Jack played junior B with Kildangan for many years. He spent the latter years of his life in the Boher-Ballina parish, and was a great supporter of Tipperary hurling. Jack will be sadly missed by his wife Bridget and all his family and many friends all over Tipperary. May he rest in peace.

**JACK RYAN (W)**  
1925-2003  
(Roscrea)

Jack Ryan passed away on May 18, the day Tipperary



were losing to Clare in the Munster championship.

He was part of the Roscrea minor hurling team that won three North titles in a row, 1944, 1945, 1946, and was on the club senior panel that won the 1945 divisional title, though still only sixteen years of age! He went on to make the county minor team in 1946, winning a Munster medal v Cork in the final. In 1947 he added a second Munster medal when Tipperary defeated Waterford in the final, and he won his first All-Ireland medal, beating Galway in the final.

In 1949 Jack progressed to the county senior panel and, after being brought on to the starting fifteen against Antrim in the semi-final, he retained his place to win an All-Ireland medal against Laois in the final. On the same day his brothers Mick and Dinny also won medals.

In 1950 Jack added a National League medal to his collection, when Tipperary defeated Kilkenny. He won second Munster and All-Ireland medals the same year with victories over Cork and Kilkenny respectively. He travelled to New York later that year when Tipperary, as Home, League champions, played New York in the first such decider.

Jack played in the 1954 county final with Roscrea but had to go off injured, and a fine career was prematurely ended. The late John Joe Maher picked Jack as his corner-forward in his Roscrea Greatest Fifteen, still raving about his tussle with Jim Young of Cork in the 1949 Munster final. He also said of him: No lifting or messing around, pulled on the ball, gave great crosses, and could finish as well". A fine tribute to a fine hurler.

Sincerest sympathy is extended to his family.



**JOHNNY RYAN (W)**  
1919-2002  
(Eire Óg, Annacarty)

Johnny Ryan passed away on November 10, 2002, just ten days after his sister, Kitty. A gentle, quietly spoken man, who was always smiling in latter years, he belied his tenacity and toughness on the playing fields with Eire Óg in the early forties. Due to the number of Ryans on the team, Johnny was better known as 'Curly', and his most prominent position was right half-back. Born in 1919, his hurling career spanned ten years, 1937 to 1947, culminating in winning four West senior hurling titles, four league medals, and a county senior title in 1943, in which Eire Óg defeated Moycarkey-Borris by 4-3 to 2-4. Pre-match notes profiled Johnny as a fearless tackler and a terror for work. He was ably assisted by his brother, Jerry, in the half-forward line. He also won a minor medal in 1937 with Brian Borus, an Eire Óg/Cappawhite combination. The club extends sincerest sympathies to his relatives and many friends.



**PADRAIG RYAN**  
(Upperchurch-Drombane)

On the 29th March 2003 the death took place of Padraig Ryan at the tender age of 28 years following a

long illness which he bore with great courage and dignity. Although Padraig's family are steeped in hurling tradition, Padraig's playing career was restricted to school and juvenile level due to his illness. In spite of this, Padraig continued to maintain a great interest in the activities of both his club and county. The massive turnout at his removal bore testament to the esteem in which he was held both in his native parish and surrounding areas. To his heart-broken parents, Timmy and Nora, to his brothers Seamus and Tim, to his grandparents, family and friends we extend our sincere sympathy. Ar dheis Dé go raibh a anam.



**JOHN SHANAHAN**  
(Upperchurch-Drombane)

John Shanahan passed on to his eternal reward on the 8th January 2002 following an illness, which he bore with great courage. John was an exuberant person and an all-round athlete.

He served his club as an officer, a player and a mentor during his long career. A noted athlete, John always showed great fitness and speed in the centre of the field.

He also played a huge part in the development of the GAA grounds in Drombane. A lively contributor to debate, particular at convention, John always had the interest of the Upperchurch-Drombane GAA Club at heart. John richly deserved the honour of Club President, a role he held up to the time of his death.

We extend our sincere sympathy to his wife Kitty, his sons and daughters, his sons-in-law and daughters-in-law, his grandchildren, many relatives and friends. Ar dheis Dé go raibh anam.



**TOMMY TIERNEY**  
(Borrisoleigh)

On Monday, 31st March 2003, we laid to rest Tom Tierney, a man who made a huge contribution to C.L.G. Buireas Uí Luíoch.

Tom's hurling career spanned the sixties and early seventies. He lined out for Borris-Ileigh in various positions in defence and attack. Indeed he won a North senior championship in 1972 as sub-goalie. However, it was as a trainer and administrator that he really left his mark on the club. In 1978 he trained our junior hurlers and he led them to an historic North final.

Two years later, he took over as chairman. Immediately he brought an infectious enthusiasm to the position and in 1981, while also acting as team trainer, North and county titles were won. Having completed his first term as chairman, Tom was elected secretary, a position he held when the Dan Breen returned to Borris-Ileigh in 1983. Back at the helm in 1986, he was a proud chairman when Borris-Ileigh senior hurlers defeated Rathnure in the All-Ireland club championship final on St. Patrick's Day 1987.

In 1986, as part of the centenary of the club, Tom presided over the publication of our club history A Century of GAA in Borris-Ileigh. In the middle of all this Tom managed to find time to run a Lone Marathon, to raise much needed funds for Bishop Quinlan Park.

The 1980s was the second Golden Era, of Borris-Ileigh hurling and Tom Tierney will always be remembered as part and parcel of that era.

To his wife Margaret, son Shane, daughters Gene, Tara and Clare, his mother, broth-



er and sisters and all his relatives and friends, on behalf of Cumann Luthchleas Gael Buireas Uí Luíoch we extend our sincere sympathy.



**DAVID WADE**  
**(Golden-Kilfeacle)**  
**1930-2003**

The passing of David Wade, Thomastown, Golden on the 10th of October 2003 was met with much sadness within the

parish of Golden Kilfeacle. Davy, as he was better known to his many friends, was regarded as one of the most promising young hurlers in the club, before his career was cut short by an unfortunate accident, while cycling to Golden for training. Davy was a member of the Tipperary minor panel in 1948 and won a West junior medal with Golden in 1946, a competition which was not played until 1947. Davy played in many different positions around the field and was one of the few players to play senior and junior hurling while still being a minor. He remained extremely interested in all club activities until the time of his death. To his wife and family, we extend our sincere sympathy.



**MAURICE (Mossy) WALSH**  
**(Carrick Swan)**  
**1954 - 2003**

While this year has been one of the most successful ever on the field of play for Carrick Swan Hurling & Football Club it has been one of the saddest off the field with the loss of one our favourite sons Mossy Walsh. If ever a person epitomised what a dedicated player and lifelong supporter

is, it was Mossy. In his playing days he led from the front, fearless committed, dedicated.

A member of numerous successful hurling and football teams for Carrick Swan he was truly someone special. After his playing days had ended he remained a faithful follower of the fortunes of our club and was always prepared to support us in any way he could. Mossy's loss is a sad one for our club but much more is his loss to his wife Connie, sons and daughter, and the extended Walsh family, to all of whom our club extends its deepest sympathy. Mossie, tá brón ar gach duine i mhuintir na hÉalaí ach tá suil againn go bhfuil an camán agus an sliotar i do lámh agat agus an liathróid peil in aice leat. Slán go fóil.

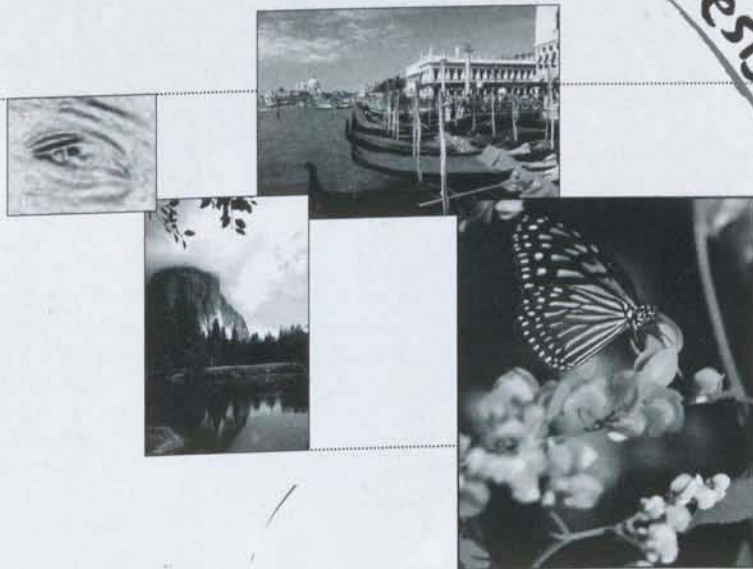

*Design • Typesetting • Layout*

call to

**Kilkenny People**  
*print & design*

Purcellsinch, Carlow Road, Kilkenny.

tel: 056-7763366 fax: 056-7763388

email: [info@kilkennypeople.ie](mailto:info@kilkennypeople.ie)

# Launch of County Tipperary Camogie History



*Elsie O'Dwyer, Coolmoyne camogie player from the 1930s receiving a bouquet of flowers from Seamus J. King*



*Left to right: Antoinette O'Donnell, Ardmayle; Jovita Delaney, Boherlahan; Mary Ryan, Cashel (Elmville) and Nora Tobin, Cashel (Elmville)*



*Marian Graham receiving a bouquet of flowers from the authors Seamus J. King and Martin Bourke*

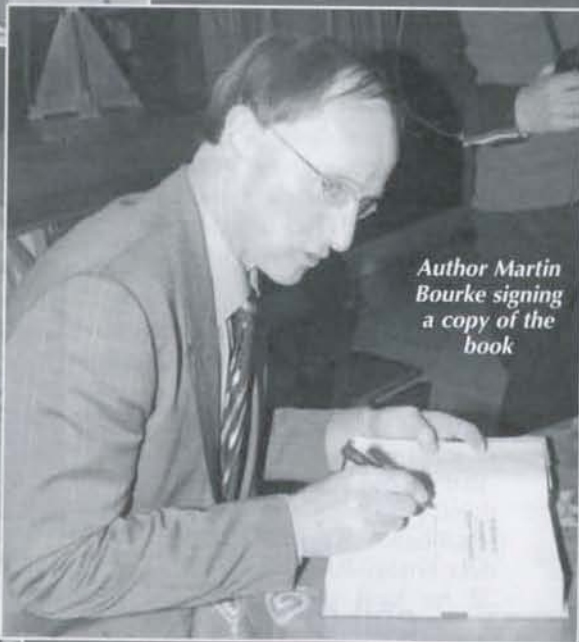

*Author Martin Bourke signing a copy of the book*



*Left to right: Jack Devanney, Noreen Timmons, Ella Nolan, Joan O'Brien, Michael O'Brien.*

# Tiobraid Árann



Front row (from left): Tom King, Shane O'Brien, Paddy Ryan, Paddy Stapleton, Ian Delaney, David Morrissey, Richie Ruth, Richie McGrath, Conor Hayes, James Woodlock, Colm Larkin, Paudie Ryan, Vinny Hannigan, Conor O'Brien  
Back row (from left): Michael Heffernan, Ray McLoughney, Brendan O'Sullivan, Joe McLoughney, Sean Ryan, David Sheppard, Niall Teehan, Darragh Egan, Kieran Bergin, Shane Long, Jim Bob McCarthy, David Young, Brendan Hanley, David McGrath, Dara Hickey, Seosamh Cleary

## MUNSTER MINOR HURLING CHAMPIONS 2003

# Tiobraid Árann



Back row (from left): Áine Mulcahy, Paula Ryan, Philly Fogarty, Suzanne Kelly, Joanne Ryan, Noelle Kennedy, Claire Madden, Therése Brophy, Claire Grogan, Angie McDermott, Danielle O'Connell, Paula Bultin, Helen Green, Irish O'Halloran, Louise Young.

Front row (from left): Niamh Connolly, Trish Ryan, Deirdre Hughes, Sinead Neaton, Ciara Gaynor, Jovita Delaney, Emily Hayden, Una O'Dwyer, Emer McDonnell, Michelle Shortt, Meave Corcoran, Sheena Howard, Lorraine Bourke.

## ALL-IRELAND CAMOGIE CHAMPIONS 2003