

Lemur Series Manual

Lemur, Lemur-S, Lemur-2, Lemur-K, Lemur-2K, Lemur-R
Ticket Printers Operator's Manual

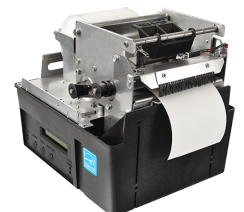
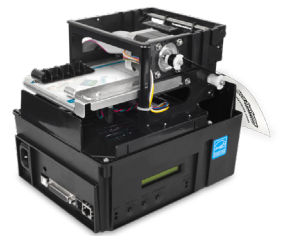

Table of Contents

Page

FCC Notice & Warranty Information	2
1.0 Introduction	3
2.0 Unpacking the printer	3
3.0 Important Safety Information	4
4.0 Installation	5
5.0 Ticket Load Procedure	8
6.0 Configuration	9
7.0 Standard Interface Pinouts	10
8.0 Thermal Paper – Theory & Specifications	11
9.0 Maintenance and Adjustments	12
9.1 Paper Guide and Print Head Assembly	12
9.1.1 Cut or Tear Opto	13
9.1.2 Load SQ Opto	14
9.1.3 Thermal Print Head	15
9.1.4 Thermal Print Head Replacement	17
9.1.5 Platen	18
9.1.6 Ticket Width Adjustment	19
9.1.7 Ticket Width Adjustment (UPG)	21
9.2 Cutter Assembly	22
10.0 General Cleaning	22
11.0 Logic Board	23
11.1 Logic Board (Removal)	23
11.2 Logic Board (Installation)	23
12.0 Spare Parts List	24
12.1 Print Head Guide	35
13.0 Troubleshooting Guide	36
Appendix A - CONTROL PANEL	38
Appendix B - VERTICAL PRINTER INSTALLATION	41
Appendix C – LEMUR-2, LEMUR-2MK OR LEMUR-2P	42
Appendix D – LEMUR-R	43
Appendix E - ETHERNET PARAMETERS	47
Appendix F – TESTING A LEMUR	49
Appendix G – DOWNLOADING SOFTWARE COMMANDS	56
Appendix H – CHANGE SPECIAL HEAD SETTING	57
Appendix I – CONFIGURE WI-FI CONNECTION	58
Appendix J – WINDOWS DRIVER INSTALLATION GUIDE	61
Appendix K – MAC DRIVER INSTALLATION GUIDE	75
Appendix L – ADHESIVE STOCK	80
Appendix M – SERVICE PLANS	82
Appendix N– TECHNICAL SUPPORT	83
Appendix O – REFERECE DRAWING	84

FCC NOTICE

NOTE: The equipment has been tested and found to comply with the limits for a class A digital device, pursuant to part 15 of the FCC rules. These limits are designed to provide reasonable protection against harmful interference when the equipment is operated in a commercial environment. This equipment generates, uses, and can radiate radio frequency energy and, if not installed and used in accordance with the instruction manual, may cause harmful interference to radio communications. Operation of this equipment in a residential area is likely to cause harmful interference in which case the user will be required to correct the interference at the user's expense.

Operation is subject to the following two conditions:

1. This device may not cause harmful interference, and
2. This device must accept any interference received, including interference that may cause undesired operation.

NOTE: This unit was tested with shielded cables on the peripheral devices. Shielded cables must be used with the unit to insure compliance.

WARRANTY INFORMATION

BOCA warrants the equipment manufactured and sold by it to be free from defects in material and workmanship under normal use and service for a specified period of time. Parts damaged by negligence or misuse (bad ticket stock, improper operating conditions, etc.) are excluded from this warranty. Warranties for printers are 1 year from date of shipment. (NOTE: The print head is a consumable part and is warranted for 90 days.) Spare parts carry a 90 day warranty. Tickets are warranted, under proper storage conditions, for a period of 3 years. All warranty work is to be performed either by BOCA or by an [authorized BOCA service center](#). Shipping charges to the repair center are the customer's responsibility. BOCA will pay for the equipment's return via ground service.

Please go to the link below if you have any reported issues with your new BOCA printer.
www.bocasystems.com/onlinesupportform.html

Equipment damaged in shipping should be reported immediately both to BOCA and to the shipper.

EXTENDED WARRANTY PLAN - BOCA offers [extended warranty plans](#) for all printer models. These plans cover all parts and labor. All labor is to be performed at the BOCA facility. Equipment damaged by misuse or negligence, including damage to print heads caused by defective ticket stock, is excluded from this extended warranty. The customer, at its option, may request BOCA to ship individual parts to expedite simple repair procedures. In certain cases where the customer is unable to wait for the normal repair cycle, BOCA will ship an exchange printer within one business day after notification by the customer. All freight charges are the responsibility of the customer.

Click here to return to > [Table of Contents](#)

1.0 Introduction

The [Lemur series printers](#) are direct thermal ticket printers that may be purchased with optional integrated cutting mechanism and LCD display. This manual will provide the user with general information regarding printer set-up, configuration and troubleshooting. Please read the important safety information section before installation is conducted. Review the [programming guide](#) for additional details.

2.0 Unpacking the Printer

The printer is shipped in a ruggedized container. **Please save packing material for future use.** Remove the printer and accessories from the box and inspect for obvious damage. If damage is noticed, please report it immediately to BOCA.

Email: cathy@bocasystems.com Tel: (561) 998-9600 Fax: (561) 998-9609

The following items should be in the box:

- a) Ticket Printer
- b) Hopper (if applicable)
- c) AC power cord
- d) Interface cable (optional)
- e) Mounting Plate (optional)



Above photo is of a Lemur-S printer.



Lemur-S with top insert removed.



Above photo of Lemur printer.

The shipping box and packaging material are specifically designed for your printer.

It is recommended you save the original box and packing material (including plastic bag if printer came with one) for future use, if needed.

Click here to return to > [Table of Contents](#)

3.0 Important Safety Information



WARNING: The appearance of this symbol indicates the proximity of an exposed high voltage area. Please follow all directions carefully for your personal safety. You must read the following safety information carefully before working on the printer.

As a safety precaution, all service to the printer should be done by **qualified persons** with power off and the AC cord unplugged from the printer. Following any procedure requiring the removal of covers and/or doors, please verify that they have been properly attached and fastened prior to operating the printer.

WARNING: "Provide an earthing connection before the mains plug is connected to the mains. And, when disconnecting the earthing connection, be sure to disconnect after pulling out the mains plug from the mains."

WARNING: Power Cord Set: This must be approved for the country where it is used:

U.S.A. and Canada

- The cord set must be UL-approved and CSA certified.
- The minimum specification for the flexible cord is:
 - No. 18 AWG
 - Type SV or SJ
 - 3-conductor
- The cord set must have a rated current capacity of at least 10A.
- The attachment plug must be an earth-grounding type with a NEMA 5-15P (15A, 125V) or NEMA 6-15P (15A, 250V) configuration.

United Kingdom only

- The supply plug must comply with BS1363 (3-pin 13 amp) and be fitted with a 5A fuse which complies with BS1362.
- The mains cord must be <HAR> or <BASEC> marked and be of type H03VVF3GO.75 (minimum).

Europe only:

- The supply plug must comply with CEE 7/7 ("SCHUKO").
- The mains cord must be <HAR> or <BASEC> marked and be of type H03VVF3GO.75 (minimum).

Denmark: The supply plug must comply with section 107-2-D1, standard DK2-1a or DK2-5a.

Switzerland: The supply plug must comply with SEV/ASE 1011.

WARNING: The appliance coupler (the connector to the unit and not the wall plug) must have a configuration for mating with an EN60320/IEC320 appliance inlet.

WARNING: The socket outlet must be near to the unit and easily accessible.

WARNING: France and Peru only:

This unit cannot be powered from IT† supplies. If your supplies are of IT type, this unit must be powered by 230V (2P+T) via an isolation transformer ratio 1:1, with the secondary connection point labelled Neutral, connected directly to earth (ground).

WARNING: RJ-45 Ports. These are shielded RJ-45 data sockets. They cannot be used as standard traditional telephone sockets, or to connect the unit to a traditional PBX or public telephone network. Only connect RJ-45 data connectors. Either shielded or unshielded data cables with shielded or unshielded jacks can be connected to these data sockets.

Click here to return to > [Table of Contents](#)

4.0 Installation

The [Lemur series printer](#) was designed to be mounted either on a desktop or shelf (horizontal model) or vertically in a counter top (see [Appendix B](#) for installation of vertical printers). Lemur-S model printer is not able to be mounted vertically.

Prior to site preparation and installation, the printer should be powered up and run in the self-test mode.

- Lay the printer flat on a counter top. On a Lemur-S model printer you will need to remove the side cover.
- Attach the AC cord and interface cable into the proper connectors.
- Install ticket hopper (if applicable) to catch the tickets. Lemur printer without a cutter won't have a ticket hopper.
- If you have a Lemur-R model printer please see section [Appendix D Lemur-R](#)
- Recommend that the stack of paper stock be fanned prior to use. This may be done by securely holding one side of the stack and fanning the other. You will want to do both sides. This fanning will help remove any paper dust or debris that may be on the ticket stock, as well as reduce the paper dust in the printer too.
- Turn power on. The LCD will display PAPER OUT and the red CHECK PAPER led will be illuminated. You will hear the cutter motor cycle if the printer contains a cutter.
- For Lemur-S printer you will need to remove the cover (see [page 6](#)). Begin loading tickets through the entrance slot with a smooth motion until the printer automatically positions the ticket. See section [5.0 Ticket Load Procedure](#).

NOTE: You want to make sure that the black timing mark is in the correct location before loading the tickets into the paper path. See www.bocasystems.com/tickets_specs.html for black mark layout specs.

- After the ticket is automatically positioned (the green READY led will be illuminated), press the TEST button located on the control panel to print a test ticket. The next page shows sample self test ticket printouts.
- Verify that the printer properly works with your system by issuing a ticket through your computer system. You may also use out customer-based program to test the printer independently of your ticketing system (see [Appendix F](#))

You may now install the printer in its permanent location. Adequate room should be provided behind the printer for the smooth feeding of ticket stock. Please do not prevent the ticket hopper (horizontal models) from operating by touching tickets during the printing cycle.

Lemur, Lemur-R & Lemur-K cover removal – The printer is shipped there are two securing screws installed to hold the cover in place. If the cover needs to be removed then it will be necessary to remove these (see photo below). When you install the cover back onto the printer it's not necessary to reinstall these screws as the black latch (metal cabinet only) will hold the cover in place. It's recommended to use the printer with the cover in place.

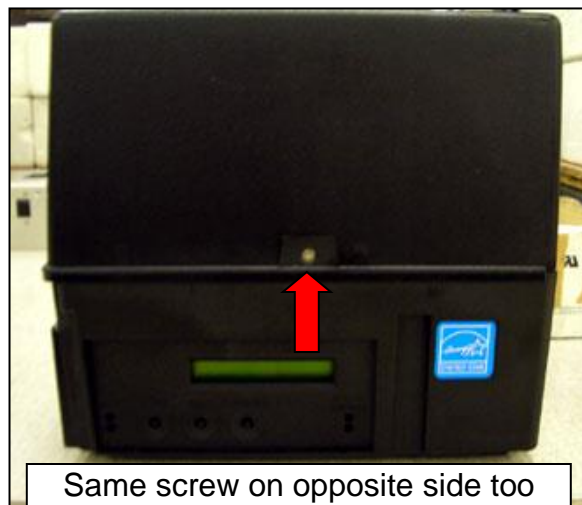
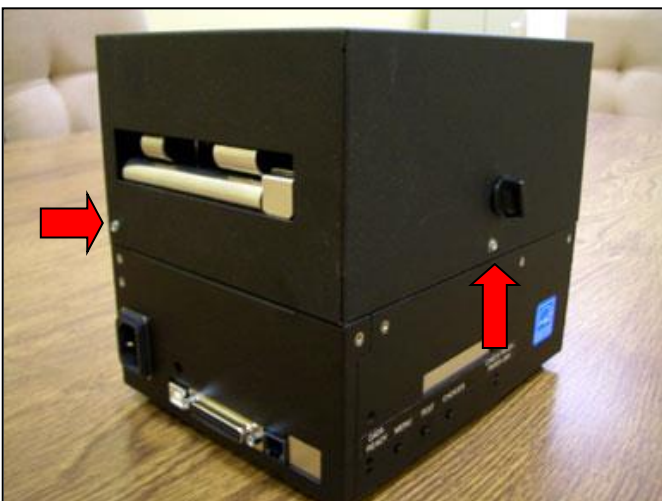

Lemur-S cover removal – The cover may be removed in the following manner.



There is a locking tab that is located on top of the Lemur-S cover



Grasp the cover with both hands. Press down on the locking tab.

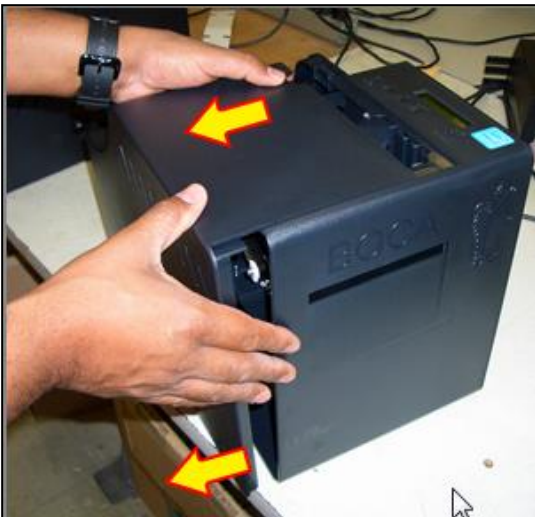

While holding down the locking tab, slide the cover outward towards you.



The cover may be installed by reversing the above procedure. Once you align the top and bottom part of the cover with the cabinet, slide the cover away from you until the tab locks.



Above sample was printed on a 4" x 6" ticket using a 300dpi FGL protocol Lemur without cutter.



Above sample was printed on a 2" x 5.5" ticket using a 200dpi FGL protocol Lemur with cutter.



Above sample was printed on a 2" x 5.5" ticket using a 300dpi PCL (HP) protocol Lemur with cutter.

Your printout may vary depending on printer configuration and ticket stock used.

Click here to return to > [Table of Contents](#)

5.0 Ticket Load Procedure

1. Turn the printer on and wait five seconds. The red CHECK PAPER led will be illuminated (if your printer has an optional LCD then it will display PAPER OUT).
2. Begin loading the tickets through the entrance slot with a smooth motion until the ticket stock comes to a stop (at this point the stock is between the thermal head and platen). Keep pressure against the stock and the printer will automatically feed the ticket stock.

NOTE: see [Appendix C](#) for loading of Lemur-2 and Lemur-2K printers.

If you have any ticket load issues then make sure the paper guild slider bar is properly adjusted (see [9.1.6 Ticket Width Adjustment](#)).

Reverse Adjustable (RADJW & RADJ4)

Adjustable (ADJ4, ADJW & ADJ2)

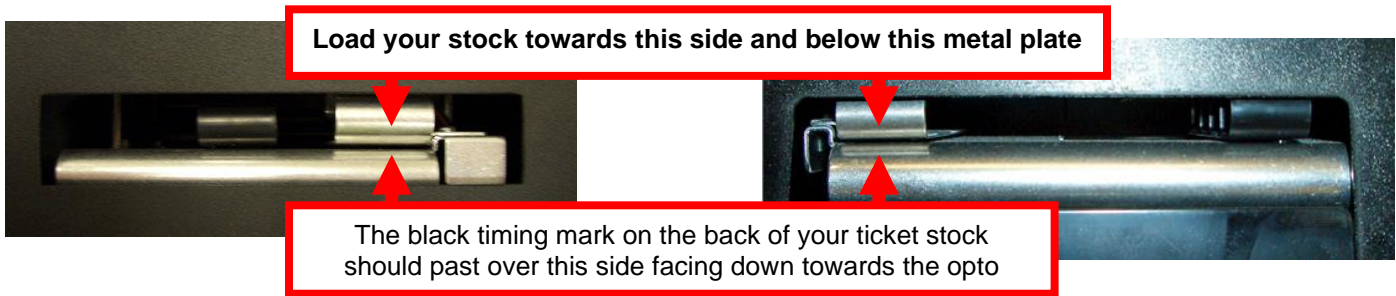

In October of 2019 BOCA transitioned over to using a Universal Paper Guide (UPG).

Below are photos of said paper guide.

If you have any ticket load issues then make sure the paper guild slider bar is properly adjusted (see [9.1.7 Ticket Width Adjustment](#)).

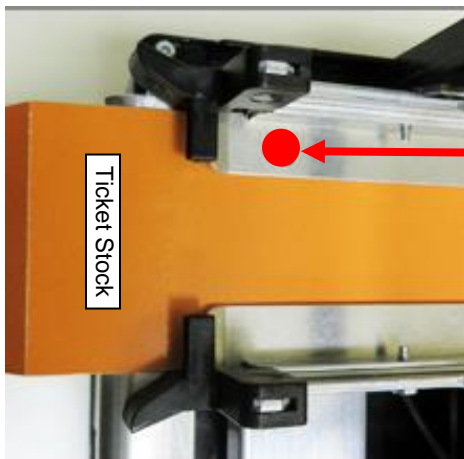
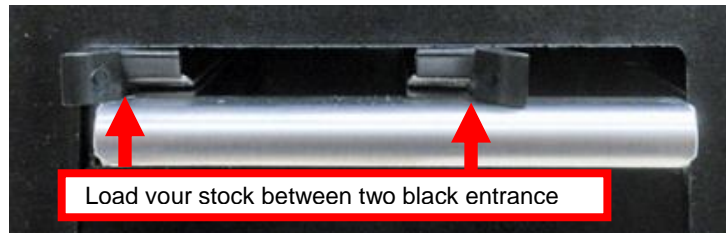

The black timing mark on the back of your ticket stock should pass under the side with the dot and is facing down towards the black mark sensor.

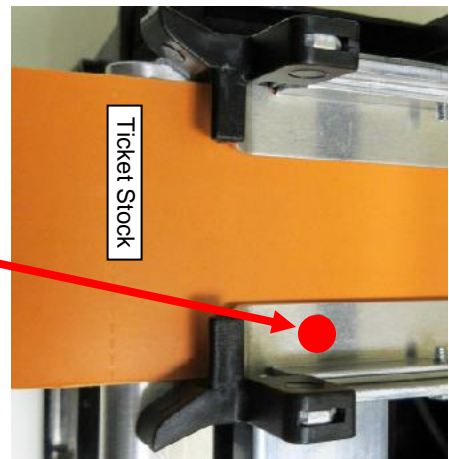

Adjustable (ADJ, ADJW & ADJ2)

Reverse Adjustable (RADJW & RADJ4)

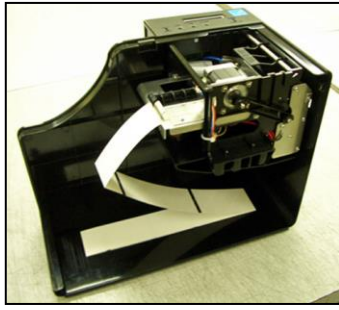

Above photo is of a plastic cabinet Lemur-S with optional cutter and cover removed. Your printer may vary. Two typical ticket formats and feed directions are shown below. The black timing mark must be facing the [opto sensor](#).

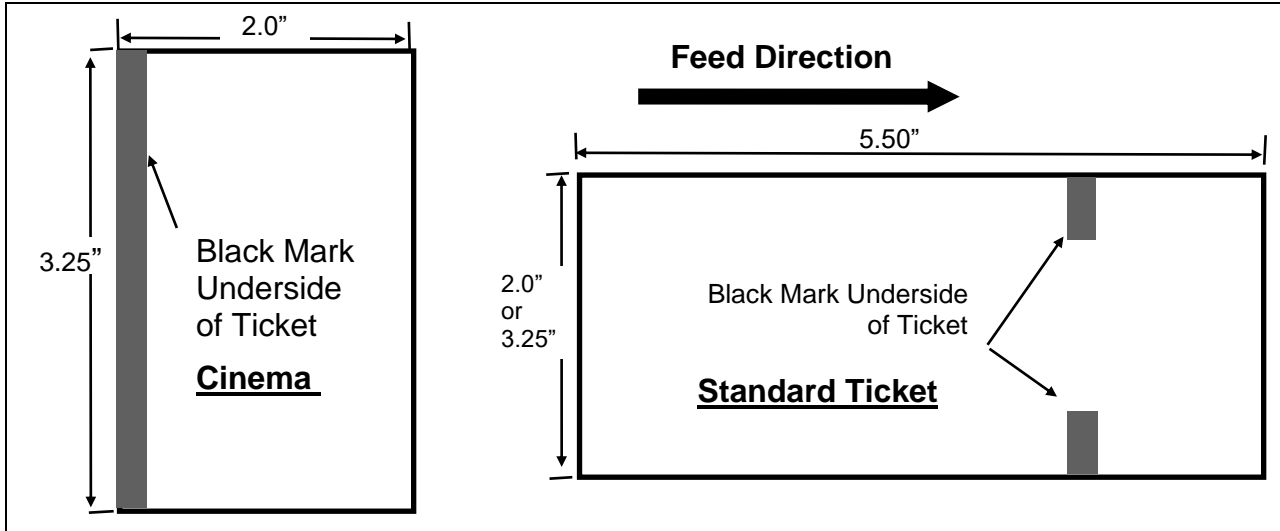

When loading 5.50" long ticket stock the black timing mark should be closest to the leading edge of the ticket (the first part that goes into the printer). When loading 2.0" long cinema ticket stock the black timing mark should be furthest away from the leading edge of the ticket (the first part that goes into the printer).

6.0 Configuration

The [Lemur series printer](#) is factory configured for a variety of customer requirements.

For a comparison of the different electronics packages, refer to the BOCA Systems [website](#) under the [BASIC](#) section.

For a listing of configuration choices, refer to the BOCA Systems [website](#) under the [SPECIFICATIONS](#) section.

Printers are configured with a reverse adjustable paper guide (RADJW) set to the customer's specified width or optional adjustable paper guide (ADJ4, ADJW, ADJ2 & RADJ4).

Reverse adjustable (RADJW & RADJ4) path printer is set to the customer's specified width. If this setting requires changing then the following will need to be done to ensure proper operation.

1. The paper path slider bar needs to be adjusted for the width stock being used (see [9.1.6 Ticket Width Adjustment](#) or [9.1.7 Ticket Width Adjustment](#) for UPG printer).
2. The SPECIAL HEAD setting needs to be changed to match the width stock being used (see section [Appendix A](#)). For those printers without a LCD display see [Appendix H](#).

Adjustable (ADJ4, ADJW & ADJ2) paper path printer may leave the factory with the slider bar set to its widest setting (ADJ4 = 4", ADJW = 3.25" & ADJ2 = 2"). Please check to make sure the paper path slider bar is properly adjusted for the width stock being used. (see section [9.1.6 Ticket Width Adjustment](#) or [9.1.7 Ticket Width Adjustment](#) for UPG printer).

Click here to return to > [Table of Contents](#)

7.0 Standard Interface Pinouts

RJ12 Serial Connection

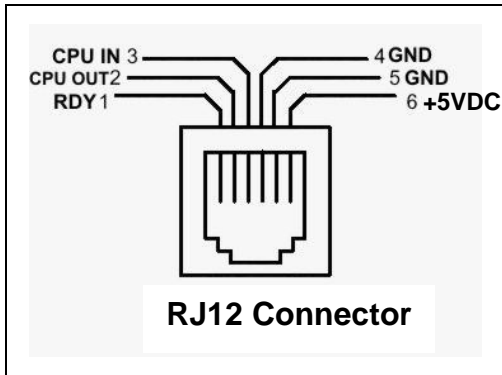

TYPICAL DB9 to RJ12 PIN CONNECTIONS

9 pin host	BOCA RJ12	
2	2	Transmit
3	3	Receive
5	4	GND
6	1	RDY
8	6	CTS

PARALLEL

PIN	FUNCTION
1	Strobe (negative)
2-9	Data (DB0 - DB7)
10	ACK (negative)
11	BUSY
12	PAPER OUT
13	SELECT (negative)
15	ERROR (negative)
18	Ground

USB Printers prior to serial number 271200 are USB 1.1 compliant devices. Printers after serial number 271200 are USB 2.0 compliant devices.

ETHERNET (Optional) is a standard RJ45 Ethernet cable connection.

WI-FI (Optional) is compatible with 802.11b/g Wi-Fi router and supports security settings WEP/WPA/WPA-2.

BLUETOOTH (Optional) may be ordered as Classic or Low Energy (LE).

NOTE: The above pinouts may vary on certain printers due to special customer request.



Click here to return to > [Table of Contents](#)

8.0 Thermal Paper - Theory & Specification

Refer to the BOCA Systems website at www.bocasystems.com, [THERMAL TICKETS](#) section for the most current [paper specifications](#).

The print head's life expectancy is composed of both a mechanical and an electrical component. Both of these factors are strongly influenced by the quality of the thermal paper used.

MECHANICAL

The print head has a theoretical rating of 60 kilometers. This number is based upon the assumption that the head will be used with a good quality, top coated thermal paper. Uncoated and poorly top coated thermal papers are abrasive to the print head and have been found to wear through the head after less than one kilometer.

Other factors which may contribute to premature mechanical wear are the use of non-thermal inks and stray metallic particles stuck in ticket perforations. Certain ink colors such as opaque white (which contains titanium dioxide) are also highly abrasive.

Unfortunately, there are no available devices for quantitatively measuring the abrasiveness of a given ticket. Fortunately, we have developed a slightly subjective, but effective method of weeding out overly abrasive ticket stock.

ELECTRICAL

Each heat element, dot, on the print head has a theoretical life expectancy of 100 million activations. This is based on the assumption that each activation will cause the dot temperature to approach the dot's maximum recommended temperature. Running at lower temperatures will increase the theoretical life expectancy, while slight temperature increases will seriously (exponentially) degrade the head life.

The thermal paper can affect the electrical head life in two ways. Insensitive, slow papers will typically encourage the user to increase the voltage to darken the printed image. This will directly increase the head temperature resulting in reduced head life. Additionally, the higher temperatures will frequently cause the ink to peel off the ticket and deposit onto the print head. The ink debris will disrupt the normal transfer of heat from the head to the paper. This further increases the head temperature above the desired level. The use of non-thermal inks and/or non-top coated papers also will cause the ink to release and deposit on the print head.

SPECIFICATION

Based upon the above technical information, BOCA has always tried to encourage our customers to use the proper thermal papers to maximize the life of their print heads. BOCA provides an extensive series of papers which meet the above criteria for low abrasion and high sensitivity. We have also tested and approved a number of Ricoh thermal papers which meet our criteria. While we have not had the opportunity to test other manufacturers' thermal papers, we feel confident that other papers manufactured with the above goals in mind should be acceptable for use in our printers. Below is a link to ticket and label materials approved by BOCA.

www.bocasystems.com/ticketandlabel.html

Please note that the 300 dpi grade materials may be used on 200 dpi printers. In fact, doing so will allow the user to decrease the head energy thereby increasing the electrical life of the head. DO NOT use 300 dpi heads with 200 dpi paper.

200dpi grade materials should not be used with a 300dpi print as the printout will be light.

Click here to return to > [Table of Contents](#)

9.0 Maintenance and Adjustments

Your ticket printer is solidly constructed and has been designed for high volume use. It requires minimal care to provide maximum service.



WARNING: The appearance of this symbol indicates the proximity of an exposed high voltage area. Please follow all directions carefully for your personal safety. You must read the following safety information carefully before working on the printer.

This section provides an overview of printer maintenance, including part alignments, adjustment and replacement.

For discussion purposes, the printer consists of three major modules or assemblies:

- Paper guide and print head assembly
- Cutter assembly
- Logic board assembly

As a safety precaution, all service to the printer should be done by [qualified persons](#) with power off and the AC cord unplugged from the printer. Following any procedure requiring the removal of covers and/or doors, please verify that they have been properly attached and fastened prior to operating the printer.

9.1 Paper Guide and Print Head Assembly

The principal function of this assembly is to guide the ticket stock to the thermal print head where thermal printing takes place. Additionally, this assembly houses the drive platen and ticket positioning sensors. If necessary, the total assembly may be removed from the unit. All replacements and adjustments of the components on this assembly may be done without removing the total assembly. The most common adjustments and replacements regarding this assembly follow:

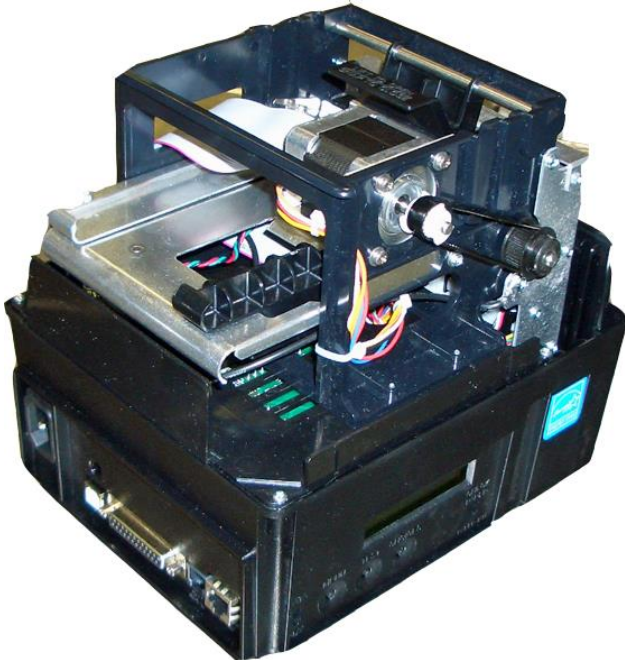

Above is a photo of a Lemur with UPG paper guide

Click here to return to > [Table of Contents](#)

9.1.1 Cut or Tear Opto

There is one optical sensor (opto) mounted on an adjustable aluminum bracket that senses the black timing mark on the ticket stock. The opto controls the cut or tear position. **Removal or adjustment of the opto should be done without removing the bracket from the paper guide.** The opto position is factory set and adjustment should not be necessary.

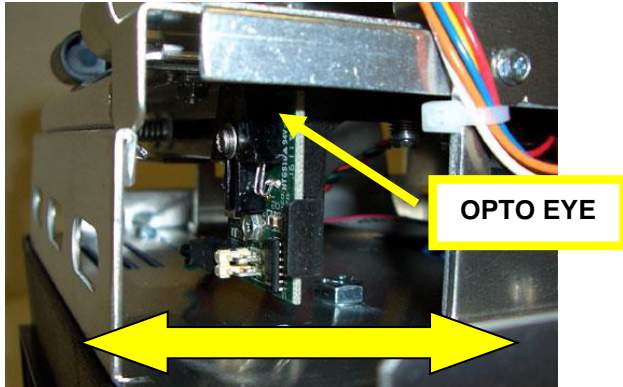

Above image shows a standard 422264 opto

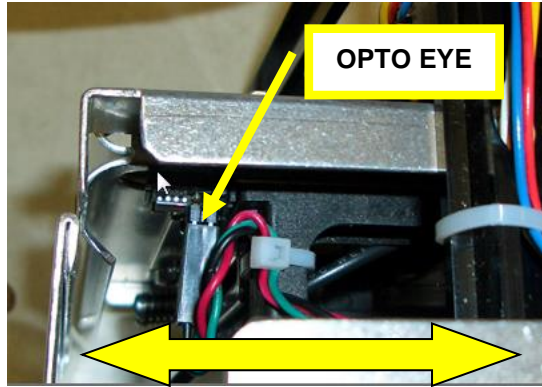

Above image shows a SQ opto

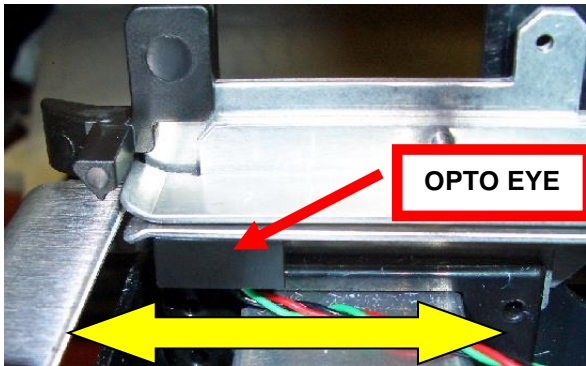

Above image shows Universal Paper Guide (UPG)

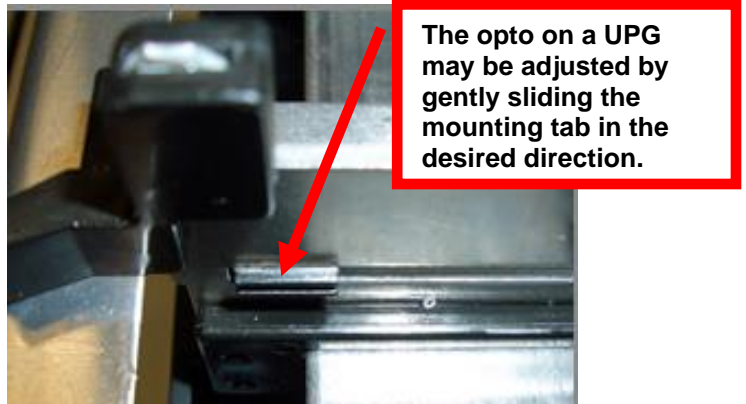

Note: Before making any opto adjustments make sure your ticket stock was manufactured to proper [ticket specifications](#).

To adjust the cut or tear position, physically adjust the opto mounting bracket forward or backwards to achieve the desired cut or tear location. On a Lemur with auto cut the cut position should be a 1/16"-1/8" away from the ticket perforation. On a Lemur without auto cut the ticket perforation should line up with the edge of the cabinet or top plate.

For a printer with a Universal Paper Guide (UPG) you may need to remove the ticket stock in order to physically adjust the black timing mark sensor (opto).

Minor adjustments (no greater than 3/16") to the cut or tear position may also be done via the control panel (if applicable) by changing the INC/DEC CUT1/2 settings. (See [Appendix A](#)). For a 200dpi printer the INC value should not exceed 38. For a 300dpi printer the INC value should not exceed 55. Going beyond these values will cause reliability issues.

If you are not able to get the desired cut position, make sure your ticket stock was manufactured to proper specifications.

Once a year the opto eye should be blown off with air. This interval will vary depending upon the environment and the quality of the ticket stock.

Click here to return to > [Table of Contents](#)

9.1.2 Load SQ Opto

A printer built after August 2014 may have a load SQ opto that is responsible for letting the printer know when it has paper stock loaded in the printer.

Once a year the opto eye should be blown off with air. This interval will vary depending upon the environment and the quality of the ticket stock.

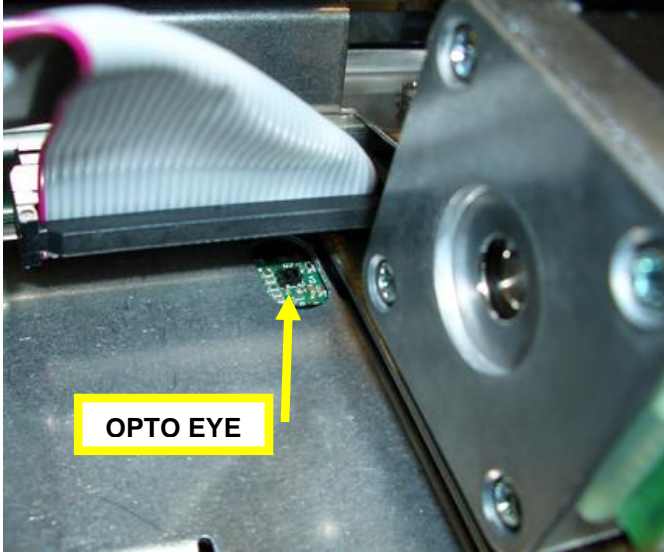

Above is a photo of a RADJW paper guide

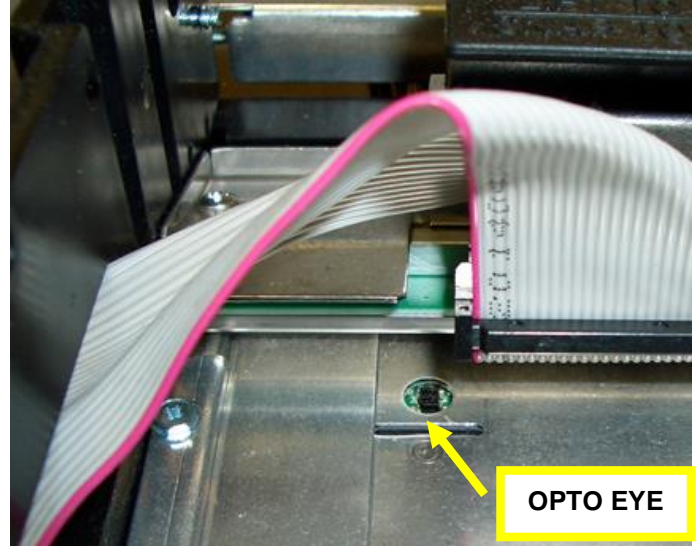

Above is a photo of an ADJ4 paper guide

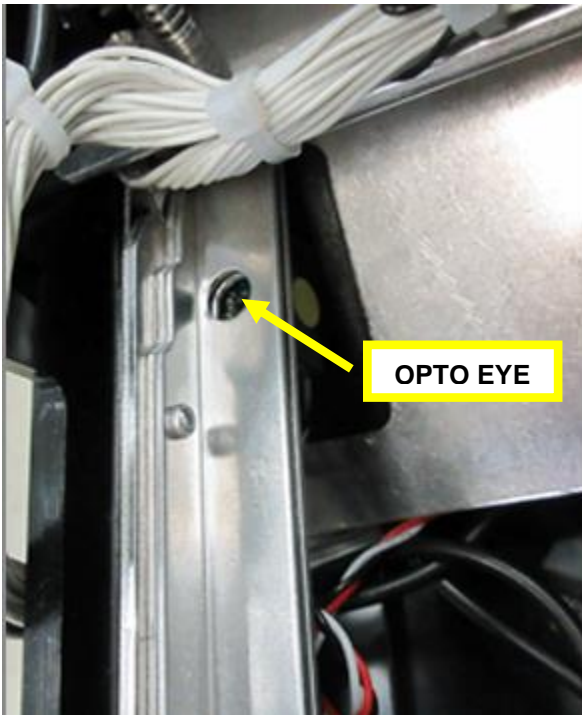

Above is a photo of a UPG paper guide

Click here to return to > [Table of Contents](#)

9.1.3 THERMAL PRINT HEAD

The print head should be cleaned periodically to prevent debris from building up on the print element. The required cleaning interval varies greatly depending on the quality of the ticket stock and the amount of dust entering the print area. Excessive dirt build up on the print head will result in reduced quality. Continuing to run the print head in a dirty condition will reduce its life expectancy, as it is unable to diffuse its heat properly.

The follow needs to be done with the printer powered off and unplugged from the AC source.

The thermal print head can be removed for cleaning or replacement, as follows:

1. Make sure power is off and the AC cord is disconnected from the printer.
2. **DO NOT UNPLUG CABLE FROM PRINT HEAD.**
3. Lift up the cam lock assembly (located above the head mounting plate) to remove pressure from the thermal head.

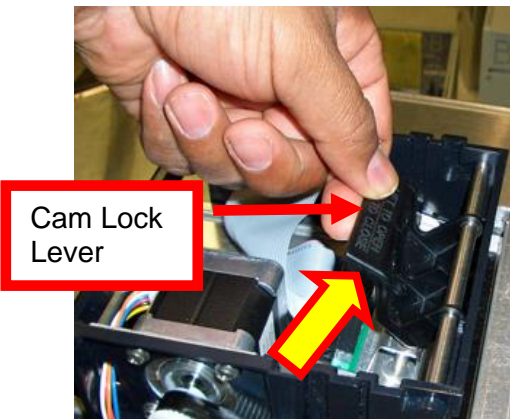

4. Position the cam lock lever as far forward as possible.

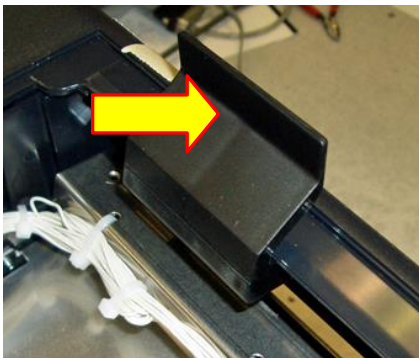

5. Flip the head back toward the rear of the printer. Denote what slot the print head was taken out of. Below photos show the different types of head mounting plates used through the production history of the Lemur series printers.

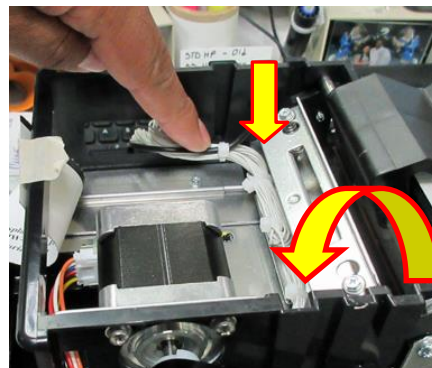
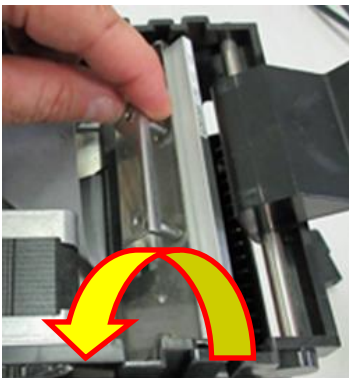

Pushing down on the head cable will aid in flipping the head plate.

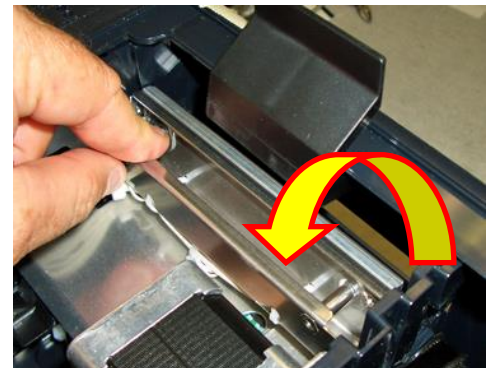

6. Lift the print head mounting plate straight out.

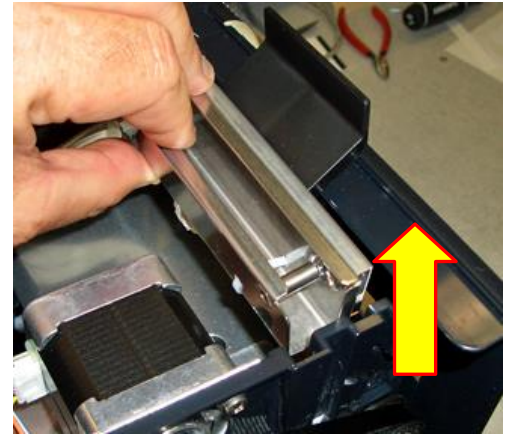
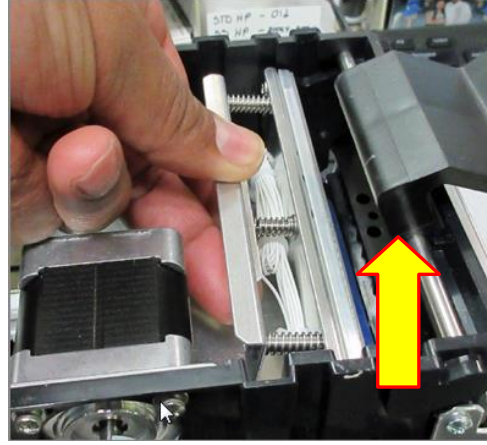
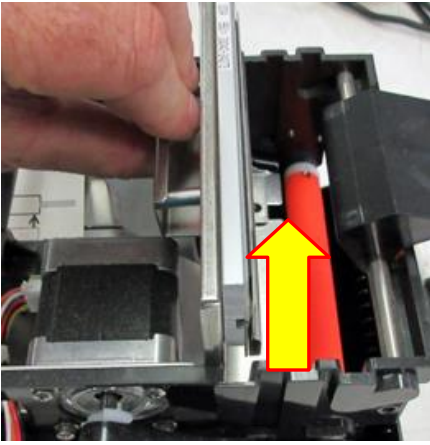

7. Clean the thermal print head surface (the side that makes contact with the paper) with isopropyl alcohol & paper towel.

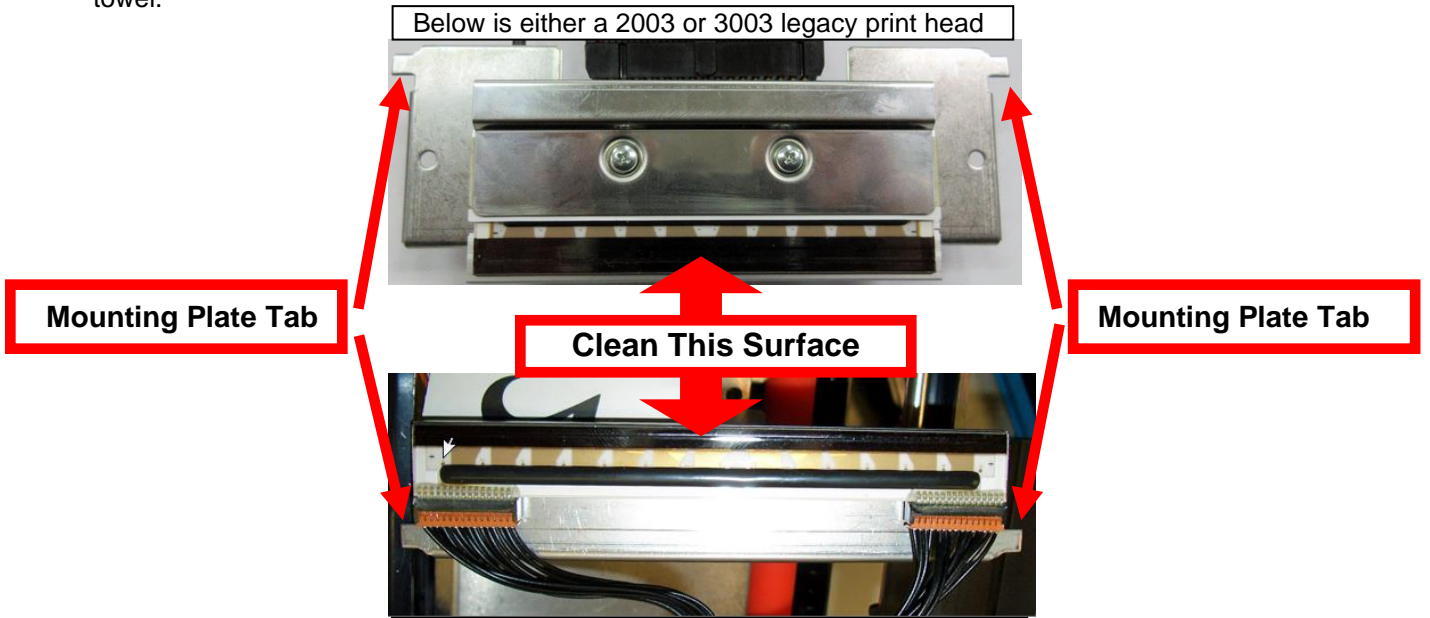

8. Install the head mounting plate. Above is either a 200L4 or 300L4 print head. the print head mounting plate tabs are in the correct print cage slots.

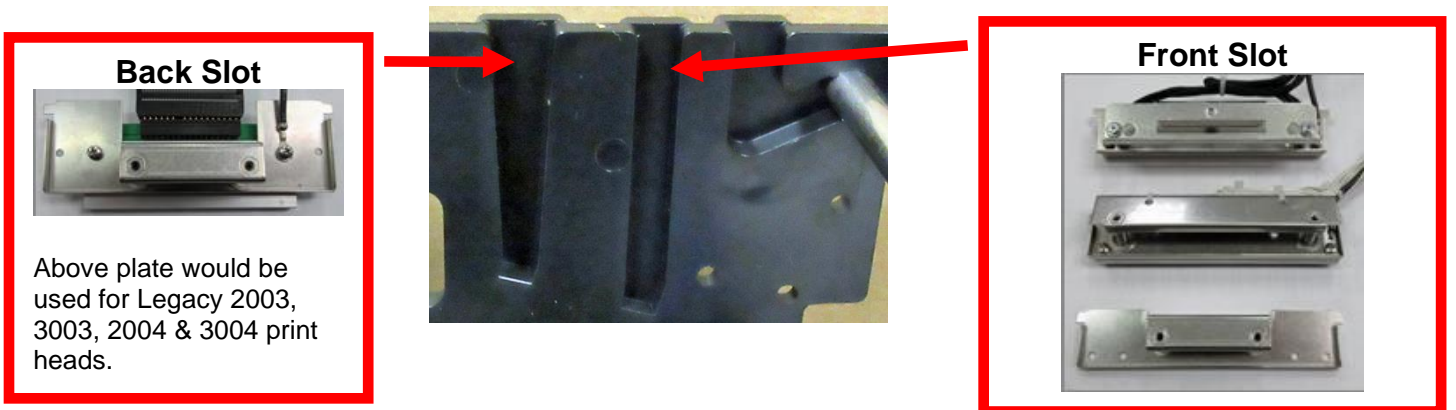

9. Restore pressure to the head by pushing down on the cam lock assembly.

10. The printer is now ready for operation. If the print quality is still poor then the thermal head needs to be replaced. See section [9.1.4 THERMAL PRINT HEAD REPLACEMENT](#)

Click here to return to > [Table of Contents](#)

9.1.4 THERMAL PRINT HEAD REPLACEMENT

Below reviews how to replace the thermal print head in your printer. Different type of print heads are used due to manufacture date, dots per inch (DPI) and size. A DPI of a printer may be determined by taking a look at the Width and DPI area of the printer's serial number tag. See section [12.1 Print Head Guide](#).

The follow needs to be done with the printer powered off and unplugged from the AC source.

1. Remove the print head mounting plate from the printer as shown in section [9.1.3](#) or [9.1.4](#) dependent on the type of printer and head mounting plate the printer has.
2. Once the head plate has been removed; loosen the two Philip head screws until the thermal print head disengages from the head plate. Take care not to lose lock and flat washers.



3. Gently unplug the cable from the old print head and plug it into the new print head. If your print head has two cables then this should be done one cable at a time so not to mix them up. The cables are keyed (see examples below). The keyed position must be lined up while plugging the cable into the print head. **You should not have to use excessive force to do this.**

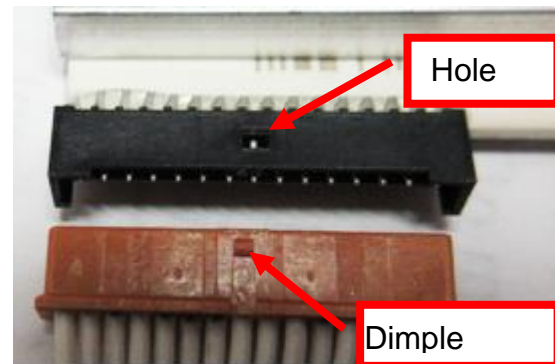
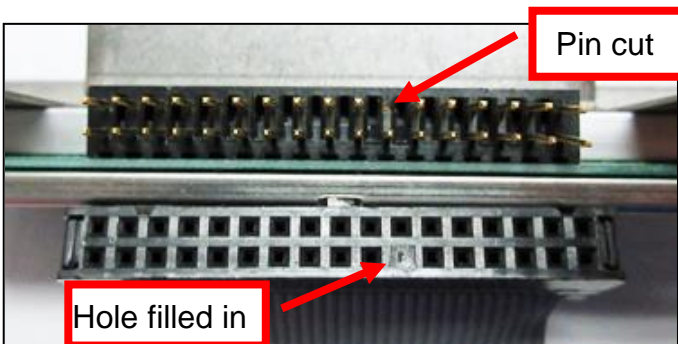

4. Install the print head back onto the print head mounting plate.
5. Install the head mounting plate/ thermal head back into the printer.

Click here to return to > [Table of Contents](#)

9.1.5 Platen

The Platen (rubber drive roller) should be cleaned once a year to prevent paper dust from building up on the roller. (NOTE: The platen may require more frequent cleaning in dusty environments or when using inferior ticket stock.)

The follow needs to be done with the printer powered off and unplugged from the AC source.

1. Make sure power is off and the AC cord is disconnected from the printer
2. Unlock the cam lock lever and remove head mounting block/ plate. (Refer to section [9.1.3 Thermal Print Head](#)). For Lemur-R printer see [Addendum D Thermal Print Head](#).
3. Apply a small amount of Isopropyl alcohol onto a paper towel to clean the rubber roller. Only clean the area where the platen makes contact with the media.
4. Clean only the part of the rubber roller where the ticket stock makes contact with.
5. Rotate the rubber roller clockwise a little and repeat step 4; continue in the same manner for one full revolution of the rubber roller.
6. Install the head mounting block/ plate and lock the cam lock lever back in place. Printer in now ready for normal operation.

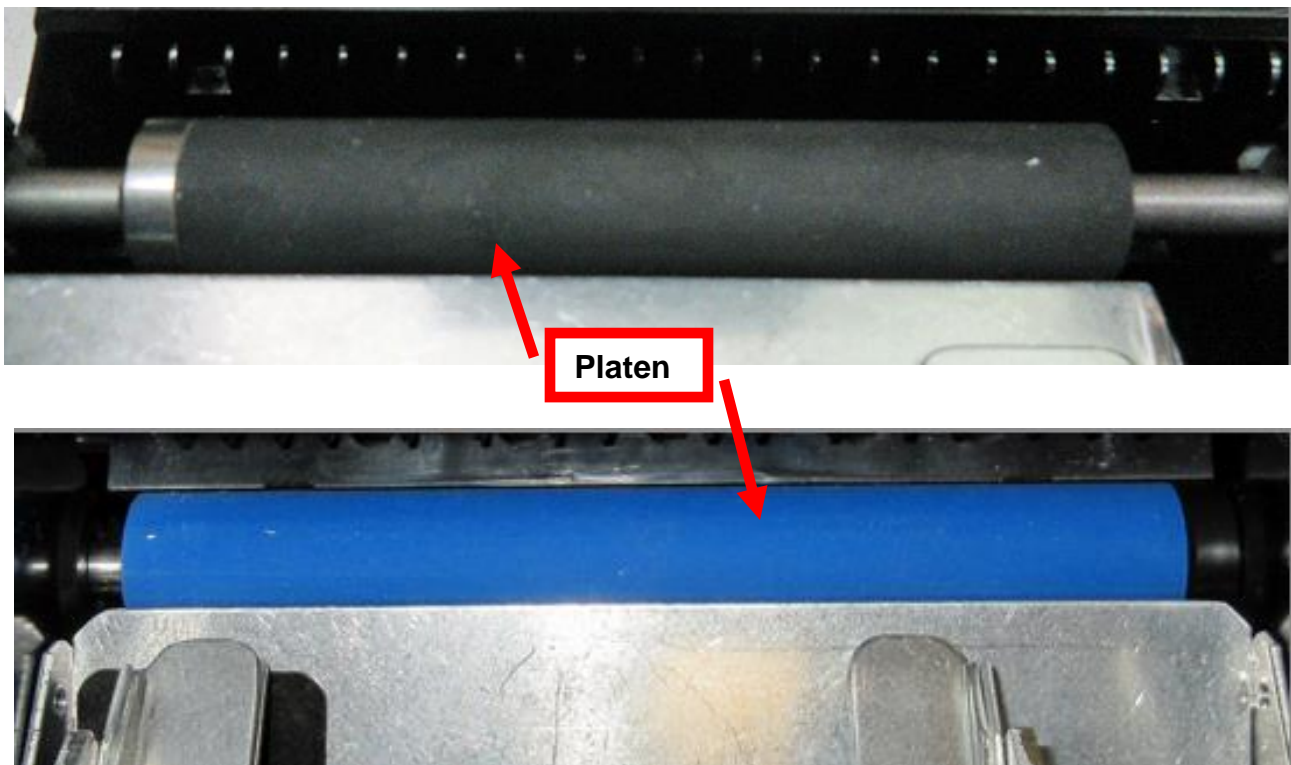

Platen size and color may vary from what is shown in the photos.

Click here to return to > [Table of Contents](#)

9.1.6 Ticket Width Adjustment

To adjust the paper path for use with a different ticket width, adjust the slider bar to the fully open position. Insert your ticket stock into the paper guide. Adjust the slider bar down to the proper ticket width, making sure the bar is not too tight against the ticket. The ticket should move freely in the paper guide path.

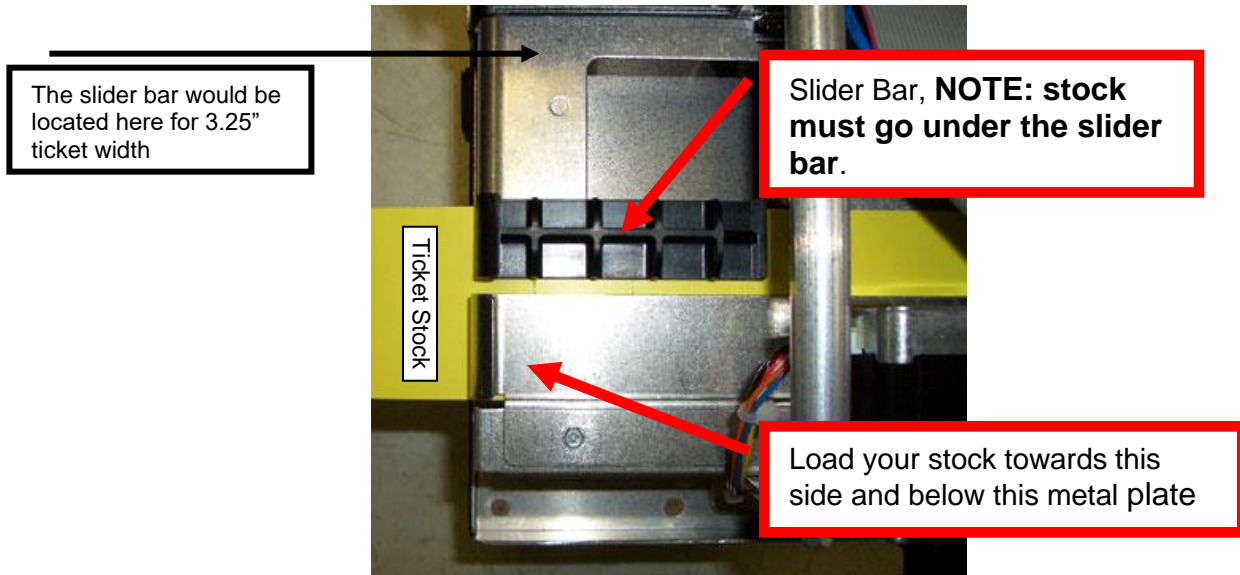

Above photo is of a RDJW paper path set for 2" wide stock

On reverse adjustable printers (RADJW or RADJ4), the "special head" setting via the control panel must be changed to match the new ticket width (see [Appendix A](#)). If the printer doesn't have the optional control panel then the width adjustment can be made via a software command (see [Appendix H](#)).

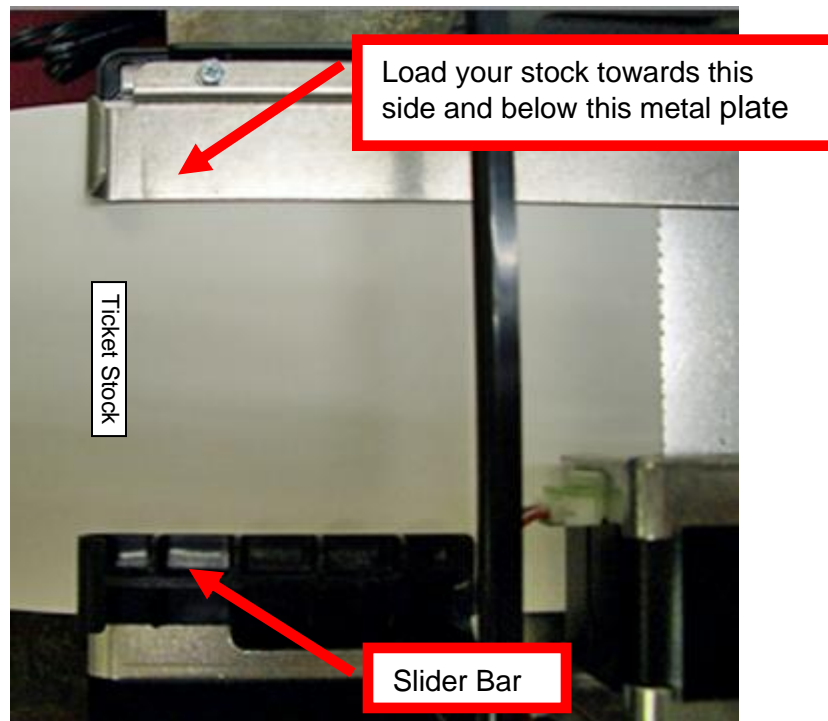

Above photo is of ADJ paper path set for 4" wide stock

No special head setting change is necessary on standard adjustable printers (ADJ4, ADJW or ADJ2).

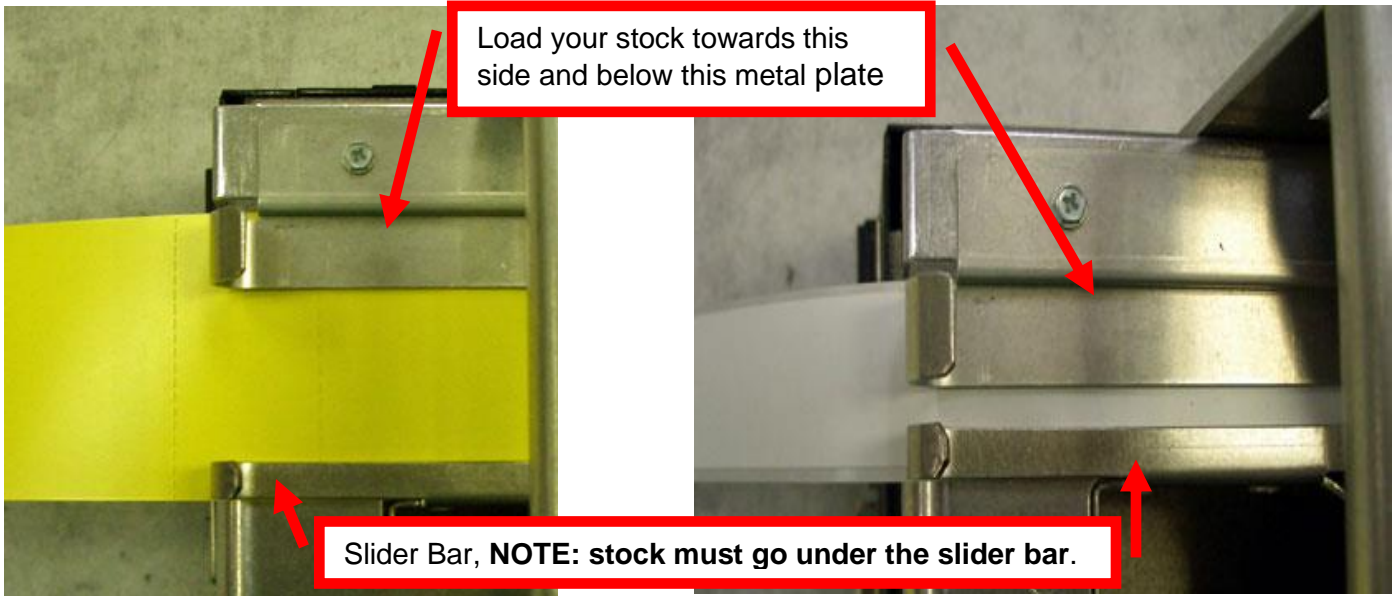

Above photo is of ADJ2 set for 2" wide stock Above photo is of ADJ2 set for 1" wristband stock

If adhesive stock is being used then please go to [Appendix L](#) Adhesive Stock to properly configure your printer for said stock.

Click here to return to > [Table of Contents](#)

9.1.7 Ticket Width Adjustment (UPG)

The below reviews how to adjust paper path of a Universal Paper Guide (UPG) printer for use with a different ticket width. Adjust the slider bar down to the proper ticket width, making sure the bar is not too tight against the ticket. The ticket should move freely in the paper guide path

The adjustable rail may be closed by gently pushing on the black plastic block shown in the area below (highlighted in yellow). This may be done with a screw driver or pen.

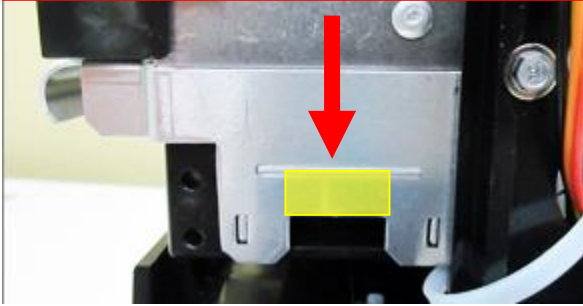

The adjustable rail may be opened by gently pushing on the paper guide rail (highlighted in yellow) with your thumb.

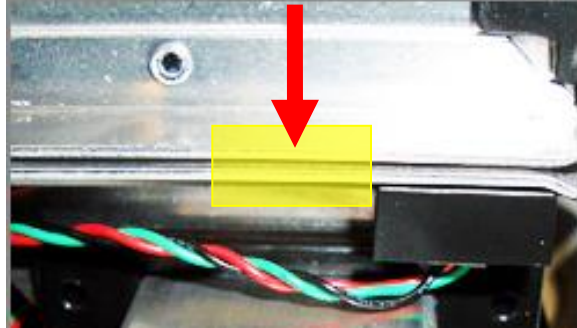

- Open up the adjustable rail so it is a little wider than the width of the stock you intend to use.
- Insert your ticket stock into the paper guide.
- Adjust the rail down to the proper ticket width, making sure the rail is not too tight against the ticket. The ticket should move freely in the paper guide path.

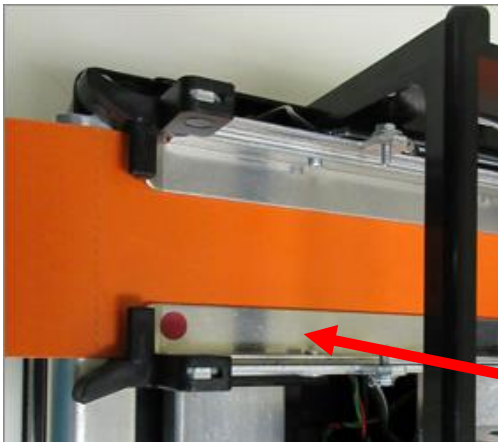

Above shows the UPG adjusted for 2" wide media



Above shows the UPG adjusted for 3.25" wide media

Adjustable Rail

CAUTION:

If the slider bar is adjusted too tightly against the ticket stock then it will cause the stock to buckle (see photos below). This will lead to feed or ticket jam issues. Ensure the adjustable rail is properly adjusted.



Click here to return to > [Table of Contents](#)

9.2 Cutter Assembly

The BOCA cutter system is a fully integrated cutter knife mechanism powered by a stepper motor. The cutter requires no adjustments and is rated for approximately 750,000 cuts. Please be aware of the following:

Wait five seconds before feeding ticket stock into the printer after power up. During this time the cutter knife will move up and down. If ticket stock is fed into the printer before five seconds, a ticket jam could occur.

The cutter area where the tickets exit the printer should be blown out with air periodically to prevent debris from building up inside the cutter area. The required cleaning interval varies greatly depending on the quality of the ticket stock and the amount of paper dust entering the cutter area.

If the printer will be used with ticket stock that has a thickness greater than .008" then the cutter speed needs to be changed to SLOW. Please contact [BOCA](#) for documentation to make this change. If the cutter speed is not changed to SLOW, then the printer will not work reliably with said stock.

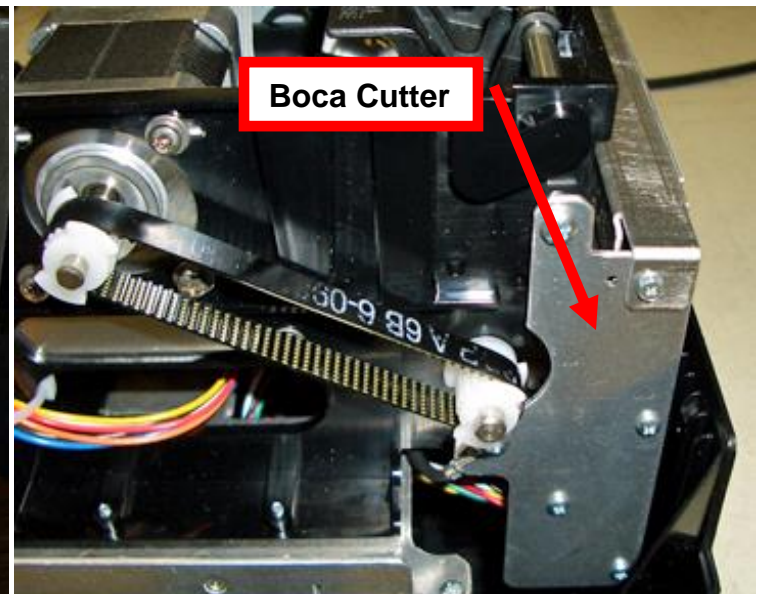
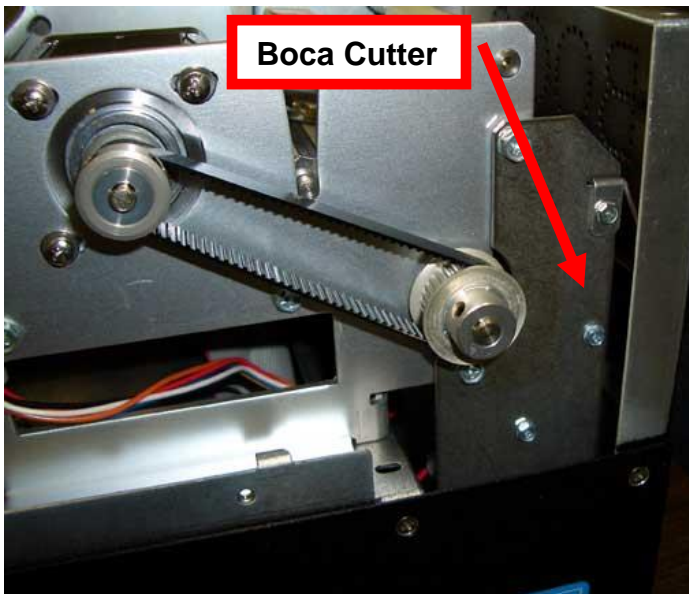

10.0 General Cleaning

The interior of the printer should be cleaned whenever there is a visible accumulation of dust. Use a small vacuum for cleaning. Be careful not to jar any of the printer's parts loose.

Click here to return to > [Table of Contents](#)

11.0 Logic Board

The printed circuit boards used in this product have been manufactured using surface mount technology. These printed circuit boards cannot be effectively repaired in the field and should be returned to the manufacturer if repair is required.

Warning: ALL SERVICE SHOULD BE DONE WITH POWER OFF AND THE AC CORD UNPLUGGED FROM THE PRINTER.

See below pictures for main logic board access: (Click on printer name for larger picture)



[Lemur & Lemur-K \(metal\)](#)
(Electronics cover removed)



[Lemur-S \(metal cabinet\)](#)
(Rear panel removed)

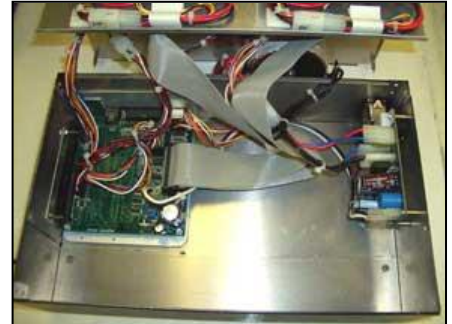

[Lemur-2](#)
(Electronics cover removed)

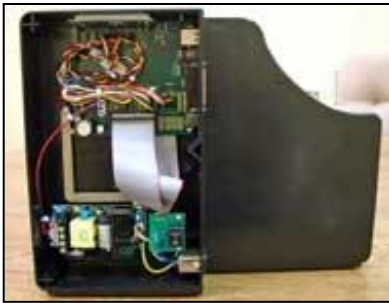

[Lemur-S \(plastic cabinet\)](#)
(Access panel removed)



[Lemur-2P](#)
(Access panel removed)



[Lemur & Lemur-K \(Plastic\)](#)
(Electronics cover removed)

11.1.1 Logic Board (Removal)

1. Gain access to the logic board. This is normally done by removing the electronics cover or rear access panel.
 - a. Lemur & Lemur-K (plastic cabinet) - Remove 4 Philip head screws and 1 hex head 1/4" screw.
 - b. Lemur, Lemur-K & Lemur-2 (metal cabinet) - Remove all screws that hold enclosure & electronics cover in place.
 - c. Lemur-S (metal cabinet) – Remove 5 Philip head screws from access panel.
 - d. Lemur-S (plastic cabinet) – Remove 3 Philip head screws from access panel.
 - e. Lemur-2P (metal cabinet) – Remove 4 Philip head screws from access panel.
2. Denote where all the cables are plugged into the logic board.
3. Unplug connectors connected to the main logic board.
4. Remove the four 3/16" head screws that secure the logic board onto the cabinet.
5. Lift board and remove.

11.1.2 Logic Board (Installation)

1. Installed the logic board into the printer.
2. Install the four 3/16" head screws that hold the logic board onto the cabinet and tighten.
3. Attach connectors going to the main logic board.
4. Install the electronics cover or rear access panel.

Click here to return to > [Table of Contents](#)

12.0 Spare Parts List

Item #	Part Number	Description
1	422557-25	Cable Ribbon, Thermal Head (for 2003, 3003, 2004 & 3004 print heads only)
1A	424010	Cable, Thermal Head (for 200C3 print head only)
1B	424059	Cable, Thermal Head (for 300L4 print head only) White in color
1B*	424060	Cable, Thermal Head (for 200L4 print head only) Black in color
2	420881Z-1	Enclosure, Lemur (metal)
3	423552-L	Cutter Assembly (BC3) all model Lemurs, except Lemur-R (METAL PRINT CAGE ONLY)
3A	423552-LP	Cutter Assembly (BC3) all model Lemurs, except Lemur-R (PLASTIC PRINT CAGE ONLY)
3A*	423980	Cutter Assembly (BC4) all model Lemurs, except Lemur-R for printer built after SEPT-2013 (PLASTIC PRINT CAGE ONLY)
3A*	424008	Cutter Assembly (BC5) all model Lemurs, except Lemur-R for printer built after NOV-2014 (Don't include metal side plates)
3*	423552-R	Cutter Assembly (BC4) for Lemur-R only (METAL PRINT CAGE ONLY)
3*	423980-R	Cutter Assembly (BC4) for Lemur-R for printer built after SEPT-2013 (PLASTIC PRINT CAGE ONLY)
3*	424008-R	Cutter Assembly (BC5) for Lemur-R printer built after NOV-2014 (Don't include metal side plates)
4	423759	Display Holder
5*	P50-1003	Drive Belt, 102T (for 300dpi)
5	P50-1017	Drive Belt, 98T (for 200dpi)
6*	P51-1011	Drive Pulley, 30T (for 300dpi)
6	P51-1007	Drive Pulley, 20T (for 200dpi)
7	P51-1014	Drive Pulley, 20T (for 200dpi & 300dpi)
8	423480Z	Upper Exit Deflector horizontal (only) printer built prior DEC-2014
8A	423480Z-VL	Upper Exit Deflector vertical (only) printer built prior DEC-2014
8B	423480Z-C	Upper Exit Deflector (complete with static brush) printer built prior DEC-2014
8C	423480Z-VL-C	Upper Exit Deflector vertical (complete w/ brush & Mylar) printer built prior DEC-2014
8D	423480C	Upper Exit Deflector ONLY BC5 horizontal & vertical printer built after NOV-2014
8E	423480C-C	Upper Exit Deflector BC5 horizontal (complete w/ static brush) printer built after NOV-2014
8F	423480C-VL	Upper Exit Deflector BC5 vertical (complete w/ brush & Mylar) printer built after NOV-2014
9	423485-VL	Lower Exit Deflector (vertical mount Lemur & Lemur-R)
10	423192	Ground Strap
11	423793	Energy Star Decal
12	422888-115L	Transformer (110VAC)
12*	422888-230L	Transformer (230VAC)
13	FGLB46	Main Logic Board (Standard)
13*	FGLB46-E	Main Logic Board (Ethernet option)
13*	FGLB46-2C	Main Logic Board (ONLY FOR LEMUR-R OR PRINTER W/ 2C PRINT HEAD)
13*	FGLB46-E2C	Main Logic Board – Ethernet (ONLY FOR LEMUR-R OR PRINTER W/ 2C PRINT HEAD)
14	P46-110	Power board, 110VAC
14*	P46-220	Power board, 220VAC
14*	DC24A	Power board, 24VDC
15	423764	Opto Detector Assembly (opto)
15A	SQ OPTO	Opto Detector Assembly (opto) printer built AUGUST-2013 & later
16	423760-L3B-1	Platen ONLY (RADJW, ADJ2 & ADJW)
16A	423760-L4B-1	Platen ONLY (ADJ4 & RADJ4)
16B	423760-FSP-1	Platen ONLY (Lemur FSP) Red
16C	423760-L3B-1-p	Platen ONLY (RADJW, ADJ2 & ADJW) for plastic print cage only
16D	423760-L3B-1-200	Platen (RADJW, ADJ2 & ADJW) complete for 200dpi with metal print cage only
16E	423760-L3B-1-300	Platen (RADJW, ADJ2 & ADJW) complete for 300dpi with metal print cage only
16F	423760-L3B-1-200-p	Platen (RADJW & ADJW paper path) complete for 200dpi with plastic print cage only
*	423760-L3B-1-200-p2	Platen (ADJ2 paper path only) complete for 200dpi with plastic print cage only
16G	423760-L3B-1-300-p	Platen (RADJW & ADJW paper path) complete for 300dpi with plastic print cage only
*	423760-L3B-1-300-p2	Platen (ADJ2 paper path only) complete for 300dpi with plastic print cage only
17	423789	AC Filter (for P46-110 & P46-220 power boards ONLY)
18	2003**	Print Head (200dpi RADJW, ADJ2 or ADJW)
18*	3003**	Print Head (300dpi RADJW, ADJ2 or ADJW)
18*	2004**	Print Head (200dpi ADJ4 & RADJ4)
18*	3004**	Print Head (300dpi ADJ4 & RADJ4)
18A	200C3**	Print Head for Lemur-R & 2C printers only
18B	300L4**	Print Head (300dpi ADJ4, RADJ4, ADJW, ADJ2 & RADJW) printers s/n 368087 & higher
18B*	200L4**	Print Head (200dpi ADJ4 & RADJ4)
19	423496	Head Mounting Plate, metal print cage ONLY (2003, 3003, 2004 & 3004 print heads only)
19A	423496-5	Head Mounting Plate, plastic print cage ONLY (2003, 3003, 2004 & 3004 print heads only)
19B	423496-ONE	Head Mounting Plate, plastic print cage ONLY (200C3 print head only)
19B*	423496-ONEL4	Head Mounting Plate, plastic print cage ONLY (200L4 & 300L4 print heads only)
20	422590	Stepper Motor
21	P28-1020	Switch, Ticket Load
21A	SQ OPTO-L	SQ Load Opto (printers built after SEPT-2014)
22	AC161A5	LCD Display
23	423236P	Take Out Head Cam Lock
24	5316H	Control Panel Decal
25	421932-DSP	Fill-in Plate, Display
*25	423923	Fill-in Plate, Display (for plastic electronics box)
27	422521Z	Electronics Box, Lemur & Lemur-K (metal)
28	423565	Dust Cover, Cutter (only) printer built prior NOV-2014
29	422718WV	Anti-Static Brush (only) for both horizontal and vertical printers
30	422521Z-DUAL	Electronics Box, Lemur-2 & Lemur-2K (metal)

Item #	Part Number	Description
31	423761-621	Shoulder Bearing, for 423760-L3B-1 & 423760-L4B-1 (.621") metal print cage
31*	423761-626	Shoulder Bearing, (.626") for metal print cage Lemur-H, metal print cage
31*	423761-FSP	Shoulder Bearing, for FSP Platen 423760-FSP-1 (.610") metal print cage
32	423790	DC Out Cable, Power Board
32*	423790-B	DC Out Cable, Power board (FGLB46 logic board ONLY)
33	423791	AC Out Cable, Power Board (Lemur-2)
33*	423791-B	AC Out Cable, Power Board (Lemur-2) FGLB46 logic board ONLY
34	423767	UL Cover, Power Board
35	P45-1009	Bearing (Large)
36	423895	Cover, Lemur (Plastic)
37	420881Z-2	Cover, Lemur
38	423894	Electronics Box, Lemur & Lemur-K (Plastic)
39	423446Z-EXP	Electronics Cover, Lemur with metal electronics box
40	423842Z-2PC	Electronics Cover, Lemur with plastic electronics box printer built prior JAN-2016
41	423843-2PC	Power Board Mtg. Bracket
42	423853	Display Holder, Lemur (Plastic)
43	423917	Switching Power Supply (SPS) As of July-2015 replaced by part number 424031
43A	424031	Switching Power Supply (SPS) 85W
44	423789-SPS	AC Filter for SPS ONLY
45	423790-SPS	DC Out Cable, SPS (for FGLA46 logic boards ONLY)
45*	424032	DC Out Cable, SPS (for FGLA46 logic boards & 424031 power supply ONLY)
45A	423790-SPS-B	DC Out Cable, SPS (for FGLB46 logic boards ONLY)
45B	424033	DC Out Cable, SPS (for FGLB46 logic boards & 424031 power supply ONLY)
46	423791-SPS	AC Out Cable, SPS
46A	424034	AC Out Cable, 424031 power supply ONLY
47	P46M	Switch, Power for SPS
48	423886-SPS	UL Shield (SPS)
49	423938	DC Harness, cutter
49*	423938-NC	DC Harness, no cutter
50	423635	Rubber Feet (all printers except Lemur-K)
51	423825-2x6	Hopper, (2" x 6") Plastic
52	423825-4x6	Hopper, (4" x 6") Plastic
53	423952-BASE	Cabinet, Lemur-S (Plastic)
54	423829	Mylar only, vertical Lemur printer built prior DEC-2014
55	423829-1	Mylar only, (BC5) vertical Lemur printer built after NOV-2014
56	423480-R	Upper Exit Deflector BC4 (Lemur-R horizontal)
57	423559-REC	Lower Exit Deflector BC4 (Lemur-R horizontal)
58	423480Z-R	Upper Exit Deflector BC5 (Lemur-R horizontal)
59	423485-REC	Lower Exit Deflector BC5 (Lemur-R horizontal)
60	423834-VLR	Upper Exit Deflector BC5 (Lemur-R vertical)
61	423842Z-P	Electronics Cover, Lemur with plastic electronics box printer built after DEC-2015
62	PS46	Switch, Power supply 424009-L
63	424009-L	Power Supply 24VDC (65W)
64	424046	DC Out Cable, for PS46 switch and FGLB46 logic board
65	423842Z-P1	Electronics Cover, Lemur with 424009-L Power supply (item # 63)
*	423786	Adaptor Plate, Lemur-K (Radiant)
*	423786-STD	Adaptor Plate, Lemur-K (SubATM configuration)
*	423786-XATM	Adaptor Plate, Lemur-K (XATM configuration)
*	P19-1000	Cable, AC cord 110VAC (US)
*	423855	Cable, AC cord 220VAC (European)
*	423856	Cable, AC cord 220VAC (UK)
*	423863	Cable, AC cord 220VAC (Australia)
*	423804	Cable, Cash Drawer internal
*	423797	Cable External, Cash drawer
*	423852	Cable External, parallel
*	423765	Cable External, serial DB9 TO RJ12
*	423947	Cable External, serial DB26 to RJ12
*	423846	Cable External, USB
*	420881Z-Plus	Cover, Lemur-S
*	420881Z-Dual-2	Cover, Lemur-2
*	423952-BCOV	Cover, Lemur-S (Plastic)
*	423952-ECOV	Cover, Electronics Lemur-S (Plastic)
*	420881Z-Dual-1	Enclosure, Lemur-2
*	424005	Fill-in plate, Ethernet (for plastic electronics box)
*	423923	Fill-in plate, Display (for plastic electronics box)
*	421421Z	Top Plate, vertical Lemur (8.70" x 9.64")
*	421421Z-P	Top Plate, vertical Lemur (8.70" x 9.64") Plastic cabinet Lemur
*	421421Z-NC	Top Plate, vertical Lemur (13.00" x 9.48")
*	421421Z-PNC	Top Plate, vertical Lemur (13.00" x 9.48") Plastic cabinet Lemur
*	421421Z-PA	Top Plate, vertical Lemur (10.25" x 10.25")
*	421421Z-P-PA	Top Plate, vertical Lemur (10.25" x 10.25") Plastic cabinet Lemur
*	421421Z-MINI	Top Plate, vertical Lemur (13.00" x 11.68")
*	421421Z-DUAL	Top Plate, vertical Lemur-2

* Customer dependent and not shown in photos

** See [Print Head Guide](#)

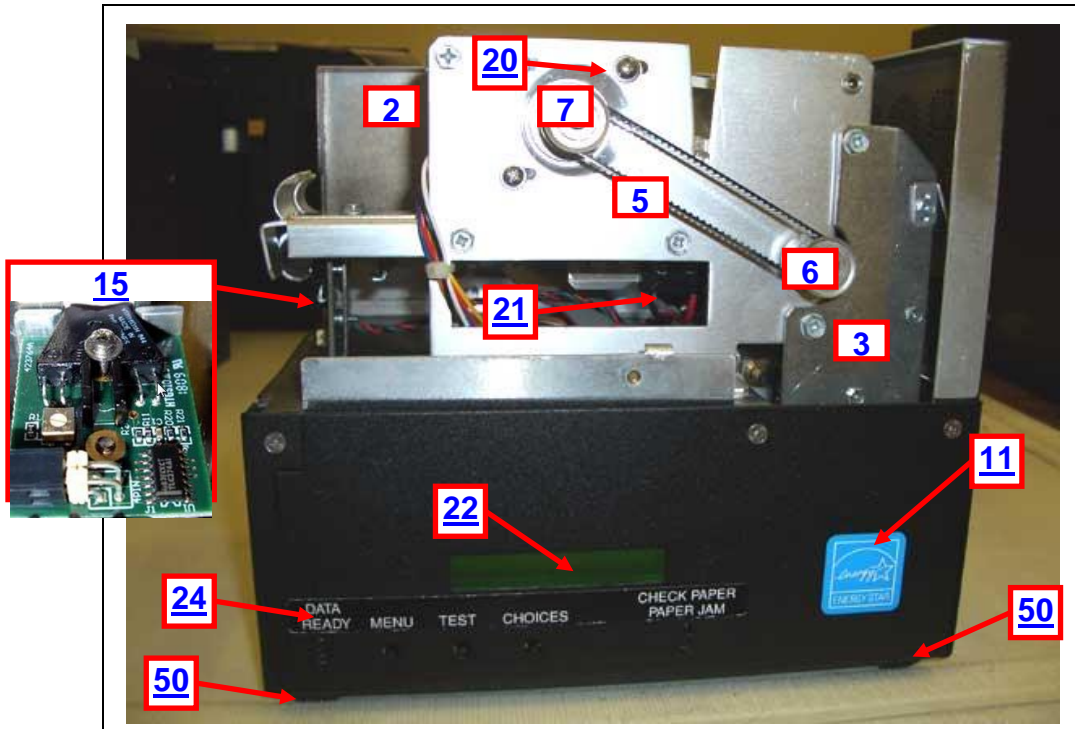

Above and below photos are of a Lemur with optional LCD display and cutter

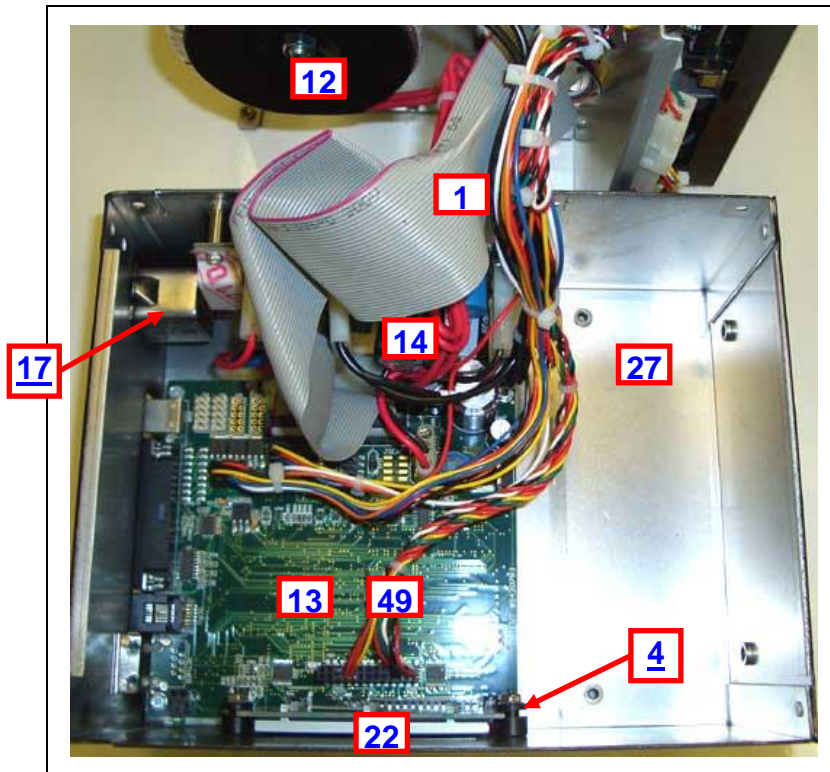

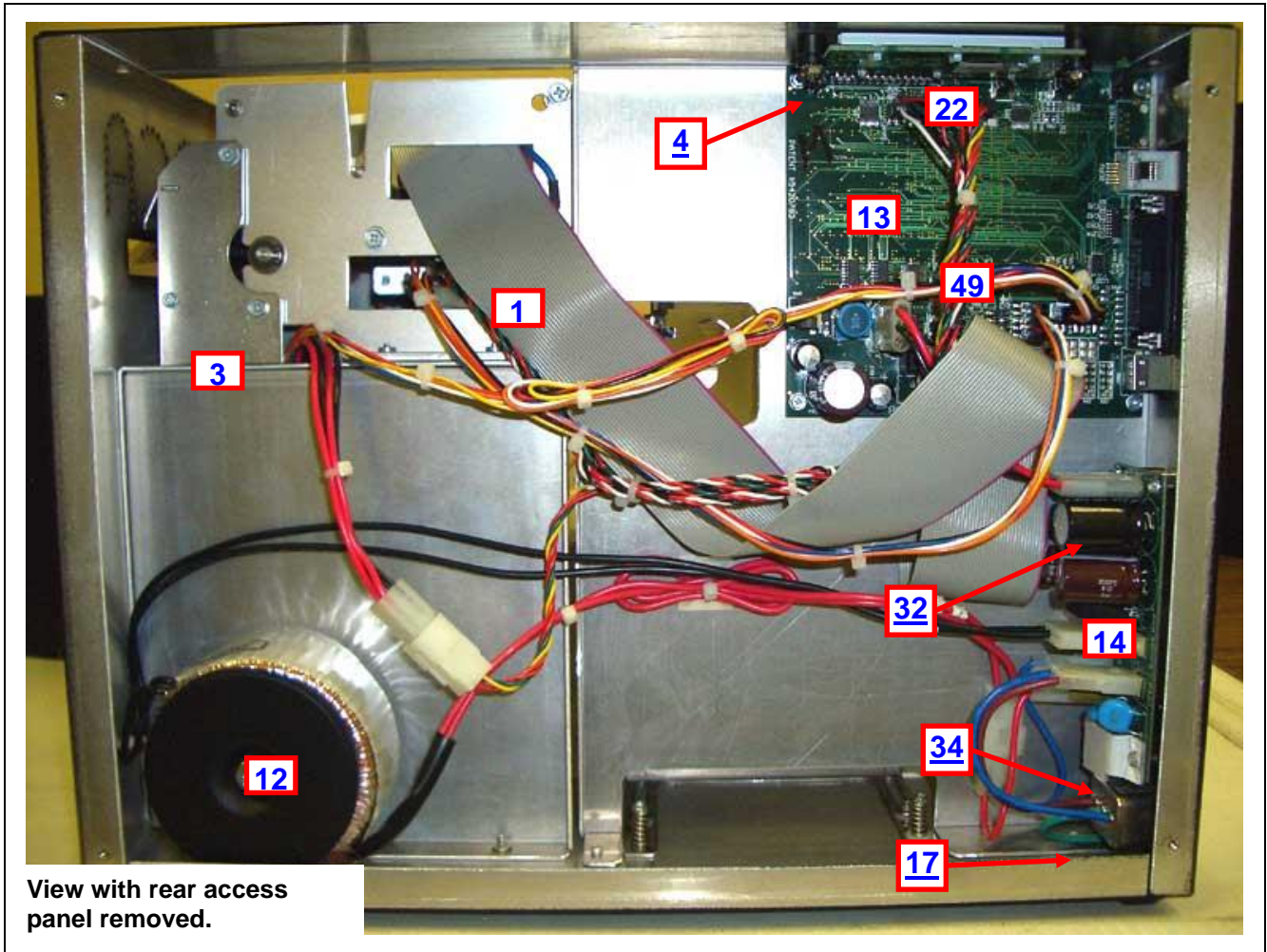

Lemur-S with optional cutter

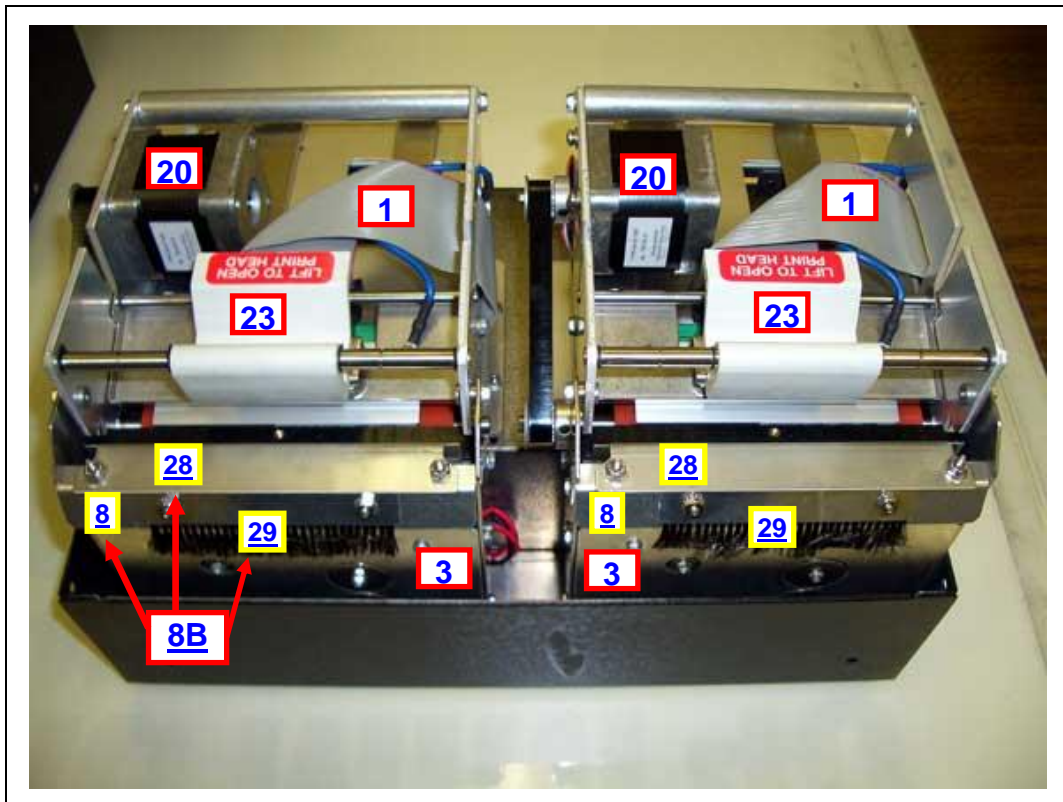

Lemur-2K with metal print cages & optional cutters

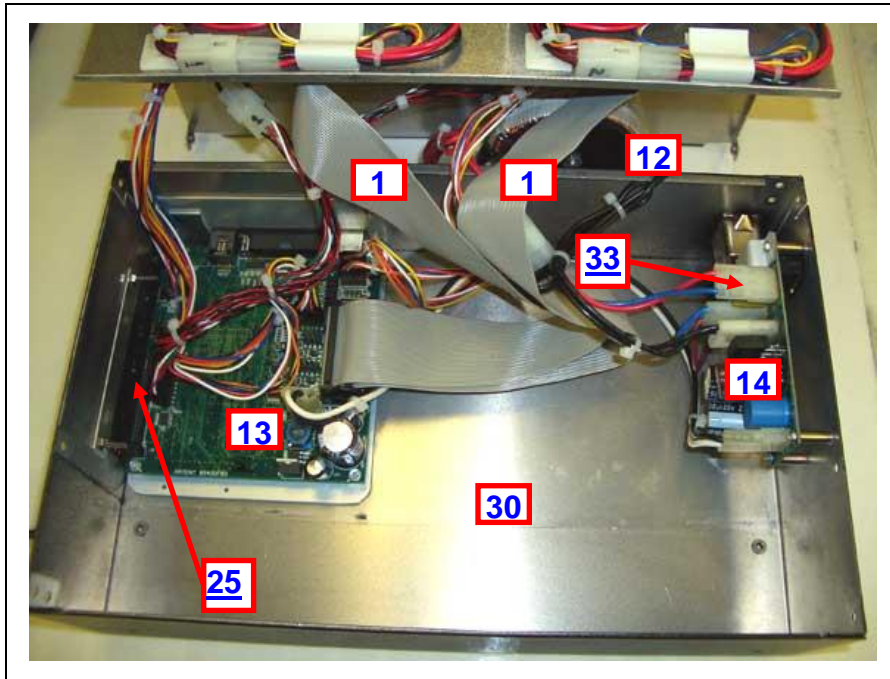

Lemur-2 or Lemur-2K without optional LCD display

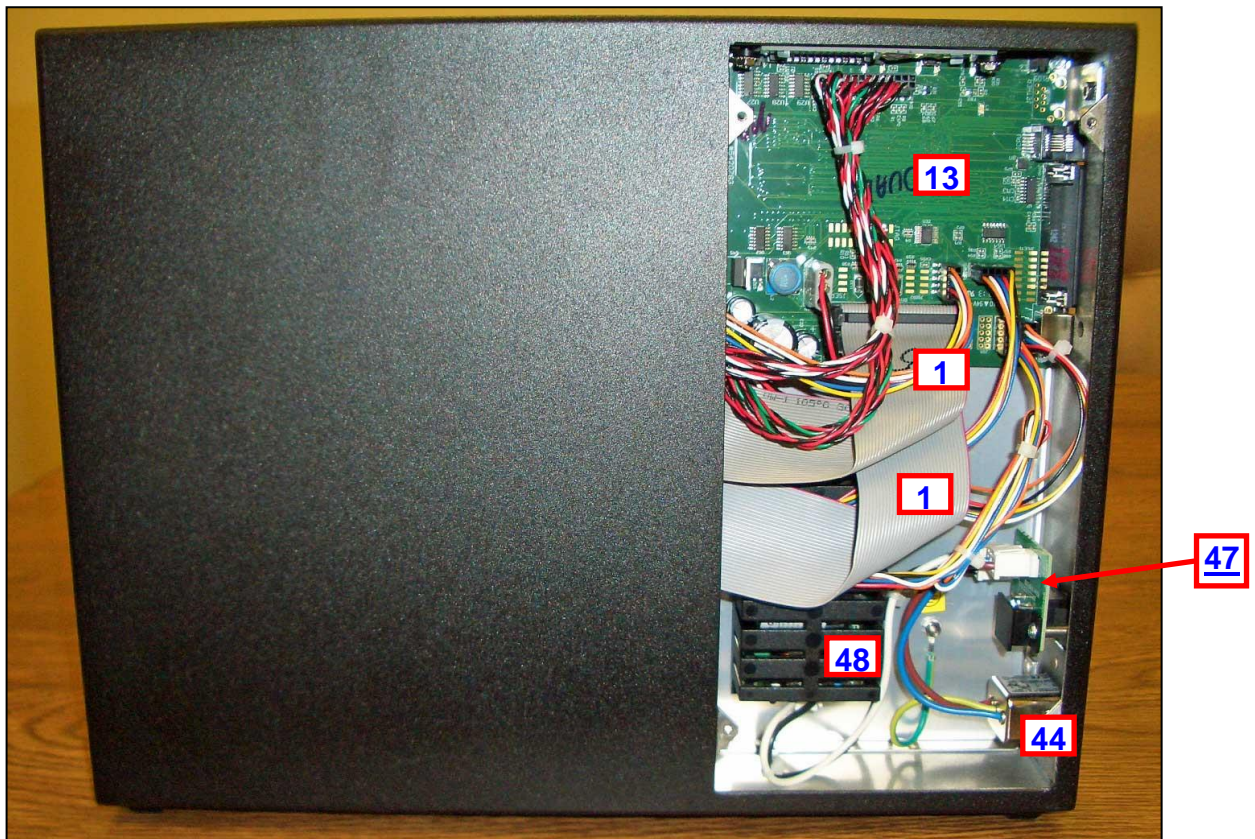

Lemur-2P with access cover removed

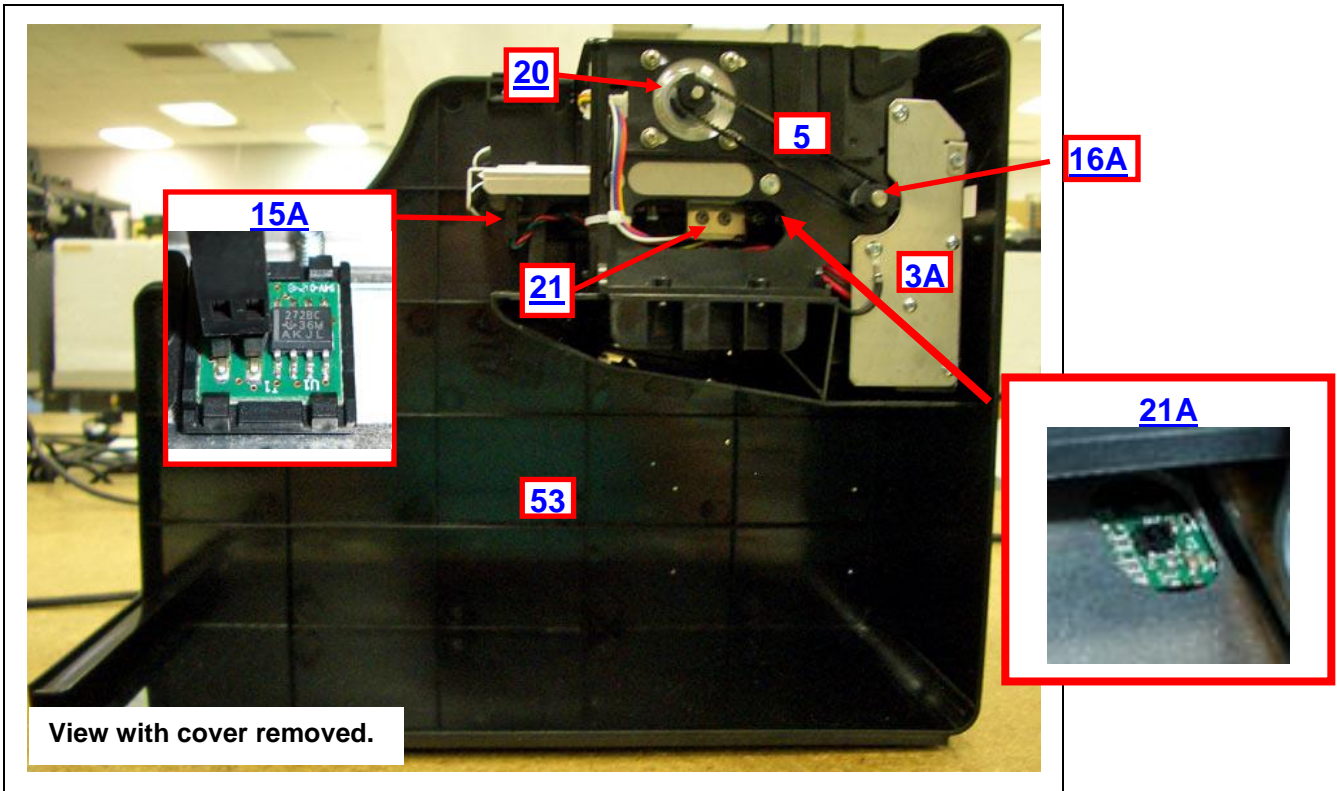

Plastic Lemur-S printer with plastic print cage & optional cutter

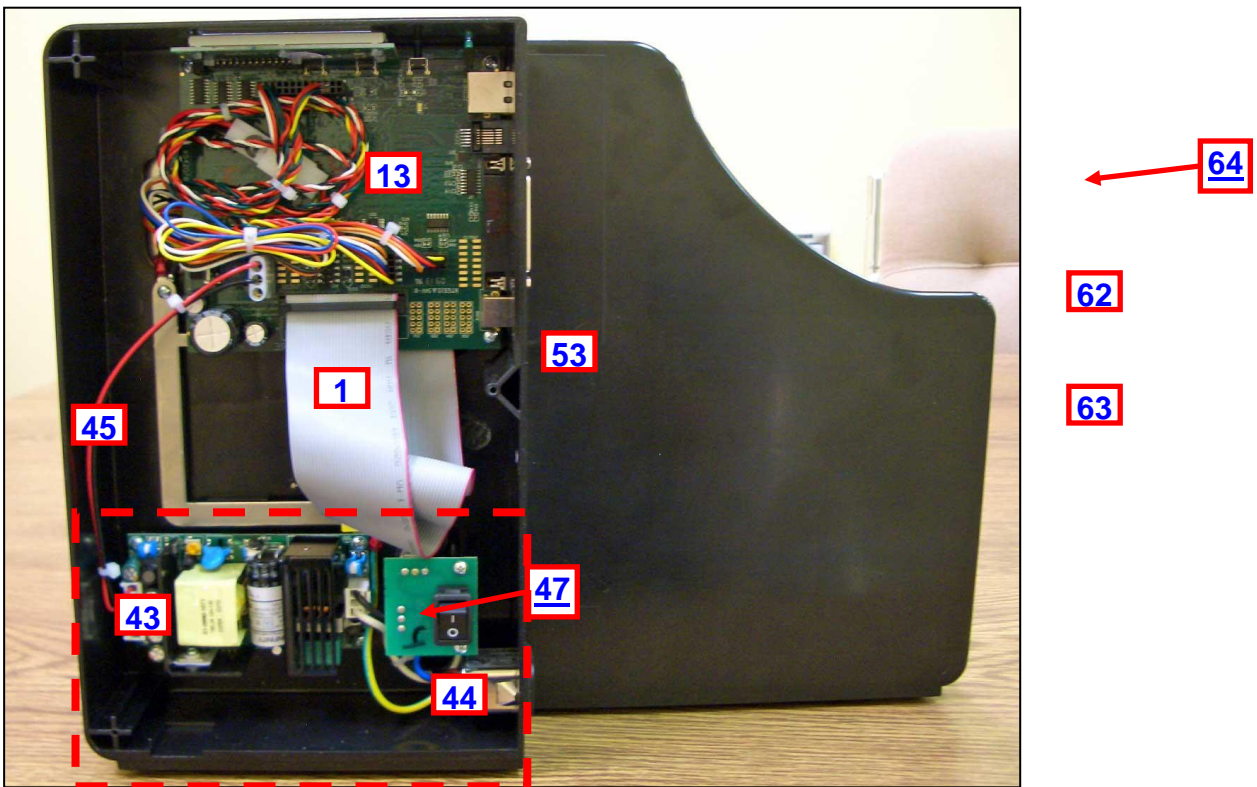

Lemur-S (plastic cabinet) access cover removed w/ optional Ethernet & LCD display

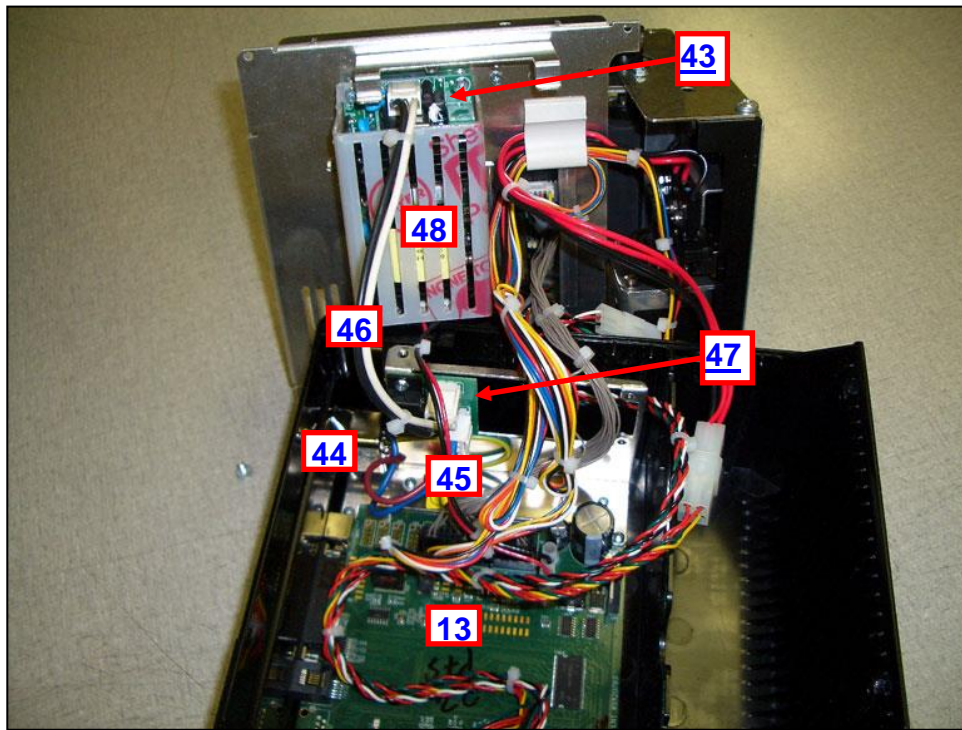

Lemur-R with switching power supply

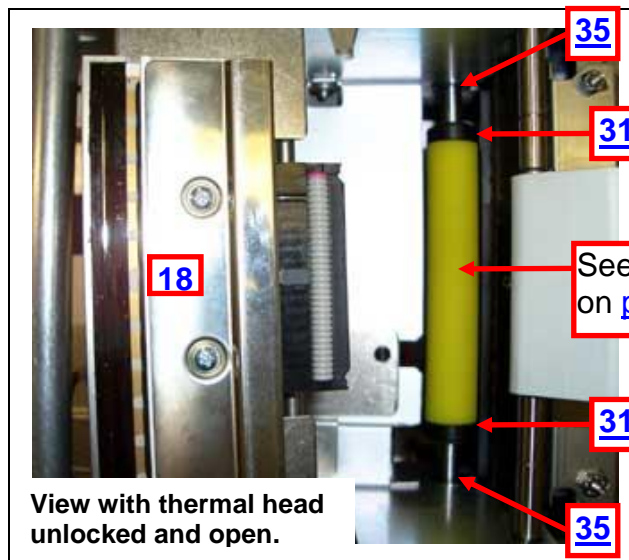
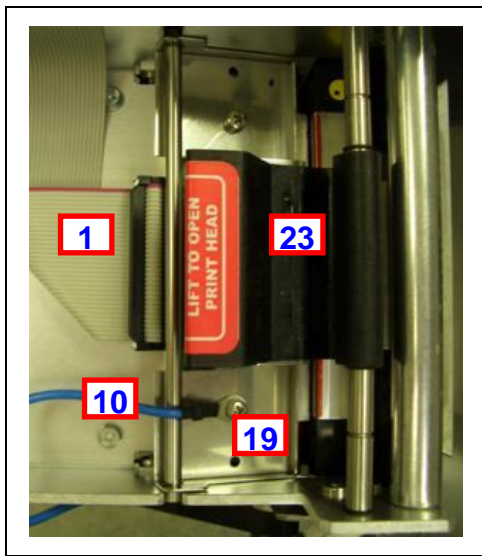

View with thermal head unlocked and open.

Above two photos are of a printer with a metal print cage

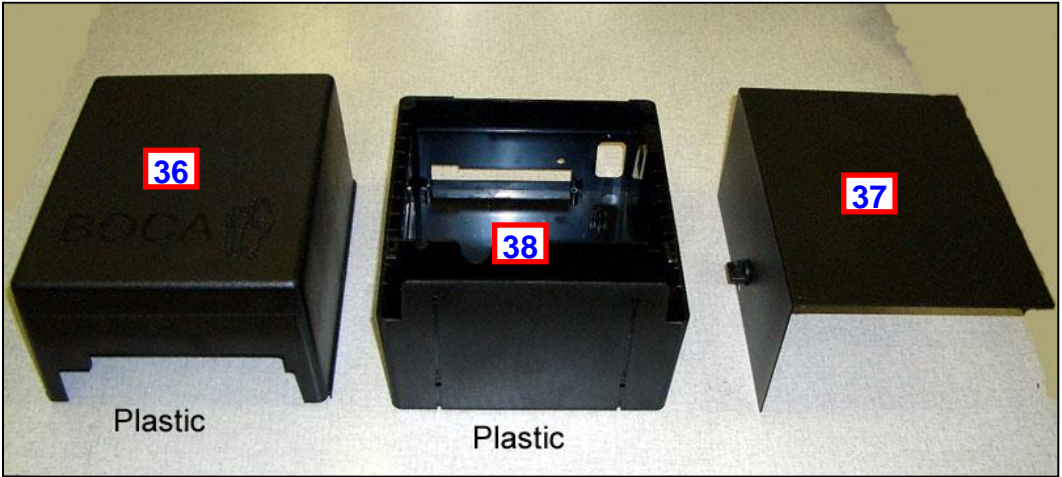

Plastic

Plastic

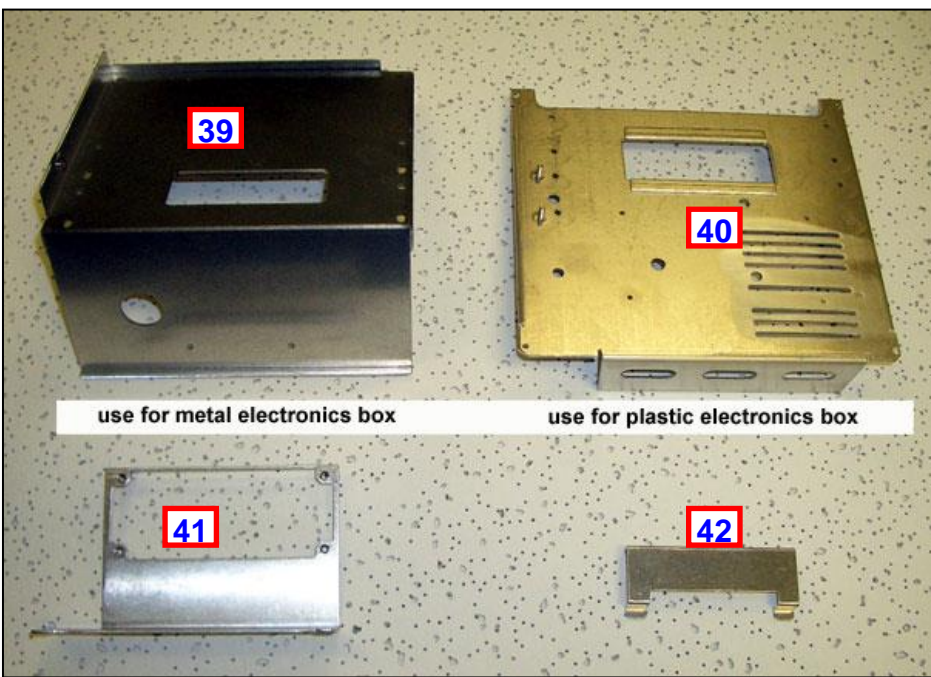

use for metal electronics box

use for plastic electronics box

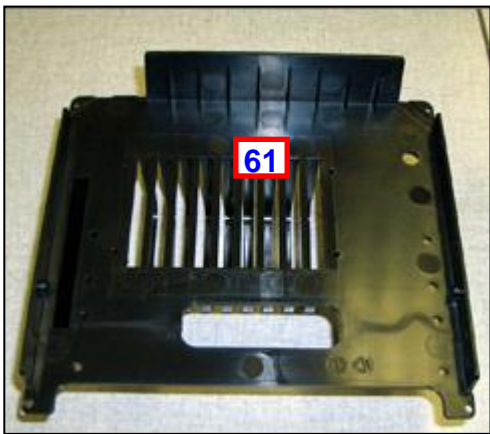

Lemur printers built after Dec-2015



Lemur & Lemur-K printers built after below dates used a 424009-L power pack:
 June-2016 **220VAC** S/N 366455 & higher
 August-2016 **110VAC** S/N 371579 & higher

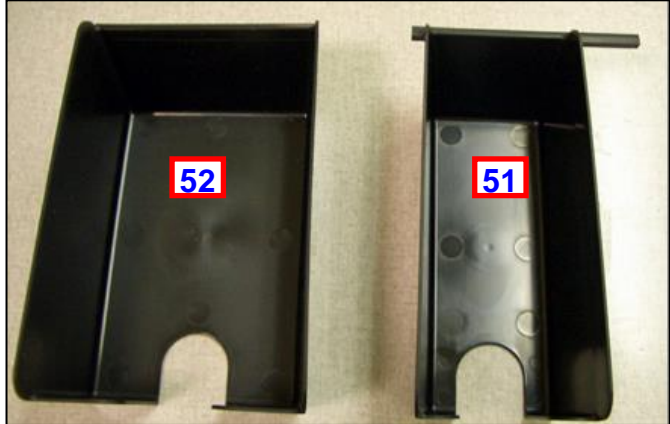

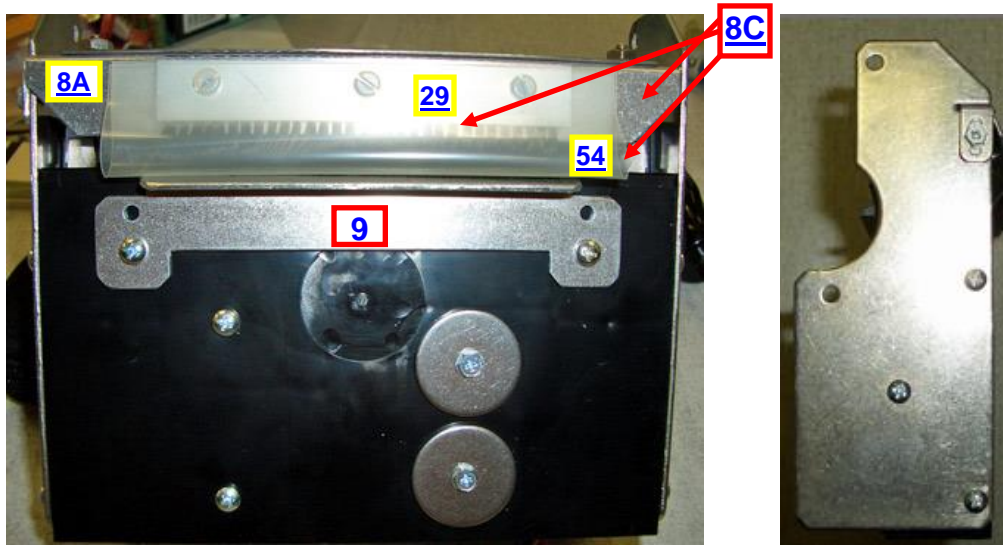

All vertical printers prior to December 2014, except Lemur-R (BC3 – BC4)

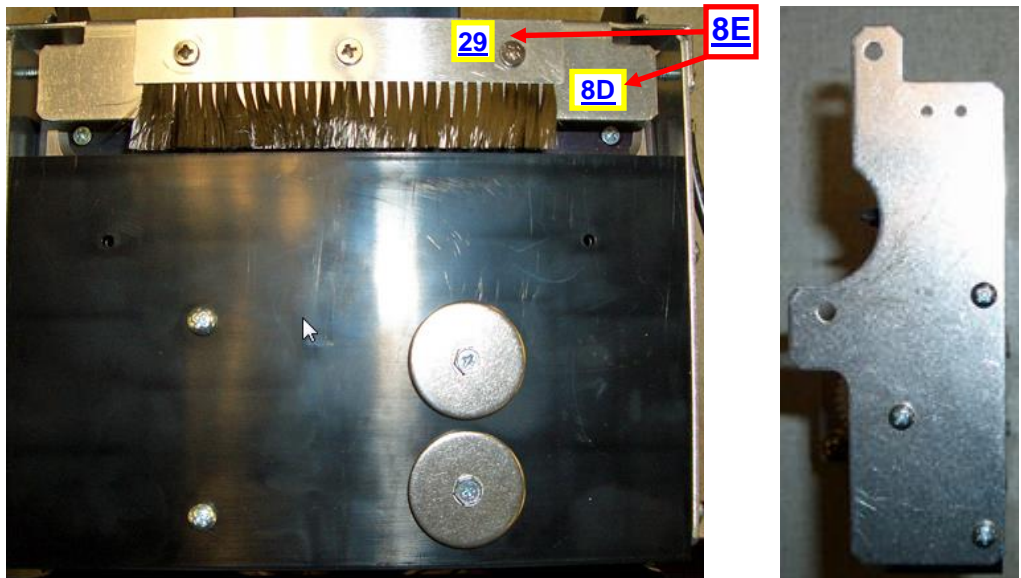

All horizontal printers except Lemur-R since December-2014 (BC5)

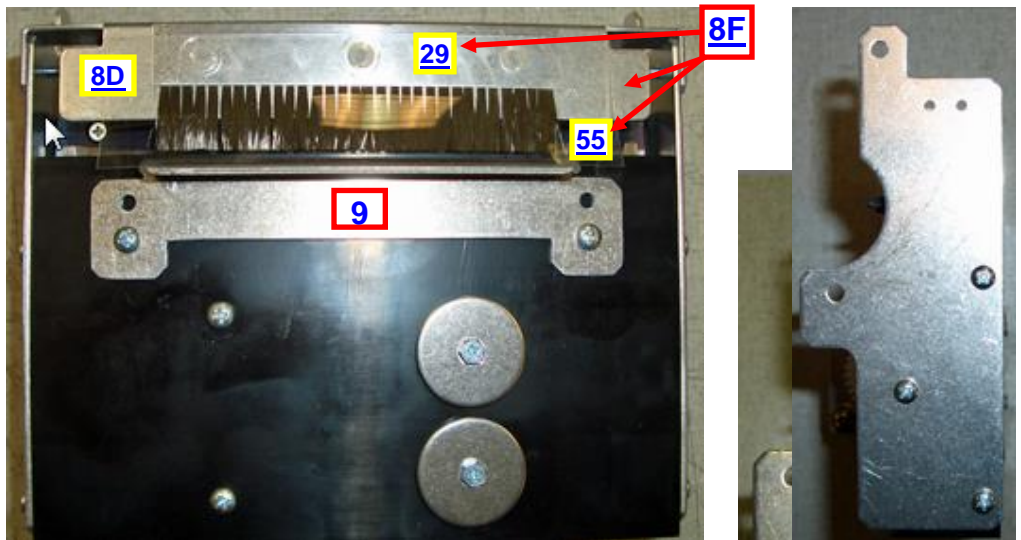

All vertical printers since December-2014 except Lemur-R
Horizontal Lemur-R (BC4 cutter)

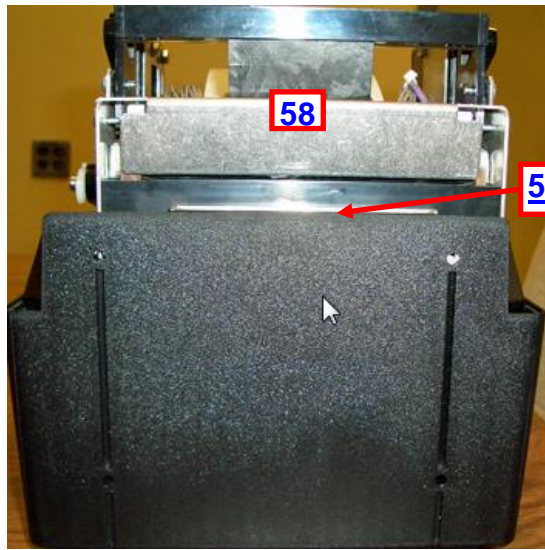

Horizontal Lemur-R (BC5 cutter)



Vertical Lemur-R (BC5 cutter)

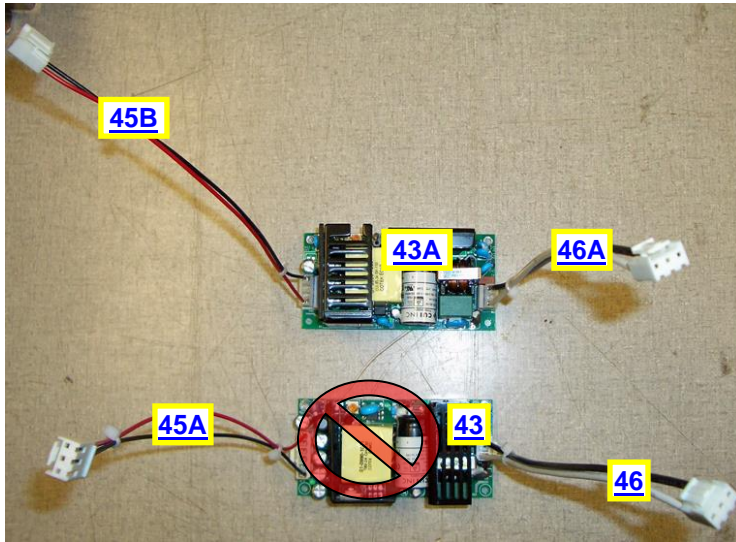

In June – 2015 part number 423917 (item #43) was phased out for 424031 (item #43A). If installing a 424031 power supply in place of a 423917 power supply you will need to order associated cables too

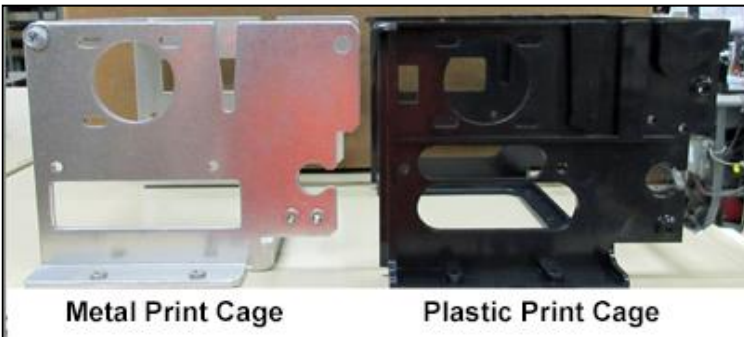

289402 & Higher.

07/19/13 started to use plastic print cage in printers s/n

Platen Guide (platen color may vary from photo)

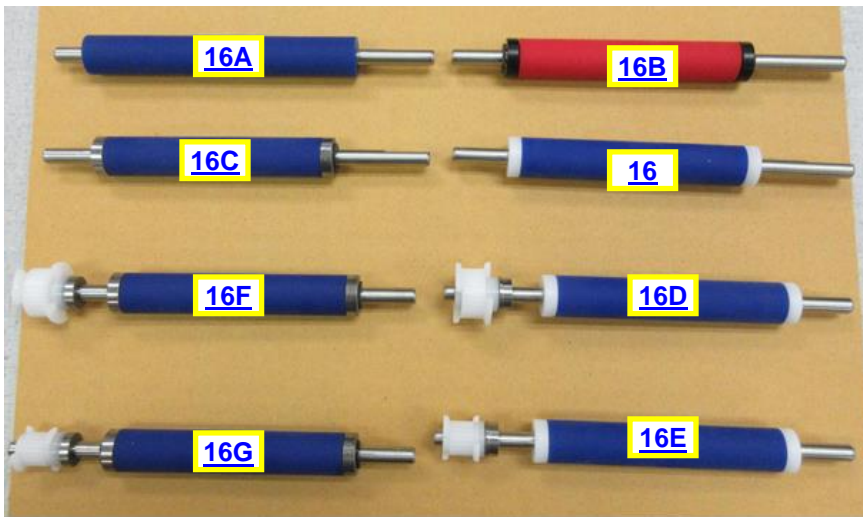

Click here to return to > [Table of Contents](#)

12.1 Print Head Guide

A DPI of a printer may be determined by taking a look at the Width and DPI area of the printer's serial number tag. The below chart should aid in determining the correct print head to order.

Width	DPI	Print head p/n	Head mtg. plate p/n (plastic cage)	Head mtg. plate p/n (metal cage)
ADJ4	300	3004	423496-5	423496
ADJ4	200	2004	423496-5	423496
ADJW	300	3003	423496-5	423496
ADJW	200	2003	423496-5	423496
ADJ2	300	3003	423496-5	423496
ADJ2	200	2003	423496-5	423496
RADJ4	300	3004	423496-5	423496
RADJ4	200	2004	423496-5	423496
RADJW	300	3003	423496-5	423496
RADJW	200	2003	423496-5	423496
Does not matter	3L	300L4	423496-ONEL4	Not used
Does not matter	2L	200L4	423496-ONEL4	Not used
Does not matter	2C	200C3	423496-ONE	Not used

Through the manufacturing timeline of the Lemur series printer different head mounting plates have been used to accommodate different print heads and take advantage of design changes. Below is an overview of the head mounting plates.



The above head plate is only used on plastic print cage printers and 2003, 3003, 2004 or 3004 print head.



Above head plate was used for 200C3 print head, was phased out in January - 2017 for P/N 423496-ONE version.



Above head plate was used for 200L4 & 300L4 print head only, was phased out in January - 2017 for P/N 423496-ONEL4 version

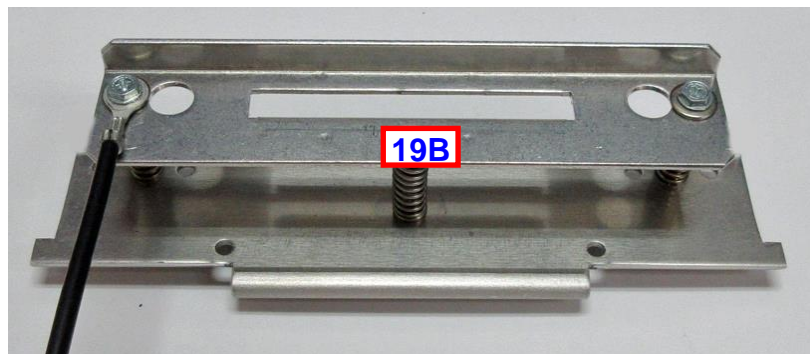

The 423496-ONE is shown in the above photo. The 423496-ONEL4 looks similar but has a wider lower entrance guide as shown below.

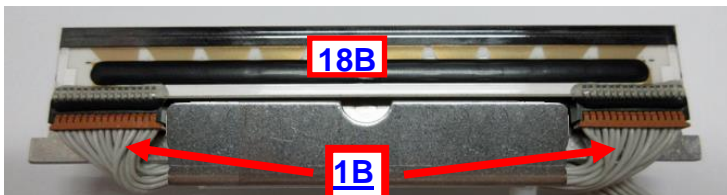

300L4 print head installed on 423496-ONEL4 head mtg. plate



200C3 print head installed on 423496-ONE head mtg. plate

Click here to return to > [Table of Contents](#)

13.0 Troubleshooting Guide

This is a simplified troubleshooting guide listing some of the typical problems. It is not intended to provide technical details or repair methods, but can serve as a guide to fault isolation in the field. **As a safety precaution, all service to the printer should be done by qualified persons with power off and the AC cord unplugged from the printer. Following any procedure requiring the removal of covers and/or doors, please verify that they have been properly attached and fastened prior to operating the printer.** If you need additional help, please visit the link below www.bocasystems.com/onlinesupportform.html

1. NO OPERATION, LED'S DON'T LIGHT UP UPON POWER UP
 - a. Power the printer off and wait 30 seconds then power it back on.
 - b. Check the power cord for proper installation at both ends.
 - c. Check that there is power at the AC outlet.
 - d. Contact your system provider or [BOCA](#) for further assistance.

2. POWER IS ON BUT NO OPERATION
 - a. Make sure the stock is being loaded properly into the printer. Consult section [5.0 Ticket Load Procedure](#).
 - b. Check to make sure the load switch (see [item #21](#) of parts list) makes a clicking sound when you load ticket stock over it. If switch needs adjustment then contact [BOCA](#) for documentation.
 - c. If printer has SQ load opto, then clean said opto. Consult section [9.1.2 Load SQ Opto](#)
 - d. If cutter knife (if so equipped) does not go up and down after power up, See # 6.
 - e. With the printer powered off, unplug the thermal head and turn on the printer. If printer works then replace the thermal head ([9.1.4 Print Head Replacement](#)).
 - f. Contact your system provider or [BOCA](#) for further assistance.

3. POWER IS ON BUT TICKET WILL NOT LOAD
 - a. See # 2
 - b. Make sure the print head/cam lock assembly is fully locked in the closed position. Consult "[Thermal Print Head](#)" section. For Lemur-R see "[Thermal Print Head](#)"
 - c. Check that the ticket stock is being loaded correctly. Consult "[Installation](#)" section.
 - d. Contact your system provider or [BOCA](#) for further assistance.

4. ERRATIC CUT POSITION
 - a. Check for defective ticket stock. Is the black mark unevenly spaced apart or light in color? Is the ticket too wide for the paper path?
 - b. Make sure the paper guild slider bar is properly adjusted (see [9.1.6 Ticket Width Adjustment](#) or [9.1.7 Ticket Width Adjustment](#) for UPG path printer).
 - c. Clean off opto eyes (see [item #15](#) of parts list) with air. For Lemur-R see "[Load & Cut Opto](#)"
 - d. Check that the platen is clean. Consult "[Platen \(Rubber Drive Roller\)](#)" section.
 - e. Replace ticket cut opto.
 - f. Default printer settings. With printer powered off hold down the TEST button and then power up the printer. Keep the test button held down for 10 seconds and release (the printer will reset).
 - g. Contact your system provider or [BOCA](#) for further assistance.

5. ERRACTIC PRINT POSITION
 - a. See # 4

6. CUTTER KNIFE DOES NOT MOVE (if equipped)
 - a. Check for blockage in the cutter area.
 - b. Default printer settings. With the printer powered off hold down the TEST button and then power up the printer. Keep the TEST button held down for ten seconds and release (the printer will reset).
 - c. Contact your system provider or [BOCA](#) for further assistance.

7. POOR PRINT OUT (light print out)
 - a. Try a different stack of ticket stock.
 - b. Make sure the print head/cam lock assembly is fully locked in the closed position.
 - c. Clean print head. Consult "[Thermal Print Head](#)" section. For Lemur-R see "[Thermal Print Head](#)"
 - d. Adjust print intensity setting via the control panel (if equipped). (see [Appendix A](#))
 - e. Replace thermal head ([9.1.4 Print Head Replacement](#)).
 - f. Contact your system provider or [BOCA](#) for further assistance.

8. POOR PRINT OUT (white voids in print out)
 - a. Clean print head. Consult "[Thermal Print Head](#)" section. For Lemur-R see "[Thermal Print Head](#)"
 - b. Replace thermal head ([9.1.4 Print Head Replacement](#)).
 - c. Contact your system provider or [BOCA](#) for further assistance.

9. NO PRINT OUT
 - a. Try a different stack of ticket stock.
 - b. Check head cable for electrical connection at both ends
 - c. Check to make sure head cable is plugged in properly into the thermal head.
 - d. Replace the thermal head ([9.1.4 Print Head Replacement](#)).
 - e. Contact your system provider or [BOCA](#) for further assistance.

10. PRINTER SKIPS TICKETS WHILE PRINTING
 - a. Check position and quality of black mark on the ticket stock.
 - b. Make sure the paper guild slider bar is properly adjusted (see [9.1.6 Ticket Width Adjustment](#) or [9.1.7 Ticket Width Adjustment](#) for UPG path printer).
 - c. Clean off opto eye (see [item #15](#) of parts list) with air.
 - d. Check that the platen is clean. Consult "[Platen \(Rubber Drive Roller\)](#)" section.
 - e. Default printer settings. With the printer powered off hold down the TEST button and then power up the printer. Keep the TEST button held down for ten seconds and release (the printer will reset).
 - f. Replace ticket cut opto.
 - g. Contact your system provider or [BOCA](#) for further assistance.

11. PRINTER SKIPS TICKETS AND DIES
 - a. See # 10.

12. TICKET JAM ENTERING THE CUTTER AREA
 - a. Make sure the entrance to the cutter area is not blocked.
 - b. Make sure the paper guild slider bar is properly adjusted (see [9.1.6 Ticket Width Adjustment](#) or [9.1.7 Ticket Width Adjustment](#) for UPG path printer).
 - c. Contact your system provider or [BOCA](#) for further assistance.

13. WI-FI WILL NOT CONNECT OR INTERMITTENT CONNECTION
 - a. Make sure you are connecting to Wi-Fi router that supports 802.11b devices. The router also needs to support 1 and 2 Mbps data rates.
 - b. On initial setup have the printer as close as possible to the Wi-Fi router.
 - c. Check to make sure you have the correct SSID and security values for the Wi-Fi router you are trying to connect to. Please note these values are case sensitive.
 - d. If you have multiple routers change the channel setting to 1, 6 or 11. Multiple routers using the same channel will cause connection and drop single issues.

Click here to return to > [Table of Contents](#)

APPENDIX A - CONTROL PANEL

The FGL46 printers allow the user to adjust various printer options through the optional control panel. To access the control panel menu, press both **MENU** and **TEST** switches simultaneously for about 3 seconds. The LCD will display the “**OPERATOR MENU!**” message to indicate that it has entered the control panel menu mode. Once in this mode, please use the following steps in the manner indicated to choose the proper menu topic and to select the proper setting.



The printer has four led lights on the control panel. All led will illuminate briefly after power up.

- **DATA** – This led will only illuminate green when the printer is receiving data
- **READY** – This led will illuminate green when the printer is ready. This led will be off if the printer is not ready.
- **CHECK PAPER** – This led will only illuminate red when the printer is out of paper.
- **PAPER JAM** – This led will only illuminate red when there is a paper jam.

To access and use the OPERATOR MENU, follow these steps:

1. Ticket stock should be loaded into the printer. The LCD window displays **FGL46G# - SB#** (# - number value depends on revision level; G represents the software series level; B# is the font)
2. Press both **MENU** and **TEST** switches simultaneously for about 3 seconds. The LCD window displays **OPERATOR MENU**. (To access the factory menu, press **MENU** and **CHOICES** instead of **MENU** and **TEST**.) **WARNING: Improper use of the factory menu may disable your printer.**
3. To scroll through the menu topic, use **MENU** stopping on the topic you wish to change.
4. Press **CHOICES** to scroll through choices in the selected topic. **NOTE:** The printer displays a blinking cursor for the values presently stored in the printer.
5. Once you have found the new value you want, press **TEST**. The LCD window displays **EXIT AND SAVE?**. If you wish to save the new value then press **TEST** again.
6. If you do not wish to save the new value then press **MENU**. The LCD window displays **JUST EXIT?**. Press **TEST** to exit the **OPERATOR MENU** without saving new values or press **MENU** to enter back into the **OPERATOR MENU**.

The chart below lists the present menu topics. These topics are subject to change.

OPERATOR MENU
BAUD RATE?
MINI/MICRO?
PRINT SPEED?
DIAGNOSTIC MODE?
STATUS ENABLED?
TRANSPARENT MODE?
PAPER MODE?
SPECIAL HEAD
CLEAR DOWNLOAD
INC CUT1 COUNT?
DEC CUT1 COUNT?
INC CUT2 COUNT?
DEC CUT1 COUNT?
PRINT MODE?
PRINT INTENSITY?
TEST TICKET?

TEST TICKET?
ETHERNET?
IP ADDRESS?
SUBNET MASK?
DEFAULT GATEWAY?
DNS SERVER?
SPEED/DUPLEX?
DEFAULT WEBPAGE?
REFRESH RATE?
TICKET REMAIN 1
TICKETS LOW1?
TICKET REMAIN 2
TICKETS LOW2?
EXIT AND SAVE?
JUST EXIT

The following is a brief overview of some representative Menu options:

BAUD RATE? Controls the serial interface baud rate, parity bit, data bits and stop bits.

Here are the following choices:

1200,N,8,1	4800,N,8,1	19200,N,8,1	38400,E,7,1
1200,E,7,1	4800,E,7,1	19200,E,7,1	57600,N,8,1
1200,O,7,1	4800,O,7,1	19200,O,7,1	57600,E,7,1
2400,N,8,1	9600,N,8,1	28800,N,8,1	115200,N,8,1
2400,E,7,1	9600,E,7,1	28800,E,7,1	115200,E,7,1
2400,O,7,1	9600,O,7,1	38400,N,8,1	

MINI/MICRO? Defines the type of printer.

MINI Is for a printer with a Silent Cutter Assembly (SC2) (Mini, Mini Plus, Mini MB, Dual Mini)

MICRO Is for a printer without a SC2 (Micro, Micro Plus, Micro MB, Dual Micro)

PRINT SPEED? Controls the speed the ticket travels at. Also effects the print quality. Printer should not be run at a print speed of 0 as it may cause ticket jams. The numbers range from **0 - FASTEST** to **7 - SLOWEST**. **3 is factory default**.

DIAGNOSTIC MODE? Your choices are **YES** or **NO**. **NO is factory default**. (Please consult your Programming Guide)

TICKET TYPE? Factory setting. Do not modify.

STATUS ENABLED? Sets status response protocols.

NONE	Disables the XON/XOFF and status response protocols
SERIAL	Enables the XON/XOFF and status response protocol for the serial port.
PARALLEL	Enables bi-directional parallel status responses if printer is configured as bi-directional.
SER/PAR	Enables both bi-directional parallel and serial status responses.
USB	Enables USB status responses
USB/SER	Enables USB and serial status responses
USB/PAR	Enables USB and bi-directional parallel
USB/SER/PAR	Enables USB, bi-directional parallel and serial status responses

TRANSPARENT MODE? **YES** (Enabled) or **NO** (Disabled). (Please consult your Programming Guide)

PAPER MODE? Is generally used only for test purposes. It may also be used on roll stock with no black marks on the ticket. Your choices are **YES** (Enabled) ,**NO** (Disabled) or **RECEIPT** (for Lemur-R printer only). **NO is factory default**.

SPECIAL HEAD? Is used when a special paper path size is installed (2.125", 2.5", 2.7"....)

Here are the following choices: **This feature is set at the factory.**

NO	DUAL & SINGLE PATH PRINTER WITH RADW paper guide set to 3.25" & RADJ4 paper guide set to 4"
ON P1	DUAL & SINGLE PATH PRINTER ONLY (Not used for a Lemur series printer)
ON P2	DUAL PATH PRINTER ONLY on path #2 (Not used for a Lemur series printer)
ON BOTH	DUAL PATH PRINTER ONLY on both paths (Not used for a Lemur series printer)
REV ADJ2 P1	DUAL & SINGLE PATH PRINTER WITH RADW or RDJW4 paper guide set to 2"
REV ADJ2 P2	DUAL PATH PRINTER WITH RADW or RDJW4 paper guide set to 2" on path #2
REV ADJ2 BOTH	DUAL PATH PRINTER WITH RADW or RDJW4 paper guide set to 2" on both paths
REV ADJ2.5 P1	DUAL & SINGLE PATH PRINTER WITH RADW or RDJW4 paper guide set to 2.50"
REV ADJ2.5 P2	DUAL PATH PRINTER WITH RADW or RDJW4 paper guide set to 2.50" on path #2
REV ADJ2.5 BOTH	DUAL PATH PRINTER WITH REV RADW or RDJW4 paper guide set to 2.50" on both paths
REV ADJ2.7 P1	DUAL & SINGLE PATH PRINTER WITH RADW or RDJW4 paper guide set to 2.70"
REV ADJ2.7 P2	DUAL PATH PRINTER WITH RADW or RDJW4 paper guide set to 2.70" on path #2
REV ADJ2.7 BOTH	DUAL PATH PRINTER WITH RADW or RDJW4 paper guide set to 2.70" on both paths
REV ADJ3 P1	DUAL & SINGLE PATH PRINTER WITH RADW or RDJW4 paper guide set to 3"
REV ADJ3 P2	DUAL PATH PRINTER WITH RADW or RDJW4 paper guide set to 3" on path #2
REV ADJ3 BOTH	DUAL PATH PRINTER WITH RADW or RDJW4 paper guide set to 3" on both paths
REV ADJ2.125 P1	DUAL & SINGLE PATH PRINTER WITH RADW or RDJW4 paper guide set to 2.125"
REV ADJ2.125 P2	DUAL PATH PRINTER WITH RADW or RDJW4 paper guide set to 2.125" on path #2
REV ADJ2.125 BOTH	DUAL PATH PRINTER WITH RADW or RDJW4 paper guide set to 2.125" on both paths
REV ADJ3.25 P1	DUAL & SINGLE PATH PRINTER WITH RADJ4 ONLY paper guide set to 3.25"
REV ADJ3.25 P2	DUAL & SINGLE PATH PRINTER WITH RADJ4 ONLY paper guide set to 3.25" on path #2
REV ADJ3.25 BOTH	DUAL & SINGLE PATH PRINTER WITH RADJ4 ONLY paper guide set to 3.25" on both paths

CLEAR DOWNLOAD? Clears those items downloaded by the operator to Flash memory.

Your choices are **YES** or **NO**.

INC CUT1/2 COUNT? moves the cut/tear position to the left (towards the ticket entrance area). Cut counts are increments of .003" for 300dpi and .005" for 200dpi. Depressing CHOICES changes the count value. **16 is factory default**. (1 is for path one; 2 is for path 2 [dual only]). For a 200dpi printer the INC value should not exceed 38. For a 300dpi printer the INC value should not exceed 55. Going beyond these values will cause reliability issues.

DEC CUT1/2 COUNT? moves the cut/tear position to the right (towards the ticket exit area). Cut counts are decrements of .003" for 300dpi and .005" for 200dpi. Depressing CHOICES changes the count value. **16 is factory default**. For a 200dpi printer the INC value

should not exceed 38. For a 300dpi printer the INC value should not exceed 55. Going beyond these values will cause reliability issues.

PRINT MODE? Defines the automatic ticket length calculation feature. (**FACTORY PRESET AND SHOULD NOT BE CHANGED**)

THERMAL The printer will feed out and then retract a ticket during this measurement.

RIBBON The printer will feed out one blank ticket. This mode is used for label stock and wristbands to prevent peeling.

RIBBON1/THERMAL2 On a Lemur-2 printer path 1 would be set to ribbon and path 2 would be set for thermal mode.

RIBBON1/THERMAL2 On a Lemur-2 printer path 1 would be set to thermal and path 2 would be set for ribbon mode.

PRINT INTENSITY? Controls the darkness of ticket printout.

Here are the following choices:

LIGHT	
MED LIGHT	
NORMAL	(factory default)
MED DARK	
SHORT HEAD LIFE	

TEST TICKET? Defines they type of self-test ticket printed.

STANDARD	Normal self test ticket pattern (factory default)
CONFIGURATION 1	To print configuration settings if printing on a 1" wide ticket
CONFIGURATION 2	To print configuration settings if printing on a 2" wide ticket
CONFIGURATION 3	To print configuration settings if printing on a 3" wide ticket
CONFIGURATION 4	To print configuration settings if printing on a 4" wide ticket

ETHERNET? Only used for printer with Ethernet interface connector.

NO	Ethernet not enabled.
YES	Uses the IP address that has been set in the printer by the customer.
Diagonstics	This feature should not be used.
Valid Packets	This feature should not be used.
DHCP Enabled	Automatically attempts to get an IP address from Local Server
DHCP/SUB/GATE	Automatically attempts to get an IP address/Subnet Mask/Gateway from Local Server
DHCP/NR	Automatically attempts to get an IP address from Local Server and then register the name with the local NetBIOS name server – usually the WINS Server
DHCP/SUB/GATE/NR	Automatically attempts to get an IP address/Subnet Mask/Gateway from Local Server and then register the name with the local NetBIOS name server – usually the WINS Server

IP ADDRESS? Enables the operator to change the printer's Ethernet IP Address. (See [Appendix E](#))

SUBNET MASK? Enables the operator to change the printer's Ethernet Subnet Mask value. (See [Appendix E](#))

DEFAULT GATEWAY? Enables the operator to change the printer's Ethernet default Gateway value. (See [Appendix E](#))
Programming Guide.

DNS SERVER? Enables the operator to change the printer's Ethernet default DNS server value. (See [Appendix E](#))
Programming Guide.

SPEED/DUPLEX? Enables the operator to change the printer's Ethernet speed and duplex setting. Please consult "Ethernet Interface Addendum" of the [FGL Programming Guide](#). Your choices are **AUTO-NEGOTIATE**, **100Mbps/FULL**, **100Mbps/HALF**, **10Mbps/FULL** and **10Mbps/HALF**.

DEFAULT WEBPAGE?, REFRESH RATE?, TICKETS REMAIN 1, TICKETS LOW1?, TICKETS REMAIN 2, TICKETS LOW2? :
Please consult "REMOTE MANAGEMENT ADDENDUM" of the [FGL Programming Guide](#).

EXIT AND SAVE ! Will save any changes made to the above menu options.
If you wish to save the new value then press **TEST**, if not press **MENU**.

JUST EXIT? Will exit the menu options without saving any changes.
If you with to exit without saving the new value then press **TEST**, if not press **MENU**.

Click here to return to > [Table of Contents](#)

APPENDIX B - VERTICAL PRINTER INSTALLATION

Prepare the counter top by cutting a rectangular hole in accordance with the dimensions specified for your printer model. **NOTE: The table or counter top must be able to support at least four times the weight of the printer.**

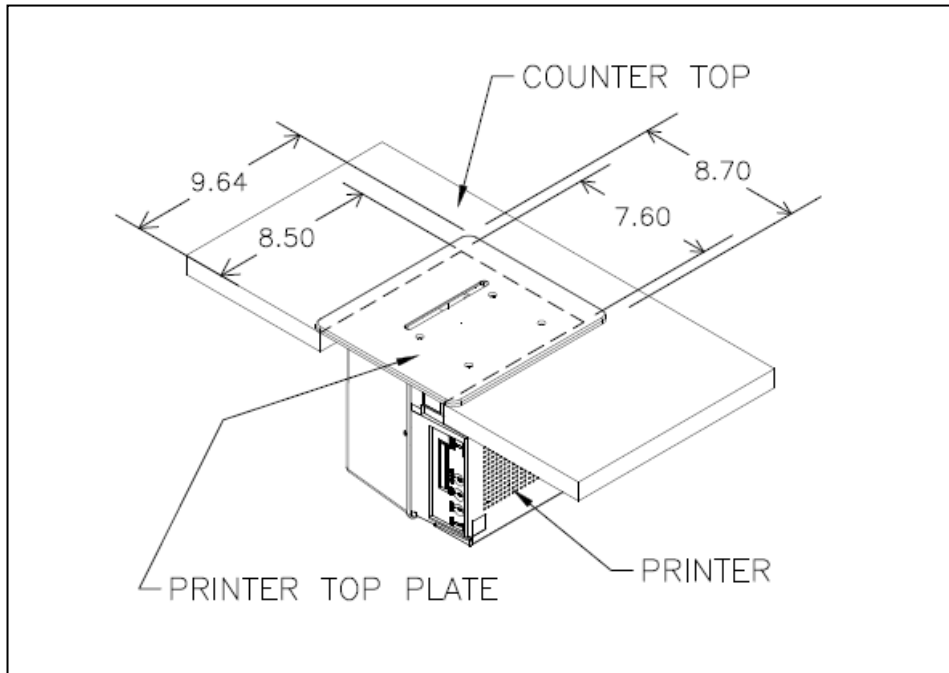

Vertical Mount Lemur

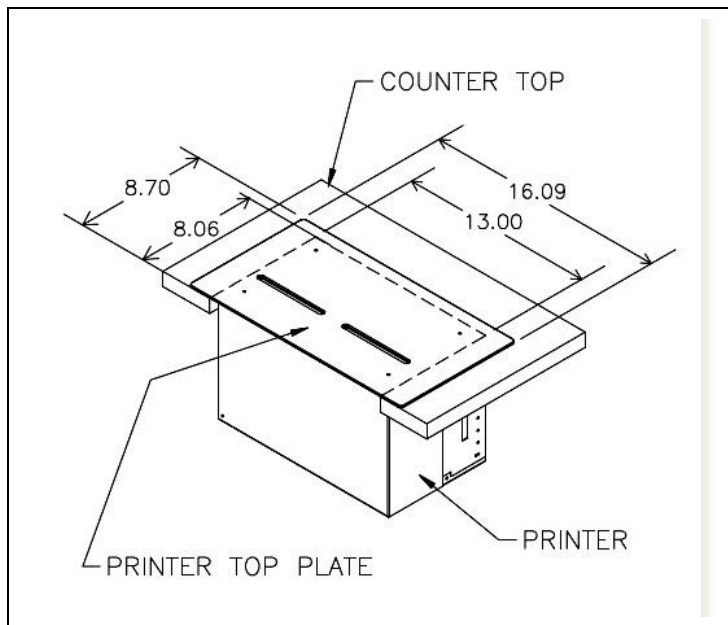

Vertical Mount Lemur-2

- Attach the top plate to the printer using only the supplied mounting hardware.
- Insert the printer with the top plate attached into the countertop cutout.
- Attach the power cord and the interface cable to the printer.
- Turn the power switch to the ON position.
- The printer is now ready for ticket stock to be loaded.

Click here to return to > [Table of Contents](#)

Ticket Load Procedure for a Lemur-2 Series Printer

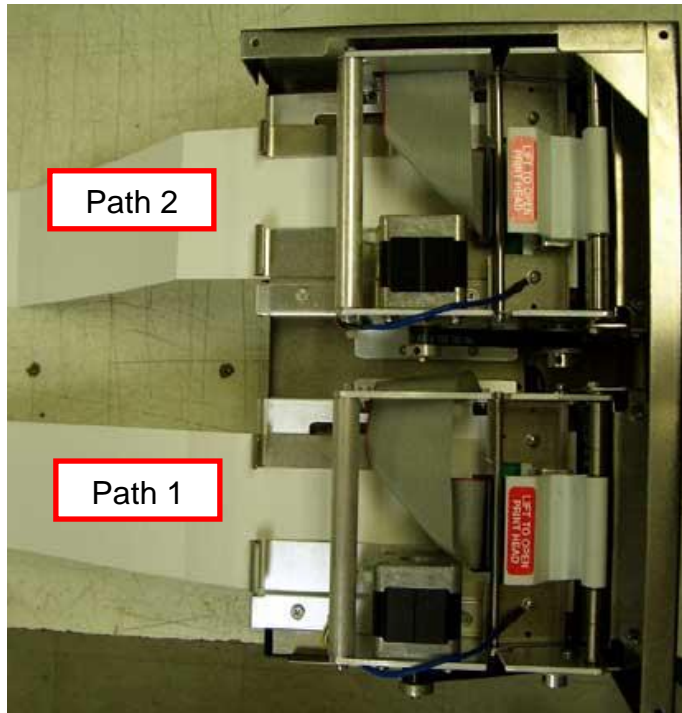

Your printer may vary from the above photo

Turn the printer on and wait five seconds. If your printer has an optional LCD then it will display PAPER OUT (the red CHECK PAPER led will be illuminated). Begin loading the tickets through the entrance slot of path #1 with a smooth motion until it stops. At this point the printer should automatically grad and positions the ticket. Once path #1 had been loaded, you then can load path #2 the same way. Both paths need to be loaded in order for the printer to work properly.

Section [5.0 Ticket Load Procedure](#) will provide information on how the stock should be loaded into the entrance slots.

After the ticket is automatically positioned (the READY LED will be illuminated), press the TEST button located on the control panel to print a test ticket. The first ticket will print out on path #2 and when you press the TEST button a second time the ticket will print out on path #1.

Which side the printer prints on is controlled by the data being sent from you host computer.

Click here to return to > [Table of Contents](#)

APPENDIX D – LEMUR-R



Ticket Load Procedure

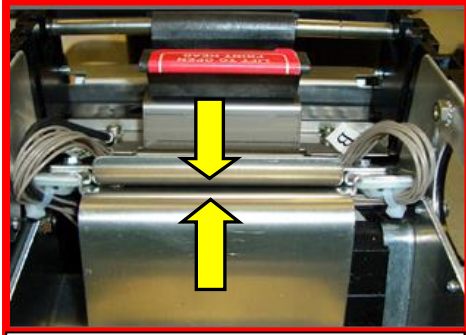

Newer Version

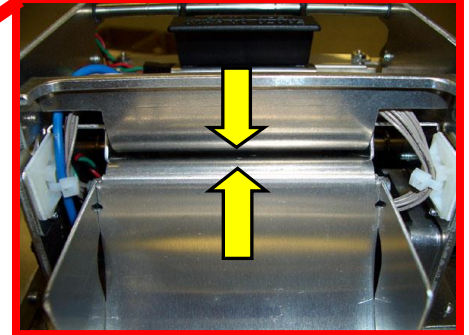
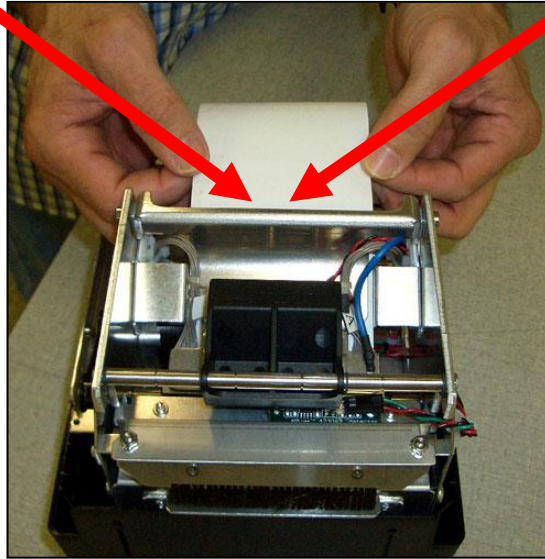

Older Version

- Turn the printer on and wait five seconds. If your printer has an optional LCD then it will display PAPER OUT (the red CHECK PAPER led will be illuminated).
- You need to make sure the leading edge (first part that is feed into the printer) has a nice clean edge. Not crumpled or tape stuck to it.
- Begin loading the tickets through the entrance slot with a smooth motion until it stops. At this point the printer will automatically grab and positions the receipt paper.
- After the ticket is automatically positioned (the READY LED will be illuminated), press the TEST button located on the control panel to print a test ticket. The printer is configured when it leaves the factory to be particle cut the receipt. Self-test printout should look similar to the image below.
- Printer is now ready for operation.

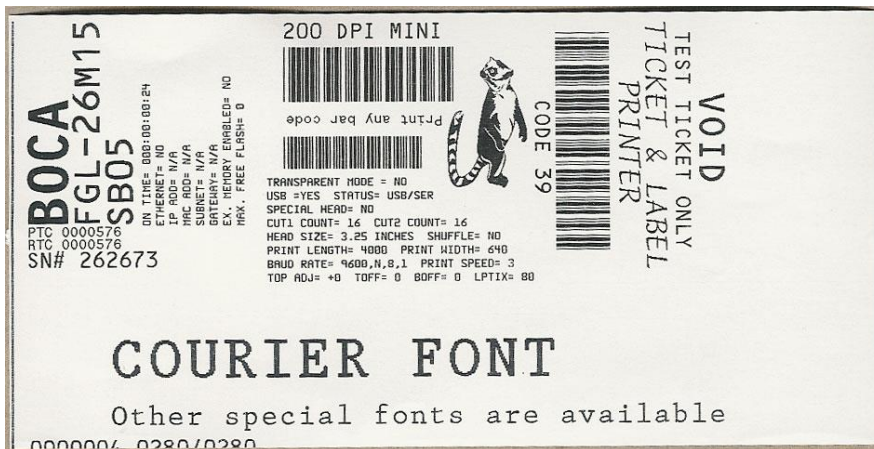

THERMAL PRINT HEAD

The print head should be cleaned periodically to prevent debris from building up on the print element. The required cleaning interval varies greatly depending on the quality of the ticket stock and the amount of dust entering the print area. Excessive dirt build up on the print head will result in reduced quality. Continuing to run the print head in a dirty condition will reduce its life expectancy, as it is unable to diffuse its heat properly.

You may gain access to the print head as follows:

1. Make sure power is off and the AC cord is disconnected from the printer.

2. **DO NOT UNPLUG CABLE FROM PRINT HEAD.**

3. Lift up on the cam lock assembly (located above the head plate) to remove pressure from the thermal head.

Photo A

4. Old Version - Swing the head mounting plate assembly back. **Photo B**

New Version – Lift head mounting plate assembly straight up. **Photo B-1**

5. Clean the thermal print head surface (the side that makes contact with the paper) with isopropyl alcohol.

Photo C

6. Install the head by reversing the above procedures.

7. Restore pressure to the head by pushing down on the cam lock assembly. Excessive force should not be needed to close the print head.

8. The printer is now ready for operation. If the print quality is still poor then Contact your system provider or [BOCA](#) for further assistance.

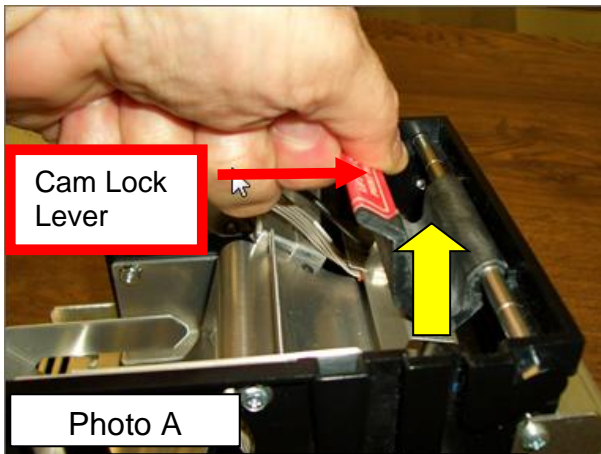

Newer Version

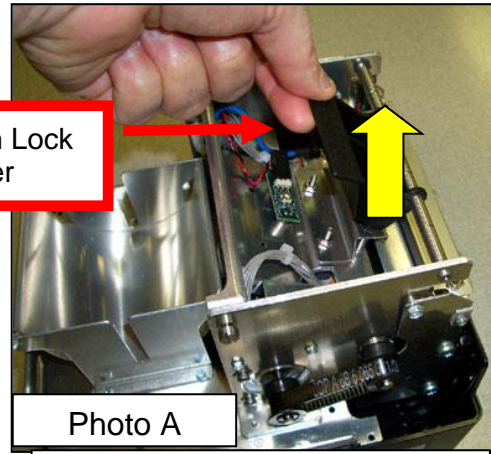

Older Version

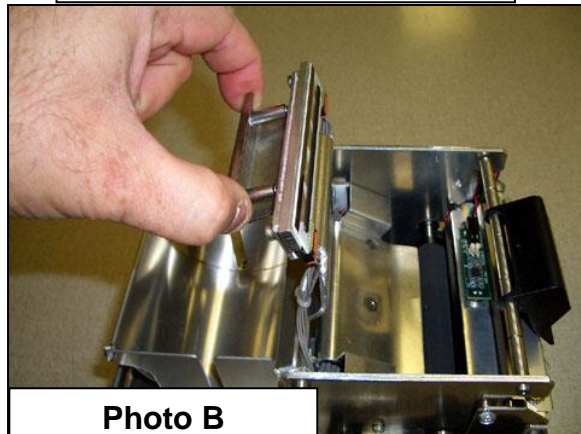
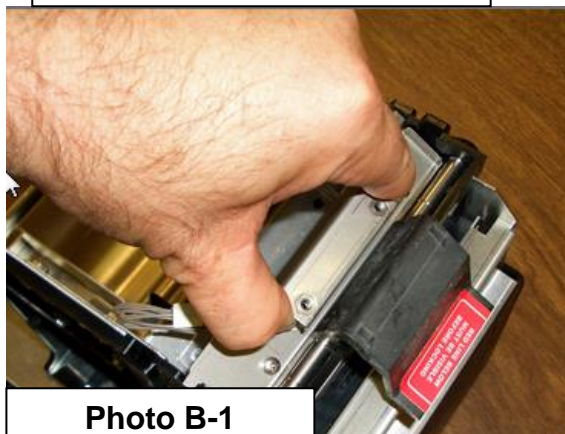

In January of 2017 was phased in the use of spring tension head mounting plates (s/n 378067 and higher). Below reviews how to remove this type of head mounting plate.

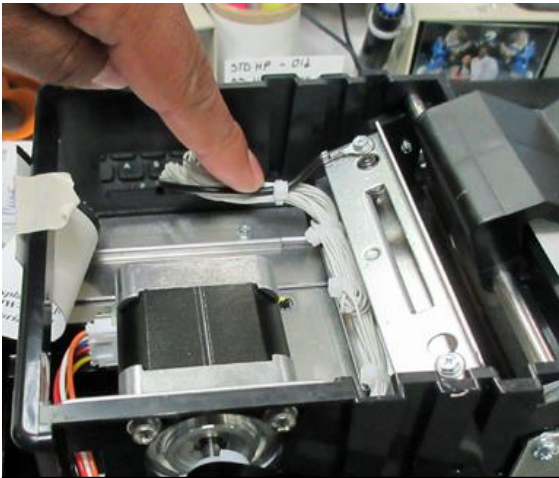

Pushing down on the head cable will aid in flipping the head plate.

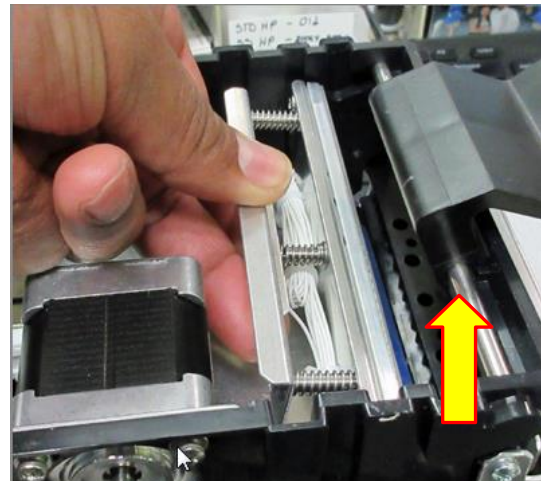

Lift the head plate straight up and out.

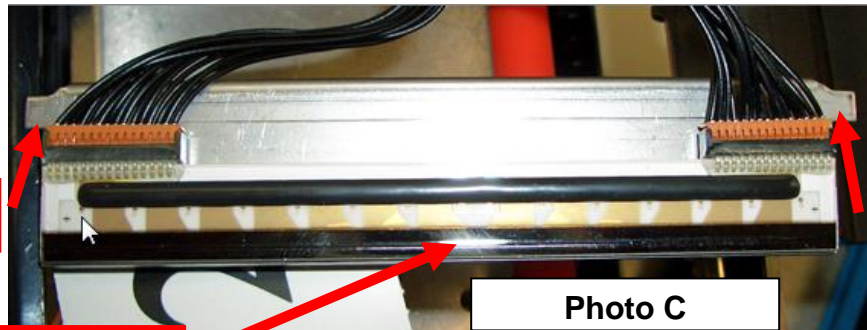

Mounting Plate Tab

Mounting Plate Tab

Photo C

Clean This Surface

When install spring tension head mounting plate black in place make sure the mounting plate tabs are both aligned with the front slots (see below photos).

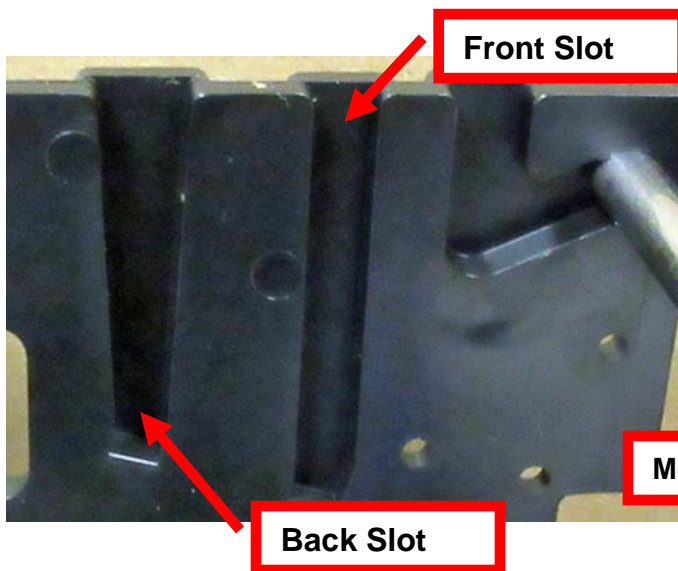

Front Slot

Back Slot

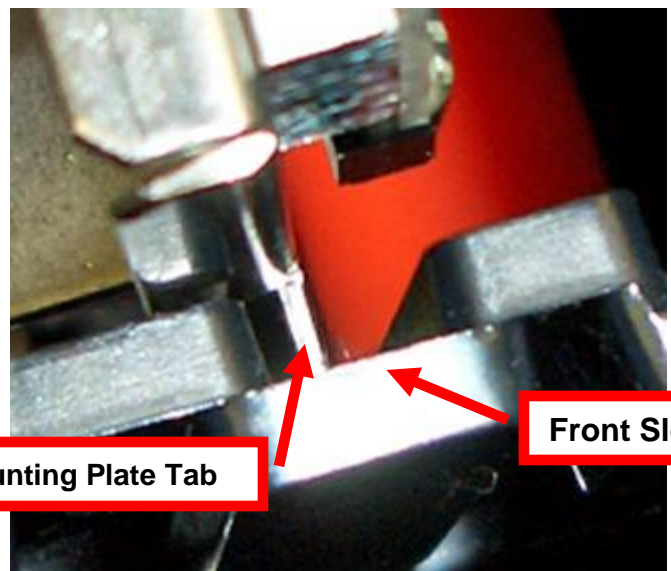

Front Slot

Mounting Plate Tab

Click here to return to > [Table of Contents](#)

LOAD & CUT OPTO

Once a year the opto eyes should be blown off with air. This interval will vary depending upon the environment and the quality of the ticket stock.

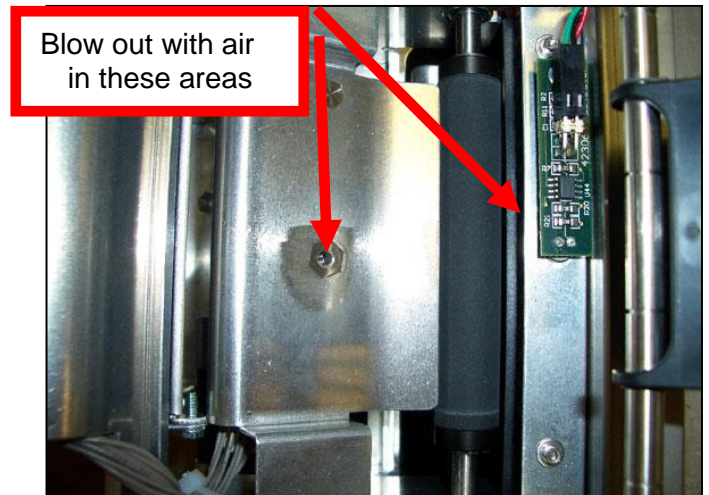

Newer Version

PLATEN (RUBBER DRIVER ROLLER)

See section [9.1.3 Platen \(Rubber Driver Roller\)](#) of this user manual

CUTTER ASSEMBLY

See section [9.2 Cutter Assembly](#) of this user manual

If you need additional help, please visit www.bocasystems.com/onlinesupportform.html

Click here to return to > [Table of Contents](#)

APPENDIX E –ETHERNET PARAMETERS

General

Each Boca Ethernet Printer is assigned a unique MAC address based in part on the printer's serial number. All Boca printers are factory configured in DHCP enabled mode. (Exceptions may be made by special request.) If the printer is unable to get a dynamic IP address from the customer's network in the allotted time period (about one minute), it will default to the 10.0.0.192 address. You can select a different fixed IP address either via a Web Browser (see below) or the printer's control panel if your printer has an optional LCD display.

ETHERNET – Quick Installation Guide

- Connect the printer to your network (the IP address will be automatically assigned by your DHCP server)
- Load tickets into the printer
- Wait one minute to allow assignment of IP address
- Print a test ticket to identify the printer's IP address
- Ping the printer
- Open your web browser and type the printer's IP address to review its configuration page (see below image).
- If you are going to set a static IP address then you will need to change the ETHERNET setting to YES.
- If you experience any problems, please refer to the Ethernet section of our [FGL Programming Guide](#).

Boca Systems' Printer Configuration Page

Firmware :	FGL-26F13 / COM-26F13 / SB02
Serial number :	208377
On Time :	000:00:02:25 d/h/m/s
MAC ID :	00.0D.71.03.2D.F9

FACTORY MENU : items with an * should not be changed or selected without first consulting Boca Systems.

BAUD RATE=	9600,N,8,1	MINI/MICRO=	MICRO	PRINT SPEED=	3	DIAGNOSTIC MODE=	NO
TICKET TYPE=	SPECIAL TICKE	STATUS ENABLED=	USB/SER	TRANSPARENT MODE=	NO	PAPER MODE=	NO
*HEAD DPI=	200	SPECIAL HEAD=	NO	PATH TYPE=	PATH1	BUFFER MODE=	MULTIPLE MOD
CLEAR DOWNLOAD=	NO	DEFAULT SETTINGS=	YES	CUT1 COUNT=	16 (1-200)	CUT2 COUNT=	16 (1-200)
*2-SIDED PRINTER=	NO	PARK TICKET=	NO	TICKET MODE=	MULTIPLE	PRINT MODE=	THERMAL
PRINT INTENSITY=	NORMAL	SKI MODE=	NO	FLASH ACK MODE=	NO	SOFTWARE BUSY=	NO
BI-DIRECTIONAL=	NO	TEST TICKET=	STANDARD	BASEBALL MODE=	NO	USB=	YES
FONT ENCODING=	NONE	ACKNOWLEDGE=	NORMAL	*HIGH SPEED MODE=	NO	BUZZER=	DISABLE
*SHUFFLE MODE=	NO	*CUTTER TYPE=	SILENT	*CUTTER SPEED=	NORMAL	ORIENTATION=	NORMAL
ETHERNET=	YES	IP ADDRESS=	010.000.000.192 (Enter 12 digits)	SUBNET MASK=	0.0.0.0	DEFAULT GATEWAY=	010.000.000.192 (Enter 12 digits)
SPEED/DUPLEX=	AUTO-NEGOTIATE	RFID=	NO	USB DEVICE TYPE=	PRINTEF	BLUETOOTH=	NO
MAGNETICS=	NO						

(Press Save button to store)

Changing Ethernet settings if your printer has a LCD display

CHANGING 'ETHERNET' SETTING

1. Please follow these steps to change the ETHERNET setting on your Ethernet printer.
2. Depress both the **MENU** and **CHOICES** buttons while turning on the printer. Keep both buttons depressed until **FACTORY MENU** appears in the LCD window or the display starts scrolling through different topics.
3. Using the **MENU** button scroll down to the **ETHERNET?**
4. Using the **CHOICE** button select the choice you want.
5. Press the **TEST** button to enter that setting.
6. Now the display will show **EXIT AND SAVE**. Press the **TEST** button to save the setting entered.
7. Note: if you selected 'YES' then you can use the default IP of 10.0.0.192 or set a different one as described next.

CHANGING 'IP ADDRESS'

1. Please follow these steps to change the fixed IP address on your Ethernet printer. Note: if using a fixed IP address make sure the 'ETHERNET' setting is set to 'YES' (see above).
2. Depress both the **MENU** and **CHOICES** buttons while turning on the printer. Keep both buttons depressed until **FACTORY MENU** appears in the LCD window or the display starts scrolling through different topics.
3. Using the **MENU** button scroll down to the **IP ADDRESS?** and press the **CHOICE** button.
4. The blinking cursor indicates the current IP numeric value selected. Every time you press the **CHOICE** button the numeric value will change.
5. Using the **TEST** button will move you over to the next numeric value.
6. Continue steps 4 & 5 to program the desired IP address value.
7. At the end the display will show **EXIT AND SAVE**. Press the **TEST** button to save the IP address you just entered.

CHANGING 'SUBNET MASK' SETTING

1. Depress both the **MENU** and **CHOICES** buttons while turning on the printer. Keep both buttons depressed until **FACTORY MENU** appears in the LCD window or the display starts scrolling through different topics.
2. Using the **MENU** button scroll down to the **Subnet Mask?** and press the **CHOICE** button.
3. Each time you press the **CHOICE** button a different mask value will be displayed.
4. Once you have the mask value you want, press the **TEST** button. The display will show **EXIT AND SAVE**. Press the **TEST** button a second time to save the address value.

CHANGING 'DEFAULT GATEWAY' ADDRESS

Follow same procedure as 'Changing IP address' above but in step 3 scrolls down to the **DEFAULT GATEWAY**.

CHANGING 'DNS SERVER' ADDRESS

Follow same procedure as 'Changing IP address' above but in step 3 scrolls down to the **DNS SERVER?**

Click here to return to > [Table of Contents](#)

APPENDIX F – TESTING A LEMUR

Boca Systems, Inc. has developed a Windows based program that allows customers to communicate from a host computer to the printer over any interface (parallel, serial, USB, Ethernet) and print drivers too. The below program link is found on our [website](#) under the [“TECH SUPPORT/ REPAIRS”](#) section.

Below is for Windows. For Apple/ Mac based systems see [APPLE/ MAC BASED SYSTEM](#)

www.bocasystems.com/documents/configure_boca.exe

FOR WINDOWS 7, 8 AND WINDOWS 10 SYSTEM THE FOLLOWING WILL NEED TO BE DONE.

- Right click on the Boca Configure icon on your desk top. Then click on Properties.



Click on the Compatibility tab. Click on the “Run this program in compatibility mode for” box so it is checked off. Set the compatibility for “Windows XP (Service Pack 3)”. Click on the OK button.

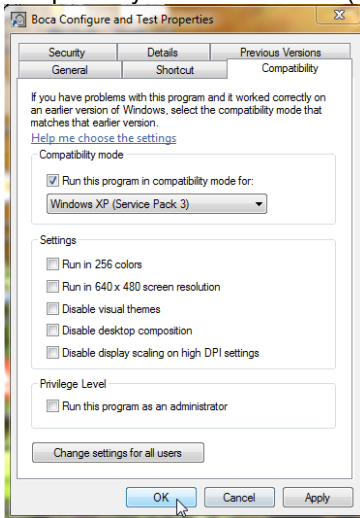

The following steps will guide you through using this program once it has been installed on your host computer.

1. Hook the BOCA printer to the host computer that you have the Configure program loaded onto. Make sure that the printer has stock loaded and is ready to go. A printer is ready to print when it is able to print out a self test ticket by depressing the TEST button. If you are not able to get a self test ticket then see section [Installation](#) to make sure you have the printer properly setup.
2. On your Window's desktop click on the Boca Configure icon.  When the program opens for the first time it will ask you to update the program. Proceed with updating the program to level 6.3.1.0 or higher.
3. Once the program is running, click on the “Select A Printer” drop-down arrow and you have two choices:
Printer Interface - if you are connecting through a Parallel, Serial, Ethernet or USB-HID mode (go to [step# 4](#))
Print Driver - if you're connecting via a print driver (go to [step # 6](#)).
4. **PRINTER INTERFACE:** You will need to choose the interface connection that you have the BOCA printer hooked up to then click the OK button. Please note that USB-HID mode is only for a printer that is configured for USB HID mode.

If you are connecting via the Ethernet port or Wi-Fi then in the IP Address box type in the printer's current IP address. The printer's current IP address is printed on the self-test ticket (when the test button is pressed). When typing in the address don't include the leading zeros (If IP=189.010.000.002 then type in 189.10.0.2). Click on the Connect button.

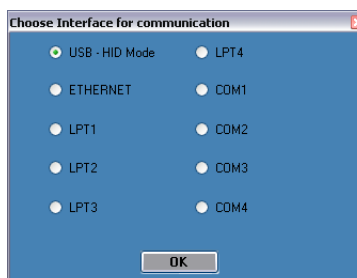

- Once connected the Printer State will show Printer Ready. Go to [step #9](#).

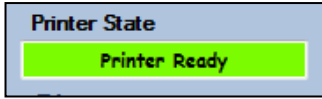

- PRINT DRIVER:** You will need to select the FGL Driver mode you want (default is Spool-Uni). If you are not sure then leave in the default mode. If your ticketing application is not designed for this configuration then please go to [PAGE 48](#) to see more detailed information on driver settings modes. The drivers will permanently stay in the selected mode. You may use this program to change the driver mode setting.



- Choose the driver you are using for the BOCA printer. Once the driver is chosen click the OK button.

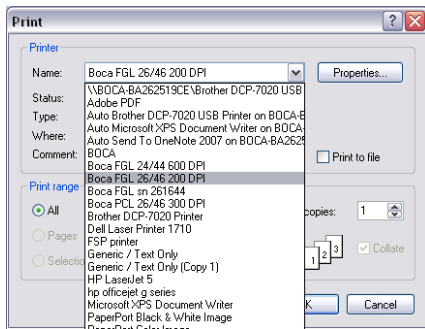

Your selection of drivers will vary from what is shown in above image

- Once connected the Printer State will show Printer Ready.

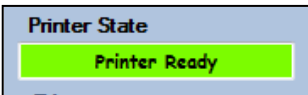

- If your printer has FGL firmware then click on the yellow “FGL Test Ticket” button or if your printer has HP firmware then clicks on the yellow “PCL Test Ticket” button.

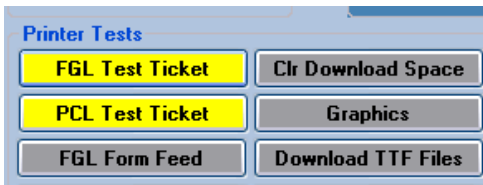

- Once the Test Ticket selection box comes up, click on the OK button to print out a ticket.

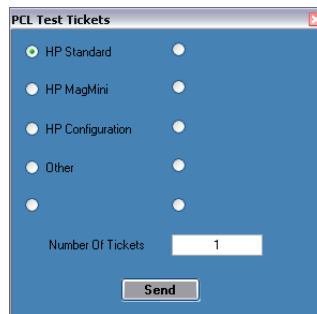
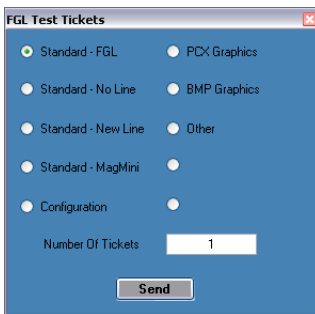

- You may also print more than one ticket by changing the number of tickets you want to printer.

Click on the HELP button at any time to open up the help window.

Below are sample printouts. Your sample printout may vary due to ticket width and length.



Above sample FGL ticket was printed on a 2" x 5.5" (concert) ticket using a RADJW-2 200dpi FGL printer



Above sample FGL ticket was printed on a 3.25" x 8" (receipt) ticket using a RADJW-3.25 200dpi FGL printer



Above sample FGL ticket was printed on a 2" x 5.5" (concert) ticket using a RADJW-2 300dpi FGL printer

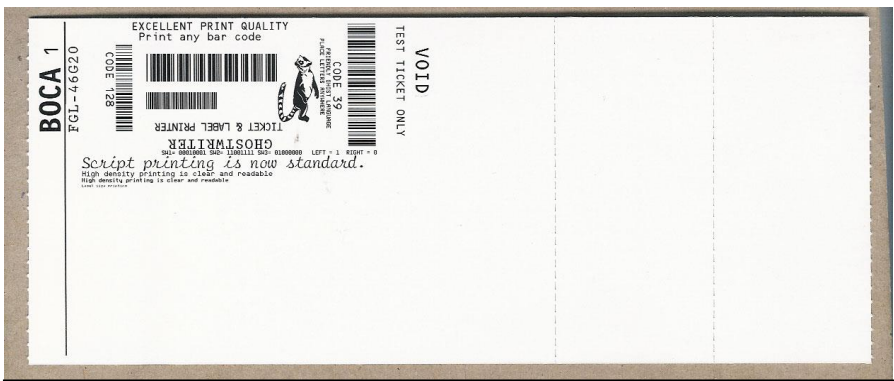

Above sample FGL ticket was printed on a 3.25" x 8" (receipt) ticket using a RADJW-3.25 300dpi FGL printer

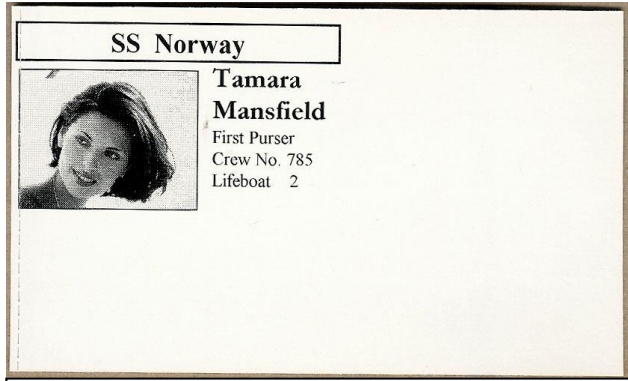

Above sample PCL ticket was printed on a 3.25" x 5" ticket using a RADJW-3.25 300dpi PCL printer

Boca Systems FGL Printer Driver Modes

There are adjustments that can be made to driver options available to accommodate the various ticketing systems. As described below, there are three modes in which the Boca Systems FGL printer drivers will operate.

1. **Spool-Uni – Unidirectional mode:** BIDI support is OFF and Spooler is ON. The printer monitor is turned off so no status is returned from the printer to the application. In this mode the current bidirectional drivers (version 3.0.6.0) will operate just as the version 2.0.2.0 standard drivers released in 2010. In this mode a printer can be set up as a shared network and be reached from web applications. This is the default mode the configure and test program will come up in.
2. **Direct-BiDi – Bidirectional Direct mode:** BIDI support is ON and Spooler is OFF. This mode is used by ticketing systems that want to read all status generated by the FGL printer. With constant monitoring of the status, a ticketing system can always know the state of the printer before sending the next ticket. In this mode a printer can be used local to the PC only.
3. **Spool-BiDi – Bidirectional Spool mode:** BIDI support is ON and Spooler is ON. This is the default mode for the newest Boca Systems drivers come up in if no changes are made. In this mode the spooler is used to write to the printer. This mode is required for applications that use a print monitor. A printer/port monitor is used to read status back from the printer and maintain some of the operating systems variables contained within the PRINTER_INFO_2 & PRINTER_INFO_6 structures. Ticketing systems can now read these variables to see when the printer is Ready, Jammed, Out of stock or Offline. In this mode a printer can be set up as a shared network printer and reached from web applications.

APPLE/ MAC BASED SYSTEM

Boca Systems, Inc. has developed two programs that allow customer to the printer. One operates over USB/HID & Ethernet interfaces and the other if a print driver is used. The below programs are found on our [website](#) under the “[TECH SUPPORT/ REPAIRS](#)” section.

[For Mac use without printer driver](#) (www.bocasystems.com/documents/boca_customer_mac.zip) customer program is used with **USB/HID & Ethernet interfaces**.

[For Mac use with printer drivers](#) (www.bocasystems.com/documents/boca_customer_driver_mac.zip) customer program is used with **print drivers or USB connection**.

You may download load the program that fits your needs. To use these programs you will need to download the zip file to your Apple/Mac based host computer. The following steps will guide you through using these programs once they have been installed on your host computer.

1. Hook the BOCA printer to the host computer that you have the Customer program loaded onto. Make sure that the printer has stock loaded and it ready to go. A printer is ready to print when it is able to print out a self test ticket by depressing the TEST button. If you are not able to get a self test ticket, refer to the user’s manual to make sure you have the printer properly setup.
2. Go to your download folder and you will see the customer program you chose. Click on this folder to expand it to see all the files.
3. You will need to click on the appropriate application file to run the program.
customer_mac for the USB/HID & Ethernet based program.
cust_driver_mac for the print driver based . Proceed to [step #5](#)
4. Once the Customer MAC Test Tool is running, click on the “Select Printer Interface” drop-down arrow. You will want to choose the interface connection that you have the BOCA printer hooked up to then go to [step #6](#). If you are connecting via the Ethernet port then in the IP Address box type in the printer’s current IP address. The printer’s current IP address is printed on the self-test ticket (when the test button is pressed). When typing in the address don’t include the leading zeros (if IP=189.010.000.002 then type in 189.10.0.2). Click on the

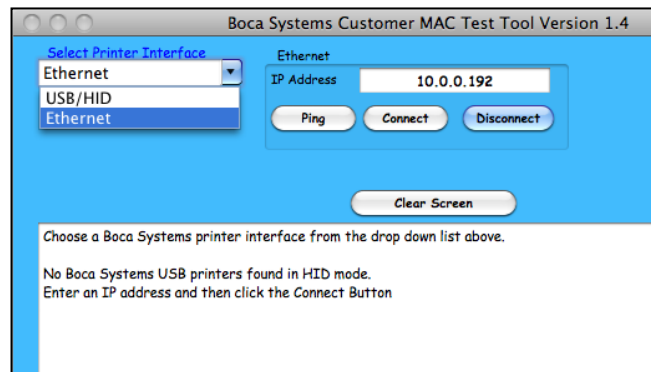

Connect button. The Message section will indicate that connection has been made. Go to [step #6](#)

5. Once the Customer USB Drivers program is running, click on the “Pick A Printer” button. You will want to choose the driver you’re using for the BOCA printer.

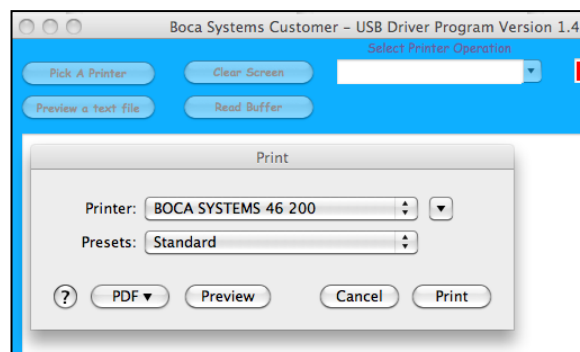

Your selection of drivers will vary from what is shown in above image

- Now click on the "Select Printer Operation" drop-down arrow and chose "Print a FGL Test Ticket". If your printer had HP firmware then chooses "PCL Test Ticket".

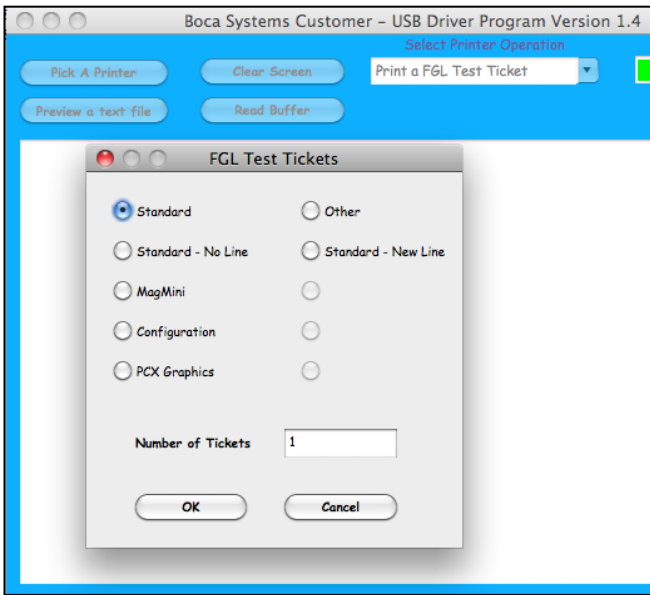

Driver program

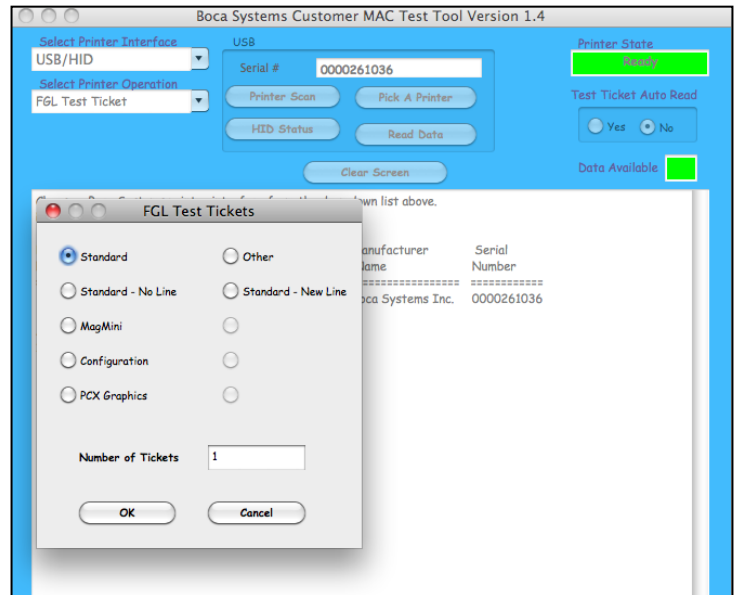

Without Driver program

- You may also print more than one ticket by changing the number of tickets you want to printer.

Below are sample printouts. Your sample printout may vary due to ticket width and length.



Above sample FGL ticket was printed on a 2" x 5.5" (concert) ticket using a RADJW-2 200dpi FGL printer



Above sample FGL ticket was printed on a 3.25" x 8" (receipt) ticket using a RADJW-3.25 200dpi FGL printer



Above sample FGL ticket was printed on a 2" x 5.5" (concert) ticket using a RADJW-2 300dpi FGL printer

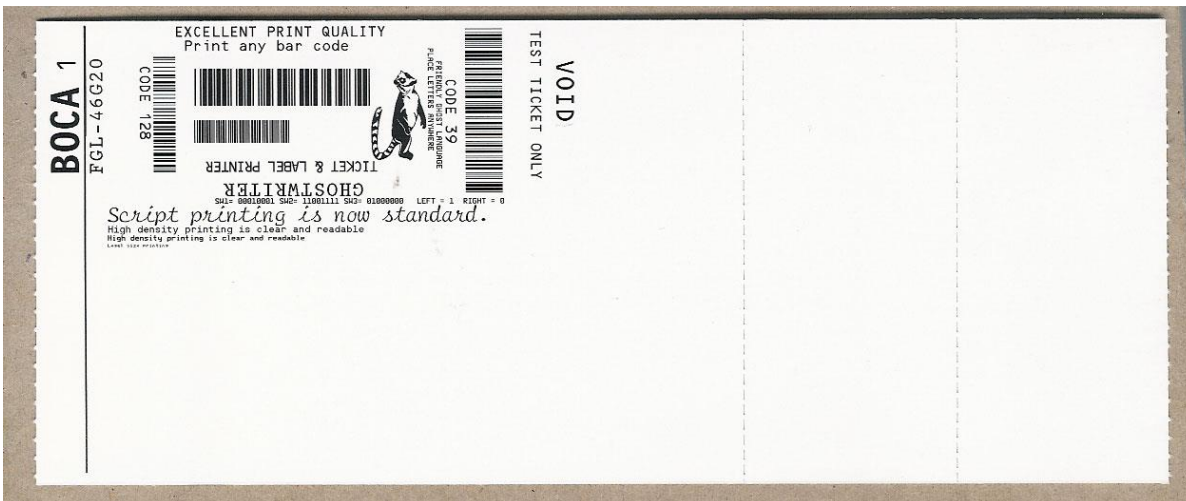

Above sample FGL ticket was printed on a 3.25" x 8" (receipt) ticket using a RADJW-3.25 300dpi FGL printer

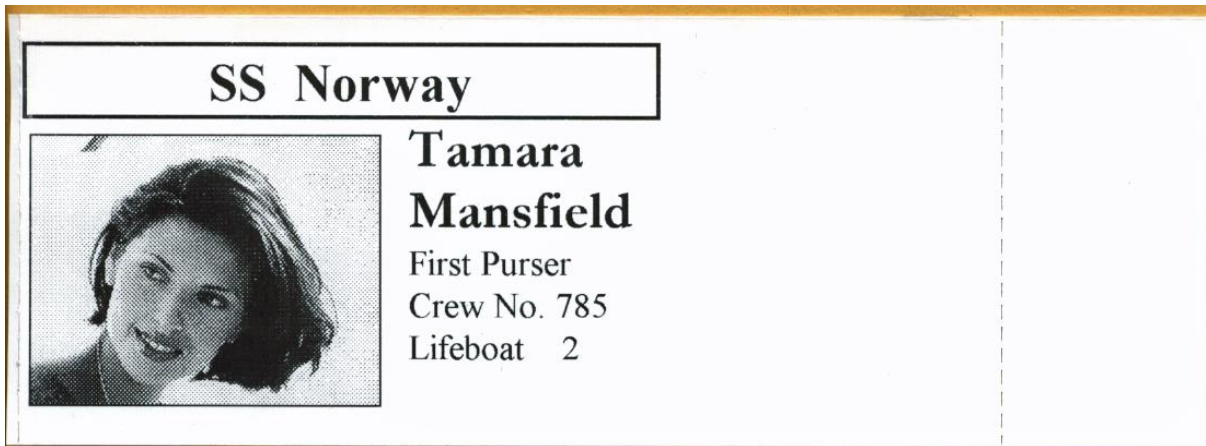

Above sample PCL ticket was printed on a 2" x 5.5" ticket using a RADJW-2" 300dpi PCL printer

Your sample printout may vary due to ticket width and length.

Click here to return to > [Table of Contents](#)

APPENDIX G – DOWNLOADING SOFTWARE COMMANDS

For those Lemurs model printers without LCD display the menu setting changes may be done by utilizing the software commands listed below. This is best done using the BOCA test program for Windows (see [Appendix F](#)) or our customer program for MAC (see [APPLE/ MAC BASED SYSTEM](#)).

If needed, the printer may be defaulted back to it's originally factory settings as follows. With the printer powered off hold down the TEST button and then power up the printer. Keep the TEST button held down for 10 seconds and release (the printer will reset at this time).

Once you have your interface or driver selected then clicks on the “Enable FGL for PCL” button. *For the MAC customer program under the Select Printer Operation choose “Enable FGL Commands (HP)”*. Click on the Yes Click the Yes button and then the OK button.

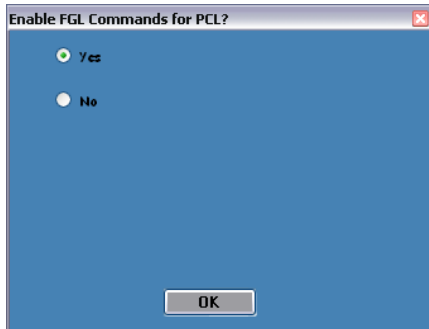

Window

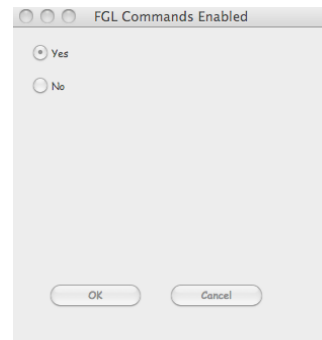

MAC

Click on the “Send Text” button. *For the MAC customer program under the Select Printer Operation choose “Send Text Commands”*. Once the Text Data box comes up you type the text command in the Data input box. Then click on the OK button and the text data will be sent to the printer.

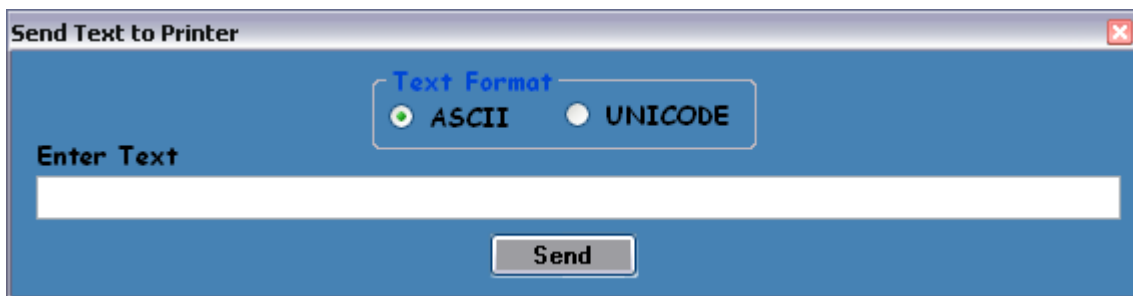

You may click on the HELP button at any time to open up the help window.

The CONFIGURATION TEST TICKET SUPPLEMENT section of the [FGL programming guide](#) shows all of the commands necessary to access the operator control panel functions.

Click here to return to > [Table of Contents](#)

APPENDIX H – CHANGING SPECIAL HEAD SETTING

For those Lemurs model printers without LCD display the special head setting changes may be done by utilizing the software commands listed below. This is best done using our configure and test program for Windows (see [Appendix F](#)) or *our customer program for MAC* (see [APPLE/ MAC BASED SYSTEM](#)).

If needed, the printer may be defaulted back to it's originally factory settings as follows. With the printer powered off hold down the TEST button and then power up the printer. Keep the TEST button held down for 10 seconds and release (the printer will reset at this time).

Once you have your interface or driver selected then clicks on the “Enable FGL for PCL” button. Click on the Yes button and then the OK button. *For the MAC customer program under the Select Printer Operation choose “Enable FGL Commands (HP)”*. Click on the Yes

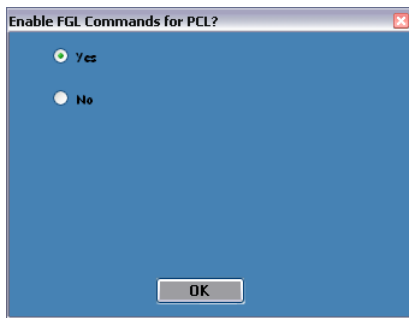

Window

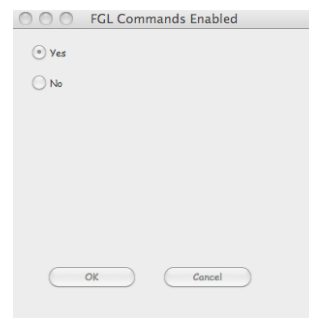

MAC

Click on the “Change Ticket Width” button. *For the MAC customer program under the Select Printer Operation choose “Special Head”*.

Once the Special Head menu box comes up you will need to choose the Head Type.

Full Size – If you want to set a RADJW path to 3.25” or a RADJ4 path to 4”. *For MAC customer program you would choose “NO”*. If selected then click the OK button

Special – Must not be used.

Rev-Adj – Is select to enable you to choose a different ticket width setting

Next you will need to choose the Path. This option will only become available if you had selected Rev-Adj.

P1 – This would be selected if you have a single path Lemur model printer or choosing Path 1 on a Lemur-2 model printer.

P2- This would be selected if you are choosing Path 2 (closest to power switch) on a Lemur-2 model printer.

BOTH – This would be select if you are choosing both paths on a Lemur-2 model printer.

Next you will need to choose the Size. You will want to choose the size the best matches the width stock being used. The 3.25 setting is to only be used for a RADJ4 path that needs to be set to 3.25”. For example if you had a RADJW path Lemur series printer you wanted to change the ticket width from 3.25” to 2” then the Special Head menu box will look like the below sample.

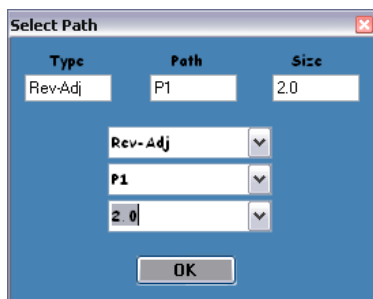

Windows

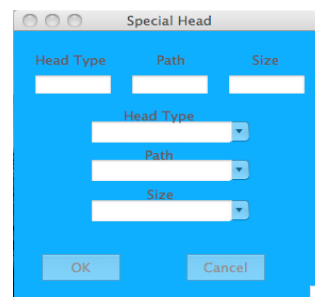

MAC

You may click on the HELP button at any time to open up the help window.

Click here to return to > [Table of Contents](#)

APPENDIX I – CONFIGURE WI-FI CONNECTION

To use the wireless capabilities of a printer equipped with the optional 802.11b wireless interface (Wi-Fi), it will first be necessary to setup the printer with information and security settings that match the settings of the IEEE 802.11b compatible wireless server/router you are connecting to. Printer purchased after April-2014 is able to support IEEE 802.11g compatible wireless server/router.

Our Wi-Fi printer is designed to work with a wireless router.



To initially configure the wireless settings it will be necessary to connect to the printer via the Parallel, RJ12 serial, USB or Ethernet (if so equipped) interface using a Windows or MAC based system.

This may be done using our Configure and Test program for Windows or Customer program for MAC (see [Appendix F](#)). The printing of a ticket via this program will confirm it is communicating with the printer.

To use the wireless capabilities in FGL and PCL 26/46 model printers equipped with a wireless interface, it will first be necessary to setup the printer with information and security settings that match the wireless settings of the local wireless server/router. To configure the printer with the correct security settings, it is necessary to acquire these settings directly from the wireless server/router or see your network administrator. Also to initially configure the wireless settings it will be required to temporarily connect a cable between the printer and the host computer.

We recommend that the Wi-Fi be configured by either your system administrator or IT support staff. You will need to know the appropriate SSID, security mode and their associated values for your Wi-Fi router.

The below steps walk you through the Wi-Fi setup in the Infrastructure mode. **The Wi-Fi router must be configured to support an IEEE 802.11b Wi-Fi device. Printers manufactured after April 2014 are able to support an IEEE 802.11g Wi-Fi device.**

1. The printer will need to be connected to the host computer via a cable (parallel, serial, USB or optional Ethernet if your printer has it. If connecting via USB then you will need to install our BOCA print driver first (see [Appendix J](#) for Windows and [Appendix K](#) for MAC). For initial install the printer must be as close as possible to the Wi-Fi router itself. This will ensure maximum signal strength. Once you have confirmed the Wi-Fi is operational, the printer may be moved to its desired location.
2. You will want to confirm you are able to print a ticket using our Configure and Test program for Windows or Customer program for MAC (see [Appendix F](#)). The printing of a ticket via this program will confirm it is communicating with the printer. Leave the program open and move onto the next step.
3. In the Configure and Test program for Windows click on the “Setup Wi-Fi button. In the Customer program for MAC select “Setup Wi-Fi” under the “Select Printer Operation”.
4. When the Configure Printer Wi-Fi and Security menu comes up you have a few choices.
 - a. **Wireless Mode** – Infrastructure (this is default setting). **DO NOT SELECT Ad Hoc (peer to peer)**
 - b. **Disable Wireless** – You would choose this if you wanted to disable the Wi-Fi
Enable with Static IP – This would be for networks that require a static IP address.
Enable with DHCP IP - Automatically attempts to get an IP address from Local Server (this is the most common one and the one we will be using for the rest of the steps).

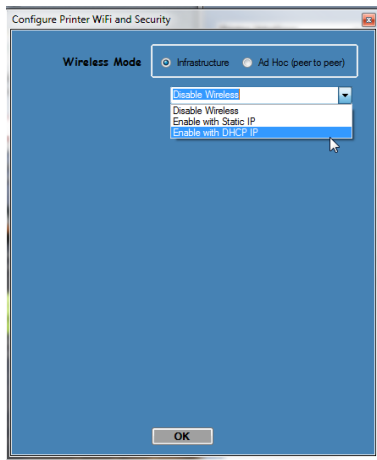

5. You will need to enter the **SSID value**. The Service Set Identifier is a 1 to 32 byte string. This normally would be the name of the Wi-Fi router you are connection to. **Please note the ID is case sensitive**.

SSID:

6. Security Mode: you will need to choose the security mode that is appropriate for your WiFi router.
 - Disable** – Allows the user to communicate through the wireless network without any security encryption involved.
 - WPA** – Go to [Step 7](#)
 - WPA2** – Go to [Step 7](#)
 - WEP** – Go to [Step 8](#)

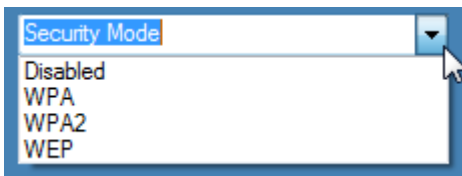

7. **WPA and WPA2 Personal Security Mode** – Allows the user to communicate through the network using WPA or WPA2 Personal wireless encryption. When this security encryption mode is chosen it will be required to enter the “WPA Shared Key” for the local wireless network. Some networks also enforce the use of an optional key value. The optional prompt field is provided for those networks. **Please note the key is case sensitive**. Finally click on OK to have these values transmitted to the printer (through the cable). The printer will reset and upon re-initialization it will establish wireless communication with the local network. The handshaking involved in establishing wireless communication can take up to 30 seconds. Go to [step #9](#).

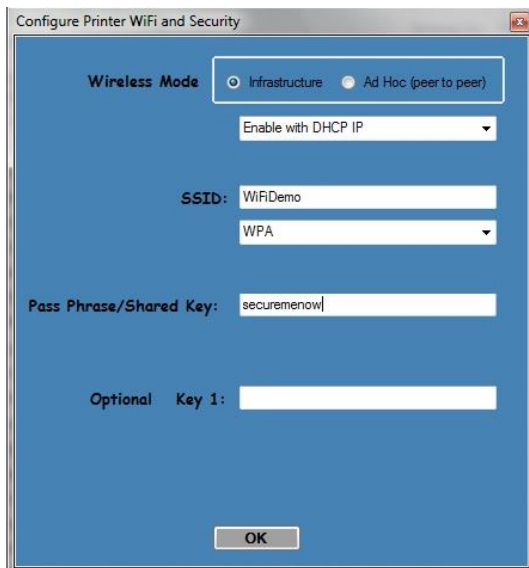

8. **WEP Security Mode** – Allows the user to communicate through the network using WEP wireless encryption. With WEP one can select 64 bit or 128 bit encryption. When the security encryption mode is chosen it will be

required to enter the “Key” for the local wireless network. **Please note the key is case sensitive.** Some networks also enforce the use of a default transmit key. If needed select one, else leave it set to “1”. Next the four security key values will have to be entered to match those of the local network. Finally click on **OK** to have these values transmitted to the printer (through the cable). The printer will reset and upon re-initialization it will establish wireless communication with the local network. The handshaking involved in establishing wireless communication can take up to 30 seconds. Go to [step #9](#).

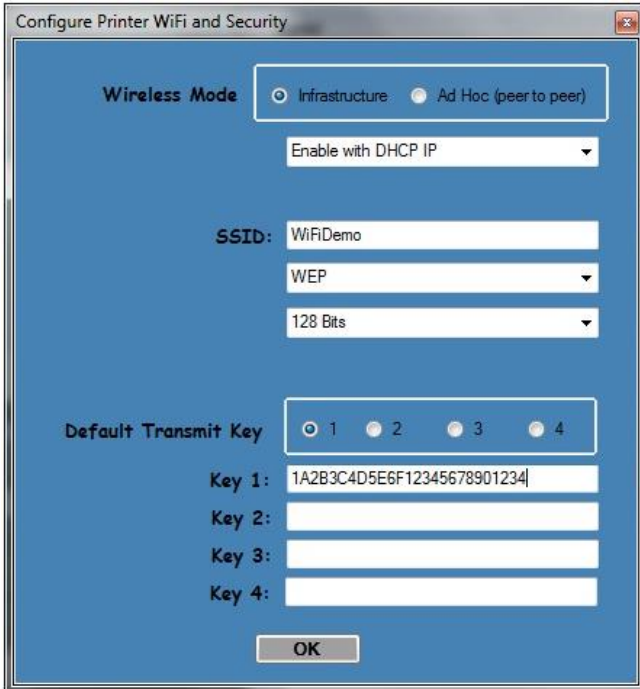

9. The printer will reset. Depending on your operating system, this rest may happen less than 60 seconds or as long as 5 minutes. Upon re-initialization it will establish wireless communication with the local network. Depending on your network, a connection can be established in less than 60 seconds or as long as 5 minutes. Messages will be displayed on the LCD display when the printer is connecting. When it is connected the display will show a series of up to 5 pound signs (#####) representing signal strength (see image below). At this point the printer is connected to your Wi-Fi router.



If it fails or displays IDLE then there is a problem. See [item #13](#) on the Troubleshooting Guide.

10. Press the TEST button to print out a self-test ticket. This ticket will show the IP address that was acquired by the printer. You may use the configuration and test program to test this interface connection. You would run the program like you are connecting to an Ethernet printer and enter in the IP address that is shown on the self-test ticket.

Please go to the link below if you need assistance in configuring your Wi-Fi connection.
www.bocasytems.com/onlinesupportform.html

If your printer has an options Ethernet port then this port will be disable while the printer is in Wi-Fi mode. The printer is not able to run both Ethernet and Wi-Fi at the same time. If you need to go back to using the Ethernet port then the Wi-Fi needs to be disable. This may be done by repeating the above procedure but at step # 4 choosing **Disable Wireless**.

Once the Wi-Fi has been enabled the RJ12 serial port will no longer work.

Click here to return to > [Table of Contents](#)

APPENDIX J – WINDOWS DRIVER INSTALLATION GUIDE

Do not connect the printer to your computer's USB port until advised to.

Please contact your software provider to confirm if the use of our driver is required for their ticketing software. We recommend that the print driver is installed by either your system administrator or IT support staff.

These print drivers are intended to be installed on Windows PC platforms X86, AMD64 or IA64. This includes Windows 7, 8.1, 10 and Server 2012 R2.

To properly install the Boca Systems printer drivers, version 4.0.0.0, follow the steps outlined below. **If you currently have another version of a BOCA print driver installed, start at step #1 to uninstall it first. If this is the first time installing the BOCA driver onto the host computer then start at [step #4](#).**

On the host computer you are installing the drivers on you will want to make sure you have the following:

- Administrate privileges as most Windows systems require this to download drivers.
- Access to the internet as the host computer will need to gain access to the Microsoft website to download the necessary drivers.

1. Turn off the BOCA printer.

2. Go to the Devices and Printers window. In the below image there is one BOCA driver currently installed via its default name.

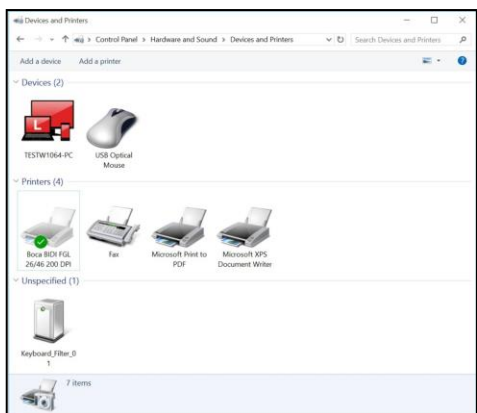

3. Right click on the driver icon and then click on "Remove Devices". You will be prompted with "Are You Sure", select Yes. If there is more than one BOCA print driver icon then repeat this step until all are removed.

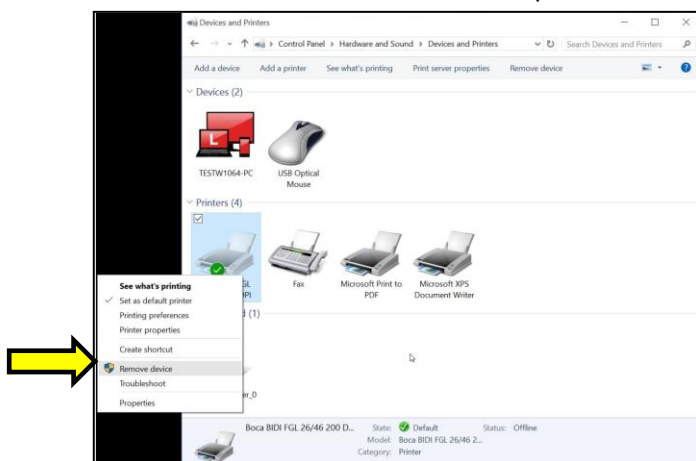

4. Click on the link below to download the zip file to your host computer. You will be prompted if you want to Open, Save or Save as. Click on **Save as** and save the file to your hard drive. You will need to denote what file folder you saved the file to.

www.bocasystems.com/bocaprinterdrivers.zip

5. Go to the file folder you saved the zip file to and right click on bocaprinterdrivers.zip. Click on Extract All... It will ask you to select a Destination and Extract Files, click on the Extract button.

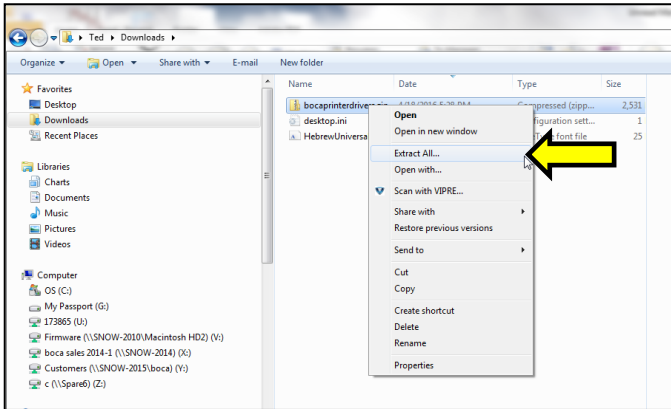

6. The file folder that was extracted will automatically pop up. Double click on the BocaPrintDrivers folder to open it up. Right click on boca.bat and click on Run as administrator.

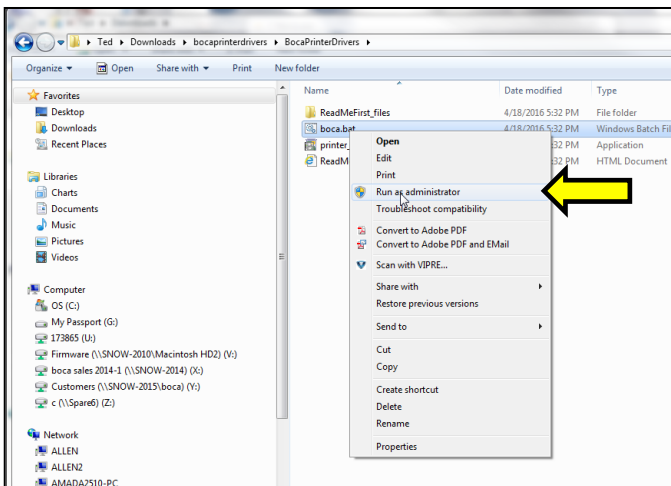

7. You will see two DOS command windows open. The first will be looking for an older version of ddkfglmon.dll file to delete so it may be replaced with new ones once the complete install process is done. The spooler will be stopped while the file is being deleted and will restart. If the PC does not have this file, a message will be displayed "File not found". This is nothing to worry about as said file did not reside on the PC.

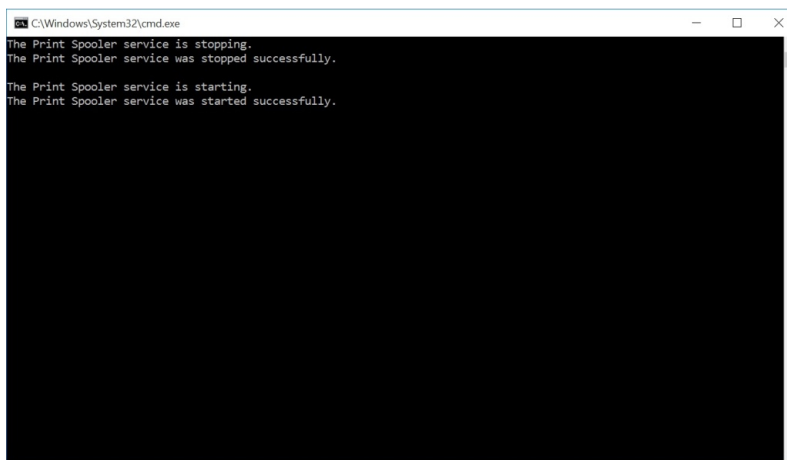

- The second DOS command window will open to install the printer files as shown below. Notice the message “Driver Package added successfully”. This is how it is displayed on a 64 bit Windows PC. Press “Enter” key to close DOS command windows.

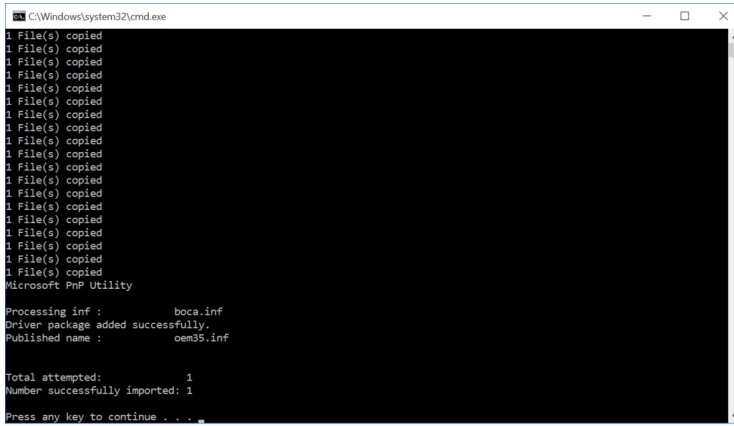

On a 32 bit Windows PC it will look more like the below. Click the “Next” button and “Finish” button when prompted to complete the install of the driver package onto the PC.

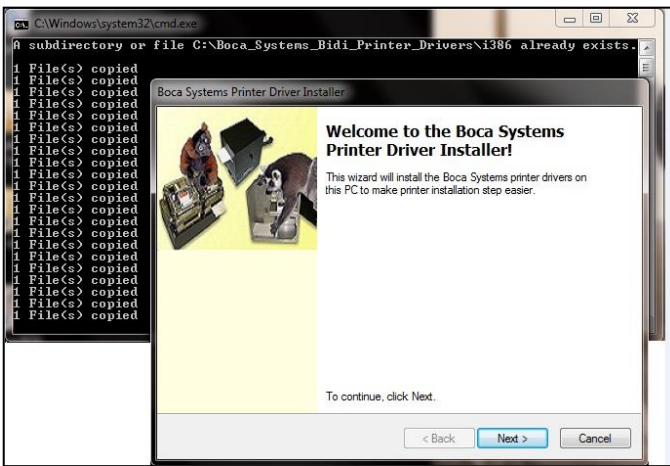

NOTE: IF INSTALLING ON WINDOWS 8 OR 10 GO TO [PAGE 65](#).

The below steps are for Windows 7 operating system only.

- Connect the USB cable to the host computer and power on the printer. If you are connecting to the printer via Ethernet or Wi-Fi then skip to [step # 4](#).
- Depending on your system, a notice box similar to the following picture should appear. Click on the **Click here for status**. This will enable to see the status of the driver software installation.

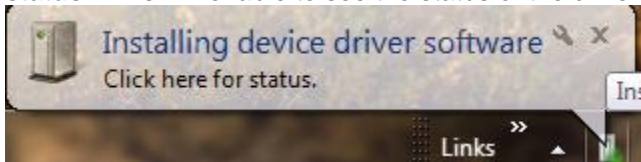

- The correct USB Printing Support and drivers will automatically install. The image below is of a 200dpi driver being installed on a Windows 7 system. The driver name will vary due to the printer's DPI and logic board level. [Go to Page 63](#) to print a windows test page.

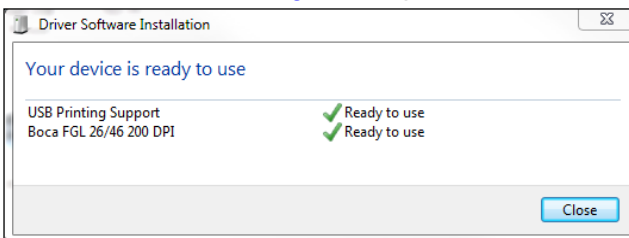

STEPS 4 THROUGH 15 ARE FOR ETHERNET OR WI-FI CONNECTION ONLY

4. The self-test ticket that is printed when the printer's TEST button pressed will show the IP address that the printer has.
5. Open up the "Devices and Printer" Menu.
6. Click on "Add a Printer". When Add Printer Wizard show up, click on the Next button. Click on "Add a local printer".

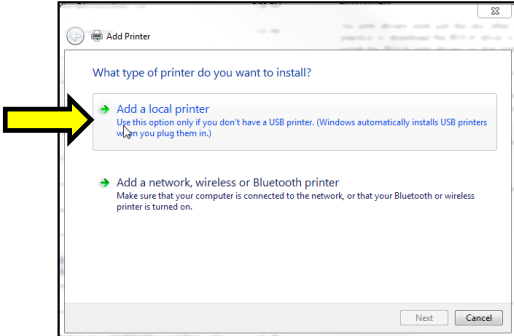

7. When the printer port menu comes up. Click on "Create a new port:" choose "Standard TCP/IP Port". Click on the Next button.

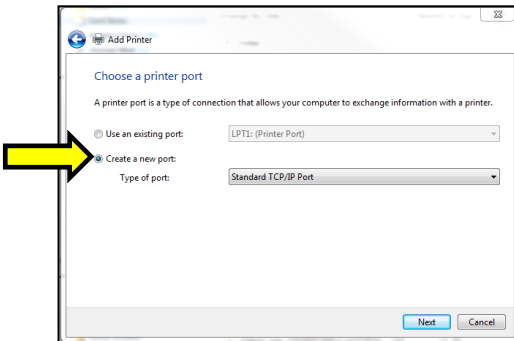

8. Type in the IP address that is shown on the self-test ticket in the "Hostname or IP address:" field. When typing in the address don't include the leading zeroes (If IP=189.010.000.002 then type in 189.10.0.2). You also have the option of typing in a specific Port name or leave as the IP address. Click on the Next button.

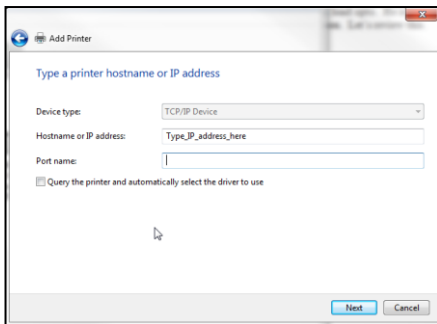

The below screen may be seen (no action is needed). It may take a few minutes for the system to move on to the next screen. This will vary depending on system and Network speeds.

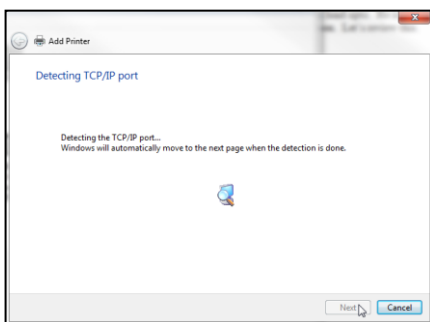

9. When the Additional Port information menu comes up click on the Next button.

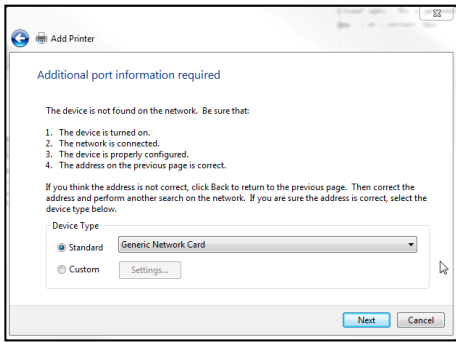

10. When the Install print driver menu comes up: Under Manufacturer select “Boca”. Under Printers select the driver that matches your printer’s protocol (FGL or PCL) and DPI. Click on the Next button.

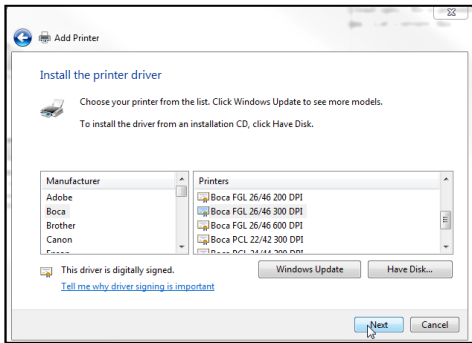

Taking a look at the printer’s serial number tag the below chart should aid in determining the correct driver to select. Self-Test ticket is printed by pressing the printer’s TEST button.

Driver	DPI	Firmware	PCL listed
Boca BIDI FGL 22/42 200 DPI	200	22 or 42	NO
Boca BIDI FGL 24/44 200 DPI	200	24 or 44	NO
Boca BIDI FGL 26/46 200 DPI	200, 2C, 2L	26 or 46	NO
Boca BIDI FGL 22/42 300 DPI	300	22 or 42	NO
Boca BIDI FGL 24/44 300 DPI	300	24 or 44	NO
Boca BIDI FGL 26/46 300 DPI	300, 3L	26 or 46	NO
Boca PCL 22/42 300 DPI	300	22 or 42	YES
Boca PCL 24/44 300 DPI	300	24 or 44	YES
Boca PCL 26/46 300 DPI	300, 3L	26 or 46	YES



Above is a typical FGL self-test ticket



Above is a typical PCL self-test ticket

11. When the version driver menu comes up click on the Next button.

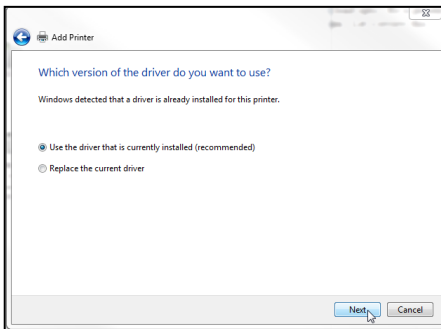

12. When the printer name menu comes up you may keep the default name or type in a different name. We recommend you keep the default name. Click on the Next button.

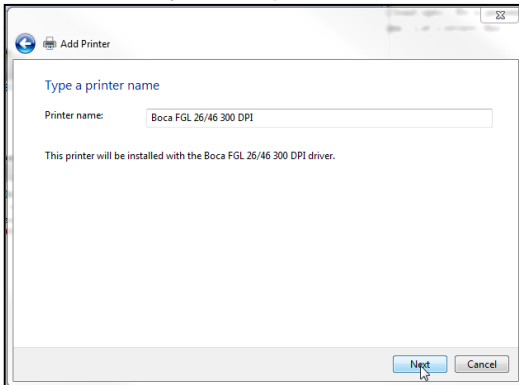

Your driver name will vary from what is shown in the above image

13. When the Printer Sharing menu comes up you may choose to share this printer or not. Click on the Next button.

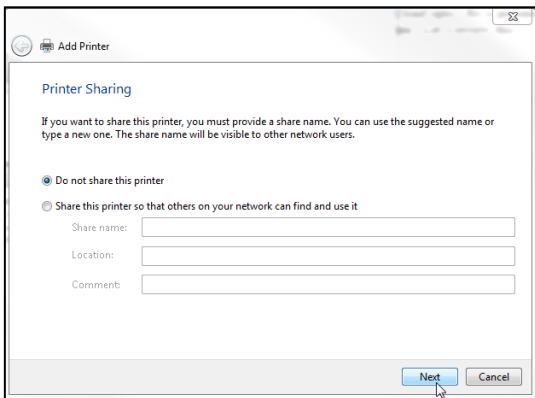

14. On the last menu you have the option to choose if you want to make the BOCA your default printer. **Do not click on Print a test page.** Click on the Finish button.

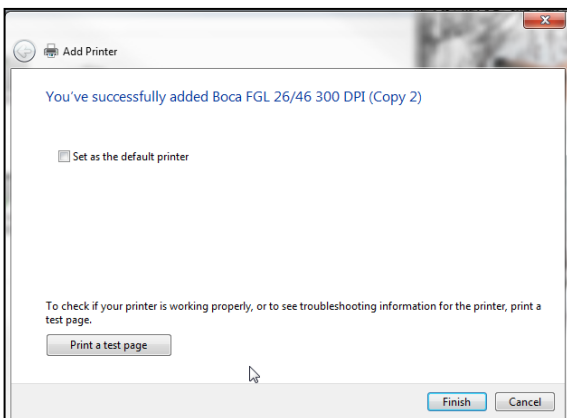

Your driver name will vary from what is shown in the above image

15. The next page reviews how to print a windows test page to confirm the driver is communicating with the printer.

Windows 7 Test Page

The following will guide you through doing a Windows test page to confirm the driver is communicating with the printer. You will want to make sure the printer has stock loaded and is able to print a self-test ticket when the TEST button is pressed. The printing of this ticket confirms that the printer is working properly mechanically. If the printer is not able to print a self-test ticket, then consult the "4.0 Installation section of the user manual (www.bocasystems.com/documents/lemur_manual.pdf).

1. Go to the **Devices and Printers** page.

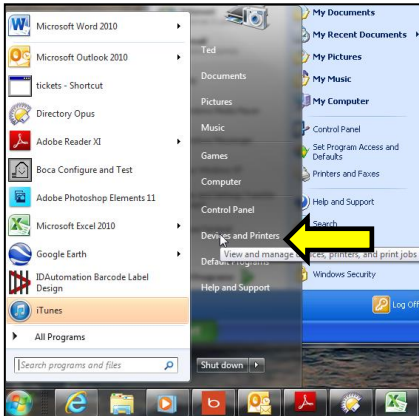

2. When the Devices and Printers page comes up, right-click on the BOCA driver that is being used. When the drop down window pops up, left click on **Printer properties**. *Your selection of driver will vary from what is shown in the below images.*

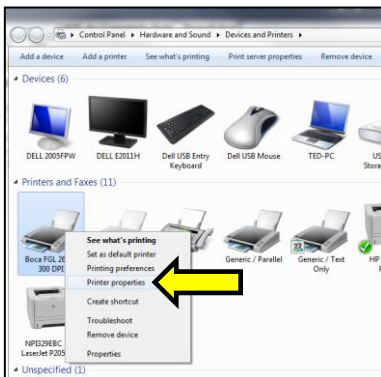

3. Once the driver's properties menu comes up click on the **Print Test Page** button. *Your drive properties will vary from what is shown in the below.*

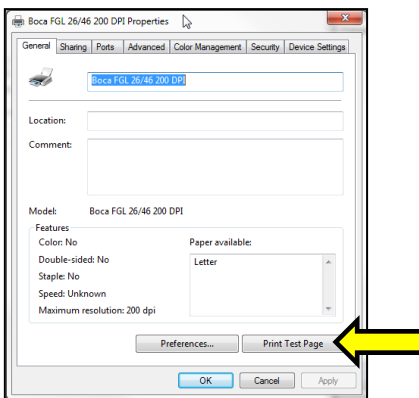

Windows 8 and 10 Install Guide

Do not connect the printer to your computer's USB port until advised to.

1. Connect the USB cable to the host computer and power on the printer. If you are connecting to the printer via Ethernet or Wi-Fi then skip to [step # 4](#).
2. Depending on your system, a notice box similar to the below picture may appear. Click on the **Click here for status** (for Windows 7) or the icon (for Windows 8 or 10). This will enable to see the status of the driver software installation.



3. The correct USB Printing Support and drivers will automatically install. The image below is of a 300dpi driver being installed. The driver name may vary due to the printer's DPI and logic board level. Go to [page 69](#) to print a Windows test page.

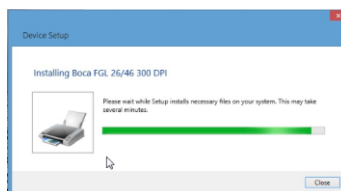
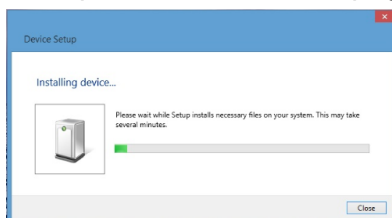

STEPS 4 THROUGH 13 ARE FOR ETHRENT OR WI-FI CONNECTION ONLY.

4. The self-test ticket that is printed when the printer's TEST button is pressed will show the IP address that the printer has.
5. Below is one of many ways to get to the devices and printers menu. **1**- Right-click the bottom corner of the Start screen. **2**- Click **All apps** icon. **3** – Click **Control Panel**.

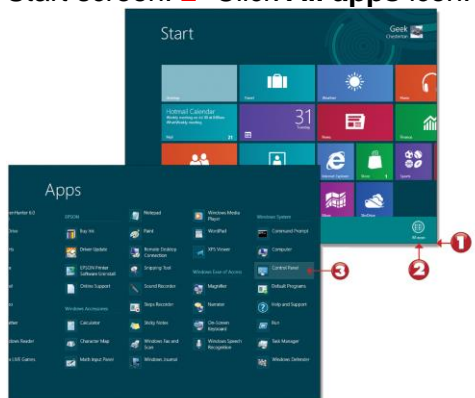

6. When the Control Panel menu comes up, click on **View devices and printers** located under **Hardware and Sound**.

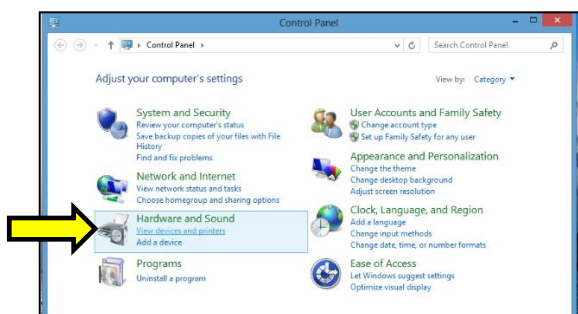

7. Open up the “Devices and Printer” Menu. Click on “Add a Printer” to run the install wizard. Click on “The Printer I want isn’t listed”. When the find a printer by other option menu comes up. Click on “Add a printer using a TCP/IP address or hostname”, click on the Next button

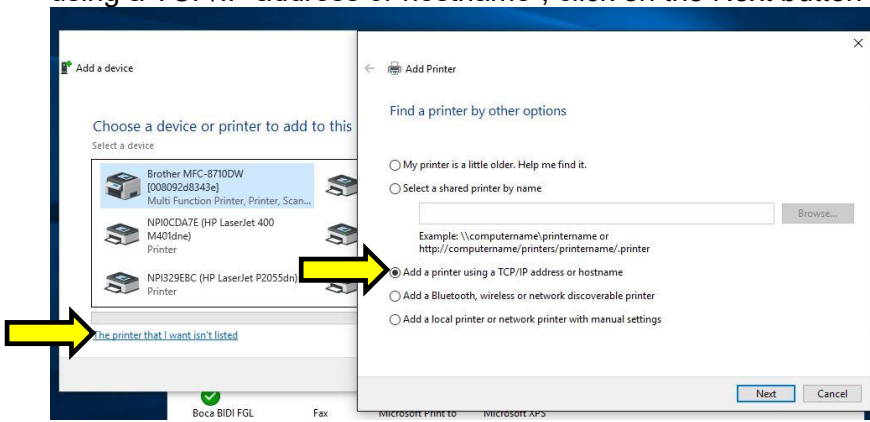

8. Type in the IP address that is shown on the self-test ticket in the “Hostname or IP address:” field. When typing in the address don’t include the leading zeroes (If IP=189.010.000.002 then type in 189.10.0.2). You also have the option of typing in a specific Port name or leave as the IP address. Uncheck the “Query the printer and.....” Box, click on the Next button.

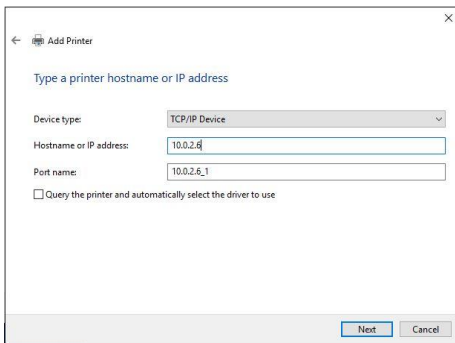

9. The below screen will be displayed (no action is needed). It may take a few minutes for the system to move on to the next screen. This will vary depending on system and Network speeds.

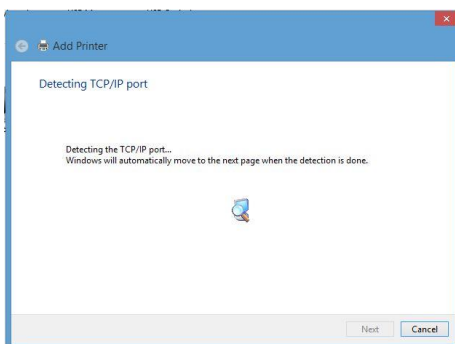

10. The host computer will move forward with detecting the IP address. Once detected the below menu will come up. Select standard network card and click next.

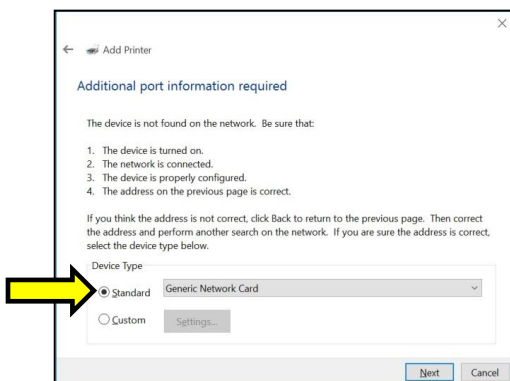

11. When the Install the print driver menu comes up select “Boca” under and the appropriate driver for your printer. Once done click on the next button.

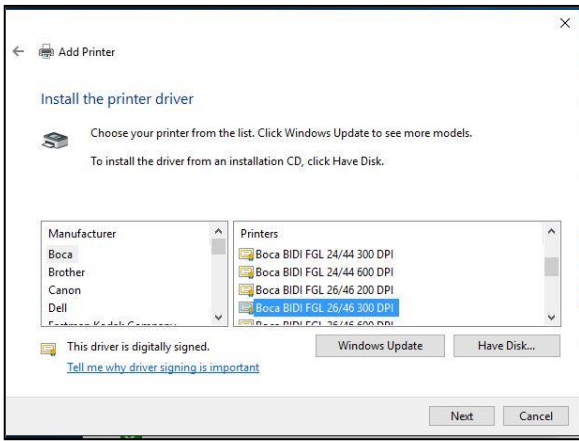

Taking a look at the printer’s serial number tag the below chart should aid in determining the correct driver to select. Self-Test ticket is printed by pressing the printer’s TEST button.

Driver	DPI	Firmware	PCL listed
Boca BIDI FGL 22/42 200 DPI	200	22 or 42	NO
Boca BIDI FGL 24/44 200 DPI	200	24 or 44	NO
Boca BIDI FGL 26/46 200 DPI	200, 2C , 2L	26 or 46	NO
Boca BIDI FGL 22/42 300 DPI	300	22 or 42	NO
Boca BIDI FGL 24/44 300 DPI	300	24 or 44	NO
Boca BIDI FGL 26/46 300 DPI	300, 3L	26 or 46	NO
Boca PCL 22/42 300 DPI	300	22 or 42	YES
Boca PCL 24/44 300 DPI	300	24 or 44	YES
Boca PCL 26/46 300 DPI	300, 3L	26 or 46	YES



Above is a typical FGL self-test ticket



Above is a typical PCL self-test ticket

12. When the below menu comes up click on next.

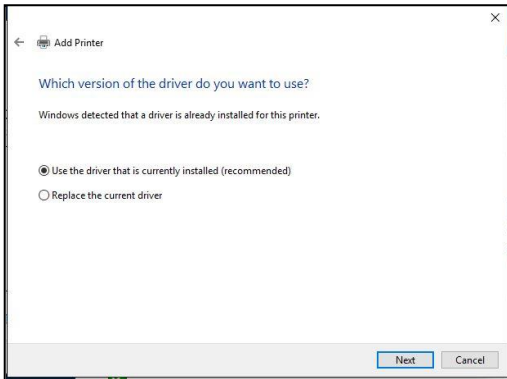

13. When the below menu comes up click on next. *Your name may vary from what is shown below.*

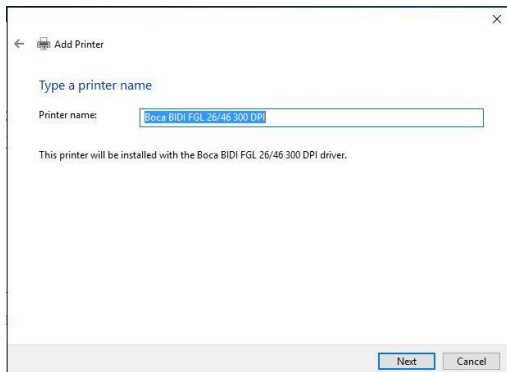

14. At this menu screen you have the option to share or not share the printer. Click on the next button.

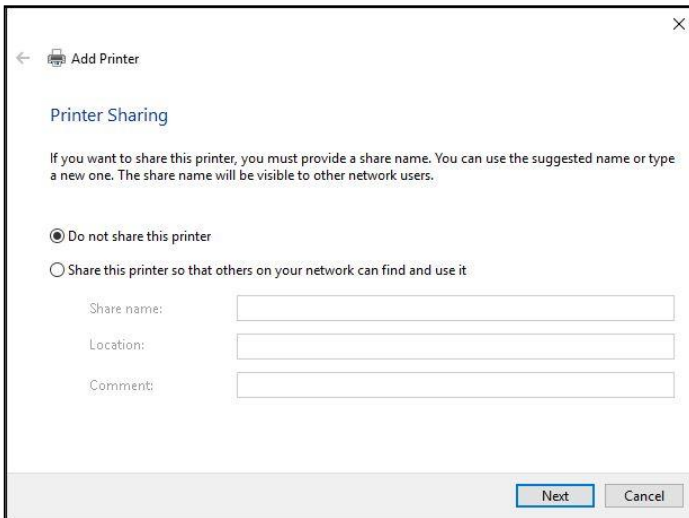

13. On the last page click on the “Print a test page” button and a windows test page should be printed by the printer. This indicates the driver is communicating with the printer. Click on the Close button and then the Finish button. [Page 70](#) shows typical printout.

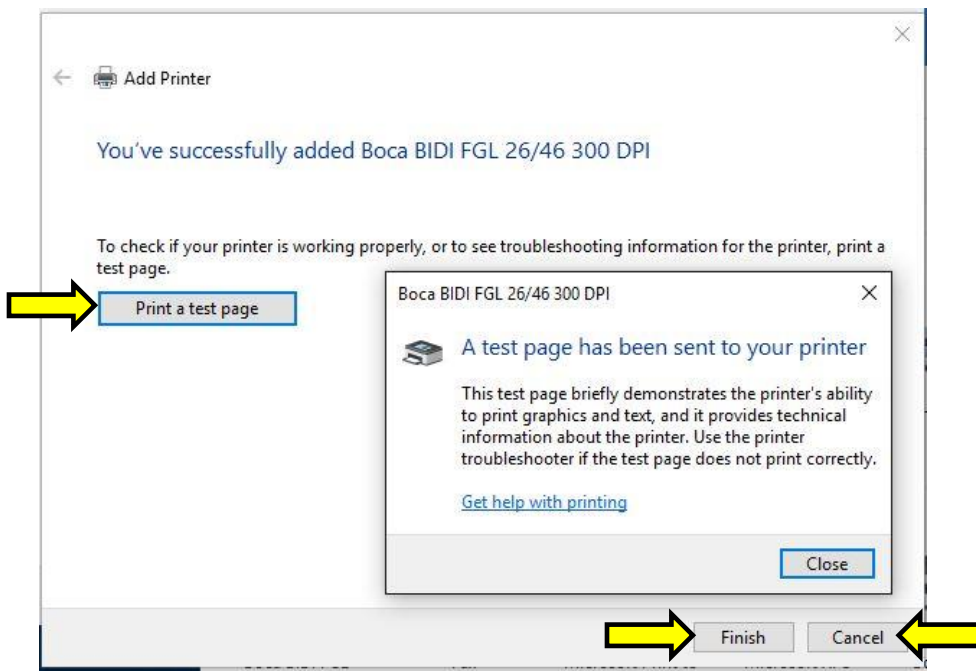

Your driver name may vary from what is shown above

Windows 8 or 10 Test Page

The following will guide you through doing a Windows test page to confirm the driver is communicating with the printer. You will want to make sure the printer has stock loaded and is able to print a self-test ticket when the TEST button is pressed. The printing of this ticket confirms that the printer is working properly mechanically. If the printer is not able to print a self-test ticket, then consult the "4.0 Installation section of the user manual (www.bocasystems.com/documents/lemur_manual.pdf).

14. Below is one of many ways to get to the devices and printers menu. **1**- Right-click the bottom corner of the Start screen. **2**- Click **All apps** icon. **3**- Click **Control Panel**.

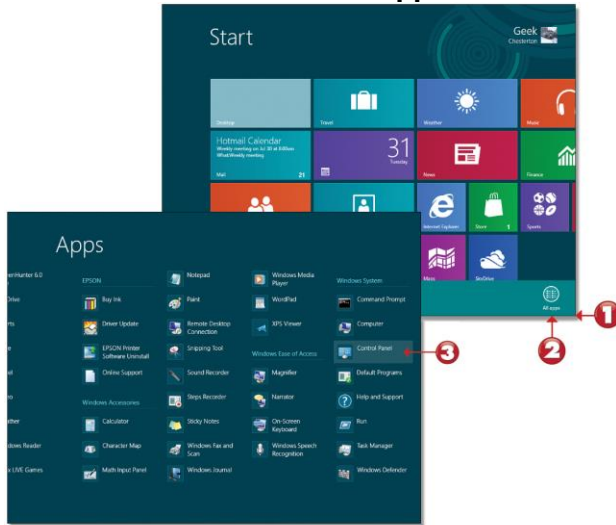

15. When the Control Panel menu comes up, click on **View devices and printers** located under **Hardware and Sound**.



16. When the Devices and Printers page comes up, right-click on the BOCA driver that is being used. When the drop down window pops up, click on **Printer properties**. Your selection of driver will vary from what is shown in the below images.

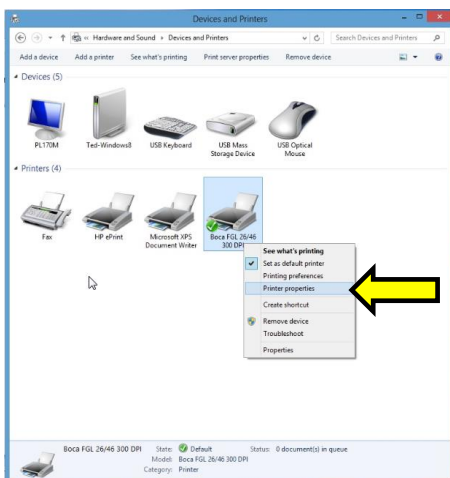

17. Once the driver's properties menu comes up click on the **Print Test Page** button. *Your drive properties may vary from what is shown in the below images.*

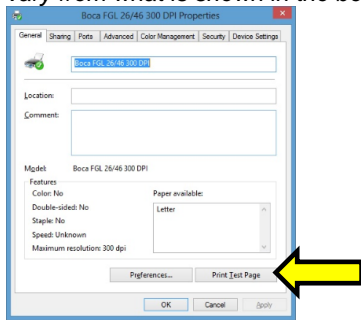

18. The printer should proceed with printing out a Windows Test page. The printing of this ticket confirms the print driver is communicating with the printer.

Below are some samples printouts for reference only and your test page may look different.

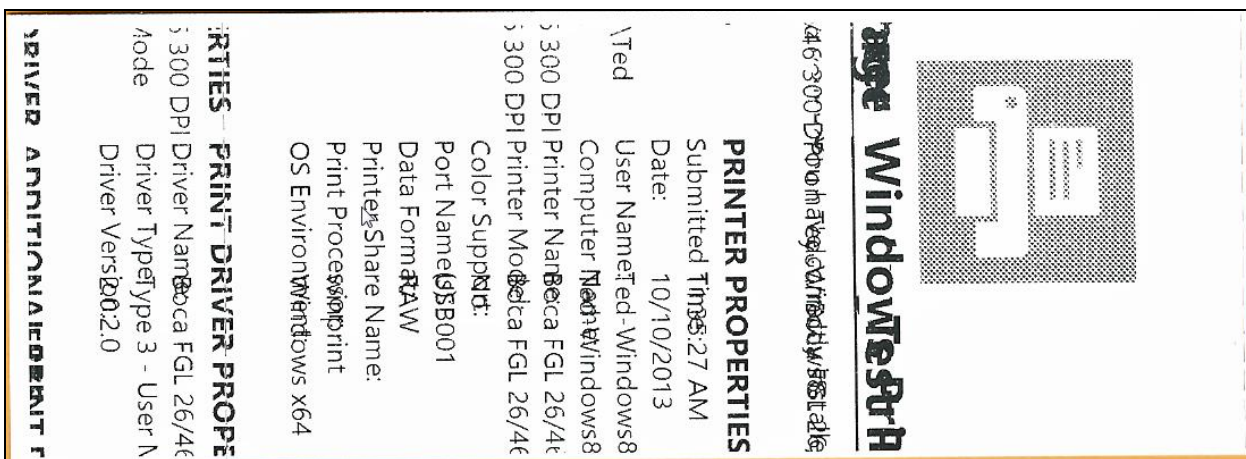

Above is from a 200DPI FGL printer with 2" x 5.5" stock

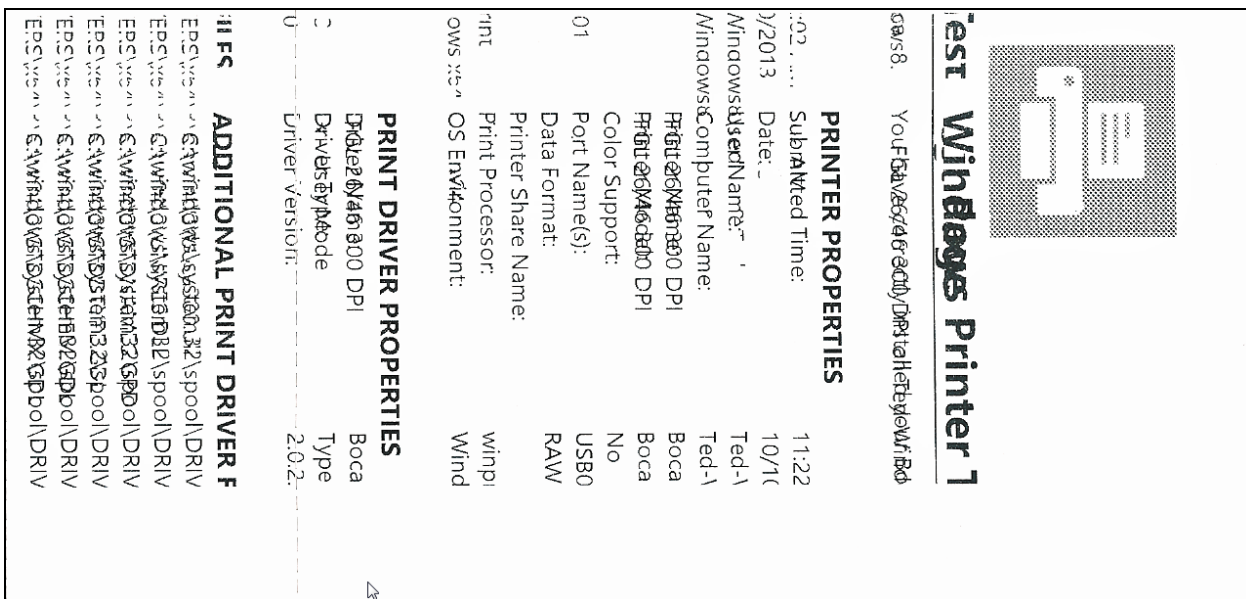

Above is from a 300DPI FGL printer with 3.25" x 6.5" stock

If you were not able to install the BOCA print driver using the above steps, please take a screenshot of the "printers and drivers" dialog and attach it to the support form located at www.bocasystems.com/online-support-form.html

APPENDIX K – MAC DRIVER INSTALLATION GUIDE

Do not connect the printer to your computer's USB port until step #13

Please contact your software provider to confirm if the use of our driver is required for their ticketing software. We recommend that the print driver is installed by either your system administrator or IT support staff. **If you previously connected the printer or tried to install the print driver, take a screenshot of the “printers and drivers” dialog and attach it to the support form located at www.bocasystems.com/onlinesupportform.html.**

1. The BOCA MAC print drivers are designed only for FGL protocol printers. They will not work with PCL protocol printers. The self-test ticket that is printed when the TEST button is pressed will indicate the printer's protocol. **FGL** = FGL protocol and **HP** = PCL protocol

2. Click on the link below MAC drive link.
[boca_driver \(mountain lion compatible\)](#)

[boca_driver \(maverick , yosemite, el capitan compatible or higher\)](#)

3. Click on the below ICON when it shows up on your taskbar. Then click on **boca_mountainlion.pkg**.



4. Click on the **Continue** button.

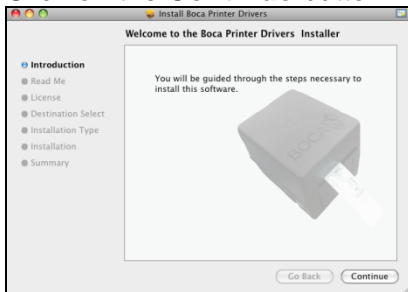

5. Click on the **Continue** button.



6. Click on **Continue** button.



7. Click on **Agree** button.

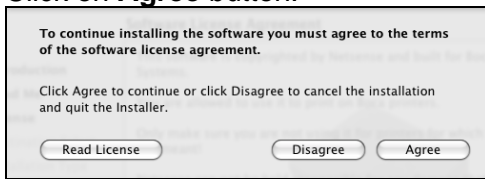

8. Click on **Install** button.



9. If your system is administrator password protected then the below dialog box will appear. Enter in the appropriate Name and Password, click on **OK** button.

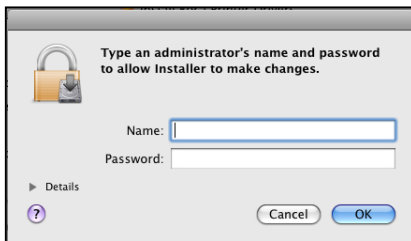

10. Click on the **Close** button.

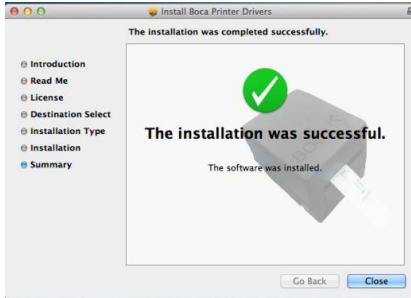

11. Click on the **System Preferences** icon that is located on your taskbar.



12. Click on **Print & Scan** icon.



+ BUTTON

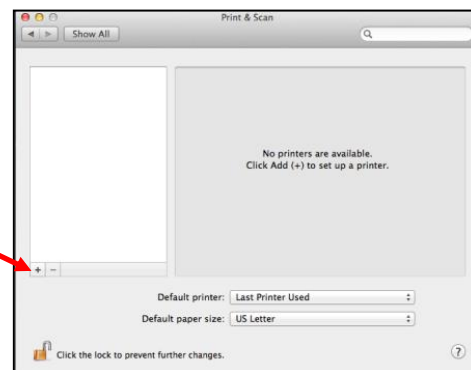

Your Print & Scan may vary from what is shown in above image

13. Connect the USB cable to the host computer; power on the printer; and go to [step 20](#). If you are not connecting to the printer via a USB cable but via an IP address (Ethernet or Wi-Fi), go to the next step.

14. The IP address of the printer is found on the self-test ticket that is printed when the TEST button is pressed.
15. Click on the **+** button in the Printer & Scan menu that was shown in step #11 to manually add a printer.
16. When the add printer menu comes up, do the following.
 - a. Click on the **IP** icon.
 - b. **Address:** type in the IP address that is shown on the self-test ticket.
 - c. **Protocol:** choose **HP Jetdirect-Socket**
 - d. **Name:** you may keep the default name or change it.
 - e. **Use:** choose **Select Printer Software....**
 - f. In the Printer Software menu type **boca** in the search area.
 - g. Choose the driver that matches your printer. The serial number tag will indicate Software (42, 44 or 46) and DPI (200, 300 or 600).
 - h. Click on the **OK** button

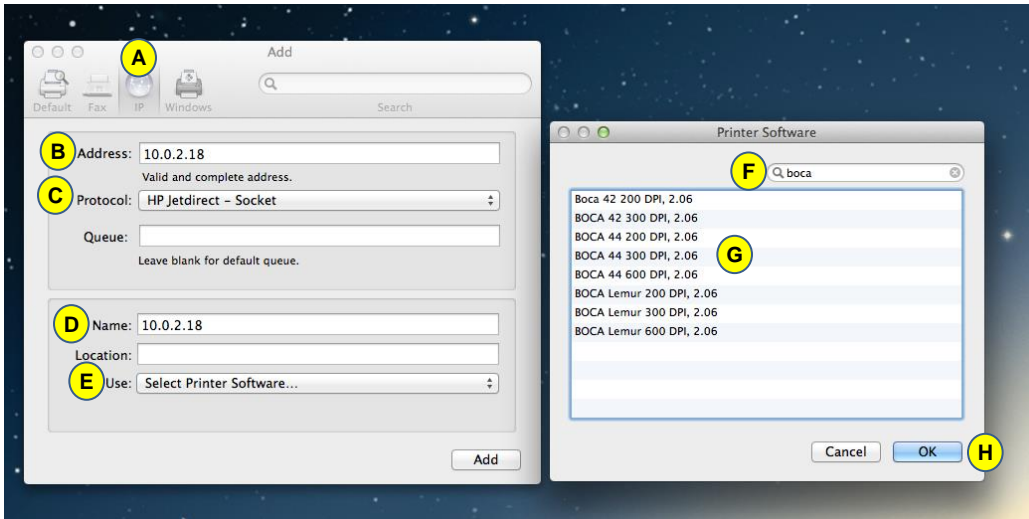

Your IP address will be different than what is show in the above image.

17. Click on **Add** icon.
18. The below box will show up while the driver is being installed, no action is needed.

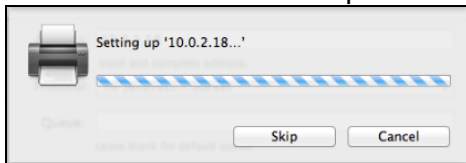

Your IP address will be different than what is show in the above image.

19. Under **Output Quality:** choose **Supercell**. Click on the **OK** button. The driver will finish installing, Go to [step 20](#).

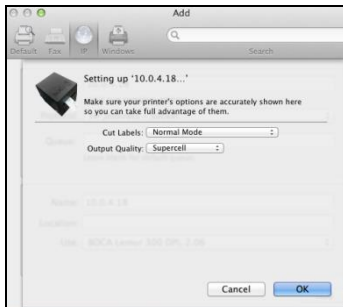

Your IP address will be different than what is show in the above image.

20. The correct print driver would have automatically installed if connected via a USB cable. If manually installed, the name entered in step 16 will show up. The image below is of a 200dpi driver. The driver name will vary due to the printer's DPI and software level.

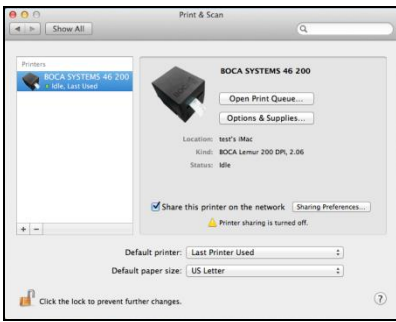

Your selection of drivers may vary from what is shown in above image

The following will guide you through doing a Windows test page to confirm the driver is communicating with the printer. You will want to make sure the printer has stock loaded and is able to print a self-test ticket when the TEST button is pressed. The printing of this ticket confirms that the printer is working properly mechanically. If the printer is not able to print a self-test ticket, then consult the "4.0 Installation section of the user manual (www.bocasystems.com/documents/lemur_manual.pdf).

21. Double Click on the BOCA print driver icon to open up the print queue. On the very top of the desktop screen click on the **Printer** and then click on **Print Test Page**. Once the driver's properties menu comes up click on the **Print Test Page** button.

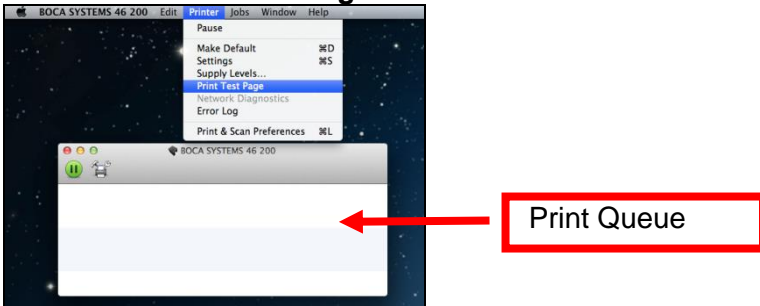

Your driver type may vary from what is shown in above image

22. The below box may show up on your screen prior to the printing of the Test page. The printing of this ticket confirms the print driver is communicating with the printer.

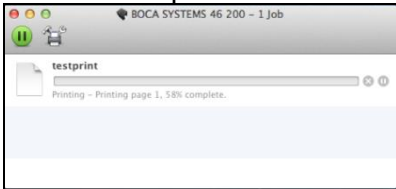

Your driver type may vary from what is shown in above image

Below are some samples printouts for reference only and your test page may look different.

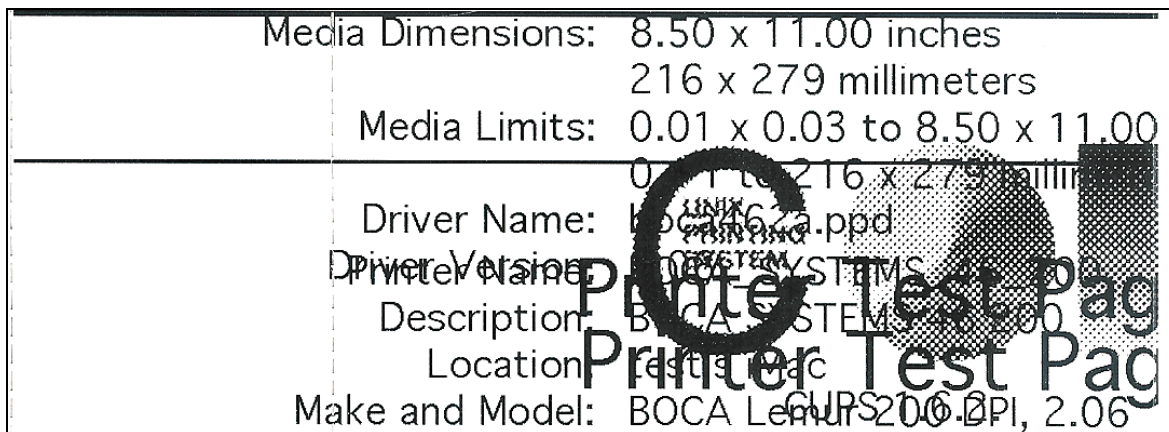

Above is from a 200DPI FGL printer with 2" x 5.5" stock

Printer Name: BOCA SYSTEMS 46300
Description: BOCA SYSTEMS 46300
Location: st's iMac
Make and Model: BOCA Lemur 300 DPI, 2.06
Media Dimensions: 8.50 x 11.00 inches
2.16 x 279 millimeters
Media Limits: 0 x 0 to 03 inches x 11.00 inches
0 x 1 to 216 x 279 millimeters
Driver Name: boca463a.ppd
Driver Version: 2.06

CUPS 1.6.2
Printer Test Page

Above is from a 300DPI FGL printer with 3.25" x 6.5" stock

If you were not able to install the BOCA print driver using the above steps, please take a screenshot of the "printers and drivers" dialog and attach it to the support form located at www.bocasystems.com/onlinesupportform.html

Click here to return to > [Table of Contents](#)

APPENDIX L – ADHESIVE STOCK

When using the adhesive label stock in your BOCA printer the below setting changes need to be made via the control panel to ensure proper operation of your printer. If your printer doesn't have a LCD display then please see the bottom section of this document.



MENU: Selects proper menu topic (baud rate, cut count, etc.)

TEST: Enters new value. Also saves new values

CHOICES: Scrolls through choices in individual menu topics

Please follow the enclosed steps to change your label mode setting.

1. Depress both the **MENU** and **CHOICES** buttons while turning on the printer. Keep both buttons depressed until **FACTORY MENU** appears in the LCD window or the display starts scrolling through different topics.
2. Using the **MENU** button scroll down to the **PRINT MODE?**
3. Use the **CHOICE** button to select **RIBBON**. Once you have done this press the **TEST** button.
4. Using the **MENU** button scroll down to the **SKI MODE?**
5. Use the **CHOICE** button to select **YES**. Once you have done this press the **TEST** button.
6. The display will show **EXIT AND SAVE**. Press the **TEST** button again and the printer will reset at this time.
7. Your printer is now configured for label stock uses.

Without LCD Display

For those printers without a LCD display the following command string needs to be sent to the printer. [Appendix G](#) explains how to do this using our configure and test program. The printer will reset upon successful receipt of the command and it only needs to be sent to the printer once to be permanently saved.

<bce><rib><sme><bcd>

Remove Upper Paper Guide Rail

When adhesive stock is used in a printer there is a possibility that a label may get stuck in the paper path requiring removal of the paper guide upper rail. The following reviews how to do this.

1. **Make sure power is off and the AC cord is disconnected from the printer.**
2. Remove the print head from the printer. See section [9.1.3 THERMAL PRINT HEAD](#).
3. Remove the two 3/16" hex head screws that hold the upper paper guide upper rail in place.

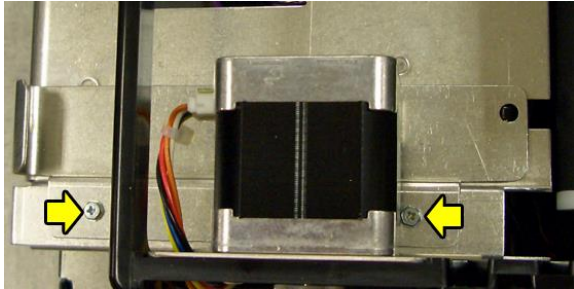

Above is RADJW or RADJ4 paper guide



Above is a RADJ2 paper guide w/ load opto

4. Remove any label or adhesive from the upper rail. You may use rubbing alcohol to remove adhesive material from the rail.
5. Install the upper rail back in place. If you printer has a SQ load opto ([see section 9.1.2](#)) then just install the upper rail back in place.

If your printer has a load switch (see photo below) then push back on the upper rail before fully tightening the screws. Take stock and load it into the printer to make sure the load switch is making a clicking noise when the stock passes over it. If it does not then you may need to read adjust the upper rail.

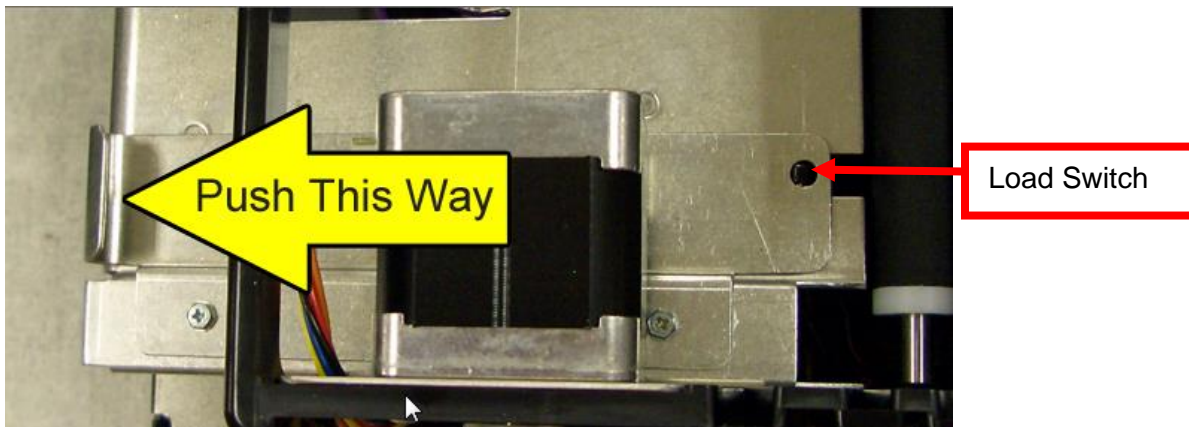

Click here to return to > [Table of Contents](#)

APPENDIX M – SERVICE PLANS

For enhanced [warranty](#) coverage or out of warranty printer, we offer two types of service plans.

GOLD SERVICE

- Printer repair at BOCA facility (3 business day turnaround)
- Replace defective parts (ship within one business day) – customer must return defective parts
- Free printer and parts return via UPS ground service (other delivery options to be billed to the customer)

PLATINUM SERVICE

- Printer repair at BOCA facility (3 day business day turnaround)
- Replace defective parts (ship within one business day) – customer must return defective parts
- Free printer and parts return via UPS ground service (other delivery options to be billed to the customer)
- Replacement printer provided within one business day, if requested. (This service will become available one week after the platinum plan begins.)

The following items are not covered by the service plans:

- **Preventative Maintenance** – the customer is responsible to provide a reasonable level of preventative maintenance as described in [section 9](#) of this manual.
- **Negligence** – parts damaged by misuse or negligence, including damage due to defective ticket stock, is not covered
- **Pre-existing conditions** - all printers must be in good working order prior to entering the plan. The customer will be invoiced for any parts and repair work needed on printers which were defective prior to the start of the maintenance plan. BOCA reserves the right to make this determination unilaterally.
- **Incoming Shipments** – the customer is responsible for shipping charges to BOCA.

Please visit the link below for the latest pricing on our service plans.

www.bocasystems.com/serviceplans.html

Click here to return to > [Table of Contents](#)

APPENDIX N – TECHNICAL SUPPORT

Please go to the link below if you require technical support with your BOCA printer. There is no fee for initial email support.

www.bocasystems.com/onlinesupportform.html

PHONE / EMAIL SUPPORT - BOCA provides free technical support via email for all printers under warranty or service contracts. (Phone support may be provided for covered printers at BOCA's sole discretion as needed.) Email support for non-warranty/non-contract printers is billable at \$100.00 per incident. However, BOCA may (at its sole discretion) choose to waive this fee for customers in good standing. Phone support for non-warranty/non-contract printers will be billed at a rate of \$100.00/hour for Level 1 support and \$200.00/hour for Level 2 support. Billing time will be rounded up to the nearest hour. A valid credit card number is required for phone support payments.

Click here to return to > [Table of Contents](#)

APPENDIX O – REFERENCE DRAWINGS

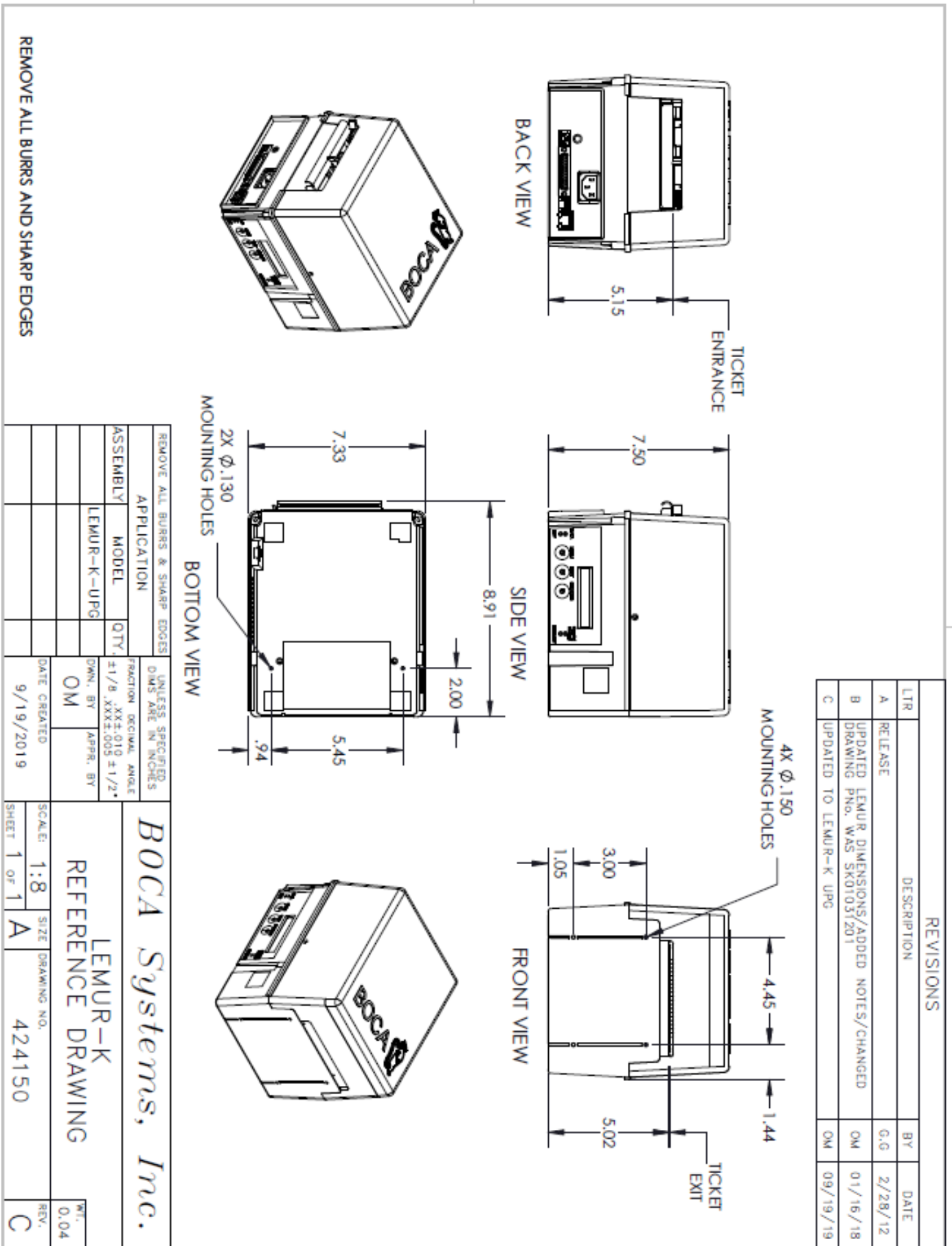

REVISIONS			
LTR	DESCRIPTION	BY	DATE
B	REDESIGN	G.G.	11-14-12
C	ADDED HOLE SIZE CHART, SHT 2	G.G.	2-14-13
D	ADDED SHEET 3 AND HOLE SIZE CHART	G.G.	2-19-13

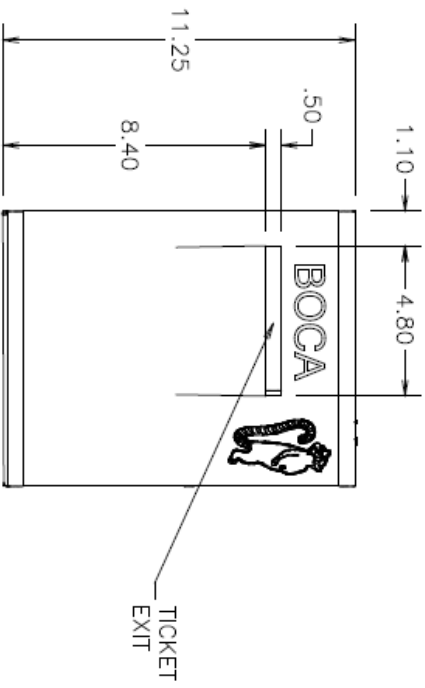
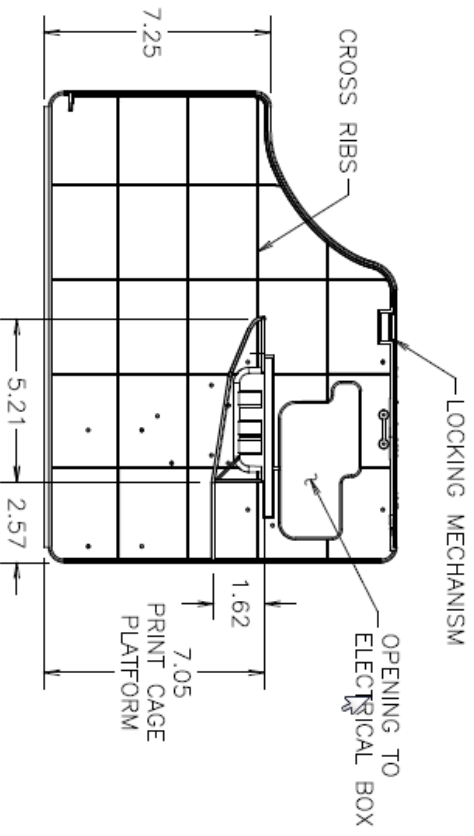
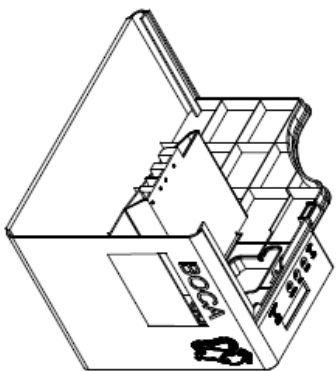
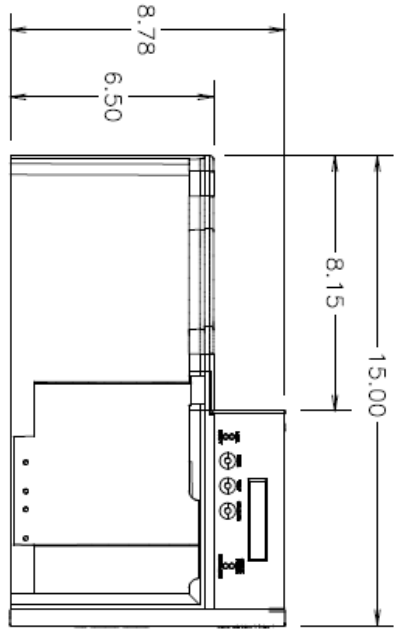

ITEM# QTY REV DATE

MATERIAL: BAYBLEND FR 3010		UNLESS SPECIFIED DIMENSIONS ARE IN INCHES		CUST. APP.	ENGR. MOD
FINISH:	RACTION ± .005	DECIMAL .XXX ± .010	ANGLE ± 1/2°	DWN. BY G.G.	ENGR. APP. T.M.
APPLICATION			PAGE 1 / 3	SCALE: NONE	
ASSEMBLY	MODEL	QTY	DATE	CODE IDENT. No.	
	PLASTIC LEMUR-S	1	10-11-12	SIZE A	DRAWING NO. 423952-BASE
REMOVE ALL BURRS AND SHARP EDGES					

BOCA Systems, Inc.

CABINET REFERENCE

REVISIONS		BY	DATE
LTR	DESCRIPTION		
A	RELEASE	T.M.	11-06-09
B	ADDED LEMUR-K MOUNTING DETAILS,	T.M.	01-22-13
C	ADDED TICKET ENTRY AND EXIT DETAILS	A.C.	10-05-15

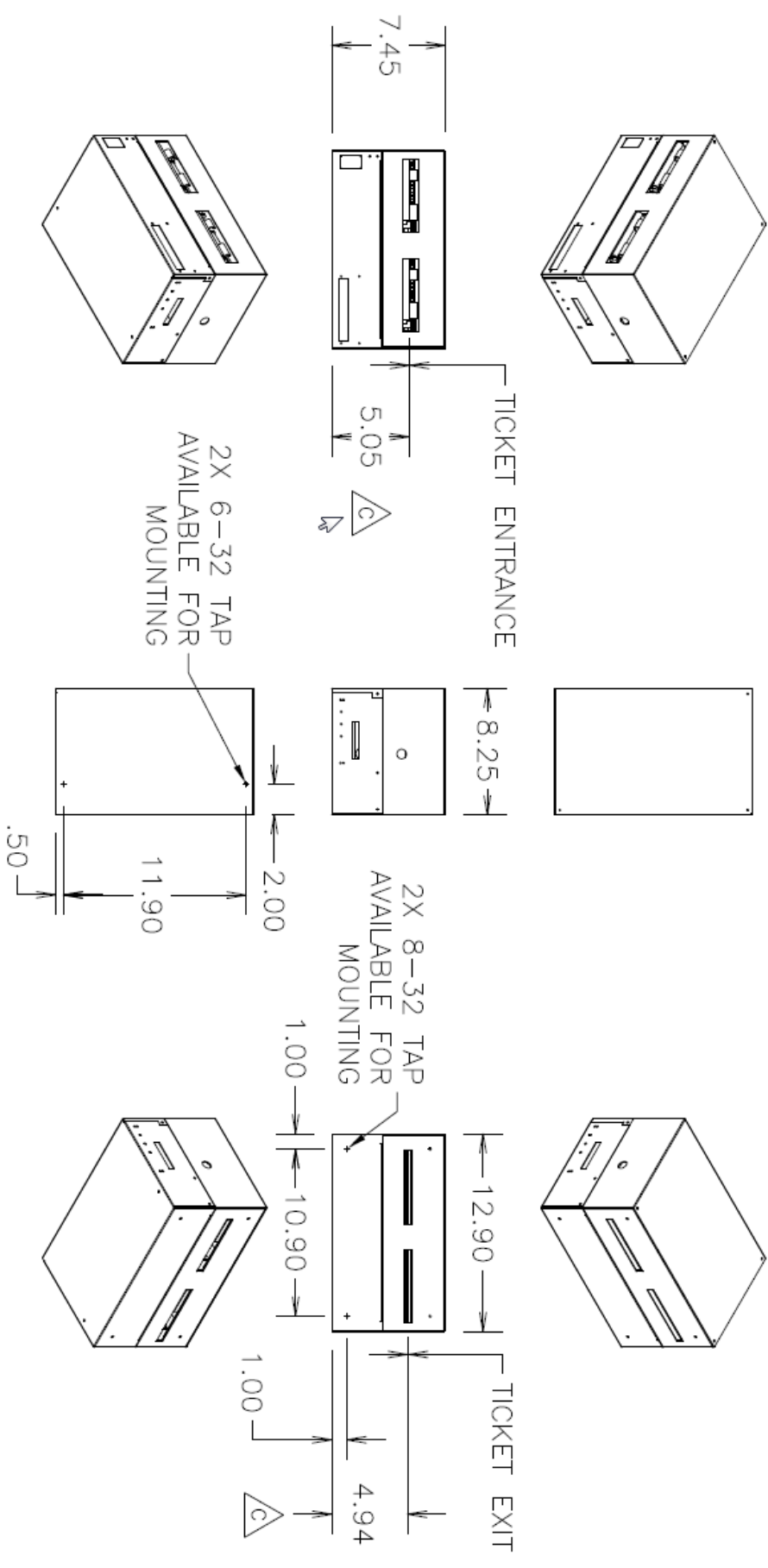

MATERIAL:	UNLESS SPECIFIED DIMENSIONS ARE IN INCHES		CUST. APP.	ENGR. MOD
FINISH:	FRACTION	DECIMAL	ANG	ENGR. APP.
	± .XX ± .010	± .XXX ± .005	± 1/2	
DOWN BY A.C.				
APPLICATION		PAGE	OF	SCALE
ASSEMBLY	MODEL			NONE
	LEMUR-2/2K	1		
		DATE		
		11-06-09		

BOCA Systems, Inc.

LEMUR-2/2K REFERENCE

CODE IDENT. No.	SIZE	DRAWING NO.	REV.
A	A	SK1106093	C

REMOVE ALL BURRS AND SHARP EDGES