

Installation Guide

V2.2 March 2011

AIWX Series

Invisible Loudspeaker

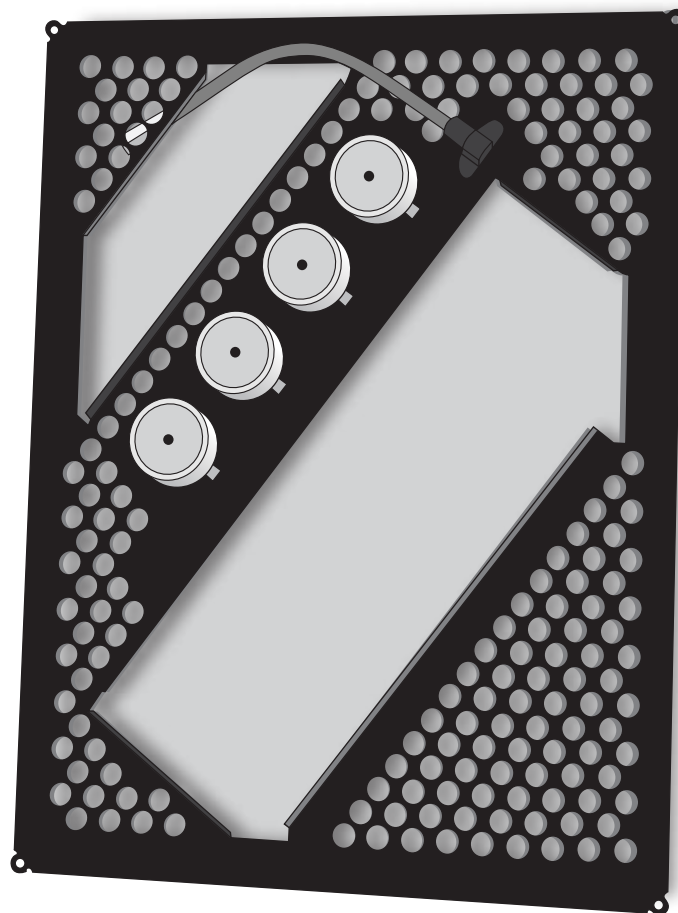

(Model shown: AIW5X)

amina[®]
TECHNOLOGIES Ltd

Caution: Read before installing this product

- To ensure optimal performance, please read this guide carefully and keep in a safe place for future reference.
- Install this product in a cool, dry, clean place - away from direct sunlight and heat sources, vibration, chemical fumes, dust and moisture (steam).
- Do not expose this product to sudden temperature changes or locate it in an environment with high humidity. This is to prevent condensation forming inside which may cause damage to the product.
- Do not clean this product with chemical solvents as this may damage the finish. Use a clean, dry or damp cloth.
- Ensure that all installation mounting surfaces are able to support the weight of the product.
- After installation, avoid pushing on the wall or ceiling surface immediately in front of the speaker. Excessive excursion, whilst unlikely to damage the speaker, will undoubtedly crack the plaster around its perimeter.
- Do not attempt to modify or repair the product. Contact your distributor or manufacturer if a fault should occur.
- The rear of the product should not be subject to chemical cleaning and should not be painted in any way.



ENVIRONMENTAL:

Before installing, ensure that the building is environmentally sealed, de-humidified and at a stable temperature of at least 16 degrees centigrade (61 degrees fahrenheit)

Please be aware that when this product is directly fitted into a solid wall structure (e.g when using the solid wall backbox) vibrational energy is inevitably transferred into the solid wall structure. This energy can travel for some considerable distance up, down and along the structure. It is therefore recommended the product be fitted within acoustically insulated stud walls or ceiling sections where possible. The use of the product directly embedded in solid walls is not recommended in multi occupation buildings.



WARNING:

No attempt should be made to install this product within existing building structures unless you are certain that no electric cables, water pipes, gas pipes or supporting joists will be cut through.

Contents

- 01 Message from the Managing Director
 - 02 Included in the carton / Packaging
 - 03 How to use this manual
 - 04 Installation overview diagram
-

Section A

Preparing the wall / ceiling and fixing the product

- 05 Cavity Installation steps 1 + 2
 - 06 Cavity Installation steps 3+4
 - 07 Cavity Installation steps 5 + 6
 - 08 Cavity Installation with backbox steps 1 + 2
 - 09 Cavity Installation with backbox steps 3+4
 - 10 Cavity Installation with backbox step 5
 - 11 Solid Wall Installation with backbox steps 1 + 2
 - 12 Solid Wall Installation with backbox steps 3+4
 - 13 Solid Wall Installation with backbox step 5
-

Section B

Alignment and plastering preparation

- 14 Retrofit / plasterboard (patch plastered)
 - 15 Retrofit / plasterboard (feathered skim)
 - 16 New Build / plasterboard
 - 17 Retrofit / solid wall (feathered skim)
 - 18 Retrofit / solid wall (patch plastered)
 - 19 New Build / solid wall
 - 20 Retrofit / drywall (patch plastered)
 - 21 Retrofit / drywall (feathered skim)
-

Section C

Testing

- 22 Testing the speakers
-

Section D

Finishing

- 23 Plastering and decorating steps 1 + 2
 - 24 Plastering and decorating steps 3, 4 + 5
-
- 25 Setup tips
 - 26 Speaker selection guide
 - 27 Further details
 - 28 Troubleshooting
 - 29 Specifications / AIWX Series & APU2
 - 30 Specifications / AIW3X/S200
 - 31 Spacesaver information
 - 32 Warranty, copyright, contact information
-

Message from the Managing Director

Congratulations and thank you for purchasing an Amina Technologies AIWX high performance invisible loudspeaker.

At Amina we are proud of being at the forefront of flat panel loudspeaker technology. All the components that make up your AIWX have been developed specifically to provide the ultimate in sound quality and reliability, while allowing you to decorate, furnish and enjoy your home in any way you wish without any visible “clutter” from your audio system.

At the heart of an AIWX is our high performance vibrational panel driver. Featuring a unique high power neodymium magnet motor system. This enables the product to provide high quality, high sound pressure levels from such a compact design. Please take a moment to read this guide which will help you achieve the best possible performance from your product.

Thanks and enjoy listening.

Richard Newlove
MD - Amina Technologies Ltd

About the manufacturer

Amina Technologies Ltd is the world's leading designer and manufacturer of truly invisible loudspeaker solutions. Their invisible loudspeakers have been used in a wide range of both commercial and residential applications for over twelve years.

Exclusive hotel spas, fashion retail outlets and stunning private residences have all benefited from using Amina invisible loudspeakers. Amina has the discreet solution ideal for architects, interior designers and all design conscious clients.

See their website for more details about Amina and a selection of prestigious projects completed using our products.

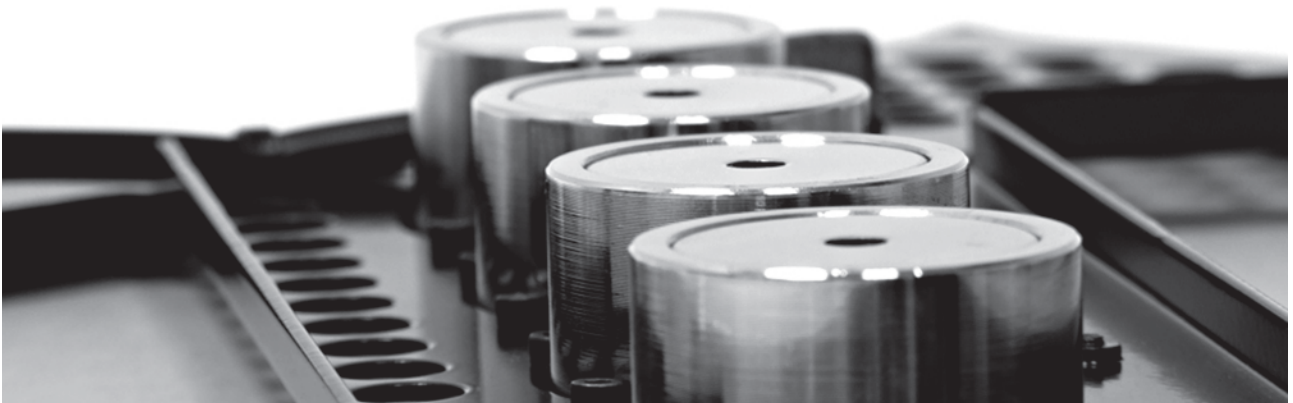

Our high power neodymium magnet structures

Included in the carton

Please check that your carton contains the correct accessories.

Model Number	Single	Pair
AIW1X	1x AIW1X Loudspeaker 1x APU2 4x plastic fixing blocks, 1x Spacesaver	2x AIW1X Loudspeaker 1x APU2 8x plastic fixing blocks, 2x Spacesaver
AIW1Xn	1x AIW1X Loudspeaker 4x plastic fixing blocks, 1x Spacesaver	2x AIW1X Loudspeaker 8x plastic fixing blocks, 2x Spacesaver
AIW2X	1x AIW2X Loudspeaker 1x APU2 4x plastic fixing blocks, 1x Spacesaver	
AIW2Xn	1x AIW2X Loudspeaker 4x plastic fixing blocks, 1x Spacesaver	
AIW3X	1x AIW3X Loudspeaker 1x APU2 4x plastic fixing blocks, 1x Spacesaver	2x AIW3X Loudspeaker 1x APU2 8x plastic fixing blocks, 2x Spacesaver
AIW3Xn	1x AIW3X Loudspeaker 4x plastic fixing blocks, 1x Spacesaver	2x AIW3X Loudspeaker 8x plastic fixing blocks, 2x Spacesaver
AIW4X	1x AIW4X Loudspeaker 1x APU2 4x plastic fixing blocks, 1x Spacesaver	
AIW4Xn	1x AIW4X Loudspeaker 4x plastic fixing blocks, 1x Spacesaver	
AIW5X	1x AIW5X Loudspeaker 1x APU2 4x plastic fixing blocks, 1x Spacesaver	2x AIW5X Loudspeaker 1x APU2 8x plastic fixing blocks, 2x Spacesaver
AIW5Xn	1x AIW5X Loudspeaker 4x plastic fixing blocks, 1x Spacesaver	2x AIW5X Loudspeaker 8x plastic fixing blocks, 2x Spacesaver
AIW3X/S200 (slimline)	1x AIW3X/S200 Loudspeaker 1x APU2 4x plastic fixing blocks, 1x Spacesaver	2x AIW3X/S200 Loudspeaker 1x APU2 4x plastic fixing blocks, 2x Spacesaver
AIW3Xn/S200 (slimline)	1x AIW3X/S200 Loudspeaker 4x plastic fixing blocks, 1x Spacesaver	1x AIW3X/S200 Loudspeaker 4x plastic fixing blocks, 2x Spacesaver

Packaging



CAUTION:

Take care when removing the speakers from the carton.

The packaging for the AIWX has been carefully designed to protect the product during transit. Please retain it in the unlikely event you need to return the product to your dealer or manufacturer. Please recycle the packaging should you wish to dispose of it.

The AIWX outer carton is made up of 80% recycled single wall board.

How to use this manual

The following pages contain step by step advice to help you achieve a successful installation of your AIWX Series loudspeaker(s).

AIWX Series loudspeakers can be installed into walls or ceilings of various construction types. This installation guide covers the two basic building construction types; plasterboard cavity walls/ceilings and brick/concrete walls/ceilings. For other construction types please contact Amina.

Cavity wall or ceiling

There are two options here for the installer. Either the supplied, basic fixing blocks can be used to mount the speaker to the plasterboard/drywall or an optional backbox (BackboxFS) can be used. If you are using the basic fixing blocks there will be no containment of the speaker's rearward sound output. This may or may not be an issue, however the potential for sound transfer into unwanted areas should be considered very carefully.

If the speaker's rearward sound output needs to be reduced due to sound transference considerations, it is highly recommended to use a BackboxFS. This will substantially reduce, although not stop entirely, the rearward sound output from the speaker. It also has the added benefit of providing a standardised enclosure volume for the speaker to operate in, which will reduce variances in sonic performance.

Solid wall or ceiling

For installation into brickwork or concrete you will need to pre-install an Amina BackboxSW (sold separately). When the BackboxSW is installed according to this guide it will position the speaker correctly and securely in the wall/ceiling, ready to be plastered over.

The details below and the flow chart on the opposite page will allow you to select the correct installation steps to follow for your particular type of installation.

Section **A** : Preparing the wall / ceiling and fixing the product

In this section, select the type of installation you will be carrying out and begin from the start page given. This will direct you through the stages, step by step.

Throughout the step by step process, reminders will advise you to view specific pages within [Section B](#). At this point you will need to ascertain the specific page that best matches your installation requirement within this section (i.e is it a retrofit installation or a new build?).

Section **B** : Alignment and plastering preparation

[Section B](#) is the reference section which is to be used in conjunction with [Section A](#). Please ensure the correct alignment and plastering method for a retrofit installation or a new build is followed. Reminders on each page throughout [Section A](#) will guide the installer to the correct reference page.

Section **C** : Testing

This section advises you on the correct procedures for speaker testing.

Section **D** : Finishing

This section covers plastering and decorating once your speaker has been installed correctly. It may again be necessary to refer to [Section B](#) in order to apply the correct plastering method.

Installation overview

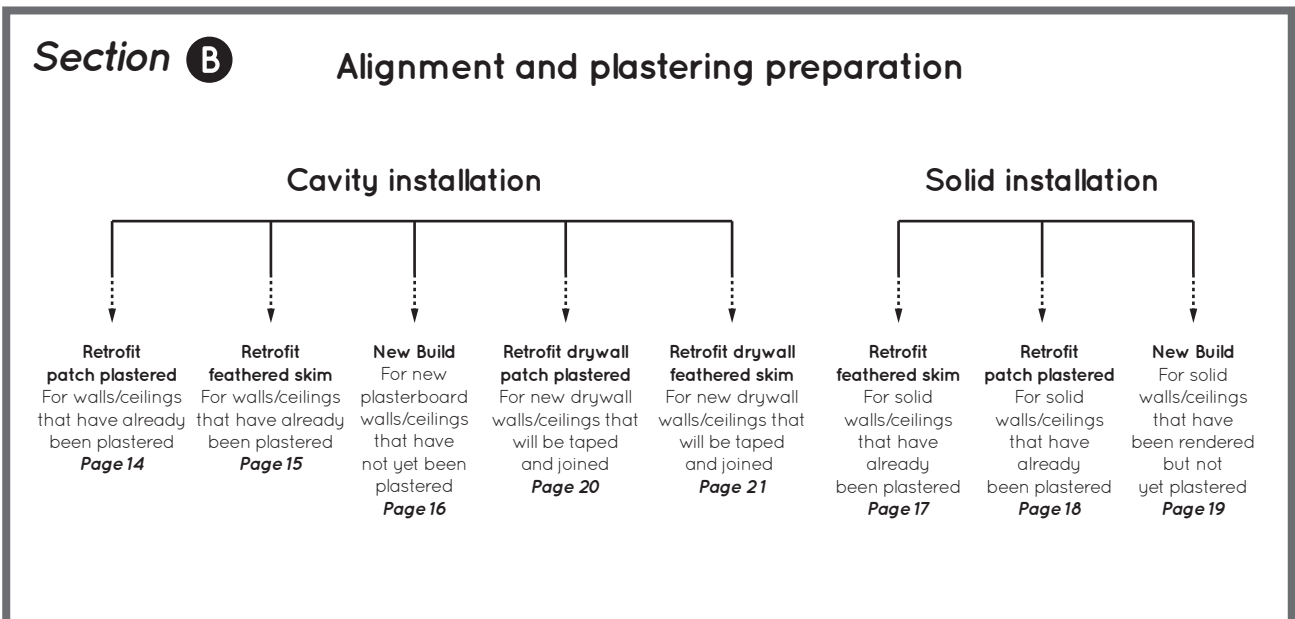
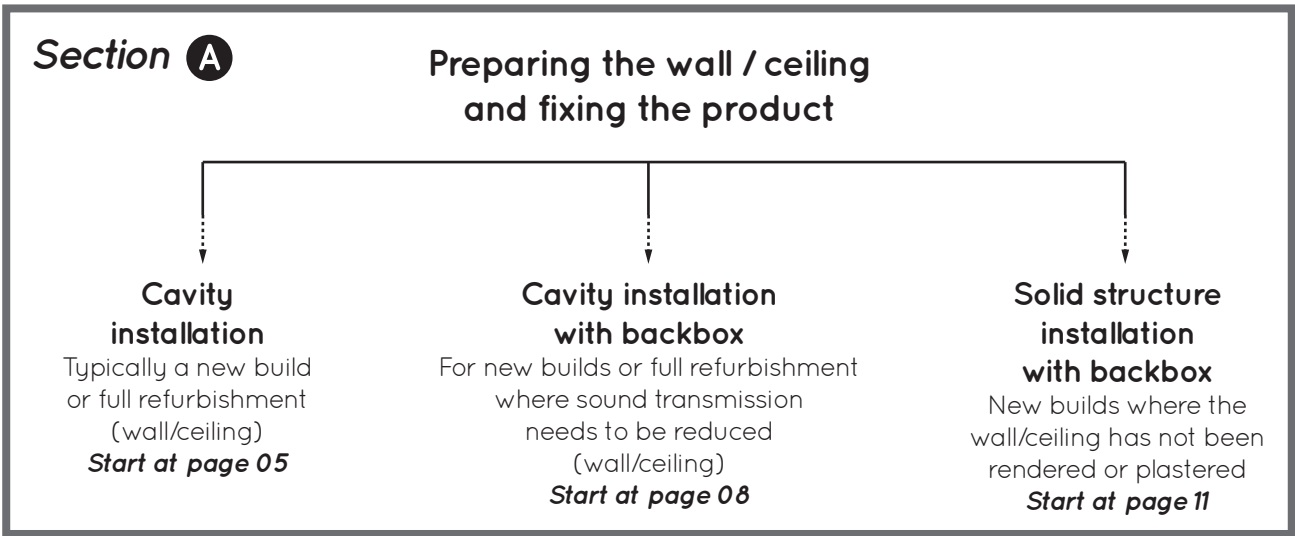

Cavity installation



Typically a new build or full refurbishment.
Uses supplied fixing blocks

01 Locate joist work

When you have chosen your speaker locations, before cutting a hole in the plasterboard it is important that you locate the position of the wall studs. Ensure the spacing between them is at least 350mm (13^{3/4}"") for a portrait orientated speaker.

Important: If the spacing between joists is less than 350mm (13^{3/4}""), consider using the AIW3X/S200 loudspeaker which only requires a 200mm (7^{7/8}"") wide cavity

SPACESAVER:

The supplied Spacesaver may be used to show the position of the speaker pre-install by securing it to the wall. Secure the speaker cable to the Spacesaver before any building electrical inspection. See page 31 for full details.

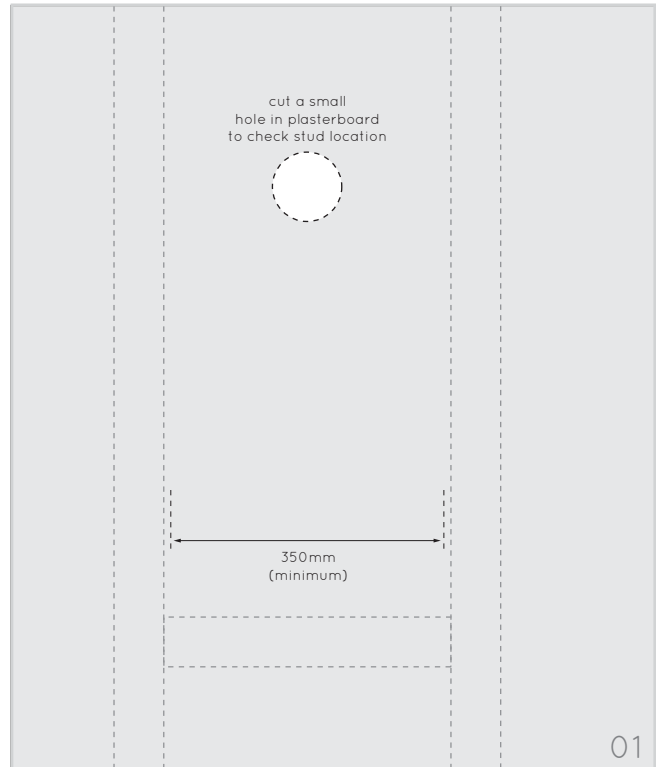

02 Create 455 x 350mm aperture

Using a sharp knife or pad saw, cut an aperture with dimensions 455mm x 350mm (18" x 14") in your plasterboard wall or ceiling. Ensure aperture is created between supporting joists or stud work.

We strongly advise that joists are not cut to make space for the backbox. Any activity of this sort may well influence the structural integrity of your property.

Important: Double check the size of the aperture is 455mm x 350mm (18" x 14") as this is important further on into the installation process.

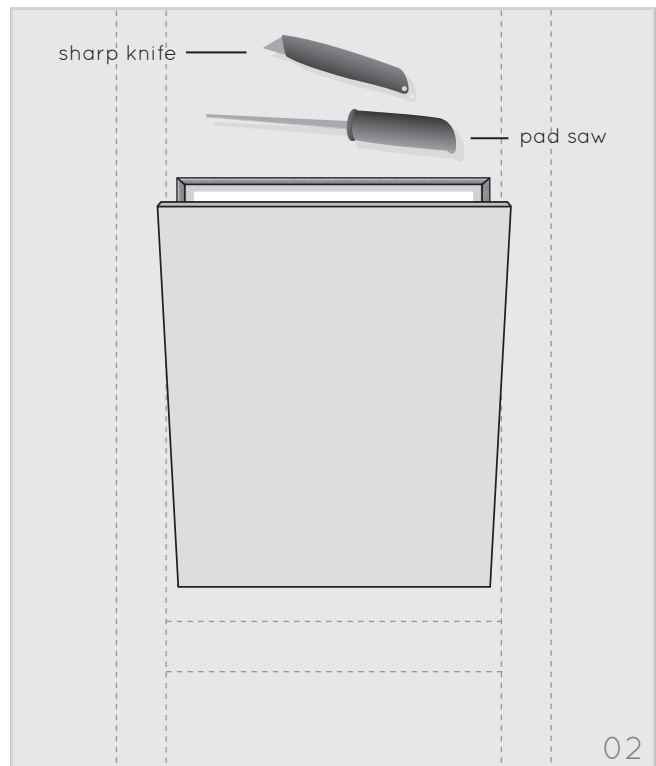

Reference pages for correct **retrofit** alignment and plastering method: **14 + 15**

Reference page for correct **new build** alignment and plastering method: **16**

Reference pages for correct **drywall** alignment and plastering method: **20 + 21**

Cavity installation continued...



03 Install speaker cable and insert insulation

Ensure all speaker cables are pulled through to the speaker location with plenty of slack. This will make it easier to connect the cable to the speaker later on in the installation process.

It is recommended to add sound absorbing mineral wool inside the cavity to reduce sound transmission behind the speaker and limit cavity resonances.

Important: Always place a mineral wool layer above a ceiling mounted AIWX to prevent debris falling onto its rear surface over time. Ensure the mineral wool only rests upon the back of the speaker, in no way should it be forced tight against the speaker.

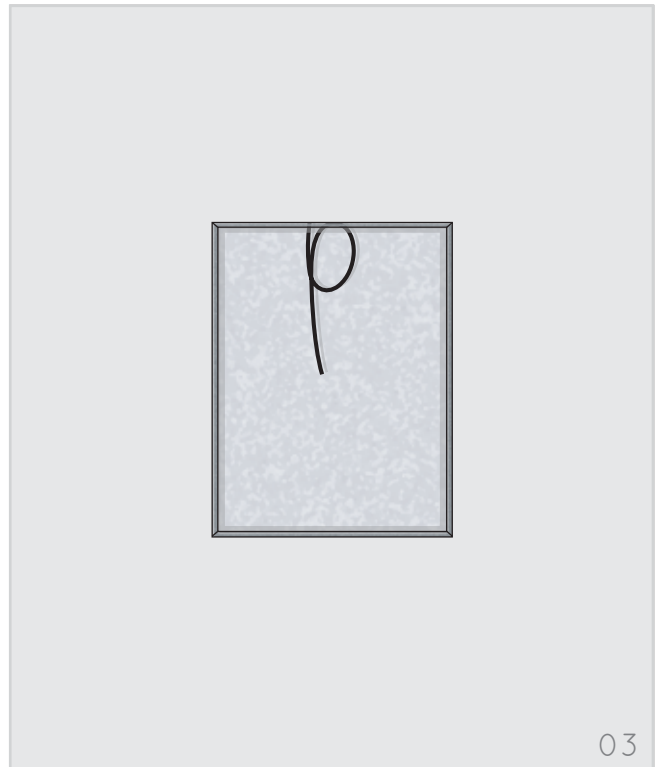

04 Attach fixing blocks (x4 per speaker)

Position a fixing block under the plasterboard at each corner of the aperture. Fasten the thicker section of the fixing blocks to the underside of the plasterboard using two drywall screws secured through the front face of the plasterboard.

NB: ensure there is no gap between the fixing block and the sawn edge of the plasterboard aperture.

Important: The standard fixing blocks are designed for 12.5mm (1/2") plasterboard (1/2" and 5/8" in North American markets). Please contact your supplier if you require fixings for an alternative plasterboard thickness.

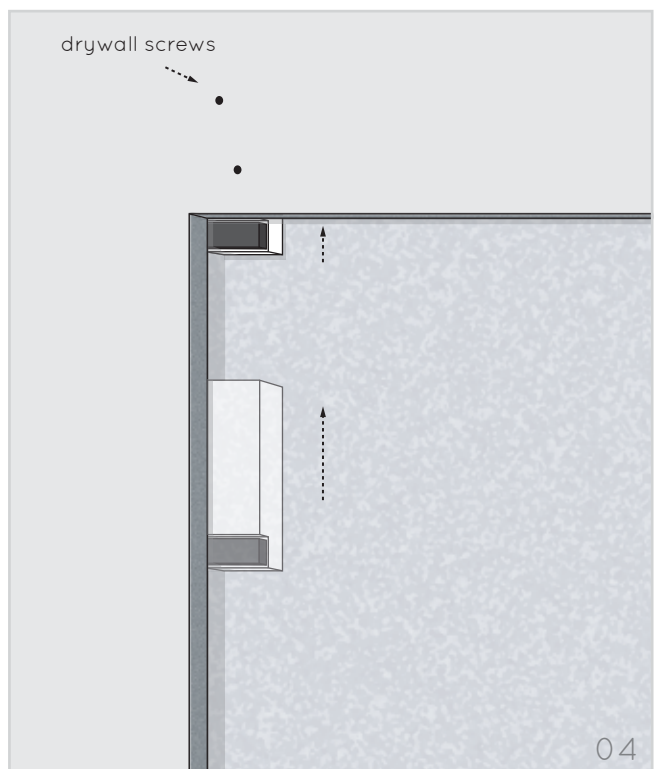

Reference pages for correct **retrofit** alignment and plastering method: **14 + 15**

Reference page for correct **new build** alignment and plastering method: **16**

Reference pages for correct **drywall** alignment and plastering method: **20 + 21**

05 Connect the AIWX speaker

Connect the speaker cable to the speaker using a high quality crimping tool.

Your AIWX speaker is fitted with blue butt splice crimp connectors which are suitable for speaker cable thicknesses of 1.5mm² - 2.5mm² (16 - 14AWG). This type of connector ensures a permanent connection is created inside your wall cavity.

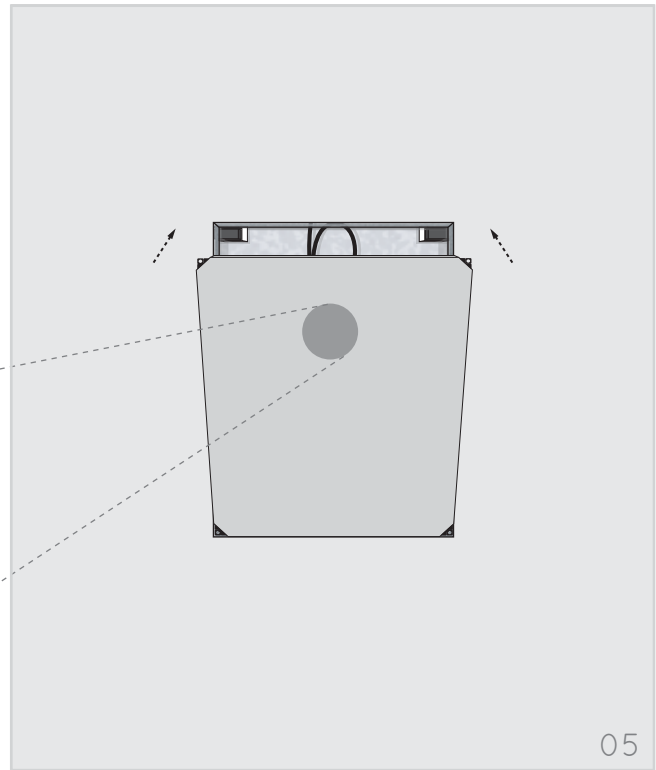
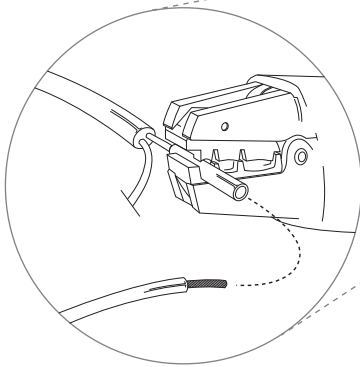

05

06 Secure the speaker to the fixing blocks

Important: Ensure there is an all around gap of 2mm between the speaker and the plasterboard. If necessary, increase the aperture size before mounting the speaker.

Using drywall screws, fix the four corner points of the speaker to the fixing blocks. Pilot holes are not necessary as drywall screws will easily self tap into the fixing block.

Ensure the front face of the speaker rests in a position flush with the front of the plasterboard and that it is firmly held in position.

Continue on to Section C (page 22)

screw through here

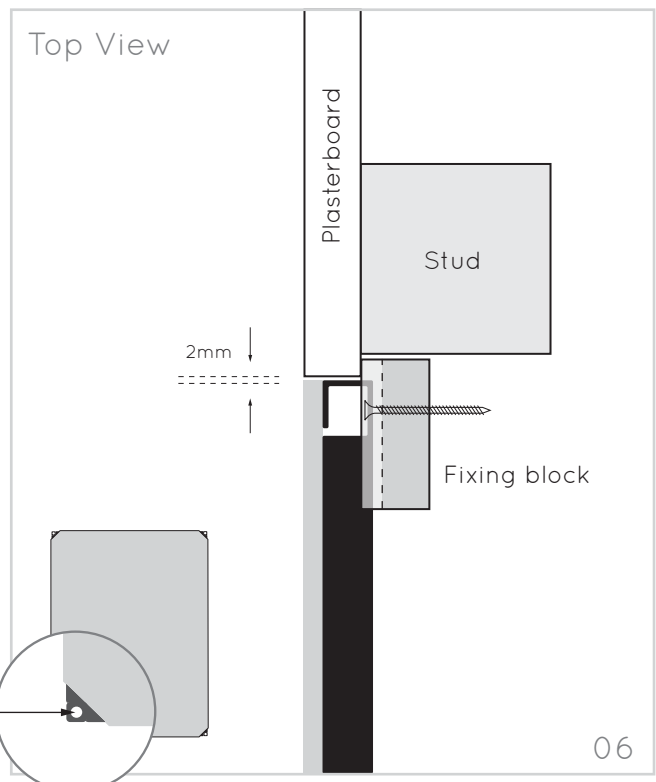

06



Reference pages for correct **retrofit** alignment and plastering method: **14 + 15**

Reference page for correct **new build** alignment and plastering method: **16**

Reference pages for correct **drywall** alignment and plastering method: **20 + 21**

Cavity installation with backbox

A

For New Builds or full refurbishment where sound transmission needs to be reduced.

01 Create 455 x 350mm aperture

Choose speaker location by following step 01, page 5. Using a sharp knife or pad saw, cut an aperture with dimensions 455mm x 350mm (18" x 14") in your plasterboard wall or ceiling. Ensure the aperture is created between supporting joists or stud work.

We strongly advise that joists are not cut to make space for the backbox. Any activity of this sort may well influence the structural integrity of your property.

Important: Double check the size of the aperture is 455mm x 350mm (18" x 14") as this is important further on into the installation process.

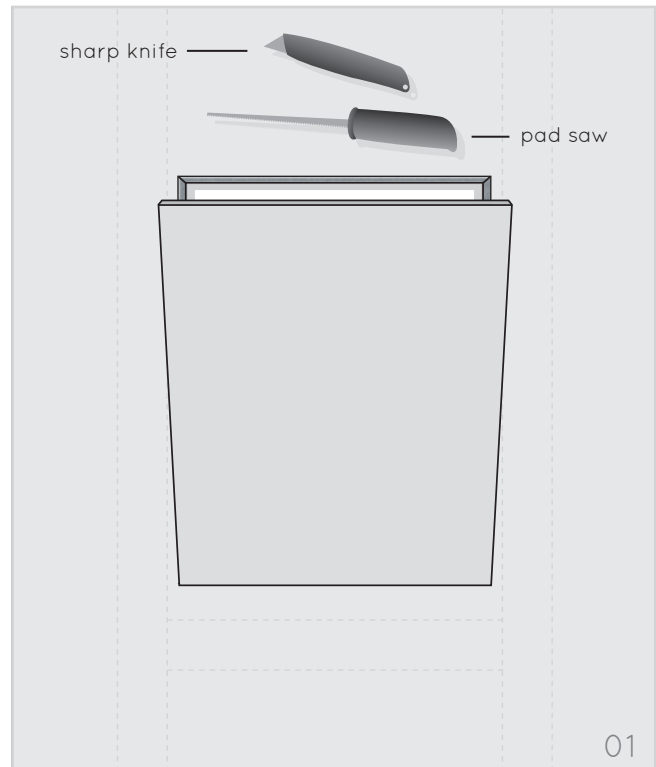

02 Locate cable and position backbox

Pull the speaker cable through the rubber grommet in the top side of the backbox and ensure speaker cables are pulled through with a manageable length available. Doing this will make it easier to connect the cable to the speaker later on in the installation process.

Position the backbox within the aperture so as to rest it against the back side of the plasterboard.

Use the fold out tabs at either end of the backbox to help support it in position before securing it to the plasterboard.

A 75mm/3" cavity depth is required to fit a Backbox FS or Backbox FSS.

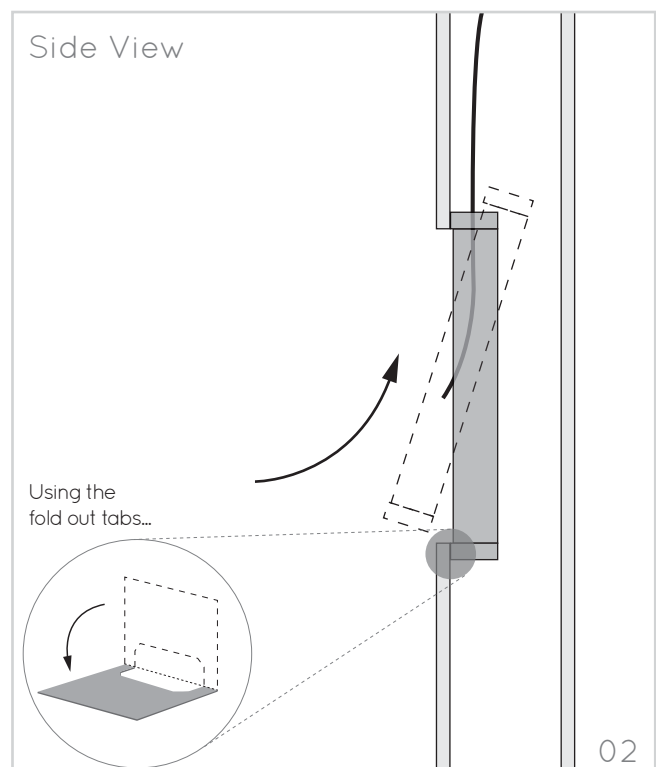

Reference pages for correct **retrofit** alignment and plastering method: **14 + 15**

Reference page for correct **new build** alignment and plastering method: **16**

Reference pages for correct **drywall** alignment and plastering method: **20 + 21**

03 Fix backbox and insert insulation

Using 8 drywall screws (4 at each end) fix the backbox by screwing through the plasterboard and self tapping into the flat areas at each end of the backbox. When positioned correctly, the backbox's speaker mounting lip with soft foam surface should be visible along all four sides of the aperture.

It is recommended to add sound absorbing mineral wool inside the backbox to further reduce sound transmission behind the speaker. (2" maximum thickness)

Front View

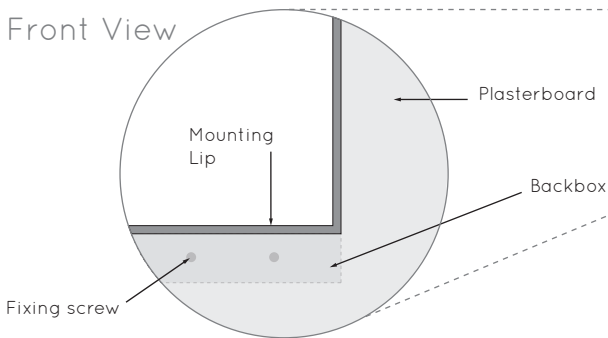

Side View

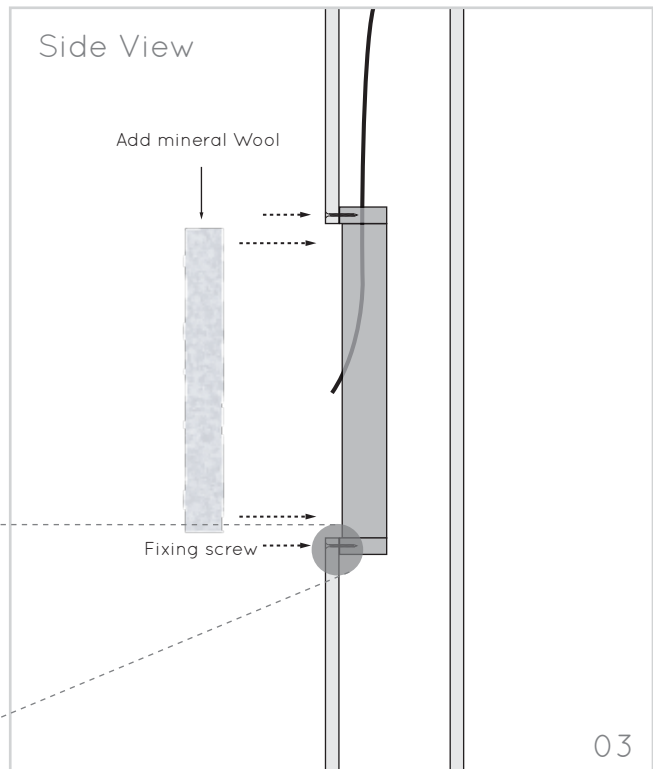

04 Connect the speaker

Connect the speaker cable to the speaker and crimp securely using a high quality crimping tool.

Locate the speaker within the aperture resting it on the soft foam on the backbox mounting lip.

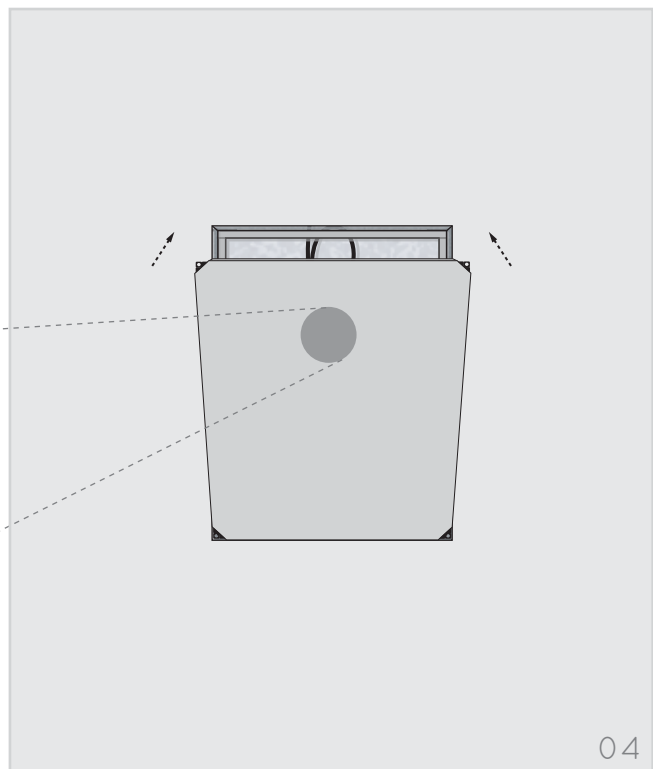
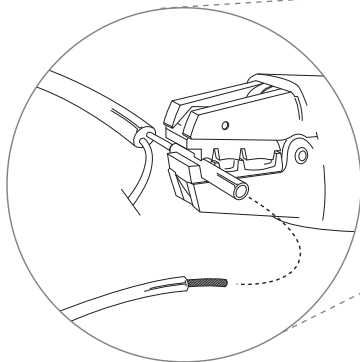

Reference pages for correct **retrofit** alignment and plastering method: **14 + 15**
 Reference page for correct **new build** alignment and plastering method: **16**
 Reference pages for correct **drywall** alignment and plastering method: **20 + 21**

Cavity installation with backbox continued...

A

05 Secure the speaker

With the speaker resting on the backbox, use drywall screws to secure the speaker onto the backbox by self tapping into the mounting lip, through the pilot hole at each corner.

Ensure the speaker face is flush with the front of the plasterboard wall and that everything is firmly held in position. Shims may be necessary. (See section B)

Amina backboxes (Backbox FS and FSS) are designed for 12.5mm (1/2") plasterboard. Shims can be supplied to adapt the backbox for different plasterboard thicknesses. Contact your supplier when ordering.

Continue on to Section C (page 22)

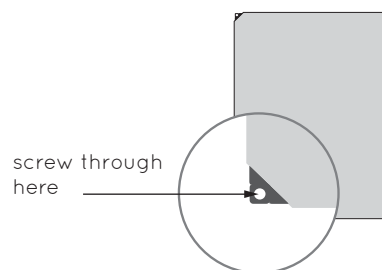
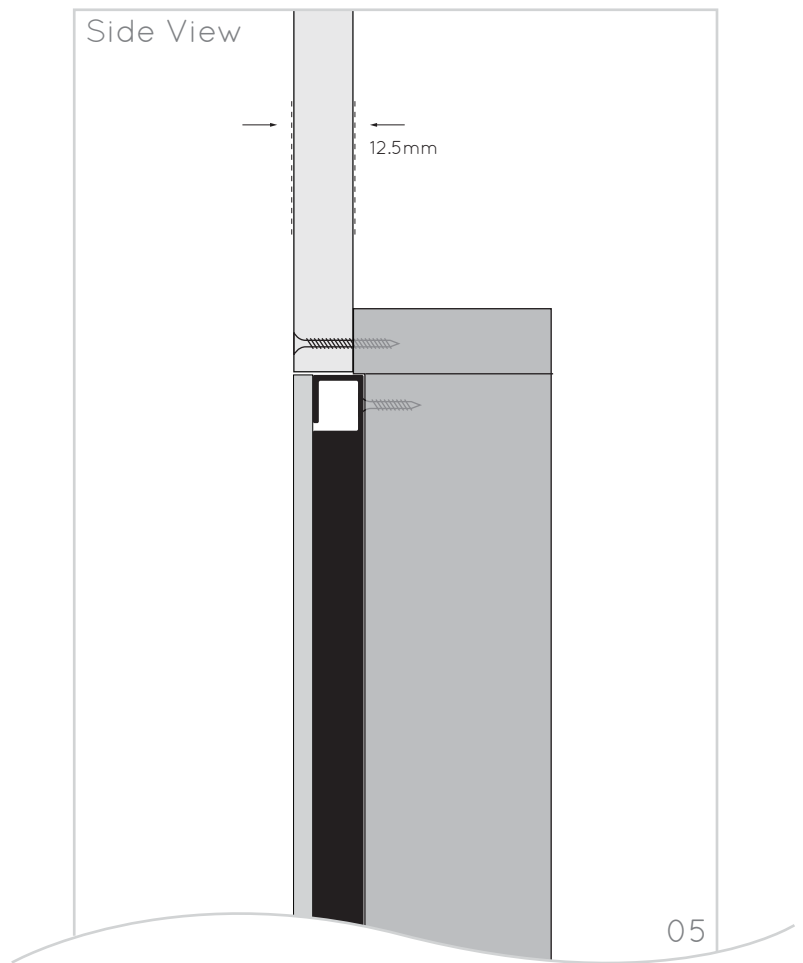

Reference pages for correct **retrofit** alignment and plastering method: **14 + 15**

Reference page for correct **new build** alignment and plastering method: **16**

Reference pages for correct **drywall** alignment and plastering method: **20 + 21**

11 Solid wall installation with backbox



For new builds or full refurbishes where the wall or ceiling has not been rendered or plastered.

01 Create aperture in brickwork

Using the combination of an angle grinder and a jackhammer drill, create a cavity of 460mm x 355mm (18²/₁₆" x 13³¹/₃₂"") within the brickwork.

Before installing the backbox you will need to know the thickness of render that will be applied to the wall/ceiling prior to the finish plaster skim.

Minus this thickness from 50mm (2") to calculate the minimum cavity depth you will need to create.

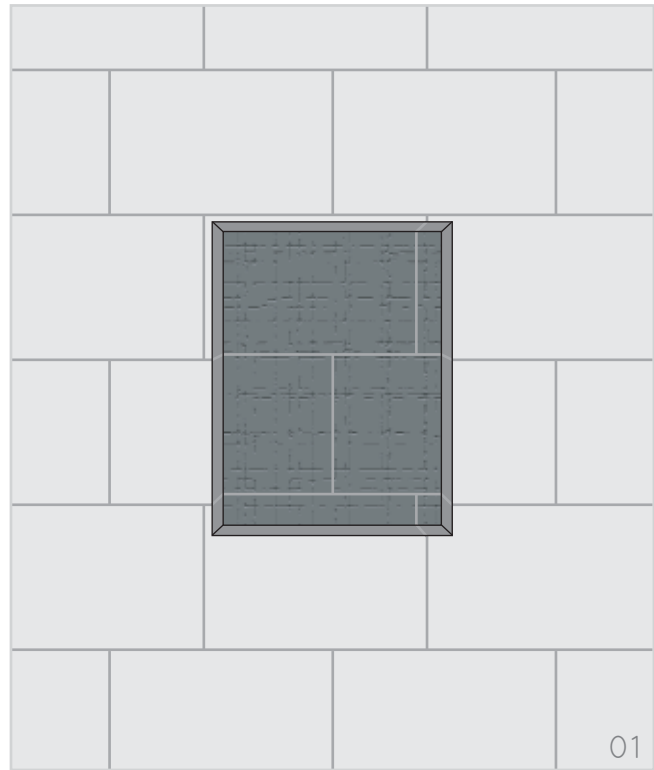

02 Create channel for cable

Using an angle grinder or hammer and chisel, create a channel that runs into the cavity. This will allow the speaker cable to be pulled into a suitable position within the cavity.

We recommend the cable is run in a suitable conduit to protect it.

Leave enough cable slack to allow connection to the speaker when it is held away from the cavity.

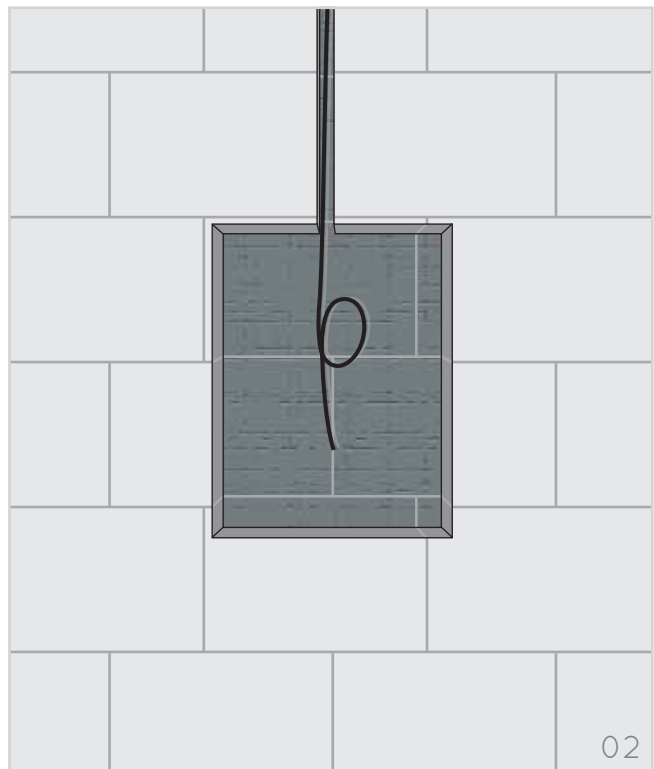

Reference page for correct **retrofit** alignment and plastering method: **17 + 18**
Reference page for correct **new build** alignment and plastering method: **19**

Solid wall installation with backbox continued...

A

03 Install backbox

Make a small hole in one of the rubber grommets and pull the speaker cable through it and into the backbox. There are four slots in the base of the backbox and using suitable screws (not supplied), fix the backbox to the brickwork within the cavity. Ensure the front edge of the backbox aligns flush with the front face of the surface which will be plaster skimmed.

We recommend shims are fitted behind the backbox to achieve a level solid fixing. It is recommended to add sound absorbing mineral wool (1" maximum thickness) to the inside of the backbox and expanding foam around the sides to prevent resonance.

NB: If there is a layer of render to be applied or already applied to the brickwork, be sure to align the front edge of the backbox to the front edge of the render (as shown in the lower section of the image)

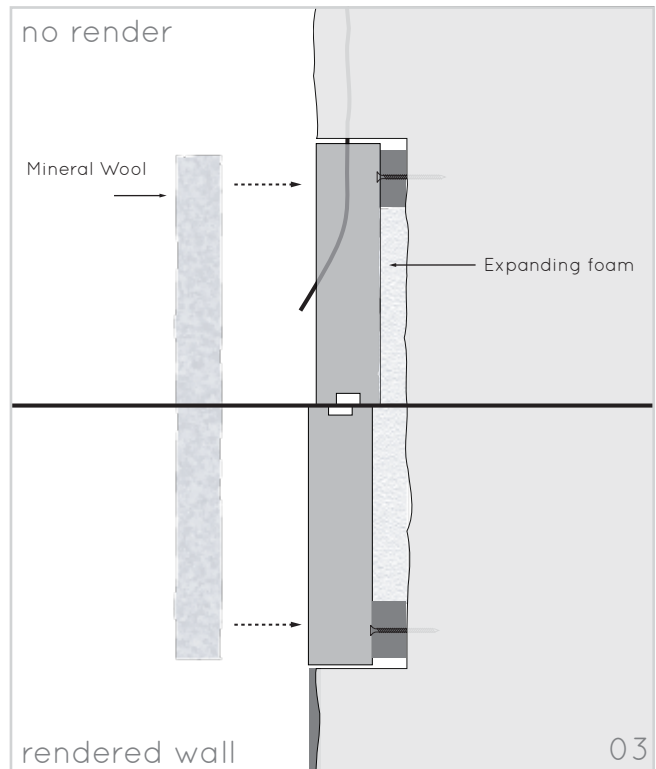

04 Connect speaker

Connect the speaker cable to the speaker and crimp securely using a high quality crimping tool.

Locate the speaker within the aperture and rest it against the 6 mounting tabs on the backbox.

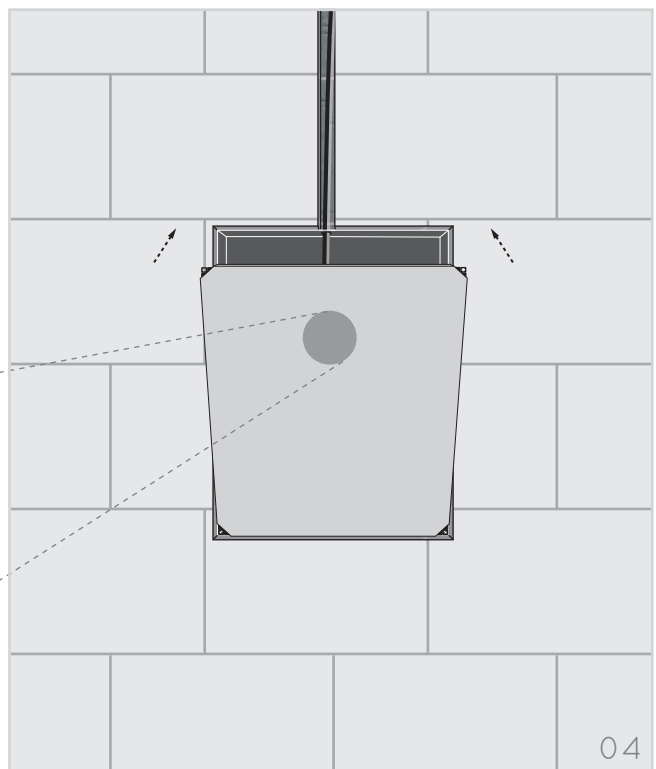
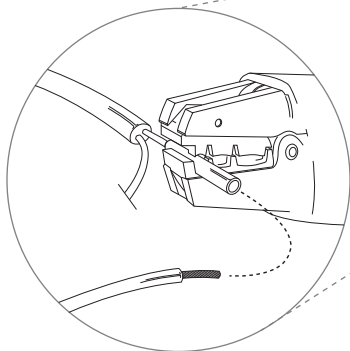

Reference page for correct **retrofit** alignment and plastering method: **17 + 18**
Reference page for correct **new build** alignment and plastering method: **19**

05 Secure the speaker

Remove the backing paper from the 6 adhesive pads on the backbox mounting tabs, carefully position the speaker onto the support tabs and apply moderate pressure. There should be an equal perimeter gap between the backbox and the edge of the speaker.

Use the flange head screws (supplied with the backbox) to fix the corners of the speaker to the four corner support tabs.

If the correct steps are taken to align the backbox with the front face of the wall/render, the loudspeaker, when screwed in place, will also sit flush with the front face of the wall/render.

Do not adjust the screws in any way, make sure they are tightly screwed in place and the whole assembly is firm.

Continue on to Section C (page 22)

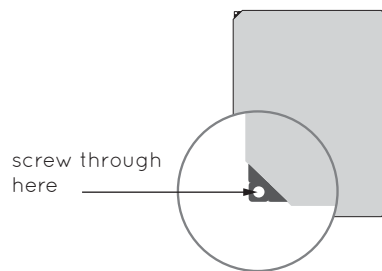
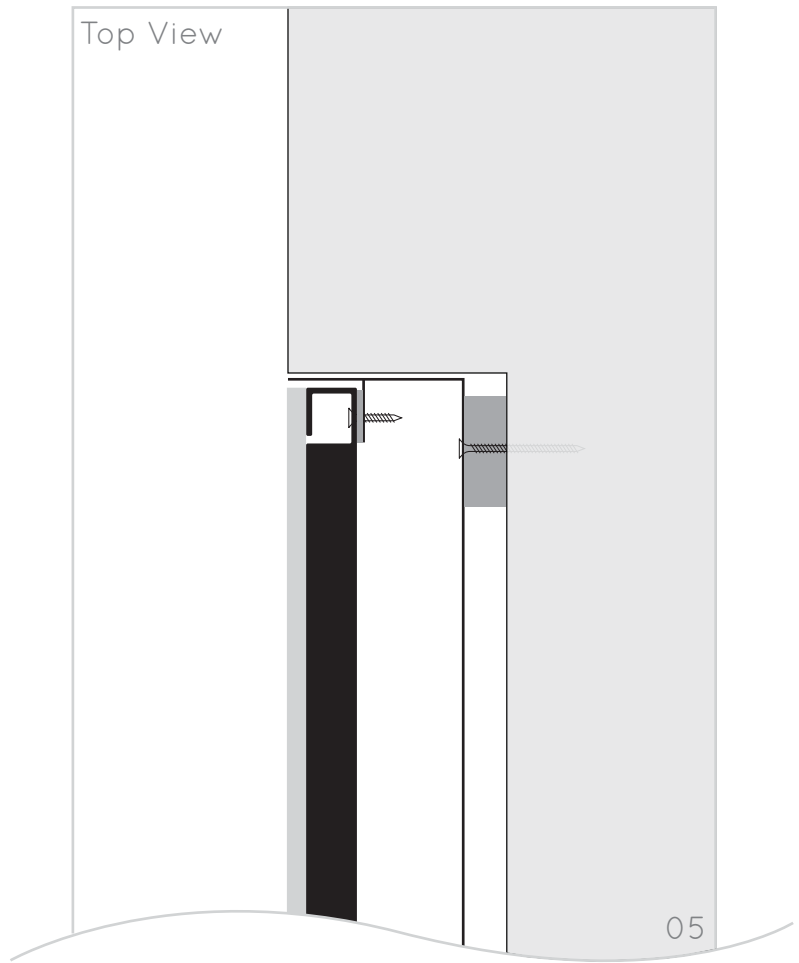

Retrofit / pre-skimmed plasterboard Patch plastered finish



For walls / ceilings that have already been plastered.

Speaker alignment required for plastering

After removing a 30-50mm (3/16 - 2") wide section of existing plaster surrounding the cutout, the front face of the speaker should be flush with the paper face of the plasterboard.

This is the method that will be used during plastering (Section D). It positions the speaker to be patch plastered with a 2mm (5/64") skim across the speaker front, blended with the existing plaster on the plasterboard. Amina recommend British Gypsum Easi-fill® which allows a smooth accurate finish using fine sandpaper or a wet sponge.

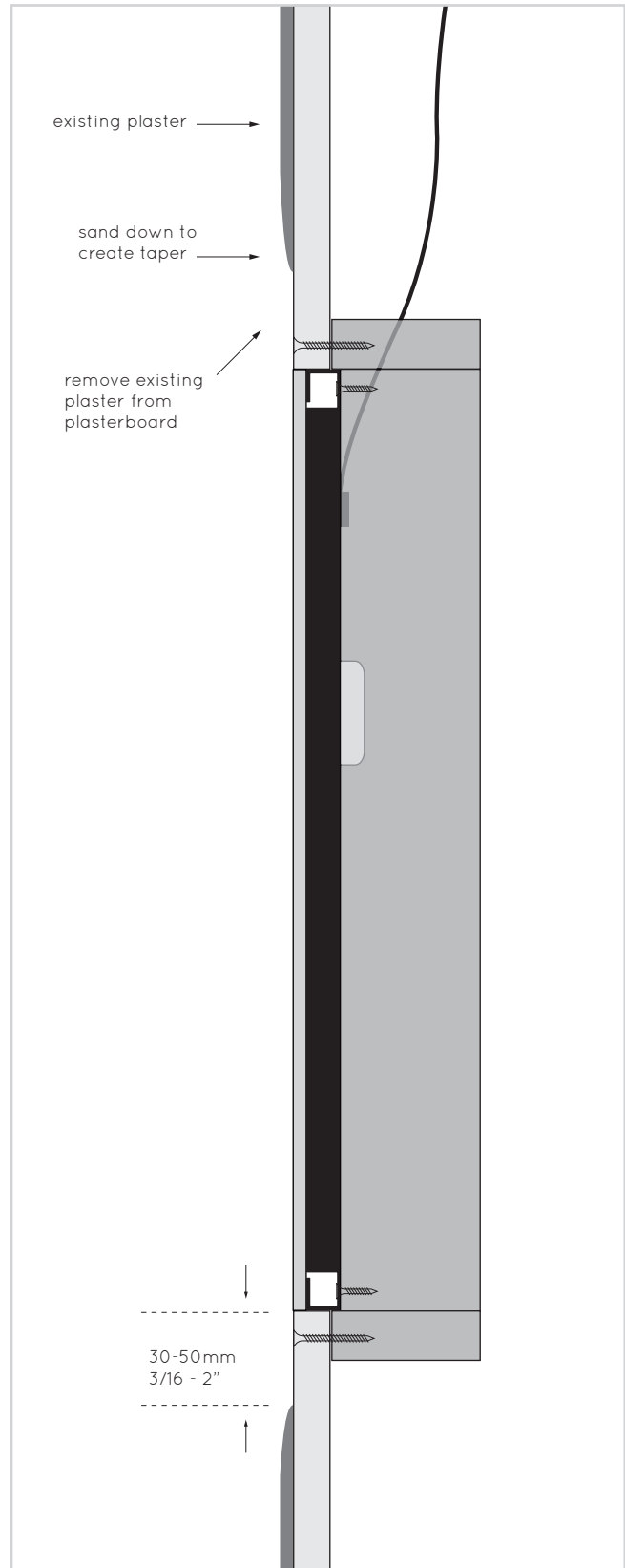

Retrofit / pre-skimmed plasterboard

Feathered skim finish

B

For walls / ceilings that have already been plastered.

Speaker alignment required for plastering

Using a 2-3mm shim set (contact your Amina supplier) between the back of the speaker and the mounting surface of the backbox (or fixing blocks), the front face of the speaker should be flush with the front face of the existing painted/plastered wall/ceiling.

This is the method that will be used during plastering (Section D). The method positions the speaker allowing a much larger area around it (approx. 1m² (39'')) to be skimmed. This 1-2mm (5/64'') thick skim is then feathered outward at the edges and blended into the existing wall/ceiling finish.

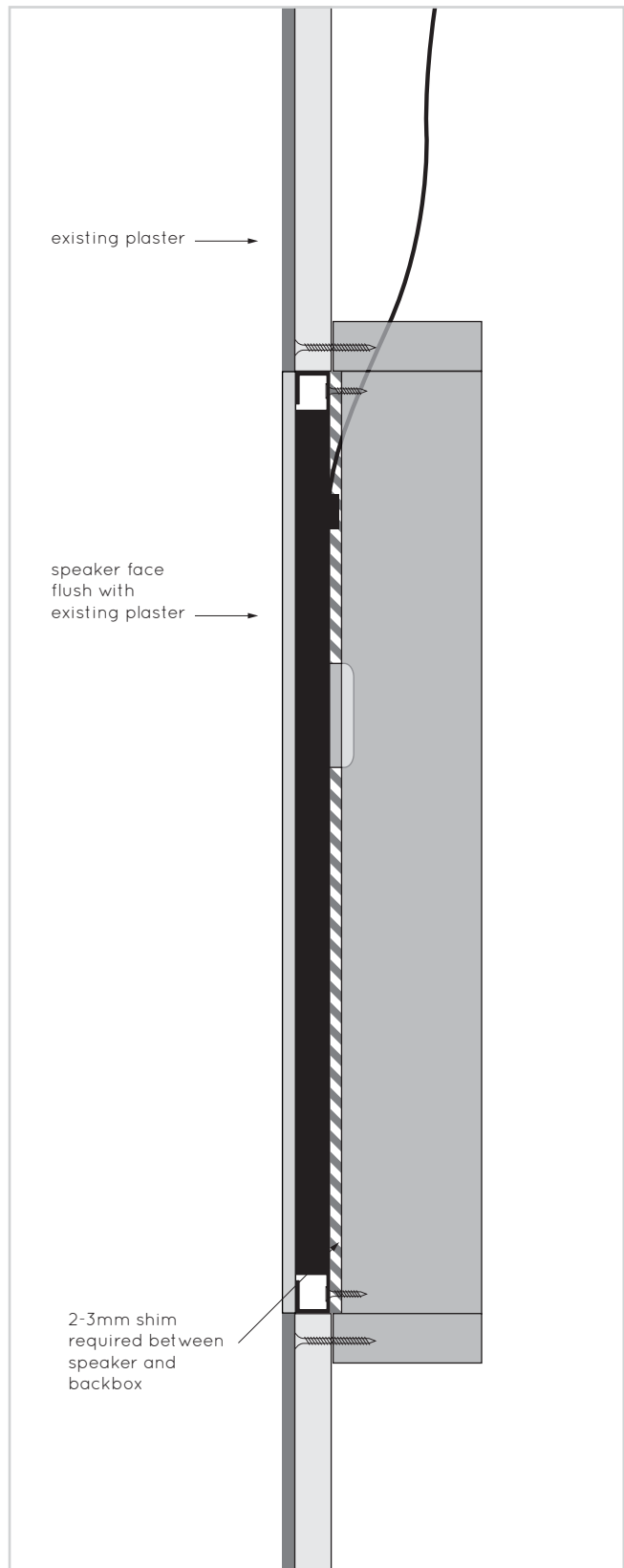

New build / new plasterboard

Full wet skim finish

B

For new plasterboard walls / ceilings that have not yet been plastered.

Speaker alignment required for plastering

The front face of the speaker should be flush with the face of the new wall/ceiling if correctly installed.

This is the method that will be used during plastering (Section D). The speaker will be skim plastered over during the process of the entire wall/ceiling being plastered.

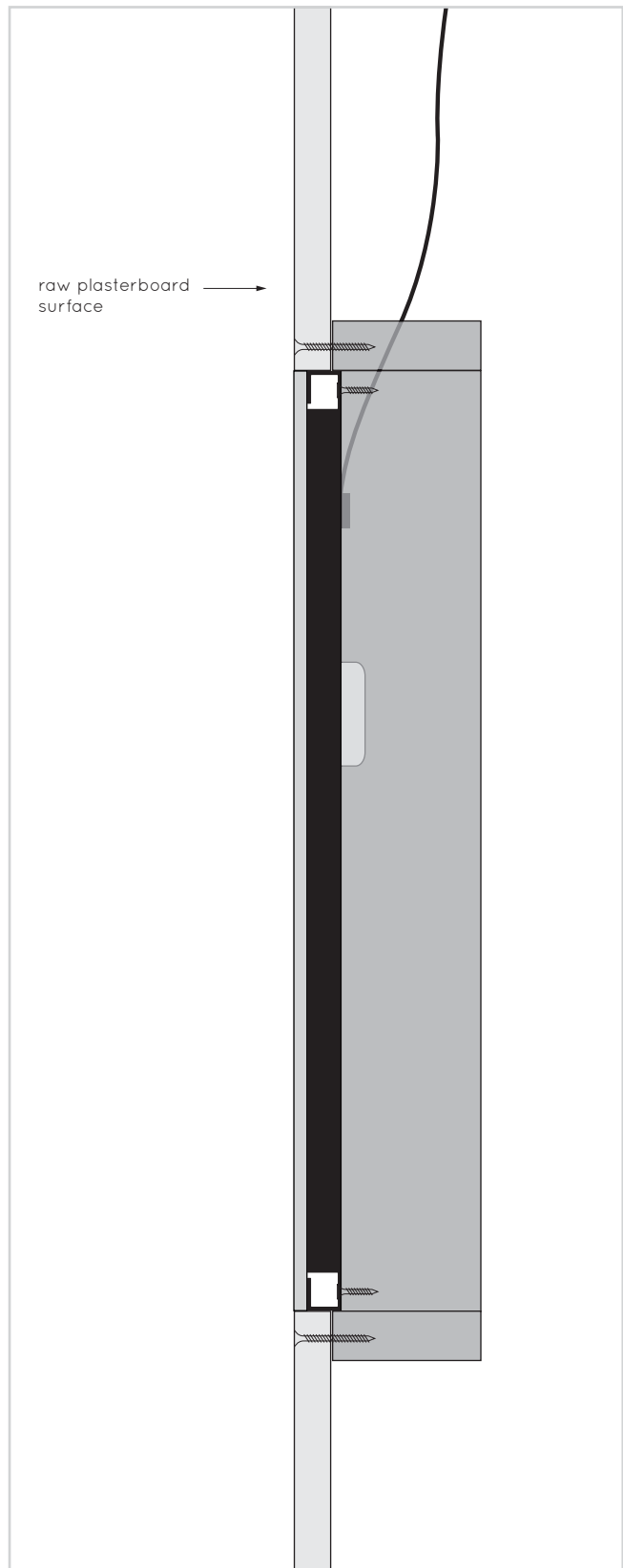
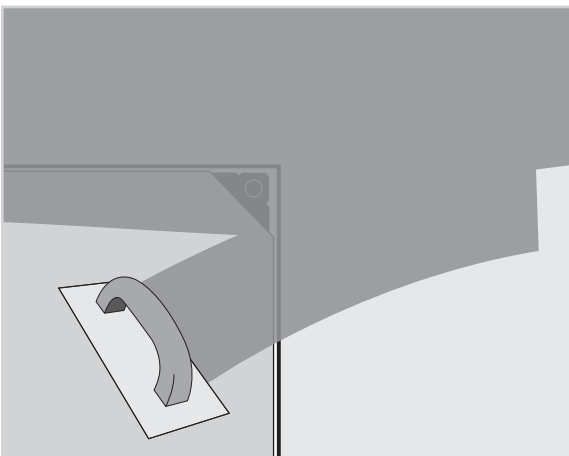

Retrofit / pre-skimmed solid wall

Feathered skim finish

B

For solid walls / ceilings that have already been plastered and painted.

Speaker alignment required for plastering

Use noggins between the back of the backbox and the inside of the cavity to align the front edge of the backbox with the front face of the finished wall.

This is the method that will be used during plastering (Section D). The method positions the speaker for a large area (approx. 1m² (39")) to be skimmed over it. This 2mm (5/64") thick skim is then feathered outward at the edges and blended into the existing wall/ceiling finish.

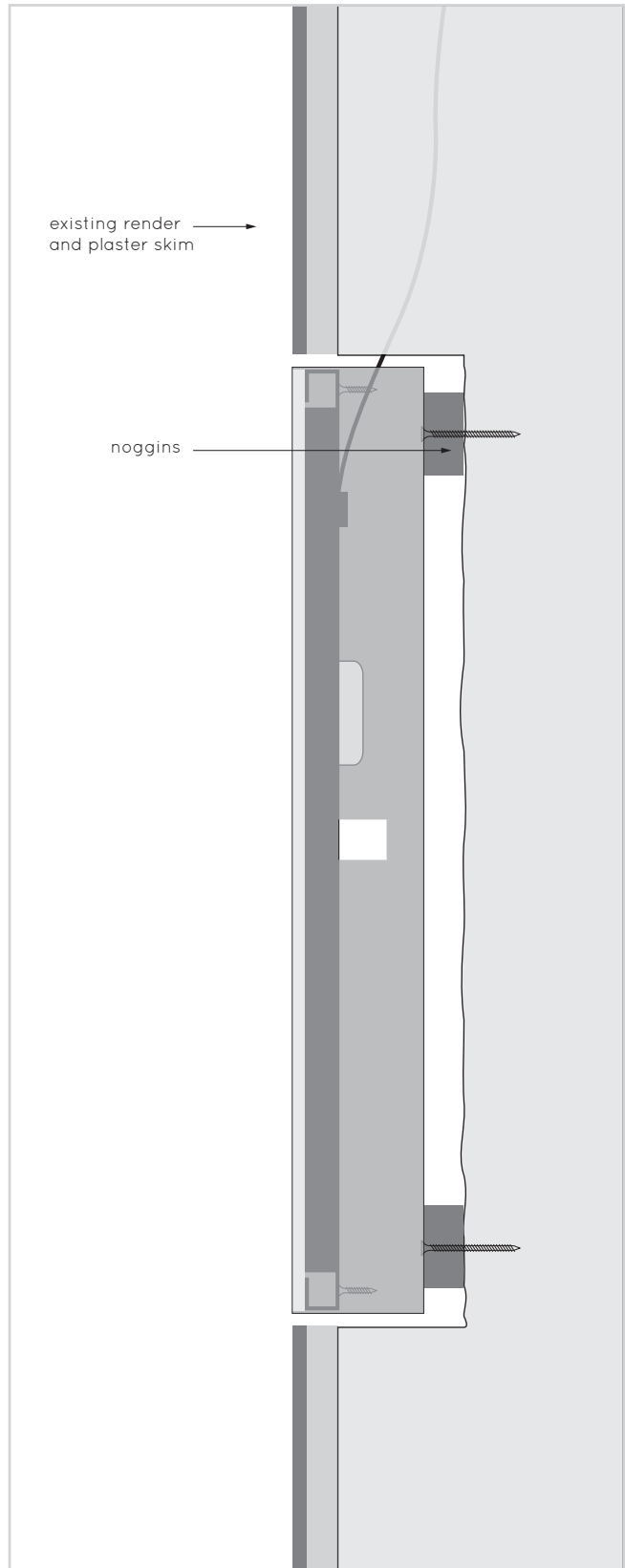

Retrofit / pre-skimmed solid wall

Patch plaster finish

B

For solid walls / ceilings that have already been plastered and painted.

Speaker alignment required for plastering

Use noggins between the back of the backbox and the inside of the cavity to align the front edge of the backbox with the front face of the base render. This should be no more than 2mm (5/64") behind the finished plaster surface.

This is the method that will be used during plastering (Section D). It positions the speaker to be patch plastered with a 2mm (5/64") skim across the speaker front and blended with the existing plaster. Amina recommend British Gypsum Easi-fill® which allows a smooth accurate finish using fine sandpaper or a wet sponge.

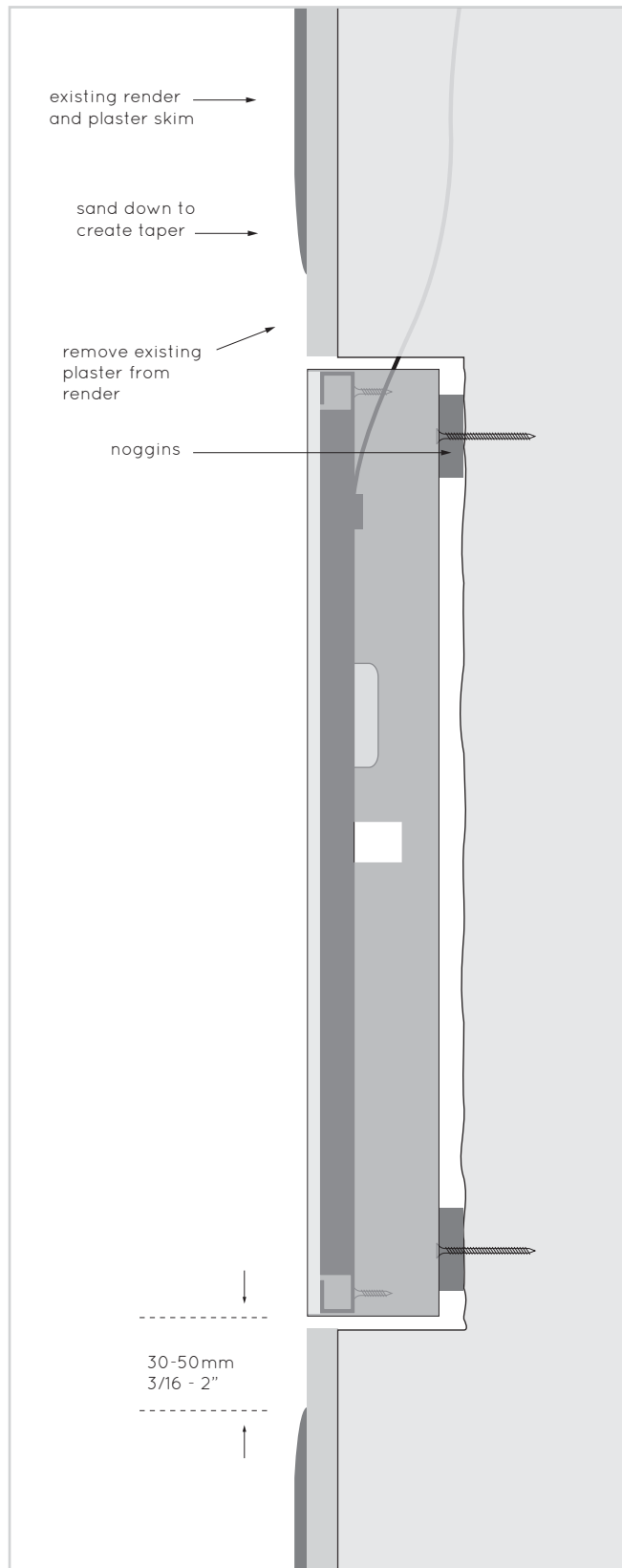

New Build / new solid wall

Full wet skim finish

B

For solid walls / ceilings that have already been rendered but not yet plaster skimmed.

Speaker alignment required for plastering

Use noggins between the back of the backbox and the inside of the cavity to align the front edge of the backbox with face of the rendered wall.

This is the method that will be used during plastering (Section D). The speaker will be skim plastered over during the process of the entire wall/ceiling being plastered.

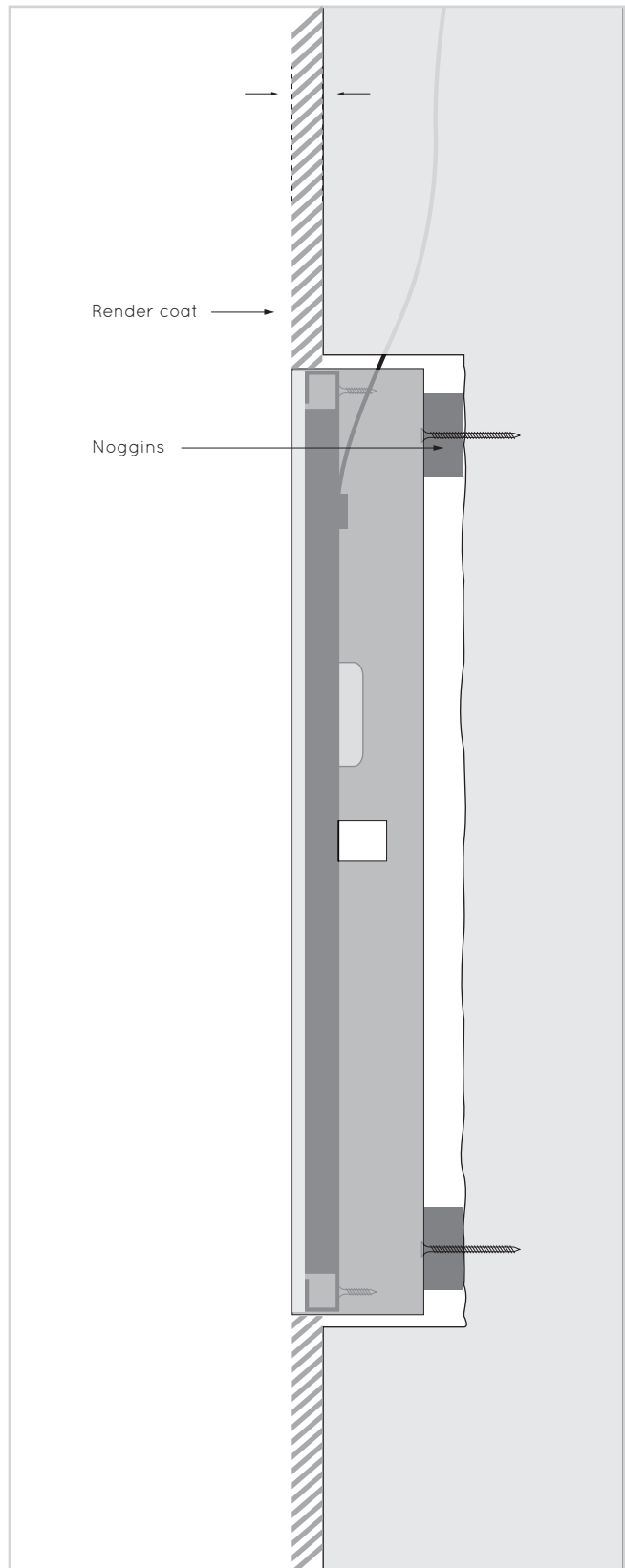
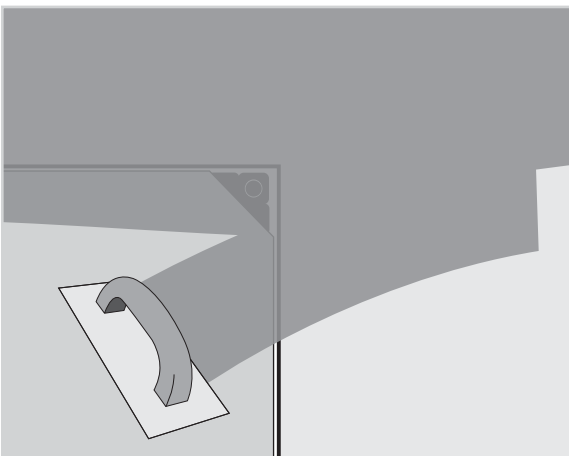

Retrofit / new drywall

Patch plaster finish

B

For new drywall walls / ceilings that will be taped and joined.

(North American construction)

Speaker alignment required for plastering

The front face of the speaker should be located 2mm (5/64") behind the face of the new wall/ceiling if correctly installed.

This is the method that will be used during plastering (Section D). It positions the speaker to be patch plastered with a 2mm (5/64") skim across the speaker front and blended with the drywall.

Amina recommend British Gypsum Easi-fill® which allows a smooth accurate finish using fine sandpaper or a wet sponge.

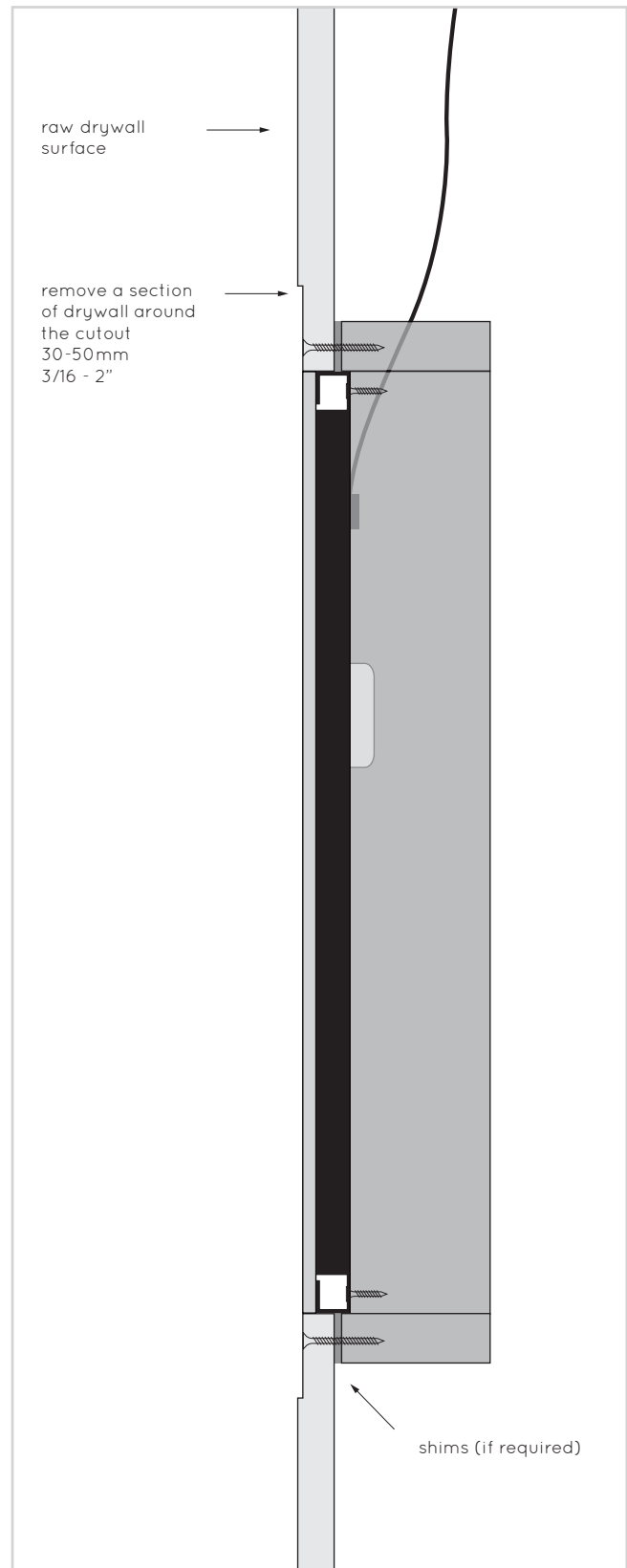

Retrofit / new drywall

Feathered skim finish

B

For new drywall walls / ceilings that will be taped and joined.

(North American construction)

Speaker alignment required for plastering

The front face of the speaker should be flush with the face of the new wall/ceiling if correctly installed.

This is the method that will be used during plastering (Section D). The method positions the speaker for a large area (approx. 1m² (39'')) to be skimmed over it. This 2mm (5/64'') thick skim is then feathered outward at the edges and blended into the existing wall/ceiling finish.

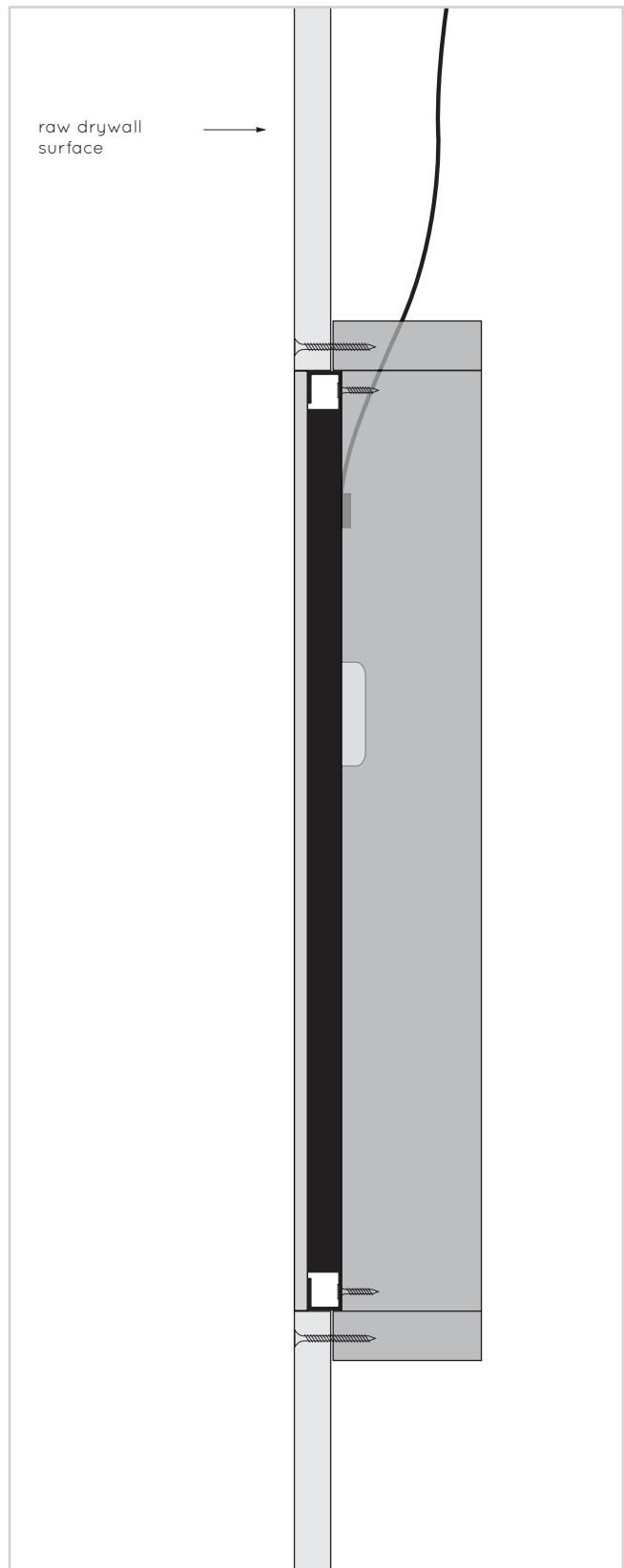

Testing the speakers



Important: Always test the speaker before plastering over it

- Amina recommends a tone sweep be used at a moderate volume level (2.83 vrms). Such a test will quickly highlight any buzzes or rattles that could be caused by loose screws, cables touching the speaker or the wall itself.
- If the plasterboard is not securely fastened to the joists this could also create a buzz or a rattle. Apply more screws if necessary - particularly around the speaker location.
- Ensure that the speaker cable is not touching any part of the speaker (or backbox) as this can lead to buzzes and rattles. To avoid this it is advised to lay the cable against the mineral wool or other wadding.
- If metal studs are used, ensure the crossover point of the studs are secured together. This can be achieved by applying drywall screws through the wall surface and through the metal joists. If they are not secure this may well lead to audible vibrations and rattles.
- Check cable continuity back to the amplifier by using a multimeter to check the impedance. After connection to the speaker, the impedance should be 8 Ohms or a little more depending on cable length. If it measures significantly different, check for breaks or shorts in the cable.
- Play music to check for buzzes and rattles during transient peaks. Do not judge the speaker's sound quality at this stage. Once plastered over it will sound as intended.
- Always connect the APU2 when testing.



CAUTION:

Without plaster on the surface of the speaker it is highly efficient and will generate very high sound pressure levels with minimal power input. Take care to protect your ears when testing at this stage.

Plastering and decorating

01 Apply PVA

Using a brush or foam roller, apply a thin coat of PVA (wood glue) to the entire speaker panel surface, this will assure proper adhesion between the panel surface and the plaster coating.

Use 1 part PVA to 2 parts water.

PVA primer is fast drying and can usually be ready to plaster after one hour or in accordance with the manufacturers instructions. Ensure PVA primer is completely dry before proceeding.

Important: Amina recommends you leave the PVA to dry for at least several hours, this will ensure the panel surface and surrounding areas are totally dry, sealed and ready for plastering.

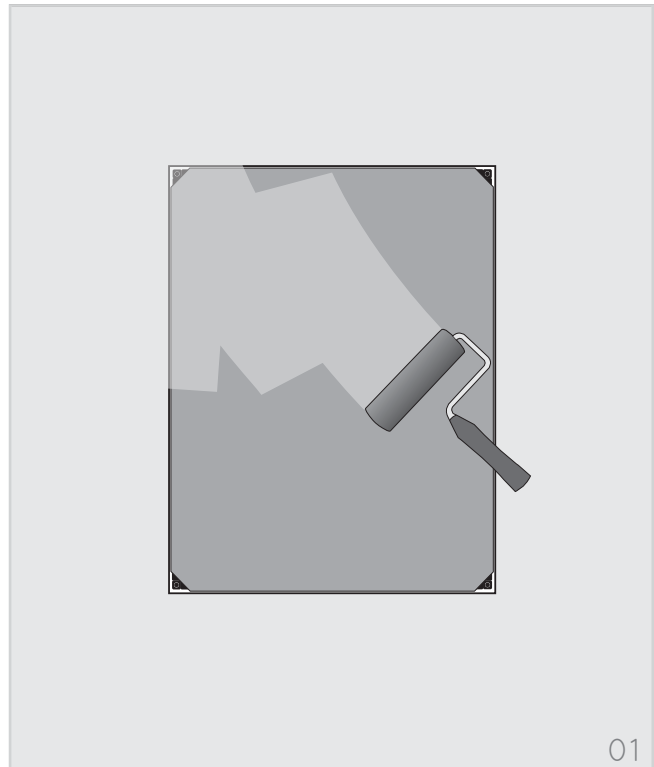

02 Fill gap between speaker and surrounding area

It is important to ensure that plaster is pushed into the 2mm (5/64") gap that surrounds the speaker. This will create a strong bond between the edge of the speaker and the wall.

This further helps to prevent any cracks appearing in the skim finish.

IMPORTANT: There MUST be a gap of 2mm (5/64") all the way around the speaker edge. If there isn't simply remove the speaker and increase the aperture size accordingly (plasterboard installations only)

If you are using a solid wall backbox, ensure there is an even gap between the speaker and the inside edge of the backbox.

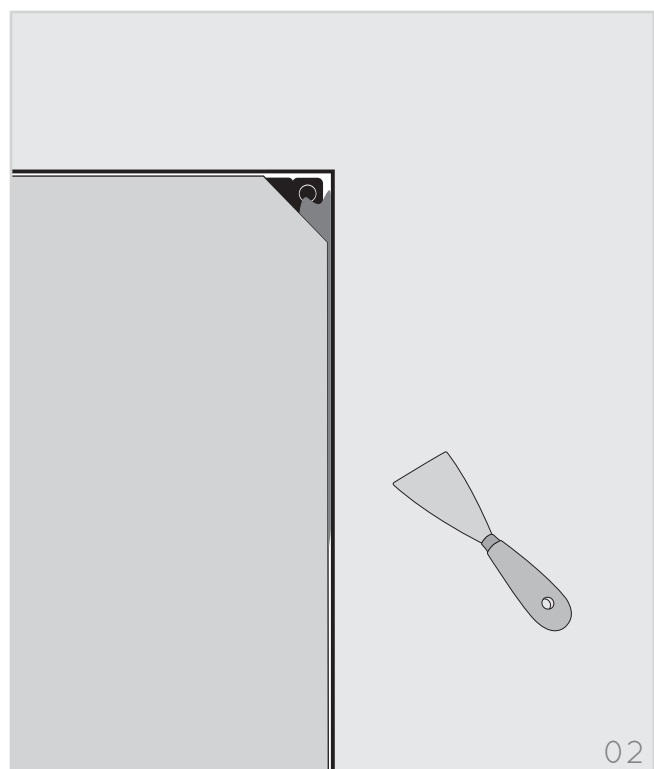

Plastering and decorating continued...



03 Apply joint tape

Apply professional plasterboard joint tape over the joint between the speaker and the surrounding wall.

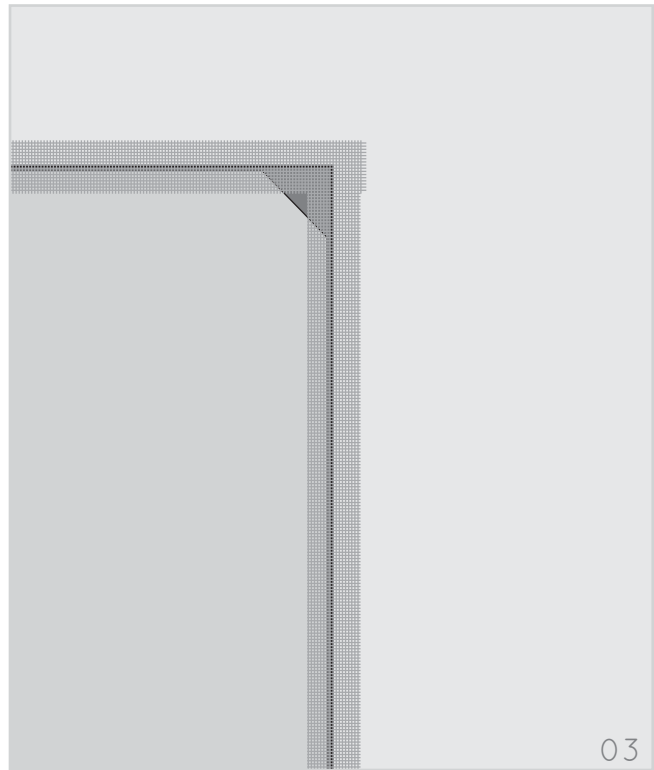

04 Plastering

Use standard finishing plaster for large areas. For patch plastering use a repair plaster such as British Gypsum Easi-fill®

Please refer to the appropriate page in Section B (alignment and plastering preparation for your specific installation type). Pages 14 - 21

Important: To ensure proper operation and sonic performance, no more than 2mm (5/64") of plaster must be applied to the surface of the panel.

05 Decorating

Allow your plasterwork to dry completely. Test the speaker again (see Section C, page 22). You can then paint the surface or hang wallpaper in the usual manner.

AIWX Series speakers have been optimised for 3 coats of emulsion once plastered. Additional coats will cause very small reductions in the maximum sound pressure levels achievable.

Note:

Amina have separate guides for information about installing the product behind other materials and surfaces such as wooden panels, acrylic and melamine (Formica®).

Contact Amina if you require any of this additional information (page 32)

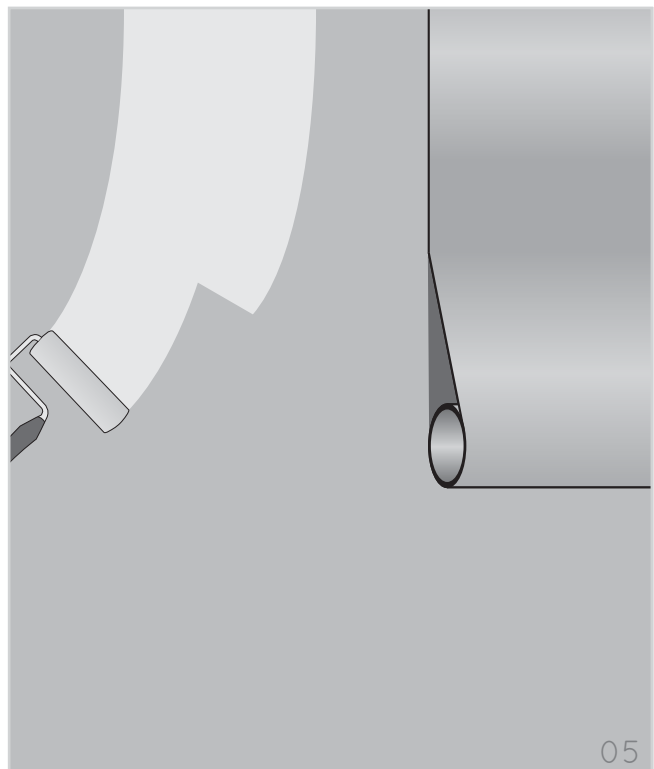

05

Setup tips

APU2 / APU-RS8

- Your AIWX speaker must be used with the supplied APU protection device. AIWXn models should be used with an APU2 or APU-RS8 or Amina approved active device in commercial systems. Please refer to the detailed instructions supplied with the APU2 and APU-RS8 for connection advice.

AIWX Audio Characteristics

- Your AIWX speaker generates sound in a similar way to an acoustic musical instrument. The speaker's front face is effectively the "musical" soundboard and the sound waves generated from it are diffuse and are dispersed over a very wide angle. This characteristic has the benefit of allowing positioning to be far less critical than with conventional speakers. Additionally, just like the acoustic musical instrument, the AIWX has excellent room filling abilities.

Wall or Ceiling Placement

- The AIWX is suitable for both wall and ceiling installations. When the most uniform audio coverage in a room is required it is best to space the speakers evenly in the ceiling. However if the room has a height greater than 6m (19') Amina suggests installing the speakers in the walls at a height of around 1.8m (6').
- In dedicated listening rooms where AIWX speakers are used in stereo or multi channel systems, position in walls so that the centre point of the AIWX is approximately 1 – 1.8m (3 - 6') from the floor, this will give excellent results. Don't worry if this is not possible to achieve as the audio characteristics of the AIWX makes exact positioning according to stereo/5.1/7.1 conventions far less critical.

Speaker Orientation

- Amina have designed the AIWX to be installed either in portrait or landscape orientations and there is no audible benefit in positioning them in one orientation over the other.

System Requirements

- From a system compatibility point of view your AIWX can be treated like any conventional 8 Ohm speaker. Amina recommend you use a good quality amplifier so as to avoid driving them with a distorted signal which may permanently damage the speaker. Amina also recommend you connect the AIWX to your amplifier with at least 16AWG OFC cable (14AWG for long runs) to avoid any chance of reduced efficiency and audio bandwidth.

For 2.1/5.1 and 7.1 systems, always set the amplifier to divert frequencies below 120Hz to the subwoofer. This will improve the overall sound quality and power handling of the system. (APU2 and APU-RS8 should still be used).

- AIWX speakers are sonically revealing and will highlight any shortcomings in the source or amplifier.

Sound Transmission

- As with any speaker designed to be fixed to a structure within a wall or ceiling, careful consideration should be given to sound transmission into adjacent rooms or properties. We recommend specialist advice is taken if sound transmission into adjacent rooms needs to be minimised. See the Amina specifiers guide for information on reducing sound transmission as a starting point.

100/70V Option

- For multi-speaker commercial and industrial installations, AIWXn speakers can be supplied with 100/70V line transformers fitted. In these systems an active high-pass filter must be installed - 24dB/octave at 120Hz minimum attenuation.

- Transformer ratings available are:

AIW1X - 5 / 10W

AIW3X - 5 / 10 / 20W

AIW5X - 5 / 10 / 20 / 40W

Speaker selection guide

Amina Technologies AIWX Loudspeakers are compatible with all standard audio amplifiers, they are passive and come supplied with an inline protection device (APU2)

There are five models in the AIWX range and referring to the table below will allow you to select the appropriate model(s) for your particular project.

	Room Size											
	<9 m ²				9 - 25 m ²				>25 m ²			
	Background Music	Foreground Music / HiFi	Home Cinema	P A	Background Music	Foreground Music / HiFi	Home Cinema	P A	Background Music	Foreground Music / HiFi	Home Cinema	P A
AIW1X	●				●				●			
AIW2X	●				●				●			
AIW3X	●	●	●		●	●			●			
AIW4X	●	●			●	●			●	●		
AIW5X		●	●	●		●	●	●		●	●	●

AIW2X and AIW4X are dual-channel speakers. They feature 2 input connectors for connecting a 2-channel feed (i.e stereo) and output this as mono. They are useful in situations where only one speaker is required, for example in small rooms.

Note 01: For home cinema applications be sure to set the AIW3X or AIW5X to “small” on the AV amplifier (alternatively set the amplifier’s internal crossover to 100Hz).

Note 02: For home cinema applications, a powerful active subwoofer is recommended.

Note 03: For main listening rooms, greater warmth is achieved through the addition of some bass enhancement such as can be provided by an Amina ALF40 subwoofer.

Further details

Maintenance and cleaning

Once your AIWX speaker is plastered into your wall or ceiling, it requires no physical maintenance. Your wall or ceiling can be cleaned with products appropriate to the finish finally applied to the plaster surface.

The wall or ceiling can be painted or redecorated any number of times (see proviso, page 24, step 5). Extreme care should be taken when removing wallpaper type coverings to ensure the plaster surface is not damaged. If damage to the plaster work occurs, use repair plaster to restore the plaster surface prior to re-decorating. Amina Technologies Ltd recommends British Gypsum Easi-fill® repair plaster. Avoid pushing the wall or ceiling surface immediately in front of the speaker. Excessive excursion, whilst unlikely to damage the speaker, will undoubtedly cause the plaster to crack around its perimeter.

Reliability

Correctly installed and used within its specification, the Amina AIWX series speaker is designed to give many years of trouble-free service. The vibrational soundboard technique used by the AIWX has very few moving parts. Compared to a conventional moving coil speaker these movements are insignificant. Whilst the human touch can feel the tiny movements, they cannot be seen by the naked eye. Such small movement of this electromechanical structure means the long term reliability is enhanced compared to much larger movements of conventional loudspeakers.

Removal

In the unlikely event of a problem developing with the product, or you simply wish to remove the item to change its location, please refer to the following guidelines:

Locate the speaker by tapping the wall or ceiling listening for a hollow sound compared to the rest of the wall/ceiling. Then, with a sharp chisel or decorator's scraper, carefully chip into the plaster to expose a small area of the panel surface. To ensure you do not damage the panel, hold the tool at an acute angle to the wall or ceiling.

Now, holding the scraper almost parallel to the panel surface, work outwards towards the product's edge easing the plaster away from the panel. Do not worry if the panel surface receives marks or indented scratches during this process (it should not, however, have holes entering through to the unique honeycomb panel). Once the product is plastered back into its original or new location, the new skim of plaster will cover all these imperfections and the speakers performance will not be unduly affected.

Clear the surface plaster material from the surrounding plasterboard to expose all the joint tape and subsequently remove it. Use a narrow chisel or flat blade screwdriver to remove the plaster and expose the screws at each corner of the product. Using a suitable screwdriver, remove the four screws and then ease the product from the wall or ceiling and disconnect the speaker cable. Leave all four fixing blocks in place as these can be used to support a small section of plasterboard when making good the wall/ceiling.

If the product needs repairing, please return it to your supplier or Amina Technologies Ltd. Once repaired, the product can be refixed into position following appropriate installation steps detailed earlier within the manual.

Troubleshooting

Thorough testing of the speakers should be carried out both prior to and after plastering to avoid time consuming repairs or modifications at a later stage. Should you encounter any problems at either of the test stages the following guide is designed to help determine possible problem areas.

Advice for testing:

- > When testing always use a basic sound system (amp, source, speakers) to eliminate the possibility of faults with other, more sophisticated components, such as control systems.
- > Test at low and medium volumes and be careful not to exceed the specific speaker model's recommended power. Using tone sweeps or music as test material, listen for distortion, buzzing or rattles at appropriate levels. Using test discs or music, confirm that all channels are in-phase.

No or low sound output:

- > Check continuity of all cables.
- > Check that all cables and connections are made correctly, are intact and that all channels are correctly phased (+ to + and - to - from amp to speaker).
- > Using an impedance meter, check the nominal impedance of the speaker (APU2/APU-RS8 must not be connected) both at the terminals and the amp end of the cable. Do these measurements match each other? (Allowing for the small impedance increase of less than 1 ohm along the wire length) do they match the stated nominal impedance on the speaker's specification label? If the nominal impedance does not match the product's stated impedance, a speaker driver may be open circuited or short circuited. If so, the product may need to be returned to Amina for repair or replacement. If the nominal impedance at the end of the cable is very different to the impedance at the speaker, check your cables. Cuts or nicks in the cable along its length can dramatically increase impedance or create a short circuit, dramatically lowering the impedance.

Distortion, buzzing or rattles at modest volumes:

- > Try to identify the location of the buzz or rattle. It may be caused by a loose screw or other mechanical object. Check the assembly and ensure screws and fixings are tight.
- > If the rattle persists, remove the speaker from the wall and check your wiring to the product. Ensure that wires, with the speaker in the final location, are not resting against the speaker or backbox (if used), causing vibrations.
- > With no audio signal applied, lightly push the speaker face in and out at its center. Listen carefully for rubbing on the driver, which may sound like scratching. This may indicate the speaker has been over driven and subsequently damaged. The speaker will need to be sent to Amina for repair.

Very low output after speaker passes electrical tests:

- > With no audio signal applied, lightly push the panel in and out at its center. Listen carefully for rubbing voice coils on the driver, which may sound like scratching. This may indicate the speaker has been over driven and subsequently damaged. The speaker will need to be sent to Amina for repair.

Distortion at higher volume levels:

- > Diffuse source panel loudspeakers of this type have an extremely fast response, articulating the signal from your audio system very accurately. Take your system back to the bare minimum (amplifier, source and speakers) to eliminate distortions introduced by other components.
 - > When using your amplifier at maximum power levels, or if the input of your amplifier is being overloaded, the signal level may be 'clipping'. With some conventional speakers this may not be evident, but with a diffuse source panel speaker you are much more likely to hear the distortion. Consider adjusting or upgrading your system.
-

Specifications

Model Number	AIW1X	AIW2X	AIW3X	AIW4X	AIW5X
Dimensions	450 x 345 x 38mm 17 ^{23/32} x 13 ^{19/32} x 1 ^{1/2} "	450 x 345 x 38mm 17 ^{23/32} x 13 ^{19/32} x 1 ^{1/2} "	450 x 345 x 38mm 17 ^{23/32} x 13 ^{19/32} x 1 ^{1/2} "	450 x 345 x 38mm 17 ^{23/32} x 13 ^{19/32} x 1 ^{1/2} "	450 x 345 x 38mm 17 ^{23/32} x 13 ^{19/32} x 1 ^{1/2} "
Weight	1.00kg	1.13kg	1.13kg	1.76kg	1.76kg
Nominal Impedance	8 Ohms	8 Ohms	8 Ohms	8 Ohms	8 Ohms
Minimum Impedance with APU connected	5 Ohms	5 Ohms	5 Ohms	5 Ohms	5 Ohms
Frequency Response	100Hz - 20kHz	100Hz - 20kHz	100Hz - 20kHz	100Hz - 20kHz	100Hz - 20kHz
Sensitivity	82dB @ 1m/1W (with 2mm plaster thickness)	85dB @ 1m/1W (with 2mm plaster thickness) both channels driven	85dB @ 1m/1W (with 2mm plaster thickness)	88dB @ 1m/1W (with 2mm plaster thickness) both channels driven	88dB @ 1m/1W (with 2mm plaster thickness)
Maximum short term SPL	95dB @ 1m/20W (with 2mm plaster thickness)	101dB @ 1m/20W per channel with both channels driven (with 2mm plaster thickness)	101dB @ 1m/40W (with 2mm plaster thickness)	105dB @ 1m/40W per channel with both channels driven (with 2mm plaster thickness)	105dB @ 1m/80W (with 2mm plaster thickness)
Connection	Twin blue butt-splice crimp terminal (suitable for 1.5mm ² - 2.5mm ² / 16-14AWG cable thickness)	Twin blue butt-splice crimp terminal (suitable for 1.5mm ² - 2.5mm ² / 16-14AWG cable thickness)	Twin blue butt-splice crimp terminal (suitable for 1.5mm ² - 2.5mm ² / 16-14AWG cable thickness)	Twin blue butt-splice crimp terminal (suitable for 1.5mm ² - 2.5mm ² / 16-14AWG cable thickness)	Twin blue butt-splice crimp terminal (suitable for 1.5mm ² - 2.5mm ² / 16-14AWG cable thickness)
High pass filter	APU2 / APU-RS8	APU2 / APU-RS8	APU2 / APU-RS8	APU2 / APU-RS8	APU2 / APU-RS8
Fixing accessories provided	Four PVC fixing blocks for 12.5mm plasterboard (other thicknesses available)	Four PVC fixing blocks for 12.5mm plasterboard (other thicknesses available)	Four PVC fixing blocks for 12.5mm plasterboard (other thicknesses available)	Four PVC fixing blocks for 12.5mm plasterboard (other thicknesses available)	Four PVC fixing blocks for 12.5mm plasterboard (other thicknesses available)
Power Handling	20W	20W + 20W	40W	40W + 40W	80W

Specifications: APU2

Model Number	APU2
Dimensions	190 x 100 x 42mm (7 ^{1/2} x 4 x 1 ^{5/8} "
Weight	0.5kg
Filter type	Passive 3rd order high pass. 20dB/octave slope, -3dB at approx. 70Hz with AIWX connected
Fuse protection	Self-resetting, current sensing type. Fuse threshold set via internal jumpers
Compatibility	Suitable for use with Amina AIW1X, AIW2X, AIW3X, AIW3X/S200, AIW4X and AIW5X
Number of channels	2
Connection type	1x Springcon® 4 pole connector per channel. Connector carries input and output for each channel
Maintenance requirements	Protection fuses can be set by the installer if necessary. Repeated tripping of fuses may require fuse replacement by the manufacturer to ensure optimal speaker performance

For multi-channel speaker systems, Amina recommend the **APU-RS8**, an 8 channel, in-line rack mounted version of the APU2 protection unit. Please contact Amina if you would like further information on this product.

Specifications: AIW3X/S200

Model Number	AIW3X/S200
Dimensions	450 x 200 x 40mm (17 ^{23/32} x 7 ^{7/8} x 1 ^{5/8} "
Weight	1040g
Nominal Impedance	8 Ohms
Minimum Impedance with APU2 connected	5 Ohms
Frequency Response	130Hz - 20kHz
Sensitivity	85dB @ 1m/1W (with 1.5mm plaster thickness)
Maximum short term SPL	101dB @ 1m/20W (with 1.5mm plaster thickness)
Connection	Twin blue butt-splice crimp terminal (suitable for 1.5mm ² - 2.5mm ² / 16-14AWG cable thickness)
High pass filter	APU2 / APU-RS8
Fixing accessories provided	Four PVC fixing blocks for 12.5mm plasterboard (other thicknesses available)
Power Handling	40W

Information

The AIW3X/S200 is a special, narrow version of the popular AIW3X invisible loudspeaker, designed to be used where wall joist spacing is too small for the standard speaker.



AIW3X/S200 Loudspeaker

31 Spacesaver information

01 Using the spacesaver for pre-install

The AIWX series spacesaver is designed to be pinned/taped to joist work prior to the plasterboard/drywall being fitted.

Your speaker cable can then be secured to the spacesaver using the holes provided.

There are two ways to secure the speaker cable in position. The first is to pull the cable through one (or both) of the holes and tape in position.

The other method is to again pull the cable through the two holes, loop and tie the cable in position.

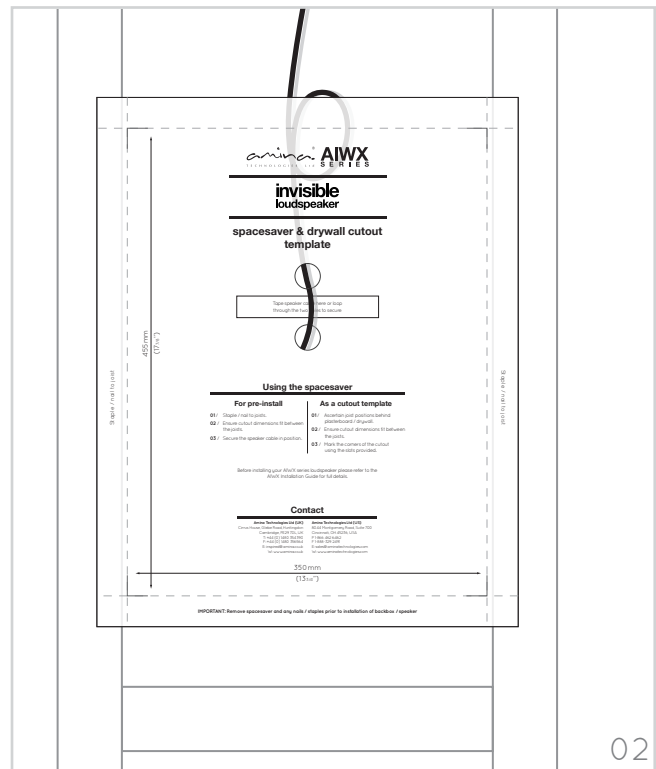

02

02 Using the spacesaver as a cutout template

For installations where the plasterboard/drywall is already in place, the spacesaver can be used purely as a hole cutout template.

Carefully mark the corners of the cutout using the four slots provided.

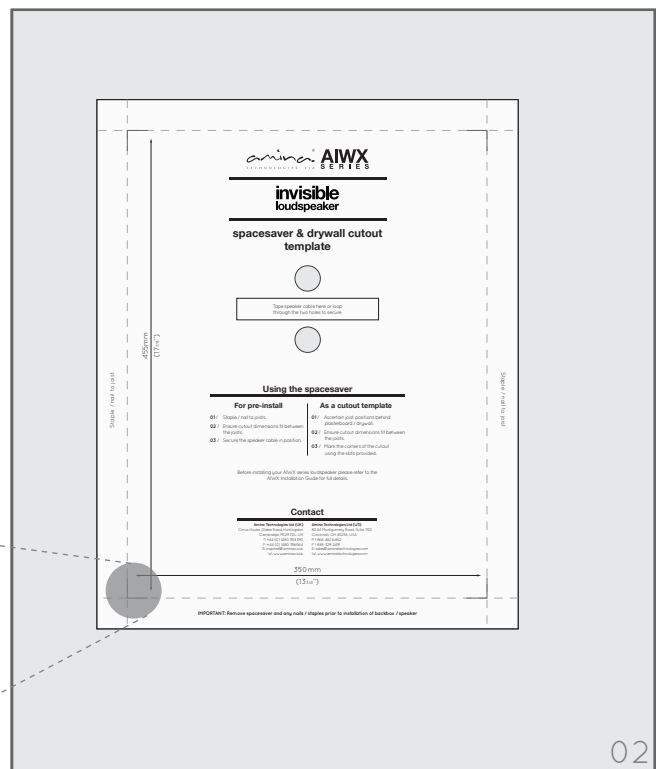
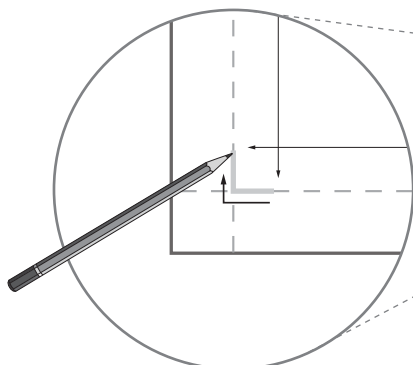

02

Warranty information

Limited Warranty:

The Amina AIWX is designed to operate reliably for many years. Correctly installed in accordance with these instructions, Amina warrants the AIWX against defective materials and workmanship for a period of five years in commercial applications and ten years in residential applications.

At the end of the speakers useful life and in compliance with the European directive on waste electrical and electronic equipment (WEEE), this product is to be returned to your supplier, or directly to Amina for recycling. If you have any questions please contact Amina Technologies Ltd.



* Please refer to our full warranty statement for details, available on our websites, or alternatively contact us via email on any of the above addresses.

Important Note: This product does not comply to European Construction Products Directive EN 54-24 and therefore must not be used in European voice evacuation systems.

Copyright information

This document is Copyright of Amina Technologies Ltd, 2011
Easi-fill is a registered trademark of British Gypsum Ltd
Formica and the Formica logo are registered trademarks of The Diller Corporation.
Amina is a registered trademark of Amina Technologies Ltd

Contact information

Amina Technologies Ltd (UK)

Cirrus House, Glebe Road, Huntingdon
Cambridge, PE29 7DL, UK
T: +44 (0) 1480 354390
F: +44 (0) 1480 356564
E: inspired@amina.co.uk
W: www.amina.co.uk

Amina Technologies Ltd (US)

8044 Montgomery Road, Suite 700
Cincinnati, OH 45236 USA
P 1-866 462 6462
F 1-888-329 2491
E: sales@aminatechnologies.com
W: www.aminatechnologies.com

Corporate Office North America Amina Technologies NA Ltd

286 Columbus Road East
Oshawa, Ontario L1H7K4
Direct 1-905 655 6411
Toll free 1-866 462 6462
Toll free Fax 1-888 329 2491



Amina Technologies Ltd
Cirrus House, Glebe Road
Huntingdon, Cambs, PE29 7DL England
T: + 44 1480 354390 / F: + 44 1480 356564
