

ALP™ G2

Area Light



DESCRIPTION

Offering up to 80,000 lumens, ALP™ G2 can replace 100W to 1000W metal halide luminaires, making it one of the most versatile fixtures currently available. Standard features include a pressure release valve, 10kV surge protection, and redesigned tool-less entry for easy maintenance. Multiple NEMA beams patterns are available, which deliver light at a maximum efficiency of 160 LpW. An extensive selection of accessories, including photocell receptacles, motion sensor, shields, finish colors, mounts, and backlight control louvers make ALP G2™ the ideal choice for superior illumination of outdoor areas.

APPLICATIONS

Commercial Parking Lots, Pedestrian Pathways, Street Lighting



FEATURES

Construction

Rugged die-cast aluminum housing.
Modular lighting engine: IP67 Rating

Finish

Dark Bronze (Standard), White, Grey, Black

EPA Rating/Enclosure Rating

EPA: See Page 4.
Enclosure: IP66 Rating

Operating Temperature

-40°F~113°F

Electrical

Input Voltage: 120-277V or 277-480V (Optional)
Projected L70 > 140,000 hrs
Surge Protection:
- 10kV Standard
- 20kV Optional

Power Factor

>0.9

Controls

1-10V Dimming standard.
Bi-level Occupancy/Daylight Harvesting Sensor available.
Photocell options available.
Dimulator Dimming Photocontrol available.
Radiant Wireless Control System available.

Optical System

Available in distribution:
Type II, Type III, Type IV, and Type V

CCT

3000K, 4000K, 5000K, 5700K

CRI

≥70

Installation/Mounting

See Page 3.

Warranty

5 Year Warranty.
See warranty documentation for more information.



IP66
Fixture



Dark Sky
Friendly
(Zero Uplight/
3000K)



Photocell
Option



Bi-Level
Occupancy/
Daylight
Harvesting
Sensor Option

Ordering Information

EXAMPLE: ALP2-200-50-3-U-SLA-D-DO

Series	Wattage	CCT	Distribution	Input Voltage	Mount	Finish	Control
ALP2	80 - 80W	30 - 3000K 40 - 4000K 50 - 5000K 57 - 5700K	2 - Type II 3 - Type III 4 - Type IV 5 - Type V	U - 120-277VAC H - 277-480VAC	SLA (For 2 3/8" Round Tenon) SLB (For 1.57" Round Tenon) SLC (For 1.97" Round Tenon) SLD (For Square Pole) SLE (For Round Pole)	D - Dark Bronze *G - Gray *B - Black *W - White	D0 (Without Control Sensors) D1 (Radiant Wireless Control System) D1-5SC (5 Pin Receptacle W/Shortcap) D1-5PC (5 Pin Receptacle W/On/Off Photocell) D1-7SC (7 Pin Receptacle W/Shortcap) D1-7PC (7 Pin Receptacle W//On/Off Photocell) D4 (Bi-level Occupancy/Daylight Harvesting Sensor) DIM4-U - Dimulator 120-277 VAC with 7 pin DIM4-H - Dimulator 480VAC with 7 pin
	100 - 100W						
	120 - 120W						
	150 - 150W						
	200 - 200W						
	240 - 240W						
	320 - 320W						
	400 - 400W						
	500 - 500W						
	600 - 600W						

Accessories

*Note: Back Light Control sold as individual units:

- ALP2-S-BLC [2 units (80W~200W)]
- ALP2-S-BLC [3 units (240W~320W)]
- ALP2-M-BLC [3 units (400W~600W)]

Please note how many units you require when ordering.

- ALP2-TRU (Trunnion)
- ALP2-TEN (Wall Mount Tenon) [Click to See Spec.](#)
- ALP2-FS (Field Adjustable Lumen Switch)
- SP-U-20kV (20kV/10kA Surge Protection [120-277V])
- SP-H-20kV (20kV/10kA Surge Protection [277-480V])
- DSF (Dark Sky Friendly [3000K])

- ALP2-S-BLS (Back Light Shield [80W~200W])
- ALP2-M-BLS (Back Light Shield [240W~600W])
- ALP2-S-FLS (Full Light Spill Shield [80W~200W])
- ALP2-M-FLS (Full Light Spill Shield [240W~600W])
- *ALP2-S-BLC (Back Light Control [80W~320W])
- *ALP2-M-BLC (Back Light Control [400W~600W])

Specifications and Dimensions subject to change without notice.

*MOQ and longer lead times may apply, please contact customer service for more information.

Optional accessories sold separately.

Features

Constructions

- IP66 Die-cast Aluminum Housing
- Modular Design For Easy Installation, Replacement, & Maintenance
- Sleek Low Profile Design: Low EPA Rating

Finish

- Corrosion Resistant Polyester
- Standard Finish: Dark Bronze
- Available Finish:



Dark Bronze
Pantone:
Black 7 U



Gray
Pantone:
Cool Gray 3 U



Black
Pantone:
Black 3 C



White
Pantone:
663 M

LED Module

- IP67 LED Module
- Type II, III, IV, V Distribution

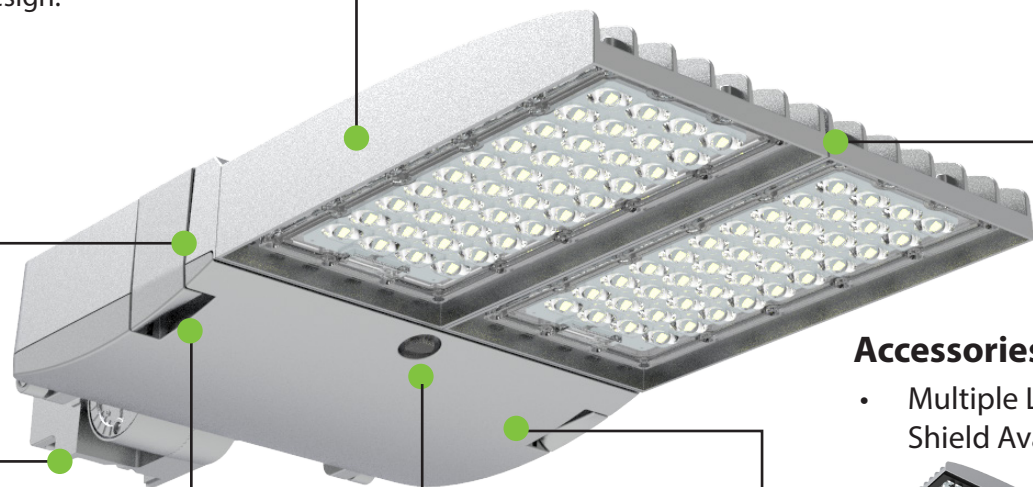

Mounting

- Standard Mounting Diameter: 2 3/8" (60mm)
- 6 Mounting Options
- Adjustable Mounting

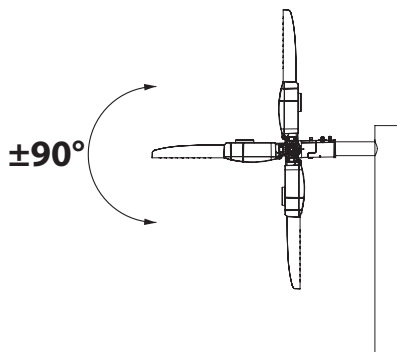

Pressure Release Valve

- Release Pressure To Prevent Moisture Buildup

Accessories

- Multiple Light Spill Shield Available



Electrical/Control

- 120-277VAC & 277-480VAC Available
- Dimulator Dimming Photocontrol, Photocell, or Bi-level Occupancy/Daylight Harvesting Sensor Available
- Surge Protection:
 - 10kV Standard
 - 20kV Optional
- Radiant Wireless Control System

Tool-less Driver Compartment

- Convenient Tool-less Driver Compartment Release For Quick Wiring & Service

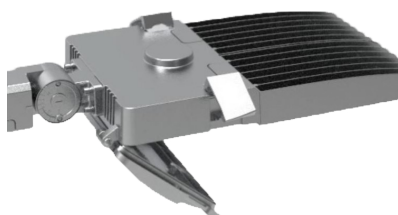

Bracket Installation

SLA (For 2 3/8" Round Tenon)

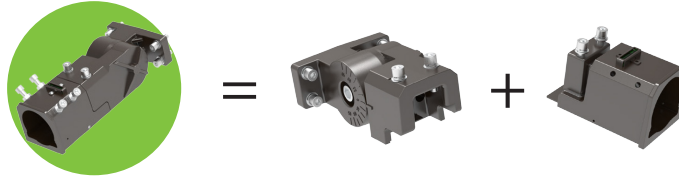

SLB (For 1.57" Round Tenon)

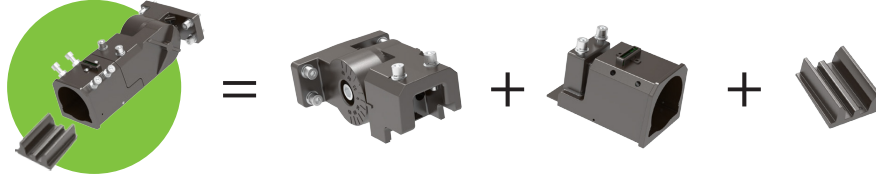

SLC (For 1.97" Round Tenon)

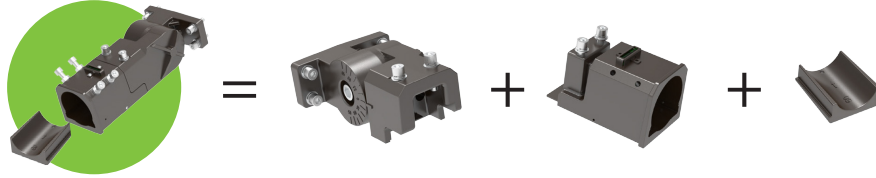

SLD (For Square Pole)

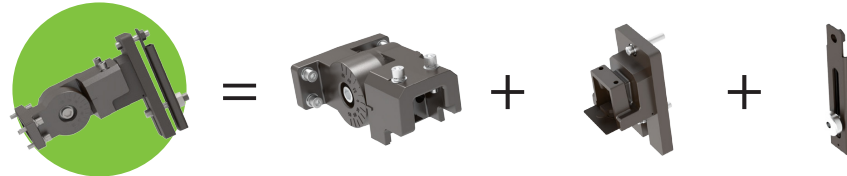

SLE (For Round Pole)

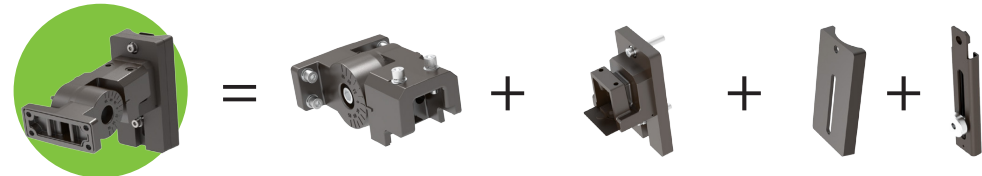

SLA, SLB, or SLC — Different O.D. Tenon Mount

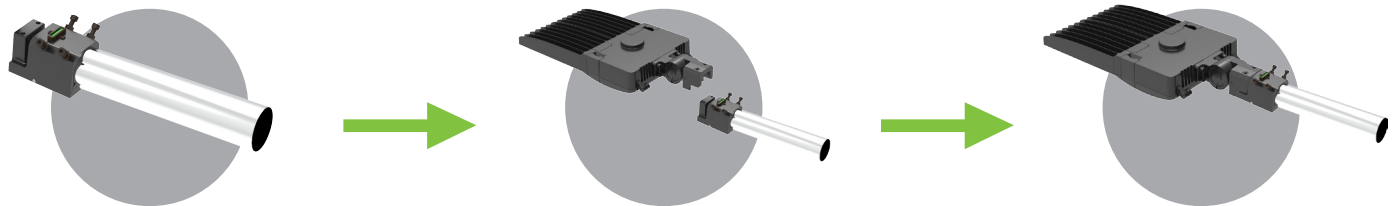

SLD — Square Pole Mount

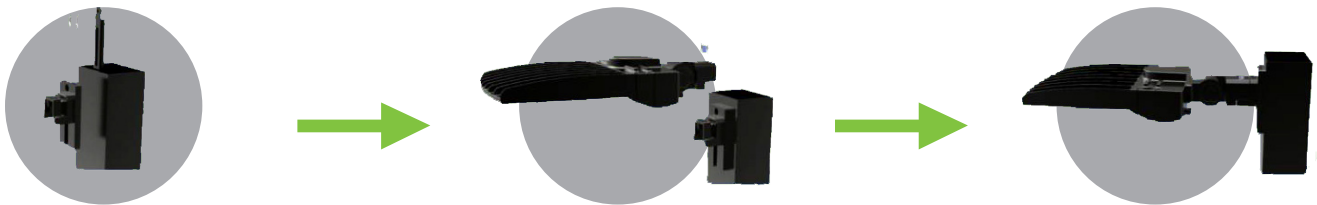

SLE — Round Pole Mount



Technical Detail

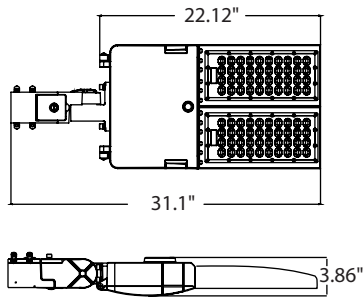

EPA: 0.5ft²

Net weight: 21.3 lbs.

Gross weight : 24.0 lbs.

Product Dimension: 31.1"x12.44"x3.86"



Wattage	*System Efficacy	
	3000K	4000K/5000K/5700K
80W	150lm/W	160lm/W
100W	150lm/W	160lm/W
120W	140lm/W	155lm/W
150W	140lm/W	155lm/W
200W	140lm/W	150lm/W

	1	2@180°	2@90°	3@90°	3@120°	4@90°
Configuration						
EPA (ft ²)	0.50	1.00	0.77	1.27	0.93	1.27
Weight (lbs.)	21.3	42.6	42.6	63.9	63.9	85.2

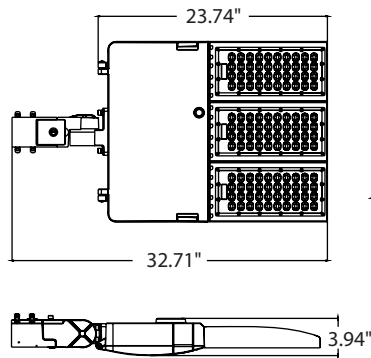

EPA: 0.53ft²

Net weight: 26.9 lbs.

Gross weight : 30.4 lbs.

Product Dimension: 32.7"x18.66"x3.94"



Wattage	*System Efficacy	
	3000K	4000K/5000K/5700K
240W	145lm/W	160lm/W
320W	135lm/W	150lm/W

	1	2@180°	2@90°	3@90°	3@120°	4@90°
Configuration						
EPA (ft ²)	0.53	1.06	0.96	1.49	0.99	1.49
Weight (lbs.)	26.9	53.8	53.8	80.7	80.7	107.6

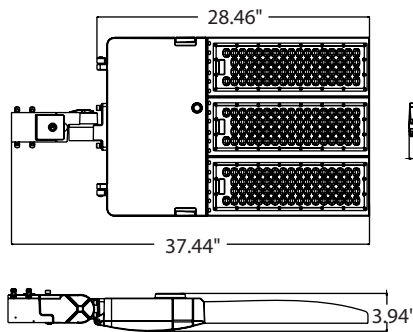

EPA: 0.6ft²

Net weight: 33.0 lbs.

Gross weight : 37.0 lbs.

Product Dimension: 37.44"x18.66"x3.94"

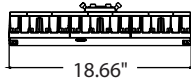

Wattage	*System Efficacy	
	3000K	4000K/5000K/5700K
400W	140lm/W	150lm/W
500W	130lm/W	135lm/W
600W	130lm/W	135lm/W

	1	2@180°	2@90°	3@90°	3@120°	4@90°
Configuration						
EPA (ft ²)	0.60	1.20	1.03	1.63	1.12	1.63
Weight (lbs.)	33.0	66.0	66.0	99.0	99.0	132.0

Performance Table

Lumen Output

Lumen value are from photometric test performed in accordance with IESNA LM-70-08. Data is considered to be representative of the configurations shown, within the tolerances allowed by Lighting Facts Contact factory for performance data on any configurations not shown here.

System Watts	Dist. Type	3000K				4000K				5000K			
		Lumens	B	U	G	Lumens	B	U	G	Lumens	B	U	G
80W	2					13390	3	0	2				
	3					13203	2	0	2				
	4					13127	2	0	3				
	5					12766	3	0	2				
100W	2					16332	3	0	2				
	3					16274	2	0	2				
	4					15961	3	0	2				
	5					15860	3	0	3				
120W	2	17205	3	0	3	17511	3	0	2	17983	3	0	2
	3	17324	2	0	2	17853	3	0	2	18396	2	0	2
	4	17514	3	0	2	17604	3	0	2	17974	3	0	2
	5	17893	4	0	2	18369	4	0	2	18601	4	0	2
150W	2	21297	3	0	3	21813	3	0	3	22381	3	0	3
	3	21448	3	0	3	22345	3	0	3	22907	3	0	3
	4	21058	3	0	3	22225	3	0	3	22401	3	0	3
	5	21603	4	0	2	22729	4	0	2	23289	4	0	2
200W	2	27891	3	0	3	28524	3	0	3	29358	3	0	3
	3	27944	3	0	3	28954	3	0	3	29612	3	0	3
	4	27083	3	0	3	28564	3	0	3	29221	3	0	3
	5	27561	5	0	3	29729	5	0	3	30264	5	0	3
240W	2	34805	4	0	3	36651	4	0	3	37339	4	0	3
	3	35476	3	0	4	36527	4	0	4	37955	4	0	4
	4	34854	4	0	4	37052	4	0	4	37685	4	0	4
	5	35529	5	0	5	37720	5	0	4	38930	5	0	3
320W	2	44481	4	0	3	45022	4	0	4	48034	4	0	3
	3	42375	4	0	4	44784	4	0	4	46333	4	0	4
	4	42401	4	0	4	45096	4	0	4	46150	4	0	4
	5	42859	5	0	3	46772	5	0	4	48317	5	0	4
400W	2	55736	5	0	5	58008	5	0	4	59172	5	0	4
	3	55611	5	0	5	57664	5	0	5	59443	5	0	5
	4	56058	5	0	4	57883	5	0	5	59168	5	0	4
	5	57085	5	0	4	59260	5	0	4	61459	5	0	4
500W	2	65018	5	0	4	67761	5	0	4	69196	5	0	4
	3	63624	5	0	5	66690	5	0	5	67478	5	0	5
	4	63963	5	0	5	65758	5	0	5	67807	5	0	5
	5	65463	5	0	4	67945	5	0	5	69639	5	0	4
600W	2									84803	5	0	5
	3									84545	5	0	5
	4									84803	5	0	5
	5									85257	5	0	4

Photometric Data

Multiplier	Mounting Height
2.8	15'
1.6	20'
1.0	25'
0.7	30'
0.5	35'

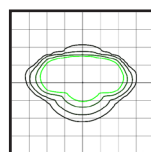

Type II

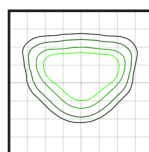

Type III

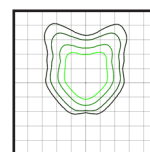

Type IV

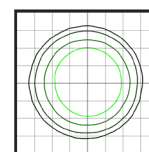

Type V

* IESNA LM-63 IES Available

Dimulator Stand-Alone LED Dimming Photocontrol



Features

- Factory preset dimming - no selector switch
- 10 Year Warranty
- Compliant with ANSI C136.41 receptacle
- Optional constant all night dimming
- Adaptive lighting control with progressive intensities
- 40kV Surge Protection
- High voltage version available
- Advance time/date algorithm auto-adjusts for daylight savings
- Automatically synchronize to local time

Bat Eye Technology

- Advanced light sensor, only reacts to sunlight
- Immune to LED and other artificial light
- No false activation (no cycling)
- May be oriented in any direction



Patent #9210746

ELL Photocell Extra Long Life Photocontrol



Features

- Designed to meet or exceed the life expectancy of LED fixtures.
- 10 Year Warranty
- 40kV Surge Protection
- High voltage version available

Bat Eye Technology

- Advanced light sensor, only reacts to sunlight
- Immune to LED and other artificial light
- No false activation (no cycling)
- May be oriented in any direction



RADIANT™ WIRELESS CONTROL SYSTEM



- Utility grade power monitoring.
- WiFi Mesh Receiver Nodes.
- Communication range is up to 1 mile line of sight.
- Control dimming and On/Off.
- Secure, over-the-air software upgrades.



- Manual/Remote/Web access to Nodes.
- Control up to 1000 Nodes.
- Weather protected.
- Optional, pre-configured 5 button switch to allow for control of all lighting (Central Base Station only).



Central Control Base Station (Optional) or SimplySnap Controller







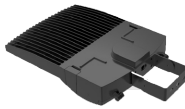

WiFi or LAN Network with browser based control interface

Optional Cloud Control with Verizon 4G LTE

Electrical Load

System Wattage (W)	Current (A)					
	120V	208V	240V	277V	347V	480V
80	0.67	0.38	0.33	0.29	0.23	0.17
100	0.83	0.48	0.42	0.36	0.29	0.20
120	1.00	0.58	0.50	0.43	0.34	0.25
150	1.25	0.72	0.63	0.54	0.43	0.31
200	1.68	0.96	0.83	0.72	0.57	0.42
240	2.00	1.15	1.00	0.87	0.69	0.50
320	2.67	1.54	1.33	1.16	0.92	0.67
400	3.33	1.92	1.67	1.44	1.15	0.83
500	4.17	2.40	2.08	1.81	1.44	1.04
600	5.00	2.88	2.50	2.16	1.72	1.25

Accessories

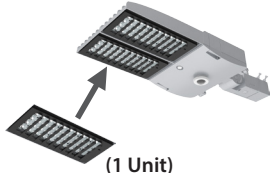
	Trunnion		ALP2-TRU		Back Light Shield	ALP2-S-BLS (80W~200W) ALP2-M-BLS (240W~600W)
	Photocell or Dimulator Dimming Photocontrol				Full Spill Light Shield	ALP2-S-FLS (80W~200W) ALP2-M-FLS (240W~600W)
	Bi-level Occupancy/Daylight Harvesting Sensor				Back Light Control	ALP2-S-BLC (80W~320W) ALP2-M-BLC (400W~600W) [80W~200W (2 UNITS)] [240W~320W (3 UNITS)] [400W~600W (3 UNITS)] (Sold as individual Units)

Control Pre-Commissioning

Default settings are indicated by *

Sensitivity Range	Time Delay	Daylight Harvesting	Stand-by Light Level Setting	Stand-by Time Setting
20%	10s	*Light sensor disabled	0%	∞
50%	1min	1 FC (10lux)	*10%	1min
75%	*5min	3 FC (30lux)	30%	30min
*100%	15min	5 FC (50lux)	50%	*60min

Sensitivity Range:
Setting that determines the range of the motion sensor when the daylight sensor is disable.

Time Delay:
The light can be set to stay ON for any period of time between approx. 10sec and the maximum of 60 min. Any movement detected before this time elapses will re-start the timer.

Daylight Harvesting:
The chosen light response threshold can be infinitely from approx. 1-5 FC.

Standby-by Light Level:
Setting determines how much lumen output is dimmed down to when no motion is detected.

Stand-by Time:
Setting determines how long after stand-by light level occurs the light will shut off. Up to 60 minutes.