



University of
Strathclyde
Glasgow

INTRODUCTION TO RADAR SIGNAL PROCESSING

Christos Ilioudis
University of Strathclyde



c.ilioudis@strath.ac.uk



CeSIP

Centre for Signal &
Image Processing

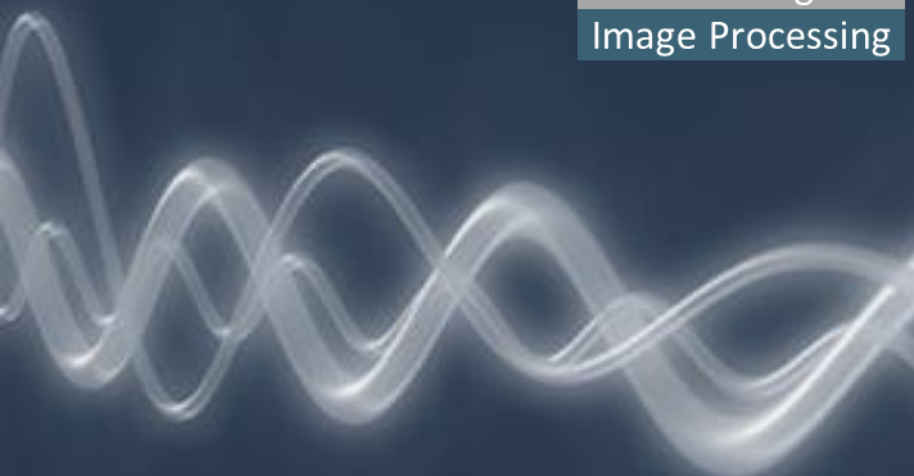

Overview

- History of Radar
- Basic Principles
- Principles of Measurements
- Coherent and Doppler Processing
- Waveforms Design and Pulse Compression
- Closing Remarks
- Reading Material

History – Before Radar

- Between the World Wars, parabolic **sound mirrors**, were used to provide early warning;
- Acoustic mirrors had a **limited effectiveness**, and the **increasing speed** of aircraft in the 1930s meant that they would **already be too close to deal with** by the time they had been detected.
- **Radio transmitters** had already been in use for over a decade for **communications**.



WW1 - WW2



Top: (L) Bombing during the WW1, (R) “Whisper Dishes”
Bottom: (L) WW2 Bombers, (R) Four-horn acoustic locator, 1930s

History – Radio Detection

- Radar was first patented and demonstrated in 1904 by the German engineer **Christian Hülsmeyer**;
- **Watson Watt** is generally credited with initiating what would later be called radar;
- In June 17, 1935, a radio-based detection and ranging was first demonstrated in Great Britain;
- The first Radar system used by the British comprised **21** stations placed along the country's eastern coast.

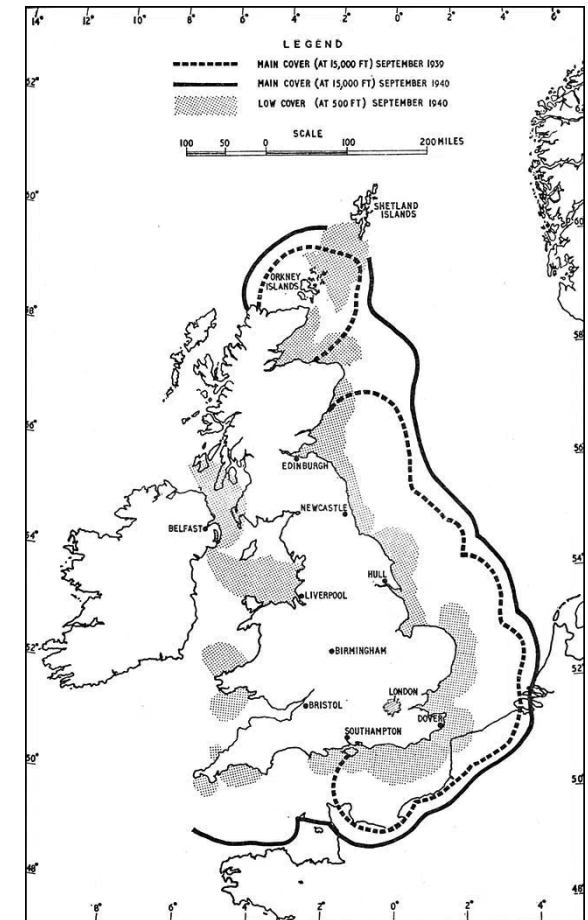
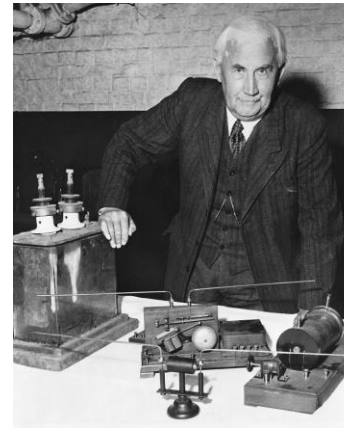

Left: (T) Christian Hülsmeyer, (B) Watson Watt,
Right: Chain Home coverage map

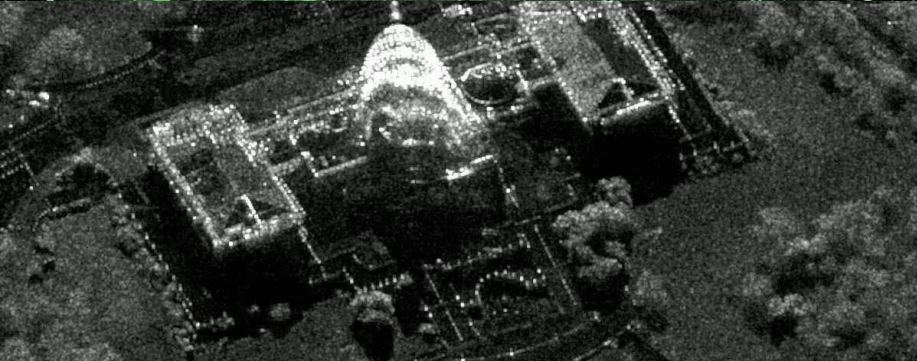

Today – Radar

- Modern Radar are very **diverse**;
 - *Military Radars*;
 - *Imaging Radars*;
 - *Radar Gun*;
 - *Automotive Radars*;
 - *Civil Aviation Radars*;
 - *Weather Radars*;
 - *Ground Penetrating Radars*;

Basic Principles

- Radar is an acronym for **RA**dio **D**etection **A**nd **R**anging;
- An object **detection** system that transmits electromagnetic (**EM**) waves and analyses the **echoes** coming from the objects;
- Why use radar?
 - *Radar can operate in any weather conditions (e.g. darkness, fog, rain);*
 - *Radar can perform its function at long and short ranges;*
 - *Radar can provide measurements in high accuracy.*

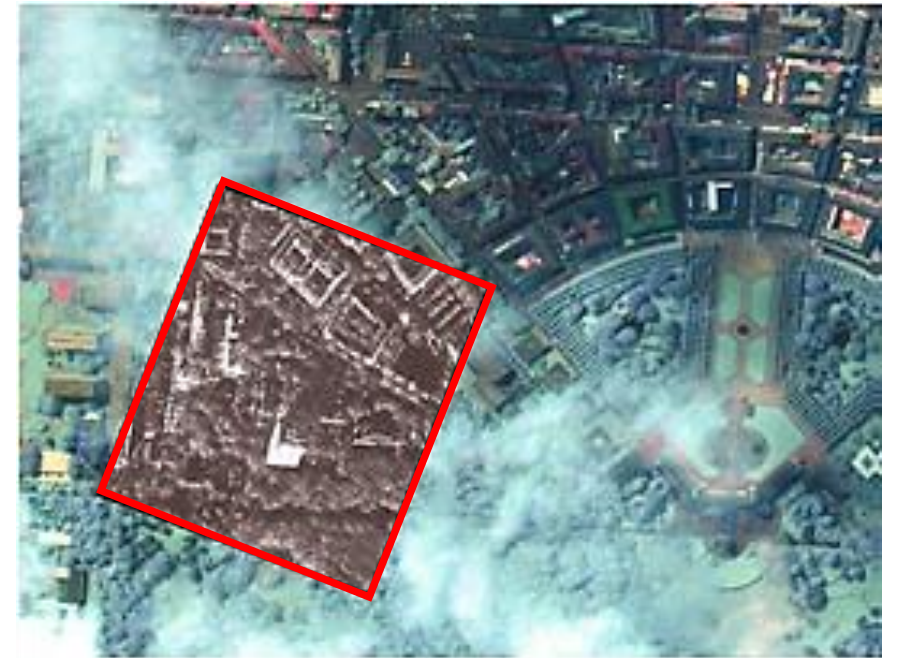

Radar vs. optical image, penetration of clouding, ©Cassidian radar, ©Eurimage, optical.

Radar Categorisation

- Operation:
 - *Primary: Target monitoring;*
 - *Secondary: Transponder on the target (Fig.);*
- Illuminator:
 - *Active: Uses its transmitter to illuminate the target;*
 - *Passive: Exploit illuminators of opportunity (Fig.);*
- Transmission rate:
 - *Pulsed: Emit separated pulses;*
 - *Continuous Wave (CW): Constant transmission (Fig.);*
- Geometry:
 - *Monostatic: Transmitter and receiver in the same location (Fig. Left);*
 - *Bistatic: Transmitter and receiver in separate locations (Fig. Right).*

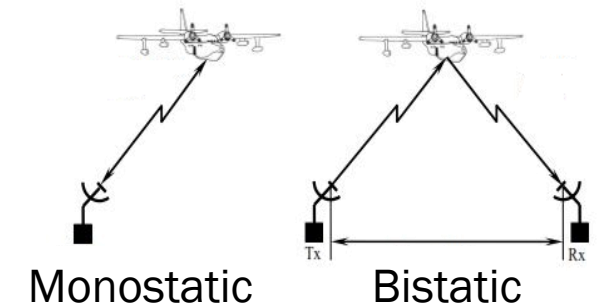
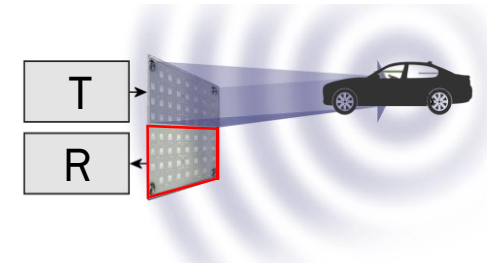
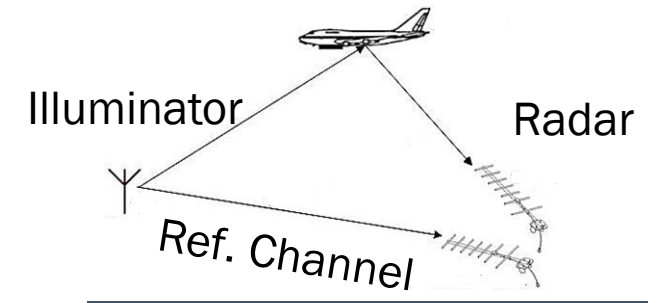
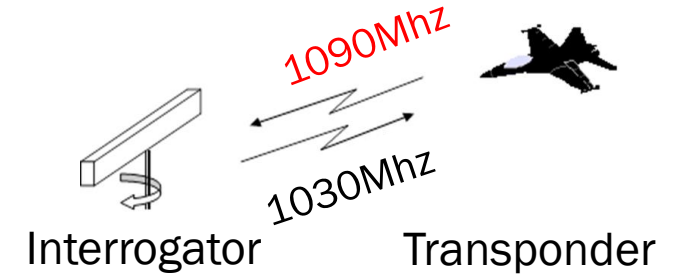

Operating Principles

- The simplest radar operation can be divided into 4 steps:
 1. *The radar is transmitting an EM pulse;*
 2. *The radar switches to listening mode;*
 3. *The pulse is reflected by a target;*
 4. *The radar receives the echoes from the transmitted pulse.*
- Using various properties of the received echo, the radar can extract parameters such as the **range** and **velocity** of the target

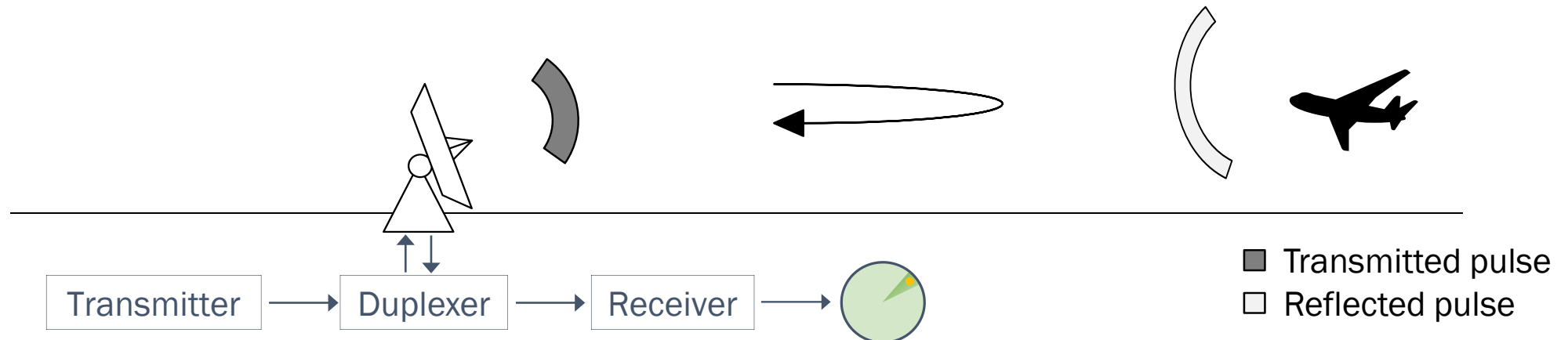

Operating Principles

- The simplest radar operation can be divided into 4 steps:
 1. *The radar is transmitting an EM pulse;*
 2. *The radar switches to listening mode;*
 3. *The pulse is reflected by a target;*
 4. *The radar receives the echoes from the transmitted pulse.*
- Using various properties of the received echo, the radar can extract parameters such as the **range** and **velocity** of the target

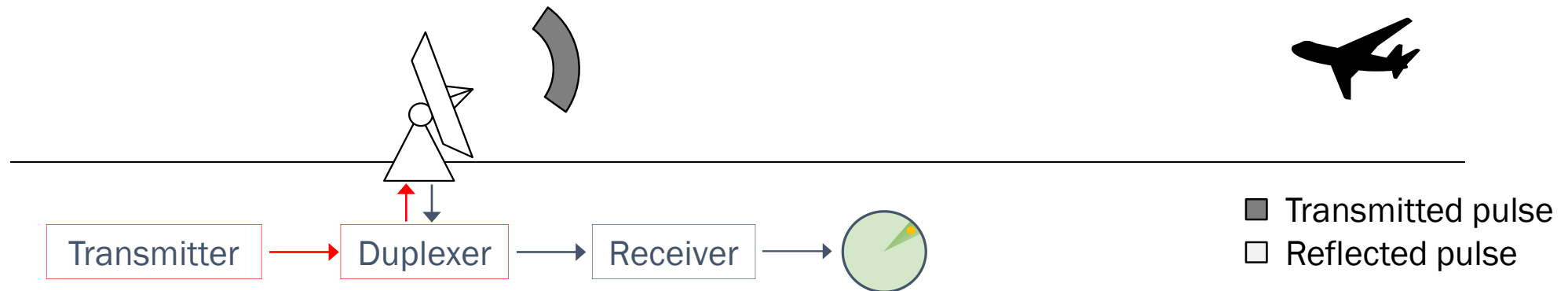

Operating Principles

- The simplest radar operation can be divided into 4 steps:
 1. *The radar is transmitting an EM pulse;*
 2. *The radar switches to listening mode;*
 3. *The pulse is reflected by a target;*
 4. *The radar receives the echoes from the transmitted pulse.*
- Using various properties of the received echo, the radar can extract parameters such as the **range** and **velocity** of the target

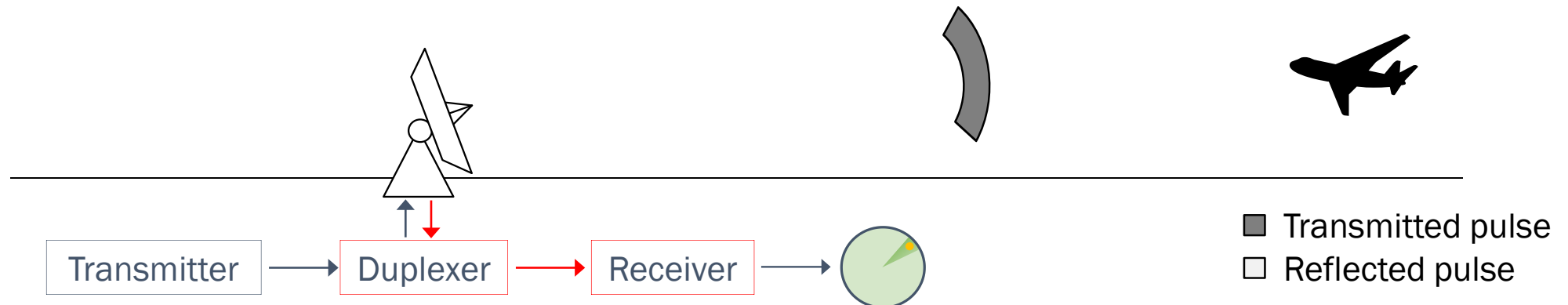

Operating Principles

- The simplest radar operation can be divided into 4 steps:
 1. *The radar is transmitting an EM pulse;*
 2. *The radar switches to listening mode;*
 3. *The pulse is reflected by a target;*
 4. *The radar receives the echoes from the transmitted pulse.*
- Using various properties of the received echo, the radar can extract parameters such as the **range** and **velocity** of the target



Operating Principles

- The simplest radar operation can be divided into 4 steps:
 1. *The radar is transmitting an EM pulse;*
 2. *The radar switches to listening mode;*
 3. *The pulse is reflected by a target;*
 4. *The radar receives the echoes from the transmitted pulse.*
- Using various properties of the received echo, the radar can extract parameters such as the **range** and **velocity** of the target

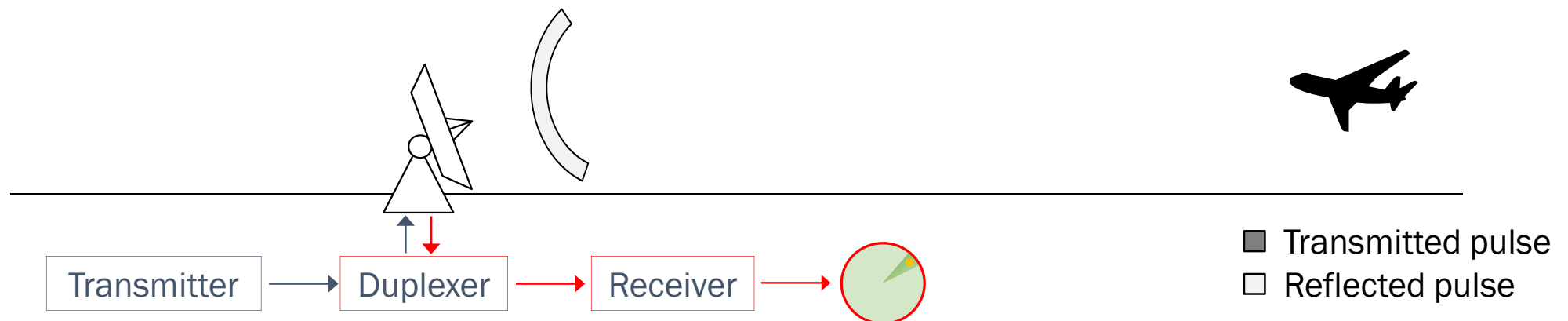



Principles of Measurements

- Radar Equation
- Distance Determination
- Range Resolution
- Direction Determination
- Pulse Repetition Interval
- Maximum Unambiguous Ranges
- Data Matrix and Data Cube



Radar Equation

- The radar equation is referring to the power of the echo returning to the radar;

$$P_r = \frac{P_t G^2 \lambda^2 \sigma}{(4\pi)^3 R^4 L} \rightarrow R = \sqrt[4]{\frac{P_t G^2 \lambda^2 \sigma}{(4\pi)^3 L P_r}}$$

- P_t : Transmit power;
- G : Antenna gain;
- λ : Radar operating wavelength;
- σ : Target radar cross section (RCS);
- R : Range from the radar to the target;
- L : Other losses (system, propagation).

- Low frequencies are preferable for long-range radar;
- Low RCS targets are harder to detect.

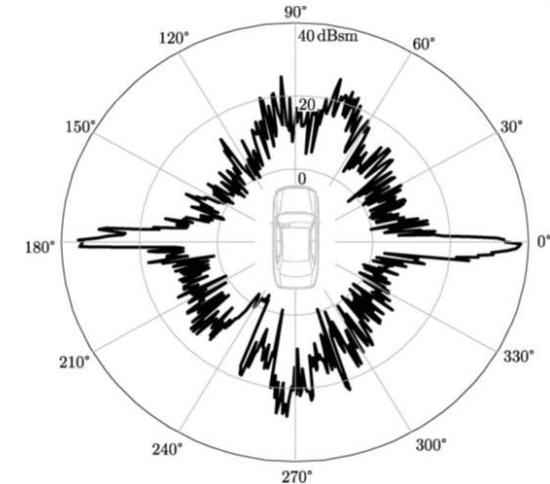
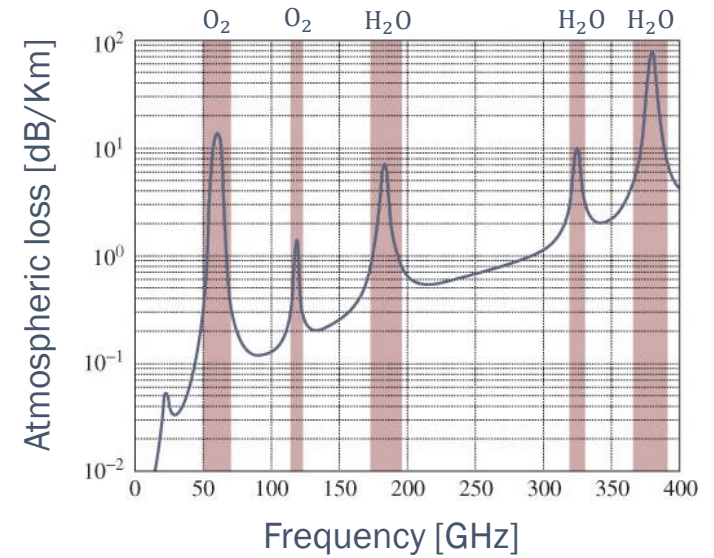

Top: Expected atmospheric path loss as a function of frequency;
Bottom: Mazda 6 RCS, Image courtesy of Hasch et al.

Distance Determination

- To determine the distance between the radar and a target, the delay of the echoed pulse is utilised;
 - Given that EM waves travel at $c = 3 \times 10^8 \text{ m/s}$
 - If the echo delay is τ , the **range** of the target is:

$$R = \frac{\tau c}{2}$$

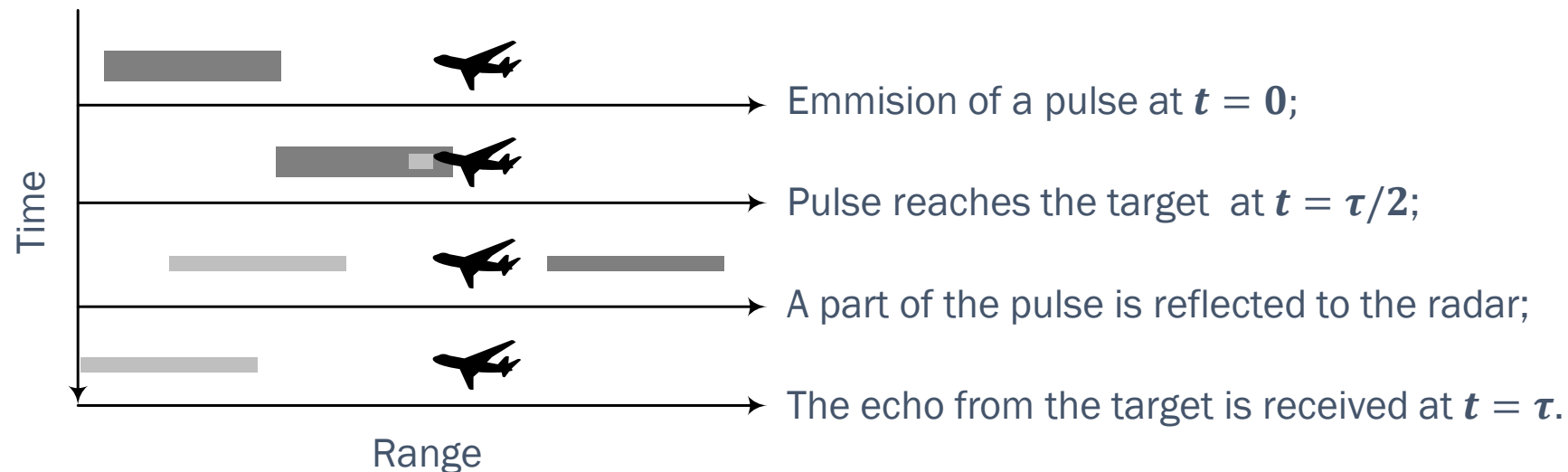

Range Resolution

- The **resolution** of radar is its ability to distinguish between targets that are in very **close** proximity.
- The **range resolution** ρ of a radar is:

$$\rho \geq \frac{cT}{2} \approx \frac{c}{2B}$$

T: Duration of pulse

B: Bandwidth of signal

- Shorter pulses will have higher bandwidth, leading to better resolution.

Range resolution issue between targets in close proximity with each other (T) Two resolved targets; (B) One resolved target.

Red part denoted the overlap between the two echoes

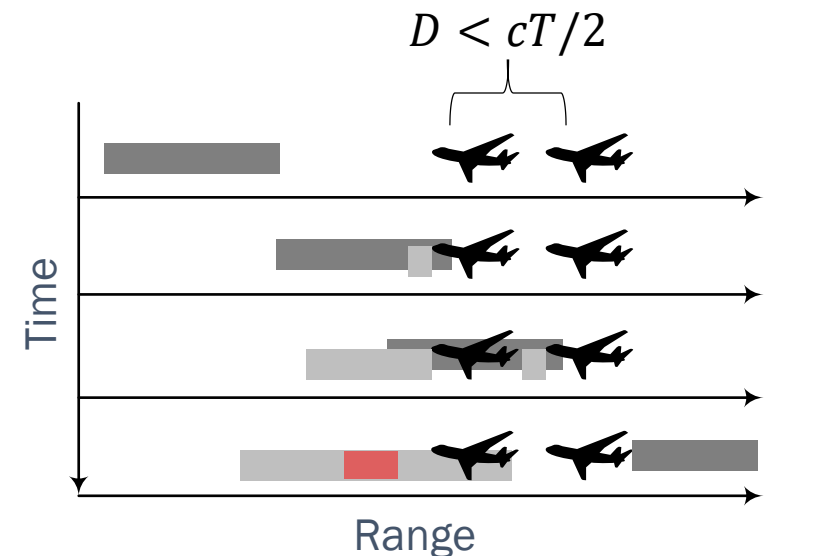
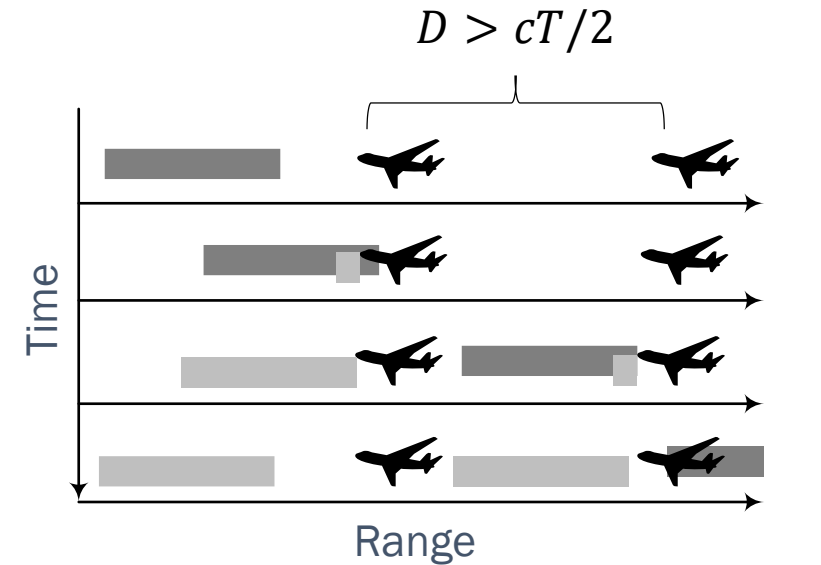

Direction Determination

- The target's direction is determined by the **directivity** of the antenna, which represents the ability of the antenna to transmit the energy in a **particular direction**.
- Both the target's **azimuth** and **elevation** angles can be determined by measuring the direction in which the antenna is pointing when the echo signal is received.

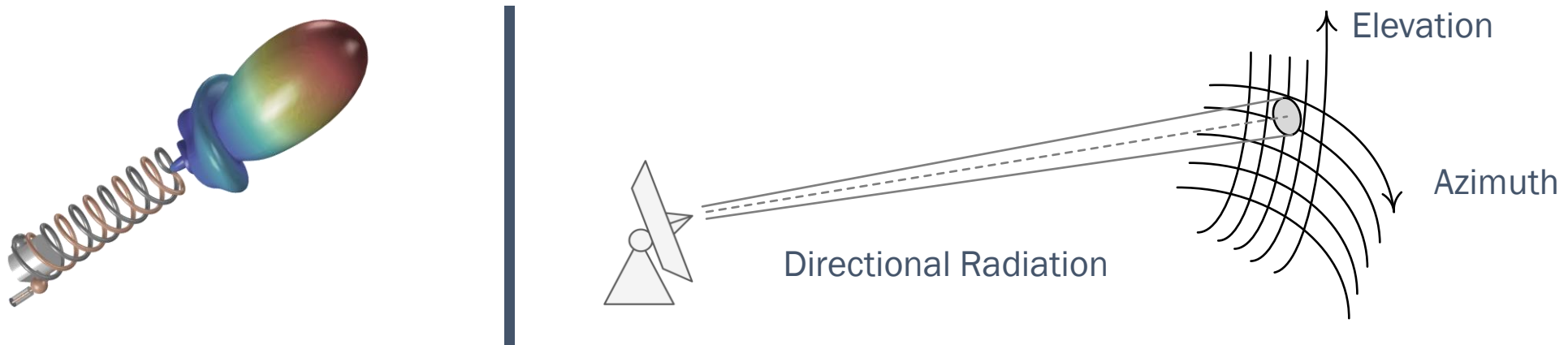

Left: Radiation pattern of a Helical Antenna

Right: Illumination in different azimuth and elevation angles using a directional antenna.

Direction Determination (cont.)

- The antenna can be steered in the desired direction **mechanically** or **electronically**.

Example of radar scanning
between two azimuth sectors,
Left: Top view;
Right: Radar indicator;



Direction Determination (cont.)

- The antenna can be steered in the desired direction **mechanically** or **electronically**.

Example of radar scanning
between two azimuth sectors,
Left: Top view;
Right: Radar indicator;

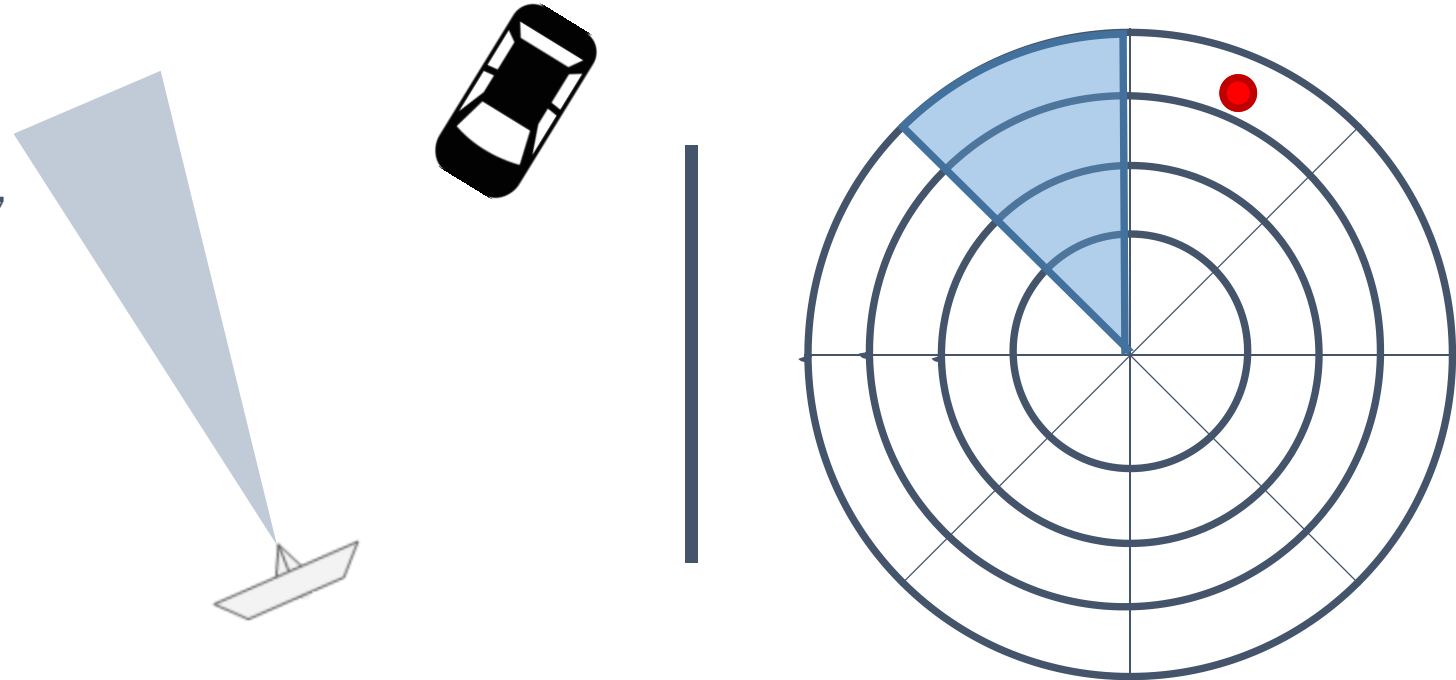

Direction Determination (cont.)

- The antenna can be steered in the desired direction **mechanically** or **electronically**.

Example of radar scanning
between two azimuth sectors,
Left: Top view;
Right: Radar indicator;



Pulse repetition Interval

- Pulse Repetition Interval (**PRI**) is defined as the time interval between consequent pulses;
- Pulse Repetition Frequency (**PRF**) is given as:
$$\text{PRF} = 1/\text{PRI}$$
- **Duty cycle** is defined as the time proportion of PRI in which the transmission takes place:
$$\text{Duty Cycle} = T/\text{PRI}$$
- If the same antenna is used for transmission and reception, the duty cycle gives a measure of how long the radar is “blind”.

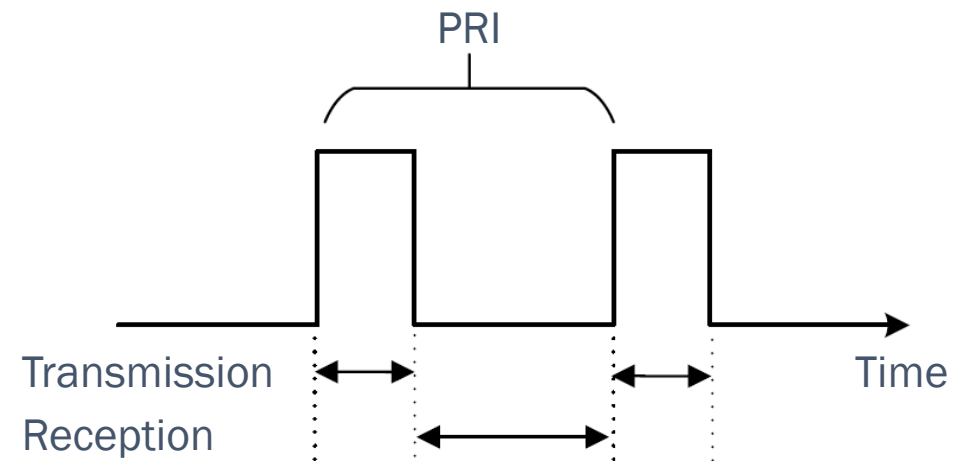

Maximum Unambiguous Range

- The maximum unambiguous range defines the maximum distance to locate a target.

$$R_{\max} = \frac{cPRI}{2} = \frac{c}{2PRF}$$

- Radar is not able to discriminate between echoes from an older and the current transmission.

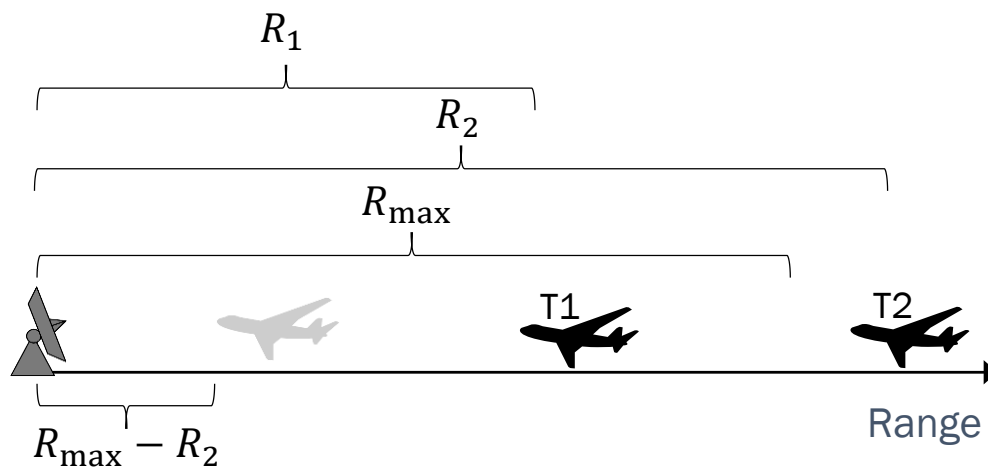

Left: Radar and two real targets (dark), one in (T1) and one out (T2) of unambiguous range, second target (T2) appears in closer range (light).

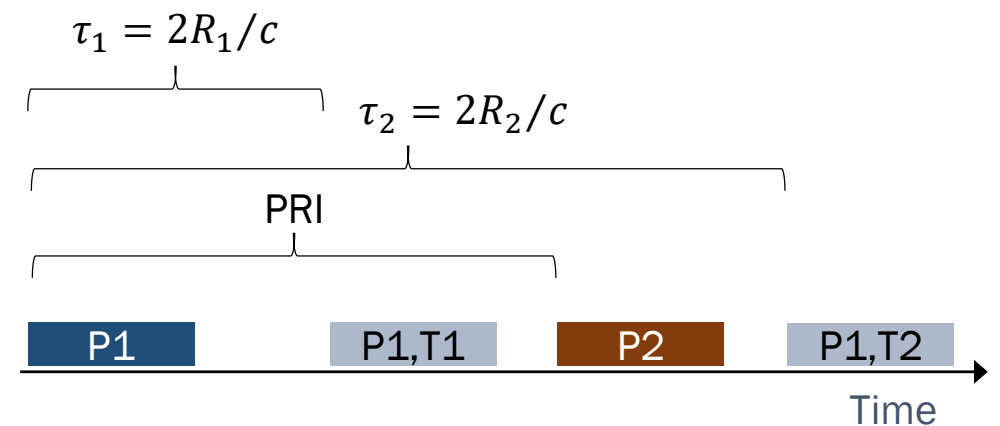

Right: Transmitted (dark) and received pulses (light) at the radar in time, radar confuses the echo from first pulse to second target (P1,T2) to an echo from second pulse (P2) and a target at a closer range ($R_{\max} - R_2$).

Maximum Unambiguous Range

- The maximum unambiguous range defines the maximum distance to locate a target.

$$R_{\max} = \frac{c\text{PRI}}{2} = \frac{c}{2\text{PRF}}$$

- Radar is not able to discriminate between echoes from an older and the current transmission.

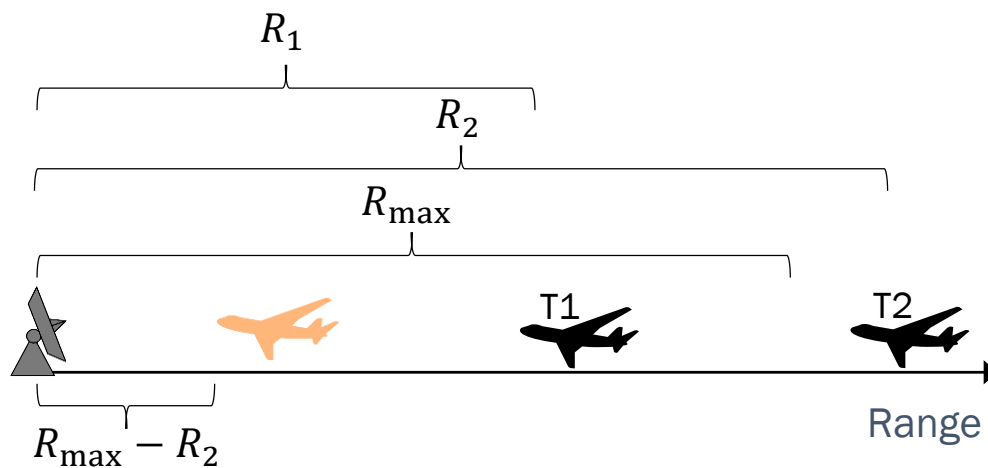

Left: Radar and two real targets (dark), one in (T1) and one out (T2) of unambiguous range, second target (T2) appears in closer range (light).

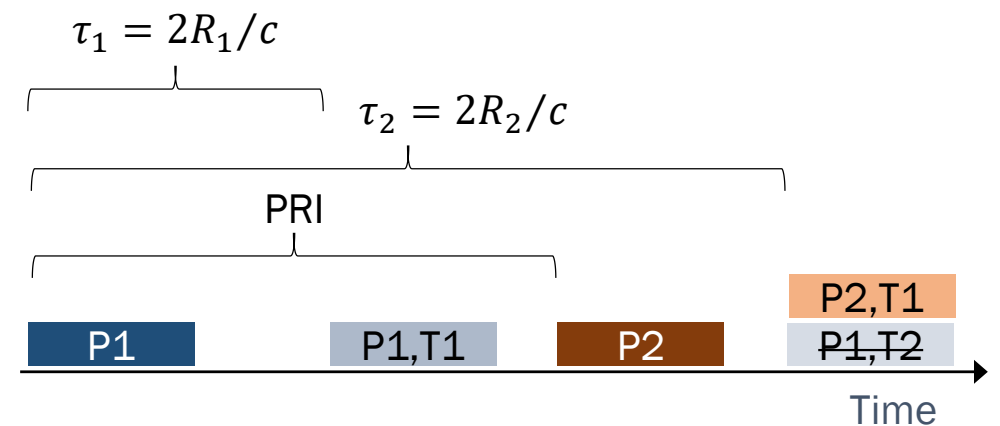

Right: Transmitted (dark) and received pulses (light) at the radar in time, radar confuses the echo from first pulse to second target (P1,T2) to an echo from second pulse (P2) and a target at a closer range ($R_{\max} - R_2$).

Data matrix

- Radar returns from each PRI are stored in memory for further processing;
- **Fast Time** refers to the different time slots composing a PRI, sampling rate dependent;
- **Slow Time** updates every PRI;

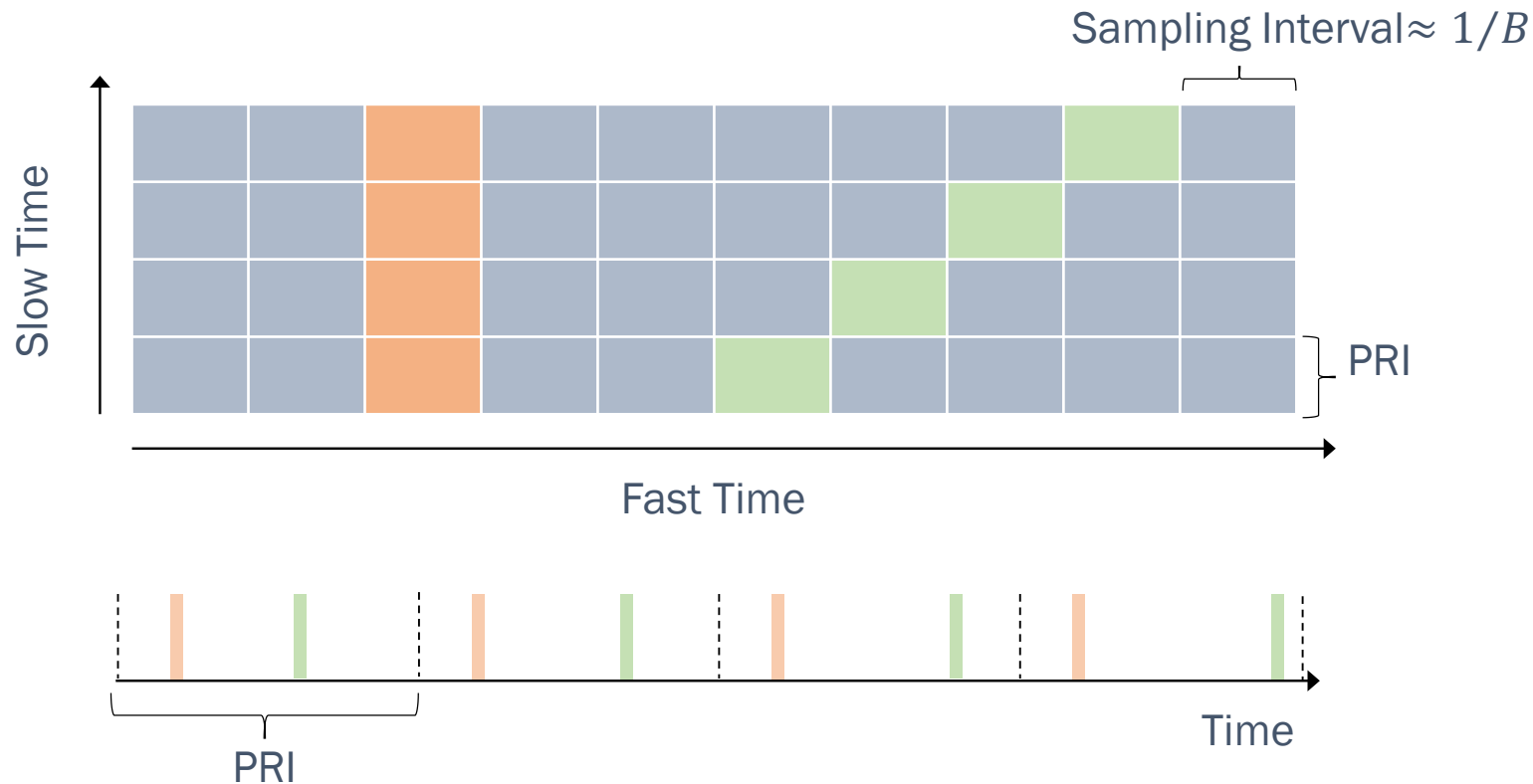

Example of two targets, one staying in the same resolution bin (orange) and one moving in different resolution bins (green);
Top: Data matrix for 10 time resolution bins and 4 PRI;
Bottom: Radar returns in time;

Data matrix

- Radar returns from each PRI are stored in memory for further processing;
- **Fast Time** refers to the different time slots composing a PRI, sampling rate dependent;
- **Slow Time** updates every PRI;

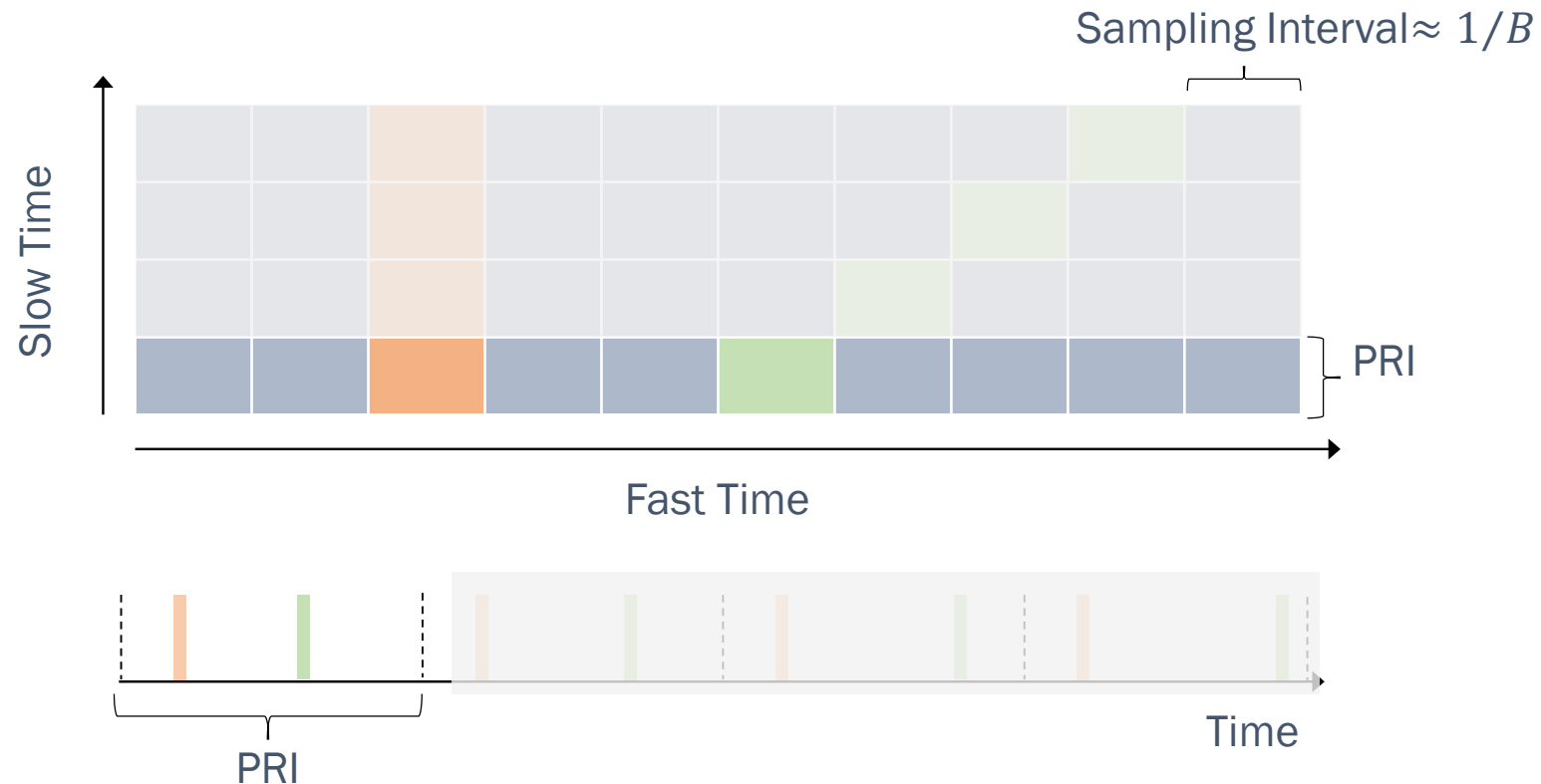

Example of two targets, one staying in the same resolution bin (orange) and one moving in different resolution bins (green);
Top: Data matrix for 10 time resolution bins and 4 PRI;
Bottom: Radar returns in time;

Data matrix

- Radar returns from each PRI are stored in memory for further processing;
- **Fast Time** refers to the different time slots composing a PRI, sampling rate dependent;
- **Slow Time** updates every PRI;

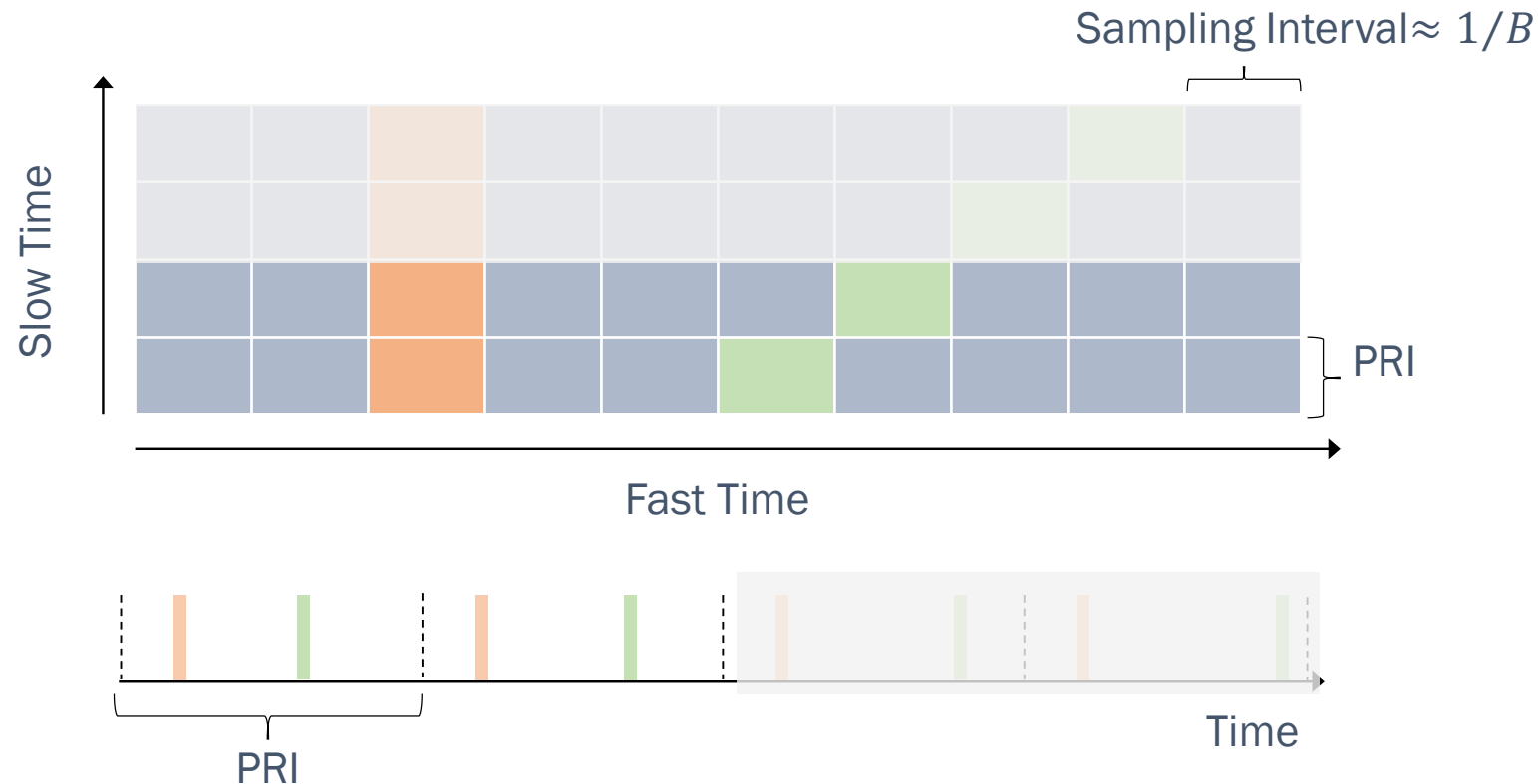

Example of two targets, one staying in the same resolution bin (orange) and one moving in different resolution bins (green);
Top: Data matrix for 10 time resolution bins and 4 PRI;
Bottom: Radar returns in time;

Data matrix

- Radar returns from each PRI are stored in memory for further processing;
- **Fast Time** refers to the different time slots composing a PRI, sampling rate dependent;
- **Slow Time** updates every PRI;

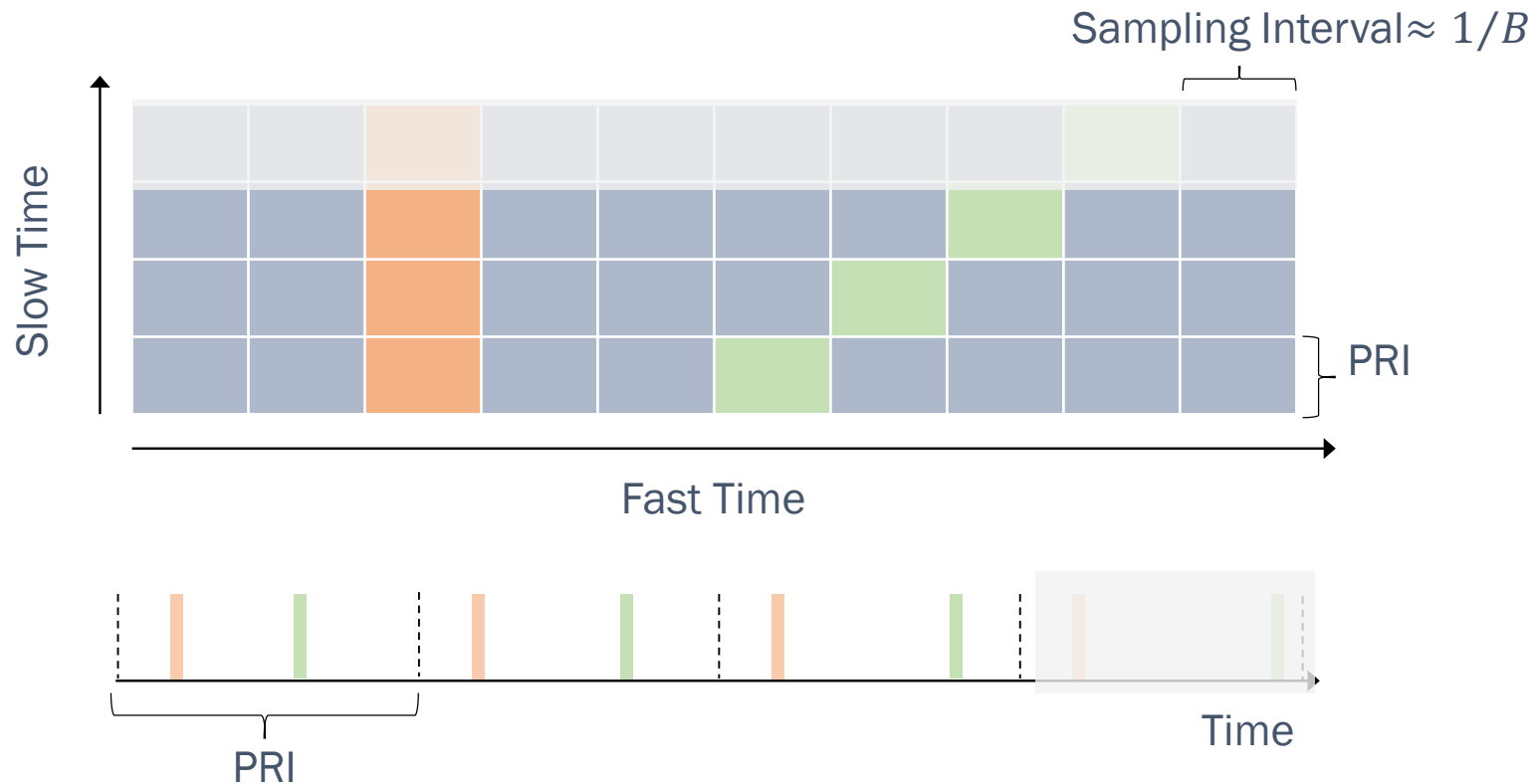

Example of two targets, one staying in the same resolution bin (orange) and one moving in different resolution bins (green);
Top: Data matrix for 10 time resolution bins and 4 PRI;
Bottom: Radar returns in time;

Data matrix

- Radar returns from each PRI are stored in memory for further processing;
- **Fast Time** refers to the different time slots composing a PRI, sampling rate dependent;
- **Slow Time** updates every PRI;

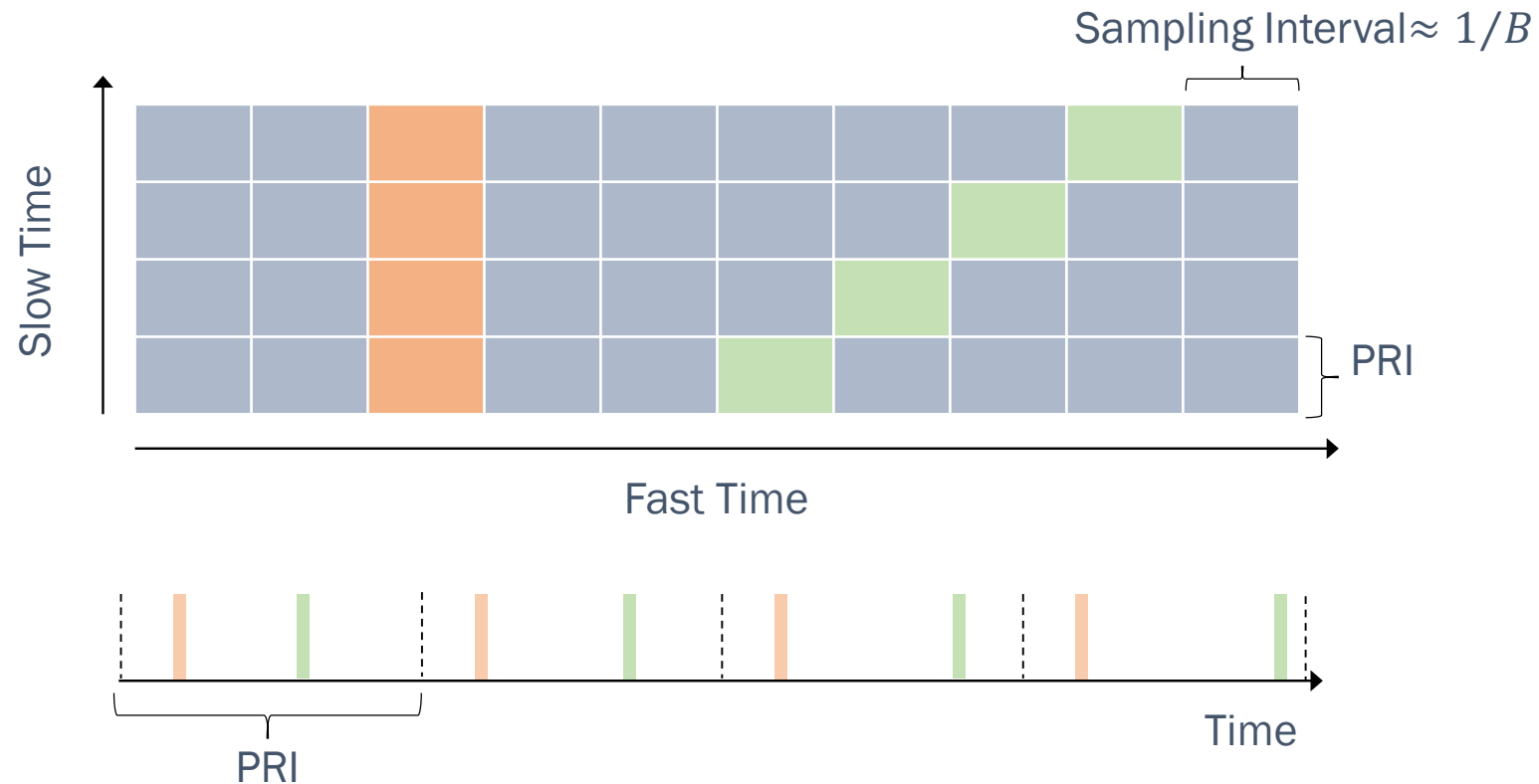

Example of two targets, one staying in the same resolution bin (orange) and one moving in different resolution bins (green);
Top: Data matrix for 10 time resolution bins and 4 PRI;
Bottom: Radar returns in time;

Data Cube

- Data Cube is an extension to Data Matrix including spatial sampling;
- In cases that the radar uses **multiple** receiving channels, the **data matrices** from each receiver are stacked to form a data cube;

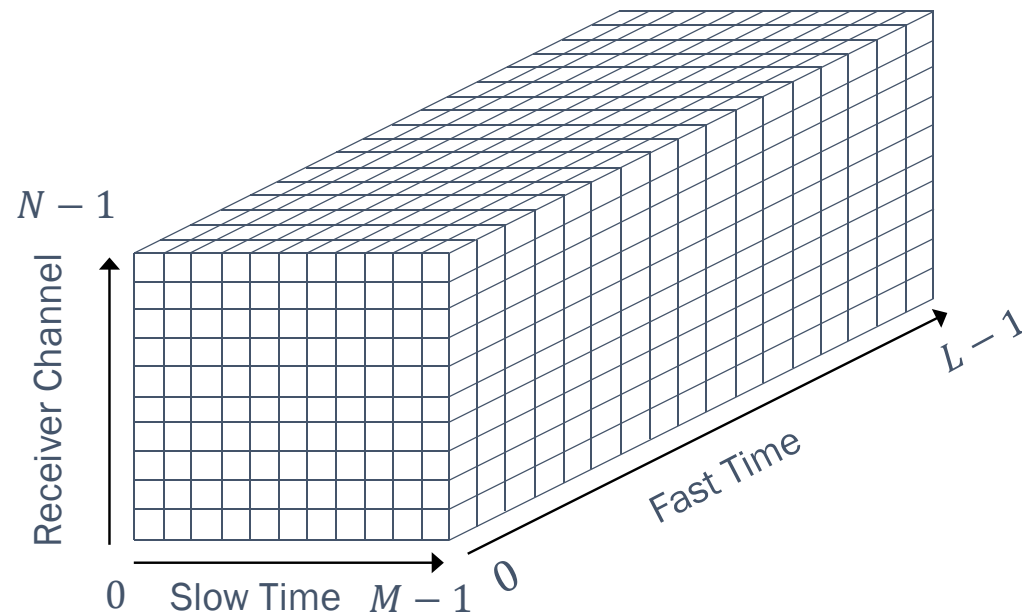
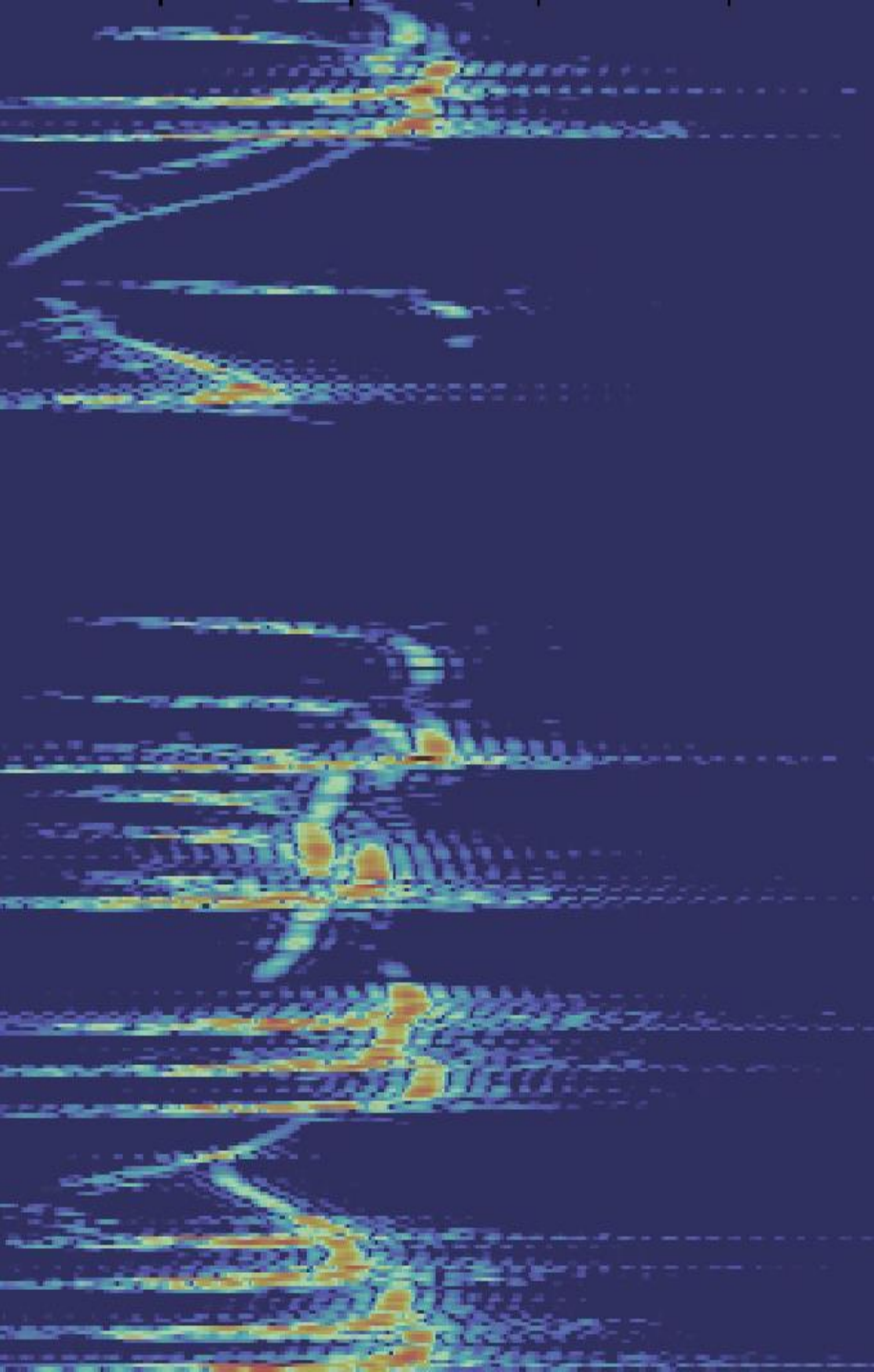

Illustration of a data cube for L time samples in each PRI and M PRI in a system composed of N receiver channels.



Coherent and Doppler processing.

- Spectrum of Continuous Wave Signal;
- Spectrum of Pulsed Signal;
- Range-Doppler Maps;

Spectrum of Continuous Wave Signal

- Consider a continuous wave (CW) radar with operating frequency f_0 ;
- In the presence of a target moving with **radial velocity** u_r , due to the **Doppler** phenomenon, the echoed signal will be shifted in frequency by:

$$f_D = \frac{u_r}{c} f_0$$

- **Positive** Doppler shifts ($f_D > 0$) indicate that the target is moving **towards** the radar, while **negative** ($f_D < 0$) **away** from it;

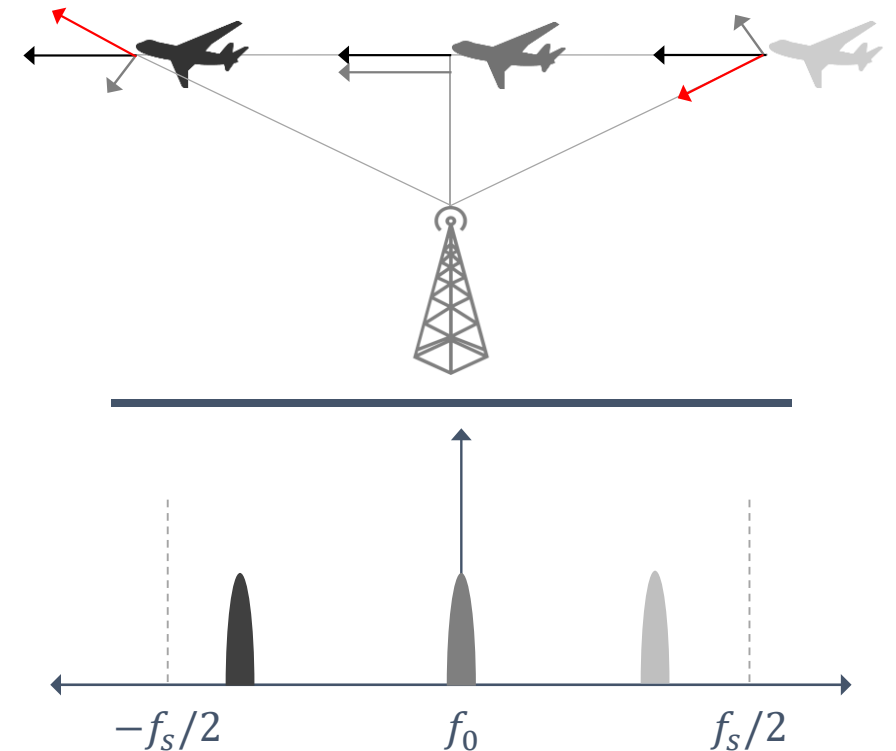

Stationary radar and moving target scenario: (T) geometry of the radar target system, (B) frequency observed by the radar

Spectrum of Continuous Wave Signal

- Consider a continuous wave (CW) radar with operating frequency f_0 ;
- In the presence of a target moving with **radial velocity** u_r , due to the **Doppler** phenomenon, the echoed signal will be shifted in frequency by:

$$f_D = \frac{u_r}{c} f_0$$

- **Positive** Doppler shifts ($f_D > 0$) indicate that the target is moving **towards** the radar, while **negative** ($f_D < 0$) **away** from it;

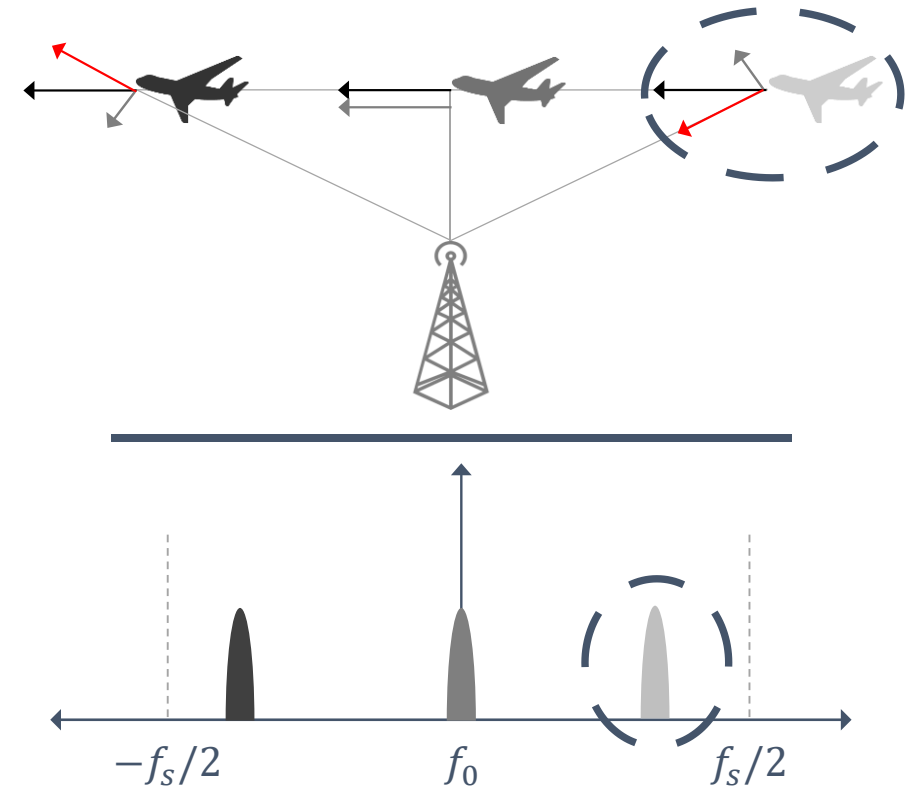

Stationary radar and moving target scenario: (T) geometry of the radar target system, (B) frequency observed by the radar

Spectrum of Continuous Wave Signal

- Consider a continuous wave (CW) radar with operating frequency f_0 ;
- In the presence of a target moving with **radial velocity** u_r , due to the **Doppler** phenomenon, the echoed signal will be shifted in frequency by:

$$f_D = \frac{u_r}{c} f_0$$

- **Positive** Doppler shifts ($f_D > 0$) indicate that the target is moving **towards** the radar, while **negative** ($f_D < 0$) **away** from it;

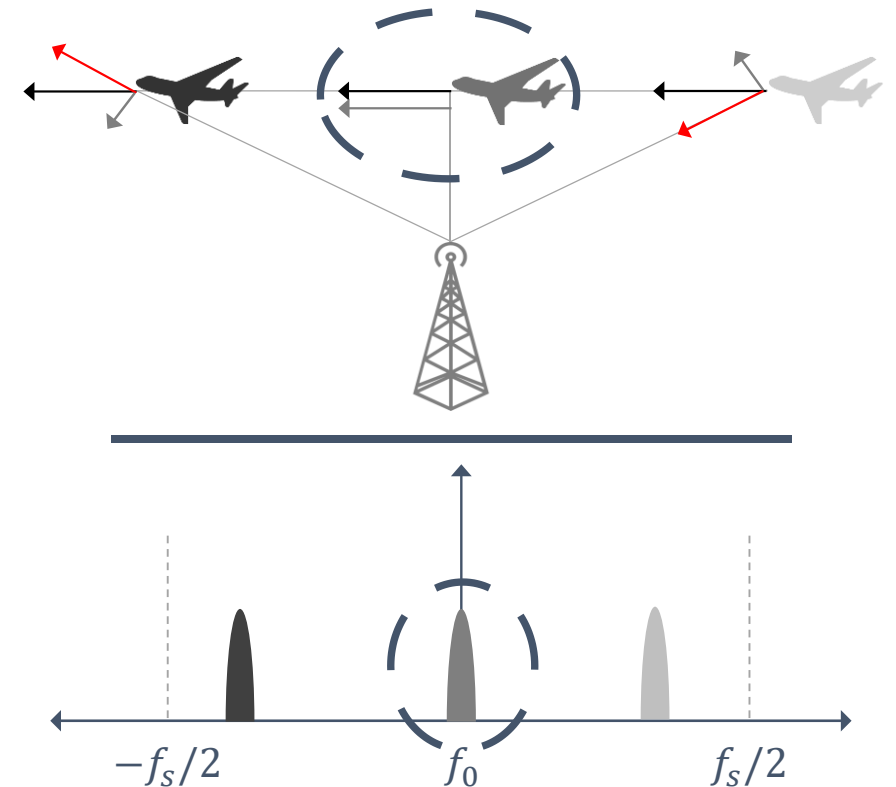

Stationary radar and moving target scenario: (T) geometry of the radar target system, (B) frequency observed by the radar

Spectrum of Continuous Wave Signal

- Consider a continuous wave (CW) radar with operating frequency f_0 ;
- In the presence of a target moving with **radial velocity** u_r , due to the **Doppler** phenomenon, the echoed signal will be shifted in frequency by:

$$f_D = \frac{u_r}{c} f_0$$

- **Positive** Doppler shifts ($f_D > 0$) indicate that the target is moving **towards** the radar, while **negative** ($f_D < 0$) **away** from it;

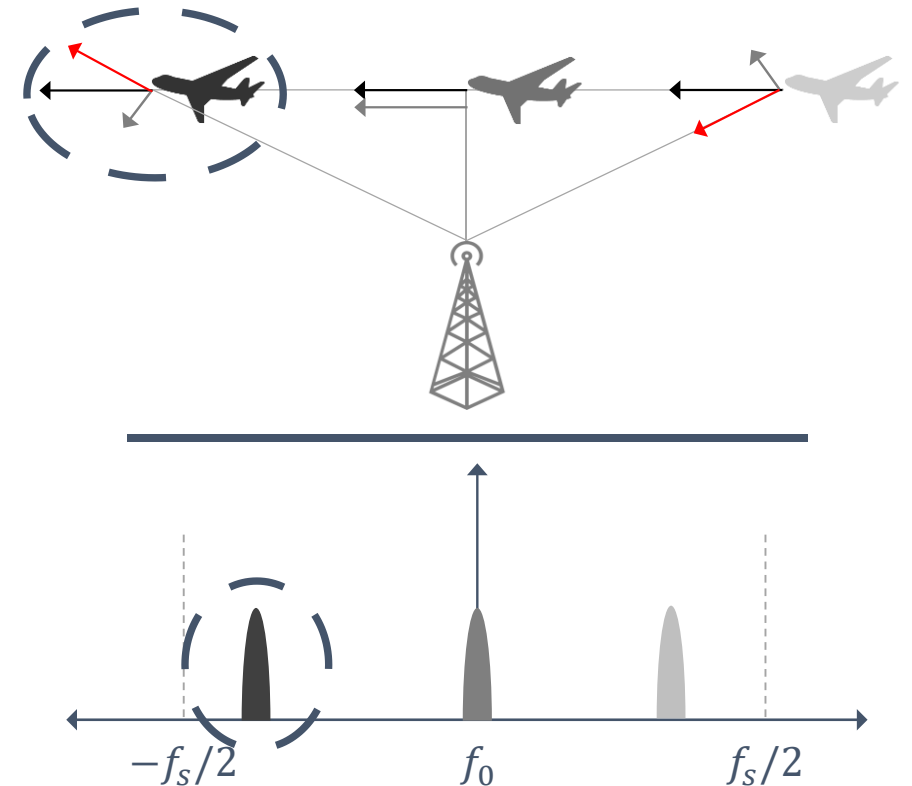

Stationary radar and moving target scenario: (T) geometry of the radar target system, (B) frequency observed by the radar

Spectrum of Pulsed Signal

- In most radar systems, the bandwidth of a single pulse may be a few orders of magnitude **greater** than the expected Doppler frequency shift:

$$\frac{1}{T} \gg f_D$$

- Echoes from moving targets **cannot be discriminated** from stationary clutter in spectrum;
- Using consequent pulsed over a coherent pulse interval (**CPI**), the single pulse bandwidth is divided into spectral line of approximate bandwidth $1/\text{CPI}$.

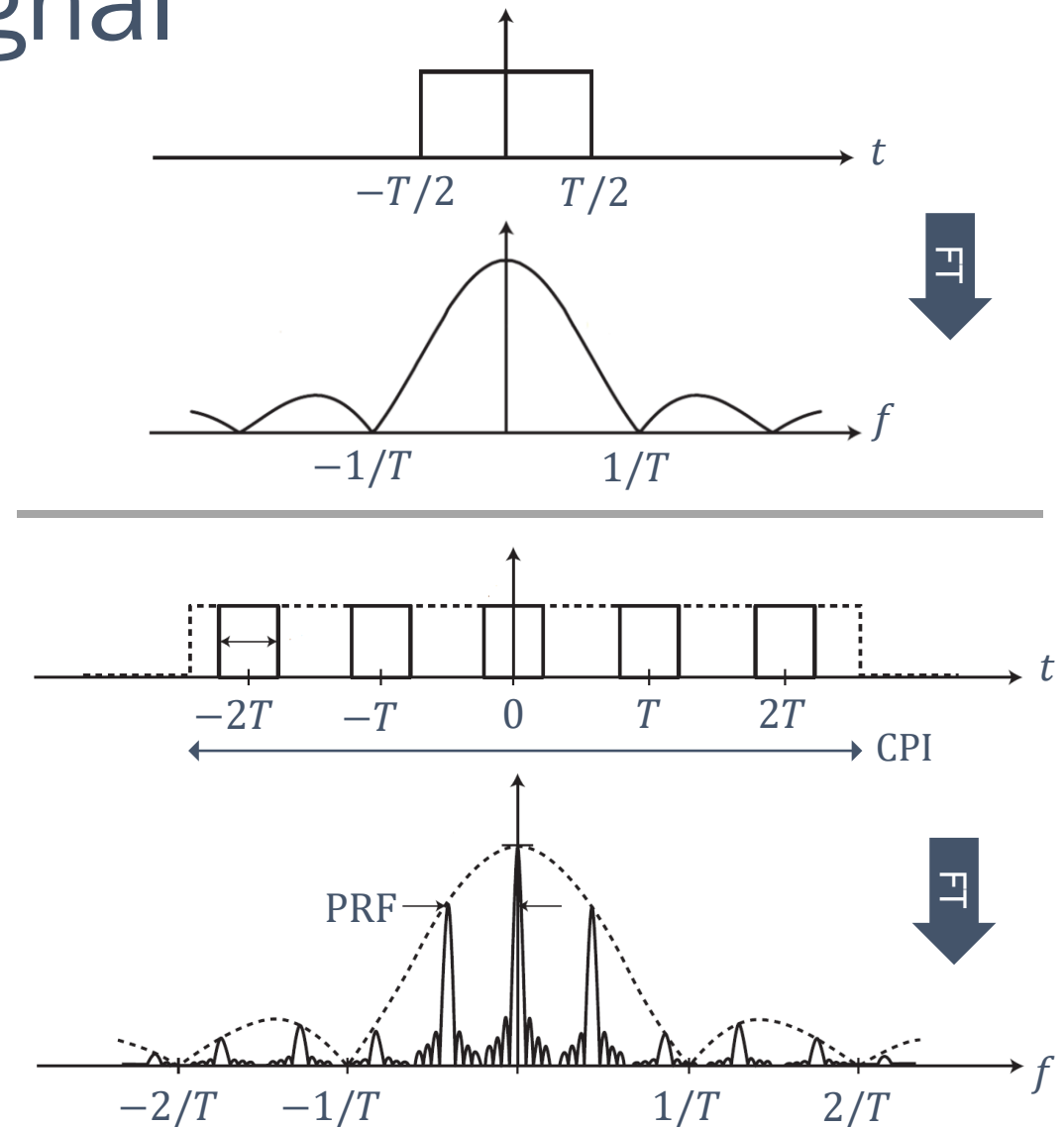

Spectrum of Pulsed Signal

- In most radar systems, the bandwidth of a single pulse may be a few orders of magnitude **greater** than the expected Doppler frequency shift:

$$\frac{1}{T} \gg f_D$$

- Echoes from moving targets **cannot be discriminated** from stationary clutter in spectrum;
- Using consequent pulsed over a coherent pulse interval (**CPI**), the single pulse bandwidth is divided into spectral line of approximate bandwidth $1/\text{CPI}$.

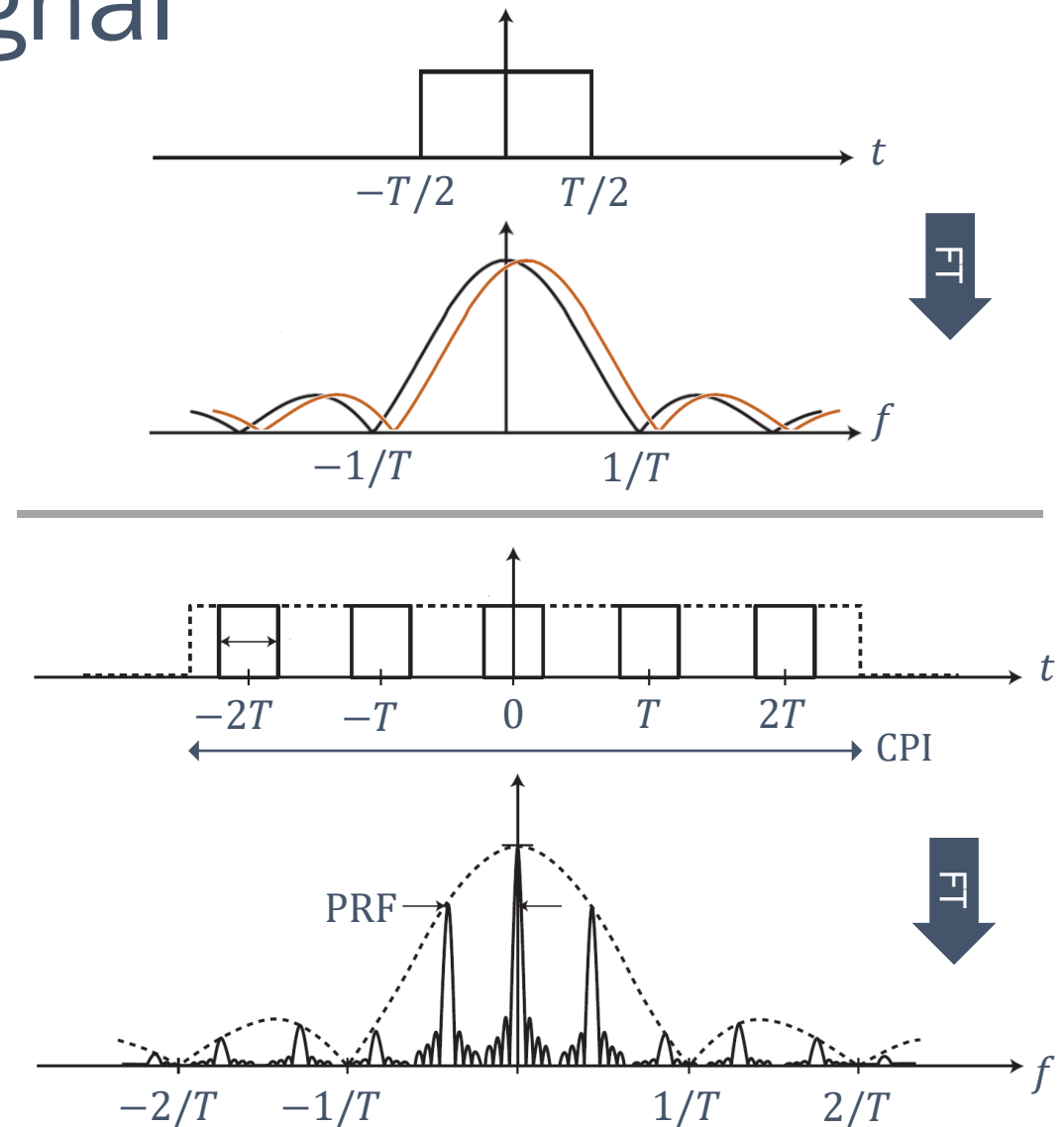

Spectrum of Pulsed Signal

- In most radar systems, the bandwidth of a single pulse may be a few orders of magnitude **greater** than the expected Doppler frequency shift:

$$\frac{1}{T} \gg f_D$$

- Echoes from moving targets **cannot be discriminated** from stationary clutter in spectrum;
- Using consequent pulsed over a coherent pulse interval (**CPI**), the single pulse bandwidth is divided into spectral line of approximate bandwidth $1/\text{CPI}$.

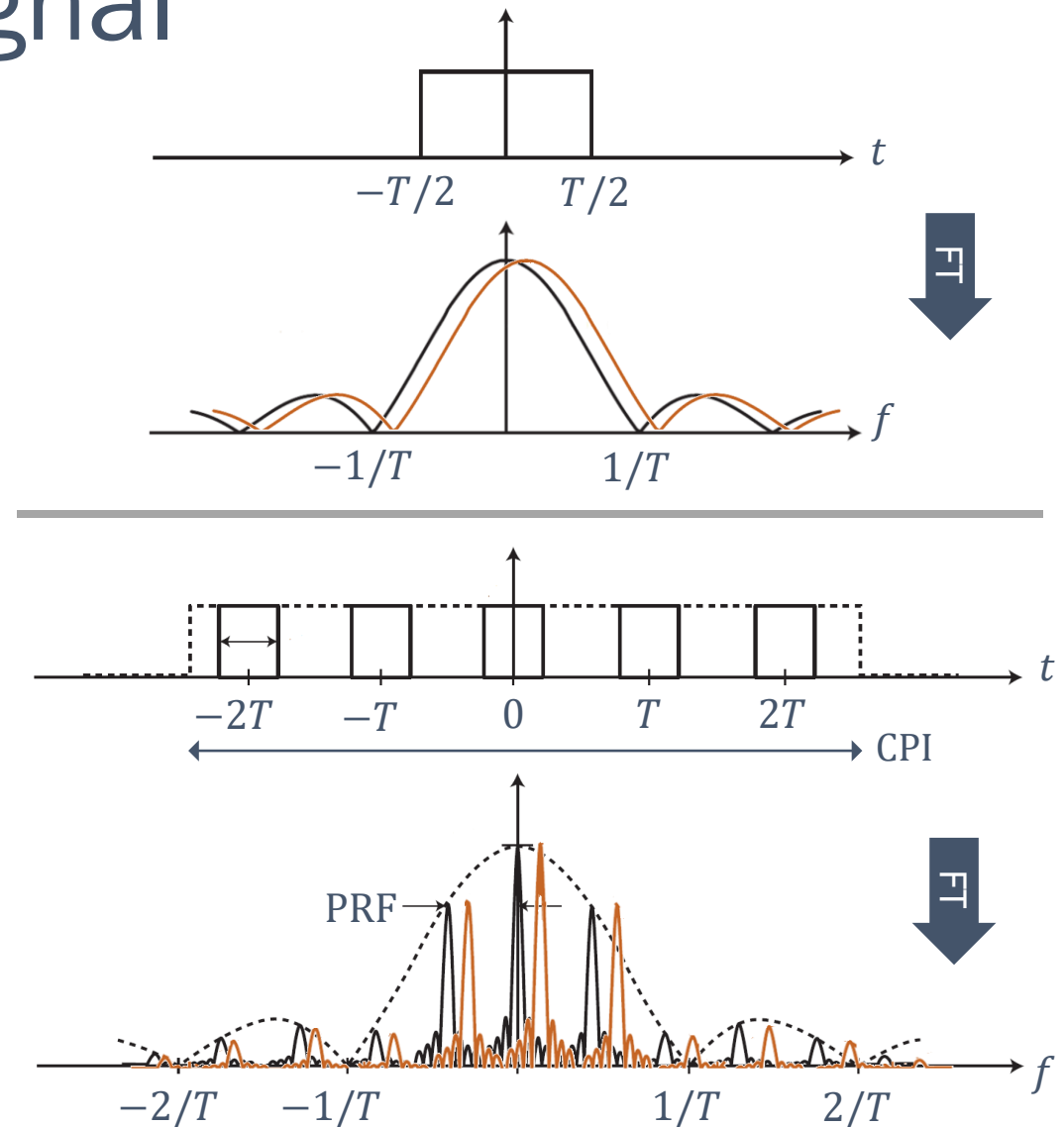

Range-Doppler Maps

- In a moving target the **phase information** appears in each received pulse.
- Different returns can be **separated** in the Doppler domain.
- Range-Doppler map is contracting by converting **Fast time** to **Range** and **Slow time** to **Doppler** by applying Fourier Transform.

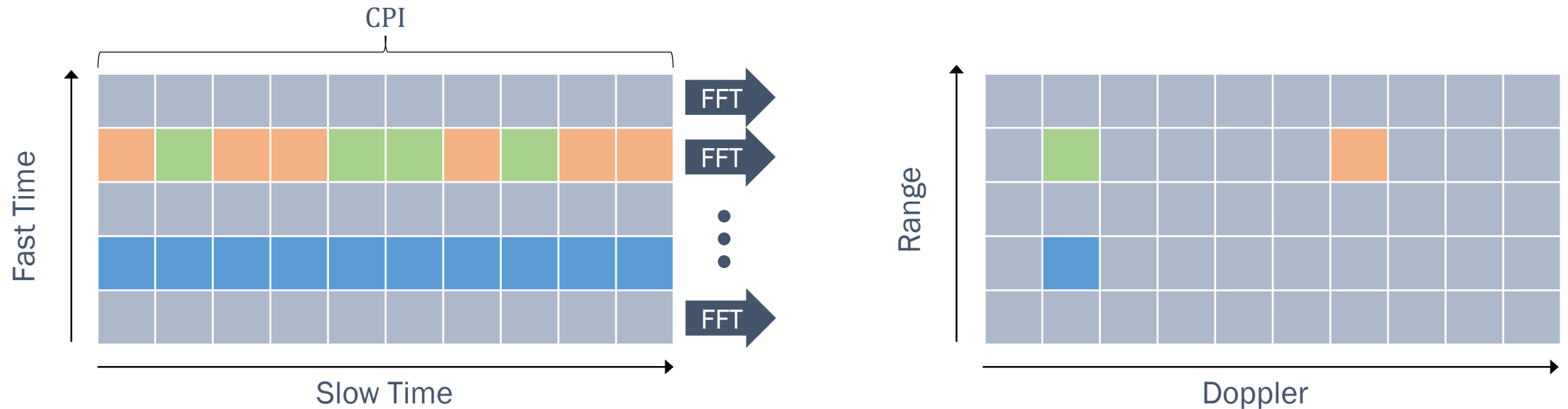

Scenario of 3 targets: two in the same range bin and different velocity (green and orange) and one in different range (blue), (L) In Data matrix two targets can be separated, (R) In Range-Doppler map all 3 targets can be separated.

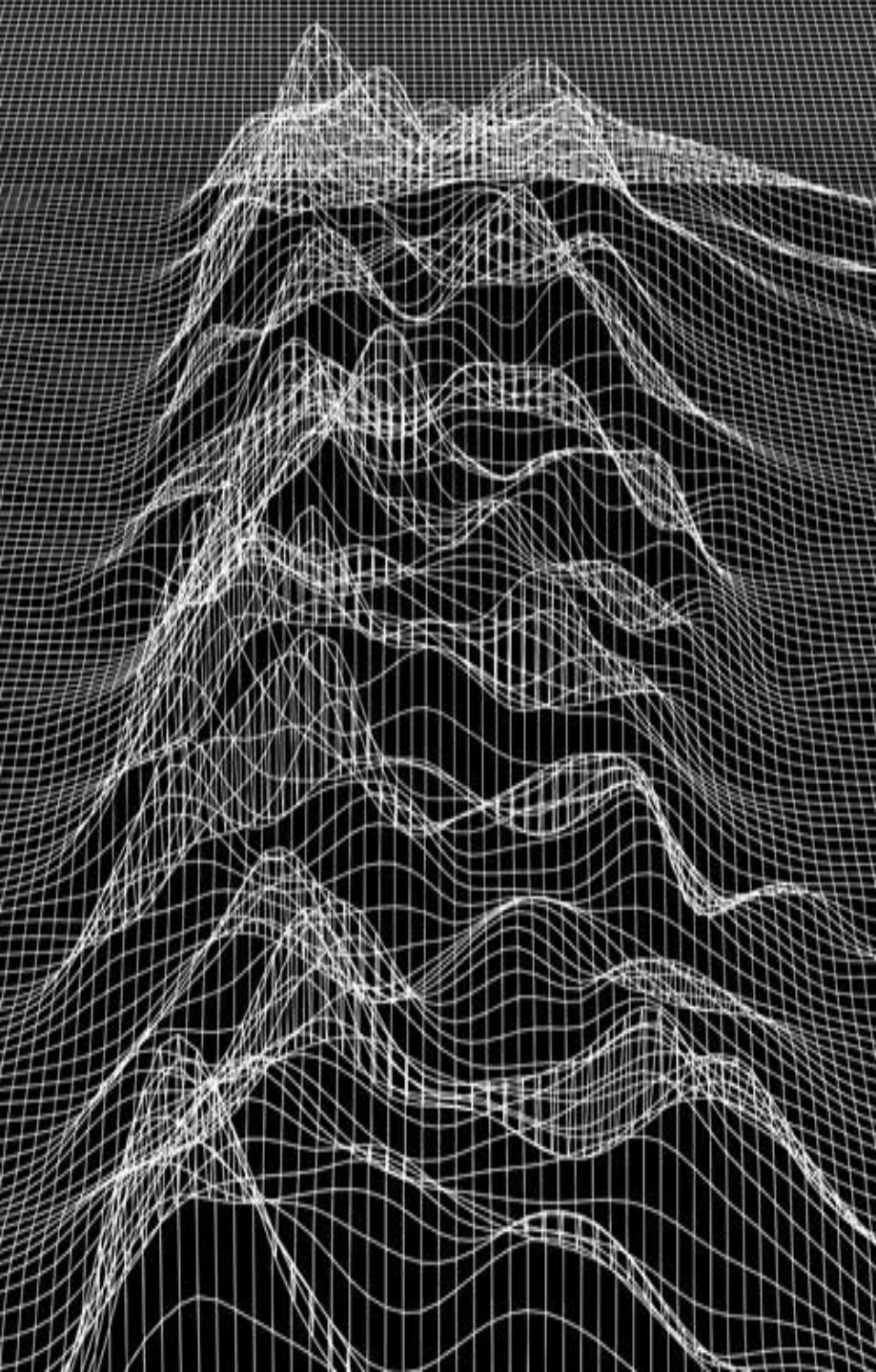

Waveforms Design and Pulse Compression

- Noise and Interference
- Matched Filter
- Pulse compression
- Linear Frequency Modulation
- Ambiguity Function

Noise and Interference

- Noise is a random, unwanted signal characterised by statistical properties;
- Sources of interference can be **internal** (equipment imperfections) or **external** (other RF transmissions), **passive** (clutter) or **active** (jammers);
- The power ratio between the **useful** and **unwanted** signal is defined as **signal-to-interfered-plus-noise ratio (SINR)**:

$$\text{SINR} = \frac{P_{\text{Signal}}}{P_{\text{Interference}} + P_{\text{Noise}}} \rightarrow \text{SNR} = \frac{P_{\text{Signal}}}{P_{\text{Noise}}}$$

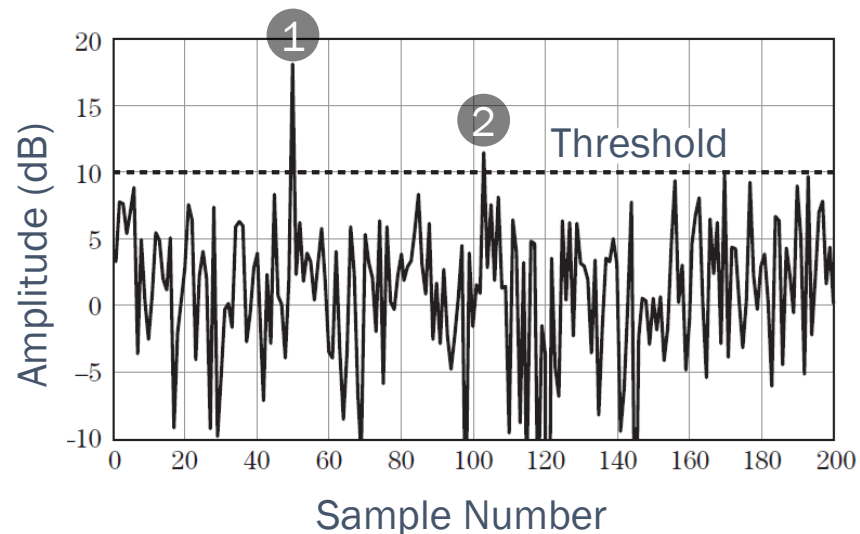

Example of a high SNR target (1) and a false detection (2), the radar is not able to discriminate between interference and low SNR targets [Principles of Modern Radar - Mark A Richards].

Matched Filter

- The knowledge of the transmitted signal is utilised to design a **linear filter** that maximises the SNR;
- In the presence of additive Gaussian noise, the optimum filter is a **time reversed** version of the transmitted signal (“matched”);

$$h(t) = x^*(\tau_{\max} - t)$$

$h(t)$: Matched filter of $x(t)$;

$\{\cdot\}^*$: Complex conjugate;

τ_{\max} : Time instant in which the SNR is maximised;

- For noise given by $\mathcal{CN}(0, \sigma^2)$, the maximum SNR is:

$$\text{SNR}_{\max} = \frac{E}{\sigma^2}$$

E : Energy of the pulse.

- The output of the matched filter is the auto-correlation of the pulse.

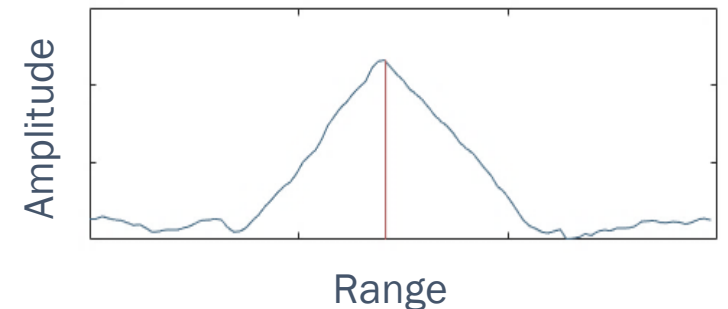
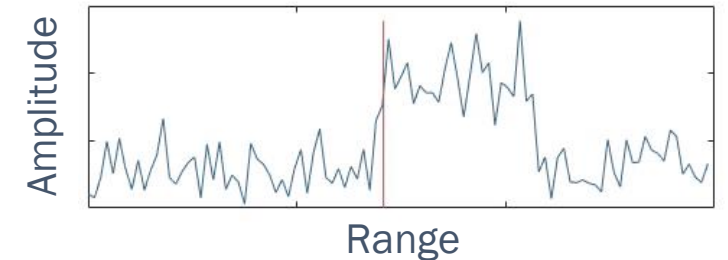

Range profile with a target at the red line (T) before and (B) after matched filter.

Pulse Compression

- Sort pulses provide good resolution but **not** enough energy for long distances;
- The resolution is (**almost**) proportional to the bandwidth;
- Using pulse compression **long waveforms** (high energy) can achieve the **resolution** of a short pulse by increasing their bandwidth through internal modulation;
- A side effect of pulse compression is the rise of **undesired sidelobes**;

Matched filter output of (T) an unmodulated square pulse and (B) a linear frequency modulated pulse.

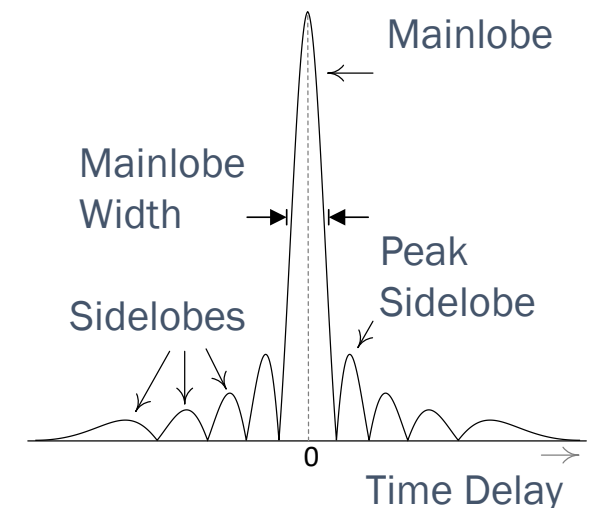
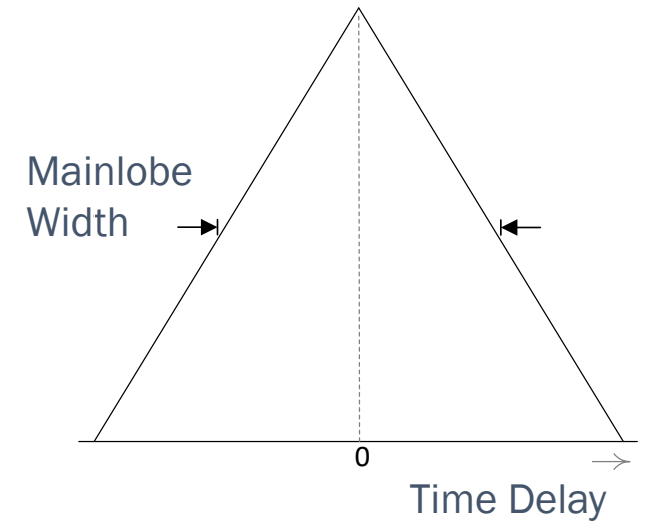

Linear Frequency Modulation

- Pulse compression can be achieved using frequency modulation (FM);
- Linear FM (LFM) is a very popular choice;
- LFM achieve high resolution while keeping the H/W implementation relative simple;

$$x(t) = e^{j\pi(B/T)t^2}, \quad 0 \leq t \leq T$$

$$f = \frac{B}{2T}t : \text{Instantaneous frequency};$$

- LFM suffer from high sidelobe levels (SLL);
- Using **non-linear** FM (NLFM) the SLL can be reduced but are more complex to generate.

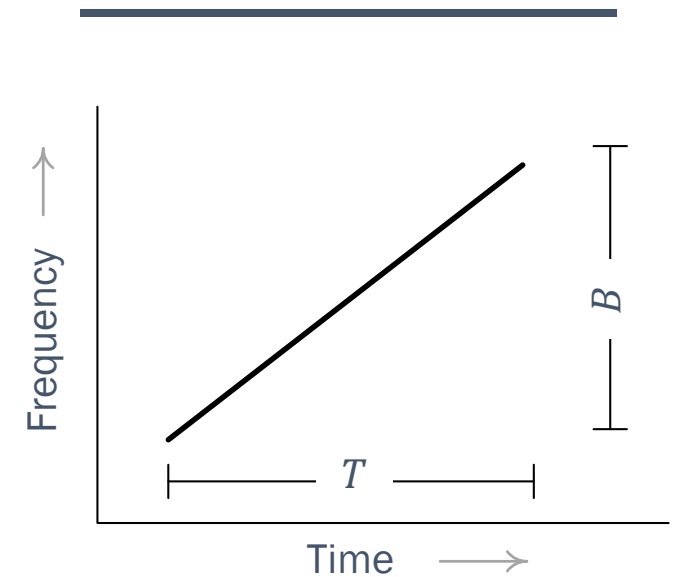

Top: Real part of (L) an unmodulated pulse and (R) a LFM pulse;

Bottom: Time-Frequency profile of a LFM pulse.

Ambiguity Function – Definition

- The ambiguity function (AF) is a 2-D function describing the response of a matched filter when the signal is received with a **delay** τ and a **Doppler shift** f_D relative to the expected:

$$A(\tau, f_D) = |x(t)x^*(t + \tau)e^{j2\pi f_D t}|$$

- The **zero-Doppler cut** of the AF is given by the **autocorrelation** of the pulse:

$$A(\tau, 0) = |x(t)x^*(t + \tau)|$$

- The **zero-Delay cut** of the AF is given by the **Fourier Transform (FT)** of the squared modulus of the pulse:

$$A(0, f_D) = \left| |x(t)|^2 e^{j2\pi f_D t} \right|$$

Ambiguity Function – Definition

- The ambiguity function (AF) is a 2-D function describing the response of a matched filter when the signal is received with a **delay** τ and a **Doppler shift** f_D relative to the expected:

$$A(\tau, f_D) = |x(t)x^*(t + \tau)e^{j2\pi f_D t}|$$

- The **zero-Doppler cut** of the AF is given by the **autocorrelation** of the pulse:

$$A(\tau, 0) = |x(t)x^*(t + \tau)|$$

- The **zero-Delay cut** of the AF is given by the **Fourier Transform (FT)** of the squared modulus of the pulse:

$$A(0, f_D) = \left| |x(t)|^2 e^{j2\pi f_D t} \right|$$

Ambiguity Function – Examples

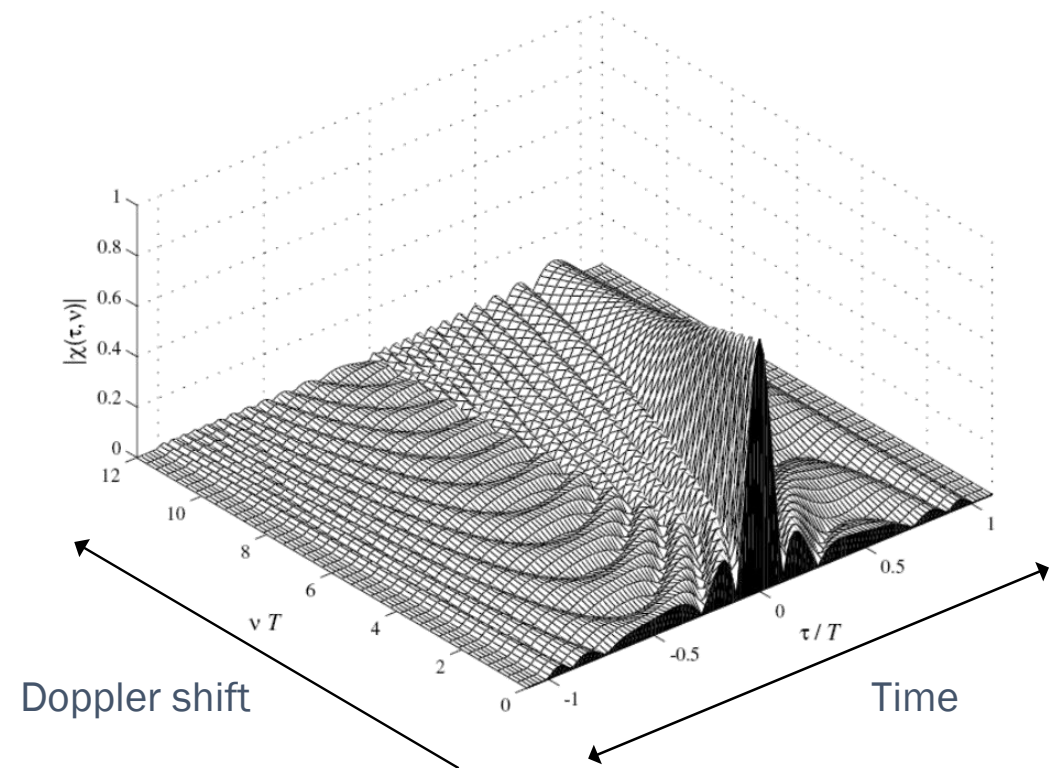
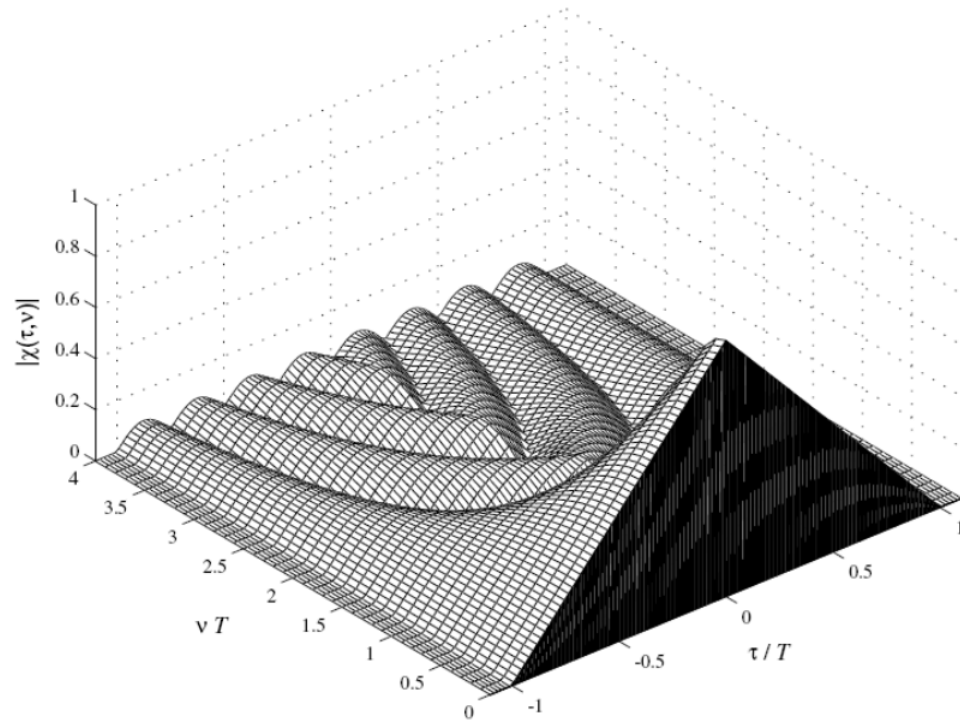

Illustration of the AF for (L) an unmodulated pulse, (R) a LFM.

Ambiguity Function – Examples

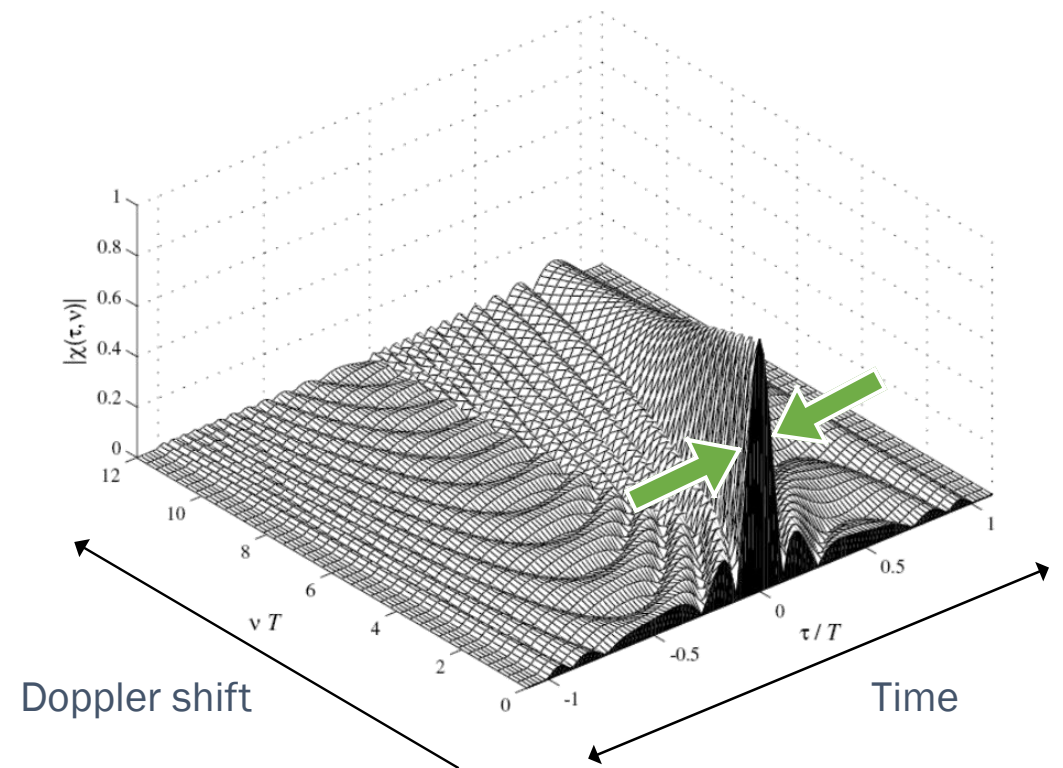
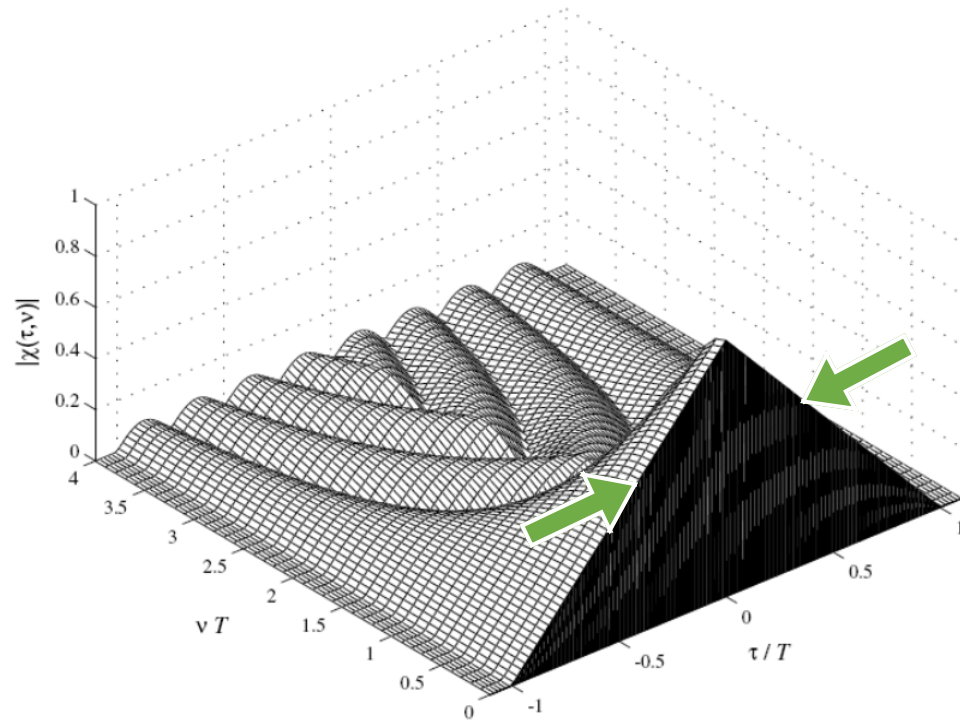

Illustration of the AF for (L) an unmodulated pulse, (R) a LFM.

Resolution

Ambiguity Function – Examples

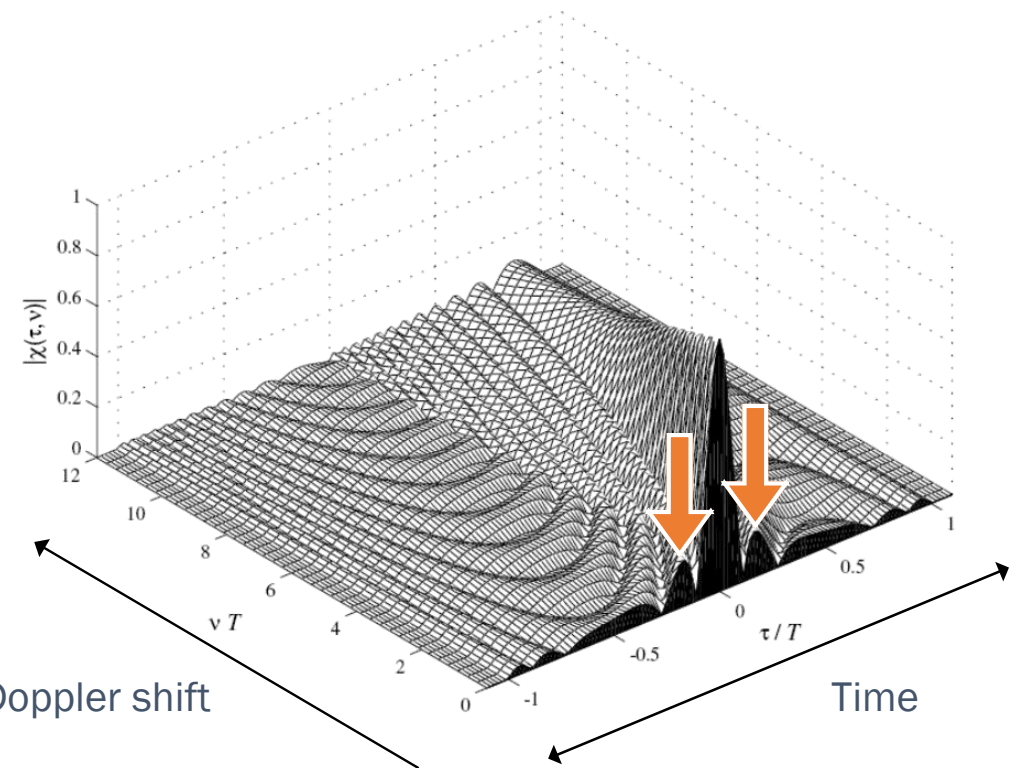
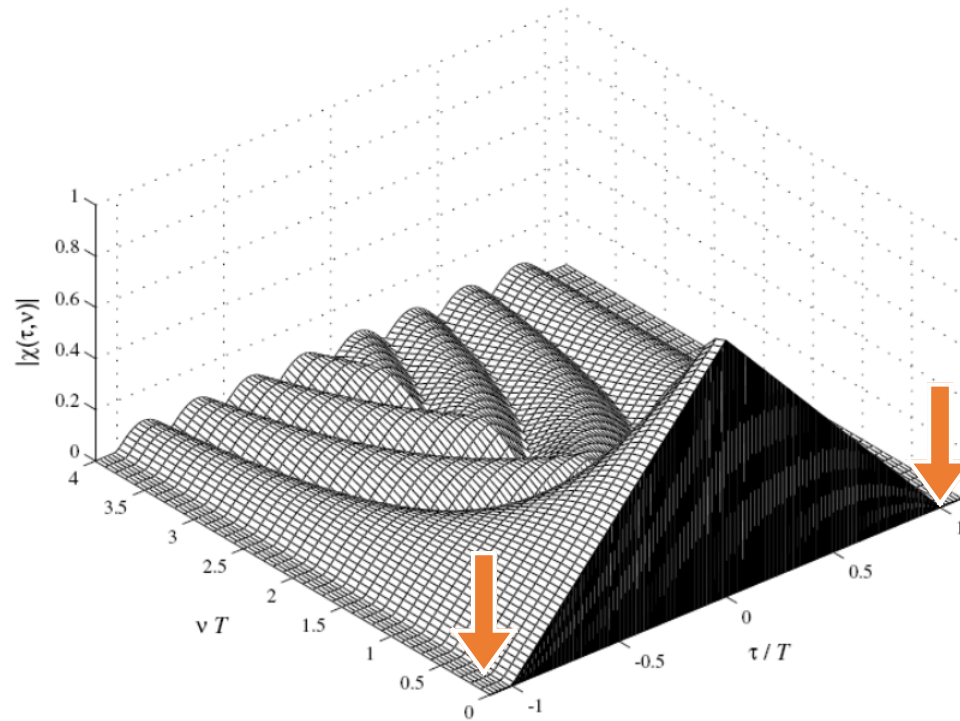

Illustration of the AF for (L) an unmodulated pulse, (R) a LFM.

Side Lobe Levels

Ambiguity Function – Examples

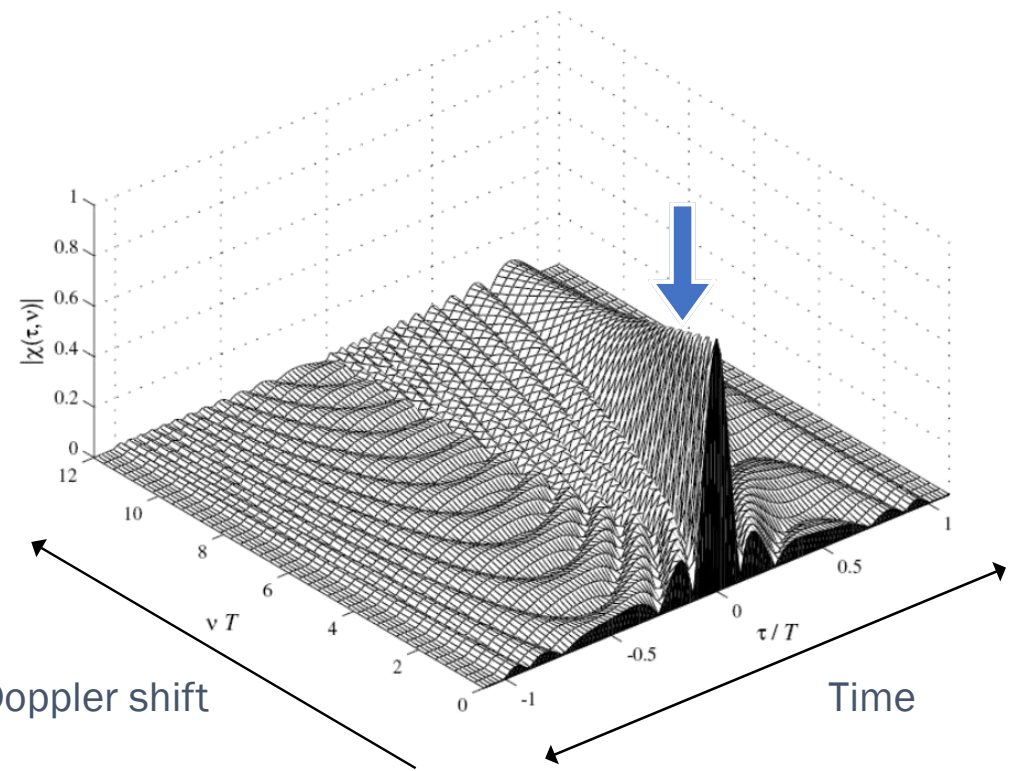
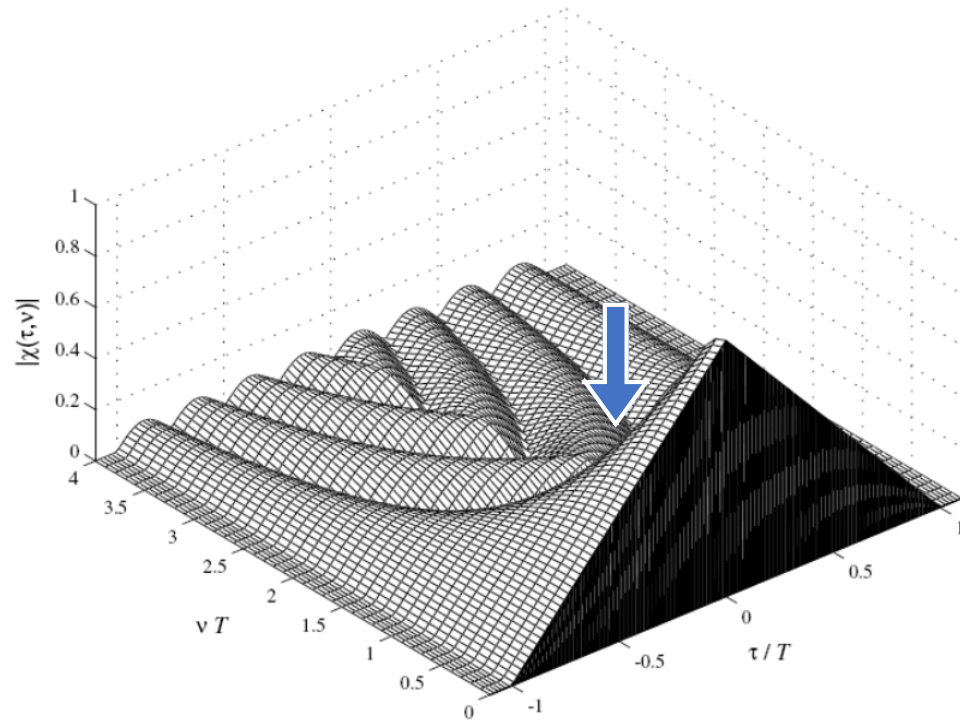

Illustration of the AF for (L) an unmodulated pulse, (R) a LFM.

Time-Frequency Response

Closing Remarks

- Basic radar principles were discussed;
- Introduction on radar acquisitions and signal processing;
- Introduction on pulse compression and waveform design tools;



That's all Folks!



Reading Material

- Principles Of Modern Radar: Basic Principles
– Mark A Richards;
- Radar Signals
– Nadav Levanon;
- Radar System Analysis and Design Using MATLAB
– Bassem R. Mahafza.



University of
Strathclyde
Glasgow

The University of Strathclyde is a charitable body, registered in Scotland, with registration number SC015263

THANK
YOU