KODAK EASYSHARE C142 Digital Camera



Extended user guide

www.kodak.com

For interactive tutorials:

www.kodak.com/go/howto

For help with your camera:

www.kodak.com/go/c142support

Kodak

Eastman Kodak Company

Rochester, New York 14650

© Eastman Kodak Company, 2009

All screen images are simulated.

Kodak and EasyShare are trademarks of Eastman Kodak Company.

4H6813_en

Front view

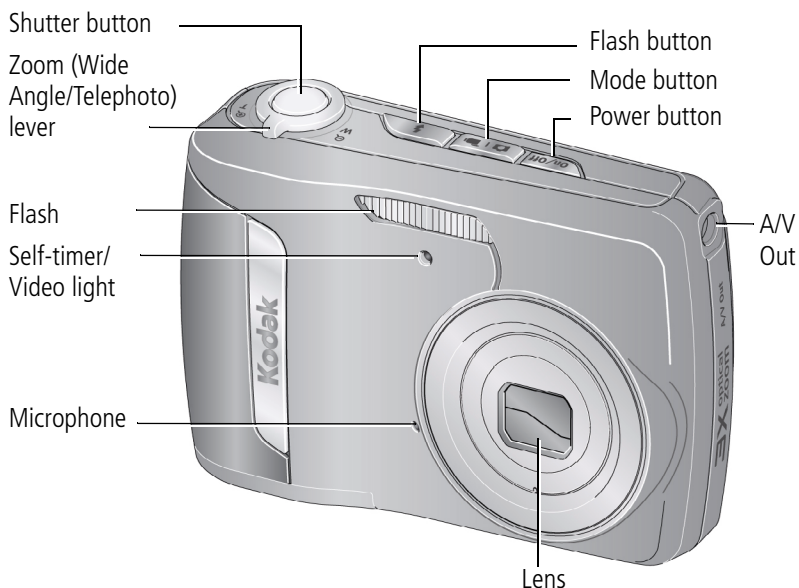

IMPORTANT: Your camera offers a built-in Help system. See page 38.

Back view

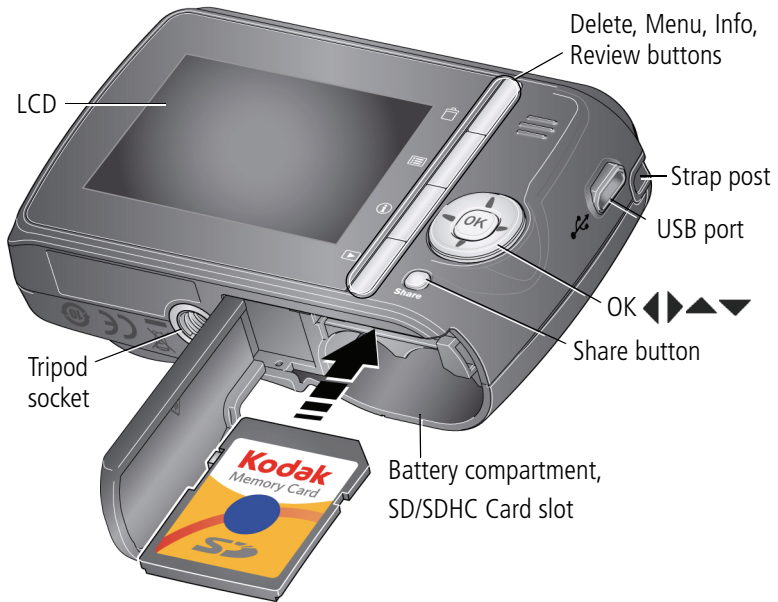

IMPORTANT: Your camera offers a built-in Help system. See [page 38](#).

Table of contents

1	Setting up your camera	1
	Attaching the strap	1
	Loading the AA batteries	1
	Turning on the camera	2
	Setting the language and date/time	2
	Storing pictures on an optional SD or SDHC Card	3
2	Taking pictures/videos	4
	Taking pictures	4
	Taking a video	5
	Understanding the picture-taking icons	6
	Know when your batteries need attention	6
	Using the optical zoom	7
	Using the flash	8
	Using different modes	9
	Using shortcuts	11
	Using the self-timer	12
	Using burst	12
3	Sharing and tagging pictures	13
	Sharing through social networks	13
	Tagging pictures	15
	Marking pictures/videos for emailing	16
4	Reviewing and editing	17
	Reviewing pictures/videos	17
	Deleting pictures/videos	18
	Viewing pictures/videos in different ways	19
	A smarter way to find and enjoy your pictures	20
	Understanding the review icons	21
	Creating a slide show	22

Displaying pictures/videos on a television.....	23
Using the menu button in review.....	24
Cropping pictures.....	24
Rotating pictures.....	25
Editing videos.....	26
Selecting multiple pictures/videos.....	27
Copying pictures/videos.....	27
5 Doing more with your camera.....	28
Using the menu button to change settings.....	28
Using the Setup menu.....	32
6 Transferring, printing pictures.....	34
Download software, transferring pictures.....	34
Printing pictures.....	35
Marking your pictures for printing.....	37
7 Troubleshooting.....	38
Getting help from your camera.....	38
Troubleshooting.....	39
Getting help on the Web.....	43
8 Appendix.....	44
Camera specifications.....	44
Care and maintenance.....	46
Upgrading your software and firmware.....	46
Storage capacities.....	47
Important safety instructions.....	47
Battery replacement, battery life.....	48
Limited warranty.....	49
Regulatory compliance.....	50

1

Setting up your camera

Attaching the strap



Loading the AA batteries

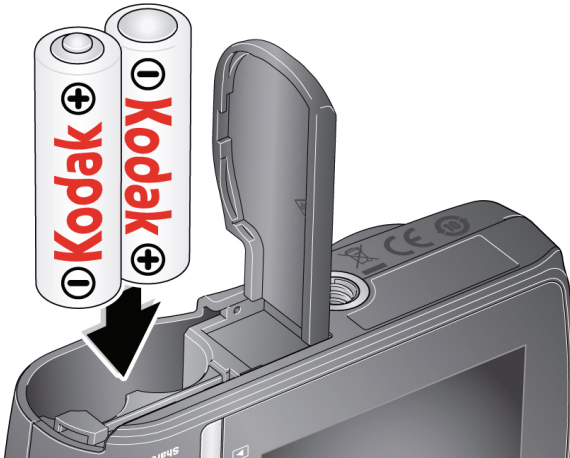

Purchase extra batteries for your special event www.kodak.com/go/c142accessories

Turning on the camera

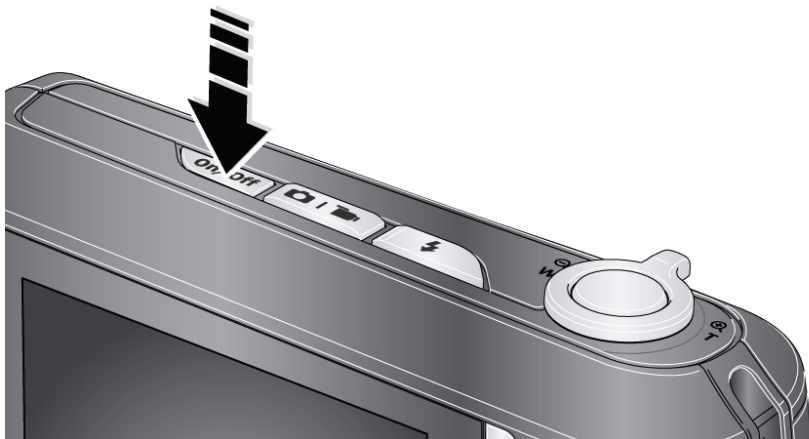

Setting the language and date/time

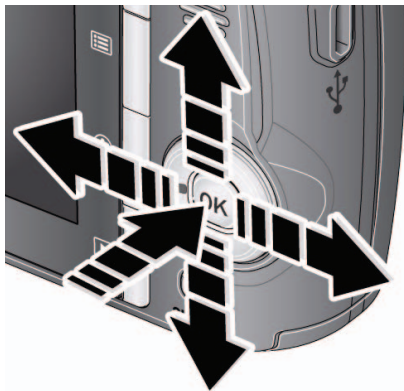

Language:

▲▼ to change.
OK to accept.

Date/Time:

At the prompt, press OK.

▲▼ to change current field.
◀▶ for previous/next field.
OK to accept.

NOTE: To change language in the future, use the Setup Menu ([see page 32](#)).

Storing pictures on an optional SD or SDHC Card

Your camera has internal memory. We recommend purchasing an SD or SDHC Card to conveniently store more pictures/videos.



CAUTION:

A card can only be inserted one way; forcing it may cause damage. Inserting or removing a card while the camera is on may damage the pictures, the card, or the camera.

- 1 Turn off the camera.
- 2 Insert the card.
Push it until it clicks.
- 3 Turn on the camera.

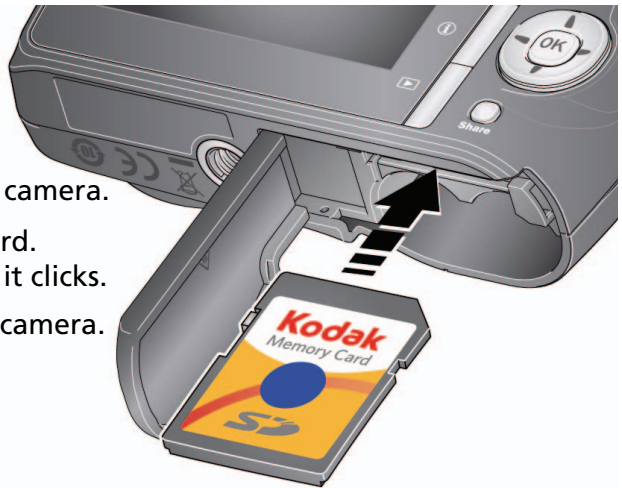

Purchase accessories www.kodak.com/go/c142accessories

2

Taking pictures/videos

Taking pictures

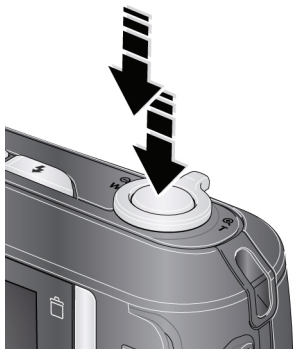

To get clear, focused pictures:

- 1 The camera turns on in Smart Capture mode. (If it's in a different mode, press the Mode button, then ▲▼ until the LCD displays Smart Capture mode , then press OK.)
- 2 Compose the picture.
- 3 Press the Shutter button **halfway** to focus and set exposure. When the framing marks turn green, press the Shutter button **completely down**.

Using the framing marks



Framing marks indicate the camera focus area.

- 1 Press the Shutter button **halfway**.
If the camera is not focusing on the desired subject, release the Shutter button and recompose the scene.
- 2 Press the Shutter button **completely down** to take the picture.

NOTE: Multiple framing marks may appear when faces are detected.

IMPORTANT: Your camera offers a built-in Help system. See page 38.

Taking a video

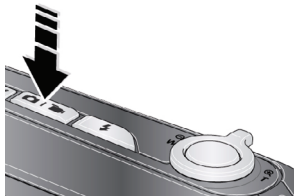

- 1 Press the Mode button, then ▲▼ until the LCD displays Video , then press OK.
- 2 Press the Shutter button **completely down**, then release it. To stop recording, press and release the Shutter button again.

To review and work with videos, see [page 17](#).

Reviewing the picture/video just taken

After you take a picture/video, the LCD briefly displays the picture or the first frame of a video. (To take new pictures/videos sooner, press the Shutter button halfway.)

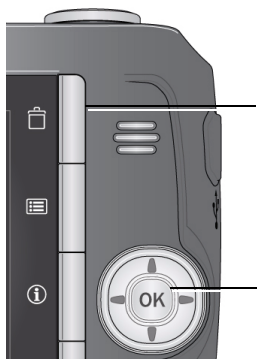

While a picture/video is displayed, you may:

Delete the current picture/video

OK Play/pause a video

NOTE: Audio is captured during video recording. Audio can be heard when the video is played on a computer or when the camera is connected to a TV (see [page 23](#)).

To review pictures/videos anytime, see [page 17](#).

Understanding the picture-taking icons

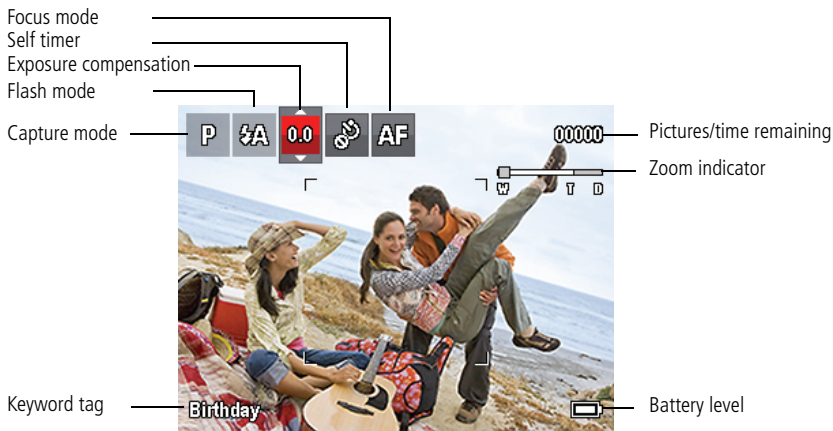

Know when your batteries need attention

The battery level icon works like the gas gauge in your car, but appears only when the battery requires your attention. (If you're viewing shortcuts, the battery level is always displayed. [See page 11.](#))

Purchase extra batteries for your special event www.kodak.com/go/c142accessories

Using the optical zoom

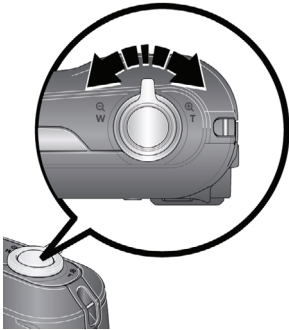

- 1 Use the LCD to frame your subject.
- 2 To zoom in, turn the Zoom lever toward Telephoto (T). To zoom out, press it toward Wide Angle (W).
- 3 Take the picture.

NOTE: For focus distances, see Specifications starting on [page 44](#).

Using digital zoom

Use digital zoom to get up to 5X magnification beyond optical zoom. (Digital zoom is not available in Smart Capture mode.) Press Telephoto (T) until the slider on the LCD is at the end of the optical zoom range. Release Telephoto (T), then press it again.

NOTE: You may notice decreased image quality when using digital zoom.

Using the flash

Press the Flash button repeatedly until the LCD displays the desired flash mode.

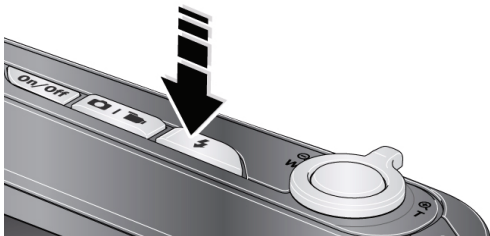



Flash modes		Flash fires
Auto		When the lighting conditions require it.
Fill (Flash On)		Every time you take a picture, regardless of the lighting conditions. Use when the subject is in shadow or is “backlit” (when the light is behind the subject). NOTE: (Not available in Smart Capture mode.)
Red-eye Reduction Choose a setting in the Setup menu, page 32 .	Preflash Digital Correction 	The flash fires before the picture is taken to reduce the chance of red-eye. The camera digitally corrects red-eye after a picture is taken. (Processing time after taking a picture may increase.) NOTE: When using digital correction, image processing takes longer than when using preflash.
Off		Never

Using different modes

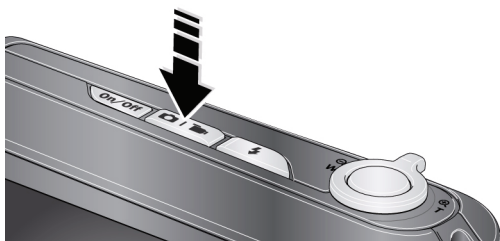
Press the Mode button, then ▲▼ until the LCD displays the mode that best suits your subjects and surroundings, then press OK.



Use this mode	For
	Smart Capture
P	Program
SCN	Scene
	Video

General picture taking—it offers excellent image quality and ease of use.

- Faces get focus and exposure priority.
- The scene is analyzed for other content and for lighting. You can choose the best picture size and aspect ratio for your needs—just press the Menu  button and choose Picture Size.
- 3:2 (the best choice when making 4 x 6 prints)
- 16:9 (wide screen)
- 4:3 (the default setting)

Advanced picture taking—allows more access to manual settings than Smart Capture.

Point-and-shoot simplicity when taking pictures in practically any situation. (See [page 10](#).)

Capturing video with sound. Audio can be heard when the video is played on a computer or when the camera is connected to a TV ([see page 5](#).)

Using Scene (SCN) modes

Choose a Scene mode—for great pictures in practically any situation.

- 1 Press the Mode button, then ▲▼ until the LCD displays SCN, then press OK.
- 2 Press ◀▶ ▲▼ to view scene mode descriptions.
If the mode description turns off before you finish reading it, press OK.
- 3 Press OK to choose a Scene mode.

SCN mode	For
Portrait	Full-frame portraits of people.
Sport	Action pictures.
Blur Reduction	Reducing blur caused by camera shake or subject motion.
Landscape	Distant scenes.
High ISO	People indoors, in low-light scenes.
Close-up	Close range. Use available light instead of flash, if possible.
Flower	Close-ups of flowers or other small subjects in bright light.
Sunset	Subjects at dusk.
Backlight	Subjects that are in shadow or “backlit.”
Candle Light	Subjects illuminated by candle light.
Children	Action pictures of children in bright light.
Manner/ Museum	Quiet occasions, like a wedding or lecture. Flash is off. For best results, place the camera on a steady surface or tripod.
Text	Documents. For best results, place the camera on a steady surface or tripod.
Beach	Bright beach scenes.
Snow	Bright snow scenes.
Fireworks	Fireworks. For best results, place the camera on a steady surface or tripod.

SCN mode	For
Self-Portrait	Close-ups of yourself. Assures proper focus and minimizes red eye.
Night Portrait	Reduces red eye of people in night scenes or low-light conditions.
Night Landscape	Distant scenery at night. Flash does not fire.
Panning Shot	Emphasizing horizontal motion, with a sharp subject and blurred background.

Using shortcuts

Your camera has a clean, uncluttered interface. For quick access to the most popular capture and review functions:

- 1 Press the Info **i** button.

*The shortcuts appear. To hide the shortcuts again, press **i**.*







- 2 Press **◀▶** to access functions like Exposure Compensation, Self-timer, and Auto focus. (You'll see different functions in different modes.)

- 3 Press **▲▼** to choose a setting.



Using the self-timer





Use the self-timer when you want to be included in a picture, or to ensure a steady Shutter button press. For best results, place the camera on a tripod or steady surface. You can turn on the self-timer using a shortcut (see page 11) or these steps:

- 1 Press the Menu  button. Press  to choose Self-timer, then press OK.
- 2 Press  to choose a Self-timer setting:
 - 10 Seconds**— A picture is taken after a 10-second delay (so you have time to get into the scene).
 - 2 Seconds**— A picture is taken after a 2-second delay.
 - 2 Picture Timer**— The first picture is taken after a 10-second delay. A second picture is taken 8 seconds later.
- 3 Compose the scene. Press the Shutter button **halfway**, then **completely down**.
The camera takes the picture/pictures after the delay.

To take a video after a 2- or 10-second delay, use the same procedure but press the Shutter button **completely down**.

Using burst

Use the burst feature to take up to 3 pictures in rapid succession. You can turn on burst using a shortcut (see page 11) or these steps:

- 1 Press the Menu  button.
- 2 Press  to choose Self-timer/Burst, then press  to choose Burst On.
- 3 Press the Menu  button.
- 4 Compose the scene. Press the Shutter button **halfway**, then **completely down and hold it**.

The camera stops taking pictures when you release the Shutter button, when pictures are taken, or when there is no more storage space. Burst is unavailable in some modes.

3

Sharing and tagging pictures

Sharing through social networks

It's never been easier to share pictures on your favorite social networking sites.

IMPORTANT: *To use the camera's social networking features, you need to download KODAK Software. (See page 34.)*

1 Press the Review  button, then   to find a picture.

2 Press the Share button.

If it's your first time, a Help screen appears.

3 Press   to choose a social networking site, then press OK.

A check mark appears. Repeat this step to choose more sites. (Press OK again to clear a check mark.)

4 Press   to choose Done, then press OK.

The picture is displayed with the Share icon. When you transfer the picture to your computer, it will be sent to the networking site(s) that you chose.

Tip: Do you send pictures to the same sites each time?

Find a picture, then press and hold the Share button for about 1 second.

The camera applies the settings that you used previously and adds the Share icon to the picture.

Choose which social networking sites to display on your camera

You can show/hide networking sites on your camera so that only your favorite sites appear.

- 1 In Review, press the Menu  button.
- 2 Press ◀▶ to choose the Setup tab, then ▲▼ to choose Share Button Settings, then press OK.
- 3 Press ▲▼ to choose a social networking site, then press ◀▶ to choose Show or Hide. Repeat this step until you have chosen Show/Hide for each social network.
- 4 When finished, press ▲▼ to choose Done, then press OK.

To return to picture-taking mode, press the Shutter button halfway down. When you are in Review and press the Share button, only chosen sites are shown.

Manage email addresses and KODAK PULSE Digital Frames

You can add, edit, or delete email addresses and KODAK PULSE Digital Frames on your camera.

- 1 In Review, press the Share button. Press ▲▼ to choose Manage Email Addresses (or Manage Frames), then press OK.
- 2 To add an email address or frame, press ▲▼ to choose Add Email or Add Frame, then press OK. Use the on-screen keyboard to make the addition. (Example: JohnDoe@domain.com)

To edit an email address or a KODAK PULSE Digital Frame, press ▲▼ to choose the address's nickname or the frame, then press OK. Use the on-screen keyboard to make edits.







To delete an email address or frame, choose Delete Email or Delete Frame, then press OK. Press ▲▼ to choose the address or frames, then press OK so that a check mark appears. Press ▲▼ to choose Delete, then press OK.

- 3 When finished, press ▲▼ to choose Done, then press OK.

To return to picture-taking mode, press the Shutter button halfway down.

Tagging pictures

You can tag pictures with a keyword to make them easy to find, later.



- 1 Press the Review  button, then  to find a picture to tag.
- 2 Press the Menu  button. Press  to choose Keyword Tag, then press OK.
- 3 Press  to choose an existing keyword, or New Keyword (See [Using the keyboard](#)) to add a new one.
- 4 Press  to add keywords to other pictures. When finished, press  to choose Done, then press OK.

To return to picture-taking mode, press the Shutter button halfway down.

Tip: You can pre-choose a tag so that new pictures are assigned that tag (see [page 29](#)).

Using the keyboard

The keyboard appears when you need to add keywords and email addresses.

- 1 Press   to choose a letter, then press OK.
- 2 When finished, press  to choose OK, then press OK.

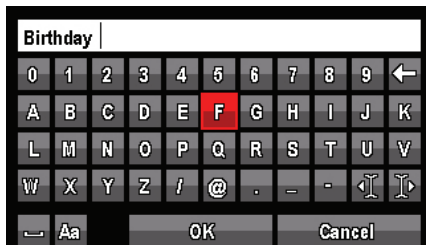

Marking pictures/videos for emailing

It's simple to mark pictures so that they're ready to email when you transfer them to your computer. First, create a new email address. (See [Using the keyboard, page 15.](#))

- 1 Press the Review  button. Press ◀▶ to find a picture.
- 2 Press the Share button.
- 3 Press ▲▼ to choose Email, then press OK.
- 4 Press ▲▼ to find an email address, then press OK.

To mark other pictures/videos with the same address, press ◀▶, then press OK.

To send the pictures/videos to more than one address, repeat step 4.

To return to picture-taking mode, press the Shutter button halfway down.

When you transfer the marked pictures/videos to your computer, the software prompts you to send the pictures/videos.

IMPORTANT: *Your camera offers a built-in Help system. See [page 38.](#)*

4

Reviewing and editing

Reviewing pictures/videos



- 1 Press the Review  button.
- 2 Press  for previous/next picture/video.
 - To exit, press the Review button or press the Shutter button halfway down.
 - To view pictures/videos as thumbnails, press the Wide Angle (W) button. (For more information, see [page 19](#).)



Find your pictures like a pro...

See “A smarter way to find and enjoy your pictures” on [page 20](#).

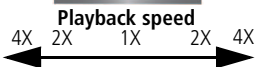
Playing a video





Press OK to play a video. Press OK to pause/resume. During playback:

- Press  to play at 2X speed; press again for 4X.
- Press  to reverse at 2X speed; press again for 4X.

NOTE: Audio can be heard when the video is played on a computer or when the camera is connected to a TV ([see page 23](#)).

Deleting pictures/videos





- 1 Press the Review  button.
- 2 Press  for previous/next picture/video.
- 3 Press the Delete button.
- 4 Follow the screen prompts.



NOTE: To delete protected pictures/videos, remove protection before deleting. (See [Protecting pictures/videos from deletion](#).)

Using the undo delete picture feature

If you accidentally delete a picture, you may be able to use Undo Delete to retrieve it. This feature is only available immediately after you delete a picture.

Protecting pictures/videos from deletion

- 1 Press the Review  button.
- 2 Press the Menu  button.
- 3 Press  to choose Protect, then press OK.
- 4 Press  to choose Protect, then press OK.

A check mark indicates that the picture/video is protected. Clicking OK again removes the check mark. Press  to protect other pictures/videos, or press  to choose Done, then press OK.

- Press the Menu  button to exit the menu.



CAUTION:

Formatting internal memory or an SD or SDHC Card deletes all (including protected) pictures/videos. (Formatting internal memory also deletes email addresses and keyword tags.)

Viewing pictures/videos in different ways

Magnifying a picture



- 1 Press the Zoom lever toward Telephoto (T) to magnify 1X–8X.
- 2 Press ◀▶ ▲▼ to view other parts of a picture.
 - Press OK to return to 1X.



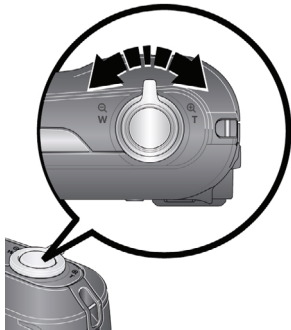





Viewing as thumbnails (multi-up)



- 1 Press the Review  button.
The camera shows the last picture that was taken.
- 2 Press the Zoom lever toward Wide Angle (W) button to view pictures/videos as thumbnails. (Press it again to see more, smaller thumbnails.)
*To view all pictures/videos, choose the All tab.
To sort by favorites, date, or tagged pictures/videos, press ◀▶ and choose the appropriate tab.*
- 3 To see a single picture/video, press ◀▶ ▲▼ to choose it. Then press the Zoom lever toward Telephoto (T) button.
 - To select multiple pictures/videos, see [Selecting multiple pictures/videos](#).
 - Press the Review button to exit Review.

A smarter way to find and enjoy your pictures

Tag pictures with a keyword to make them easy to find, later. You can also find pictures by date taken or if it's marked as a favorite.

- 1 Press the Review  button.
- 2 Press the Wide Angle (W) button to view pictures by thumbnail (or choose View Thumbnails shortcut).
- 3 Press     to choose a tab and sort pictures by All, Date, Favorite, or Keyword.
- 4 Press     to choose a keyword, then press OK.

Press Telephoto (T) see pictures in a stack or to see an individual picture. Press Wide Angle (W) to see thumbnails or picture stacks.

To return to picture-taking mode, press the Shutter button halfway down.



Tip: For best results, make sure the camera's date/time is current (see page 32).

Understanding the review icons

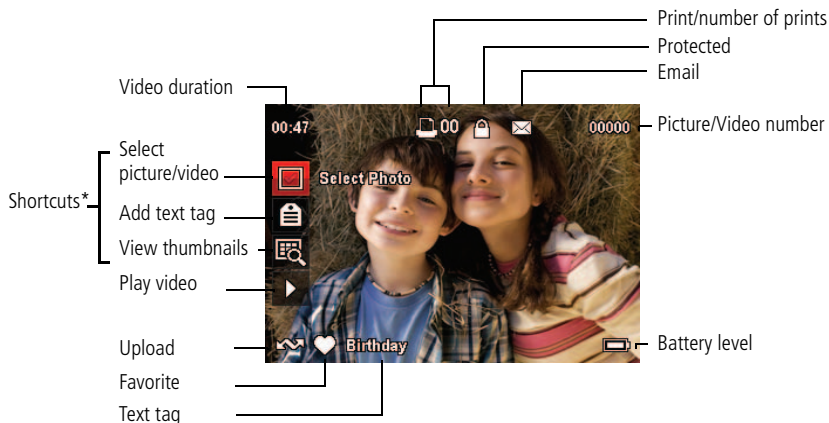

* For more about shortcuts, see [page 11](#).

Know when your batteries need attention



The battery level icon works like the gas gauge in your car, but appears only when the battery requires your attention. (If you're viewing shortcuts, the battery level is always displayed. [See page 11.](#))

Purchase extra batteries for your special event www.kodak.com/go/c142accessories

Creating a slide show

Use Slide Show to display your pictures/videos on the LCD. You can play all pictures/videos, or choose pictures to include in the slide show.

Make a slide show



- 1 Press the Review  button. Select pictures (see [page 27](#)). If you don't select any, then all pictures will be shown.
- 2 Press the Menu  button.
- 3 Press  to choose Slide Show, then press OK.

Each picture/video is displayed once. To interrupt the slide show, press OK.

IMPORTANT: *Your camera offers a built-in Help system. See [page 38](#).*

Play a slide show loop

When you turn on Loop, the slide show is continuously repeated.

- 1 On the Slide Show menu, press  to choose Loop, then press OK.
- 2 Press  to choose On, then press OK.
- 3 Press  to choose Preview Slide Show, then press OK.

The slide show repeats until you press OK or until the batteries are exhausted.

Displaying pictures/videos on a television







You can display pictures/videos on a television, computer monitor, or any device equipped with a video input. To connect the camera directly to a television, use an A/V cable (may be sold separately).



Purchase accessories www.kodak.com/go/c142accessories

NOTE: To control the audio portion of a video, use the TV (or TV remote control) volume controls. Ensure that the Video Out setting (NTSC or PAL) is correct (see page 32). The slide show stops if you connect or disconnect the cable while the slide show is running. (Image quality on a television screen may not be as good as on a computer monitor or when printed.)

Using the menu button in review

- 1 Press the Review  button, then the Menu  button.
- 2 Press   to choose a tab:
 - **Review**
 - **Edit**
 - **Setup**
- 3 Press   to choose a setting, then press OK.
- 4 Choose an option, then press OK.

IMPORTANT: *Your camera offers a built-in Help system. See page 38.*

Cropping pictures











You can crop a picture so that only the desired portion of the picture remains.



Picture



Cropped picture

- 1 Press the Review  button, then   to find a picture to crop.
- 2 Press the Menu  button, then   to choose the Edit tab. Choose Crop, then press OK.
- 3 Press the Zoom lever toward Telephoto (T) to shrink the crop area or Wide (W) to stretch it. Press     to move the crop box. When satisfied with the crop box, press OK.
- 4 Follow the screen prompts.



The picture is cropped. (The original is saved.) Cropped pictures cannot be cropped again on the camera.

Press the Shutter button halfway down to return to Capture mode.

IMPORTANT: *Your camera offers a built-in Help system. See page 38.*

Rotating pictures

You can rotate a picture to portrait or landscape orientation.

- 1 Press the Review  button, then ◀▶ to find the previous/next picture.
- 2 Press the Menu  button. Press ◀▶ to highlight the Edit tab.
- 3 Press ▲▼ to highlight Rotate Picture, then press OK.
- 4 Press to highlight an option:
 - Rotate Right—rotates the picture 90 degrees clockwise.
 - Rotate Left—rotates the picture 90 degrees counterclockwise.
- 5 Press OK. Follow the screen prompts to replace the original picture or to save the rotated picture as a new one.

Press the Shutter button halfway down to return to Capture mode.

IMPORTANT: *Your camera offers a built-in Help system. See page 38.*





Editing videos

You can do incredible things with your videos.

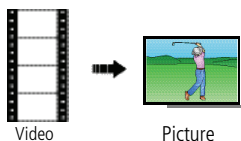
Making a picture from a video

You can choose a single frame from a video, then make a picture suitable for a 4 x 6-inch (10 x 15 cm) print.



- 1 Press the Review  button, then  to find a video.
- 2 Press the Menu  button, then  to choose the Edit tab. Choose Make Picture, then press OK.
- 3 Follow the screen prompts.





A picture is created. (The original video is saved.) Press the Shutter button halfway down to return to Capture mode.

IMPORTANT: Your camera offers a built-in Help system. See page 38.

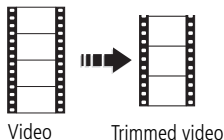
Trimming a video

You can remove an unwanted start or end from a video, saving only the desired portion.







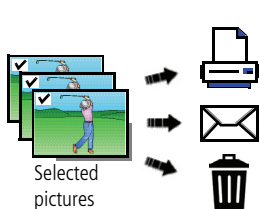

- 1 Press the Review  button, then  to find a video.
- 2 Press the Menu  button, then  to choose the Edit tab. Choose Trim, then press OK.
- 3 Follow the screen prompts.

The video is trimmed. (You can save it as a new video or replace the original.) Press the Shutter button halfway down to return to Capture mode.

Selecting multiple pictures/videos

Use the multi-select feature when you have two or more pictures/videos to print, transfer, delete, etc. Multi-select is used most effectively in Multi-Up mode, [Viewing as thumbnails \(multi-up\)](#).



1 Press the Review  button, then   (and   if you're in multi-up mode) to find a picture/video.



2 Press OK to select pictures/videos.



A check mark appears on the picture. (Press OK again to remove a check mark.) You can now print, transfer, delete, etc. the selected pictures.



Copying pictures/videos

You can copy pictures/videos from a card to internal memory or from internal memory to a card.

Copy pictures/videos:

1 Press the Review  button, then   to find a picture. (You can also use multi-select. See ["Selecting multiple pictures/videos" on page 27.](#))

2 Press the Menu  button, then   to choose the Edit tab.

3 Press   to choose Copy, then press OK. Make a choice, then press OK.

NOTE: Pictures/videos are copied, not moved. To remove pictures/videos from the original location after copying, delete them (see [page 18](#)).

IMPORTANT: *Your camera offers a built-in Help system. See [page 38](#).*

5





Doing more with your camera

IMPORTANT: *Your camera offers a built-in Help system. To get the most from your camera, see [page 38](#).*

Using the menu button to change settings

You can change settings to get the best results from your camera.

NOTE: Some modes offer limited settings. Some settings remain until you change them; others, until you change modes or turn off the camera.

- 1 Press the Menu  button.
- 2 Press   to choose a tab:
 - **Capture/Video** for the most common picture- and video-taking settings
 - **Setup** for other camera settings
- 3 Press   to choose a setting, then press OK.
- 4 Choose an option, then press OK.





Using the capture tab

Press Menu, , , , , **Picture-taking Options** and OK to access settings

Picture Size

Choose a picture resolution.

See [Camera specifications, page 44](#).

Press Menu,  ,  ,  ,  , and OK to access settings		Picture-taking Options
<p>Self-timer/Burst Choose Self-timer or Burst feature.</p>	<p>Off 10 Seconds 2 Seconds 2 Picture Timer Burst On—Press the Shutter button halfway to focus and set exposure. Press the Shutter button completely down and hold it to take up to 3 pictures.</p>	
<p>Preset Keyword Tag Create keywords and assign them to pictures/videos. See page 37.</p>	<p>New Keyword Delete Keyword</p>	
<p>Exposure Compensation Make a picture lighter or darker. (Available in Program mode.) To access this feature with a shortcut, see page 11.</p>	<p>See Camera specifications, page 44.</p>	
<p>ISO Speed Control the sensitivity of the camera sensor.</p>	<p>Auto—For general picture taking. For manual settings, see Camera specifications, page 44.</p>	
<p>Long Time Exposure Choose how long the shutter stays open (normally in low-light conditions). For best results, place the camera on a tripod or steady surface.</p>	<p>None 0.5, 1.0, 2.0, 4.0, 8.0 seconds</p>	

Press Menu, ◀▶, ▲▼, and OK to access settings **Picture-taking Options**

Color Mode

Choose color tones.
Unavailable in Video and Smart Capture modes.

High Color

Natural Color

Low Color

Black & White

Sepia—For a reddish-brown, antique look.

White Balance

Choose your lighting condition. (Available only in Program mode.)

Auto—Automatically corrects white balance. Ideal for general picture taking.

Daylight—For pictures in natural lighting.

Tungsten—Corrects the orange cast of incandescent light bulbs. Ideal for indoor pictures under tungsten or halogen lighting without flash.

Fluorescent—Corrects the green cast of fluorescent lighting. Ideal for indoor pictures under fluorescent lighting without flash.

Open Shade—For pictures in shade in natural lighting.

Focus Mode

Choose a focus distance.

Auto—For general picture-taking.

Macro—For sharpness and detail in pictures at close range. Use available light instead of flash, if possible. The camera automatically sets the focus distance depending on the zoom position.

Infinity—For distant subjects; auto-focus framing marks are unavailable.

Focus/Exposure Zone

Choose how the camera assesses the scene for exposure and focus.

Face Priority—If faces are detected, they receive focus/exposure priority. (If faces are not detected, the camera switches to Multi-Zone.)

Multi-Zone—Evaluates 5 zones to give an even picture focus. Ideal for general picture taking.

Center-Zone—Evaluates the small area centered in the lens. Ideal for focusing on a precise area.

Press Menu, ◀▶, ▲▼, and OK to access settings **Picture-taking Options**

AF Control (Still)

Choose an auto-focus setting.

Continuous AF—Because the camera is always focusing, there is no need to press the Shutter button halfway down to focus.

Single AF—Focuses when the Shutter button is pressed halfway down. (This setting uses less battery power.)

Sharpness

Control picture sharpness or softness.

High

Normal

Low

Video settings

IMPORTANT: *Your camera offers a built-in Help system. See page 38.*

Press Menu, ◀▶, ▲▼, and OK to access settings **Video-taking Options**

Self-timer

Choose Self-timer feature.

Off

10 Seconds

2 Seconds

Using the Setup menu

Use Setup to customize other camera settings.

IMPORTANT: *Your camera offers a built-in Help system. See page 38.*

Press Menu, ◀▶ to choose Setup, then ▲▼ to access settings	Setup Options
Date & Time	Set date and time.
Auto Time Setting	Date and time are set when camera is connected to a computer.
LCD Brightness Choose LCD brightness during picture/video capture.	High Power —Brighter LCD; uses more battery power. Power Save —Dimmer LCD; uses less power.
Share Button Settings Choose what is displayed when the Share button is pressed in Review.	Show or hide: <ul style="list-style-type: none">■ Individual social networking sites■ E-mail addresses (all or none)■ KODAK Digital Frames (all or none)
Red-eye Reduction The Red-eye flash fires automatically before a picture is taken.	Preflash —The flash fires before the picture is taken to reduce the chance of red-eye. Digital correction —The camera digitally corrects red-eye after a picture is taken. (Processing time after taking a picture may increase.)
Video Out Choose the regional setting that lets you connect the camera to a television or other external device.	NTSC —Used in North America and Japan; most common format. PAL —Used in Europe and China.
Image Storage Choose a storage location for pictures/videos.	Auto —The camera uses the card if one is in the camera. If not, the camera uses internal memory. Internal Memory —The camera always uses internal memory, even if a card is installed.

Press Menu, ◀▶ to choose Setup, then ▲▼ to access settings	Setup Options
Language	Choose your language.
Reset Camera Reset settings to their default.	Reset All Camera Settings —Settings revert to their factory defaults. Reset Startup Application —Resets camera to startup mode to allow KODAK Software download.
Format  CAUTION: Formatting deletes all pictures/videos, including those that are protected. Removing a card during formatting may damage the card.	Memory Card —Deletes everything on the card; formats the card. Cancel —Exits without making a change. Internal Memory —Deletes everything in internal memory including email addresses and keyword tags; formats the internal memory.
KODAK Camera Software View URL to download KODAK Software.	
About View camera information.	

6

Transferring, printing pictures

Download software, transferring pictures

Download KODAK Software—so it's easy to transfer and share pictures and videos.

Make sure the computer is connected to the Internet. When you connect the camera to the computer, the KODAK Software Downloader automatically runs. Follow the prompts to download and install KODAK Software.*

- 1 Turn off the camera.
- 2 Use the KODAK Camera USB Cable, Micro B / 5-Pin to connect camera to computer.
- 3 Turn on the camera.

After the software is installed, follow the prompts to transfer pictures and videos to your computer.



* If the downloader does not run, find and launch it:

- WINDOWS OS: in My Computer
- MAC OS: on your Desktop

NOTE: You can also use a card reader to transfer your pictures/videos.

Download KODAK Software later

www.kodak.com/go/camerasw

Get Software help

www.kodak.com/go/support

To use this camera on more than one computer, use the camera's Reset Startup Application feature [see page 33](#)

Printing pictures

Direct printing with a KODAK All-in-One Printer

Your camera is compatible with PICTBRIDGE Technology, so you can print directly to PICTBRIDGE enabled Printers. You need a camera, a PICTBRIDGE enabled Printer, and a USB cable.

Connecting the camera to a KODAK All-in-One Printer

- 1 Turn off the camera and printer.
- 2 Connect the USB cable from the camera to the printer.

Printing from a KODAK All-in-One Printer

- 1 Turn on the printer. Turn on the camera.

The PictBridge logo is displayed, followed by the current picture and menu. (If no pictures are found, a message is displayed.) If the menu turns off, press any button to redisplay it. If the printer sees the camera as a mass storage device, turn the camera off and then back on.

- 2 Choose a printing option, then press OK.

Current Picture—Press ◀▶ to choose a picture.

Tagged Pictures—If your printer is capable, print pictures that you marked for printing.

Index Print—Print thumbnails of all pictures. (This option requires one or more sheets of paper.)

All Pictures—Print all pictures in internal memory or on a card.

Image Storage—Access Auto or Internal Memory.

NOTE: During direct printing, pictures are not permanently transferred or saved to the printer. To transfer pictures to your computer, see [page 34](#).

Purchase cables, accessories www.kodak.com/go/c142accessories

Disconnecting the camera from a KODAK All-in-One Printer

- 1 Turn off the camera and printer.
- 2 Disconnect the USB cable from the camera and the printer.

Ordering prints online









KODAK Gallery (www.kodakgallery.com) makes it easy to:



- Upload your pictures.
- Edit, enhance, and add borders to your pictures.
- Store pictures, and share them with family and friends.
- Have prints, photo greeting cards, frames, and albums delivered to your door.

Printing from an optional SD or SDHC Card

- Automatically print tagged pictures when you insert your card into a printer with an SD/SDHC Card slot. See your printer user's guide for details.
- Make prints at an SD/SDHC Card-capable KODAK Picture Kiosk. Go to www.kodak.com/go/picturemaker.
- Take the card to your local photo retailer for professional printing.

Marking your pictures for printing

- 1 Press the Review  button. Press   to find a picture.
- 2 Press the Menu  button.
- 3 Press   to choose Print, then press OK.
- 4 Press   to choose the number of copies.

Optional: You can apply a print quantity to other pictures. Press   for previous/next. Repeat this step until the desired print quantity is applied to each picture.

- 5 Press OK.

Press the Shutter button halfway down to return to Capture mode.

IMPORTANT: *Your camera offers a built-in Help system. See [page 38](#).*

7

Troubleshooting

Getting help from your camera

You want the most from your camera. You want to understand:



- What it can do for you
- And how to take the best possible pictures and videos

Great news!

Your camera offers a built-in Help system. It describes every setting for every menu choice. If you learn nothing else about your camera, learn how to use on-camera Help.

Turning on camera Help



- ① Press the Menu  button, choose a menu choice.
- ② Press the Info  button.
▲▼ Scroll through a Help topic.

Troubleshooting

Camera problems

Status	Solution
Camera does not turn on	<ul style="list-style-type: none"> ■ Make sure the batteries are installed correctly (see page 1). ■ Make sure batteries are new. If batteries are rechargeable, make sure they are fully charged (see charger documentation).
Camera does not turn off	
Camera buttons and controls do not function	
In Review, a blue or black screen is displayed instead of a picture	<ul style="list-style-type: none"> ■ Transfer <i>all</i> pictures to the computer (see page 34). ■ Take another picture.
Pictures remaining number does not decrease after taking a picture	<ul style="list-style-type: none"> ■ Continue taking pictures. The camera is operating normally. (The camera estimates the number of pictures remaining after each picture is taken, based on picture size and content.)
Flash does not fire	<ul style="list-style-type: none"> ■ Check the flash setting, and change as needed (see page 8). NOTE: The flash does not fire in all modes.
Memory card is almost or entirely full	<ul style="list-style-type: none"> ■ Transfer the pictures to the computer (see page 34). ■ Delete pictures from the card (see page 18) or insert a new card.
Battery life is short	<ul style="list-style-type: none"> ■ Make sure the correct battery type is installed (see page 48). ■ Wipe the contacts with a clean, dry cloth before inserting batteries in the camera. ■ Insert new/charged batteries (see page 1).

Status	Solution
You cannot take a picture	<ul style="list-style-type: none">■ Turn the camera off, then on again.■ Depress the Shutter button all the way (see page 4).■ Insert new/charged batteries in the correct orientation (see page 1).■ When inserting a memory card, push it in until it clicks (see page 3).■ Memory is full. Transfer pictures to the computer (see page 34), delete pictures (see page 18), or insert another card.
Memory card not recognized or camera freezes with card	<ul style="list-style-type: none">■ Use a card reader to check the card on a computer. If it's corrupted, format the card in the camera (see page 33).■ Try another SD or SDHC Card.
Cannot find the desired picture/video	<ul style="list-style-type: none">■ To view pictures on a card or in internal memory, see page 17.

Computer/connectivity problems

Status	Solution
Slide Show does not run on an external video device	<ul style="list-style-type: none">■ Adjust the camera Video Out setting to NTSC or PAL (see page 32).■ Make sure the external device settings are correct. (See the device's user guide).
Computer does not communicate with the camera	<ul style="list-style-type: none">■ Turn off the camera, then turn it back on.■ Make sure the battery is charged and installed correctly (see page 1).■ Make sure the KODAK Camera USB Cable, Micro B / 5-Pin is connected to the camera and the computer (see page 34). Then turn on the camera.■ See KODAK Software Help at www.kodak.com/go/camerasw.

Picture quality problems

Status	Solution
Picture is not clear	<ul style="list-style-type: none"> ■ To automatically set exposure and focus, press the Shutter button halfway. When the framing marks turn green, press the Shutter button completely down to take the picture. ■ Clean the lens (see page 46). ■ Make sure the camera is not in Macro mode if you are more than 27.6 in. (70 cm) from your subject (see page 30). ■ Place the camera on a flat, steady surface or use a tripod (especially in high-zoom settings or in low light). ■ Use a larger picture size (see page 28). ■ If you're manually adjusting the ISO speed, realize that high ISO setting may cause grainy pictures (see page 29).
Picture is too dark	<ul style="list-style-type: none"> ■ Reposition the camera for more available light. ■ Use Fill flash (see page 8) or change your position so light is not behind the subject. ■ Move so that the distance between you and the subject is within the effective flash range. (See Camera Specifications starting on page 44.) ■ To automatically set exposure and focus, press the Shutter button halfway. When the framing marks turn green, press the Shutter button completely down to take the picture. ■ In Program mode, adjust the Exposure Compensation (see page 29).
Picture is too light	<ul style="list-style-type: none"> ■ Reposition the camera to reduce the amount of available light. ■ Turn the flash off (see page 8). ■ Move so that the distance between you and the subject is within the effective flash range. (See Camera Specifications starting on page 44.) ■ To automatically set exposure and focus, press the Shutter button halfway. When the framing marks turn green, press the Shutter button completely down to take the picture. ■ In Program mode, adjust the Exposure Compensation (see page 29).

Direct printing (PICTBRIDGE enabled printer) problems

Status	Solution
Cannot find the desired picture	■ Use the Direct printing menu to change the image storage location.
The Direct printing menu interface turns off	■ Press any camera button to redisplay the menu.
Cannot print pictures	■ Make sure there is a connection between the camera and the printer (see page 35). ■ Make sure the printer and the camera have power.
Camera or printer displays an error message	■ Follow the prompts to resolve the issue.

Getting help on the Web

Camera

Get support for your product (FAQs, troubleshooting information, arrange for repairs, etc.)	www.kodak.com/go/c142support
See step-by-step solutions and repair information	www.kodak.com/go/itg
Purchase camera accessories	www.kodak.com/go/c142accessories
Download the latest camera firmware and software	www.kodak.com/go/c142downloads
See online demonstrations of your camera	www.kodak.com/go/howto
Register your camera	www.kodak.com/go/register
Chat, email, write, or phone Kodak (Chat not available in all languages)	www.kodak.com/go/contact

Software

Download and get Help with other KODAK Software	www.kodak.com/go/camerasw
Download KODAK EASYSHARE Software	www.kodak.com/go/easysharesw (or see Help in EASYSHARE Software)
Get help with the WINDOWS OS and working with digital pictures	www.kodak.com/go/pcbasics

Other

Get support for cameras, software, accessories, more	www.kodak.com/go/support
Get information on KODAK All-in-One Printers	www.kodak.com/go/inkjet

Camera specifications

CCD—1/2.5-type

Effective pixels—10 MP (3672 x 2760)

LCD—2.5 in. (6.35 cm) LCD; 230K pixels; 4:3 aspect ratio

Image storage—Optional SD/SDHC Card  (The SD logo is a trademark of the SD Card Association.) Maximum supported card size: 32 GB

Internal storage capacity—32 MB internal memory (15 MB available for image storage. 1 MB equals one million bytes.)

Taking lens—3X optical zoom; f/2.9–f/5.2; 35 mm equivalent: 34–102 mm

Lens protection—Built-in

Digital zoom—5X continuous

Focus system—TTL-AF (through-the-lens auto focus); Multi-Zone, Center-Zone, Face Priority. Working range:

0.6 m (2 ft)–infinity @ wide, normal

0.6 m (2 ft)–infinity @ telephoto, normal

13–70 cm (5.1–27.6 in.) @ wide, Macro mode

35–70 cm (13.8–27.6 in.) @ telephoto, Macro mode

Auto focus control—Continuous and Single AF

Face detection—Yes

Shutter speed—8–1/1600 seconds

Long time exposure—0.5–8 seconds

ISO speed—Smart Capture mode: Auto 80–400

Program mode: Auto 80-400; manual 80, 100, 200, 400, 800, 1600

Exposure metering—TTL-AE; Face Priority, Multi-Zone, Center-Zone

Exposure compensation—+/-2.0 EV with 1/3 EV step

White Balance—Auto, Daylight, Tungsten, Fluorescent, Open Shade

Electronic Flash—Auto flash; Auto, Fill, Red Eye, Off; Guide No. 6.3 (m); working range @ ISO 250: 0.6–3.4 m (2–11.2 ft) @ wide; 0.6–1.9 m (2–6.2 ft) @ telephoto

Self-timer mode—10-second, 2-second, 2-shot

Burst mode—Maximum 3 pictures @ 1.1 fps

Capture modes—Smart Capture, Program, Scene modes, Video

Image file format—

Still: EXIF 2.21 (JPEG compression); file organization DCF

Video: QUICKTIME (CODEC Motion JPEG; audio: μ -Law)

Picture size—10.0 MP (4:3): 3648 x 2736 pixels

8.9 MP (3:2): 3648 x 2432 pixels

7.5 MP (16:9): 3648 x 2048 pixels

5.0 MP (4:3): 2592 x 1936 pixels

3.1 MP (4:3): 2048 x 1536 pixels

2.1 MP (16:9): 1920 x 1080 pixels

1.2 MP (4:3): 1280 x 960 pixels

Color modes—High Color, Natural Color, Low Color, Black & White, Sepia

Sharpness modes—High, Normal, Low

Video capture—4 GB maximum; VGA (640 x 480 @ 30 fps)

Communication with computer—USB 2.0 full speed (PIMA 15740 protocol); via KODAK Camera USB Cable, Micro B / 5-Pin

Video output—NTSC or PAL

Microphone—Yes

Beeper—Yes

PICTBRIDGE support—Yes

Power—KODAK MAX Alkaline Batteries AA; KODAK Ni-MH Rechargeable Digital Camera Batteries AA (Pre-Charged); KODAK Ni-MH Rechargeable Digital Camera Batteries AA; AA lithium batteries

Tripod mount—1/4 inch

Size—92.9 x 62 x 29.6 mm (3.7 x 2.4 x 1.2 in.) @ power off

Weight—170 g (6 oz) with card and batteries

Operating temperature—0–40° C (32–104° F)

Care and maintenance

- If you suspect water has gotten inside the camera, remove the batteries and card. Allow all components to air-dry for at least 24 hours before using the camera.
- Blow gently on the lens or LCD to remove dust and dirt. Wipe gently with a soft, lint-free cloth or an untreated lens-cleaning tissue. Do not use cleaning solutions unless designed specifically for camera lenses. Do not allow chemicals, such as suntan lotion, to contact painted surfaces.
- Service agreements may be available in your country. Contact a dealer of KODAK Products for more information.
- For digital camera disposal or recycling information, contact your local authorities. In the US, go to the Electronics Industry Alliance site at www.eiae.org or www.kodak.com/go/c142support.

Upgrading your software and firmware

Download the latest versions of KODAK Software and the camera firmware (the software that runs on the camera). Go to www.kodak.com/go/c142downloads.

Storage capacities

The LCD displays the approximate number of pictures (or minutes/seconds of video) remaining. Actual storage capacity varies depending on subject composition, card size, and other factors. You may be able to store more or fewer pictures and videos.

Important safety instructions



CAUTION:

Do not disassemble this product; there are no user-serviceable parts inside. Refer servicing to qualified service personnel. KODAK AC Adapters and Battery Chargers are intended for indoor use only. The use of controls, adjustments, or procedures other than those specified herein may result in exposure to shock and/or electrical or mechanical hazards. If the LCD breaks, do not touch the glass or liquid. Contact Kodak customer support.

- The use of an accessory that is not recommended by Kodak may cause fire, electric shock, or injury. For approved accessories, go to www.kodak/go/accessories.
- Use only a USB-certified computer equipped with a current-limiting motherboard. Contact your computer manufacturer if you have questions.
- If using this product in an airplane, observe all instructions of the airline.
- When removing the batteries, allow them to cool; they may be hot.
- Follow all warnings and instructions supplied by the battery manufacturer.
- Use only batteries approved for this product to avoid risk of explosion.
- Keep batteries out of the reach of children.
- Do not allow batteries to touch metal objects, including coins. Otherwise, a battery may short circuit, discharge energy, become hot, or leak.
- Do not disassemble, install backward, or expose batteries to liquid, moisture, fire, or extreme temperature.

- Remove the batteries when the product is stored for an extended period of time. In the unlikely event that battery fluid leaks inside the product, contact Kodak customer support.
- In the unlikely event that battery fluid leaks onto your skin, wash immediately with water and contact your local health provider. For additional health-related information, contact your local Kodak customer support.
- Go to www.kodak.com/go/reach for information about the presence of substances included on the candidate list according to article 59(1) of Regulation (EC) No. 1907/2006 (REACH).
- Dispose of batteries according to local and national regulations. Go to www.kodak.com/go/kes.
- Do not charge non-rechargeable batteries.
For more information on batteries, go to www.kodak.com/go/batterychart.

Battery replacement, battery life

KODAK MAX Alkaline Batteries AA: 200 pictures per charge. Battery life per CIPA testing method. (Approx. number of pictures in Smart Capture mode, using an SD Card.) Actual life may vary based on usage. For other compatible batteries, see the Power section in [Camera specifications, page 44](#).

Extending battery life

- Use power-saving features (see [Using the Setup menu, page 32](#)).
- Charge Ni-MH batteries when they are nearly depleted.
- Dirt on the battery contacts can affect battery life. Wipe the contacts with a clean, dry cloth before loading batteries in the camera.
- Battery performance is reduced at temperatures below 41° F (5° C). When using your camera in cold weather, carry spare batteries and keep them warm. Do not discard cold batteries that do not work; when they return to room temperature, they may be usable.

Limited warranty

Kodak warrants its digital cameras and accessories (excluding batteries) to be free from malfunctions and defects in both materials and workmanship for the warranty period specified on your KODAK Product packaging. Retain the original dated sales receipt. Proof of purchase date is required with any request for warranty repair.

Limited warranty coverage

Warranty service is only available from within the country where the Products were originally purchased. You may be required to ship Products, at your expense, to the authorized service facility for the country where the Products were purchased. Kodak will repair or replace Products if they fail to function properly during the warranty period, subject to any conditions and/or limitations stated herein. Warranty service will include all labor as well as any necessary adjustments and/or replacement parts. If Kodak is unable to repair or replace a Product, Kodak will, at its option, refund the purchase price paid for the Product provided the Product has been returned to Kodak along with proof of the purchase price paid. Repair, replacement, or refund of the purchase price are the sole remedies under the warranty. If replacement parts are used in making repairs, those parts may be remanufactured, or may contain remanufactured materials. If it is necessary to replace the entire Product, it may be replaced with a remanufactured Product. Remanufactured Products, parts and materials are warranted for the remaining warranty term of the original Product, or 90 days after the date of repair or replacement, whichever is longer.

Limitations

This warranty does not cover circumstances beyond Kodak's control. This warranty does not apply when failure is due to shipping damage, accident, alteration, modification, unauthorized service, misuse, abuse, use with incompatible accessories or attachments (such as third party ink or ink tanks), failure to follow Kodak's operation, maintenance or repacking instructions, failure to use items supplied by Kodak (such as adapters and cables), or claims made after the duration of this warranty. Kodak makes no other express or implied warranty for this product. In the event that the exclusion of any implied warranty is ineffective under the law, the duration of the implied warranty will be the length of the express warranty period

specified on your Kodak product packaging. The option of repair, replacement, or refund is Kodak's only obligation. Kodak will not be responsible for any special, consequential or incidental damages resulting from the sale, purchase, or use of this product regardless of the cause. Liability for any special, consequential or incidental damages (including but not limited to loss of revenue or profit, downtime costs, loss of the use of the equipment, cost of substitute equipment, facilities or services, or claims of your customers for such damages resulting from the purchase, use, or failure of the Product), regardless of cause or for breach of any written or implied warranty is expressly disclaimed.

Your rights

Some states or jurisdictions do not allow exclusion or limitation of incidental or consequential damages, so the above limitation or exclusion may not apply to you. Some states or jurisdictions do not allow limitations on how long an implied warranty lasts, so the above limitation may not apply to you. This warranty gives you specific rights, and you may have other rights which vary from state to state or by jurisdiction.

Outside the United States and Canada

In countries other than the United States and Canada, the terms and conditions of this warranty may be different. Unless a specific Kodak warranty is communicated to the purchaser in writing by a Kodak company, no warranty or liability exists beyond any minimum requirements imposed by law, even though defect, damage, or loss may be by negligence or other act.

Regulatory compliance

FCC compliance and advisory

This equipment has been tested and found to comply with the limits for a Class B digital device, pursuant to Part 15 of the FCC Rules. These limits are designed to provide reasonable protection against harmful interference in a residential installation. This equipment generates, uses, and can radiate radio frequency energy and, if not installed or used in accordance with the instructions, may cause harmful interference to radio communications. However, there is no guarantee that interference will not occur in a particular installation. If this equipment does cause

harmful interference to radio or television reception, which can be determined by turning the equipment off and on, the user is encouraged to try to correct the interference by one or more of the following measures: 1) reorient or relocate the receiving antenna; 2) increase the separation between the equipment and the receiver; 3) connect the equipment to an outlet on a circuit different from that to which the receiver is connected; 4) consult the dealer or an experienced radio/TV technician for additional suggestions. Any changes or modifications not expressly approved by the party responsible for compliance could void the user's authority to operate the equipment. Where shielded interface cables have been provided with the product or specified additional components or accessories elsewhere defined to be used with the installation of the product, they must be used in order to ensure compliance with FCC regulation. The KODAK High Performance USB AC Adapter K20-AM complies with part 15 of the FCC Rules. Operation is subject to the following two conditions: (1) This device may not cause harmful interference, and (2) this device must accept any interference received, including interference that may cause undesired operation.

Waste Electrical and Electronic Equipment/Battery disposal



In Europe: For human/environmental protection, it is your responsibility to dispose of this equipment and batteries at a collection facility established for this purpose (separate from municipal waste.) For more information, contact your retailer, collection facility, or appropriate local authorities; or go to www.kodak.com/go/recycle. Product weight: 170 g (6 oz) with card and batteries.



Canadian DOC statement

DOC Class B Compliance—This Class B digital apparatus complies with Canadian ICES-003.

Observation des normes-Classe B—Cet appareil numérique de la classe B est conforme à la norme NMB-003 du Canada.

CE

Hereby, Eastman Kodak Company declares that this KODAK Product is in compliance with the essential requirements and other relevant provisions of Directive 1999/5/EC.

Australian C-Tick



VCCI Class B ITE

この装置は、情報処理装置等電波障害自主規制協議会（VCCI）の基準に基づくクラスB情報技術装置です。この装置は、家庭環境で使用することを目的としていますが、この装置がラジオやテレビジョン受信機に近接して使用されると、受信障害を引き起こすことがあります。
取扱説明書に従って正しい取り扱いをして下さい。

Russian GOST-R



Eastman Kodak Company
Rochester, NY 14650

Фотокамера изготовлена в Китае; остальные элементы -
АЮ-40 в соответствии с маркировкой.

China RoHS

环保使用期限 (EPUP)

在中国大陆，该值表示产品中存在的任何危险物质不得释放，以免危及人身健康、财产或环境的时间期限（以年计）。该值根据表中所规定的产品正常使用而定。

有毒有害物质或元素名称及含量标识表

部件名称	有毒有害物质或元素					
	铅	汞	镉	六价铬	多溴联苯	多溴二苯醚
数码相机电路板元件	×	○	○	○	○	○
充电电池	×	○	○	○	○	○
电池充电器	×	○	○	○	○	○

○：表示该有毒有害物质在该部件所有均质材料中的含量均在SJ/T 11363-2006规定的限量要求以下。
×：表示该有毒有害物质至少在该部件的某一均质材料中的含量超出SJ/T 11363-2006规定的限量要求。



USB 数据线

Korean Class B ITE

B급 기기 (가정용 방송통신기기)	이 기기는 가정용(B급)으로 전자파적합등록을 한 기기로서 주로 가정에서 사용하는 것을 목적 으로 하며, 모든 지역에서 사용할 수 있습니다.
-----------------------	---

Index

A

- A/V out, 23
- about this camera, 33
- accessories
 - battery, 48
 - buying, 43
 - SD/SDHC Card, 3
- add keywords, 15
- AF control (Still), 31
- AF control (video), 31
- AF zone, 30
- auto, 9
 - focus control, 31
 - focus framing marks, 4
- auto focus (AF)
 - zone, 30

B

- backlight, 10
- battery
 - expected life, 48
 - loading, 1
 - purchase, 6, 21
 - status, 6, 21
 - types, 48
- beach, 10
- burst, 12
- button
 - delete, 5
 - telephoto/zoom, 7

C

- cable
 - audio/video, 23
- Canadian compliance, 51
- care and maintenance, 46
- children, 10
- clock, setting, 2
- color mode, 30
- computer
 - connect camera, 34
 - transfer to, 34
- connector, USB / A/V, 23
- copy pictures
 - card to memory, 27
 - memory to card, 27
 - to computer, 34
- cropping pictures, 24
- customize camera, 32

D

- date setting, 2
- deleting
 - during quickview, 5
 - from internal memory, 18
 - from SD/SDHC Card, 18
 - protecting pictures, videos, 18
- digital zoom, 7
- displaying slide show, 22
- disposal, recycling, 46
- download
 - KODAK Software, 34
 - download pictures, 34

E

- edit videos, 26
- emailing pictures, videos, 16
- expected battery life, 48
- exposure
 - long time, 29, 32
- exposure compensation, 29
- external video device
 - viewing pictures, videos, 23

F

- FCC compliance, 50
- find pictures, 20
- fireworks, 10
- firmware, upgrading, 46
- flash, using, 8
- flower, 10
- focus framing marks, 4
- focus mode, 30
- format, 33
- framing marks, 4

G

- guidelines, battery, 48

H

- help
 - camera help, 38
 - Web links, 38
- high ISO, 10

I

- icons, modes, 9
- image storage, 32
- installing

- battery, 1
 - SD/SDHC Card, 3
- ISO speed, 29

K

- keyboard, 15
- KODAK Software
 - upgrading, 46
- KODAK Software, download, 34
- Kodak Web sites, 38

L

- language, 33
- LCD
 - brightness, 32
 - reviewing pictures, 17
 - reviewing videos, 17
- LCD brightness, 32
- lens
 - cleaning lens, 46
- loading
 - battery, 1
 - SD/SDHC Card, 3
- locate pictures, 20
- long time exposure, 29, 32

M

- magnify a picture, 19
- maintenance, camera, 46
- make picture from video, 26
- manner/museum, 10
- marking
 - for email, 16
- memory
 - inserting card, 3

- menu settings, 28
- modes, 9
 - auto, 9
 - backlight, 10
 - beach, 10
 - children, 10
 - fireworks, 10
 - flower, 10
 - high ISO, 10
 - manner/museum, 10
 - night landscape, 11
 - night portrait, 11
 - scene (SCN), 10
 - self-portrait, 11
 - snow, 10
 - text, 10
- modes, capture
 - smart capture, 9
- multiple selections, 27
- multi-up, 19

N

- night landscape, 11
- night portrait, 11

O

- online prints, ordering, 36
- optical zoom, 7

P

- PICTBRIDGE enabled printer, 35
- picture size, 28, 29
- pictures
 - copying, 27
 - cropping, 24

- emailing marked, 16
- marking, 37
- protecting, 18
- review icons, 21
- reviewing, 17
- taking, modes, 9
- transfer to computer, 34
- pictures/video
 - deleting, 18
- playing a video, 17
- power
 - camera, 2
- printing
 - from a card, 36
 - optimizing printer, 38
 - order online, 36
 - PICTBRIDGE, 35
 - tagged pictures, 36
- protecting pictures, videos, 18

Q

- quickview, using, 5

R

- recycling, disposal, 46
- regulatory information, 50
- repair, 43
- reset camera, 33
- reviewing pictures/video
 - as you take them, 5
 - deleting, 18
 - LCD, 17
 - protecting, 18
 - slide show, 22

running slide show, 22

S

safety, 47

scene modes (SCN), 10

SD/SDHC Card

inserting, 3

printing from, 36

search pictures, 20

select multiple pictures/videos, 27

self-portrait, 11

self-timer, 12

set tag, 29

setting

AF zone, 30

auto-focus, 31

color mode, 30

date and time, 2

image storage, 32

ISO, 29

language, 33

LCD brightness, 32

long time exposure, 29, 32

picture size, 28, 29

picture-taking mode, 9

self-timer, 12

sharpness, 31

video out, 32

white balance, 30

setting up the camera, 1

setup menu, 32

Share button, 32

sharpness, 31

shutter

problems, 40

self-timer delay, 12

slide show

continuous loop, 22

running, 22

smart capture, 9

smart display, 32

smart find, 20

snow, 10

software

upgrading, 46

software downloader, 34

specifications, camera, 44

strap, 1

T

taking pictures, videos, 4

television, slide show, 23

text, 10

text, entering, 15

time, setting, 2

timer, shutter delay, 12

tips

battery guidelines, 48

care & maintenance, 46

transfer pictures, 34

trash can, deleting, 5

trimming a video, 26

troubleshooting, 38

turning camera on and off, 2

typing, 15

U

undelete, undo, 18

upgrading software, firmware, 46
URLs, Kodak Web sites, 38
USB
 transfer pictures, 34

V

VCCI compliance, 52
video
 copying, 27
 edit, 26
 emailing marked, 16
 out, 32
 playback, 17
 protecting, 18
 review icons, 21
 transfer to computer, 34
 viewing, 17
video out, 32
viewing
 by multi-up, 19
 picture, after taking, 5, 17

W

warranty, 49
white balance, 30

Z

zoom
 digital, 7
 optical, 7