Kodak EasyShare M820/M1020 digital frame



Extended user guide

www.kodak.com

For help with your picture frame, www.kodak.com/go/digitalframesupport

Kodak

Eastman Kodak Company

Rochester, New York 14650

© Eastman Kodak Company, 2008

All screen images are simulated.

Kodak and EasyShare are trademarks of Eastman Kodak Company.

Eastman Kodak Company is an authorized licensee of the CompactFlash trademark.

P/N 4F8175_en

Front View

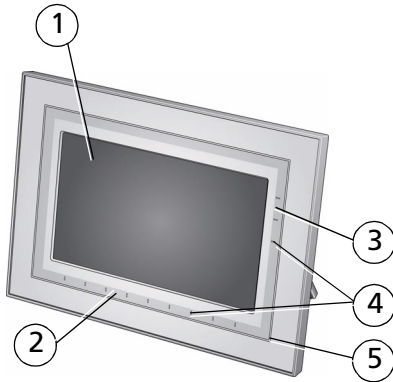



- 1 LCD screen
- 2 Touch border (tap/slide)
- 3 Touch border (tap only)
- 4 Lights
- 5 Raised guide

NOTE: When screen icons appear, Lights turn on at touch-sensitive points near the raised guide.

To use the touch border, see page 3.

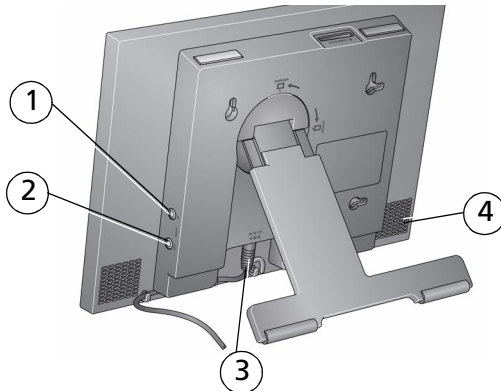
Back/Right View



- 1 Audio In
- 2 Audio Out 
- 3 DC-In (12V) 
- 4 Speakers (2)

Back/Side View

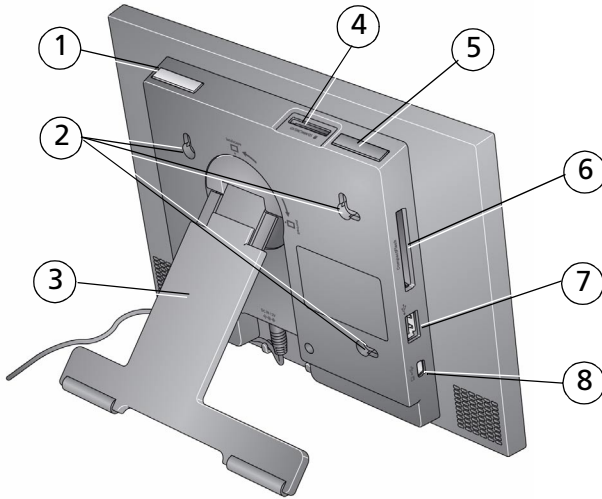

- | | |
|--|--|
| 1 Power button | 5 Volume button |
| 2 Wall mounting holes | 6 Memory card slot - CF, MD |
| 3 Rotating/extending stand (see page 1) | 7 USB connector (to camera/USB device) |
| 4 Memory card slot - SD, MMC, MS, xD | 8 USB connector (to computer) |

Table of contents

1 Getting started	1
Setting up your frame.....	1
Turning on your frame.....	2
Using your frame's touch border.....	3
Setting your language	4
Enjoying your pictures immediately!	4
Inserting a memory card.....	5
Connecting a digital camera or other USB device	5
Turning off your frame.....	6
Changing your frame orientation	6
Mounting your frame on the wall	7
2 Viewing pictures	8
Accessing your pictures	8
Running a slide show	9
Viewing thumbnails (multi-up).....	10
Viewing a single picture	10
Viewing pictures by filename	11
3 Doing more with your frame	12
Playing music only.....	12
Playing a video.....	13
Printing pictures.....	14
Copying on your frame	16
Copying between your frame and computer.....	17
Deleting pictures.....	20
Selecting multiple pictures.....	20
4 Changing settings and more	22
Changing frame settings	22
Settings menus	22
Setting the clock and timer.....	25

Upgrading your firmware.....	26
Installing the software.....	27
Customizing your frame	28
Maintaining your frame and mattes	28
Learning more about your frame.....	28
5 Troubleshooting and support	29
Picture frame problems	29
Picture frame/computer communications	30
Screen messages.....	31
6 Appendix	33
Digital frame specifications.....	33
Important safety instructions	35
Upgrading your software and firmware.....	35
Additional care and maintenance	36
Limited warranty.....	36
FCC compliance and advisory	38

1

Getting started

Welcome to your Kodak EasyShare M820/M1020 digital frame. Viewing your pictures couldn't be simpler!

Setting up your frame

Setting up the stand

Your frame displays pictures in landscape  orientation. To change to portrait  orientation, see [page 6](#).

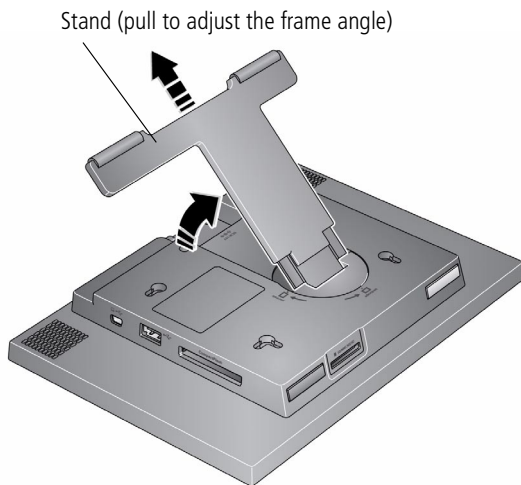

When displayed with the stand extended, the frame rests at a 68-90 ° angle.

Attaching the power cable



CAUTION:

Do not use this power cable with other devices, including digital cameras.

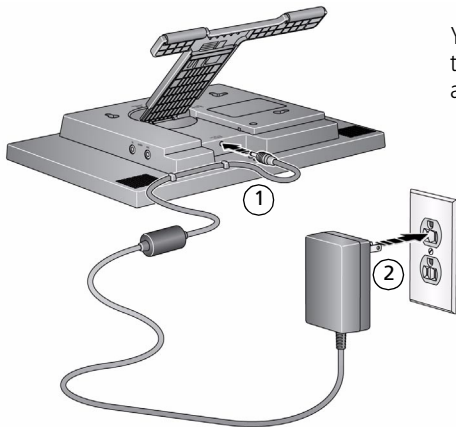

Your power cable may look different from the one pictured. Use the plug that accommodates your type of power outlet.

Turning on your frame

Power button - press and hold (for about 2 seconds), then release

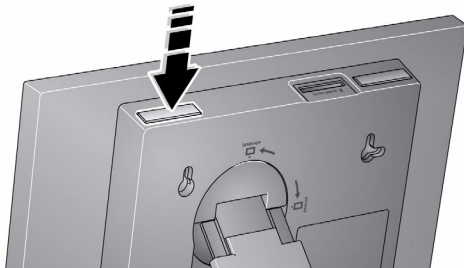

Using your frame's touch border

Touch at the bottom (tap/slide) or right (tap only) border to find/highlight menu items or pictures. Press OK to select them.

NOTE: The screen is not touch-sensitive. Do not touch. Lights appear on the border to show you where to touch.



CAUTION:

Only use your finger to touch the borders. Using sharp or metal objects may damage the border or screen.



On the side border, tap on lights next to the icons.



(Home)



(Slide show)



(Close),



or



(Done)

Raised guide

On the bottom border, tap on lights between the icons and the raised guide.



(Slider): Under slider, **slide**, or **touch and hold** (for about 3 seconds to scroll even faster through your images), or **tap** slider arrows.

Tap Menu for more options, or tap  to resume a slide show.

If the icons disappear, tap the bottom or right border.



Setting your language

The language screen appears the first time you turn on your frame.

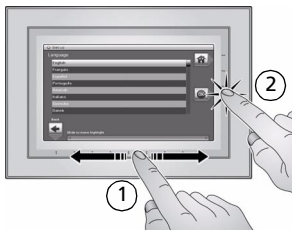
- Slide or tap below slider arrows to find your language, then tap OK.



To change the language at a later time:

- Tap  (Home) →  (Settings) → Language.
The language screen appears.
Slide to find your language, then tap OK.

Enjoying your pictures immediately!

NOTE: If the software installation screen appears, dismiss it and start playing a slide show immediately. To install the software later, see [page 27](#).



- **To view your pictures or play a slide show**, insert a memory card, or connect a camera or other USB device (see [page 5](#)).

If a slide show is already playing (for example, from the pre-loaded sample pictures/video), your pictures begin playing automatically.

To increase your frame's internal memory, delete the pre-loaded samples. Access them on My Frame (see [page 8](#)), then see [page 20](#) to delete them.

If you are at the Home screen, see [page 8](#) to start your slide show.

To change the slide show order, see [page 11](#).

Inserting a memory card

To insert a card, push the card firmly into the slot until it stops.

To remove a card from:
top card slot - push in the card to release it
side card slot - pull out the card

CAUTION: Insert a micro or mini memory card in an adapter first, or the card will get stuck in your frame.

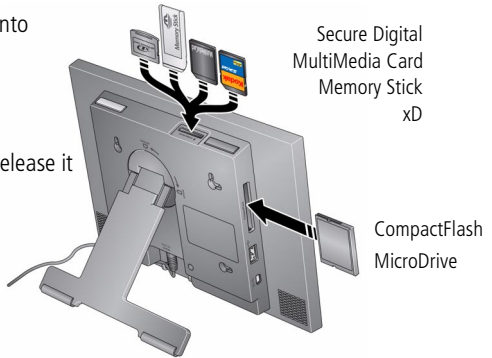

Connecting a digital camera or other USB device

USB devices: camera, flash drive, card reader, computer, etc. (sold separately)

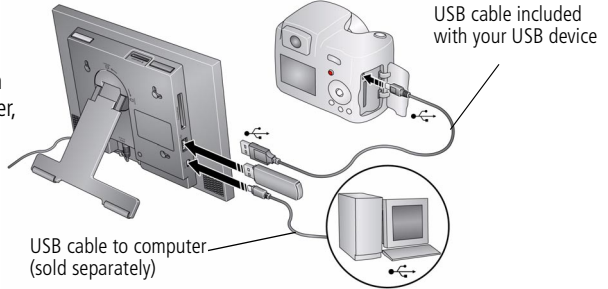

Turning off your frame

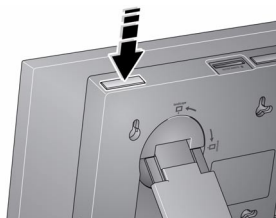

- **Standby mode**—Press and hold the power button (for about 2 seconds), then release.
- **Power off**—Unplug the power cable.

Changing your frame orientation

Change the frame orientation setting if you change to portrait  orientation.

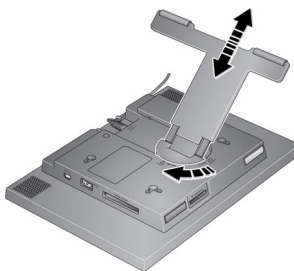





Change the stand position and angle:

- Rotate the stand 90 °, then pull it out or push it in to adjust the frame angle.

NOTE: When displayed with the stand extended, the frame rests at a 68-90 ° angle.

Change the frame orientation setting:

- 1 Tap  (Home) →  (Settings).
- 2 Slide to highlight  (Viewing options), then tap OK.
- 3 Slide to highlight Frame orientation, then tap OK.
- 4 Slide to highlight Portrait, then tap OK
- 5 Tap  to exit.

Your frame is set up now to display pictures in portrait  orientation.

Mounting your frame on the wall

Use wall-anchoring hardware (not included) to anchor your frame securely to your wall.

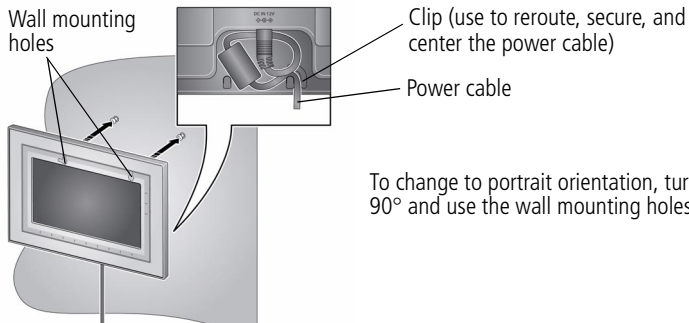





2

Viewing pictures

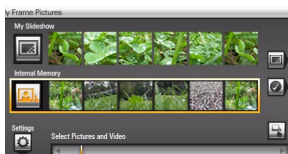
Accessing your pictures

Tap Home to access pictures, videos, music from internal memory, your memory card, and all connected devices. Use the touch borders to make your selections (see [page 3](#)).



- 1 Tap  (Home) →  (Pictures and Videos). *The frame's internal memory and connected picture sources are displayed.*
- 2 Slide to highlight a picture source, then:
 - Tap  (Slide show) to start a slide show.
 - OR
 - Tap OK to view thumbnails.

Picture source icons and settings:



My Frame—the frame's 128 MB internal memory. Copy your pictures into My Frame from a memory card or other device ([page 16](#)).



Memory card—appears when you insert a card ([page 5](#)). The label and icon indicate the type of card.



Camera—appears when you connect a digital camera via USB cable ([page 5](#)).



USB drive—appears when you insert a USB flash drive ([page 5](#)).





Settings—customize your frame settings. For example; set slide show durations and transitions, set viewing options, screen brightness, clock, and timer. See [page 22](#).



My Slide show—appears when you save a slide show you are viewing for quick access anytime (see [page 9](#)).

Running a slide show

There are two ways to start a slide show on your frame:

- Turn on the frame, then insert a card or connect a USB device—a new slide show starts automatically, replacing a currently running slide show or single view picture.
- Select a picture in thumbnail view or tap  (Home) →  (Pictures and Videos) to select a picture source. Then, tap  (Slide show).

Other slide show information

- A slide show plays continuously until you stop it or turn off the frame.
- You can change the slide duration and transition style (see [page 22](#)).

Saving your favorite slide show for easy access

While viewing the slide show:



- Tap the touch-sensitive border to pause your slide show and to display the screen icons.
- Tap  (Viewing Options) → Save as My Slide show → OK. Tap Yes to confirm.

NOTE: The saved slide show appears on the Pictures and Videos screen as a picture source (see [page 8](#)).

Viewing thumbnails (multi-up)

There are two ways to view your pictures as thumbnails:







- Tap  (Home) →  (Pictures and Videos), then select a picture source (see [page 8](#)). Tap OK.
- OR,
- From a slide show (tap the touch-sensitive border to display the icons) or from single view, tap  (Multi-up).

To navigate through the thumbnails, slide your finger left/right along the slider at the bottom. To move even faster through the thumbnails, touch and hold until the screen changes (about 3 seconds).

To play a folder of thumbnail (multi-up) images, highlight the folder then tap  (Slide show).

Viewing a single picture

- **To view a single**, full-screen picture, highlight it in thumbnails view, then tap OK.
- **To magnify** a picture up to 8X, tap  (Menu), then tap  (Zoom). Slide from left to right under the zoom bar to magnify the picture. To view other parts of the picture, tap . To return to 1X, slide from right to left.
- **To rotate** a picture, tap  (Menu), then tap .

Viewing pictures by filename

By default, the pictures on your frame are arranged and played by date, starting with the oldest. You can play the arrangement or order by date, newest to oldest, or alphabetically by filename.

NOTE: If a picture source with numerous images (greater than 500) takes too long to load, change the order to play by filename.

To change the play order:



- 1 Select a picture source (for example, a folder with pictures), or multiple pictures (see [page 20](#)), then tap OK.
- 2 Tap  (Viewing Options).
- 3 Highlight Sort, then tap OK.
- 4 Select a sort order:
 - Date, oldest to newest (default)
 - Date, newest to oldest
 - Filename, A - Z
 - Filename, Z - A
- 5 Tap OK.

3

Doing more with your frame

Playing music only





- 1 Tap the touch border to pause your slide show and to display the screen icons.
- 2 Tap  (Home), then  (Music) to view music sources.
- 3 Slide to the right/left to move up/down the music source list, then tap OK.
- 4 Slide right/left to go to the previous/next song, or select Play all songs, then tap OK.

Your music starts playing.

- 5 Tap  (Slide show) to return to your picture or slide show.





NOTE: Music plays automatically when a memory card or USB device with music on it is connected.

Notes on playing, copying, deleting music:

- A headphone jack is available on the side of the frame ([page i](#)).
- Adjust the volume with the Volume button ([page ii](#)).
- To copy or delete music files (MP3), slide to highlight each song in the music source, then tap  (Select). Or tap  (Select All) to highlight all the songs. Tap OK. Tap  (Menu) → Copy or Delete → OK.
 - For copying, highlight the source you want to copy to, then tap OK.
 - For deleting, tap Yes to confirm.
- To copy music files (MP3) to internal memory, drag and drop them from your computer. See [Copying pictures to/from your computer, page 17](#).

Playing a video

- During a slide show, videos play automatically. When the video ends, the slide show resumes. To play a video from thumbnails view, highlight a video thumbnail, then tap OK.
- Videos in thumbnail view:
 - MOV videos are indicated with .
 - AVI, MPEG, and MPG videos display the first frame.
- Video control buttons:

	play, pause, and resume the video.
	rewind / fast forward.
 or 	stop the video and return to thumbnails.

Printing pictures

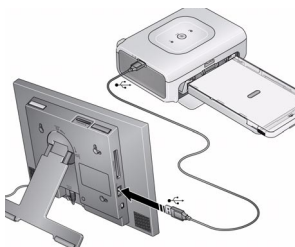

Your frame is compatible with PictBridge technology, so you can print directly to PictBridge enabled printers.



- 1 Turn off the frame and printer.
- 2 Make sure your frame is disconnected from the printer.
- 3 On the frame, change your connection mode from Computer to Printer. See [page 15](#).
- 4 Reconnect your frame to the printer, using the USB cable.

Printing to a PictBridge enabled printer

- 1 Turn on the printer. Turn on the frame.
- 2 From a slide show (tap the touch-sensitive border to pause the slide show and display the icons) or from single view:

- Tap  (Menu), then  (Print).

Printing begins.

If you are in thumbnails (multi-up) view:

- Slide to select a picture, or see [page 20](#) to select multiple pictures.
- Tap  (Menu).



If you selected multiple pictures to print, they appear on the screen.

- Tap  (Print), then Yes to start printing.

NOTE: Remember to change your connection mode back to Computer when you are done (see [page 15](#)).

Manually changing USB connection mode

The connection mode must match the device you connect the frame to: Computer or Printer. The default is Connect to computer. You can change the connection mode manually.

- 1 Disconnect the printer or computer from the frame.
- 2 On the frame, tap  (Home).
- 3 Tap  (Settings).
- 4 Slide to highlight Device configuration, then tap OK.
- 5 Highlight USB connection mode, then tap OK.
- 6 Slide to highlight the mode you want to connect to, printer or computer, then tap OK.
- 7 Reconnect the device (printer or computer) that matches the connection mode.

Copying on your frame

Copy pictures from your current viewing location to other connected devices (see [page 5](#)).



CAUTION:

Removing a card or disconnecting a device while copying may damage your card, pictures, or device.

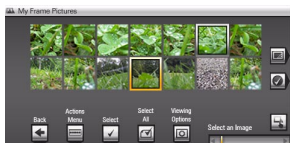

- 1 Highlight a picture to copy:
In thumbnails view, slide or tap below the slider arrows to find a picture; or, display a picture in single view (see [page 10](#)).

- 2 Tap  (Menu).

- 3 Tap  (Copy), then OK.

- 4 Tap the available destination you want to copy to, then tap OK.

The picture is copied.

- 5 Tap  (Close) to close the menu.

To copy multiple pictures, see [page 20](#).

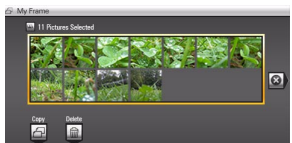

Copying between your frame and computer

Copy pictures, videos, and music via a USB cable.

Connecting to your computer

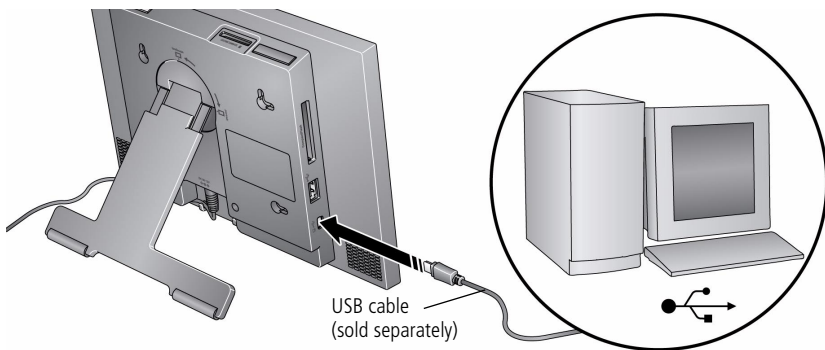

Copying pictures to/from your computer

Drag and drop pictures, videos, and music easily between your frame and computer, then play a slide show on your frame right away. See [page 33](#) for applicable file formats.

- 1 Install the software that came with your frame (see [page 27](#)).
- 2 Set the USB connection mode to Computer (see [page 15](#)), then connect the USB cable from the frame to your computer (see [page 17](#)).
- 3 Double-click  (Kodak EasyShare digital display software icon) on your desktop to open the software.

The frame, memory card, and connected devices appear in the Drag and Drop Zone.

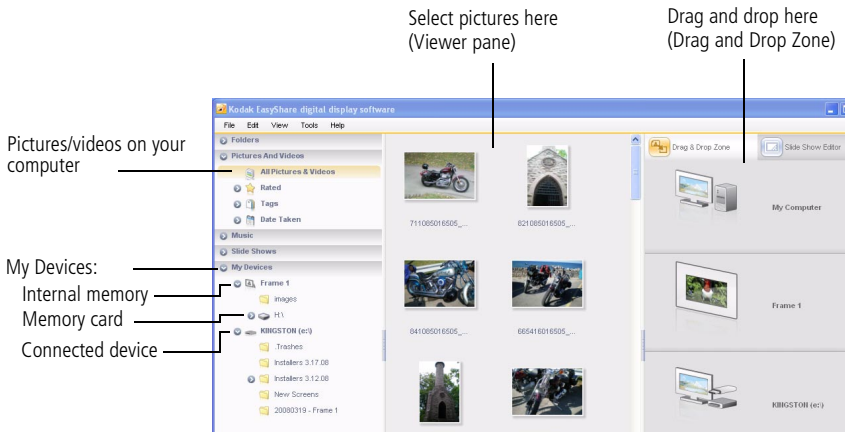

- 4 Click My Devices to see the folders on your frame and the connected devices.

The frame appears as removable drives—one drive for each picture source on the frame's picture source: internal memory (My Frame), and any inserted memory cards or connected devices.

- 5 In Pictures and Videos, click the folder or location on your computer that contains the pictures you want to copy.
- 6 In the Viewer pane, select the pictures, videos, etc., then drag and drop them to the new location in the Drag and Drop Zone (for example, the frame's internal memory, a memory card, or connected USB device).
- 7 Unplug the USB cable, then go to the copy location (see [page 8](#)) to play a slide show with your copied picture.

NOTE: The slide show order of play for available sources is: memory card, USB device, internal memory.

NOTE: To maintain the slide show order during playback, see [page 11](#) and select Filename, A - Z.

Copying pictures from EasyShare software

It's easy to copy pictures/videos from My Collection to your frame.

- 1 Install the software that came with your frame (see [page 27](#)).
- 2 Set the USB connection mode to Computer (see [page 15](#)), then connect the USB cable (see [page 17](#)).
- 3 On your computer, open EasyShare software. Click My Collection, then select the pictures in the Viewer pane. Drag and drop them into the Picture tray.
- 4 In the menu bar, select File → Copy to.

The frame appears as removable drives—one drive for each connected picture source in the frame: internal memory, memory cards, USB devices.

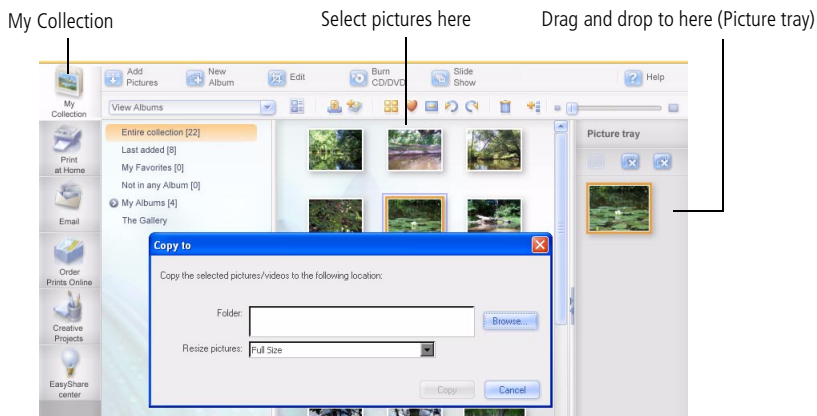

- 5 Browse to the frame location to which you are copying.
- 6 Select *Best For Digital Picture Frame* to resize the picture you are copying. Full resolution is unnecessary and quickly fills up the frame's memory.
- 7 Click Copy. Pictures are copied to your frame.
- 8 Unplug the USB cable, then go to the copy location (see [page 8](#)) to view your copied pictures on your frame and to play a slide show.



Deleting pictures



CAUTION:

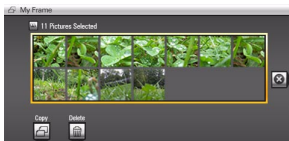

Removing a card or disconnecting a device while deleting may damage your card, pictures, or device.



- 1 Highlight a picture to delete:
In thumbnails view, slide or tap below the slider arrows to find a picture; or, display a picture in single view.
- 2 Tap  (Menu) → , then tap OK.
- 3 Tap Yes to confirm.
The picture is deleted.
- 4 Tap  (Close) to close the menu.
To delete multiple pictures, [see page 20](#).

Selecting multiple pictures

Use the multi-select feature to copy or delete two or more pictures or to play a slide show of selected pictures.

- 1 In multi-up (thumbnails) view, slide or tap below the slider arrows to find a picture, then tap  (Select).
A check mark appears on the selected picture.
- 2 Continue selecting pictures.
To remove a check mark, tap  (Unselect) while the picture is highlighted.

Select/Unselect all



Select all

- In thumbnails view ([page 10](#)), tap  (Select All).

Unselect all



- To remove all check marks, tap Unselect All.

4

Changing settings and more

Changing frame settings

The options in the Settings menu let you customize and configure your frame.

- 1 Tap  (Home), then  (Settings).
- 2 Slide or tap below the slider arrows to highlight a setting, then tap OK.
- 3 Follow the on-screen instructions. Tap OK to accept your selections.
- 4 Tap  (Back) to exit.

Settings menus



Setting	Options
Upgrade firmware This option is only displayed if the upgrade file (.img) is available on the frame (memory card, flash drive, internal memory, etc.).	Upgrade firmware —load the latest version of firmware on your frame (page 26). Exit —return to the Home screen.

Setting	Options
Viewing options	<p>Slide duration—specify how long each picture is displayed in a slide show, from 3 seconds to 1 hour. (The default is 5 seconds.)</p> <p>Transitions—specify the transition style between pictures in a slide show. See screen for options. The default is Random.</p> <p>Shuffle—plays the images in random order.</p> <p>Slide show start—when pictures are sorted from oldest to newest (see page 11), specify where a slide show starts automatically (from picture dated 1 week back, or from oldest picture).</p> <p>Brightness—slide to adjust the screen brightness according to your lighting conditions.</p> <p>Frame orientation—display your frame in landscape (default) <input type="checkbox"/> or portrait <input type="checkbox"/> orientation.</p> <p>Screen Fit or Fill—</p> <p>Fit entire image <input checked="" type="checkbox"/> (default). Show the entire picture. Black borders may appear around the image.</p> <p>Fill the screen <input type="checkbox"/>. The picture fills the entire screen; some of the picture may be cut off (cropped).</p> <p>Music auto-play—choose to play music automatically during a slide show. (Music files must be in the same location as your pictures.)</p> <p>Audio priority—when you are playing music (page 12), choose whether or not to play the audio portion of a video.</p> <p>Play music (default). Music continues to play, video plays but its audio is muted. Play video soundtrack. Music stops playing while the video, with audio, plays.</p>
Clock and timer	<p>On/Off schedule—set your frame to turn on and off at a specified time every day (page 25).</p> <p>Set time—manually set the clock to the current time (page 25).</p>

Setting	Options
Language	Choose your language (page 4).
Automatic resizing	Choose to turn on or off automatic resizing of your pictures when copying. Full resolution is unnecessary and quickly fills up the frame's memory.
About	Check your frame model, serial number, and firmware version.

Setting the clock and timer



Manually setting the clock

- 1 Tap  (Home), then  (Settings).
- 2 Highlight Clock and timer, then tap OK.
- 3 Highlight Set time, then tap OK.
- 4 Slide to set the hour. Tap the right arrow to highlight the next setting (minutes), then slide to adjust it.
- 5 Tap OK to accept your changes.

Setting automatic on/off

Set your frame to turn on and off at a specified time every day.

NOTE: Set the clock before enabling auto on/off.

- 1 Tap  (Home), then  (Settings).
- 2 Highlight Clock and timer, then tap OK.
- 3 Highlight On/Off schedule, then tap OK.
The current time is displayed and the hour field is highlighted.
- 4 Slide to adjust the hour. Tap the right arrow to highlight the next setting (minutes), then slide to adjust it. Repeat to set Turn off time.
- 5 Tap Enable, then OK when you're done.

Your frame will now automatically turn on and off at the times you specified.



NOTE: Make sure the power button on the frame is On. See [page 2](#).

If your frame loses power, the clock time returns to the factory setting and the automatic on/off times, if set, are disabled. To reset the clock and re-enable your on/off times, see [Resetting the clock after losing power, page 30](#).

Upgrading your firmware

Firmware is the software that runs on your frame. To check for the latest version, visit www.kodak.com/go/digitalframedownloads.

Download the firmware to your computer, then upgrade your frame:

- 1 On your computer, go to www.kodak.com/go/digitalframedownloads.
- 2 Follow the screen directions to download the frame firmware to your computer.
- 3 Copy the IMG file to a memory card or USB flash drive, then insert into the frame. See [page 17](#) for copying files.
- 4 Tap  (Home), then  (Settings).
- 5 Highlight Firmware Upgrade, then tap OK to begin the upgrade.

IMPORTANT: *Do not turn off the frame or remove the memory card or USB flash drive during the upgrade!*

When the upgrade is complete, your frame automatically restarts. If it doesn't, press the power button on the frame to Off, then back to On.

Installing the software

Follow these directions to install the software CD that was packaged with your frame. The CD contains the Kodak EasyShare software and the Kodak EasyShare digital display software. While these software applications work well independently, both applications work together for the best experience when working with your pictures (see [page 17](#)).

- 1 Close all software applications that are open on your computer (including anti-virus software; see the anti-virus software manual for details).
- 2 Place the EasyShare software CD into the CD-ROM drive.
The Kodak EasyShare software Install Wizard opens on your computer screen.
- 3 If the Install Wizard does not appear, choose Run from the Start menu and type **d:\setup.exe** where **d** is the drive letter that contains the CD.
- 4 Follow the on-screen instructions to install the software. Select Complete to automatically install both the Kodak EasyShare software and the Kodak digital display software. Or, click Customize to choose the applications you wish to install.

NOTE: When prompted, take a few minutes to electronically register your picture frame and software. To register later, visit www.kodak.com/go/register.

- 5 If prompted, restart the computer. If you turned off anti-virus software, turn it back on.

The software icon(s) appear on your desktop when the installation is complete.

Customizing your frame

For a custom look, remove the adhesive matte (included) from its liner, align it carefully, then attach it to your frame.

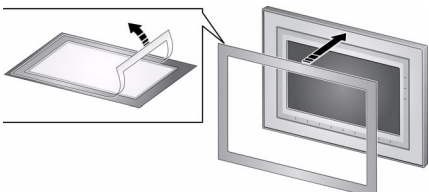

When you are not using the matte, reapply it to the liner and store in a plastic bag to keep the adhesive backing clean.

Maintaining your frame and mattes

IMPORTANT: *Always disconnect the power before cleaning. Do not use water, cleaning solutions, or other adhesives on the frame or any of its parts.*

Gently wipe the frame, LCD, or matte with a clean, dry, lint-free cloth (included). For fingerprints on the frame, apply light pressure.

Learning more about your frame

www.kodak.com/go/digitalframes

Frame accessories, including decorative faceplates and custom mattes

www.kodak.com/go/digitalframesupport

Interactive troubleshooting and repairs

Interactive tutorials

FAQs

Downloads

Product registration

5

Troubleshooting and support

For step-by-step product support, visit www.kodak.com/go/digitalframesupport and select Interactive Troubleshooting & Repairs.

Picture frame problems

If..	Try one or more of the following
Frame does not turn on.	<ul style="list-style-type: none"> ■ Make sure the power cable that was included with your frame is connected securely (see page 2). ■ Unplug the power cable from the frame. Wait 5 seconds, then reconnect the cable. Press and hold the power button (for about 2 seconds), then release.
Nothing happens when a memory card, camera, or USB device is connected.	<ul style="list-style-type: none"> ■ Insert a certified SD/MMC/MS/xD/CF/MD card with images into the designated card slot, then push to seat it (see page 5). In the top card slot, make sure the card is seated flush with the top. ■ Make sure the USB cable that was included with your camera or USB device is connected securely (see page 5). ■ Make sure the file format of your pictures and videos are supported. (See page 33). <p>NOTE: A large picture file may take time to appear.</p>
Touch border doesn't work.	<ul style="list-style-type: none"> ■ Use your finger to make your selections on the touch-sensitive borders (see page 3). Lights on the border show you where to touch. <p>IMPORTANT: <i>Do not slide on the right border (tap only).</i></p> <ul style="list-style-type: none"> ■ Unplug the power cable from the frame. Wait 5 seconds, then reconnect the cable. Press and hold the power button (for about 2 seconds), then release.
Frame freezes up.	<ul style="list-style-type: none"> ■ Unplug the power cable from the frame. Wait 5 seconds, then reconnect the cable. Press and hold the power button (for about 2 seconds), then release.

If...	Try one or more of the following
Music doesn't play.	<ul style="list-style-type: none"> ■ Make sure the volume is turned up (see page ii). ■ If your frame has songs you purchased, they may be protected files. Convert the files to standard (unprotected) AAC or MP3 formats.
You set automatic on/off but the frame doesn't turn on and off at the specified times.	<ul style="list-style-type: none"> ■ Make sure you Enabled the on/off setting after you set the times, then press OK (not Back). See page 25. ■ If your frame loses power, the clock returns to the factory setting and auto on/off times are disabled. See Resetting the clock after losing power, page 30.

Resetting the clock after losing power

If you turn off the power on the frame or otherwise lose power for half a day or more, the clock time returns to the factory setting and the automatic on/off times, if set, are disabled.

- When you turn the frame back on, the set time screen appears on the frame.
- Slide to set the hour. Tap the left/right arrows to highlight the previous or next setting (hour and minutes), then slide to adjust the setting.
- Tap OK.

The Home screen appears. The time is reset and the automatic on/off times (if set) are re-enabled. It is not necessary to reset the on/off times.

NOTE: If you exit the set time screen without setting the time, you can manually reset the clock and re-enable the automatic on/off times (see [page 25](#)). It is not necessary to reset the on/off times.

Picture frame/computer communications

If...	Try one or more of the following
Cannot copy pictures to my computer.	<ul style="list-style-type: none"> ■ Make sure your computer is on. ■ Make sure the USB cable is securely connected (page 17).
Cannot see my frame as a removable drive.	<ul style="list-style-type: none"> ■ Make sure the power button on the frame is On (page ii).

If...	Try one or more of the following
Cannot copy pictures from Kodak EasyShare software.	<ul style="list-style-type: none"> ■ Make sure your frame and computer are on. ■ Make sure the USB cable is securely connected (page 17). ■ Make sure to install the software that was packaged with your frame (page 27). ■ From My Collection in EasyShare software, make sure the pictures are in the Picture Tray.

Screen messages

Screen message	Try one or more of the following
Create file failed.	<p>The device (memory card, USB drive, camera, etc.) you are trying to copy to is protected.</p> <ul style="list-style-type: none"> ■ See your device documentation to remove write protection. ■ Insert or connect a different device.
Printer unavailable. Unable to connect to printer.	<ul style="list-style-type: none"> ■ Make sure your printer is on and the USB cable is securely connected (page 14). ■ Make sure you changed your USB connection mode from computer to printer (page 15).
Printing error.	<ul style="list-style-type: none"> ■ Make sure your printer is on and the USB cable is securely connected (page 14). ■ Check your printer for more info.
Time out occurred while printing.	<ul style="list-style-type: none"> ■ Check cables and printer supplies. Print again.
Write failed. Select another location.	<p>The frame was unable to copy the picture.</p> <ul style="list-style-type: none"> ■ Insert a different card or device (page 5).

Screen message	Try one or more of the following
Unable to create file. Device write protected or full.	<p>The frame was unable to copy the picture.</p> <ul style="list-style-type: none"> ■ Insert a different card or device (page 5). ■ Remove write protection, unlock card. ■ Delete pictures from card.
Disk full.	
Error attempting to open file or directory.	<ul style="list-style-type: none"> ■ Turn off the frame, then turn it back on. Press and hold the power button (for about 2 seconds), then release. If the problem persists, contact customer support help, at www.kodak.com/go/digitalframesupport.
Error duplicate filename.	
Error occurred while closing a file.	
Error invalid filename	
Error reading from file.	
Error writing from file.	
Error writing a file.	
Error writing to a file.	
File Copy Failed!	
Internal error.	
Parameter is invalid.	
Unknown error.	

6

Appendix

Digital frame specifications

For more specifications, visit www.kodak.com/go/digitalframesupport.

Kodak EasyShare M820/M1020 digital frame	
Color display	
M820	20.3 cm (8 in.) diagonal digital LCD, 800 x 480 pixels, 4:3 or 16:9 aspect ratio, 17.6 x 10 cm (6.9 x 3.9 in.) viewable area
M1020	25.4 cm (10 in.) diagonal digital LCD, 800 x 480 pixels, 16:9 aspect ratio, 23.5 x 14.6 cm (9.3 x 5.8 in.) viewable area
Internal storage capacity	
M820, M1020	128 MB
Power	
Leader Electronics Inc. AC adapter, model MU18-2120150-A1, 12-volt, 1.5 amp. Europe: Phihong AC adapter, model PSA 18R-120P (See page 35 for more information.)	
Communication with computer	
USB 1.0 cable	
Wi-Fi wireless network compatibility	
M820, M1020	No
Other features	
PictBridge support	Yes
Picture formats	JPEG, EXIF 2.2

Kodak EasyShare M820/M1020 digital frame	
Video formats	MOV, AVI, MPG, MPEG (Video formats created with digital cameras are certified for Kodak digital frames. Videos created with or copied from other sources may not play on the frame.)
Music format	MP3
Memory cards	MMC (MultiMedia Card); SD/SDHC (Secure Digital/Secure Digital High Capacity); Memory Stick, xD; CF; MD
Tripod mount	1/4 inch
Temperature	Operating: -4 to 140°F (-20 to 60°C) Storage: -22 to 185°F (-30 to 85°C)
Size	M820: 28.5 x 21 x 3.8 cm (11.2 x 8.3 x 1.5 in.) M1020: 33 x 24 x 3.8 cm (13 x 9.5 x 1.5 in.)

Important safety instructions



CAUTION:

Do not disassemble this product; there are no user-serviceable parts inside. Refer servicing to qualified service personnel. Do not expose this product to liquid, moisture, or extreme temperatures. The use of controls, adjustments, or procedures other than those specified herein may result in exposure to shock and/or electrical or mechanical hazards. If the LCD breaks, do not touch the glass or liquid. Contact Kodak customer support.

- The use of an accessory that is not recommended by Kodak may cause fire, electric shock, or injury. For approved accessories, visit www.kodak/go/accessories.
- Use only a Leader Electronics Inc. AC adapter, model MU18-2120150-A1, 12-volt, 1 amp.
In Europe, use only a Pihong AC adapter, model PSA 18R-120P.
Use of other AC adapters may damage the frame and void your warranties.
- Use only a USB-certified computer equipped with a current-limiting motherboard. Contact your computer manufacturer if you have questions.

Upgrading your software and firmware

Upgrade to the latest versions of the software included on the Kodak EasyShare software CD and the frame firmware—www.kodak.com/go/digitalframedownloads. See [page 26](#) for upgrading firmware.

Additional care and maintenance

- Wipe the frame and the LCD gently with a soft, lint-free cloth (included). Do not use cleaning solutions unless designed specifically for LCD screens. Do not allow chemicals, such as suntan lotion, to contact painted surfaces.
- Service agreements are available in some countries. Contact a dealer of Kodak products for more information.
- For digital frame disposal or recycling information, contact your local authorities. In the US, visit the Electronics Industry Alliance Web site at www.eiae.org or visit www.kodak.com/go/digitalframesupport.

Limited warranty

Kodak warrants Kodak consumer electronic products and accessories ("Products"), excluding batteries, to be free from malfunctions and defects in both materials and workmanship for one year from the date of purchase. Retain the original dated sales receipt. Proof of the date of purchase will be required with any request for warranty repair.

Limited warranty coverage

Warranty service is only available from within the country where the Products were originally purchased. You may be required to ship Products, at your expense, to the authorized service facility for the country where the Products were purchased. Kodak will repair or replace Products if they fail to function properly during the warranty period, subject to any conditions and/or limitations stated herein. Warranty service will include all labor as well as any necessary adjustments and/or replacement parts. If Kodak is unable to repair or replace a Product, Kodak will, at its option, refund the purchase price paid for the Product provided the Product has been returned to Kodak along with proof of the purchase price paid. Repair, replacement, or refund of the purchase price are the sole remedies under the warranty. If replacement parts are used in making repairs, those parts may be remanufactured, or may contain remanufactured materials. If it is necessary to replace the entire Product, it may be replaced with a remanufactured Product. Remanufactured Products, parts and

materials are warranted for the remaining warranty term of the original Product, or 90 days after the date of repair or replacement, whichever is longer.

Limitations

This warranty does not cover circumstances beyond Kodak's control. This warranty does not apply when failure is due to shipping damage, accident, alteration, modification, unauthorized service, misuse, abuse, use with incompatible accessories or attachments (such as third party ink or ink tanks), failure to follow Kodak's operation, maintenance or repacking instructions, failure to use items supplied by Kodak (such as adapters and cables), or claims made after the duration of this warranty. Kodak makes no other express or implied warranty for this product, and disclaims the implied warranties of merchantability and fitness for a particular purpose. In the event that the exclusion of any implied warranty is ineffective under the law, the duration of the implied warranty will be one year from the purchase date or such longer period as required by law. The option of repair, replacement, or refund is Kodak's only obligation. Kodak will not be responsible for any special, consequential or incidental damages resulting from the sale, purchase, or use of this product regardless of the cause. Liability for any special, consequential or incidental damages (including but not limited to loss of revenue or profit, downtime costs, loss of the use of the equipment, cost of substitute equipment, facilities or services, or claims of your customers for such damages resulting from the purchase use or failure of the Product), regardless of cause or for breach of any written or implied warranty is expressly disclaimed.

Your rights

Some states or jurisdictions do not allow exclusion or limitation of incidental or consequential damages, so the above limitation or exclusion may not apply to you. Some states or jurisdictions do not allow limitations on how long an implied warranty lasts, so the above limitation may not apply to you. This warranty gives you specific rights, and you may have other rights which vary from state to state or by jurisdiction.

Outside the United States and Canada

In countries other than the United States and Canada, the terms and conditions of this warranty may be different. Unless a specific Kodak warranty is communicated to the purchaser in writing by a Kodak company, no warranty or liability exists beyond any minimum requirements imposed by law, even though defect, damage, or loss may be by negligence or other act.

FCC compliance and advisory

 Kodak EasyShare M820/M1020 digital frames

This equipment has been tested and found to comply with the limits for a Class B digital device, pursuant to Part 15 of the FCC Rules. These limits are designed to provide reasonable protection against harmful interference in a residential installation.

This equipment generates, uses, and can radiate radio frequency energy and, if not installed or used in accordance with the instructions, may cause harmful interference to radio communications. However, there is no guarantee that interference will not occur in a particular installation.

If this equipment does cause harmful interference to radio or television reception, which can be determined by turning the equipment off and on, the user is encouraged to try to correct the interference by one or more of the following measures: 1) reorient or relocate the receiving antenna; 2) increase the separation between the equipment and the receiver; 3) connect the equipment to an outlet on a circuit different from that to which the receiver is connected; 4) consult the dealer or an experienced radio/TV technician for additional suggestions.

Any changes or modifications not expressly approved by the party responsible for compliance could void the user's authority to operate the equipment. Where shielded interface cables have been provided with the product or specified additional components or accessories elsewhere defined to be used with the installation of the product, they must be used in order to ensure compliance with FCC regulation.

FCC and Industry Canada

This device complies with Industry Canada RSS-210 and FCC Rules. Operation is subject to the following two conditions: (1) this device may not cause harmful interference, and (2) this device must accept any interference received, including interference that may cause undesired operation.

FCC et Industrie Canada

Cet appareil est conforme à la norme RSS-210 d'Industrie Canada et aux réglementations de la FCC. Son utilisation est soumise aux deux conditions suivantes : (1) cet appareil ne doit pas provoquer d'interférences nuisables, et (2) cet appareil doit supporter les interférences reçues, y compris celles susceptibles de nuire à son bon fonctionnement.

CE

Hereby, Eastman Kodak Company declares that this Kodak product is in compliance with the essential requirements and other relevant provisions of Directive 1999/5/EC.

Canadian DOC statement

DOC Class B Compliance—This Class B digital apparatus complies with Canadian ICES-003.

Observation des normes-Classe B—Cet appareil numérique de la classe B est conforme à la norme NMB-003 du Canada.

Waste Electrical and Electronic Equipment labeling



EU: It is the final user's responsibility to discard this equipment into an approved, segregated collection scheme to enable its suitable treatment/disposal and to improve human/environmental protection. For more information, see your retailer, local authority, or www.kodak.com/go/recycle.

Australian C-Tick



MPEG-4

Use of this product in any manner that complies with the MPEG-4 visual standard is prohibited, except for use by a consumer engaging in personal and non-commercial activities.

Russian GOST-R



Eastman Kodak Company
Rochester, New York 14650

Цифровая фоторамка изготовлена в Китае; остальные элементы – в соответствии с маркировкой

China RoHS

环保使用期限 (EPUP)

在中国大陆，该值表示产品中存在的任何危险物质不得释放，以免危及人身健康、财产或环境的时间期限（以年计）。该值根据操作说明中所规定的产品正常使用而定。

Environmental Protection Use Period (EPUP)

In China, this number indicates the time period (in years) within which any hazardous substances present in the product are not expected to be released such that there is risk to human health, property, or the environment. This value is assigned based on normal use of the product as described in the operating instructions.

Product Disclosure Table

有毒有害物质或元素名称及含量标识表
table of hazardous substances' name and concentration

部件名称 Component name	有毒有害物质或元素 hazardous substances' name					
	铅 (Pb)	汞 (Hg)	镉 (Cd)	六价铬 (Cr6+)	多溴联苯 (PBB)	多溴二苯 醚 (PBDE)
数码相架电路板元件 (Digital Photo Frame circuit board components)	X	O	O	O	O	O
控制器 (Controller)	X	O	O	O	O	O
交流变压器电路板元件 (AC Adapter circuit board components)	X	O	O	O	O	O

O: 表示该有毒有害物质在该部件所有均质材料中的含量均在SJ/T 11363-2006规定的限量要求以下。
X: 表示该有毒有害物质至少在该部件的某一均质材料中的含量超出SJ/T 11363-2006规定的限量要求。
O: indicates hazardous substance concentration lower than MCV
X: indicates hazardous substance concentration higher than MCV



USB 数据线

Korean Class B ITE

이 기기는 가정용으로 전자파적합등록을 한 기기로서 주거지역에서는 물론 모든 지역에서 사용할 수 있습니다.

Licensing

Supply of this product does not convey a license nor imply any right to distribute content created with this product in revenue-generating broadcast systems (terrestrial, satellite, cable and/or other distribution channels), streaming applications

(via Internet, intranets and/or other networks), other content distribution systems (pay-audio or audio-on-demand applications and the like) or on physical media (compact discs, digital versatile discs, semiconductor chips, hard drives, memory cards and the like). An independent license for such use is required. For details, please visit <http://mp3licensing.com>.

Index

A

- about, frame, 24
- appendix, 33
- automatic on/off, 23, 25

B

- battery
 - safety, 35
- button
 - macro/landscape, ii

C

- cables
 - USB, connecting, 5
- camera, connecting, 5
- changing picture locations, 8
- clock and timer, setting, 23, 25
- computer
 - connecting to frame, 17
 - copying to/from, 17
 - help with communicating, 30
- connection mode, 15
- copying
 - from EasyShare software, 19
 - to/from computer, USB, 17

D

- deleting pictures and videos, 20
- displaying slide show, 9
- disposal, recycling, 36
- doing more with your frame, 12

E

- EasyShare software
 - copying pictures from, 19
 - installing, 27
- error messages, 31

F

- fast forward video, 13
- firmware
 - checking version, 24
 - upgrading, 22, 35
- flash drive, connecting, 5
- frame, picture
 - changing orientation, 1
 - checking model, firmware, serial number, 24
 - setup, 1
 - specifications, 33
 - troubleshooting, 29
 - turning on/off, 6

H

- help
 - communicating with computer, 30
 - frame, 29
- home
 - changing picture locations, 8
 - screen, 8

I

- installing software, 27
- internal memory

capacity, 33

L

landscape, set orientation, 23

language

setting, 24

setting first time, 4

loading software, 27

M

macro/landscape button, ii

multi-up view, 10

O

on/off, setting auto, 23, 25

orientation setting, 1, 23

P

PictBridge enabled printer, 14

pictures

copying connected, 17

copying from EasyShare software, 19

deleting, 20

location, changing, 8

selecting more than one, 20

viewing, 8

play/pause, video, 13

portrait, set orientation, 23

power

specifications, 33

turning on, 6

printer connection mode, 15

printing, PictBridge printer, 14

R

recycling, disposal, 36

regulatory compliance, 38

rewind video, 13

running slide show, 9

S

safety information, 35

screen

cleaning, 36

error messages, 31

selecting multiple pictures, 20

serial number, checking, 24

setting

auto on/off, 23, 25

language, 24

language first time, 4

time, 23

viewing options, 23

setup

picture frame, 1

slide duration, setting, 23

slide show

running, 9

slide transitions, setting, 23

software

installing, 27

upgrading, 35

source, picture location, 8

specifications, frame, 33

stop

video, 13

storage capacity, internal memory, 33

T

- thumb drive. See flash drive., 5
- thumbnails, 10
- time, setting, 23
- transitions, slides, setting, 23
- troubleshooting
 - error messages, 31
 - frame, 29
- turning on/off frame, 6

U

- upgrading
 - firmware, 22
 - software and firmware, 35
- USB connection mode, 15
- USB device, connecting, 5

V

- viewing
 - full screen picture, 10
 - pictures/videos, 8
 - thumbnails, 10

W

- warranty, 36