

Journal of the Royal Microscopical Society

CONTAINING ITS TRANSACTIONS AND PROCEEDINGS

AND

A SUMMARY OF CURRENT RESEARCHES RELATING TO
ZOOLOGY AND BOTANY

(principally Invertebrata and Cryptogamia)

MICROSCOPY, &c.

EDITED BY

R. G. HEBB, M.A. M.D. F.R.C.P.

Joint Lecturer on Medicine at Westminster Hospital

WITH THE ASSISTANCE OF THE PUBLICATION COMMITTEE AND

J. ARTHUR THOMSON, M.A. F.R.S.E.

Regius Professor of Natural History in the University of Aberdeen

A. N. DISNEY, M.A. B.Sc.

J. W. H. EYRE, M.D. F.R.S.E.

Bacteriologist to Guy's Hospital

FELLOWS OF THE SOCIETY

AND

A. B. RENDLE, M.A. D.Sc. F.L.S.

Assistant in Botany, British Museum

Minimis partibus, per totum Naturæ campum, certitudo omnis innititur
quas qui fugit pariter Naturam fugit.—*Linnaeus.*

FOR THE YEAR

1902



TO BE OBTAINED AT THE SOCIETY'S ROOMS,
20 HANOVER SQUARE, LONDON, W. ;
OF MESSRS. WILLIAMS & NORGATE ; AND OF MESSRS. DULAU & CO.

247

THE

Royal Microscopical Society.

(Established in 1839. Incorporated by Royal Charter in 1866.)

The Society was established for the promotion of Microscopical and Biological Science by the communication, discussion, and publication of observations and discoveries relating to (1) improvements in the construction and mode of application of the Microscope, or (2) Biological or other subjects of Microscopical Research.

It consists of Ordinary, Honorary, and Ex-officio Fellows of either sex.

Ordinary Fellows are elected on a Certificate of Recommendation signed by three Ordinary Fellows, setting forth the names, residence, and description of the Candidate, of whom the first proposer must have personal knowledge. The certificate is read at two General Meetings, and the Candidate balloted for at the second Meeting.

The Admission Fee is 2*l.* 2*s.*, paid at the time of election and the Annual Subscription is 2*l.* 2*s.*, payable on election, and subsequently in advance on 1st January in each year, but future payments may be compounded for at any time for 3*l.* 10*s.* Fellows elected at a meeting subsequent to that in February are only called upon for a proportionate part of the first year's subscription. The annual Subscription of Fellows permanently residing abroad is 1*l.* 11*s.* 6*d.* or a reduction of one-fourth.

Honorary Fellows (limited to 50), consisting of persons eminent in Microscopical or Biological Science, are elected on the recommendation of five Ordinary Fellows and the approval of the Council.

Ex-officio Fellows (limited to 100), consisting of the Presidents for the time being of any Societies having objects in whole or in part similar to those of the Society, are elected on the recommendation of ten Ordinary Fellows, and the approval of the Council.

The Council, in whom the management of the property and affairs of the Society is vested, is elected annually, and is composed of the President, four Vice-Presidents, Treasurer, two Secretaries, and twelve other Ordinary Fellows.

The Meetings are held on the third Wednesday in each month, from October to June, at 20 Hanover Square, W. (commencing at 8 P.M.). Visitors are admitted by the introduction of Fellows.

The Journal, containing the Transactions and Proceedings of the Society, and a Summary of Current Researches relating to Zoology and Botany (principally Invertebrata and Cryptogamia), Microscopy, &c., is published bi-monthly, and is forwarded post-free to all Ordinary and Ex-officio Fellows residing in countries within the Postal Union.

The Library, with the Instruments, Apparatus, and Cabinet of Objects, is open for the use of Fellows daily (except Saturdays), from 10 A.M. to 5 P.M. It is closed for four weeks during August and September.

Forms of proposal for Fellowship, and any further information, may be obtained by application to the Secretaries, or, Assistant-Secretary, at the Library of the Society, 20 Hanover Square., W.

Patron

HIS MAJESTY THE KING.

Past-Presidents.

	Elected
*SIR RICHARD OWEN, K.C.B., D.C.L., M.D., LL.D., F.R.S.	1840-1
*JOHN LINDLEY, Ph.D., F.R.S.	1842-3
*THOMAS BELL, F.R.S.	1844-5
*JAMES SCOTT BOWERBANK, LL.D., F.R.S.	1846-7
*GEORGE BUSK, F.R.S.	1848-9
*ARTHUR FARRE, M.D., F.R.S.	1850-1
*GEORGE JACKSON, M.R.C.S.	1852-3
*WILLIAM BENJAMIN CARPENTER, C.B., M.D., LL.D., F.R.S..	1854-5
*GEORGE SHADBOLT	1856-7
*EDWIN LANKESTER, M.D., LL.D., F.R.S.	1858-9
*JOHN THOMAS QUEKETT, F.R.S.	1860
*ROBERT JAMES FARRANTS, F.R.C.S.	1861-2
*CHARLES BROOKE, M.A., F.R.S.	1863-4
*JAMES GLAISHER, F.R.S.	1865-6-7-8
*REV. JOSEPH BANCROFT READE, M.A., F.R.S.	1869-70
*WILLIAM KITCHEN PARKER, F.R.S.	1871-2
*CHARLES BROOKE, M.A., F.R.S.	1873-4
HENRY CLIFTON SORBY, LL.D., F.R.S.	1875-6-7
*HENRY JAMES SLACK, F.G.S.	1878
LIONEL S. BEALE, M.B., F.R.C.P., F.R.S.	1879-80
*PETER MARTIN DUNCAN, M.B., F.R.S.	1881-2-3
REV. WILLIAM HY. DALLINGER, M.A., LL.D., F.R.S.	1884-5-6-7
CHARLES THOS. HUDSON, M.A., LL.D. (Cantab.), F.R.S.	1888-9-90
ROBERT BRAITHWAITE, M.D., M.R.C.S.	1891-2
ALBERT D. MICHAEL, F.L.S.	1893-4-5-6
EDWARD MILLES NELSON.	1897-8-9
WILLIAM CARRUTHERS, F.R.S., F.L.S., F.G.S.	1900-1

* Deceased.

COUNCIL.

ELECTED 15TH JANUARY, 1902.

President.

HENRY WOODWARD, Esq., LL.D., F.R.S., F.G.S., F.Z.S.

Vice-Presidents.

*ROBERT BRAITHWAITE, Esq., M.D., M.R.C.S., F.L.S.

*WILLIAM CARRUTHERS, Esq., F.R.S., F.L.S., F.G.S.

*GEORGE C. KAROP, Esq., M.R.C.S.

THE RIGHT HON. SIR FORD NORTH, P.C., F.R.S.

Treasurer.

J. J. VEZEY, Esq.

Secretaries.

REV. W. H. DALLINGER, LL.D., D.Sc., D.C.L., F.R.S.

R. G. HEBB, Esq., M.A., M.D., F.R.C.P.

Ordinary Members of Council.

CONRAD BECK, Esq.

†ALFRED W. BENNETT, Esq., M.A., B.Sc., F.L.S.

E. T. BROWNE, Esq.

REV. EDMUND CARR, M.A., F.R.Met.S.

*A. N. DISNEY, Esq., M.A. B.Sc.

*A. D. MICHAEL, Esq., F.L.S.

*E. M. NELSON, Esq.

HENRY GEORGE PLIMMER, Esq., M.R.C.S., F.L.S.

THOMAS H. POWELL, Esq.

PERCY E. RADLEY, Esq.

*CHARLES F. ROUSSELET, Esq.

THOS. W. SHORE, Esq., M.D., B.Sc., F.L.S.

Librarian.

PERCY E. RADLEY, Esq.

Curator.

CHARLES F. ROUSSELET, Esq.

Assistant Secretary.

MR. F. A. PARSONS.

* Members of the Publication Committee.

† Mr. Bennett died 23rd January, 1902, and the Council elected Mr. Jas. Mason Allen in his place.



CONTENTS.

TRANSACTIONS OF THE SOCIETY.

PAGE.

i.—Report of a Demoustration of the Methods used in the Photomicrography of Iron and Steel. By William H. Merritt, Assoc. R.S.M., F.C.S. (Figs. 1 and 2, and Plates I. and II.)	1
II.—On Stereomicrography. By G. P. Girdwood, M.D., M.R.C.S.Eng., F.R.S.C., F.I.C., &c., Professor of Chemistry Med. Fac. M'Gill College, Montreal; Consulting Surgeon Montreal General Hospital; late Asst.-Surgeon Grenadier Guards. (Fig. 14)	12
III.—The First English Achromatic Objectives. By Edward M. Nelson. (Fig. 15)	16
IV.—The President's Address: On the Life and Work of Nehemiah Grew. By William Carruthers, F.R.S.	129
V.—New Methods in Microscope Work. By Edward M. Nelson. (Figs. 34 and 35)	142
VI.—Third List of New Rotifers since 1889. By Charles F. Rousselet, Curator and F.R.M.S.	148
VII.—The Genus <i>Synchæta</i> : A Monographic Study, with Descriptions of Five New Species. By Charles F. Rousselet, Curator and F.R.M.S. (Plates III.-VIII.)	269, 393
VIII.—Undescribed Palpi on the Proboscis of Some Dipterous Flies, with Remarks on the Mouth-parts in several Families. By Walter Wesché, F.R.M.S. (Plates IX. and X.)	412
IX.—Report on the Recent Foraminifera of the Malay Archipelago collected by Mr. A. Durrand, F.R.M.S.—Part XIII. By Fortescue William Millett, F.R.M.S. (Plate XI.)	509
X.—Electrical Method of Taking Microscope Measurements. By Philip E. Shaw, B.A., D.Sc. (Figs. 126-128)	625

NOTES.

	PAGE
Holtzapffel's Microscope. By Edward M. Nelson. (Figs. 16 and 17)	19
A Bibliography of Works (dated not later than 1700) dealing with the Microscope and other Optical Subjects. By Edward M. Nelson	20
Waddel's Erecting Microscope. By Edward M. Nelson	291
Photograph of <i>Pleurosigma angulatum</i> by F. E. Ives. (Plate XII.)	529

OBITUARY

Henry George Madan, M.A.	24
A. W. Bennett. Biographical Memoir of, by J. G. Baker. F.R.S. (Portrait) ..	155
Thomas Comber	158
William Miller Ord, M.D., F.R.C.P.	417
Richard Leach Maddox	530

SUMMARY OF CURRENT RESEARCHES

RELATING TO ZOOLOGY AND BOTANY (PRINCIPALLY INVERTEBRATA AND CRYPTOGAMIA), MICROSCOPY, &c., INCLUDING ORIGINAL COMMUNICATIONS FROM FELLOWS AND OTHERS.*

25, 159, 292, 418, 533, 631

ZOOLOGY.

VERTEBRATA.

a. Embryology.

FRAENKEL, L., & F. COHN— <i>Function of Corpus Luteum in Relation to Insertion of Ova in Uterus</i>	25
GIARD, A.— <i>Note on the History of Merogony</i>	26
LESLIE, C. DE— <i>Influence of Spermatoxin on the Fertilising Power of Spermatozoa</i> ..	26
HERTWIG, OSCAR— <i>Germ-layers of Vertebrates</i>	26
STUDNÍČKA, F. K.— <i>Origin of Cerebral Hemispheres</i>	26
HAMMAR, J. AUG.— <i>Development of Tongue in Man</i>	26
MACCALLUM, J. B.— <i>Development of Pig's Intestine</i>	27
HOCHSTETTER, F.— <i>Variations in the Aortic Arches and the Origin of Arteries in Reptiles</i>	27
KAPEL'KIN, W.— <i>Development of Axial Skeleton in Amphibia</i>	27
BRAS, HERMANN— <i>Dorsal Groove and Dorsal Suture in Gastrula of Triton</i>	28
MONTGOMERY, T. H., JUN.— <i>Larva of Plethodon cinereus</i>	28
BARBADORO, LUIGI— <i>Development of Frog's Retina</i>	28
DEAN, BASHFORD— <i>Reminiscence of Holoblastic Cleavage in Ovum of Cestracion</i> ..	29
ALLIS, E. P., JUN.— <i>Ophthalmic Nerves of Mustelus lævis</i>	29
LUBOSCH, W.— <i>Development of Olfactory Organ of Anmocoetes</i>	29
HATTA, S.— <i>Relation of Metameric Segmentation in Petromyzon to that in Amphioxus and in Higher Craniota</i>	29
CHARRIN, A., & G. DELAMARE— <i>Influence on Offspring of Injecting Toxins into Parents</i>	29

* In order to make the Contents complete, the papers printed in the 'Transactions' and the Notes printed in the 'Proceedings' are included here.

	PAGE
KAESTNER, SANDOR— <i>Embryological Methods</i>	30
ROSNER, A.— <i>Monochorial Twins</i>	159
BERGH, R. S.— <i>Origin of Blood-vessels</i>	160
SCHIMKEWITSCH, W.— <i>Influences of Injections into the Albumen of Fowls' Eggs</i> ..	160
NUSSBAUM, M.— <i>Cell-division and Mitosis</i>	160
LOYEZ, MARIE— <i>Germinal Vesicle of Reptiles</i>	161
BATTELLI, F.— <i>Rheotactic Properties of Spermatozoa</i>	161
LOISEL, G.— <i>Function of Sertoli's Cells</i>	161
BROMAN, IVAR— <i>Movements of Spermatis and their Parts</i>	162
PROWAZEK, S.— <i>Tetrads in Spermatogenesis</i>	162
BILD, A.— <i>Development of Teeth in Sus domestica</i>	162
FISCHER, EUGEN— <i>Chondrocranium of Cercopithecus cynomolgus</i>	163
AIGNER, ALBERT— <i>Epithelium of Epididymis in Mammals</i>	163
HAMMAR, AUG.— <i>Development of Ear in Man</i>	163
SZILI, A.— <i>Development of Iris in Man</i>	164
LECHE, W.— <i>Alleged Case of Transmission of Acquired Characters</i>	164
SALVI, G.— <i>Copulation of Bats</i>	164
STRASSER, H.— <i>Olfactory Organ in Vertebrates</i>	164
VÖLKER— <i>Development of Pancreas in Amniota</i>	165
PEDASCHENKO, D.— <i>Development of Mid-brain in Bony Fish</i>	165
SCHUMACHER, SIEGMUND V.— <i>Yolk-organ of Salmo fario</i>	166
WAITE, EDGAR R.— <i>Development of Galeus antarcticus</i>	166
SCHNEIDER, GUIDO— <i>Life-history of Clupea sprattus</i>	166
BYRNE, L. W.— <i>Young of Montagu's Blenny</i>	167
DYBOWSKI, B.— <i>Life-history and Young Stages of the "Fat-Fish" of Lake Baikal</i>	167
KENNEL, J.— <i>Progeny of a Tailless Cat</i>	292
LOISEL, G.— <i>Spermatogenesis in Sparrow</i>	293
KOLSTER, R.— <i>Peculiar Process in Seminal Vesicles of Elk</i>	293
HOUSAY, F.— <i>Influence of Diet on Egg-Laying in the Fowl</i>	294
MITROPHANOW, P.— <i>Early Stages in the Development of Duck and Tern</i>	294
LE HELLO— <i>Maternal Impression in a Mare</i>	294
CUÉNOT, L.— <i>Heredity Studied in Mice</i>	294
HUNTER, S. J.— <i>Artificial Parthenogenesis in Arbacia induced by the Use of Sea-water concentrated by Evaporation</i>	418
BOVERI, TH.— <i>Problem of Fertilisation</i>	418
HERTWIG, R.— <i>Nature of Fertilisation</i>	419
BLANCHARD, N.— <i>Grand-parental Inheritance</i>	419
BEARD, J.— <i>Numerical Law of the Germ-Cells</i>	419
KORF, K. VON— <i>Spermatogenesis in Phalangista vulpina</i>	419
SWINNERTON, H. H.— <i>Morphology of Teleostean Head Skeleton</i>	420
DENIS, P.— <i>Development of Inner Ear in Bat</i>	420
WILLIAMS, S. R.— <i>Migration of Eye of Flat-Fish</i>	420
REESE, A. M.— <i>Thyroid of Lamprey</i>	421
ZOLOTNISKY, N.— <i>Reproduction of Gerardinus decemmaculatus</i>	421
BRAUER, A.— <i>Development of Excretory Organs in Gymnophiona</i>	421
SOUTHWELL, T.— <i>Hermaphroditism in the Herring</i>	421
KIDD, W.— <i>Argument for the Use-Inheritance Interpretation</i>	421
EWART, J. COSSAR— <i>Variation: Germinal and Environmental</i>	533
BEARD, J.— <i>Determination of Sex in Animal Development</i>	534
VAN LINT, A.— <i>Determination of Sex</i>	535
BULLER, A. H. R.— <i>External Phenomena of Fertilisation</i>	536
MORGAN, T. H.— <i>Dispensability of Gravity in Development of Toad's Egg</i>	537
GIARDINA, A.— <i>Early Stages in Oogenesis and the Synaptic Phases</i>	537
BATAILLON, E.— <i>Experimental Parthenogenesis in Amphibians</i>	537
MEYER, J. A.— <i>Disruptive Processes in Ovarian Ova of Lacerta agilis</i>	538
LOISEL, G.— <i>Internal Secretion of Testis</i>	538
JANSENS, J. A.— <i>Spermatogenesis in Newt</i>	538
MERLIN, A. A.— <i>Spermatozoon of Rat</i>	538
BALLOWITZ, E.— <i>Two-tailed Spermatozoa</i>	538
CAPURRO, M. A.— <i>Alleged Peritubular Lymphatic Tubes of the Testis</i>	538
CAMERON, J.— <i>Development of Layers of Retina</i>	538
BERLINER, K.— <i>Hofmann's Nuclei (Kölliker) in Spinal Cord of Chick</i>	539

	PAGE
PRENANT, A., & G. SAINT-REMY— <i>Branchial Clefts in Ophidia</i>	539
NORRIS, H. N.— <i>Pseudotohyroid of Frog</i>	539
LAMB, A. B.— <i>Eye-Muscles of Acanthius</i>	539
HUNTER, G.— <i>Notes on Development of Liver</i>	540
TECQUMENNE, CH.— <i>Development of Ventral Pancreas in Lacerta muralis</i>	540
HERRING, P. T.— <i>Comparative Anatomy and Embryology of the Malpighian Bodies</i>	540
WILLIAMS, W. ROGER— <i>Precocious Sexual Development</i>	541
WINDLE, B. C. A.— <i>Recent Teratological Work</i>	541
EDWARDS, C. L.— <i>Influence of Temperature on Development of Fowl's Egg</i>	631
BÜHLER, A.— <i>Retrogressive Changes in Ovarian Follicles</i>	631
EBNER, V. VON— <i>Albuminoid Crystals in Ora of Roe Deer</i>	632
HALBAN, J.— <i>Ovary and Menstruation</i>	632
D'HOLLANDER, F.— <i>Pseudochromosomes in Ora of Birds</i>	632
BROMAN, I.— <i>Atypical Spermatozou</i>	632
STRICHT, O. VAN DER— <i>Fertilisation in the Bat</i>	633
GHIGI, A.— <i>Epithelial Structures on Parrots' Beaks</i>	633
BARFURTH, D., & O. DRAGENDORFF— <i>Regeneration of the Lens in Chick Embryos</i>	633
PRENANT & SAINT-REMY— <i>Branchial Clefts in Lizard and Slow-worm</i>	634
SEWERTZOFF, A. N.— <i>Skull and Nervous System of Ceratodus</i>	634
HILTON, W. A.— <i>Structural Feature connected with Mating of Diemyctylus viri-</i> <i>descens</i>	634
KOKEN, E.— <i>Palæontology and Evolution</i>	634

b. Histology.

HOUSER, G. H.— <i>Brain of Mustelus</i>	30
ANCEL, P.— <i>Skin-Glands of Amphibians</i>	30
SALA, GUIDO— <i>Structure of Herbst's Corpuscles in the Sparrow and Fowl</i>	31
GIGLIO-TOS, E.— <i>So-called Germinative Cells in Medullary Canal of Man</i>	167
SHINKISHI HATAI— <i>Efferent Neurons in Electric Lobes of Torpedo occidentalis</i>	168
BOTEZAT, EUGEN— <i>Nerve-Endings in Taste Menisci</i>	168
TIMOFEEJEW, D. A.— <i>Nerve-Endings in Peritoneum of Mammals</i>	168
BURNE, R. H.— <i>Innervation of Supra-orbital Canal in Chimæra monstrosa</i>	168
STERZI, G.— <i>Membranes of the Spinal Cord</i>	169
MORANDI, E., & P. SISTO— <i>HæmolympH Glands in Man and Mammals</i>	169
LIMON, M.— <i>Lacteal Secretion</i>	169
HELLY, K.— <i>Circulation in the Spleen</i>	169
VINCENZI, L.— <i>Limiting Membrane in Human Serosa</i>	169
GURWITSCH, A.— <i>Filamentous Tufts of Epithelial Cells in Vas epididymis of Man</i>	170
SCHWALBE, ERNST— <i>What are "Blood-plates"</i>	170
METCHNIKOFF, E.— <i>On the Process of Hair Turning White</i>	295
LACHI, P.— <i>Accessory Lobes on Spinal Cord of Birds</i>	295
SCHÄFER, E. A.— <i>Nutritive Channels within the Liver-Cells communicating with</i> <i>the Lobular Capillaries</i>	295
GRABOWER— <i>Nerve-Endings in Human Muscle</i>	295
JOSEPH, H.— <i>Supporting-Substances of the Nervous System</i>	296
ADDARIO, C.— <i>Matrix of Vitreous Humour in the Eye of Man and Animals</i>	296
ADACHI, B.— <i>Skin-Pigment in Man and Monkeys</i>	296
BROWICZ, M. T.— <i>Intracellular Canals in Hepatic Cells</i>	422
AUERBACH, M.— <i>Brown Fat in Rodents and Insectivores</i>	422
RAMÓN Y CAJAL, P.— <i>Evolution of Pyramidal Cells of the Cerebrum</i>	422
KOSAKA, K.— <i>Cerebral Degenerations</i>	422
GROSSE, O.— <i>Arterio-Venous Anastomoses in Man and Mammals</i>	422
POLLICARD, A.— <i>Lympho-myeloid Connective Stroma in Testes of Young Rays</i>	422
STEFHAN, P.— <i>Interstitial Cells of the Testis</i>	423
CCGGI, A.— <i>Nerves of Lorenzini's Annullæ</i>	423
KOPPEN, H.— <i>Spines of Spinax</i>	423
BERNARD, H. M.— <i>Studies on the Retina</i>	541
VIRCHOW, HS.— <i>Retina of Halteria</i>	541
MILLS, C. K.— <i>Neurofibrillar Theory</i>	542
SCHÄFER, E. A.— <i>Minute Structure of the Muscle-Fibril</i>	542
MAYER, S.— <i>Muscularisation of Capillary Vessels</i>	542

	PAGE
CALLEJA, C.— <i>Cæca of Birds</i>	542
WERNER, R.— <i>Artificially induced Anomalies in Cell-Division</i>	635
SCHINKEWITSCH, W.— <i>Direct Division in Artificial Conditions</i>	635
JAWOROWSKI, M.— <i>Reticular Apparatus in Spinal Ganglion Cells</i>	635
BOCHENEK, A.— <i>Pituitary Body of Amphibians</i>	635
PRYMAK, T.— <i>Structure and Function of Thymus in Teleostean</i>	636
GRYNFELT, E.— <i>Supra-renal Bodies of Plagiostomes</i>	636
" " <i>Inter-renal Body of Plagiostomes</i>	636
HERRERA, A. L.— <i>Plasmic Appearance of Metaphosphate of Calcium</i>	636

c. General.

GAUTIER, ARMAND— <i>Chemical Basis of Variation</i>	31
LE DANTEC, FELIX— <i>Two States of Living Matter</i>	31
NAGEL, W. A.— <i>Effect of Light on Animals</i>	31
REINKE, FR.— <i>Outlines of General Anatomy</i>	32
PATERSON— <i>Segmentation of the Vertebrate Body</i>	32
PIZON, ANTOINE— <i>Mechanical Theory of Vision</i>	32
FLORESCO, N.— <i>Correlation of Colouring in Liver, Skin, and Hairs</i>	32
CAMICHEL & MANDOUL— <i>Blue and Green Coloration in Skin of Vertebrates</i>	33
JOHNSTONE, JAMES— <i>Cervical Glands of Marsupials</i>	33
BANCHI, A.— <i>Parasibula in Marsupials</i>	33
RULOT, H.— <i>Hibernation of Bats</i>	33
BOHN, G.— <i>Marine Intoxications and the Life of Burrowers</i>	34
EYCLESHYMER, A. C.— <i>Breeding Habits of Ameiurus nebulosus</i>	34
OSBORN, H. L.— <i>Axolotl and Amblystoma</i>	34
DRÜNER, L.— <i>Musculature of Urodela</i>	35
JOSEPH, H.— <i>Abnormalities in Veins of Salamander</i>	35
SHIPLEY, A. E.— <i>Abysmal Antarctic Fauna</i>	35
ZSCHOKKE, F.— <i>Fauna of Switzerlund and the Glacial Period</i>	35
SEELIGER, O.— <i>Deep-Sea Fauna</i>	35
KEISSLER, CARL V.— <i>Plankton of Attersee</i>	36
MULLER, F. C.— <i>History of Medicine and Biology in the Nineteenth Century</i>	170
ZIEGLER, H. E.— <i>Present Position of the Theory of Descent</i>	171
MUDGE, G. P.— <i>Aid to the Study of Zoology</i>	171
METCHNIKOFF, ÉLIE— <i>Immunity</i>	171
CAMERANO, L.— <i>Statistical Study of Organisms</i>	171
ISSEL, R.— <i>Animals in Hot Water</i>	171
LANKESTER, E. RAY— <i>Okapia johnstoni</i>	172
BEDDARD, F. E.— <i>"Chestnuts" of Horse</i>	172
HOUSSAY, F.— <i>Modifications in Alimentary System of Birds induced by Diet</i>	172
NEUVILLE, HENRI— <i>Vascularisation of Intestine in Vertebrates</i>	172
BARRETT-HAMILTON, G. E. H.— <i>Origin of Colour in Animals</i>	173
POCHE, FRANZ— <i>Distribution of Siluroids</i>	173
" " <i>Distribution of Anoplopterus platyhir</i>	173
THOMSON, J. STUART— <i>Periodic Growth of Fish-Scales</i>	173
JACKSON, C. M.— <i>Vascular System of Bdellostoma dombeyi</i>	174
ALLEN, E. J., & R. A. TODD— <i>Fauna of Eze Estuary</i>	174
PALACKÝ, J.— <i>Distribution of Marine Mammals</i>	297
LO BIANCO, S.— <i>Plankton and Abyssal Fauna around Capri</i>	297
ROULE, L.— <i>New Species of Atherine in Fresh Water</i>	297
MINGAZZINI, P.— <i>Molluscum Contagiosum in Amphibians</i>	297
WERNER, FR.— <i>Prodromus of Monograph on Chamæleons</i>	297
GOODRICH, E. S.— <i>Excretory Organs of Amphioxus</i>	298
YUNG, E.— <i>Monstrosity in a Trout</i>	298
STILES, C. W.— <i>Questions of Nomenclature</i>	298
GAUTRELET, JEAN— <i>Occurrence of Compounds of Phosphorus in Invertebrates</i>	298
BOHN, GEORGES— <i>Biological Theory of Vision</i>	298
HOFMEISTER, F.— <i>Chemical Organisation of the Cell</i>	423
KÜKENTHAL, W.— <i>Practical Course of Zoology</i>	423
LINDSAY, B.— <i>Story of Animal Life</i>	423
WARREN, E.— <i>Variations in Vascular System of Rana temporaria</i>	424

ANCEL, P., & L. SENCERT— <i>Variations in Human Vertebral Column</i>	424
ECKEL, E. C.— <i>Variation in Snakes</i>	424
WARREN, E.— <i>Teeth of Hag and Lamprey</i>	424
GOODRICH, E. S.— <i>Excretory Organs of Amphioxus</i>	424
PATON, D. NOEL— <i>Amount of Dissolved Oxygen in Water required by Young Salmonidæ</i>	425
KYLE, H. M.— <i>Action of Spurge on Salmonoid Fishes</i>	425
GRANDIS, V.— <i>Electrical Properties of Nerves</i>	425
ROOS, E.— <i>Function of the Thyroid Gland</i>	425
LYDEKKER, R.— <i>European Wild Cattle</i>	425
JACOBI, A.— <i>Biogeographical Regions</i>	426
ZACHARIAS, O.— <i>Plankton of the Lake of Maria-Laach</i>	426
MÖBIUS, K.— <i>Concept of Species</i>	542
RABAUD, E.— <i>Pathogenic and Teratogenic Agents</i>	543
HOUSSAY, F.— <i>Growth and Auto-Intoxication</i>	543
NUTTALL, G. H. F.— <i>Biological Test for Blood</i>	543
GAUTIER, A.— <i>Minute Traces of Arsenic in Animals</i>	544
BOUTAN, L.— <i>Experiments on Pigeons in relation to the Semicircular Canals</i>	544
ENRIQUES, P.— <i>Reactions to Anisotonic Solutions</i>	544
CALMETTE, A.— <i>Hæmolytic Action of Cobra Poison</i>	544
PHISALIN, C.— <i>Hæmolytic Effect of Viper's Venom</i>	544
PELLEGRIN, J.— <i>Long Fast of Python</i>	545
DENDY, A.— <i>Ciliated Grooves in Brain of Ammocoete</i>	545
KINGSLEY, J. S.— <i>Cranial Nerves of Amphiuma</i>	545
" " <i>Systematic Position of Cæcilians</i>	545
JOHNSTON, J. B.— <i>Homology of Selachian Ampullæ</i>	546
BOEKE, J.— <i>Homologue of Infundibular Organ in Amphioxus</i>	546
VANEY, C., & A. CONTE— <i>Note on Additions to Fresh-water Fauna</i>	546
WILLIAMS, H. S.— <i>Fossil Faunas and Geological Formations</i>	546
JAQUET, M.— <i>Dolphin Carp</i>	547
EASTMAN, C. R.— <i>Carboniferous Cestracionts and Acanthodians</i>	547
PACKARD, A. S.— <i>Lamarck, Life and Work</i>	547
JORDAN, D. S., & H. HEATH— <i>Introductory Text-book of Zoology</i>	547
GARDINER, J. STANLEY— <i>Classification</i>	636
MANDOUL, H.— <i>Physical Coloration</i>	637
DUBOIS, R.— <i>Copper in the Animal Organism</i>	637
BOUTAN, L.— <i>Lesion of the Semicircular Canals</i>	637
SMITH, G. ELLIOT— <i>Brain of Macroscelides proboscideus</i>	637
GAKUTARO OSAWA— <i>Anatomy of Giant Salamander of Japan</i>	637
ALCOCK, A., & L. ROGERS— <i>Toxic Properties of the Saliva of Certain Non-poisonous Colubrines</i>	638
DELEZENNE, C.— <i>Venom of Snakes</i>	638
BOULENGER, G. A.— <i>Systematic Position of Pleuronectidæ</i>	638
REICHENBACH, E. STROMER VON— <i>Vertebræ of Terrestrial Carnivores</i>	638
ZOOLOGISCHER Jahresbericht	638
CAMERANO, L.— <i>Bonelli, an early Italian Lamarckian</i>	638

Tunicata.

BONNIER, J., & C. PEREZ— <i>New Giant Pyrosoma</i>	426
REDIKORZEW, W.— <i>Ovary within Testes of Fragarium elegans</i>	548
HUNTER, G. W., JUN.— <i>Heart of Molgula manhattensis</i>	548
VAN NAME, W. G.— <i>Ascidians of Bermudas</i>	548
PIZON, A.— <i>Heart of Diplosomidæ</i>	638
DAMAS, D.— <i>Development of Molgulidæ</i>	638

INVERTEBRATA.

RIGGENBACH, EMANUEL— <i>Autotomy in Marine Invertebrates</i>	174
SCOTT, ANDREW— <i>Additions to British Fauna</i>	175
THIELE, JOH.— <i>Homologies of Coelom</i>	175
ZSCHOKKE, F.— <i>Fauna of a Mountain Stream</i>	548
YUNG, E.— <i>Variations of Plankton in Lake Geneva</i>	639

Mollusca.

	PAGE
FRIELE, H., & J. A. GRIEG—North Atlantic Molluscs	176
SANCHEZ, DOMINGO—Diverticulum of Duct of <i>Spermotheca</i> in <i>Helix aspersa</i>	176
KREMBZOW, ERNST—Papillæ of <i>Eolidæ</i>	176
SMIDT, H.—Free Intra-epithelial Nerve-endings in <i>Helix</i>	176
SIMROTH, HEINRICH—New Genus of <i>Stylommatophora</i>	177
STURNAY, R.—New Cave Gasteropod	177
GRAEFFE, E.—Fauna of the Gulf of Trieste	548

a. Cephalopoda.

DEAN, BASIFORD—Notes on Living <i>Nautilus</i>	36
ROTTMANN, G.—Development of <i>Radula</i> in Cephalopoda	36
PARONA, C.—Dichotomy of Arms in Cuttlefish	299
PFEFFER, G.—Synopsis of <i>Egopsid</i> Cephalopods	299
IJIMA, I., & S. IKEDA— <i>Amphitretus</i> from the Sagami Sea	639

β. Scaphopoda.

ARIOLA, V.—“ <i>Pseudogamy</i> ” in <i>Dentalium entalis</i>	299
--	-----

γ. Gastropoda.

MITSUKURI, K.—Experiments on <i>Littorina</i>	37
PILSBRY, H. A.—Affinities of Genus <i>Neobeliscus</i>	37
COCKERELL, T. D. A.—Pigments of <i>Nudibranchs</i>	38
KERR, J. GRAHAM—Relationship between <i>Amphineura</i> and <i>Cephalopoda</i>	38
MAZZARELLI, G.—Affinities of <i>Phyllaplysia</i>	38
KOWALEVSKY, A.—The Genus <i>Chaetoderma</i>	38
ASHBY, E., & W. G. TORR—Fossil <i>Polyplacophora</i>	177
FRANSEN, P.—Reactions of <i>Limax maximus</i>	299
ENRIQUES, P.—Digestive Gland in Molluscs	300
CORNEY, R. G.—Poisoning from <i>Conus</i>	301
BONNEVIE, KRISTINE—New Parasitic Gasteropod in <i>Holothurian</i>	426
RANDLES, W. B.—Crystalline Style and Style-Sac in <i>Turritella communis</i>	427
BEUTLER, B.— <i>Paryphanta hochstetteri</i> Pfr.	427
VAYSSIÈRE, A.—‘ <i>Talisman</i> ’ <i>Opisthobranchs</i>	427
PRUVOT, G.—Classification of <i>Neomenians</i>	549
DRUMMOND, ISABELLA M.—Development of <i>Paludina vivipara</i>	549
FLEURE, H. J.—Relations of <i>Kidney</i> in <i>Haliotis</i>	550
LETELLIER, A.—Purple of <i>Purpura lapillus</i>	550
BAKER, F. C.—Structure of <i>Limnæa emarginata</i>	550
CUÉNOT, L.—Bivalves with Red Blood-Corpuscles	550
COUVREUR, E.—Blood of the Snail	640
DIGBY, LETTICE—Tanganyika Gastropods: <i>Chytra</i> and <i>Limnotrochus</i>	640

δ. Lamellibranchiata.

DUBOIS, R.—Formation of Pearls	38
SEURAT, L. G.—Origin of Pearls	39
JOURDAIN, S.—Formation and Diseases of Pearls	39
STENTA, M.—Inferior Backward Current in Bivalves	39
SCOTT, A.—Spawning Period of Mussels	178
KOSTANECKI, C.—Artificial Parthenogenesis in <i>Macra</i>	640
THIELE, J.—Systematic Position of the <i>Solenogastres</i>	641
DOWNING, E. R.—Variation in Position of Adductors in <i>Anodonta grandis</i> Say	641
RIDEWOOD, W. G.—Structure of Gills of <i>Lamellibranchs</i>	641
REIS, O. M.—Ligament of Bivalves	642

Arthropoda.

MEJERE, J. C. H. DE—Last Joint of the Limbs in Arthropods	427
BEECHER, C. E.—Ventral Integument of Trilobites	427

LÉGER, L.—*Epithelial Regeneration in Mid-gut of Arthropods* 551
 TROUSSERT, E.—*Collection of Microscopic Marine Arthropods* 551
 BEECHER, C. E.—*Eurypterid Remains in Cambrian* 642

a. Insecta.

FIELDE, ADELE M.—*Senses of Ants* 39
 WHEELER, W. M.—*Macroergates in Pheidole commutata* 40
 KOHL, FRANZ FRIEDR.—*Gynandromorphy in a Wasp* 40
 STITZ, HERMANN—*Female Genital Apparatus in Microlepidoptera* 40
 GIARD, A.—*Determination of Sex in Lepidoptera* 41
 MARSHALL, G. A. K.—*Experiments in Seasonal Dimorphism* 41
 McCLUNG, C. E.—*Accessory Chromosome in Insect Spermatogenesis* 41
 ENRIQUES, PAOLO—*Histolysis in Metamorphosis of Flies* 42
 WAHL, BRUNO—*Development of Hypodermal Imaginal Discs in Larval Diptera* .. 42
 MÜGGENBURG, —.—*Miniery of a Moss by a Larva and Pupa* 43
 WASMANN, E.—*Genus Termitozenia* 43
 SINÉTY, R. DE—*Spermatocytic Kineses in Orthoptera* 43
 ZANDER, ENOCH—*Copulatory Apparatus of Male Trichoptera* 43
 BÖRNER, CARL—*New Collembola* 44
 HOLMGREN, NILS—*Chitin-Formation, Muscle-Insertion, and Cell-Connections in Insects* 178
 SUTTON, WALTER S., & C. E. McCLUNG—*Spermatogenesis in Insects* 179
 NEEDHAM, J. G., & CORNELIUS BETTEN—*Aquatic Insects in the Adirondacks* 179
 DEWITZ, J.—*Hindering Pupation* 180
 DONISTHORPE, HORACE ST. JOHN K.—*Coloration of British Beetles* 180
 CHAMFION, G. C.—*Sexual Dimorphism in Buprestis sanguinea* 180
 KLOS, RUDOLF—*Life-history of Tephroclystia virgaureata* 180
 PETRI, L.—*Stigmata of Sericaria mori* 180
 DICKEL, FERD.—*Life-history of Hive Bee* 180
 GATTA, MANUEL FERNANDEZ DE—*Studies on Galls* 181
 NEEDHAM, J. G., & HART, C. A.—*Dragon-flies of Illinois* 181
 BÖRNER, CARL—*New Collembola* 181
 CARPENTER, G. H.—*Collembola from Franz Josef Land* 182
 BERLESE, A.—*Copulation of House-Fly* 301
 ESCHERICH, K.—*Development of Nerve-Cord* 301
 DE GATTA, D. M. F.—*Notes on Galls* 301
 SILVESTRI, F.—*Notes on South American Termites and their Termitophilous Associates* 302
 CROFT, W. B.—*Colours of Butterflies not due to Diffraction* 302
 DEGENER, P.—*Odoriferous Organ of the Male Hepialus hectus* 302
 VERHOEFF, K. W.—*Dermoptera and the Microthorax* 302
 BÖRNER, CARL—*Structure and Classification of Collembola* 302
 DONISTHORPE, HORACE ST. JOHN K.—*Life-History of Clythra quadri-punctata* .. 303
 WESCHÉ, W.—*Undescribed Palpi on the Proboscis of some Dipterous Flies, with Remarks on the Mouth-parts in several Families (Plates IX. and X.)* 412
 TICHOMIROV, A.—*Artificial Parthenogenesis of Silk-Moth Ova* 428
 MELJERE, J. C. H. DE—*Prothoracic Respiratory Apparatus in Dipterous Pupæ* .. 428
 BUTLER, E. A.—*Some British Hemiptera* 428
 SCUDDER, S. H.—*Index to North American Orthoptera* 428
 NEWSTEAD, ROBERT—*Monograph on Coccidæ occurring in Britain* 429
 SILVESTRI, F.—*Studies on Thysanura* 429
 WHEELER, W. M.—*New Agricultural Ant from Texas* 429
 AEROLON, C.—*New Moravian Cave-Insect* 429
 FELT, E. P.—*Insects injurious to Elm-Trees* 429
 JIMERO, H.—*Honey of Bees* 429
 COMSTOCK, J. H., & V. L. KELLOGG—*General Course of Entomology* 551
 GIARD, A.—*Habits of Larvæ of Sciaru medullaris* 551
 „ „ *Expulsion of Spermatozoa in Sciaru* 551
 FIELDE, ADELE M.—*Studies on Ants* 551
 COBELL, R.—*Sense of Taste in an Ant* 552
 LEON, N.—*Morphology of Labial Parts in Hydrocoridæ* 552

	PAGE
MCCLENDON, J. F.— <i>Life-History of Ulula hyalina</i> Latreille	552
WESCHÉ, W.— <i>Setæ on the Legs of Flies</i>	553
CHOLODKOVSKY, N.— <i>Hermaphroditism in Species of Chermes</i>	553
KUWANA, S. I.— <i>Scale-Insects of Japan</i>	553
OSBORN, H.— <i>Interesting Case of Miniery</i>	612
ANTHONY, MAUDE H.— <i>Metamorphosis of Sisyra</i>	612
SILVESTRI, F.— <i>So-called Microthorax of Insects</i>	643
HILTON, W. A.— <i>Sense-Hairs of Lepidopterous Larvæ</i>	643
SOULIÉ, H.— <i>Culicidæ of Algiers</i>	643
MEGUŠAR, FR.— <i>Oogenesis in Hydrophilus piceus</i>	643
AGGAZZOTTI, A.— <i>Nerve-Endings in Striped Muscle of Insects</i>	644
LINDEN, M. VON— <i>Influence of Temperature during Pupation</i>	644
NEVEU-LEMAIRE, M.— <i>Receptacula seminis in Culicidæ</i>	644
DEMOKIDOFF, K.— <i>Testis of Tenebrio</i>	644
VERSON, E.— <i>Exuvial Glands</i>	644

β. Myriopoda.

HEYMONS, R.— <i>Development of Scolopendra</i>	44
THOMAS, ROSE HAIG— <i>Luminosity in Centipedes</i>	182
BLACKMAN, M. W.— <i>Spermatogenesis of Scolopendra</i>	182
TÖNNIGES, CARL— <i>Spermatogenesis and Oogenesis in Lithobius forficatus</i>	304
VERHOEFF, K. W.— <i>Comparative Morphology of Chilopoda</i>	305
ROSSI, G.— <i>Resistance of Myriopods to Asphyxiation</i>	305
SILVESTRI, F.— <i>Notes on Myriopods</i>	306
POCOCK, R. I.— <i>Annectant Type of Chilopod</i>	429
SILVESTRI, F.— <i>Anterior or Cephalic Glands of Diplopoda</i>	553
ROSSI, G.— <i>Locomotion of Myriopods</i>	553
“ “ <i>Alimentary Tract of Julus communis</i>	553
VERHOEFF, K.— <i>Chilopoda in Bronn's 'Tierreich'</i>	644

γ. Prototracheata.

DENDY, A.— <i>Oviparous Species of Onychophora</i>	306
BOUVIER, E. L.— <i>Papillæ of Onychophora</i>	306

δ. Arachnida.

BORDAS, L.— <i>Bites of Latrodectus 13-guttatus</i>	45
BÖSENBERG, W.— <i>Monograph on Spiders of Germany</i>	45
THOR— <i>New Genera of Hydrachnids</i>	183
PROTZ, A., & R. PIERSIG— <i>New Hydrachnids</i>	183
BERLESE, A., & G. LEONARDI— <i>South American Acarids</i>	183
WASMANN, E.— <i>Myrmecophilous Mites</i>	183
STSCHELKANOVZEFF, J. P.— <i>Breathing Organs of Pseudoscorpionidæ</i>	184
CARPENTER, G. H.— <i>Arctic Pantopoda</i>	184
COLE, LEON J.— <i>Discoarachne brevipes</i> Noek	307
CRONEBERG, A.— <i>Hydrachnids of Central Russia</i>	307
GOUGH, L. H.— <i>Development of Admetus pumilio</i> Koch	430
OUDEMANS, A. C.— <i>Hibernating Cyst of a Mite</i>	431
MICHAEL, A. D.— <i>British Tyroglyphidæ</i>	431
TROUËSSART, E.— <i>Arctic Halacaridæ</i>	431
RECHINGER, C.— <i>Peculiar Phytoptid Galls</i>	553
TROUËSSART, E.— <i>New Uropodidæ</i>	554
SOAR, C. D.— <i>New British Hydrachnid</i>	554
DAHL, FR.— <i>Arrangement of a Spider Collection</i>	554
“ “ <i>Classification of Spiders</i>	554
LAMY, E.— <i>Tracheæ of Spiders</i>	645
POCOCK, R. I.— <i>Studies on the Arachnid Entosternite</i>	645
BÖSENBERG, W.— <i>Spiders of Germany</i>	645
TRÄGÅRDH, I.— <i>Limbless Acarid</i>	645

	PAGE
WALLENGREN, HANS— <i>Glands of Alimentary Canal in Decapoda</i>	46
KENT, W. J.— <i>Colours of American Crayfish</i>	46
KANE, W. F. DE VISMES— <i>Mysis relicta in Ireland</i>	46
MALACQUIN, A.— <i>Life-history of Monstrillidæ</i>	46
DAVENPORT, C. B., & W. B. CANNON— <i>Reaction of Daphnia to Light</i>	47
NICHOLS, M. LOUISE— <i>Spermatogenesis of Oniscus asellus</i>	47
HARRIS, J. ARTHUR— <i>Structure of Male in Genus Cambarus</i>	48
SAYCE, O. A.— <i>New Blind Crustacea</i>	48
PRZIBRAM, HANS— <i>Observations on Homarus europæus</i>	185
BELL, F. JEFFREY— <i>Occurrence of Squilla desmaresti in North Sea</i>	185
GARBIN, A.— <i>New Gammarus</i>	185
WOLFENDEN, R. N.— <i>Copepods of Faroë Channel and Shetlands</i>	185
SCOTT, ANDREW— <i>Structure of Lepeophtheirus and Lernæa</i>	185
CALMAN, W. J.— <i>Affinities of Uronectes</i>	185
STINGELIN, TH.— <i>Notes on Fauna of Neuenburgersee</i>	307
MORGAN, T. H.— <i>Regeneration in Hermit Crab and Crayfish</i>	431
WILLIAMSON, H. C.— <i>Larval Stages of the Shrimp</i>	431
SAMTER, M., & W. WELTNER— <i>Relict Crustaceans in North German Lakes</i>	432
FILATOWA, E.— <i>Observations on Young Stages of Balanus improvisus</i>	432
SCHENKEL, E.— <i>Decapods of Celebes</i>	432
SAYCE, O. A.— <i>New Genus of Blind Isopods</i>	432
FULTON, S. W., & F. E. GRANT— <i>New and little-known Victorian Decapods</i>	432
HAECKER, V.— <i>Reproduction of Linnætic Crustacea</i>	432
BÜRGER, O.— <i>Lateral Hermaphroditism in Palinnurus frontalis</i>	433
SCOURFIELD, D. J.— <i>Ephippia of the Lynceid Entomostraca</i>	554
COUTIÈRE, H.— <i>New Rhizocephalid Type</i>	555
“ “ <i>Structure of Thylacoplethus</i>	555
SCOTT, T.— <i>Scottish Crustacea</i>	555
BONNIER, J., & C. PÉREZ— <i>Commensal Schizopod</i>	555
BIGELOW, M. A.— <i>Early Development of Lepas</i>	555
HUE, L. H.— <i>So-called Hepatico-Pancreatic Glands of Isopods</i>	556
ZYKOFF, W.— <i>Mysis in the Volga</i>	556
GRUVEL, A.— <i>Dwarf Males and other Sexual Peculiarities in Cirripedia</i>	646
FULTON, S. W., & F. E. GRANT— <i>New Victorian Decapods</i>	646
STEUER, A.— <i>New Parasitic Copepod in Intestine of Mussel</i>	646
SAYCE, O. A.— <i>New Victorian Amphipods</i>	646

Annulata.

BOHN, G.— <i>Seasonal Histolysis in Polychæts</i>	48
WALLENGREN, HANS— <i>Sensory Cells in Proboscis of Polychæts</i>	49
WILLCOX, M. A.— <i>Commensal Oligochæta in New England</i>	49
BRETSCHER, K.— <i>Life of Earthworms</i>	186
MATEOS, MARCELO RIVAS— <i>Hirudo troctina John</i>	186
JANDA, V.— <i>Notes on Æolosoma tenebrarum</i>	186
SKORNIKOW, A. S.— <i>Geographical Distribution of Priapulus</i>	186
PRUVOT, G., & E. PERRIER— <i>Stolonial Growth in Syllidæ</i>	307
BRASIL, J.— <i>Alimentary Canal of Lagis koreni</i>	308
NUSBAUM, J.— <i>Regeneration in Enchytræidæ</i>	433
JOHNSTON, J. B., & SARAH W. JOHNSON— <i>Circulation in Lumbricus</i>	433
BEDDARD, F. E.— <i>Two new Earthworms</i>	433
HÉRUBEL, M. A.— <i>Peritoneal Elements of Phascolosoma vulgare</i>	433
OKA, A.— <i>Vascular System of Hirudinea</i>	556
TORREY, J. C.— <i>Early Development of Mesoblast in Thalassemia</i>	557
BOCHNIOL, J.— <i>Respiration in Polychæta</i>	647
WINKLER, G.— <i>Regeneration of Alimentary Canal in Rhynchelmis limosella</i>	647
OPPENHEIMER, ADELE— <i>Sense-Organs of the Polychæt Proboscis</i>	647
BRETCHER, K.— <i>Observations on Siciss Oligochæta</i>	648
ROSA, D.— <i>Chloragogen of Oligochæta</i>	648

	PAGE
BARTOLOTTI, C.— <i>Function of Chlorogogen Cells</i>	648
FOOT, KATHARINE, & ELLA CHURCH STROBELL— <i>Spermatozoa of Allolobophora fetida</i>	648
BÜRGER, O.— <i>Development of Clepsine</i>	648
HERUBEL, MARCEL A.— <i>Brain of Phascosolonia</i>	649
DONCASTER, L.— <i>Development of Sagitta</i>	649

Nematohelminthes.

GOLOWIN, E. P.— <i>Phagocytic Organs in Nematodes</i>	49
BONNEVIE, KRISTINE— <i>Chromatin-Reduction in Somatic Cells</i>	50
STRONG, R. P.— <i>Strongyloides intestinalis</i>	50
WILLOT, —.— <i>Heterodera schachtii</i>	50
ZYKOFF, W.— <i>Cystopsis acipenseri</i>	308
LINSTOW, O. VON— <i>New Nematodes</i>	434
WEINLAND, E.— <i>Fermentation of Glycogen in Ascaris</i>	557
LINSTOW, O. VON— <i>New Nematodes</i>	557
GEMMILL, J. F., & O. VON LINSTOW— <i>Largest of known Nematodes</i>	650
LINSTOW, O. VON— <i>New Filuria</i>	651

Platyhelminthes.

FUHRMANN, O.— <i>Avian Cestodes</i>	50
SAINT-REMY, G.— <i>Germinal Layers in Cestoda</i>	50
LINSTOW, O. VON.— <i>Position of Ligula</i>	51
SSINITZIN, D. TH.— <i>Life-history of Distomum folium</i>	51
HALKIN, H.— <i>Early Stages in Development of Polystomum integerrimum</i>	51
LINTON, EDWIN— <i>Fish Parasites</i>	52
BENHAM, W. BLAXLAND— <i>Platyhelminia, Mesozoa, and Nemertini</i>	186
MINGAZZINI, P.— <i>Superficial Secretion of Tapeworms</i>	187
RICHIARDI, S.— <i>New Species of Didymozoon</i>	187
JOHNSTON, S. J.— <i>New Species of Distomum from the Duckmole</i>	187
PUNNETT, R. C.— <i>Structure of Lineus gesserensis</i>	187
VOIGT, W.— <i>Distribution of Planarians as affected by Temperature</i>	308
ODHNER, TH.— <i>New Trematodes from Crocodile</i>	308
THOMPSON, CAROLINE B.— <i>Zygeupolia litoralis, a new Heteronemertean</i>	309
BERGENDAL, D.— <i>Notes on Carinoma armandi</i>	309
LAIDLAW, F. F.— <i>New Rhabdocolæ</i>	434
RASPAIL, X.— <i>Notes on a Planarian</i>	434
REUSS, H.— <i>Distomum duplicatum in Fresh-water Mussels</i>	434
HENNEGUY, L. F.— <i>Maturation and Fertilisation in Distomum hepaticum</i>	434
FUHRMANN, O.— <i>Fertilisation in Cestodes</i>	557
SCHNEIDER, G.— <i>New Species of Caryophyllæus</i>	557
ZSCHOKKE, F.— <i>Unusual Human Parasite</i>	558
ODHNER, TH.— <i>New Distomids</i>	558
BRAUN, M.— <i>Fasciolid Parasites of Birds</i>	558
CAULLERY, M., & F. MESNIL— <i>Fecampia</i>	558
COE, W. R.— <i>Nemertean Parasites of Crabs</i>	558
KOSTANECKI, C.— <i>Maturation and Fertilisation in Cerebratulus marginatus</i>	651
THACHER, HENRIETTA F.— <i>Regeneration of Pharynx in Planaria maculata</i>	651
COHN, L.— <i>New Species of Monostomum</i>	651

Incertæ Sedis.

IKEDA, IWAJI— <i>Development of Phoronis ijimai</i>	52
TORREY, HARRY BEAL— <i>New Species of Phoronis</i>	53
CAULLERY, M., & F. MESNIL— <i>Free Phase in the Life-Cycle of Orthonectids</i>	53
FRIELE, H., & J. A. GRIEG— <i>North Atlantic Brachiopods</i>	187
VOIGT, MAX— <i>New Species of Gastrotricha</i>	187
MACK, H. VON— <i>Central Nervous System of Sipunculus nudus L.</i>	309
SPENGLER, J. W.— <i>Genera of Enteropneusta</i>	310
ZYKOFF, W.— <i>Plumatella and Vicipara</i>	310

	PAGE
LONGCHAMPS, M. DE SELYS— <i>Development of Phoronis</i>	435
MENON, K. R., & A. T. MASTERMAN— <i>Notes on Actinotrocha</i>	559
NAOHIDÉ YATSU— <i>Habits of Lingula</i>	559
HISATO KUWANO— <i>New Euteropneust</i>	560
CUMINGS, E. R., & A. V. MAUCK— <i>Variation in Platystrophia Lynx</i>	651
HARMER, S. F.— <i>Structure of Cheilostomata</i>	652
CONTE, A., & C. VANEY— <i>Contributions to the Anatomy of Rhabdopleura normani</i>	652

Rotatoria.

ROUSSELET, C. F.— <i>Third List of New Rotifers since 1889</i>	148
VOIGT, MAX, & C. F. ROUSSELET— <i>New Rotifer</i>	187
ROUSSELET, C. F.— <i>The Genus Synchroneta: A Monographic Study, with Descriptions of Five New Species (Plates III.—VIII)</i>	269, 393
DIXON-NUTTALL, F. R., & OTHERS— <i>New Rotifers</i>	435
ZACHARIAS, O.— <i>Parasites of Rotatoria</i>	653
MURRAY, JAMES— <i>New Rotifers from Scotland</i>	653
H. S. M.— <i>Key to the Rotifera for the Amateur</i>	653

Echinoderma.

THÉEL, HJALMAR— <i>Hermaphrodite Holothurian</i>	54
CUÉNOT, L.— <i>Physiology of Echinoderms</i>	54
HEROUARD, ED.— <i>Calcareous Plates of Synapta and Ankyroderma</i>	436
BARTHEL, PH.— <i>Minute Structure of Cuvierian Organs</i>	436
REIFFEN, A.— <i>New Holothurian from New Zealand</i>	436
HARTMANN, M.— <i>Maturation in Asterias glacialis</i>	437
CLARK, H. L.— <i>Echinoderms from Puget Sound</i>	437
DELAGE, YVES— <i>Function of Sphaeridia in Sea-Urchins</i>	437
MARSHALL, W. S.— <i>Genital Pores of Male Antedon rosacea</i>	437
FOLLMANN, O.— <i>New Crinoid</i>	437
CLARK, H. L.— <i>Extraordinary Animal</i>	560
HÉROUARD, E.— <i>Body-Wall and Gut-Wall in Echinoderms</i>	560
ACKERMANN, A.— <i>Structure and Hermaphroditism of Cucumaria levigata</i>	653
DUBOIS, R.— <i>Red Pigment of Asterias rubens</i>	654
VIGUIER, C.— <i>Natural Parthenogenetic Development</i>	654
BRYCE, T. H.— <i>Maturation in Echinus esculentus</i>	654

Cœlentera.

TORREY, H. B.— <i>Regeneration and Regulation in Renilla</i>	54
CITRON, E.— <i>Multicellular Sense-Organs in Syncoryne sarsii</i>	55
WULFERT, J.— <i>Development of Gonothyræa loveni</i>	55
HARTLAUB, CL.— <i>Revision of Genus Sertularella</i>	55
LINKO, A.— <i>An Interesting Medusoid</i>	188
PERKINS, H. F.— <i>Occurrence of Cladonema in the Bahamas</i>	188
MORGENSTERN, PAUL— <i>Development of Cordylophora lacustris</i>	188
HICKSON, S. J.— <i>Structure of Alcyonium digitatum</i>	189
DUERDEN, J. E.— <i>Relationships of Rugose Corals</i>	189
TORNQUIST, A.— <i>Position of Neostroma</i>	189
FRIEDEMANN, O.— <i>Post-Embryonic Development of Aurelia aurita</i>	310
BEDOT— <i>Historical Study of the Zoological Investigation of Hydrocids</i>	311
WULFERT, J.— <i>Development of Gonothyræa loveni</i>	311
DUERDEN, J. E.— <i>Relationships of the Rugosa to Living Zoanthææ</i>	437
DENDY, A.— <i>Free-Swimming Hydroid</i>	561
PERKINS, H. F.— <i>Budding in Larvæ of Gonionema murbachii</i>	561
DUERDEN, J. E.— <i>Aggregated Colonies in Madreporarian Corals Actinians of Porto Rico</i>	561
DUERDEN, J. E.— <i>Dispersal of Sagartia luciae</i>	562
DUERDEN, J. E.— <i>Increase of Mesenteries in Madrepora</i>	655
GODLEWSKI, E.— <i>Regeneration in Tubularia</i>	655

ROWLEY, H. T.— <i>Regeneration in Hydra</i>	655
KAMAKICHI KISHINOUE— <i>Japanese Scyphomedusæ</i>	656

Porifera.

MAAS, OTTO— <i>Gemmation of Tethya</i>	55
COTTE, J.— <i>Suberites domuncula</i>	56
BIDDER, GEORGE— <i>Modifications or Metamphy in Halichondria panicea and in Suberites domuncula</i>	190
<i>Sycon compressum</i>	190
WHITELEGGE, THOMAS— <i>Sponges from New South Wales</i>	190
URBAN, F.— <i>New Calcareous Sponge</i>	312
WILSON, H. V.— <i>Asexual Origin of the Ciliated Sponge Larva</i>	562
TOSSENT, E.— <i>Algerian Sponges</i>	562
ISAO IJIMA— <i>Studies on Hexactinellids</i>	656

Protozoa.

WEST, G. S.— <i>British Fresh-water Rhizopods</i>	56
NISHIKAWA, T.— <i>Discoloration of Water by Gonyaulax</i>	57
DANGEARD, P. A.— <i>Zoospore and Spermatozoon</i>	57
SCHERFFEL, A.— <i>Phylogeny of Protists</i>	57
LEMERMANN, E.— <i>Silicoflagellate Protozoa</i>	57
METZNER, RUDOLPH— <i>Megastoma entericum Grassi</i>	58
LAVERAN, A., & F. MESNIL— <i>Trypanosoma in Fishes</i>	58
VANEY, C., & A. CONTE— <i>New Microsporidian</i>	58
LÉGER, LOUIS— <i>Sex-Elements in Stylohynchus</i>	58
LAVERAN, A., & F. MESNIL— <i>Two New Hæmogregarines from Fishes</i>	59
JENNINGS, H. S.— <i>“Artificial Protoplasm”</i>	190
WOLFENDEN, R. N.— <i>Radiolarians of Farøe Channel and Shetlands</i>	191
SOSNOWSKI, J.— <i>Changes in the Geotaxis of Paramœcium aurelia</i>	191
JENNINGS, H. S., & E. M. MOORE— <i>Reactions of Infusorians to Carbonic and other Acids</i>	191
WALLENGREN, HANS— <i>Comparative Morphology of Hypotrichous Infusoria</i>	192
VOIGT, MAX— <i>New Ciliata</i>	192
GARBINI, A.— <i>New Species of Peridinium</i>	192
MINKIEWICZ, ROMUALD— <i>Adaptability of Infusoria to Concentrated Solutions</i>	192
STASSANO, H.— <i>Conjugation in Trypanosoma of Rat</i>	193
JOHNSTONE, JAMES— <i>Protozoon Parasite in Plaice</i>	193
FLORENTIN, R.— <i>Significance of Ionisation in Acclimatisation</i>	312
PENARD, E.— <i>Heliozoa around Geneva</i>	312
LÉGER, LOUIS— <i>Multiplication of Herpetomonas</i>	313
BRASIL, L.— <i>New Sporozoon</i>	313
LAVERAN, A.— <i>Action of Human Serum on Trypanosoma brucei</i>	313
ZYKOFF, W.— <i>Protozoa of the Volga-Plankton</i>	313
HICKSON, S. J.— <i>Conjugation of Dendrocometes paradoxus</i>	438
ENRIQUES, P.— <i>Osmotic Phenomena in Infusorians</i>	439
CHAPMAN, F.— <i>Foraminifera</i>	439
BRADFORD, J. R., & H. G. PLIMMER— <i>Trypanosoma brucei</i>	440
LAVERAN, A.— <i>New Trypanosoma</i>	440
LANKESTER, E. RAY— <i>Terminology for various Stages of the Malaria Parasite</i>	440
HINTZE, R.— <i>Life-History of Lankesterella minima</i>	441
CRAWLEY, H.— <i>Progressive Movement of Gregarines</i>	441
FEINBERG, L.— <i>Cabbage and Cancer</i>	441
MILLETT, F. W.— <i>Report on the Recent Foraminifera of the Malay Archipelago, collected by Mr. A. Durrand (Plate XI.)</i>	509
CHRZĄSZCZ, T.— <i>Yeast-eating Amœboid Organism</i>	562
MOUTON, H.— <i>Digestion in Amœbæ</i>	562
PRZESMYCKI, A. M.— <i>Parasites of Rotifers</i>	563
SIEDLECKI, M.— <i>New Parasitic Infusorian</i>	563
ZACHARIAS, O.— <i>Two new Dinoflagellata</i>	563

	PAGE
LEDOUX-LEBARD— <i>Action of Blood-Serum on Paramœcium</i>	563
WEITLAUER, FR.— <i>Marine Phosphorescence</i>	563
SIMPSON, J. Y.— <i>Observations on Protozoa</i>	563
BRUCE, D.— <i>New Trypanosoma</i>	564
LAVERAN, A., & F. MESNIL— <i>Multiplication of Trypanosoma in Fishes</i>	564
LÉGER, L., & O. DUBOSCQ— <i>Sexual Phenomena in Pteroccephalus</i>	564
VUILLEMIN, P.— <i>Sarcocystis tenella in Man</i>	564
SILVESTRI, A.— <i>Variations of Nodosaria scalaris</i>	656
" " <i>Dimorphism of Foraminifera</i>	656
TORREY, H. B.— <i>Discoloration of the Sea by Dinoflagellata</i>	656
ZACHARIAS, O.— <i>Infusoria in Cuckoo-Spit</i>	657
LAVERAN, A., & F. MESNIL— <i>Coccidium of Frog's Kidneys</i>	657
GALLI-VALERIO, B.— <i>Hamosporidia of Alpine Birds</i>	657
FUHRMANN, O.— <i>Myxosporidia of Coregonus</i>	657

BOTANY.

GENERAL,

Including the Anatomy and Physiology of Seed Plants.

Cytology,

including Cell Contents.

	PAGE
GERASSIMOW, J. J.— <i>Influence of the Nucleus on the Growth of the Cell</i>	60
ISHIKAWA, C.— <i>Reduction of Chromosomes in Larix leptolepis</i>	60
ALLEN, C. E.— <i>Middle Lamella of Cells</i>	61
CROSS, C. F., & E. J. BEVAN— <i>Researches on Cellulose</i>	61
KRAEMER, H.— <i>Crystalline and Crystalloid Substances in Plants</i>	61
D'ARBAËMONT, J.— <i>Evolution of Chlorophyll and Starch in the Stem</i>	62
SYNIEWSKI, W.— <i>Structure of Starch</i>	62
DEHÉRAIN, P. P., & E. DUPONT— <i>Formation of Starch in the Grain of Wheat</i>	63
BERTHELOT, M., & G. ANDRÉ— <i>Distribution of the Acids in Plants</i>	63
SCHNEIDER, A.— <i>Function of Calcium oxalate</i>	63
BOURQUELOT, E.— <i>Determination of the Presence of Cane-sugar in Plants</i>	63
MICHELETTI, L.— <i>Poisonous Properties of Lolium temulentum</i>	64
LAURENT, E.— <i>Poisonous Principle in the Mistletoe</i>	64
HABERLANDT, G.— <i>On Fibrillar Structure of Protoplasm</i>	194
PETIT, L.— <i>Refringent Globules in the Parenchyme of Leaves</i>	194
KIENITZ-GERLOFF— <i>Protoplasmic Continuity in Cryptogams</i>	314
EWART, A. J.— <i>Protoplasmic Streaming in Plants</i>	314
MOLISCH, H.— <i>Scutellarin</i>	315
VAN RYSELBERGHE— <i>Permeability of Protoplasm</i>	442
GRAM, BILLE— <i>Aleurone-Grains in Oily Seeds</i>	442
PERKIN, W. H., JUN., & J. YATES— <i>Constitution of Hæmatozylin</i>	443
PERKIN, A. G., & S. H. C. BRIGGS— <i>Colouring Matters of Green Ebony</i>	443
“ “ & E. J. WILKINSON— <i>Colouring Matter from Flowers of Delphinium consolida</i>	443
PARATORE, E.— <i>Nature and Function of the Nucleolus</i>	565
TORREY, J. C.— <i>Cytological Changes accompanying the Secretion of Diastase</i>	565
PERCIVAL, J.— <i>Crystals of Calcium Oxalate in Seedlings of Alsike</i>	565
DUNSTAN, W. R., & T. A. HENRY— <i>Cyanogenesis in Plants</i>	566
RAMMELBERG, K.— <i>Composition of Orchid Tubers</i>	566
LEUSCHER, E.— <i>Composition of Bananas</i>	566
STÄGER, R.— <i>Chemical Demonstration of Nectaries in Pollen Flowers and Anemo- philous Flowers</i>	566
BORNTRAEGER, A.— <i>Sugars and Organic Acids in certain Fruits</i>	567
TAURET, C.— <i>Two new Sugars extracted from Manna</i>	567
BROWNE, C. A., JUN.— <i>Constituents of Pith of Maize and Elder</i>	567
MARCHLEWSKI, L.— <i>Colouring Matters obtainable from Isatis tinctoria</i>	567
PERKIN, A. G.— <i>Constituents of Acacia and Gambier Catechus</i>	568
SCHLAGDENHAUFFEN, M., & REEB— <i>Lecithin in Plants</i>	568
BARGER, G.— <i>Saponarin</i>	568
THORPE, T. E., & G. STUBBS— <i>Taxine</i>	568
DUNSTAN, W. R., & T. A. HENRY— <i>Poison of Lotus arabicus</i>	658

Structure and Development.

Vegetative.

HÖHLKE, D. F.— <i>Resin-Receptacle in the Polypodiaceæ and in some Phanerogams</i> ..	64
THISELTON-DYER, W. T.— <i>Persistence of Leaf-traces</i>	64

	PAGE
DINGLER, H.— <i>Floating Organs of Plants</i>	66
HANSGIRG, A.— <i>Biology of Leaves</i>	67
CHURCH, A. H.— <i>Phyllotaxis</i>	67
BERRY, E. W.— <i>Stipules of Liriodendron</i>	67
MACDOUGAL, D. T.— <i>Bulbils of Lysimachia terrestris</i>	67
DALE, E.— <i>Tubers of Dioscorea</i>	68
MILLER, J.— <i>Assimilating Roots of Tenuiophyllum</i>	68
LINSBAUER, K.— <i>Anatomy of Cassiope</i>	68
PERROT, E.— <i>On the Ksopo or Tanghin de Menabé (Menabea venenata Baill.), a Poison Plant of the Sakulaves</i>	194
JEFFREY, E. C.— <i>Stem of Pteridophytes and Gymnosperms</i>	194
SCHROEDER, A.— <i>Anatomical Investigation of the Leaf and of the Axis in the Lipariæ and Bossiæ (Tribe Geuistæ)</i>	195
HILL, A. W.— <i>Histology of the Sieve-tubes of Pinus</i>	195
MAIGE, A., & C. L. GATIN— <i>Structure of the Tuberos Roots of Thrinicia tuberosa</i>	196
THESELTON-DYER, W. T.— <i>Sucker of Loranthus aphyllus</i>	196
MELERHOFER, H., & S. PROWASEK— <i>Bladders of Utricularia</i>	196
HEINRICHER, H.— <i>Green Hemi-Parasites</i>	197
FISCHLER, G.— <i>Formation of New Stems from Old Willows</i>	197
RENNERT, R. J.— <i>Seeds and Seedlings of Arisæma triphyllum and A. Dracontium</i>	198
SCOTT, D. H.— <i>The Old Wood and the New</i>	315
SCHWABACH, E.— <i>Development of Stomata in Conifers</i>	315
BARBICKOW, M.— <i>Secondary Growth in Thickness in Palms</i>	316
TOBLER, F.— <i>Origin of the Peripheral Stem-Structure</i>	316
BOUYGUES, M.— <i>Origin and Differentiation of Vascular Meristems in the Leaf-Stalk</i>	316
PIROTTA, R.— <i>Primary Vascular Elements in Roots of Monocotyledons</i>	317
SABLON, L. DU— <i>Tubercle of Tamus communis</i>	317
BARTELETTI, V.— <i>Study of the Family Oclmaceæ, especially of Malayan Species</i> ..	318
SAITO, K.— <i>Bast-Fibres of Japanese Fibre-Plants</i>	318
GUIGNARD, L.— <i>The Secreting Apparatus of Daniellia</i>	318
FRITSCH, F. E.— <i>An Anatomical Systematic Investigation of Leaf and Axis in the Hippocrateaceæ</i>	318
LONAY, H.— <i>Anatomy of Ranunculaceæ</i>	444
GOFFART, J.— <i>Anatomy of the Leaves in the Ranunculaceæ</i>	444
GAUCHER, L.— <i>Anatomy of the Euphorbiaceæ</i>	445
TERNST, C.— <i>Morphology and Anatomy of Azorella Selago</i>	446
BRENNER, W.— <i>Air-Roots of Avicennia tomentosa</i>	446
SARGANT, E.— <i>Origin of the Seed-leaf in Monotyledons</i>	446
GLÜCK, H.— <i>Stipular Structures of Monocotyledons</i>	447
LEAVITT, R. G.— <i>Subterranean Plants of Epiphegus</i>	447
WINKLER, H.— <i>Regeneration of Leaf-Blade in Cyclamen</i>	447
AMBERG, O.— <i>Cork-formation in the Interior of the Leaf-Stalk of Nuphar luteum</i> ..	448
LENEČEK, O.— <i>Union of Branch and Stem of the same Tree</i>	448
SCHULZE, H.— <i>Leaf-anatomy of Rutaceæ</i>	568
PEARSON, H. H. W.— <i>Dischidia with Double Pitchers</i>	569
CHAUVEAUD, G.— <i>Precursors of Sieve-tubes in Gymnosperms</i>	569
PERROT, E., & G. LEFÈVRE— <i>Botanical Origin of Kinkeliba</i>	569
HARSBERGER, J. W.— <i>Germination of Carapa guianensis</i>	658
PRESTON, C. E.— <i>Peculiar Stages of Foliage in the Genus Acacia</i>	658
FAIRCHILD, D. G.— <i>Precocious Branching</i>	658
RIMBACH, A.— <i>Subterranean Organs of Californian Liliaceæ</i>	658
DANIEL, L.— <i>Rejuvenescence as a Result of Grafting</i>	659
SIMON, S.— <i>Structure of the Wood in Deciduous and Evergreen Trees</i>	659
BORTHWICK, A. W.— <i>Increase in Diameter of Trees</i>	660
CLARK, A. M.— <i>Abnormal Secondary Thickening in Kendrickia</i>	660
PITARD, J.— <i>Pericycle of Angiosperms</i>	660

Reproductive.

TALIEW, W.— <i>Polychroism of Flowers</i>	64
UEXHÜLL-GYLLENBAND, M. VON— <i>Distribution of the Sexes in the Compositæ</i> ..	64
MOLLIARD, M.— <i>Double Flowers and Parasitism</i>	65

	PAGE
WINTON, A. L.— <i>Fruit of the Cocoa-nut</i>	65
THISELTON-DYER, W. T.— <i>Carpophyll of Encephalartos</i>	65
MURBECK, S.— <i>Amphicarpous Plants</i>	65
PÉCHOUTRE, L.— <i>Integument of the Ovule and Seed of Geum</i>	66
RENDLE, A. B.— <i>Bulbiform Seeds of Amaryllidææ</i>	66
SCHNIEWIND-THIES, J.— <i>Reduction in the Number of Chromosomes in the Embryo-sac Mother-cell</i>	68
GUIGNARD, L.— <i>Double Fertilisation in Naias</i>	69
ARNOLDI, W.— <i>Embryogeny of the Sequoiææ</i>	70
FERGUSON, M. C.— <i>Development of the Oosphere and Fertilisation in Pinus Strobus</i>	70
DU CAMP, L.— <i>Formation of the Ovule and Embryo-sac in the Araliææ</i>	71
" " <i>Embryo of Hedera</i>	71
CLOS, D., & MAINARDI, A.— <i>Cross-Pollination and Self-Pollination</i>	71
GALLARDO, A.— <i>Change of Sexuality in Plants</i>	71
MENDEL'S <i>Laws of Hybridity</i>	71
LOEW, E.— <i>Cleistogamy of Stellaria pallida</i>	72
IBERG, E.— <i>Biology of Ranunculus Ficaria</i>	73
NICOTRA, L.— <i>Origin of the Flower</i>	198
HERZOG, J.— <i>Strengthening and Nourishing System in Flowers</i>	198
KLEIN, J.— <i>Staminode-like Structures in Dentaria bulbifera</i>	198
STRASBURGER, E., & T. C. FRYE— <i>Formation of the Pollen in the Asclepiadææ</i>	199
VELENOVSKY, M.— <i>Abnormal Flowers of Forsythia viridissima Lindl.</i>	199
GUIGNARD, L.— <i>Double Fertilisation in the Solanacææ and Gentianacææ</i>	199
CORRENS, C.— <i>Hybridism and Xenia</i>	200
WEBBER, H. J.— <i>Spermatogenesis and Fecundation of Zamia</i>	201
BESSEY, C. E.— <i>Morphology of the Pine-Cone</i>	318
COKER, W. C.— <i>Gametophytes and Embryo of Podocarpus</i>	319
WORDELL, W. C.— <i>Vascular Structure of the Flowers of Guetacææ</i>	320
MARTEL, E.— <i>Anatomy and Morphology of the Flower of Cruciferæ, &c.</i>	320
GAGER, C. S.— <i>Development of Pollinium and Sperm-Cells in Asclepias Cornuti</i>	320
TSCHERMAK, E.— <i>Influence of Pollination on the Development of the Pericarp</i>	321
MITLACHER, W.— <i>Microscopic Characters of the Fruit-Envelopes in the Acorn</i>	321
GUÉRIN, P.— <i>Development of the Seed in Sapindacææ</i>	321
HECKEL, E.— <i>Germination of Onguetkoa and Strombosia</i>	322
HARSHBERGER, J. W.— <i>Cockscomb Fasciation of Pine Apples</i>	322
WIELAND, G. R.— <i>Notes on Living Cycads: The Zamias of Florida</i>	448
ROSENBERG, O.— <i>Development of Pollen in Zostera</i>	449
" " <i>Embryology of Zostera marina</i>	449
COOK, M. T.— <i>Development of Embryo-sac and Embryo in Castalia and Nymphææ</i>	449
DU CAMP, L.— <i>Embryogeny of Araliææ</i>	450
OVERTON, J. B.— <i>Parthenogenesis in Thalictrum purpurascens</i>	451
SHOEMAKER, D. N.— <i>Development of Hamamelis virginiana</i>	570
JOHNSON, S.— <i>Development of the Embryo-Sac in Piper and Heckeria</i>	570
HALL, J. G.— <i>Embryology of Limnocarhis</i>	570
VILLARI, E.— <i>Structure of Achenes</i>	571
JOHNSON, D. S.— <i>Germination in Piperacææ</i>	571
HARSHBERGER, J. W.— <i>Germination of Seeds of Carapa guianensis</i>	572
COOK, M. T.— <i>Polyembryony in Gingko</i>	661
GARDINER, W., & A. W. HILL— <i>Histology of the Endosperm</i>	661
LLOYD, F. E.— <i>Comparative Embryology of the Rubiæææ</i>	662
PÉCHOUTRE, F.— <i>Development of Ovule and Seed in Rosacææ</i>	664
TIGHEM, PH. VAN— <i>Existence of a Hypostase in the Ovule and Seed of Rosacææ</i>	666
WEBB, J. E.— <i>Development of Flower and Embryo of Spirææ</i>	667

Physiology.

Nutrition and Growth.

MEEHAN, T.— <i>Bending of Mature Wood in Trees</i>	66
BARANETZKY, J.— <i>Causes of the Direction of Branches</i>	66
MACCHIATI, L.— <i>Chlorophyll Assimilation</i>	72
PETHYBRIDGE, G. H.— <i>Action of Inorganic Salts on the Structure and Development of Plants</i>	73

	PAGE
KÖVESSI, F.— <i>Relation of the Supply of Water to the Ripening of Woody Plants</i>	73
JURIE, A.— <i>Hybridisation by Grafting</i>	73
DANIEL, L.— <i>Grafting, Pinching, and Annular Decortication</i>	73
FRIEDEL, J., & M. HARROY— <i>Chlorophyll Assimilation of Cut Leaves</i>	73
BOYER, G.— <i>Vitality of Leaves after their Fall</i>	73
ARKER, J.— <i>Influence of the Surrounding Medium on the Growth of Roots</i>	74
GENAU, K.— <i>Development of Saurodatum guttatum Schott</i>	202
ANDRÉ, G.— <i>Nutrition of the Seedling at the Expense of its Cotyledons</i>	203
PORTHEIM, L. RITTER V.— <i>Necessity of Lime for Plants</i>	203
MARCHAL, E., & E. LAURENT— <i>Influence of Mineral Salts on the Production of Root-tubercles in Pisum</i>	203
MIANI, D.— <i>Action of Copper on the Growth of Living Cells</i>	203
ARBER, A. E. N.— <i>Nitrates and the Carbon-Assimilation of Algæ</i>	204
BURGERSTEIN, A.— <i>Germinating Power of the Seeds of Cereals</i>	204
GAIN, E.— <i>"Ageing" of the Embryo of Grasses</i>	204
JOST, L.— <i>Theory of the Shifting of Lateral Organs through Mutual Pressure</i>	322
KNY, L.— <i>Influence of Tension and Pressure on the Direction of the Cell-Wall</i>	322
SPEERLICH, A.— <i>Suckers of the Green Rhinanthaceæ</i>	323
CHARPENTIER, P. G.— <i>Assimilation of Carbon by a Green Alga</i>	323
RENARD, LE.— <i>Chemauzism of Copper Salts on Penicillium glaucum</i>	324
CAVARA, F.— <i>Resistance to Salt Solution</i>	324
HEINRICHER, E.— <i>Green Hemiparasites</i>	451
VÖCHTING, H.— <i>Germination of Potato Tubers</i>	452
DEHERAIN, P. P., & C. DUPONT— <i>Cultivation of Beet-root</i>	452
SCHULZE, E.— <i>Leucine and Tyrosine as Food-stuffs</i>	452
PITSCH, O.— <i>Yield of Leguminous Plants</i>	452
CLAUSEN, H.— <i>Influence of Nitrogenous Manures on the Form of Cereals</i>	455
PICCIOLI, L.— <i>Soils suitable for Chestnuts</i>	453
REMY, T., & O. ENGLISH— <i>Nutrition of Hops</i>	453
HANUSCH, F.— <i>Value of Green Manures</i>	455
GERLACH, M.— <i>Value of Kainite</i>	453
LEISERING, B.— <i>Shifting in Heads of Sunflower during Development from Flowering to Ripening</i>	455
CORRENS, C.— <i>On the Separation of Characters in Hybrids of the Pea Type</i>	454
CURTIS, C. C.— <i>Observations on Transpiration</i>	572
SHYNSUKE KUSANO— <i>Transpiration of Evergreen Trees in Winter</i>	573
MAY, W.— <i>Relations of Calcium and Magnesium to Plant Growth</i>	573
ANDRÉ, G.— <i>Accumulation of Mineral and Organic Matter in Woody Plants</i>	573
BROWN, H. T., & OTHERS— <i>Influence of Varying Amounts of Carbon Dioxide in the Air on Photosynthesis and Plant Growth</i>	668
POISSON, JULES— <i>Duration of Germinating Power of Seeds</i>	669

Irritability.

BLACKMAN, F. F., & GABRIELLE L. C. MATTHAEI— <i>Reaction of Leaves to Traumatic Stimulation</i>	74
MASSART, M. J.— <i>Irritability of the Higher Plants</i>	74
WIESNER, J.— <i>Position of Flowers with respect to Light</i>	204
SELBY, A. D.— <i>Resistance of Seeds to Low Temperatures</i>	204
ANDRÉ, G.— <i>Action of Temperature on the Absorption of Minerals in Etiolated Plants</i>	324
SCHULZ, N.— <i>Light and Spore-Germination</i>	324
NEWCOMBE, F. C.— <i>Rheotropism of Roots</i>	454
SECKT, H.— <i>Influence of X-rays on the Plant Organism</i>	455
PASSERINI, N.— <i>Effect of Sunshine on Plants</i>	574
TOMPA, A.— <i>Electrical Phenomena in Plants</i>	574
BOSE, J. C.— <i>Electric Response in Plants under Mechanical Stimulus</i>	574
DARWIN, F.— <i>Method of Investigating the Gravitational Sensitiveness of the Root-tip</i>	575
SUKATSCHOFF, L.— <i>Action of Alcohol on Germination of some Seeds</i>	575
MCCALLUM, W. B.— <i>Nature of the Stimulus causing the Change of Form and Structure in an Amphibious Plant</i>	669
HEALD, F. D.— <i>Electrical Conductivity of Plant Juices</i>	669

Chemical Changes.

	PAGE
ZALESKI, W.— <i>Formation of Proteids</i>	74
AHRENS, F. B.— <i>Fermentation without Cells</i>	75
BUSCALIONI, L., & G. POLLACCI— <i>New Mode of Measuring Transpiration</i>	75
NEWTON, C. R.— <i>Oxidising Enzymes</i>	205
VINES— <i>The Proteolytic Enzyme of Nepenthes</i>	205
TIMBERLAKE, H. G.— <i>Starch-formation in Hydrodictyon utriculatum</i>	205
MAZÉ, M. P.— <i>On the Transformation of Fatty Matters into Sugars in Oily Grains during Germination</i>	206
SCHUNCK— <i>Contributions to the Chemistry of Chlorophyll</i>	206
BROWN, A. J., & OTHERS— <i>Enzyme Action</i>	325
VINES, S. H.— <i>Tryptophane in Proteolysis</i>	325
BOURQUELOT, E.— <i>Cane-Sugar in the Reserve Food-Staffs of Phanerogams</i>	326
GRÜS, J.— <i>Conversion of Carbohydrate in the Germination of the Date</i>	326
KASTLE, J. H., & OTHERS— <i>Reaction and Nature of Oxidising Ferments</i>	455
EMMERLING, O.— <i>Action of Sunlight on Enzymes</i>	456
ANDRÉ, G.— <i>Transformation of Proteids during Germination</i>	456
NEDOKUTSCHAEFF, N. K.— <i>Changes in Nitrogenous Substances in Ripening of Cereals</i>	456
OTTO, R.— <i>Changes during Ripening of Apples</i>	457
IWANOFF, K. S.— <i>Composition of Proteids and Cell-Membranes in Bacteria and Fungi</i>	457
CZAPEK, F.— <i>Proteid Formation in Plants</i>	457
KIRKWOOD, J. E., & W. J. GIES— <i>Chemical Studies of the Coco-nut</i>	575
JAVILLIER, M.— <i>Investigation and Presence of Rennet-ferment in Plants</i>	575
BAKER, J. L.— <i>Action of Ungerminated Barley Diastase on Starch</i>	576
WOODS, A. F.— <i>Mosaic Disease of Tobacco</i>	576
MOURELL, R. S., & J. S. CROFTS— <i>Action of Hydrogen Peroxide on Carbohydrates in Presence of Ferrous Sulphate</i>	576
MANN, H. H.— <i>Enzymes of the Tea-leaf</i>	670

General.

HARSBERGER, J. W.— <i>Limits of Variation in Plants</i>	75
KORSCHINSKY, S.— <i>Heterogenesis and Evolution</i>	75
VOGEL, P.— <i>Means of Distribution of Alpine Plants</i>	76
BEAUVÉRIE, J.— <i>Influence of Osmotic Pressure on the Form and Structure of Plants</i>	76
WARD, H. MARSHALL— <i>Disease in Plants</i>	76
CARRUTHERS, W.— <i>On the Life and Work of Nehemiah Grew</i>	129
JACCARD, P.— <i>Distribution of Plants in the Alps and Jura Mountains</i>	206
SHULL, G. H.— <i>Quantitative Study of Variation in the Bracts, Rays, and Disk-florets of Species of Aster</i>	326
GIARD, A.— <i>Passage from a Bisexual to a Unisexual Condition by Unilateral Parasitic Castration</i>	326
BOULAY, N.— <i>Topographical Botany</i>	327
GIBBS, R. E.— <i>Phyllospadix as a Beach-Builder</i>	327
LOVELL, J. H.— <i>Colours of Northern Polypetalous Flowers</i>	457
GRIFFITHS, D.— <i>Anchoring of Plantain Seed</i>	458
WARMING, EUG.— <i>Burmanniaceae from Brazil</i>	458
ENGLER, A.— <i>Vegetation of the Mountainous Districts North of Lake Nyasa</i>	458
WARBURG, O.— <i>History and Development of Applied Botany</i>	458
HANSGIRG— <i>Phylobiologic Types in some Orders of Seed-Plants</i>	576
ZODDA, G.— <i>Study of the Genus Serapias</i>	577
STENZEL, GUSTAV— <i>Malformations of the Flower of Orchids</i>	577
HOLM, THEO.— <i>North American Carices</i>	577
ENGELHARDT, H.— <i>Tertiary Plants from the Himmelsberg</i>	577
RODWAY, L.— <i>Botany of Tasmania</i>	577
HARSBERGER, J. W.— <i>Ecological Sketch of the Flora of Santo Domingo</i>	578
BENNETT, A.— <i>Liparis Loeselii and Teucrium Scordium</i>	670
NICHOLSON, W. A.— <i>Variations in Perianth of Ranunculus Ficaria</i>	670
PANTANELLI, E.— <i>Albinism in Plants</i>	670
PLOWRIGHT, C. B.— <i>British Dye-plants</i>	671
FERNALD, M. L.— <i>Relationship of American and Old World Birches</i>	671

CRYPTOGAMS.

General.

GOEBEL, K.— <i>Homologies in the Development of Male and Female Sexual Organs</i> ..	PAGE 206
--	-------------

Pteridophyta.

LYON, FLORENCE M.— <i>Sporange and Oophyte of Selaginella</i>	76
LANG, W. H.— <i>Prothallus of Ophioglossum, Helminthostachys, and Psilotum</i>	77
BERTRAND, C. E., & F. CORNAILLE— <i>Fibrovascular Bundles in the Stem and Leaf of Filicineæ</i>	78
BURGENSTEIN, A.— <i>Germination of Fern-Spores</i>	78
GIESENHAGEN, K.— <i>Niphobolus</i>	79
RENAULT, B.— <i>Fossil Heterosporous Ferns</i>	79
BOODLE, L. A.— <i>Anatomy of the Gleicheniaceæ</i>	207
BERTRAND, C. E., & F. CORNAILLE— <i>Fibrovascular Chains of Filicineæ</i>	207
ARBER, E. N.— <i>The Type-Specimens of Lyginodendron Oldhamium</i>	208
THOMAS, A. P. W.— <i>Prothallium of Phylloglossum</i>	208
LANG, W. H.— <i>Prothalli of Ophioglossum and Helminthostachys</i>	327
UNDERWOOD, L. M.— <i>Classification of Ferns</i>	328
FORD, S. O.— <i>Anatomy of Ceratopteris thalictroides</i>	328
TANSLEY, A. G., & R. B. LULHAM— <i>A New Type of Fern-stele</i>	329
THOMAS, A. P. W.— <i>Alga-like Fern-prothallus</i>	329
” ” <i>Affinities of Tmesipteris</i>	329
SEWARD, A. C.— <i>So-called Phloem of Lepidodendron</i>	330
RACIBORSKI, M.— <i>Vegetative Propagation in Angiopteris evecta</i>	459
STEINBRINCK, C.— <i>Spore-casting Mechanism of Selaginella Sporangia</i>	459
WATERS, C. E.— <i>Analytical Key for the Ferns of the North-Eastern States, based on the Stipes</i>	578
BRITTON, E. G.— <i>Filmy Ferns of South America</i>	578
HIERONYMUS, G.— <i>New Species of Selaginella</i>	578
RENAULT, B.— <i>Pollen and Male Prothallia from the Coal Measures</i>	671
SELLARDS, E. H.— <i>Fossil American Ferns: Fertile Fronds of Crossotheca and Myriotheca</i>	671
SEWARD, A. C., & ELIZABETH DALE— <i>Structure and Affinities of Dipteris</i>	672
CHRISTENSEN, C.— <i>Danish Pteridophyta</i>	672
CHRIST, H.— <i>Brazilian Ferns</i>	672
SLOSSON, M.— <i>Hybrid Origin of Asplenium ebenoides</i>	672
GWYNNE-VAUGHAN, D. T.— <i>Nature of the Stele of Equisetum</i>	672

Muscineæ.

LORCH, W.— <i>Anatomy and Biology of Mosses</i>	79
KINDBERG, N. C.— <i>Hypopterygiaceæ</i>	79
LANG, W. H.— <i>Apospory in Anthoceros</i>	79
GIESENHAGEN, K.— <i>Leaf-Movements in Polytrichum</i>	209
PHILIBERT, H.— <i>Structure of the Peristome</i>	209
JONES & OTHERS— <i>Mosses new to Britain</i>	209
LIMPRICHT, K. G.— <i>Rabenhorst's Cryptogamic Flora of Germany (Musci)</i>	210
STEPHAN, F., & OTHERS— <i>Lists and New Species</i>	210
GARJEANNE, A. J. M.— <i>Spore Distribution</i>	330
PALACKÝ, J.— <i>Geographical Distribution of Mosses</i>	331
PHILIBERT, H.— <i>Peristome of Mosses</i>	331
MÖNKEMEYER, W., & F. TOBLER— <i>Abnormalities</i>	331
MACVICAR, S. M., & OTHERS— <i>Lists and New Species</i>	331
HUNTER, J., & E. ARMITAGE— <i>Irish Mosses</i>	459
BRAITHWAITE, R.— <i>British Moss-Flora</i>	459
HOWE, M. A.— <i>Notes on American Hepaticæ</i>	459
NICHOLSON, W. E.— <i>Mosses of South-Western Switzerland</i>	460
PARIS— <i>Mosses of West Tropical Africa</i>	460
PIERCE, G. J.— <i>Forcible Discharge of Antherozoids in Asterella californica</i>	578

	PAGE
GIL, A. CASARES— <i>Red-coloured Hepatics</i>	579
KINDBERG, N. C.— <i>Genus Thamnium</i>	579
LEVIER, E., & G. DISMIER— <i>French Muscineæ</i>	579
MIGULA, W.— <i>Mosses of Central Europe</i>	580
PODPÉRA, J.— <i>Bohemian Species of Bryum</i>	580
PARIS, E. G.— <i>Mosses of Madagascar</i>	580
MÜLLER, K.— <i>Australian Mosses</i>	580
SALMON, E. S.— <i>Bryological Notes</i>	580
SAVERY, G. B., & OTHERS— <i>British and Irish Mosses</i>	581
CARDOT, J.— <i>Leaf-Anatomy of the Leucobryaceæ</i>	673
NICHOLSON, W. E.— <i>British Moss Flora</i>	673
MENTZ, A.— <i>Mosses of Jutland</i>	673
BRITTON, ELIZABETH G.— <i>European Species of Sematophyllum</i>	673
WILLIAMS, R. S.— <i>Preliminary List of Montana Mosses</i>	673
STEPHANI, F.— <i>Species Hepaticarum</i>	673
SOMMIER, S.— <i>Petalophyllum Ralfsii</i>	674
STEPHANI, F.— <i>Siamese Hepatics</i>	674
PORSILD, M. P.— <i>Riella cultivated from dried Mud</i>	674
EYANS, A. W.— <i>Hepatics of Puerto Rico</i>	674
LEVIER, E.— <i>Priority of the Name Calypogeia</i>	674

Algæ.

KJELLMAN, F. R.— <i>Galaxaura</i>	79
MONTEMARTINI, L.— <i>Abnormal Conjugation in Spirogyra</i>	80
OTT, EMMA— <i>Chromatophores of Fresh-water Diatoms</i>	80
KARSTEN, G.— <i>Colourless Diatoms</i>	81
MERESCHKOWSKY, C.— <i>Stauronella, a New Genus of Diatoms</i>	81
" " <i>Okedevia</i>	81
PERAGALLO, H. & M.— <i>Marine Diatoms of France</i>	82
SCHNIDT'S <i>Atlas der Diatomaceen-Kunde</i>	82
WILLE, N.— <i>Pseudonclonium, a New Genus of Algæ</i>	82
BRAND, F.— <i>Cladophora</i>	82
FLEISSIG, P.— <i>Oil in Vaucheria</i>	83
SCHKEFFEL, A.— <i>Remarks on Edogonia with Semicircular Foot-cell</i>	210
SAUVAGEAU, M. C.— <i>Sphacelariaceæ</i>	211
MERESCHKOWSKY, C.— <i>Classification of Diatoms</i>	211
BRUN, J.— <i>Fresh-water Diatoms from the Island of Jan Mayen and the East Coast of Greenland</i>	212
HITCHCOCK, R.— <i>Capillary Absorptive Action of Diatom Frustules</i>	212
HEYDRICH, F.— <i>Perispermum, a new Genus of Corallinaceæ</i>	212
CLEVE, ASTRID— <i>Contributions to the Flora of Bear Island</i>	212
SCHMIDLE, W., & REINBOLD— <i>Algæ from the Caroline Islands</i>	213
WEST, W.— <i>New Mougeotia</i>	333
COPELAND, E. B.— <i>Sexuality in Spirogyra</i>	333
BRAND, F.— <i>Cladophora Ægagropila</i>	333
KOLDERUP ROSENVIINGE— <i>Spiral Arrangement in the Rhodomelaceæ</i>	334
HASSENKAMP, A.— <i>Development of the Cystocarp in some Floridææ</i>	334
FORTI, ACHILLE— <i>Algæ of Verona</i>	335
COLLINS, F. S.— <i>Algæ of Jamaica</i>	335
PROWAZEK, S.— <i>Structure and Division of Polytoma</i>	460
FRICKE, F.— <i>Atlas of Diatoms</i>	460
LEDERBAUER— <i>Growth of Cladophora cornea in the Form of Balls</i>	460
SCHRÖTER, C. & P. VOGLER— <i>Variation in Fragilaria crotonensis</i>	461
CHODAT, R.— <i>Fresh-water Algæ of Switzerland</i>	461
JONSSON, HELGI— <i>Marine Algæ of Iceland</i>	461
WEST & OTHERS— <i>Flora of Koh Chang</i>	462
CLEVE, P. T.— <i>Plankton</i>	581
FRITSCH, F. E., & IDA A. KELLER— <i>Edogonium</i>	582
BULLOCK-WEBSTER, G. R.— <i>Characeæ from Co. Monaghan</i>	582
McMILLAN, CONWAY— <i>Observations on Pterygophora californica</i>	582

	PAGE
CLEVE, P. T., & OTHERS—Recent Publications on Diatoms	582
HEYDRICH, F.—Development of Tetrasporangium in <i>Floridæ</i>	583
JÖNSSON, B.—Structure and Development of the <i>Desmaretiæ</i>	583
FALKENBERG, R.—The <i>Rhodomelacæ</i>	583
YENDO, K.— <i>Corallinæ</i> from Port Renfrew, Vancouver	584
” ” <i>Japanese Corallinæ</i>	584
SCHMIDLE, W.—Notes on some Fresh-water Algæ	584
WEST, WILLIAM, & GEORGE S.—Fresh-water Algæ of Ceylon	584
BATTERS, E. A. L.—British Marine Algæ	585
MAZZA, A.—Marine Flora of the Gulf of Naples	585
FORTI, ACHILLE—Algæ of the Verona District	585
SAUNDERS, DE ALTON—Algæ of the Harriman Alaska Expedition	585
LOHMANN, H.—Coccospheres and Coccoliths	674
KESSLER, CARL V.—Plankton of Alpine Lakes	675
ZACHARIAS, OTTO—Pond Plankton	675
LANZI, MATTEO—Diatoms of Lake Cotronia	676
BREHM, V., & OTHERS—Phyto-plankton of the Erlaufsee, and the Caspian Sea	676
CORTI, BENEDETTO—Diatoms of the River Olona	676
SENFT, E.—Diatoms in Agar-Agar	676
PEIRCE, GEORGE J.—Extrusion of Gametes in <i>Fucus</i>	677
BRAND, F.—The Genus <i>Trentepohlia</i>	677
DARBISHIRE, OTTO V.— <i>Chondrus crispus</i>	678
BARTON, ETHEL S.—The Genus <i>Halimeda</i>	678
OKAMURA, K.—Japanese Marine Algæ	679
ARDISSONE, FRANCESCO—Marine Algæ of the Mediterranean	679
MATRUCHOT, L., & M. MOLLIARD— <i>Stichococcus bacillaris</i> Naeg.	679
SCOTT, RINA—Salt-water Aquarium	680

Mycetozoa and Fungi.

STEVENS, F. L.—Gametogenesis and Fertilisation in <i>Albugo</i>	83
CONSTANTINEANU, J. C.—New <i>Chytridincæ</i>	84
VUILLEMIN, P.— <i>Penicillate</i> Tubes of <i>Phyllactinia</i>	84
BITTER, G.—Variability of Lichens under different external conditions	84
” ” <i>Parmelia</i>	85
WRÓBLEWSKI, A.—Buchner's Yeast Extract	85
HARDEN, A., & S. ROWLAND—Microscopical Appearances of Pressed Yeast after Liquefaction	85
DIETEL, P.—Storing up of Water in the Spores of the <i>Uredinæ</i>	85
ALLESCHER, A.—Kabenhorst's Cryptogamic Flora of Germany, &c. (<i>Fungi Imperfecti</i>)	86
HENNINGS, P., & OTHERS—Parasitic Fungi	86
FISCHER, E.— <i>Phalloidæ</i>	87
MAGALHAËS, P. S. DE— <i>Microbe of Piedra</i>	87
JOEL, H. O.— <i>Pyrrhosorus</i> , a new Marine Fungus	213
BREFELD, O.—Sexual and Non-sexual Reproduction in the <i>Zygomycetes</i>	213
CLINTON, G. P.— <i>Cladochytrium Alismatis</i>	214
THAXTER, R.—New Genera and Species of <i>Laboulbeniaceæ</i>	214
NEGER, F. W.—Contributions to the Biology of the <i>Erysiphaceæ</i>	215
M'ALPINE, D.—“Shot-hole” Fungi	216
VESTERGREN, TYCHO—An Arctic-Alpine <i>Rhabdospora</i>	216
GUILLIERMOND, A.—Sexuality of certain Yeasts	216
MAGNUS, P., & OTHERS— <i>Uredinæ</i>	217
HARPER— <i>Binucleate</i> Cells in certain <i>Hymenomycetes</i>	217
ZAHLEBRUCKNER, A., & R. P. LONGINOS NAVAS—Lichens	218
SERNANDER, R.— <i>Haptera</i> of Lichens	218
GOLENKIN, M.— <i>Mycorhiza</i> in the <i>Marchantiaceæ</i>	219
TROTTER, A., & OTHERS—Parasitic Fungi	219
KLEBAHN, VON, & OTHERS—Fungal Diseases of Plants	219
POIRAULT, M., & OTHERS—Mycology in France	221
SARNTHEIN, COUNT VON—Fungus Flora of Tyrol	222

	PAGE
HENNINGS, P., & L. ROMELL— <i>South American Fungi</i>	222
BERTRAND, G.— <i>Blue Colour in Fungi</i>	222
CLARK, F.— <i>On the Toxic Properties of some Copper Compounds</i>	222
MASSE, G., & E. S. SALMON— <i>Coprophilous Fungi II.</i>	335
MIYAKE, KÜCHI— <i>Fertilisation of Pythium de Baryanum</i>	335
PATOCILLARD, N., & P. HARIOT— <i>Bovista ammophila</i>	336
BEAUVÉRIE, J.— <i>Mycorhiza</i>	336
MAGNUS, P.— <i>An Underground Species of Urophlyctis</i>	336
LAXA, O.— <i>Decomposition of Butter-Fat</i>	336
ULPIANI & SARCOLI— <i>Alcoholic Fermentation of Indian Fig-Must</i>	337
BUBAK, FRANZ— <i>Puccinia</i>	337
WARD, MARSHALL— <i>Pure Cultures of a Uredine</i>	337
ERIKSSON, JAKOB— <i>Rust of Cereals</i>	338
HOWARD, A.— <i>Diplodia cacaoicola</i>	338
POTTER, M. C.— <i>Canker of the Oak</i>	338
MIYOSHI, M., & T. INUI— <i>Spore-Distribution in a Lichen</i>	339
WARD, MARSHALL, & OTHERS— <i>British Mycology</i>	339
LLOYD, C. G.— <i>The Gasteromycetes</i>	339
BATAILLE, F.— <i>Fungus Flora</i>	340
ODEMANS, C. A. J. A.— <i>Fungi of the Netherlands</i>	340
SCHRENK, H. VON— <i>Vegetable Pathology</i>	340
PECK, C. H., & OTHERS— <i>Lists and New Species of Fungi</i>	340
SACCARDO, P. A., & P. SYDOW— <i>Sylloge Fungorum</i>	341
LISTER, ARTHUR & G.— <i>Notes on Mycetozoa</i>	462
OLIVE, EDGAR W.— <i>The Acrasieæ</i>	462
SCHOSTAKOWITSCH, W.— <i>Genus Mucor</i>	463
MARPMANN— <i>Parasitic Fungi of the Diatomaceæ</i>	463
BEER, RUDOLF— <i>Coemansiella alabastrina</i>	464
RABENHORST'S <i>Cryptogamic Flora of Germany, &c. (Fungi Imperfecti)</i>	464
KLÖCKER, ALB.— <i>New Gymnoascus</i>	464
KUPFER, ELSIE M.— <i>Studies on Urnula and Geopyxis</i>	464
SALMON, E. S.— <i>Notes on the Erysiphaceæ</i>	465
ADERHOLD, R.— <i>New Species of Venturia</i>	466
UYEDA, Y.— <i>"Benikoji" Fungus</i>	466
ARTHUR, J. C.— <i>New Uredinæ</i>	466
KLEBAHN, H.— <i>Uredinæ Cultures</i>	466
GRIFFITHS, DAVID— <i>West American Fungi</i>	467
DIETEL, P.— <i>Paraphyses of the Uredinæ</i>	467
WHITE, V. S.— <i>The Nidulariaceæ of North America</i>	467
FINK, BRUCE, & OTHERS— <i>Lichens</i>	467
RANOJEVIĆ, N.— <i>Serbian Fungus Flora</i>	468
LÁZARO, D. B.— <i>Spanish Fungi</i>	468
PENZIG, O., & P. A. SACCARDO— <i>Fungi from Java</i>	468
HENNINGS, P., & OTHERS— <i>Some New Fungi</i>	469
PRUNET, M. A., & OTHERS— <i>Plant Diseases.—Black Rot of the Vine</i>	469
PEGLION, V.— <i>Disease of Maize</i>	470
CORBIE, M. C.— <i>Fungus Pests of the Carnations</i>	471
MASSE, G.— <i>Coprophilous Fungi</i>	471
TRZEBINSKI, M. J.— <i>Influence of Irritation on the Growth of Unicellular Plants</i>	471
O'BRIAN, ABIGAIL— <i>Resistance to Temperature of Fungi</i>	471
PULST, CARL— <i>Resistance of some Moulds to Metal Poisoning</i>	472
WESENBERG, G.— <i>Germicides</i>	472
DE GOMONT DE LESPARRE, A.— <i>Spore-Germination in the Higher Fungi</i>	472
WARD, MARSHALL— <i>Predisposition and Immunity in Plants</i>	473
LAFAR, FRANZ— <i>Technical Mycology</i>	473
JAHN, E.— <i>Studies in Mycomycetes</i>	585
FEINBERG— <i>Plasmodiophora Brassicæ</i>	586
FEISTMANTEL, CARL— <i>Streptothrix farcinica</i>	586
MAGNUS, P., & FR. BUBAK— <i>Urophlyctis</i>	586
BOKORNY, T.— <i>Energy of Assimilation in Fungi</i>	587
MAZÉ, M.— <i>Zymase in Fungal Hyphæ</i>	587
BREFELD, O.— <i>Pleomorphism and Chlamydospore Formation among Filamentous Fungi</i>	587

	PAGE
MINDEN, M. V.— <i>The Saprolegniææ</i>	587
KLEBS, GEORG— <i>Sporodinia grandis</i>	588
WINKLER, W.— <i>Mucor as an Alcohol Yeast</i>	588
SCHOSTAKOWITSCH, WL.— <i>Actinomucor repens</i>	589
ADERHOLD, R.— <i>Clasterosporium carpophilum</i> (Lév.) Aderh.	589
MARCHAL, EM.— <i>Erysiphe Graminis</i>	589
SMITH, RALPH E.— <i>Parasitism of Botrytis cinerea</i>	590
DURAND, ELIAS J.— <i>Some North American Discomycetes</i>	590
ALLESCHER, ANDREAS— <i>Kryptogamen-Flora</i>	590
MARPMANN, G.— <i>Yeasts</i>	591
WILL, H.— <i>Observations on the Vitality of the Yeast Plant</i>	591
TUBEUF— <i>Smut of Cereals</i>	591
GRÜSS, J.— <i>Biological Phenomena in the Cultivation of Ustilago Maydis</i>	591
BUSSE, WALTER— <i>Rust of Andropogon Sorghum</i>	592
ERIKSSON, JAKOB— <i>Witch's Brooms on the Barberry</i>	592
" " <i>Rust of Timothy Grass</i>	592
WARD, MARSHALL— <i>Relation between Host and Parasite</i>	593
LYDOW, P. & H.— <i>Monograph of the Uredineæ</i>	593
LLOYD, C. G.— <i>Geastræ</i>	593
MASSE, G.— <i>European Agarics</i>	594
GOFFART, JULES— <i>Rhizomorpha</i>	594
AMERICAN <i>Mycology</i>	594
BRZEZINSKI, F. P.— <i>Vegetal Pathology</i>	595
HENNINGS, P.— <i>Fungi on Andromeda polifolia</i>	595
ZIMMERMANN, A.— <i>Fungal Parasites of Tropical Cultivated Plants</i>	596
PIERCE, N. B.— <i>Black Rot of Oranges</i>	596
VOGLINO, P.— <i>Disease of Cultivated Chrysanthemums</i>	596
PRUNET, A.— <i>Black Rot</i>	596
HOLBORN, KAEL— <i>Some Fungus Cultures</i>	596
SCHOSTAKOWITSCH, WLAD.— <i>Mucors of East Siberia</i>	680
P'RIILLIEUX, ED.— <i>Dematophora in Fruit</i>	680
WEHMER, C.— <i>The Genus Aspergillus</i>	680
ROMMEL, W.— <i>Fruit Yeasts</i>	680
COHN, E.— <i>New Pathogenic Yeast (Klein's Yeast)</i>	681
LINDROTH, J. T.— <i>New Uredineæ</i>	681
DIEDICKE, H.— <i>Relationship between Plectospora and Helminthosporium</i>	681
TUBEUF— <i>Infection Experiments with Uredineæ</i>	681
LINDROTH, J. J.— <i>Rusts of the Umbelliferæ</i>	681
MAGNUS, P.— <i>Function of Paraphyses in the Uredineæ</i>	682
KLEBAHN— <i>Experiments with Rusts</i>	682
LANZI, MATTEO— <i>Amanita ovoidea</i>	682
FERGUSON, MARGARET C.— <i>Germination of Basidiospores</i>	682
BANKER, HOWARD J.— <i>Hydnaceæ</i>	682
BAMBEKE, CH. VAN— <i>Crystalloids of the Basidiomycetes</i>	683
PERCIVAL, J.— <i>Silver-leaf Disease</i>	683
LLENAS Y FERNÁNDEZ, M.— <i>Spanish Lichens</i>	683
ZANFROGNINI, CARLO— <i>Contribution to the Lichen Flora of Emilia</i>	683
ZOFF, W.— <i>Compounds from Lichens</i>	684
ALLESCHER, ANDREAS— <i>Kryptogamen-Flora</i>	684
RANOJEVIĆ, N., & OTHERS— <i>Contributions to Fungus Floras</i>	684
HENNINGS, P.— <i>Fungi Javanici</i>	685
STRASSER, P. PIUS— <i>Fungus Flora of the Sonntagberg</i>	685
FERRARIO, TEODORO— <i>Fungus Flora of Piedmont</i>	685
EARLE, F. S.— <i>North American Mycology</i>	685
MASSE, G.— <i>Diseases of Plants</i>	686
HASSELBRING— <i>Canker in Apple-Trees</i>	686
WEHNER— <i>Economic Fungi</i>	686
GEDOELST, L.— <i>Pathogenic Fungi</i>	686
HAAN, J. DE— <i>Fungal Disease in Horses</i>	687
MEYER, ARTHUR— <i>Continuity of Protoplasm in Fungi</i>	687
MAXIMOW, N. A.— <i>Influence of Light on the Respiration of the Lower Fungi</i>	687
KOSTYTSCHEW, S.— <i>Respiration of Fungi</i>	688

	PAGE
SAGO, KARL.— <i>Weather and Parasitic Fungi</i>	688
ROSENHEIM, O.— <i>Decomposition of Compounds of Selenium and Tellurium by Moulds</i>	688
FERNBACH, A.— <i>Influence of Sulphocyanic Acid on Growth of Aspergillus niger</i> ..	688
KLEIN, E.— <i>New Pathogenic Blastomyces</i>	689

Protophyta.

Schizophyceæ.

SCHMIDT, J.— <i>Richelia, a New Genus of Cyanophyceæ</i>	88
SCHMIDLE, W.— <i>Pilgeria, a New Genus of Chroococcaceæ</i>	88
TEODORESCO, E. G.— <i>Gomontiella, a new Genus of Schizophyceæ</i>	223
HYAMS, ISABEL F., & ELLEN H. RICHARDS— <i>Oscillaria prolifica</i>	341
MASSART, J.— <i>Structure and Affinities of the Schizophyta</i>	473
WEST, G. S.— <i>Flora of Hot Springs</i>	597
FRI TSCH, F. E.— <i>Observations on Aphanochæte</i>	597
WAGER, H.— <i>Cytology of Cyanophyceæ</i>	689

Schizomycetes.

CACACE, E.— <i>Proteolytic Power of Bacteria</i>	88
JENNINGS, H. S., & J. H. CROSBY— <i>Reaction of Bacteria to Stimuli</i>	88
PAKES, W. C. C.— <i>Effect of Nitrates on the Shape of certain Bacteria</i>	88
MÜLLER, P. T.— <i>Agglutination of Bacteria</i>	89
MATZUSCHITA, T.— <i>Effect of Salt in Nutrient Media on the Growth of Micro-organisms</i>	89
GREIG-SMITH, R.— <i>Bacteria and the Disintegration of Cement</i>	89
KROMPECHER, E.— <i>Metachromatic Granules in Sporiferous Bacteria</i>	89
BLIESENER, — <i>Spore-formation in Cholera Bacilli</i>	90
HECKE, L.— <i>Bacteriosis of Kohlrabi</i>	90
CONN, H. W., & W. M. ESTEN— <i>Ripening of Cream</i>	90
HOUSTON, A. C.— <i>Bacteriological Examination of Potable Water</i>	91
GOLDBERG, S. J.— <i>Influence of Alcohol on Natural Immunity</i>	91
ROSENFELD, A.— <i>Involution Forms of some Plague-like Bacteria</i>	91
FLEXNER, S.— <i>Ætiology of Dysentery</i>	92
GESSARD, C.— <i>Melanogenic Variety of Bacillus pyocyaneus</i>	92
LEVENE, P. A.— <i>Biochemical Studies on the Tubercle Bacillus</i>	92
DELÉPINE, S.— <i>Human and Bovine Tuberculosis</i>	92
RAYNEL, M. P.— <i>Virulence of Bovine and Human Tubercle Bacilli</i>	92
ROTH, J.— <i>Variability of Gas Formation by Bacillus coli communis</i>	92
LIGNIÈRES, J.— <i>Classification of the Hæmorrhagic Septicæmids</i>	93
HEWLETT, R. T.— <i>Probable Identity of Achalmé's Bacillus of Acute Rheumatism and the Bacillus enteritidis sporogenes</i>	93
" " <i>Indol-like Reaction given by Cultures of Diphtheria and Pseudo-diphtheria Bacilli</i>	93
SMITH, R. GREIG— <i>Vibrio denitrificans Sewerin</i>	93
LEVY & FICKLER— <i>Corynebacterium lymphæ vaccinalis</i>	94
BIBLIOGRAPHY	94
DELACROIX, G.— <i>Bacterial Disease of the Potato</i>	223
HINZE, G.— <i>Beggiatoa</i>	223
MAASSEN, A.— <i>Decomposition of Nitrates and Nitrites by Bacteria</i>	224
MEYER, A.— <i>Chlamydospores of Bacteria</i>	224
SCHULTZ-SCHULTZENSTEIN— <i>Effect of the Human Gastric Juice on Cholera Vibrios</i>	224
MACFADYEN, A., & S. ROWLAND— <i>Intracellular Constituents of the Typhoid Bacillus</i>	225
PARATORE, E.— <i>Polymorphism of Bacillus radiceicola</i>	225
GUÉRIN, C.— <i>Avian Diphtheria</i>	225
FOLLI— <i>Acid-resisting Bacilli in Gangrene</i>	226
LESIEUR, CH.— <i>Pseudo-diphtheria Bacilli</i>	226
FREUDENREICH, E. VON— <i>Use of Tyrogen in Cheese-making</i>	226
STUTZER, A.— <i>Formation of Bacteroids in Artificial Nutrient Media</i>	226
HINTERBERGER— <i>Capsule and Flagella of B. anthracis</i>	226
NEISSER & LUBOWSKI— <i>Formation of Agglutins</i>	227

	PAGE
WEIL, R.— <i>Preparation of Spores for Testing Methods of Disinfection, &c.</i>	227
EMMERICH & LOEW— <i>Bio-chemical Antagonisms</i>	228
GOLDBERG— <i>Interpretation of Agglutination Reaction Results</i>	228
KOHLBRUGGE— <i>Agglutination of Vibrios</i>	228
CAHN— <i>Gram-staining Bacteria in the Intestines of Infants</i>	229
WALBAUM— <i>Enumeration of Water Bacteria</i>	229
BOSSE, BRUNO— <i>Experiments with Deycke's Media</i>	229
BIBLIOGRAPHY	230
NEUMANN— <i>Nitrogen-Assimilating Bacteria in Soils</i>	341
BAYER, FR.— <i>Almit-Bacillus Beta</i>	342
BARNARD— <i>Luminous Bacteria</i>	342
RČŽIČKA— <i>Variability of Micro-Organisms</i>	342
SARTORI— <i>Detection of Tubercle Bacilli in Milk</i>	343
FASCHING— <i>New Capsulated Bacillus</i>	343
RIST & KHOURY— <i>Micro-organisms of Egyptian "Leben Raib"</i>	343
MOELLER, A.— <i>Acid-fast Bacilli</i>	344
KRESLING, K.— <i>Fat-Substance of the Tubercle Bacillus</i>	345
BEYERINCK, MARTINUS— <i>Lactic Ferments in the Arts</i>	346
BRA, M.— <i>Presence of a Parasite in the Blood of Epileptics</i>	346
BESREDKA— <i>Streptococcus Hæmolysin</i>	346
VOGES— <i>Normal Serum in Pneumo-Enteritis</i>	347
ROGOZINSKI— <i>Resorption of Bacteria from the Intestines</i>	347
FÜTTERER— <i>Micro-organisms in the Systemic Circulation</i>	348
FISCHER— <i>Plasmoptysis</i>	348
BECK & RABINOWITSCH— <i>Agglutination of the Tubercle Bacillus</i>	348
MIQUEL & CAMBIER'S <i>Bacteriology</i>	349
BIBLIOGRAPHY	350
LEPONTRE— <i>Experimental Production of Parasitic Races of Bacteria</i>	474
BINOT— <i>Bacterial Flora of Mont Blanc</i>	475
HAUMAN— <i>Retting of Flax</i>	475
BURR, R.— <i>Source of Acid Organisms of Milk</i>	476
LOCHMANN— <i>B. caseolyticus</i>	477
RUSSELL & HASTINGS— <i>Efficiency of Pasteurisation</i>	477
HAACKE, P.— <i>Decomposition of Lactose by B. acidi lactici</i>	478
HARRISON— <i>B. tuberculosis in Cheese</i>	478
ANJESZKY— <i>B. tuberculosis in Buda-Pesth Butter</i>	478
HERZOG— <i>Tuberculosis in Cold-blooded Animals</i>	479
SABRAZES— <i>Pseudo-tuberculosis (Streptobacillary) of the Grey Rat</i>	479
ABBOTT & GILDERSLEEVE— <i>Lesions produced by Acid-resisting Bacilli</i>	480
VEDDAR & DUVAL— <i>Etiology of Acute Dysentery</i>	480
SCHMIDT, G.— <i>Resistance of B. dysentericæ to Cold</i>	480
WOOD, C.— <i>Diphtheria Toxins in Serum Media</i>	481
NEUMANN— <i>B. diphthericæ in Simple Rhinitis</i>	481
OMELIANSKI, V.— <i>Fermentation of Cellulose</i>	597
POTTER, M. C.— <i>Parasitism of Pseudomonas destructans</i>	597
STRONG— <i>Infection by Paracolon Bacillus</i>	597
WOLFF— <i>Differential Diagnosis of Coli and Typhoid</i>	598
MARMOREK— <i>Unity of Pathogenic Streptococci</i>	598
MACCALLUM— <i>Actinomyces asteroides</i>	599
VALERIO, GALLI— <i>Botryomycosis</i>	599
KLEIN, E.— <i>Bacterium phasianicida</i>	600
WILDBOLZ— <i>Cultivations of Gonococcus</i>	601
STEFANSKY— <i>New Pyogenic Bacillus</i>	601
ISSATSCHENKO— <i>Bacillus Pathogenic to Rats</i>	602
RUSSELL & HASTINGS— <i>Heat-resisting Micrococcus</i>	602
VUILLEMIN— <i>Association of Amylomyces and a Micrococcus</i>	602
SCHULZE, C.— <i>Almit</i>	603
WILLE— <i>Gas Vacuoles in Thiothrix</i>	603
PETIT ET BORNE— <i>Handbook of Bacteriology and Pathology</i>	603
HEFFERAN, MARY— <i>Unusual Bacterial Grouping</i>	689
LEGER— <i>Intestinal Bacteria of Chironomus Larvæ</i>	690
GROBER— <i>Bacillus Lacto-rubificiens</i>	690

CONTENTS.

xxxiii

	PAGE
MIDDLETON, & POTTER— <i>Black Dry-rot in Swedes</i>	691
DE LILLE & JULLIEN— <i>New Syphilis Bacillus</i>	691
JOSEPH, MAX, & PIORKOWSKI— <i>Bacilli in Syphilitic Semen</i>	692
GOSIO— <i>Transmissibility of Plague to Bats</i>	692
KLEIN, E.— <i>Shell-fish and Typhoid</i>	692
GALEOTTI & ZARDO— <i>Pathogenic Bacillus in Cockles</i>	693
GORDON, M. H.— <i>Streptococcus of Scarlet Fever</i>	694
" " <i>Bacteriology of Scarlatina</i>	694
PEGLIONE, V.— <i>Bacteria and Hemp</i>	695
KLEIN, A.— <i>Bacteriology of Human Fæces</i>	695
LESAGE— <i>Bacillus Coli in Dysentery</i>	696
KLEIN, E., & A. C. HOUSTON— <i>Cereal Products and Bacteria</i>	696
MARTIN, S.— <i>Antagonism of the Soil to the Bacillus typhosus</i>	696
CHESTER, F. D.— <i>Manual of Determinative Bacteriology</i>	697
BIBLIOGRAPHY	697

MICROSCOPY.

A. Instruments, Accessories, &c.

(1) Stands.

	PAGE
NELSON, E. M.— <i>Holtzappel's Microscope</i> (Figs. 16 and 17)	19
BECK'S <i>Imperial Microscope</i> (Fig. 18)	95
BAKER'S <i>Portable Diagnostic Microscope</i> (Fig. 19)	98
SEIBERT'S <i>Travelling Microscope</i> (Figs. 20 and 21)	98
„ <i>New Dissection Microscope</i> (Fig. 22)	101
„ <i>Large Model Microscope, No. 3</i>	101
„ <i>Laboratory Microscope</i> (Fig. 23)	101
ROSS' <i>New Microscope</i> (Figs. 36-39)	231
ASHE'S <i>Two-speed Fine Adjustments</i> (Figs. 40-42)	232
SEIBERT'S <i>Mineralogical Stand</i> (Fig. 43)	234
BIBLIOGRAPHY	236
NELSON, E. M.— <i>Waddell's Erecting Microscope</i>	291
„ „ <i>Two Early Microscopes by Andrew Ross ?</i> (Figs. 65 and 66)	351
PILLISCHER'S " <i>Lenticular Microscope</i> " (Fig. 67)	353
SEIBERT'S <i>Large Model Microscope No. 2</i> (Fig. 68)	354
WATSON'S <i>New "Holo-Fram" Microscope</i> (Fig. 69)	354
„ <i>New Two-Speed Fine Adjustment</i> (Fig. 70)	354
BECK'S <i>Micrometer Microscope</i> (Fig. 71)	357
ALBRECHT'S <i>Microscope for Measuring Plant-growth</i> (Fig. 72)	358
PYE'S <i>Reading Microscope</i> (Fig. 73)	358
„ <i>Short Table-Cathetometer</i> (Fig. 74)	359
NELSON, E. M.— <i>An Old Rackwork Draw-tube</i>	360
ZEISS' <i>Stand for Brain Sections</i> (Fig. 95)	483
CZAPSKI'S <i>Cornea-Microscope</i> (Fig. 96)	484
ZEISS' <i>Preparation Stand and Drawing Apparatus for Weak Magnifications</i> (Fig. 97)	485
HILGER, A.— <i>Photo-measuring Micrometer</i> (Fig. 98)	486
ZEISS' <i>Smaller Mechanical Stage</i> (Fig. 110)	605
GREENOUGH'S <i>Binocular</i> (Fig. 111)	607
MICROSCOPE <i>Adjustment</i> (Fig. 112)	607
MALES-WATSON <i>Two-speed Fine Adjustment</i> (Figs. 113 and 114)	609
BERGER'S <i>Fine Adjustment</i> (Fig. 115)	610
ZEISS' <i>Small Mineralogical Stand</i> (Fig. 116)	610
„ <i>Small Model Polarising Microscope</i> (Fig. 117)	613
MESSTER'S <i>Attachable Mechanical Stage</i>	613
HUNTINGDON'S <i>Tilting-stage for Holding and Adjusting Minerals</i> (Fig. 118)	613
SWIFT'S " <i>Ariston</i> " <i>Fine Adjustment</i> (Fig. 129)	698
BIBLIOGRAPHY	698

(2) Eye-pieces and Objectives.

NELSON, E. M.— <i>The First English Achromatic Objective</i> (Fig. 15)	16
ADEE, A. A.— <i>Hastings Apochromat</i>	236
DEARNESS, J.— <i>Magnifiers</i>	237
BIBLIOGRAPHY	237
BECK-STEINHEIL <i>Orthostigmats</i> (Fig. 75)	360
LEITZ' <i>Spherically, Chromatically, and Astigmatically corrected Objective</i> (Fig. 76)	360
ZEISS' <i>Objectives</i>	487
MURBACH, L.— <i>Demonstration Eye-piece</i> (Fig. 99)	487
SCHAFFNER, J. H.— <i>Oculars for General Laboratory Work</i>	487
BIBLIOGRAPHY	487

	PAGE
ZEISS' A* Objective (Fig. 119)	614
„ Assorted Pairs of Objectives for Binocular Microscopes	614
„ Orthomorphic Eye-piece	615
BERGER'S Stereoscopic Loups	698
ZEISS' Improved Algascope	699

(3) Illuminating and other Apparatus.

SEIBERT'S New Projection Microscope with Electric Light (Fig. 24)	103
MEYER'S New Microscope Lamp (Fig. 25)	104
SEIBERT'S Large Polarising Apparatus (Figs. 26 and 27)	104
ABBE Drawing Camera (Fig. 28)	105
ROSS' Lens for Dark-Ground Illumination	237
ALBRECHT'S Objective-Carriers (Figs. 44 and 45)	237
TAMMES, T.—Microscopist's Electrical Lamp (Fig. 46)	239
LEGGETT, F. W.—Glass-rod Substage (Fig. 47)	240
WINKEL'S Drawing Apparatus for Weak Magnifications (Fig. 77)	361
MOLL'S Apparatus for the Adjustment of a Projection Microscope (Figs. 78 and 79)	362
GILTSCH'S Drawing Stand (Fig. 100)	488
ANGUS, H. F.—The Apertometer and its Use (Fig. 101)	488
ERSSER, T. D.—Acetylene Gas for the Lantern	490
ZEISS' Centring Apparatus for Microscope Objectives when used as Condensers (Fig. 120)	615
COLE, A. H.—Solar Projection Apparatus and its Adjustment	615
ZEISS' Epidiascope (Figs. 130-132)	699
COLE, A. H.—Projection Microscopes using Electric Arc or Oxyhydrogen Light (Fig. 133)	702
IVES, F. E.—Method of Measuring Objects in the Microscope (Fig. 134)	704
REIGHARD, J.—Form of Vertical Camera and its Uses (Figs. 135-139)	705

[(4) Photomicrography.

MERRETT, W. H.—Report of a Demonstration of the Methods used in the Photomicrography of Iron and Steel (Figs. 1 and 2, and Plates I. and II.)	1
GIRDWOOD, G. P.—On Stereomicrography (Fig. 14)	12
SEIBERT'S Apparatus for Vertical Photomicrography (Fig. 29)	106
DENNIS, D. W.—Photomicrography	240
BRASSEUR & SAMPOLO—A Notable Advance in Colour Photography (Figs. 48-50)	241
DENNIS' High-power Photomicrography (Fig. 51)	242
RICHARDSON, F. L.—Colour Photomicrography (Figs. 52-54)	243
STRINGER'S Focussing Attachments to Photomicrographic Cameras (Fig. 55)	246
FORGAN, W.—Simple Means of Producing Microphotographs with an ordinary Camera	246
BIBLIOGRAPHY	247
RICHARDS & ARCHIBALD—Study of Growing Crystals by Instantaneous Photomicrography (Fig. 80)	364
DUNCAN, F. M.—Stereo-Photomicrography (Figs. 81 and 82)	366
NELSON, E. M.—Panoramic View Camera	367
FOOT, KATHARINE, & ELLA C. STROBEL—New Method of Focussing in Photomicrography	490
IVES, F. E.—Photomicrographic Device (Fig. 102)	491
GOLDEN, KATHERINE E.—Photomicrography with Simple Apparatus (Fig. 103)	492
FORGAN, W.—Photomicrographs on Gelatino-bromide Films	493
IVES, F. E.—Photograph of <i>Pleurosigma angulatum</i> (Plate XII.)	529
OBSERVING Prism for Photomicrography (Fig. 121)	616
DUNCAN'S Photomicrography	616
BIBLIOGRAPHY	709

(5) Microscopical Optics and Manipulation.

NELSON, E. M.—A Bibliography of Works (dated not later than 1700) dealing with the Microscope and other Optical Subjects	20
„ „ New Methods in Microscope Work (Figs. 34 and 35)	142

	AGE
BIBLIOGRAPHY	247
RHEINBERG, J.— <i>The Black and White Dot Phenomenon</i> (Figs. 83-88)	367
WOOD, R. W.— <i>Prisms and Plates for showing Dichromatism</i>	493
ANDREWS, W.— <i>Stopping-down the Lenses of the Human Eye</i>	494
BIBLIOGRAPHY	494, 617, 709

(6) Miscellaneous.

LANGLEY, S. P.— <i>The New Spectrum</i>	247
KÖHLER, A.— <i>Tape Measure for Adjustment of Projection Oculars</i>	248
HAAS, G. C. F.— <i>Some Evidences of Unscientific Conservatism in the Construction of Microscopes</i>	248
STOKES, W. BALFOUR— <i>Images of Diatom Structure</i>	248
RHEINBERG, J.— <i>Double-Image Discs and Complementary Interference Colours</i>	249
HOLDER for <i>Metallurgical Work</i> (Fig. 104)	494
MERLIN, A. A.— <i>Certain Minute Structure observed in some Forms of Triceratium</i>	495
THOMPSON, SILVANUS— <i>Opto-Technics</i>	495
ZEISS' <i>Crystal Films and Plates for Double Refraction</i>	617
CHAMBERS & INSKEEP'S <i>Improved Ophthalmometer</i> (Figs. 140-143)	709
BORELLI, <i>Interesting Extracts from</i>	712

B. Technique.

(1) Collecting Objects, including Culture Processes.

SLUPSKI, R.— <i>Does Anthrax form Spores under Anaerobic Conditions?</i> (Fig. 30)	107
COOK, M. T.— <i>Method for Rearing Amœbæ</i>	107
WILL, H.— <i>Yeast-water for Biological Analysis</i>	107
SCHOUTEN, S. L.— <i>Demonstration of Enzymes</i>	108
BOEKHOUT, F. W. J., & VRIES H. OTT DE— <i>Cultivation Medium for Cheese Bacteria</i>	108
GREG-SMITH, R.— <i>Cultivation of Rhizobium Leguminosarum</i>	108
VALLET, G.— <i>New Method for Isolating the Typhoid Bacillus from Water</i>	249
KEDROWSKI, W. J.— <i>Cultivation of the Leprosy Bacillus</i>	249
CAMBIER, R.— <i>Medium for Isolating Bacillus Typhosus in presence of Bacillus coli communis</i>	250
TURRÓ, R.— <i>Apparatus for Anaerobic Cultures</i> (Figs. 56 and 57)	250
BOMBICCI— <i>Apparatus for Cultivating Anaerobes</i> (Fig. 58)	251
HAMMERL— <i>Cultivation of Anaerobic Bacteria</i>	370
MOORE, A.— <i>Isolation of the Typhoid Bacillus</i>	371
DRIGALSKI, V., & H. CONRADI— <i>Medium for Isolating Typhoid Bacilli</i>	371
LINDNER, P.— <i>Adhesion Cultures</i>	372
GRÜNBAUM, A. S., & E. H. HUME— <i>Media for Distinguishing B. coli, B. typhosus, and related Species</i>	496
CASTELLANI, A.— <i>Method for the Detection of the Typhoid Bacillus in the Blood</i>	496
GABRITSCHESKY, G.— <i>Polythermostats</i>	496
KAROP, G. C.— <i>Hanging-drop Cultivation</i>	496
OMELIANSKI, W.— <i>Simple Apparatus for Cultivating Anaerobes in Test-tubes</i> (Fig. 105)	497
WEISSBEIN, S.— <i>Method for Examining Nutrient Media</i>	498
ROBIN, A.— <i>Flask for Storing Culture Media</i> (Fig. 122)	617
DEBRAND, L.— <i>New Method of Cultivating Tetanus Bacillus</i>	618
OMELIANSKI, W.— <i>Cultivation of Nitrite-formers on Paper Disks</i>	618
WHIPPLE, G. C.— <i>Physical Properties of Gelatin, in reference to its use in Culture Media</i>	713
HARRISON, F. C.— <i>Method of Cultivating Anaerobic Bacteria</i> (Figs. 144 and 145)	713
DORSET— <i>Eggs as a Medium for the Cultivation of Bacillus tuberculosis</i>	714
WEBB, T. L.— <i>Apparatus for Removing Pieces of Tissue for Microscopical Examination</i>	714

(2) Preparing Objects.

	PAGE
BRADLON, W. L.— <i>Handy Method of Preparing Slides and Slips for taking Blood-films</i>	108
DIEDERICHS, K.— <i>Formol as a Preservative and Fixative</i>	109
HEIM, U.— <i>Demonstration of Cholera Vibrios</i>	110
ARGUTINSKY, P.— <i>Demonstrating the Malaria Parasite</i>	251
DEETJEN & OTHERS— <i>Examining Blood-plates</i>	252
WENDT, G. VON— <i>Method of Making Microscopical Preparations for Photographic Purposes</i>	253
BRADFORD, J. R., & H. G. PLIMMER— <i>Fixing and Staining Trypanosoma</i>	372
LENOBLE & DOMINICI— <i>Method for Fixing Blood-Preparations</i>	372
DOMINICI— <i>Method for Fixing and Staining Hæmatopoietic Tissue</i>	372
SOULIER, A.— <i>Fixation of Polychæta Embryos</i>	373
MACK, H. VON— <i>Examining Nervous System of Sipunculus nudus</i>	373
DIEDERICHS, K.— <i>Preparation of Radula</i>	374
HEGLER, R.— <i>Fixing and Staining Phycochromaceæ</i>	374
ENRIQUES, P.— <i>Preparing Liver of Mollusca</i>	375
WENDT, G. VON— <i>Simple Method of Fixing Bacteria to the Slide or Cover-slip without Drying</i>	498
PETERS, A. W.— <i>Methods for Use in the Study of Infusoria (Figs. 123 and 124)</i>	619
CROSS, M. L.— <i>Preparation of Metal Specimens for the Microscope</i>	621
ROSENBERGER, H. G.— <i>Simple Method of Preparing Bone Sections</i>	714
HARDESTY, IRVING— <i>Neurological Technique</i>	715

(3) Cutting, including Imbedding and Microtomes.

NOLL, A.— <i>New Ether Freezing Apparatus for the Microtome (Fig. 31)</i>	111
STEEN, R. H.— <i>Electrothermal Paraffin Bath</i>	111
REGAUD, CL., & R. FOULLIAND— <i>Paraffin Bath heated by Electricity</i>	112
HEIDENHAIN, M.— <i>Carbon Bisulphide in Paraffin Imbedding</i>	112
KOLSTER, R.— <i>Paraffin Imbedding in Vacuo</i>	112
ARNDT, G.— <i>Saw for making Microscopic Preparations of Hard Objects</i>	112
STANDING'S <i>Imbedding Microtome (Fig. 89)</i>	375
SLIDE-BRAKE of <i>Jung's Microtome (Figs. 90 and 91)</i>	375
MEISSNER, P.— <i>Apparatus for Imbedding in Paraffin</i>	377
WRIGHT, J. H.— <i>Rapid Method of Making Permanent Preparations of Frozen Sections</i>	377
BURKHOLDER, J. F.— <i>Simple Method for making Bone Sections</i>	498
WITTMACK, L., & J. BUCHWALD— <i>Improved Method of Sectioning Carbonised Wood</i>	499
BORN & PETER'S <i>Orientation Plate</i>	621
STREETER, E. C.— <i>Marble Blocks for Celloidin Tissues</i>	715
BIBLIOGRAPHY	715

(4) Staining and Injecting.

REUTER, K.— <i>Preparation of Pure Romanowsky-Nocht Stain</i>	112
MORSE, R. L.— <i>Kresylecht Violet</i>	112
MICHAELIS, L.— <i>New Fat-staining Pigment</i>	112
MANGIN, L.— <i>Staining Woody Tissue</i>	113
HOFFMEISTER, C.— <i>Demonstration of the Cell-nucleus of Saccharomyces</i>	113
MINERVINI, R.— <i>Modifications of Weigert's Method of Staining Elastic Tissue</i>	113
BETTMANN— <i>Neutral Red for Staining Nucleated Red Blood-Corpuscles</i>	114
REGAUD, C. O.— <i>Demonstrating the Seminal Tubules of the Rat by means of Renaut's Fluid</i>	114
SPULER, A.— <i>New Method for Staining en masse</i>	114
KODIS, T.— <i>New Methods for Staining Nervous Tissue</i>	114
AMBERG, S.— <i>Staining Dysenteric Amœbæ</i>	254
MEYER, S.— <i>Iron Impregnation of Nerve-Fibrillæ</i>	254
SHINKISHI HATAI— <i>Staining Nerve-Fibrillæ of Neurones in Electric Lobes</i>	254
QUENSEL, U.— <i>New Method of Examining Sputum</i>	254
DIEDERICHS, K.— <i>Picro-carmin Solutions</i>	255
GURWITSCH, A.— <i>Rapid Method of Iron-Hæmatoxylin Staining</i>	256

	PAGE
HARRIS, H. F.— <i>New Method of Staining Elastic Tissue</i>	256
NENCKI, L., & T. PODCZASKI— <i>Differential Staining for Tubercle and Smegma</i> <i>Bacilli</i>	256
ROBERTSON, W. F.— <i>Platinum Method for the Central Nervous System</i>	256
PAPPENHEIM, A.— <i>New Triple Stain</i>	257
RÄBIGER— <i>Staining the Capsule of Anthrax</i>	257
GIEMSA, G.— <i>Staining Malaria Parasites</i>	378
SLONAKER, J. R.— <i>Method for Washing, Staining, and Dehydrating Small Specimens</i>	378
PLATO, J., & H. GUTH— <i>Intra vitam Staining of Fungi</i>	378
SPULER, A.— <i>New Method for Staining in Bulk</i>	378
GABRITSCHESKY, G.— <i>Influence of High Temperatures on the Stainability of</i> <i>Bacteria</i>	499
ANGLADE, D., & C. MOREL— <i>New Method of Staining Neuroglia</i>	499
KADYI— <i>Staining the Grey Matter of Spinal Cord after Mordanting with Metallic</i> <i>Salts</i>	500
WYNN, W. H.— <i>Staining the Medullary Sheath of Nerve-Fibres</i>	500
PATON, S.— <i>Staining the Neuro-Fibrils in the Ganglion-Cells of the Cerebral Cortex</i>	500
ROBERTSON, W. F., & J. H. MACDONALD— <i>Methods of rendering Golgi-Sublimate</i> <i>Preparations permanent by Platinum Substitution</i>	501
KOLSTER, R.— <i>Acid-fuchsin Staining for Degenerated Nerve-Fibres</i>	501
KENDALL, A. J.— <i>New Method of Flagella-Staining</i>	502
GOLDHORN, L. B.— <i>Staining Mast-Cells and the Chromatin of Malaria Parasites</i> ..	502
CIECHANOWSKI, ST.— <i>Staining Biliary Canaliculi</i>	622
BEST— <i>Glycogen Staining</i>	622
MARINO— <i>Rapid Method of Staining the Morphotic Elements of Blood</i>	715
OSBORN, H. L.— <i>Staining Axis-Cylinders of Fresh Spinal Cord</i>	715
LOEWENTHAL, N.— <i>New Alcoholic Carmin Solution</i>	715
KUNTZE, W.— <i>Flagella Staining</i>	716
RAWITZ, B.— <i>Staining Sections of Spinal Cord with Cerulein S</i>	717
" " <i>Simplified Method of Staining with Polychrome Methylene-Blue</i>	717
KOPSCH, F.— <i>Staining the Reticulum of Spinal Ganglion-cells</i>	717
BIBLIOGRAPHY	717

(5) Mounting, including Slides, Preservative Fluids, &c.

LONDON, E. S.— <i>Examination of Hairs for Medico-legal Purposes</i>	115
PRANTER, V.— <i>Substitute for Cover-slips</i>	115
MARPMANN, G.— <i>Preparation and Preservation of Urinary Sediment</i>	115
ROUSSELET, C. F.— <i>Preserving and Mounting Rotifera</i>	378
SCHÜRHOFT— <i>Sodium Silicate as a Mounting Medium for Microscopical Preparations</i>	622
ROHNSTEIN, R.— <i>Simple Method for Preserving Urinary and other Deposits</i>	622
PERKINS, H. F.— <i>Double Mounting for Whole Objects</i>	717

(6) Miscellaneous.

WESENERG, G.— <i>Dropper for Sterile Fluids (Fig. 32)</i>	116
DODGE, C. W.— <i>Immersion Oil in Collapsible Tubes</i>	116
VEIENS, J. G. C.— <i>Raising the Melting-point of Gelatin by means of Formalin</i> ..	117
CALIFER GAUGE (Fig. 33)	117
LAVERAN, A., & F. MESNIL— <i>Methods for Examining Trypanosoma Lewisii</i>	118
GAGE'S 'The Microscope'	118
MARPMANN, G.— <i>Microchemical Reactions of Wood affected with Dry Rot</i>	118
APÁTHY'S (S.) <i>Microtechnique of Animal Morphology</i>	257
MARPMANN, G.— <i>Distinguishing between Pleurosigma angulatum and balticum under</i> <i>Low Powers</i>	257
SCHNEIDER, G.— <i>Gelatin as a Substitute for Glass</i>	257
FORTI, A.— <i>Use of Formaldehyde for Preventing Liquefaction in Glycerin-jelly</i> <i>Mounts</i>	258
MARPMANN, G.— <i>New Fluid Medium for Preserving Zoological Objects</i>	258
LESHURE— <i>Modification of Cornet's Forceps</i>	258
BARBAGALLO— <i>Preserving Intestinal Worms</i>	258
MEEK, S. E.— <i>Mounting Fish for Museums</i>	258
INGHILLERI, F.— <i>New Injection Syringe for Bacteriological Purposes (Fig. 59)</i> ..	259
HOLZAPFEL, K.— <i>Stand for Holding Slides (Figs. 60 and 61)</i>	259

	PAGE
DAVIS, T. J.— <i>New Cover-glass Forceps</i> (Figs. 62 and 63)	260
PREISZ, H.— <i>Practical Filtering Apparatus</i> (Fig. 64)	260
HEYCOCK & NEVILLE— <i>Results of Chilling Copper-Tin Alloys</i>	261
CAMPBELL, W.— <i>Crystallisation produced in Solid Metal by Pressure</i>	261
STEAD, J. E.— <i>Copper-Iron Alloys</i>	261
EWING & ROSENHAIN— <i>Crystalline Structure of Metals</i>	262
BIBLIOGRAPHY	263
GALT, H.— <i>Method of Preserving Museum Specimens</i>	379
FLINT, J. M.— <i>Method for Demonstrating the Framework of Organs</i>	379
EPSTEIN, ST.— <i>Burette for Removing Definite Quantities of Sterile Fluids</i> (Fig. 92)	380
HILL, A. W.—“ <i>Hanging Block</i> ” <i>Preparation for observing developing Bacteria</i> ..	380
HUBBERT, W. R.— <i>Ink for Writing on Glass</i>	381
ERSER'S <i>New Reversible Live-box</i> (Fig. 93)	381
NICOLLE, M., & ADIL-BEY— <i>Cattle Plague</i>	381
COHN— <i>Trocar for the Aseptic Collection of Portions of Tumours</i> (Fig. 94) ..	383
ARNOLD, J. O.— <i>Properties of Steel Castings</i>	382
CAMPBELL, W.— <i>Alloys of Copper and Tin</i>	383
BIBLIOGRAPHY	383
HARRIS, N. M.— <i>Improved Method of making Collodion Sacs</i>	502
JONES, L.— <i>Method of Cleaning Slides</i>	503
TIESSEN, F.— <i>Bottle for Cedar-Wood Oil</i> (Fig. 106)	503
SCHOTTMÜLLER, H.— <i>Germ- and Water-tight Stopper for Flasks</i> (Figs. 107-109) ..	503
ANDREWS, T.— <i>Micro-Crystalline Structure of Platinum</i>	504
BIBLIOGRAPHY	505
MICROMETER <i>Gauge</i> (Fig. 125)	622
LEE & HENNEGUY'S <i>Histological Technique</i>	623
WALL'S <i>Dictionary of Photography</i>	623
ROSENHAIN, W.— <i>Re-crystallisation of Platinum</i>	623
ANDREWS, T. & C. R.— <i>Microscopic Effects of Stress on Platinum</i>	624
BIBLIOGRAPHY	624
THIELE, R.— <i>New Counting Apparatus for Plate Cultures</i> (Fig. 146)	718
GÖRANSSON, K. F.— <i>Effect of Reheating upon Overheated Steel</i>	718
JOB, R., & OTHERS— <i>Steel Rails: Relation between their Structure and Durability</i>	718
HUMFREY, J. C. W.— <i>Effects of Strain on the Crystalline Structure of Lead</i> ..	719
STEAD, J. E.— <i>Structure of Copper-Antimony Alloys</i>	720
BIBLIOGRAPHY	720

PROCEEDINGS OF THE SOCIETY.

	PAGE
Meeting, December 18, 1901	119
Anniversary Meeting, January 15, 1902	122
Meeting, February 19, 1902	264
„ March 19	265
„ April 16	384
„ May 21	388
„ June 18	506
„ October 15	721
„ November 19	724

INDEX OF NEW BIOLOGICAL TERMS	730
GENERAL INDEX TO VOLUME	731

JOURNAL
 OF THE
 ROYAL MICROSCOPICAL SOCIETY.
 FEBRUARY 1902.

TRANSACTIONS OF THE SOCIETY.

I.—*Report of a Demonstration of the Methods used in the
 Photomicrography of Iron and Steel.*

By WILLIAM H. MERRETT, Assoc. R.S.M., F.C.S.

(Read March 20th, 1901.)

PLATES I. AND II.

THE photomicrography, or, as it is now more frequently termed, the "metallography" of iron and steel, has of late years received much attention from eminent engineers and metallurgists; for it is possible by the aid of the Microscope not only to determine the amount of carbon in the metal, but also to ascertain the exact thermal treatment it has received during its manufacture.

It appears that the metallography of iron and steel has not been developed from petrography, but is a natural extension of the study of meteoric irons. Dr. Sorby, who was one of the first to work on this subject, established a method of examining opaque bodies under the highest powers of the Microscope, and applied this method to different products in the metallurgy of iron. Professors Marten and Wedding were probably the first to systematically examine iron and steel under the Microscope. Recently M. Osmond, of Paris, has done much to develop the science of metallography, and has given us methods by which reliable results may be rapidly obtained. During the past few years much advance has been made in the subject, and already many laboratories in steel-works are fitted with photomicrographic apparatus.

Although it is possible, by the aid of the Microscope, to learn much about the chemical composition of the metal under examination, it is nevertheless not for this purpose that the Microscope is especially useful. Many samples of steel, having identical chemical compositions, vary enormously in mechanical properties; and it is by the

aid of the Microscope that the causes of these variations may be explained. Metallography is intended to augment, rather than supplant chemical analysis. The Microscope enables us to ascertain much about the mechanical and thermal treatment the metal has received, which in commerce is often of the utmost importance.

It is well known that specimens of both steel and iron, produced under apparently the same conditions, often display totally different properties. This is especially the case with steel, which, on account of its more complex character, is easily affected by small alterations in the conditions of its manufacture.

The causes of the variation in properties of similarly produced samples of metal may often be explained by the aid of the Microscope, when all other methods of investigation have failed.

To be able to determine the quality of the quenching of a steel is of vital importance, especially in the case of large masses of metal, e.g. the ingots used in the manufacture of ordnance. If a gun-tube is quenched below its critical point, it will be soft, and consequently very unsafe for firing purposes, on account of its low elastic limit. The Microscope would, however, be invaluable in such circumstances, as it would enable one to say definitely whether the metal had been properly quenched and tempered or not.

For the engineer, the Microscope is especially useful in determining the influence exerted by thermal treatment on varieties of steel of different composition. It is also useful for detecting slag patches, defective welds, "cold rolling" effects, minute blow-holes, cracks, flaws, and allotropic changes in the metal.

It will, perhaps, be as well at this period to give a short account of the constitution of iron and steel, and also to show the effect of altering their thermal treatment during manufacture.

Steel is composed of iron, which may contain from 0·05 to 2 per cent. of carbon, together with other impurities, such as manganese, sulphur, phosphorus, silicon, and arsenic. As the presence of these impurities complicates the subject considerably, it will be better in this demonstration to neglect their influence altogether. Carbon-free iron is most difficult to obtain, and can only be prepared by depositing it electrically, or by reducing ferric oxide by aluminium.

Cast iron contains from 2 to 4·5 per cent. of carbon, and may be either white, mottled, or grey, according to the state in which the carbon is present; this state is modified by the thermal treatment the iron has received during its manufacture. Grey iron under certain conditions may be made to absorb as much as 6 per cent. of carbon.

In steel the whole of the carbon is combined with a portion of the iron, forming the iron carbide Fe_3C . This Fe_3C contains by weight about 7 per cent. of carbon. The carbide in a slowly cooled steel is distributed throughout the balance of the iron.

Steel may therefore be considered as a mixture or an alloy of iron and iron carbide (Fe_3C), and it has been shown in the Reports of the Alloys Research Committee to the Institution of Mechanical Engineers* that if studied from this standpoint, the formation of its structures will be found to follow the laws which govern the formation of frozen saline solutions.

In order to understand the analogy between frozen saline solutions and steel, it will be necessary to refer to the work of Guthrie in 1876:—

It is well known that by dissolving common salt (sodium chloride) in water, the freezing-point of the water is lowered. By increasing the amount of salt the freezing-point of the resulting mixture is, at first, correspondingly lowered, until it contains a certain percentage of salt. The lowest possible freezing-point of a solution of sodium chloride in water is then reached, and further addition of salt will gradually raise the freezing-point of the brine. Dr. Guthrie found that the mixture which has the lowest freezing point contains about 23.50 per cent. of salt; and as the hydrate containing 10 molecules of water would require 24.50 per cent. of salt, Dr. Guthrie inferred that the solution of lowest freezing-point was a hydrate of the formula $\text{NaCl} + 10 \text{H}_2\text{O}$. He proposed for it, and for all similar mixtures, i.e. for all saline solutions of lowest freezing-points, the name of cryohydrate or eutectic, by which he meant to imply that they can only exist in the solid state at a low temperature. What actually takes place in the freezing of solutions of salt and water may, perhaps, be better explained by the aid of a diagram.† Fig. 1 shows how a thermometer, plunged in the solution, falls as the solution cools down. The dots along the lines are points of retardation in the fall of the mercurial column; it is seen that in most cases there are two points for each stage of concentration.

The diagram consists of two branches, the one marked "ice," and the other "salt." It will be best explained by taking two solutions containing two definite amounts of salt on either side of the point B where the branches meet. If, for instance, a thermometer be placed in a solution of 10 per cent. of salt in water which is being slowly cooled down by means of an external freezing mixture, the mercury will stop in its fall at about -8°C . or 18°F .; this is due to the separation of pure ice. This gives the point *d* on the branch A B. The mercury then continues to fall until the temperature of -22°C . or -8°F . is reached, and the cryohydrate or eutectic of ice and salt solidifies. This eutectic consists of alternate laminæ of ice and salt in juxtaposition, and is merely a mechanical mixture, not a chemical

* See 4th and 5th Reports of the Alloys Research Committee to the Institution of Mechanical Engineers.

† Reproduced from Sir W. C. Roberts-Austen's Reports to the Alloys Research Committee, by permission of the Council of the Institution of Mechanical Engineers.

compound. As the degree of concentration of salt in the original solution increases, the initial freezing-point on the branch AB will be lower and lower, while the second freezing-point always remains constant at -22° C. or -8° F.; and when the solution contains 23.5 per cent. of salt, both freezing-points coincide in the point B at -22° C. or -8° F.

A frozen solution of salt in water containing less salt than that necessary to form the eutectic, will therefore be made up of ice surrounded by eutectic, while one containing more salt than that necessary to form the eutectic will be made up of crystals of salt surrounded by eutectic. If one of these mixtures of ice and eutectic, or salt and eutectic, be suitably prepared and examined under the Microscope it will be found that, whilst the ice or salt crystals are homogeneous,

*Freezing-point Curves
of solution of Common Salt in Water.*

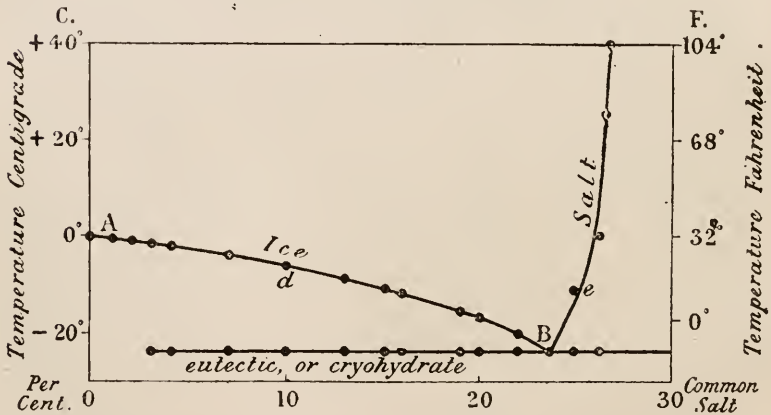

FIG. 1.

the cryohydrate or eutectic is made up of a mechanical mixture of intimately mixed ice and salt laminae similar to that shown in plate I. fig. 3, which is mainly an eutectic of iron and iron carbide.

It will now be shown how closely structures obtained with frozen masses of ice and salt are related to those obtained with alloys of iron and iron carbide.

It will hardly be possible on the present occasion to do more than roughly consider the laws controlling the formation of the structures of pure iron, steel, and white iron. The case of grey and mottled irons is much more complicated, and will have to be left for the present.

Fig. 2 is an equilibrium curve, by Sir W. Roberts-Austen, of the carbon-iron series, and was obtained in a similar manner to the ice-salt curve, although, of course, a pyrometer had to be substituted

for the thermometer used in the Guthrie experiments, on account of the high temperatures at which the constituents separate.

In fig. 2 it will be seen that the line G O S marked "iron" corresponds to the "ice" line in fig. 1, and the line S E marked "iron carbide" corresponds to the "salt" line in fig. 1, and the eutectic line P S P' is similar to the eutectic line in the ice-salt curve.

It will, for the present, be as well to neglect all curves not already mentioned in the description of fig. 2, as they only tend to complicate the case.

It will be seen from the curve that the point S in fig. 2, indicating 0·8 per cent. carbon, is the eutectic point, and that steels containing less than this amount of carbon are made up of iron and eutectic, whilst

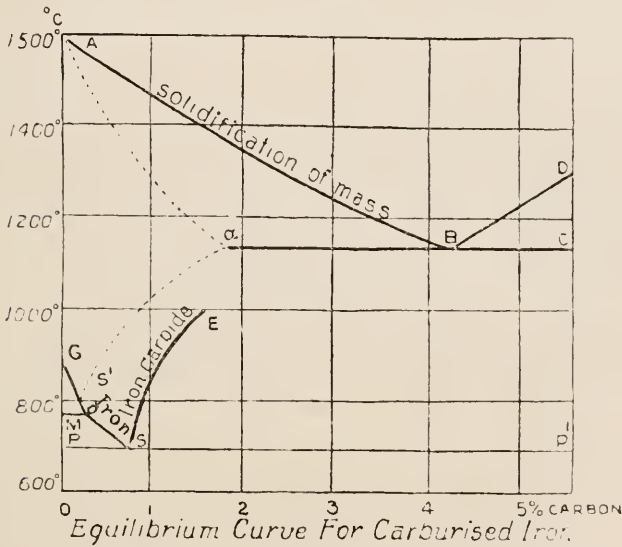

FIG. 2.

the steels or white irons containing more than 0·8 per cent. of carbon are composed of eutectic and iron carbide.

While the formation of the structures of frozen ice-salt solutions and those of iron and iron carbide are very similar, yet there is one feature in which they differ very much indeed. In the equilibrium curves of saline solutions the temperatures at which the constituents begin to segregate from the mass also indicate the beginning of the solidification of the constituents; but in the case of the iron-carbon alloys the mass has long been solid when the critical changes occur. In other words, in the iron-carbon alloys the separation takes place from a solid solution some hundreds of degrees below their melting-points.

Having briefly considered the laws controlling the structures of slowly cooled iron-carbon alloys, it will perhaps be well now to consider how these structures may be made evident under the Microscope.

The specimens for examination are generally prepared by removing sections from the original sample about three-quarters of an inch square and a quarter of an inch thick. The surface is carefully ground on a series of emery papers, mounted on carefully "trued" wooden discs attached to a lathe head, using ultimately the finest grades which can be produced. As the finest commercial papers are much too coarse, it is necessary to prepare the final papers oneself. This is done by washing the very finest slime from the best flour emery, mixing it with a solution of egg-albumen in water, and brushing it on paper specially free from grit. The paper is then allowed to dry in a cupboard, great care being taken to exclude all dust.

Prof. H. le Chatelier has recently succeeded in shortening the polishing operation by means of a new method of preparing the powders. The operation which has been until now considered the most tedious has become the quickest. The most important point in the preparation of polishing powders, and also of emery powders, is to obtain an absolutely accurate classification with regard to the size of the particles in each case. The levigation method previously mentioned is altogether defective, even when carried out in the laboratory with all the precautions indicated by M. Osmond. Prof. le Chatelier claims, however, that perfect classification is obtained by the washing method used by M. Schloesing for the analysis of kaolins.*

Briefly, his method is to obtain some suitable polishing powder, such as the alumina obtained by calcining ammonia alum or even flour emery, and treat it with water containing 0.1 per cent. of nitric acid, in order to dissolve the carbonate and sulphate of lime and other salts that might be present. The mixture is stirred occasionally for several hours, and is allowed to settle, which it will then do rapidly. The powder is then washed several times by decantation with distilled water until it will no longer settle rapidly. The conditions are now favourable for levigation, which operation is facilitated by adding two cubic centimetres of ammonia to each litre of water, which helps the finest particles to remain in suspension. Decantation is now resorted to at intervals of fifteen minutes, one hour, four hours, twenty-four hours, and eight days. The first deposit contains all the grains unsuitable for polishing; the second is not very homogeneous, but may be used to start the polishing; the third constitutes a good polishing powder for hard metals such as iron and steel. It is, however, the fourth deposit that constitutes true polishing powder. Instead of waiting eight days for this last deposit, it may be thrown down immediately after the removal of the twenty-four hours one by neutralising the ammonia with acetic acid, when the whole of the particles will

* See Prof. H. le Chatelier's paper in the *Bulletin de la Société d'Encouragement pour l'Industrie Nationale*, Sept. 1900.

be deposited in a few hours. Prof. le Chatelier recommends that the powders should be converted into a paste by mixing them with soap. Very dry castile soap is cut into thin shavings and mixed with the wet powder in the proportion of one part of soap to ten parts of wet powder. The mixture is then melted in a water-bath, stirred thoroughly, and when the mass begins to thicken, it is poured into tin tubes similar to those used for keeping oil paints.

The metals may be polished by placing a little of the paste on a piece of cloth stretched over a cast-iron disc, which can be made to revolve mechanically.

Having obtained a thoroughly polished specimen by the aid of emery and rouge papers, or by means of the paste of soap and powder, the piece of metal is lightly rubbed on a wet rouge wheel for about two thousand revolutions. The rouge wheel generally consists of a well-surfaced horizontal cast-iron disc, which is driven either by a hand-wheel and belt, or better, by a small electric motor. The disc is covered with clean non-ribbed cloth, which is wetted and slightly covered with the finest washed rouge. At this stage the specimen becomes lightly engraved, the harder constituents appearing in relief; it should, of course, be quite free from scratches. The structure of the specimen, in most cases, is not shown by polishing only, and must be made evident by physical or chemical processes, which produce different effects upon its constituents.

The constituents are usually shown up either (1) by rubbing the specimen with liquorice juice on parchment; (2) by attacking it with a very dilute solution of nitric acid (0.1 p.c.) in either alcohol or water; or (3) by heating it in air to about a straw colour (about 240° C.).

Since the specimens are opaque, it is necessary to illuminate them from above. Natural illumination can be used for eye observation only. For oblique illumination we have the well-known parabolic mirrors of Sorby and Lieberkühn, both of which may be mounted upon the objective. For vertical illumination, Beck's vertical illuminator is extremely useful. This is a small transparent mirror, which, placed at 45° in the axis of the Microscope, receives the light from a hole in the side of the apparatus, and reflects it upon the objective; the lenses concentrate the light upon the object. A small prism devised for vertical illumination by Nacet, of Paris, is very good, especially when it is necessary to economise light.

By far the best source of illumination is a small arc lamp, either hand-fed or automatic. When a Nacet vertical illuminator is used, the filament of an incandescent electric lamp placed in front of the slit will often give sufficient light.

If electricity is not available, either incandescent gas or even a paraffin lamp may be used, but the time of exposure will be much longer. Where long exposures are necessary, it is imperative to have the apparatus fitted so as to be quite free from vibration and also light-

tight. When using a small arc lamp, the exposures with Lumière's plates, sensitive to yellow and green, vary from two to five seconds; with a paraffin lamp under similar conditions, it would probably be necessary to give an exposure of at least twenty minutes. Faults in the construction of the apparatus, which are hardly noticed when the exposure is short, become very formidable with a long exposure.

The camera may be either vertical or horizontal; for general purposes the latter is much more convenient, and even when using immersion objectives, very little inconvenience will be experienced. It is as well to use a long camera—about seven feet is a very serviceable length—and to have the Microscope fitted with a low-power projection eye-piece, the results obtained being invariably better than when a high-power eye-piece had been employed.

The most useful magnifications are the 60, 200, 1000, and 2000 diameters. When using a seven-foot camera at full length, and a low-power Zeiss projecting eye-piece, these magnifications may be obtained with the Zeiss 35 mm. projecting, the 24 mm., the 4 mm. with correcting collar, and the 2 mm. immersion objectives respectively. The projecting lens is, of course, used without an eye-piece.

Steel for micrographic purposes is viewed as if it were a rock with various minerals distributed through it, and mineralogical names are conveniently adopted for the constituents.

Pure iron, being an elementary body, is made up of one substance only, to which the name "ferrite" has been given. A sample of ferrite, magnified 850 diameters, is shown in fig. 4. It will be seen that it is composed of a number of interlocking crystals.

Steel is composed of iron containing approximately from 0·05 to 2·6 per cent. of carbon, and it has the peculiar property of becoming much harder when it is made red-hot and quenched. The carbon in steel which has been slowly cooled is combined with a portion of the iron, forming iron carbide, which is known as "cementite." This constituent contains about 7·0 per cent. of carbon, and remains bright after a polished section of the steel is attacked by an infusion of

EXPLANATION OF PLATE I.

All figs. \times 850 diameters.

- Fig. 3.—Iron and entectic (iron the plane, and eutectic the laminar structure).
 „ 4.—Pure iron (ferrite).
 „ 5.—Steel containing 0·6 p.c. of carbon (pearlite the dark, and ferrite the white constituent).
 „ 6.—Steel containing 1·8 p.c. of carbon (pearlite the dark, and cementite the white constituent).
 „ 7.—White cast iron containing 2·2 p.c. of carbon (pearlite the dark, and cementite the white constituent).
 „ 8.—Mottled cast iron containing 3·8 p.c. of carbon (pearlite, cementite, and graphite).

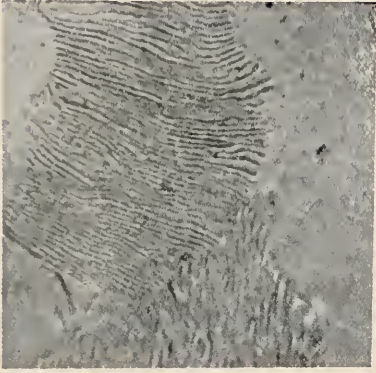

FIG. 3.



FIG. 4.

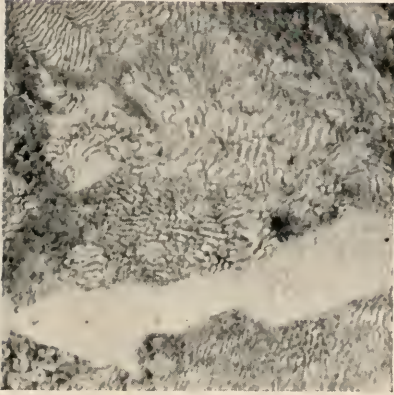

FIG. 5.

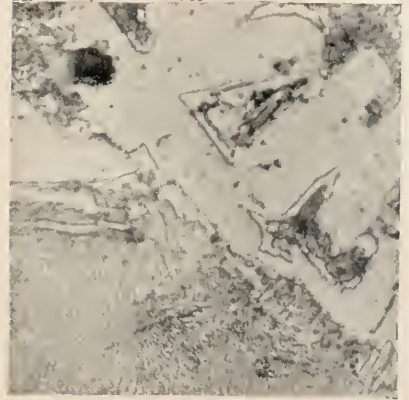

FIG. 6.

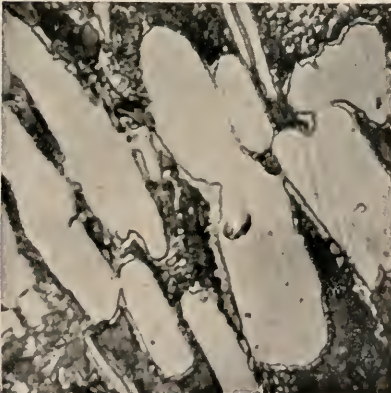

FIG. 7.

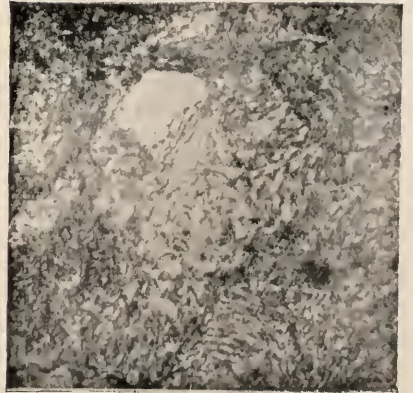

FIG. 8.

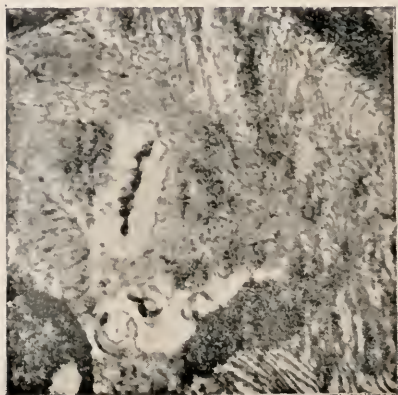

FIG. 9.

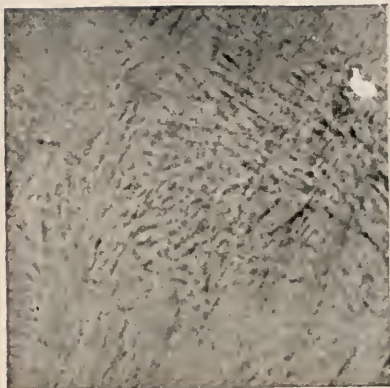

FIG. 10.

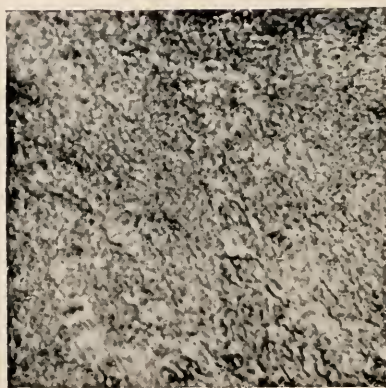

FIG. 11.

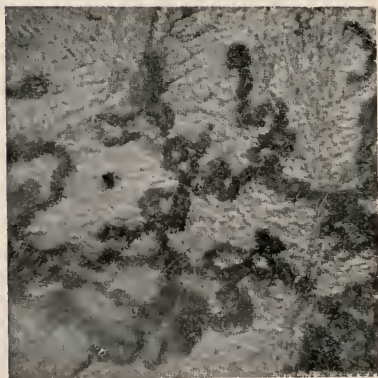

FIG. 12.

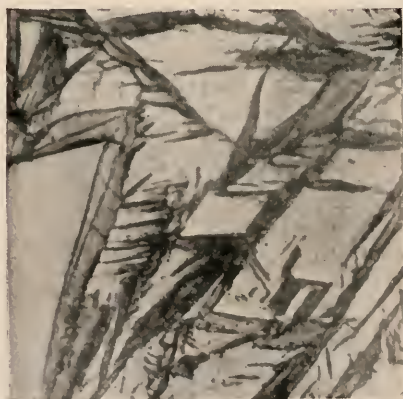

FIG. 13.

liquorice or a solution of nitric acid. Cementite is very hard, and stands in relief when the steel is polished on the finest rouge on wet cloth. A good specimen of cementite is shown in fig. 6 magnified 850 diameters. Free cementite, however, does not often occur in low carbon steel, but usually assumes the form of "pearlite," which is an intimate mixture of cementite and ferrite arranged in laminæ which are alternately hard and soft. These laminæ are very minute, and it is necessary to use a magnification of at least 300 diameters for their identification. The laminæ of pearlite often assume a more or less granular form. Pearlite is so called on account of its resemblance to mother-of-pearl. When pearlite is attacked with either an infusion of liquorice or a solution of nitric acid, a voltaic action is set up which causes the ferrite to become dark in colour. A pure steel containing 0.9 per cent. of carbon will consist entirely of pearlite; if the carbon be less than this amount, the mass will be composed of pearlite and ferrite. If the carbon exceed 0.9 per cent., it will consist of pearlite and cementite. Fig. 5 shows a photomicrograph of a steel containing 0.6 per cent. of carbon. It consists of ferrite (the white portion) and pearlite under a magnification of 850 diameters. Fig. 6 represents a steel containing about 1.8 per cent. carbon, and is composed of cementite (the white raised portion) and pearlite.

Cementite may be distinguished from ferrite by its greater hardness. It will be seen that the cementite in figs. 6 and 7 appears to stand in relief. Ferrite is easily scratched by an ordinary sewing needle, while cementite is not.

Cast iron contains more carbon than steel, the amount varying from 2 to 5 per cent. It practically consists of three varieties, white, mottled, and grey. The first variety is composed of pearlite and cementite; the second of pearlite, cementite, and a little graphite; and the third of pearlite together with either cementite or ferrite and graphite. In both cast iron and steel it seldom happens that free cementite and ferrite exist in the same specimen.

Fig. 7 is a sample of white iron containing 2.2 per cent. of carbon. Fig. 8 is a mottled iron containing 3.8 per cent. of carbon, of which 2.6 per cent. is graphite. Fig. 9 (plate II.) is a grey iron containing about 4.6 per cent. of carbon. As it has been before stated, steel differs from cast iron by being capable of acquiring

EXPLANATION OF PLATE II.

All figs. \times 850 diameters.

Fig. 9.—Grey cast iron containing 4.6 p.c. of carbon (pearlite, cementite, and graphite).

„ 10.—Quenched steel (martensite).

„ 11.—Steel which has been quenched and tempered to straw colour.

„ 12.—Troostite (the black) in a matrix of ferrite and martensite.

„ 13.—Austenite (the white) and a variety of martensite.

various degrees of hardness, and it is upon this special property that the great value of steel depends. Although there is no well defined line of demarcation between high carbon steel and white iron, yet the former has a much wider range of hardness than the latter when submitted to suitable thermal treatment.

The changes in the hardness of a steel are accompanied by a corresponding change of structure. Take, for example, the ordinary process of tempering. Steel is generally tempered by two processes: (1) hardening by quenching in water, oil, or mercury; and (2) re-heating the hardened steel to a given temperature and plunging in water, or allowing to cool in air. Fig. 10 represents the quenched structure of the steel shown in fig. 5; it is composed of a system of interlacing crystalline fibres, and is known as "martensite," after Prof. Martens, of Berlin. The structure of martensite is developed by a prolonged etching with an infusion of liquorice, or by an attack of alcohol containing 1 p.c. of nitric acid. When a quenched steel is tempered, the interlacing crystalline fibres disappear, and the structure becomes granular. The character of the tempered structure varies greatly with the temperature and the time the steel is re-heated. No name has yet been assigned to the tempered structure. Fig. 11 shows the structure of a steel which has been re-heated to a straw colour.

In practice, the workman tempers steel by watching the various colours assumed by the surface of the metal during the progress of the operation, and when the proper colour makes its appearance the object is suddenly cooled. These tints, some of which are extremely brilliant, are probably occasioned by films of oxide corresponding with considerable exactitude to the degree of heat to which the metal is exposed, and they consequently serve as a tolerably accurate guide in determining the hardness which the object will acquire on being cooled. Although this method is often wonderfully accurate, it must be borne in mind that the colours will appear even when the metal has not been quenched, so that the tint alone is not indicative of a good result. This may, however, be easily determined by the Microscope. As the time and intensity of the re-heating increases, the structure more and more resembles that of pearlite, so that it is quite possible to ascertain the quality of the temper from the micro-structure alone.

The hardening of a steel by quenching is not merely due to a change in the condition of the carbon, but also to the molecular transformation of the iron, which may exist in a soft or α state, and a hard or γ state, the latter being produced, in the case of a high carbon steel, above 800° C. Therefore, in order to produce hard steel, the metal must be quenched above this temperature. Should the temperature of quenching be rather low, the structure, instead of consisting wholly of martensite, will be found to contain another constituent known as "troostite" (from Troost, the chemist). Troostite almost invariably

occurs in a matrix of martensite or a mixture of martensite and ferrite. Fig. 12 shows a variety of troostite in a matrix of martensite. Steels containing troostite are soft; they are, however, not so soft as steel containing pearlite. In ordinary steel the pearlite develops at about 700° C. Should a specimen be quenched after the formation of this constituent, it will not harden. In practice, steel is generally quenched at nearly 1000° C., which has the effect of converting the whole mass into martensite.

If the proportion of carbon in a steel be high, say 1.5 per cent., and if the cooling be rapidly effected in iced brine, another constituent appears, which may be scratched with a hard needle, and to which M. Osmond, who discovered it, has given the name of "austenite," after Sir W. Roberts-Austen. Its general appearance is shown white in fig. 13, magnified 850 diameters.

Very rapid advance has lately been made in the metallography of iron and steel, and the effects of elements other than carbon on iron have been carefully studied. Mr. J. E. Stead, of Middlesborough, has recently published a most interesting paper on the alloys of iron and phosphorus.*

Although the metallography of iron and steel was originally of scientific interest only, it has lately become of the greatest commercial importance; as from a suitable photomicrograph one is able almost to read the life-history of a piece of steel, at any rate as regards the thermal treatment it has received.

The demonstration was illustrated by a number of lantern slides of the structures of iron and steel, a few of which have been reproduced in this Report.

* See this Journal, 1901, pp. 608, 721.

II.—*On Stereomicrography.*

By G. P. GIRDWOOD, M.D., M.R.C.S. Eng., F.R.S.C., F.I.C., &c.

PROFESSOR OF CHEMISTRY MED. FAC. M'GILL COLLEGE, MONTREAL;
CONSULTING SURGEON, MONTREAL GENERAL HOSPITAL;
LATE ASST.-SURGEON GRENADIER GUARDS.*(Read November 20th, 1901.)*

THE beauties of the stereoscopic vision of ordinary objects, the greater amount of detail which is brought out thereby, the greater amount of information afforded by a stereoscopic over an ordinary picture of an object, which enables the third dimension in space to be appreciated, have doubtless been noticed by other workers with the Microscope, and the desire to obtain a stereoscopic picture of a microscopic object often been felt by them; but as to how to obtain the two pictures of an object viewed from different points which are necessary to produce the true stereoscopic effect, and as to methods to obtain this end, if thought out by others, no one, so far as the author is aware, has published anything practical.

It occurred to the author that this might be attainable in a manner somewhat similar to the plan he adopted for taking stereoscopic skiagraphs by X-rays, only reversed;* he therefore devised a small piece of apparatus to adjust to his Microscope that would enable him to get the necessary two pictures at an angle to the object which should equal the angle of normal vision, with eyes the axes of which are at a distance of $2\frac{1}{2}$ in. apart and converging to a point at a focal distance of 12 in.

Inasmuch as the object-glass of the Microscope is a monocular apparatus and cannot be moved, it became necessary to move the object itself in such a way that it should give a picture on the screen of the camera, as seen by one eye, and a picture thereof taken, and then to move it in such a way as to present a picture as seen by the other eye, and a picture taken in the second position, taking care to keep the same object or point thereof in the axis of the tube in each position, and thus obtain two pictures, one of which is as seen by each eye.

If we take two points $2\frac{1}{2}$ in. apart, and join them by a line, and then draw lines from the two points to a third point which is 12 in. from the first line, and in such a position that a line drawn therefrom would bisect the first line, we should have an isosceles triangle, of which the two equal sides would represent the axes of the two eyes when converged upon a point at 12 in. focus. The same may be arrived at by drawing a circle at 12 in. radius from a point, and selecting any

* Montreal Medical Journal, March 1899.

two points in the circumference $2\frac{1}{2}$ in. apart, and joining those points by radii to the centre; the two radii will represent the axes of the two eyes, and the line between them the distance between the centres of the two pupils. And now, if a Microscope slide be so placed as to form a normal with the radius representing the axis of the left eye, a picture will be given representing the object as seen by the right eye, and then, if sloped in the opposite direction without moving the central object or part thereof, it will, when viewed in the course of the second radius, present a picture as seen by the left eye.

Now, if a Microscope slide with the objects upon it be moved on a centre or point of convergence so as to make the surface of the slide a plane normal to the line representing the axis of the left eye, it

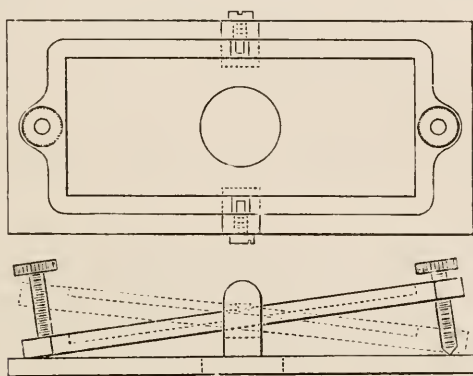

FIG. 14.

The apparatus is adjusted upon the stage of the Microscope so that the centre is in the optic axis of the instrument. The object is placed on the tilting table by spring pressure (springs not shown). The level of the object is the same as the axis upon which the tilting table swings, so that the motion of the table does not alter the position of the object except as to inclination. The object may be moved about till the required portion to be photographed is found, the tilting table being rigidly attached to the Microscope; and the inclination of the table is set by means of the two screws at its ends.

will give a picture as seen by the right eye; and shows from the right what is hidden behind the central object of the picture; and if it be inclined so as to form a normal with the line representing the axis of the right eye, the picture seen in the Microscope will be the picture as seen by the left eye, and shows objects behind the central object as seen from the left side. If two pictures be taken thus, and these two pictures printed and mounted, they will give most beautifully the stereoscopic effect, and will show at once in the stereoscope the third dimension and the different planes in which the objects are seen at the time of observation.

The plan adopted by the author to obtain these results was to have a rocking stage made in such a way that an ordinary glass slide with its object shall be held securely and focussed; and as soon as the particular part of the specimen to be photographed is placed exactly in the centre of the field, and the nearest part of the object focussed sharp, or in such a manner as to give the best picture of the object, then the rocking stage is rocked by means of the screws for that purpose till the one side is depressed (say the right side of the slide) to an angle of $7\frac{1}{2}$ degrees to the plane of the Microscope stage, and a picture taken. Then, after seeing that the focus is unimpaired by the movement, and that the object has not moved from its central position, the slide is made to rotate about the point of convergence till it is rocked to the extent of $7\frac{1}{2}$ degrees inclination to the proper stage of Microscope on the opposite side. Then, on seeing that the focus is correct and the object still in the centre, the picture as seen by the right eye is represented, and a picture is taken. The negatives so obtained are printed, and the prints mounted give the proper stereoscopic effect. The accompanying mount, which is a photograph of uric acid crystals, shows the result. The results so obtained, when seen by any one, will be admitted to give a better idea of the object than a single picture.

The rocking slide used by the author consists of a flat stage with a central opening which attaches to the ordinary Microscope stage by springs. From the upper surface of this project two lugs, one in front and one in rear, and from these lugs project inwards towards each other two knife-edges, the edges placed downwards towards the Microscope stage; under these knife-edges, and pressed up against them and rocking on them, is a flat plate of brass cut out flat to receive a glass slide so as to allow of the movement of the object, and cut out of such a depth that the surface of the glass and the knife-edges are in the same plane. This plate of brass is extended far enough on either side to be drilled at equal distances from the centre and tapped for a screw; a thumb-screw is placed in each; and as one screw is turned in the other is turned out, till the slide is either parallel with the Microscope stage proper, or at the required angle to it.

A little angle of brass being screwed on to the bed-plate of the stage and projecting up in front of one end of the rocking stage, and marked with a zero point at which the rocking stage will be parallel with the bed-plate, and then with 10 degrees marked above and below the zero point, the inclination of the slide in the two positions can be made exact; and $7\frac{1}{2}^\circ$ angle with the stage-base is enough to place the slide in the position of a normal to the axis of vision. The author avails himself of this opportunity of recording his thanks to Messrs R. and J. Beck, of Cornhill, London, for the kind attention they gave him in making the piece of apparatus by which these results have been attained.

The author gives this account of his success, that others may be

able to extend the work, apply this method to other objects, and produce pictures of microscopic objects in relief, and thus give to students a more realistic idea of the objects before them.

The method adopted in taking the pictures exhibited with this paper was to place an ordinary photographic camera horizontally on the table, raised so that the opening for the lens should be just centred with axis of the Microscope tube; when the Microscope was turned on its stand to the horizontal position, a thin sheet of vulcanised india-rubber was secured over the hole for the lens in front of the camera, a small hole was cut in the centre of the rubber-sheet, and the Microscope tube without an eye-piece was thrust through the small hole in the rubber, which fits tight round the tube and stops all light entering; a small diaphragm was placed in the end of the tube to stop light reflected from the inside of the tube, and the object was illuminated by a coal-oil lamp placed opposite the opening in the stage and condensed by a bull's-eye focussed in the usual way. If necessary a micrometer might be used on the stage to show magnification.

In the case of the crystals of uric acid shown, a 1-in. object-glass was used, 30 seconds exposure with a small single coal-oil lamp, and the picture was developed with Rodinal developer in the ordinary manner. In the case of starch-granules of ginger grown and prepared by the author himself, a $\frac{1}{6}$ -in. object-glass was used with polariscope; exposure for each picture half an hour.

Since perfecting the apparatus for this work, the author has had brought to his notice the original article by Sir Charles Wheatstone, 'Contributions to the Physiology of Vision, Part the First, On some remarkable and hitherto unobserved Phenomena of Binocular Vision,' *Philosophical Transactions*, 1838, reprinted in 1879, wherein the correctness of the ideas the author had in designing this stage are completely borne out.

When a picture is taken by a Microscope, the picture of the object is reversed, and when this negative is printed it is reversed again, so that the print corresponds to the object itself as seen in the Microscope; but in transparent objects, reversal of the prints in mounting would give a stereoscopic view of the object as seen from the other side, which in some cases may be desirable.

III.—*The First English Achromatic Objectives.*

By EDWARD M. NELSON.

*(Read December 18th, 1901.)**The Goring-Tulley Triple (1824).*

THIS first English achromatic object-glass was made in 1824 by W. Tulley,* the telescope-maker at Islington, at the suggestion of C. R. Goring, M.D., who paid 90*l.* for it. An account of this historical lens may be of interest.

The back lens is an equi-convex of Dutch plate of specific gravity 2·519, thickness 0·175, the radii being 0·575. The middle lens is an equi-concave made of Guinand's flint, specific gravity 3·627, thickness at edge 0·164, and the radii 0·500. The front lens is a biconvex crown of specific gravity 2·527, thickness 0·15, radius back surface (next flint) 0·525, and front surface (next object) 0·825. The focus of the combination is 0·933, diameter of the lenses 0·55, the clear aperture 0·50, the initial magnifying power 10·72, the N.A. 0·259, and the O.I. the large amount of 24·2. Fig. 15 A is drawn to scale and is enlarged twice.

The Chevalier-Euler Achromatic Doublet (1824).

In 1823-4 Messrs. Vincent and Charles Chevalier, of Paris, made an achromatic Microscope objective for M. Selligie. In this Microscope the lenses of the objective were turned round the wrong way, viz. with their convex surfaces facing the object. In the next year, 1824-5, Messrs. Chevalier brought out a "Microscope d'Euler," in which the lenses of the object-glass were turned round the right way, so that the plane side faced the object.

The mention of Euler's name in the title of this Microscope refers to the objective, the doublet of which it was composed being constructed upon principles published by Euler at St. Petersburg, in 1774. The principle was the combination of an equi-convex crown with a plano-concave flint, the radii of the three spherical surfaces being alike. The data of the Chevalier-Euler cemented plano-convex doublet are as follows.

Back lens an equi-convex of plate glass, thickness 0·072, radii 0·66, cemented to a plano-concave front lens of Guinand's flint, radius 0·66, thickness at edge 0·074, diameter of the doublet 0·36. Focus 1·65, N.A. 0·109, O.I. 18·0. These measurements, as well as of those above, are in inches. Fig. 15 B is to scale and is enlarged twice.

* Also spelt Tully.

The Lister Achromatic Combination (1827).

In 1827 Mr. J. J. Lister put one of Chevalier's doublets as a front, Tulley's triple being the back lens; the combination was of 0.52 focus, 0.53 N.A., and 27.6 O.I. This constituted the finest Microscope objective that had up to that time been produced. (Fig. 15, A and B.) It was, strictly speaking, the first really successful scientific Microscope objective. Attempts have been made to belittle Mr. Lister's work in connection with the evolution of the Microscope objective; * in answer, allow me to present to you what is probably the true history of the early Microscope objective.

Mr. Lister, who had interested himself in the Microscope from boyhood, began to work at the objective in 1825, and it was the possession of a $\frac{4}{10}$ and a $\frac{2}{10}$ of Tulley's that directed his attention to this subject. He rightly judged that these objectives were too thick, and he persuaded Mr. W. Tulley to make for him a $\frac{9}{10}$ much thinner in proportion to its focal length. (The reason one hears and reads so much about "thickness" in old books is that when $\mu = \frac{3}{2}$,

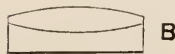

FIG. 15.

the thickness is equal to $\frac{y^2}{f}$, and this is the factor in one limb of the mathematical expression for spherical aberration; so, by reducing the thickness the spherical aberration is diminished.) Lister found that the performance of this new lens was very nearly equal to Tulley's best $\frac{2}{10}$; he noted that whereas the $\frac{9}{10}$ was free from "coma" the $\frac{4}{10}$ and $\frac{2}{10}$ were not free from it, except in a small part in the centre of the field. The testing of a lens on a mercury globule and the observation of "coma" at this early date indicates not only an important advance but also a thorough acquaintance with the subject.

In December 1826 Lister examined a set of four Chevalier-Euler objectives, and found the apertures were much stopped down; he improved them by opening out the stop. Afterwards he combined a Chevalier front with a Tulley back, which made what may be called the first scientific Microscope objective. Fig. 15 shows this combination. In 1830 his paper on the two aplanatic foci was read before the Royal Society; and towards the end of that year he took up lens-grinding because Tulley was too busy to continue the experiments. In 1837 he began to coach Andrew Ross, and drafted for him a triple fronted $\frac{1}{8}$. It is therefore manifest that Andrew Ross owed his success in a great measure to improvements which Mr. Lister originated. In 1840 he coached James Smith, who made 1-in., $\frac{1}{2}$ -in. and $\frac{1}{4}$ -in. objectives on his formula. With regard to Powell, his older objectives show no

* Society of Arts, Cantor Lecture, Dec. 21, 1885, pp. 94, 95.

superiority over those of his contemporaries, but eventually he adopted the Lister formula and continued to make use of it for upwards of fifty years.

There can be no doubt that up to the time of the Great Exhibition of 1851* the objectives made by Ross, Smith, and Powell, on the Lister formula, were far superior to those made on the Continent or anywhere else; they had greater aperture, were more achromatic, and had less spherical aberration than any other lenses of that date. This is not a matter of theory or of conjecture but of fact, for the lenses are in existence, and may be tested by any one wishing to satisfy himself on this point. After this the Amici water-immersion, the solid front, and other devices, in which Mr. Lister took no part, were introduced; these greatly improved the higher powers, but the lower powers constructed on Lister's principles remained without a rival for fifty years; then at last his $\frac{1}{4}$ had to give way to one with a duplex front, but the other powers, viz. the $\frac{1}{10}$, $\frac{1}{2}$, $\frac{2}{3}$, 1-in., $1\frac{1}{2}$, 2-in. still remained the best until the advent of the apochromatics and semi-apochromatics in 1886. These facts are sufficient to demonstrate the value and importance of Lister's work.

* The following extracts are from the Jurors' Report, Great Exhibition, 1851:—

“Nachet (France). The object-glasses, though inferior to both those of Ross and Smith and Beck, are by far the best of the foreign ones.”

“Chevalier (France). A Microscope with indifferent object-glasses. The workmanship of the mechanical parts, however, is very good.”

NOTES.

Holtzapffel's Microscope.

By EDWARD M. NELSON.

As Holtzapffel's Microscope, in which there are several original details, is little known, a short account of it may be of interest. On reference to fig. 16, it will be at once seen that the foot is similar to that of Cornelius Varley's Microscope,* inasmuch as it is a screw-clamp for attachment to the edge of a table, a form evidently suggested by the stand of Wollaston's camera lucida. The main stem, which is a cylindrical rod with a groove in it, is joined to the foot by a kind of universal ball-joint (not ball-and-socket). A mirror slides on this rod, and it is stated that the back of this mirror is flat polished brass, so that monochromatic light may be reflected by it. On the top of the rod is the lens-(Wollaston doublet) holder (fig. 17); this, instead of fitting in a V-groove, slides between three studs, of which *a* and *b* are fixed and *c* loose; *c* is acted on by a spring so as to keep the slide pressed against *a* and *b*. This lens-holder is moved by the milled head *d*; but in place of a rack-and-pinion gear, there is a steel tape which takes a round turn round the pinion, an end being fixed to each end of the lens-holder; the screw *e* is for the purpose of keeping this tape taut. A similar mechanical device was, twenty years afterwards, used by Ladd,† who fitted a steel chain with a turn round a pinion for the coarse adjustment of his Microscope.

The milled head *f* is for the purpose of rotating the lens-holder

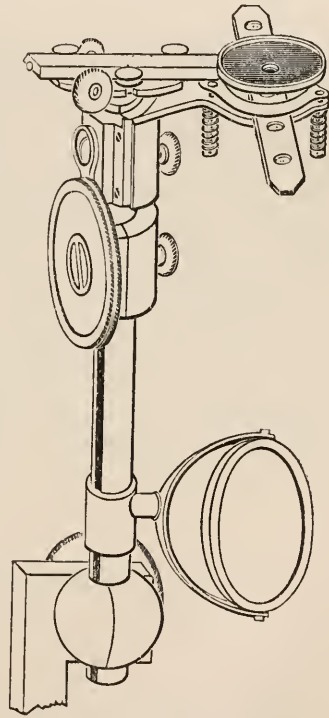

FIG. 16.

* Journ. R.M.S., 1900, p. 283, fig. 70.

† Exhibited at the Great Exhibition, 1851. This movement is said to have been applied to the Microscope many years previously by Mr. Julius Page.

on the top of the pillar ; this gives the lens a transverse motion in arc across the object. The idea, in those days, was to move the lens over the object, so that when infusoria were being examined they might not be disturbed by the movement of the stage.

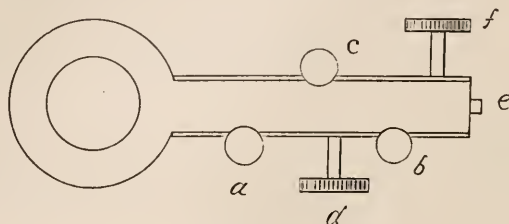

FIG. 17.

This Microscope is a stage-focuser; a rough adjustment is obtained by sliding the mechanism on the rod by the hand, and then clamping it by a pinching screw, after the manner employed in many old Microscopes, J. Cuff's for example. The mechanical adjustment is by means of an excentric strap on the head of the pinion, in fact, similar to the coarse adjustment on the Plössl Microscope lately presented to the Society by Sir Ford North, the difference being that, while the Plössl has a crank-pin and a connecting-rod, Holtzapffel's has an excentric.

The lenses were supplied by Andrew Pritchard.

The date of this Microscope is 1830, and in it we find four original devices:—(1) The clamp-foot; predating that of Varley's in 1831. (2) The polished brass monochromatic mirror. (3) The focussing movement by an excentric, which differs from and predates the somewhat analogous device of Plössl. (4) The extension movement of the lens-holder by a steel tape and pinion.

A Bibliography of Works (dated not later than 1700) dealing with the Microscope and other Optical Subjects.

By EDWARD M. NELSON.

- Acta Eruditorum. (Leipsic, 1686.)
 Alhazen (1100): Thesaurus Opticæ. (Translated from Arabic, Basil. 1572.)
 Aquilonius Franciscus: Optica.
 Bacon, Roger: Opus Majus Pt. V. De perspectiva. (1268.)
 Barrow, Dr. Isaac: Lectiones Opticæ. (1669.)
 Bartholinus, Erasmus: Experimenta Crystalli Islandici. (Hagæ Comit. 1669.)
 Bayer, John: Uranometria. (1603.)
 Bettinus, Marius: De Apiariis novissimis.

Bonnani, Philip: *Micrographia Curiosa*. (Rome, 1691.) Observations circa viventia. (1698.)

Borellus, Petrus: *De vero Telescopii inventore*.* (Hagæ Comitum, 1655.) *Historiarum et Observationum*. (Paris, 1657.)

Boyle, Robert: *Experiments and Considerations touching Colours*. (Lond. 1663.)

Brahé, Tycho: *Astronomica Instaurata Mechanica*. (1598.)

Butterfield: *Phil. Trans.* (1677.)

Camerarius, Philip: *De Horis succisivis*.

Campani-Alimenis, Matteo: *Horologium*. (1678.)

Carlo di Napoli: *Nuove Inventioni di tubi ottici*. (Rome, 1686.)

Cassegrain, N.: *Journal des Sçavans*. (1672.)

Cassini, Giovanni Domenico: discovers three satellites of Saturn. (1672-84.)

Chérubin d'Orléans (François Laserré): *La Dioptrique Oculaire*. (1671.) *La vision parfaite*. (1677.)

Clutius, Augerius: *De Hemerobio sive Ephemero Insecto*. (Amsterdam, 1634.)

Dechales, Claudius Franciscus Milliet: *Mundum Mathematicum*. (2nd ed. 1690.)

Dee, John: Preface to Sir Henry Billingsley's *Euclid*. (1570.)

Descartes, René: 'La Dioptrique' in 'Essais Philosophiques.' (Leyden, 1637.)

Digby, Sir Kenelm: *de Natura corporum*. (Circa 1645.)

Digges, Leonard: *Pantometrica*. (1571. 2nd ed. 1591.)

Digges, Thomas: *Stratioticus*. (1579.)

Divini, Eustachio: *Phil. Trans.* (1668.)

Dominis, Antonio de: *De Radiis Visus et Lucis*. (1611.)

Elsholt: *Miscell. Acad. Nat. curiosa*. (1678-9.)

Fabri, Honorato: *De Coloribus; Synopsis Optica*. (Lugd. 1667.)

Fontana, Franciscus: *Novæ Observationes Cœlestium et Terrestrium rerum*. (Naples, 1646.)

Forest, Nicholas: *De Florilegio Mathematico*.

Fracastoro, Hieronymo: *Homocentrica*. (Venice, 1535.)

Fuchsius, Samuel: *De Ophthalmoscopia*.

Galileo Galilei: *Nuncius Sidereus*. (Venice, 1610.) *Saggiatore*. (Romæ, 1623.)

Gascoigne, William: invents the Screw Micrometer. (1639.)

Gassendi, Petri: *Mercurius in Sole visus*. (1632.) *Institutio Astronomica*. (Londini, 1653.)

Gemma Frisius, Cornelius †: *Cosmocritica*. (Circa 1530.)

Giornale de Letterati I. (1668.)

Goedaert, J.: *Metamorphosis et Historia Naturalis Insectorum*. (Medioburgi, 1662.)

Gray, Stephen: *Phil. Trans.* (1696.)

* Probably the earliest work on Microscopical Objects.

† Inventor of the Ring Dial (1534), a form of Astrolabe.

Gregory, David: *Catoptricæ et Dioptricæ Sphæricæ Elementa.* (1695.)

Gregory, James: *Optica promota.* (1663.)

Grew, Nehemiah: *The Anatomy of Vegetables* (London, 1672), and other botanical works. (1673-82.)

Grimaldi: *Physico-Mathesis de Lumine, Coloribus et Iride.* (Bononia, 1665.)

Grindl ab Ach, Johannes Franciscus: *Micrographia Nova.* (Norimb. 1687.)

Harriot, Thomas: examines Spots on the Sun through a Telescope. (July 1609.)

Harris: *Lexicon technicum.* (1704.)

Harsdorffer, George Philip: *In delitiis Mathematicis.*

Hartsoeker: *Essay de Dioptrique.* (Paris, 1694.)

Hévelius, John: *Selenographia.* (Gedani, 1647.)

Hire, De la: *Traité des differens accidens de la veüe.* *Mem. de Math. et Phys. Ann.* (Paris, 1694.)

Hooke, Robert: *Micrographia.* (1665.) *Microscopium.* (Lond. 1678.)

Horrocks, Jeremiah: *Venus in sole visa.* (1639.) *J. Horroccii opera posthuma.* (Lond. 1672.)

Huygens, Christiaan: *Systema Saturnium.* (Hagæ, 1659.) *Astroscopia compendiaria.* (Hagæ, 1684.) *Traité de la Lumière.* (1690.) *Dioptrica.—De vitris figurandis.* (Leyden, 1703.)

Kepler, John: *Astronomiæ pars Optica.* (1604.) *Astronomia Nova.* (Prague, 1609.) *Dioptrice.* (Augsburg, 1611.)

Kircher, Athanasius: *Ars Magna Lucis et Umbrae in Mundo.* (Rome, 1646.) *Mundus Subterraneus.* (Amstelodami, 1665.)

Kolhansi, John Christopher: *Tractus Opticarum et Novarum Curiositatum.*

Kunckelius, John: *Ars vitraria.*

Langenmantell, Ambrosius: *Miscellanea curiosa.* (1689.)

Lamus, Franciscus Tertius de: *Magisterium Naturæ et Artis.*

Leeuwenhoek, Antony van: *Opera Omnia.* (Lugduni et Delphis Batavorum, 1687-1719.) Translated from Dutch and Latin by Samuel Hoole. (London, 1798-1807.)

Leibnitz, Gottfried Wilhelm: *The Principle of Optics, Catoptrics and Dioptrics, one and the same.* (Leipsic, 1682.)

Maignan, Emanuel: *Perspectivum Horarium.*

Malpighi, Marcellus: *Anatome plantarum.* (Londini, 1675.) *Opera Omnia, etc.* (Lond. 1686.)

Manzini: *L'occhiale all'occhio.* (Bologna, 1660.)

Marius, Simon: *Nuncius Jovialis.* (1614.)

Maurolicus: *Theoremata Lucis et Umbrae et Diaphanorum partes.* (1575.)

Menage: *Origini della Lingua Italiana.* (Geneva, 1685.)

Merritt, Christopher: translates the *Ars vitraria* of Antonio Neri. (1662.)

- Mersenne, Père Marin: *Catoptrics*. (1651.)
 Miscell. Curiosa. Langenmantell. (1689.)
 Molyneux, William: *A Treatise of Dioptrics*. (Lond. 1692.)
 Monconys: *Journal des voyages de Monsieur de Monconys*.
 (Lyon, 1665.)
 Mouffet, Thomas: *Insectorum sive Minimorum*. (Londini, 1634.)
 Theater of Insects. (London, 1658.)
 Neri, Antonio: *Ars vitraria*. v. Merritt.
 Newton, Isaac: *Principia*. (Cambridge, 1686.) *Optics*. (1704.)
 Phil. Trans.
 Porta, Giambattista della: *Magia Naturalis*. (1569.) *De re-
 fractione*. (1593.)
 Power, Dr. Henry: *Experimental Philosophy*.* (1664.)
 Ptolemy, Claudius (140): *Almagest*. (Translation, Venice, 1515.)
 Recorde, Robert: *Pathway to Knowledge*. (London, 1551.)
 Redi, Francesco: *Esperienze intorno*. (Firenze, 1668.) *Ex-
 perimenta circa generationem Insectorum*. (Amstelodami, 1671.)
Opusculorum. (Amstelodami, 1686.)
 Regius, Henricus: *Fundamentum Physicæ*.
 Rheita, Antonius Maria Schyrlæus de: *Oculus Enoch et Eliæ*.
 (Antwerp, 1645.)
 Riccioli, Giovanni Battista: *Almagestum Novum*.
 Roemer, Ole: discovers Velocity of Light. (1676.)
 Scheiner, Christopher: *Oculus et Rosa ursina*. (1630.)
 Schott, Gaspar: *Magia Universalis*. (Herbipol. 1657.) *Tech-
 nica Curiosa*. (Herbipol. 1687.)
 Schrader, Friedrich: *De Microscopiorum usu*. (Gotting. 1681.)
 Sirturus: *Telescopium sive ars perspicendi etc*. (Francof. 1618.)
 Snell, Willebrord: Discovers law of Refraction. (Circa 1621.)
 Stellutus, Franciscus: *Apiarium ex frontispiciis etc*. (Romæ,
 1625.)
 Sturm, Johann Christoph: *Collegium Experimentale sive Curio-
 sum*. (Norimb. 1676.)
 Swammerdam, Johannes: *Histoire générale des Insectes*.
 (Utrecht, 1685.)
 Traber, Zacharias: *Nervus Opticus*. (Vienna, 1675.)
 Vitellio (1260): *Thesaurus Opticæ*. (Norimb. 1535.)
 Vopiscus, Fortunatus Plembius: *Ophthalmographia*.
 Voss, Isaac: *De lucis Natura et Proprietate*. (Amsterdam,
 1662.) *Responsio ad Objectiones etc*. (Hagæ Com. 1663.)
 Willis, Thomas: *De Anima brutorum et De Fermentatione*.
 (Amsterdam, 1682.)
 Zahn, John: *Oculus Artificialis*. (Herbip. 1685. 2nd ed.
 Norimb. 1702.)
 Zucchi, Nicholas: *De Optica philosophia*. (Lugd. 1652.)

* The earliest English work on the Microscope.

OBITUARY.

HENRY GEORGE MADAN, M.A.,
Fellow of Queen's College, Oxford.

Died Dec. 22, 1901, aged 63.

ALTHOUGH not a Fellow of this Society, Mr. Madan contributed several valuable papers to our *Journal*. His researches on Dense Mounting Media will be remembered by many Fellows; but probably few are aware that he was the first to point out the value of "Signal" green glass as a screen for Microscope work. He was also the designer of a polarising prism. Shortly after reading his last paper he met with an accident, being crushed by a railway truck; although he made light of it, he really never got over the effects of this serious accident. He was a genuine worker, and his genial companionship will be missed by all who knew him.

The following is a list of his papers published in our *Journal*:—

A Modification of Darker's Selenite Holder. (1883, p. 718.)

A Method of Isolating Blue Rays. (1885, p. 327.)

A Modification of Foucault's and Ahrens' Polarising Prism. (1885, p. 328.)

On some High Refractive Organic Substances. (1898, p. 273.)

On a Method of Increasing the Stability of Quinidine. (1901, p. 246.)

On the Spectrum of Piperine. (1901, p. 603.)

SUMMARY OF CURRENT RESEARCHES

RELATING TO

ZOOLOGY AND BOTANY

(PRINCIPALLY INVERTEBRATA AND CRYPTOGAMIA),

MICROSCOPY Etc.*

ZOOLOGY.

VERTEBRATA.

a. Embryology. †

Function of Corpus Luteum in Relation to Insertion of Ova in Uterus. ‡—Dr. L. Fraenkel and F. Cohn have made a number of experiments which support an interesting theory suggested by the late Prof. G. Born shortly before his death. The theory was that the corpus luteum had in part a glandular significance, secreting into the blood substances which prepare the uterus for the attachment of the ovum, and give an impulse to the changes associated with pregnancy.

The authors regard the following facts concerning the rabbit's sexual processes as certain:—(1) On the day of parturition (*Wurf*) an ovulation occurs, and a large number of ripe follicles burst; (2) on this day the doe readily yields to the buck; (3) the insemination is fertile in about 90 p.c. of cases; (4) the fertilisation of the ova follows within 24 hours in the Fallopian tube; and (5) the insertion of the ova in the uterus is effected in about six days. By removing both ovaries during these six days the authors prevented pregnancy in the thirteen cases experimented on. To the objection that the severity of the disturbance might be a sufficient cause of the absence of pregnancy, they answer that, when *one* ovary was removed, in nine cases pregnancy occurred in two-thirds of the cases. They conclude that the ovary, besides being an egg-producing organ, has a glandular function associated with pregnancy.

After removal of both ovaries, they injected corpus-luteum-extract, but no conclusive results followed from this experiment. With a galvanocaustic needle they destroyed all the corpora lutea in eight cases, and no pregnancy occurred. There seems some basis, therefore, for the theory that the lutein-tissue is essential in preparing the uterus for the implantation of the ova.

* The Society are not intended to be denoted by the editorial "we," and they do not hold themselves responsible for the views of the authors of the papers noted, nor for any claim to novelty or otherwise made by them. The object of this part of the Journal is to present a summary of the papers as *actually published*, and to describe and illustrate Instruments, Apparatus, &c., which are either new or have not been previously described in this country.

† This section includes not only papers relating to Embryology properly so called, but also those dealing with Evolution, Development, Reproduction, and allied subjects.

‡ Anat. Anzeig., xx. (1901) pp. 294-309.

Note on the History of Merogony.*—Prof. A. Giard points out that the first to discover the possibility of merogony was J. Rostafinski,† who experimented on the ovum of *Fucus*. A useful summary of his paper is given. The method used was bruising and cutting. Prof. Giard also recalls Balbiani's experiments on merotomy of Infusorians, but concludes that merogony was first demonstrated in plants by Rostafinski (1877) and in animals by Boveri (1885).

Influence of Spermotoxin on the Fertilising Power of Spermatozoa.‡—Mlle. C. de Leslie injected male white mice with spermatoxic serum furnished by the guinea-pig, and found that sterility resulted, lasting for 16–20 days. There was no effect on the sexual appetite or on the spermatogenetic function, but the spermatozoa had lost their fertilising power.

Germ-layers of Vertebrates.§—Prof. Oscar Hertwig returns to the discussion of some contested points in regard to this subject. The first of these has reference to the question as to what represents the gastrula in the development of the three highest vertebrate classes. The author believes that, to decide this point, it is necessary to distinguish two phases in gastrulation in the Anamnia. The first phase, that in which the layer lining the future intestine is formed, cannot be said to be definitely represented in Amniota; but the second, that in which the mesoblast and notochord originate from cells in the vicinity of the blastopore lip, is distinctly shown, and may be emphasised by the appearance of small invaginations, such as those of the embryonic shield in certain reptiles.

The second disputed question is the part played by the blastopore in the formation of the Vertebrate body. Hertwig believes that the lips of the blastopore fuse together in front along the middle line, and at the same time go on growing backwards so long as the body continues to increase in length. He thus holds that the blastopore is an important factor in the formation of the dorsal region of the embryo; while some other embryologists believe that the increase in length of the embryo is due to a special zone of growth in front of the blastopore. Hertwig finds confirmation of his own view in the malformation known as *spina bifida*, which is most readily explained as due to want of fusion of the lips of the blastopore.

Origin of Cerebral Hemispheres.||—Prof. F. K. Studnička maintains that the cerebral hemispheres have from the first a paired origin, which is by no means the general conclusion. The cerebral hemispheres arise from the upper portions of the lateral walls of the primitive first vesicle, and are as truly paired, as the eyes are. At the same time it is admitted that the median anterior portion of the first vesicle may grow forward into an "epencephalon."

Development of Tongue in Man.¶—J. Aug. Hammar finds that the tuberculum impar is not the rudiment of the tip and body of the tongue,

* Comptes Rendus Soc. Biol., Oct. 19, 1901, 3 pp.

† Osobne oddicie z Rozpraw Akad. Umiejet, 1877.

‡ Comptes Rendus, cxxxiii. (1901) pp. 544-6.

§ SB. Akad. Wiss. Berlin, xxiv. (1901) pp. 528-33.

|| SB. böhmisch. Ges. Wiss., 1901, 33 pp. and 11 figs. See Zool. Centralbl., viii. (1901) pp. 776-7.

¶ Anat. Anzeig., xix. (1901) pp. 570-5.

but is a structure of transitory nature. The root of the tongue develops from the ventral ends of two visceral arches, the third arch playing no part in its formation. The large salivary glands develop in the following order:—parotid, sub-maxillary, sub-lingual.

Development of Pig's Intestine.*—Dr. J. B. MacCallum has dissected numerous pig embryos of sizes varying from 12 mm. to 12 cm. The various loops were modelled with copper wire. At an early stage the gut consists of an uncoiled tube which sends a single loop out into the cœlom of the umbilical cord. The first half of the loop is on the right side, and gives rise to the small intestine. From the other half is formed the large intestine. The gut increases in length by the formation of regular loops, which grow around an axis corresponding with that of the cord and the large intestine. These loops form first in the part which is to become the small intestine. They also develop in the part of the small intestine near the stomach before they appear in the cord. Up to a certain stage the further growth in complexity is greatest near the stomach. After the small intestine has become considerably coiled, a mass of loops is formed in the large intestine. In embryos between 35 mm. and 40 mm. in length the group of coils which has formed in the cœlom of the cord enters the general body-cavity by a mechanism which is not clearly understood. In embryos of the above sizes the coils are constant in arrangement and definite in their position; in older embryos the *groups of coils* always hold the same relative position in the body. These groups arrive at their final situation by a rotation which takes place posteriorly and to the right round an axis, running from the beginning of the duodenum to a point a short distance posterior to the opening of the cord.

Variations in the Aortic Arches and the Origin of Arteries in Reptiles.†—F. Hochstetter has observed and collected a large number of cases which he arranges in four groups:—(1) Cases in which the obliteration of the ductus Botalli is partial or has not been effected, on one side or on both sides; (2) cases of supposed or real persistence of a ductus caroticus (the region of the dorsal aortic root between the openings of the third and fourth aortic arches), on one side or on both sides; (3) cases in which certain portions of the carotid system which normally disappear are persistent; (4) cases in which certain portions of the aortic system which normally persist are obliterated.

Development of Axial Skeleton in Amphibia.‡—W. Kapelkin has studied the embryos of various species of *Triton*, *Salamandra*, &c., with the special object of deciding some of the disputed questions in regard to the number and origin of the sheaths of the notochord, and the part played by its elements in forming the bodies of the vertebræ, together with some other points. He finds that the central cells of the notochord early become vacuolated and degenerate, but the peripheral cells persist, and form the so-called notochord epithelium, which forms the thin notochordal sheath on its outer surface. This sheath later splits into two, the inner fibrous and the outer elastic sheath (*elastica externa*). Mean-

* Bull. Johns Hopkins Hosp., xii. (1901) pp. 102-8 (2 pls. and 19 figs.).

† Morph. Jahrb., xxix. (1901) pp. 415-38 (1 pl.).

‡ Bull. Soc. Imp. Nat. Moscou, 1900 (published 1901) pp. 433-48 (2 pls.).

time, the surrounding connective tissue (skeletal layer) has formed a homogeneous sheath—the cuticula sceleti or skeletal sheath. The fibrous sheath is thickened intervertebrally, where the notochordal epithelium is also better developed than round the future vertebræ. When these sheaths are fully differentiated round the notochord, a mass of cells appears between the notochord and the medullary canal, in the regions which form the future vertebræ. These cells spread above the nerve-cord, become cartilaginous, and form the superior arches of the vertebræ; together with the skeletal sheath they form bone. At the same time the perichordal tissue forms intervertebral swellings, whose cells rupture the skeletal sheath in three places, and come to lie between it and the underlying elastic sheath. They there form the intervertebral cartilage, and, as Gadow first showed, are the homologues of the interdorsalia and interventralia of other Anamnia. The cells of the intervertebral cartilage spread backwards and forwards from their points of entrance, splitting the skeletal sheath from the *elastica externa*, and increasing more and more in number, and finally by division into two halves, form the articular surfaces between the contiguous vertebræ. At the time when this occurs, the cells of the notochordal epithelium in the region of the vertebræ proliferate and form the plugs of cartilage within the vertebræ, which have thus no connection with the intervertebral cartilage, but originate from notochordal cells.

Dorsal Groove and Dorsal Suture in Gastrula of Triton.*—Prof. Hermann Braus finds that his statement that in the embryo of *Triton alpestris* a primitive or dorsal groove and a dorsal suture (blastopore suture of Semon), occur on the future dorsal region, has been disputed by Röthig, who investigated *T. taeniatus*. He therefore figures the appearances observed in both living and preserved eggs of *T. alpestris*; in both cases the structures mentioned can be clearly seen during certain stages.

Larva of Plethodon cinereus.†—Dr. T. H. Montgomery, jun., describes the terrestrial larvæ of this American Urodele. He found five eggs beneath a stone with the female curled round them. The eggs were of relatively large size, and contained larvæ with three pairs of gills, and the limbs fully formed. The posterior limbs were larger than the anterior. The eggs showed a large yolk-mass, round which the larvæ were curled, but close examination showed that this is not a yolk-sac, but an integral part of the intestine. The anterior and posterior regions of the intestine are both tubular, but the middle region is made up of large yolk-cells.

Development of Frog's Retina.‡—Dr. Luigi Barbadoro finds that all the layers of the retina increase in size in *Rana esculenta* during the passage from the larval to the adult state. He gives a table showing the thickness of the whole retina, and of each of its constituent layers, in various stages of development from specimens of 5 mm. in length, to adults of 65 mm. The cells of all the strata multiply, and their nuclei increase in number, and change in form and size.

* Anat. Anzeig., xx. (1901) pp. 238-40 (5 figs.).

† Proc. Acad. Nat. Sci. Philadelphia, 1901, pp. 503-8 (1 pl.).

‡ Anat. Anzeig., xix. (1901) pp. 597-601 (3 figs.).

Reminiscence of Holoblastic Cleavage in Ovum of Cestracion.*—Prof. Bashford Dean notes the interesting fact that in the eggs of *Heterodontus (Cestracion) japonicus*, the surface which keeps uppermost, the animal pole, is traversed by definite and sharply marked lines, separating areas resembling the blastomeres in a late cleavage stage of *Lepidosteus*, and easily visible from a distance of six or seven feet. The red-coloured germinal disc is further down the side of the egg.

The author presents the arguments for and against regarding the lines as reminiscent of holoblastic cleavage, and concludes that there can be little doubt that the lines are cleavage lines. We can thus conclude that the great size of the eggs of sharks was attained before total cleavage became lost; and that the yolk region of such eggs is homologous with the lower pole-cells in other Ichthyopsids.

Ophthalmic Nerves of *Mustelus lævis*.†—E. P. Allis, jun., has made a useful analytic study of the ophthalmic nerves in this Selachian and in other fishes. It is well known that there are in fishes several ophthalmic nerves between which it is necessary to distinguish. While their exact interhomologies cannot as yet be definitely affirmed, certain very probable homologies can be arrived at, and there is no doubt that the problem has been advanced towards solution by Mr. Allis's investigation.

Development of Olfactory Organ of *Ammocœtes*.‡—Dr. W. Lubosch finds that the olfactory organ arises from an ectodermic thickening which lies exactly in the position of the last connection between brain and ectoderm. In *Bdellostoma*, according to Kupffer, the olfactory plate appears ventrally to the neuropore, and the author suggests that the difference is due to differences in the rate of development of the anterior point of the head in the two types, in other words, to a difference in the time of closure of the neuropore. Lubosch discusses the relation of his observations to the comparison which Legros has elaborated between the head in *Amphioxus* and in *Ammocœtes*.

Relation of Metameric Segmentation in *Petromyzon* to that in *Amphioxus* and in Higher Craniota.§—Prof. S. Hatta directs attention to the close resemblance between the history of the mesoblast in *Petromyzon* and in *Amphioxus*. In its earlier stages the differentiation of the mesoblast in *Petromyzon* is exactly parallel with that in *Amphioxus*, while in later stages it shows the features seen in the higher Craniota. "We can thus observe in one and the same animal, *Petromyzon*, the stages through which the primitive state of the mesoblast in *Amphioxus* has developed into the condition in the higher Craniota." Thus the lamprey is in this respect a connecting link.

Influence on Offspring of Injecting Toxins into Parents.||—A. Charrin and G. Delamare experimented with rabbits of both sexes, and found that the injection of bacterial toxins was apt to be followed by abortion, death at birth, nanism, rachitism, and various malformations. Even digestive ferments were followed by abnormal results, and the

* Annot. Zool. Japon., iv. (1901) pp. 35-41 (1 pl.).

† Quart. Journ. Micr. Sci., xlv. (1901) pp. 87-236 (3 pls.).

‡ Morph. Jahrb., xxix. (1901) pp. 402-14 (4 figs.).

§ Annot. Zool. Japon., iv. (1901) pp. 43-7.

|| Comptes Rendus, cxxxiii. (1901) pp. 955-7.

authors refer especially to nodular tuberculiform growths (pseudo-tuberculosis), apparently occurring apart from bacterial infection.

Embryological Methods.*—Sandor Kaestner discusses in an introductory lecture the history of embryology, and emphasises the transition from a morphological to an experimental basis. Modern regeneration-experiments and teratogenetic experiments represent the high-water mark. The recapitulation-doctrine was a powerful impulse for a time, but the conception of *Entwicklungsmechanik*, so prominently associated with the work of Roux, is now dominant.

b. Histology.

Brain of *Mustelus*.†—Prof. G. H. Houser has made a detailed study of the structure of the brain in this Selachian, with particular reference to the neurones and supporting elements. We must restrict ourselves to noticing his most general conclusion. There is a most remarkable structural similarity between the brain of *Mustelus* and the brains of higher vertebrates. The neurones are, of course, simpler in their external structure, and their architectural relations are of a far less complicated order, yet it is none the less true that they anticipate the conditions found in higher vertebrates in all important particulars. The fact can only be interpreted to mean that the nervous system of the primitive vertebrate had its essentials of organisation well defined before the divergence of the several phyla occurred.

The cerebellum is far more highly differentiated than that of amphibian or reptile; the medulla oblongata, on the contrary, has retained the plan of structure of the primitive neural tube without the intervention of profound changes; a more extreme degree of simplicity is found in the inter-brain or thalamencephalon; the fore-brain is far in advance of that of teleosts or ganoids.

These illustrations point to an underlying principle. The organisation of the brain is the expression of the adjustment which has constantly taken place between the race of animals and the stimuli to which they have been subjected. Hence it is that the cerebellum of *Mustelus* is so highly organised; for this is the correlative of the powerful swimming capacity of the animal, requiring an adequate mechanism of equilibrium. The fore-brain, with its luxurious development of neurones, has arisen in connection with the large place occupied by olfactory impressions in the Selachii.

Skin-Glands of Amphibians.‡—Dr. P. Ancel shows that these glands have an ectodermic origin. The primordium, arising from the cells of the deep layer of the epidermis, protrudes into the dermis, and comes to be surrounded by it except at the upper pole. The excretory canal is formed from a depression of the stratum corneum between several epidermic cells. As to the "collar," it is formed secondarily at the union of the epidermis and glandular bud, and is from the very first distinguishable into an internal and external portion. Precisely the same

* Embryologische Forschungsmethoden. Antrittsvorlesung, Leipzig, 1900, 30 pp. See Biol. Centralbl., xxi. (1901) p. 683.

† Journ. Comp. Neurol., xi. (1901) pp. 65-175 (8 pls.).

‡ Arch. Biol., xviii. (1901) pp. 257-89 (2 pls.).

mode of development was seen in both kinds of gland (large and small) in the salamander's skin. The large poison-glands must be described as more perfectly differentiated towards a special function. Dr. Ance! maintains that even the smooth muscle-fibres which penetrate into the epidermis arise from epidermic cells; they do not assume their elongated form until the bud has penetrated into the dermis, and they remain (in the adult) united to neighbouring epidermic cells by protoplasmic bridges.

Structure of Herbst's Corpuscles in the Sparrow and Fowl.*—Guido Sala, by the use of chloride of gold, has succeeded in demonstrating that the stroma of these corpuscles does not consist, as has been hitherto supposed, of the union of concentrically arranged lamellæ of connective tissue, but is formed of a thick network of skein-like twisted fibres, in whose meshes the connective-tissue cells are placed.

c. General.

Chemical Basis of Variation.†—Armand Gautier returns to the thesis of a well-known memoir which he published in 1886,—that the variations which mark the beginning of a new variety are detectable even in the chemical composition of the cells, and that they may appear suddenly without intermediate steps. He brings forward some fresh facts supporting this view. The plant or animal organism may exhibit important variations with some abruptness; these variations have their basis in changes in the plasmic molecules of particular organs, and these plasmic changes are referable to the reciprocal influence of other plasmas, and to a less extent to changes in environment and nutrition.

Two States of Living Matter.‡—Felix Le Dantec argues in support of the hypothesis that there is a fundamental and widespread occurrence of cellular dimorphism, of units with n chromosomes and units with $2n$ chromosomes, as seen in the contrast between the cells of sporophyte and gamophyte in ferns, between somatic cells and germ-cells in animals. He applies his idea to the phenomena of maturation and fertilisation.

Effect of Light on Animals.§—Prof. W. A. Nagel gives a critical *resumé* of recent research on this subject, with special reference to the comparisons which have been made between plants and animals in respect to their reaction to light. He applies the term *phototropism* to the peculiarity displayed by many sedentary organisms or special organs, of taking up a fixed position in regard to light, by means of bending movements, movements of growth or of torsion. On the other hand, *phototaxis* is the peculiarity displayed by free-swimming organisms of orienting the body so as to place its long axis in a definite relation to the direction of the rays, and of retaining this position, if movement ensues, during progression through the surrounding medium. In both cases a positive and negative form of the phenomena can be distinguished. Rothert has given the name of "apobatic phototaxis" to that susceptibility to alterations of intensity (*Unterschiedsempfindlichkeit*) which is so pronounced in, e.g. *Amphioxus*, many tube-inhabiting worms, burrowing

* Anat. Anzeig., xix. (1901) pp. 595-6 (1 pl.).

† Comptes Rendus, cxxxiii. (1901) pp. 570-2.

‡ Tom. cit., pp. 698-700.

§ Bot. Ztg., lix. (1901) pp. 289-99.

molluscs, and so on; but the author regards this combination as unjustifiable, and prefers simply to speak of a susceptibility to differences of intensity. Again, certain animals respond to light-changes, either by active movements or by a cessation of the usual movements: to such cases the author would apply the term *photokinetic*. Certain burrowing molluscs, for instance, display great activity if entirely exposed to light, but become quiescent if in darkness, e.g. within their burrows.

Outlines of General Anatomy. *—Prof. Fr. Reinke has written an introduction to anatomy from a biological basis. He discusses the cell-theory, the life of cells, functional adaptation, regulative processes in growth and regeneration, correlation, and so on,—in short, not anatomy, but the biological prolegomena.

Segmentation of the Vertebrate Body. †—Prof. Patterson considers that too much stress has been laid upon the occurrence of segmentation in various organs of the Chordata. He believes that it is really a secondary process in vertebrate architecture, and emphasises the number of important organs which form a longitudinal series, such as notochord, central nervous system, alimentary canal, vascular and genital systems, and are only secondarily and partially affected by the process of segmentation. Even where structures are distinctly segmented, the process is often incomplete, e.g. in regard to the vertebral column. Segmentation is suppressed in the sacrum in most mammals, and in the cervical region in certain Cetacea. In brief, the process of segmentation is superadded to the still more fundamental style of architecture, the longitudinal tubular arrangement of the essential organs of the body.

Mechanical Theory of Vision. ‡—Antoine Pizon refers to some of the difficulties which beset the theory that in vision light has a chemical action on the retinal purple with which the rods are impregnated. He refers to the absence of the retinal purple in Invertebrates and in the fovea lutea of Vertebrates, to the absence of both rods and purple in snakes, to the absence of purple in pigeons, bats, and albinos. After prolonged exposure to bright light, the retinal purple is destroyed in frogs, but the animals seem still to see as usual.

Pizon maintains that the pigment-granules are influenced by the light, not chemically, but so as to exhibit a vibratory movement, which they transmit to the cones or rods with which they find themselves in contact. He refers to Bernard's recent theory, and gives evidence in support of his own, that the phototactic granules move under the influence of light, and transmit their movements to contiguous visual cells.

Correlation of Colouring in Liver, Skin, and Hairs. §—N. Floresco has previously shown (1) that a snail with a dark shell has a dark mantle and a dark liver; that a snail with a yellowish-grey shell has an almost transparent mantle and a yellowish liver, and that there are intermediate gradations; (2) that there is more iron in the livers and

* Grundzüge der allgemeinen Anatomie. Zur Vorbereitung auf das Studium der Medizin nach biologischen Gesichtspunkten bearbeitet, Wiesbaden, 1901, xxii. and 339 pp. and 64 figs.

† Proc. Liverpool Biol. Soc., xv. (published 1901), pp. 3-18.

‡ Comptes Rendus, cxxiii. (1901) pp. 835-7. § Tom. cit., pp. 828-30.

mantles of snails with dark shells than in those of snails with light-coloured shells.

He now extends his observations to dogs and cats. Again there seems to be correlation. The liver and the skin of the animals with dark hair contain almost twice as much iron and pigment as those with light hair.

Blue and Green Coloration in Skin of Vertebrates.*—Messrs. Camichel and Mandoul have made a physical study of some of the blue and green colorations familiar in mackerel, dragonet, frog, lizard, throat of casuary, snout of mandrill, &c. The blue coloration is due to a black pigment, and analogous phenomena can be obtained from Chinese ink and the like. In the case of the green colorations, there is a yellow pigment in addition to the black one. It is suggested that the value of the coloration is as a screen which admits useful rays, but is impermeable to those which would injuriously affect the skin. In short, the coloration is functionally *protective*.

Cervical Glands of Marsupials.†—James Johnstone has examined a young male of a species of *Dendrolagus* and a male of *Acrobates pygmaeus*, in order to find out whether the peculiar superficial cervical thymus, described in certain other Diprotodonts, is also present in these cases. In the first-named, he finds that the cervical thymus is large and two-lobed; it exceeds in size the typical thoracic thymus. In *Acrobates*, the organ appeared to be absent, but close examination showed that it was bound up with a portion of the sub-maxillary, being enclosed in the same sheath as this gland. Comparing these cases with those of other marsupials previously examined, it appears certain that in Diprotodonts generally this cervical thymus is present, while in Polyprotodonts, as in other mammals, it is absent. Too little is known of the development of the cervical thymus to make it possible as yet to draw any general conclusion as to the meaning of its presence.

Parafibula in Marsupials.‡—Dr. A. Banchi has previously described in various Lacertilians a skeletal element whose primitive position is on the external side of the fibulo-femoral articulation. He finds distinct evidence of the same in the embryos of two Marsupials, *Pseudechinus archerii* and *Halmaturus thetidis*, and in the young of *Macropus antilopinus*.

Hibernation of Bats.§—H. Rulot finds (1) that the proportion of water in the body increases from November to April, though there is absolute loss, especially towards the end of the hibernation; (2) that the absolute and relative weight of fat diminishes through the winter, most rapidly in the later months; (3) that the same is true for glycogen from November to March, with a slight increase in April, but the quantity is too small to form an important nutritive reserve; (4) that the consumption of proteids is almost nil in the first months, that it is more considerable in the later months, and that the relation between the quantity of proteid used up and the quantity of fat consumed increases

* Comptes Rendus, cxxxiii. (1901) pp. 826-s.

† Proc. Liverpool Biol. Soc., xv. (published 1901) pp. 354-62 (3 figs.).

‡ Anat. Anzeig., xx. (1901) pp. 273-83 (10 figs.).

§ Arch. Biol., xviii. (1901) pp. 365-75.

markedly in April; and (5) the sleep is more profound at the beginning than towards the end of winter,—the quantity of carbon used up increasing from November to April.

Marine Intoxications and the Life of Burrowers.*—G. Bohn has some interesting observations and suggestions on this subject. He has shown that sea-water in which red Algæ (especially *Lithothamnium*) have been living is “very toxic (alkaline), while that which has filtered through the sand is not.” Burrowing animals have chemical as well as mechanical protection.

We are unable clearly to understand Bohn’s somewhat too terse sentences in regard to burrowing Crustaceans, where the respiratory current is reversible. The animals are said to dispose their anterior appendages in such a way that the entrant currents filter through the sand, and to return to the direct current when external poisons or their own excreta begin to reach the gills, which thus act as *organes avertisseurs*. We hope that a less condensed memoir will give a full account of the actual procedure.

The author goes on to discuss *Arenicola marina* and other burrowing Annelids. The lobworm in its vertical burrow, and *Pectinaria* in its tube, produce ascending (inverse) and descending (direct) currents of water by active and successive dilatations of the segments of the middle region of the body. By altering its position or the direction of the muscular wave, the exceedingly sensitive worm averts the external alkaline intoxication. Yet at the end of August circulatory troubles begin in the gills and skin; there is an autumnal intoxication; leucocytes accumulate around the vessels; phagocytosis sets in; the skin is ruptured near the parapodia (such as they are) and the nephridial orifices. One of the consequences of histolysis is the escape of the ova.

Breeding Habits of *Ameiurus nebulosus*. † — Dr. A. C. Eycleshymer has made some observations on the nesting and spawning of this American catfish, both in natural and artificial conditions. In natural conditions the egg-mass is laid in shallow water under logs or stumps, or even in old pails, pieces of stove-pipe, and so on; it is first watched by both parents, but later only by the male. Where, as in artificial fish-ponds, objects which may serve as shelters are absent, the fish excavates deep holes, in which the eggs are deposited. Both sexes appear to take part in the process of excavation.

Axolotl and *Amblystoma*. ‡ — Prof. H. L. Osborn describes various axolotls obtained from different regions, and makes some remarks on the relation of the two forms. He distinguishes between the primary and the secondary adult characteristics. The acquisition of the first involves radical morphological changes, and these changes take place in all forms, whether terrestrial or aquatic. The secondary characteristics are largely points connected with the external anatomy, and instead of always taking place *pari passu* with the primary changes, may occur later, or not at all. The author distinguishes three types of development:—the amblystoma, where primary and secondary changes occur simultaneously; the sireon, where the secondary changes take place later than the primary; and the axolotl, where the latter never occur at all.

* Comptes Rendus, cxxxiii. (1901) pp. 593-6.

† Amer. Nat., xxxv. (1901) pp. 911-8. ‡ Tom. cit., pp. 887-903 (6 figs.).

At St. Paul the amblystoma first becomes terrestrial and then matures, acquiring the spotted salamander-like coloration of the land form; in Colorado the animals mature in the water, and there also, at a later stage, acquire the terrestrial characters; in Mexico the terrestrial characters are never acquired at all. But all three forms become truly mature. Very careful measurements are given of the parts of the body in the different forms, and they show that the terrestrial amblystoma ("salamander" form) differs, especially as regards the shape of the head, alike from the axolotl and from the metamorphosing siredon stage.

Musculature of Urodela. * — Dr. L. Drüner has published a paper on certain of the muscles of the anterior region in these Amphibia, which, being entirely anatomical, is beyond our scope. But his results have led him to the general conclusion that the ancestors of the Urodeles must have had at least seven gill-arches between the hyoid and the shoulder-girdle; that is, there cannot have been any Selachian-like forms in the direct line of ancestry; for the development of specifically Urodele characters must have occurred at a much older phylogenetic stage. Mention should be made of the very fine anatomical plates accompanying the paper.

Abnormalities in Veins of Salamander. † — Dr. H. Joseph describes two interesting cases of abnormality in *Salamanca maculosa*. The first recalls primitive conditions,—the persistence of two separate symmetrical hepatic veins (cf. *Torpedo*, &c.), or the suppression of the hepatic sinus anastomosis. This seemed to be due to an adhesion of the pericardium to the anterior pole of the liver by means of stiff connective-tissue exactly between the two large veins. In the second case there was a defect in the anterior part of the inferior vena cava, and an associated exaggeration of the left cardinal vein. But this is a commoner occurrence.

Abysmal Antarctic Fauna. ‡ — A. E. Shipley gives a summary account of the characteristics of abysmal animals generally, with lists of the forms found by the *Challenger* in the Antarctic region.

Fauna of Switzerland and the Glacial Period. § — Prof. F. Zschokke gives a concise account of the present fauna of Switzerland, particularly of the animals of the Alpine lakes and streams, with the special object of showing to what a large extent the peculiar forms are Arctic species, and therefore relics of the glacial period. He lays special stress upon the Salmonidæ of the lakes, showing that the ancestors of the existing species must have migrated from the north at the close of the glacial period, but have remained isolated for a time long enough to permit them to form new varieties or species.

Deep-Sea Fauna. || — O. Seeliger discusses in a popular style the abysmal fauna, and the results of the German Deep-Sea Expedition (1898). Attention is directed to the present-day methods of investigation and the general biological importance of the study of the deep-sea.

* Zool. Jahrb., xv. (1901) pp. 435-622 (7 pls.).

† Anat. Anzeig., xx. (1901) pp. 283-93 (4 figs.).

‡ Antarctic Manual, London, 1901, pp. 241-75.

§ Die Tierwelt der Schweiz in ihren Beziehungen zur Eiszeit, Basel, 1901, 69 pp.

|| Tierleben der Tiefsee, Leipzig, 1901, 8vo, 49 pp. and 1 coloured pl.

Plankton of Attersee.* —Dr. Carl v. Keissler gives a list of the organisms of this Upper Austrian lake during the month of August 1900, together with some critical remarks. The nettings at a depth of 20–30 metres showed a smaller amount of plankton than that present at the same depths in the North German lakes, but greater than that of the large Alpine lakes, e.g. the Neuenberger See. Just as in the Alpine lakes, the upper layers of water showed a small volume of plankton; for not till a depth of five metres was reached was any considerable amount obtained. But as also occurs elsewhere, the organisms rise to the surface in the evenings, and then the layers from 0–5 metres and from 2–5 metres contain three to four times the plankton volume which they possess by day.

The same author † gives an account of the contents of two tow-nettings made in April in the Aber or Wolfgang Lake in Salzburg. The most numerous animals were Crustacean larvæ and *Diaptomus graciloides*. Rotifers were remarkable for their absence.

INVERTEBRATA.

Mollusca.

a. Cephalopoda.

Notes on Living Nautilus.‡ —Prof. Bashford Dean has studied Nautilus in the region of southern Negros (Philippines), where it is collected by the fishermen in fish-cages.

There are often visible sexual differences in the shells, that of the female being wider at the sides of the oral aperture and with a somewhat angular contour. But this test is not always applicable. Irregular, sometimes undulating, lines of growth on the shell may be seen, sometimes several on the wall of a single chamber. In captivity the animal often rests quietly for hours, with its face and exposed parts a clean opaque white, like the shell; the dorsal surface of the hood, which is brownish, is almost the only area of pigmentation. They died in less than a day in captivity, but retain a life-like position after death. One dead one was seen to float on the surface. The appearance of the animal when resting and when retracting is carefully described.

The author notes the mobility of the tentacles, their great possibilities of extension and retraction, and suggests that the lengthening and shortening may be connected with the transverse foldings which enable the tentacles to serve as adhesive organs. There can be little doubt that the Nautilus is naturally very active; it will suddenly sweep from the bottom and bump into a corner with some force, rising usually not more than three or four inches off the ground; rotation (turning to right or left) is readily accomplished; a curious rocking movement is common.

A fisherman's uninspired description of what may have been the deposited eggs is given.

Development of Radula in Cephalopoda.§ —G. Rottmann, who has chiefly employed *Loligo vulgaris* as material, finds that the radular sac

* Verhandl. k. k. Zool.-bot. Ges. Wien, li. (1901) pp. 392–401 (2 figs.).

† Tom. cit., pp. 401–4. ‡ Amer. Nat., xxxv. (1901) pp. 318–37 (15 figs.).

§ Zeitschr. wiss. Zool., lxx. (1901) pp. 236–62 (2 pls.).

arises as an evagination of the ectodermal fore-gut. The radula fold is developed at an early stage, but the organ itself does not appear till later. It begins with the formation of a cuticular plate by the basal epithelial cells. At the base of the sac, and exactly in the middle line, this plate is elevated, owing to the formation of fresh substance by the odontoblasts, which are the epithelial cells in the fundus of the sac. The further development takes place by the constant formation of new teeth by fresh odontoblasts, which move forward with the teeth, and become converted anteriorly into flattened epithelial cells. Each tooth arises as a thin lamella, continuous in front and at both sides with the cuticular plate; this forms the back of the tooth, and the body and base are produced by the activity of the odontoblasts. The median row of teeth is the first to be developed, and is followed by two side-rows, and so on in this order. The forward move of the embryonic tongue is due only to the gradual growth of odontoblasts and teeth in the forward direction, no motor apparatus being as yet present.

γ. Gastropoda.

Experiments on *Littorina*.*—Prof. K. Mitsukuri has made a number of interesting observations and experiments on *Littorina exigua*, and formulates the following conclusions:—(1) The mollusc shows a strong negative phototaxis under ordinary circumstances. That this is not due to negative hydrotaxis is shown. (2) There is a disinclination to be submerged, and a rise of water drives the molluscs upwards. When negative phototaxis and negative hydrotaxis act together, the mollusc is driven upward without hesitation; when they act against each other, at least in small depths, negative phototaxis seems to overcome negative hydrotaxis. (3) In nature they occur scattered over the rocks, because the unevennesses which provide them with holes occur irregularly. On smooth glass plates they move until stopped by some obstacle which they cannot overcome. (4) When splashed on by water for some length of time, as by waves in rising tide, or artificially by a jet, and then left quiet, they may become positively phototactic, and then they go down from the land towards the sea. But they still hesitate on touching the water's edge, which shows that the behaviour is not due to hydrotaxis. (5) While disliking deep water, they cannot live on dry surfaces. They must have a certain amount of water if they are to crawl and feed (?). Those left dry at the highest tide-level pass into a dormant state till the next spring-tide comes round again in a fortnight. (6) The individuals do not seem to wander much. One that was marked had not stirred from the identical spot after an interval of about four months. These remarks probably hold true of *L. sitchana* var. *brevicula*, which was also observed, and of other species. It seems likely that the facts under (2) and (5) are the primary ones; that the animals live by preference on slightly moist surfaces of rocks. "The mollusc probably knows instinctively only to go toward dark when water begins to splash it, and to move toward light when splashing has stopped."

Affinities of Genus *Neobeliscus*.†—Dr. H. A. Pilsbry modifies some of his former † statements in regard to this genus of South American

* Annot. Zool. Japon., iv. pp. 1-19 (6 figs.).

† Proc. Acad. Nat. Sci. Philadelphia, 1901, p. 142. ‡ Op. cit., 1899, p. 366.

land snails. He now finds that it is most nearly allied to the West African *Atopocochlis*, which is apparently also viviparous and has the albumen-gland greatly reduced.

Pigments of Nudibranchs.*—T. D. A. Cockerell calls attention to the pigmentation in three hitherto undescribed species of *Chromodoris*, e. g.—*C. universitatis* (bearing the colours of the University of California), ultramarine and cobalt-blue with orange spots. In this species and in *C. porterae*, the blue dissolves out in formalin; in *C. mefarlandi* the dominant pigment is purple and does not dissolve out. The blue solution referred to is bleached by caustic potash, and turned pink by hydrochloric acid. The orange is not affected by the formalin. No doubt all the pigments illustrate "warning coloration."

Relationship between Amphineura and Cephalopoda.†—J. Graham Kerr is of opinion that Prof. Ludwig Plate has failed to fully appreciate his view as to the phylogenetic relation between these two groups of Mollusca. Prof. Plate denies that Cephalopods can be regarded as having descended from forms resembling Chitons; but Mr. Kerr states that he had no intention of maintaining such a position. He only suggested that the Amphineura were the nearest living allies of the Cephalopoda, that is, "that the ancestral group common to the two groups was probably more recent than that common to either of them and any other group of molluscs." This position the author considers is fully justified by the existence in the two groups of numerous points of resemblance in regard to deep-seated morphological features without any apparent adaptive relations to conditions of existence.

Affinities of Phyllaplysia.‡—Prof. G. Mazzarelli has been able to make some observations on two species of this Molluscan genus, *P. lafonti* and *P. paulini* sp. n. He figures and describes the brain, jaw, penis, and radula teeth of the first species, and concludes that the genus is most nearly allied to *Notarachus*, the two differing chiefly as regards secondary characters.

The Genus Chætoderma.§—A. Kowalevsky has obtained, while dredging in the Sea of Marmara, two species of *Chætoderma*, both of which appear to be new. The first of these is characterised by the presence of a complex radula, bearing nine rows of teeth; it has in consequence received the name of *Ch. radulifera*, in order to mark the contrast with other known species in which the radula is rudimentary. The other species externally resembles to some extent both *Ch. productum* and *Ch. nitidulum*, but differs from both in the structure of its radular apparatus. The author makes it a new species, and names it *Ch. gutturosum*, from a curious habit which it displays of inflating the head-region, a habit which is of great aid in burrowing.

5. Lamellibranchiata.

Formation of Pearls.||—Prof. R. Dubois finds that in *Mytilus edulis* pearls are formed around a small Trematode—*Distomum luteum* (?), or

* Nature, lxx. (1901) pp. 79-80.

† Zool. Anzeig., xxiv. (1901) pp. 437-8. ‡ Tom. cit., pp. 433-7 (6 figs.).

§ Arch. Zool. Expér., ix. (1901) pp. 261-83 (3 pls.).

|| Comptes Rendus, cxxxiii. (1901) pp. 603-5.

as the author proposes to call it, *D. margaritarum*. He suggests that a Sporozoon or the like may also be involved in the death of the Trematode; but in many cases the Trematode, encysted in August of one year, is liberated from its pearly investment in the following summer. Shortly before liberation the cyst is quite gelatinous. A true or permanent pearl implies the death of the parasite,—is, in short, its “brilliant sarcophagus.”

Origin of Pearls.*—L. G. Seurat calls attention to the observations of Garner † (1863, &c.) from which it was concluded that pearls in *Alasmodon* and *Mytilus* are formed around parasitic Distomes. Even before this (1852) de Filippi had referred to *Distoma duplicatum* as the provoking cause. Küchenmeister (1856) had suggested *Atax ypsilophorus*. For the pearl oyster, likewise, the importance of parasitic worms in producing pearls has been indicated by Möbius, Kelaart and Humbert, Thurston, and Giard. But no definitive proof has yet been given, not even by Dubois in his recent paper referred to above.

Formation and Diseases of Pearls.‡—S. Jourdain expounds the view that a lesion, or the presence of an organic or inorganic intrusion which produces a depression of the pallial surface of the shell, is followed by a hyper-secretion of nacreous matter around the nucleus whatever that may be. He alludes to the “nacrotyping” which follows when a foreign body is inserted between the mantle and the shell.

There are two kinds of diseases in pearls,—spontaneous and acquired. In the first case the superficial layers may undergo disintegration and thus destroy “*l'éclat et l'orient de la perle*.” But, as he has said, this may be doctored. The acquired diseases are due to prolonged and repeated contact with the skin, whose acid secretions, “sebaceous matters,” and “gaseous emanations” spoil the pearl if their action is long continued. For the pearl so diseased there is no known cure.

Inferior Backward Current in Bivalve.§—M. Stenta finds that in “open” forms (*Meleagrina*, *Anomia*), and in those which get rid of suspended foreign particles by sudden closure of the shell (*Pecten*), there is no hint of inferior backward current. In “half-open” forms (*Cardium*), and in sedentary forms (*Mytilus*), there is more or less of an inferior backward current. In *Pinna*, whose shell lies upright, half-hidden in the sand, there is a strong development of the inferior backward current, and *Pinna* possesses, in association with this, a special ciliated groove on the mantle.

Arthropoda.

a. Insecta.

Senses of Ants.||—Adele M. Fielde finds that *Stenammina fulvum* var. *piccum* apparently follows the trail made by her own feet by means of its scent, but this power of following without hesitation an old track is lost if the tenth segment of the antenna is removed. Similarly, ants of

* Comptes Rendus, cxxxiii. (1901) pp. 700-2.

† Rep. Brit. Ass. for 1863; Journ. Linn. Soc. (Zool.), xi. (1873) pp. 426-8.

‡ Comptes Rendus, cxxxiii. (1901) pp. 832-3.

§ Zool. Anzeig., xxiv. (1901) pp. 521-4.

|| Proc. Acad. Nat. Sci. Philadelphia, 1901, pp. 521-44 (1 fig.).

the same lineage, whether queens or workers, appear to possess a diffused scent which is the same for all the individuals of common descent, and is the means of recognition. The power of recognising this scent is lost if the eleventh segment of the antenna be destroyed. Again, the ants appear to recognise the aura of their own nest by means of the twelfth segment of the antenna. If the eighth and ninth segments of the antennæ are destroyed, the ants no longer show any care for the eggs or young, and if the five distal segments are destroyed, they no longer exhibit gregarious instincts. The care bestowed by the ants on the eggs, larvæ, and pupæ, does not appear to be essential for the development of these, but if not so tended they become overgrown with the mycelium of *Penicillium crustaceum*. The author believes that the worker ants feed upon this mould, which they obtain by constantly licking the eggs and young. It does not grow upon the bodies of dead ants, which become covered by *Rhizopus nigricans*, a mould with spreading hyphæ apparently not used as food.

Macroergates in *Pheidole commutata*. * — Prof. W. M. Wheeler describes the finding in Texas of nests of this ant which contained the one six, and the other three specimens of very large workers, answering to Wasmann's definition of macroergates. The body was about four times as large as that of the normal workers, and though the total length did not greatly exceed that of the normal soldiers, the enormous distension of the abdomen made the macroergates appear more bulky. They had not however the large heads of the soldiers. Close examination showed that these giant forms contained within the distended abdomen a parasitic Nematode belonging to the genus *Mermis*. In one case the parasite was fully 50 mm. long, some ten times the length of the ant. The author ascribes the great increase in size of the body to the presence of the parasite increasing the appetite of the host, while the fact that ants feed each other and their larvæ renders it possible for the parasitised forms to obtain extra food with ease. Infection must take place in the larval stage.

Gynandromorphy in a Wasp. † — Franz Friedr. Kohl has found, among a collection of American wasps, a specimen of *Ammophila abbreviata* F., which has the head and legs of a female, but bears normal male genitalia at the end of the abdomen. The abdomen resembles that of a female in its robust form, but in the number of its segments, no less than in its genital apparatus, is definitely male. The author is satisfied that the specimen is genuine and is not an artifact. This is the first time gynandromorphy has been described in a wasp. Though the legs are definitively of the female type, they are slightly stouter in form, and the tarsus bears a few more hairs than usual. The case falls into Dalle-Torre and Friese's Group iii. 2, b.

Female Genital Apparatus in Microlepidoptera. ‡ — Hermann Stitz finds that there are three kinds of chitinous structures round the genital openings, the squamæ, the setæ, and the spinæ. The abdomen in the female consists originally of ten segments, of which the first is aborted

* Amer. Nat., xxxv. (1901) pp. 877-86.

† Verh. k. k. Zool.-bot. Ges. Wien, li. (1901) pp. 405-7 (4 figs.).

‡ Zool. Jahrb., xv. (1901) pp. 385-434 (5 pls.).

ventrally, and the ninth and tenth are fused. The end of the abdomen bears the laminæ abdominales, between which lie the genital and anal apertures in a groove. Except in *Tineola* the two openings are however distinct from one another. In relation to the laminæ abdominales, there are two pairs of chitinous rods—the apophyses. The ovaries, as in Lepidoptera in general, consist of four ovarian tubes. The common oviduct of each side opens into the vestibulum, which again opens into the vagina. The vestibulum receives the common ductus sebaceus of the paired sebaceous glands, and also the canalis vestibuli of the receptaculum seminis. This organ consists of a glandular tube, the glandula receptaculi, and the lagena receptaculi, or receptacle proper, from which leads the canalis receptaculi, which becomes the canalis spiralis before passing into the canalis vestibuli. The bursa copulatrix consists of a spacious sac and a narrowed neck (cervix); it communicates with the vestibule by a tube called the ductus seminalis. Full details of all these organs are given for the forms studied by the author.

Determination of Sex in Lepidoptera. * — Prof. A. Giard calls attention to the need for caution in drawing conclusions from experiments on caterpillars in reference to the determination of sex. The morphological facts must be kept in view, and this fact in particular, that the sex is often clearly marked at hatching, and is sometimes quite certainly determined in the ovary. This was, he says, established years ago by the investigations of La Valette St. George and of Brocadello. The experiments of Mary Treat, Gentry, Landois, and Giard himself, in subjecting caterpillars to restricted diet and so on, do not offer any general physiological conclusion as to sex-determination.

Experiments in Seasonal Dimorphism. † — G. A. K. Marshall has made in Mashonaland a number of experiments, especially with species of *Terias*, in order to ascertain how far humidity alone, as apart from heat, can be regarded as responsible for the marked differences between the summer (wet) and the winter (dry) broods.

From his results it seems probable that, in the case of those species which are amenable to the influences of climate, the stimulus necessary to induce seasonal change would consist in a combination of either moisture and heat, or dryness and cold, and not in either of these factors exclusively.

Accessory Chromosome in Insect Spermatogenesis. ‡ — C. E. McClung gives a brief abstract of a paper on this subject which he has written for publication elsewhere. The structure called "accessory chromosome" is identical with the "small chromosome" of Paulmier, and the "chromatin nucleolus" of Montgomery. It is most distinct in the first spermatocyte, has been recorded in a number of insects belonging to different orders, and probably occurs elsewhere. The special peculiarities are:—that it exhibits a remarkable uniformity of staining power, similar to that exhibited by chromosomes in the metaphase; that it occupies a peripheral position during at least the spireme stage; that it is isolated from the chromatin reticulum and does not participate in its changes;

* Comptes Rendus, cxxxiii. (1901) pp. 407-10.

† Ann. Nat. Hist., viii. (1901) pp. 398-403.

‡ Anat. Anzeig., xx. (1901) pp. 220-6.

and that, during metakinesis, it divides by fission like the chromosomes. As to history, it is first observed in one of the early generations of the secondary spermatogonia, and subsequently takes part regularly in the spermatogonial mitoses, differing from other chromosomes chiefly in the possession of a separate vesicle during the prophase. At the end of the spermatogonial divisions it persists as a more or less clearly defined chromosome, at a time when the other chromatin elements break up to form the spireme. During the first spermatocyte division it divides with the other chromosomes, but fails to do this in the second division, so that two kinds of spermatozoa are produced in equal numbers. The author believes that those derived from the spermatocyte containing the accessory chromosome possess the power of causing the eggs they fertilise to develop into males, and that thus the accessory chromosome determines sex.

Histolysis in Metamorphosis of Flies.*—Dr. Paolo Enriques finds that in *Calliphora* and *Sarcophaga* a crystalline substance is formed within many of the larval muscular fibres. This substance finally finds its way into the adipose cells, where it appears in the form of minute crystals. The aggregation of these crystalline bodies produces the appearance described by former authors as endocellular phagocytes. In the sarcolytes engulfed by the phagocytes the striation is lost, and the anisotropic substance segregates to form a large zone, which is luminous when examined with the spectroscope under crossed nicols. This luminous substance shows successive stages in the development of the crystals mentioned above, and the author believes that these are in all probability derivatives of the anisotropic substance which is taken up by the adipose cells.

Development of Hypodermal Imaginal Discs in Larval Diptera.†—Dr. Bruno Wahl, as the result of his own observations on *Eristalis* larvæ, and those of other observers on other flies, finds that in the Diptera generally, the imaginal hypodermis together with its derivatives arises from the larval hypodermis. In the Cycloraphæ, the imaginal organs develop from small parts only of the larval organs. Many of the imaginal discs sink below the surface in the form of sacs, and remain united with the surface only by stalks. In *Eristalis* this occurs with regard both to the thoracic and the abdominal discs. In both cases the formation of the discs is preceded by histological changes in certain parts of the larval tissues, the cells concerned exhibiting what the author calls "renovation." Its result is to give to the cells a renewed strength and vitality, enabling them to withstand the histolytic influences to which the cells which have not been renewed yield at once. The renewal of the cells of the imaginal discs gives them further the power of regenerating the whole organ of which they themselves originally formed but a part. In other cases, instead of a part only of the cells composing an organ becoming renewed, the whole organ may undergo rejuvenescence in this way, and thus a larval structure may pass over with but little change into the adult. This seems to occur in regard to certain parts of the tracheal system, perhaps is also true of

* Anat. Anzeig., xx. (1901) pp. 207-19 (1 pl.).

† Zeitschr. wiss. Zool., lxx. (1901) pp. 171-91 (1 pl. and 4 figs.).

the nervous system, and possibly of the heart. On the other hand, regeneration occurs chiefly in regard to those organs in which the larval type differs from the adult.

Mimicry of a Moss by a Larva and Pupa.*—Müggenburg points out the remarkable resemblance to a moss presented by the larva and pupa of a gnat, *Cylindrotoma glabrata*. The eggs are laid in August in the axils of the leaves of the moss, *Hypnum (Hylocomium) squarrosum*. The larvæ soon emerge, and remain very small through the winter; they are of a moss-green colour, and are furnished, especially on the back, with curved spines which closely resemble the leaves of the moss; while dark patches on the upper side of the body recall dead plant-remains and patches of shade. They are about 2 cm. in length. They feed on the moss, and change, in the summer, into the very similar pupa; the imago emerging in a very few days.

Genus Termitoxenia.†—E. Wasmann adds some further notes to his previous ‡ description of this interesting Dipteron from the nests of Termites. He now finds that the genus must be regarded as the type of a new family, to which he gives the name of Termitoxeniidæ, and which must be regarded as standing between the Eumyidæ and the Pupipara. Some of the most striking differences from the Eumyidæ are that the frontal cleft (*Stirnspalte*) lies in front of instead of behind the origin of the antennæ, the ovaries consist at each side of only a single tube, and finally, owing to the suppression of the larval and pupal stages, the Termitoxeniidæ have become ametabolic. In *Termitoxenia* s. str., the stenogastric imago emerges direct from the very large eggs, while in the sub-genus *Termitomyia* the development apparently takes place within the body of the mother, from which the stenogastric imago emerges. This imago possesses certain larval characters, and gradually develops into the physogastric adult. The four known species are protandrous hermaphrodites, and, as indicated above, the one sub-genus is oviparous and the other viviparous.

Spermatocytic Kineses in Orthoptera.§—R. de Sinéty has studied the spermatogenesis in many Orthoptera, and confirms some of the results of McClung. It is necessary, however, to admit that there is a *double* longitudinal division of the chromosomes. The author has also found the "accessory chromosome" ("small chromosome" of Paulmier, "chromosome x" of Montgomery), whose behaviour is, to say the least, peculiar.

Copulatory Apparatus of Male Trichoptera.||—Dr. Enoch Zauder has studied the genital armour of these insects as a continuation of his previous work on Hymenoptera. He finds that though the mature insects of the two orders appear to be markedly contrasted as regards the organs in question, yet these are in both cases developed from morphogenetically equivalent rudiments. In both cases a genital pocket is developed near the post-segmental border of the twelfth sternum. At the base of this pocket a pair of projections appear which develop into

* Arch. Naturgesch., 1901, Beih., pp. 169-86 (1 pl.). See Hedwigia, xl. (1901) Beibl., p. 133. † Zeitschr. wiss. Zool., lxx. (1901) pp. 289-98.

‡ Cf. this Journal, 1901, p. 33. § Comptes Rendus, cxxxiii. (1901) pp. 824-6.

|| Zeitschr. wiss. Zool., lxx. (1901) pp. 192-235 (1 pl. and 21 figs.).

the rudiments of the penis and the valvæ at each side. Later, the two penis-rudiments fuse in each case in the middle line to form a single structure. From this point the development differs in the two orders. In the Hymenoptera, the genital pocket persists, and the penis and valvæ remain close to one another. In the Trichoptera, the genital pocket disappears, the penis, owing to the development of a secondary invagination, sinks into the abdomen, while the valvæ advance to the surface. In other words, the male genital apparatus in Hymenoptera remains in a far more primitive condition than in Trichoptera.

New Collembola.*—Carl Börner describes a number of new forms, one of which he places in a new genus as *Willemia anophthalma*. The characters of the new genus are as follows:—Shape of body as in *Aphorura*; antennæ cylindrical; the fourth segment with olfactory hairs but no olfactory papillæ; post-antennal organ present, but eyes entirely absent; mouth-parts biting; tarsus with two claws; furca and tenaculum entirely suppressed; two anal spines placed on small papillæ. The author also finds a new sub-family of the Achorutidæ, under the name of Neanurinae, for the following genera:—*Pseudachorutes*, *Aphoromma*, *Anurida*, and *Neanura*, all of which have primitive ocellæ, and not ommatidia as in the sub-family Achorutinae.

β. Myriopoda.

Development of Scolopendra.†—Dr. R. Heymons has been successful in breeding from *S. cingulata* and *S. dalmatica* in captivity, and thus obtaining abundant material of eggs and embryos. He finds that the female coils herself round the eggs after these are laid, and that the presence of the mother is essential to hatching. He ascribes this partly to the glandular secretion with which she lubricates the eggs, partly to the fact that her presence prevents the eggs coming into immediate contact with the surrounding soil.

The embryological part of the paper is so comprehensive that some only of the more general of the results can be indicated here. In regard to the segmentation and the formation of the germ-layers, the author is of opinion that, anomalous as these processes seem in *Scolopendra*, they may without difficulty be homologised with those of Annelids, the differences being due to the great development of yolk in the Myriopods. In *Scolopendra* the method of formation of the blastoderm is to be regarded as due to a modified epibole of yolk-laden macromeres by yolk-free micromeres. As in Annelids and in Arthropods in general, it is possible to divide the body into three regions, a head-region or acron (= prostomium of Annelids), which is without appendages or cœlomic cavities, a terminal telson (= end-segment of Annelids), of which the same is true, and between these extremes a series of metameres furnished, during embryonic life at least, with paired appendages, with paired cœlomic cavities, and with paired ganglia. In *Scolopendra* there is also for a long period an undifferentiated zone between the last (30th) metamere and the telson, which is homologous with the zone of budding in lower forms. The author's results lend no

* Zool. Anzeig., xxiv. (1901) pp. 422-33 (9 figs.).

† Zoologica, Leipzig, xiii. (1901) pp. 1-244 (8 pls. and 42 figs.).

support whatever to the suggestion that the coelom-sacs of Myriopods are enterocoelic in origin, as in Annelids the coelom arises by the splitting of the mesoderm. In *Scolopendra* there are two kinds of mesodermal lymphoid organs, (1) the lymph-bodies of the head which are present only in the embryo, and (2) apparently replacing these, the lymphatic bands (*filaments acides* of Daboseq) of the adult. The author brings forward reasons for believing that the latter are morphologically as well as physiologically the equivalents of the nephridia of Annelids, while he further compares the cephalic lymph-bodies (= the sub-oesophageal bodies of insects) to the green glands of Crustacea, and with less certainty to the primitive kidneys of Annelids. Again, the author finds that the brain of *Scolopendra* consists of a preoral syncerebrum, homologous with the Annelid brain, plus three pairs of postoral ganglia. The "head" in Diplopoda, Chilopoda and Insecta consists of the acron united to six anterior metameres. This is true also of the Crustacea, but in the Arachnoidea and Gigantostrea another segment is added. A new classification of Arthropods is proposed, based in part upon the number of segments composing the head, and in part upon the nature of the appendages. In regard to the question of the origin of the mid-gut in Myriopods and Insects generally, the author considers that in *Scolopendra* and in many Apterygota the primary endoderm is partly converted into embryonic yolk-cells, and partly forms the permanent endoderm lining the mid-gut; but in the majority of Pterygota the primary endoderm is entirely converted into the embryonic yolk-cells, and the mid-gut is therefore lined by ectoderm. But this does not affect the fact that the mid-gut is phylogenetically homologous throughout these groups.

5. Arachnida.

Bites of *Latrodectus 13-guttatus*.*—L. Bordas has made a number of experiments in regard to the bites of this spider, popularly called *malmignatte*. In some countries, e.g. Corsica, they are believed to be fatal to man and large animals; the author finds no evidence of this. Bites on arm and wrist were followed by slight inflammation and much itching, but by no serious symptoms. To insects—flies, beetles, Orthoptera—the bite is rapidly fatal. The author describes the structure of the poison-glands.

Monograph on Spiders of Germany. †—W. Bösenberg begins what promises to be a very valuable monograph. The first part gives detailed diagnostic tables, and goes on to a description of the members of the families Euetriodæ, Uloboroidæ, Tetragnathoidæ, and Theridioidæ.

In the introduction the author directs attention to the great variability that makes identification often difficult. Abundant food may double the usual size, and colour varies according to locality. Experiments with *Tegeneria domestica* and *Theridium* corroborated this observation. In general terms it may be said that in dark places the characteristic colour and markings tend to be lost. Even the genital appendages change not a little according to the functional state.

* Comptes Rendus, cxxxiii. (1901) pp. 953-5.

† Zoologica, xiv. Heft 35¹ (1901) 93 pp., 10 pls. and 11 figs.

e. Crustacea.

Glands of Alimentary Canal in Decapoda.*—Dr. Hans Wallengren, by the use of nitrate of silver, has been successful in making a number of preparations of the alimentary canal in Decapod Crustacea, which show clearly the glands called intestinal by various authors. He finds that these occur freely in the wall of the œsophagus, as well as on such outgrowths of the mouth region as upper lip and labium, and also on the wall of the hind-gut. The function of the glands remains uncertain. Perhaps those of the œsophagus are salivary, and those of the hind-gut, mucous glands, but all may be mucous glands.

Colours of American Crayfish.†—W. J. Kent finds that in *Cambarus immunis*, and some other species, the colours generally resemble those of the surroundings, except that the colour of those living in shallow water in small streams is red. This fact, the author believes, is due to the influence of light, which has the power of turning the pigment of the crayfish red. He finds confirmation of this view in the fact that in *C. diogenes*, which is a burrowing species, the colour is varied in spring, but in autumn, after exposure to the light throughout summer, nearly all the individuals are red. In confinement the crayfish acquire, though slowly, the colour of their surroundings.

Mysis relicta in Ireland.‡—W. F. de Vismes Kane, in an interesting paper, reports the abundant occurrence of this species in Lough Neagh and Lough Erne, into which it was doubtless introduced by the Glacial sea.

Life-History of Monstrillidæ.§—A. Malaquin, in the course of some observations on the reproduction of the Annelids *Filograna* and *Salmacyna*, unexpectedly obtained, instead of the trochospheres for which he hoped, a cloud of Copepoda of the family Monstrillidæ. These emerged from the bodies of the Annelids, and as the life-history has not hitherto been adequately worked out, he gave up his first research and devoted himself to the Copepoda. The results, of which the following are the most striking, are published in an extensive memoir. From the eggs contained in the ovigerous sacs of the free-swimming female, nauplii develop, which possess the normal number of appendages. Of these, the first have the usual structure, the second are slightly modified, while the third pair (mandibles) are entirely converted into organs of fixation. There is no alimentary canal, but the eye is present and well developed. There is a distinct nerve-mass, and the muscles are striated. These nauplii attach themselves to their host by means of their piercing mandibles, and lose their cuticle, appendages, and furcal bristles, while the central mass of cells only penetrates first the skin, and then one of the blood-vessels of the host. During this period of penetration, the only differentiated part of the body is the nauplius eye, which is retained, but even this gradually breaks down, so that the Copepod within the blood-vessel has returned to an undifferentiated embryonic condition

* Zeitschr. wiss. Zool., lxx. (1901) pp. 321-45 (12 figs.).

† Amer. Nat., xxxv. (1901) pp. 933-6.

‡ Ann. Nat. Hist., viii. (1901) pp. 391-7.

§ Arch. Zool. Expér., ix. (1901) pp. 81-232 (7 pls. and 6 figs.).

—a phenomenon to be compared with that observed by Delage in the case of *Sacculina*.

In the case of the Monstrillid, a secondary process of development begins as soon as the blood-vessel is reached, a cuticle is formed, and two appendages appear in the form of unjointed tentacles, which are bathed by the blood of the host, and constitute the organs of nutrition. At the same time the cells of the body become differentiated into layers. Later a pair of jointed antennæ appear in front of the "tentacles," showing that these are to be regarded as the second antennæ. As at this stage the body is unsegmented, and appendages homologous with mandibles are sometimes present, this must be regarded as a second nauplius stage. From this point the development takes place normally, save that that of the alimentary canal ceases with the appearance of the stomodæum. Finally the adult leaves the body of the host, and enters upon the brief free-living life.

It is interesting to note that the eggs of the Monstrillid chiefly studied—*Hæmocera danæ*—are green, and, according to the author's coloured plates, the same tint as the green blood of the Annelid host.

Reaction of *Daphnia* to Light.*—C. B. Davenport and W. B. Cannon have experimented on the effect of light on this crustacean. They find that it moves, under certain conditions, from a strong light to a feeble one, but this does not depend upon the intensity of the illumination, but only upon its direction. In other words, *Daphnia* is phototactic. A diminution of the intensity of the light only affects the swiftness of the movements to a slight extent. Thus, when they diminished the intensity to one-fourth the crustacean took 18 per cent. more time to move over a given distance than when the light had the original intensity.

Spermatogenesis of *Oniscus asellus*.†—M. Louise Nichols finds that in this form the spermatogenic chromosomes are joined together in pairs in the synapsis to form sixteen bivalent chromosomes, and at this stage a splitting of the chromosomes occurs. In the structure and mode of origin of the bivalent chromosomes two main types may be distinguished, (1) that in which the component chromosomes lie end to end, and (2) that in which they lie side by side. In the first maturation division univalent chromosomes are separated, so that the division is reducing. The idiozome is only discernible for a short time during the prophase of the first spermatocyte. The nucleolus of the spermatogonium disappears shortly after the dissolution of the nuclear membrane, while that of the spermatocyte first discovered in the synapsis persists throughout the division. The spermatids become associated in groups to form colonies of nuclei lying in a common plasma. Within the latter arise bundles of fibres of great length, whose connection with the nuclei could not be demonstrated, as well as single fibres of greater delicacy which are continuous with the nuclei. The mature sperm colony consists of a variable number of filamentous nuclei contained, together with the bundle of cytoplasmic fibres, in a tenuous sheath, which is flagellate at its anterior extremity.

* Journ. Physiol., xxi. (1901). See also Bot. Centralbl., lxxxvii. (1901) p. 486.

† Amer. Nat., xxxv. (1901) pp. 919-26 (8 figs.).

Structure of Male in Genus *Cambarus*.*—J. Arthur Harris discusses the "dimorphism" which has been described in the males of the species of this genus. He has been able in the first place to entirely confirm Faxon's statement that the two forms alternate in the life-history of the individual. Of the two forms, the first is definitely male and capable of copulation, while the second approaches the female in type, and from the shape of the copulatory abdominal appendages is probably incapable of sexual union. In *C. immunis* the animals emerge from their winter burrows in the first form, and retain this form till about the end of April when they moult and appear in the second form. The length of time during which this form is retained is not perfectly definite, but in the late summer and in autumn another moult occurs, and the first form reappears. To these statements there are, however, exceptions, the regular alternation being absent in some adult individuals. No very marked differences could be made out between the testes of the two forms, but the author is on the whole disposed to believe that the greater part of the regeneration of the sexual elements takes place during the period in which the body has the second form.

New Blind Crustacea.† — O. A. Sayce records the very interesting discovery of three new Crustacea from the same fresh-water runlet in the district of Gippsland, Victoria, Australia, which, though not closely allied, resemble one another in the absence of eyes. The streamlet is in a densely wooded region in which the thick undergrowth largely shuts out the direct rays of the sun but, in addition to the blind forms, contains numerous specimens of a crayfish (*Astacopsis*) and an Amphipod (*Atyloides*), both of which have normal eyes and occur elsewhere. The new forms are two Isopods, not nearly related (*Phreatoicoides gracilis* and *Janirella pusilla*), and an Amphipod (*Niphargus pulchellus*), all of which have been described by the author elsewhere. All are perfectly blind, are of a uniform white or pale yellow colour, and appear, as contrasted with related forms, to have the antennæ elongated. Except in *Janirella* the body further appears to be remarkably slender, a common character in subterranean forms. The interesting point is that the author was not able to find any subterranean waters in the locality, and the geological characteristics of the district appear to negative the idea that any large caves can occur in the district.

Annulata.

Seasonal Histolysis in Polychæts.‡—G. Bohn describes some of the autumnal troubles of *Arenicola* and *Pectinaria*, such as disappearance of gills and perforations of the skin. There seems to be a seasonal histolysis, and the author believes that one of the determining conditions is an "alkaline intoxication" due to red Algæ, such as *Plocamium coccineum*, and this seems to have for its consequence an absorption of carbonic acid on the part of the animal. [Here the author's physiology seems to us somewhat elliptical.]

"The histolytic changes exhibited by Annelids in autumn, and

* Zool. Anzeig., xxiv. (1901) pp. 683-9.

† Ann. Mag. Nat. Hist., viii. (1901) pp. 558-64.

‡ Comptes Rendus, cxxxiii. (1901) pp. 646-8.

accompanied by circulatory and respiratory troubles of toxic origin, may have as their consequence, either the dissemination of the eggs by a pelagic form (epitoky), or simply the expulsion of the eggs by a rupture in the integument of a sedentary form (matricidal epitoky.) These facts show once more the great importance of external and internal intoxication in the life-history of organisms, and in particular the importance of the rôle of marine Algæ."

Sensory Cells in Proboscis of Polychæts. *—Hans Wallengren has studied the proboscis in a number of genera, and finds that sensory cells are restricted to the papillæ. In *Nephtys* and *Phyllodoce* they are radially arranged, but not integrated into multicellular organs as in *Glycera* and *Goniada*. The sensory cells penetrate the cuticula peripherally, and in *Glycera*, if not also in others, they terminate in a kind of brush. It seems likely that these free ends are retractile. Proximally the cells may extend unbranched towards the central organ (as in *Nephtys*), or they may divide like the letter T below the base of the papillæ. The subcutaneous nerve-plexus is very richly developed in the wall of the proboscis. It seems likely that the function is tactile, or both tactile and gustatory.

Commensal Oligochæte in New England. †—Prof. M. A. Willcox describes a small Oligochæte, probably identical with *Chætogaster limnæi* von Baer, which occurs on snails belonging to the genera *Physa* and *Planorbis*, in a small stream at Willesley. The worms occur apparently free on the head and within the respiratory cavity of the snail, and are probably not parasitic. They reproduce by fission, and chains consisting of three persons are frequent, but it is rare to find colonies with more persons than this. The worms differ from the European forms chiefly as regards the number and arrangement of their setæ, but it is uncertain whether this does or does not constitute specific difference.

Nematohelminthes.

Phagocytic Organs in Nematodes. ‡—E. P. Golowin has made a detailed study of the tuft-like bodies or phagocytic organs in many different nematodes, both parasitic (*Ascaris lumbricoides*, *A. spiculigera*, *A. ostroumovi* sp. n. from the sturgeon (*Acipenser ruthenus*), *Filaria papillosa*) and free-living forms,—*Oncholaimus vulgaris*, *Symplocostoma longicolle*, *Anticomma pellucida*, *Anguillula oxophila*, &c. In the large parasitic forms the tuft is known to consist of a large central nucleus and small roundish "terminal organs," sometimes with chromophilous central corpuscles. In the small free-living forms there are ovoid organs with a large reticular nucleus and numerous rod-like or roundish chromophilous granular bodies, sometimes with small end-organs on the external surface. They lie on the inner side of the musculature, sometimes in groups, sometimes distributed over the whole body, and in *Cyatholaimus ocellatus* in longitudinal rows. In the small forms *intra vitam* coloration of the phagocytic organs alone—apart from the rest of the body—was successfully effected.

* Jenaische Zeitschr. Naturwiss., xxxvi. (1901) pp. 165-80 (1 pl.).

† Amer. Nat., xxxv. (1901) pp. 905-9.

‡ Beobachtungen von Nematoden, Kasan, 1901, 149 pp. and 3 pls. (in Russian). See Zool. Centralbl., viii. (1901) pp. 751-2.

Chromatin-Reduction in Somatic Cells.*—Kristine Bonnevie finds that this interesting process occurs (as O. Meyer described) in *Ascaris lumbricoides*; but no hint of it was seen in *Strongylus paradoxus* or *Rhabdonema nigrovenosa*. The process was seen in four generations of cells; each chromosome breaks up in the prophase into three spherules, of which the two lateral ones are thrown off. The remaining middle piece does not break up into small particles, as in *A. megalcephala*. It is also noted that the position of the second polar body is quite irregular, and that it is sooner or later absorbed by the cell to which it is apposed.

Strongyloides intestinalis.†—Dr. R. P. Strong records a fatal case of infection with this Nematode in Baltimore, U.S.A., in a man of German birth, and four other cases (one fatal) in Manila. In no case did he find embryos in the blood, nor eggs nor adults in the feces, though embryos of the rhabditis type occurred there abundantly. These embryos gave rise to free-living males and females producing filariform larvæ, but in some cases this generation was omitted, and the rhabditiform embryos gave rise directly to filariform larvæ. The adult females of the strongyloid type were found abundantly in the duodenum and jejunum of the host. No males of this generation were found. No suggestions are made as to the means of infection.

Heterodera schachtii.‡—Willot found that in 1901 the brown female nematodes in the beetroot, which are usually dead and empty in July and August, were full of living eggs, embryos, and larvæ even in September. He sees in this confirmation of what he indicated in 1890, that warmth and moisture cause the dead females to swell and rupture, allowing the larvæ to escape. The prolonged drought of last summer hindered this mechanical rupture of the vaginal canal.

Platyhelminthes.

vian Cestodes.§—O. Fuhrmann discusses the structure and relations of several new Cestodes which have been recently described by various authors. He especially criticises descriptions by Sintzin || of various new forms, rejecting entirely two new genera (*Trichocephaloides* and *Copesoma*) founded by this author for tape-worms which in the one case at least are not even new species.

Germinal Layers in Cestoda.¶—G. Saint-Remy discusses the difficulty of bringing the early stages in the development of Cestodes into line with those of other Metazoa. If one insists on finding the two primary germinal layers in Cestodes, the elements of the external envelope, the "vitellophagous cells," have most claim to be regarded as endoderm. But this is far-fetched, and the author prefers to say that the abbreviated development of these parasites has resulted in

* Jenaische Zeitschr. Naturwiss., xxxvi. (1901) pp. 275-88 (2 pls.). See Zool. Centralbl., viii. (1901) p. 640.

† Johns Hopkins Hosp. Rep., Baltimore, 1901, pp. 91-132 (2 pls.).

‡ Comptes Rendus, cxxxiii. (1901) p. 703.

§ Centralbl. Bakt., xxix. (1901) pp. 757-63.

|| Arb. Zool. Lab. Univ. Warschau, 1896 (Russian).

¶ Arch. Parasitol., iv. (1901) pp. 333-52. See Zool. Centralbl., viii. (1901) pp. 748-9.

(mechanical) conditions which have inhibited the distinct formation of the primary germinal layers.

Position of Ligula.*—Dr. O. von Linstow gives a diagnosis of the genus:—In the dorsal and ventral median line a longitudinal groove; rudimentary dorso-ventral suckers without special musculature; no formation of proglottides, "segmentation" absent in the larva and restricted to the anterior third of the body in the adult; gonads as in *Bothriocephalus*, but compressed into closely compacted successive groups to which the segmentation does not correspond; cirrus, vagina, and uterus open beside one another in the ventral median line in a genital sinus in a transverse row (the vagina in the middle, the cirrus sometimes right, sometimes left); excretory vessels in the larva in the medullary and cortical layers, in the sexual form two sets of longitudinal vessels in the cortical layer.

Therefore, he says, the genus *Ligula* belongs to the Bothriocephalidæ along with the nearly related *Schistocephalus*.

Life-history of Distomum folium.†—D. Th. Ssinitzin has found that the first host of this fish-parasite is *Dreissensia polymorpha*. The miracidium probably enters with the water of respiration; it at least finds its way to the gills, there loses its covering of cilia, and by peristaltic contractions of the body forces its way into the interfoliar space of the gills. There it becomes a sporocyst and within the body germ-cells develop, and produce 12–14 new sporocysts. The process is repeated several times, until the interfoliar spaces of the host's gills become crowded with the parasites. The last generation includes forms of large size, with the cells of the body-wall crowded with drops of fat, and containing cercariae in various stages of development. Absolute proof of the identity of these with *D. folium* was obtained by removing specimens from the sporocysts, and rearing them in a nutritive solution. Successful infection experiments were also made with fish in aquaria. Full details are promised later.

Early Stages in Development of Polystomum integerrimum.‡—Dr. H. Halkin finds that there is the usual period of maturation resulting in the elimination of two polar bodies; that these, though very small, are formed from a karyokinetic figure occupying the whole diameter of the ovum; that the first maturation division is characterised by the presence of central corpuscles in the form of long bent rods (divided or not), while the second division shows none; that the pronuclei, lobulated from the start, persist throughout, enclosing the nucleoli from their formation, and subsequently exhibiting a chromatic network; that the first division figures show large central corpuscles, spherical and slightly stainable; that the typical number of chromosomes is twenty; and that the aspect of the vitellus is characteristic for each of the three successive mitotic figures which are formed in it.

The cleavage is unequal and "adiaphorogenetic"—a term used by Hallez to express the fact that the blastomeres are not from the first specifically differentiated (e.g. into ectoderm and endoderm). It may be permitted to us to hope that the ungainly term will have a short life.

* Zool. Anzeig., xxiv. (1901) pp. 627–31 (1 fig.). † Tom, cit., pp. 689–94.

‡ Arch. Biol., xviii. (1901) pp. 291–363 (5 pls.).

The blastomeres have at first but little coherence, yet the reciprocal position of the first cells is typical. At first there is no apparent plan of symmetry, but later on there is bilaterality. In the first blastomeres the nuclei are lobulated, but as the cells become smaller the nuclei are "regulated," though there may be considerable diversity of size even in the same embryo. There seems to be an epibole resulting in a solid mass, but it is impossible to distinguish germinal layers. Around the ellipsoidal solid mass there is differentiated an enveloping layer of flat cells.

As to organogenesis, the solid mass which forms the larva gives rise to (ectodermic) bulb, cerebral ganglion, sense-organs, and hooks, and to the (endodermic) wall of the gut, and to presumably mesodermic elements occupying the rest of the space. The gut arises from a hollowing (*creusement*) of the solid rudiment; its primitive dorsal orifice is different from the definitive ventral orifice; there is at first a complete tube as in *Hirudinea*. Complications in the gut appear later, but in the larva, as in the adult, there are glands annexed to the pharynx. There is an anterior hint of a cœlomic cavity, primarily in communication with the gut. The hooks have a twofold origin,—(a) a deep part arises in a sort of follicle, (b) the superficial part is cuticular. The cuticle arises from a complete investment whose cells go further and further apart, remaining connected by a delicate membrane. Among the cells some are differentiated into ciliated elements with particular localisation.

Fish Parasites.*—Dr. Edwin Linton gives a list of fish parasites from the Woods Holl region, with their hosts. A number of forms are described, amongst which are twelve new species, seven of which belong to the genus *Distomum*. Some notes on certain pathological conditions in the hosts are also given.

The same author † gives an annotated list of the parasites of Woods Holl fishes which have been previously described by him in various papers. Analytical keys for the determination of genera of Cestodes and species of Distomes mentioned in the paper—and there is a goodly list—are added. Notes on the food of the fishes examined for Entozoa are also given.

Incertæ Sedis.

Development of *Phoronis ijimai*. ‡—Iwaji Ikeda finds that this species occurs abundantly in shallow water near the Misaki Marine Biological Station, and breeds from about November to May or June. The eggs and early embryos occur in embryonal masses attached to the lophophore of the adult, while four kinds of *Actinotrocha* larvæ were found in the surface waters of the inlets near the station. The abundance of the material, especially as regards early stages, enabled the author to make some observations on fertilisation and segmentation. He finds that in *Ph. ijimai*, the oogonia fall into the body-cavity by the dehiscence of the ovarian wall, and develop there until they reach the state of primary oocytes. They then travel gradually upwards to the region of the nephridia, and finally leave the body by these and are

* U.S. Fish Commission Bulletin, 1899, pp. 267-304.

† Tom. cit., pp. 405-92.

‡ Journ. Coll. Sci. Tokyo, xiii. (1901) pp. 507-92 (6 pls.).

fertilised externally. Segmentation was not very regular, the blastomeres frequently not dividing simultaneously, so that odd numbers of cells occurred. The "plasmic corpuscles" described by other authors were found within the advanced blastula, and shown to be distinct from the mesoblast cells. In regard to gastrulation, the author finds that both the anterior diverticula and the ventral groove are simply temporary remnants of the original mesentoblast, and sooner or later split into mesoblastic and entoblastic cells.

In regard to the Actinotrocha, it is probable that the four forms found near Misaki represent as many species of *Phoronis*; the four types are described by the author in detail. The author believes that Masterman's "oral and pharyngeal grooves," compared by the latter to the gill-slits of Chordata, are artifacts. The body-cavities of the larva are not enterocœlic but schizocœlic in origin, and do not genetically correspond to those of the adult. The preoral cavity of the larva largely disappears in the adult, the collar-cavity becomes a vascular space in the adult, while the trunk-cavity only of the larva persists as the infraseptal cavity. The author does not find that, as stated by Masterman, the canals of the nephridia open into the collar-cavity in the larva, the nephridia seem to him to end blindly. The paper contains numerous other details in regard to the structure of the Actinotrocha and the process of metamorphosis, but for those the original paper must be consulted. The author does not make any suggestions as to the affinities of *Phoronis*.

New Species of Phoronis.*—Harry Beal Torrey has examined five specimens of this genus from Humboldt Bay, California, and three from Puget Sound. This is the first time *Phoronis* has been recorded from the Pacific, and all the specimens prove to belong to one species, described as *Ph. pacifica*. The lophophore is spirally coiled with $1\frac{1}{2}$ –2 complete turns, the tentacles number 170–200, the lophophore organ when present is very variable in form, and may be absent, the tube is straight, cylindrical, and encrusted with sand, the sexes are possibly separated. The material was not well preserved, but it was made out that the longitudinal nerve-trunks unite across the median line between mouth and anus. Just beneath the median longitudinal blood-vessel there is a ridge of thickened epithelium in the descending limb of the digestive canal.

Free Phase in the Life-Cycle of Orthonectids.†—M. Caullery and F. Mesnil think that they have found evidence to prove that there is a free phase in the life-history of Orthonectids,—a phase in which the female is fertilised by the male, and in which the ova develop into free-living embryos. Eventually, the embryos invade new hosts and assume plasmodial form.

From observations on *Rhopalura ophiocomæ* (from *Amphiura squamata*) the investigators conclude that there is an alternation of (1) a parasitic, sporocyst, or plasmodial phase producing males and females; and (2) a free-living phase of non-sexual embryos which become plasmodia after invading a new host.

* Biological Bulletin Boston, ii. (1901) pp. 283–8 (5 figs.).

† Comptes Rendus, cxxxiii. (1901) pp. 592–3.

Echinoderma.

Hermaphroditic Holothurian.*—Hjalmar Théel describes the hermaphroditism of *Mesothuria intestinalis*. The genital tubules, developed on the "genital basis" from in front backwards, occur in male and female sets. In the "genital strand," which is the foundation from which the genital basis and the transitory genital tubules arise, there are young germ-cells. The older genital tubules with unused ova and sperms degenerate and show much phagocytosis. Ludwig notes in a report on Théel's paper that hermaphroditism also occurs in *Cucumaria crocea*, *C. lævigata*, and *Pseudopsolus macquariensis*.

Physiology of Echinoderms.†—Prof. L. Cuénot has made a series of observations on certain points connected with the physiology of Asteroids. He finds that the amœbocytes multiply only by direct division; there is no organ having for its function the production of amœbocytes. The digested food is absorbed by a system of lacunæ, lying on the radial cæca, which communicate with the ovoid gland. In *Asterias rubens*, two longitudinal lacunæ lie on each of the ten radial cæca. All these lacunæ unite together, and pass ultimately into the ovoid gland (plexiform organ); their contents probably there undergo some change, and then pass by the nutritive lacunæ to the oral and aboral surfaces, where they probably reach the organs by means of osmosis through the walls of the lacunæ. In starfish and sea-urchins, two kinds of excretory cells exist, the indigo-nephrocytes, represented by the epithelium of parts of the digestive tube, and the carminate-nephrocytes, represented by the epithelium of the cœlom, of the perilacunar and ambulacral cavities, and of Tiedemann's bodies, and by the free amœbocytes and the internal cells of the ovoid gland. It is probable that the excretory substances produced by the cells excreting carminate of ammonia fall into the cœlom, and are taken up by the phagocytes; as already observed by Durham, the phagocytes are capable of leaving the body by means of the skin-gills, whose walls they cross.

Cœlentera.

Regeneration and Regulation in Renilla.‡—H. B. Torrey finds that colonies of *Renilla* readily regenerate lost parts. They exhibit a strong polarity; when a peduncle is removed by a transverse cut an axial polyp is never regenerated in its place, and *vice versa*. There is an anterior limit beyond which anterior pieces do not regenerate posteriorly, and a posterior limit beyond which posterior pieces do not regenerate anteriorly. These correspond to the limits of the budding zone. The colonies regulate themselves in a plastic fashion when cut in certain ways, obliquely, for instance. It is thus possible to obtain two new colonies, one of which retains the original peduncle with a lateral polyp displaced into the position formerly occupied by the axial polyp. Whether the colony develops symmetrically around this new axis is not known. If the oblique cut makes with the colonial axis an

* Bih. Svensk. Vet.-Ak. Handl., Bd. 27, Afd. iv. No. 6 (1901) 38 pp., 2 pls., and 12 figs. See Zool. Centralbl., viii. (1901) pp. 717-8.

† Arch. Zool. Expér., ix. (1901) pp. 233-59 (1 pl.).

‡ Biol. Bull., ii. (1901) pp. 355-6.

angle larger than 45° , there is no displacement of the lateral polyp, the extirpated axial polyp regenerating as though it alone had been removed by a transverse cut. When a lateral group of polyps is removed by a longitudinal cut, it regenerates a new peduncle approximately at a right angle to the cut surface, and approximately in the axis of the chief lateral polyp of the group. The futuro of such pieces is unknown. This is a case of heteromorphosis.

Multicellular Sense-Organs in *Syncoryne sarsii*.*—E. Citron has studied what Schulze describes as palpoceils on the tentacles of this hydrozoan, and finds that each consists of a group of (at least two) sensory cells ending peripherally in a stiff pointed filament, and basally in a nervous plasmic process. The adjacent covering cells of the ectoderm form a conical protection for the sensory group, and this is perforated by the projecting filament.

Development of *Gonothÿræa loveni*.†—J. Wulfert notes in a preliminary communication the following points. The migratory primitive sex-cells appear *very early*, soon after the fixing of the planula. They arise from interstitial ectoderm cells, and migrate eventually to the gonangia; in older stocks there is a continuous procession. The form and position of the ovum in the gonophore is variable. Two polar bodies are given off. Fertilisation occurs in two ways (not mentioned), and the cleavage is of two types connected by intermediate modes. A cœlblastula is formed and the endoderm is established by multipolar immigration. But in the second type of cleavage some cells are internal at about the 24-cell stage, so that cleavage and endoderm-formation cannot be rigidly separated. The segmentation-cavity is filled up with endoderm cells, and the embryo becomes a solid planula. This settles down, becomes a flat disc, and buds off a hydrocaulus from its centre.

Revision of Genus *Sertularella*.‡—Cl. Hartlaub has tried to put this genus in order. There are about 90 species, mostly littoral, predominantly Arctic and Antarctic (47 sp.). There is great diversity in bathymetrical distribution, e.g. *S. tricuspidata* from 11 to 2438 metres, and *S. polyzonias* from the shore to 509 metres. The specific tables show that there is great variability in details. Two groups are recognised,—with a 3-valved operculum (*tricuspidata*) and with a 4-valved operculum (*rugosa-polyzonias*). These groups are also marked by differences in the position and form of the gonothecæ.

Porifera.

Gemmation of *Tethya*.§—Dr. Otto Maas has studied the methods of reproduction of this interesting sponge, which is not known to produce sexual elements. It periodically gives rise to buds, which are liberated from the parent, and float away as young sponges, but the exact origin of these has not hitherto been ascertained. Maas finds that they do not arise from parthenogenetic ova, but nevertheless offer

* Zool. Anzeig., xxiv. (1901) pp. 625-6. † Tom. cit., pp. 626-7.

‡ Abh. Nat. Ver. Hamburg, xvi. (1901) 143 pp., 6 pls., and 56 figs. See Zool. Centralbl., viii. (1901) pp. 567-8.

§ Zeitschr. wiss. Zool., lxx. (1901) pp. 263-88 (2 pls.).

an interesting parallelism in development to ova. Ova in sponges arise normally from clusters of archæocytes, but of these certain lose their individuality, and are sacrificed to feed the one successful ovum-cell. The buds of *Tethya* arise from similar groups of archæocytes, but here the cells for the most part retain their individuality, though even here certain of them fuse together to form a few large complexes similar to blastomeres, within a chitinoid capsule. A further even more striking resemblance between developing bud and developing egg is that, before the sponge-bud becomes functional, its cells become arranged in two layers, an inner gastral, and an outer dermal, and the development of the central cavity and flagellated chambers takes place according to methods comparable to those exhibited by other groups of sponges. The method of formation of the chambers, whether lacunar or parenchymatous, depends in sponges in general on the time at which histological differentiation takes place. In Calcareous Sponges this differentiation occurs first during or after fixation; in Siliceous Sponges often in the larvæ or even in the embryo. In *Tethya* the method of development approaches the one condition or the other, according as the bud is liberated early or late. A striking difference between the development of the buds of *Tethya*, and of the embryos of other sponges, lies in the fact that in the latter case the flagellated cells, which are not here temporarily required for locomotor purposes as in the larvæ of other forms, develop late instead of early, and the remarkable metamorphosis of larval development is therefore here absent. But this mode of development by buds must be looked upon as secondary and not primary, as derived from a sexual condition.

Suberites domuncula.*—J. Cotte discusses the commensalism between this interesting sponge and the hermit-crab, but, in particular, the chemical composition of the body. It is very rich in bromine, with traces of iodine; without iron or arsenic; with some manganese along with the silicon in the ash. He found no mucin, uric acid, fat, or glycogen, and very little starch. The pigment is regarded, with Krakenberg, as a kind of tetronerythrin; it is not due to symbiotic Algæ; it is usually orange-yellow, but may be blue on the surface.

A study of the expressed juice showed the presence of many kinds of ferments:—oxydising (?), diastatic, fat-splitting, proteolytic, &c.

Prctozoa.

British Fresh-water Rhizopods.†—Prof. G. S. West contributes notes on 68 species of Rhizopods (including Heliozoa) which he has observed in Britain. He describes as new species *Cochliopodium longispinum*, *C. minutum*, *Gromia stagnalis*, *Acanthocystis paludosa*, &c.; and establishes a new genus *Leptochlamys*, undoubtedly near to Penard's *Cryptodifflugia*. Some of the observations in the paper relate to the habits and structure of well-known forms; others are descriptive of peculiar variants in common species; others again are records of rarer and less-known species. A point of considerable interest is the presence

* Notes Biologiques sur le *Suberites domuncula*, Paris, 1901, 128 pp. See Zool. Centralbl., viii. (1901) p. 561.

† Journ. Linn. Soc. Zool., xxviii. (1901) pp. 308-42 (3 pls.).

of a perforation at the apex of the shell of some forms of *Difflugia acuminata*. The paper is a very welcome contribution to a little-worked field of British Zoology.

Discoloration of Water by Gonyaulax.* — T. Nishikawa investigated streaks and patches of brownish-yellow water emitting an unpleasant odour in the Bay of Agu in the southern part of the province of Shima, on the Pacific side of the Hondo. The "red-tide," as it is called, is due to *Gonyaulax polygramma* Stein, one of the Peridiniaceæ (identified by Mr. George Murray), of which there may be 800-3000 in a drop. Nishikawa refers to previously recorded cases of unusual coloration, due to *Peridinium sanguineum*, *Glenodinium rubrum*, and *Gymnodinium*. The appearance of the red-tide is associated with great mortality among fishes, molluscs, shrimps, &c., but it is also certain that the pearl oysters feed upon the *Gonyaulax* forms as they usually do on Bacillariaceæ. It is probable that the injurious effects are indirect.

Zoospore and Spermatozoon.† — Prof. P. A. Dangeard finds a remarkable confirmation of his theory of sex in the minute homologies which seem to exist between the zoospores of *Polytoma uella* and the spermatozoa of various Metazoa. In *Polytoma* the locomotor apparatus consists of two flagella. At the base of these is a blepharoplast or small thickening of the ectoplasm, which is slightly chromatic. From this there runs towards the nucleus a chromatic thread, to which he gives the name of *rhizoplast*, which is inserted in the nucleus by means of a little swelling, to which he gives the name of *condyle*. All these structures are also to be found in spermatozoa, or have been described there by various authors. Dangeard believes that the zoospore of *Polytoma* is to be regarded as the ancestor of the Metazoon sperm, and considers that the resemblance described above confirms his conclusions. As, however, the structures described in *Polytoma* are mere transitory differentiations of the protoplasm comparable to the flagella, while those of the Metazoon sperm have been ascribed to the centrosome, the author is of opinion that the centrosome of the sperm does not play the important part attributed to it by embryologists.

Phylogeny of Protists.‡ — A. Scherffel discusses some of the difficult questions connected with the relationships of the lower organisms, and especially their relation to the Algæ and Fungi. He does not believe that nearly related Protists have independently acquired chromatophores, but maintains that the chlorophyll-containing and colourless forms have followed throughout independent, though it may be parallel, lines of evolution. But at the same time he admits that members of chlorophyll-containing groups may lose their chlorophyll, as an adaptation to special conditions. Examples of such forms are the colourless forms of the Euglenoids, the *Polytomæ* among the Volvocinæ, and so on.

Silicoflagellate Protozoa.§ — E. Lemmermann has obtained from various sources plankton nettings containing specimens of the organisms described by Borgert as *Silicoflagellata*, and gives a summary account of

* Annot. Zool. Japon, iv. (1901) pp. 31-4.

† Le Botaniste (Dangeard), vii. (1901) pp. 269-72 (3 figs.).

‡ Bot. Ztg., viii. (1901) pp. 143-58 (1 pl.).

§ Ber. Deutsch. Bot. Ges., xix. (1901) pp. 247-71 (2 pls.).

the group. In several cases the hard parts only were available, and it is on the basis of these that the genera and species are defined. The author recognises five genera, *Mesocena*, in which the skeleton occurs in its simplest form, *Dictyocha*, *Distephanus*, *Cannopilus*; in all these the skeleton is constructed out of hollow rods of silica, while in *Ebria* the rods are solid. All the species are very variable, and on the whole the peripheral spines seem longer in the forms from the colder regions of the sea than in those from the warm regions.

Megastoma entericum Grassi.* — Prof. Rudolph Metzner has obtained an abundant material of this parasite from the intestine of the rabbit, and has been able to make some observations on the finer details of structure. The organism in life has the body prolonged into a long vibratile tail furnished with two terminal flagella. But in spite of its active movements, this tail is not the main organ of propulsion, the locomotor function being discharged by the "middle flagella" of the body. In addition to these two middle flagella there are two anterior and two lateral flagella. In each case there is a basal swelling, which is obviously the centre from which the movement starts. From these knob-like structures non-motile prolongations of the flagella extend inwards through the protoplasm. Internally there is not only a nucleus divided into two halves united by a bridge, but also in very many cases another body of variable form, lying near the insertion of the middle flagella. The author believes that the above-mentioned prolongations of the flagella constitute a system for the transmission of stimuli, which pass first to the "central body," and from it to the nucleus, thence, perhaps, to the middle flagella, the main organs of locomotion. The anterior, lateral, and caudal flagella may thus be regarded as a kind of feelers connected with a central organ. The author briefly compares these results with those of other investigators of other flagellates or of ciliated cells.

Trypanosoma in Fishes. † — A. Laveran and F. Mesnil describe *Trypanosoma remaki* sp. n. from a fresh-water fish (*brochet*), *Tr. soleæ* sp. n. from the sole (in four cases), and *Trypanoplasma borreli* g. et sp. n. from *Scardinius erythrophthalmus*.

New Microsporidian. ‡ — C. Vancy and A. Conte describe *Pleistophora mirandellæ* g. et sp. n. from the ovary of the fish *Alburnus mirandella*. There are small cysts forming microspores and large cysts forming macrospores (evaginating a very long filament in iodised water). All the spores have a nucleus like a double T at right angles to the longitudinal axis; this has been seen by the authors in *Henneguya tenuis*, *Glugea bombycis*, and *Nosema varians*. The eggs of the fish are invaded by amœboid forms which produce the spores. The microspores are more resistant, and probably spread to other hosts; the macrospores and the amœboid form probably spread on the host itself.

Sex-Elements in Stylorhynchus. § — Louis Léger makes another of his interesting communications on the reproduction of Stylorhynchid

* Zeitschr. wies. Zool., lxx. (1901) pp. 299-320 (1 pl.).

† Comptes Rendus, cxxxiii. (1901) pp. 670-5. ‡ Tom. cit., pp. 644-6.

§ Tom cit., pp. 414-7.

Gregarines. Within the cyst, one of the two Gregarines gives rise to flagellate gametes (*spermatozoa*), and the other to clear spherical *ova*. In fact, in a normal cyst there is a male and a female Gregarine; and the observer describes the differentiation and (anisogamous) conjugation of the gametes. A very remarkable fact is that the flagellate gamete—so-called spermatozoon—is relatively large, and bears with it the great part of the nutritive reserve, while the spherical gamete—so-called ovum—is much smaller, and with much less nutritive material. It seems like a strange by-path in the evolution of sex.

Two New Hæmogregarines from Fishes.* — A. Laveran and F. Mesnil report the discovery of *Hæmogregarina simondi* sp. n. from the sole (*Solea vulgaris*) and *H. bigemina* sp. n. in blennies (*Blennius pholis* and *Bl. gattorugine*). Hitherto the recurrence of true Hæmogregarines in fishes has been rather doubtful, but the two forms described and provisionally figured are in many ways like known Hæmogregarines, especially *H. ranarum* and *H. stepanowi*. As with all other Hæmogregarines, the source of infection is in the above cases unknown.

* Comptes Rendus, cxxxiii. (1901) pp. 572-7 (2 sets of figs.).



BOTANY.

A. GENERAL, including the Anatomy and Physiology of the Phanerogamia.

a. Anatomy.

(1) Cell-Structure and Protoplasm.

Influence of the Nucleus on the Growth of the Cell. *—A further series of experiments on non-nucleated cells of *Spirogyra bellis* have led J. J. Gerassimow to the following results.

The growth of cells containing an unusually large amount of nuclear substance exceeds the average growth of the ordinary uninucleated cell; the cell-walls, the chlorophyll-bands, and apparently also the protoplasm grow more energetically. The division of these cells is usually delayed, and does not commence until they have attained a larger size. Non-nucleated cells are capable of growing in length, though only to a small extent. Their turgor at first increases, diminishing when they die. The extensibility of their lateral walls is less than in the ordinary nucleated cells. Non-nucleated cells under the influence of the nucleus of adjoining cells grow for a longer period and more energetically than other non-nucleated cells. Cells which contain an unusually large amount of nuclear substance are capable of conjugating both with one another and with ordinary cells, whether one or the other is a male or female cell. The size of the resulting zygotes is directly proportionate to the size of the conjugating cells, and therefore to the amount of nuclear substance in them.

Reduction of Chromosomes in *Larix leptolepis*. †—Prof. C. Ishikawa has made the following observations.

The nuclei of the young pollen mother-cells are characterised by the presence of a loose knot; a rather large oval or round nucleole is usually found at this stage. At the next stage the separate chromosomes are well developed, and are usually united in pairs, of which there are twelve. They then contract; pairs often uniting at one or both ends and forming a variety of different figures. The stainability of the chromosomes gradually increases, while that of the nucleoles diminishes. The nuclear membrane and the nucleoles now disappear, and the pairs of chromosomes arrange themselves in the equatorial plane of the spindle. Then they disperse in pairs to the opposite ends of the spindle, forming different figures, finally separating from one another. The daughter-chromosomes take a U or V form, and gradually travel towards the two poles.

When they reach the poles the arms of the chromosomes separate from one another, twelve pairs being thus again formed. But this separation lasts only for a short time, for the separated arms again unite, not only at the broken, but also at the other ends, thus forming twelve ring-

* Bull. Soc. Imp. Nat. Moscou, 1901, pp. 185-220 (2 pls. and 3 figs.). Cf. this Journal, 1900, p. 475.

† Beih. z. Bot. Centralbl., xi. (1901) pp. 6-7.

shaped chromosomes lying close on one another. The chromosomes gradually disperse until they are evenly distributed through the nucleus. Many nucleoles are now visible, and cell-division commences. The chromatin elements gradually form a knot; the nucleoles decrease in number, but increase in size. In the daughter-nuclei the chromosomes again make their appearance in rings or in paired strings; the nuclear membrane disappears, and the nucleoles lose their stainability. The division of the daughter-chromosomes appears to take place in the same way as that of the mother-chromosomes.

Middle Lamella of Cells. *—C. E. Allen differs from both of the current explanations of the differentiation of a central layer in the membrane of cellular tissues, differing, in its optical and staining properties, from the layers on each side of it, viz.—that it is an intermediate product, a *Zwischensubstanz*, distinct from the cell-walls proper, and that it is a cementing substance for keeping them together. The author details the results of observations made on a number of woody plants which show that this layer is, from a chemical point of view, of a pectic nature, and that it is a plastic portion of the cell-wall itself, capable of increase or decrease, and of alterations in chemical composition, adapting the cell-wall to the changes in size and form of the protoplast itself. The staining reactions at various stages of development are given in great detail.

Researches on Cellulose. †—C. F. Cross and E. J. Bevan publish a supplement to their work issued in 1895, giving an account of all the observations and discoveries of importance that have been made during the five succeeding years. It is divided into the following sections:—Introduction, dealing with the subject in general outline; General chemistry of the typical cotton cellulose; Synthetical derivatives: sulphocarbonates and esters; Decompositions of cellulose such as throw light on the problem of its constitution; Cellulose group, including Hemi-celluloses and Tissue-constituents of Fungi; Furfuroids: i.e. Pentosanes and furfural-yielding constituents generally; the Ligno-celluloses; Pectic group; Industrial and Technical; General review. Indices of authors and subjects are appended.

(2) Other Cell-contents (including Secretions).

Crystalline and Crystalloid Substances in Plants. ‡—Dr. H. Kraemer has studied the structure and mode of formation of these substances.

Sphere-crystals are spherical aggregates of crystals with sharp angular contours, which are made up of but one substance, the molecule of which is simple, or at least not very complex. It includes carbon compounds as well as inorganic substances. Some of these substances are soluble in water (the glucosides and alkaloidal salts, amygdalin, &c.); while others are insoluble (calcium phosphate and oxalate, the alkaloids such as strychnine, berberine, &c.). Spherites are distinguished from sphere-crystals in having a more complex constitution, and in the individual crystals having a somewhat rounded outline, or being

* Bot. Gazette, xxxii. (1901) pp. 1-34.

† Researches on Cellulose, 1895-1900, London, 1901, vii. and 180 pp.

‡ Proc. Acad. Nat. Sci. Philadelphia, liii. (1901) pp. 450-6. Cf. this Journal, 1900, p. 478.

imbedded in colloidal substances. They are also soluble in water (hesperidin, inulin, and other carbohydrates), or insoluble (starch and the fundamental substances entering into the composition of the cell-wall).

In the cell-wall the crystalloids occur in very close radial and tangential rows, and constitute by far the greater proportion of the wall. In the starch-grain, on the other hand, there is apparently a greater preponderance of colloidal matter which takes up certain stains. The structure, as well as the mode of formation of spherites and spherocrystals, appears to be the same.

The author enters into further particulars with respect to certain of these substances of both kinds, and compares them with those produced artificially.

Evolution of Chlorophyll and Starch in the Stem.*—J. d'Arbaumont has a very elaborate treatise on this subject, arranged under the following heads:—Period of Formation; Summer and Autumn; Winter Period; Renovation in the Spring. The observations were made on a large number of trees and shrubs belonging to many different natural orders.

In the course of his observations the author distinguishes between two kinds of cell in which starch and chlorophyll are found:—*cyanocysts*, which contain substances stainable by aqueous solutions of methylen-blue and anilin-violet-blue; and *achroocysts*, the contents of which do not stain by these reagents. The chlorophyllous plastids, or *chlorites*, are also classified under two categories:—*gymnochlorites*, or chlorites contained in cyanocysts, which usually become detached at an early period from the protoplasmic layer in which they were formed; and *endochlorites*, those contained in achroocysts, which remain for an indefinite period enclosed within that layer.

The special points investigated are as follows (for details the original memoir must be consulted):—The formation of amylo-chlorophyll in the growing cone and the first internodes of the growing stem; the reciprocal relations of chlorophyll and starch in the course of the summer and autumn, in other words, during the period when the stem ceases to increase in length and establishes for each period a maximum annual increase in diameter; the condition of starch and chlorophyll, and of the medium in which they are imbedded during the winter; the phenomena of regeneration of which they are the seat on the return of spring. In the adult stem are found the two kinds of amylo-chlorophyllous plastids mentioned above, distinguished both by their morphological characters and by their behaviour towards reagents.

Structure of Starch.†—According to W. Syniewski, the composition of starch itself is perfectly uniform, with the empirical formula $C_6H_{10}O_5$; the more resistant constituent—starch cellulose, α -amylose—being a reversion-product subsequently formed from the starch which has become dissolved. The substances formed by the action of boiling water or of KOH on starch-grains, are the product of the hydrolytic

* Ann. Sci. Nat. (Bot.), xiii. (1901) pp. 319-423; xiv. (1901) pp. 125-212.

† Akad. Wiss. Krakau, naturw. Cl., xxxix. (1899) (Polish). See Bot. Centralbl., lxxxvii. (1901) p. 408.

splitting-up of starch. The simplest of these is a substance with the composition $C_{54}H_{96}O_{48}$, to which the author proposes to give the name *amylogen*. He further suggests that the term dextrin should be limited to the products of the hydrolysis of starch (except the sugars), those which do not reduce Fehling's solution, and which are coloured indigo-blue by iodine being *amylo-dextrins*.

Formation of Starch in the Grain of Wheat. * — P. P. Dehérain and E. Dupont point out that the relative times at which the starch and the proteids are formed differs in the case of wheat from what occurs in the potato, tobacco, vine, &c. While in these plants reserves of starch are formed in the leaves, this is never the case with wheat. It would appear that the starch ultimately formed in the grains is not transferred from the leaves, as is the case in the other plants mentioned, but is formed at a later period in the upper part of the stem.

Distribution of the Acids in Plants. — M. Berthelot and G. André † point out that the intensity of the acid reaction of the sap is not a certain test for the amount of acids contained, the proportion of them which exists in the form of saline (neutral) compounds being very variable. The sap of plants has most commonly an acid reaction.

According to A. Astruc, ‡ the maximum amount of acid is always found in the youngest part of the plant; it is connected with the vigour of growth and with the activity of cell-division. Thus the acidity of the stem increases as the apex is approached. The leaves contain more acid than the stem, and the largest amount is towards the zone of growth. The acidity of the flower decreases from the bud condition up to the period of complete expansion.

Function of Calcium oxalate. § — A. Schneider discusses the purpose of the crystals of calcium oxalate so widely distributed in plants, and disputes the accepted theory that they are protective, since calcium oxalate, being insoluble in water, has no taste, and is not poisonous. The salt occurs in plants in four predominate types:—as crystal-sand (root of *Atropa Belladonna*, stem-parenchyme of *Solanum dulcamara*, sp. of *Datura* and *Physalis*, bark of *Sambucus* and *Cinchona*, &c.); in the aggregate form; in the prismatic form; and as needle-shaped crystals (raphides); the last especially in Monocotyledonous plants. The author believes the function of calcium oxalate to be mainly that of mechanical support; while secondarily it plays the part of a reserve product. This argument is supported by a reference to the parts of the plant in which these crystals are most commonly found.

Determination of the Presence of Cane-sugar in Plants. || — E. Bourquelot recommends, as a test for the presence of cane-sugar, the use of the invertin of yeast, which decomposes cane-sugar (also gentianose and raffinose, but these sugars are rare in plants). This reagent has determined the presence of cane-sugar in the substances tested,—rhizome of *Scrophularia nodosa*, succulent pericarp of *Cocos Yatai* (25 grm. per kgrm.), and horny endosperm of *Asparagus officinalis* (15 grm. per

* Comptes Rendus, cxxxiii. (1901) pp. 774-8. † Tom. cit., pp. 502-4.

‡ Tom. cit., pp. 491-3. § Bot. Gazette, xxxi. (1901) pp. 142-4.

|| Comptes Rendus, cxxxiii. (1901) pp. 690-2.

kgrm.). In neither of these two latter was the reaction with emulsin obtained, showing the absence in these organs of a glucoside which is decomposed by that ferment.

Poisonous Properties of *Lolium temulentum*.*—L. Micheletti confirms the observations of Guérin and Nestler that the seeds of *Lolium temulentum* always contain a poisonous principle, due to the presence of a fungus-mycel.

Poisonous Principle in the Mistletoe.†—E. Laurent finds in seedling plants of mistletoe a substance which is toxic to the pear-tree. It occurs also in the pulp of the berry, and is, no doubt, secreted by the embryo.

(3) Structure of Tissues.

Resin-Receptacle in the Polypodiaceæ and in some Phanerogams.‡—D. F. Höhlke finds the formation of resin to be a very widely distributed phenomenon in ferns (Polypodiaceæ). The resin-forming organs are always glands; and these may be either external or internal. The resin is usually a product of transformation of a layer of the cell-wall, being formed between the cuticle and the inner layer; less often it is excreted by the cell-membrane. The internal glands occur in a large number of species, and on different organs; they are almost invariably unicellular trichomic structures; the external glands often consist of a number of cells, but the head is always unicellular.

In the flowering plants examined—*Senecio viscosus*, *Ononis spinosa*, *Pelargonium zonale*, *Erodium cicutarium*, the author finds, in opposition to the statement of Behrens, that the resin is also always a product of the disintegration of a layer of the cell-wall.

Persistence of Leaf-traces.§—Sir W. T. Thiselton-Dyer finds the persistence of leaf-traces already recorded by him not to be confined to *Araucaria*, but to occur also in other genera of the Araucariaceæ. He has found it in *Agathis australis*, and in *Cunninghamia sinensis*, but not in *Sciadopitys verticillata*.

(4) Structure of Organs.

Polychromism of Flowers.||—By this term W. Taliev expresses the tendency of a species to produce flowers of more than one colour. The differently coloured flowers may either be produced on the same plant, as *Pulmonaria officinalis* and *Orobis vernus*, or—which is much more common—on different individuals. Of this a number of examples are given:—*Anemone ranunculoides*, *A. patens*, *Iris pumila*, *Tulipa Gesneriana*, *Myosotis amœna*, *Primula acaulis*, *Matthiola odoratissima*.

Distribution of the Sexes in the Compositæ.¶—M. von Uexhüll-Gyllenband treats in great detail of the distribution of the sexes in the capitule of the Compositæ, his conclusions being founded on observations

* Bull. Soc. Bot. Ital., 1901, pp. 215-7. Cf. this Journal, 1899, p. 191.

† Comptes Rendus, cxxxiii. (1901) pp. 959-61.

‡ Beih. z. Bot. Centralbl., xi. (1901) pp. 8-45 (3 pls.).

§ Ann. Bot., xv. (1901) pp. 547-8. Cf. this Journal, 1901, p. 660.

|| Beih. z. Bot. Centralbl., x. (1901) pp. 562-4.

¶ Bibliotheca Botanica, lii. (1901) 80 pp., 2 pls., and 2 figs. See Bot. Ztg. lix. (1901) 2^o Abt., p. 262.

made on no less than 458 species, which are classified in a number of groups, according to the presence or arrangement of male, female, hermaphrodite, and non-sexual flowers. The original type of flower is unquestionably the hermaphrodite tubular flower. These, when present, always occupy the centre of the capitule, the most strongly modified forms of flower being at the periphery. The most complicated arrangements occur in *Antennaria dioica* and *Leontopodium*; in the former there are no less than seven forms of flower.

Double Flowers and Parasitism.*—M. Molliard gives a summary of the examples at present known where flowers assume a "double" character or are otherwise modified by the attacks of insects or of fungi:—*Knaulia arvensis* by *Peronospora violacea*; *Matricaria inodora* by *P. Radii*; *Viola sylvatica* by *Puccinia Violæ* (petalody of the stamens); many Umbelliferæ and Cruciferæ by the attacks of Hemiptera or Acari. He now adduces two other instances of petalody caused by parasitic fungi:—Petalody of the stamens and carpels in *Primula officinalis*, caused by the invasion of the root by the mycelium of a fungus belonging to the Dematiæ; petalody of the stamens in plants of *Scabiosa Columbaria*, the roots of which were infested by galls of *Heterodera radicolica*.

Fruit of the Cocoa-nut.†—A. L. Winton gives an elaborate description of the anatomical structure of the fruit of *Cocos nucifera*. The cells of the endosperm contain bundles of needle-shaped "fat-crystals," and lumps of proteid matter, each lump containing, as a rule, a single crystalloid.

Carpophyll of Encephalartos.‡—Sir W. T. Thiselton-Dyer has studied the structure of a monstrous female cone of *Encephalartos villosus*, from which he concludes that in this species the carpophyll is a reduced and modified equivalent of an entire foliage-leaf, the pinnæ of the lamina being represented by teeth. In *E. longifolius*, *brachyphyllus*, and other species, on the other hand, the carpophyll is entirely petiolar; below, and concealed by the peltate extremity, it bears a pair of ovules, one on each side.

Amphicarpous Plants.§—S. Murbeck describes the following cases of amphicarpous plants from the flora of N. W. Africa:—(1) *Emex spinosa* (Polygonacæ). The object of the underground formation of fruit does not appear to be here protection against frugivorous animals, since this is already effected by the spiny nature of the fruit. The underground female flowers display a remarkable development of the stigmas. (2) *Scrophularia arguta*. The underground flowers are cleistogamous, although the corolla is not altogether suppressed. (3) *Catananche lutea* (Compositæ). The underground capitule consists of only from 1-3 flowers; its flowers are not cleistogamous, but are apparently self-fertilised. In all these three cases there appears to be a connection between the production of underground flowers and the partial suppression of the tap-root.

* Comptes Rendus, cxxxiii. (1901) pp. 548-50.

† Amer. Journ. Sci. (Silliman), xii. (1901) pp. 265-80 (11 figs.).

‡ Ann. Bot., xv. (1901) pp. 548-50 (1 pl.).

§ Ofv. k. Vetensk. Akad. Forhandl., lviii. (1901) pp. 549-71 (7 figs.) (German).

Integument of the Ovule and Seed of Geum. * — L. Péchoutre has investigated this process in the case of *Geum urbanum*, and states that, as in the case of other so-called "exalbuminous" genera of Rosaceæ, the term is not literally correct; but the endosperm is reduced to a single proteid layer of cells. The ovule is strictly monochlamydeous, the single integument corresponding to the outer integument in bitegumentary seeds. In the allied genus *Dryas*, the ovule is bitegumentary.

Bulbiform Seeds of Amaryllideæ. † — Dr. A. B. Rendle gives a detailed account of what had been previously known respecting these singular structures, found chiefly in species of *Amaryllis* and *Crinum*, and thus sums up the results. Three forms of seed may be distinguished:—A. *True Seeds*; (1) Developed from a normal ovule, the outer integument of which becomes thick and fleshy after fertilisation, and forms the substance of the bulbiform mass (*Hymenocallis*); (2) Developed from a naked ovule, the fleshy substance being derived entirely from the endosperm, which develops chlorophyll in its outer layers, and continues to grow for some time (*Crinum asiaticum*, &c.). B. *A vegetative growth replacing the seed*; (3) A normal ovule is produced, but a viviparous growth of an adventitious shoot and root takes place at its base, and a bulbil is formed, the ovule integuments forming the outer coats (*Calostemma Cunninghamsi*). Germination of these structures follows a course common to many bulbs of Monocotyledons.

Bending of Mature Wood in Trees. ‡ — The late T. Meehan calls attention to the stupendous power exhibited by plant life in the enormous weight lifted by roots, or shifted by the bending of boughs. This bending may take place without a break in an old branch or trunk that would require an immense mechanical pressure for man to accomplish. The life-growth of a plant is, according to the author, in a measure a struggle against gravitation; it is to energy transmuted from nutrition that we have to look for the various forms that plants assume.

Causes of the Direction of Branches. § — J. Baranetzky goes in great detail into this subject from an experimental point of view, giving the results of a large number of experiments on trees and shrubs. It is discussed under the following heads:—The property of counter-acting curvature (*Gegenkrümmung*); Experiments and observations in the open air; Unequal length in growth of the secondary woody elements. Every unilateral growth of the stem incites, in many plants, and especially in those that are woody, a more active growth on the opposite side, in consequence of which the curvature may ultimately become effaced.

Floating Organs of Plants. || — H. Dingler gives a *résumé* of our knowledge of the parts of plants which assist in their distribution by their power of floating in the air; the subject being treated mainly from a mathematical point of view, i.e. in regard to the mechanics of the motion.

* Journ. de Bot. (Morot), xv. (1901) pp. 213-7.

† Journ. R. Hort. Soc., xxvi. (1901) pp. 89-96 (5 figs.).

‡ Proc. Acad. Nat. Sci. Philadelphia, 1901, pp. 354-65 (2 pls.).

§ Flora, lxxxix. (1901) Ergänzbld., pp. 138-239 (20 figs.).

|| Die Bewegung d. pflanzlichen Flugorgane, München, 1899, ix. and 342 pp. and 8 pls. See Bot. Centralbl., lxxxvii. (1901) p. 283.

The organs treated of are spores of flowerless plants, seeds, fruits, pollen-grains, &c. ; these are arranged in classes characterised by the nature of the motion rather than by their morphological characters.

Biology of Leaves.*—With immense wealth of detail, Prof. A. Hansgirg treats of the great variety in the form and structure of leaves, classifying them under a number of different heads. While in individual cases the process is always obscure, yet, as a general law, the frequent enormous difference in the form and structure of the leaves of closely related species, and in other cases the minute resemblance between the leaves of plants in no way related to one another, must be attributed to natural selection acting through the internal laws of variation about which so little is known. The archaic form of leaf from which all others have been derived, was probably simple, entire, sessile, of delicate structure, deciduous, glabrous, and without any special protection against excessive transpiration, insolation, or cold. The highest type of leaf is to be found in the higher Monocotyledons and Dicotyledons, and in some ferns. The author classifies leaves in two great classes from a biological point of view:—(A) Aquatic and Marsh leaves, Hydrophytes and Halophytes; (B) Aerial land-leaves; these are again classified under leaves belonging to Tropophytes, Mesophytes, Xerophytes, Ombrophytes, and Halophytes.

Phyllotaxis.†—Rejecting the various mathematical theories that have been proposed to account for the phenomena of phyllotaxis, Dr. A. H. Church has arrived at the conclusion that the whole subject is a question of the mechanical distribution of energy within the substance of the protoplasmic mass of the apex of the plant; and that the phenomena of phyllotaxis are the result of inherent properties of protoplasm; the energy of life being in fact distributed according to the laws which govern the distribution of energy in any other form.

Stipules of *Liriodendron*.‡—From the examination of a large number of leaves of *Liriodendron Tulipifera*, and a comparison with those of some fossil species, E. W. Berry supports the view that the large fugacious stipules of our living tulip-tree represent former leaf-lobes, which, becoming separated, formed basilar lobes, then winged petioles, and finally the modern stipules.

Bulbils of *Lysimachia terrestris*.§—Prof. D. T. MacDougal regards the bulbils formed in the axils of the aerial stems of this plant as representing a new category of propagative bodies. They are branches of restricted development, and are formed under conditions unfavourable for seed formation. They are free from transpiratory organs of any kind, and resemble rhizomes in structure rather than the aerial stems on which they are borne. The germination of the bulbil occurs without any appreciable resting period, and is followed by the final stages in the differentiation of the stele. The bulbil becomes the main axis of the new plant, becoming converted into a rhizome.

* SB. k. böhm. Ges. Wiss. Prag. Math.-nat. Cl., 1900, 142 pp.

† Ann. Bot., xv. (1901) pp. 481-90 (2 figs.).

‡ Bull. Torrey Bot. Club, xxviii. (1901) pp. 493-8 (2 pls.).

§ Bull. N. York Bot. Gard., ii. (1901) pp. 82-9. See Bot. Gaz., xxxii. (1901) p. 65.

Tubers of *Dioscorea*.*—Miss E. Dale describes in detail the structure of the tubers of *Dioscorea sativa*, which occur both underground and in the axils of the leaves, and which resemble potato-tubers in possessing both "eyes" and adventitious roots. When planted the "eyes" develop stems bearing axillary tubers. The axillary tubers are, in all cases, stem-structures; and the authoress differs from most previous authorities in regarding the underground tubers of the *Dioscoreaceæ* as also, in most cases, stem-structures.

Assimilating Roots of *Tæniophyllum*.† — An examination by J. Müller of the anatomy of the assimilating roots of *Tæniophyllum Zollingeri* (Orchidæ) leads to the following among the more important results.

The assimilating organs consist exclusively of dorsiventral aerial roots. The envelope, consisting of two layers of cells, persists only on the ventral side. The exoderm is more strongly developed on the dorsal than on the ventral side, and is, in the former case, exposed. The pneumathode cells are found only on the ventral side. The walls of the ordinary exoderm cells consist of alternate suberified and non-suberified layers. In older roots the passage of air may be stopped by suberified chlorophyllous wedge-shaped cortical parenchyme cells.

Besides the ordinary exoderm cells, the pneumathode cells, and those for the passage of air, there occurs in the exoderm a fourth kind of cell. They are very thin-walled dead cells, occurring singly or in large numbers, into which the adjoining cortical parenchyme cells force their way. They have somewhat thickened and suberised walls, are destitute of chlorophyll, and obviously possess the function of checking transpiration through the overlying very thin-walled exoderm cells.

Anatomy of *Cassiope*.‡ — Dr. K. Linsbauer has investigated the anatomical structure of the vegetative organs of *Cassiope tetragona*, an Arctic representative of the *Ericaceæ*, with the following results. The leaf has on its under side a closed cavity, which is cap-shaped in its upper portion. This cavity is not caused by a rolling up of the margin of the leaf, but by a swelling on all sides of a horseshoe-shaped part of the under side of the leaf, and hence from intercalary growth. The arrangement of the tissues of the leaf differs materially from that of normal dicotyledonous leaves, especially in the fact that the palisade-parenchyme is formed on the under side of the leaf.

β. Physiology.

(1) Reproduction and Embryology.

Reduction in the Number of Chromosomes in the Embryo-sac Mother-cell.§ — In a number of *Liliifloræ* examined, J. Schniewind-Thies finds three different types in the development of the embryo-sac from its mother-cells, viz. :—(1) An embryo-sac mother-cell divides into two daughter-cells; and these again into four cells, each of which is capable

* Ann. Bot., xv. (1901) pp. 491-501 (1 pl.).

† SB. k. Akad. Wiss. Wien, cix. (1900) pp. 667-83 (1 pl.).

‡ Tom. cit., pp. 685-99 (2 pls.).

§ Die Reduction d. Chromosomenzahl u.s.w., Jena, 1901, 34 pp. and 5 pls. See Bot. Ztg., lix. (1901) 2^{te} Abt., p. 276.

of development into an embryo-sac. In the embryo-sac three divisions then succeed one another, the last of which gives rise to the ovum-nucleus. There are here, therefore, four stages in the reduction of the number of chromosomes. (2) An embryo-sac mother-cell divides into two daughter-cells, of which either only the upper or only the lower is capable of developing into an embryo-sac. In the embryo-sac three further divisions take place, the last of which gives birth to the ovum-nucleus. The number of stages in the reduction is only three. (3) An embryo-sac mother-cell develops directly into an embryo-sac, in which three stages in the process of division are required for the production of the ovum-nucleus. There is therefore a further reduction in the number of stages.

In the first type (*Galtonia candicans*, *Convallaria majalis*), the heterotype and homotype divisions of the nucleus are completed in the two progamic generations which precede the formation of the embryo-sac; in the embryo-sac three typical nuclear divisions succeed one another. In the second type (*Scilla sibirica*, *Allium ursinum*) only the heterotype nuclear division is progamic; the homotype division represents the first nuclear division in the embryo-sac; the two following divisions in the embryo-sac are typical. In the third type (*Tulipa Gesneriana*) both heterotype and homotype divisions take place in the embryo-sac; only the third nuclear division is typical.

The result is that the reduction of the number of chromosomes in the nucleus of the embryo-sac mother-cell causes in it a heterotype division; this is succeeded by a homotype division, and only the subsequent divisions are typical. These observations point to the conclusion that the reduction in the number of chromosomes in the rudiment of the seed is the point of time of the birth of the new generation.

Double Fertilisation in Naias.* — L. Guignard describes another case of double fertilisation in the case of *Naias major*. The formation of the egg-apparatus in the embryo-sac takes place in the usual way. The nuclei of the pollen-mother-cells and those derived from them present the phenomenon of chromatic reduction; instead of containing twelve chromosomes, they possess only six, the smallest number which has as yet been found in the sexual nuclei of plants; and these present greater differences than usual in length in the same nucleus. Similar characteristics are presented by the nuclei of the embryo-sac. The three antipodals are not alike; the two lower ones are bounded by cell-walls, and are distinguished from the upper one by their smaller nuclei; while they become gradually absorbed, this latter, which has no limiting wall, continues to grow, and persists, after impregnation, at the base of the embryo-sac. The two polar nuclei do not fuse until shortly before impregnation. One of the synergids is also absorbed considerably before the other one. The fusion of the male with the female nuclei takes place with great rapidity, and is very difficult to follow.

After impregnation, contrary to what usually occurs, the division of the ovum-cell takes place before that of the secondary nucleus. Two embryos were several times observed in an embryo-sac, presenting all the characters of normal embryos formed by impregnation.

* Journ. de Bot. (Morot), xv. (1901) pp. 205-13 (15 figs.).

Embryogeny of the Sequoiaceæ.*—W. Arnoldi has studied the development of the embryo in the family Sequoiaceæ, comprising the genera *Sequoia*, *Wellingtonia*, *Taxodium*, *Cryptomeria*, *Cunninghamia*, *Arthrotaxis*, *Glyptostrobus*, and *Sciadopitys*, especially in *Sequoia sempervirens*.

From his observations the author concludes that the Sequoiaceæ do not form a single sharply differentiated family, but that they are composed of at least three distinct sections. The first two genera form a distinct group, the Sequoieæ; *Sciadopitys* should probably be made the type of a distinct family; while *Taxodium*, *Cryptomeria*, and *Cunninghamia* might be referred to the Cupressineæ.

The characteristics of the family Sequoieæ indicate their antiquity. In *Sequoia (sempervirens)* there may be one or more embryo-sacs, the number being quite indefinite; in *Wellingtonia (gigantea)*, more than one never become fully developed. In these two species there are also all possible transitional forms between a single sessile archegone and a complex of archegones; the solitary sessile archegones are never fertilised, but represent functionless organs. The structure of the pollen-tube, and to a large extent that of the archegone, in the Sequoieæ, agrees with that in Cupressineæ, differing from the other families of Coniferae. The Cupressineæ have probably been derived from the Sequoieæ, through *Taxodium* and *Cryptomeria*.

Development of the Oosphere and Fertilisation in Pinus Strobilus.†

—An examination of the development of the "egg" (oosphere) and of the process of fertilisation in several species of *Pinus*, especially *P. Strobilus*, leads Miss M. C. Ferguson to the following, among other, conclusions.

The time at which the archegones appear varies somewhat; but in general they can be detected about two weeks before fertilisation; they are usually found at the micropylar end of the prothallium. The number of archegones varies in the different species from one to nine. The number of cells of which the neck is composed varies between four and eight. The ventral canal-cell is cut off about a week before fertilisation. In the division of the central cell the spindle arises as a multipolar diarch, and lies wholly within the nucleus. During the maturation of the oosphere, many nutritive spheres arise in the cytoplasm. As the nucleus of the oosphere assumes its central position, it increases much in size, and many threads arise in the cytoplasm surrounding it. The cytoplasm of the oosphere presents a delicate network. Immediately before fertilisation an opening appears in this cytoplasm, apparently for the reception of the sperm-cell. At the time of fertilisation an opening is formed in the apex of the pollen-tube, and the cells of the male gametophyte which still persist, together with a portion of the cytoplasm and some of the starch of the pollen-tube, pass into the protoplasm of the oosphere. The larger sperm-nucleus escapes from the protoplasm of the sperm-cell, and moves directly towards the oosphere nucleus. At the time of conjugation the oosphere nucleus is several times larger than the sperm-nucleus. There is no

* Bull. Soc. Imp. Nat. Moscou, xiv. (1900) 1901, pp. 449-76 (2 pls. and 30 figs.). Cf. this Journal, 1900, p. 482; also 1896, p. 647.

† Ann. Bot., xv. (1901) pp. 435-79 (3 pls.).

actual fusion between the two nuclei. No individualised centrosomes or centrospheres have been found to occur in connection with the first division following fertilisation. The number of chromosomes in the nucleus of the ventral canal-cell, in the nuclei of the sheath-cells, and in the nucleus of the oosphere, has been found to be twelve, while the mitotic figure in the first division following fertilisation, shows twenty-four chromatic segments.

A good bibliography is appended to the paper.

Formation of the Ovule and Embryo-sac in the Araliaceæ.*—L. Ducamp has followed these out in several genera of this order, the following being among the more important results obtained.

The ovular protrusions are formed in pairs for each loculus on the margin of the carpel; one of the two grows upwards and aborts; the other descends into the cavity of the ovary and occupies a lateral position. The nucellus is developed from three or four hypodermal cells. One of these, the privileged cell, gives birth, after several divisions, to the primordial mother-cell of the embryo-sac. The fusion of the polar nuclei in the embryo-sac takes place before the flower opens. When the embryo-sac is developed, the nucellus has become reduced to a small column of four or five filaments of cells; the result of a diastatic action in the cells before the formation of the embryo-sac. A similar change appears to take place in the integument, an inner zone of which contributes to the nutrition of the embryo-sac. At maturity the endosperm is covered by a membrane-like layer representing the inner zone of the integument, a horny layer with masses of calcium oxalate derived from the outer zone, and the external integument.

Embryo of Hedera.†—L. Ducamp gives further details of the development of the embryo in the ivy, which presents no important departure from the normal in its early stages. The first division of the impregnated cell is transverse; the upper segment giving birth to the embryo, the lower to the suspensor. In the formation of the root-cone, the central cylinder is entirely independent of the suspensor; the growth downwards of the latter gives rise to the cap; while the upper elements of the cap are formed by the base of the embryonal epiderm.

Cross-Pollination and Self-Pollination.—Dr. D. Clos ‡ describes the phenomena connected with the flowering and pollination of several species grown in the botanic garden at Toulouse, including *Cobæa scandens*, which he regards as self-pollinated.

A. Mainardi§ regards the poppy (*Papaver Rhœas*) as probably originally anemophilous. The dark spots at the base of the petals now serve to attract species of *Xylocopa*; these press out the pollen on to the hairs which cover the abdomen; then carry it away, and deposit it on the stigma of another flower.

Change of Sexuality in Plants.¶—A. Gallardo has experimented on the production of male and female flowers in successive generations of a

* Comptes Rendus, cxxxiii. (1901) pp. 753-6.

† Tom. cit., pp. 651-3.

‡ Bull. Acad. Sci. Toulouse, 1900, pp. 219-31.

§ Nuov. Giorn. Bot. Ital., viii. (1901) pp. 49-63.

¶ Comm. d. Mus. Nat. Buenos Aires, i. (1901) pp. 273-91. See Bot. Centralbl., lxxxvii. (1901) p. 434.

number of species with unisexual flowers, and has arrived at the general conclusion, in accordance with that of Klebs, that the production of female flowers is promoted by a copious supply of nutrient substances, that of male flowers by deficient nourishment. While the pruning of the root or rhizome will tend to the production of male flowers, the formation of female flowers is promoted only by increased vital activity.

Mendel's Laws of Hybridity.—A reprint of G. Mendel's important treatise on Hybridity in Plants—which appeared in the *Verhandlungen des naturw. Vereins in Brünn* for February 8 and March 8, 1865 (published in 1866)—appears in the *Ergänzungsband* of *Flora* for 1901, pp. 364-403; and a Translation, with an Introductory Note by W. Bateson, in the *Journal of the Royal Horticultural Society*, vol. xxvi. (1901) pp. 1-32.

Cleistogamy of *Stellaria pallida*.* — E. Loew regards *Stellaria pallida* as a clearly distinct species from *S. media*. The former is a typical cleistogamous plant; impregnation takes place within the closed flowers, the pollen-tubes fixing the anthers to the stigma; the corolla is greatly reduced or entirely abortive. In *S. media*, although the flowers often do not open under unfavourable conditions, the corolla is fully formed, and it is only exceptionally that impregnation takes place within the closed flower. The species is only pseudo-cleistogamous.

(2) **Nutrition and Growth (including Germination, and Movements of Fluids).**

Chlorophyll Assimilation.†—L. Macchiati regards the production of the numerous diastases or enzymes which exist in animals and in the higher plants as a function of the vital activity of the living cell. The chlorophyll function of green cells is in all probability the result of the action of a special diastase secreted by the chloroplasts, and the chlorophyll-pigments under the influence of solar radiation. The phenomena of synthesis (assimilation) and of decomposition (dissimilation) are equally expressions of fermentative processes. The author classifies under seven heads the various modes in which these numerous ferments occur in the vegetable kingdom. Further researches are promised.

Action of Inorganic Salts on the Structure and Development of Plants.‡ — A series of experiments by G. H. Pethybridge, chiefly on wheat, oat, and maize, leads to the conclusion that growth in distilled water causes very great lengthening of the root, and thickening of the cell-walls of the endoderm and central cylinder. In contrast to a normal nutrient solution, dilution of the solution and the addition of sodium chloride have both a similar effect, viz.:—lengthening of the root, diminution in the number of shoots and in the number of leaves, also of the average length and breadth of the leaf. As regards anatomy, they bring about a decrease in the diameter of the roots, of the vessels in the root, and of the haulm, an increase in the thickness of the cell-walls of

* Abhandl. Bot. Verein Prov. Brandenburg, xli. pp. 169-83. See Bot. Centralbl., lxxxviii. (1901) p. 172.

† Bull. Soc. Bot. Ital., 1901, pp. 323-35.

‡ Beitr. z. Kenntniss d. Einwirkung d. anorganischen Salzen u.s.w., Göttingen, 1899, 95 pp. See Bot. Centralbl., lxxxvii. (1901) p. 235.

the endoderm and central cylinder in the root, haulm, and leaf, and of the absolute number of fibres in the leaf. In wheat grown in sodium chloride or in distilled water, the stomates disappear almost entirely from the under-side of the leaf.

Relation of the Supply of Water to the Ripening of Woody Plants.*—According to F. Kővessi, the form of a tree, as well as the location of its flowering branches, are largely determined by the conditions relating to ripening. The degree of ripening of the branches, and, in consequence, the abundance of flowers and fruits for the following year, are in inverse proportion to the quantity of water received by the plant.

Hybridisation by Grafting.†—A. Jurie records an instance of the transmission of characters from the graft to the stock. Using as the stock a vine which had never produced any but male flowers, there was grafted on this a bud from an ordinary hermaphrodite vine. The stock put out a long and vigorous shoot which bore fertile flowers producing a well-developed bunch of grapes.

Grafting, Pinching, and Annular Decortication.‡—L. Daniel draws an anatomical comparison between the processes of grafting (simple and mixed), pinching (*pincement*), and annular decortication. He further points out that the artificial increase in the number of concentric layers corresponds with what takes place in nature by the action of phytophagous animals or of wind.

Chlorophyll Assimilation of Cut Leaves.—In an additional note on the assimilation carried on by leaves (*Pelargonium*, spinach, chickweed) after being detached from the parent plant, J. Friedel§ states that this process goes on much less energetically in the autumn than in the summer, the difference displayed in the two seasons being greater even than is the case with living leaves.

M. Harroy|| has repeated Friedel's experiments, with negative results.

Vitality of Leaves after their Fall.¶—G. Boyer has noticed that after leaves have fallen to the ground in the autumn, they still, as a rule, exhibit some of the phenomena of life. Especially can it be demonstrated that the process of respiration has not altogether ceased; but that it may even proceed with considerable energy. The experiments were chiefly made with leaves of *Euonymus*.

Biology of *Ranunculus Ficaria*.**—E. Berg has noticed that the axillary buds will develop, whether borne on barren shoots or on those which produce ripe fruits and seeds, but only after a period of rest. In Germany and Switzerland the species is propagated not only by the bulbils but also sexually through insects attracted by the bright corolla and the fragrant nectaries.

* Comptes Rendus, cxxxii. (1901) pp. 1359-61. Cf. this Journal, 1901, p. 302.

† Op. cit., cxxxiii. (1901) pp. 445-6.

‡ Tom. cit., pp. 837-40. Cf. this Journal, 1901, pp. 178 and 182.

§ Tom. cit., pp. 840-1. Cf. this Journal, 1901, p. 436.

|| Tom. cit., pp. 890-1.

¶ P.V. Soc. Sciences phys. et nat. Bordeaux, 1900, pp. 68-72.

** Studien üb. d. Dimorphismus v. *Ranunculus Ficaria*, Erlangen, 1899, 49 pp. and 1 pl. See Bot. Centralbl., lxxxvii. (1901) p. 315.

Influence of the Surrounding Medium on the Growth of Roots.*—As the result of experiments on *Lupinus albus*, J. Arker states that the rapidity of the growth of the roots is increased when a current of atmospheric air is passed through the soil in which they grow (or through the water in the case of aquatic plants). In the open air, on the other hand, the growth of roots is extremely slight.

(3) Irritability.

Reaction of Leaves to Traumatic Stimulation.†—According to Dr. F. F. Blackman and Gabrielle L. C. Matthaei, leaves of the cherry-laurel or oleander will retain their vitality for weeks or even months after being cut off, if kept in the dark and supplied with water; a callus being formed in the former case over the cut surface; while in the latter case a large number of adventitious roots are produced from the stump of the leaf-stalk. If a clean cut be made through the substance of the leaf (cherry-laurel), or even if the leaf be cut into a number of strips, no healing reaction will follow, only the cells which are actually cut through being killed. But if patches of cells in the leaf are killed, the surrounding tissues will always react by cutting off and exfoliating the injured patch, so that it drops out of the leaf, leaving a hole. The mode of formation of the new tissue is described in detail.

Irritability of the Higher Plants.‡—M. J. Massart defines as the "equilibrium of reaction" (*équilibre réactionnel*) the position ultimately attained by organs, when subjected at the same time to various reflex actions, each of which tends to bring about a displacement of its own. There are two sets of reflex action, one having its source in the part of the organ which displays curvature, the other in the apex of the organ. The author has especially studied the phenomena of irritation in the climbing species of *Ficus*, which have three kinds of aerial root differing from one another in their origin and in their sensitiveness:—early adhesive roots, later adhesive roots, and nutrient roots.

(4) Chemical Changes (including Respiration and Fermentation).

Formation of Proteids.§—According to W. Zaleski, none of the theories at present propounded fully account for the formation of the proteids in plants. He brings forward evidence to show that it may take place both from organic nitrogen compounds and from nitrates, even in the dark, though it is greatly promoted by light. A good material for demonstrating the formation of proteids out of organic nitrogen compounds in the dark is the bulbs of *Allium Cepa*. It does not take place, as has generally been stated, at the cost of the asparagin, but of other unknown nitrogen compounds. The regeneration, or secondary formation of proteids out of the products of the decomposition of these substances is illustrated in the case of etiolated seedlings of *Lupinus angustifolius*;

* Die Beeinflussung d. Wachstums d. Wurzeln durch d. umgebende Medium Erlangen, 1900, 76 pp. See Bot. Centralbl., lxxxvii. (1901) p. 433.

† Ann. Bot., xv. (1901) pp. 533-46 (1 pl. and 5 figs.).

‡ Acad. R. Belg. Bull. Cl. Sciences, 1901, pp. 547-9.

§ The Conditions of the Formation of Proteids in Plants, Charkow, 1900 (Russian). See Bot. Centralbl., xxxvii. (1901) p. 277. Cf. this Journal, 1901, p. 558.

the synthesis of proteids out of nitrates and sugar in the leaves of *Helianthus annuus*; this can take place in the dark.

Fermentation without Cells. * — F. B. Ahrens finds that yeast extract may be concentrated by cooling to a temperature not lower than -2° , stirring and expressing the liquor from the resulting magma of crystals. By repeating this process several times the specific gravity of the liquor may be raised from 1.0378 at 12° to 1.0765 at 14° . This concentrated extract gave satisfactory results on experiments where the original extract was too dilute. The author considers that zymase is present as a colloidal substance and not in a state of true solution; that its loss of activity is due to acidity which always develops in a few hours, and that the fluorescence which disappears when the extract is kept or used as a fermenting agent is caused by the zymase itself.

New Mode of Measuring Transpiration. † — L. Buscalioni and G. Pollacci utilise for this purpose the property of an alcohol-ether solution of collodion to become turbid in contact with aqueous vapour. By this means they determined that, in a large number of plants, transpiration is less energetic from the red than from the green plants.

γ. General.

Limits of Variation in Plants. ‡ — Dr. J. W. Harshberger describes and tabulates the results of a long series of observations on the variability of the following organs:—Fruit of *Podophyllum peltatum*, leaf of *Liriodendron tulipifera*, leaf of *Ampelopsis Veitchii*, fruit of *Quercus alba* and of *Q. prinus palustris*, leaf of *Menispermum canadense*, entire plant of *Arisæma triphyllum*, leaf of *Sanguinaria canadensis*, leaf of *Ailanthus glandulosa*. In three instances (*Liriodendron tulipifera*, *Sanguinaria canadensis*, *Ailanthus glandulosa*) it was found that variation in the size and shape of the leaves is in part due to the persistence of juvenile forms, to the arrested development of such leaves, and to their evolution and transformation into higher forms. These changes are in most cases due to two causes,—the internal hereditary impulse and the direct environmental influence.

Heterogenesis and Evolution. § — S. Korschinsky marshalls a large number of observations on heterogenesis, especially in connection with their bearing on the evolution of species, under the following heads:—Variations in growth; variations in the stem; variations in the foliage; form of the leaves; colour of the leaves; colour of the flowers; variations in the structure of the flower; variations in the time of blossoming; variations in the fruit; the nature of heterogenesis; the peculiarities of heterogenetic characters; the external conditions of heterogenesis; the directions of variability; the properties of heterogenetic variations; the heredity of heterogenetic deviations.

* Zeit. angew. Chem., 1900, pp. 482-6. See Journ. Chem. Soc., lxxviii. (1900) Abstr. ii. pp. 610-1. Cf. this Journal, 1899, p. 622.

† Atti Ist. Bot. Univ. Pavia, vii. (1900) 13 pp. and 1 pl. See Bot. Centralbl., lxxxviii. (1901) p. 186.

‡ Proc. Acad. Nat. Sci. Philadelphia, liii. (1901) pp. 305-19.

§ Flora, lxxxix. (1901) Ergänzbld., pp. 240-363.

Means of Distribution of Alpine Plants.*—Dr. P. Vogel points out what a large part is played in the Swiss Alps by the wind in the dissemination of plants, the very strong and variable winds being accompanied by a comparative scarcity of animal life and the almost complete disappearance of stagnant waters. By the law, therefore, of natural selection, those plants which are furnished with ready means of wind dispersion, such as the possession of winged seeds, are more likely to establish themselves in Alpine regions than those with no such advantage. Although the carriage of seeds to much greater distances does occur, it is the transport to distances between 3 and 40 kilometres that plays the most important part in the dispersion of Alpine plants. A number of tables are appended, exhibiting the mode of distribution of a very large number of Alpine plants: by the wind, by birds, by ants or other insects, by barbed bristles, by violent expulsion of the seeds, &c., &c.

Influence of Osmotic Pressure on the Form and Structure of Plants.†—From a series of experiments on the higher plants (*Phaseolus*, *Pisum*, *Lupinus*, *Triticum*, *Zea*), J. Beauverie concludes that the external changes manifested by cultivation are connected with modifications in the anatomical and histological structure. In the case of *Phaseolus* the use of a concentrated Knop's solution results in the disappearance of the pith from the roots, while an abundant pericyclic suber is produced at an early period. The cells, reacting against the medium in order to ensure the excess of osmosis necessary to maintain their integrity, absorb especially certain elements which are capable of retaining the water in their interior.

Disease in Plants.‡—Prof. H. Marshall Ward publishes an exhaustive and excellent manual on this subject. The following are the headings of the chapters:—The Plant and its surroundings; The Plant and its Food; The Plant a living machine; Metabolism; Roots and Root-hairs; The Function of Root-hairs; The Biology of soil; Hybridisation and Selection; Phyto-pathology; Health and Disease; Causes of Disease; Nature of Disease; Spreading of Disease and Epidemics; The Factors of an Epidemic; Remedial measures; Variation and Disease; Symptoms of Disease; Artificial Wounds; Natural Wounds; Excrescences; Exudations and Rotting; Necrotic Diseases; Proliferations; Grafts; Life and Death. A copious index is appended.

B. CRYPTOGAMIA.

Cryptogamia Vascularia.

Sporange and Oophyte of Selaginella.§—Florence M. Lyon has studied the structure and development of the microsporangies and megasporangies, and of the gametophyte (oophyte) in two American species of *Selaginella*, *S. apus* and *S. rupestris*.

In both species the sporange may frequently, if not always, be traced to a single superficial cell, the archesporc. The sporogenous tissue

* Flora, lxxxix. (1901) Ergänzb., pp. 1-137 (4 pls. and 1 fig.).

† Comptes Rendus, cxxxii. (1901) pp. 226-9.

‡ Disease in Plants, London, 1901, xiv. and 291 pp.

§ Bot. Gazette, xxxii. (1899) pp. 124-41, 170-94 (5 pls.).

arises in two ways:—in *S. rupestris* from the single hypodermal cell formed by the archesporium being divided by a periclinal wall, thus producing a wall and a sporogenous cell; or by the archesporium dividing into four cells by a periclinal wall, the two hypodermal cells thus formed developing the sporogenous tissue. The tapete is formed in part from the sporogenous cells near the exterior of the mass, in part from adjacent vegetative cells.

The micro- and megasporangia are indistinguishable before the spore-mother-cells are differentiated. The normal number of megaspores in a sporangium is 4; but in *S. rupestris* only 2, or even only 1, may reach maturity. In both species the megaspore has three distinct coats,—exospore, mesospore, and endospore. The female oöphyte is formed by free-cell-division of the megaspore, the nuclei dividing by indirect division. The microspores develop in a manner analogous to the megaspores. The male oöphyte (of *S. apus*) consists of a single prothallial cell and a mass of potential sperm-cells; there is no antherid, nor is there a wall separating the prothallial from the sperm-cells. In both species the spermatozoid is a spirally coiled body, on which no cilia were detected. Both kinds of sporangium open by definite lines of dehiscence. Fertilisation occurs, in both species, while the spores are unshed and the sporangia are still attached to the strobile.

Prothallus of Ophioglossum, Helminthostachys, and Psilotum.*—Dr. W. H. Lang gives a preliminary account of the prothallus of these genera of Vascular Cryptogams found in the Malay Peninsula and Ceylon.

Ophioglossum pendulum. The very young prothallus is button-shaped. A close covering of paraphyses extends uninterruptedly from just above the base over the whole surface. The youngest prothalli are radially symmetrical. Subsequently a more active growth takes place at two or three points on the margin; a corresponding number of cylindrical branches arise, and the prothallus becomes irregularly star-shaped; the larger prothalli consist of branches radiating in all directions. From a short distance behind the smooth, bluntly conical apex the surface of the branch is covered with short wide unicellular paraphyses, which are absent only above the sexual organs. The prothalli are monœcious, archegones and antherids being found close together on the same branch. The surface projects very slightly above the large sunken antherid; the neck of the archegone, which, as seen from above, consists of four rows of cells, hardly projects from the prothallus. Rhizoids were not seen on any of the prothalli examined. An endophytic fungus occupies a middle zone of tissue in all the branches.

Helminthostachys zeylanica. The prothalli were found at a depth of about three inches. The youngest prothallus obtained was a short cylindrical body a little over $\frac{1}{16}$ in. in length; the lower end bore a number of short rhizoids; the apex was bluntly conical. The lower vegetative region increases in size and becomes lobed, while the antherids are confined to the cylindrical upper portion. Seven of the young prothalli found were male, two female. The female prothalli were stouter and more lobed than the male ones; but both antherids and archegones might occur on the

* Proc. Roy. Soc., lxxviii. (1901) pp. 405-9 (3 figs.).

same prothallus. The antherids were large, and often closely crowded together; they hardly projected from the surface; the wall being only slightly convex. The archegonial neck, which was formed of four rows of cells, projected distinctly from the prothallus. An endophytic fungus occupied a wide zone in the basal part between the two or three superficial layers of cells and the central tissue, but was entirely absent from the reproductive region. The young plants attained a considerable size while still attached to the prothallus.

Psilotum sp. (The single prothallus found was not in genetic connection with a sporophyte, and may possibly belong to a *Lycopodium*.) The prothallus was about $\frac{1}{4}$ in. in length by about $\frac{3}{16}$ in. at the widest part. The lower portion is cylindrical and rounded below; on one side near the lower end is a well-marked conical projection directed obliquely downwards. Rhizoids were borne on the lower three-fourths of the prothallus, but were absent from the upper part. In the tissue of the overhanging margin the numerous sunken antherids occur, closely crowded together. No archegones were seen.

Fibrovacular Bundles in the Stem and Leaf of Filicineæ.* — C. E. Bertrand and F. Cornaille point out that in the stipe and leaf of Filicineæ (Megaphyllidæ) the conducting tissue occurs in the three following forms:—(1) a bipolar bundle; (2) a diverging bundle, which may be closed or reduced to the condition of a bipolar mass; (3) an indeterminate fibrovacular mass or bundle. The first form is represented in the foliar trace of *Osmunda*; the second in that of *Cyathea medullaris*. The third form has a concentric structure; the tracheæ are central in relation to the xylem, this latter being surrounded by a phloem. The bipolar bundles of the Filicineæ are usually convex towards their anterior face; this convexity may be slight, but never disappears altogether. A divergent bundle may have very unequal wings. When the anterior phloem is greatly reduced, it may assume the aspect of a unipolar bundle. When the indeterminate fibrovacular masses are destitute of tracheæ, they are termed by the authors "apolar." Divergent and bipolar bundles unite laterally into fibrovacular chains. A chain is continuous when there is no solution of continuity in its xylem between its extremities; discontinuous when there is such a solution; dialy divergent when all its divergents are independent in their xylem portion. A chain is open when its extremities are separated from one another. An example of a closed dialy divergent chain is afforded in the external arc of the foliar trace in the centre of the petiole of *Helminthostachys zeylanica*.

Germination of Fern-Spores. † — A. Burgenstein confirms the statement of most previous observers, that a certain amount of light is necessary both for the germination of the spores of ferns (*Pteris*) and for the development of the prothallus. Under favourable conditions the spores of ferns will, however, retain in the dark their power of germination for many weeks. The conditions of germination are, therefore, not the same for fern-spores as for seeds.

* Comptes Rendus, cxxxiii. (1901) pp. 524-6, 546-8, 695-8.

† Wien. illustr. Gartenzeit., 1900, 2 pp. See Bot. Centralbl., lxxxviii. (1901) p. 105.

Niphobolus.* — Dr. K. Giesenhagen publishes a monograph of this genus of tropical and subtropical ferns, preceded by a general account of the structure of the genus and a statement of the general principles of the classification of ferns. Fifty species are enumerated and described, including several new ones.

Fossil Heterosporous Ferns.† — B. Renault points out that the family of fossil Vascular Cryptogams known as Botryopterideæ, having megaspores and microspores closely resembling one another, may be regarded as a family intermediate between the isosporous Filices and the heterosporous Hydropterideæ (Rhizocarpeæ). He now calls attention to the fact that in the *terrain houiller* of Grand-Croix are the remains of a true leptosporangiate fern, *Pecopteris asterotheca*, in which there were distinctly two kinds of spore. It would appear that at that period both Eusporangiate and Leptosporangiate ferns had both isosporous and heterosporous genera.

Muscineæ.

Anatomy and Biology of Mosses.‡ — W. Lorch supplements his earlier treatise on the Anatomy and Biology of Musci with some additional notes on the following points:—Development of the leaf of *Leucobryum vulgare*; Development of the leaf of *Encalypta streptocarpa*; Anatomical investigation of the leaf of *E. ciliata* and of some species of *Barbula*; Development and anatomy of the leaf of *Sphagnum*.

Hypopterygiaceæ.§ — Dr. N. C. Kindberg gives a monograph of this chiefly tropical family of Mosses, of which the following are given as the characters of the reproductive organs:—Bryineæ dicholepideæ platylepideæ; peristomium duplex, vel in uno genere simplex, processus endostomii carinati, dentibus vix angustiores; capsula collo sæpissime destituta; operculum rostratum, seta lævis; spori vix 0·01 mm. The family consists of two genera, *Catharomnion* with one, and *Hypopterygium* with thirty-six species.

Apospory in Anthoceros.|| — Dr. W. H. Lang describes a case of artificially produced apospory in *Anthoceros lævis*, the first recorded in the Hepaticæ. The process was the same as that which has been successful with some Mosses. Small pieces were cut off an unopened sporogone and laid on damp sand under a bell-glass. In the course of a few weeks small outgrowths of a deep green colour had been formed on some of the pieces, and had put out rhizoids. In almost every case the new growth appeared to owe its origin to a single cell of the sporogone.

Algæ.

Galaxaura.¶ — F. R. Kjellman gives a detailed account of the structure of this genus of Florideæ, with a monograph of the known

* Die Farngattung Niphobolus, Jena, 1901, 223 pp. and 20 figs.

† Comptes Rendus, cxxxiii. (1901) pp. 648-51 (5 figs.).

‡ Flora, lxxxix. (1901) Ergz.-Band, pp. 434-54 (32 figs.). Cf. this Journal, 1894, p. 596.

§ Hedwigia, xl. (1901) pp. 275-303.

|| Ann. Bot., xv. (1901) pp. 503-10 (1 pl.).

¶ K. Svensk. Vet.-Akad. Handl., xxxiii. (1900) pp. 1-110 (20 pls.). See Bot. Ztg., lix. (1901) 2^o Abt., p. 337; also Bot. Centralbl., lxxxviii. (1901) p. 330.

species. The flat or round always erect thallus has a regular dichotomous branching; the basal portion or stipe differs in form and structure from the rest of the thallus. The growing point is very uniform in structure throughout the genus, and is composed of a mass of densely interwoven hyphæ.

Carpogones in a rudimentary condition were found only in one species; but ripe cystocarps were not infrequently obtained, though in comparatively few species. Antherids were met with frequently, always in separate individuals, the appearance of the male organs resembling that of the male conceptacles of *Fucus*. The tetrasporanges are, at present, of much greater use in characterising the species. The assimilating tissue consists (in *G. Diesingiana*) of two or three layers of cells, covered by short, unbranched, club-shaped shoots. From the terminal cells of these shoots spring two-celled filaments, the upper cell of which, dividing crucially, becomes a tetrasporange. In *G. striata* the stalk of the sporange consists from the first of a number of cells. Proliferation is common.

The numerous species are classified under nine sections, and the specific characters and relations of the sections to one another are discussed in detail.

Abnormal Conjugation in Spirogyra. * — Dr. L. Montemartini regards the mode of conjugation in *Spirogyra* as exhibiting an advance on that in the Desmidiæ, where there is no differentiation between the conjugating cells; *Mesocarpus*, where conjugation takes place in the canal which unites the two conjugating cells, presenting an intermediate stage. He records instances of abnormal conjugation in different species of *Spirogyra*, some of which correspond to abnormalities frequently met with in flowering plants:—conjugation between three cells; polygamy and polyandry; parthenospory; and hermaphroditism.

Chromatophores of Fresh-water Diatoms. † — Emma Ott has examined in detail the structure, arrangement, and mode of division of the chromatophores in a number of genera and species of fresh-water diatoms. The following are the more important new observations.

In all the genera which have two chromatophores (*Fragilaria*, *Synedra*, *Eunotia*, *Pleurosigma*, *Navicula*, *Pinnularia*) a transverse septation is the most essential factor in the process of division, viz. at right angles to the longer diameter. A transverse division was established by the authoress for the first time in *Navicula* and *Pinnularia*. In *Nitzschia*, although it has two chromatophores, the fission is longitudinal; but the formation of the new cell-wall begins even here in the middle. In genera with only one chromatophore, longitudinal fission has the greatest influence in the process of division. The formation of the new cell-walls causes the chromatophore to be pushed aside.

The following is suggested as a classification of the genera of fresh-water diatoms founded on the mode of division of the chromatophores.

* La Nuova Notarisia, xii. (1901) pp. 129-36 (1 pl.).

† SB. k. Akad. Wiss. Wien, cix. (1900) pp. 769-801 (6 pls.)

A. Chromatophore single.

I. Chromatophore divides by longitudinal fission.

(a) Without translocation (*Umlagerung*), *Rhoicosphenia*,
Cymbella, *Encyonema*, *Gomphonema*, *Epithemia*.

(b) With translocation.

(a) With previous translocation, *Amphipleura*.

(β) With subsequent translocation, *Cymatopleura*,
Surirella, *Campylodiscus*.

B. Chromatophores two.

I. Chromatophores divide by longitudinal fission, *Nitzschia*.

II. Chromatophores divide by transverse septation.

(a) With subsequent translocation, *Synedra*, *Eunotia*.

(b) With previous and subsequent translocation, *Fragilaria*,
Pleurosigma, *Navicula*, *Pinnularia*.

Colourless Diatoms.*—The cultivation by G. Karsten of *Nitzschia palea* in favourable nutrient media—glycerin, glycocoll, and grape-sugar—brought out the peculiarity of the appearance of a fatty shimmer (*Speckglanz*) throughout the cell-contents, larger or smaller fat-like drops being dispersed among them. The size of the chromatophores gradually decreased, especially when the culture was exposed to strong illumination; and they were finally reduced to a minute dot-like residue but the diatoms still retained their power of motion under the saprophytic conditions, and the capacity for propagation was increased. On the other hand, all attempts to induce the production of chromatophores or leucoplasts in the colourless *Nitzschia putrida* failed.

Stauronella, a New Genus of Diatoms.†—Out of *Stauroneis constricta* Ehr., C. Mereschowsky proposes to establish a new genus *Stauronella*, with the following characters:—Valve narrow, linear, or attenuated towards the ends, usually constricted in the middle; extremities truncate or rounded, rarely cuneate; raphe straight, symmetrical; central nodule elongated transversely in a stauros; girdle-face constricted, zone complex; endochrome composed of two plates disposed transversely along one of the connecting zones, each plate with a conspicuous pyrenoid.

Okedenia.‡—C. Mereschowsky proposes the re-establishment of this MS. genus of diatoms of Eulenstein's, to include *Navicula scopulorum* Bréb., *Amphipleura inflexa* Bréb., and two new species. The following is the diagnosis of the genus:—Valve elongated, very narrow, linear, often inflated at the middle and at the extremities, straight and symmetrical, or arcuate and asymmetrical, terminal nodules usually distant from the margin; striæ fine; connecting zone complex; endochrome composed of numerous chromatophores usually of the shape of the letter H, sometimes rounded, disposed in pairs along the connecting zone, rarely along the valves, with a central pyrenoid usually common to each pair.

* Flora, lxxxix. (1901) Ergz.-Heft, pp. 404-33 (1 pl.). Cf. this Journal, 1901, p. 306.

† Ann. Nat. Hist., viii. (1901) pp. 424-34 (1 pl. and 3 figs.).

‡ Tom. cit., pp. 415-23 (1 pl. and 2 figs.).

Marine Diatoms of France.*—The second part of this very fine work, by H. and M. Peragallo, is devoted to the Pseudoraphideæ, a commencement being made also of the Anaraphideæ, distinguished by the central structure of the valves. The genera are arranged under two tribes, the Biddulphioidæ and the Discoideæ.

Schmidt's Atlas der Diatomaceen-Kunde.—Heft 57 of this work contains the usual 4 plates of the customary excellence, viz. pls. 225–228. It is chiefly devoted to the genus *Stephanodiscus*, but species of *Cyclotella*, *Coccinodiscus*, and *Thalassiosira* are also illustrated.

Pseudenclonium, a New Genus of Algæ.†—In the first seven instalments of his studies on Chlorophyceæ, made at the biological station at Dröbak, Prof. N. Wille has a number of notes on the structure and life-history of algæ belonging to the Chlorophyceæ, with descriptions of several new species and forms, and of one new genus *Pseudenclonium*, a marine genus of Chætophoraceæ. The thallus consists of an irregular foot with irregularly branched cells, some of which form unicellular or less often multicellular branched rhizoids. The terminal bristle is wanting in the erect branches; they branch irregularly, and often form *Pleurococcus*-like colonies. The cells have a parietal chlorophyll-disc with a pyrenoid and a nearly central nucleus. Propagation takes place by zoospores and akinetes. The zoospores are broadly ovate with four cilia, but with no red eye-spot. The resting akinetes have a thick membrane and yellow-green contents, and are surrounded by a gelatinous envelope.

Cladophora.‡—Pursuing his researches on the structure of this genus of Algæ, F. Brand states that in young cells of aquatic species, in addition to the inner and outer layers of the cell-wall, there is always a distinct outermost stratum, which can be detached by the application of acetic acid. The membrane of old cells becomes thin at the spots where adventitious branches are about to be formed, apparently by the action of some solvent proceeding from the apical protoplasm, in the same way that the cell-wall is completely absorbed at the spots where the zoospores escape. A similar process, proceeding from the apical protoplasm, appears to be the efficient cause of the layers which compose the hinge-portion of the filament. The necessary pushing upwards of the base of a branch in the process of formation is assisted by a corresponding increase in the upper portion of the mother-cell. The most common form of the chlorophores is reticulate; there are all intermediate forms between an elongated reticulum and isolated plates; but the extreme cases do not occur in ordinary vegetative cells; the statement that spiral bands have been observed in *Cladophora* is probably erroneous. The number of nuclei in a cell is usually great, but they are often reduced to two, and occasionally to one.

* Les Diatomées marines de France, 2^me partie, Paris, 128 pp. and 39 pls. Cf. this Journal, 1890, p. 91.

† Vidensk. Skrift. I. Math.-naturw. Cl., 1900, No. 6, Christiania, pp. 1–46. See Hedwigia, xl. (1901) Beibl., p. 73.

‡ Beih. z. Bot. Centralbl., x. (1901) pp. 481–521 (10 figs.). Cf. this Journal, 1900, p. 92.

Oil in *Vaucheria*.*—P. Fleissig inclines to the view that the oily substance found in the filaments of *Vaucheria* is a reserve substance, analogous physiologically to starch, rather than a product of assimilation or of degeneration. It is never accompanied by starch, tannin, cane-sugar, or aldehyd, and by only traces of glucose. The oil-drops are always found in connection with chloroplasts, but not enclosed within the chlorophyll-bodies.

Fungi.

Gametogenesis and Fertilisation in *Albugo*.† — F. L. Stevens has further followed out the life-history and phenomena of impregnation in four species of *Albugo*, *A. candida*, *Bliti*, *Portulacæ*, and *Tragopogonis*, and has arrived at the following general conclusions.

A. Portulacæ possesses a multinucleate oosphere; the nuclei all pass to the periplasm, dividing mitotically; some of the daughter-nuclei re-enter the ooplasm and divide again, their products becoming the female nuclei, the plasmoderma being in the meantime differentiated. Two mitoses occur in both oogenesis and spermatogenesis. The nuclear figure of the second mitosis is clearly distinguishable from the first by the diminished kinoplasm. The antheridial tube is multinucleate. The numerous antheridial nuclei fuse in pairs with the numerous oospheric nuclei; these fusion nuclei passing the winter without further change. A cœnocentrum is present. The receptive papilla is larger than in the other known species.

In *A. Tragopogonis* a multinucleate oosphere develops in the same manner, and is then reduced to a uninucleate condition by disorganisation of the supernumerary nuclei. The nuclei pass to the periplasm, divide, and return to the ooplasm much diminished in achromatic content. Two mitoses occur in oogenesis and in spermatogenesis. The nuclei figure of the second division may be distinguished from the first by a diminution of kinoplasm. The antheridial tube conveys one or more nuclei into the oosphere, where one fuses with the female nucleus. Both the supernumerary male and female nuclei disorganise. The fusion-nucleus undergoes repeated mitosis, and the winter oosphere is consequently multinucleate. The cœnocentrum is very highly developed; it possesses an attraction for the primary oospheric nuclei, and serves as a source of nourishment for the surviving female nucleus.

In *A. candida* the oosphere is developed in a manner quite different from that in the other three species. The periplasm and ooplasm are not differentiated until the second mitosis is completed. The nuclei, excepting one, eventually pass to the periplasm, which is then cut off by a wall. One nucleus remains in the oosphere attached to the cœnocentrum. The cœnocentrum attracts the nuclei very strongly, and later serves as a source of nourishment for the surviving female nucleus. The antheridial tube occasionally contains two nuclei.

The processes leading to zonation may be regarded as the differentiation of an ooplasm rich in trophoplasm. The cell-plate is formed, with-

* Ueb. d. phys. Bedeutung d. oelartigen Einschlüsse in d. *Vaucheria*, Basel, 1900, 46 pp. See Bot. Centralbl., lxxxvii. (1901) p. 340.

† Bot. Gazette, xxxii. (1901) pp. 77-98, 157-69, 238-61 (4 pls. and 9 figs.). Cf. this Journal, 1900, p. 92.

out the participation of the nuclei, by a rearrangement of alveolar planes. The simultaneous mitosis in gametogenesis is a phylogenetic reminiscence, and was of value in ancestral forms in increasing the number of gametes. The supernumerary nuclei are phylogenetically gametes. The receptive papilla is the result of a softening of the oogonial wall by the oogonial contents; while the receptive spot is a differentiated region of the oosphere.

The four species, *A. Portulacæ*, *Bliti*, *Tragopogonis*, and *candida*, constitute a series in which the cœnocentrum increases in complexity, the receptive papilla decreases, and the number of functional nuclei decreases. The cœnocentrum was an important factor in evolution from the multinucleate to the uninucleate condition of the oosphere. The division of the fusion-nucleus before passing to the winter condition is a consequence of the uninucleate condition, and constitutes the initial step in germination.

The paper concludes with a statement of the author's views as to the phylogenetic relationship of *Albugo* to other genera belonging to the Phycomyces, — *Peronospora*, *Saprolegnia*, *Pythium*, &c.

New Chytridineæ.* — In the commencement of an account of the mycological flora of Roumania, J. C. Constantineanu describes several new species of Chytridineæ, parasitic on fresh-water algæ, and completes the hitherto imperfectly known cycle of development of other species.

Penicillate Tubes of Phyllactinia.† — P. Vuillemin now confirms Neger's statement that the penicillate tubes on the perithece of *Phyllactinia* spring from the outer wall of the upper portion of the perithece. When the perithece falls off, it lies in an inverted position; and these gelatinous tubes then fix it to the substratum. The author compares these tubes to the periphyses which clothe the canal of the ostiole of the perithece of many Pyrenomyces.

Variability of Lichens under different external conditions.‡ — G. Bitter treats of this subject copiously, his observations, chiefly made on species of *Parmelia*, being arranged under the following heads: — The behaviour of certain lichens according to the angle which the substratum makes with the horizontal; the conditions of the transition from vegetative growth to soral formation; the relationship of the production of apothecies and soredes, dependent on external conditions; the influence of external conditions on the growth and form of the sorals; the conditions for the formation of isidia-like branchings in *Parmelia physodes* and *P. tubulosa*; the influence of the intensity of illumination on the colour and structure of the thallus; the disposition (*Feldërung*) of the assimilating surfaces of various lichens by portions destitute of gonids, and the influence on them of the conditions of the habitat; the influence of the thallus on the structure of later branchings within its closed central portion; variations in individuals of the same species under similar external conditions.

* Rev. Gén. de Bot. (Bonnier), xiii. (1901) pp. 369–89 (15 figs.).

† Rev. Mycol., xxii. (1900) pp. 124–5. See Bot. Centralbl., lxxxviii. (1901) p. 161. Cf. this Journal, 1900, p. 491.

‡ Pringsheim's Jahrb. f. wiss. Bot., xxxiv. pp. 421–92 (7 pls. and 9 figs.).

Parmelia.*—G. Bitter enters, in great detail, into the characters which distinguish the species of the subgenus *Hypogymnia* of this genus of Lichens from one another. The specific characters especially relied on are those connected with the place and mode of formation of the soredes. Nineteen species in all are described, six of them new.

Buchner's Yeast Extract.†—The extract as obtained by A. Wróblewski is a somewhat viscous liquid, of aromatic odour and sweet taste, and exhibits a brownish-yellow or greyish-blue fluorescence. It is either optically inactive or feebly dextro-rotatory. Filtration through a Berkefeld or sandstone filter diminishes, and through a Chamberland filter entirely removes the fermenting power. The extract does not act on starch-granules, but ferments starch-paste, soluble starch, glycogen, and sucrose. In fermentation by yeast-cells, the zymase remains in the cells and does not diffuse into the sugar solution. If the cells are collected on a sandstone filter, fermentation in the sugar solution ceases. The sugar solution probably passes into the cells and is there fermented. Alcohol and carbon dioxide accordingly are true excreta of the yeast-cells. The author believes that the zymase is not an enzyme but a colloidal substance, which exists in the extract in a state of semi-solution and belongs to the group of protoplasmic ferments.

Microscopical Appearances of Pressed Yeast after Liquefaction.‡
—A. Harden and S. Rowland, after narrating the changes culminating in the liquefaction of yeast, describe the following series of structural changes which were observed microscopically. The freshly pressed yeast consists of large cells with a small vacuole and granular protoplasm, staining a deep brown with iodine. As the evolution of carbon dioxide proceeds, the vacuole increases in size, the brown stain obtained with iodine diminishes, and just before liquefaction there is usually no glycogen left in the cell. After liquefaction, the cells have no vacuole and are shrunken, the cell-walls being crumpled, and the cell substance highly granulated and contracted to a centrally aggregated mass, floating in a small amount of clear fluid. No brown reaction is, as a rule, obtainable, and although in the case of yeast liquefied at 50°, the brown stain is obtained, the cell does not in other respects differ from the normal character. It therefore seems probable that the liquefaction of the yeast is due to the discharge of the contents of the vacuole, and that the progressive increase in the size of the vacuole results from the accumulation of some substance produced along with carbon dioxide from the glycogen. The changes described terminating in the extrusion of the contents of the vacuole were watched on the hot stage, and the cell-wall could be readily distinguished throughout the process.

Storing up of Water in the Spores of the Uredineæ.§—According to P. Dietel, the thickenings which are so frequently found in the walls and in the stalks of spores of Uredineæ serve as a reservoir of water, to prevent the spores getting prematurely dried up and thus inhibiting

* Hedwigia, xl. (1901) pp. 171–274 (2 pls. and 21 figs.).

† Journ. Pr. Chem., lxiv. (1901) ii. pp. 1–70. See Journ. Chem. Soc., lxxx. (1901) Abst. ii. pp. 616–7.

‡ Journ. Chem. Soc., lxxix. (1901) pp. 1227–35.

§ Naturw. Rundschau, xvi. (1901) pp. 41–1. See Hedwigia, xl. (1901) Beibl., p. 74.

germination. The germinating pores of many uredospores are protected by stoppers of this kind. This absorption of water is most strongly displayed in spores of *Gymnosporangium*; also in some species of *Puccinia* and *Uromyces*, especially in the Brazilian *U. giganteus*.

Rabenhorst's Cryptogamic Flora of Germany, &c. (Fungi Imperfecti).—Parts 78–81 by A. Allescher, are now published. The genus *Hendersonia* is completed with 163 (besides 11 doubtful) species, followed by *Couturea* (1), *Wojnowicia* (1), *Angiopoma* (1), *Cryptostictis* (8), *Eriosporina* (1), *Prosthemium* (3), and *Hendersonula* (1 sp.). The eighth section of this division, the Dictyosporæ, has rusty or olive-coloured ovate or elongated spores with two or more septa. It comprises the genera *Camarosporium* (92), *Cytosporium* (2), and *Dichomera* (10 sp.).

The second family, the Nectrioideæ, are characterised by having the receptacle and stroma, when present, somewhat fleshy and waxy, light-coloured (whitish, yellow, red, or orange), spherical, or less often two-lobed or bowl-shaped. They are divided, according to the colour or septation of the spores, into Hyalosporæ, Didymosporæ, Hyalophragmiæ, and Scolecosporæ. The Hyalosporæ have spherical, ovate, or elongated spores, which are unicellular and hyaline. The genera are *Zythia* with 10, *Libertiella* with 1, *Roumegueriella* with 1, *Pleosporopsis* with 1, *Chætozythia* with 1, *Collacystis* with 1, and *Sphæronæmella* with 9 species. The Didymosporæ, comprising the single monotypic genus *Pseudodiplodia*, have slightly olive-coloured uniseptate spores. The Hyalophragmiæ have hyaline spores with two or more septa, and comprise the genera *Stagonopsis* (3), *Pseudostictis* (2), and *Chiatospora* (1 sp.). In the Scolecosporæ, the spores are filiform or rod-shaped; they comprise the monotypic genera *Trichocrea*, *Rhynchomyces*, and *Polystigmia*.

The third family, the Leptostromaceæ, have a membranous or carbonaceous receptacle, which is more or less distinctly bisected. A similar classification is made into Hyalosporæ, Phæosporæ, Hyalodidymæ, Phæodidymæ, Hyalophragmiæ, Phæophragmiæ, and Scolecosporæ. In the Hyalosporæ are comprised *Leptothyrium* with 68 species, *Piggotia* with 5, *Actinothecium* with 1, *Leptostroma* with 45, *Labrella* with 10, *Socidium* with 14, *Melasmia* with 2, and *Trichophila* with 1 species. The Phæosporæ include only a single genus, *Pirostoma*, with 3 species; the Hyalodidymæ also a single monotypic genus *Leptothyrella*; and the Phæodidymæ a single monotypic genus *Diplopeltis*. The Hyalophragmiæ are made up of two genera, *Discosia* (5 species), and *Entomosporium*, of which two species are described.

Parasitic Fungi.—On the leaves of a grass, *Cynosurus elegans*, from Tunis, P. Hennings* finds an undescribed species of *Uromyces*, which he names *U. phyllachoroides* sp. n.

As the result of an examination of the infection of species and varieties of *Bromus* by *Puccinia dispersa*, Prof. H. Marshall Ward† concludes that the uredospores infect most easily the species and variety on which they have been developed, less easily species or varieties more remote, and fail altogether to gain a hold on more distant ones. The acts of infection and incubation occupy about 10 days. The lack

* Hedwigia, xl. (1901) Beibl., pp. 129–30.

† Ann. Bot., xv. (1901) pp. 560–2.

of certain mineral substances, e.g. potassium or phosphorus, causes a starvation of the fungus; partial etiolation of the host, or any other hindrance to free nutrition, assimilation, transpiration, &c., also act detrimentally to the well-being of the mycele.

L. Lewton-Brain * has studied the parasitism of *Cordyceps ophioglossoides* on various species of *Elaphomyces*. The connection between the two fungi appears to be one of true parasitism; but nothing in the shape of a definite haustorium could be made out in the *Cordyceps*. Fusion takes place between the hyphæ of the two species, the adjoining walls fusing and becoming considerably thinner. *Elaphomyces variegatus* forms a mycorrhiza with the roots of conifers, presenting different forms under different conditions.

J. Eriksson † has an elaborate memoir on the origin and propagation of the rust of cereals, in which he includes four species,—*Puccinia graminis*, *P. glumarum*, *P. triticea*, and *P. coronifera*.

Phalloideæ ‡—Prof. E. Fischer describes the development of the receptacle in a number of genera and species of Phalloideæ,—*Clathrella chrysomycelina*, *C. pseudocancellata* sp. n., *Blumenavia rhacodes*, *Dictyophora irpicina*, *Itajahja galericulata*, *Echinophallus Lauterbachii*, *Mutinus Zenkeri*, *M. Nymanianus*. A description is given in detail of all new species described since 1893. All the pseudoparenchymatous parts of the receptacle in the Phallaceæ and Clathraceæ are regarded by the author as a paraphyse structure which fills up the sterile portions of the gleba-chamber and is homologous with the cortical layer of the surface of the receptacle.

The Phalloideæ consist of two series, the Phallaceæ and the Clathraceæ. The origin of the latter may be traced to *Phallogaster*, of the former to the Secotieæ. The Gastromycetes cannot be regarded as a single independent series of forms; but must be arranged in a number of parallel rows, viz. the Secotiaceæ, Hysterangiaceæ, Hymenogastraceæ (with the Nidulariaceæ as a side-branch), Podaxaceæ, Sclerodermataceæ, Sphærobolaceæ, and Tulostomataceæ.

Microbe of Piedra. §—P. S. de Magalhães studied the development of the parasite of this disease in hanging drops, the medium being gelatin or sugar-gelatin. Thin filaments were observed to grow from the nodosities on the hairs. The filaments were divided by transverse septa into short segments. In their interior, while still young, small granules could be made out, and in later stages chains of spores. The spores were terminal or inclosed in the continuity of the filament, and from any one a fresh mycelial filament might arise.

The presence and the appearance of the parasite in the hair were studied by the aid of various stains which showed up the filaments and the spores. The action of caustic potash solution was found to be detrimental.

* Tom. cit., pp. 521-30 (1 pl.).

† Ann. Sci. Nat. (Bot.), xiv. (1901) pp. 1-124 (1 pl. and 2 figs.).

‡ Denkschr. schweiz. naturf. Ges. Bern, xxxvi. (1900) 84 pp., 6 pls., and 6 figs. See Bot. Centralbl., lxxxvii. (1901) p. 259. Cf. this Journal, 1897, p. 153.

§ Comptes Rendus, cxxxiii. (1901) pp. 601-3.

Protophyta.

a. Schizophyceæ.

Richelia, a New Genus of Cyanophyceæ.*—In plankton from the Indian Ocean, J. Schmidt finds, within the cells of certain diatoms, a blue-green alga which he names *Richelia intracellularis* g. et sp. n. The genus is distinguished from *Microchæte* by the absence of a sheath and by its intracellular habit; and the author states that it is the first recorded example of a cyanophycous alga living within the cells of the host.

Pilgeria, a New Genus of Chroococcaceæ.†—Under this name W. Schmidle describes a new genus of blue-green Algæ from Brazil, consisting of polyedric closely associated cells, forming small hollow spheres not enclosed in jelly, the cells being empty or filled with jelly.

β. Schizomycetes.

Proteolytic Power of Bacteria.‡—Dr. E. Caccace shows that when bacteria decompose proteids, protalbumose, deuteralbumose, and pepton are formed. But when bacterial action has attained to an advanced condition, the products of proteid decomposition may be wanting. Proteolysis is practically the same in all living animals. The foregoing results were obtained by cultivating *Sarcina aurantiaca*, *Bac. anthracis*, and *Staphylococcus pyogenes aureus* on gelatin and on blood-serum, and submitting the products to chemical examination.

Reaction of Bacteria to Stimuli.§—H. S. Jennings and J. H. Crosby describe the movements of *Spirillum volutans* when exposed to the influence of oxygen, light, and chemical stimuli. When the microbe reaches the extremity of the area in which it is swimming and comes in contact either with an area, say, devoid of oxygen or containing, say, salt, it reverses its movement and swims back in the opposite direction. This reaction is termed the motor reflex. The movement is comparable to that of the ciliate Infusoria, but differs therefrom in that the bacterial motor-reflex consists merely in a reversal of the direction of the movement, without subsequent return to the original direction except as a response to a new stimulus. The reason is that there is no difference between the bacterial ends while the infusorian has a fore and aft.

Effect of Nitrates on the Shape of Certain Bacteria.||—W. C. C. Pakes describes the action of various percentages of nitrates in ordinary broth or broth cultures without pepton, containing quantities of nitrate from 1–10 p.c., upon certain bacteria. With *B. typhi abdominalis* the presence of nitrate causes a thickening of the rod, imparting a Clostridium-like appearance. With greater amounts the thickening increases, the rodlet shortens until finally (6 p.c.) a yeast-like form is arrived at. With *B. coli communis* the changes are less marked, the yeast-like forms are absent, the bacilli are merely thickened here and there, but form

* Hedwigia, xl. (1901) Beibl., pp. 112–5 (1 fig.).

† Tom. cit., p. 45 (1 pl.).

‡ Centralbl. Bakt., 1^{te} Abt., xxx. (1901) pp. 244–8.

§ Amer. Journ. Physiol., vi. (1901) pp. 31–7.

|| Trans. Path. Soc., lii. (1901) pp. 246–7.

long chains of oval cocci. With *B. enteritidis* Gärtner the changes more nearly resemble those of *B. typhi abdominalis*. On *B. pyocyaneus* the first effect of nitrate is to produce long non-motile rodlets; with higher percentages the bacilli show spurious branching and resemble *Cladotrix*.

Agglutination of Bacteria.*—Dr. P. T. Müller, after dealing with the position taken up by Emmerich and Loew relative to the agglutination of bacteria, maintains that his observations and experiments show that:—(1) There is no proof that the sediment formed in old cultures has anything whatever to do with true agglutination; (2) that with old bouillon cultures (whether in the undiluted or diluted condition or even after heating to 55°) fresh suspensions of *Bacillus pyocyaneus* do not exhibit typical agglutination; (3) that the formation of the agglutinating substances must be located in the animal organism and not in the cultures of the bacillus in question.

Effect of Salt in Nutrient Media on the Growth of Micro-organisms.†—T. Matzuschita found that different microbes are very differently affected by the presence of salt in the medium. Many will stand 10 p.c. without alteration of shape, while others on the slightest addition of salt exhibit striking involution forms. The degeneration forms exhibited by the plague bacillus, cultivated on 2·5–3·5 p.c. salt-agar at 37° for 24–48 hours, are very characteristic, and are not likely to be confounded with the changes presented by other microbes cultivated under the same conditions.

Bacteria and the Disintegration of Cement.‡—R. Greig-Smith thinks that on the whole there is considerable reason for doubt regarding the action of micro-organisms upon cement. There is more reason to believe that the action is purely chemical and brought about by the decomposing and solvent action of the water alone upon the cement. The presence of free lime in the cement, capable of being dissolved, is the source of weakness. He found that a cement which after exposure to the action of the water for a number of years had become porous and disintegrated, still contained 1·4 p.c. of free lime capable of being dissolved. The presence of three micro-organisms, *Micrococcus radiatus*, *Vibrio denitrificans*, and *Bacterium croceum*, was detected in the disintegrated cement; but experiments showed that they had no action upon cement blocks. In the course of the investigation it was noted that *Bact. croceum* was able to grow in bouillon containing as much as 5 p.c. by weight of sodium carbonate.

Metachromatic Granules in Sporiferous Bacteria.§—Dr. E. Krompecher has detected the existence of a new kind of granule in anthrax by staining with methylen-blue. The granules are centrally placed and stain red. These granules are not the same as the Babes-Ernst corpuscles as is shown by the coexistence and different location and colour of the two kinds.

* Centralbl. Bakt., 1^o Abt., xxx. (1901) pp. 65–9. Cf. this Journal, 1901, p. 690.

† Zeitschr. f. Hygiene u. Infektions., xxxv. p. 495 (36 figs.). See Bot. Centralbl., lxxxviii. (1901) pp. 65–6.

‡ Proc. Linn. Soc. N.S.W., xxvi. (1901) pp. 107–17.

§ Centralbl. Bakt., 1^o Abt., xxx. (1901) pp. 385–95, 425–8 (1 pl.).

Babes-Ernst corpuscles were also found in *Bacillus alvei* and in a species of *Oidium*.

Spore-formation in Cholera Bacilli.*—Blicsener filled test-tubes with 20 cm. of dirty ditch water, sterilised them, and then inoculated with a loopful of cholera culture. 376 days after, when the tubes had dried, in the reddish flocculent deposit were found oval highly refracting motionless shining corpuscles which could be stained like spores. From the deposit the author cultivated on plates typical cholera bacilli. The "cholera spores" were no more resistant to drying than cholera bacilli. Eight hours after complete drying the power of developing had disappeared. Suspended in water, they were dead in about half an hour at 50°. The cholera spores could retain their vitality for 878 days in water. The author suspects that these "cholera spores" represent the resting forms which enable the cholera to hibernate, and then to break out in places where it had apparently been extinguished.

Bacteriosis of Kohlrabi.†—L. Hecke describes a disease of kohlrabi affecting the plants in Lower Austria. The chief effect of the disorder was to deteriorate the quality, the plants being of good size. The fleshy parts of the diseased specimens presented a marbled appearance, produced by a bacterial mucus in which the organisms existed. The parasite was found to be a rodlet of very variable size. On meat-extract-pepton-gelatin the young colonies were colourless spherules, which later became yellow with liquefaction of the medium. The microbe in cultures is a bacillus 0.9 to 1.6 μ long and 0.5 μ broad; it exhibits lively movements, and possesses a single polar flagellum. It is identical with, or closely allied to, the *Pseudomonas campestris* described by Smith and Pammel.

Ripening of Cream.‡—H. W. Conn and W. M. Esten give the following general summary, drawn from a long series of experiments, as to the actual bacterial development occurring on the normal ripening of cheese. Milk, as it is drawn from the cow, contains great quantities of bacteria, most of them being liquefying, and other non-acid species. At the outset the number of acid bacteria is small. All the species increase during the setting of the milk for the separation of the cream. For a few hours the alkaline bacteria, and also some others, increase quite rapidly, while the lactic acid bacteria are hardly evident. After about 12 hours the lactic bacteria are as numerous as the others; they reach their maximum in about 48 hours, after which they decrease, and finally disappear. The ripened cream contains vast numbers of bacteria, nearly all being lactic. After the first 12 hours all species save two lactic bacteria decrease and disappear. These two species increase regularly from the beginning of the experiments to the maximum; one is always present, and during the ripening increases in numbers, though not in proportion. The ripening which takes place in the creamery is wholly, or almost wholly, due to the growth of lactic

* Zeitschr. f. Hygiene u. Infektions., xxxvi. p. 71. See Bot. Centralbl., lxxxviii. (1901) p. 130.

† Zeitschr. f. d. landwirthsch. Versuchswesen in Oesterreich, 1901, p. 469. See Bot. Centralbl., lxxxvii. (1901) pp. 150-1.

‡ Centralbl. Bakt., 1^o Abt., xxx. (1901) pp. 743-52, 769-75.

bacteria. A ripened cream is almost a pure culture of acid bacteria, but whether the lactic bacteria are the sole agents in the ripening is not clear. The flavour of June butter is not due to the presence of common lactic bacteria, but to what it should be ascribed is left to future experiments to decide.

Bacteriological Examination of Potable Water. * — Dr. A. C. Houston, in some remarks on the bacteriological examination of potable water from the public health point of view, discusses the significance of the presence of *Bacillus coli communis*, *B. enteritidis sporogenes*, and Streptococci, and gives it as his opinion that the presence of Streptococci is to be regarded as indicating extremely recent, and *B. coli* less recent but still not remote, pollution of animal soil. The presence of *B. enteritidis sporogenes* cannot be considered to afford evidence of pollution bearing a necessary relation to the recent evacuation of animals.

Influence of Alcohol on Natural Immunity. † — Dr. S. J. Goldberg records experiments made on pigeons for the purpose of testing the effect of alcohol on their natural immunity to anthrax, and on the course of anthrax infection. The results showed that pigeons, which are naturally immune to anthrax, become susceptible of anthrax infection when the infected animals are dosed with alcohol (2–3 ccm. of 40 p.c. brandy) sufficient to produce merely a transitory alcohol-intoxication, and insufficient to cause death. Chronic alcoholic intoxication diminishes the natural immunity of pigeons to anthrax. Small doses of alcohol, when repeatedly administered to pigeons infected with lethal doses of anthrax, do not save the animal from death, and have no therapeutic influence whatever.

Involution Forms of some Plague-like Bacteria. ‡ — Dr. A. Rosenfeld, after alluding to the value of Hankin's method, communicates the results obtained by cultivating the following bacteria on salt-agar:— (1) *Bacillus typhi murium*; (2) *B. suipestifer*; (3) *B. mustelæ septicus*; (4) Danysz bacillus; (5) *B. cholerae gallinarum*; (6) *B. pseudotuberculosis* (*Streptobacillus pseudotuberculosis rodentium*); and (7) *B. suisepiticus*. The results are given as a series of tables, and may be summed up shortly as follows:—In (1), (2), (3), and (5) the involution forms exhibit little or no resemblance to those of plague. The involution forms of Danysz bacillus present certain resemblances to those of plague, but no real difficulty arises in differentiating between the two. The resemblances between the involution forms of (6) *Pseudotuberculosis* and of *Suisepiticus* and those of *B. pestis* are, under some circumstances, more pronounced; though even here care will enable the observer to discriminate between them. Hankin's salt-agar medium is pronounced to be a very valuable medium for diagnosing plague.

Ætiology of Dysentery. § — Prof. S. Flexner has little doubt that the acute epidemic dysenteries of America are caused by the same micro-organism. This opinion is founded on a comparative study of material derived from five different sources. In growth, shape, size, motility, and in their serum reaction, there is such close resemblance

* Brit. Med. Journ., 1901, ii. pp. 1793–7.

† Centralbl. Bakt., 1^o Abt., xxx. (1901) pp. 696–700, 731–41.

‡ Tom. cit., pp. 641–53.

§ Tom. cit., pp. 449–54.

that the general acceptance of a specific organism of dysentery seems unavoidable.

Melanogenic Variety of *Bacillus pyocyaneus*. * — C. Gessard, after alluding to Cassin's discovery of a variety of *Bacillus pyocyaneus* which in certain media produced a red, and finally a black pigment shows that the principal factors in the production of the pigment are the presence of tyrosin in the medium and the existence of tyrosinase in the microbe. The bacterium uses another diastase, trypsin, to bring the tyrosin into a condition suitable for the action of the tyrosinase. It can attack tyrosin in combination and in the free state, and thus may be compared to Millon's reagent.

Biochemical Studies on the Tubercle Bacillus. † — Elementary analysis of tubercle bacilli cultivated on different media was found by P. A. Levene to give widely different results, especially in the amount of alcohol-ether extract. Differences were also observed in the amounts of proteid and of free nucleic acid present. By fractional heat-coagulation the proteid material can be separated into three substances, each of which contains phosphorus. The nucleic acids separated vary much in composition; some of the preparations made are looked on as purer than the others. The only carbohydrate studied was one which closely resembles glycogen; this appears to be always present.

Human and Bovine Tuberculosis. ‡ — Prof. S. Delépine, in a preliminary communication on the communicability of human tuberculosis to cattle, relates the results of four experiments on calves. The animals were inoculated with a mixture of several tuberculous sputa, representing several types of human tuberculous sputa. Of these four calves two survived long enough to allow definite results to be obtained, and showed that tuberculosis had been contracted as the result of ingestion of a peritoneal infection with human tuberculous sputa.

Virulence of Bovine and Human Tubercle Bacilli. § — Dr. M. P. Ravenel records some important experiments and observations which he has made on the comparative virulence of the tubercle bacillus derived from human and bovine sources. From these he draws, among others, the following conclusions:—The bovine bacillus has in culture fairly constant and persistent peculiarities of growth and morphology, by which it may be tentatively differentiated from that ordinarily found in man. The cultures from the two sources differ markedly in pathogenic power, affording further means of differentiation; the bovine bacillus being much more active than the human for all species of experimental animals treated, with the possible exception of swine, which are highly susceptible to both. It is a fair assumption from the evidence at hand and in the absence of evidence to the contrary, that the bovine tubercle bacillus has a high degree of pathogenic power for man also, which is especially manifest in the early years of life.

Variability of Gas-formation by *Bacillus coli communis*. || — J. Roth finds that the power of *B. coli communis* to ferment grape-sugar is

* Ann. Inst. Pasteur, xv. (1901) pp. 817-31.

† Journ. Med. Research, vi. (1901) pp. 135-44. See Journ. Chem. Soc., lxxx. (1901) Abstr. ii. p. 675.

‡ Brit. Med. Journ., 1901, ii. pp. 1224-6.

§ Lancet, 1901, ii. pp. 349-56, 443-8.

|| Inaug. Diss. Heidelberg. See Bot. Centralbl., lxxxviii. (1901)

as variable as that of forming acid or indol, or of coagulating milk; and that this power is seriously influenced by the serum of animals immunised by sterilised coli cultures.

Classification of the Hæmorrhagic Septicæmia.*—According to J. Lignières, the following are the specific characters of the *pasteurella*, a group of pathogenic micro-organisms which give rise to hæmorrhagic septicæmia:—Non-motile cocco-bacilli, not staining by Gram's method, very polymorphic, with involution forms, not liquefying gelatin, not coagulating milk which retains its normal reaction, no visible growth on potato, not forming indol in pancreatic-bouillon, not reddening Wurtz *gélose*, markedly aerobic but also anaerobic, developing an odour *sui generis*. No spores, no flagella, virulence variable but usually high. On intravenous injection, a special affinity for synovial sheaths of tendons and joints.

The group of *pasteurelloses* includes diseases affecting birds, pigs, sheep, cattle, horses, and dogs. The part played by the *pasteurella* is variable: it is rapid and severe, in which case the organisms are easily detected; or it is slow, passive, and preparatory, in which case the difficulties of unmasking it are very great.

Probable Identity of Achalme's Bacillus of Acute Rheumatism and the Bacillus enteritidis sporogenes.†—R. T. Hewlett compared Achalme's bacillus and *B. enteritidis sporogenes* Klein, and was unable to discover any distinct difference between them. Both are anaerobic anthrax-like bacilli which stain well by Gram's method; both curdle milk in the same peculiar manner, form gas, liquefy serum and gelatin, and form spores under certain but identical conditions, viz. in gelatin and serum, but not on agar or in milk. Their pathogenic action on guinea-pigs also appears to be the same. Morphologically, culturally, and in their pathogenic action the two organisms appear to be identical.

Indol-like Reaction given by Cultures of Diphtheria and Pseudo-diphtheria Bacilli.‡—R. T. Hewlett found that a pink reaction followed the addition of strong acid and weak nitrite solution to cultures of the diphtheria and pseudo-diphtheria bacilli. The pink colour was found to be due to some non-volatile substance, and was therefore not indol. Chemical tests showed that it was skatol-carboxylic acid. The formation of this body by both diphtheria and pseudo-diphtheria bacteria points to the close relationship of the two organisms, and it further indicates that the routine method of testing for indol is insufficient, the cultures must be distilled and the distillate tasted.

Vibrio denitrificans Sewerin.§—R. Greig Smith isolated from Sydney water an organism which morphologically much resembled *Rhizobium leguminosarum*, but differs therefrom in being able to grow on ordinary media as well as in media containing little nutriment, and in reducing nitrate to nitrogen. It is polymorphic, and Y-forms and cells bent at angles are not infrequent. It is readily stained. It is motile; the flagella are usually two in number, and are polar. The optimum temperature is 28°–30° C. On acid-potato the growth is luxuriant, moist and

* Ann. Inst. Pasteur, xv. (1901) pp. 734–6.

† Trans. Path. Soc., lii. (1901) pp. 114–5.

‡ Tom. cit., pp. 113–4.

§ Proc. Linn. Soc. N.S.W., xxvi. (1901) pp. 118–21 (1 pl.).

creamy white, ultimately becoming brownish-yellow. There is practically no growth in nitrate bouillon at 37°. *V. denitrificans* is a budding fungus; and as it simulates a bacterium the term *Mycobacterium denitrificans* would be more appropriate. It does not form true branchings, unless we agree to call everything within a single capsule an organism; and this would be unwise. The branching is caused by the capsules and not by the simple organisms.

Corynebacterium lymphæ vaccinalis.* — Levy and Fickler found two microbes in animal lymph, one of which produced on Loeffler's blood-serum an orange-yellow pigment. Neither organism formed any demonstrable toxin in the cultures. In young cultures the bacteria were wedge-shaped or cylindrical, becoming bent with increasing age, and exhibiting a granulation of their protoplasm, and finally became club-shaped. The last-named forms developed on egg-white and egg-yolk plates. They were stainable by Gram's method, but did not exhibit the granules with Neisser's staining. They grew well at 37° and badly at 21°. On gelatin the colonies were opaque. On agar the deeplying growth was brownish and small, the superficial layer granular and with yellowish-brown centre. Bouillon was rendered turbid by one, while the other formed a collection of spherules; both produced a sediment and occasionally a surface scum. Milk was not coagulated. The bacteria were killed by moist heat at 60° in ten minutes. The authors consider their bacteria to be identical with Nakanishi's, and to belong to the *Actinomyces* group.

BIBLIOGRAPHY.

- FROST, W. D.—*A Laboratory Guide in Elementary Bacteriology*.
Madison, Wisconsin, 1901, viii. and 205 pp.
- GOTTHEIL, O.—*Botanische Beschreibung einiger Bodenbakterien*.
[A series of articles dealing with earth bacteria, the method of species determination, and the importance of earth bacteria in agriculture.]
Centralbl. Bakt., 2^o Abt., VII. (1901) pp. 430-5, 449-65, 481-97,
529-44, 582-91, 627-37, 680-91, 717-30 (4 pls.).
- LINDNER, P.—*Mikroskopische Betriebskontrolle in der Gährungsgewerben*.
3rd ed., Berlin, 1901, 468 pp., 229 figs., and 4 pls.

* *Deutsche Med. Wochenschr.*, 1900, No. 26. See *Centralbl. Bakt.*, 1^o Abt., xxx. (1901) pp. 470-1.



MICROSCOPY.

A. Instruments, Accessories, &c.*

(1) Stands.

Beck's Imperial Microscope.—This instrument has been designed for critical work of the most advanced type. At the same time it is compact, and does not stand too high from the table to be comfortably used in a vertical position. In its complete form it is provided with coarse focussing adjustment, double speed fine adjustment with graduated head, full size eye-pieces, rack-and-pinion focussing draw-tube, graduated, additional sliding draw-tube, graduated clamp to joint, graduated concentric rotating stage, rack-and-pinion movement to rotating stage, centring screws to stage, graduated vertical and horizontal stage motion, coarse focussing sub-stage adjustment, fine focussing sub-stage adjustment, centring sub-stage adjustment, swinging and sliding mirror.

The stand is made upon two models; the English tripod foot, and the Continental base and pillar. In the English or tripod model there is a splay between the front feet of $8\frac{1}{2}$ in., and 9 in. from front to back. A long lever clamp is provided to fix the Microscope at any inclination, and the latter is limited in its motion in the exact horizontal and vertical positions. The Continental model stand is unusually large and steady; the base measures $6\frac{3}{4}$ in. in length by $4\frac{1}{2}$ in. in width, and is provided with a similar clamp to the joint. The limb of the Microscope is pierced with a square hole and clamp screw, in which an illuminator for opaque objects may be held.

The body-tube of the Microscope is 2 in. in diameter, and 3.6 in. long, but with the nose and draw-tubes in their closed position it measures 140 mm. or $5\frac{1}{2}$ in. The nose-piece and draw-tubes may be removed, and a photographic lens mounted in the centre of this short and large diameter-tube allows of the use of a wide angle for low-power photomicrographic work. The draw-tube is provided with a rack-and-pinion adjustment, and has a ring fitting at its lower extremity, which carries the object-glass screw-thread. An additional sliding draw-tube is supplied, and both are graduated in millimetres; a total extension of tube with the two draw-tubes of 260 mm. is obtained. The diameter of the tube is that of the No. 4 largest Royal Microscopical Society's standard gauge, 1.41 in., and an adapter is supplied to take the No. 1 size, .917 in. Low-power and orthoscopic eye-pieces may be made of the full size, which give a much larger field of view than can be attained with the small size eye-piece. A small size body, with sliding graduated draw-tube with a range of length of 140 mm. to 200 mm., is supplied to the simpler forms of the instrument.

The coarse focussing adjustment is by means of a spiral rack-and-

* This subdivision contains (1) Stands; (2) Eye-pieces and Objectives; (3) Illuminating and other Apparatus; (4) Photomicrography; (5) Microscopical Optics and Manipulation; (6) Miscellaneous.

pinion movement, actuated by large milled heads, the slide being a most substantial dovetail cradle. When at its highest point the nose-

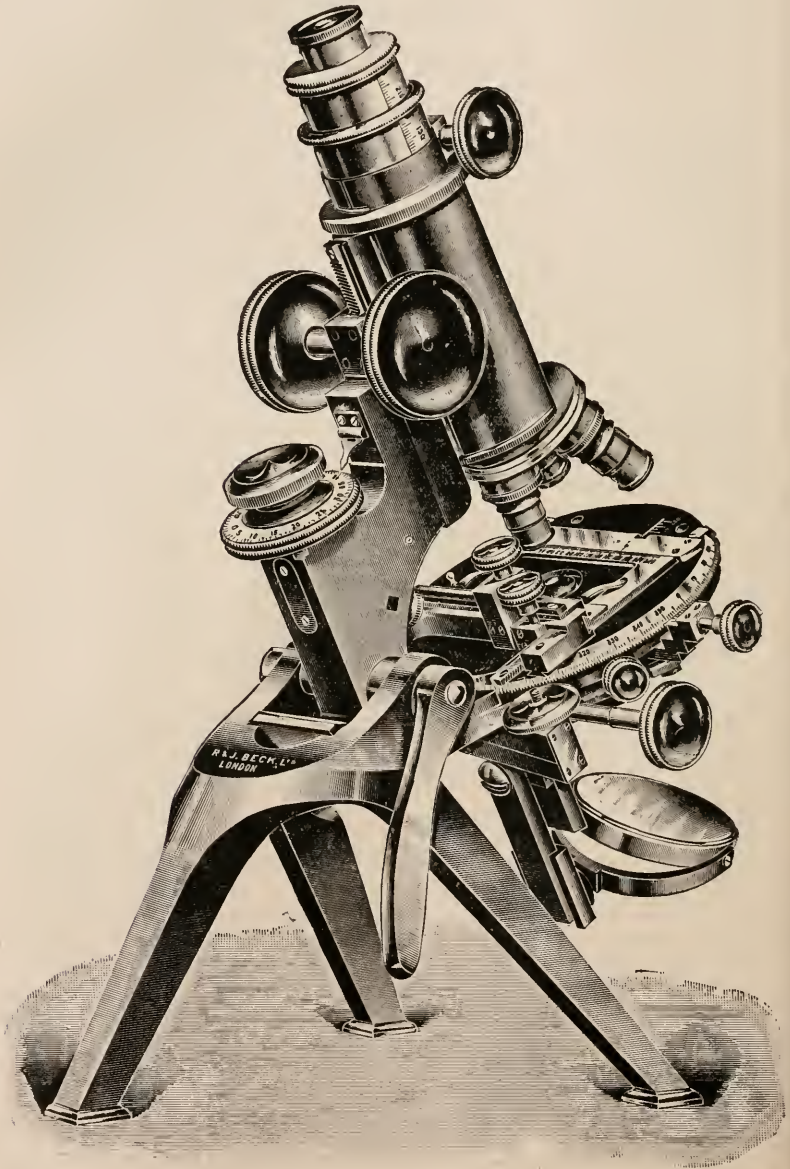

FIG. 18.

piece of the Microscope is 4.1 in. from the stage. The fine focussing adjustment is upon a new patented method invented by Mr. Ashe. A strong lever moves the cradle, which carries the body of the Microscope by means of a block which is a projecting portion of the cradle. The cradle slides in a fitting in the limb with a spring acting upon the upper side of the projection, which drives it on to the lever. The lever is moved by a steel screw with milled head; this screw works through an outer screw which is provided with a large graduated milled head, read by a folding indicator.

One screw has a comparatively coarse thread, and when revolved raises the body a distance of $\frac{1}{100}$ th of an inch in a complete revolution. The other screw has a fine thread, and when revolved carries the former screw with it, moving the body only $\frac{1}{3000}$ th of an inch in a complete revolution. At any moment either milled head may be used, giving a moderately fine adjustment for such powers as $\frac{1}{4}$ -in. or $\frac{1}{6}$, or a very fine movement for $\frac{1}{2}$ or higher powers. The convenience of such an arrangement can scarcely be overstated.

A slow motion fine enough for focussing the highest powers is most troublesome for moderate-power lenses.

The Stage.—In the complete model of the instrument the stage is circular, 5 inches in diameter, with a graduated circle divided in degrees and moved by a rack-and-pinion, which may be thrown out of gear. Centring screws are provided to adjust the centre of rotation. A mechanical rack-and-pinion top stage works upon its surface by two milled heads having a horizontal motion of $2\frac{1}{2}$ in. and a vertical motion of $1\frac{1}{2}$ in. This is so designed that during its whole travel it does not come in contact with the substage condenser. Graduated finder-divisions are provided to both motions for recording and finding again individual points of an object, and for rough measurement purposes. When these are used the centring screws should be unscrewed to their full extent in order that the divisions should always indicate the same position. A folding stop for Maltwood's finder and folding springs are carried by the mechanical stage. Even with the mechanical stage *in situ*, except in its extreme positions of travel, a complete rotation of the stage can be obtained.

The mechanical stage can be entirely removed, leaving the stage free for large culture plates or dishes. Spring clips are provided for use with the plain stage.

The simpler models of the instrument are provided with a large square top, $4\frac{1}{2}$ in. by $4\frac{1}{2}$ in., with a removable mechanical stage, having a horizontal travel of 2 in. and a vertical travel of $1\frac{1}{8}$ in.

The substage is made to the Royal Microscopical Standard size, 1.527 in. It has coarse adjustment by spiral rack-and-pinion, and a lever and micrometer-screw fine adjustment. It has two centring screws in directions at right angles. The substage itself has no swinging-out motion, but a mount may be supplied carrying the condenser, in which the diaphragms and the optical portion swing out.

The mirror is flat on one side and concave on the other. It is $2\frac{1}{2}$ in. in diameter, and is swung on a fitting which slides up and down on a dovetailed bar. This bar is held in the optic axis by a spring stop, but may be swung to one side or the other if desired.

The Binocular.—A special form of the Imperial Microscope is made with a binocular body, in which the limb of the instrument is somewhat lengthened to give extra length of fitting for the body, or a binocular body interchangeable with the ordinary body may be supplied.

Baker's Portable Diagnostic Microscope.—This instrument, which in 1896 was described in this *Journal*, has now been made of "magnalium" by Messrs. C. Baker, and was exhibited by Mr. Curties at the October Meeting, 1901. This Microscope was originally designed by Surgeon-Major Ronald Ross for the special use of officers in the Indian Army Medical Department for the diagnosis of malarial fever. It is

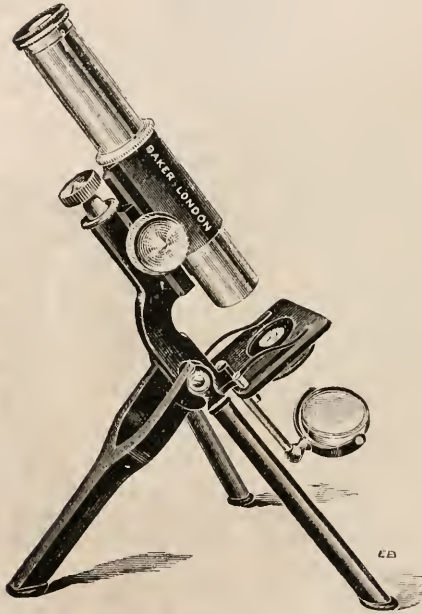

FIG. 19.

fitted with a spiral pinion and rack coarse adjustment, a direct-acting screw fine adjustment, a draw-tube, which when extended gives a tube length of $6\frac{3}{4}$ in. (170 mm.), a sliding tube to carry a substage condenser, and plane and concave mirrors. Its weight is 14 oz. (397 grams). When folded the instrument measures 7 by 3 by $2\frac{3}{4}$ (178 by 76 by 70 mm.), but when open the spread of the tripod is $6\frac{1}{2}$ by 6 (165 by 152 mm.). "Magnalium," an alloy of aluminium and manganese, is a tougher and much more useful metal than aluminium, though it possesses a specific gravity of only 2.5.

Seibert's Travelling Microscope.*—In this Microscope the designer has tried to reduce the weight to a minimum, and yet to adapt the instru-

* *Zeitschr. f. angew. Mikr.*, vii. (1901) pp. 141-3 (2 figs.).

ment for the most delicate investigations likely to be required on a journey. The stand is of a simple character with parallelogram screw adjustment, illuminating apparatus, and arrangements for oblique light.

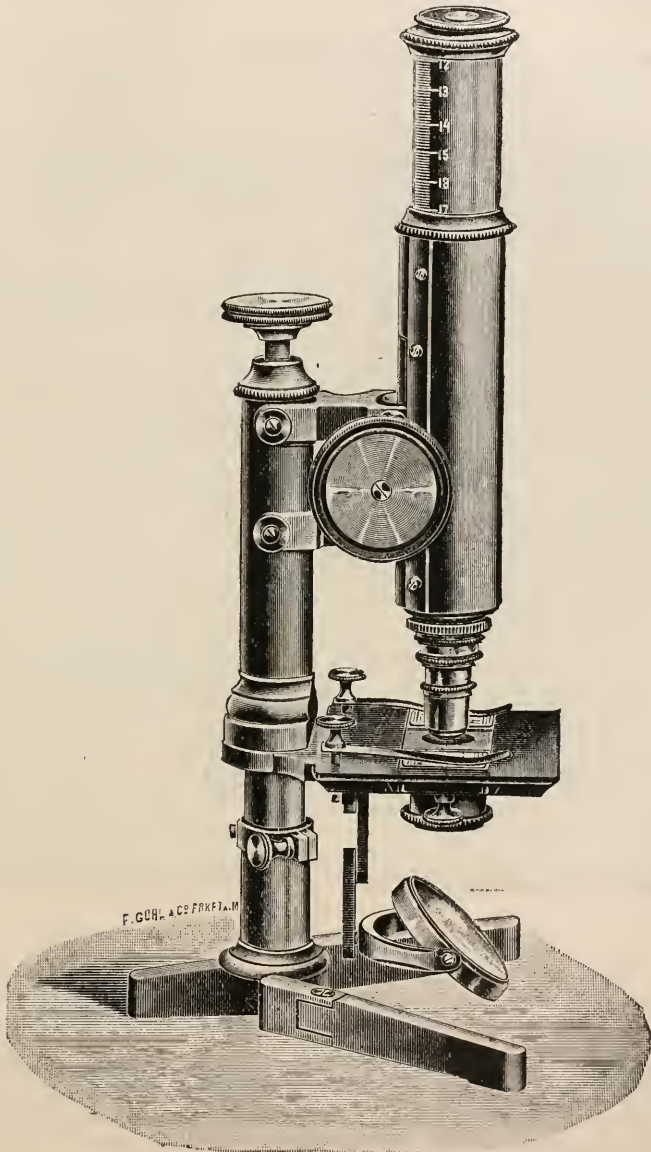

FIG. 20.

The illuminating apparatus is provided with good iris diaphragm and gives light sufficient for working with a $\frac{1}{2}$ immersion lens. The stage is large enough to receive the ordinary object-slides safely: it is strong and not removable (as is generally the case with travelling Microscopes):

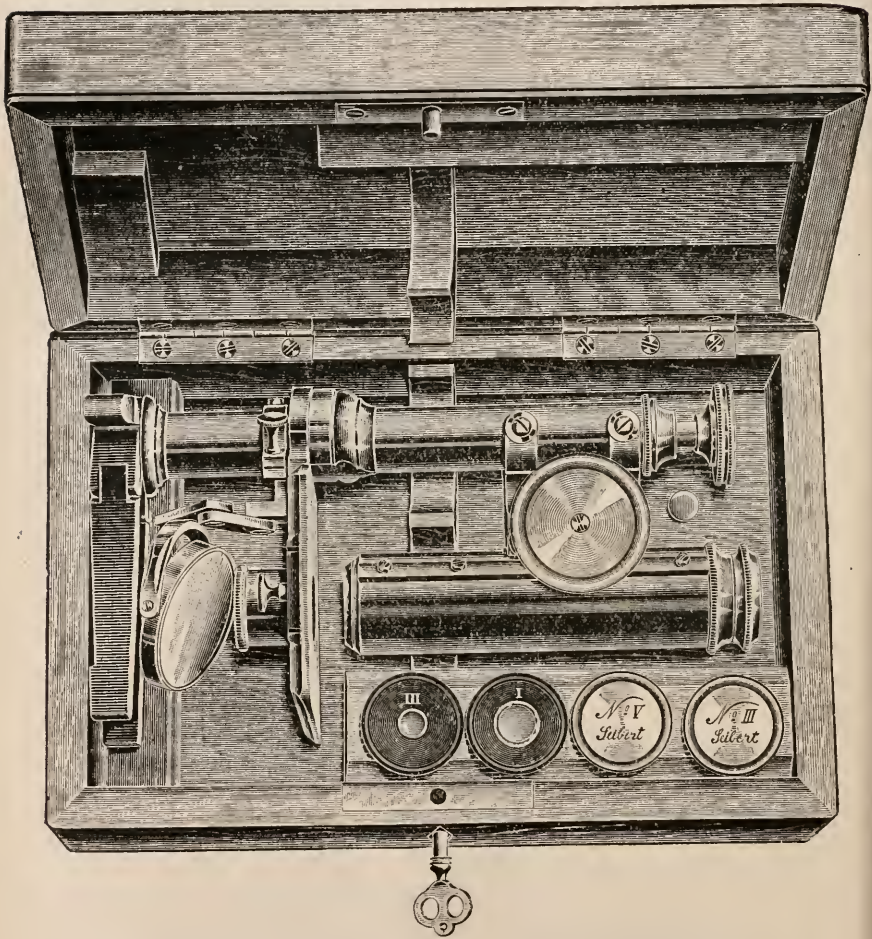

FIG. 21.

it is rigidly connected with the pillar, and so provides a permanent centring. Figs. 20 and 21 show the instrument half the full size: in figure 20 it is set up for use: in figure 21 packed away in its case. In order to prepare the Microscope for use the feet are everted, the

pillar under the stage pulled out and clamped, the tube drawn out to graduation 17, and the jointed mirror arm arranged. The coarse adjustment is by rack-and-pinion, and the fine by micrometer screw. The movement and the illumination are of such a nature that oil-immersions can be used and the instrument applied to bacteriology.

Seibert's New Dissection Microscope.—The foot and object-stage of this instrument are both of large size, the latter being 10 by 10 cm. The adjustment is by means of rackwork. The lens-carrier is movable, as is also the mirror. The support for the operator's arms can be disconnected and removed. The instrument can be fitted with a drawing apparatus (fig. 22), formed of a pillar erected on the horse-shoe foot, and

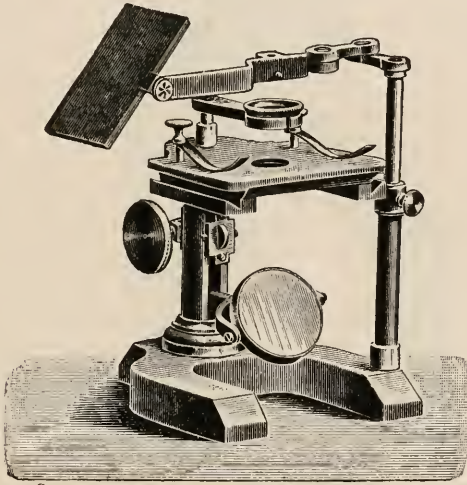

FIG. 22.

carrying a jointed arm with a camera lucida. A suitable loup and concave lenses are also supplied for drawing larger objects slightly magnified or minified.

Seibert's Large Model Microscope, No. 3.—This instrument is chiefly distinguished from the No. 2 stand by somewhat smaller dimensions, and is remarkable for its low price. It corresponds to the Zeiss ii A. It has a horse-shoe foot and no clamp for inclination.

Seibert's Laboratory Microscope.—This instrument is remarkable for its low price. As will be seen from fig. 23, the construction is of the simplest character. The body is focussed by rack-and-pinion, and the careful workmanship of the arrangement renders the instrument available for use with high-power objectives. The stage is of large size (100 by 120 mm.). The movable mirror is plane and concave. The makers recommend it for the detection of trichinae and as a very useful laboratory adjunct.

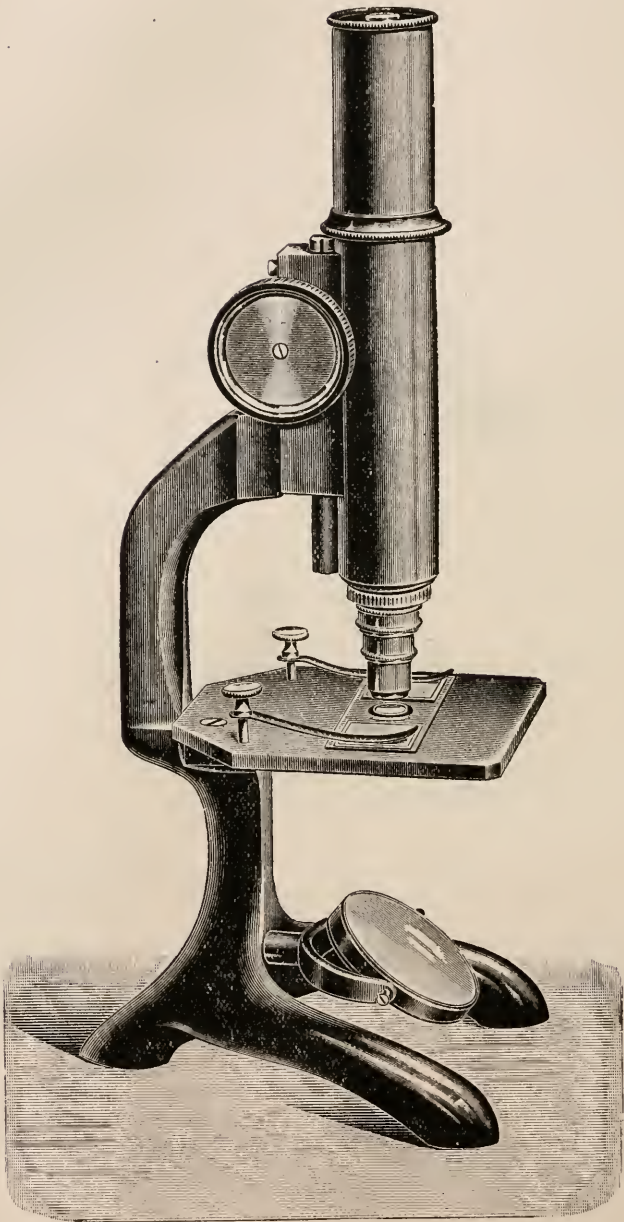

FIG. 23.

(3) Illuminating and other Apparatus.

Seibert's New Projection Microscope with Electric Light.*—The light-source of this instrument (fig. 24) is obtained from a Schuckert's arc lamp of 16 ampere, triple, large illuminating system (16 cm. diameter). A water-cooling chamber is placed between the plano-convex

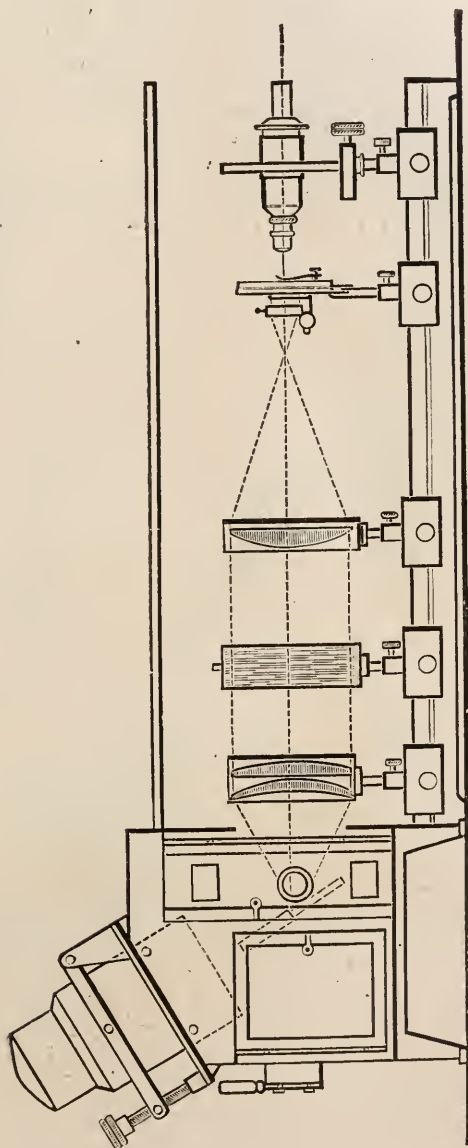

FIG. 24.

* Seibert's Catalogue, No. 18, p. 43.

lenses. The Microscope stand consists of two parts: (1) the object-stage with Abbe's illuminating apparatus and iris diaphragm; and (2) the tube with the adjustments, rack-and-pinion for the coarse, and micrometer screw for the fine. The object-stage is movable by a simple method. The Microscope parts run on iron tongues and can easily be exchanged for the apparatus for the projection of photographic slides. All other apparatus and objects for projection can be easily applied. The instrument also lends itself to photomicrography if it is connected with a corresponding camera. The apparatus can be used both with apochromatic and the stronger achromatic objectives in conjunction with projection oculars; it can also be used with the weaker achromatic and photomicrographic objectives without oculars.

New Microscope Lamp.* — Prof. A. Meyer, in carrying out his researches on the structure of the bacterial cell, experienced the need of a suitable substitute for strong sunlight, and devised the following

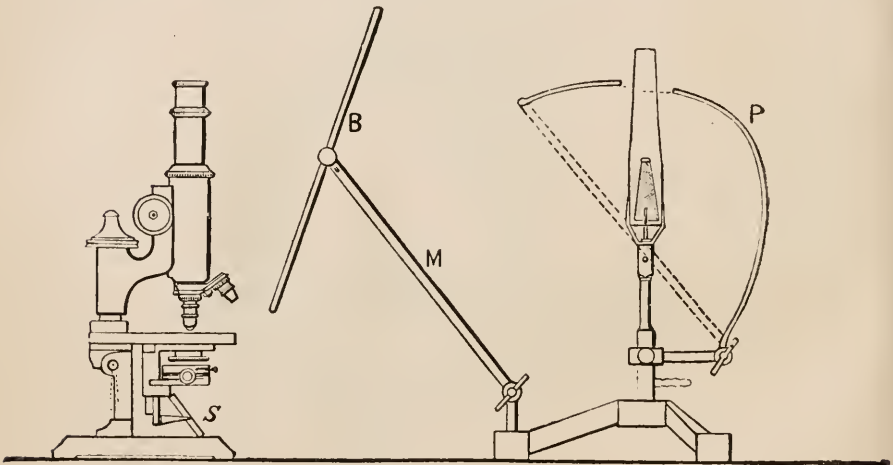

FIG. 25.

apparatus, which gave excellent results:—The source of light is an incandescent gas-lamp mounted on a tripod. The light is placed in the focus of a parabolic mirror P, which can be raised or lowered on the pillar of the tripod-stand, fig. 25. The rays pass through a ground-glass plate M to the mirror of the Microscope S. The grain of the ground-glass plate is very fine. B is a screen to intercept the light coming to the eyes of the worker. The Microscope is placed from 25 to 35 cm., according to the power of the objective in use, from the tripod-stand.

Seibert's Large Polarising Apparatus. — The polariser, with condenser combined, is shown in fig. 26, and the analyser in fig. 27. The polariser is pushed into the collar of the diaphragm-holder. The rotation direction of the nicol is fixed by the clamping of a screw-head in a groove. The analyser is combined with an ocular fitted with cross-

* Zeitschr. f. wiss. Mikr., xviii. (1901) pp. 144-6 (1 fig.).

threads, and has two divided circles: one graduated to every ten degrees (for reading off the rotations of the fixed cross-threads): and a finer one graduated in degrees with a vernier. The prism has right-angled end planes and provides a field of the largest possible size. The instrument can be fitted, if desired, with a long glass tube provided with quadrant Bertrand's quartz plates for sugar analysis.

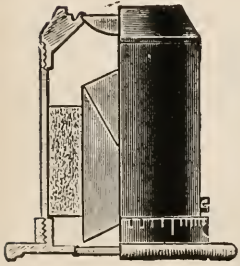

FIG. 26.

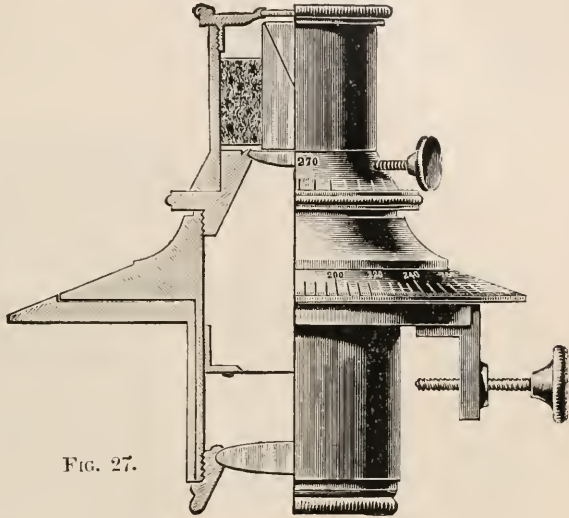

FIG. 27.

Abbe Drawing Camera.— This form of Abbe camera, made by Messrs. Zeiss (fig. 28), was designed by Dr. H. W. Heinsius (1889), and was described in this *Journal* (1890), p. 94, but was not figured. It

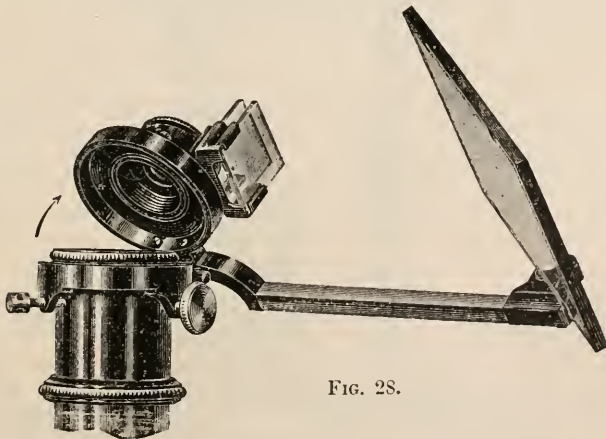

FIG. 28.

differs from the one figured in the *Journal* (1884, p. 119, fig. 18), inasmuch as it is attached by a hinge to the collar which fixes it to the Microscope. This permits it to be turned out of the way when it is not in use.

(4) Photomicrography.

Seibert's Apparatus for Vertical Photomicrography.—This apparatus, whose design is easily understood from fig. 29, is applicable to every

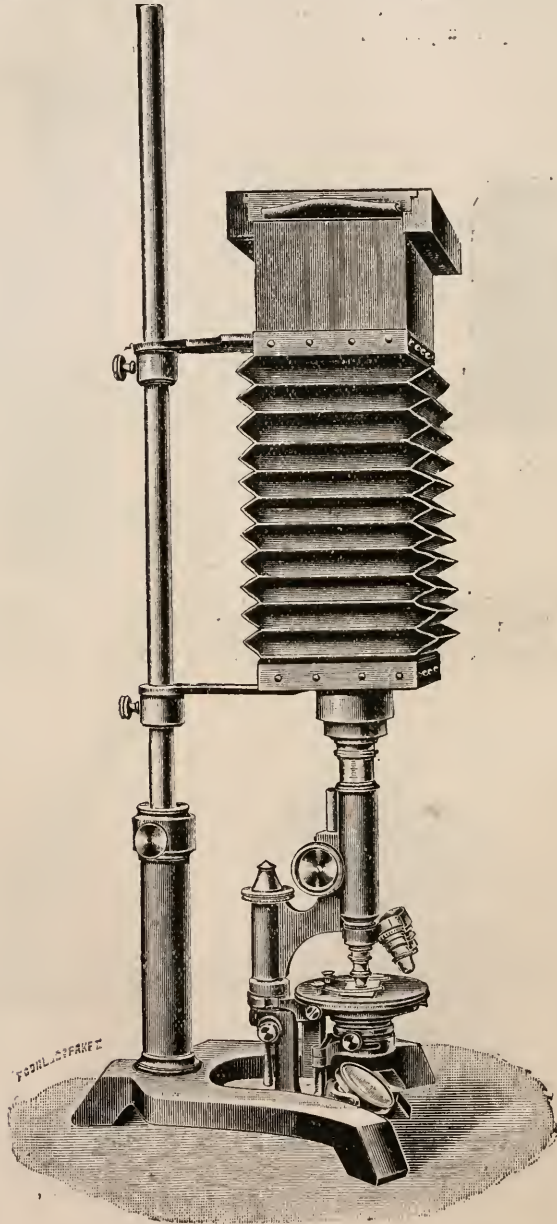

Fig. 29.

Microscope stand. It has a double dark slide and a lens for fine adjustment. The size of the image is 9 by 12 cm., and the bellows have an extension of 50 cm.

B. Technique.*

(1) Collecting Objects, including Culture Processes.

Does Anthrax form Spores under Anaerobic Conditions? — R. Slupski † answers the question whether anthrax when cultivated under strictly anaerobic conditions forms spores, in the negative. The method adopted and the apparatus used are as follows. The essential feature in the apparatus is a glass pan with a broad lip (fig. 30, *c*). This pan, which is 15 cm. in diameter, 5 cm. high, and the breadth of the lip $1\frac{1}{2}$ cm., is placed inside another glass pan upon the bottom of which are two dishes *a* and *b*. The dish *a* is for pyrogallic acid, the dish *b* for distilled water. Over the dish *a* is placed a glass tripod the legs of which rest in *b*. Upon the tripod is placed a double layer of blotting paper, and on this rests an open Petri capsule. One half of the agar plate in the Petri capsule is inoculated with anthrax blood and the other with

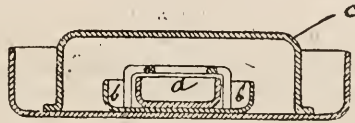

FIG. 30.

tetanus. As tetanus is an essential anaerobe its growth affords an excellent criterion of the fulfilment of anaerobic conditions. After the plate is inoculated two bits of caustic potash (about 14 gm.) are placed in the pyrogallic acid (about 25 gm.) over which has been poured some 25 ccm. of warm distilled water. The various parts of the apparatus having been adjusted, warm paraffin is poured into the outer jar to form a layer of 3–4 cm. high; and when this has cooled and set another layer of liquid paraffin. This done, the whole apparatus is removed for 40–50 hours to a refrigerator at a temperature of 5–6° C. This is to prevent the growth of anthrax while the oxygen is being absorbed. The final step is to incubate for 70–80 hours at 37°.

Methods for Rearing Amœbæ.‡—M. T. Cook makes a medium by boiling dead leaves. When cool, liquid and leaves are placed in a jar and unboiled leaves and enough water to stand about 1 in. above the leaves added. In 2 or 3 days scum forms, and in from 5–10 days, according to the temperature, amœbæ will be found in the scum in large numbers. They are small but very satisfactory for class purposes.

Yeast-Water for Biological Analysis.§—H. Will recommends the use of yeast-water rendered alkaline by the addition of ammonia for bacteriological purposes. 8–10 ccm. of neutral perfectly clear yeast

* This subdivision contains (1) Collecting Objects, including Culture Processes; (2) Preparing Objects; (3) Cutting, including Imbedding and Microtomes; (4) Staining and Injecting; (5) Mounting, including slides, preservative fluids, &c.; (6) Miscellaneous.

† Centralbl. Bakt., 1^o Abt., xxx. (1901) pp. 396–403 (2 figs.).

‡ Journ. Applied Microscopy, iv. (1901) p. 1566.

§ Zeitschr. ges. Brauwesen, xxiv. (1901) pp. 289–91. See Centralbl. Bakt., 2^o Abt., vii. (1901) pp. 892–3.

water are placed in Freudenreich's flasks, and just before inoculation a drop of ammonia sp. gr. 0.96 is added.

Demonstration of Enzymes.*—S. L. Schouten gives a method for more quickly demonstrating enzymes than that of Fermi. He mixes water saturated with thymol, $7\frac{1}{2}$ per cent. gelatin, and an equal quantity of cinnabar. The solution, which is red, is distributed into test-tubes. By rotating the tubes under a stream of water, a thin layer of gelatin is formed above a thicker one. When the fluid which is to be examined for the presence of enzyme is put into the tube the action takes place readily on the thin layer, and the result is more easily discovered owing to the red colour of the solution. This method was adopted for examining enzymes of the Saprolegniaceæ.

Cultivation Medium for Cheese Bacteria.†—F. W. J. Boekhout and J. J. Ott de Vries, in their investigation on the ripening of Edam cheese, used cheese-gelatin which was prepared as follows:—Pieces of cheese were ground up fine in a mill and a definite quantity ($1\frac{1}{2}$ times its weight) of water added. The mixture was macerated for two hours at 40° and then heated to 50° , being stirred the while, so that the insoluble and partly soluble constituents might sink to the bottom. The supernatant fluid was then poured off and allowed to stand for some hours. The scum, which is composed of fat and albumen, was then skimmed off, and the residue filtered. The filtrate or cheese-broth was worked up into cheese-gelatin by the addition of 10 per cent. gelatin. This medium, suitable for aerobic and anaerobic cultures, contains no milk-sugar and is of acid reaction, thus fulfilling the conditions requisite in cheese-ripening investigation.

Cultivation of *Rhizobium leguminosarum*.‡—R. Greig Smith has obtained fairly luxuriant cultures of *Rhizobium leguminosarum* in a gelatin medium containing glucose and inorganic salts, and also on a medium composed of faintly acid agar (2 p.c.) glucose (2 p.c.) and inorganic salts (CaCl_2 and KH_2PO_4), nearly neutralised with KOH. In the latter medium there is no nitrogen except that which may be present as impurity in the washed agar, the glucose, or the tap-water. He has also grown the organism in an agar-free fluid medium prepared exactly as the agar medium. Such a fluid, after inoculation, becomes turbid, and forms a slight sediment of organisms, together with a bulky zooglœa cloud or sedimentary film. The experimental flasks were found to contain exactly the same amount of nitrogen as the control flasks, hence no fixation of nitrogen could have occurred.

(2) Preparing Objects.

Handy Method of Preparing Slides and Slips for taking Blood Films.§—W. L. Braddon draws attention to a simple method of preparing slips and slides for blood-examination. (1) A slip is placed on a slide in such a position that one of its edges coincides exactly with that of the slide. Then, for temporary use vaselin, for permanent pur-

* Konk. Akad. v. Wetensch. Amsterdam, 1901. See Centralbl. Bakt., 1^o Abt., xxx. (1901) p. 780. † Centralbl. Bakt., 2^o Abt., vii. (1901) pp. 817-33 (1 pl.).

‡ Proc. Linn. Soc. N.S.W., xxvi. (1901) pp. 152-5.

§ Journ. Tropical Med., iii. (1900) p. 110.

poses white cement, is smeared round the margins of the slip except that which corresponds with the border of the slide and a small portion of the edge opposite. (2) Two slips, preferably square ones, are accurately superposed, and then vaselin or cement smeared over the combined rims except one, which is left free, and a part of the edge opposite.

To use the slips or slides, touch with the free edge the drop of blood, and when the whole space has been slowly filled the unsmearred portions of the margin are closed up with vaselin or cement. Stains are best added by placing a drop on the surface and puncturing through the drop.

The advantages claimed for this method are that an extremely thin and uniform film is secured; that the slides or slips can be used by the most unskilful; and that when prepared beforehand a large number, especially of paired slips, can be kept in a small space quite ready for use.

Formol as a Preservative and Fixative.*—K. Diederichs in some notes on the use of formalin, which is a 40 p.c. solution of gaseous formaldehyde (CH_2O) in water, alludes to its most important uses as a fixative and preservative agent. For soft animals such as Mollusca and even Medusæ it is excellent in the proportion of 1 part formalin to 20 or more parts of water. As a rule plants do not keep so well as animal specimens, though for fruit and fungi it is suitable. While formalin hardens animal objects it softens vegetables, but in the full 40 p.c. solution, plants can be hardened and thus rendered suitable for microscopical technique.

In combination with Müller's fluid 1-10 it forms an excellent medium for hardening brain. For the lens 1-40 is sufficient. At the present time it is extensively employed in bacteriological technique, many stains being made up with it, so that the specimens are stained and fixed simultaneously. It is of inestimable advantage for preserving cultures so that they shall retain their characteristic appearance at any given stage. It is equally applicable to plate and tube cultures.

Large anatomical preparations are preserved by immersing them wrapped in cotton wool in a mixture of 200 ccm. formalin, 1000 ccm. water, 15 grm. potassium nitrate, and 30 grm. potassium acetate for 24-48 hours. Alternative solutions are: (1) Formalin 100, acetate of soda 30, chlorate of potash 5, distilled water 1000. (2) Water 1000, formalin 750, nitrate of potash 10, and acetate of potash 30. (3) Formalin 50, artificial Carlsbad salts 40, water 1000. After removal from any of the foregoing the preparations are transferred to 60 p.c. alcohol for 2 days, and then for similar periods to 80 p.c., 90 p.c., and 93 p.c. alcohol. By this stage the colour is regenerated. The preparations are next transferred to the preservative which consists of 290 parts glycerin, 100 parts acetate of potassium, 1000 parts water. Alternative solutions are: (1) Water 90, glycerin 54, acetate of soda 27. (2) Water 1000, nitrate of potash 2.5, saccharum 20, chlorate of soda 250.

Formalin-gelatin has recently been applied to anatomical objects. In 200 ccm. of water at 90° , 6-7 p.c. of gelatin is dissolved without stirring. The supernatant thin opalescent layer is decanted off, filtered

* Zeitschr. f. angew. Mikr., vii. (1901) pp. 146-9.

and if necessary clarified by the addition of a few drops of nitric acid. To every 10 ccm. gelatin 6-8 drops of formalin are added. The objects, previously hardened in alcohol, are washed in water and then placed in glass vessels containing formalin-gelatin cooled down to about 60°. When the gelatin has set the jars are hermetically closed.

Another similar method consists in making a 5 p.c. gelatin solution, and then treating it with $\frac{1}{2}$ -1 p.c. formalin. The objects are for this method previously fixed with formalin.

Demonstration of Cholera Vibrios.*—Prof. L. Heim states that the presence of blood in the medium much facilitates the demonstration of cholera vibrios in suspected fluids. A decoction of blood is prepared by boiling clot and then filtering the solution. To 200 ccm. of water containing cholera vibrios 4 gm. of pepton and 2 gm. of common salt are added. When these ingredients have become perfectly dissolved the fluid is distributed into two glass vessels. To one is added 50 ccm., or more, of the blood decoction, and both are incubated for 24 hours. The growth in the sample containing blood is more copious, the indol reaction more marked, and the motility of the vibrios greater, than in the pepton-salt medium. On plates containing blood the colonies are more luxuriant than on ordinary gelatin plates, the difference becoming still more striking in a few days.

(3) Cutting, including Imbedding and Microtomes.

New Ether Freezing Apparatus for the Microtome.†—Dr. A. Noll has devised a freezing apparatus, by which the necessary coldness is

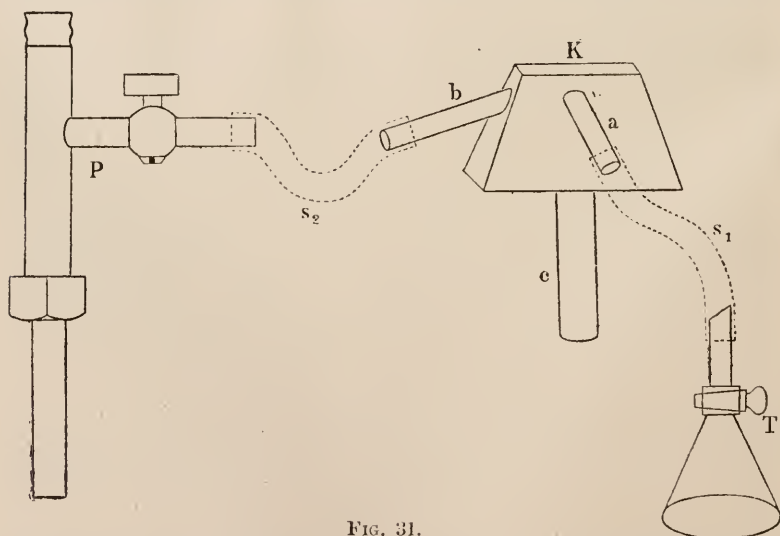

FIG. 31.

obtained by the evaporation of ether in a vacuum. It consists (fig. 31) of a metal chamber *K* with two side pipes *a* and *b*, and a bar *c* for fixing

* Centralbl. Bakt., 1^o Abt., xxx. (1901) pp. 570-3 (1 pl.).

† Zeitschr. f. wiss. Mikr., xviii. (1901) pp. 141-4 (2 figs.).

to the microtome. The side pipes are connected by tubes s_1 s_2 ; s_1 joins on to a funnel and is supplied with a stop-cock T; s_2 connects with a suction apparatus p (water pump) which exhausts the air in the chamber.

The apparatus is worked by pouring in ether through the funnel, and then (having closed T) opening P. In about half-a-minute the specimen which lies on the surface K is frozen, and will keep so for about 15 minutes. The apparatus works well, the consumption of ether is small, and though intended for the Schanze can be adapted to any microtome. The measurements of the freezing box are: lower surface 4-2.5 cm.; upper surface 2.5-2 cm.; height 3 cm.

Electrothermal Paraffin Bath. * — Dr. R. H. Steen has devised an apparatus in which the electric current from the main is utilised to raise the temperature of a paraffin bath by means of the heat radiated from one or two ordinary lamps placed in an asbestos box beneath it. A mercurial thermostat placed in the bath maintains the temperature at a constant level by causing the lamps to be switched off and on when the temperature tends to rise or fall below the degree required. An incubator could be worked by the same apparatus, as the upper wire in the thermostat can be adjusted for any required temperature. The bath works satisfactorily without any attention, and its temperature does not alter to an extent which is appreciable to any ordinary thermometer.

Paraffin Bath heated by Electricity. † — Cl. Regaud and R. Fouilliand have devised a paraffin bath which is heated by an electric current. The inventors claim that it possesses many advantages over baths heated by gas or petroleum, that it is much lighter, and can be manipulated with greater facility. For saturating the pieces, wire baskets, suspended by a wire in the paraffin bath, are used.

Carbon Bisulphide in Paraffin Imbedding. ‡ — Prof. M. Heidenhain describes a new method of imbedding in paraffin, carbon bisulphide being used for saturating the objects. Three glass vessels with ground stoppers are required. One contains a mixture of equal parts of bisulphide and alcohol, the other two pure bisulphide. The dehydrated pieces are passed through these three bottles, remaining 24 hours in each. For imbedding, two thermostats are used, one at from 36° to 38°, the other from 56° to 57°. Two other similar glass-stoppered bottles are placed one on each of the two thermostats. Each bottle contains bisulphide (about $\frac{1}{2}$ to $\frac{1}{4}$ in. in height), and in each is placed as much paraffin as will dissolve. When the pieces have been passed through both mixtures, from the lower to the higher, they are removed to pure paraffin at 55°, and the last step repeated. In the two pure paraffin baths the pieces remain for an hour to an hour and a half. The repetition is necessary in order to completely remove the bisulphide. The results from the new procedure are excellent, but certain precautions are necessary. On account of the inflammability of the bisulphide the manipulation should be carried out in a part of the laboratory remote from open fire or flame. The disagreeable odour may be avoided to a great extent by refraining

* Brit. Med. Journ., 1901, ii. pp. 1733-4 (1 fig.).

† Journ. Anat. Physiol., xxxvi. (1900) pp. 574-9 (3 figs.).

‡ Zeitschr. f. wiss. Mikr., xviii. (1901) pp. 166-70.

from shaking the bottles. When it is necessary to remove the stoppers this should be done in a closed gas-chamber.

Paraffin Imbedding in Vacuo. * — Dr. R. Kolster uses chloroform xylol or toluol as solvents, and after saturating the pieces in the usual way places them under the air-pump and exhausts the air. In the vacuum the last traces of the volatile solvent or of air are removed and a solid homogeneous block remains.

Saw for making Microscopic Preparations of Hard Objects. † — G. Arndt has devised a saw for making microscopical sections of hard objects. It is on the lines of a fret-saw but having two parallel blades which are kept in a state of tension and prevented from sagging by clamping screws. The results obtained from its use are satisfactory.

(4) Staining and Injecting.

Preparation of Pure Romanowsky-Nocht Stain. ‡ — Dr. K. Reuter prepares eosin-methylen-blue by heating for three days in an incubator at from 50°–60° C. 0.5 Na₂CO₃ and 100 ccm. 1 p.c. aqueous solution of medicinal methylen-blue Höchst, and after filtering, adding saturated aqueous eosin solution. The precipitate which comes down is washed with distilled water and, having been dried, is dissolved in a water-bath in hot absolute alcohol. The solution is filtered, and to every 100 ccm. 2 ccm. of anilin oil are added. The results obtained by staining malaria blood-films are said to be very striking. It is best to keep the pigment dry and make a stock solution from time to time. Then about 0.2 grm. is dissolved in 100 ccm. C₂H₆O by the aid of heat and 2 ccm. of anilin oil added. Of this stock solution 30 drops are added to about 20 ccm. of distilled water. The preparations are stained for a half to several hours, and to obtain a good effect the films should be protected against aqueous moisture. Attention is drawn to the fact that the solution is alkaline.

Kresylecht Violet. § — R. L. Morse recommends kresylecht violet for general staining purposes, and prepares the solution by mixing together 5 p.c. aqueous solution of phenol 80 cc. and 95 p.c. ethyl alcohol 20 cc., and then adding 1 grm. of the pigment. After all the stain is dissolved the solution is filtered. Stain for 1–5 minutes. Wash in distilled water. Mop up. Anilin-xylol (2–1). Pure xylol balsam.

Very good results are obtained with Gonococcus, mucin, amyloid, plasma-cells, and cancer bodies.

New Fat-staining Pigment. || — Dr. L. Michaelis recommends a scarlet or poppy-red pigment for staining fat. The chemical name of the new dye is Azo-orthotuloazo β-naphthol; its trade name Scharlach R, or Fettponceau. The pigment is insoluble in water, soluble with difficulty in alcohol, but easily soluble in chloroform, oils, and melted paraffin. It is soluble in strong H₂SO₄, the solution being blue; all other solutions are red. A saturated solution of Scarlet R in 60–70 p.c.

* Zeitschr. f. wiss. Mikr., xviii. (1901) pp. 170–3.

† Tom. cit., pp. 146–59 (9 figs.).

‡ Centralbl. Bakt., 1^a Abt., xxx. (1901) pp. 248–56 (2 pls.).

§ Journ. Applied Microscopy, iv. (1901) pp. 1492–4.

|| Virchow's Archiv., clxiv. (1901) pp. 263–70.

alcohol is made and the preparations treated therewith for $\frac{1}{4}$ to $\frac{1}{2}$ hour. Even the smallest drops of fat are stained a bright red. The preparations may be contrast-stained with Böhmer's hæmatoxylin, and should be mounted in glycerin or in lævulose syrup.

Staining Woody Tissue. *—L. Mangin has examined the selective staining action of naphthylamin, toluidin, benzidin, toolidin and dianisidin. The first two stain the ligneous tissue yellow, while benzidin and dianisidin impart a red-brown hue. Toluidin gives a dull brown. He prefers benzidin, of which a solution is prepared by dissolving 1 grm. together with 1 grm. of acid (citric, tartaric, or lactic) in 100 ccm. of water. After boiling the mixture is filtered. The simple solution may be used, or some glycerin added to the filtrate.

Demonstration of the Cell-nucleus of Saccharomyces. †—C. Hoffmeister recommends the following solutions for fixing, viz. von Rath's and Merkel's solutions, perchloride and iodo-potassic iodide.

The best staining results were obtained with Böhmer's hæmatoxylin and with Heidenhain's iron-hæmatoxylin. The procedure adopted was the following:—The yeast-cells were fixed with von Rath's mixture, and after washing out the fixative, films were made on cover-slips from suspensions. When dry the slips were floated on 2.5 p.c. iron-alum solution for 6–24 hours. They were then washed again, and transferred to 0.5 p.c. aqueous hæmatoxylin solution for at least 24 hours, after which they were differentiated in $\frac{1}{4}$ p.c. iron-alum solution. The cytoplasm is decolorised, the nucleus remaining black, violet, or dark grey.

Modifications of Weigert's Method of Staining Elastic Tissue. ‡—Dr. R. Minervini has obtained satisfactory results from the following procedures:—(1) Staining in bulk: the pieces are fixed in formalin alcohol or Müller's fluid. Pieces about 1 cm. are immersed in the staining fluid for 48 hours, after which they are transferred to alcohol with 1 per cent. HCl for 24 hours; next, to 90 per cent. alcohol for a similar period, and finally to absolute alcohol, turpentine, or xylol, and imbedded in paraffin. The pigment is made by precipitating an aqueous solution of fuchsin with iron chloride and dissolving the precipitate in alcohol.

(2) An aqueous 1 p.c. solution of safranin with 1 p.c. resorcin is made. When cool it is filtered. To the filtrate a quarter of its bulk of iron chloride is added. The solution is heated to boiling, and the residue after filtering is washed, dried, and dissolved in 100 parts of 90 p.c. alcohol with 1 p.c. HCl. The sections are stained for two hours, decolorised in alcohol, and may be contrast-stained with hæmatoxylin or methylen-blue. This pigment is quite suitable for staining tissue in bulk, especially if fixed with some chromic acid salt solution. Indeed, Weigert's method or its modification is always improved by the presence of chromic acid or one of its salts.

(3) An aqueous 1 p.c. solution with 1 p.c. resorcin is prepared by the aid of heat. When cold it is filtered, and a quarter of its volume of

* C.R. Soc. de Biol., liii. (1901) pp. 837–9.

† SB. Deutschen naturwiss.-med. Vereins f. Böhmen "Lotos," xx. (1900) pp. 251–63 (1 pl.). See Bot. Centralbl., lxxxvii. (1901) pp. 129–30.

‡ Zeitschr. f. wiss. Mikr., xviii. (1901) pp. 161–5 (1 pl.).

2 p.c. chromic acid or of 5 p.c. potassium bichromate is added. The solution is heated to boiling, and when cold filtered. The residue is dried in an incubator at 30°, and then dissolved in 90 p.c. alcohol (100 parts). After acidulation with 1 p.c. HCl it is filtered. The sections are immersed for two hours and then transferred to 90 p.c. alcohol for half an hour. The elastic tissue is stained a dark violet.

Neutral Red for Staining Nucleated Red Blood-Corpuscles.* — Dr. Bettmann has found neutral red a most satisfactory reagent for demonstrating the presence of nucleated erythrocytes. The technique is simple. It is sufficient to mix with a drop of blood some saturated solution of neutral red, or to add a granule of the solid pigment. But by adopting Arudd's elderpith method (see this *Journal*, 1897, p. 81) still better results were obtained. The nuclei of the erythroblasts show up as dark brownish-red masses surrounded by the pale brown cell-body.

Demonstrating the Seminal Tubules of the Rat by means of Renaut's Fluid.† — C. O. Regaud demonstrates the membrane of the seminal tubules of the rat by injecting Renaut's fluid into the testicle. The fluid consists of saturated aqueous solution of picric acid 80 vols., 1 p.c. osmic acid 20 vols.; to 3 vols. of this mixture 1 vol. of 1 p.c. nitrate of silver solution.

New Method for Staining en masse.‡ — A. Spuler describes a method for staining pieces which has the advantages of imparting a regular staining to each section, and of affording excellent preparations for demonstration with the projection-apparatus. The fixed pieces are treated with cochineal solution prepared by boiling finely powdered cochineal in distilled water, filtering, and evaporating down almost to dryness. Distilled water is again added and the mixture filtered. In this solution the pieces are left for 24 hours or more on the top of a paraffin oven. After having been washed they are mordanted in a thin solution of iron-alum. This converts the red colour to black. The mordanting over, the pieces are thoroughly washed with distilled water and then imbedded in the usual way.

New Method for Staining Nervous Tissue.§ — Dr. T. Kodis has devised the following procedure, in which hæmatoxylin molybdate is the effective ingredient:—Pieces of fresh tissue $\frac{1}{2}$ –1 cm. thick are placed in saturated aqueous solution of mercury cyanide for 1–2 days, or longer. They are then put straight away without washing into 10 p.c. formalin for 1–3 days. Sections are made by a freezing microtome, and stained for 1–2 minutes in much-diluted solution of the hæmatoxylin molybdate (hæmatoxylin crystals 1; molybdic anhydride 1.5; aq. destill. 100; H₂O₂ 0.5, or a crystal of HgO: the solution is ready for use in a few days). The stained sections are washed for 1–2 minutes in water, and having been contrast-stained with alcoholic solution of Lichtgrün, are mounted in balsam.

* Zeitschr. f. angew. Mikr., vii. (1901) pp. 177–82.

† Arch. Anat. Microscop., iv. (1901) pp. 101–53 (2 pls.).

‡ Deutsch. Med. Wochenschr., xxvii. (1901) No. 14, Vereinsbeilage, p. 116. See Zeitsch. f. wiss. Mikr., xviii. (1901) pp. 183–4.

§ Arch. f. Mikr. Anat. u. Entwickl., lix. (1901) pp. 211–20 (1 pl.).

The author also mentions that the foregoing fixation is suitable for iron-hæmatoxylin staining. The sections, made by freezing microtome, are immersed for 2-5 hours in 2 p.c. iron-alum solution, and having been washed in water, are placed for 10-12 hours in $\frac{1}{2}$ p.c. aqueous solution of hæmatoxylin. They are next differentiated in 2 p.c. iron-alum solution (from 1-3 hours). The medullary sheath of the nerves is dark blue, the rest of the tissue being unstained. The sections are then washed very thoroughly (several hours), and afterwards mounted in the usual way in balsam.

(5) Mounting, including Slides, Preservative Fluids, &c.

Examination of Hairs for Medico-legal Purposes.*—E. S. London states that hairs intended for medico-legal examination should be mounted dry in balsam without any preliminary preparation or treatment, as reagents cause them to lose many of their characteristic features. From many thousand examinations of hairs of man and of animals (39 species) he comes to the following conclusions. By the use of the Microscope it is easy to distinguish the hair of man and of animals from any body or substance of a similar appearance. With a little practice it becomes easy to discriminate between human hair and that of the lower animals; and if all the peculiarities be taken into consideration the original site of a hair may be diagnosed. From the appearance presented by the roots it is possible, if several specimens be available, to determine whether the hairs have fallen out naturally or have been plucked out. By means of the polariscope a grey hair can be diagnosed from a pale blond. With crossed nicols blond hair gives a golden yellow band on a black ground, while grey hair gives a particoloured band (*cordon*), the red-purple predominating.

In arsenic poisoning the metal passes into the hair. This was shown by injecting arsenic solution into animals hypodermically and testing the hair by the usual chemical methods. The control animals gave a negative result.

Substitute for Cover-slips.†—Dr. V. Pranter recommends gelatin-paper as a substitute for the more expensive glass slips of large size. The paper consists of pure gelatin, is almost colourless, perfectly transparent and smooth. It can be used with advantage for all preparations which do not contain, or are not mounted in water or glycerin. It allows examination under oil immersions. Though less suitable than glass for permanent preparations, the specimens will keep for months without deterioration provided they be stored in a cool, dry place. Dirt or grease on the surface is easily removed by means of xylol or benzin.

Preparation and Preservation of Urinary Sediment.‡—G. Marpmann prepares and preserves urinary sediment as follows:—Some 100 to 200 ccm. of urine are placed in a conical vessel, and when a sediment of, say, 20 ccm. has been deposited the supernatant fluid is decanted off. To the sediment 1 ccm. of eosin and 1 ccm. of methylen-blue in aqueous

* Archiv. Sci. biologique St. Petersb., viii. (1900) pp. 136-57 (6 pls.).

† Zeitschr. f. wiss. Mikr., xviii. (1901) pp. 159-61.

‡ Zeitschr. f. angew. Mikr., vii. (1901) pp. 182-4.

solution are added. In about twenty minutes 1 ccm. of formalin is added, and in another twenty minutes the vessel is filled up with water. After standing for 1-2 days the deposit, about 1 ccm., is removed and mixed with 10 parts of liquid glycerin jelly. A drop of this is placed on a slide and covered with a cover-slip. The preparation is then placed in a closed glass jar containing a few drops of formalin. In the course of a few days the external layer of gelatin becomes set by the action of formalin, so that a ring of varnish or balsam becomes unnecessary.

(6) **Miscellaneous.**

Dropper for Sterile Fluids.*—G. Wesenberg describes a dropping apparatus (fig. 32) which is of simple construction and of especial advantage

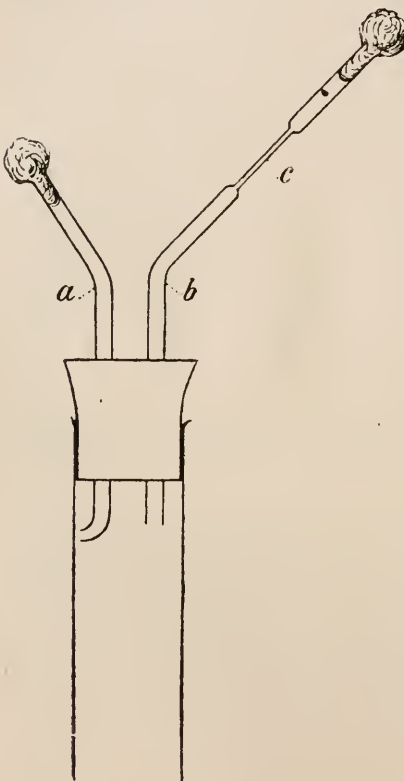

FIG. 32.

in disinfection experiments for washing the disinfectant out of the object to be tested. It consists of a caoutchouc plug, which is inserted into a test-tube or the neck of a flask. The plug has two perforations, one for a bent tube *a* through which air enters, and the other for the bent tube *b*. The latter is narrowed at *c* so that it can be broken off or scaled up in the flame. The way of using the apparatus is obvious. If the fluid does not flow freely it may be forced on by blowing through *a*.

There is little chance of air-infection if the end of *b* be held close to a flame when the tube is set upright after using it.

Immersion Oil in Collapsible Tubes.†—C. W. Dodge mentions that he has used immersion oil stored in metal collapsible tubes for over a year, and has found the method satisfactory and without signs of deterioration in the oil.

Raising the Melting-point of Gelatin by means of Formalin.‡—Dr. J. G. C. Vriens alludes to H. J. van't Hoff's remarks on raising the melting-

point of gelatin by means of formalin, and points out that this property was employed by Brown, in 1897, for hardening the gelatin layer of

* *Centralbl. Bakt., 1^o Abt., xxx. (1901) pp. 703-4* (1 fig.).

† *Journ. Applied Microscopy, iv. (1901) p. 1567.*

‡ *Centralbl. Bakt., 1^o Abt., xxx. (1901) pp. 74-2.* [Cf. this Journal, 1901, p. 719.

negatives by immersing the plates in a formalin bath (4 ccm. formalin and 30 ccm. water.) In 1898 Trillat devised a method for the estimation of gelatin in gums and food-stuffs which was based on this property of formalin. A 4 per cent. solution of formalin is employed with success for preserving and hardening microscopical objects, while in the bacteriological laboratory it has many uses, among which may be mentioned that of inhibiting the growth of cultures. The vapour of formalin acts very detrimentally on the pigment of chromogenic bacteria and on the fluorescence of micro-organisms. It would be of great value if the exact strength of formalin, which was harmless to the growth and development of microbes, and which did not affect the good properties of gelatin, could be determined.

Useful Caliper Gauge.—This convenient little out-and-in caliper gauge (fig. 33), which may be purchased for 3s. or 4s. at any watch-makers' tool shop, is a very cheap and handy gauge for a microscopist's outfit. Among other uses it is convenient for measuring the thickness of cover-glasses. It reads by a vernier to 0.1 mm. It is graduated both ways, and the points A and B form an end gauge. For low-power work the scale may be placed on the stage of a Microscope, and the constant of an eye-piece micrometer found by comparison with the mm. divisions.

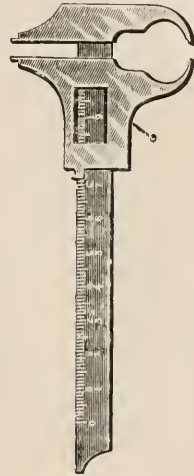

FIG. 33.

Methods for Examining Trypanosoma Lewisii.*

—A. Laveran and F. Mesnil remark that observations on *Trypanosoma* in fresh blood are quite easy. The blood obtained by puncturing the tip of the tail of an infected rat is spread on a slide and covered with a slip. For prolonged observations the hanging drop is recommended. The blood may be mixed with physiological salt solution, then defibrinated with citrate solution to prevent coagulation, or mixed with rat serum. The length of time *T. Lewisii* can be preserved depends greatly on the temperature: in summer rarely beyond four days; in winter as long as eighteen days; in a glacierium (5° to 7° C. above 0°) they will keep for four to seven weeks. For studying the structure of *Trypanosoma* it is necessary to use stained preparations, and the following procedure gave the best results. A thin film of blood is spread on a slide, dried quickly, and fixed in absolute alcohol (ten to fifteen minutes). For staining, three solutions are necessary:—(1) Borrel's blue. To make this, place some crystals of nitrate of silver in a bottle capable of holding 150 ccm. and 50 to 60 ccm. of distilled water. When the crystals are dissolved the bottle is filled with soda solution. The black oxide of silver thus formed is washed several times with distilled water to remove the soda. Over the silver oxide is then poured a saturated aqueous solution of methylen-blue (Höchst). The mixture is allowed to stand for fifteen days, being shaken up frequently the while. (2) A one per thousand aqueous solution of eosin. (3) A 5 per cent. solution of tannin.

* Ann. Inst. Pasteur, xv. (1901) pp. 678-82 (2 pls.).

When required for staining, the solution is prepared by mixing together 4 ccm. of the eosin solution, 1 ccm. of the Borrel's blue solution, and 6 ccm. of distilled water. The slide with the fixed film is immersed in the foregoing for 20-30 minutes. After removal, it is washed freely with water, and then treated with the tannin solution for 10-15 minutes. It is then washed again with tap and afterwards with distilled water, and then dried.

If there be a precipitate on the film this may be removed with oil of cloves followed by xylol, and the surface wiped with a cloth dipped in xylol.

In default of the foregoing stain, Romanowsky's method may be adopted or the preparation may be stained with alcoholic solution of fuchsin or with carbolate of thionin.

Gage's 'The Microscope.'*—The eighth edition of Prof. S. H. Gage's well-known and much appreciated work on the Microscope, an introduction to microscopic methods and to histology, has recently appeared. For the present issue the work has been revised and enlarged, and though preserving the same general features as its predecessors contains new matter of some importance. In re-writing this edition the author has re-cast the work and has added new figures as well as textual matter. Chapters on Class Demonstrations in Histology and Embryology and on the Projection Microscope are not only extremely valuable in themselves but also indicate one of the paths along which microscopical science is advancing, and the pioneering efforts of the author to keep his work abreast of the knowledge of the time.

Micro-chemical Reactions of Wood affected with Dry Rot. †—G. Marpmann mentions that wood affected with dry rot gives the following micro-chemical reactions:—(1) Iodol + dilute HCl or H_2SO_4 turns the diseased parts yellow, or brownish-yellow, healthy wood staining a carmine red. (2) Chlor-zinc-iodin or iodine + H_2SO_4 turns the attacked places blue in about $\frac{1}{2}$ hour, the healthy wood remaining yellow. (3) Nessler's reagent imparts a dark brown hue to the diseased parts, the apparently healthy portions being yellowish-grey or grey.

* Comstock Publishing Company, Ithaca, New York, 1901, viii. and 299 pp. and 230 figs.

† *Centralbl. Bakt.*, 1^{te} Abt., xxx. (1901) pp. 775-82.

PROCEEDINGS OF THE SOCIETY.

MEETING

HELD AT 20 HANOVER SQUARE, W., DECEMBER 18TH, 1901.

W. CARRUTHERS, ESQ., F.R.S., PRESIDENT, IN THE CHAIR.

The Minutes of the Meeting of 20th November last were read and confirmed, and were signed by the President.

The List of Donations to the Society, exclusive of exchanges and reprints received since the last Meeting, was read, and the thanks of the Society were voted to the respective donors.

Ward, H. Marshall, Diseases in Plants. (8vo, London, 1901)	From <i>The Publishers.</i>
Söderbaum, H. G., Jac. Berzelius Själfbiografiska anteckningar. (8vo, Stockholm, 1901).. .. . }	<i>L'Acad. R. Suédoise des Sciences.</i>
Cross and Bevan, Researches on Cellulose, 1895-1900. (8vo, London, 1901) }	<i>The Publishers.</i>
Giesenhagen, Dr. K., Die Farngattung Niphobolus. (8vo, Jena, 1901) }	<i>The Publisher.</i>

Mr. C. Beck exhibited and described a new Micrometer Microscope in which the body was made to traverse across a long stage by means of the rotation of a fine screw, the milled head of which was graduated so as to indicate a movement of $\frac{1}{100}$ mm. An ingenious arrangement enabled the body to be placed in a horizontal position so that it could be used as a telescope for the measurement of distant objects.

The President said that this instrument afforded a very simple, but very efficient means of measuring large objects under the Microscope.

The thanks of the Meeting were voted to Mr. Beck for showing and explaining this instrument.

The President said they had, through the kindness of Mr. Watson Baker, been provided with an exhibition illustrating the structure and development of the eye, and asked Mr. Baker if he wished to say anything in explanation of his exhibit.

Mr. F. W. Watson Baker said that he had nothing to add to the descriptions given upon the cards placed by each Microscope. His object had been to exhibit the most perfect specimens which could be obtained, and for this purpose most of the best preparers, foreign as well as British, had been applied to.

Mr. Vezey was sure that the Fellows of the Society who were present felt very much obliged to Mr. Watson Baker for the great trouble he

had taken to get together this very fine collection, and for affording this opportunity of seeing them. Their very hearty thanks were due to him for having done so.

The President said that the applause with which they had followed Mr. Vezey's remarks expressed gratitude which they all felt to Mr. Watson Baker for this instructive exhibition.

Dr. Hebb said the Fellows would regret to hear that Mr. Nelson was still too unwell to be able to attend the Meeting, but he had sent three short notes, the first of which, describing an old form of Microscope, had been illustrated by drawings which Mr. Karop had enlarged upon the blackboard. The second dealt with the earliest forms of achromatic objectives, and the third described a useful caliper gauge, also illustrated upon the board. He then read the several notes.

The President said he was gratified that Mr. Nelson had placed before them the great services rendered to Microscopy by Mr. Lister, which were too much overlooked.

A vote of thanks to Mr. Nelson for his communications was unanimously passed.

The Chair having been taken *pro tem.* by the Hon. Sir Ford North, the President gave an interesting account of some recent investigations which he had made in reference to a disease which had caused great mischief in the cherry orchards in Kent.

Prof. Bennett said he was sure the Fellows present had all listened with great interest to the very lucid account which the President had given them of this important fungus disease, and he should like to take the opportunity of calling attention to the small amount of work which was being done in this country towards the study of such matters, and to the very little encouragement which the Government gave to researches of this kind. In the United States the agricultural department undertook these investigations and employed experts to carry them out, and issued bulletins describing what had been discovered, and advising the course to be taken. Independently of this almost every separate State had its own experimental station where this kind of work was done, whereas in this country work of this kind had to be carried out by private means. Some short time ago they had a paper before them describing the parasitic fungi found on farm seeds, and now they had another description of a similarly destructive disease, but in both cases the investigations were entirely private work. He felt they were very much indebted to the President for bringing this subject before them, and he thought their Society was doing a very useful work in publishing the information thus communicated.

The Chairman then moved that the thanks of the Society be given to the President for his very interesting and instructive address, and on putting it to the Meeting, it was carried by acclamation.

The President said he was glad that Mr. Bennett had called attention to the want of a public department for investigating diseases that attack farm and garden plants. It was not creditable to England that no such institution existed here, while on the Continent, and especially in the United States, important services were being rendered to the

farmer and gardener under Government direction and control. For thirty years, as Consulting Botanist to the Royal Agricultural Society, he had been assisting the members of the Society in such matters. But the importance of agriculture, and the great need of farmers as a class, demand the establishment of a fully equipped Government Laboratory where help could be obtained by any farmer or gardener throughout the kingdom.

The President having resumed the Chair, reminded the Fellows that their next Meeting would be the Anniversary Meeting of the Society, and it would therefore be necessary to have nominations for Officers and Council made on the present occasion.

The following nominations by the Council were then made:—

President—Dr. Henry Woodward.

Vice-Presidents—Dr. Braithwaite, Messrs. Carruthers, Karop, and Sir Ford North.

Treasurer—Mr. Vezey.

Secretaries—Rev. Dr. Dallinger and Dr. Hobb.

Council—Messrs. Beck, Bennett, Browne, Carr, Disney, Michael, Nelson, Plimmer, Powell, Rousselet, Radley, and Shore.

Librarian—Mr. Radley.

Curator—Mr. Rousselet.

Auditor on behalf of the Council—Mr. J. M. Allen.

The Fellows having been requested to appoint an Auditor on behalf of the Society, Mr. G. E. Mainland was proposed by Mr. C. L. Curties, seconded by Mr. G. H. J. Rogers, and unanimously elected.

It was announced that the Rooms of the Society would be closed from December 23rd to January 3rd.

The following Instruments, Objects, &c., were exhibited:—

Messrs. R. and J. Beck:—A new Micrometer Microscope.

Mr. F. W. Watson Baker:—Microscope Slides illustrating Eye Structure.—Development of Eye: 1, Fœtal Rabbit, Head and Eyes; 2, Rabbit, whole Section; 3, Tadpole; 4, Young Frog; 5, Frog, whole Section. Compound Eyes, Sections: 6, Butterfly, Vanessa; 7, Crab; 8, Crayfish; 9, Cockchafer, Melolontha; 10, Dronefly, Eristalis; 11, Fly, Volucella; 12, Water Beetle, Agabus. Simple Eyes, Sections; 13, Carp; 14, Spider; 15, Snail. Structure: Calf Retina, Fovea centralis: 17, Human Retina, Sections at different points; 18, Human Retina, Fovea centralis; 19, Human Endothelium, Descemet's Membrane; 20, Human, Meibomian Glands.

New Fellows:—The following were elected *Ordinary* Fellows:—Messrs. Wm. H. Browne, Geo. Tilling, Walter Wesché, Frank Winter.

ANNIVERSARY MEETING

HELD ON THE 15TH OF JANUARY, 1902, AT 20 HANOVER SQUARE, W.
WILLIAM CARRUTHERS, ESQ., F.R.S., PRESIDENT, IN THE CHAIR.

The Minutes of the Meeting of 18th December, 1901, were read and confirmed, and were signed by the President.

The President having appointed Messrs. Rogers and Rheinberg to act as Scrutineers, the Ballot for the election of Officers and Council for the ensuing year was proceeded with.

The List of Donations to the Society received since the last Meeting, exclusive of exchanges and reprints, was read, and the thanks of the Society were voted to the donors.

Prodromus Floræ Batavæ. Vol. i. pt. i. (8vo, Nijmegen, 1901) Apàthy, S., Die Mikrotechnik der Thierischen Morphologie. Zweite Abtheilung. (8vo, Leipzig, 1901) Index Catalogue of the Library of the Surgeon-General's Office. U.S.A. Army. Second series, vol. vi. (8vo, Washington, 1901)	{	From <i>La Société Provinciale des Arts et Sciences établie à Utrecht.</i> <i>The Publisher.</i> <i>The Surgeon-General U.S. Army.</i>
---	---	---

The President said they had a very interesting exhibition on the table of malaria parasites, prepared by Mr. E. A. Parsons of the School of Tropical Medicine, and shown under a number of Microscopes lent for the occasion by Messrs. Baker.

Mr. Parsons said these specimens were selected to show the malaria parasite in various stages as seen in the red corpuscles of the human blood.

The thanks of the Society were unanimously voted to Mr. Parsons for exhibiting these objects, and to Messrs. Baker for placing the Microscopes at the disposal of the Society for the purpose.

The Scrutineers having reported the result of the ballot, the President then declared the following duly elected.

President—Henry Woodward, Esq., LL.D., F.R.S., F.G.S., F.Z.S.

Vice-Presidents—Robert Braithwaite, Esq., M.D., M.R.C.S., F.L.S.;

William Carruthers, Esq., F.R.S., F.L.S., F.G.S.; George C. Karop, Esq., M.R.C.S.; The Right Hon. Sir Ford North, P.C., F.R.S.

Treasurer—J. J. Vezey, Esq.

Secretaries—Rev. W. H. Dallinger, LL.D., F.R.S.; R. G. Hebb, Esq., M.A., M.D., F.R.C.P.

Other Members of Council—Conrad Beck, Esq.; Alfred W. Bennett, Esq., M.A., B.Sc., F.L.S.; E. T. Browne, Esq.; Rev. Edmund Carr, M.A., F.R.Met.S.; A. N. Disney, Esq., M.A., B.Sc.; A. D. Michael, Esq., F.L.S.; E. M. Nelson, Esq.; Henry Geo. Plimmer, Esq., F.L.S.; Thomas H. Powell, Esq.; Percy E. Radley, Esq.; Charles F. Rousselet, Esq.; Thos. W. Shore, Esq., M.D., B.Sc., F.L.S.

Librarian—Percy E. Radley, Esq.

Curator—Charles F. Rousselet, Esq.

The Annual Report of the Council was then read by Dr. Hebb as follows.

REPORT OF THE COUNCIL FOR 1901.

The most important event of the past year affecting the interests of the Society is the renewal of the Patronage which His Majesty accorded to the Society as Prince of Wales in 1866.

The Council feels that the honour cannot fail to exercise a beneficial influence on the affairs of the Society.

FELLOWS.

Ordinary.—During the year 1901, 15 new Fellows have been elected, whilst 13 have died, 17 have resigned, and 4 have been removed.

Among the deaths the Council records with regret the names of G. Shadbolt, who was President 1856–7, and of J. Ware Stephenson, Treasurer from 1872–81.

Honorary.—The election of Dr. T. C. Hudson to be an Honorary Fellow has made the total number 47.

The list of Fellows now contains the names of 438 Ordinary, 1 Corresponding, 47 Honorary, and 83 Ex-Officio Fellows, being a total of 569.

FINANCES.

The total amount received for Subscriptions during the year is less than that under the same head of last year; this is largely due to the fact that there were less arrears to collect, the diminution being in the years previous to 1901.

The subscriptions of the new Fellows elected during the year have not been sufficient to compensate for the loss by deaths, resignations, and removals; it is necessary therefore to urge on Fellows the desirability of increasing the membership of the Society so that its operations shall not be curtailed.

The expenses of the year are rather less than those of 1900; the

balance in hand at the close of the year is much smaller than that of the previous year, but the amount on deposit at the Bank nearly accounts for the difference.

The admission fees received in 1900 and the compounding fees received during the present year have been invested, in accordance with the Rules, in India 3 per cents. The admission fees for 1901 will be invested early in the new year.

JOURNAL.

The original papers published in the Journal during 1901 have been ten, as against seven last year, and they have belonged to all branches of the field occupied by our Society,—Zoology, Botany, the construction of the Microscope, and Microscopic Optics.

The Summary of Current Researches has been continued as before, with the addition, mentioned in the Report last year, of the microscopy of metallurgy; abstracts have been given of many interesting and important papers on the microstructure of metals and alloys.

INSTRUMENTS AND APPARATUS.

In accordance with the Council's decision of last year, the Instruments, object-glasses, and apparatus in the Society's collection have been engraved with the letters R.M.S. and a number, so that every piece can now be readily identified.

The instruments have been rearranged in the Cabinet, and the whole are in good condition.

The following valuable additions have been made to the collection during the past year:—

Jan. 16, 1901.—An old Pocket Field Microscope by H. Gilbertson. Presented by Mr. H. E. Freeman.

Feb. 20.—A Double Reflecting Microscope by P. and I. Dollond. Presented by Mr. J. J. Kern.

Two old Objectives: 2 in. and $\frac{1}{2}$ in., by Andrew Ross. Presented by Mr. F. R. Dixon-Nuttall.

Oct. 16.—An old Microscope by Cary. Presented by Mr. Chas. Lees-Curties.

A Patent Graphic Telescope by Cornelius Varley. Presented by Mr. Chas. F. Rousselet.

Nov. 20.—A Microscope by Plössl & Cie. of Vienna. Presented by Right Hon. Sir Ford North.

An old Microscope by Cuff. Presented by Mr. Chas. Lees-Curties.

An old Microscope by Hugh Powell. Presented by Messrs. W. Watson and Sons.

A Microscope by Powell and Lealand, dated 1848. Presented by Rev. Canon Carr; J. W. Gifford; Sydney T. Klein; A. D. Michael; E. M. Nelson.

CABINET.

Four slides of mounted Rotifers, received from the Hon. Thos. Kirkman of Natal, have been the only additions to the Cabinet in the year 1901.

LIBRARY.

The rearrangement of the Library in accordance with modern principles and the requirements of the Society, and the compilation of a card catalogue, the work of Mr. P. E. Radley, have now been completed.

BY-LAWS.

The changes made in the By-laws at a Special Meeting of the Fellows in June last will, it is hoped, be conducive to the better working of the Society. The chief points are:—(1) The mode of payment of the admission fee, the system in vogue prior to 1897 being reverted to; (2) The formation of hybrid Committees, Ordinary Fellows being now eligible to serve on Committees of Council; (3) The Treasurer and Secretaries made ex-officio Members of all Committees; and (4) The formation of a new office, that of Hon. Librarian.

Mr. J. J. Vezey, Treasurer, then read the Balance Sheet and Statement of Accounts for the past year, which had been duly certified as correct by the elected Auditors.

Mr. Vezey said he did not think the Accounts called for any further remark from him, as the chief points had been adverted to in the Report. He should like, however, to call attention to the large amount which was expended in connection with the *Journal*, equal to the whole of the income from subscriptions. He did not wish it to be inferred that he thought this was not well spent, but he hoped the Fellows would realise the desire of the Council to give them the best *Journal* possible, and would do their best to obtain new Fellows, so that the item of subscriptions might be increased.

It was then moved by the Rev. Canon Carr, "That the Report and Balance Sheet be received and adopted, and that they be printed and circulated in the usual way."

Mr. Freshwater having seconded the motion, it was put from the Chair and unanimously carried.

The President said that he had great satisfaction in appearing before the Society that evening at the end of another year of office, a satisfaction which was increased by the fact that they had elected as his successor a gentleman with whom he had been associated for nearly half a century at the British Museum, where he had made a very marvellous collection in the Geological Department. Dr. Woodward had been President of the Geological Society, was a Fellow of the Royal Society, and had occupied other positions in the scientific world, and he was eminently qualified to carry out the duties of President of their Society. Dr. Woodward, having recently retired from the public service, was at the present time taking a well-earned holiday on the Mediterranean Coast, so that it would not be possible now to induct him, but it was expected that he would return in time to preside at their

Dr.

THE TREASURER'S ACCOUNT FOR 1901.

Cr.

1901.		£	s.	d.	1901.		£	s.	d.
To Balance from 1900	204	16	3	By Rent, Coals, &c.
" Admision Fees	36	0	6	" Salaries and Reporting	140 2 0
" Compounding Fees	34	2	6	" Books, &c., purchased	152 13 0
" Annual Subscriptions—					" Bookbinding	81 18 10
1895	0	7	11		" Expenses of Journal—				18 16 7
1898	1	6	0		Printing	£450	17	3
1899	4	4	0		Illustrations	62	15	8
1900	25	9	9		Editing	175	4	6
1901	622	8	10						
1902	28	7	6		" Purchase of India Threo per Cents.	688	17	5
1903	2	2	0		" Placed on Deposit at Union Bank	83	4	6
Interest on Investments and Deposit Account	684	6	0	" Refreshments at Meetings	13	10	0
Sale of Journal	46	1	2	" Stationery	15	18	7
Receipts for Advertisements	337	16	0	" Fire Insurance	2	0	0
" Sale of Surplus Books	60	0	0	" Postage and Petty Expenses	37	16	0
" List of Fellows sold	0	1	0	" Repairs	1	18	6
" Reprints sold	5	15	3	" Engraving and numbering Apparatus	9	18	6
" Screw Tools sold	2	17	6	" Instruments purchased	1	0	0
" Income Tax returned	5	14	1	" Balance in hand	37	5	0
" Sundries	0	0	8					
							£1434	0	11

Investments.

- 400*l.* Nottingham Corporation Stock Three per Cents.
 315*l.* 11*s.* 1*d.* New South Wales Three and Half per Cents.
 400*l.* North British Railway Three per Cents.
 439*l.* 2*s.* 4*d.* India Three per Cents.
 149*l.* 2*s.* on Deposit at Union Bank.

We have examined the foregoing Account, and compared the same with the Vouchers in the possession of the Society; we have also verified its Securities as above mentioned, and find the same to be correct.

J. J. VEZEY, *Treasurer.*

J. MASON ALLEN } *Auditors.*
 G. E. MAINLAND }

January 13th, 1902.

next Meeting. The *résumé* of the year's work was so clearly given in the Report that it did not need any further reference from him, and he was sure all were satisfied that the *Journal* had been carried on with an ability that made them feel proud of it. He would say further that he was extremely glad that two important pieces of work had been done during his period of office as President. The property of the Society consisted of its Library and its instruments, and both these had been carefully examined, arranged, and catalogued. Hitherto they had no proper list of the instruments and apparatus, but Mr. Rousselet, with the assistance of Mr. Nelson, had gone carefully over the entire collection, and had made a complete catalogue, whilst every piece had been engraved with the initials of the Society and a consecutive number to facilitate reference. As regarded the books, they were extremely obliged to Mr. Radley, who had taken this matter in hand, and with the assistance of Members of the Council, had gone over the whole, and got rid of a large quantity of books and papers which were of no value to the Society, for which they obtained some money. The Library had been arranged, and an excellent card catalogue made of the entire collection. He thought that the Library was not made so much use of by the Fellows as it might be; it contained a large number of valuable works of reference of great use to anyone making researches on subjects connected with the early history of scientific work. The only thing which seemed to want mending was their annual income. Their *Journal* had continued to give them a valuable *résumé* of all the most important observations and discoveries made in connection with the Microscope both here in this country and abroad. The improvements connected with the Microscope were brought under the notice of the Members by the London makers, who were amongst the most able makers of Microscopes in the world. In the great value of the *Journal*, as well as the interesting exhibitions and subjects brought before their meetings, he thought they had abundant reason for inducing persons to join the Society. He then gave, as his Annual Address, a very interesting *résumé* of the scientific work of Nehemiah Grew, 1641–1712, whom he ably defended from the charges of plagiarism which had been brought against him in respect to his discoveries as to plant life and structure.

Dr. Braithwaite rose to move, "That the best thanks of the Society be given to the President for his address, and that he would allow it to be printed in the *Journal* in the usual way." It had been a great pleasure to him personally to hear the very interesting reference which had been made to one of the great fathers of their sciences, and he thought there were many things to be found in their writings which might be taken as examples by those who were now carrying on the work. They might remember that before 1750, when Linnæus invented the binomial nomenclature for animals and plants, they were recognised by a short descriptive character, and a contemporary of Grew—born indeed in the same year—John Ray, may be cited for the apt descriptions of one or two lines, which embodied the most striking features of each plant, though sadly inconvenient for quotation. He was sure it would be of great service to students to have their attention directed to the work of these early writers who had laid the foundations upon which much of the work done in the last century was carried on.

Mr. Karop having seconded the motion, it was carried by acclamation.

The President said he was glad to find that the subject had proved of interest; it was one which had interested him very much, and he had taken great delight in making the researches necessary for the account of Grew, and especially in having the opportunity of refuting the charges that had been made against him.

Votes of thanks were passed to the Honorary Officers for their services during the past year, and also to the Auditors and Scrutineers for the duties in connection with the present Meeting.

The President said it now only remained for him to express his thanks to the Officers and Fellows of the Society for the forbearance and help which had been extended to him during his term of office. He felt that a great honour had been done to him in electing him to the position, and he felt also that if he had succeeded in any way in carrying out the duties this was largely owing to the help which he had received from those with whom he had been associated in the work of the Society.

The following Instruments, Objects, &c., were exhibited:—

Mr. E. A. Parsons:—The following slides of Malaria Parasites:—
 (1) Benign Tertian Parasite, full grown. (2) Ditto, about 12 hours old. (3) Malarial Crescent. (4) Section of Brain showing Sporulating Malignant Tertian Parasite in Capillary. (5) Full-grown Benign Quartan Parasite. (6) Early Form of Benign Quartan.

Messrs. Ross:—Five Students' "Standard" Microscopes, two being fitted with swing-out substage. Two No. 2 "Standard" Microscopes, one fitted with substage. A new Dark-ground Illuminator.

New Fellows.—The following were elected *Ordinary* Fellows:—
 Messrs. Abraham Flatters, Joseph Gibson, Thos. A. O'Donohoe, and Chas. Jas. Sharpe.

JOURNAL
OF THE
ROYAL MICROSCOPICAL SOCIETY.

APRIL 1902.

TRANSACTIONS OF THE SOCIETY.

IV.—*The President's Address: On the Life and Work of
Nehemiah Grew.*

By WILLIAM CARRUTHERS, F.R.S.

(Delivered January 15th, 1902.)

NEHEMIAH GREW was born in 1641. At his birth England was in the throes of a gigantic and unprecedented revolution. Charles, after vainly trying to govern as an absolute monarch, had been forced to summon a parliament, which, not agreeing to his wishes, was immediately dissolved. Another summons brought together the Long Parliament, and on that followed the Civil War. The issues of the contending parties were settled on the battle-field, and the Commonwealth held its ground for some years. Much more important and more enduring in its issues was the battle waged through the press. Every subject—political, ecclesiastical, social—was fought out there. The two decades from 1641 were years of extraordinary mental activity. Periodical publications—daily, weekly or monthly—were scarcely known. When occasion required the publication of some home or foreign news, a sheet folded into four small quarto leaves was brought into requisition. In our days the regularly published journals supply channels for ventilating opinions. But in the middle of the seventeenth century, each man who had anything to say had to issue his utterance as a separate publication. The showers of pamphlets that were thus sent out from the press were immense. Some idea may be formed of their extent from the collection made by Thomason, a London bookseller, which is preserved intact in the Library of the British Museum. It consists of more than 30,000 items. Natural knowledge, though represented by only a fraction of this letterpress, was not overlooked. The men who met weekly in London from 1645, to read and consider papers on natural philosophy and other parts of human learning, continued their fellowship until

April 16th, 1902.

K

the Restoration, when they were incorporated by charter as the Royal Society of London for the Promotion of Natural Knowledge.

The vegetable kingdom had been up to this time studied chiefly because of the real or imaginary virtues which the plants were believed to possess. The first English botanical work was published in 1516. It was little more than a translation of the 'Hortus Sanitatis,' and was illustrated with many rude woodcuts copied on a smaller scale from the illustrations of the earlier work. This volume had the title:—'The Grete Herball, whiche giveth knowledge and understanding of all manner of Herbes and there gracyous virtues,' &c.

William Turner, the father of English botany, was a native of Morpeth. He was in 1538 a student of Pembroke Hall, Cambridge. He had already acquired a love of plants, but he got little help in Cambridge. He says, "I could learn never one Greek, neither Latin, nor English name, even amongst the physicians, of any herb or tree; such was the ignorance at that time; and as yet there was no English Herbal, but one all full of unlearned cacographies and false naming of herbs." This, no doubt, refers to 'The Grete Herball.' At the University he adopted decided Puritan opinions, and these being obnoxious to Bishop Gardiner, he was put in prison. On being liberated he went to the Continent, where in many places he visited he found opportunities for studying botany. He graduated M.D. at Ferrara. He lived for some time at Cologne, and there published the first part of his great Herbal in 1551. It was completed in 1568.

Thereafter followed three famous and still well-known Herbals. John Gerard was an apothecary, living in Holborn, and having a Botanical Garden there. His 'Herball or Generall Historie of Plantes' was published in 1597. Thomas Johnson, also an apothecary, whose shop was in Snow Hill, issued in 1633 a new and greatly improved edition of Gerard's 'Herball.' He was an ardent Royalist, and joined the king's army at Oxford, with the rank of lieutenant-colonel. He gained for himself, on this account, from the Royalist University, the degree of M.D. in 1643, but on the 14th September of the following year he was fatally wounded in an encounter with the enemy, and died a fortnight thereafter. He was an exact and learned botanist. John Parkinson, like his predecessors, was a London apothecary. His first work was specially devoted to horticulture; this I mention because of its title—'Paradisi-in-Sole Paradisus terrestris,' a play on his name Park-in-son. His 'Theatrum Botanicum, the Theater of Plants, or a Herball of a large extent,' was published in 1640. It is a more learned and able Herbal than those that preceded it.

The first British Flora was published by Dr. William How in 1650, under the title 'Phytologia Britannica.' How joined the Royalist army, but on the failure of the king's cause he settled in Milk Street, London, and practised medicine, but survived the publication of his Flora only six years.

This short narrative indicates the stage which botanical studies had reached in England and elsewhere, when Grew entered upon his investigations. The Microscope had not been used for botanical research. Cornelius Drebbel is said to have brought the first compound Microscope to England from Holland in 1619. There is no record of any scientific use being made of it. The first application of the Microscope to the examination of the minute structure of plants was made by Robert Hooke. He was one of the original Fellows of the Royal Society, and was elected Secretary in 1677. Hooke was a very learned and ingenious man. He constructed simple Microscopes, and greatly improved the compound Microscope. His methods are clearly described in the Preface (p. 22, &c.), to his 'Micrographia,' published in 1667; and a figure of the Microscope which he as well as Grew used in their investigations is given in the first plate of that work.

Grew was born at Mancaster, in Warwickshire, where his father Obadiah Grew was schoolmaster. His father afterwards entered the Church, and succeeded the famous Puritan clergyman Richard Vines, at St. Michael's, Coventry, in which city Nehemiah spent his youth and received his early education. He was a student at Pembroke Hall, Cambridge, taking his B.A. in 1661. The illustrious John Ray, who had studied at St. Catherine's Hall and then in Trinity College, had been from 1651 lecturer in that College, in Greek, Mathematics and Latin successively. In 1660 Ray published his '*Catalogus Plantarum circa Cantabrigiam nascentium*,' which contained a list of 626 species that he had collected in the neighbourhood of Cambridge. We may indulge the supposition that Grew during the years of his attendance at Pembroke Hall, may have been known to Ray and may have accompanied him in some of his "simpling" walks. Grew's published works show that he was well acquainted with British plants. He everywhere writes freely about them, and in his '*Anatomy of Seeds*' he figures with singular fidelity the seeds of forty of our native plants.

On leaving Cambridge Grew went to Leyden to study medicine. After receiving his M.D. there he returned in 1664, and settled at Coventry to practise. A great change had taken place while he was in Holland, consequent on the Restoration in 1660. His father remained vicar of St. Michael's till August 1662, when the Act of Uniformity, passed in the previous May, was enforced. Obadiah Grew was one of the two thousand clergy who were unable to accept the terms of the oath required by that Act, and who were in consequence ejected from their livings. He suffered much, and was in prison for six months, because he was found living in Coventry in contravention of the Five Mile Act.

The circumstances that led Grew to the minute study of plants are thus narrated in the preface to his '*Anatomy of Plants*,' 1682. He says:—"The first occasion of directing my thoughts this way

was in the year 1664, upon reading some of the many and curious inventions of learned men, in the bodies of animals. For, considering that both of them (plants and animals) came at first out of the same Hand, and were, therefore, the contrivances of the same Wisdom, I thence fully assured myself that it could not be a vain design to seek it in both. And being then newly furnished with a good stock of seeds, in order to make a nursery of plants, I resolved, besides what I first aimed at, to make the utmost use of them for that purpose, that so I might put somewhat upon that side the leaf which the best botanicks had left bare and empty."

He watched the progress of germination in his garden, and recorded his observations. He noticed the difference between the monocotyledonous seed of wheat and the dicotyledonous seed of the bean, though he did not, of course, realise the importance of his observation. In 1668 he showed the results of his work to his half-brother, Dr. Henry Sampson, who approved of his investigations, and encouraged him to proceed with them; and having completed the manuscript of his first book, 'The Anatomy of Vegetables Begun,' he communicated, in 1670, a part of it to Mr. Oldenburg, then Secretary of the Royal Society. After reading the manuscript, Oldenburg delivered it, on his own motion, to Dr. John Wilkins, Bishop of Chester, who, after perusal, produced it at a meeting of the Royal Society. The Fellows desired to see the remainder of the work, which being presented to them, was perused by the President, Lord Brouncker. On the 11th May, 1671, the Council ordered it to be printed by the printer of the Society. The formal order to the printer was dated 9th November, 1671, and on the 30th of the same month Grew was admitted a Fellow of the Society. The printed book was delivered complete at the meeting of the Royal Society on the 7th December, 1671. 'The Anatomy of Vegetables Begun' is a small octavo of 186 pages, with dedication, preface, and contents prefixed, and the explanation of the plates appended. The plates are three in number, with twenty-nine figures. The text deals with the germinating seed, the structure of the root, stem, branch, leaf, flower, fruit, and the formation of seed. The work was mainly done without the help of the Microscope. In his preface to the original edition of his 'Anatomy' he says:—"What we have performed thus far lieth, for the most part, open to the use and improvement of all men. Only in some places, and chiefly in the third chapter, we have taken in the help of glasses; wherein after we had finished the whole composure, some observations made by that ingenious and learned person, Mr. Hooke, a worthy member of the Royal Society, my much honoured friend, and by him communicated to me, were super-added: as likewise some others also microscopical, of my own, which his [observations] gave me the occasion of making." In the third chapter, 'Of the Trunk' (page 71), he further acknowledges his debt to Hooke, especially in his investigation of the fibro-vascular bundles, which he

calls the fibres of the "lignous body." The only figures in this little book for which the Microscope was used are the transverse sections of Burdock (fig. 15) and Oak (fig. 17).

The work opened up an untrodden field of investigation in botany. Grew had nothing to guide him in his interpretations of the structures he observed. He started with the conviction that he would be helped by analogies in the structure and organisation of animals. This became a constant source of error in his arguments and generalisations. The instruments he used in investigating the minute structures dealt with in his first work to some extent, but more extensively in his subsequent works, were very imperfect. He held "that some things may be demonstrated by reason and the eye jointly, without a glass, which cannot be discovered by the help of the glass; or else the discovery is so dark that it may not be safely depended upon." A dangerous maxim, and happily abandoned by all careful observers in these days.

In his account of the germinating seed Grew gave to the descending axis the name of radicle, and the ascending axis he called the plume. He distinguished the cotyledons, and determined that they were leaves from observing that in some plants they spread themselves in the air. The "seminal roots" which, from animal analogies and the exercise of his "reason," he found in the cotyledons, were, in his judgment, the essential structures, while the somewhat accidental cellular tissue was filled in around these organs. He called this tissue parenchyma, because it was "the part through which the inner body is disseminated."

In his anatomy of the root, stem, and branches he distinguished two different elementary tissues, the one parenchymatous found in the cortex, medullary rays ("insertions" he named them), and the pith; the other the "lignous," with its vessels and fibres which are always elongated in the direction of the axis, whereas the parenchyma is "extended much alike both in the length and breadth" of the axis. This was very near to an accurate definition of what is now called parenchyma and prosenchyma. He quotes with approval Hooke's observations. "Mr. Hooke," he says, "sheweth us that the pores of the pith, particularly of elder-pith, so far as they are visible, are all alike discontinuous; and that the pith is nothing else but an heap of bubbles." And he adds that this observation of Hooke's "confirms what in the second chapter we have said of the pith and cortical body, and of the sameness of both their natures with the parenchyma of the seed. For, upon farther enquiry with better glasses, I find that the parenchyma of the plume and radicle, and even of the lobes (cotyledons) themselves, though not so apparently, is nothing but a mass of bubbles." To Hooke undoubtedly belongs the discovery of the vegetable cell, and Grew's difficulty in fully accepting this discovery arose from his conviction that the parenchyma of the pith, medullary rays, and bark was a medium of circulation, and the

analogy of the vessels of animals required the parenchyma to be open "pores," and not closed cells. His further use of the Microscope compelled Grew to surrender the demonstration of "reason" to observation of sense, and in his later writings he says, "the pith consists of very small vesicles or bladders as the bark."

The structure of the leaf is clearly described, and the presence of the stomata observed, figured, and described. He says: "The skins of at least many plants are formed with several orifices or passports, either for the better escape of superfluous sap or the admission of air." This was a very shrewd prophecy, and his works abound in such suggestions. But the general functions of the leaf are misunderstood, though he holds that they imbibe and elaborate the sap. Little more could be ascertained until chemistry was established on a new basis by Lavoisier, after the middle of the eighteenth century. The investigations, under the influence of the new chemistry, by Ingenhaus, Senebier, and Saussure established the nature of the plant-food, the sources from which it was derived, and the organs through which it was obtained.

The account of the flower is least satisfactory. He distinguishes the calyx (empalement), corolla (foliation), and stamens (attire) which consist of filament (chive), and anther (semet). He says nothing of the pistil in ordinary flowers. He deals at greater length with the composite flower which he calls the florid attire. It consists of three parts, the corolla (flore), the stamens (sheath), and the stigma (blade). He does not recognise that the sheath is his attire (stamens), and he supposes that the pollen-grains adhering to the stigma lay, before its opening, "enclosed up within its clefts, and are of the same nature with those of the semet (anther), though not so copious." In his later work on the flower (read November 9th, 1676) he describes and figures the pistil. He had some conversation with the Savilian Professor, Sir Thomas Millington, as to sexes in plants. The Professor explained his views as to the stamens and pistil being sexual organs, and this agreeing with the opinions he had been forming, he expressed them at length in his Memoir published in 1682.

The fruit and seed have their forms and structure clearly set forth.

The more complete investigations subsequently published were expansions of the chapters of this small volume.

On the day on which Grew's published work was presented to the Royal Society (7th December, 1671) Oldenburg, Secretary to the Society, received through the Ambassador to St. James's, the manuscript of the '*Anatomes Plantarum Idea*,' by Malpighi, which is printed on pages 1-15 of his '*Anatome*,' and on the same day laid it before the Society. A week after (14th December) Oldenburg wrote to Malpighi acknowledging the receipt of the manuscript, and sent him a copy of Grew's published work, by the hands of Bocconi, but he remained so long in Belgium that it had not reached Malpighi

in August 1674. Malpighi's 'Idea' is a clear and succinct statement of the work which he promised to submit to the Society in detail for their judgment. No illustrations were sent with the 'Idea.'

Having begun a work which had met with so much favour from the Society, Grew resolved to prosecute it further, and drew up a detailed scheme of his whole design. Hearing, however, from London that Malpighi had entered on the same work, and considering that the Society had the prospect of a memoir from so illustrious a man, he stayed his hand.

So important, however, did Grew's work on plants appear to the Royal Society, that on the 18th April, 1672, on the recommendation of Dr. Wilkins, he was appointed the Society's Curator of the Anatomy of Plants for a year, for which he was to receive fifty pounds, to be obtained by a subscription from "such members as should be willing to contribute that sum." The Bishop of Chester agreed to take charge of the subscriptions.

When his friend the Bishop of Chester informed him of this, and of the Society's desire that he should proceed with his researches, he resolved to continue his work, "considering that it would be no disadvantage to the credit of those matters, which were so new and strange, to be offered to the world from a double authority." He removed to London, and established himself there as a physician.

He again took up the scheme of work he had set aside, and on the 9th and 15th of January, 1672-3, he submitted to the Society his 'Idea of a Phytological History Propounded,' and continued his researches on the Anatomy of Plants by describing in detail the structure and functions of the Root. These two papers were ordered to be printed, and were published as another small octavo volume in 1673, containing 144 pages and 7 plates.

The purpose of the 'Phytological History' was very different from Malpighi's 'Idea.' Grew was groping after a philosophical basis for the classification of plants. He considered that five points should be kept in view for this purpose:—(1) a particular and comparative survey of whatever is of more external consideration; (2) a similar survey of the anatomy; (3) of the contents of plants; (4) of the principles of the organised parts; and (5) a survey of those bodies from which these principles are derived. If we look at these suggestions from the point of view of the middle of the seventeenth century, we see that Grew had advanced views of what had to be considered in constructing a scientific classification of plants. His five points were the environment of the plants, the structure of all their parts, their properties, the elements of which they are composed, and the sources from which these elements were obtained. His own estimate of his work is given in the closing sentences of the 'Idea,' which I may here quote:—"This is the design," he says, "and these the means I propose in order thereunto. To which, I suppose, they may all appear to be necessary. For what we obtain of Nature, we must not

do by commanding but by courting her. Wherever men will go beyond fancy and imagination, depending upon the conduct of Divine Wisdom, they must labour, hope, and persevere. And as the means proposed are all necessary, they may in some measure prove effectual. How far, I promise not; the way is long and dark: and as travellers sometimes amongst mountains, by gaining the top of one, are so far from their journey's end, that they only come to see another before them; so the way of Nature is so impervious, and, as I may say, so down-hill and up-hill, that how far soever we go, yet the surmounting of one difficulty, is wont still to give us the prospect of another. We may therefore believe our attainments will be imperfect, after we have done all; but because we cannot attain to all, that therefore we should do nothing, is an inference that looks so much away from the practical sense of men, that it ought not to be answered. Nor with better reason may we go about determining what may be done. If but a little should be effected, yet to design more can do us no harm; for though a man shall never be able to hit stars by shooting at them, yet he shall come much nearer to them than another that throws at apples."

'The Anatomy of Vegetables particularly prosecuted upon Roots,' was read to the Royal Society in 1673, and published the same year in the volume mentioned already, together with his 'Idea,' and was illustrated by seven plates.

In a letter to Malpighi dated 5th March, 1672-3, Grew says:—"I have myself benefited from your writings, and am truly proud so to have benefited." This can, of course, only refer to the 'Idea.' He names one point for which he is indebted to Malpighi: "I learnt first from your works the spiral formation of the wide tubes which you call tracheæ, and from them I seized the opportunity of adding also a few observations on the conformation of the said tubes." In this same letter he says he is just sending to the printer (by desire of the Royal Society) his anatomical observations on roots, to which he intends to prefix the 'Idea of Phytological Science,' which he says, as soon as it is published, he proposes to submit to Malpighi's learned and kind perusal.

'The Comparative Anatomy of Trunks, together with an Account of their Vegetation grounded thereupon,' was presented to the Royal Society in 1673 and 1674, and read in February 1674, and June 1675, and was published the same year in an octavo volume of 81 pages and 18 plates.

Malpighi despatched from Bologna to London the first part of his work on plant anatomy in August 1674. It did not reach the Secretary of the Royal Society till the 28th January, 1675, when it was immediately exhibited to a Meeting of the Society which was being held that day. It was ordered to be printed as soon as possible in the best style. The thanks of the Society were given to Malpighi, and the earnest hope was sent him that his health might enable him

speedily to complete the work. The 'Anatome Plantarum' was published in the same year, with the President's order for printing dated 24th June, 1675. It is a folio volume of 84 pages and 54 plates, and contains as an appendix the dissertation 'De Ovo incubato,' paged separately, and consisting of 20 pages and 7 plates.

The completion of the work was received later, and was published in 1679 as 'Anatomes Plantarum Pars altera,' forming a folio volume of 93 pages and 39 plates.

Grew continued his investigations on the plant as set out in his first work, and communicated the separate memoirs to the Royal Society. On the 26th October, 1676, was read, 'The Anatomy of Leaves, prosecuted with the bare Eye, and with the Microscope.' On the 9th November and 6th December, 1676, was read 'The Anatomy of Flowers, prosecuted with the bare Eye, and with the Microscope.'

In 1677 'The Anatomy of Fruits, prosecuted with the Eye, and with the Microscope,' was read to the Society. Grew's scheme of the anatomy of plants was completed by the presentation to the Society in the same year of 'The Anatomy of Seeds, prosecuted with the bare Eye, and with the Microscope.' On the 22nd February, 1681-2, the Council of the Royal Society recorded in their minutes that, "Dr. Grew having read several Lectures of the Anatomy of Plants, some whereof have been already printed at divers times, and some are not printed, with several other Lectures of their Colours, Odours, Tastes and Salts; as also of the Solution of Salts in Water; and of Mixture; all of them to the satisfaction of the Society; It is therefore Ordered, That he be desired to cause them to be printed together in one volume." This resolution is signed by Christopher Wren, President. The folio volume, with the contents specified, was published in 1682, containing 304 pages and 83 plates. The memoirs published in octavo (in 1671, 1673 and 1675) were carefully revised, and the large majority of the plates re-issued, though a few were added to or re-engraved. The title of each of these three memoirs bears that it was "The Second Edition." The lectures on the Leaves, Flowers, Fruits, and Seeds were here published for the first time.

I have to crave forbearance for setting out in what may appear unnecessary detail the separate works of Grew. I am anxious that the remarkable labours of this original investigator should be realised by the members of the Society. But I have also a further purpose in view in submitting these details, which is to make plain how erroneous are the attempts that have been made to depreciate the work of Grew and to rob him of the credit that belongs to him as an original worker.

Schleiden promulgated these charges in his 'Grundzüge' 1845. They are thus expressed by Lankester in his translation of Schleiden's work published in London 1849, under the title of 'Principles of Scientific Botany' (pp. 37, 38).

“Marcellus Malpighi, professor at Bologna, gave a more accurate account of the structure of plants [than Hooke]. He sent to the Royal Society of London his great work ‘Anatome Plantarum,’ in the year 1670, and which was published in two volumes, folio, at the expense of the Society, in 1675. This work claims for him the title of the creator of scientific botany. He is so accurate, and pursues so correct a method, that it was a century before (i.e. in advance of) the time at which he wrote it, and at the present day many so-called botanists do not know so much of plants as Malpighi. He not only observed the cellular structure of plants, but maintained that it was composed of separate cells, which he called *Utriculi*.

“Nehemiah Grew was Secretary to the Royal Society at the time Malpighi’s work was publishing. He published his ‘Anatomy of Plants’ in 1682; is much indebted to Malpighi. He first took up the wrong view that the walls of the cells are composed of fibres; he also, by comparing the cells of plants to the froth of beer, would appear to have thought that they were mere cavities in a homogeneous substance, a view which was afterwards supported by Wolff.”

The assertions of Schleiden are based upon dates, but they are erroneous dates. Malpighi’s preliminary discourse which occupies the first fifteen pages of his ‘Anatome,’ has inscribed on the last page, “Dabam Bononiæ Calendis Novemb. 1671.” It could not have been sent to the Royal Society in 1670. The first part of his ‘Anatome Plantarum’ was sent by Malpighi in August 1674, but did not reach the Secretary of the Royal Society till the 28th January, 1675; it was published the same year in one volume. Grew was elected Secretary in 1677, and had nothing to do with the publication of this earlier part of Malpighi’s work. The second part of the ‘Anatome Plantarum’ (the second of Schleiden’s two volumes) reached the Society in 1679, and was published in the same year. No doubt Grew, who was still Secretary, took care of it through the press. But this part deals with the germination of seeds, galls, and roots of plants. Grew has said nothing about galls. His completed observations on germination were published in 1672, and on roots in 1673. Grew could not have been indebted to Malpighi for any help in these subjects. Schleiden makes his position apparently strong by asserting that Grew’s work was not published till 1682, and this he does in face of the fact that the memoirs which occupy 140 pages out of 212 have on each title-page in bold letters “The Second Edition.” And still further Schleiden blunders. Grew had noticed the unrolling of spiral vessels, and figures them in the leaves, and naturally, though erroneously, interpreted this appearance as due to their being composed of spiral fibres: but this is very different from the statement, “that the walls of the *cells* were composed of fibres.” And it is difficult to understand the consistency of Schleiden when he proceeds in the same sentence to say, “he also by comparing the cells of plants to the froth of beer would appear to have thought that they were

mere cavities in a homogeneous substance." The two interpretations of the structure of the vegetable cell could not be entertained by any sane man; they certainly were not entertained by Grew.

One regrets to find that Sachs in his 'History of Botany' (translated by Garnsey and Balfour, 1890), repeats the charges, though in a somewhat modified form. He says, "As to which of the two [Malpighi and Grew] the priority belongs has been repeatedly discussed, though the facts to be considered are undoubted. The first part of Malpighi's large work, the 'Anatomie Plantarum Idea,' which appeared at a later time, is dated Bologna, November 1, 1671; and Grew, who from 1677 was Secretary to the Royal Society, informs us in the preface to his anatomical work of 1682, that Malpighi laid his work before the Society on December 7, 1671, the same day on which Grew presented his treatise, 'The Anatomy of Plants Begun,' in print, having already tendered it in manuscript on the 11th May in the same year. But it must be observed that these are not the dates of the larger works of these two men, but only of the preliminary communications, in which they give a brief summary of the researches they had then made; the fuller and more complete treatises appeared afterwards; the preliminary communications formed the first part of the later works and to some extent the introduction to them. The first part of Malpighi's longer account was laid before the Society in 1674, while Grew produced a series of essays on different parts of vegetable anatomy between 1672 and 1682; and these appeared together with his first communication in a large folio volume under the title, 'The Anatomy of Plants,' in 1682. Thus Grew had opportunity to use Malpighi's ideas in his later compositions; he actually did so, and the important point as regards the question of priority is, that where he makes use of Malpighi he distinctly quotes from him. No more is necessary to remove the serious imputation which Schleiden has made against Grew."

Sachs' modified charge is also based on erroneous dates. He was unaware that the larger portion of Grew's 'Anatomy of Plants' was published in 1672, 1673, and 1675, the latter year being the date of the reception and publication of Malpighi's 'Anatome.' I have been able to discover only a single reference to Malpighi in Grew's 'Anatomy of Plants,' and there (p. 73) he quotes, as Sachs says, the words of the 'Anatome,' but for the purpose of correcting and adding to Malpighi's statement.

The fact is that Grew and Malpighi were original investigators of plant anatomy. A comparison of their published works on this subject shows that throughout they are entirely independent, frequently differing in their interpretations, and often complementary to each other. Grew was first in the field. Both men were no doubt moved with a common purpose expressed thus by Grew, "that the same subject, being prosecuted by two hands, would be the more illustrated by the different examples produced by both; and that the

defects of both would mutually be supplied." And this was the opinion of the men of that day, for in a notice of Grew's 'Anatomy of Trunks' in the *Philosophical Transactions*, No. 120, December 27, 1675, the writer says: "As there hath been a very happy concurrence of these two eminently learned persons, Signor Malpighi and our present author Dr. Grew, both Fellows of the Royal Society, in making and exhibiting their ingenious and accurate beginnings concerning the anatomy of plants, and thereby giving a new country of philosophy; so they have both been very industrious in pursuing this subject, in many things confirming one another's observations, and in some few ones supplying one another's defects." It is abundantly evident from the letters of Malpighi, Oldenburg, and Grew that the most cordial relations existed between Malpighi and Grew. The following letter preserved among the manuscripts of the Royal Society, which has not been published, is an interesting confirmation of this, as well as a specimen of the quaint courtesy of these olden times.

"LONDON, 5th March, 1672-3.

MOST ILLUSTRIOUS SIR,

Since you have given me manifold occasion for writing to you, and the illustrious Mr. Oldenburg has shown me a way of sending a letter, I could not (without sacrificing all good manners) any longer restrain my pen. And, indeed, I did not consider it unsuitable that you should learn from me as well as from others how worthy of praise are your writings dedicated to our Royal Society; from me, I say, who have myself benefited from them, and am truly proud so to have benefited. Moreover, it is not at all fitting to recall the great candour with which it pleased you to notice my work, without expressing the gratitude and honour that is in my mind.

I find that all your observations fully agree with mine: some, however, on the flower, the fruit, and the seed, it has pleased you to pass over. Of the wide tubes, which you call tracheæ, I first learned the spiral formation from your works, from which I seized the opportunity of adding also a few observations on the conformation of the said tubes.

The anatomical observations which I collected concerning roots in the year just closed, together with the figures, some the natural size of the roots, others microscopical, I shall shortly (by the advice of the Royal Society) send to the printer. To these I have added the functions of the parts, and in individual cases the methods of nutrition and configuration; the magnitude of the whole root, the causes of the figures, movements, ages, contents, briefly elucidated. To which, also, I determined to prefix the 'Idea of Phytological Science' as it was delineated in my mind; and at the same time that they are published, to submit them to your learned and kind perusal. I saw also with the greatest pleasure your descriptions of the incubating ovum, both former and recent; the rest are all such accurate and

graceful specimens of the same skill, learning and talent, that they plainly declare their Malpighian origin. Proceed, most learned Sir, in the things you have so excellently begun, and strive to bind us and posterity more each day to your honourable memory.

Your most affectionate
NEHEMIAH GREW."

Grew was a man of extensive knowledge and possessed by a philosophic spirit, with a keen appreciation of the affinities of plants and animals, though frequently led astray by the imperfect knowledge and fanciful theories of his day. He laid the foundations of vegetable histology with remarkable intelligence and accuracy. His descriptions are careful, and his drawings admirable, though sometimes diagrammatic and often helped by "reason" because of the imperfections of his Microscope and its adjuncts. His sections of woods, his details of flowers, fruits, and seeds have scarcely been surpassed.

One that knew him well says that "he was grave and serious in his conversation, yet affable and courteous with an obliging civility without nervousness, at the same time inviting your acquaintance and commanding your respect. He did not only mind his own things, but was truly concerned for the public." He was much beloved as a physician. His death took place suddenly, when engaged in his professional work, on the 25th March, 1712.

V.—*New Methods in Microscope Work.*

By EDWARD M. NELSON.

(Read February 1st, 1902.)

Polarizing with the Microscope.

POLARIZING work with the Microscope is of two distinct kinds:—

1. The magnification of minute objects under polarized light.
2. The investigation of phenomena due to the interference of polarized light (known as “rings and brushes”).

With reference to the first kind the images are much sharper, i.e. more critical, if a pair of tourmalines be substituted for the Nicol prisms usually supplied by the opticians for this purpose.

One tourmaline should be selected with care; it should be of a smoky tint with the slightest dash of pink, free from veins and specks, and not less than $\frac{1}{4}$ in. in diameter. It should be mounted in a cap to fit over the eye-piece.

The other tourmaline may be of the ordinary yellow-green variety, but it should be larger than the first; a rectangle $\frac{4}{10}$ by $\frac{6}{10}$ would be a convenient size and shape. This tourmaline should be mounted in a metal screen, say $2\frac{3}{4}$ by $3\frac{1}{2}$, with an aperture in it of such a size as to exclude all light that does not pass through the tourmaline. This screen may be mounted either on a separate stand, or on an arm attached to the lamp, as the position it is intended to occupy is in front of, and close to the lamp chimney.

The method of using this apparatus in the first kind of investigations needs no explanation. The Microscope is set up in the usual way; the image of the edge of the lamp flame is sharply focussed by the substage condenser on the object; the screen holding the tourmaline is placed close to the chimney of the lamp. The object is then examined and, when all the adjustments (collar correction, tube length, size of illuminating cone, &c.), are completed, the second tourmaline, in the cap of the eye-piece, is applied, and the eye-piece and object rotated until the desired effect is obtained. If the substage condenser were an achromatic Abbe, and a large axial illuminating cone was required, under the old regime a very large, and therefore expensive, Nicol would be necessary, because the Nicol would have to be large enough to pass a beam equal to the size of the back lens of the Abbe condenser; but with this new method a tourmaline large enough to show the middle portion of the lamp flame is sufficient, even when the widest angled cones are employed

with any kind of condenser. The images obtained by this new method will be just as critical as those in a Microscope when no polariscope is used.

In the old method the polarizing prism interfered with the correct performance of the substage condenser; the analysing prism also, when mounted immediately above the objective, destroyed the sharpness of the image, and when placed over the eye-piece removed the eye too far from the eye point; it also caused a deterioration of the image, but not to the same extent as when placed above the objective. Mr. Gordon has shown that the Microscope image is sharpened up when the size of the antipoints is reduced, and that one way of obtaining small antipoints is by using large axial cones of illumination. The importance of being able to fill the back lens of the condenser is therefore manifest.

An apochromatic condenser should not be used in polariscope work, because the fluorite of which it is composed itself polarizes.

Rings and Brushes.

I have previously described* a method of investigating these by the apparatus supplied in an ordinary microscopical outfit, and therefore will, without repetition, merely point out that large cones of illumination are essential for the demonstration of wide angled biaxial crystals, and other allied phenomena. The substitution of tourmalines for Nicols is of much advantage, because the illuminating cones may be made as large as possible, and the size of the back lens of the objective on the nose-piece need not be restricted to the width of an analysing prism. The tourmalines are used in the same position as before, viz. one close to the chimney of the lamp, and the other in the cap over the eye-piece. The Zeiss large a^* objective is a convenient lens to use at the bottom of the draw-tube.

It is a pity that these interesting and very beautiful phenomena are not more generally studied. One meets microscopists who own perhaps more than one Microscope, with polariscopes fitted and all the necessary apparatus, and yet who have never seen a ring and brush.

The Measurement of W.R., W.A. and N.A.

While on the subject of improved methods of microscopical manipulation, attention might be directed to a most useful piece of apparatus, which hitherto has only been used in connection with a telescope. I allude to Ramsden's Dynamometer, two examples of which are shown in figs. 34 and 35.

The arrangement of the micrometer screw, as invented in 1639 by William Gascoigne, was very ingenious. On a pinion, which

* Journ. R.M.S., 1892, p. 683, fig. 81.

terminated in a drum-head, two threads were cut, one being twice the pitch of the other; if, for example, one screw gave one millimetre the other would give half a millimetre of movement for each complete revolution of the drum-head. There were two separate sliding plates, one, which we will call A, carried the other B, with it. The slow-speed screw was connected with the sliding plate A and moved it, together with the plate B, in a certain direction, at the rate of half a millimetre for a revolution, but the other screw was attached to the plate B, and moved it in an opposite direction at double the speed; the resultant of these motions being that the plates were either separated from, or brought to, a certain point at a uniform speed of half a millimetre for each revolution of the drum-head.

A similar action is now obtained by means of right and left-handed screws, but as such things were quite unknown in Gascoigne's time, one cannot help admiring the ingenuity of his invention.

Each plate carries the half of a biconvex lens, and by this simple device measurements of small intervals can be made with great accuracy; so also the diameter of the disc of light, seen in front of

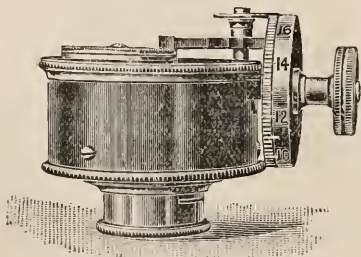

FIG. 34.

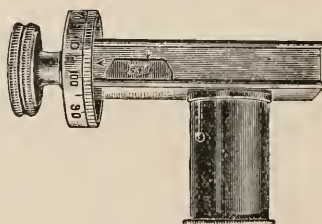

FIG. 35.

the eye-piece of either a telescope or a Microscope, commonly known as the Ramsden disc, can be readily determined.

This ingenious system of micrometry by means of a divided lens or two lenses is due to Savary in 1743, but Dollond in 1754 effected a substantial improvement by making the lenses move in the line of their section.

It appears then that Gascoigne invented the screw movement, and Dollond the divided lens, so it is not easy to see where Ramsden comes in; but he may have been, and probably was, the first to apply this form of micrometer to the measurement of the diameter of the emergent pencil of a telescope, for the purpose of finding its power; at any rate he made micrometers on this principle, and they were known as "Ramsden's Dynameters." These instruments are still made and sold by opticians who keep accessories for the telescope, but they are now called dynameters.

In fig. 34 complete revolutions of the drum-head are indicated on

the small dial seen at the top of the instrument at right angles to the drum, but in fig. 35 they are shown on the engraved plate which traverses across a fixed arrow-head.

Having described the instrument we will now pass on to its application for microscopical purposes. In the *Journal* for 1901, p. 243, it was pointed out that a dynamometer would be a very convenient, if costly, instrument for the determination of the Working Ratio or Aperture, and, on account of the expense, an alternative device was recommended. Experience has since shown that, while this alternative apparatus is quite suitable for the determination of the Working Ratio, it fails to measure the precise diameter of the back lens of the objective, because of the difficulty of finding the exact point when the back lens is in focus. But, by measuring with a dynamometer the diameter of the eye-discs, representing both the full aperture, and also that portion of it which is illuminated, not only can the Working Ratio be found, but the N.A. be determined as well.

In order to measure any interval by a dynamometer the constant of the instrument must first be found out: in other words, a tenth of an inch, or one millimetre, on a well divided scale must be measured, and all other measurements referred by proportion to this standard; thus, in one of the instruments in fig. 34 one-tenth of an inch requires five complete revolutions and $\frac{35}{100}$ of a revolution, which may be written as 5·35; then, if some other interval measured 3·8 revolutions, it would represent $\frac{3\cdot8 \times 0\cdot1}{5\cdot35}$ or 0·071 inch.

It should be mentioned that these instruments are supposed to read off in inches directly, but although several have been examined only a single one gave a correct reading; they mostly read too high. For instance, the drum-head in fig. 34 is divided into twenty primary divisions, so that the real reading in the observation above is not 5·35, but the double of this, or 10·70, which ought to have been 10·00, if the instrument indicated correctly.

By far the better plan is to disregard these readings altogether, and to find the constant of the instrument once for all, and apply it in the manner pointed out above. It will be noticed that in carrying out this idea, the drum-head in fig. 34 is read decimally, and not as it is engraved; thus 14 is read 7, 16 read 8; in brief, the reading on the drum-head is halved, and the complete revolutions left as they really are. The drum-head in fig. 35 is divided decimally, and one-tenth of an inch reads exactly five revolutions, or 500. The reading of these instruments is affected by myopia and presbyopia, therefore every observer should find out his own constant of the instrument.

If the Working Ratio be required the two dynamometer drum-head readings need not be converted into linear measure, as their

quotient is the Working Ratio; but in order to find the N.A. it is necessary to measure both the diameter of the eye-disc, corresponding to the entire back lens, in linear measure, and also to determine the magnifying power of the entire Microscope, either by projection, or by means of some convenient camera, the distance of the eye-disc to the paper, or screen, being 10 in. Then if B be the diameter of the back lens,* and e , that of the eye-disc for the full aperture, ϕ being the focal length of the entire Microscope, and f that of the object glass, M being the magnifying power of the entire Microscope at a projection distance of 10 in., and m the initial magnifying power of the objective. The following relations between these quantities will subsist:

$$M = \frac{10}{\phi}; \quad m = \frac{10}{f}; \quad \text{and } \frac{e}{B} = \frac{\phi}{f} = \frac{m}{M};$$

$$e = 2 \text{ N.A. } \phi; \quad \text{and } B = 2 \text{ N.A. } f; \quad \text{so N.A.} = \frac{M e}{20}.$$

The optical index = $\frac{50 M e}{m} = 50 B$.

All that is required, then, in order to find the N.A. is to multiply the magnifying power of the complete Microscope by the diameter of the eye-disc, corresponding to the full aperture, and divide the product by 20.

When the measurement of the eye-disc is made, it is important that the back lens of the objective be either filled with light by the substage condenser directly, or if, on account of insufficiency of aperture in the condenser, that cannot be done, indirectly, by dispersed light from a coarse diatom, or other suitable object, placed on the stage.

It therefore becomes a question of practical microscopy whether to purchase an Apertometer or a Dynamometer. As an Apertometer will only do the one thing, viz. measure the aperture of an object glass, the preference will probably be given to the Dynamometer, which, besides measuring the N.A., will measure either the Working Ratio, or Working Aperture, and also is useful for many other purposes.

The Measurement of the Focus of a Lens.

In the *Journal* for 1901, p. 126, a formula is given for finding the true focal length of any objective, by the help of a reciprocal table, *without calculation*, the magnifying power, at a projection distance of 100 in. from the micrometer to the screen, being known. Another method of accomplishing the same object may be of interest.

* In this article "Back lens" means of course the optical, and not the actual back lens; its diameter equals the Optical Index divided by 50.

Project a stage micrometer on to a screen at any convenient distance, measured from some part of the lens mount; determine the magnifying power, and call it M . Move the screen nearer the lens, and again measure its distance from the same point on the lens mount, and call the difference between these distances d ; determine the new magnifying power, and call it m ; then, the focal length is given by the formula

$$f = \frac{d}{M - m}.$$

During the operation the position of the lens must on no account be shifted. The distance the screen has been moved d , may with advantage be made 10 or 100, and then the result can be found in a reciprocal table, *without calculation*. This formula is a very convenient one, and the necessary measurements may be easily made when a photomicrographic outfit is available.

VI.—*Third List of New Rotifers since 1889.*

By CHARLES F. ROUSSELET, Curator and F.R.M.S.

IN continuation of my two previous lists published in this *Journal* in August 1893 and February 1897, I now submit a third list of 98 new names which have since been added to the literature of the Rotifera, and which brings the total number to 393 new names of Rotifers since Hudson and Gosse's Monograph was completed in 1889. I say new names advisedly, which does not mean new species, for out of the 98 in the present list no fewer than 38 can be identified as old species, and some of the others will ever remain unrecognisable.

It seems a great pity that authors should continue to burden science with so much dead weight, when a little more search and care in the identification would make their lists and work so much more useful. Mr. H. S. Jennings* has well expressed what should be the guiding idea for workers in this department, and his words deserve to be repeated here for the benefit of all. Mr. Jennings writes: "No one has a right to cumber scientific literature with the names of species 'presumably undescribed,' as a recent paper naively puts it, without recognising the fact that a vast volume of literature has appeared on the group since the publication of Hudson and Gosse's Monograph, including descriptions of many new species. The recognition and description of a new species must therefore be regarded as a most laborious piece of work, involving a careful examination of large numbers of papers in various languages, besides a consultation of Hudson and Gosse. There is no excuse for omitting such a study before publishing descriptions of species as new, in view of the full lists of new Rotifers published at intervals by Mr. C. F. Rousselet, with the titles of the papers in which the descriptions are published. If a student finds himself unable to see a large share of these papers, it is his duty to recognise the fact that he is not in a position to publish names of new species. If he wishes to publish his notes and drawings, these may be of great use to other workers; but if he proceeds to append new names to his descriptions, increasing the already heavy burden of synonymy, his work becomes a positive injury to science and a nuisance to all careful scientific students.—The publication of new species without a figure, which has been practised by some American authors, as well as by some of those of Europe, is greatly

* *Rotatoria of the United States* (108), 1900, p. 70.

to be deprecated. Usually the figure is the most important part of the account of a rotifer, and a description could, as a rule, be much better dispensed with than a good figure. To sum up, therefore, anyone who proposes to publish a description of a rotifer as new should fulfil the following conditions:—

1. Not only Hudson and Gosse's Monograph, but all subsequent papers containing descriptions of rotifers in any way related to the one in hand, should be consulted.

2. New species should not be described as a result of the discovery of some hitherto unmentioned anatomical detail in an otherwise known species.

3. Great care should be exercised not to describe as new species mere variations of an old species.

4. If any doubt can possibly exist, the figures and descriptions should be submitted, before publishing, to some expert who has all the literature at hand.

5. A description of a new species should be accompanied by a detailed comparison with any very closely related species that may exist, to show wherein this one differs, and why it is considered new.

6. Every description of a new species should be accompanied by a good figure or figures."

An excellent model of how the work of recording the fauna of a lake or a district should be done is furnished by Dr. E. F. Weber's 'Faune Rotatorienne du Bassin du Léman,' in which about 125 species, accurately described and beautifully figured, are recorded, but only one new species is named.

The time, surely, is past when new species of rotifers can be found wholesale in any lake, and with the publication of these lists, together with the titles of papers, the work of identification, always laborious, is rendered comparatively easy. I may add that I shall always be glad to assist in identifying sketches and descriptions of rotifers, or still better preserved specimens, that may be sent to me addressed to the Rooms of this Society at 20 Hanover Square, London, W., a task which is facilitated by my collection of slides of preserved Rotifera containing at present over 300 different species.

As before, the numbers behind each name in the subjoined list refer to the Bibliography at the end.

RHIZOTA.

- Melicerta flocculosa* Kellicot (109) (= ?*M. janus* Hudson).
" *fimbriata* Shephard and Strickland (122) (= ?*M. tubicolaria* Ehrbg.).
Lacinularia elliptica Shephard (120).
" *strolata* Shephard (121).
Megalotrocha binotata Daday (102) (= *M. semi-bullata* Thorpe).

Limnias nymphææ Stenroos (123).

Conochilus limneticus Stenroos (123) (= *C. unicornis* Rousselet).

New Genus.

Pseudœcistes rotifer Stenroos (123).

BDELLOIDA.

Philodina (?) *emini* Collin (101).

„ *parasitica* Marchoux (115).

Callidina *branchicola* Némec (117).

„ *brycei* Weber (127).

„ *cataracta* Lord (112).

„ *quadridens* Hilgendorf (107).

PLOÏMA. I. Pl-loricata.

Asplanchna papuana Daday (102) (= *Asplanchnopus myrmeleo* Ehrenbg.).

„ *brightwellii* var. *ceylonica* Daday (103).

Sacculus orbicularis Kellicot (109) (= *Gastropus stylifer* Imhof).

Synchæta neglecta Zacharias (130, 119) (= *S. oblonga* Ehrenbg.).

„ *cecilia* Rousselet (119).

„ *kitina* Rousselet (119).

„ *vorax* Rousselet (119).

„ *neapolitana* Rousselet (119).

Triarthra brachiata Rousselet (118).

Hydatina monops Hilgendorf (107) (= *H. senta* Ehrenbg.).*

Notops fennicus Stenroos (123) (= *Gastropus minor* Rousselet).

„ *pelagicus* Jennings (108).

„ *brachionus* var. *spinus* Rousselet (111).

Taphrocampa nitida Lord (112).

Pleurotrocha parasitica Jennings (108).

Notommata vorax Stokes (124) (= *N. torulosa* Dujardin).

„ *monostylæformis* Stenroos (123) (= *Monostyla bifurca* Bryce).

„ *pentophthalma* Hilgendorf (107).

Monommata appendiculata Stenroos (123).

Proales hyalina Stokes (124) (= *Cyrtonia tuba* Ehrenbg. Rousselet).

„ *algicola* Kellicot (109).

„ *mirabilis* Stenroos (123).

Furcularia trihamata Stenroos (123) (= *F. forficula* Ehrenbg.).

„ *macroductyla* Stenroos (123) (= ? *Diaschiza semi-aperta* Gosse).

Eosphora viridis Stenroos (123) (= *E. aurita* Ehrenbg.).

Diglena contorta Stokes (124) (= ? *Notommata forcipata* Ehrenbg.).

Diglena rostrata Dixon-Nuttall and Freeman (105).

Microcodides abbreviatus Stenroos (123) (= *M. robustus* Glas-cott).

New Genera.

Diarthra monostyla Daday (102).

Planoventer varicolor (?) Hilgendorf (107).

Postclausa circularis Hilgendorf (107) (= *Gastropus minor* Rousselet).

„ *minuta* Hilgendorf (107) (= *Gastropus minor* Rousselet).

PLÖIMA. II. Loricata.

Mastigocerca spinifera Stokes (124) (= *M. bicuspes* Pell).

„ *hamata* Zacharias (128) (= *M. setifera* Lauterborn).

„ *multicrinis* Kellicott (109).

„ *grandis* Stenroos (123) (= ? *M. elongata* Gosse).

„ *unidens* Stenroos (123) (= ? *M. scipio* Gosse).

„ *cuspidata* Stenroos (123) (= ? *M. scipio* Gosse).

„ *rosea* Stenroos (123) (= *M. bicornis* Ehrenbg.).

„ *flectocaudatus* Hilgendorf (107) (= *Cœlopus tenuior* Gosse).

„ *rectocaudatus* Hilgendorf (107) (= *M. lophoessa* Gosse) (or *M. mucosa*).

„ *birostris* Minkiewicz (116) (= *Rattulus bicornis* Western).

„ *hamata* var. *bologoënsis* Minkiewicz (116) (= *M. setifera* Lauterborn).

Cœlopus intermedius Stenroos (123).

„ *rousseleti* Voigt (126).

Dinocharis similis Stenroos (123).

„ *inornata* (?) Hilgendorf (107).

Stephanops tenellus Bryce (100).

Diaschiza taurocephalus Hilgendorf (107) (= *D. tenuior* Gosse).

„ *ventripes* Dixon-Nuttall (104).

Salpina macracantha var. *ceylonica* Daday (103).

Diplax ornata Daday (102).

Diplois sculpturata Daday (102) (= *Distyla ludwigii* Eckstein).

Euchlanis longicaudata Collin (101).

Cathypna scutaria Stokes (124).

„ *glandulosa* Stokes (124).

„ *flexilis* Stenroos (123).

„ *brachydactyla* Stenroos (123).

„ *magna* Stenroos (123) (= *C. ungulata* Gosse).

„ *macroductyla* Daday (103) (= *C. leontina* Turner).

„ *ligona* Dunlop (106).

- Distyla oxycauda* Stenroos (123) (= *D. ludwigii* Eckstein).
Monostyla incisa Daday (102).
 „ *bicornis* Daday (102).
 „ *pygmæa* Daday (102).
 „ *bicornis* Stenroos (123).
 „ *appendiculata* Skorikow (125) (= *M. lamellata* Daday).
Colurus gracilis Hilgendorf (107).
Metopidia quadricarinata Stenroos (123).
 „ *dactyliseta* Stenroos (123).
 „ *sulcata* Stenroos (123).
Pterodina emarginula Stenroos (123) (= ? *Pt. reflexa* Gosse).
Brachionus tetracanthus Collin (101) (= *Br. angularis* Gosse).
 „ *mirabilis* Daday (102).
 „ *papuanus* Daday (102) (= *Br. angularis* var. Gosse).
 „ *falcatus* Zacharias (129).
Ploesoma mollis Kellicot (105).
Noteus stuhlmanni Collin (101).
Anuræa cochlearis var. *macracantha* Lauterborn (113, 114).
 „ „ „ *hispidæ* Lauterborn (113, 114).
 „ „ „ *irregularis* Lauterborn (113, 114).
 „ *aculeata* var. *dumasi* Richard (131) (= *A. aculeata* var. *valga* Ehrenbg.).
Notholca regularis Hilgendorf (107) (= *N. scapha* Gosse).

New Genus.

- Tetramastix opoliensis* Zacharias (129).

BIBLIOGRAPHY.

N.B.—The works here enumerated contain the descriptions of the new Rotifers in preceding list, but they are not, and do not pretend to be, a complete list of papers on Rotifera in general that have appeared during the period covered by the list.

100. BRYCE, DAVID.—Contributions to the Non-Marine Fauna of Spitsbergen. Part II. Report on the Rotifera. Proc. of the Zool. Soc. of London, June 1897, pp. 793–799.
 101. COLLIN, ANTON.—Rotatorien, Gastrotrichen und Entozoen Ost-Afrikas, Berlin, 1897, 14 figs.
 102. DADAY, EUG. VON.—Rotatoria Novæ Guineæ. Math. Természettudományi értesítő, Budapest, 1897, pp. 131–148, 12 figs. in text.
 103. ——— Mikroskopische Süßwasserthiere aus Ceylon. Budapest, 1898, pp. 1–123, with figs.
 104. DIXON-NUTTALL, F. R.—On *Diaschiza ventripes*, a new Rotifer. Journ. Quekett Micr. Club, April 1901, vol. 8, pp. 25–28, pl. 2.

105. — and Rev. R. FREEMAN.—On *Diglena rostrata*, a new Rotifer. Journ. Quekett Micr. Club, April 1902, vol. 8, pp. 215-6, pl. 9.
106. DUNLOP, M. F.—On a new Rotifer: *Cathypna ligona*. Journ. Quekett Micr. Club, April 1901, vol. 8, pp. 29-32, pl. 2.
107. HILGENDORF, F. W.—A Contribution to the Study of the Rotifera of New Zealand. Transactions New Zealand Institute, vol. 31, 1898, pp. 107-134, 4 pls.
108. JENNINGS, H. S.—Rotatoria of the United States. U.S. Fish Commission, Bulletin for 1899, pp. 67-104, 9 pls.
109. KELLICOT, D. S.—The Rotifera of Sandusky Bay. Transactions of the American Micr. Soc., 1896, pp. 155-164.
110. — The Rotifera of Sandusky Bay. Second Paper. Transactions of the Amer. Micr. Soc., 1897, pp. 43-54, 3 figs.
111. KIRKMAN, THOS.—List of some of the Rotifera of Natal, with a note by C. F. Rousselet. Journ. Royal Micr. Soc., 1901, pp. 229-241, pl. 6.
112. LORD, J. E.—On two new Rotifers. Journ. Quekett Micr. Club, Nov. 1898, vol. 7, pp. 75-80, pl. 7.
113. LAUTERBORN, ROBERT.—Vorläufige Mittheilung über den Variationskreis von *Anuræa cochlearis*. Zool. Anz., No. 574, 1898, pp. 597-604.
114. — Der Formenkreis von *Anuræa cochlearis*. I. Theil. Verhandl. des Naturhist.-Medizin. Vereins zu Heidelberg, Bd. 6 (1900) pp. 412-448, 1 pl.
115. MARCHOUX, E.—Note sur un Rotifère vivant dans le tube digestif de larves aquatiques d'insectes. Compte Rendu Soc. Biol., 1898, tome 5, pp. 749-750.
116. MINKIEWICZ, R.—Petites études morphologiques sur le limno-plancton. Zool. Anz., Bd. 23 (1900) pp. 618-623, 3 figs.
117. NĚMEC, B.—O ectoparasitech *Ligidia*, a new Species of Rotifer, 1895, pp. 1-13, 1 pl.
118. ROUSSELET, C. F.—*Triarthra brachiata*, a new Species of Rotifer, &c. Journ. Quekett Micr. Club, Part Nov. 1901, vol. 8, pp. 143-5, pl. 8.
119. — A monographic Study of the Genus *Synchæta* with descriptions of four new species. Journ. Roy. Micr. Soc., 1902 (to be published in June-Aug.).
120. SHEPHARD, JOHN.—A new Rotifer: *Lacinularia elliptica*. Victorian Naturalist, Oct. 1897, 1 pl.
121. — A new Rotifer: *Lacinularia striolata*, with note on *L. pedunculata*. Proc. Royal Society of Victoria, Aug. 1899, vol. 12, pp. 20-35, pls. 3 to 5.
122. — and W. STRICKLAND.—A new Rotifer: *Melicerta fimbriata*. Victorian Naturalist, vol. 16, No. 3, July 1899, pp. 38-40, 1 pl.
123. STENROOS, K. E.—Das Thierleben im Nurmijärvi-See. Acta Societatis pro Fauna et Flora Fennica, Helsingfors, 1898, vol. 17, pp. 1-178, pls. 1-4.
124. STOKES, Dr. A. C.—Some New Forms of American Rotifers. II. Ann. and Mag. of Nat. Hist., London, June 1897, vol. 19, pp. 628-633, pl. 14.

125. SKOBKOW, A.—Ein neues Räderthier. *Zool. Anzeiger*, Bd. 21, No. 571, 24 Oct. 1898, 1 fig.
126. VOIGT, MAX.—Diagnosen bisher unbeschriebener Organismen aus Plöner Gewässern. *Zool. Anz.*, Bd. 25, No. 660, 30 Dec. 1901, pp. 35–39.
127. WEBER, Dr. E. F.—Faune Rotatorienne du Bassin du Léman. *Revue Suisse de Zoologie*, Genève, 1898.
128. ZACHARIAS, Dr. OTTO.—Forschungsberichte aus der Biol. Station zu Plön, Th. 5, 1897, pp. 8–9, 1 fig.
129. ——— Untersuchung über das Plankton der Teichgewässer. *Forschungsberichte aus d. Biol. Station zu Plön*, Th. 6, 1898, pp. 1–49, pl. 4.
130. ——— Ueber die im Süßwasserplankton vorkommenden Synchroneten. *Biol. Centralblatt*, Bd. 21, 1901, pp. 381–383.
131. RICHARD, JULES.—Sur quelques animaux inférieurs des eaux douces du Tonkin. *Mém. Soc. Zool. de France*, tome 7, 1894, pp. 237–243.



A. W. BENNETT.

OBITUARY.

A. W. BENNETT,

Biographical Memoir of, by J. G. BAKER, F.R.S.

ALFRED WILLIAM BENNETT was born at Clapham on the 24th of June, 1833. His father, William Bennett, a man of great energy and originality, retired from business as a wholesale tea-dealer at an unusually early age. He was a friend of Edward Newman and of Edward and Henry Doubleday, and was much interested in both botany and entomology, so that his children were brought up in a natural history atmosphere. His mother was a great friend of Mary Howitt. His father was greatly interested in education, and visited Switzerland to confer with Pestalozzi's favourite pupil upon the subject, and also went to America to consult Emerson. During the winter of 1841-1842 the whole family spent several months at a Pestalozzian educational establishment in Canton Appenzell, where Alfred obtained the first rudiments of that knowledge of German which he afterwards turned to such good account as a translator of German botanical works. With this exception, his early education was entirely conducted at home. In 1851 the family removed to Brockham, a village which is in a valley at the foot of the chalk downs midway between Reigate and Dorking. Here they had a large garden, and William Bennett interested himself in rearing and breeding emus, which he kept to the third generation.

From 1851-1854, in company with his father and elder brother, Edward Trusted Bennett, he made several long walking tours in Wales and the West of England. The observations they made will be found in various notes and papers scattered through the earlier series of the *Phytologist*, written sometimes by one and at another time by others of the trio. They principally refer to Wales, Cornwall, Hampshire, and Herefordshire. In one of them will be found a list of Welsh ferns, arranged according to their frequency; in another, the account of how the day after visiting the Sussex locality for *Leersia oryzoides*, which had just been added to the British flora by Mr. Borrer, Alfred walked across the bridge that spans the river Mole just outside the garden, and saw abundance of the new grass on the banks of the stream around him. On a trip, a few years

earlier, to the English Lakes they called on the poet Wordsworth, who took them a walk up the slope of Fairfield, and showed them *Silene acaulis* in flower. Alfred Bennett attended the classes at University College, London, and took his M.A. degree about 1856, and his B.Sc. some years afterwards. After leaving college he acted as tutor for a short time to Gurney Barclay, the banker, and whilst there was thrown from his horse and sustained injuries which left him an inheritance of insomnia from which he suffered all his life. In 1858 he married Katharine, the daughter of Wm. Richardson, of Sunderland, and in the same year entered into business as a bookseller and publisher in Bishopsgate Street, E.C. He was one of the first publishers who used photography in the illustration of books. I remember specially a pretty little volume on the Abbeys of Yorkshire with photographic views of each of them. At this period he was both proprietor and editor of the *Friend*, then a monthly, now a weekly journal, specially devoted to matters interesting to the Society of Friends, of which he was through life a member. He published the early poems of the poet-botanist, the Hon. J. Leicester Warren, afterwards Lord De Tabley. He gave up business about 1868, and in that year became a Fellow of the Linnean Society. Up to the time of his death he was one of the most regular attenders of the meetings of that Society, took part frequently in the discussions, and served more than once as a member of the council and vice-president. He took great interest in the higher education of women, and in 1869 he and his wife opened their house in Park Village East, near the Gloucester Gate of the Regent's Park, as a home for a limited number of ladies who came up to London to attend classes at the Bedford College and elsewhere.

From 1871 to 1873 he wrote several papers on flower-fertilisation and kindred subjects. A list of nineteen papers written at this time will be found in the second series of the catalogue of scientific papers published by the Royal Society. The best known are his 'Observations on Protandry and Protogyny in British Plants' (*Journal of Botany*, vol. viii. p. 315), and his paper on the fertilisation of *Parnassia* in the *Journal of the Linnean Society*, vol. xi. p. 24. These papers brought him the acquaintance of Charles Darwin, who encouraged him with characteristic kindness. About 1870 he began his studies on the Polygalaceæ, of which he contributed a synopsis of the Indian species to Sir J. D. Hooker's 'Flora of British India,' and of the far more numerous Brazilian species to the great 'Flora Brasiliensis,' published at the expense of the Brazilian Government, and edited in succession by Endlicher, Von Martius, Eichler and Urban. In 1873 his father died. About 1875 Alfred Bennett and the writer took a long walking tour together in Switzerland. We visited Chamounix, Zermatt, and the Bernese Oberland, and although it was rather late in the year, we identified two hundred species of Phanerogams which neither of us had seen in a living state before.

In 1875, with the effectual aid of Mr., now Sir William Thiselton-Dyer, he translated into English for the Oxford University press Sachs' great 'Text-book of Botany.' This book had a most important effect on the teaching of botany in England, turning it away from lectures on organography and systematic botany illustrated by wall-diagrams to laboratory courses on anatomy and physiology. In 1877 he translated and annotated a smaller German book, Thomé's 'Structural and Physiological Botany,' of which a new edition was called for in 1885. In 1882 he translated Dalla Torre's 'Tourists' Guide to the Flora of the Austrian Alps,' and between 1880 and 1882 edited, for Messrs. Swan, Sonnenschein & Co., an English edition of Seboth's beautiful coloured figures of Alpine plants, four volumes, with 100 plates in each. About this time he turned his attention to the study of fresh-water Algæ, on which his principal publications were a new classification of the genera, published in the 34th volume of the Journal of the Linnean Society, and one on the London fresh-water Algæ and their localities, in the Journal of the Microscopical Society. In 1889 he published, in conjunction with Mr. George Murray, F.R.S., a 'Text-book of Cryptogamic Botany.' This is probably his most valuable original work. It has been largely used by teachers and advanced students, both in England and America. He revised, for Dr. Masters, F.R.S., the chapter on the Cryptogamia for his fourth edition of Henfrey's 'Elementary Course.' In 1897 he published a 'Flora of the Alps,' in two volumes, with coloured plates of the genera and short descriptions of all the species. For many years he held the office of Lecturer on Botany to St. Thomas's Hospital and the Bedford College. He was an excellent and painstaking teacher, and a careful examiner. For about four years he acted as biological sub-editor of *Nature*, under Sir J. Norman Lockyer, and from the beginning of the *Academy* acted as its botanical reviewer and notice-writer. He joined the Royal Microscopical Society in 1879, and from that date till his death, wrote the summaries of botanical papers contained in its Journal. For many years he served on the Council, was several times a Vice-President, and from 1897 till 1902, editor of the Journal of this Society. He was from the commencement a member of the Saville Club, and frequently spent his evenings there. His death was painfully sudden. He was riding home from his club on the top of an omnibus, and when the omnibus reached Oxford Circus he fell on to the driver's shoulders, and died before he could be lifted down to the ground. A post-mortem examination revealed extensive disease of the heart. He was buried on Tuesday, January 28th, 1902, in the Friends' Cemetery at Isleworth. His wife died a few years ago, and they had no children.

THOMAS COMBER,

Born Nov. 14, 1837. Died Jan. 24, 1902.

THOMAS COMBER, the eldest son of the late Edward Comber, of Myddleton Hall, Warrington, Lancashire, was born at Pernambuco, Brazil, and was educated at Whitchurch, Salop. Early in life he entered on a commercial career and spent several years in India. As a merchant in Liverpool and Manchester he was well known and much respected, and was a director of several public companies. A pamphlet by him on the silver question created considerable sensation, and was generally recognised as a valuable addition to the literature of that subject. He resided at Leighton, Parkgate, near Chester, was a staunch Conservative in politics, and was a J.P. for the counties of Lancashire and Cheshire. He retired from business about two years ago.

Always fond of scientific pursuits, Mr. Comber early took to the study of Microscopy, but afterwards abandoned it temporarily for that of botany, a subject on which he wrote many interesting papers. He subsequently resumed his microscopical investigations, devoting himself more particularly to the study of the Diatomaceæ, on which he was a recognised authority.

Mr. Comber was a Fellow of the Linnæan and Royal Microscopical Societies. This Society he joined in 1893, and for some years served on the Council, where his advice was much appreciated. He was specially consulted in reference to questions arising in connection with Diatomaceæ, not only by the Council of the Society, but also by the authorities of the British Museum.—JOHN COMBER.

The following is a list of papers by the late Thomas Comber, F.R.M.S., F.L.S. :—

On the Diatomaceæ of the neighbourhood of Liverpool. Quarterly Journ. Mic. Sci., vol. viii. (1860) p. 111. Read before Historic Society of Lancashire and Cheshire (Dec. 1858).

On a simple form of Heliostat. J.R.M.S., 1890, p. 429, figs. 47-9.

Photomicrography. J.R.M.S., 1891, p. 407. Abstract from Journ. Liverpool Mic. Soc., 1891, pp. 99-110.

On the Unreliability of certain Characters generally accepted for Specific Diagnosis in the Diatomaceæ. J.R.M.S., 1894, p. 428.

Development of the Young Valve of *Trachyneis aspera* Cleve. J.R.M.S., 1895, p. 400, plate VIII. (photo).

On the Occurrence of Endocysts in the Genus *Thalassiosira*. J.R.M.S., 1896, p. 489, plate IX. (photo).

The Limits of Species in the Diatomaceæ. J.R.M.S., 1897, pp. 455-466.

SUMMARY OF CURRENT RESEARCHES
RELATING TO
ZOOLOGY AND BOTANY
(PRINCIPALLY INVERTEBRATA AND CRYPTOGRAMIA),
MICROSCOPY ETC.*

ZOOLOGY.

VERTEBRATA.

a. Embryology. †

Monochorial Twins. †—A. Rosner discusses the numerous theories as to the origin of monochorial twins in man, and comes to the conclusion that they arise from a bi-ovular Graafian follicle, whose two ova, liberated together and normally fertilised, are borne to the uterus united by some cells of the discus proligerus, and become surrounded by a common caduca (decidua capsularis, seu reflexa). The chorionic areas which are in contact and form the partition between the two developing ova may disappear, simply because they are not in immediate touch with the nutritive caduca. In other words, the single chorion is the result of the coalescence of two chorions in consequence of deficient local nutrition in the chorionic areas which are in contact.

It occurred to Rosner that some secure basis for interpretation might be obtained by a study of two well-known mammals, which *habitually* produce monochorial twin, or rather multiple foetuses. These are two armadillos—*Praopus hybridus*, § studied by von Ihering, and *Dasyppus novemcinctus*, § studied by Kölliker, Milne Edwards, Dugès, and von Ihering. The first has usually eight foetuses, always of the same sex, and with a common chorion; the second has four within a common chorion, and also, according to von Ihering, of similar sex. Now, by sectioning the ovaries of *Dasyppus*, Rosner found that many of the Graafian follicles are pluri-ovular. Out of 52 follicles, 22 contained more than one ovum; of these, 11 had 2; 7 had 3; 2 had 4; 1 had 5; and 1 had 7. The two most developed contained four each, i.e. the number usually found within one chorion in the pregnant female.

As the primordial follicles in the ovary of *Dasyppus*, whether foetal

* The Society are not intended to be denoted by the editorial "we," and they do not hold themselves responsible for the views of the authors of the papers noted, nor for any claim to novelty or otherwise made by them. The object of this part of the Journal is to present a summary of the papers as *actually published*, and to describe and illustrate Instruments, Apparatus, &c., which are either new or have not been previously described in this country.

† This section includes not only papers relating to Embryology properly so called, but also those dealing with Evolution, Development, Reproduction, and allied subjects.

‡ Bull. Internat. Acad. Sci. Cracovie, No. 8, Nov. 1901, pp. 443-50 (1 pl.).

§ We keep to Rosner's terminology.

or adult, contain only one ovum, the question naturally arises, how do the pluri-ovular follicles originate? Rosner's sections suggest the answer, that several follicles fuse within the ovary. The whole process may now be summed up,—several primordial follicles fuse, a pluri-ovular follicle results, each of the contained ova is normally fertilised, each develops with a chorion of its own, but within the investment of the caduca the chorionic partitions are dissolved till only one chorion is left surrounding all the fœtuses, in this case usually four in number. That the mono-chorial fœtuses should always be of the same sex is interpretable as due to the similarity of environing conditions, from the Graafian follicle onwards.

If the evidence from armadillo to man be admitted as cogent, we may venture to conclude that mono-chorial human twins start from a bi-ovular Graafian follicle, whose two ova, normally fertilised, find lodgment within one caduca-investment and develop within one chorion formed from the fusion of two.

Origin of Blood-Vessels.*—Prof. R. S. Bergh outlines a theory as to the phylogenetic origin of the blood-vessels from a foundation of contractile cells. The full argument is promised at an early date.

A study of the vascular system of Vertebrates leads one to give prominence to the internal epithelium (so-called endothelium), which is present in all the blood-vessels and in the heart, is the sole component of the capillaries, and appears in development before other parts of the vessels. Is it the *Urgewebe*? A negative answer is suggested by a study of Invertebrates, where endothelium in the main vessels is conspicuous by its absence. Only in the small vessels is a true internal epithelium demonstrable.

Bergh supposes that canals were formed in the primitive body-cavity with contractile walls, that the contractility became afterwards localised to definite regions of the canal system, and that in the parts where contractile elements disappeared a new tissue—the endothelium—was differentiated, especially where active exchange of substances between the blood and the tissues occurred. This endothelium—regulating exchange—was at first perfected peripherally, and its centripetal extension was secondary.

Influences of Injections into the Albumen of Fowls' Eggs.†—Prof. W. Schimkewitsch gives a preliminary account of the strange changes induced by injecting solutions of sugar, salt, &c., into the albumen of the developing egg of the hen. The list includes blastodermic discs which show a syncytium of cells and yolk-spherules, unequal growth, imperfect development, complete inhibition of development, deformations, dwarfings, local enlargements, asymmetry, and so on. But we must await the more detailed description with figures and interpretations which the author promises to publish shortly.

Cell-division and Mitosis.‡—Prof. M. Nussbaum discusses some of the debated points connected with the division of cells and of nuclei, giving an account of his own observations on the segmentation of living and

* Anat. Anzeig., xx. (1902) pp. 488-92.

† Tom. cit. pp. 507-10.

‡ Arch. Mikr. Anat., lix. (1902) pp. 647-84 (2 pls. and 1 fig.).

preserved eggs of *Rhabditis nigrovenosa* and *Ascaris megalocephala*. In the first place he discusses the form of nucleus called mulberry-shaped or polymorphic, and shows that the appearance of this shape may precede either mitotic or amitotic division. In *Ascaris megalocephala*, again, the nuclei of the first two blastomeres, as shown by Boveri, are unlike. The author calls one of these blastomeres the primitive somatic-cell, and the other the primitive sex-cell, from the structures to which they ultimately give rise, and follows in detail the differences between their respective nuclei and those of their respective daughter-cells. The result is to show how important are these differences, for while the cells which yield the future body contain in their nuclei numerous small, rounded chromosomes, those of the cells yielding the future gonads, retain the large horse-shoe-shaped chromosomes of the egg. In other words, there is a diminution in the amount of chromatin in the somatic cells as compared with the sex-cells.

Germinal Vesicle of Reptiles.*—Marie Loyez describes some of the changes in the nucleus of the ovarian ovum of *Platydictylus muralis*, *Lacerta muralis* and *viridis*, and *Anguis fragilis*, and finds that while the chromosomes change as to form, number, and staining reactions, they never disappear. During the early changes, the nucleoli become more and more conspicuous as the chromosomes become less dominant, but there was no evidence of nucleoli being transformed into chromosomes, or *vice versa*. Indeed, the staining reactions of chromosomes and nucleoli remained distinct throughout. It is concluded that the nucleoli are in some way essential to the activity of the germinal vesicle during the period of vitellus-formation.

Rheotactic Properties of Spermatozoa.†—F. Battelli, by means of an ingenious little piece of apparatus, has experimented on the effect of currents on spermatozoa. He employed for the experiment the sperms of the guinea-pig in a nutritive solution, and with the spermatic fluid so produced filled a glass tube with an internal diameter of $\frac{1}{4}$ mm. This tube had ampullæ blown on it, and by heating the air in these the author was enabled to produce currents of varying intensity in the fluid. He found that active spermatozoa swim *against* and not with a current, directing their heads in the direction opposite to that in which the stream is moving. This is important, for it explains how they are able to pass up the oviducts of the female in spite of the downward current which the cilia of the latter must produce; this downward current probably indeed promotes instead of hindering, as might be supposed, the upward movement.

Function of Sertoli's Cells.‡—G. Loisel has been led to conclude that Sertoli's cells in the testes are derived from germinative cells, and that their rôle is to secrete periodically a substance which exerts a positive chemotactic influence on the spermatozoa in process of development. Through this influence the spermatozoa acquire the special form which is so well adapted to their function. To this influence is due the disposition of the spermatozoa in bundles uniformly arranged.

* Comptes Rendus, cxxxiii. (1901) pp. 1025-6.

† Arch. Sci. Phys. Nat. Genève, xii. (1901) pp. 650-2.

‡ Comptes Rendus, cxxxiii. (1901) pp. 895-7.

Movements of Spermatids and their Parts.*—Dr. Ivar Broman has especially studied the spermatids in the dogfish and in man. Not only the spermatids, but their more important cellular parts—to wit nucleus, central corpuscle, and idiozom—exhibit regular movements, probably in response to various directive stimuli. Thus, the union of human spermatids with Sertoli's cells is probably trophotactic; the immigration of the central corpuscles to the nucleus is a positive (perhaps polar) karyotaxis; the central corpuscle exerts an attraction on the nucleus (positive microcentrotaxis!); and so on. But the whole research leads one into a somewhat rarefied atmosphere, in which tactic and tropic phenomena are abundant—so abundant that the intruding reviewer cannot but gasp. It is certain, however, that the author discloses an intricacy of vital movement more complex than has been hitherto recognised.

Tetrads in Spermatogenesis.†—S. Prowazek has continued by means of *Astacus*, his work on this subject done previously on material obtained from *Helix* and the rhinoceros beetle. As his new results complement his previous ones, he gives figures showing the homologous stages in the three types, and sums up his conclusions as follows:—The chromatin first undergoes a division into fine dust-like particles, but this stage is absent in the rhinoceros beetle; it then forms a number of irregular islands, from which the double chromosomes then develop; from these double chromosomes the tetrads are formed. In *Astacus* the mitochondria are unusually well-developed, and their behaviour shows that they belong to the group of genetic or formative granulations, as distinct from ergastic or functional granulations.

Development of Teeth in *Sus domestica*.‡—Dr. A. Bild finds that the deciduous incisors are better developed in pig-embryos in the upper than in the lower jaw, in which they are squeezed together. As to prelacteal rudiments in the upper jaw, Id_1 has none, Id_2 has one which has a very brief existence, early fusing with the tooth-rudiment, while in connection with Id_3 in the same jaw there is a fairly well-developed prelacteal epithelial-ridge which does not unite with the tooth-germ. The thickening described by Adolf as a germ of a fourth incisor was very plainly seen, and is due to the fusion of a prelacteal epithelial-ridge with the dental ridge. The deciduous canine of the upper jaw has connected with it a very well-marked prelacteal rudiment. In the lower jaw all the deciduous incisors and the canine have prelacteal germs connected with them, that of Id_2 being the best developed. The deciduous molars have also prelacteal germs both in the upper and lower jaws, and these fuse with the lacteal tooth-germs. Behind the last deciduous molar both in the upper and lower jaw, the author finds a prelacteal epithelial ridge which fuses with the tooth-ridge. The author entirely contests the views of Wilson and Hill that this epithelial ridge is the rudiment of the lip-furrow, and describes the development of the lip-furrow which he regards as independent of the dental ridge. Further, he believes that the tooth described by Wilson and Hill as the first molar is really the last pre-molar. The author is of opinion that his

* Arch. f. Mikr. Anat., lix. (1901) pp. 106-43 (59 figs.).

† Zool. Anzeig., xxv. (1901) pp. 27-9 (16 figs.).

‡ Anat. Anzeig., xx. (1902) pp. 401-10 (12 figs.).

results remove the concrecence theory from the region of hypothesis to that of proved fact.

Chondrocranium of *Cercopithecus cynomolgus*.*—Dr. Eugen Fischer describes the primordial brain-case in an embryo of this monkey of 25 mm. in length, and points out the close general resemblance to that of man. A point of much interest is the fact that the nasal surface is of conspicuous breadth, especially at the root. The interest of this fact is that it confirms the hypothesis of Schwalbe, that man and the monkeys are both descended from an ancestor with a broad interorbital septum, and that this has persisted in man, and undergone reduction in the monkeys, especially in the Catarrhine forms. Now the monkey investigated has in adult life a singularly narrow interorbital septum, but in the embryo it is as wide as in a human embryo, so that the embryo affords a striking confirmation of Schwalbe's view.

Epithelium of Epididymis in Mammals.†—Albert Aigner has examined the epididymis from recently killed animals in the case of a number of common mammals. He finds that in the ductuli efferentes the activity of the cilia is so great as to produce a constant current, driving onwards the mass of sperms contained in the ducts; the sperms do not here display movements of their own. In the ductus epididymidis, on the other hand, no ciliary movement could be made out; here the sperms are themselves actively motile. Histological examination shows in both cases what appear to be cilia on the cells, but in the ductus epididymidis basal swellings are absent in connection with the "cilia," and the cells show a tendency to replace this resting tuft of "cilia" by a structureless process. These conditions the author explains as follows:—In the ductuli efferentes both ciliated cells and gland-cells are present, but in the ductus epididymidis only gland-cells, and the so-called cilia of these cells are so modified by the secretion poured out by the cells that they become irregular processes, incapable of movement. The author believes that the "cilia," so-called, of these cells are not true cilia at all, but are analogous to the cell-prolongations described elsewhere in gland-cells. A search for gland-cells shows that in rabbit, horse, cat, and rat certain cells of the ductuli efferentes display clear signs of secretory activity, but the author is unable to believe that these same cells may also display active cilia. In the ductus epididymidis patches of secretory cells are quite distinct. The general result is thus to emphasise the difference between the ductuli efferentes and the ductus epididymidis.

Development of Ear in Man.‡—Dr. Aug. Hammar publishes a paper on the structures which develop in connection with the first visceral cleft, as the first of a series upon the development of the fore-gut, and the organs connected with it. He finds that the fossa conchæ arises from a deepening of the ventral part of the first gill-cleft. The fossa then becomes divided into three regions, a deep median, the *cavitas conchæ*, a lower, the *incisura intertragica*, and a superior, the *cyma conchæ*. The primary auditory meatus arises in the later part of the

* *Anat. Anzeig.*, xx. (1902) pp. 410-7 (1 fig.).

† *SB. k. Akad. Wiss. Wien*, cix. (1900) pp. 555-81 (2 pls.).

‡ *Arch. Mikr. Anat.*, lix. (1902) pp. 471-628 (4 pls.).

second month as a hollow, somewhat funnel-shaped tube from the future cavitas conchæ. From this primary auditory meatus there arises, in the beginning of the third month, an epithelial plate, the lamina epithelialis meatus. This becomes differentiated into a tympanic and a non-tympanic part, and in the seventh month splits into two layers. The cavity so produced forms the final or secondary meatus, the primary one corresponding chiefly to the cartilaginous part of the permanent structure. The bony and cartilaginous parts of the meatus differ from one another as regards their epithelial lining, that of the former region being without hairs and glands, while the latter possesses these. From the time of the first appearance of the primary auditory meatus its inner end is evaginated in the form of a rounded projection, the tuberculum membranæ tympani, which ultimately forms the membrana propria of the tympanic membrane.

Development of Iris in Man.*—A. Szili gives a preliminary account of his researches on this subject. The most important point shown by his preparations is that in man the musculus sphincter iridis is an epithelial muscle, and arises at the beginning of the fourth month out of the epithelial cells at the line of junction of the outer and inner layers of cells in the secondary optic vesicle.

Alleged Case of Transmission of Acquired Characters.†—Prof. W. Leche describes the thick, horny, hairless callosities on the carpals of *Phacocheerus africanus*, and interprets them as directly induced by the way in which these hogs rout about for roots and tubers. They get down on their knees (carpal-joints) and press forwards as they dig with their upper canines. The fact that the callosities are distinctly seen in the embryos leads the author to conclude that we have here to do with a case of the transmission of an acquired character. [It is, however, an unproved assumption that the callosities were, to begin with, somatic modifications.] Leche also refers to the molars of the dugong, which have tubercles in the embryo that undergo apical absorption and become flat before any chewing has begun.

Copulation of Bats.‡—G. Salvi describes his observations on the bats inhabiting the "grotta dell' Inferno," near Sassari, and shows, if we rightly understand his point, that copulation often occurs in spring, though the autumnal pairing is undoubted. Out of 479 individuals, 341 were males and 138 were females, and there seemed clear evidence of vernal sexual union.

Olfactory Organ in Vertebrates.§—Prof. H. Strasser, following His, points out how much the characteristic appearance of the different vertebrates depends upon the degree of development of the structures related to the olfactory organ, and discusses the significance of the great development of these parts in the higher vertebrates. In the first place, he rejects the idea that the complex nature of the skeleton of the nose in e.g. mammals, is to be ascribed to the needs of the olfactory organ itself, and also doubts the validity of the suggestion that this

* Anat. Anzeig., xx. (1902) pp. 161-75 (6 figs.).

† Biol. Centralbl., xxii. (1902) pp. 79-82 (1 fig.).

‡ Atti Soc. Sci. Nat., xiii. (1902) pp. 239-41.

§ Arch. Sci. Phys. Nat. Genève, xii. (1901) pp. 609-22.

complexity is due to the necessity for providing space for the sinuses and accessory cavities. He does not regard these cavities as of prime importance, and believes that they, like the surrounding bones, owe their form in the first instance to the necessity for providing adequate space for the teeth, the muscles, jaws, eyes, and brain. He illustrates and enforces his view by giving some account of the development of the nasal cavities.

Development of Pancreas in Amniota.* — Dr. Völker has studied this in *Lacerta agilis*, *Spermophilus citillus*, and the pig. In regard to the lizard, he corroborates and amplifies the observations of Janošik. The pancreas arises as a simple diverticulum of the dorsal enteric wall more distal than the primordium of the liver; it becomes secondarily connected with the rudimentary ductus choledochus; from this pancreatic duct the proximal pancreas arises, and the connection is never lost; the diverticula which Brachet described in *Lacerta muralis* as appearing on both sides of the ductus choledochus, between the opening of the ductus hepato-entericus and the ductus cysticus, which he regarded as pancreatic primordia, unite in *Lacerta agilis* with the hepatic tissue, and form right and left ductus choledochohepatici; these canals take the place of the ductus hepato-entericus, which eventually atrophies. It remains clear that in the lizard the whole pancreas is formed from the dorsal primordium.

In Mammals, likewise, the dorsal pancreas is the constant structure. In pig embryos there is added to this another portion which takes its origin from the ductus choledochus, but this fades into the dorsal pancreas and its duct atrophies, though there may be occasional instances of persistence. In the embryos of *Spermophilus citillus*, the only part developed is the dorsal pancreas, which arises directly from the dorsal enteric wall.

Development of Mid-brain in Bony Fish.† — D. Pedašchenko finds that in the embryos of various Teleosts the mid-brain is distinctly segmented at an early stage. This segmentation is most distinct in *Zoarces viviparus*, in which he has studied it in detail. The segmentation is only obvious on the inner wall of the roof of the mid-brain, and the author does not discuss its relation to the segmentation of the head. The roof of the mid-brain at an early stage becomes so marked with furrows internally as to produce rows of polygonal projections or columns. The maximum number of segments, as defined by the cross-furrows, appears to be six, and as each row contains 3-4 columns, there are 20-24 of these. Later the columns increase enormously in number, and become smaller in size, for the new columns arise by divisions of the old ones. The subsequent disappearance of the columns is accompanied by the formation of bundles of fibres connecting the floor and roof of the mid-brain together. This precedes the growing together of floor and roof, and the consequent obliteration of the medullary cavity, except in the extreme posterior region of the mid-brain. The author proposes on another occasion to discuss the theoretical significance of these facts.

* Arch. Mikr. Anat., lix. (1901) pp. 62-93 (21 figs.).

† Tom. cit., pp. 295-314 (3 pls. and 4 figs.).

Yolk-organ of *Salmo fario*.*—Dr. Siegmund v. Schumacher points out that in spite of the numerous researches on the embryology of bony fish, little is known of the absorption of the yolk-sac, and he has studied this process in the river trout. As is well known, in the trout the communication between the gut and the yolk-sac is early obliterated. At the time of hatching the yolk-sac consists of the following parts: in the centre an almost homogeneous mass of yolk; round this a layer containing yolk-spheres and prolongations of the protoplasmic sheath^h, which surrounds the median layer on its outer side; these three layers constitute the yolk. Outside the yolk is an endothelial layer, which is the splanchnopleure, and is separated by a narrow coelomic cavity from the somatopleure and body-wall. At the time of hatching the protoplasmic layer of yolk contains oval yolk-nuclei, constituting a yolk syncytium; at a later stage these have disappeared, and their place is occupied by bodies of irregular shape, which give the staining reactions of nuclei, but are not parablasts or merocyte nuclei, but are remnants of degenerating vitelline vessels, and finally break down and disappear. The author ascribes considerable importance to the protoplasmic layer as an agent in yolk-absorption, both in the earlier and in the later stages, but believes that the peritoneal epithelium of the yolk-sac is also of importance in this respect.

Development of *Galeus antarcticus*.† — Edgar R. Waite has been able to make some observations on embryos of this fish. As was shown by the late Prof. T. J. Parker, the embryos lie in separate compartments of the uterus, enveloped in membranes which, though of maternal and not foetal origin, foreshadow the chorion and amnion of higher forms. It now appears that these membranes are produced by the shell-gland, and are to be regarded as vestigial shells. The shell-gland itself is of somewhat remarkable shape. In the young fœtus the yolk-sac is also highly peculiar, the cord being very long, and the sac itself elongated. An examination of the chambers of the uterus shows that this shape is determined by the space at the disposal of the fœtus.

Life-history of *Clupea sprattus*.‡—Guido Schneider remarks that it has been long maintained that the sprat does not lay eggs in the eastern regions of the Baltic, but migrates westward before becoming ripe. So long ago as 1894 he found ripe sprats in the Gulf of Finland, but this did not prove that the eggs are capable of fertilisation and development in water of such low salinity as that of this bay. Later the author found pelagic Clupoid eggs which, from their size, he hesitated to ascribe to the sprat. Subsequent captures have, however, shown that the developing eggs in this region differ from the unfertilised and from those found in the North Sea, in that they have a greatly developed perivitelline space. This increases the bulk of the egg and lowers the specific gravity, so that it is an adaptation to life in water of low salinity. The larvæ have similarly a large yolk-sac, which enables them to float in water in which herring larvæ would sink.

* SB. k. Akad. Wiss. Wien, cix. (1900) pp. 675-99 (1 pl.).

† Records of Australian Museum, Sydney, iv. (1902) pp. 175-8 (1 fig.).

‡ Zool. Anzeig., xxv. (1901) pp. 9-11.

Young of Montagu's Blenny.*—L. W. Byrne has notes on some young forms of *Blennius galerita*, captured on the north coast of Cornwall. Emery's description seems the only previous one. They were caught in sandy pools, surrounding or surrounded by rocks, in the shelter of which they seemed to be fond of lying. When disturbed, they darted with considerable rapidity from place to place, seemingly assisted by the large pectoral fins which were carried nearly at right angles to the body when at rest. There was a remarkable amount of individual variation. The presence of the interorbital "helmet" (a single broadish leaf-like tentacle, followed by several smaller ones), taken in conjunction with their comparatively small size and radial formula, seems to be diagnostic from a length of 15.5 mm. (including caudal fin) upwards.

As in *B. pholis* and *B. ocellaris*, the size and dark pigmentation of the pectoral fins increase until a certain stage of growth is reached, after which they gradually assume the form and coloration of the adult. It may be that these large and darkly pigmented accessory organs serve to divert the attacks of enemies from a defenceless but almost transparent larval fish during the pelagic stage of its existence, and this theory is, to a certain extent, borne out by the fact that the decrease in size and loss of pigment would appear in *Blennius* to coincide to some extent with the adoption of the habits and colours of the adult.

Life-history and Young Stages of the "Fat-Fish" of Lake Baikal.†—B. Dybowski gives an account of *Comephorus baicalensis*, which is restricted to Lake Baikal. It is, according to the author, one of the Cottidæ—adapted to abyssal life. It is delicate, whitish, fatty, translucent, with no pelvic fins, with protruding eyes, living at depths of 700–1500 metres. The specimens found near the coast are all females, and are either moribund or dead. From November onwards the females seek the shores to liberate their young, but the males seem to remain in the depths.

It seems as if all the females died after reproducing, and Dybowski thinks that this is a primitive peculiarity, seen also in *Gasterosteus chachalza* (Kamtschatka), *Phoxinus perenurus* Pall. var. *jacuticus* Dyb. (Siberia), *Phoxinus laevis* (East Galicia), eels, and lampreys.

In some uterine ova the young forms were already apparent, twisted in a spiral; and the author was on one occasion fortunate enough to come across a swarm of young swimming freely near the surface. The members of the swarm measured 17–18 mm.; they were reddish-white and silvery, the eyes were black, the visceral region was short, the caudal region was very long, and the pectorals were relatively smaller than in the adults.

b. Histology.

So-called Germinative Cells in Medullary Canal of Man.‡—Dr. E. Giglio-Tos recalls the conclusion of His that two kinds of cells are found in early stages in the wall of the medullary canal,—(a) epithelial cells which are transformed into spongioblasts, and (b) the germinative

* Journ. Mar. Biol. Ass., vi. (1902) pp. 383–6.

† Kosmos (Lemberg), xxvi. (1901) pp. 112–41 (Polish). See Zool. Centralbl., viii. (1901) pp. 683–6 (3 figs.).

‡ Anat. Anzeig., xx. (1902) pp. 472–80 (6 figs.).

cells (*Keimzellen* of His). The latter divide by karyokinesis, and give origin to other cells which are transformed into neuroblasts.

With this conclusion Dr. Giglio-Tos cannot agree. In early stages in man only one kind of cell—epithelial—is distinguishable. These are capable of dividing by karyokinesis, and in so doing they lose their elongated form and appear like the *Keimzellen* of His.

Efferent Neurons in Electric Lobes of *Torpedo occidentalis*.*—Shinkishi Hatai finds that these present a fibrillar appearance of the ground-substance, but that this is due to an alteration in the shape of the meshes of the reticulum, and, therefore, cannot be compared with the fibrils described by Bethe, Apáthy, and others. The meshes of the reticulum, which the author regards as primitive, are altered by the growth of the cell-body where the processes, both axone and dendrite, arise. In these branches they become extremely elongated. In confirmation, the author describes, in the spinal ganglion-cells of the white rat, the gradations from the primitive shape of the meshes to the altered form which appears fibrillar.

Nerve-Endings in Taste Menisci.†—Dr. Eugen Botezat has studied these end-organs in various mammals, and finds that they are to be regarded as telodendrites, which surround epithelial cells from one, several, or all sides, and convert the cells into taste-cells. The menisci are connected with each other by means of primitive fibres, and the telodendrites often give off fine fibrils, which in all probability have intracellular terminations.

Nerve-Endings in Peritoneum of Mammals.‡—Dr. D. A. Timcfejew finds that the peritoneum of mammals is usually abundantly furnished with sensory end-organs. In the parietal peritoneum he finds the following types:—(1) In the sub-serosa numerous free end-organs in the form of end-tufts; (2) a smaller number of organs of peculiar shape which may be called “denticulated end-plates”; (3) in the deeper layers of the sub-serosa cylindrical end-bulbs. In addition, the serous layer contains a plexus of non-medullated fibres which sends out fine branched non-medullated fibrils. The diaphragm contains also the three types of end-organs mentioned above. In the centrum tendineum there are flattened or leaf-like end-organs, and also cylindrical end-bulbs. In the muscular regions there are motor end-organs of the usual type. All the forms of sensory end-organs mentioned above appear to arise from medullated fibres, and in certain cases, e.g. that of the cylindrical end-bulbs of the diaphragm, the author was able to prove that they originate from the phrenic nerve. He therefore believes that this nerve is to be regarded not only as the motor nerve of the diaphragm, but also as the sensory.

Innervation of Supra-orbital Canal in *Chimæra monstrosa*.§—R. H. Burne comments on Cole's discovery that two organs in the middle of the supra-orbital canal in this fish are innervated by twigs from the ramus ophthalmicus profundus of the Vth cranial nerve—apparently the only genuine case of connection between the nerves of the lateral

* Journ. Cincinnati Soc. Nat. Hist., xx. (1901) pp. 1-12 (1 pl.).

† Zeitschr. wiss. Zool., lxx. (1901) pp. 559-66 (1 pl.).

‡ Arch. Mikr. Anat., lix. (1902) pp. 629-46 (1 pl.).

§ Proc. Zool. Soc. London, 1901, pp. 184-7 (1 fig.).

line and the trigeminal. In three dissections Burne found that the branch of the profundus, which Cole described as innervating two organs of the supra-orbital canal, was joined, after leaving the orbit, by two twigs from the ramus ophthalmicus superficialis of the facial. The organs in question probably receive their nerves from the superficialis, as do the other organs of that canal, and in their mode of innervation show a close similarity to those in front of them; for in both cases the actual nerve-trunk from which the filaments for the individual sense-organs arise is of a compound nature formed by an intimate blending of the superficialis VII with the profundus V, differing only in the fact that in the case of these two sense-organs the union occurs between the smaller branches of the nerves, while in that of the organs in front it involves their main trunks.

Membranes of the Spinal Cord.*—Dr. G. Sterzi gives a detailed account of the structure of the medullary investments from the lancelet to man, and shows the gradually increasing complexity. The work is a model of thoroughness, and the author describes the state of affairs in more than fifty forms. He also gives an account of the development, and a theoretical discussion of the phylogenetic evolution.

Hæmolymp Glands in Man and Mammals.†—E. Morandi and P. Sisto conclude that the hæmolymp glands have to do, not only with the formation of the white blood-corpuseles, but also with the destruction of the red. They refer especially to three facts:—(1) the presence in the glands of globuliferous and pigmentiferous cells; (2) the great abundance of these elements in cases where the spleen has been removed; and (3) the increased production of hæmolytic substance in such conditions.

Lacteal Secretion.‡—M. Limon has made observations on the guinea-pig, and has reached the following conclusions:—The mammary gland functions during lactation like a serous gland. The nucleus shares in the secretion, its structure changes, it divides amitotically, and degenerates. But the degeneration is little more than the expression of functional exhaustion, and the frequent amitosis does not imply the death of the cell. It is the cytoplasm which elaborates the secretion, with the co-operation of ergastoplasmic filaments in the basal region of the cell.

Circulation in the Spleen.§—Dr. K. Helly has studied this in the new-born infant, and in kittens, rabbits, &c., and is definitely opposed to the view that the circulation is not a closed system. The blood flows through a closed capillary network, whose walls show no permanent gaps for the exit of red blood-corpuseles. Where these pass out it is by true diapedesis. He also gives evidence to show that leucocytes pass through the closed walls.

Limiting Membrane in Human Serosa.||—Prof. L. Vincenzi has studied the delicate connective-tissue membrane which Bizzozero described in 1874, directly below the endothelium in pleural, pericardial,

* Atti R. Ist. Veneto, lx. (1901) pp. (x.) and 1101-1361 (5 pls.).

† Atti R. Accad. Sci. Torino, xxxvi. (1901) pp. 384-90 (1 pl.).

‡ Journ. Anat. Physiol., xxxviii. (1902) pp. 14-34 (1 pl.).

§ Arch. Mikr. Anat., lix. (1901) pp. 93-105 (1 pl.).

|| Anat. Anzeig., xx. (1902) pp. 492-5 (2 figs.).

and peritoneal linings. According to Bizzozero, it was non-cellular, but Vincenzi brings forward evidence to show that this very delicate membrane always includes cellular elements:—(a) Elements with oval nucleus, sparse cytoplasm, and very fine prolongations of considerable length, and (b) flat elements, finely granular, very transparent, and very irregular in outline. These cells are not numerous, but they are never absent. They form the most superficial stratum—an extremely delicate stratum—of the underlying supporting tissue.

Filamentous Tufts of Epithelial Cells in Vas epididymis of Man.*—Dr. A. Gurwitsch describes the remarkable *Haarbüschel* which vary in form according to the condition of the secretory process. The fluid or semi-fluid secretion of the cells is got rid of via the tufts, and the internal ends of the tuft-filaments, which go deep down into the cell, have to do with the accumulation and breaking up of the secretion.

The author shows that the plasmic threads which project, apparently without sharp boundary, from the free surface of the cells, which one might on account of their motor changes be inclined to call genuine pseudopodia of the epithelial cells, retain their individuality deep within the cell-substance, and form a structure quite distinct from the surrounding cytoplasm.

The "*diplosomes*" (Zimmermann) associated with the tufts suggest centrosomes in several respects, but as no direct rôle in mitosis has been demonstrated, the identification lacks security. If they are equivalent to centrosomes, then it would be necessary to credit centrosomes with some rôle in connection with the form-changes associated with the secretory process.

What are "Blood-plates" ? †—Dr. Ernst Schwalbe gives a critical account of the different positions held on this question, and on the basis of his own researches sums up as follows:—There is no doubt that the blood-plates of most authors are derivatives of red blood-corpuscles, and to a smaller extent of white corpuscles. They stand in intimate relation to the phenomenon of coagulation, and bring about the morphological dependence of the blood-corpuscles and the clotting. Among the plates are some with and some without hæmoglobin, often there is an internal body which can be differentiated by means of hæmatoxylin. Blood-plates are not homologous with the spindles of the frog's blood. It is *possible* that in addition to the kind of blood-plates described above, another kind, not derived from degenerating corpuscles but pre-existent, is found in the blood, but there is as yet no positive evidence in support of such a view, and such evidence can only be looked for by a study of the embryology of blood.

c. General.

History of Medicine and Biology in the Nineteenth Century. ‡—Dr. F. C. Müller has written a very successful historical sketch of the progress of Anatomy, Physiology, Embryology, Bacteriology, Medicine,

* Arch. Mikr. Anat., lix. (1901) pp. 32-62 (1 pl. and 1 fig.).

† Anat. Anzeig., xx. (1901) pp. 385-94.

‡ Geschichte der organischen Naturwissenschaften im neunzehnten Jahrhundert. Medizin und deren Hilfswissenschaften, Zoologie und Botanik, Berlin, 1902, 8vo, xv. and 714 pp. and 16 portraits.

Surgery, Zoology, Botany, and so on, throughout the nineteenth century. Although the book is heavy, the contents are not; and the author deserves congratulation on his achievement. He has succeeded in avoiding platitudinarian vagueness on the one hand and mere cataloguing on the other, and his work should find a place in the libraries of those interested in the historical development of the science of biology and the art of medicine. Most of the portraits, which include Virchow, Darwin, Pasteur, Haeckel, Lister, Koch, Sachs, are very successful.

Present Position of the Theory of Descent.*—Prof. H. E. Ziegler has made a separate publication of his lecture on this subject to the 1901 meeting of the German naturalists and physicians. All that Ziegler says is worth reading, and the lecture has appended to it bibliographic notes and appendices on Natural Selection, Neovitalism, Brain and Mind, &c.

Aid to the Study of Zoology.†—G. P. Mudge has written an introduction to the study of zoology on what may be called the comparative anatomy method. After an introduction on the scope of biology and the characters of the great phyla, he discusses (a) the comparative morphology of Vertebrates, illustrated by *Amphioxus*, dogfish, frog, and rabbit; (b) the same for Invertebrates, illustrated by crayfish, cockroach, fresh-water mussel, and earthworm; (c) the structure of *Hydra*, illustrating diploblastic non-cœlomate animals; (d) *Paramœcium* and *Amœba*, illustrating the Protozoa. Then follow chapters—with more individuality—on development and reproduction, heredity, and variation. The book is a model of terseness, and, while we do not think that it can be fairly called a "Text-book of Zoology," it is an accurate and informative introduction to comparative morphology and to certain aspects of Biology.

Immunity.‡—Prof. Élie Metchnikoff published in 1883 a now well-known work on the comparative physiology of inflammation, in which he emphasised the importance of the phagocytes. He has now given us a similar treatise on immunity against infectious diseases, in which he maintains, against the conclusions of many other investigators, that the theory of phagocytosis is indispensable in the interpretation of immunity.

Statistical Study of Organisms.§—Prof. L. Camerano has previously discussed || the determination of indices of variability, variation, frequency, &c.; and he deals in the present communication with the index of the absence of a given character, the index of correlation, and the index of asymmetry. We cannot summarise the paper, but the reference may be useful to those interested in statistical study.

Animals in Hot Water.¶—R. Issel has studied the fauna of hot springs and pools in Italy, and gives a list of 110 species. Many flourish

* Jena, 8vo. See Anat. Anzeig., xx. (1902) p. 544.

† A Text-book of Zoology, London, 1901, 8vo, viii. and 416 pp., 100 figs., and 2 col. pls.

‡ L'immunité dans les maladies infectieuses, Paris, 1901, 8vo, 43 coloured figs. See Journ. Anat. Physiol. norm. path., xxxviii. (1902) p. 104.

§ Atti Acc. Sci. Torino, xxxvi. (1901) pp. 371-6. || Op. cit., xxxv. (1900).

¶ Boll. Mus. Zool. Genova, No. 100 (1900) pp. 1-4; No. 106 (1901) pp. 1-15 (2 pls. and 4 figs.). See Zool. Centralbl., ix. (1902) pp. 38-9.

in water up to 40° C., between 40° and 45° the number of species decreases, while the number of individuals increases. Even in water of 54.5° he found *Pelomyxa villosa* thriving.

Issel recognises five categories:—(1) widely distributed forms common in cold water, e.g. *Philodina roseola* and *Chilodon cucullus*; (2) animals which ascend periodically from the sea (*Anguilla vulgaris*), or which have recently immigrated into fresh water (*Palæmonetes varians*); (3) forms which are at home in the warm water, but absent in the surrounding basins (e.g. *Hydroscapha gyrynoides*); (4) forms now restricted to the thermal waters, but found elsewhere as fossils (*Melanopsis etrusca*); (5) typical inhabitants of hot mineral springs (*Lacobius sellæ*). In his second paper the author discusses in particular the differences between thermal forms and their relatives elsewhere.

Okapia johnstoni.*—Prof. E. Ray Lankester points out the general resemblance in skull and dentition between this new mammal from Central Africa and the giraffe. Both he and Gaudry † corroborate the suggestion of the discoverer, Sir Harry Johnston, that *Okapia* is genetically related to the extinct *Helladotherium*.

“Chestnuts” of Horse.‡—F. E. Beddard suggests that these may be profitably compared with the tactile (?) carpal tufts of vibrissæ which he has observed in numerous mammals, which Bland Sutton first noted in Lemuroids. In *Dasybus villosus* the carpal tuft of vibrissæ is present, but instead of being a closely compacted tuft of about six hairs, as is usually the case, the hairs in the armadillo are not much larger than those of the skin generally, are spread over a thickened patch of skin about half an inch in length, and are more numerous. In *Lemur catta* there is a callous tract of skin close to which is a tuft of vibrissæ. If the latter were lost we should have the “chestnut” of the horse, which, on the fore-limb, occupies “the right position,” a little above the wrist.

Modifications in Alimentary System of Birds induced by Diet.§—F. Houssay refers to previous experiments on this subject. (Hunter, Edmonstone, Semper, Holmgren, and Brandes), and gives a careful account of his own, which relate to two similar sets of fowls (three in each set). The members of the one set were fed on grain, the others on flesh. Precise measurements are given. In those fed on flesh the crop was much shorter and smaller; the intestine and cæca were also much reduced in dimensions; there was also a considerable reduction in the weight of the gizzard. But there is need for a larger number of data.

Vascularisation of Intestine in Vertebrates.||—Henri Neuville has studied the vessels of the alimentary canal in Cyclostomes and Elasmobranchs, in order to compare the physiology of absorption in the higher and lower Vertebrates. His results show that, as might have been expected, the higher show considerable division of labour as compared with the lower. Neither in the lamprey nor in Elasmobranchs is there any trace of the complicated chyliferous system of mammals. In both cases the vessels of the intestine are either arteries or veins, no lymph-

* Comptes Rendus, cxxxiii. (1901) pp. 857-8.

† Tom. cit., pp. 858-9 (appended note).

‡ Nature, lxxv. (1902) p. 222.

§ Comptes Rendus, cxxxiii. (1901) pp. 1022-5.

|| Ann. Sci. Nat. Zool., xiii. (1901) pp. 1-116 (2 pls. and 22 figs.).

atics being present, and absorption is entirely carried on by the veins. In the lamprey there is present in the sub-mucosa a kind of cavernous tissue, which seems to play the part in absorption taken higher up by the network of lymphatics. Somewhat similar conditions exist in Elasmobranchs, but here the arrangement of the veins has undergone certain complications.

Origin of Colour in Animals.*—G. E. H. Barrett-Hamilton returns to the discussion of the theory previously expressed by him, that in the animal kingdom generally the splendour of the nuptial tints in many animals may be ascribed, in origin at least, to pathological changes brought about by the effort to produce as large an amount as possible of the genital products. In its first statement his theory was based chiefly on the colouring of the Salmonoid genus *Oncorhynchus*. In the present paper, he endeavours to show that the Fishery Board Investigations on the life-history of *Salmo salar* also support his theory, and reviews these investigations from his own standpoint.

Distribution of Siluroids.†—Franz Poche points out that Boulenger's statement that the genus *Pimelodus* has no African representatives is incorrect, for *P. guttatus* from the Cameroons shows that this South American genus does occur in Africa. He also emphasises the fact that still another South American Siluroid genus is represented in Africa, namely *Auchenipterus*, for *A. (Laimumena) borbonica* from Madagascar and Bourbon (?) is closely related to the American *A. nodosa*. This remarkable affinity between the fresh-water fishes of the Ethiopian and Neotropical regions is emphasised by the occurrence of the genus *Cotylolopus* (family Gobiidae) in Madagascar, Reunion, and in Central and South America, but nowhere else. In the same connection the distribution of the snake genera *Boa* and *Corallus* should be noticed.

Distribution of Anoplopterus platyichir.‡—Franz Poche publishes a note on the distribution of this remarkable Siluroid fish. The species was erected by Günther for a specimen labelled Sierra Leone, but Boulenger, having found that two Siluroids from northern Nyassaland fall into this species, suggested that the locality Sierra Leone on Günther's specimens was an error, for he considered it very unlikely that so highly specialised a form should occur in two such distant regions of Africa. But Poche points out that whatever the locality of Günther's specimens, there can be no doubt that the species does occur in West Africa, for it is described by Rochebrune as tolerably common in Senegal and Senegambia. Poche believes that it will be found to occur across the whole breadth of the African continent.

Periodic Growth of Fish-Scales.§—J. Stuart Thomson points out in an interesting preliminary note on this subject, that in Gadoid and Pleuronectid fishes there is distinct evidence of periods of growth. The scale growth is accelerated during the warmer season of the year; but diminished during the colder season in such a methodic manner as to cause the formation of annual rings. The lines of growth on the scale surface are comparatively widely separated in that portion formed during

* Ann. Mag. Nat. Hist., ix. (1902) pp. 106-20.

† Zool. Anzeig., xxiv. (1901) pp. 569-71. ‡ Op. cit., xxv. (1902) pp. 121-2.

§ Journ. Mar. Biol. Ass., vi. (1902) pp. 373-5 (1 pl.).

the warmer season of the year; but much less widely separated in that part built up during the colder season. Thus the annual rings enable one to infer the age of the fish, much as the rings in the wood of a tree stem inform us as to the age of the tree. Hoffbauer has recently (1899) reached similar conclusions in regard to the scales of carp.

Vascular System of *Bdellostoma dombeyi*.*—C. M. Jackson gives a careful and very welcome description of the vascular system in this Myxinoid. We cannot within our space follow his anatomical account, but we cite his conclusions as to the primitive and the secondarily acquired characters.

The primitive characters are:—persistent pericardio-peritoneal foramen, simple tubular heart, the large number (up to 14) of functional branchial vessels, the origin of the carotid arteries from a lateral commissural vessel on each side connecting all the efferent branchial arteries, the complete sub-chordal aorta (dorsal aorta) extending forwards into the head region, the segmental arrangement of the somatic and renal arteries and veins, the frequent anastomosis between the posterior cardinal veins, the persistent sub-intestinal vein which does not join the portal system, the presence of an inferior jugular vein, and the well-developed portal heart which occurs nowhere else among Vertebrates except in the closely related *Myxine*.

The characters secondarily acquired are:—the asymmetry of the venous system, the distribution of branchial vessels to gill-slits instead of to gill-arches, the extension of the portal system into the territory of the right anterior cardinal vein, the connection of the caudal vein with the posterior cardinals, and the valvular character of the portal heart.

Fauna of Exe Estuary.†—Dr. E. J. Allen and Mr. R. A. Todd give a valuable account of the fauna of the Exe estuary, similar to that previously given for the Salcombe estuary. A comparison of two faunas is interesting in many respects. That of the Exe estuary is much more limited, and this seems to a large extent due to the following causes:—The banks uncovered in the Exmouth estuary are left dry for a very long time between the two tides, and in most parts of the estuary there is little difference in the area uncovered by the spring and neap tides; the great strength of the tidal stream involves a scouring of the banks; a large quantity of fresh water enters the estuary. In an appended paper ‡ R. H. Worth reports on the Foraminifera, of which about twenty species are common.

INVERTEBRATA.

Autotomy in Marine Invertebrates.§ — Dr. Emanuel Riegenbach gives a preliminary account of some observations on self-mutilation made on common marine forms. In the Echinoderm *Ophioderma longicauda*, the mere removal of the natural element is sufficient to induce movements of the arms, so vigorous as to lead to separation of parts of these. Fragments break off in rapid succession from the extremities

* Journ. Cincinnati Soc. Nat. Hist., xx. (1901) pp. 13-47 (3 pls. and 10 figs.).

† Journ. Mar. Biol. Ass., vi. (1902) pp. 295-335 (1 map).

‡ Tom. cit., pp. 336-43. § Zool. Anzeig., xxiv. (1901) pp. 587-93 (6 figs.).

towards the centre, until soon little is left save the disc. The ease and swiftness with which the autotomy takes place is very remarkable. Other more or less familiar cases described by the author are the throwing-off of the marginal tentacles by species of *Lina*, of papillæ by Eolids, and by *Tethys leporina*, of the arms by *Octopus defilippii*, and the limbs by various Crustacea. The paper is entirely descriptive, no suggestions as to the use of the habit being made in any case.

Additions to British Fauna.*—Andrew Scott gives a list of new records, including many fish-parasites from Liverpool Bay. Some of the forms mentioned have not hitherto been described in the British area. In the brain of a specimen of *Lophius piscatorius* cysts of the Protozoon *Glugea lophii* were found, a form previously known only from the Mediterranean. Among the parasitic Copepoda, a new species of *Caligus* (*C. brevicaudatus*) occurred, while *C. brevipedes* Basset Smith was found in abundance, and owing to the structure of the fourth pair of legs, is referred by the author to a new genus, *Pseudocaligus*.

Homologies of Cœlom.†—Joh. Thiele gives a summary of the views on this question which he intends to put forward in a forthcoming work on the phylogeny of the Mollusca. The Mollusca in the general case possess only a hæmocœle; a secondary body-cavity is not a universal characteristic of them or of their ancestors, but in certain isolated cases the primitive ducts of the gonads have become greatly enlarged, and so produced cavities which resemble a secondary body-cavity. Such are the right nephridia of Fissurellidæ and the pericardium of Cephalopoda. The author believes that the designation cœlom should be avoided in both these cases, but if it is used then, as both cavities are excretory, the term nephrocœle must be employed. Quite different from these cavities is the body-cavity of Annelids, which the author regards as having arisen as a lymph-space by the absorption of parenchyma, and therefore as comparable to, though separate from the hæmocœle, with which however it may become secondarily united. This Annelid body-cavity may become secondarily connected with the sexual organs, a process in regard to which the following series of stages exists:—In *Neomenia* there is a regular series of segmentally arranged gonads connected with a longitudinal duct which opens to the exterior at the posterior end of the body. In the Gordiidæ the gonads have the same relations, but the longitudinal duct is not able to carry the whole of the generative products, which burst through its thin wall and enter the body-cavity. In *Polygordius* there is no longitudinal duct, and the generative products fall directly into the body-cavity, whence, finding no exit, they burst through the body-wall. In certain Polychætes the primitively excretory segmental organs become enlarged and take on the function of genital ducts. Finally, in the higher Annelids, the gonads become limited to the anterior region of the body-cavity, and from part of the body-cavity there arise special genital ducts not homologous with the excretory segmental organs. In consequence the author holds that the gonocœle theory is not true for the Annelids, for in them the cavities of the gonads and their ducts have degenerated, and there is no homologue of

* Proc. and Trans. Liverpool Biological Soc., xv. (1901) pp. 342-53 (3 pls.).

† Zool. Anzeig., xxv. (1902) pp. 82-4.

the pericardium and nephridia of Mollusca, for these are certainly derivatives of the primitive genital ducts. Save for its secondary relation to the sexual products, the cœlom of Annelids is a schizocœle.

Mollusca.

North Atlantic Molluscs.*—H. Friele and J. A. Grieg conclude their report on the Molluscs of the Norwegian North Atlantic Expedition (1876–1878), and this part is the last of the whole series. The first volume on molluscs treated of the Buccinidæ, the second of the genus *Bela* and some new or rare forms, the concluding volume takes a faunistic survey of all the species collected, with information respecting their horizontal and vertical distribution. The list includes 108 Bivalves, 8 Scaphopods, 10 Placophora, 22 Nudibranchs, 5 Pteropods, 192 other Gastropods, and 7 Cephalopods.

Diverticulum of Duct of Spermatheca in *Helix aspersa*.†—Domingo Sanchez gives a detailed description of this well-known diverticulum. He distinguishes three longitudinal regions and two distinct strata in its wall.

Papillæ of Eolidæ.‡—Ernst Krembrow has investigated the structure and development of the dorsal appendages of *Eolis exigua*, and has checked his results by a comparison with some other members of the same family. Much of the interest of the research is concentrated in the question of the origin of the “cnidophore-sac”—regarded as ectodermic by Herdman, as endodermic by Davenport. The author's results confirm those of Davenport. He finds that the liver contains undifferentiated cells of embryonic type, which form the future cnidoblasts, and these grow out into the ectodermic invagination which forms the first rudiment of the papilla. Into the space between ectoderm and endoderm in the developing papilla mesenchyme cells find their way. As the endoderm grows out into the papilla, however, it is seen to consist, not only of the embryonic cells mentioned above, but also of a certain number of true liver-cells. Between the distal embryonic cells—now rapidly undergoing differentiation into cnidoblasts—and the proximal liver-cells a furrow appears, and here the mesenchyme cells form the sphincter muscle. The cnidophore sac then acquires an opening to the exterior, and the cnidoblasts, few in number but of large size, each produce numerous stinging capsules, a process initiated at an earlier stage. Certain cells which lie between ectoderm and endoderm, regarded as mucus-secreting by Herdman, the author believes to have arisen from liver-cells. In *Eolidiella glauca* the cnidoblasts differ in form, number, and arrangement from those of *Eolis exigua*. They are more numerous, long and narrow in shape, and do not begin to form capsules until a relatively later stage. In both the forms mentioned nematocysts are produced in the liver as well as in the papillæ.

Free Intra-epithelial Nerve-endings in *Helix*.§—Dr. H. Smidt begins his communication on this subject by noting that while free

* Norske Nordhavs Exped., xxviii. (1901) xviii. and 131 pp., 2 figs., and a map.

† Boll. Soc. Espan. Hist. Nat., i. No. 10 (1901) pp. 380–5 (1 fig.).

‡ Arch. Mikr. Anat., lix. (1901) pp. 181–210 (2 pls.).

§ Anat. Anzeig., xx. (1902) pp. 495–506 (8 figs.).

intercellular nerve-endings are well known in the epithelia of Vertebrates, the records for Invertebrates are few. He sums up about eight previously described cases in Plathelminthes, Annelids, and Molluscs. By using Smirnow's modification of Golgi's method, he has succeeded in demonstrating (in the snail) free nerve-endings in the cutis, in the foot-gland, in the cesophagus and buccal cavity. He suggests that the free nerve-endings may be related to a chemical sense, and he calls particular attention to the interesting fact (which Smirnow also noted) that the endings come into close association, though not connection, with sensory cells.

New Genus of Stylommatophora.*—Dr. Heinrich Simroth describes as *Ostracolethe fruhstorfferi* g. et sp. n., a Pulmonate Gasteropod from Tonkin, which possesses so many peculiarities that a new family must be created for its reception. The chief peculiarities are in regard to the shell and the relations of the visceral hump, and the presence of a puzzling organ in connection with the reproductive system. The visceral hump is very prominent, and the shell internal, covered by a tough, but thin, mantle. It consists of an anterior calcareous plate, and a large cap-shaped structure of conchiolin, which is of such a shape that a narrow region of it ["ein schlanker Zipfel"] protrudes posteriorly from the mantle-pocket through a cleft. In the absence of a figure the exact relations of shell, mantle, and visceral hump are not altogether easy to make out.

In regard to the reproductive system, side by side with the vas deferens, which opens into the proximal end of the penis, there runs another structure, which becomes densely muscular below, and is inserted into the distal end of the penis. This muscular band appears to contain a fine canal. At its point of origin there are within the muscular band about fourteen cup-shaped discs, which are arranged in a plate, containing each a narrow split-like lumen, and consist of circular and radial muscle-fibres. These discs are possibly comparable to the muscular thickenings sometimes seen in the penis of other snails; they may have some function in connection with the promotion of self-fertilisation, but their form and structure make them quite different from any organs previously described. Only one specimen of the new mollusc was obtained.

New Cave Gasteropod.†—Dr. R. Sturnay describes the shell of a new Mollusc obtained from a cave in the island of Curzola, in Dalmatia. The soft parts of the new form are not known, but the shell resembles that of *Torquilla* in general shape, while, from the characters of the umbilicus, it recalls the species of *Zospeum*, which are also cave-dwellers. The author describes it as *Spelæoconcha paganettii* g. et sp. n.

γ. Gastropoda.

Fossil Polyplacophora.‡—E. Ashby and Dr. W. G. Torr give a systematic account of the valuable collection of fossil Polyplacophora made by the late Prof. Ralph Tate and Mr. J. Dennant, and now de-

* Zool. Anzeig., xxv. (1901) pp. 62-4.

† Verhandl. k. k. Zool.-bot. Gesell. Wien, li. (1901) pp. 761-2 (1 fig.).

‡ Trans. and Proc. R. Soc. S. Australia, xxv. (1901) pp. 136-44 (1 pl.).

posited in the University Museum, Adelaide. The collection comprises seventeen or eighteen species (in seven genera), and at least half of these species are new, though most show a close affinity to living forms.

δ. Lamellibranchiata.

Spawning Period of Mussels.*—A. Scott records a series of observations on this subject made on tank specimens of *Mytilus edulis*, but constantly checked by comparison with forms living under natural conditions. The mussels began to discharge eggs on May 6th, and this continued without any corresponding discharge of sperms until June 13th, when the sperms first made their appearance. Two days after the first appearance of sperms another discharge occurred, and though sperms were not again observed, all the subsequent eggs proved fertile. Prior to June 13th none of the eggs developed, and all were apparently unfertilised. Fertilisation is apparently effected internally. After being shed the ova fall to the ground near the parent, and here remain for eight to twelve hours, during which they undergo the earlier stages of development. They then rise to the surface and enter upon the free-swimming stage, which lasts about four days.

Arthropoda.

a. Insecta.

Chitin-Formation, Muscle-Insertion, and Cell-Connections in Insects.†—Nils Holmgren has studied these subjects in *Sarcophaga carnaria*, *Musca vomitoria*, and *Chironomus* larvæ. He confirms Tullberg's conclusion (1881) that chitin usually arises from a direct transformation of the distal parts of epithelial cells. The same occurs in muscle-cells. Only in one case could it be said that the chitin was formed as a secretion of the epithelium, as Bütschli, referring to the egg-shell of the crayfish, maintained against Tullberg.

In the vagina of *Sarcophaga* the matrix-cells form parallel lamellæ of chitin; in the efferent ducts of the sperm-capsules the filar substance of the cells is gradually chitinised distally, but into pillars, not lamellæ; in the median oviduct of *Musca* the conical matrix-cells are prolonged into points (chitinised only at their tips), and between these threads almost structureless chitin is formed—mainly as a secreted product.

Holmgren shows that before a muscle-cell reaches the epithelium it loses its striation. Its fibrils enter the epithelial cell, traverse its whole length, and end with a chitinised portion in the epithelial chitin. Besides the connections between epithelial cells and those between muscle-cells there are very distinct direct connections between epithelial cells and muscle-cells.

Spermatogenesis in Insects.‡—Walter S. Sutton has studied the spermatogonial divisions in the grasshopper *Brachystola magna*, with special reference to the chromatin. The adult testis displays spermatozoa near the collecting duct, spermatids a little further up, and finally, in some cases, primary and secondary spermatogonia. Preparatory to

* Proc. and Trans. Liverpool Biol. Soc., xv. (1901) pp. 161-4.

† Anat. Anzeig., xx. (1902) pp. 480-8 (6 figs.).

‡ Kansas University Quarterly, ix. (1900) pp. 135-60 (4 pls.).

the last division, the chromatin in the nucleus of the primary spermatogonium becomes diffused, and a number of spiremes are formed, these split and become short rods, the centrosomes appear, and two secondary spermatogonia are thus produced. Round the two cells a membrane appears, producing a two-cell spermatocyst. Each chromosome in the new cells disintegrates, and at the same time reconstructs its share of the nuclear membrane as a closed vessel round itself. Later these vesicles become intercommunicating with one another, except for one—that of the accessory chromosome—which remains apart in a separate vesicle. The nuclear chromatin then passes through a spireme stage, splits, and breaks up as before to form chromosomes. The accessory chromosome has no spireme stage, but splits up like the others. Division then takes place, and this is repeated until each cyst contains secondary spermatogonia of the seventh or eighth generation, when the transformation into spermatocysts occurs. In the telophases of the last spermatogonial division the sacculations of the nucleus disappear, leaving a smooth vesicular membrane to which the accessory chromosome is applied.

Prof. C. E. McClung* has studied the spermatocyte divisions in *Hippiscus phænicopterus* and other members of the family Acrididæ. He finds that at the end of the last spermatogonial division, the daughter-cells possess the somatic number of chromosomes. These break down to form the spireme, except one which persists as the accessory chromosome. The thread splits longitudinally, and then at right angles to this cleft, to form quadrivalent chromosomes. When separation takes place, it occurs along the plane corresponding to the original longitudinal cleft, without divergence of the constituent chromatids. Not till this separation has taken place do the dyad chromatids begin to diverge from one another, and form V-shaped structures. There is no rest-stage either between spermatogonium and spermatocyte, or between first and second spermatocyte division. In the last-named division there is a small spindle, and the loosely joined chromatids separate easily at a point which marks the previous cross-division. The author believes that this sequence of longitudinal and cross-divisions is constant. The accessory chromosome, after the appearance of the mitotic figure of the first spermatocyte, takes its place with the other chromatic elements and divides. Henceforth it becomes inconspicuous till the spermatids are formed, when it again becomes distinct and conspicuous. In regard to its function the author has no suggestion to make.

Aquatic Insects in the Adirondacks. †—Prof. J. G. Needham and Cornelius Betten publish a report based on ten weeks' work at the Entomologic Field Station at Saranac Inn, New York, which illustrates admirably the kind of work which can be done at such stations. The primary object of the investigation was economic, in relation to the food-supply of fishes, and the ten weeks' visit resulted in the working-out of the life-histories of about 100 species of insects, the discovery of ten new species and two new genera, and the accumulation of a large amount of material still to be worked out. In the report the biological

* Tom. cit., pp. 73-100 (3 pls.)

† New York State Museum, Bulletin xlvii. (1901) pp. 383-612 (36 pls. and 42 figs.).

features of the locality are clearly presented, and the relation of the different forms described to their natural surroundings and to other species formed an important part of the investigation. While, from the nature of the case, an abstract is impossible, attention should be called to the report as the kind of work so much needed at present.

Hindering Pupation.*—J. Dewitz finds that maggots of flies ready to pupate may be inhibited when there is lack of air (in a securely closed glass vessel); some pupate immediately, but others do not. After fourteen days the maggots which had not pupated but had remained sluggish, were still alive. On the entrance of air they recovered activity and began to pupate. Similar experiments were made with the larvæ of *Lucilia cæsar* and *Picris brassicæ*. The Ichneumon-larvæ (*Microgaster glomeratus*) in the caterpillars were hindered from pupating by an atmosphere saturated with moisture.

Coloration of British Beetles.†—Horace St. John K. Donisthorpe has gone through a collection of Coleoptera with a view to the discovery of cases of protective coloration, mimicry, and so on. Few of the cases adduced are convincing, and many are qualified with a "probably" or "perhaps."

Sexual Dimorphism in Buprestis sanguinea.‡—G. C. Champion studied this species in Aragon, and found very marked dissimilarity in the colours of the two sexes. It seems almost certain that the males correspond to *B. margaripicta* of Marseul, and the females to *B. sanguinea* Fabr. = *levaillanti* Lucas. This is the first record of sexual dimorphism in Buprestid beetles.

Life-history of Tephroclystia virgaureata.§—Rudolf Klos notes the interesting discovery that in this butterfly there are spring and summer broods of caterpillars, feeding on entirely different plants. At the end of June and beginning of July he took caterpillars which seemed to him to generally resemble those of this species, on hawthorn and *Prunus spinosa*. To his astonishment the butterflies—which proved to be *T. virgaureata*—emerged at the end of July and throughout August, proving that the caterpillars were a second brood. The imagines were smaller than the spring form, and differed in colour. The spring caterpillars fed only on species of *Solidago* and *Senecio*, and the spring broods of butterflies emerge at the end of March or in April.

Stigmata of Sericaria mori.||—Dr. L. Petri gives an intimate description of the tracheal vestibule, the chitinous armature, and the three muscles of a stigma, and shows how well adapted the mechanism is.

Life-history of Hive Bee.¶—Ferd. Dickel describes in detail a number of experiments which he has made in attempting to decide the question whether it is true that the fertilised queen can "voluntarily" withhold spermatozoa from certain eggs, and that such eggs give rise to the drones, which have thus a "mother, but no father." He grants that

* Arch. Entwickmeh., xi. (1901) pp. 690-9 (1 fig.). See Zool. Centralbl., viii. (1901) pp. 863-4. † Trans. Entomol. Soc. London, 1901, pp. 345-77.

‡ Tom. cit., pp. 379-84 (1 pl.).

§ Verhandl. k. k. Zool.-bot. Gesell. Wien, li. (1901) p. 785.

|| Bull. Soc. Entom. Ital., xxxiii. (1901) pp. 83-104 (5 figs. and 1 pl.).

¶ Zool. Anzeig., xxv. (1901) pp. 39-56.

eggs laid by unfertilised queens or by workers do invariably give rise to drones, but maintains that such drones show well-marked differences from those which appear in a colony with a healthy fertilised queen at its head; he considers that his results prove that such a queen can only lay fertilised eggs, and that it is the influence of the workers which determines the future development of the eggs. He believes, further, that the workers, in crawling over the brood-cells as soon as eggs have been laid in them, pour out a secretion which penetrates the chorion and reaches the egg. More than this, the wax which makes the cells is kneaded in the mouth, and during this process he believes that it is impregnated from the "salivary glands" with the secretion characteristic of drone, of worker, or of queen-cells. According to the particular nature of the secretion, the type of the cell is determined, and the presence of the particular secretion in the walls of the cell determines the nature of the additional secretion poured into the cell when the egg is laid. The question as to whether each worker is capable of producing the three types of secretion, or whether three kinds of worker exist, is left undetermined. The author believes that this theory will explain in a satisfactory way all the anomalies of bee-development. Further, he compares the secretion of fluid from the "salivary glands" in the workers to a sexual act, and believes that it produces in them the same emotions as those usually associated with sexual union.

In another paper,* the author replies to Petrunkevitch's re-assertion of the traditional position in regard to drone eggs. Petrunkevitch believes that all eggs laid by the queen in drone-cells are unfertilised, basing his belief largely on the fact that no sperm and no centrosome rays have been observed in such eggs. Dickel, however, replies that as such eggs do in some cases give rise to worker bees, Petrunkevitch proves too much for his own case. On other grounds also Dickel thinks the microscopic evidence unreliable.

Studies on Galls.†—Manuel Fernandez de Gatta discusses the galls of Salicaceæ (due to *Nematus versicolor*, *N. gallicola*, *N. vallisnerii*, &c.); of Ulmaceæ (due to *Schizoneura lanigera*, *Sch. ulmi*, &c.); of Papilionaceæ (due to a species of *Diastrophus* and to Bacteria); of Terebinthaceæ (due to *Pemphigus cornicularius*, *P. utricularius*, &c.); of Rosaceæ (due to species of *Rhodites*, &c.); of Oleaceæ (due to Bacteria); and so on.

Dragon-flies of Illinois.‡—Prof. J. G. Needham and Mr. C. A. Hart give an account of the Petaluridæ, *Æschnidæ*, and Gomphidæ of Illinois (twenty-eight species), and it is noteworthy that they describe the nymphs of twenty-four species (six for the first time). The authors give an interesting account of the habitats and food-relations, and useful diagnostic tables.

New Collembola.§—Carl Börner describes a number of new species of Collembola, and discusses some points connected with the nomenclature of the previously known species. One of the new species falls into a new genus—*Micranurida*, which resembles *Anurida* in general form,

* Tom. cit., pp. 20-7.

† Bull. Soc. Espan. Hist. Nat., i. No. 10 (1901) pp. 385-402.

‡ Bull. Illinois State Lab. Nat. Hist., vi. (1901) pp. 1-94 (1 pl.).

§ Zool. Anzeig., xxiv. (1901) pp. 696-712 (10 figs.).

but differs in the reduction of the mouth-parts, here adapted only for piercing and sucking. The mandibles, maxillæ, and paraglossæ are mere styles, the mandible being furnished with two teeth at the tip.

Collembola from Franz-Josef Land.*—Mr. G. H. Carpenter reports on the collection of Collembola made by Mr. W. S. Bruce in Franz-Josef Land. Seven species are represented in the collection from this new locality, including one new species—*Isotoma brevicauda*. The distribution of northern Collembola, as summed up by Carpenter, lends support to our belief in a Pliocene or Pleistocene land-connection to the north of the Atlantic Ocean, a belief already upheld by so much evidence, both geological and zoological.

B. Myriopoda.

Luminosity in Centipedes.†—Rose Haig Thomas records an interesting observation on *Geophilus*. It had discharged its "fluid" on a dozen or so of red ants which were pursuing it, so that a curving thread of light seemed to have a scattered tail of brilliant points. When the centipede was dropped into a tumbler, it "splashed out a mass of light. Hurriedly placing my hand over the tumbler to prevent the insect from escaping, I felt suddenly a strange prickly sensation, such as is caused by a slight contact with electricity, so that I hastily removed my hand, calling to a friend who, placing her hand over the tumbler, felt the same thing. I lit another match and watched the *Geophilus* writhe the light out of its body in blue-green flashes. It soon ceased to shine, having probably exhausted all the luminosity on its enemies." Defence seems certainly to be one of the uses of this secretion.

Spermatogenesis of Scolopendra.‡—M. W. Blackman has made a series of observations on the spermatocytes and spermatids of an undetermined species of this genus. He finds that the spermatocytes, at the time of their formation, are small cells with very little cytoplasm. The chromatin, with the exception of that of the accessory chromosome, becomes arranged in a spireme and the cytoplasm increases in amount. Next the spireme breaks down, and forms a reticulum which stains feebly, and becomes finer and finer until it is no stronger than the cytoplasmic reticulum; meanwhile the accessory chromosome increases enormously in size. Later the chromatin reappears in the form of diffuse masses, which quickly take on the tetrad shape; at this stage the accessory chromosome has decreased in size, and become irregular in outline; it subsequently recovers its spherical shape, and persists till the disappearance of the nuclear plate preparatory to division. Soon after the tetrads are formed, the centrosome appears, divides into two, and the two halves as usual migrate to the poles of the nucleus. After the last maturation division, a portion of the nucleus is budded off, and passing through the cytoplasm, is extruded from the cell; to this protruded portion the author gives the name of *itomere*. Its formation and protrusion is accompanied by the formation of yolk-masses, and by a

* Sci. Proc. R. Dublin Soc., ix. (1900) pp. 271-8 (18 figs.).

† Nature, lxx. (1902) p. 223.

‡ Kansas University Quarterly, x. (1901) pp. 61-76 (3 pls.).

great increase in the size of the cell. The pathway taken by the itomore through the cytoplasm persists and grows stronger; by a condensation of the cytoplasmic reticulum in this pathway the axial filament of the spermatozoon is formed. The author regards the accessory chromosome as a reservoir in which is deposited the nuclear chromatin.

δ. Arachnida.

New Genera of Hydrachnids.*—Sig. Thor describes as *Hjartdalia uncinata* g. et sp. n., and *Mesobates forcipates* g. et sp. n., two new forms obtained in Norway. The first named genus is nearest to *Aturus* Kramer, but the genital cups are numerous, small, and extend in a broad band at either side from the extremity of the ventral surface forwards towards the insertion of the last pair of legs. In a note on two specimens of the new species observed in copula, the author gives reasons for supposing that the fourth pair of legs act as carriers of the spermatozoa. The genus *Mesobates* occupies an intermediate position between *Megapus* and *Hygrobates*; as regards the maxillæ it is nearest the latter genus, as regards other structures the former. The paper includes descriptions of two other new species.

New Hydrachnids.—A. Protz † describes as *Aturus crassipalpis* sp. n. a new species of Hydrachnid found in a collection from Switzerland. Swimming bristles are absent from the legs, and on the fifth joint of the fourth pair there is a hollow from which springs a sabre-shaped bristle.

R. Piersig ‡ describes as *Aturus protzi* a new species which, though closely related to *A. intermedius*, from the nature of the bristles on the fourth pair of legs merits specific distinction. It was taken in the Bohemian-Bavarian forests, and the female is unknown.

From the same district Piersig § describes as *Aturellus crassipalpis* g. et sp. n. another new form, which, as regards the structure of the fourth pair of legs, seems at least in part to resemble Protz's *Aturus crassipalpis*.

South American Acarids.||—A. Berlese and G. Leonardi describe a collection of Acarids made by Dr. Silvestri Filippo, many of which prove to be new species, some falling into new genera. The new genera are *Celænogamasus*, which is closely related to *Cyrtolælaps*; *Urozercon*, with one species from termites' nests; and *Stereotydeus*, which is closely related to the genera *Ereynites* and *Penthaleus*.

Myrmecophilous Mites.¶—E. Wasmann, in an interesting paper on this subject, points out that some confusion has hitherto existed in regard to the European species of *Antennophorus*. He distinguishes the following three species:—*A. uhlmanni* Hall, parasitic on *Lasius fuliginosus*, *L. mixtus* and *L. umbratus*, *A. pubescens* Wasm., on *L. flavus*, and *A. foreli* sp. n., on *L. niger* and *L. alienus*. According to his observations each worker, save in exceptional circumstances, does not bear more

* Zool. Anzeig., xxiv. (1901) pp. 673-80 (13 figs.).

† Op. cit., xxv. (1901) pp. 1-2 (2 figs.).

‡ Tom. cit., pp. 33-5 (1 fig.).

§ Tom. cit., pp. 18-20 (3 figs.).

|| Tom. cit., pp. 12-6.

¶ Tom. cit., pp. 66-76.

than one parasite, this almost invariably occurring in one definite position on the under side of the head of the host. Here it is able to exert such pressure on the crop of the host as to cause the latter to regurgitate food-material which is eagerly licked up. In the feeding of one worker by another also, the parasite comes in for its share; but there is no direct connection between parasite and host. Parasitised ants are very shy, concealing themselves more quickly than others if the nest be exposed, and frequently exhibit an uncertainty of gait. The author describes in detail the observations which lead him to the conclusion that the mites are not guests, but are what he describes as parasitic caricatures of guests. His experiments show that transference from one nest to another of the parasite is possible if the inmates of the strange nest be suitable hosts. An interesting experiment was the placing of an infected specimen of *Lasius flavus* in a *Formica sanguinea* nest; the *Lasius* was bitten to death, and its parasite climbed on the body of one of the attacking forms, but it was unable to obtain a hold here, the larger and stronger *Formica* being able to remove the small parasite by means of its fore-legs, an operation which the species of *Lasius* attempt, but are unable to carry out.

The paper also contains an account of the two known American species of *Antennophorus*, and of some related European myrmecophilous mites belonging to other genera. Further, the author points out that the resemblance as regards mode of life between ants and termites, is emphasised by the similarity of their guests and parasites. Into so much detail is this carried, that there have been described from the nests of termites, mites which in all probability belong to the genus *Antennophorus*.

Breathing Organs of Pseudoscorpionidæ.*—J. P. Stschelkanovzeff has made some observations upon these organs in two species of *Chernes*. He finds that the stigmata resemble those of insects in having a frame of thickened chitin round their margin. The outer opening does not lead directly into the tracheæ but into a stigma-chamber, in whose walls lies the opening into the tracheal stem. The closure of the stigmata is provided for by a mechanism consisting of a chitinous thickening of the wall of the chamber, and of two muscles, one of which opens and the other closes. In general type therefore, the closing mechanism resembles that of insects. The main tracheal stems do not possess a spiral thread, and in general structure, position, and significance recall the initial tracheæ (*trachées d'origine* of Strauss-Durekheim) in insects, and the stigmatic pockets of the tracheæ in Diplopoda. The fasciculi of fine tracheæ do not arise from the summit of the main stem, but from the anterior end of its inner wall, so that all the little tubes of the fasciculus are united at one spot of the wall, as also occurs in Diplopoda. At this spot the whole of the inner wall is covered by folds of chitin, which prevent the entrance of foreign bodies into the fine tracheal tubes.

Arctic Pantopoda. †—G. H. Carpenter reports on the Pantopoda dredged by W. S. Bruce in 1898 in the Arctic Ocean. The eight species recorded are all fully described and figured in Sars' monograph (1891).

* Zool. Anzeig., xxv. (1902) pp. 126-35 (5 figs.).

† Sci. Proc. R. Dublin Soc., x. (1900) pp. 279-82.

ε. Crustacea.

Observations on *Homarus europæus*.*—Dr. Hans Przibram has kept a number of lobsters in the aquaria of the Trieste zoological station, for the purpose of making observations on regeneration, and gives some notes in regard to habits. As was observed by Herrick in the case of the American lobster, the animals excavated for themselves holes in the sand. Much difficulty was at first found in getting the lobsters to feed, eventually they were supplied with Lamellibranchs (*Cardium*, *Scrobicularia*, *Mytilus*) which they took greedily, using the knobbed cheliped to crush the shells. The other—the toothed—cheliped was employed as a grasping organ, and appears to carry sense-organs. Tables are given of the variations in weight of the captive forms, and of the changes in dimensions which follow the moult.

Occurrence of *Squilla desmaresti* in North Sea.†—Prof. F. Jeffrey Bell has received a specimen of this species dredged in the North Sea. There seems no previous record of this or any other species of *Squilla* in that area.

In a subsequent note ‡ Prof. Bell acknowledges receipt of a specimen of this Stomatopod from off Selsea Bay.

New *Gammarus*.§—Dr. A. Garbini describes *Gammarus tetracanthus* sp. n. from Lake Müggel. It is readily defined by the presence of a dorsal spinous prolongation on the last thoracic and first three abdominal segments. Thus there is the appearance of a dorsal saw with four teeth. The author writes *G. tetrachantus*, but *tetracanthus* would be more in accordance with usage.

Copepods of Faroë Channel and Shetlands.||—Dr. R. N. Wolfenden has added considerably to I. C. Thompson's list of Dr. Fowler's collection of Copepods from these waters. Six new species are described.

Structure of *Lepeophtheirus* and *Lernæa*.¶—Andrew Scott describes the structure and life-history of these two fish parasites, as types of the two families Caligidæ and Lernæidæ. In regard to the first-named form, he finds no evidence that the males and immature females inflict injury upon the fish, no blood being usually to be seen in the alimentary canal. On the other hand, the mature females, which live on or under the fins, seem to cause a considerable amount of laceration. The parasites only attack healthy fish, and leave the body should the fish become weak and emaciated. In *Lernæa branchialis* the parasitic habit is much more firmly established, and the adults are incapable of life if separated from their host. The paper is illustrated by a number of figures.

Affinities of *Uronectes*.** — Dr. W. J. Calman replies to Prof. Fritsch's rejection of the view that this fossil Crustacean genus is allied to the living Tasmanian genus *Anaspides*. Fritsch rejects the view solely

* Zool. Anzeig., xxv. (1902) pp. 76-82 (1 fig.).

† Journ. Mar. Biol. Ass., vi. (1902) pp. 387-8.

‡ Nature, lxxv. (1902) p. 366.

§ Zool. Anzeig., xxv. (1902) pp. 153-4 (1 pl.).

|| Journ. Mar. Biol. Ass., vi. (1901) pp. 361-72 (2 pls. and chart).

¶ Proc. Trans. Liverpool Biol. Soc., xv. (1901) pp. 181-241 (5 pls.).

** Zool. Anzeig., xxv. (1902) pp. 65-6.

on the ground that the thoracic legs of *Uronectes* are destitute of exopods, but Calman doubts the statement that the absence of these has been definitely proved, and regards the discovery of stalked eyes, both in *Gasocaris* and in *Uronectes* as confirmation of his view. He thinks that exopods were in all probability absent in the former of these two genera, but were present in *Uronectes*. But he points out that as his original contention was that *Gasocaris* and *Uronectes* are related to *Anaspides*—a doubtful Schizopod—the presence or absence of exopods does not in any way affect the question.

Annelida.

Life of Earthworms. * — Dr. K. Bretscher communicates some careful biological observations on earthworms. (1) There are normal wanderings, at all seasons and at all ages, prompted by nutritive and reproductive needs. (2) All the local species (Zürich), both large and small, whether young or old, burrow deeply; there are no forms which can be described as restricted to the humus; and there is no particular relation between form of body (flat or cylindrical) and the burrowing power. (3) The process of pairing, in spite of the numerous observations which the author partly corroborates and partly criticises, remains in various respects obscure.

Hirudo troctina John. † — Marcelo Rivas Mateos gives a diagnosis of this leech, common in some parts of Spain. He notes its variability, but maintains its specific distinctness.

Notes on *Æolosoma tenebrarum*. ‡ — V. Janda refers to Miss Brace's work § on this worm, and points out that it is in great part a corroboration of what he had previously described || in regard to the nervous system and musculature. The authoress has also overlooked the work of P. J. Schmidt on the same subject.

Geographical Distribution of *Priapulid*. ¶ — A. S. Skorikow has several notes on this subject, but his most interesting statement is that *Pr. caudatus* var. *antarcticus*, which was formerly regarded as wholly antarctic, is really bipolar. It has a circumpolar Arctic distribution, and it seems to be widely distributed in the south.

Platyhelminthes.

Platyhelminia, Mesozoa, and Nemertini. ** — Prof. W. Blaxland Benham discusses these in the fourth part of the 'Treatise on Zoology,' edited by Prof. E. Ray Lankester. His careful and detailed treatment of forms which are so often passed over summarily in zoological textbooks is very welcome, and will form a valuable work of reference for those interested in Turbellarians, Trematodes, Cestodes, Nemertini, and the heterogeneous Mesozoa.

* Biol. Centralbl., xxi. (1901) pp. 538-50 (3 figs.).

† Boll. Soc. Espan. Hist. Nat., i. No. 10 (1901) pp. 375-7 (1 fig.).

‡ Zool. Anzeig., xxv. (1902) pp. 172-4.

§ Journ. Morphol., xviii. (1901).

¶ Zool. Anzeig., xxv. (1902) pp. 155-7 (1 fig.).

** A Treatise on Zoology. Edited by E. Ray Lankester. Part iv. 'The Platy-

helminia, Mesozoa, and Nemertini,' by Prof. W. Blaxland Benham, London, 1902, 8vo, iv. and 204 pp. and many figs.).

Superficial Secretion of Tapeworms.* — P. Mingazzini concludes, after careful use of various histological methods, that the whole surface of the body of an adult Cestode secretes a substance which has a notable physico-chemical action on the intestinal contents of the host. What has been so often described as a cuticle is a complex investment formed by the intestinal juice, modified by the action of the secreted substance, and intimately attached to a delicate chitinoid stratum, which is the true cuticle of the tapeworm.

New Species of Didymozoon.† — S. Richiardi describes as *D. micropterygis* sp. n. what seems to be a very distinctively new species of this interesting genus of Trematodes. He found a large and a small specimen beneath the skin in the interparietal region of *Micropteryx dumerilii* Cuv.

New Species of Distomum from the Duckmole.‡ — S. J. Johnston describes as *D. ornithorhynchi* sp. n. a Trematode from the stomach, duodenum, and anterior small intestine of *Ornithorhynchus anatinus* Shaw. The simple nature of the intestine, the absence of hooks or lobes from the oral sucker, the almost total obliteration of the œsophagus, and the absence of a retractile telescopic tail-part, place the species in Dujardin's sub-genus *Brachylaimus*, but it does not show a striking likeness to any particular species.

Structure of Lineus gesserensis.§ — R. C. Punnett gives a general account of the anatomy, histology, and development of this worm, illustrated by some clear figures. The paper forms one of the Memoirs published by the Liverpool Marine Biological Committee.

Incertæ Sedis.

North Atlantic Brachiopods.|| — H. Friele and J. A. Grieg include Brachiopods in their report on North Atlantic Mollusca, and briefly discuss eight species.

New Species of Gastrotricha.¶ — Max Voigt describes from the lakes of Plön three new species of these forms, *Ichthyidium forcipatum* sp. n., *Chætonotus chuni* sp. n., *Dasydytes stylifer* sp. n. The first-named owes its name to the long forked tail, which resembles the forceps of the earwig. The new species of *Chætonotus* has its forked-tail distinctly expanded, the edges of the expansion bearing two slight depressions. The third form is characterised by the nature of the bristles in the posterior region.

Rotifera.

New Rotifer.** — Max Voigt gives a short description of *Cœlopus rousseti* sp. n., which he has found in the lakes near Plön, and which

* Atti R. Accad. Lincei (Rend.), cxcviii. (1901) pp. 307-14.

† Atti Soc. Tosc. Sci. Nat., xiii. (1902) pp. 4-5.

‡ Proc. Linn. Soc. N.S. Wales, xxvi. (1901) pp. 334-8 (1 pl.).

§ Proc. and Trans. Liverpool Biol. Soc., xv. (1901) pp. 242-78 (4 pls.).

|| Norske Nordhavs-Expéd., xxviii. (1901) viii. and 131 pp., 2 figs. and a map.

¶ Zool. Anzeig., xxv. (1901) pp. 37-8.

** Tom. cit., pp. 38-9.

he has named after the Curator of the Royal Microscopical Society. The principal distinctive feature is that the short and slightly curved lorica is deeply serrated in front, having nine large teeth on the anterior edge, and two unequal and but slightly curved toes. The size of the body is 95 μ . A further description with figure is promised in the next volume of the *Plöner Forschungsberichte*.

Chas. F. Rousselet* describes *Triarthra brachiata* sp. n., a very small species allied to *T. brevispina*, but with larger skipping spines, which are quite broad and arm-like at their base. A good figure accompanies the description. The author adds some general remarks on the protective use of spines in *Triarthra*.

Coelentera.

An Interesting Medusoid.†—A. Linko describes, from a collection off the Murman Coast, an interesting Medusoid which seemed to be nearly allied to *Sarsia brachygaster* Grönberg, but differed from it in the absence of ocelli and in the form of the manubrium. Sections showed that the manubrium bore four endodermic inter-radial longitudinal folds from the stomach to near the mouth. These folds suggested the tæniolæ of *Acalephæ*, but they seemed to be wholly digestive, for the gonads were located in the ectoderm.

Occurrence of Cladonema in the Bahamas.‡—H. F. Perkins records the finding of a representative of this genus, hitherto only known from Northern Europe, in Nassau Harbour, where it was taken in the tow-net. The distinctions from the European *C. radiatum* seem in themselves sufficient to warrant the erection of a new species, but this view is rendered more doubtful by the fact that the European form is known to be exceedingly variable, and meantime the author reserves judgment on the point. The living medusa possessed the power of attaching itself by means of its tentacles, and then, in spite of its minute size, required some force before it could be dislodged. A fully illustrated account of the structure is given.

Development of Cordylophora lacustris.§—Paul Morgenstern sums up his investigations on this subject as follows:—The female sex-cells have an ectodermal origin, and arise in the embryonic zone of the stalk of the chief hydranth. Even at an early stage a distinction into egg-cells and nutritive-cells is obvious, and this becomes more marked in the gonophore where the eggs ripen. After maturation is accomplished by the extrusion of two polar bodies, the ectoderm and endoderm of the gonophore undergo degeneration, and then fertilisation takes place. The formation of polar bodies, fertilisation, and the formation of the first segmentation spindle, all occur at the same pole. Segmentation is approximately regular, and results in the formation of a large segmentation cavity. The formation of endoderm results from the tangential division of the blastomeres, and is multipolar. But the solid cell-mass which arises in this way is not to be regarded as the result of segmentation;

* Journ. Quek. Micr. Club, viii. (1901) pp. 143-5 (1 pl.).

† Zool. Anzeig., xxv. (1902) pp. 162-4 (2 figs.).

‡ Johns Hopkins Univ. Circ., xxi. (1902) pp. 25-7 (1 pl.).

§ Zeitschr. wiss. Zool., lxx. (1901) pp. 567-91 (2 pls.).

it constitutes the two-layered embryo. The gastral cavity arises by the absorption of certain of the endoderm-cells. Then follows the swarming period during which no sign of mouth or tentacles is apparent. Fixation occurs by the pole which is anterior in the planula stage, and afterwards mouth and tentacles arise at the opposite pole.

Structure of *Alcyonium digitatum*.* — Prof. S. J. Hickson contributes a memoir on this subject to the series in process of publication by the Liverpool Marine Biological Committee. In regard to reproduction, Prof. Hickson's experience is that at Plymouth spawning takes place only during the last fortnight of December and the first fortnight of January. In the Isle of Man the time is probably later, as larvae apparently of this species have been found in spring ("Easter"). The memoir is based upon Prof. Hickson's previously published observations.

Relationships of Rugose Corals. † — J. E. Duerden has been able to study a series of sections of the fossil *Lophophyllum proliferum* in an unusually fine state of preservation, and to make out the order of succession of the septa. He finds that, as stated by Pourtalès thirty years ago, this coral is primarily hexamerous, not tetramerous, for there are six primary septa, separated by six interseptal spaces. Subsequent septa only appear within four of the six primary interseptal spaces, and of these the larger, which are entosepta, all appear before the smaller or exosepta. According to the author, the Rugosa must therefore be regarded as nearer to the Zoanthids than to any other type of Anthozoa. He suggests the following arrangement to indicate the different types of metacnemic sequence now known in Actiniaria and Madreporaria, and the position amongst them of Rugosa:—

(1) The metacnemes arise as unilateral pairs at one, three, seven, &c., regions within all the six primary exocoelæ, and become arranged in one, two, three, or more cycles—

(a) Non-skeletal. Most Actinians.

(b) Skeleton-forming. Most recent Madreporarian corals.

(2) The metacnemes arise as bilateral pairs at only one region within two or more of the primary exocoelæ—

(a) Non-skeletal. Zoanthids.

(b) Skeleton-forming. *Lophophyllum*, and probably other Rugosa.

(3) The metacnemes arise as bilateral pairs at one region within one or both of the axial exocoelæ—

(a) Non-skeletal. Cerianthids.

(b) Skeleton-forming. *Porites*. *Madrepora*.

Position of *Neostroma*. ‡ — Prof. A. Tornquist gives an account of *Neostroma sumatraensis* sp. n., and shows that it is a mesozoic Stromatoporida, referable to the family Disjectoporidae. The three families of Stromatoporidae (or Lamellatazoa)—Stromatoporidae, Actinostromidae, and Disjectoporidae—extend far into the Mesozoic, and it is not beyond the limits of possibility that living representatives may be found. Of their relation to other Hydrozoa nothing can be safely said.

* Proc. and Trans. Liverpool Biol. Soc., xv. (1901) pp. 92-113 (2 pls.).

† Johns Hopkins Univ. Circ., xxi. (1902) pp. 19-25 (12 figs.).

‡ SB. Preuss. Akad., 1901, pp. 1115-23 (5 figs.).

Porifera.

Modifications or Metampy in Halichondria panicea and in Suberites domuncula.*—George Bidder contrasts the deep-water *H. panicea* of Exmouth with the surf specimens from Plymouth, and the dense *S. domuncula* from the back of a hermit-crab with looser (ripe plum-like) specimens found growing on rock in the deep waters of Millbay Channel. The differences are referable to the differences in the conditions of life; they are not due to germinal variations. It appears useful, in instances where this can be proved, to have a term for such observed difference, and Mr. Bidder suggests "metamp" (from μεταμπεχομαι = "to put on a different dress"). But would not the technical use of the word "modification," or the term "somatic modification" suffice? The author believes that not only varieties, but many so-called species of sponges, are merely "metamps" of each other.

Sycon compressum.†—George Bidder asks whether the unique dermal spicules of this sponge are adaptive to peculiar circumstances in its mode of life. Though apparently fragile, it is a sponge with great endurance, able to resist evaporation and the entrance of noxious fluids. While *S. compressum* and *S. ciliatum* live side by side in every sheltered cranny, on the working tops of the rocks *S. compressum* is alone—often with little even of seaweed hardy enough to bear it company—exposed for hours every day to sun, rain, or wind. The thick, continuous cortex, set with its dense mass of club-shaped radial spicules, enables the sponge to pursue its daring existence, clothing it with a deep armour of calcareous mosaic, through which, when the skin is contracted on its pores, a minimum amount of permeation and evaporation can take place. The shillelagh-like outer ends of the spicules serve, like the heads of iron nails set in a pile at sea, to cover and protect the surface of the substance in which their points are embedded. The flat form, whose sides come gradually together if evaporation occurs, is also adaptive. No bubble is ever formed in the cloaca. Thus "the most definitely characterised common species of sponge has the most definite use for its species characters."

Sponges from New South Wales.‡—Thomas Whitelegge describes a collection of six hundred and thirty sponges from the coast of New South Wales. In naming the sponges from the type-collection in the Australian Museum, he found that the descriptions in Dr. R. von Lendenfeld's 'Descriptive Catalogue of the Sponges in the Australian Museum' do not agree in many cases with the characters of the type specimens, and he therefore regards the Catalogue as unreliable for the determination of species, and rejects many of von Lendenfeld's names. About eight species and varieties of the sponges in the collection prove to be of economic value.

Protozoa.

"Artificial Protoplasm."§—H. S. Jennings gives a very interesting account of a series of experiments designed to illustrate the protoplasmic

* Journ. Mar. Biol. Ass., vi. (1902) pp. 380-2. † Tom. cit., pp. 376-80.

‡ Records of Australian Museum, Sydney, iv. (1901) pp. 55-118 (15 pls.).

§ Journ. of Applied Microscopy and Laboratory Methods, Rochester, N.Y., v. (1901) pp. 1597-1602.

activities by means of artificial imitations of protoplasm. A drop of clove oil in a mixture of three parts of glycerin and one part of 96 p.c. alcohol will behave like an amœba, putting out pseudopodial processes, creeping about, and even dividing. More than this, by adding a drop of alcohol to the drop it is possible to cause it to move in a definite direction—towards the side at which the alcohol was introduced, and by heating areas of the medium, it is possible to make the artificial amœba react to the stimulus of heat as a living one does. Again, if an artificial amœba be made with a drop of chloroform floating on water, it is possible to imitate the apparent choice of food-substances which is so striking a feature of the living organism. In brief, the chloroform drop is attracted to and flows round such substances as it is able to dissolve, just as an amœba flows round particles it is able to digest; both amœba and chloroform drop are repelled from substances they cannot dissolve. Very striking is an experiment whereby a chloroform drop is seen to fold up and enclose a thin thread of shellac, many times longer than the diameter of the drop, just as an amœba folds up and encloses a long thread of an alga. Again, drops of chloroform can be made to build up shells from fine particles of glass, entirely analogous to the shells formed naturally by *Diffugia*. The author gives such details as to render possible the repetition of his experiments.

Radiolarians of Faroë Channel and Shetlands.*—Dr. R. N. Wolfenden has made some interesting discoveries in his plankton investigations round the Shetlands and in the Faroë Channel. A new species of *Collozoum* (*C. brandtii*) occurred in great swarms; *Thalassiosolen atlanticus* is a new genus and species; the singular Challengerida were not uncommon, e.g. *Challengeron walwini* sp. n. and *Challengeria zelandica* sp. n.

Changes in the Geotaxis of Paramœcium aurelia.†—J. Sosnowski points out that this infusorian usually exhibits negative geotaxis; it swims to the top of an upright tube. But in some cultures, after the shaking involved in transferring the individuals to the upright tube, there is in some cases a very marked temporary positive geotropism, for the individuals swim to the foot of the tube. A rise of temperature, in some cases to 24° C., in other cases to 37° C., was found to have a similar effect in changing negative to positive geotaxis. The investigator notes that chemical changes in the medium have a similar influence.

Reactions of Infusorians to Carbonic and other Acids.‡—H. S. Jennings and E. M. Moore show by very careful experiments: (1) that some infusorians, e.g. *Colpidium colpoda*, *Cyclidium glaucoma*, and *Chilomonas paramœcium*, collect in solutions of carbonic and other acids, just as *Paramœcium* does, so that the spontaneous collections of these organisms may be due to their excretion of carbon dioxide; (2) that others, *Loxozephalus granulatus* and *Oxytricha veruginosa*, form spontaneous collections similar to those of *Paramœcium*, but do not gather in carbonic or other acids, so that their aggregations must be due to other causes; (3) that many, e.g. *Oxytricha fallax*, *Euplotes charon*, *Stylometra pustulata*,

* Journ. Mar. Biol. Ass., vi. (1902) pp. 344-61 (2 pls. and 1 chart).

† Verh. Akad. Wiss. Krakaw, xxxviii. See Bot. Centralbl., lxxxviii. (1901) pp. 199-200.

‡ Amer. Journ. Physiol., vi. (1902) pp. 233-50 (6 figs.).

neither collect in carbonic or other acids, and were not observed to form spontaneous gatherings.

Comparative Morphology of Hypotrichous Infusoria.* — Hans Wallengren points out that, although it is well known that the cirri in the Hypotricha are very different in the newly formed daughter-cells and in the adult, and undergo a series of changes after the division, yet these changes have not as yet been worked out in detail. There can be no doubt that the Hypotricha which are most richly ciliated are more primitive than those in which the cilia are reduced in number, and on the basis of this assumption the author has worked out the changes undergone during and after division by a series of forms, choosing both primitive and differentiated types. The object of the investigation was to determine whether or not homologies exist between the cirri of the different forms. Prior to division the old cirri are absorbed, and six rows of cilia appear, whose members undergo changes of position, and become ultimately transformed into the adult cirri. In the five species studied these six rows are all homologous, and it is possible to derive the adult condition in each case from a type by varying degrees of reduction, the reduction always taking place after a precisely similar fashion.

New Ciliata. † — Max Voigt describes, from the lakes of Plön, *Didinium cinctum* sp. n., a brown, free-swimming Protozoon with a ring of cilia round the anterior distended part of the body and six longitudinal rows passing backwards from this. The mouth is at the anterior end, and the contractile vacuole close to the posterior end near the anus. On *Canthocamptus staphylinus* the author also took a new stalked Protozoon with a test which he places in the genus *Cothurniopsis* as *C. longipes* sp. n. The stalk is very long, and each test contains two individuals.

New Species of Peridinium. ‡ — Dr. A. Garbini describes *Peridinium alatum* sp. n., a new member of the plankton of the Lake of Monate. It closely resembles *P. tabulatum* in general appearance, but differs in the presence of three rigid, membranous wing-like structures. Of these, two are anterior and ear-like, the third posterior, and resembling a caudal fin. All are transparent and delicately undulated. In the same paper the author gives a list of the commoner members of the plankton of the lake.

Adaptability of Infusoria to Concentrated Solutions.§ — Romuald Minkiewicz states that Atsushi Yasuda,|| in his paper bearing the above title, has greatly minimised the value of his observations by a want of care in the identification of the species employed in the experiments. He maintains especially that the form described by Yasuda as *Mallomonas plösslii* is not a species of *Mallomonas* at all, but is a species of *Cyclidium*, and is shown by the author's own figure to be totally devoid of the brown chromatophore characteristic of *Mallomonas* as of other *Chrysomonadina*.

* Handl. K. Svensk. Vet.-Akad., xxvi. (1901) pp. 1-31 (18 figs.).

† Zool. Anzeig., xxv. (1901) p. 36.

‡ Tom. cit., pp. 123-4 (2 figs.).

§ Tom. cit., pp. 124-5.

|| Journ. Coll. Sci. Imp. Tokyo, xiii. (1900) pp. 101-40 (3 pls.).

Conjugation in Trypanosoma of Rat. * — H. Stassano briefly describes what he interprets as conjugation-processes in the *Trypanosoma* of the rat (7–10 days after inoculation). Individuals were seen united, the anterior end of the one to the posterior end of the other, and the author made some observations on the behaviour of the nuclei. But more detailed descriptions and figures seem desirable.

Protozoan Parasite in Plaice. † — James Johnstone describes certain remarkable appearances noticed in the gut of two specimens of *Pleuronectes platessa*, apparently due to the presence of a Sporozoon. In both cases the intestine, from the pylorus to near the anus, was thickened and granulated, so that its wall resembled the ripe ovary. Sections showed that the mucosa had disappeared, and the sub-mucosa was crowded with little spherical bodies consisting of capsules filled with minute spore-like bodies.

* C.R. Soc. Biol. Paris, liii. (1901) pp. 14–6. See Centralbl. Bakt., xxx. (1901) p. 312.

† Proc. and Trans. Liverpool Biol. Soc., xv. (1901) pp. 184–7 (1 pl.).



BOTANY.

GENERAL,

Including the Anatomy and Physiology of Seed Plants.

Cytology,

including Cell-Contents.

On Fibrillar Structure of Protoplasm.*—G. Haberlandt confirms Němec's description of the fibrillar structure of protoplasmic strands in living cells from the perome layer of the root-tip of the onion, and also in adventitious roots of *Aspidium violascens*. He points out that reference to such a structure has previously been made by various observers of protoplasmic movement. His preparations as the result of fixing and staining were also identical with those of Němec. The suggestion is made that the fibrillar structure is associated with the conduction of plastic food-stuffs.

Refringent Globules in the Parenchyma of Leaves.†—L. Petit calls attention to the frequent occurrence, in the chlorophyll parenchyma of leaves, of strongly refringent globules (usually single), to which he applies the term *spherulin*. As a rule their presence or absence is characteristic of the greater number of genera in a family. They are most frequent in the Gamopetalæ with inferior or superior ovary, and in the Polypetalæ with inferior ovary. The author has failed to find them in the Apetalæ, or in the Polypetalæ with superior ovary, except in the Rosaceæ.

Structure and Development.

Vegetative.

On the Ksopo or Tanghin de Menabé (Menabea venenata Baill.), a Poison Plant of the Sakalaves.‡—E. Perrot gives an account of the morphology and histology of this member of the Asclepiadaceæ. The latex contains a virulent poison, which resides principally in the root.

Stem of Pteridophytes and Gymnosperms.§—Starting from the conception that Van Tieghem's polystelic type of stem does not originate by the repeated bifurcation of the epicotyledonary central cylinder, but that the latter becomes at first a concentric fibrovascular tube, with gaps for the branches alone, or with gaps for both leaves and branches,—Dr. E. C. Jeffrey believes he has found, in the Osmundaceæ, evidence of the derivation of the medullated monostelic and astelic types from the siphonostelic condition with internal phloem by the degeneration of the latter. He is of opinion that there are two great primitive stocks of vascular plants,—the Lycopsidea and the Pteropsida. The former

* Ber. Deutsch. Bot. Ges., xix. (1902) pp. 569-78 (1 pl.).

† Comptes Rendus, cxxxiii. (1901) pp. 1250-2.

‡ Op. cit., cxxxiv. (1902) pp. 303-6.

§ Proc. Roy. Soc., lxix. (1901) pp. 119-20.

include the Lycopodiales and the Equisetales, and are palingenetically microphyllous and cladosophonic; the latter include the Filicales and Phanerogams, which are primitively megaphyllous and phyllosiphonic.

Anatomical Investigation of the Leaf and of the Axis in the Lipariæ and Bossiæ (Tribe Genisteæ).*—A. Schroeder has worked out the details of the anatomy of the leaf and stem in the genera included by Bentham and Hooker in these two subtribes of the tribe Genisteæ. These genera are characterised by simple leaves associated with a marked xerophilous habit, and are natives of South Africa and Australia. Leathery texture, reduction in size of blade, rolling under of the margins, hairiness, and appression to the stem are notable characters, while in the species of *Bossiæ* and *Templetonia* the leaves are reduced to rudiments and the axis becomes assimilatory. The author describes in detail the characters of the epidermal cells, the distribution of the stomata on the upper and lower leaf-surfaces, and their position relatively to the general level of the epidermis, the arrangement of the mesophyll, which may be bifacial or show a greater or less tendency to a centric development, the character of the veins, the form of the calcium oxalate crystals, and the structure of the hairs.

As regards the stem anatomy, the author confirms the presence of the characters previously indicated by Solereder for the Papilionaceæ as a whole, namely, simple perforation of the vessels, the constitution of the ground-substance of the wood of simple-pitted wood-fibres, and the relation between the pitting of the vessels and parenchyma. He also notes the relative small lumen of the vessels, narrow medullary rays and superficial development of cork. Presence or absence of spiral thickening of the pitted vessels, and the character of the pericycle, whether composed of isolated groups of bast-fibres, or forming a broken or continuous sclerenchyma ring, are points of variation.

The South Australian genus *Goodia*, which is exceptional in having compound leaves, should, the author suggests, preferably be included in the tribe Galegeæ.

Histology of the Sieve-tubes of Pinus.†—A. W. Hill has made a careful investigation of the sieve-tubes of *Pinus* by means of W. Gardiner's methods for demonstrating cell-connections. The youngest sieve-plates examined showed connecting threads like those in parenchymatous tissues. In the "boundary cells" (youngest thick-walled sieve-tubes) the threads have been changed, apparently by ferment action, into slime-strings, around which are formed the callus rods, while at the middle lamella the median nodule encloses the nodes of the slime-strings. The author describes the effect of ferment action on the threads in the endosperm-walls of germinating seeds of *Tamus*, and points out its similarity to the state of affairs in the developing sieve-plates of *Pinus*. He has also worked out the development of the plates between the albuminous cells of the medullary ray and the sieve-tubes, and finds that the portions of the thread on the sieve-tube side of the middle lamella undergo changes precisely similar to those described for the sieve-plates, whilst the shorter portions on the cell-side of the

* Beiheft. Bot. Centralbl., xi. (1902) pp. 368-417.

† Ann. Bot., xv. (1901) pp. 575-611 (3 pls.).

lamella retain their protoplasmic character. The vexed question as to the origin of callus is discussed, and reasons are given for the view, previously suggested by Kandle in the case of the callus-formation in the "vesicular vessels" of the onion, namely, that it may be formed partly by alteration of the cell-wall, partly by deposition from the protoplasm. The function of the callus rods seems to be the regulation of the size of the pores of the active sieve-plate, while the further development of the callus-cushions finally closes them entirely.

Structure of the Tuberos Roots of *Thrinicia tuberosa*.*—A. Maige and C. L. Gatin find an interesting and peculiar method of secondary thickening in the roots of this Composite which is common in the neighbourhood of Algiers. At the base of the stem each year are formed adventitious roots which become much thickened near their point of insertion. The primary structure is normal, but whereas in the non-tuberos upper part of the root a normal cambium layer is produced, in the tuberos portions this is replaced by a number of separate layers. Each of these surrounds a bundle of primary wood, and produces on the outside secondary parenchyma in which are formed islands of secreting cells, and on the inside radiating threads of polyhedral cells, some of which become differentiated into wood-vessels. There are thus formed at the periphery of the central cylinder a number of rounded areas of secondary tissue, each resembling a small stele. The cortical layers become stretched and divided tangentially to allow of this increase in bulk of the central tissues. Inulin is secreted in these secondary formations, and subsequently used by the plant as it is not found in the withered tubers.

Sucker of *Loranthus aphyllus*.† — Sir W. T. Thiselton-Dyer describes the external appearance of the haustorium of this remarkable leafless parasite which grows on the leafless spine-bearing stems of the Chilian *Cereus Quisco*. The sucker has a thalloid appearance and ramifies widely in the cortex of the host, sending up aerial shoots which always emerge on the upper side of the spine-tufts. An examination of the anatomy of the structure by Mr. L. A. Boodle showed that the sucker is completely covered by a layer of periderm formed in the enveloping cortex of the cactus.

Bladders of *Utricularia*.—H. Meierhofer ‡ has studied the development of the bladders in several species of *Utricularia*, and has established that, from a morphological point of view, they are leaves or segments of leaves. Though they unquestionably act as floating organs, they are not indispensable to the plant in this respect. While the "antennæ" prevent the access to the bladders of animals of any considerable size, he attributes importance to the fact that the ciliated Infusorians, especially *Paramœcium caudatum*, are positively chemotactic to weak acid solutions. All the shoots, even the smallest (in *U. vulgaris*) form winter-buds, and the production of ripe seeds is rare. All the glands, both the 2-armed and the 4-armed, are trichomic, originating from a single epidermal cell. The nutritive or insectivorous function of the bladders was fully established.

* Comptes Rendus, cxxxiv. (1902) pp. 302-3.

† Ann. Bot., xv. (1901) pp. 749-57 (1 pl.).

‡ Flora, xc. (1902) pp. 84-113 (9 pls.).

Dr. S. Prowasek * also describes the formation of both the 2-armed and the 4-armed glands of *Utricularia vulgaris*. The 4-armed glands possess the property of absorbing ammonium carbonate and nitrate, as well as the products of decaying animal substances; the bacteria which occur in the bladder play but an unimportant part in digestion.

Green Hemi-Parasites. †—H. Heinricher now gives, in considerably greater detail, his observations on the germination and development of *Bartsia* (*Bartschia* in op.) *alpina*, and *Tozzia alpina*, both belonging to the Rhinanthææ.

In *Bartsia alpina* haustoria make their appearance on the root in a very early stage of germination. This fact, and the entire absence of root-hairs, seem to prove that parasitism is absolutely essential for this species; and this was confirmed by the constant failure to keep autonomous plants alive for more than a few months. It appears to have no exclusive host; the haustoria will attach themselves to roots of both Monocotyledons and Dicotyledons; like, however, most Rhinanthææ, especially *Euphrasia* and *Alectorolophus*, this species has retained its power of assimilation. The parallel is further drawn between *Bartsia* and *Lathræa*, and especially between *B. alpina* and *L. clandestina*.

The seed-vessel of *Tozzia* is not a capsule, but a nucule. The seeds contain a very small embryo. Unlike all other green Rhinanthææ, the cotyledons are developed underground. Again, *Tozzia* resembles *Orobanche* and *Lathræa*, and differs from all other Rhinanthææ, in requiring the chemical irritation of the root of the host-plant for the full germination of its seeds. *Tozzia alpina* may blossom the second year after germination, while *Bartsia alpina* requires four or five years. After once blossoming, the plant perishes. Artificially, *Tozzia* was cultivated on *Alchemilla vulgaris*, *Rumex alpinus*, and *Ranunculus lanuginosus*; doubtfully on a grass, and on *Medicago lupulina*. During by far the greater part of its life it is holoparasitic; its hemi-parasitic life lasts only for a few weeks. Its power of assimilating is much less than that of other green Rhinanthææ.

Some further anatomical details respecting *Tozzia* are given, and the probable genetic connection of the Rhinanthææ and Lathrææ with one another and with non-parasitic forms is discussed.

Formation of New Stems from Old Willows. ‡—Dr. G. Fischler describes the process of rejuvenescence of portions of the stem which occasionally occurs in old willows. When the heart-wood has perished we frequently find strips of the splint-wood also dying throughout the whole length from root to crown. Between these dead strips there remain strips of living splint-wood with sound bark. By the activity of the cambium on the living strip a callus is formed which gradually grows round and separates the living from the dead wood, and may ultimately form a new stem distinct from the old. Figures of sections of *Salix alba* are given in illustration of the process, with a photograph of an old tree with a dead main stem and a quite distinct and vigorous regenerated young stem.

* Verhandl. k. k. Zool.-bot. Ges. Wien, li. (1901) pp. 648-51 (11 figs.).

† Pringsheim's Jahrb. f. wiss. Bot., xxxvi. (1901) pp. 665-762 (2 pls. and 7 figs.). Cf. this Journal, 1900, p. 607.

‡ Flora, xc. (1902) pp. 273-8.

Seeds and Seedlings of *Arisæma triphyllum* and *A. Dracontium*.*
 —R. J. Rennert has made a comparative study of the seeds and seedlings in these two species. The seeds are similar, as also are the first stages in germination, but a marked difference obtains in the manner of development of the corm. In *A. triphyllum* the emergence of the hypocotyl is followed by vigorous growth of root and plumule, and it is only after the seedling has separated from the seed that the hypocotyl begins to enlarge to form the corm. In *A. Dracontium* on the other hand, the enlargement of the hypocotyl begins immediately on its emergence from the seed, while the development of root and plumule is retarded. In a large majority of cases the plumule never becomes functional, the first assimilating leaf being borne on the corm in the second season. Thus, whereas in *A. triphyllum* the corm is the product of the photosynthetic activity of the plumule, in *A. Dracontium* it is the result of the transference of the food-stuffs stored in the endosperm.

Floral.

Origin of the Flower.†—L. Nicotra describes the mode of appearance and the development of the sepals and petals, and essays to deduce therefrom a theory of anthogenesis. He regards the primitive type of flower as one consisting only of the sexual organs necessary for reproduction. The absence of a perianth may be primitive or secondary, and the absence or presence of a perianth is a very unsafe ground for classification, since this may occur in all gradations in the course of development of a single family.

Strengthening and Nourishing System in Flowers.‡—J. Herzog has studied the mechanical relations between the different floral whorls and finds that in actinomorphic flowers with clawed petals a diminution of the petal limb with a shortening and thickening of the claw is correlated with a diminution of the mechanical system in the calyx, and *vice versa*. Also that a corolla of free clawed petals is associated with a stronger calyx than an otherwise similar corolla with a gamopetalous tube. Similarly the strength of the calyx varies with the diameter and length of the corolla-tube, the form of its transverse section, and the thickness of its walls. Flowers of Papilionaceæ showed a striking relationship between the amount of mechanical tissue in the calyx and that in the lower parts of the remaining floral whorls, the amounts varying inversely in the two cases. The author also finds an increase in the tissues by which the plastic food-stuffs travel, in the androecium and gynæcium as compared with the perianth whorls.

Staminode-like Structures in *Dentaria bulbifera*.§—J. Klein describes staminode-like structures found, under certain conditions, in the flower of this crucifer, often followed by the formation of peculiar structures from the base of the pistil after the other parts of the flower have fallen. As *Dentaria bulbifera* is dependent on insects for cross-pollination, and as this does not take place in damp and shady situations, and as no siliquæ were formed on the plants which bore these peculiar

* Bull. Torrey Bot. Club, xxix. (1902) pp. 37-54.

† Atti r. Accad. Sci. Acireale, x. (1901) pp. 2-30.

‡ Ber. Deutsch. Bot. Ges., xix. (1901) pp. 564-9.

§ Tom. cit., pp. 421-8 (1 pl.).

structures, the theory of the author is that they are adventitious organs, the formation of which uses up the food-material that would otherwise be employed in the production of pollen and ovules.

Formation of the Pollen in the Asclepiadæ.*—Prof. E. Strasburger has followed the formation of the pollen in *Asclepias Cornuti*, and has found it to be much more closely in accordance with that in typical Angiosperms than has hitherto been supposed. He does not confirm the statement of Vines that in *Asclepias* each pollen-mother-cell develops directly into a pollen-grain without division. He states, on the other hand, that the pollen-grains of which the pollinium is composed are formed in fours in the mother-cells, corresponding to the divisions in the embryo-sac mother-cells; but they present the peculiarity that the two divisions take place in the same direction, so that the four daughter-cells form a row instead of an ordinary tetrad. In the nucleus of the pollen-mother-cells he found the ordinary number of chromosomes to be ten, a number not yet recorded in the reduction phenomena of generative cells. The chromosomes are very small, notwithstanding the comparatively large size of the resting nucleus. With regard to the presence of centrosomes in the division of the pollen-mother-cells, Strasburger's results were entirely negative; he was unable to confirm the statements made by other observers of their presence in similar conditions in other Angiosperms, and by Raciborski in *Asclepias*. Similar results were obtained with *Cynanchum Vincetoxicum*.

An examination by T. C. Frye† of several species of *Asclepias* and *Acerates* led to results similar to those obtained by Strasburger. A careful study showed that in the species examined the development of the microsporangies is the same in general as in other plants [Angiosperms]; while there are no indications of the phylogenetic history of the reduction in number. The primary sporogenous cells become the pollen-mother-cells without further division. The latter divide each into four with the usual phenomena of tetrad-division.

Abnormal Flowers of Forsythia viridissima Lindl.‡—M. Velenovsky describes abnormal flowers in which the sepals have become leaf-like, while the corolla is not only reduced in size, but also in number of parts. Some flowers showed only two free petals, which alternated with the inner sepals and stamens, making a regularly dimerous flower. In others the two petals were more or less split lengthwise, showing, therefore, various transition stages to the normal whorl of four, characteristic both of the genus and family to which it belongs. These cases support Eichler's view of the origin of the typical tetramerous corolla of *Oleaceæ* from doubling of two petals, and may be compared, from this point of view, with *Fraxinus dipetala*.

Physiology.

Reproduction and Embryology.

Double Fertilisation in the Solanaceæ and Gentianaceæ.§—In addition to the Compositæ, the only order of Gamopetalæ in which the

* Ber. Deutsch. Bot. Ges., xix. (1901) pp. 450-61 (1 pl.).

† Bot. Gazette, xxxii. (1901) pp. 325-31 (1 pl.).

‡ Oesterr. Bot. Zeitschr., li. (1901) pp. 325-8.

§ Comptes Rendus, cxxxiii. (1901) pp. 1268-72. Cf. this Journal, 1901, p. 173.

phenomenon of double fertilisation has at present been observed, L. Guignard now describes it in the Solanaceæ (*Nicotiana Tabacum*, *Datura lævis*), and in the Gentianaceæ (*Gentiana ciliata*). These orders present no important deviation from the process already described. With regard to the formation of the endosperm, the difference in the time when it takes place in these two orders indicates that there is not so close a relationship as has been supposed by some between the septation of the embryo-sac and its form and dimensions.

In *Nicotiana* the oosphere is well distinguished from the two synergids by its greater size. The two male gametes are formed only during the passage of the pollen-tube down the conducting tissue of the style; they consist of little besides the nucleus. Their fusion with the oosphere and the polar nuclei respectively takes place with great rapidity.

Hybridism and Xenia. * — C. Correns has studied very fully hybridism and xenia in the various races of *Zea Mays*. The work was begun in 1894 for the purpose of studying "the direct action of the pollen on the fruit" (Xenia of Focke), and a preliminary account was published in 1899. The author was then led to investigate the characters of the various hybrids produced. The investigation was carried out on the lines of Gregor Mendel's well-known work on pea hybrids, attention being paid only to certain selected characters in which the crossed races differ from one another, and the behaviour of these characters investigated in relation to xenia and the hybrids. The observations show clearly that on crossing there is produced a hybrid endosperm as well as a hybrid embryo, a result which was at first very surprising, but can now be clearly understood in the light of Nawaschin and Guignard's discovery of double fertilisation. Correns discusses critically certain other cases where the influence of the foreign pollen has been described as extending to parts of the fruit other than the endosperm, and concludes that the evidence for these is quite untrustworthy, and often capable of another explanation. He affirms that xenia occurs only in connection with the endosperm, as would be expected from the newly discovered morphological features of fertilisation. By crossing races which differ in certain pairs of characters (such as sugary and starchy endosperm, colour of aleurone layer, &c.), the exact behaviour of various characters can be studied in the hybrid. He points out that the characters must be distinguished as independent and dependent, and in the former category as free or conjugate. As Mendel showed, there are two quite distinct stages to be studied in the behaviour in a hybrid of a pair of characters derived each from a different race. The first stage is that of vegetative development, in which there are obviously two extreme cases: (1) one character only is developed, so that the hybrid shows only the characters of one parent, the other being latent; (2) both characters develop, and the hybrid shows a new intermediate character. Pairs of characters which behave in the first manner Correns calls *heterodynamic*, one being dominant and the other recessive, in Mendel's terminology. Those of the second class he calls *homodynamic*. The other stage to be studied is that of the relation of the characters to the

* Bibliotheca Botanica, Heft 53, 1901, 161 pp. and 2 pls.

sexual cells. Here, similarly, two cases can be distinguished: (1) where the sexual cells of the hybrid show each only one character, but both occur, and in equal numbers, i.e. the characters obey Mendel's law; (2) where both characters occur together in the sexual cells. Pairs of characters which behave in the first way Correns calls *schizögonous* (isogonous of De Vries), and those of the second class *homögonous* (anisogonous of De Vries). If attention is paid only to extreme cases, the author points out that four possible combinations in the behaviour of any pair of characters can obviously be distinguished: (1) heterodynamic and schizögonous; (2) heterodynamic and homögonous; (3) homodynamic and schizögonous; (4) homodynamic and homögonous. The first and fourth Correns distinguishes as the *Pisum* and *Hieracium* type respectively, for, as Mendel showed, most of the characters of these two forms behave on hybridising in the manner indicated. The third Correns characterises as the *Zea* type, for his observations show that most of the characters of *Zea Mays* hybrids behave in this special way. The second type is not yet known in nature. It is clearly shown in *Zea Mays* that some of the characters can behave in one way and some in another; thus, all the characters fully studied were homodynamic with the exception of the chemical nature of the endosperm, which was found to be heterodynamic. In relation to sexual cell-formation, the characters were in part schizögonous, in part homögonous. Those taking part in xenia seemed all schizögonous. The question of the usually preponderating effect in xenia of the characters derived from the female side is to be partly explained by the fact of the fusion of *two* polar (female) nuclei with *one* generative (male) nucleus. The fact that the sexual cells bearing the heterodynamic characters occur in equal numbers leads Correns to believe that the segregation of the characters is brought about by a nuclear division of the type of Weismann's reducing division. The question of the stage of development at which the separation of characters takes place is ably discussed. Correns concludes that in the pollen-grain it probably takes place at the time of separation of the vegetative nucleus and generative mother-nucleus; and in the ovule at the time of formation of the embryo-sac mother-cell.

Spermatogenesis and Fecundation of *Zamia*.*—H. J. Webber gives a full account of his investigations on this subject. The pollen-grains are carried by the wind to the female cones, and finally come to lie in the pollen-chamber at the apex of the nucellus. There seem to be three prothallial cells cut off from one side of the grain; the first is resorbed, as in *Gingko* and *Pinus*. In the development of stalk-cell and central or generative-cell *Zamia* corresponds closely to the Coniferæ. The blepharoplasts are formed *de novo* in the cytoplasm of the central cell; they are at first very small but gradually increase in size, reaching a maximum at the prophase stage of division of the central cell, when their contents present a beautiful regularly vacuolate structure and stain red with safranin. As the division approaches the equatorial-plate stage the blepharoplasts begin to break up, the contents contracting and gradually disappearing while the outer membrane begins to break apart here and

* U.S. Dept. of Agricult., Bureau of Plant Industry, Bull. No. 2 (1901) 92 pp. and 7 pls.

there and can be seen to be made up of very numerous granules. In an early anaphase the stainable contents have quite disappeared, and finally the blepharoplasts break up entirely into numerous granules, by which time the two daughter-nuclei in the central cell have been fairly well organised. The granules fuse to form a band, while the daughter-nuclei reach a resting condition and form the spermatid cells, each of which is then metamorphosed directly into a spermatozoid. The bands form a helicoid spiral around the spermatid, and in a very early stage protuberances can be distinguished in its outer surface which ultimately grow into cilia.

Meanwhile, the grain ends of the pollen-tubes have grown down and come to hang free in the archegonial chamber. In fertilisation they push against the neck-cells and finally burst and discharge the spermatozoids over the archegonia. The fluid in which the spermatozoids swim is certainly derived in part from the pollen-tube, and may be partially formed by extrusion from the egg-cell. The mature spermatozoids are the largest known to occur in any plant or animal, and are visible to the naked eye. They are ovate or nearly spherical; their motion is mainly by means of the cilia, but they have also a sort of selective amoeboid motion of the spiral end. The entire spermatozoid enters the egg-cell, swimming in between the ruptured neck-cells; the cilia-bearing band remains at the apex of the cell while the nucleus passes on and fuses with the egg-nucleus. At the same time the spermatozoid cytoplasm fuses with the egg-cytoplasm. The first division of the egg-nucleus was not observed, but the second and later divisions were carefully studied. In no case has any centrosome been noticed. The cilia-bearing band has certainly no function in the formation of the first cleavage spindle, or the spindles in any of the divisions immediately following, as it remains intact at the apex of the egg-cell until the egg-nucleus has divided into very many small nuclei; it disappears later. It appears to be simply a mechanism for transference of the functional male cell, and not comparable with centrosome or centrosphere, as it is located entirely outside of the spindle, and has no connection with the spindle formation. It is moreover limited to the division of a single cell, no similar organ appearing in any other stage of the plant's development.

Nutrition and Growth.

Development of *Sauromatum guttatum* Schott.* — K. Genau describes an experiment in which this Himalayan Aroid was grown from the tuber up to complete opening of the flower without receiving any external supply of water. Plants were grown both in the light and dark; in the former case the plant began to wither after about five weeks, having lost in the meantime 21.5 p.c. of its weight. In the dark the plant grew for six weeks before beginning to wither and lost only 17 p.c. of its weight. The tuber contains a very large amount of water (over 84 p.c. was found in one examined) which is protected from evaporation by a thick periderm immediately inside which is a layer of parenchymatous cells rich in mucilage.

* Oesterr. Bot. Zeitschr., li. (1901) pp. 321-5.

Nutrition of the Seedling at the Expense of its Cotyledons.*—G. André tabulates the results of determinations taken at different periods after germination, of the relative weight of the seedling (i.e. of the root, stem, and leaves) and of the cotyledons, in the case of *Phaseolus multiflorus*. The results were taken at five intervals, respectively 9, 11, 13, 15, and 17 days after the commencement of germination. At the last period the weight of the ashes of the cotyledons was not more than two-fifths of that of the seed. The tables show the relative rapidity with which the various mineral ingredients were withdrawn from the cotyledons by the growing seedling. The fatty matters disappear gradually from the cotyledons, while the soluble carbohydrates are absorbed rapidly during the early stages of germination, as also do those which are converted into sugar by dilute acids. The mineral matters are never completely absorbed.

Necessity of Lime for Plants.†—L. Ritter v. Portheim disputes the statement of previous observers that, at a high temperature, lime is not necessary for the germination of seedlings. He found the contrary to be the case with the species experimented on, viz.:—*Lepidium sativum*, *Rumex Acetosella*, *Secale cereale*, *Hordeum*, *Triticum*, *Avena sativa*, *Larix europæa*, and *Pinus sylvestris*. The absence of lime produces all the symptoms of poisoning caused by the great accumulation of acid potassium oxalate when no calcium salt is present.

Influence of Mineral Salts on the Production of Root-tubercles in Pisum.—As the result of a series of experiments on growing a variety of the garden pea in soils of different compositions, E. Marchal ‡ finds a confirmation of the view that their formation is dependent on a deficiency of nitrogen in the soil. The presence of alkaline nitrates to the extent of 0·01 p.c. prevents the formation of the tubercles; salts of ammonium, in the proportion of 0·05 p.c., have the same effect; as also have salts of potassium to the amount of 0·5 p.c., and of sodium to 0·33 p.c. On the other hand, salts of calcium and magnesium promote the formation of the tubercles; and this is also usually the case with phosphoric acid, though dependent on the base with which it is combined.

Similar results were obtained by E. Laurent, § except that, in the case of *Faba*, nitrogenous manures were found to promote, instead of to hinder the production of tubercles.

Action of Copper on the Growth of Living Cells.||—D. Miani has experimented on the effect produced on the germination of pollen-grains and fungus-spores by contact with the water in which they germinate of coins or some other form of metallic copper. If the cuprification of the water is only very slight, the effect on germination is a decidedly favourable one, germination taking place more rapidly, and the pollen-tubes being better developed. If the surrounding air is saturated with moisture, it is not necessary for the copper to be actually in contact with the hanging drop in which the pollen-grains germinate. The pollen experimented on belonged to a number of different species.

* Comptes Rendus, cxxxiii. (1901) pp. 1011-3, 1229-31.

† Sitzungsber. k. Akad. Wiss. Wien, cx. (1901). See Bot. Centralbl., lxxxviii. (1901) p. 282.

‡ Comptes Rendus, cxxxiii. (1901) pp. 1032-3.

§ Tom. cit., pp. 1241-3. || Ber. Deutsch. Bot. Ges., xix. (1901) pp. 461-4.

Nitrates and the Carbon-Assimilation of Algæ.*—A. E. N. Arber has continued his experiments on the effect of salts on the carbon-assimilation of *Ulva latissima* and other green sea-weeds. He finds that the addition of a nitrate to sea-water causes an inhibition of the carbon-assimilation, the extent of which varies with the nature of the base. Thus the presence of ammonium nitrate quickly proves fatal, while potassium nitrate has a greater effect than sodium nitrate. The addition of magnesium nitrate, which is normally present in sea-water, causes the least marked inhibition. He also finds that the presence of an appreciable quantity of potassium phosphate causes considerable inhibition.

Germinating Power of the Seeds of Cereals.†—Dr. A. Burgerstein has made a further observation on the power of seeds to retain their germinating power under favourable circumstances. He found that grains of maize lost their power of germinating after 10, those of wheat after 15 years; while after this latter period 75 p.c. of grains of barley and oat germinated and produced normal plants.

“Ageing” of the Embryo of Grasses.‡—E. Gain has continued his observation on the grains of a variety of cereals obtained from Egyptian mummies. The changes which take place during long periods in the embryo, and which are either the cause or the result of its loss of vitality, are indicated by a gradually deepening brown tint; and the depth of this colour is a rough indication of the age of the grain.

Irritability.

Position of Flowers with respect to Light.§—Prof. J. Wiesner points out that flowers are governed by the same laws as leaves in respect to their exposure to light. The formation of flowers especially on the side facing the light, is not necessarily the result of heliotropism, but may be a phenomenon of *phototrophy*, i.e. the stronger development of organs or of tissues on the more strongly illuminated side, in plants which are unequally illuminated on different sides. Phototropic flowers are hence contrasted with photometric; though the object is the same in both cases, viz. to render the flowers as accessible as possible to visiting insects. Leaves are *euphotometric*, i.e. are so placed as to receive the greatest possible amount of light, when the plane of the blade is vertical to the direction of the strongest diffused daylight; in euphotometric flowers, the opening of the flower is vertical to the direction of greatest illumination. A good example is furnished by *Ipomœa purpurea*.

Resistance of Seeds to Low Temperatures.||—Experiments by A. D. Selby confirm the results arrived at by Thiselton-Dyer and others. With the seeds of a number of different plants, immersed for periods varying from 3 to 28 days in liquid air (-190° C.), some suddenly, some gradually, it was not apparent that any marked unfavourable effect on their germination could be traced to their immersion.

* Ann. Bot., xv. (1901) pp. 669-81.

† Verhandl. k. k. Zool.-bot. Ges. Wien, li. (1901) pp. 645-7.

‡ Comptes Rendus. cxxxiii. (1901) pp. 1248-50. Cf. this Journal, 1900, p. 640.

§ Biol. Centrabl., xxi. (1901) pp. 801-14. Cf. this Journal, 1899, p. 599.

|| Bull. Torrey Bot. Club, xxviii. (1901) pp. 675-9. Cf. this Journal, 1900, p. 84.

Chemical Changes.

Oxidising Enzymes.*—C. R. Newton suggests the use of suitable enzymes, procured from other plants, to aid and intensify the action of the enzyme, these, already existing in the tea-leaf, which is the principal factor in the fermentation of the leaf. The author states that considerable improvement in quality has taken place in those cases in which he was able to try the plan; and believes that if successful it will probably have greater effects on the tobacco industry than on that of tea.

Proteolytic Enzyme of *Nepenthes*.†—Prof. Vines criticises the results of experiments *in vitro* by the late Georges Clautriau who concluded that the proteolytic enzyme present in the pitchers of *Nepenthes* was a pepsin, that is, an enzyme acting on the higher proteids in an acid medium giving rise to peptones, but incapable of decomposing proteids into non-proteid substances, such as leucin and tyrosin. Clautriau had also adversely criticised Vines's statement that the enzyme is not peptic, but tryptic in action. In his present paper the author adduces the tryptophan reaction in support of his view. It has been shown that chlorine-water when added to the liquid resulting from a pancreatic (tryptic) digestion, gives after acidification, a colour varying, according to concentration, from pink to violet. This coloration is due to the presence of a substance (tryptophan) which together with leucin, tyrosin, and other bodies, is a product of tryptic, as distinguished from peptic, proteolysis. Vines obtains this colour reaction with the liquids resulting from the digestion in pitchers of *Nepenthes*, and also from the digestion of fibrin by pine-apple juice and papain. He therefore concludes that the three enzymes, nepenthin, bromelin, and papain, have essentially the same proteolytic action—a tryptic one, though they differ as regards the media in which they act. Nepenthin, like pepsin, acts only in acid liquids, bromelin and papain are most active in neutral liquids, while the animal ferment trypsin is most active in alkaline liquids. These results strengthen the suggestion that all known proteolytic plant enzymes are tryptic in action.

Starch-formation in *Hydrodictyon utriculatum*.‡—H. G. Timberlake investigates the nature of the relation of the pyrenoid to the formation of starch. *Hydrodictyon* contains no differentiated chromatophore, both pyrenoids and nuclei are scattered throughout the protoplasmic layer, often in immediate juxtaposition. The whole process of starch-formation can be traced from structural changes occurring in the body of the pyrenoid, the first indication of which is its differentiation into two portions, one of which is transformed into a starch-grain, while the other remains unchanged. The starch-grain when formed is separated from the pyrenoid and appears to lie in a vesicle or vacuole in the cytoplasm. When starch-formation is going on very rapidly, the grains, as they are formed, are continually crowded outward by the later-formed grains, so that finally they are densely packed through nearly the whole protoplast.

* Indian Gardening and Planting, Nov. 28, 1901.

† Ann. Bot., xv. (1901) pp. 564-73.

‡ Tom. cit., pp. 619-35 (1 pl.).

Transformation of Fatty Matters into Sugars in Oily Grains during Germination.*—M. P. Mazé describes some experiments with seeds of *Arachis* which indicate that the digestion of fats during germination is effected by a progressive fixation of oxygen from the air, accompanied probably by a slight loss of carbon and resulting, on ultimate analysis, in production of sugars. The experiment was made with cotyledons from seeds which had begun to germinate; the embryo having been removed the cotyledons were exposed in glass vessels to a current of air, and the carbonic acid gas which was evolved carefully collected and estimated. The experiments lasted seventeen days.

Contributions to the Chemistry of Chlorophyll. †—Dr. Schunck finds that the fæces of animals supplied with green vegetable foods only, contain no chlorophyll but substances which are presumably chlorophyll derivatives, formed by the action of acids or other agency on the chlorophyll of the food. One of these substances is apparently identical with phylloxanthin; another seems to be a new body nearly resembling phyllocyanin. It is characterised by a fine purplish-blue colour and a brilliant metallic lustre.

General.

Distribution of Plants in the Alps and Jura Mountains. ‡—Prof. P. Jaccard has made an elaborate comparative examination of the flora of restricted areas at different altitudes and showing a variety of characteristics of soil, exposure, &c. By means of tables of distribution he works out a coefficient of specific and generic community by aid of which the degree of resemblance or difference between the floras of different stations can be estimated. He concludes that independently of general biologic factors (soil, exposure, climate, &c.) the variations in which determine the broad lines of plant distribution, there exist in every limited area local causes of variation occasioning a true elementary biologic difference which finds expression in a parallel floral difference.

CRYPTOGAMS.

General.

Homologies in the Development of Male and Female Sexual Organs.§—Starting from the agreement in structure and development of the male and female sexual organs at their first appearance in the Algæ, Prof. Goebel endeavours to show that the homology in development is retained, both in the higher Algæ and in the Archegoniata. The antheridium in *Characeæ* is a remarkably different structure from the oogonium, and the same remark applies to the antheridia and archegonia of the Archegoniata. "Yet the assumption that these organs, like the micro- and macro-sporangia of the Pteridophytes, have developed from a similar 'ground form' is an obvious one."

The author has previously discussed the homology in development of antheridia and oogonia in certain algæ, e.g. *Cedogonium* and *Cutleria*,

* Comptes Rendus, cxxxiv. (1902) pp. 309-11.

† Proc. Roy. Soc., lxxix. (1902) pp. 307-12.

‡ Bull. Soc. Vaud. Sci. Nat., xxxvii. (1901) pp. 517-79.

§ Flora, xc. (1902) pp. 279-305 (figs. in text).

and has shown that in the antheridia the spermatozoids arise through a repeated bipartition of the nucleus, i.e. on the same lines as the egg-cell in the oogonium. Divisions occur in the antheridium which are suppressed in the oogonium.

The author first reviews in detail the course of division resulting in the formation of the oogonium in *Chara* and *Nitella*, with special reference to the work of A. Braun, and more recently of Götz. The sterile cells (the *Wendungszelle* of A. Braun) are not to be considered, as Götz suggests, as representing a rudimentary archegonial-wall, but their homology is to be sought in the cell-divisions which occur in the young archegonium. Braun's term *Wendungszelle* implying an alteration in the direction of growth is misleading. The meaning of the sterile cells is probably nutritive.

In the Bryophyta the author compares the early stages in development of the antheridium of the *Marchantiaceæ* and the *Jungermanniaceæ* with that of the typical Liverwort archegonium, and concludes that the latter "corresponds to a half antheridium, or in other words, to such a one in which one longitudinal half is become sterile."

For the agreement in the plan of development of the male and female organs in the *Pteridophyta*, the author refers to his previously published 'Organographie der Pflanzen.'

Pteridophyta.

Anatomy of the Gleicheniaceæ.*—L. A. Boodle has examined the anatomy of the rhizome and petiole in various species of *Gleichenia* and in *Platyzoma microphyllum*. In *Gleichenia*, with the exception of *G. pectinata*, where it is solenostelic, the stem-structure is protostelic. *Platyzoma* has a medullate stele with annular xylem and internal endodermis. The xylem is mesarch with distinct groups of spiral protoxylem. A single leaf-trace enters the petiole; the xylem is usually in the form of an arch with incurved ends. When the bundle is small there are one median and two lateral protoxylem groups on the upper side, but in larger bundles the protoxylems are more numerous. In several species a nodal island is found in the xylem of the stele; it contains phloem and sclerenchyma, the latter surrounded by an endodermis. *Platyzoma* has a collateral leaf-trace, but apparently a concentric petiolar bundle. The roots are mostly tetrarch, but diarch in *Platyzoma*.

Fibrovascular Chains of Filicineæ.†—According to C. E. Bertrand and F. Cornaille, the broadening of a fibrovascular chain is effected at first by the extension of its elementary bundles, their number remaining constant. When the broadening is very great, the bundles split and the chain loses its continuity. Under other circumstances, when a chain widens, it either forms new groups of tracheæ between those already existing, or the old groups divide. A chain may become broader by the addition of external divergents or by the addition of other chains. The addition may take place in the chain, or at one of the extremities if the chain is open. Examples are given; and these results are discussed from a mathematical point of view.

* Ann. Bot., xv. (1901) pp. 703-47 (2 pls.).

† Comptes Rendus, cxxxiii. (1901) pp. 1027-9, 1309-12.

The foliar traces of the Filicineæ clearly exhibit their special characters only in sufficiently strong leaves. The greatest complication of the foliar trace is found in the petiole. In the great majority of living Filicineæ the fibrovascular chains of the foliar trace usually form a single curve. The special characteristics of the foliar trace are described in *Osmunda*, in the Cyatheaceæ, in the Ophioglossaceæ, and in some genera of Polypodiaceæ. By means of the foliar trace the fundamental tissue of the petiole may be seen to consist of an external fundamental tissue and an internal fundamental tissue, which is well defined when the trace is closed.

Type-Specimens of Lyginodendron Oldhamium.*—E. A. N. Arber figures and gives descriptions of some of the original sections on which Binney, in 1866, founded his account of the fossil plant *Dadoxylon Oldhamium*, subsequently transferred by Williamson to *Lyginodendron*. Binney did not figure any of his sections.

Prothallium of Phylloglossum. †—A. P. W. Thomas, of Auckland, finds prothallia growing naturally among the parent plants in three localities only, suggesting that special conditions are necessary for the germination of the spores, conditions which are not of regular annual occurrence wherever *Phylloglossum* grows. Perhaps the most important is the presence of a fungus, with which, as in the case of the prothallia of *Lycopodium*, that of *Phylloglossum* lives symbiotically. The prothallium varies much in external form. In the youngest stage observed it consisted of an oval tuber from which rises a simple cylindrical shaft with a rounded apex. The tuber, which is of constant occurrence, doubtless corresponds with the primary tubercle in the prothallium of *Lycopodium cernuum*. The shaft varies considerably in length and thickness, and may be straight or curved, the whole prothallium varying from less than 2 mm. in length to thrice this. Rhizoids are numerous on the lower part, especially on the tubercle. The shaft expands above into a crown, which may be conical, rounded, or projecting to one side, and bears the sexual organs. The whole upper part of the prothallium is green, except the projecting necks of the archegonia; the green colour passes away as the shaft enters the ground. Sections show little internal differentiation of the prothallia; an endophytic fungus may be traced in the cells of the lower half, the hyphæ may be seen passing in through the rhizoids. The fungus forms a close felt around the tubercle, passing below it into a root-like strand. The archegonia, which reach from ten to twenty in number, appear to be formed in basipetal succession, the neck projects as a hemisphere of colourless cells, usually in two tiers of four cells each. The venter, with the large oosphere, lies at a little depth below the surface. The antheridia form an elongated cavity with a single layer of cover-cells. The sexual organs resemble most those of *Lycopodium cernuum*; there are no paraphyses as in *L. Selago* and *L. Phlegmaria*.

The development of the embryo at first resembles that of *L. cernuum*. It first grows obliquely downwards and outwards; the part near the venter is the foot; at the opposite end are formed the stem-apex and

* Proc. Camb. Phil. Soc., xi. (1902) pp. 281-5 (2 figs.).

† Proc. Roy. Soc., lxix. (1902) pp. 285-91.

leaf. Immediately on escaping from the prothallium it forms a protocorm, apparently in the same way that the adult plant forms its annual tuber. The first leaf grows upwards, attaining a height of 2 to 5 mm. above the ground. No root was formed during the first year of growth; the sporophyte seemed to depend largely for its moisture upon the prothallium. Sometimes rhizoids are formed on the protocorm and its pedicel. The first leaf has exactly the structure of a small leaf as produced in later years. Further development of the sporophyte seems to be slow; in many cases the plant comes up a second and third year with only one leaf.

On the whole the prothallium of *Phylloglossum* probably most resembles one of the *Lycopodium cernuum* type, though it lacks the leaf-like assimilatory lobes of the latter. It may perhaps be regarded as the simplest known type of the isosporous Lycopodiinæ.

The author has also observed an occasional branching of the spike, and frequently the production of two tubers, sometimes on opposite sides, sometimes close together on the same side of the plant. He reiterates the view that *Phylloglossum* is a primitive, and not a reduced type.

Muscineæ.

Leaf-Movements in Polytrichum.*—K. Giesenhagen gives an account of the late F. Stolz's researches into the movements of the leaves of *Polytrichum juniperinum*, as controlled by moisture or drought. Starting from the previous determinations of Firtsch and of Bastit as to the actual tissues which contract or expand in response to the absence or presence of water, Stolz demonstrated the important part played by the transverse band of quadrate cells across the upper surface of the leaf at the line of transition from leaf-sheath to lamina. The walls of these cells imbibe water; the band of tissue expands and bends back the lamina of the leaf until it stands at about a right angle with the always appressed sheath.

Structure of the Peristome.†—After a long interval, H. Philibert resumes his study of the peristome of Mosses, and points out the great variability in the structure of this organ within the same genus, *Buxbaumia*. In *B. indusiata* the peristome has by no means always, or even generally, the composite structure which has usually been ascribed to it. It may even be reduced to the endostome, and this endostome itself does not always consist of an entire cylindrical tube, but may be broken up into a confused agglomeration of filaments. In this state it presents a close resemblance to the peristome of the Dawsoniæ; and there can be little doubt of the close affinity of the two families, the Dawsoniæ being the older.

Mosses new to Britain.‡—Messrs. Jones and Horrell describe and figure an arctic and subarctic species, *Tetraplodon Wormskioldii* Lindb., which they discovered fruiting on the summit of Widdy Bank Fell, Durham, last August. The plant is common in all high northern

* Flora, xc. (1902) pp. 305-15. |

† Rev. Bryol., xxviii. (1901) pp. 127-30. Cf. this Journal, 1896, p. 545.

‡ Journ. Bot., 1902, pp. 49-53 (1 pl.).

latitudes, but has hitherto not been found below about 62° N. latitude (in Scandinavia). It was growing at an altitude of about 1600 ft.

J. B. Duncan has discovered *Octodicerias julianum* Brid., an aquatic moss resembling in general appearance young plants of *Fontinalis*, growing on submerged timbers, stones, and boulders in the river Severn, at and near Bewdley in Worcestershire and Shropshire. The plant was previously known throughout Europe, and from North Africa to North America. It is suggested that it may have been introduced with foreign timber.

Rabenhorst's Cryptogamic Flora of Germany (Musci).—The 36th part of this work, by Dr. K. G. Limpricht, completes the account of the genus *Hylocomium*, and of the Hypnaceæ. The remainder of this part and the whole of Part 37 are occupied by additions and revisions of the descriptions of the families, genera, and species in the preceding parts.

Lists and New Species.—F. Stephani* gives a list of 187 species of hepatics, including 55 new species, gathered in the rich forests, &c., of West Patagonia and South Chile by P. Dusén, who describes in an introduction to the paper his travels and the geographical distribution of the more interesting species.

The same authors † treat the hepatics of the Magellan's-Straits territory in similar fashion. 136 species are recorded, and of these ten are new.

V. F. Brotherus ‡ has described 66 new species in a list of 192 mosses gathered in Brazil and Paraguay, by C. A. M. Lindman during his Regnell expedition.

P. Dusén § also gives a list of 24 vascular plants and 38 mosses, one of which is a new species, collected in the arctic island of Jan Mayen during Nathorst's expedition to the east coast of Greenland in 1899.

Algæ.

1 **Remarks on *Ædogonia* with Semicircular Foot-cell.**||—A. Scherffel here describes the germination of the zoospores of *Ædogonium rufescens*. This may take place in one of two different ways, according to whether they become fixed to some substratum or remain free in the water. In the former case there arises directly through a circular opening an *Ædogonium* filament; while in the case of those spores which remain free in the water, the cell-contents break up into swarm-spores, which in their turn escape. The zoospores of *O. Vircebergense* behave in the same manner. The oospores of both species were observed by the author, but no antheridia. The attraction possessed by the oogonia for the swarm-spores is noticed, and this may be attributed, according to the author, either to a chemotactic influence, or, which is less likely, to the fact that the oogonia form a convenient surface attachment for the swarm-spores. In the concluding paragraph is described an interesting malformation in *O. Vircebergense*.

* Bihang k. Svensk. Vet.-Akad. Handl., xxvi. iii. No. 6 (1900) 69 pp.

† Tom. cit., No. 17 (1901) 36 pp. ‡ Tom. cit., No. 7 (1900) 65 pp.

§ Tom. cit., No. 13 (1900) 16 pp. and 1 pl.

|| Ber. Deutsch. Bot. Ges., xix. (1901) pp. 557-63 (1 pl.).

Sphacelariaceæ.*—In a lengthy paper on this family of Phæosporeæ, M. C. Sauvageau makes the following remarks on their general structure. He agrees with Magnus in regarding the most common mode of branching as sympodial rather than monopodial as stated by Pringsheim. A character which distinguishes the Sphacelariaceæ from the most nearly allied order, the Ectocarpaceæ, is the black coloration of the thallus by eau de Javelle, due to the presence of a substance, the nature of which is at present unknown, and apparently not identical in all the species. The chromatophores always have the form of discs or grains, never of plates or bands. Tannin is almost invariably present, either generally diffused or limited to special cells. The hairs are of endogenous origin, differing in this respect from those of the Ectocarpaceæ, and agreeing with the Myrionemaceæ.

M. Sauvageau has no doubt about the existence of sexuality in the Sphacelariaceæ; there are (at least in *Sphacelaria hystriæ*), two kinds of plurilocular organ, one of which certainly consists of antheridia, the other probably of oogonia. The act of impregnation has not, however, been actually observed. The classification of the species into autonomous and parasitic is not a natural one; the parasitism, where it occurs, is not obligatory.

The greater part of the paper is occupied by a special account of the following species:—*Battersia mirabilis*, *Sphacella subtilissima*, *Sphacelaria pulvinata*, *S. bracteata* (Sauv. MS.), *S. pygmæa*, *S. fœcunda* (Sauv. MS.), *S. Borneti*, *S. sympodicarpa* (Sauv. MS.), *S. chorizocarpa* (Sauv. MS.), *S. Reinkei* (Sauv. MS.), *S. spuria* (Sauv. MS.), *S. radicans*, *S. britannica* (Sauv. MS.), *S. olivacea*, *S. plumula*, *S. plumigera*, *S. racemosa*, *Chætopteris plumosa*.

Classification of Diatoms.†—C. Mereschkowsky proposes to abolish the accepted classification of Diatoms into Raphideæ, Pseudoraphideæ, and Anaraphideæ, and to substitute one primarily into two classes, Mobiles and Immobiles, derived from the presence or absence of movement, this power being dependent on the presence or absence of a slit in the wall of the frustule. Whether this slit be placed at the centre of the valve or near one of its margins is of secondary importance. The Mobiles are again divided into two families,—the Raphideæ, characterised by the presence of nodules and the usually central position of the raphe (arranged in three groups, the Heteroideæ, Naviculoideæ, and Tropidoideæ), and the Carinatæ (Surielloideæ and Nitzschioideæ), characterised by the absence of nodules (except *Rhopalodia*) and the lateral position of the slit (except some species of *Nitzschia*). The Immobiles again consist of two families,—the Bacilloideæ (Pseudoraphideæ, except Carinatæ, marked by the elongated or bacillar form of the valves, the usual presence of a pseudoraphe, and the usual absence of appendages or spines (again divided into the Fragilarioideæ and Tabillarioideæ, according to the presence or absence of internal partitions; and the Anaraphideæ (Biddulphioideæ and Discoideæ). In the Anaraphideæ the two valves of the same frustule do not generally correspond with respect to the position of their pattern or of their processes.

* Journ. de Bot. (Morot), xiv. (1900) pp. 213-34, 247-59, 304-22; xv. (1901) pp. 22-36, 50-62, 94-116, 137-49 (24 figs.).

† Ann. Nat. Hist., ix. (1902) pp. 65-8 (4 figs.).

Fresh-water Diatoms from the Island of Jan Mayen and the East Coast of Greenland.*—J. Brun gives here the result of his examination of the diatoms collected by the Swedish expedition in 1899. The author finds that three-fourths of the Greenland species are found living in the Swiss Alps, and he also notes that the northern forms of diatoms are less variable in size and striation than those of the high Alps. This comparative stability of form he attributes to the fact that in the polar circle the heat and light of summer are more equable during the time of their season, whereas in the glaciers of the high Alps the growth of diatoms is necessarily affected by the rapid daily alternations of frost and thaw.

A list of forms follows under the headings of the various localities.

Capillary Absorptive Action of Diatom Frustules.†—Prof. R. Hitchcock describes the effect of diatomaceous earth in removing grease from raw wool, which he suggests is due to the capillary absorptive action of the frustules. The deposit employed consisted mostly of *Pinnularia*, *Stauroneis*, and other large forms. The cleaning was done by shaking up the wool with the earth in a tin box after application of heat sufficient to melt the fat.

Perispermum, a new Genus of Corallinaceæ.‡—From German New Guinea F. Heydrich describes a corallinaceous alga, belonging to the Melobesiceæ, which he makes the type of a new genus, *Perispermum*, with the following diagnosis:—Calcareous thallus with basal disc, attached to the host by rhizoids which do not penetrate into its tissue, composed of several layers of cells and not segmented; tetrasporanges and sexual organs in conceptacles; carpogone and auxiliary cell superposed terminally on a filament; the auxiliary cell becomes a gonimoblast with one or more spores; male organs surrounding the female in the same conceptacle. Special descriptions are given of the habit, the thallus, the tetrasporanges, the germination of the tetraspores, and the male and female organs, in the single species *Perispermum hermaphroditum*. In the hermaphrodite conceptacles the male greatly outnumber the female organs.

In another paper § Heydrich describes several new tropical species of Lithothamnieæ (*Lithothamnion* and *Lithophyllum*). The procarps of these species were not seen.

Contributions to the Flora of Bear Island.||—Miss Astrid Cleve publishes a list of 90 species of diatoms from Bear Island, which shows an increase of 49 species on the list given by Lagerstedt in 1873. The Swedish expedition to that island in 1899 brought back specimens collected from many habitats, and though the actual number of specimens was not great, there was considerable variety of specific form. Two new species are described and figured, *Pinnularia curta* and *Achnanthes nodosa*, and two new varieties of other species. Short critical remarks

* Bihang k. Svensk. Vet.-Akad. Handl., xxvi. pt. 3, No. 18, 22 pp.

† Journ. New York Micr. Soc., xv. (1900) pp. 4-7.

‡ Ber. Deutsch. Bot. Ges., xix. (1901) pp. 409-20 (3 figs.).

§ Tom. cit., pp. 403-9.

|| Bihang k. Svensk. Vet.-Akad. Handl., xxvi. pt. 3, No. 10 (1900) 25 pp., and No. 11 (1900) 25 pp.,

follow some of the species-names, and general comparisons are drawn between the diatom floras of Bear Island, Spitzbergen, and Jan Mayen.

A second contribution to the flora of Bear Island follows Miss Cleve's paper, the subject being the Vegetable Plankton of the Lakes, by G. Lagerheim. The organisms in question were obtained from Lake Ella and from a pond in the neighbourhood of the Russian harbour. Each locality is treated separately, each species-name being followed by remarks on its geographical distribution. Only six species are recorded from Lake Ella of which one, *Hormospora subtilissima* is new; while fifteen species were found in the pond near Russenhafen. The author finds no Peridineæ in Bear Island, the plankton of which resembles in this respect that of Lapland, investigated by Prof. Cleve; but the similarity between the two regions is only negative, for the species recorded from each locality are as different as possible. Remarks on the distribution of forms found in Bear Island close this paper.

Algæ from the Caroline Islands.*—W. Schmidle and Major Reinbold publish, in two papers, records of fresh-water and marine algæ respectively. They are collected principally from the Island of Yap. Schmidle records twenty-four fresh-water species, of which three are new: *Plectonema Volkensii*, *Pithophora variabile*, and *Cosmarium Lindavi*. A new variety and a new form are also described. Critical notes, varying in length, are appended to each record, and two of the new species are figured, as well as the new form and variety. Major Reinbold records twenty-four marine species.

Fungi.

Pyrrhosorus, a new Marine Fungus.†—This new genus was found by H. O. Joel on a decaying alga, *Cystoclonium purpurascens*. His attention was drawn to it by the bright yellow appearance of the alga. On examination he found that some of the cells were packed with a sorus of orange-coloured, spherical, naked cells, which at a later stage developed zoospores also brightly coloured. A detailed investigation revealed the following stages in the life-history of the fungus: naked solitary cells which succeed the zoospores, and of which one or more may fuse and form a multinucleate plasmodium large enough to occupy more than one cell of the *Cystoclonium*, and becoming more amœba-like in form. At a later stage the plasmodium divides into vegetative cells, and these form the round spore-mother-cells about 8 μ in diameter. By three successive divisions these come to lie in groups of eight, in sori, as already noted, and finally develop into pear-shaped zoospores provided with two lateral cilia. The author places *Pyrrhosorus* in the Phytomyxineæ near to *Tetramyxa*. The different stages are well illustrated by drawings and by microphotographs.

Sexual and Non-sexual Reproduction in the Zygomycetes.‡—Prof. O. Brefeld points out that in the Zygomycetes the complexity of the sexual and non-sexual modes of reproduction are, as a general rule,

* Hedwigia, xl. Heft 6 (1901) pp. 343-51 (1 pl.).

† Bihang k. Svensk. Vet.-Akad. Handl., xxvi. pt. 3, No. 14, 16 pp. and 1 pl.

‡ Jahresber. Schles. Ges. Vaterl. Cult., Dec. 13th, 1900, 14 pp. See Bot. Centralbl., lxxxviii. (1901) p. 289.

in inverse proportion to one another. In the simplest form of sexual reproduction (*Mucor Mucedo*, *Sporodinia grandis*) there is only one kind of sporangium. Then come forms with two kinds of sporangia, either on the same or on two kinds of sporangiophore (*Thamnidium*), ordinary sporangia and smaller sporangioles, the latter reverting to one-spored closed sporangia or conidia. In *Choanephora* both kinds of sporangia occur on distinct sporangiophores; in *Chætocladium*, &c., sporangioles only are formed. The conidia can also take up an oidium form by septation, as in *Piptocephalis*. A further complication takes place when the sporangiophores are produced only on stolons.

Among the very numerous forms of the Zygomycetes that have been investigated, there is at present only one species known, *Sporodinia grandis*, in which the sexual sporangiophores and the zygotes are produced with the same frequency, or nearly so, as the non-sexual sporangia. The formation of one or the other kind of fructification is largely dependent on the supply of water; and the same was found to be true also in regard to other Zygomycetes—*Phycomyces*, species of *Mucor* and *Chlamydomucor*, *Rhizopus*, *Thamnidium*, *Chætocladium*, &c.

The author regards the higher non-sexual families of Fungi, such as the Basidiomycetes, as not so much non-sexual as apogamous forms, in which the production of zygote or other sexual organs has gradually died out. This view has been obscured by the mistaken theory that the "spermatia" of the Laboulbeniaceæ and other families are degenerated male sexual organs; they are simply a special form of conidium.

Cladochytrium Alismatis. * — A detailed study of this fungus has been made by G. P. Clinton on material collected at Cambridge, Mass. It has been found in various parts of Europe on the leaves, &c., of *Alisma Plantago*, but this is its first record for America. The author succeeded in germinating the fungus and re-infecting young seedlings of *Alisma*; he was thus able to follow every stage in the development of the *Cladochytrium*, and to determine the existence of a temporary sporangium. The different stages are well illustrated. Mr. Clinton at the same time obtained *Cladochytrium Menyanthis*, and germinated its sporangia, but the fungus would grow neither on *Alisma* nor on various algæ, and as plants of *Menyanthes* were not available for infection, further investigation of that species was impossible.

New Genera and Species of Laboulbeniaceæ. † — Together with a number of new species, R. Thaxter now describes the following new genera of Laboulbeniaceæ.

Eumonoicomycetes g. n. (separated from *Monoicomycetes*). Receptacle consisting of a basal and sub-basal cell; the latter producing terminally a sterile appendage, and laterally usually one fertile branch, the axis of which is coincident with that of the receptacle, from which it is not distinguished, and consists of a series of superposed cells, which may bear a sterile appendage, an antherid, or an antherid and a perithece. The antherid consists of a single stalk-cell and a single, often obscure, basal cell; the body of the antherid consists of a series of

* Bot. Gaz., xxxiii. (1902) pp. 49-61.

† Proc. Amer. Acad. Arts and Sci., xxvii. (1901) pp. 21-45. Cf. this Journal, 1901, p. 565.

numerous antheridial cells, in rows which extend obliquely inward and upward, emptying into a common cavity.

Euhaplomyces g. n. Receptacle consisting of two cells, the upper being a free stalked antherid and a stalked perithece. Antherid conical, consisting of a single stalk-cell, followed by a basal cell, from which is separated a group of smaller cells, some of which extend upward and inward to form antheridial cells; above these follow three external marginal cells, the lowest of which lies beside the antheridial cells; the uppermost succeeded by a conical chamber terminating in a pore, and extending downwards along the inner sides of the marginal cells to form a cavity into which the antheridial cells empty. Perithece resembling that of *Haplomyces*, and having two ascogenous cells.

Dioicomyces g. n. Male individual consisting of four superposed cells, the upper of which is a simple antherid bearing a sub-terminal discharge-tube. Receptacle of the female individual ending distally in a peculiarly modified sterile cell corresponding to the upper spore-segment; the sub-basal cell producing a single perithece laterally, and separated from the sterile terminal cell by a second small cell. Perithece free-stalked, the ascogenous cell single; the spores more or less obliquely once-septate, and of two kinds corresponding to the sexes.

Acompsomyces g. n. Receptacle 2-celled, bearing an antheridial branch terminally and a single perithece laterally. Antherid consisting of several superposed cells, from which single simple antherids are borne directly. Perithece borne on a stalk, the cavity of which becomes continuous with that of the ascogenous cavity.

Stichomyces g. n. Receptacle consisting of two cells, the upper bearing one or more stalked peritheces laterally, and an antheridial appendage terminally. The appendage consisting of several superposed cells, the lowest sterile, or having one or two opposite lateral peritheces, those above it bearing opposite lateral branchlets distally, the series ending in a terminal sterile branch. Antherids simple, flask-shaped, free, borne in small groups on short branchlets.

Kainomyces g. n. Receptacle as in *Zodionomyces*, broad and flattened, consisting of a single basal cell and a typical foot, above which the successive cells become variously divided by longitudinal septa into transverse rows or tiers of cells; the distal portion more or less definitely distinguished, and consisting of superposed cells, the lowest of which alone becomes longitudinally divided, all producing laterally antheridial(?) branches; several of the tiers immediately below this appendiculate portion growing out laterally at right angles to the main axis of the receptacle on one or both sides to form "perithecial branches" consisting of superposed cells, and terminated by solitary peritheces. The perithece of peculiar form, with six wall-cells in each row in addition to the lip-cells; the base of the trichogyne persistent in the form of a peculiarly modified unicellular appendage.

Contributions to the Biology of the Erysiphaceæ.*—In this paper F. W. Neger makes a second communication on the Erysiphaceæ. It is largely devoted to a study of the form genus *Oidium*, the conidial form of the fungus. The author has germinated conidia gathered from a great variety of host-plants, and takes special note of the posi-

* *Flora*, xc. (1902) pp. 221-72.

tion of the germinating tube, whether terminal or lateral; the length of the hyphæ; their form, whether simple or branched; the form of the haustoria and the reaction to light of the hyphæ. He considers that as these are fairly constant phenomena, they ought to have due weight in the determination of species. The various forms of germination are illustrated in the text. He made many infection experiments with conidia, and the results are given in a carefully tabulated form. They serve, he holds, to establish the conclusions he had already arrived at from his observations on the germination of the conidia, viz. that all stages of the life-history must be considered in the diagnosis of species. On many plants that he watched throughout the season he found that conidia only were produced, and the question arose as to the wintering of the fungus. He is of opinion that the ascus spores have a wider range of capability of infection than have the conidia; that the *Oidium* form has become specialised to particular hosts. The same ascus fruit will develop on various plants, but the resulting conidia will not transfer from one host to another. He contrasts them with similar infection results in the Uredineæ. There is also a short discussion of the haustoria of *Sphærotheca Humuli*; these were found to penetrate only the epidermis cells of the host.

"Shot-hole" Fungi.*—D. M'Alpine enumerates and describes the so-called "shot-hole" Fungi of Anstralia, which attack the cultivated Amygdalæ and Pomæ, producing round holes in the leaves as if caused by shot. A callus of healing-tissue is formed round the edge of the spot, and the author sees no evidence that the destruction is brought about by the excretion of a poisonous substance by the mycele of the fungus. There are over 20 species known in Australia, one of the most frequent being *Clasterosporium Amygdalearum*, the pycnidial stage of which is known as *Phyllosticta prunicola*; also *Gnomonia circumscissa*, belonging to the Pyrenomyces, of which the conidial form is *Ascochyta chlorospora*.

An Arctic-Alpine Rhabdospora.†—Tycho Vestergren gives a list of plants belonging to fifteen natural orders of Dicotyledons on which he has found *Rhabdospora cercosperma*. It grows also on Monocotyledons and Vascular Cryptogams, and is very frequently met with in northern Europe and in Greenland. The author gives a detailed account of the developments of the fungus and also the results of his experiments on the germination of the spores. He got easily a growth of hyphæ and the production of secondary conidia, but was unable to reproduce the perithecium. He has included *Septoria caudata* in the species, and from his observations and researches he concludes that the ascomycetous form of the fungus will be found in *Heterosphaeria*; probably *H. atella* var. *alpestris*.

Sexuality of certain Yeasts.‡—A. Guilliermond, after describing the phenomena of conjugation by isogamy occurring in certain yeasts (*Schizosaccharomyces octosporus* and *Sch. pombe*), states that these phenomena are always accompanied by nuclear fusion. That, at least, is

* Proc. Linn. Soc. N. S. Wales, xxvi. (1901) pp. 221-32.

† Bihang k. Svensk. Vet.-Akad. Handl., xxvi. pt. 3, No. 12, 23 pp. and 2 pls.

‡ Comptes Rendus, cxxxiii. (1901) pp. 1252-4.

the rule, which, however, may be subject to certain exceptions due to anomalous development. After referring to the observations of Hansen on *S. Ludwigii* and of Barker on a conjugating yeast,* the author remarks on the importance and interest of the phenomena, urging that, even if confined to a small group of yeasts, they are none the less instructive and convincing as to the value of the ascus, which must be regarded as a higher form of these fungi which appear to be definitely retained among the Ascomycetes. A monograph dealing with the whole subject is promised later.

Uredineæ.—Dr. P. Maguns † describes a species growing on *Aspidium spinulosum*, from Saxon Switzerland. The uredo stage of the fungus was that of *Uredo Scolopendri*, but the subsequent discovery of the intercellular telentospores caused him to place it unhesitatingly in the genus *Melampsorella* with the specific name *Kriegeriana*. A closer examination of the two species of this genus also growing on ferns *M. Aspidiotus* and *M. polypodii* showed him that their uredospores had not the characteristic germinating pores of *Melampsorella*; he therefore created a new genus *Hyalospora* for the inclusion of these two forms, *H. Aspidiotus* found on *Phegopteris Dryopteris* and *H. Polypodii* on *Cystopteris fragilis*. He discusses the relationships between the different closely allied genera, and places *Melampsorella* and *Hyalospora* very near to *Uredinopsis*, the species of which grow only on ferns.

On a dried specimen of *Derris uliginosa*, H. and P. Sydow ‡ find a parasitic fungus belonging to the Uredineæ, which they make the type of a new genus *Hapalophragmium*.

J. C. Arthur, § Purdue University, gives us an account of his method of collecting Rusts, so as to gain in the field a knowledge of related forms. He keeps a careful record of plants and localities where the rusts are to be found, and visits the places marked at stated intervals, so as to catch the successive stages of the fungus. Cultures are made to verify the field observations, and these have a much better prospect of success when all possible clues to identification have been followed. A rust on a species of *Carex* was thus traced to an *Æcidium* on *Sambucus* after two seasons' work. One of the best methods is to watch for the earliest appearance of *Æcidia* and then to examine the ground in the near neighbourhood for any rusted grasses or sedges that may have caused the infection.

Binucleate Cells in certain Hymenomycetes. || — Prof. Harper of Madison describes another of his interesting studies on the development of the higher Fungi. The problem he set himself to work out was the equivalence, if any existed, of the nuclear fusions in the ascus and basidium. His investigations were made on *Hypochnus subtilis*, one of the less highly organised Hymenomycetes. The vegetative part of the plants, which permeated the tissue of rotten wood, consisted of hyphæ of which the cells are all binucleate. These hyphæ on reaching the surface of the wood branch freely in a shrubby or tree-like manner,

* See this Journal, 1901, p. 565.

† Ber. Deutsch. Bot. Ges., xix. (1901) pp. 578-84.

‡ Hedwigia, xl. (1901) Beibl., pp. 62-5 (1 fig.).

§ Bot. Gaz., xxxiii. (1902) pp. 62-6.

|| Tom. cit., pp. 1-25.

and the tip of each branch forms a basidium. The two nuclei of the basidial cell increase in size and fuse together when the cell has reached about one-half or two-thirds of its ultimate size. The fused nucleus increases still further with the growth of the cell, and migrates to the apex. There are 8-12 chromosomes in the nucleus before the anaphases begin. Two successive divisions follow and the four resultant nuclei travel down to the middle of the cell, which elongates, and the sterigmata bud out at its apex. The author observed occasionally fibres extending from the nuclei to the developing sterigmata, but could not determine their origin; the nuclei are drawn up into the sterigmata and each spore is uninucleate.

There are no multinucleate cells in *Hypochnus* such as have been described in other Basidiomycetes, but it is a very primitive form without any carpophore, and Dr. Harper found in several species of agarics that while the cells of the vegetative body were multinucleate, the cells of the hymenium and the basidia were always binucleate.

While the wide-spread occurrence of the binucleate condition in the reproductive series of cells, the *Keimbahn*, strengthens the view of the close relationship between the cells of the Basidiomycetes and the binucleated cells of the Uredineæ, it forms a strong piece of evidence against any connection with the Ascomycetes. Binucleate cells have not been found in the latter group; and any resemblance of outer form between the formation of basidiospores and the development of conidia in the Ascomycetes is of little value as evidence of relationship. The author considers it highly probable that the fusing nuclei of the basidium and of the teleutospore are of widely separated ancestry.

Lichens.—Dr. A. Zahlbruckner* of Vienna has published a list of the Lichens of Dalmatia largely from material collected by J. Baumgartner. He has also made use of all previous well-established records. He notes the entire absence of Caliciaceæ and the poor representation of shrubby and leafy forms, which is partly owing to the fact that the higher ranges of hills where these abound have not yet been fully explored. In all he has as yet established only 209 species, a smaller number, he notes, than Steiner has recorded for the Greek mainland.

R. P. Longinos Navas † gives a list of species of *Parmelia* in Spain. The species are divided into two sections according to the colouring of the plants. The enumeration does not aim at completeness, rather is it a gathering together of records from the scattered lists of previous workers. Six of the recorded plants are new to Spain.

Haptera of Lichens. ‡—R. Sernander classifies the haptera or organs of attachment of the Fruticose Lichens under six heads, viz.—the *Cladonia* type, the *Thamnolia* type, the *Alectoria* type, the *Cladina* type, the *Cetraria* type, and the *Physcia ciliaria* type, each of which is described in detail. The haptera appear to become very rapidly attached to any substance with which they come into contact, after which they increase greatly both in weight and thickness.

* Oest. Bot. Zeitschr., li. (1901) pp. 273-85, 336-50.

† Bol. Soc. Esp. Hist. Nat., i. (1901) pp. 310-7.

‡ Bot. Notis., 1901, Hefts 1 and 2, 19 pp. See Bot. Centralbl., lxxxviii. (1901) p. 293.

Mycorrhiza in the Marchantiaceæ.*—M. Golenkin has studied the occurrence of *Mycorrhiza* in different members of the Hepaticæ, especially in the family of the Marchantiaceæ. He finds the fungus in the rhizoids, and in the red-violet cells, but the hyphæ do not penetrate the chlorophyll cells of the thallus. The starch disappears from the cells inhabited by the fungus, but there must be some sufficient compensation afforded by the fungus as the Hepatic does not suffer but rather profits from the symbiosis. It has not been possible to determine the species of fungus causing the *Mycorrhiza*.

Parasitic Fungi.—A. Trotter † finds, on *Cotyledon Umbilicus* the æcidium stage of a fungus which he names *Æcidium Umbilici* sp. n.; and on the same plant also the teleutospore-form which he believes to be genetically connected with it, viz. *Puccinia Umbilici*. The latter must be removed from the subgenus *Leptopuccinia* to *Pucciniopsis*.

E. Heinricher ‡ records the occurrence on *Tozzia alpina* of a parasitic fungus belonging to the Ustilagineæ and to the genus *Entyloma*, which he regards as probably a new species, and names *Entyloma Tozziae*.

E. Fischer § has identified *Æcidium elatinum*, which produces witch-broom on the silver fir, with *Melampsora Caryophyllaccarum* DC. (*M. Cerastii* Pers.) on *Stellaria nemorum* as its uredoform.

In a collection of Fungi sent by Bornmüller from Turkmenia, P. Magnus || finds, on *Calligonum comosum*, a new parasitic fungus which he names *Leptothyrium Bornmülleri*. To what genus of Ascomycetes it belongs is at present undetermined.

V. Peglion ¶ states that species of *Botryosporium* are saprophytic rather than parasitic on wheat, being found only in tissues which have already been attacked by *Tylenchus*.

Fungal Diseases of Plants, &c.**—Von Klebahn has discovered the related forms of a number of heterœcious rusts of which he gives a preliminary list.

An anthracnose of clover due to a fungus *Glæosporium Trifolii* has been detected by Dr. Mehner near Freiberg in Saxony. From 25 to 30 p.c. of the plants in the fields attacked were destroyed. The fungus seizes on both leaves and stem, and the plant succumbs very soon. The disease has been known in America for some time, and it is supposed that it has been brought over to Europe with American clover seeds.

Fritz Noack gives an account of various diseases to which the coffee-plant is liable in Brazil. *Cercospora coffeicola* grows on the leaves and reduces the vitality of the plant so that the beans are badly developed.

The author has found growing along with *Cercospora* a pyrenomycete which he names *Mycosphærella coffeæ*; it is sporadic in its occurrence and does not do much damage. Another fungus, also a new species, *Colletotrichum coffeanum*, grows along with *Cercospora*. Noack does not consider that it causes much harm to the coffee plants, it appears only on branches already weakened by some other cause.

The leaves of juniper in Smolensk were found to be attacked by a

* Flora, xc. (1902) pp. 209-20. † Bull. Soc. Bot. Ital., 1901, pp. 143-4.

‡ Ber. Deutsch. Bot. Ges., xix. (1901) pp. 362-6 (2 figs.).

§ Tom. cit., pp. 396-8.

|| Tom. cit., pp. 447-9 (1 pl.).

¶ Zeitschr. f. Pflanzenkrank., xi. (1901) pp. 89-92. See Bot. Centralbl., lxxviii. (1901) p. 314. ** Zeitschr. f. Pflanzenkrank., xi. (1901) Hefts 4 and 5 (1 pl.).

parasitic fungus described by Ellis as a *Coryneum*. A. V. Jaczewski has named it *Exosporium juniperinum*. It destroys the needles, and in a year or two the tree dies. The author found on the juniper a number of microscopic fungi, *Calia juniperina*, in close connection with the *Exosporium*, and *Hendersonia notha* which occurred on the withering needles.

F. W. Neger discusses the method of preventing the spread of disease caused by members of the Erysiphaceæ. He finds that many of the perithecia fall from the leaves before they are fully decayed, and that destruction by burning ought to take place at an earlier stage than is commonly practised. He bases this opinion on a prolonged study of the organs of attachment of the perithecia.

A note on *Botrytis cinerea* is published by K. Mohr-Laubenheim. The fungus has proved destructive to vine twigs, and caused much loss to the cultivators.

A. P. Anderson* has studied a disease on *Abies balsamea* which induced canker growths and swellings on the stem, and which he finds to be due to a fungus *Dasyascypha resinaria*, already recorded from Wales and from Hungary but hitherto unknown in America. The smooth bark of the tree becomes rough at the diseased spot and there is a continuous exudation of resin. The cambium is at first excited to greater activity by the presence of the fungus, and a wider ring of wood is formed. In time it is killed, and if the whole zone is affected the branch dies. The author found also that the wood of the affected tree invariably contained pathogenic resin-canals in the region of the disease. Such canals occur only when the wood has been injured mechanically or by the presence of mycelium. The fruiting form of the fungus does not form until the stem or branch has been killed by the action of the mycelium, and then the ascomata are produced one year only. *Dasyascypha resinaria* has not hitherto been regarded as a parasite, but the author has no doubt of the identity of his fungus with this species. He was not able to carry out infection experiments, but he is none the less convinced that the canker is caused by the *Dasyascypha*. The spores gain access to the tree through wounds caused by insects or by the breaking of branches.

The same author † publishes a note on the rice smut (*Tilletia horrida*) of South Carolina, which he finds to be identical with the smut found in Japan. It had been introduced to South Carolina along with seed-rice brought from Japan in 1896.

F. Blumentritt ‡ cultivated on various media an *Aspergillus* (*A. bronchialis* sp. n.) which had been detected in a bronchus of a diabetic by Prof. H. Chiari. The substrata used were gelatin, bread, plum and dung decoctions, Molisch's medium (H₂O 500; cane-sugar 15; ammonium chloride 3; magnesium sulphate 0.25; potassium monophosphate 0.25; a trace of iron); and 5 p.c. sugar solution. On the quality of the nutrient medium depended the quantity of fructification, of the mycelium, and the colour of the spore masses. The *Aspergillus* is strongly aerobic, its optimum temperature is 32° and it liquefied gelatin. The mycelium is at first white and afterwards yellowish. The hyphæ

* Bull. Tor. Bot. Club, xxix. (1902) pp. 21-34.

† Tom. cit., pp. 35-6.

‡ Ber. Deutsch. Bot. Ges., xix. (1901) pp. 442-6 (1 pl.).

are branched and septate; they vary much in thickness from 2–12 μ . The conidiophores are erect, simple, rarely septate, and almost colourless; the head varies from 12–19 μ in diameter, and their length from 280–300 μ . The conidia are round, smooth, and from 3–4.2 μ in diameter: in colour they vary from grey, through green to brown.

M. Bouchard* describes an affection of the hairs of the moustache due to a form of *Trichosporium* which he found to be identical with the parasite of chignons, *Trichosporium Beigeli*. The hairs are covered with nodosities, and have a silvery look. The parasite was successfully cultivated on carrots, and produced in two days white, somewhat inclining to yellowish, growths of the fungus.

Mycology in France.†—A lengthy account is given of the excursion of the members of the Société Mycologique to the Jura. M. Poirault describes a new member of the Chytridiaceæ, *Woroninopsis radicolica*, which grows on the roots of *Azolla filiculoides*; also a new species of *Endophyllum*, parasitic on *Centranthus ruber*, which he named *E. Centranthi rubri*. M. Patouillard exhibited *Microstroma album* on oak leaves. He finds that instead of a monosporous conidiophore, there was developed at the tips a swelling bearing six conidia. He therefore creates a new genus for the parasite which is henceforth to be known as *Heterostroma album* Pat. P. Dumée and R. Maire present a note on *Zaghouania Phyllyreæ*, a genus of Uredineæ found in Corsica on the leaves of *Phyllyrea*, which Patouillard had placed in the family Coleosporiaceæ. The authors conclude that the genus ought to form a distinct family, which they name *Zaghouaniaceæ*. The teleutospore germinates *in situ* as does that of *Coleosporium*; but there is a probasidium in *Zaghouania* though only partly encysted, and on germination the protobasidium does not entirely leave the teleutospore. M. L. Rolland laid before the Society a new hymenomycete, *Tricholoma bisontinum* Roll., gathered in the neighbourhood of Besançon. M. Rolland also described to the Society his methods of photographing fungi. Doctors Victor and Xavier Gillot publish an account of cases of poisoning by species of *Amanita* and *Russula*. M. Patouillard describes some new or little known fungi from Algeria and Tunis. The new species are *Gymnosporangium gracile* on *Juniperus Oxycedrus*, *Cintractia algeriensis*, which destroys the flowers of *Danthonia Forskalii*, *Cortinarius Aurasiacus*, *Coprinus dryophilus*, *Melanopus tunetanus*, *Hydnum chlorascens*, a var. *lachmopoda* of *Helvella sulcata*, *Phragmonævia Lauri* parasitic on the leaves of *Laurus nobilis*, *Sphærella Hertizæ*, and a new genus *Helostroma* in which the author has placed *Fusisporium album* of Desmazières. It is a parasite on oak leaves. Prof. Van Bambeke contributes an account of a monstrous form of *Polyporus sulphureus* which grew in the gallery of a mine.

L. Matruchot and C. Dassonville describe a new pathological fungus *Trichophyton caninum* which causes a scurf on the skin of dogs. In cultures the fungus produced tufts of mycelium with intercalary chlamydospores and lateral spores on short stalks.

M. Barbier contributed a list of Hymenomycetes from the neighbourhood of Dijon. It is a continuation of the list published in the Bulletin

* Comptes Rendus, exxxiv. (1902) pp. 316–8.

† Bull. Soc. Myc. de France, xviii. (1902).

for 1901. M. Barbier gives the date of growth, and notes the species that are edible. French species of the genus *Amanita* have been revised by P. Dumée.

M. Ménier and Dr. U. Monnier have conducted a series of experimental researches on volvate Agarics (*Amanita* and *Volvaria*). They find that *Volvaria gloiocephala* is innocuous, that *Amanita mappa* is poisonous to a limited extent only, and they confirm the deadly poisonous nature of *A. muscarius* and *A. phalloides*. The investigators studied the physiological effect of the poisons on the dogs that died from eating the fungi.

Fr. Hélier records an instance of poisoning caused by eating *Entoloma lividum*. The cases did not, however, prove fatal. He also gives an account of the fungi which grow on leather and help to bring about its decomposition.

Fungus Flora of Tyrol.*—Count von Sarnthein gives a list of the larger fungi of the Tyrol made from specimens observed by himself in September.

South American Fungi.—P. Hennings † gives a preliminary list of fungi from Brazil. The new species are *Puccinia Huberi*, growing on the leaves of *Panicum ovalifolium*, *Meliola paraensis*, on leaves of *Vitex*, *Claviceps pallida* var. *Orthocladæ*, *Cordiceps olivaceo-virescens*, *Phyllachora Huberi*, *Auerswaldia Guilielmæ*, *Leptosphæria saccharicola*, *Tryblidiella Loranthi*, *Septoria Spigelizæ*, and *Melasmia Loranthi*. Many of the species grew in the botanical gardens at Para.

L. Romell ‡ gives an account of the fungi collected on the Regnell expedition to Brazil (1892–94), by C. A. M. Lindman and G. O. Malmé. They belong almost entirely to the more durable and portable forms such as *Polyporus* and *Hydnum*. The new species are *Lentinus angustifolius*, *Chætoporos melleofulvus*, *Hirneola albida*, *Fomes subfomentarius*, *Trametes fumosovellanea*, *Phæoporos luteoumbrinus*, *P. ferrugineus*, *Pelloporos hamatus*, *Polyporus roseofuscus* and *Lenzites distantifolia*. The author lays special stress on the size of the pores in the *Polyporeæ* and on the form and dimensions of the spores. Many of the species are illustrated by reproductions from photographs.

Blue Colour in Fungi.§—G. Bertrand has investigated the nature of the blue colour produced by the exposure to the air of certain species of *Boletus*, but which rapidly disappears. It is extracted by alcohol as a yellow liquid, from which the author succeeded in crystallising the chromogen, to which he gives the name *boletol*. It has the properties of a phenol-acid, and is turned blue on exposure to the air by the addition of laccase, though only with difficulty. The presence of manganese, or of a compound of manganese, appears to be necessary for the production of the blue colour.

On the Toxic Properties of some Copper Compounds. ||—One of the most universal and most valuable fungicides is known as Bordeaux mix-

* Oest. Bot. Zeitschr., li. (1901) pp. 473–80.

† Bol. Mus. Para. Hist. Nat., iii. (1901) pp. 231–7.

‡ Bih. k. Svensk. Vet.-Akad. Handl., xxvi. pt. iii. No. 12.

§ Comptes Rendus, cxxxiii. (1901) pp. 1233–6.

|| Bot. Gaz., xxxiii. (1902) pp. 26–48 (7 figs.).

ture, a solution of copper sulphate and lime in water. Other copper compounds are also found effective, and F. Clark, Cornell University, has made a large series of experiments with fungus spores to test their effects on fungus development. He grew the spores on a decoction of sugar-beet, that being found most suitable for comparative tests. Copper salts dissolved in pure water were more toxic in their effect than in any other medium. The addition of potassium sulphate or chloride caused a reduction in toxic properties. An ammoniacal solution of copper carbonate was more deadly in its effects than copper sulphate, but as in the open field the ammonia evaporates quickly it is found to be less efficient than Bordeaux mixture. The author deduced from his experiments, as already suggested by Swingle, that the spores themselves have a solvent action on the copper and thus bring about their own destruction. Almost all vegetable decoctions have the power of dissolving copper. If a too concentrated solution of copper is used for spraying peach trees, the leaves of which have a delicate cuticle, the epidermal cells dissolve enough copper to seriously injure the plant. One value of the lime ingredients in the Bordeaux mixture is the retarding action that it exercises on the solution of the copper by the ammonia, and by the nitrites and nitrates of the atmosphere; it is thus rendered effective as a fungicide over a more prolonged period of time.

Protophyta.

Schizophyceæ.

Gomontiella, a new Genus of Schizophyceæ.* — In bogs in Roumania E. G. Teodoresco finds a new form, in which the edges of the elongated frond are brought nearly close together, forming a nearly closed cylinder, with only a narrow longitudinal fissure. The following is the diagnosis of the new genus *Gomontiella*:—Trichomata libera, simplicia, longitudinaliter in canaliculum cylindricum v. modice planum convoluta; vaginæ firmæ, pertenuæ: cellulæ omnes conformes a vertice (in sectione transversa) visæ profunde semilunatæ v. in annulum contortæ, apices versus sensim paululumque attenuatæ; cellula apicalis calyptram non præbens. Propagatio divisione transversali filamentorum.

Schizomycetes.

Bacterial Disease of the Potato. † — G. Delacroix now claims the microbe which causes the wide-spread disease of the potato already described, as a new species, and names it *Bacillus solanicola*. It also attacks the tomato, but not so virulently.

Beggiatoa. ‡ — G. Hinze has investigated the structure of the remarkably large cells (the largest among Schizomycetes) of *Beggiatoa mirabilis*. He finds the protoplasmic contents to consist of a parietal layer, and of thick bands which separate the vacuoles from one another. There is no sharply differentiated central body or nucleus. The strongly refringent granules of sulphur occur both in the parietal layer

* Verhandl. k. k. Zool.-bot. Ges. Wien, li. (1901) pp. 757-60 (1 pl.).

† Comptes Rendus, cxxxiii. (1901) pp. 1030-2. Cf. this Journal, 1901, p. 689.

‡ Ber. Deutsch. Bot. Ges., xix. (1901) pp. 369-74 (1 pl.).

and in the protoplasmic bands. The cell-wall is composed of two layers differing from one another in their property of swelling. The only mode of multiplication is by intercalary division.

7 **Decomposition of Nitrates and Nitrites by Bacteria.***—A. Maassen found that potassium nitrate in 0.5 p.c. solutions containing 5 p.c. pepton was reduced to nitrite by 85 of the 109 varieties of microbes examined; 50 destroyed nitrites and 4 liberated free nitrogen. Many bacteria which reduced nitrites without liberation of oxygen, had little or no effect on nitrates. The presence of carbohydrates is favourable to denitrification, whilst, in absence of organic nitrogen, nitrates and nitrites are attacked by microbes which have no effect when proteids are present. The so-called denitrifying organisms destroy nitrates independently of the nature of the nutritive solutions, whilst others act only in presence of certain carbon compounds. The action of both classes of microbes is retarded by the presence of highly oxygenated compounds, such as chlorates, without injury to their growth. Some bacteria, such as *Bacterium præpollens*, act on nitrates only in symbiosis with other varieties, liberating nitrogen, and producing potassium carbonate. The co-operating bacteria in the case of *B. præpollens* are exclusively those which reduce nitrates to nitrites.

Chlamydo-spores of Bacteria.†—Prof. A. Meyer expresses the opinion that many species of the genus *Bacillus* are capable of forming chlamydo-spores. In old cultures of *Bacillus coherens*, *ellenbachensis*, and *ruminatus* can be found forms which are extremely like the chlamydo-spores of fungi. Such forms are cells rich in plasma, often vacuolated, and always invested in a thick membrane, and stain well with fuchsin, or with iodopotassic iodide. In connection with this question, it is mentioned that the cell-membranes of some bacteria stain blue with iodine: thus *Bacterium pasteurianum* and *kützingianum* Hansen both do in mass, as Hansen showed, while the author finds that it is the internal lamina of the membrane which becomes blue when the cell is treated with iodopotassic iodide, which renders it probable that the bacterial nucleus is formed by the swelling up of the outer lamina of the membrane.

Effect of the Human Gastric Juice on Cholera Vibrios.‡—Dr. Schultz-Schultzenstein obtained the following results. When the cholera vibrio is suspended in pure water it is killed in 6 minutes by the addition of 0.05 p.c. of acid. Pepsin plus a trace of acid acts inhibitory on the vibrios and causes them to become granular. The association of pepsin and hydrochloric acid is fatal to the vibrios when the proportion of acid reaches 0.019 p.c. 600 c.cm. of water removed, after a stay of 12–15 minutes, from the stomach, was found in 75 p.c. of the cases to have acquired an acidity of 0.03 p.c., and such water was able to kill cholera vibrios in 15 minutes. In 25 p.c. of the cases the quantity of the acid was less, and when it did not amount to more than 0.0142 p.c. the vibrios were not killed in 1½ hours.

In fluids containing albumen or pepton, or both, a much greater

* Arb. k. Ges.-A., xviii. (1901) pp. 21–77. See Journ. Chem. Soc., Abst. ii., lxxii. (1902) p. 39. † Ber. Deutsch. Bot. Ges., xix. (1901) pp. 428–31 (1 pl.).

‡ Centralbl. Bakt., 1^o Abt., xxx. (1901) pp. 785–90.

quantity of acid (0.097-0.217 p.c.) is necessary than in pure water and an action of 1 hour's duration.

Intracellular Constituents of the Typhoid Bacillus.*—Dr. A. Macfadyen and S. Rowland describe experiments made for the purpose of studying the properties of intracellular plasma. In the present communication they describe certain methods for obtaining the intracellular substance of the typhoid bacillus. One of these was to triturate the organisms with sand, care being taken to keep the cylinder cool. Animals treated with the juice thus obtained developed the Widal reaction very promptly and also became immunised, the protection lasting for about 4 weeks. Apparently there is no close connection between the agglutinins and the bacteriolysins, for an animal might become protected without giving evidence of the Widal reaction and might give a strong reaction though having lost its immunity.

Another method was to triturate at the temperature of liquid air, the brittleness of the cells at this low temperature permitting disintegration without admixture of sand and thus affording a yield of chemically unaltered cell-plasma.

In the course of this study it was found that *B. typhosus* produces a hæmolysin in various culture media, and that if it produce a soluble toxin it is of a very mild character or the culture media are unsuitable for its proper development. The principal object of the present preliminary communication is intended to emphasise the importance of attacking the question of immunity from an intracellular standpoint, both as regards the organism and the soil on which it grows.

Polymorphism of Bacillus radicolica.†—Dr. E. Paratore remarks that the root-tubercles of the Leguminosæ are altered rootlets, the change being due to the pathogenic action of bacteria. These bacteria after an active life are metamorphosed into bacteroids. The stages of this change were observed in the tubercles of *Vicia Faba* during the period of fructification. Sections of these tubercles showed, besides normal bacteria, Y-shaped, coralloid and dendritic bacteroids. The bacilli become modified first by increasing in size; one extremity enlarges and divides dichotomously, producing a Y-form. By repetition of the process the dendritic appearances arise. The internal structure of the bacillus also undergoes a change. The protoplasm becomes granular and finally disintegrated, and in this last condition is absorbed partly by the plant and partly by the still living bacteria.

Avian Diphtheria. ‡—C. Guérin communicates the results of an experimental study on the pathogenesis, vaccination, and serotherapy of avian diphtheria. The characters of the microbe worked with were as follows:—A coccobacillus exhibiting oscillatory movements, not staining by Gram's method, not liquefying gelatin, not coagulating or altering the reaction of milk, not growing on naturally acid potato, not forming indol, a potential aerobe and non-aerobe, and exhaling a characteristic odour especially from old cultures. The microbe cannot be included in the Pasteurella group of Lignières since it is motile, nor in that of the

* Centralbl. Bakt., 1^o Abt., xxx. (1901) pp. 753-9.

† Malpighia, xv. (1902) pp. 175-7 (1 fig.).

‡ Ann. Inst. Pasteur, xv. (1901) pp. 941-52.

Salmonella (hog-cholera type), as it does not grow on potato. The best medium was found to be fresh peptonised bouillon and horse-serum in the proportion of 8 of bouillon to 1 of serum. The results of the investigation were as follows. The pigeon, of all the domestic fowls, is the most sensitive to avian diphtheria. Experimental transmission of the disease is easily effected in the pigeon, both by inoculation, by feeding with infected food, and by the dejecta of sick birds. An active immunity may be imparted by means of attenuated virus injected into the peritoneal sac, but not by subcutaneous inoculation. From horses a powerful preventive anti-microbial serum may be obtained, and this will impart to sensitive animals an active immunity by means of serum vaccination.

Acid-resisting Bacilli in Gangrene.*—Folli found in 3 out of 6 cases of gangrene, acid-resisting bacilli. Such pseudo-tuberculous bacteria may be differentiated from true tubercle bacilli by means of tartaric acid (1 in 20), which decolorises the former in 5 minutes while the real tubercle bacilli hold out for 20. The pseudo-bacilli are longer, thinner, less granular, more pointed, and more often in clumps or chains. The author suggests that some of the cases of cured phthisis were possibly due to these pseudo-tubercle bacilli.

Pseudo-diphtheria Bacilli.†—Ch. Lesieur discusses at some length the numerous points in connection with differentiating the Klebs-Loeffler bacillus from the pseudo-diphtheria bacilli. The important practical conclusions are that the Ernst-Neisser stain is very valuable, and that the pseudo-diphtheria bacilli are comparatively rare. In the doubtful cases no definite diagnosis can be arrived at without a long, tedious examination and experiments on animals. Hence it is advisable to assume that the bacilli are diphtheritic if they be morphologically identical with any of the three accepted varieties.

Use of Tyrogen in Cheese-making.‡—Dr. E. von Freudenreich records some experiments made with tyrogen (*Bacillus nobilis* Adametz). The cheeses made with tyrogen turned out very well both with regard to flavour and taste, and compared very favourably with those made with natural rennet, though occasionally they were a little bitter.

Formation of Bacteroids in Artificial Nutrient Media.§—A. Stutzer records the results of cultivating the bacteroids of certain Leguminosæ in aqueous extracts of the seeds of this particular species, especially with reference to the concentration of the nutritive fluid and to the presence of certain mineral substances, notably phosphate of potassium. For the details, which are too numerous for collation, the original should be consulted.

Capsule and Flagella of *B. anthracis*.||—Dr. Hinterberger describes the capsule and flagella of the anthrax bacillus, which, he states, can be demonstrated by applying Van Ermengen's method to the staining of film preparations from agar cultivations, which must be at least 24 hours old if incubated at 37° C., or 48 hours if grown at the room

* *Riforma Med.*, Aug. 27, 1901. See *Brit. Med. Journ.*, 1901, *Epit.* 462.

† *Journ. Phys. et Path. Gén.*, iii. (1901) pp. 961-76, 1000-15.

‡ *Centr. bl. Bakt.*, 2^o Abt., vii. (1901) pp. 857-71. § *Tom. cit.*, pp. 897-912.

|| *Op. cit.*, 1^o Abt., xxx. (1901) pp. 417-24 (1 pl.).

temperature. These structures, he states, cannot be seen in young cultivations. In support of the existence of flagella he gives some not very convincing photomicrographs.

After carefully describing the form and shape of the flagella and the "thread-network" occasionally formed by them, Dr. Hinterberger pertinently asks whether the structures which he has described are really portions of the bacilli in question, or whether they are only artificial products due to faults in technique, or to the presence in his films of portions of the nutrient medium. He replies to these questions in the negative, but admits that his work is not sufficiently complete for him to be absolutely certain.

Formation of Agglutins.*—Prof. Neisser and Dr. Lubowski carefully investigated certain points in connection with the formation of agglutinating substances present in the blood of animals, such as whether the injection of agglutinated cultures of the *B. typhosus* is followed by the formation of agglutins, and also whether the injection of similar cultures tends to raise the agglutinative power previously possessed by the serum of a given animal. Their experiments lead them to return a negative answer to these questions. If, however, non-agglutinated cultivations of the *B. typhosus* were employed, as was done in their control experiments, the injections were followed by a marked rise in the agglutination value of the serum in each group of experiments.

Preparation of Spores for Testing Methods of Disinfection, &c.†—Dr. R. Weil comments upon the difficulty of obtaining strains of anthrax bacilli which shall form spores which are equally resistant to moist heat, to act as test objects in determining the relative values of disinfection apparatus or disinfection methods. The most suitable spores for the purpose are such as will resist exposure to streaming steam at 100° C. for about ten minutes; but unfortunately, when cultivated under laboratory conditions the anthrax bacillus rapidly becomes attenuated in so far as the resistance of its spores to moist heat is concerned, though it may still retain a high degree of virulence.

After trying various methods, the author discarded the use of anthrax spores in favour of those of the *B. mesentericus ruber*. These spores possess much higher resistance, and it was therefore necessary to devise some means of permanently lessening this resistance. Chemical antiseptics being inadmissible, and the exposure to light unreliable, Dr. Weil employed a water-bath regulated at 100° C., and after a series of experiments, found that after exposing suspensions of the spores of different strains of the *B. mesentericus ruber* to the action of streaming steam for from 55 to 65 minutes, he could obtain spores which, when dried on threads by a few hours' stay in a sulphuric acid desiccator and tested in Professor Dunbar's steam oven, were only capable of resisting the action of streaming steam for a period of about 10 minutes.

He states further that this diminished spore-resistance is a characteristic that is transmitted from the parent spores to those formed in the daughter cultures, thus showing that Darwinian principles hold good even in the bacteriological world.

* Centralbl. Bakt., 1* Abt., xxx. (1901) pp. 483-91.

† Tom. cit., pp. 500-4, 526-36 (1 fig.).

Bio-chemical Antagonisms.*—Emmerich and Loew, after referring to the selective action exercised by some fungi for optically active components (some preferring the dextro-, others the lævo-) of an optically inactive food-substance, suggest as a new theory of immunity, agglutination and hæmolysis, that anti-bodies formed in the blood-serum of animals are simply the optically active opposites of the bodies that stimulated their production, and by combination with them form racemic compounds which are inert physiologically as well as optically.

Interpretation of Agglutination Reaction Results.†—The many and conflicting opinions held by different observers with regard to the meaning and value of agglutination reactions, led Dr. Goldberg to attempt to determine the time at which the reaction first became apparent in severe infections, and also to estimate, from the reaction, the degree of immunity artificially conferred upon an animal, chiefly with reference to infections caused by the *B. pyocyaneus* and the *B. typhosus*. In performing the reactions he employed 24-hour-old broth cultivations of these organisms, filtered through Swedish filter-paper, and blood itself diluted with normal saline solution, and examined for half an hour in hanging-drop preparation. As the result of his experiments Dr. Goldberg agrees with Chantemesse that the toxins formed by the bacteria are the responsible agents in provoking the formation of agglutinins, and then proceeds to formulate the following conclusions:—

In fatal infections the agglutinative value remains unaltered. Non-fatal medium-sized doses usually, but not invariably, cause an increase in the agglutinative value of the blood. This agglutinative value undergoes a progressive increase, reaches a maximum, and then gradually subsides to normal.

The intensity of the reaction forms no criterion of the degree of immunity possessed by the animal from which the blood was obtained, although the increase of agglutinative value is an early indication of successful self-protection on the part of the infected animal.

Agglutination of Vibrios.‡—Dr. Kohlbrugge criticises the hypothesis of Emmerich and Loew (whose experiments he had unsuccessfully attempted to repeat), who assert that the deposit appearing in old bouillon cultivations of the *B. pyocyaneus* is a true agglutination due to the presence in the medium of enzymes elaborated by the organism itself, and contends that agglutination should not be inferred simply from the naked-eye appearances, but the existence of the phenomenon should be demonstrated by microscopical examination of hanging-drop specimens.

He then details his experiments with toxins obtained from two pathogenic water vibrios, in which broth cultivations were first prepared from the various organisms; incubated for about 48 hours at 37° C.; sterilised by heat (70° C. and 100° C. to eliminate the possible action of enzymes), or by first heating and then filtering through a porcelain bougie or centrifugalising; and then used as media in which to cultivate several different strains of cholera vibrios, including both virulent and non-pathogenic varieties. The resulting growth was found in every

* Centralbl. Bakt., 1^{te} Abt., xxx. (1901) pp. 552-5.

† Tom. cit., pp. 605-17.

‡ Tom. cit., pp. 639-96.

case to consist of agglutinated masses and of shining motionless bodies, which when transferred to fresh media initiated vigorous growth of typical vibrios. On the other hand, the toxin of one water vibrio was incapable of agglutinating cultures of the other.

Gram-staining Bacteria in the Intestines of Infants.*—Dr. Cahn, following on the lines of Tissier, isolated a number of organisms from the evacuations of breast-fed and hand-fed (cow's milk) infants, and studied such as were not decolorised when stained by Gram's method. The *B. anaerobicus* was not met with in the course of these experiments, but the *acidophilus* was invariably present (post-mortem) in the organs of infants which were the subjects of intestinal catarrh, &c. An extremely sketchy description of some of the cultural characteristics of *B. bifidus*, *acidophilus*, and *aerobius ramificatus* is included in the communication.

Enumeration of Water Bacteria.†—As the result of a series of experiments to confirm or disprove the statement made by Abba at the Congress on Hygiene at Como, Walbaum lays down the following data.

In bacteriological examinations of water for the purpose of determining the number of organisms present, the examination should be carried out by means of plate cultivations on nutrient agar, and only in special cases should gelatin be resorted to, e.g. only when it is necessary to identify the organisms. The plates should be kept at a constant temperature of 20° C., and the result expressed as the number of bacteria per cubic centimetre after 14 days' incubation.

The reasons which led him to formulate these conclusions were that in the first place gelatin liquefies so rapidly as to be useless after a few days' incubation, while parallel experiments with agar plates proved that it possessed no advantage over the agar in point of number of colonies developing after incubation. Secondly, that only in a few cases were any colonies visible after 24 hours' incubation; usually from the second to the third day's incubation the number of colonies remained stationary, but showed a definite increase from the fourth up to about the eighth day, after which no alteration in numbers took place. The daily increase in the number of colonies was so irregular that it was impossible to utilise or even accept Abba's statement that "at the end of three days 30 p.c. of the bacteria present in a sample of water have developed colonies."

Experiments with Deycke's Media.‡—Dr. Bruno Bosse grew fresh virulent strains of the *Vibrio cholerae*, *V. Kochi*, *Bacillus diphtheriae*, *B. typhi abdominalis*, *B. coli communis*, *B. pyocyaneus*, *streptococci*, *staphylococci*, &c., upon the various Deycke's media and compared his results with those obtained from control plate and streak cultivations upon ordinary agar and gelatin. He found that nutrient medium 0 retarded the growth of all except the two vibrios; whilst the colour production of the *B. pyocyaneus* was markedly affected.

Nutrient medium I. favoured the growth of the colon, typhoid, and diphtheria bacilli, also the cholera vibrio.

Nutrient medium IIa forms a good selective medium for the Klebs-

* Centralbl. Bakt., 1^{te} Abt., xxx. (1901) pp. 721-6.

† Tom. cit., pp. 790-8.

‡ Tom. cit., pp. 798-804.

Löffler bacillus, and at the same time retards the growth of associated bacteria. The medium being transparent permits the early recognition of the diphtheria colonies.

Nutrient medium III. inhibited the growth of all the organisms experimented with.

It may be mentioned that the leading principle of Deycke's medium 0 is the conversion of the albumen in the meat, used in preparing ordinary gelatin and agar, into alkali-albumen by means of caustic soda. In nutrient medium I., further conversion into peptone is secured by the action of pepsin. In nutrient media IIa, IIb, and IIc, trypsin also is employed and albumoses thereby formed as the result of artificial digestion for periods of 6, 24, or 48 hours (i.e. IIa, IIb; and IIc respectively). In nutrient medium III. the dissolved alkali-albumen is treated with pancreatin.

BIBLIOGRAPHY.

- BUIST, J. B.—Recent Advances in our knowledge of some Pathogenic Micro-organisms. *Proc. Scot. Micr. Soc.*, III. (1900-1) pp. 57-72.
- LAFAR, F.—Technical Mycology. Fischer, Jena, 1901, first third of vol. 2, with 68 figs.
- MIQUEL, P., ET CAMBIER, R.—*Traité de Bactériologie pure et appliquée à la Médecine et à l'Hygiène.* C. Naud, Paris, 1901, 1059 pp. and 224 figs.
- SCHMIDT, J. U. F.—*Die Bacterien.* Fischer, Jena, 1902, 416 pp. and 205 figs.



MICROSCOPY.

A. Instruments, Accessories, &c.*

(1) Stands.

Ross' New Microscope.—Messrs. Ross have brought out a new Microscope which follows their "Standard" model and is specially intended for the use of medical students (figs. 36 and 37).

Its special feature is a new patent fine adjustment which, instead of

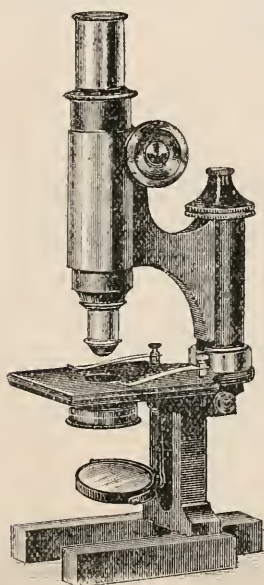

FIG. 36

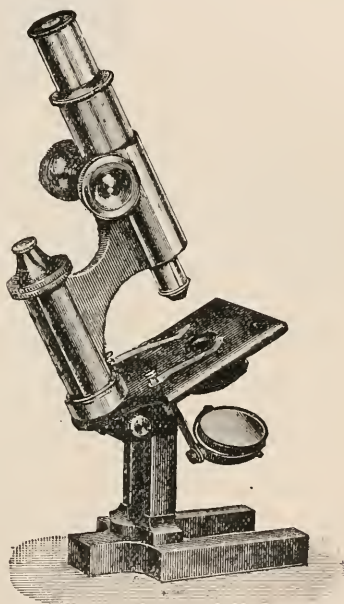

FIG. 37.

the triangle bar, consists of a parallel slide fitting, firmly fixed to the stage.

The moving part is cast on the limb carrying the optical tube, and held in its place by a sleeve-piece bolted securely at the back. A spiral spring, which is placed forward to compensate for the overhanging weight of the body, raises the limb, while the micrometer screw, with its point working on a hardened steel surface, depresses it.

* This subdivision contains (1) Stands; (2) Eye-pieces and Objectives; (3) Illuminating and other Apparatus; (4) Photomicrography; (5) Microscopical Optics and Manipulation; (6) Miscellaneous.

Besides the ordinary accessories, the instrument can be supplied with a dust-proof nose-piece, and a swing-out substage for a condenser (figs. 38 and 39).

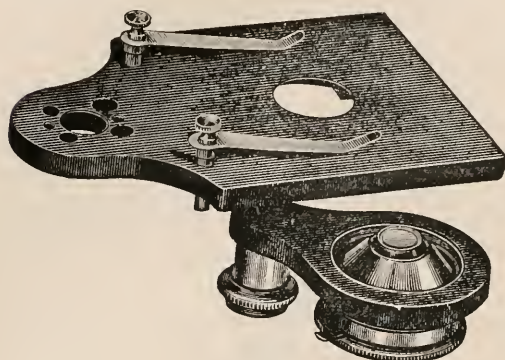

FIG. 38.

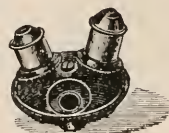

FIG. 39.

Ashe's Two-speed Fine Adjustments.†—A. Ashe's designs are intended to produce an adjustment which should combine the slowest and smoothest motion possible with the capability of giving a far more rapid motion when needed. Fig. 40 shows his first arrangement. It consisted

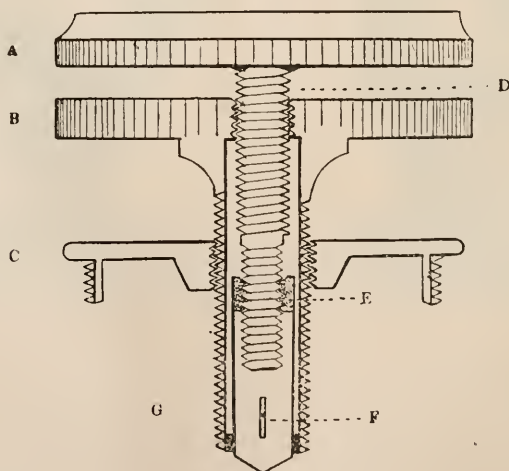

FIG. 40.

of a hollow screw of comparatively coarse pitch G, to which the lower milled head B was attached. This worked in the cap C on the top

* Journ. Quek. Micr. Club, viii. (1901) pp. 131-6 (3 figs.).

of the pillar, and formed the rapid movement. The slow movement was produced by a differential screw D passing through the first and inserted into the top of the rod E actuating the lever. The rod was prevented from rotating by a slot and pin F. The differential screw was rotated by the upper milled head A. When the upper head was rotated and the lower untouched, the slow motion obtained was derived from the action of the differential screw. If both were turned together, the resulting movement would be derived from the lower head only. This form of fine adjustment was designed for lever instruments in which efficiency is the chief consideration. Its principal drawback is that it involves the use of a differential screw, which would require to be very accurately made.

For many instruments with direct-acting fine adjustments, especially

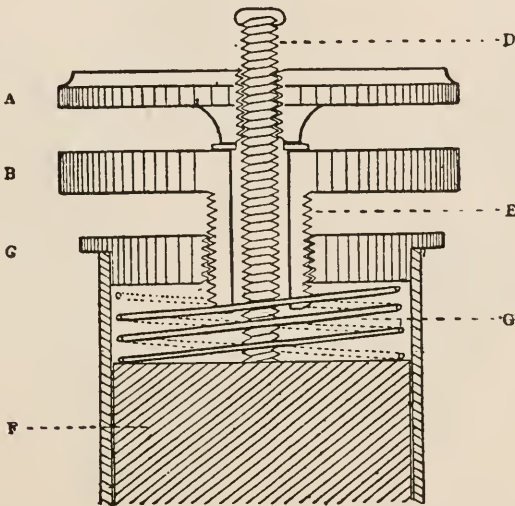

FIG. 41.

instruments of the Continental type, a more simple plan is recommended. In many Microscopes of this class the limb of the instrument is attached to a sleeve, C in fig. 41, sliding up and down outside a prismatic bar F, which is a fixed part of the stand. A micrometer screw D, secured at its base to the top of the upright bar, is carried upwards through an aperture in the cap, and the milled head A is really a loose nut working upon this screw, whilst the cap, limb, tube, &c. are forced up into contact with the milled head by the action of a spring G. This very simple adjustment may, by a single addition, be converted into one having two rates of speed, it only being necessary to insert under the ordinary head A, a second head B attached to the hollow screw E, working into the cap. The latter screw is made hollow, so that it may slide freely over the first screw D. The relative action of the two milled heads in this case is as follows:—the upper head when turned to

the right operates downwards, lowering the focus by depressing the sleeve C carrying the body of the Microscope, and compressing the spring G. The lower head B has, in this instance, simply the action of a washer placed between A and C. A left-handed rotation of A, like the loosening of a nut, permits the expansion of the spring to force upwards both C and B, until stopped by A. When, on the contrary, B is turned to the right it screws itself into C, thereby tending to leave a space between A and B. But this space is at once taken up by the expansion of the spring, thereby raising the cap C together with B, and consequently the focus. Thus, although both screws are right-handed,

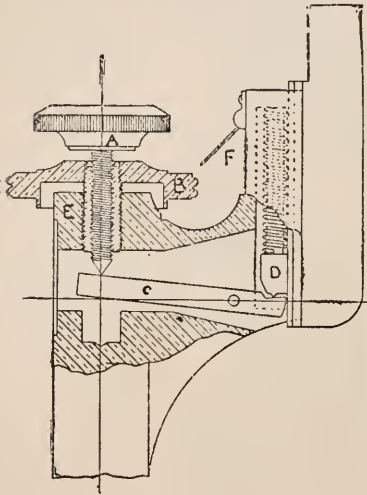

FIG. 42.

the milled heads produce opposite motions in the adjustment. Hence the simultaneous rotation of the two heads in the same direction will give the same effect as a differential screw, provided the screws are not of the same pitch. In another common type of instrument the limb, actuated by a lever, moves in a slot cut in the pillar. To this Microscope the adjustment just described cannot be applied, and as the differential screw is unnecessary for the purpose, Mr. Ashe replaced it by a fine micrometer screw, leaving the rest intact as in fig. 40. Fig. 42 shows how this design has been carried out by Messrs. R. and J. Beck, who have co-operated with the author for the purpose. A strong, quick-moving screw A in the centre forms the coarser adjustment, whilst, in place of a central fine micrometer screw, a thread is cut upon the exterior of a cylinder of large diameter, attached to the milled head B, thus reducing wear and tear to a vanishing point, and adding greatly to its durability. In this form the upper milled head controls the quick screw, which in practice proves to be a more convenient arrangement than does the converse. Fig. 42 is essentially the same adjustment as that adopted by Reichert in one of his latest instruments,* but it was worked out independently and was completed and manufactured before Reichert's instrument was heard of in England.†

Seibert's Mineralogical Stand.‡—This stand (fig. 43) is the most developed member of a set of four "Polarization-Microscopes," made by the Wetzlar firm. The unusually high projection of the arm joining the pillar and tube permits the examination of very thick objects with weak magnification, as well as the application of rotatory apparatus on

* See *The Microscope and its Revelations*, 8th edition, pp. 210-1.

† The idea of a two-speed fine adjustment is not new. It was worked out by Anderson in 1886. See this *Journal*, 1886, p. 325, fig. 62.—Ed.

‡ Catalogue No. 30, pp. 28-36, fig. 12.

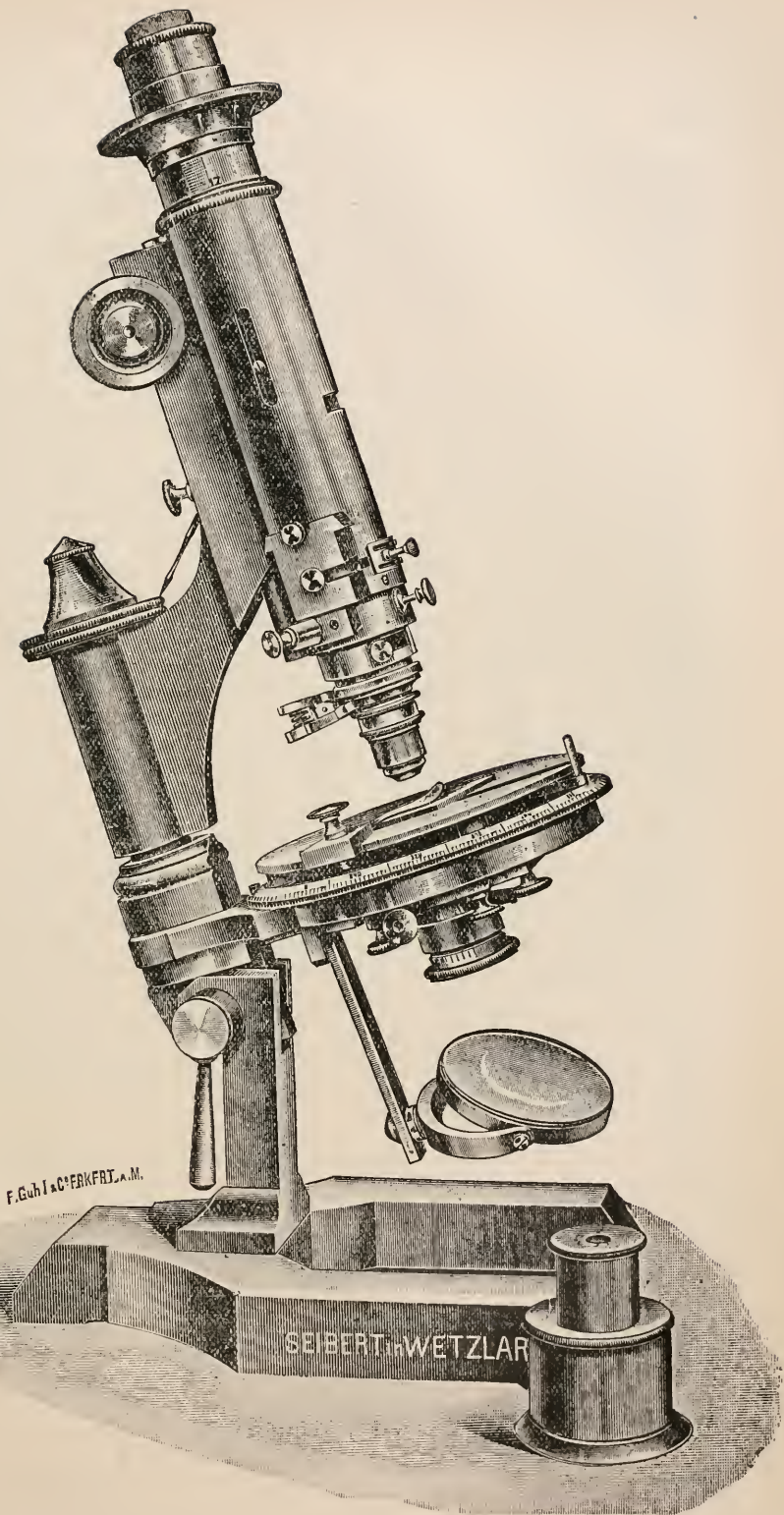

F. GUBI & CO. PERKREUTZ & M.

SEIBERT & WETZLAR

FIG. 43.

the object-stage. The stand is hinged with a clamping lever. The coarse adjustment is by rack-and-pinion; the fine by a micrometer screw, whose head is divided for thickness measurements (1 division = 0.01 mm.). The draw-out tube has millimetre graduations. The object-stage is circular (diameter 105 mm.) and rotatory; the rim is graduated and has a vernier. Under the stage is a screw for securing the rotatory plates. For orientating the object two radii perpendicular to one another are scored on the stage. Centring is performed at the lower end of the tube by two fine screws. The illumination is effected by concave and plane mirrors with universal movement. There are two analysers. One, provided with graduations and verniers, is applied above the ocular; the graduated disc belonging to it being placed close to the ocular end of the draw-tube. The second analyser can be pushed in and out of the tube immediately above the objective without being detached from the tube. The change in the focal length of the objective due to the insertion of the analyser is rectified by the application of a lens of long focus over the prism, so that after the insertion of the analyser no new adjustment of the object is necessary. The inner nicol of the second analyser is rotatory, and a graduation shows its position. The prisms of the analysers have right-angled end-planes, and give a maximum field of view. The polarizer is placed in a push-sleeve under the object-stage; at other times this sleeve may contain diaphragm-holders; it is provided with a lever arrangement for convenient elevation and depression. The rotation movement of the nicol is controlled by a screw working in a slot. Over the polarizer a double condenser is placed for axial images. The polarizer can be exchanged for a cylindrical mounting provided with three diaphragms of various diameters. A Bertrand lens for the magnification of axial images can be used with the ocular, and is slipped into the tube from above into the position of the diaphragm of the draw-out tube. The oculars are all provided with cross-threads, and specially designed for polarizing work; a screw engages in a notch in the tube and so fixes the direction of the cross-threads, this direction being rendered visible by a mark on the outer rim of the mount. Other marks are placed on the side of the ocular at angles of 45° to the cross-threads in order to reveal the direction of minimum elasticity in the application of the gypsum plate. The illustration shows the objective and condenser, fitted with Weinschenk's pliers, which hold the lens firmly to the tube, and yet allow a rapid and easy exchange.

VOINOW, D. N.—*Principii de Microscopie*. Bucaresti (Göbl), 1901, 8vo, 271 pp.

(2) Eye-pieces and Objectives.

Hastings Apochromat.*—A. A. Adee, after testing the 5 mm. apochromatic objective designed by Prof. Hastings of Yale University, speaks very highly of its performances in difficult photomicrography. He finds it superior in working quality to any apochromatic lens he has yet tried, except the Zeiss apochromat of 4 mm.; and, as regards that, the Hastings lens holds its own in photomicrography. The

* Journ. App. Micr., 1901, pp. 1442 and 3.

correction for actinic rays is surprisingly good, so that exquisite definition is obtainable, even with a projection ocular No. 4. Notwithstanding the extremely wide aperture, the field is perfectly flat, so that perfect photographic definition is obtained at the edges of a large circle on the focussing screen. The lens can take an unusual quantity of light, and the condenser and diaphragm can be opened at least 40 p.c. more than with other lenses, and excellent photographic results still be obtained.

Magnifiers.*—J. Dearness, of London, Canada, finds that many students are incapable of getting the best results out of the simple Microscope. Instead of a folding lens or tripod he uses, in his classes, a watchmaker's glass with two lenses. The lens on the tip may be removed, thereby rendering the remaining lens lighter to hold in the eye, while at the same time giving sufficient amplification for most work. The great advantage of this magnifier is that both hands are free; but the objection is that many students are unable to retain the magnifier by the eyebrow. He has therefore had a detachable heavy watch-spring added to the mounting. This spring goes round the head and, when properly adjusted, holds the lens comfortably in a suitable position. Even those who can use the lens in the ordinary way, find the necessary fatigue minimised by this device. As the spring is detachable the glass can be carried in the pocket, and used for simple hand magnification if desired.

HÉNOCQUE.—Oculaire spectroscopique destiné aux études de micro-spectroscopie.
Comptes Rend. Soc. de Biol., LII. (1901) No. 37, p. 1009.

(3) Illuminating and other Apparatus.

Lens for Dark-Ground Illumination.—Messrs. Ross have added to their list a new simple lens for dark-ground illumination. It consists of a meniscus lens bored through the centre to receive a spot turned out of vulcanite, and having a stem to drop into the hole in the centre of the lens. A most perfect dark ground with the object brilliantly illuminated is obtained. It can be fitted to any Microscope.

Albrecht's Objective-Carriers.†—This piece of auxiliary apparatus is adapted for receiving any desired number of objectives, which it sets rapidly and accurately in their proper optical positions; it also effects any easy interchange among the objectives, and securely protects them from dust. Fig. 44 gives a section, and fig. 45 a plan seen from above. The apparatus consists essentially of a broad ring *a*, in reality, the circular section of a hollow cone, and by means of a collar *b*, with bayonet clutch *c*, it is fastened under the tube *d*, and can be easily removed. This ring *a* is immovable, and is provided under *d* with an opening which forms a continuation of the tube. An arm *f* of the collar *b* supports the ring at its centre. On its under side *a* possesses a concentric dovetailed groove which a ring *g* engages pushwise; this ring is on its inner side also provided with a dove-tailed tenon. The hollow part of the ring *a* is provided, at the proper place, for receiving an objective

* Journ. App. Micr., 1901, pp. 1448-9.

† Central-Zeit. f. Opt. u. Mech., xxiii. (1902) p. 2 (2 figs.).

with two cross-walls forming a species of shaft open on top. In the dovetailed grooves set in these shafts are situated the special objective-

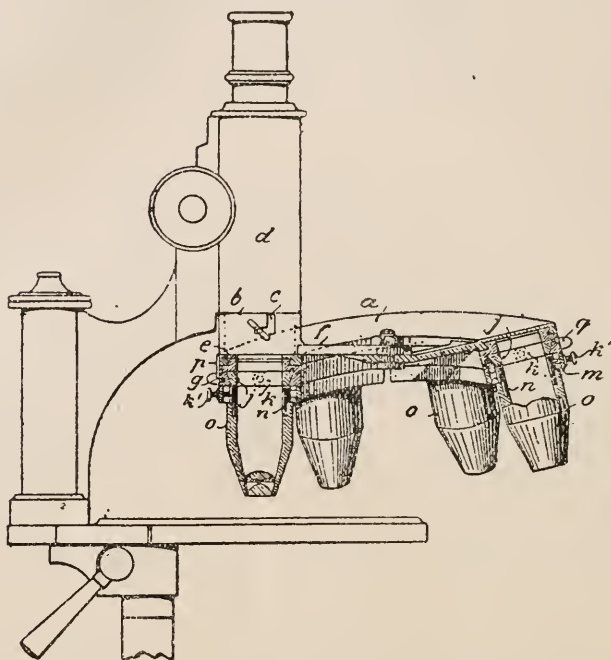

FIG. 44.

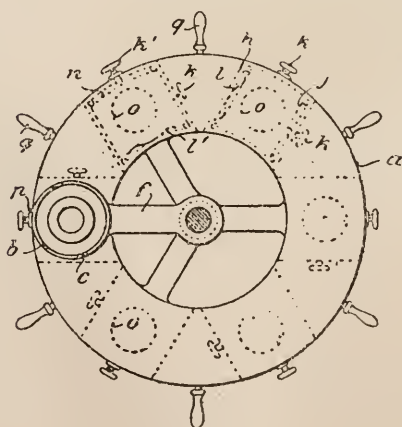

FIG. 45.

carriers *j*, in such a manner that the space between the shafts serves as free room for adjusting the carriers. This adjustment is conveniently

done by a set-screw *k*, on the one side, and a spring *l* on the other. On the under side the carriers *j* form bars *m*, of the breadth of the ring *g*, to which they are closely applied while, sideways, they somewhat project beyond the partitions *h*, so that no dust can penetrate into the objectives between these walls and the carriers.

In use, the ring *g* is pushed round until the desired objective is under the tube *d*. When this occurs, a spring automatically snaps and holds the objective rigidly in its place. Any adjustment required is easily done by the set-screws *k*, *k*. The rotation of *g* is to be done by means of the little handles *q*, in order to avoid any possible disturbance of the centring of the objectives. To prevent entrance of dust during an exchange of oculars, the ring *g* is rotated so that one of the inter-shaft spaces comes under the tube *d*.

Microscopist's Electrical Lamp. * — Fig. 46 represents this lamp about half size, as devised by T. Tammes. The light source is an

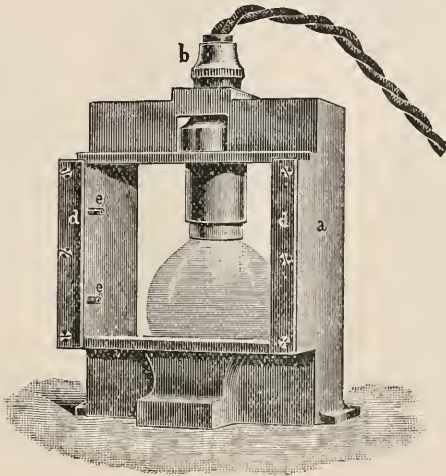

FIG. 46.

almost spherical electric incandescent lamp of about 4 cm. diameter. It is made of 5 or 10 candle-power, the first sufficing for ordinary purposes. The carbon filament is wound several more times than is usual, and when in use the planes of the coils should be perpendicular to the observer. In the figure the thread is not visible as the glass is ground. The frame is of cast iron, and of such a height as to just fit between the foot and stage of an ordinary Microscope. The lamp can thus be brought close to the mirror. The sides so enclose it that an operator is confined to his own lamp, and not affected by that of an adjoining observer. The open back reduces inconvenience from excess of heat. The open front permits of the insertion from above of coloured screens.

* Zeitschr. f. wiss. Mikr., xviii. (1902) pp. 280-5 (1 fig.).

The ground glass of the lamp is of a kind not to absorb much light, and yet of a fine grain. The 5-candle lamp suffices for magnifications of 500 to 600 diameters; the 10-candle for immersion systems. The electromotive force recommended by the inventor is 105 volts.

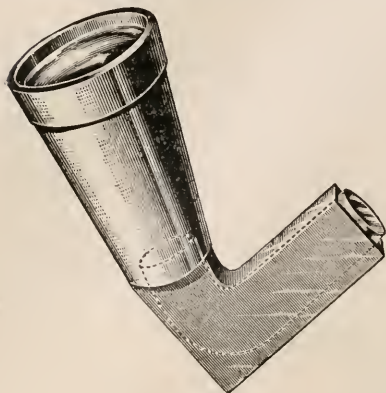

FIG. 47.

Glass-rod Substage.*—F. W. Leggett has found that a glass rod gives a fine illumination with $\frac{1}{6}$ objective and No. 3 eye-piece. The rod consists of Bohemian glass $\frac{1}{2}$ in. diameter, $3\frac{1}{4}$ in. long, bent at an angle and polished at both ends; this is incased in metal, the inner surface of which is polished. Attached to the end toward the light there is a funnel $3\frac{1}{2}$ in. long, expanding from $\frac{1}{2}$ in. to $1\frac{3}{4}$ in. in diameter and highly polished in its interior. At the end near the light is inserted an ordinary bull's-eye lens, so placed that the rays of light pass through

the rod to the object on the stage of the Microscope. Should the light be too intense for low powers, it can be modified by removing the bull's-eye condenser.

(4) Photomicrography.

Photomicrography. † — D. W. Dennis, in the first of a series of articles on this subject, gives in the following words his opinion regarding the choice of apparatus.

“One reason why photomicrography has not hitherto succeeded better is that a cheap apparatus, scraped together from a microscopic and a photographic outfit, has been recommended. This cheap apparatus was always the most expensive to be had, for the reason that the time consumed in getting ready for, and making, a successful exposure costs, in the end, more than the investment for a correct outfit. In the second place the results, for reasons above given, were never valuable except in the case of slides so perfectly prepared that they had to be the best of an expert microscopist's work. I, again and again, concluded, while using these makeshifts, that histological slides could not be successfully photographed. I thought photomicrography was an art, the usefulness of which was confined to the resolving of lines on diatoms, and reproducing the silhouettes of bacteria so prepared that the contrast was sharp and the field flat. The cheap way to make successful photomicrographs is to have a complete apparatus: Microscope, stand, lenses, camera, and illuminating appliances dedicated to this one work, mounted to stay, on tables adapted to the purpose, resting on a floor that cannot be jarred, with a fully equipped dark room immediately at hand.” An example of Mr. Dennis's high-power work ($\times 1500$) is given. It represents the

* Journ. New York Micr. Soc., xvi. (1901) pp. 16-7 (1 fig.).

† Journ. App. Micr., 1901, pp. 1399-1403 (6 figs.).

early telophase of mitosis in *Ascaris megalcephala* var. *bivalens*; the polar bodies and the egg-cell wall are seen; the centrosome is divided just below the polar bodies.

A Notable Advance in Colour Photography.*—"It is now possible for a newspaper correspondent in China to take snap-shots in his ordinary camera, fitted with a newly perfected screen, to send the negative to New York, and there have the picture reproduced in all its original colours, the printer having no previous knowledge of the colours themselves."

The preceding quotation is Messrs. Brasseur and Sampolo's own description of their new process in three-colour work. But, in contradistinction to the older methods, only one negative is required, and the exposure is not more than one-tenth to one-sixtieth of a second. All makes of polychrome screens can be used to obtain the negatives, but

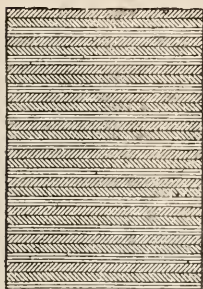

FIG. 48.

Enlarged 53 times. Positive on glass made from original negative; successive groups of coloured lines, each colour repeated every third line.



FIG. 49.

Black and white screen placed over positive and showing only one of the positives.

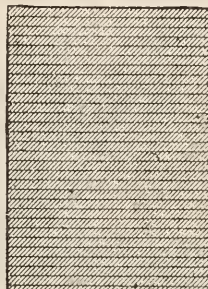

FIG. 50.

Completed negative of one of the images. Entire surface is now occupied by image which on original only occupied one-third.

the best are those ruled in groups of threes, one line being in a reddish-yellow, one in a yellowish-green, and the other in a blue-violet colour. The screens made by Mr. Brasseur have 531 lines per inch, with no mistakes in any inch of more than one fifty-thousandth of that space. When the negative has been obtained a positive on glass must be made. This positive apparently does not differ from ordinary positives; but when examined under the Microscope it is found to consist of three interwoven images corresponding with the three sets of lines of the taking screen (fig. 48). Suitable printing plates must now be made from each one of these interwoven images. This is done by placing over the positive a black and white screen ruled in such a way that each black stripe exactly corresponds to two adjacent stripes, and each

* Annual Report of Smithsonian Institution, 1900, pp. 523-6 (5 figs. and 1 coloured plate; and *The World's Work*, Dec. 1900.

white stripe to one stripe of fig. 48. Thus all the stripes corresponding to one colour of fig. 48 are exposed, say the yellow (fig. 49). A half-tone negative is made of this, and during the exposure the most important step occurs: the negative plate is moved continuously until the image which occupied the one-third of the plate occupies the entire surface (fig. 50). This is essential, as in order to obtain the proper colours the prints must be superposed, and not juxtaposed as in the original positive. The screen is now shifted the width of one line, covering up the image of which a printing plate has been made, and exposing a new image, say the red one. A plate is made of this one, and the operation repeated for the third image, the blue one. A set of photographs of a tiger are given to illustrate the different stages of the process. The final result is very lifelike.

Dennis' High-power Photomicrography.*—Fig. 51 shows D. W. Dennis' arrangement of the 1899 Zeiss apparatus, which was placed on

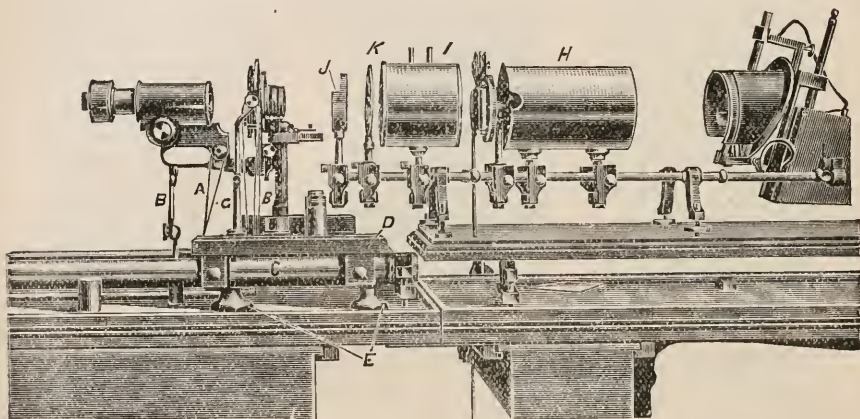

FIG. 51.

an unshakable stone floor, and consisted of two tables supported on adjustable metal legs, the combined length being $10\frac{1}{2}$ feet. One table, 4 ft. long, carries the arc light and illuminating accessories; the other carries the Microscope and camera. The objectives are apochromatic, from 70 mm. to 2 mm., with compensating and projecting eye-pieces. The fine adjustment screw is controlled by a brass rod, which lies on the bench under the camera, and has a pulley and cord attachment A, with the milled head of the micrometer screw. The Microscope is so supported by an adjustable brass pillar B, that this pulley cannot in the least affect it. The camera is carried on two nickered steel tubes C, which rest on adjustable metal supports, and the board D, on which the Microscope rests, is bound also by clamps to these same tubes. Four strong adjustable pillars E hold the board firmly at one distance from the table. The total effect of these arrangements is to make the Microscope and its supports immovable.

* Journ. App. Micr., Nov. 1901, pp. 1525-7 (3 figs.).

The movable stage is also controlled from the ground glass 6 ft. away by brass rods with milled heads and cord and pulley attachment, and the stage is supported against the strain of these by an adjustable brass pillar G. The stage can thus easily and quickly be searched over a space $\frac{3}{8}$ in. square. The coarse adjustment of the Microscope is similarly controlled.

The adjustable pillar B, under the Microscope, to offset the pull of the cord on the fine adjustment screw, was specially added by Mr. Dennis, and seems to suggest that the Zeiss model in its original form was not sufficiently steady for very high powers. Mr. Dennis has also added the controlling arrangements of the coarse adjustment, the stage, the adjustable pillars under the Microscope bench, and the adjustable pillar under the stage. He has, moreover, placed scales on both the camera table and the optical bench, so that all parts of the apparatus can be quickly brought into any desired relationship.

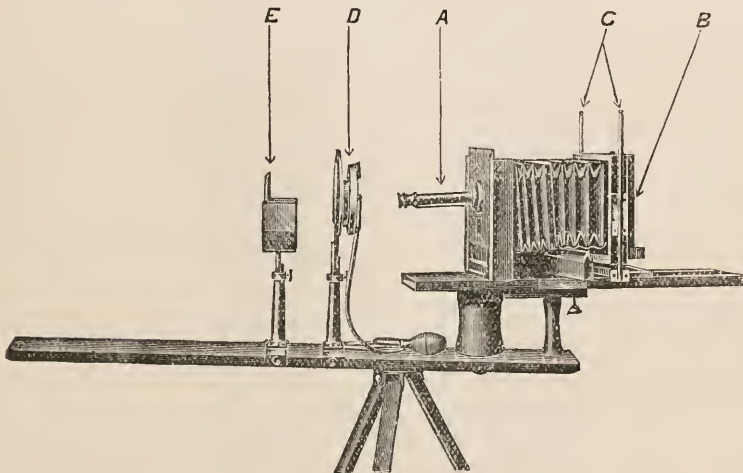

FIG. 52.

Colour Photomicrography.* — F. L. Richardson makes some contributions to our knowledge of this subject. He considers that, of the plates now in use, the orthochromatic approaches most nearly the ideal colour plate, but that this is not perfectly satisfactory, as it does not give sufficient contrast. He therefore undertook some investigations to determine the relative merit of various photographic plates. The apparatus, as illustrated in fig. 52, consisted of a direct vision spectroscop, so mounted in the front board of an ordinary camera (with lenses removed) that the spectrum, when projected on the plate, would come in the centre horizontally and at the top of the plate. The back of the camera was constructed in such a manner as to allow of its being moved

* Journ. Boston Soc. Med. Sci., 5, pp. 460-4; and Journ. App. Micr., 1901, pp. 1489-92 (3 figs.).

in the vertical plane; thus four exposures could be made on the same plate, and therefore an accurate comparison was possible between them. In the figure A is the spectroscope; B the back of the camera, carrying screen and plate-holder; C, supports upon which the back B may be moved; D, shutter; E, colour-screen in colour-screen-holder. The plates examined were grouped, according to their degree of perfection, as follows:—

Group i.—Characterised by a very high degree of sensitiveness, a little above the line D, falling off abruptly on either end, and only slightly sensitive to greens and blues.

Group ii.—Characterised by two distinct maxima, one a little above the D line, and the other in the blue-green. Between these two maxima the sensitiveness falls very considerably.

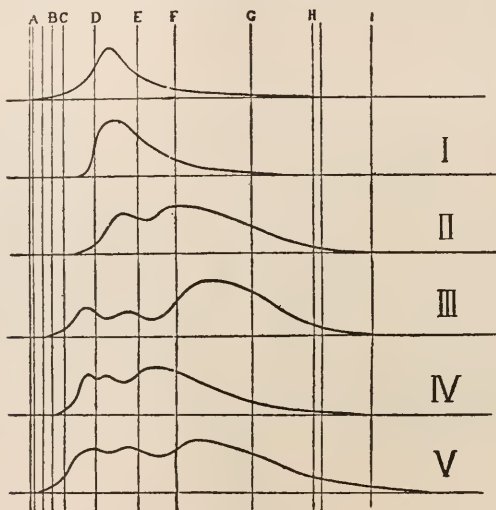

FIG. 53.

Group iii.—Characterised by having its maximum sensitiveness in the blue (as with ordinary plates), with lesser bands of sensitiveness extending below the D line.

Group iv.—Characterised by bands of sensitiveness extending below line D, with greatest intensity in the yellow-green, and falling off at the violet end before H_2 .

Group v.—This group most nearly approaches perfection. It is characterised by a sensitive band well below line D, and somewhat below the red end of Groups iii. and iv. This plate gives an almost uniform degree of sensitiveness with a maximum intensity in the green.

In fig. 53 the upper curve shows the visual intensity of the spectrum (from Fraunhofer). Curves i.-v. represent the photographic intensity of the spectrum taken on plates corresponding to the groups of the same number. Group i., Cramer isochromatic (slow); Group ii., the

standard orthochromatic (slow); Forbes orthochromatic (slow); Carbutt orthochromatic (slow); Otto Perutz; Group iii., Lovell colour-differentiating; American spectrum plate. Group iv., Cadett and Neal spectrum plate (slow); Group v., International "Erethro."

If sensitiveness to the spectrum were the only feature to be considered in the selection of a plate for photomicrographic work, a plate from Group v. would be chosen, but the general working of the plate as well as the keeping qualities are factors that must be considered. For practical work and keeping qualities the author found the Cadett and Neal special slow spectrum plate of Group iv. most satisfactory, and used it in the preparation of the spectrographs illustrated in fig. 54, which is a reproduction of spectrographic analysis of some of the common

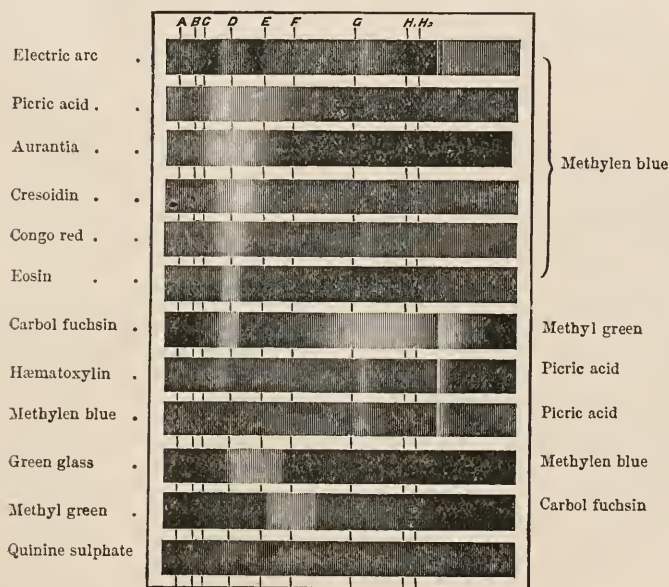

FIG. 54.

stains. The red end of the spectrum is on the left. The principal Fraunhofer's lines are marked. The name of the stain is on the left, while on the right is the name of the proper screen for increasing the photographic intensity. To decrease the contrast, a screen of the same colour should be used; to increase the photographic intensity a screen of complementary colour should be used. The colour screens were made by soaking a cleared lantern-slide in a solution of the desired stain until the gelatin was saturated, and then by rinsing and removing the surface liquid with a cotton pad. The screen was then dried and covered with a cover-glass, as in mounting a lantern slide. The depth of colour in these screens is dependent upon the degree of concentration of the staining solution rather than upon the duration of soaking.

Stringer's Focussing Attachments to Photomicrographic Cameras.*

Among the various methods invented for making an effective connection between the Microscope fine adjustment and the long rod from the end of the camera, the favourite has been an endless band passing round

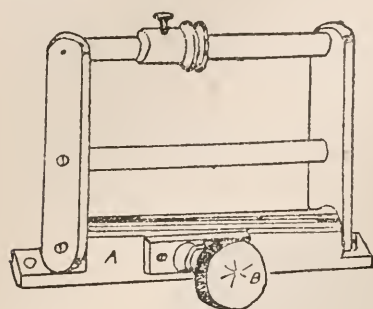

FIG. 55.

the milled head of the Microscope and round a similar head attached to the camera-rod. The arrangement has, however, possessed the drawback of not being readily detached from the Microscope. E. B. Stringer's method of overcoming this is shown in fig. 55, which shows an adjustable roller to keep the cord taut. The usual milled head of the camera-rod, around which the cord is passed, is mounted on a frame, the lower portion of which fits into a sleeve A, and permits the rod on which the milled head is carried to be

tilted forward, when the band is to encircle the fine adjustment head, or to be removed; the band is then made taut by setting the fitting vertical again, a clamping screw B being provided for securing it. The long camera-rod then engages with it.

Simple Means of Producing Microphotographs with an ordinary Camera.†—Mr. W. Forgan describes how, with a simple accessory to an ordinary camera, small photographs of large objects may be obtained. The camera should have a rigid front, and that portion carrying the dark slide should be capable of being fixed rigidly in the position it is to occupy while the photograph is being taken. The old form of box camera would seem the very best for the purpose. The flange in the camera front, used along with the accessory referred to, was that taking the Ross portable Symmetrical and other lenses having the same size of screw. Into this flange there was screwed a thick drawn tube, as large as the aperture would allow, and on its outside was soldered a ring, screwed to take the screw in the flange. The tube entered inside the flange about 2 in. and was sprung at the end inside with cuts resembling the letter T placed horizontally. The other end of this tube or jacket was cut with an inside screw of 50 threads to the inch. Another piece of telescope drawn tube was selected about 6 in. long and made to slide easily in this jacket. A ring about $\frac{1}{4}$ in. broad was soldered outside within an inch from the other end of this last tube, and was also cut with a screw of 50 threads to the inch, so that, when this tube was placed inside the jacket and turned round, it could be made to approach or recede from the sensitive plate in the dark slide by a very minute quantity. To enable this to be done easily a large ring, knurled on the edge, was soldered on to the extreme outer end of the tube. The effect of the whole arrangement was that the tube could be rotated without the least apparent movement of the image on

* Knowledge, Dec. 1901, p. 285 (1 fig.).

† Proc. Scot. Micr. Soc., iii. (1901) pp. 79-82.

the screen during focussing. The inner end of the inside tube had the universal Microscope screw to take the object-glasses used, which were the 75 and 35 mm. of Zeiss. A single dark slide was employed, and a carrier made to fit it having an aperture in the centre to take plates the size of a twelfth of a quarter plate. One of these small plates was emery ground on one side and used for rough focussing. Another was marginally ground leaving a clear space of about $\frac{1}{2}$ in. square in the centre, and this was evenly smeared with thin virgin wax. This was the fine focussing screen. The negatives to be copied were quarter plates, illuminated by a 4-in. condenser placed immediately behind them, and in almost close contact with them, their distance from the camera being regulated by the size of the microphotograph desired with each object-glass used. An ordinary paraffin lamp was the source of light. It will be seen that no focussing screen on a separate frame was used, the focussing glass being carried in the dark slide itself, and removed each time the sensitive plate was put in, thus preserving the perfect register obtained.

HINTERBERGER, HUGO.—Ueber Mikrophotographie.

[An interesting lecture to the Vienna Camera Club. Describes the various methods, and gives several good examples of photomicrography.]

Published as a pamphlet from the *Wiener Photographische Blätter*, 8 pp. and 6 figs.

Einiges aus der mikrophotographischen Praxis mit Zeiss' grossem Instrumentarium.

[A pamphlet of 6 pp. and 1 fig., detailing the method of using the instrument—apparently intended mainly for his laboratory students.]

Eine Notiz über mikrophotographische Aufnahmen von Insektenpräparaten.

[A practical pamphlet of 4 pp. and 4 pls. on the proper preparation and treatment of insect specimens for photomicrography.]

Published as a tract from the *Photographischen Centralblatt* (Callwey), München.

Versuch der farbenrichtigen Reproduction eines doppel-farbigem mikroskopischen Präparates nach zwei mit den gewöhnlichen Hilfsmitteln der Mikrophotographie hergestellten Aufnahmen. (Investigation of the reproduction in proper colours of a doubly stained microscopical preparation with the ordinary accessories of photomicrography after two suitable exposures.)

Camera Lucida, 1901, 8vo, H. 24, 3 pp. and 1 pl.

Mittheilungen aus dem photographischen Privat-Laboratorium des Universitäts-Lehrers Hugo Hinterberger in Wien.

[A Report of the work for 1901, mainly in the department of photomicrography.]

Wien, January 1902.

M'CLUNG, C. E.—Laboratory Photography. High-power Photomicrography.

Journ. App. Micr., IV. (1901) p. 305.

Photomicrographic Apparatus. Tom. cit., p. 1199.

PENNY, R. G.—Photomicrographic Apparatus. *Amer. Mon. Micr. J.*, 1900, p. 310.

(5) Microscopical Optics and Manipulation.

STREHL, DR. KARL.—Bericht über optische Fortschritte. (Review of progress in Optics.) *Central-Zeit. f. Opt. u. Mech.*, XXIII. (1902) p. 1.

(6) Miscellaneous.

The New Spectrum.* — Dr. S. P. Langley has now thoroughly mapped out the infra-red spectrum. As far back as 1884 he had ascer-

* Annual Report of Smithsonian Institute, 1900, pp. 683-92 (1 pl.).

tained that this invisible part of the solar spectrum extended as far as a wave-length of 5.3μ . But with the bolometer then in use, delicate though it was, the mapping out would have involved a labour of fifty years. He has since then succeeded in increasing the sensibility of the instrument from the detection of a temperature variation of one-thousandth of a degree Centigrade to that of one hundred-millionth of a degree. He has also connected it with a self-recording photographic apparatus of extreme precision. By these methods he has six series of observations which differ inappreciably from their mean, and the spectrum is found to contain over 700 lines.

Tape Measure for Adjustment of Projection Oculars.* — Dr. A. Köhler, in order to minimise the difficulties connected with the adjustment of projection eye-pieces, has devised a rearrangement of the scale on the oculars. If the index stands on the zero then the front focus of the projection system lies in the plane of the ocular diaphragm; if the index is set on another figure then the focus is pushed a corresponding number of millimetres behind the diaphragm plane.

In order to conveniently adjust the ocular head for any desired projection distance (within its due limits) a specially marked tape measure is used. One side of this measure is blue and marked with the figure P_2 ; it is intended for oculars 2 and 3. The other side is red, marked P_4 , and intended for oculars 4 and 6. The tape is divided into divisions corresponding to the graduations on the oculars. In using the tape the operator brings the first graduation into the plane of the screen, measures towards the ocular, and discovers at what interval the plane of the ocular-division will lie; the figure, found there, gives the number of millimetres by which the ocular head must be screwed out in order to throw, at the required distance, an image of the diaphragm on the screen.

Details are given of the method by which the calculation of the scales on the tape was made.

Some Evidences of Unscientific Conservatism in the Construction of Microscopes.† — The Rev. G. C. F. Haas, whilst fully admitting the immense improvements of the last half century in the construction of Microscopes, points out that many objectionable features seem to be retained in various types of instruments simply from the makers' disinclination to adopt a change. He thus severely criticises the horse-shoe foot, the want of an inclination joint, small stages, stage-clips, immovable mirror-bars, non-parfocal eye-pieces, &c. There is a Society screw; why then not one, or at most two, diameters of tube and sub-stage ring? Why have we a dozen or more different tube-lengths instead of one short and one long one; both measured in the same way? When shall we have adjustable objectives marked in a rational manner, instead of being engraved with a series of numbers that have no relation whatsoever to thickness of cover-glass or to tube-length, and only serve as a continual puzzle to the memory?

Images of Diatom Structure.‡ — W. Balfour Stokes discusses the "white dot" and "black dot" images and concludes that *Pleurosigma*

* Zeitschr. wiss. Mikr., xviii. (1902) pp. 273-9 (3 figs.).

† New York Micr. Soc., xv. (1900) pp. 2-6.

‡ Journ. Quek. Micr. Club, 1901, pp. 109-12.

formosum, in which with an axial cone the black dot image occurs above the white dot (the reverse of the usual order), is structurally peculiar. He suggests that the minute perforations in this diatom are silted up with silica, and that what has been taken for special structure, as seen in the black dot image, is really irregular openings in the siliceous material.

Double-Image Discs and Complementary Interference Colours.*—J. Rheinberg, by placing a disc above the objective, obtains two images of the same diatom in complementary colours. The disc is prism-shaped, but a circular central portion has plane parallel sides. The effect is to produce a direct dioptric image and a diffraction image of the first order. When the dioptric image of a diatom shows colour due to interference, the diffraction image shows the complementary colour.

B. Technique.†

(1) Collecting Objects, including Culture Processes.

New Method for Isolating the Typhoid Bacillus from Water.‡—G. Vallet takes a large quantity of water and treats it with lead nitrate. The precipitate which carries down the bacteria is dissolved in sodium hyposulphite and is then submitted to bacteriological examination. Another method is to precipitate with alum or with barium nitrate. For example, 200 ccm. of water to be tested is treated with 25 ccm. of either precipitate. In 1 to 2 hours a deposit containing the bacteria is formed.

A still better method is a combination of mechanical and chemical precipitation: centrifuge tubes of 20 ccm. content receive 4 drops of saturated sodium hyposulphite solution and 4 drops of saturated barium nitrate solution, both sterilised. After centrifuging for 3–4 minutes (3000 turns) the clear fluid is decanted off, and to the sediment is added, drop by drop, hyposulphite until it is dissolved. The dissolved precipitate is then distributed over Elsner's gelatin plates. After 3 or 4 days the differentiation may be begun, and for this litmus-lactose-agar is recommended. Instead of this, lactose-bouillon may be used. The coagulation or non-coagulation of milk should be tried and also the agglutination test.

Cultivation of the Leprosy Bacillus.§—W. J. Kedrowski successfully cultivated the microbe of leprosy from three cases; the bacilli thus obtained, however, were less resistant to acid than the leprosy organisms in the human tissues. The nutrient media used were meat-pepton-bouillon and agar mixed with aqueous extract of human placenta filtered through a Chamberland bougie. The media were inoculated with blood and also with pieces of leprosy skin. By the second or third day there was a luxuriant growth in both the solid and liquid media. On gelatin the

* Journ. Quek. Micr. Club, 1901, pp. 151–2 (1 fig.).

† This subdivision contains (1) Collecting Objects, including Culture Processes; (2) Preparing Objects; (3) Cutting, including Imbedding and Microtomes; (4) Staining and Injecting; (5) Mounting, including slides, preservative fluids, &c.; (6) Miscellaneous.

‡ Arch. Méd. expér. et d'Anat. pathol., 1901.

§ Zeitschr. f. Hygiene u. Infekt., xxxvii. p. 52. See Centralbl. Bakt., 1st Abt., Ref., xxxi. (1902) p. 90.

growth was scanty and the medium was not liquefied. On egg-yolk and blood the growth was very good, but the bacilli were very short and resembled diplococci. On other media the bacilli were like those found in the living body, being slightly bent, one end often thicker than the other, and undoubtedly motile.

Medium for Isolating Bacillus Typhosus in presence of Bacillus coli communis.*—R. Cambier uses a freshly made bouillon prepared by mixing cold 50 ccm. of a 3 p.c. pepton solution, 4–6 ccm. of 1 p.c. soda, and 4–6 ccm. of sea salt, all sterilised at 115°. With this nutrient medium and the bougie method he has been able to isolate in pure culture the typhoid bacillus from a liquid consisting of equal parts of coli and typhoid bouillon cultures, and under even more difficult conditions. The method appears to be specially adapted for seeking the typhoid bacillus in stools.

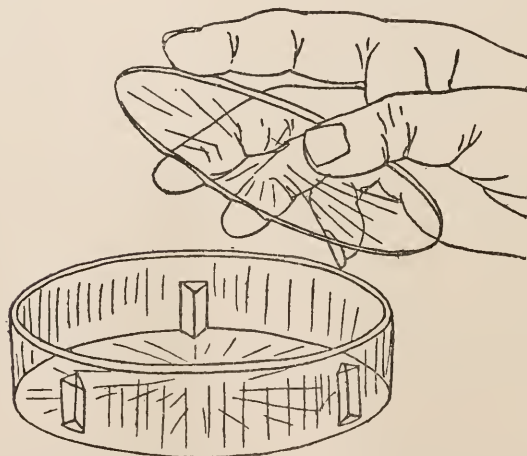

FIG. 56.

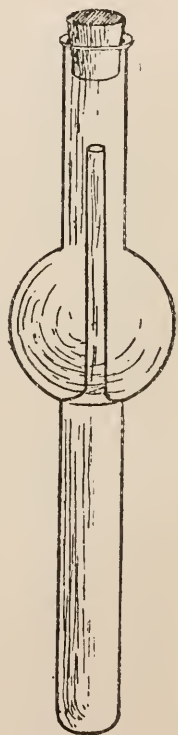

FIG. 57.

Apparatus for Anaerobic Cultures.†—R. Turro claims that his simple apparatus is an improvement on its predecessors for isolating anaerobic bacteria. It consists (fig. 56) of a glass pan on the inside of which are fixed three angular pieces of glass. These serve to support a round plate or

* Comptes Rendus, cxxxiii. (1901) pp. 1226–9.

† Centralbl. Bakt., 1^{te} Abt. Orig., xxxi. (1902) pp. 175–6 (2 figs.).

disk. On this disk plates of air-free agar or gelatin are made and are then inoculated with properly diluted cultures or fluids containing bacteria. On the bottom of the pan are placed pyrogallic acid solution and a piece of caustic alkali. The plate is then turned over and placed in the dish so that it rests on the three supports. The edge of the disk is then made air-tight with paraffin or wax. The apparatus is then placed in the incubator, and after the necessary time has elapsed the plate is removed and examined in the usual way.

Another apparatus devised by the author obviates two difficulties, viz. the slow withdrawal of the air and the difficulty of direct observation of the culture. It consists (fig. 57) of a flask into the bottom of which is let a tube, the long thin neck of the latter projecting into the broad neck of the flask. The nutrient medium is placed in the lower tube, and in the upper caustic alkali and pyrogallic acid. The neck of the flask is closed with a rubber plug and rendered air-tight with paraffin.

Apparatus for Cultivating Anaerobes.*—Bombicci uses an apparatus for cultivating anaerobes, which consists of a flat flask drawn out at the bottom into a flat tube (fig. 58). This receptacle holds about 10 ccm. of nutrient medium, and after inoculation, a caoutchouc stopper with two tubes bent at right angles is inserted. Hydrogen gas is passed through in the usual way for half an hour and then the tubes are closed with sealing-wax, after which the apparatus is placed in the incubator.

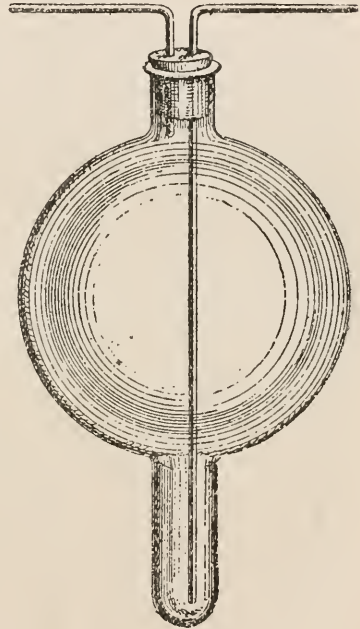

FIG. 58.

(2) Preparing Objects.

Demonstrating the Malaria Parasite. †—Prof. P. Argutinsky fixes the films in sublimate alcohol. 7 gm. of sublimate are dissolved in 100 ccm. of hot 1 p.c. aqueous salt solution, and when the solution is sufficiently cool 100 ccm. of absolute alcohol are added. The films are immersed in the foregoing for from 5–8 minutes and then washed in absolute alcohol, after which they are treated with iodine-alcohol. The iodine-alcohol is prepared by mixing 100 ccm. of absolute alcohol and 2 ccm. of 1 p.c. alcoholic tincture of iodine. In this they remain for 10 minutes and are then transferred to absolute alcohol for 10 minutes, after which they are dried with blotting-paper and stained at once or on some following day.

* *Centralbl. Bakt.*, 1^o Abt. Ref., xxxi. (1902) p. 154.

† *Arch. f. Mikr. Anat. u. Entwickl.*, lix. (1901) pp. 319–28 (4 pls. and 107 figs.).

For staining the blood-film, soda-methylen-blue and eosin are exclusively used. The author uses both solutions, freely diluted, without subsequent differentiation and 1 p.c. solutions of soda-methylen-blue and eosin followed by differentiation. The former procedure gives good results for clinical observations, while the latter is more advantageous for the study of nuclear changes.

For the first method the stock solutions consist of (1) 0.1 p.c. eosin solution; (2) 1 p.c. methylen-blue solution, to every 100 ccm. of which are added 6 ccm. of 5 p.c. soda solution; the mixture is then inoculated for 48 hours at 55°–60° C. The eosin solution may be added immediately after removal of the methylen-blue solution from the incubator or at any subsequent period. When required for staining films 3 ccm. of the methylen-blue solution are diluted with 42 ccm. of distilled water and 5 ccm. of the eosin solution with 25 ccm. of distilled water. The eosin is poured slowly into the methylen-blue solution, and the mixture kept stirred the while. The time required for staining is about 15 minutes. On removal the preparations are washed with water, dried with blotting-paper, and mounted in balsam.

In the second method or that followed by differentiation, the methylen-blue solution is the same, but the eosin is a 1 p.c. and they are mixed in the proportion of 5 of the former to 2 of the latter. The staining takes from 3–5 minutes. The overstained films are decolorised and differentiated with the following solution:—120 ccm. of 95 p.c. alcohol, 4–5 drops of acetic acid, and 2 ccm. of aqueous 1 p.c. eosin solution. The time required for differentiating is from 5–15 seconds. The preparations are then washed with water for 1–2 minutes, and having been dried in the usual way, are mounted in balsam. Judging the right moment to cease differentiating requires a little practice and experience. The coloured illustrations are extremely effective.

Examining Blood-plates.—Dr. Deetjen* used films of agar, to which were added small quantities of sodium chloride, metaphosphate of soda, and potassium biphosphate. Some blood from the finger was placed on the agar film, and the preparation examined at once, or after fixation with osmic acid and staining with hæmatoxylin-eosin. By this method it was shown that blood-plates of mammalian blood are nucleated masses of protoplasm, exhibiting amœboid movements.

H. Hirschfeld† fixed blood-films by heat at 110° for 5–30 minutes, and afterwards stained them with eosin-methylen-blue, and also with Delafield's hæmatoxylin. By this method it was demonstrated that blood-plates originated from red corpuscles.

M. C. Dekhuyzen‡ employed the following methods for examining thrombocytes or blood-plates. For the study of living blood-cells he used physiological salt solutions which were, as far as possible, isotonic with the blood itself, about 0.8 p.c.

For permanent preparations a mixture of osmic and acetic acids and methylen-blue was used for fixing and staining. This mixture (osmacet)

* Virehow's Archiv, clxiv. (1901) pp. 239–63 (1 pl.).

† Tom. cit., pp. 195–211 (1 pl.).

‡ Anat. Anzeig., xix. (1901) pp. 529–40. See Zeitschr. wiss. Mikr., xviii. (1902) pp. 539–41.

consisted of 3 or 9 vols. of 2 p.c. osmic acid and 1 vol. of 6 p.c. acetic acid and 0.125 p.c. methylen-blue. A trace of acid fuchsin imparted some advantage, but it was not indispensable. The 9/1 osmacet cooled with ice is suitable for the demonstration of thrombocytes or blood-plates in mammalian blood. The finger, or ear of rabbit, is pricked through the cold osmacet.

F. Kopsch,* who confirms Deetjen's observations, recommends, as well as the other fixatives previously alluded to, 1-2 p.c. osmic acid, or iodopotassic iodide solution.

P. Argutinsky † points out that it is advantageous to use the Romanowsky-Nocht stain for malaria, as it is excellent for chromatin staining in blood preparations. The films should be fixed in sublimate alcohol, and then stained with the eosin-soda-methylen-blue solution, which gives good pictures of the blood-plates (thrombocytes).

Method of Making Microscopical Preparations for Photographic Purposes.‡ — G. von Wendt communicates the following procedure for making preparations suitable for photomicrography:—(1) Fixation and hardening. The material is cut up into blocks not exceeding 3 mm. thick, and fixed in 3 p.c. nitric acid for 12-20 hours. Nitric acid-alcohol and picric acid are also good fixatives. From the fixative the blocks are transferred to 90 p.c. alcohol for at least 24 hours. (2) Before the blocks are treated with the first mordant they are immersed in ammonia 1 part and 75 p.c. alcohol 10 parts for 6-10 hours at a temperature not exceeding 15° C., and afterwards in 90 p.c. alcohol for about 24 hours. From this they are transferred for 4-6 hours to a mixture of 75 p.c. alcohol 12 parts, hydrochloric acid 1 part, and then again to 90 p.c. alcohol for 24 hours, after which to water for some hours. (3) Mordant A. As mordants, are used 5 p.c. tungstate of ammonium or ammonium molybdate solution. The process lasts about 24 hours, and the temperature should at first be 17°-20° C., but during the last few hours should not exceed 12°-15° C. After this mordanting the preparations are washed in cold water, and then immersed in 90 p.c. alcohol. (4) The blocks are imbedded in paraffin in the usual way. (5) The sections must be smoothed out over warm alcohol and stuck on with Mayer's albumen-glycerin, and then passed through xylol to water in the usual way. (6) Mordant B. After the water has been run off from the slide, the section is flooded with 2 p.c. iron-alum solution. The slide is then placed in a thermostat at 55° for 2-7 minutes. The mordant is then washed off with cold water. (7) Staining. The stain is made from a saturated alcoholic solution of hæmatoxylin by dropping this into distilled water until the mixture is of a yellowish-brown hue. This staining fluid must stand for some time before it can be employed with advantage. It is used by flooding the section, and then incubating the preparation for 10 minutes at 55°. (8) Differentiation. The stained preparations are differentiated in cold iron-alum solution. (9) After which they are washed in water and mounted in balsam in the usual way.

* Tom. cit., pp. 541-51. See *Zeitschr. wiss. Mikr.*, xviii. (1902) p. 541.

† Tom. cit., pp. 552-4. See *Zeitschr. wiss. Mikr.*, xviii. (1902) p. 342.

‡ *Zeitschr. wiss. Mikr.*, xviii. (1902) pp. 293-5.

(4) Staining and Injecting.

Staining Dysenteric Amœbæ.*—Dr. S. Amberg bases the diagnosis of amœbic dysentery on the finding of motile amœbæ containing red corpuscles in the stools. A suitable piece of material is stained with aqueous solution of toluidin-blue, or with methylen-blue and neutral red. The two last may be used in aqueous solution or in substance. With neutral red the erythrocytes are at first of a brassy colour, and finally red. The results with methylen-blue were very similar. The methods are only successful with living amœbæ, and the staining fades out in a few hours. Attempts to preserve the specimens were unsuccessful. The presence of Charcot-Leyden crystals and eosinophilous cells in the fæces was almost constant.

Iron Impregnation of Nerve Fibrillæ.†—Dr. S. Meyer gives the following method for impregnating nerve fibrillæ with iron. Pieces of moderate size are fixed for 24 hours in 10 p.c. formalin solution. They are then transferred for 8–20 days to $2\frac{1}{2}$ p.c. ferrocyanide of potassium, followed by 10 p.c. iron-alum for 2–4 days, after which they are washed for some hours. The subsequent treatment is absolute alcohol 2 days, xylol 2 hours, paraffin 2–4 hours. The sections, 10–60 μ , are stuck on with albumen-glycerin; xylol, balsam. By this the fibrillæ are better stained than by other procedures, and it also has the advantage of not depositing a granular or crystalline precipitate among the stained elements.

Staining Nerve-Fibrillæ of Neurones in Electric Lobes.‡—Shinkishi Hatai fixed the material in 10 p.c. formalin. Then a thin piece was cut from the electric lobe of *Torpedo occidentalis* and immersed in distilled water for about six hours. The material was then removed to 35 p.c. alcohol for about an hour, after which it was carried through graded alcohols and imbedded in paraffin. The sections, about 12 μ thick, were stained with saturated aqueous solution of toluidin-blue and contrast-stained with alcoholic solution of erythrosin. By this procedure the fibrillar arrangement of the cytoplasm was shown.

New Method of Examining Sputum.§—Dr. U. Quensel mixes the sputum to be examined with an equal bulk (or more) of a mixture composed of 1 vol. 25 p.c. formalin and 1 vol. 95 p.c. alcohol. The mixture is shaken up vigorously for 1 or 2 minutes, and is then allowed to sediment or is centrifuged. A small drop of the sediment is then squeezed out between the cover-glasses and the films dried in the air. They may be fixed in the flame, but this step is unnecessary.

The films may be stained with carbol-fuchsin, though the author prefers anilin-water gentian-violet, and after decolorising, contrast-stains with vesuvin or with an aqueous solution of auramin. Instead of the gentian-violet solution, which is somewhat unstable, the following is recommended as it keeps better:—One vol. of saturated solution of crystal violet in 70 p.c. alcohol, 1 vol. of 1 p.c. solution of hydrochloric acid in 70 p.c. alcohol, and 2 vols. anilin-oil-water.

* Johns Hopkins Hosp. Bull., xii. (1901) pp. 355–63.

† Anat. Anzeig., xx. (1902) pp. 535–43.

‡ Journ. Cincinnati Soc. Nat. Hist., xx. (1901) pp. 1–12 (1 pl.).

§ Nord. Med. Arkiv, Afd. ii. xxxiv. (1901) No. 22, pp. 1–3.

Should it be desired to stain both tubercle bacilli and elastic fibres the preparation should be stained with the anilin-gentian solution, decolorised with hydrochloric acid-alcohol, and then stained with Weigert's solution for 20–30 minutes. After this it is again decolorised in hydrochloric acid-alcohol and then stained with auramin. By this method the tubercle bacilli are blue and the elastic fibres grey-blue, both standing out sharply against the yellow background.

Picro-carmin Solutions.*—In connection with radula preparations K. Diederichs gives the following list of picro-carmin solutions, all of which are suitable for staining radulae.

(1) Ranvier's. A saturated solution of picric acid and a saturated solution of ammoniacal carmin are mixed and evaporated in a water-bath to one-fifth of the previous volume. The carmin precipitate is filtered off when cold. On further evaporation the solid picro-carmin is obtained as a yellowish-red powder, which is dissolved in distilled water and used as a 1 p.c. solution.

(2) Bizzozero's is made by dissolving 0.5 gm. of carmin in 3 ccm. of ammonia and 50 ccm. of water. To this is added, stirring constantly the while, a solution of 0.5 picric acid in 50 gm. water. The fluid is evaporated to half its bulk (50 ccm.) in a water-bath, and when cold 10 ccm. alcohol are added.

(3) Friedlaender's. To 1 part of ammoniacal carmin, 1 part of ammonia, are gradually added 2–4 parts of a saturated solution of picric acid. The mixture is constantly stirred the while, and the picric acid solution is added until it ceases to be dissolved. After filtration a few drops of phenol for every 100 ccm. are added. Subsequent cloudiness is removed by addition of ammonia.

(4) Weigert's. 2 gm. carmin and 4 ccm. of ammonia are mixed, and after 24 hours 200 ccm. of cold saturated aqueous picric acid solution are added. After a further 24 hours acetic acid is added until a precipitate forms. Then the solution is treated with ammonia until it becomes clear.

(5) Hoyer's. 1 gm. of carmin is dissolved in 1–2 ccm. of ammonia and 6–8 ccm. of water, and then the mixture is heated in a sand-bath until the ammonia is driven off. When cold the solution is filtered, and then 4–6 times its bulk of alcohol are added. The precipitate which forms is filtered off, washed and dried, and then dissolved in a strong solution of neutral picrate of ammonia.

(6) Orth's picrolithium-carmin. Lithium-carmin solution 1 part, saturated aqueous solution of picric acid 2 parts.

(7) Blochmann's Lyons-blue borax-carmin. Stain first with borax-carmin and afterwards with aqueous solution of bleu de Lyon with 10 p.c. alcohol (96°). When the sections look blue extract with alcohol.

(8) Orange G alum-carmin. Stain for 24 hours in saturated aqueous solution of orange G, then in Grenacher's alum-carmin for 10 minutes. Wash and treat with alcohol.

(9) Carmin-hæmatoxylin (Fritsch). After dissolving carmin in ammonia the latter is evaporated off. When required for use, a small

* Zeitschr. angew. Mikr., vii. (1901) pp. 30–3.

quantity of the foregoing is mixed with water and then stirred with a glass rod dipped in acetic acid. The solution turns bright red. The sections are immersed therein for 1 hour, after which they may be stained with logwood.

(10) The process may be reversed by first staining with Böhmer's hæmatoxylin and afterwards with neutral carmin.

Rapid Method of Iron-Hæmatoxylin Staining.*—Dr. A. Gurwitsch has for a long time adopted the following procedure which takes about 10 minutes instead of the usual 36 hours. The sections, stuck on by the water or albumen method, are, after the paraffin has been removed and they have been further treated with alcohol and with water, flooded with 2·5 p.c. iron mordant and then placed in the steam of an open water-bath. In this they remain until the mordant begins to bubble or become turbid, when they are washed with water, after which they are treated in a similar way with the hæmatoxylin solution. Although the sections are usually stained effectually with one application a repetition of the stain may be required. Differentiation is carried out at ordinary temperature.

New Method of Staining Elastic Tissue.†—Dr. H. F. Harris has discovered that hæmatein solutions have an affinity for elastic tissue when made in the following way:—hæmatoxylin 0·2 grm., aluminium chloride 0·1 grm., 50 p.c. alcohol 100 ccm. Dissolve the hæmatoxylin and aluminium chloride and heat to boiling, then add slowly 0·6 grm. mercuric oxide. As soon as the mixture turns purple remove from the flame and cool rapidly. The solution is filtered and one drop of hydrochloric acid added. The solution is then set aside for some weeks in order to ripen. When ripe the stain is used by immersing those sections of tissue in it for 5–10 minutes, then washing for about a minute in a 1 p.c. solution of nitric acid in alcohol, after which the sections are cleared and mounted. On account of the close relationship of this stain to Mayer's machæmatein the name of elasthanæmatein is suggested. In connection with the present notice a previous paper by the author may be consulted.‡

Differential Staining for Tubercle and Smegma Bacilli.§—L. Nencki and T. Podczaski state that smegma and tubercle bacilli may be differentiated by treating the acid-decolorised preparations with alcohol and then contrast-staining with methylen-blue. The smegma bacillus is much less resistant to alcohol than the tubercle bacillus.

Platinum Method for the Central Nervous System.||—The platinum method, says Dr. W. F. Robertson, consists essentially in placing small pieces of formalin-hardened tissue in a mixture of platinum bichloride ($\frac{1}{2}$ p.c.) and formalin (5–20 p.c.) for several weeks or months. Sections are cut by the dextrin freezing method, and mounted in balsam in the usual way. A deposit of platinum-black occurs in the tissues, tending specially to take place in certain elements.

* Zeitschr. wiss. Mikr., xviii. (1902) pp. 291–2.

† Tom. cit., pp. 290–1.

‡ Cf. this Journal, 1890, p. 649.

§ Gazeta Lekarska, 1901, No. 45. See Centralbl. Bakt., 1^o Abt. Ref., xxxi. (1902) p. 90.

|| Proc. Scot. Micr. Soc., iii. (1900–1) pp. 122–3 (1 pl.).

New Triple Stain.* — Dr. A. Pappenheim has devised a new triacid stain, the basis of which is Unna's polychrome methylen-blue. It is apparently useful for staining blood-films. It gives three colours, red, blue, yellow, in various shades, and hence has a selective action. The stain is made by Grübler, and can be obtained in aqueous solution or in powder.

Staining the Capsule of Anthrax.† — Rübiger treats air-dried films of anthrax with a solution of 15–20 gentian-violet to 150 formaldehyde, thus simultaneously fixing and staining the preparation. The time required is about 20 seconds, after which the preparation is washed with water and examined.

(6) Miscellaneous.

Microtechnique of Animal Morphology.‡ — The second portion § of Prof. S. Apáthy's work on the microtechnique of animal morphology has recently appeared. It contains the sections E, F, G, of which the first deals with methods for more closely appreciating the microscopic pictures of living objects, their measurement, and representation by photomicrography. The second treats of the methods of illuminating preparations by non-polarised light, while section G reviews the methods of illumination with polarised light for biological purposes, and the methods for determining the refractivity of microscopic objects. The facts, which are arranged in chronological sequence, are positively astounding in number, and their mere enumeration tells of the extraordinary labour which the author has bestowed on the work, and the knowledge of the subject exhibited therein.

Distinguishing between *Pleurosigma angulatum* and *balticum* under Low Powers.¶ — According to G. Marpmann, *Pleurosigma angulatum* and *Pl. balticum* can be discriminated by low powers and direct illumination, the former being greenish-yellow, the latter yellowish-brown. With dark-ground illumination the valves of *Pl. balticum* pass through blue, green, yellow, to red on the dark blue ground, while the colours of *Pl. angulatum* only come out later. Some of the discoid species exhibit analogous phenomena when examined under similar conditions.

Gelatin as a Substitute for Glass.¶¶ — G. Schneider mentions, in connection with Pranter's suggestion of gelatin cover-slips, that gelatin capsules, such as are used by chemists, are very convenient for keeping specimens in, and for sending them by post, &c. The tubes are filled with a solution of formalin, or with 70 p.c. alcohol, and after inserting the specimen along with a ticket, are closed with another gelatin tube, which is slipped over it. Several of these tubes may be placed, for preservation or transport, in a large vessel filled with formalin solution

* Deutsch. Med. Wochenschr., No. 46. See Zeitschr. angew. Mikr., vii. (1901) pp. 237–40.

† Zeitschr. f. Fleisch- u. Milchhyg., xi. No. 3. See Centralbl. Bakt., 1^{te} Abt., xxx. (1901) p. 937.

‡ Die Mikrotechnik der thierischen Morphologie, 2nd part, Leipzig, 1901, pp. 321–60. § See this Journal, 1896, p. 690.

¶ Zeitschr. angew. Mikr., vii. (1902) pp. 253–4.

¶¶ Zeitschr. wiss. Mikr., xviii. (1902) pp. 288–90.

or 70 p.c. alcohol, but too many should not be inserted, as overcrowding distorts and damages the tubes and their contents.

Use of Formaldehyde for Preventing Liquefaction in Glycerin-jelly Mounts.*—Dr. A. Forti states that the chief defects inherent in glycerin-jelly may be obviated by the use of formalin. He uses Kaiser's gelatin; i.e. to 1 part of gelatin dissolved in 6 parts of water are added 6 parts of glycerin; to every 100 grm. of the mixture add $\frac{1}{2}$ grm. of carbolic acid, and heat, stirring the while, until the acid is thoroughly incorporated. The formaldehyde used is the ordinary commercial formalin diluted to 10 p.c. if fresh, to 25 p.c. if old. A piece of the jelly is placed on the slide and warmed, and then a droplet of the formalin solution is thoroughly mixed with it. Then place the specimen in position, and wait until the air-bubbles have risen to the top, when they may be pricked out if they do not spontaneously disappear, after which put on a warmed cover-slip. In this way permanent preparations may be obtained free of air-bubbles, and without requiring the edges to be luted down with some cement.

New Fluid Medium for Preserving Zoological Objects.†—G. Marpmann recommends a solution composed of glycerin 10, chloral hydrate 5, common salt 5, water 80. After the animals are washed they are immersed in the above fluid, which in about a week is replaced by a fresh quantity. The old fluid can be used for the preliminary treatment of other preparations. If the animals be soft, or the specimen contain much blood, it is advisable to add about 5 p.c. of formalin.

Modification of Cornet's Forceps.‡—Dr. Leshure devised a modification of Cornet's cover-glass forceps, which has the advantage of being able to manipulate a slide as well as a slip. The jaws terminate in T-pieces which, being ground on their opposing surfaces, grasp a slip or slide firmly and allow of no sliding motion, the effect being enhanced by extra stiffness of the spring handles.

Preserving Intestinal Worms.§—Barbagallo recommends a 2-3 p.c. solution of formalin in distilled water with $\frac{3}{4}$ p.c. common salt for preserving worms and other soft animals. The parasites do not shrink, and keep their colour well.

Mounting Fish for Museums.||—S. E. Meek describes the method adopted in museums for putting up fish. The procedure consists of 3 parts: (1) preparation and preservation; (2) painting; (3) setting up the glass boxes. The animals are killed with 10 p.c. alcohol and are afterwards preserved in strong alcohol, or fixed first in formalin 1-20 and afterwards transferred to strong spirit. The natural colours are represented by means of water-ground pigments and occasionally some marine blue. Paints containing lead or chrome yellow are unsuitable. The fish are fastened in oblong glass boxes by means of gelatin. For the details of the manipulation the original may be consulted.

* Bull. Soc. Bot. Ital., 1901, pp. 224-6.

† Zeitschr. angew. Mikr., vii. (1901) p. 235.

‡ Med. News N.Y., lxxiv. (1899) p. 556.

§ Berlin Tierärztl. Wochenschr., 1901, No. 36. See Zeitschr. angew. Mikr., vii. (1901) p. 241.

|| Amer. Naturalist, xxxvi. (1902) pp. 53-61 (1 fig.).

New Injection Syringe for Bacteriological Purposes.*—Dr. F. Inghilleri has invented a syringe (fig. 59) which consists of a glass tube divided by constrictions into three portions A B C. B is the receiver for the fluid to be injected. It may be made of different capacities, is marked with a scale, and ends in a nozzle on which the trocar fits. The expansion C is intended to provide against the fluid being accidentally drawn into the air chamber A, the lower part of which is stuffed with cotton-wool. The piston D works in A. The piston-rod is a hollow

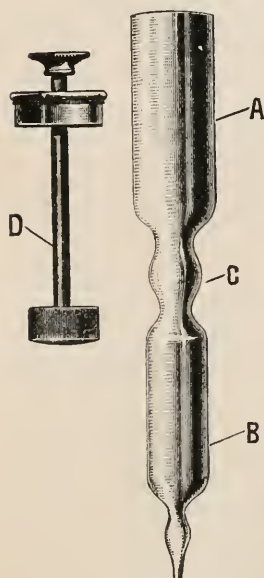

FIG. 59.

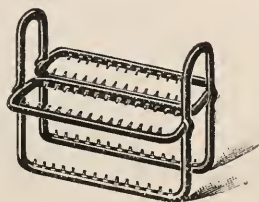

FIG. 60

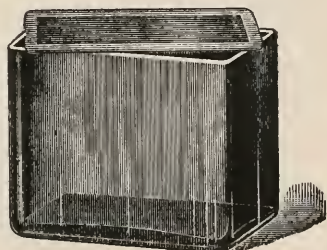

FIG. 61.

tube and its upper end carries a cap over which the thumb is pressed during injection. When the apparatus is to be sterilised the piston is removed and the trocar inserted in A after the lower end has been plugged with cotton-wool. The object of the hollow piston-rod is to allow the plunger to be pushed down if the receiver B does not fill sufficiently.

Stand for Holding Slides.†—K. Holzapfel describes a frame or stand for holding a considerable number of slides. The apparatus is intended for the treatment of paraffin serial sections. It is made of glass and is so constructed that it fits inside a glass jar. The construction and the way it is intended to be used are easily gathered from an inspection of the accompanying illustrations (figs. 60 and 61).

* *Centralbl. Bakt.*, 1^o Abt. Orig., xxxi. (1902) pp. 171-3 (2 figs.).

† *Arch. Mikr. Anat. u. Entwickl.*, lix. (1901) pp. 457-9 (2 figs.).

New Cover-glass Forceps.*—T. J. Davis has invented a forceps for holding cover-glasses whilst staining and decolorising in bacteriological work. The material, which is an alloy used by dentists, possesses con-

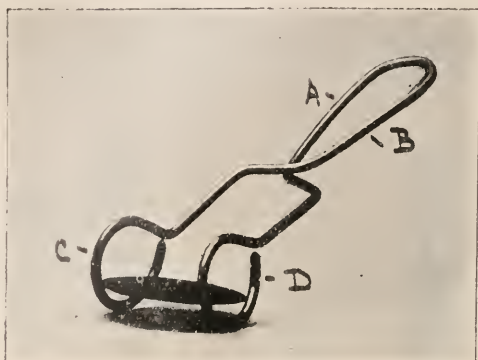

FIG. 62.

siderable elasticity and is not damaged by dilute acids. The shape of the instrument is shown in the illustrations (figs. 62 and 63), and from these it will be seen that when A and B are compressed C and D open to receive the cover-glass, which is then held in position by slight

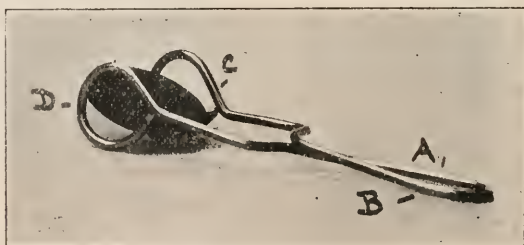

FIG. 63.

pressure on four points of C and D. From the construction of the instrument it is evident that it may be laid down without fear of contaminating the film.

Practical Filtering Apparatus.†—Prof. H. Preisz has devised an apparatus for filtering diphtheria serum and such like fluids. It consists of two parts, the upper being the filter proper and the lower the receptacle. The filter is a Nordtmeyer-Berkefeld bougie, the lip of which (see fig. 64, one-third natural size) is clamped to that of the receptacle, caoutchouc rings intervening to render the joints air-tight.

* Journ. Quek. Micr. Club, viii. (1901) pp. 155-6 (2 figs.).

† Centralbl. Bakt., 1^o Abt. Orig., xxxi. (1902) pp. 173-4 (2 figs.).

The lower portion or receptacle has a funnel-shaped upper end, the tube of which passes through a rubber stopper into the flask. Into the main tube is let a secondary tube bent at right angles, the outlet end of which is connected with an exhaust apparatus. The method of action is easily understandable from the accompanying illustration.

Results of Chilling Copper-Tin Alloys.*
 —Messrs. Heycock and Neville describe their experiments. Their results, which do not lend themselves to abstraction, are illustrated by a series of photomicrographs showing very remarkable changes in the metals under the influence of the treatment.

Crystallisation produced in Solid Metal by Pressure.†—W. Campbell describes the change of micro-structure produced by hammering a button of tin. He found that even the slight pressure exerted in the use of a file affected the structure. Lead, cadmium, and zinc were similarly affected.

Copper-Iron Alloys.‡—After quoting the results obtained by previous investigators in the formation of copper-iron alloys, J. E. Stead surmises that their discordancies must be due to disregard of the presence or absence of carbon in their irons. He therefore first describes his experiences with copper and commercially pure iron, and concludes, as the result of very many experiments, that:—

(1) Copper and iron alloy in every proportion by direct fusion, and in none of the alloys is there any tendency for the metals to separate into two conjugate liquid layers.

(2) That the complete series of alloys may be classed into three distinct sections:—

- A. Alloys with traces to 2.73 p.c. iron and 97.20 p.c. copper.
- B. Alloys with between 2.73 p.c. iron and 97.20 p.c. copper, and 92.00 p.c. iron and about 8.00 p.c. copper.
- C. Alloys containing between 8.0 p.c. and traces of copper.

In his experiments with a carbon-iron

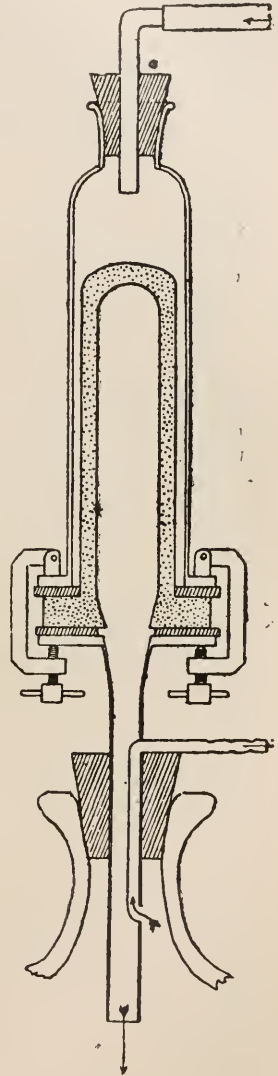

FIG. 64.

* Proc. Roy. Soc., lxxviii.; Metallographist, v. (1902) pp. 41-52 (7 figs.).

† Metallographist, v. (1902) pp. 57-8 (3 figs.).

‡ Tom. cit., pp. 25-41 (6 figs.); and Iron and Steel Institute, Sept. 1901.

he found that the effect of the carbon was to limit the amount of the copper which could be alloyed with the iron.

Crystalline Structure of Metals. * — The above was the subject of the Bakerian Lecture by Prof. Ewing and Mr. Rosenhain before the Royal Society. The writers dealt with a branch of the subject hitherto somewhat overlooked, viz. the effects of strain. They believe that they have established the fact that the structure of metals is crystalline, even under conditions which might be supposed to destroy crystalline structure. They found that the plastic yielding of metals when severely strained occurs in such a manner that the crystalline structure is preserved. The distinction which is often drawn between crystalline and non-crystalline states in metals appears to be unfounded. The difficulty of obtaining a good surface on the more fusible metals (e.g. lead, zinc, and tin) by polishing was avoided by pouring the molten metal upon glass or polished steel, in contact with which it was allowed to solidify. In the case of lead, another method of obtaining a good surface was also used. A face of the specimen was freshly cut to remove the tarnish, and was then pressed against a smooth surface of plate glass. Whenever a sufficient pressure could be reached without breaking the glass, a very beautiful surface was obtained. In some specimens a quantity of air-bubbles appeared arising from the imprisonment of air between the metal and the glass surface, or arising from air occluded or dissolved in the metal itself. These bubbles always took a geometrical form, and they were of great assistance in elucidating the phenomena. It was found that, although the "grains" (or crystal aggregates) suffered deformation, the individual crystals preserved the same orientation. The effect of strain was in reality to cause a slipping of one grain in whole or in part over another. The effects of such movements were to cause a series, or several series, of lines in the microscopic field, and their true nature was recognised by oblique illumination.

In their second paper † on this subject the authors state that their object was to study the phenomena of annealing. It is well known that prolonged annealing tends to produce large crystals in iron and steel. But even short exposure at a suitable temperature produces complete recrystallisation, and it has been suggested that these changes occur at critical points corresponding to the arrest-points in the cooling of the metal. These arrest-points indicate evolutions of heat, and it is natural to suppose that they are evidences of rearrangement of the structure of the metal. It was hoped that this change could be observed under the Microscope; but, although the experimental difficulties of keeping a specimen under microscopic observation while it was being heated were successfully overcome, the attempt to watch the recrystallisation of iron failed. It was found that it could not be expected to see the process of recrystallisation in any metal where etching, staining, or relief polishing is needed to differentiate the constituents. Attention was therefore turned to more fusible metals, especially lead. With this metal great success was obtained, and it was found that in lead which has been severely strained recrystallisation goes on at all temperatures, from that

* Phil. Trans., exciii. (1899) pp. 353-75 (14 pls. of 51 microphotos).

† Op. cit., excv. (1900) pp. 279-301 (13 pls. of 38 microphotos).

of an ordinary room up to the melting-point. A set of plates illustrates the results obtained. These give a series of views of a single specimen of crushed lead taken at intervals during six months, showing the growth of crystals at the air-temperature, seen under oblique light and magnified 12 diameters. The metal was scored in unsymmetrical shapes, so as to facilitate identification of the same crystals. Great pains were taken to secure a constant direction of the oblique light. The metal was always prepared by etching a piece of ordinary plumbers' lead by dilute nitric acid, and by viewing when wet. The large size of the crystals rendered low powers and oblique light very suitable.

GAGE, SIMON H.—**The Microscope.**

[Includes for the first time the microscopical examination of photomicrography of metallic surfaces.]

8th ed., Comstock Publishing Co., Ithaca, New York.

HÉNOUCQUE, A.—**La spectroscopie et la microscopie en anatomie générale.**

Comptes Rend. 13 Congr. internat. de Med. Sect. d'Hist. et d'Embryol., Paris, 1900, p. 145.

HOWE, H. M.—**Metallurgical Laboratory Notes.**

[Gives much attention to metallography.]

Published by Boston Testing Laboratories.

KOENIGSBERGER, J.—**Zur optischen Bestimmung der Erze.** (On the Optical Determination of Ores.)

Centralbl. f. Mineral., 1901, No. 7, p. 195.

LANGLEY, J. N.—**Practical Histology.** London (Macmillan), 1901, 8vo, 340 pp.

MALCOLM, J.—**Influence of Stain Solvent on Protoplasmic Staining.**

Proc. Scot. Micr. Soc., III. (1900-1) pp. 76-8.

MASCHKE, O.—**Mikroskopische Studien über die Krystallisation des Gypses.** (Microscopical Studies on the Crystallisation of Gypsum.)

Zeit. f. Krystallogr., XXXIII. (1900) p. 57.

MILROY, T. H.—**Protoplasmic Staining.**

Proc. Scot. Micr. Soc., III. (1900-1) pp. 73-5.

RICHTER, O.—**Mikrochemische Nachweis des Kobalts als Ammonium-Kobaltphosphat.** (Microchemical Determination of Cobalt as Ammonium cobaltophosphate.)

Tschermak's Mineral. u. Petrog. Mittheil., XX. (1901) pp. 99-109.

SCHMORL, G.—**Die pathologisch-histologischen Untersuchungsmethoden.** (Pathological and Histological Investigation Methods.)

2nd ed., Leipzig (Vogel), 1901, 8vo, 263 pp.

SMITH, SYDNEY, W.—**The Microstructure of Metals and Alloys.**

[A useful practical paper, mainly dealing with general methods.]

Journ. Quek. Micr. Club, Nov. 1901, pp. 125-30 (1 pl. of 6 figs.).

STREHL, K.—**Ueber Achromasie.**

[Explains the formulæ: specially with reference to telescopes.]

Central-Zeit. f. Opt. u. Mech., XXIII. (Feb. 1902) p. 21.

TEDESCHI, A., & A. ROSSELLI—**A Self-regulating Electric Thermostat.**

Centralbl. Bakt., 1^o Abt., XXX. (1901) pp. 969-76 (5 figs.).

WILLIAMS, J. LEON—**Use and Value of the Microscope in Dentistry.**

Journ. Brit. Dental Ass., XXIII. (1902) pp. 1-19 (13 figs.).

PROCEEDINGS OF THE SOCIETY.

MEETING

HELD ON THE 19TH OF FEBRUARY, 1902, AT 20 HANOVER SQUARE, W.
WM. CARRUTHERS, ESQ., F.R.S., VICE-PRESIDENT, IN THE CHAIR.

The Minutes of the Meeting of January 15th, 1902, were read and confirmed, and were signed by the Chairman.

The List of Donations to the Society, exclusive of exchanges and reprints, received since the last Meeting, was read, and the thanks of the Society were voted to the donors.

Calkins, Gary N., <i>The Protozoa.</i> (8vo, New York, 1901) ..	From The Publishers.
Seward, A. C., <i>The Jurassic Flora. Part i.</i> (8vo, London, 1901)	The Trustees of the British Museum (Nat. Hist.)

The Chairman said, that if the Fellows had looked at the interesting exhibits on the tables, by Messrs. Beck, they would doubtless have been struck by the very clear and instructive specimens shown of typical bacteria. So clear were they that no difficulty need in future be experienced in recognising them when met with. The Chairman felt sure that it was the wish of all present that the thanks of the Society be conveyed to Messrs. Beck for their extremely interesting exhibit.

The Secretary read a paper by Mr. Nelson on "Polarising with the Microscope." At the conclusion of the paper Dr. Hebb mentioned that Mr. Nelson, who, unfortunately, was unable to attend that evening, proposed to put an addendum to his paper, which he asked the Meeting to take as read.

Mr. G. C. Karop said he thought it would be a great advantage if a tourmaline could be rendered effective, as at present Nicol's prisms were so expensive. He thought, however, that a sufficiently large piece of flawless tourmaline would be as expensive as a Nicol's prism.

A vote of thanks to Mr. Nelson for his paper was passed by the Meeting.

The Chairman said he had to announce the death of their Editor, Mr. Bennett, so long a Fellow of the Society, and for many years Editor of their *Journal*. At the wish of the Council, he had been present at his burial, to represent the Society. They had obtained a short biography of Mr. Bennett from Mr. Baker, the distinguished

botanist, and his old and intimate friend. This would be published in their *Journal*. Both Mr. Bennett and Mr. Baker were members of the Society of Friends, and at the burial of the former it had been interesting to the Chairman to see that, so far as a Friend's burial can be said to be conducted by anyone, Mr. Bennett's had been conducted by Mr. Baker.

The Secretary then read the Biography of Mr. A. W. Bennett.

The Chairman said he felt sure that they were much indebted to Mr. Baker for this detailed account of Mr. Bennett and his work. All present who knew the deceased gentleman would appreciate the kindly and loving words used by Mr. Baker. The Council had already recorded their thanks to Mr. Baker for his kindness, and doubtless the Fellows present would wish to do the same. The Biography would be accompanied by a portrait of Mr. Bennett and be published in the next number of their *Journal*.

The Chairman said that this terminated the business on the paper before him. He had only to announce that the next Meeting would be held on March 19th, 1902. He hoped that their President would then be present. This gentleman was now having a holiday in the Mediterranean after his long life of active service. He had over-exerted himself, and he was, in consequence, laid up for a time; otherwise he would have been present that evening, and he had no doubt he would be present at their next Meeting.

The following Objects were exhibited:—

Mr. Conrad Beck :—Pneumococcus; Streptococcus of Erysipelas; Comma Bacillus of Cholera; Bacillus of Bubonic Plague; *Bacillus coli communis*, showing flagella; Bacillus of Glanders; Bacillus of Leprosy; Bacillus of Skin; Bacillus of Tetanus; *Bacillus typhosus*, showing flagella.

New Fellows:—The following were elected *Ordinary* Fellows:—Messrs. Alexander Eugen Conrady, David Hughes Davies, Wm. Gardner, and Rev. Hy. Aldwin Soames.

MEETING

HELD ON THE 19TH OF MARCH, 1902, AT 20 HANOVER SQUARE, W.

DR. HENRY WOODWARD, F.R.S., &c., PRESIDENT, IN THE CHAIR.

Mr. W. Carruthers, F.R.S., late President of the Society, addressing the Fellows from the dais, said it was usual when the President of a Society took the chair for the first time, that he should do so at the Annual Meeting on the occasion of his election to the office. It happened, however, that his friend and late fellow officer at the Natural History Museum was in a foreign land at the time of their Annual

Meeting, and had been, in consequence, unable to be present then; but he was glad to say he was with them that evening. In now asking him to take the Chair as their President, he desired very cordially to commend him to the Fellows as one who would be found in every way worthy of the position to which they had elected him. Personally he could say that he had known him and worked with him for many years, and the longer he knew Dr. Henry Woodward the better did he esteem him. He was very glad to know that the office which he had himself held—he feared somewhat inefficiently—during the last two years, was now to be filled by so distinguished a naturalist as Dr. Woodward.

Dr. Woodward—who on taking the Chair was received with applause—thanked the Fellows of the Society for the honour which they had done him in electing him as their President, and expressed a hope that during the period when he occupied that Chair he should be able faithfully to perform his duties to the Society; certainly he could assure them it would not be through any want of effort on his part if he failed to do so.

The Minutes of the Meeting of 19th February, 1902, were read and confirmed, and were signed by the President.

The List of Donations to the Society, exclusive of exchanges and reprints received since the last Meeting, was read, and the thanks of the Society were voted to the donors.

	From
Chapman, F. The Foraminifera. (Svo, London, 1902) ..	<i>The Publishers.</i>
Bolles Lee et Henneguy. Méthodes Techniques de l'Anatomie Microscopique. (Svo, Paris, 1902)}	<i>The Authors.</i>
Recueil de l'Institut Botanique (Université de Bruxelles)} Tome v. Bruxelles, 1902}	<i>The Director of L'Institut Botanique.</i>

The President said they had the advantage that evening of an exhibition of Foraminifera arranged by Mr. Earland, and shown under about twenty Microscopes lent by Messrs. Baker and other friends for the occasion. He was sure it would be their pleasure to return their thanks to Mr. Earland for this very interesting exhibition, and also to those who had so kindly placed Microscopes at his disposal for the purpose.

A vote of thanks to these gentlemen was put and carried by acclamation.

Mr. C. Beck exhibited and described Prof. Huntingdon's new stage with orientating motions, designed specially for use in the examination of minerals. He also exhibited a Microscope fitted with an observing prism and eye-piece for use in photomicrography, by means of which the object could be seen and focussed accurately without disturbing the camera—the focus as seen through the tube being exactly the same as that of the image upon the ground glass. It was explained that the success of this arrangement depended upon the accuracy with which

the right-angled prism was figured and polished, and how perfectly this had been done in the instrument before them was rendered evident by the clear resolution of a slide of *Amphipleura pellucida* placed on the stage. The prism is carried in a sliding fitting, and may be placed in or out of use without interfering with any adjustments of the instrument.

Mr. F. W. Watson Baker, for Messrs. W. Watson and Sons, exhibited a Microscope fitted with a new two-speed fine adjustment. The ordinary single micrometer-screw carries a milled stem of small diameter, of convenient length, above the usual large milled head. The former may be rolled rapidly between thumb and finger to obtain a quick fine adjustment, whilst the full-sized milled head remains available for a final delicate adjustment. The ratio between the two speeds is obviously that of the diameters of the milled head and the milled stem respectively, which in the case of the instrument exhibited was about six to one, but the speed may be varied to suit individual requirements. He also showed their well-known "Fram" Microscope fitted with a mechanical stage, as in the "H" Edinburgh Student's Microscope, but without the revolving top-plate.

On the motion of the President, votes of thanks were passed to Mr. Beck and to Mr. Baker for their exhibits and the explanations given.

Dr. Hebb said they had received another paper from Mr. F. W. Millett, being Part 13 of his series of communications 'On the Foraminifera of the Malay Archipelago.' This paper, like those which had preceded it, would be taken as read, and would appear in due course in the *Journal*.

Mr. C. F. Rousselet presented a third list of new Rotifers which had been discovered since 1889. The introduction to this paper only was read, in which it was stated that the additions now recorded were 98 in number, making in all 393 new species since the time of Hudson and Gosse. Occasion was taken to protest strongly against persons who were unacquainted with what had already been done, giving new names to old species which they themselves had found for the first time; the value of careful drawings or mounted type specimens being pointed out as a means of preventing this cause of confusion.

The President said that the thanks of the Meeting had already been signified by the way in which this paper had been received. He hoped, however, that it would not be long before Mr. Rousselet would be able to give them the figures as well as the descriptions of the Rotifers referred to.

The following Instruments, Objects, &c., were exhibited:—

Messrs. R. and J. Beck:—Prof. Huntingdon's Tilting Stage. Observing Prism for use in Photomicrography.

Messrs. W. Watson and Sons:—A new Two-speed Fine Adjustment. The "Club Fram" Microscope.

Mr. A. Earland: The following Foraminifera:—

1. Family Miliolidæ. *Peneroplis pertusus* Forskal. A series of specimens illustrating the range of variation between the extreme varieties *P. planatus* P. and M., and *P. lituus* Gmelin.
2. Family Astrorhizidæ. *Technitella legumen* Norman. From Philippine Islands, 120 fathoms, and Timor Sea, 50 fathoms.
3. Family Lituolidæ. *Webbina clavata* J. and P. Normal specimens, and specimens with minute primordial chamber and prolonged stolon tube. Possibly megalospheric and microspheric varieties.
4. Family Textularidæ. *Bulimina pyrula* d'Orb.
5. *Bolivina beyrichi* Reuss; and variety *alata* Seguenza.
6. Family Lagenidæ. A type-slide illustrating sixty varieties of the genus *Lagena*.
7. Group of the genus *Lagena*, illustrating the chief forms of ornament developed.
8. *Lagena radiato-marginata* P. and J. From Challenger Station, Raine Island, Torres Straits, 155 fathoms.
9. Family Globigerinidæ. *Globigerina æquilateralis* Brady. Spinous specimen *in situ* in globigerina ooze, from a sounding, Bay of Bengal, 1300 fathoms.
10. *Orbulina universa* d'Orb. Specimens cut open to show the internal globigerine chambers *in situ*.
11. Family Rotalidæ. *Truncatulina præcincta* Karrer. And internal glauconitic casts of the sarcode body.
12. *Rotalia papillosa* Brady. And internal glauconitic casts of the sarcode body and secondary skeleton.
13. *Culcarina hispida* Brady. And internal casts of the sarcode body and secondary skeleton.
14. Family Nummulinidæ. *Polystomella craticulata* F. and M. And internal casts showing megalospheric primordial chamber, retral processes and secondary skeleton.
15. "Plastogamy" in Foraminifera. Single and double (twin) specimens of—*Textularia folium* P. and J; *Verneuilina spinulosa* Reuss variety; *Patellina corrugata* Williamson; *Discorbina pileolus* d'Orb.
16. The Arenaceous Test. Examples of neat construction and finish, including—*Haplophragmium foliaceum* Brady; *Trochammina trullissata* Brady; *Reophax spiculifera* Brady.
17. "Dimorphism" in Foraminifera. *Fronicularia alata* d'Orb. From Cuba. Megalospheric specimens regularly frondicularian; microspheric specimens, at first flabelline then frondicularian.
18. Group of Foraminifera, from Anchor Mud, Trondhjem Fjord, Norway. Typical Northern forms.
19. Circle slide, including most of the known British species.
20. Typical coral mud species, from Timor Sea, 50 fathoms.
21. Circle slide, of about 300 of the most beautiful species from all parts of the world.

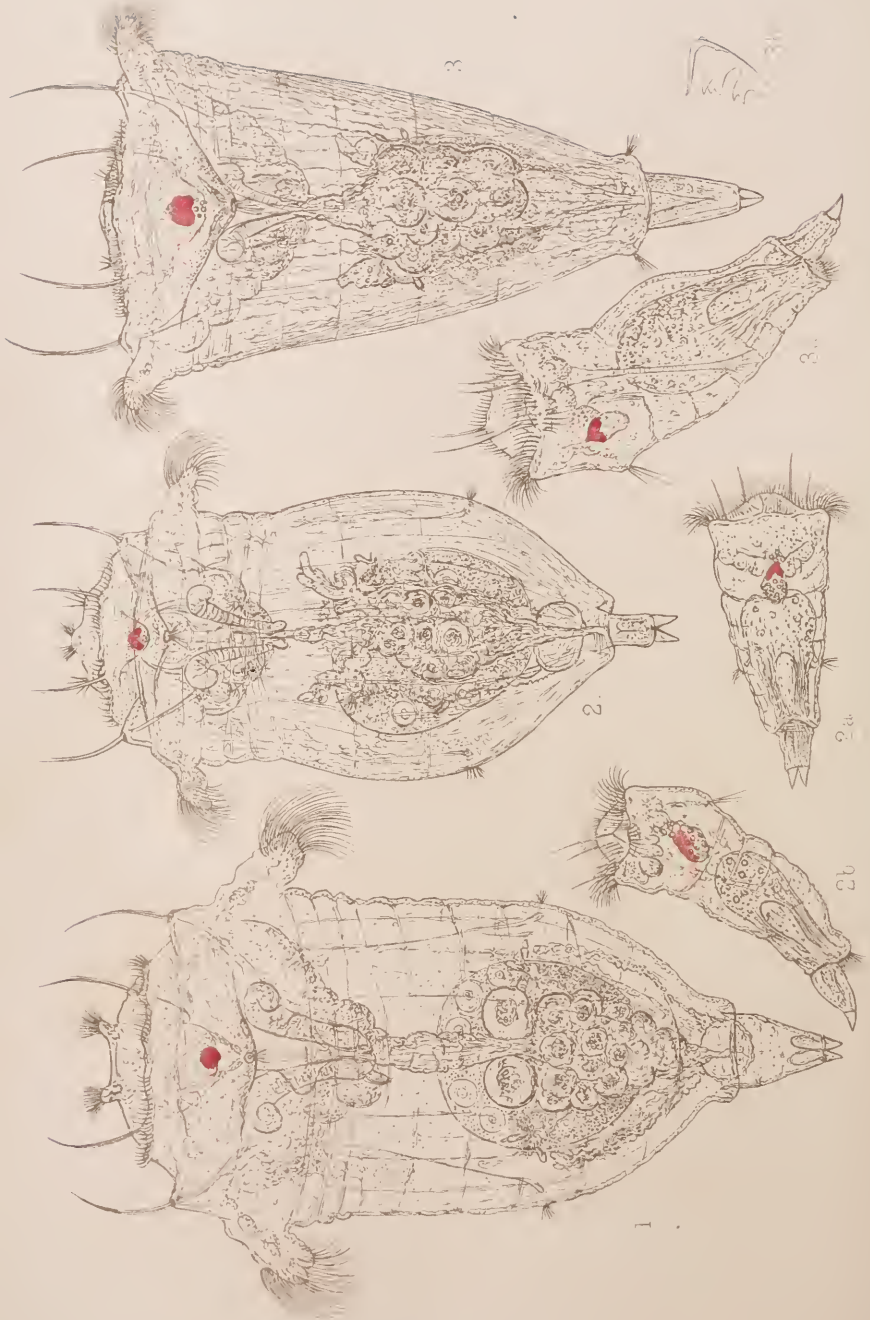

JOURNAL
OF THE
ROYAL MICROSCOPICAL SOCIETY.

JUNE 1902.

TRANSACTIONS OF THE SOCIETY.

VII.—*The Genus Synchæta* :
A Monographic Study, with Descriptions of Five New Species.

By CHARLES F. ROUSSELET, Curator and F.R.M.S.

(Read June 18th, 1902.)

PLATES III. TO VIII.

SOME of the members of this genus are amongst the commonest Rotifers inhabiting fresh-water lakes and ponds, as well as brackish tide pools and the open sea. Being also of fair size they will necessarily have been amongst the Rotifers observed by the early investigators with the Microscope. Pastor Eichhorn (1761) and F. O. Müller (1786) are probably the earliest authors who have left sketches that can be recognised as Rotifers belonging to this genus, but the species cannot be determined. Our real knowledge of these Rotifers dates from about 1831 to 1834, when Prof. Ehrenberg determined four species of *Synchæta*:—*S. pectinata*, *tremula*, *oblonga*, and *baltica*. Up to 1886, when Hudson and Gosse's monograph was published, these four remained the only known kinds, and in the Supplement published in 1889 only two more species, *S. longipes* and *gyrina*, were added to the list. At

EXPLANATION OF PLATE III.

- | | | | | | |
|---------|---|---------------------------|----------|------------------------|----------------------------------|
| Fig. 1. | — | <i>Synchæta pectinata</i> | Ehrbg. ♀ | Dorsal view. | × 250. |
| " 2 | " | <i>oblonga</i> | Ehrbg. ♀ | Dorsal view. | × 375. |
| " 2a | } | " | " | " | The male, dorsal and side views. |
| " 2b | | | | | |
| " 3 | " | <i>tremula</i> | Ehrbg. ♀ | Dorsal view. | × 300. |
| " 3a | " | " | " | The male, side view. | × 450. |
| " 3b | " | " | " | One uncus of the jaws. | |

June 18th, 1902

T

the present time I can record the following sixteen species of *Synchæta*, five of which are here described for the first time:—

IN FRESH WATER.

1.	<i>Synchæta pectinata</i> Ehrbg.	Greatest size	408 μ ($\frac{1}{82}$ in.).
2.	„ <i>tremula</i> Ehrbg.	„	292 μ ($\frac{1}{87}$ in.).
3.	„ <i>oblonga</i> Ehrbg.	„	225 μ ($\frac{1}{112}$ in.).
4.	„ <i>grandis</i> Zach.	„	505 μ ($\frac{1}{50}$ in.).
5.	„ <i>stylata</i> Wierz.	„	292 μ ($\frac{1}{87}$ in.).
6.	„ <i>longipes</i> Gosse.	„	204 μ ($\frac{1}{125}$ in.).
7.	„ <i>kitina</i> sp. n. Rouss.	„	136 μ ($\frac{1}{186}$ in.).

IN BRACKISH WATER.

8.	<i>Synchæta tavina</i> Hood.	Greatest size	254 μ ($\frac{1}{100}$ in.).
9.	„ <i>littoralis</i> sp. n. Rouss.	„	238 μ ($\frac{1}{107}$ in.).

MARINE.

10.	<i>Synchæta baltica</i> Ehr.	Greatest size	523 μ ($\frac{1}{48}$ in.).
11.	„ <i>gyrina</i> Hood.	„	326 μ ($\frac{1}{78}$ in.).
12.	„ <i>triophthalma</i> Laut.	„	265 μ ($\frac{1}{96}$ in.).
13.	„ <i>monopus</i> Plate.	„	254 μ ($\frac{1}{100}$ in.).
14.	„ <i>cecilia</i> sp. n. Rouss.	„	142 μ ($\frac{1}{80}$ in.).
15.	„ <i>vorax</i> sp. n. Rouss.	„	340 μ ($\frac{1}{75}$ in.).
16.	„ <i>neapolitana</i> sp. n. Rouss.	„	163 μ ($\frac{1}{158}$ in.).

Both Prof. Ehrenberg and Mr. Gosse have associated some marine *Synchæta* with the luminosity of the sea, for which, however, no evidence has been produced other than the fact that some *Synchæta* were found in water which was luminous at the time. Their own experiments showed, moreover, that *Synchæta* was not the cause of the luminosity, and the sea-water contained other organisms such as *Noctiluca* and *Peridinia* which are known to be luminous.

The chief characteristic peculiarities of the *Synchæta* are their prominent, rounded, ciliated auricles situated on each side of the head, and the more or less cone-shaped body, by means of which they can at once be distinguished from all other Rotifers. Their internal organization also presents peculiarities which are not found in other families. The structure of the large heart-shaped mastax, containing a V-shaped finely striated muscle, and forcipate jaws, is unique; then also the four large, stiff, styliform frontal setæ, which Ehrenberg thought were pincers connected with the jaws, are very characteristic and conspicuous.

The jaws are of large size, but the parts are so extremely thin and fine that they will hardly sink in the water when dissolved out with potash, and their exact shape is therefore exceptionally diffi-

cult to make out. After considerable trouble I have obtained a number of isolated clean jaws and have mounted them separately. There are two types of jaws in the *Synchætæ* which may be designated as the *pectinata* and *tremula* types, and which are represented in fig. 7, pl. IV. and fig. 10, pl. V. The main difference between these two types is that in the *pectinata* type the thin triangular unci have no teeth, whilst in the *tremula* type they have six to seven well developed teeth. In both types the fulcrum is very long, thin in front view and wide or broad from the side, and the narrow manubria, as well as the rami, have large rounded, but extremely thin, wing-like lateral prolongations which are quite invisible in the living animal, and can be seen only when the jaws have been completely dissolved out with potash, and then only satisfactorily by a good dark-ground illumination. When all the parts are in position the jaws form a nearly globular structure, and therefore no single view can give a good idea of the shape and form of the parts. By transmitted light only the outline of these thin plates is perceived. Fig. 7 shows a front view and fig. 7a a side view of the jaws of *S. pectinata*, and fig. 10 a front view of those of *S. oblonga*, whilst fig. 10a represents the unci and fig. 10b a separated manubrium of the same. The unci of *S. tremula*, *triophthalma*, and *vorax* are shown in figs. 3b, 14a, and 19b respectively. The jaws as a whole are nearly globular in shape, and therefore any drawing of them, showing the various parts in position, is bound to be semi-diagrammatic. The unci are situated immediately below the shield-shaped mouth, ready to seize anything that may enter, and a view of them with a high power can readily be obtained in the living animal by adding one drop of 2 p.c. cocaine, or of 1 p.c. eucaine, in a watch-glass full of water containing the *Synchætæ* and then transferring some to a compressor, when the animals will soon fix themselves with their heads to the cover-glass and remain there for a long time almost motionless, except the movement of cilia. With a high power (I use a fine Zeiss $\frac{1}{10}$ apochromatic water-immersion) this affords an excellent view of the whole front of the head, which it is otherwise almost impossible to obtain.

The great majority of *Synchætæ* have jaws of the *tremula* type. I do not think any *Synchæta* can project its jaws through the mouth, for the unci are quite twice as large as the shield-shaped mouth-opening. The heart-shaped mastax contains in its interior a roughly dumb-bell shaped cavity. The muscles of the mastax can expand this cavity suddenly, and it is my belief that by this sucking action the food-particles, consisting of diatoms, algæ, infusoria, and small rotifers, are forced into the mouth when they are at once seized by the unci.

Figs. 11a and 12a, pl. VI., represent the front view of the head of *S. baltica* and *S. monopus* respectively, which have been drawn

and communicated to me by Dr. K. M. Levander. This arrangement of the mouth, auricles, vibratile cilia, and frontal styles is common to all *Synchaeta*. Another peculiarity of all species of this genus, which has not been described before, is the single row of very fine short setæ which surround the shield-shaped mouth, all curving over the opening and forming a dome-shaped screen through which all food-particles must pass before reaching the mouth. In some species some of these stiff fine hairs can just be perceived at the extreme front from a dorsal view, but the real shape and structure of this screen can only be seen well from a good front view with a high power.

There are other bundles of sense-hairs on the front of the head which vary in different species and are described in their respective places.

Unlike what obtains in most other Rotifers, it appears that in no *Synchaeta* do the lateral canals and flame-cells (vibratile tags) extend much beyond the anterior end of the gastric glands. The lateral canals lie close to the walls of the stomach on each side, if they are not actually fixed to them by connective tissue threads; near the gastric glands they make a convolution to which two flame-cells are usually attached, and send on each side a single short branch forward which is attached to the body-wall by a fine thread, and terminates in one or two flame-cells. Two more flame-cells are situated on the branch lying near the middle of the stomach on each side. In no case have I observed a lateral canal or flame-cell in the head of a *Synchaeta*. Posteriorly the lateral canals usually make a loop in the wall of the contractile vesicle before opening into it.

In all *Synchaeta* the muscular bands, retractors of the head and foot, are very narrow and finely striated.

The brain-sac is large and usually lobed, very transparent and not readily seen; it carries the cervical eye, which is a spherical vesicle filled with granules which may be all red or partly red and partly white. In the first case the eye appears spherical as in *S. pectinata* and *stylata*; in the other cases, as in *S. tremula*, *oblonga*, *tavina*, &c., it appears more or less completely divided into closely apposed halves, which may be unequal in size. In two species, i.e. *S. triophthalma* and *littoralis*, there is a very fine double canal connecting the cervical eye with two red eye-spots in the front part of the head; the canals are filled with numerous very fine red granules. I have observed similar canals containing a few scattered red granules occasionally in *S. tremula* and *oblonga*. The colour of the eyes of *Synchaeta* is usually red, sometimes with a tinge towards violet. The red may occasionally be so deep as to appear black by transmitted light. These eyes enable the *Synchaeta* to perceive light, and they quickly collect to the light side of a small aquarium, but there is no evidence that they can see

objects, as I have shown to be the case with some other rotifers, such as *Pedalion mirum*.^{*} They never collide with others, however, in their incessant and quick movements through the water.

The eggs of *Synchæta* are clear and transparent, nearly spherical, or slightly oval in shape, and contain usually a small cluster of golden yellow granules. As a rule the eggs are laid in the water, where they fall to the bottom, but having a sticky surface they adhere to any plant or object which they may touch. In a few pelagic marine species, i.e. *S. baltica*, *cecilia*, *triophthalma*, and *neapolitana*, the eggs are habitually carried about, attached to the toes till hatched. In *S. oblonga* I have seen the extrusion of an egg: it remained attached to the toes for a few seconds and then fell off. *S. stylata* has developed an egg of very unusual character, being surrounded by very fine, long, stiff spines, about three times as long as the diameter of the egg, which prevents it from sinking, and the egg consequently floats in the water, fig. 4a, pl. IV. All these are summer eggs; thick-shelled or spiny resting eggs have not been observed in any species. Dr. Zacharias has stated that in the lakes of the north of Germany *S. pectinata* and *tremula* habitually carry their eggs attached to their toes, which they certainly never do in this country, nor am I aware of anyone else having observed this in any other part of the world.

The males of *Synchæta* are rather rare; I have seen those of the following species:—*S. tremula*, *oblonga*, *tavina*, *cecilia*, *vorax*, *neapolitana*, and *littoralis*, which are described in their places in the following pages. Mr. John Hood has seen that of *S. gyryna*, and has also reported to me doubtfully the male of *S. pectinata*. In every case the males are very small, conical in shape, with cervical eye, four frontal styles, prominent dorsal and lateral antennæ, and devoid of mastax and intestine. It is strange, however, that no fertilised resting egg has ever been observed in any *Synchæta*, though the males were occasionally present in great numbers.

The *Synchæta*, particularly *pectinata* and *tremula*, are not infrequently subject to both external and internal parasites. The external parasites I have observed consist of Infusoria: a species of minute vorticella with a very short stalk, which attaches itself singly anywhere on the integument, and also *Trichodina pediculus* the parasite of Hydra, which I have once seen running all over a *S. pectinata*; the connection, however, may have been quite accidental and temporary. The internal parasites are more serious and consist of numerous spherical bodies, $22\ \mu$ ($\frac{1}{1150}$ in.) in diameter, filled with clear protoplasm and some fine refractive granules, and of elongated sausage-shaped bladders $68\ \mu$ ($\frac{1}{374}$ in.) long by $13.6\ \mu$ ($\frac{1}{1870}$ in.) wide. At first these latter are similar in structure to the spherical bodies, but afterwards the whole bladder becomes

* On the Sense of Vision in Rotifers. Journ. Quekett Micr. Club, vol. iv. pp. 371-3 and 376-7 (1892).

filled with small spherical cells of uniform size, pl. VI. figs. 13 and 13a. The spherical bodies are probably a stage in the development of the elongated bodies. The real nature of these parasites, which probably belong to the class known as Sporozoa, their development and mode of entry, remain obscure; they have no motion of their own, but float in the fluid of the body-cavity on which they live and are continuously shifted about by the contraction of the rotifer's muscles. The Synchætæ do not seem to be much inconvenienced by the parasites, but no doubt they succumb eventually. These parasitic protozoa are evidently the same which Dr. Bertram has described as "Parasitische Schläuche in der Leibeshöhle von Rotatorien,"* and which he found in some *Brachionus pala*. They have also been mentioned by Dr. Zacharias as occurring in Synchætæ and named by him *Ascosporeidium blochmanni*; † and Prof. A. Fritsch has described similar parasites under the name of *Glugea asperospora*. ‡ The parasites lately described by Mr. A. M. Przesmycki § as occurring in *Brachionus* are of a different nature; the latter are very much smaller unicellular cells which render *Brachionus* and other rotifers quite white and milky.

The Synchætæ occur both in fresh and brackish water and in the open sea, but it seems to me that they keep to their respective elements and that the fresh-water species are never found in salt water, and the salt-water species never in fresh water. If a *S. pectinata* be placed in brackish or sea water it dies in a few minutes, and if the marine *S. triophthalma* be placed in fresh water the same thing occurs. It cannot be supposed that salt water or fresh pond water can exert a poisonous influence on these species respectively. The inability of these rotifers to live in an element to which they are not accustomed is due to the mechanical action of fluids having different densities on the cell-contents of their tissues and organs. The specific gravity of fresh water being 1, that of sea water is 1.027, and this is quite sufficient to produce strong diffusion currents by osmosis between the outside fluid and that contained in the body-cavity, and eventually in the cells of the various organs. The lighter fluid will get through the cell-walls quicker than the denser fluid can get out and *vice versa*, with the result that the cells and the whole animal will either swell or shrivel up, and this will injure or burst the delicate cells and completely stop the functions of the various organs, causing the death of the animal.

As regards their appearance, some forms such as *S. pectinata*, *tremula*, and *oblonga* can be found all the year round, but often appear in greatest numbers in the winter months or very early

* Zool. Jahrbücher, Bd. v. 1892, pp. 596-600.

† Plöner Forschungsberichte, Teil 6, 1898, p. 48.

‡ Ueber Parasiten bei Crustaceen und Räderthieren der süßen Gewässer. Bull. Intern. de l'Académie des Sciences de l'Empereur François Joseph I., Prague, 1895.

§ Ueber Parasitische Protozoen aus dem Innern der Rotatorien. Bull. de l'Académie des Sciences de Cracovie, 1891.

spring; other kinds like *S. littoralis*, *tavina*, *gyrina*, *vorax*, *cecilia*, and *kitina* like a little warmer weather, but are most erratic in their sudden appearance and disappearance. *S. grandis*, *stylata*, and *longipes* I have found only in the summer months, July to September, whilst the pelagic marine species *S. baltica*, *monopus*, *triophthalma*, and *neapolitana* seem to come to the surface in the summer when the sea has been calm for a considerable time.

All *Synchætæ* can be prepared easily and preserved fully extended by the method I have described, of which the following are the main stages:—Isolation in a watch-glass full of clean water; narcotisation with one or two drops of 2 p.c. cocaine or 1 p.c. eucaïne for about half an hour; killing and fixing with $\frac{1}{4}$ p.c. osmic acid or Hermann's platino-osmic mixture, washing in water (the marine species in sea water), preserving in 2 $\frac{1}{2}$ p.c. formaldehyde. Marine species die fully extended when placed in distilled water. I possess preserved specimens of all the sixteen species, and they are here under Microscopes for your inspection.

I am very greatly indebted to my friend Mr. F. R. Dixon-Nuttall, J.P., of St. Helens, for the excellent drawings of the various species which accompany this paper, and which he has spared no pains to make, with his accustomed skill, from the living animal whenever possible, or from preserved specimens; it would indeed have been impossible for me to have made such life-like representations, which so very greatly increase the value of this memoir, and will assist in the identification of the various species. My thanks are also due to Mr. John Hood, of Dundee, and Mr. H. E. Hurrell, of Great Yarmouth, for sending me living specimens of the various marine species, and to Dr. K. M. Levander, of Helsingfors, for preserved specimens of the species living in the Baltic Sea, and for the figures of *S. monopus* which he has been good enough to send me.

It has been found impracticable to draw all the animals on a uniform scale, as was at first intended, because if that had been done, either the smaller *Synchætæ* would have been drawn too small for recognition, or else the larger species would have gone beyond the limit of the plates. The figures therefore have been drawn of convenient dimension, irrespective of their size, which must be ascertained from the descriptions. All species vary considerably in size, as the newly hatched individuals are only about half the bulk of the adult. In most cases the largest observed proportions have been given. It must not be forgotten also, in comparing the figures with the living animals, that the shapes also vary considerably, some species being more conical when young, and stouter and rounder occasionally when the food-material is exceptionally abundant.

It has not been the object of this paper to give an exhaustive description of the minute anatomy of the various organs of

Synchætæ, which on the whole are much the same as in other Rotifers, and moreover, would require a separate volume. My intention rather has been to give a sufficiently detailed description and good figure of each species, so as to clear up the existing uncertainty and allow any one of the species to be readily identified. I trust this has been accomplished in this memoir on which I have been at work for some years.*

Synchæta pectinata Ehrenberg.

Pl. III. fig. 1, and Pl. IV. fig. 7.

SYNONYMY.

Synchæta mordax Gosse.

Synchæta oblonga Gosse.

BIBLIOGRAPHY.

- EHRENBURG, G. F.—Abhandl. der Akad. d. Wissensch. zu Berlin, 1831, p. 135; 1833, pp. 221, 335, pl. x. fig. 3.
 — Die Infusionsthierchen. Leipzig, 1838, p. 437, pl. 53, fig. 4.
 GOSSE, P. H.—Ann. and Mag. of Nat. Hist., 1851, p. 197.
 LEYDIG, F.—Ueber den Bau u. Systemat. Stellung der Räderthiere. Zeitsch. f. w. Zool., Bd. vi. 1854, p. 41.
 HUDSON, C. T.—Synchæta mordax. Mon. Micr. Journ., vol. iv. 1870, p. 26, pl. 56.
 HUDSON & GOSSE.—The Rotifera. London, 1886, vol. i. p. 125, pl. 13, fig. 3.
 WEBER, E. F.—Faune Rotatorienne du bassin du Léman. Revue Suisse de Zool., Genève, 1898, vol. v. p. 392, pl. 16, fig. 15.

Spec. Char.—Body sub-conical, very broad and convex anteriorly; auricles large, more or less pendent; two small cylindrical fleshy prominences bearing a broad brush of setæ on front of head; four frontal styles, the outer pair the largest; eye round, dark red or bluish-purple in colour; toes two, small, acute. Size

EXPLANATION OF PLATE IV.

- Fig. 4.—*Synchæta stylata* Wierz. ♀ Dorsal view. × 350.
 " 4a " " " " The egg. × 275.
 " 5 " *longipes* Gosse ♀ Dorsal view. × 400.
 " 6 " *kitina* sp. n. Rouss. ♀ Dorsal view. × 500.
 " 7 }
 " 7a } " *pectinata* Ehrbg. The jaws. × 275.

* Dr. Wesenberg-Lund of Copenhagen, in a paper published in 1900 (Biologisches Centralblatt, Bd. xx. Nos. 18 and 19, 1900), wished to recognise only two freshwater species of *Synchæta*, namely *S. pectinata* and *tremula*, considering all the other described species as merely seasonal varieties of these main forms. I am not inclined to make or maintain new species out of mere variations of size or form, but when these are accompanied by constant internal and external anatomical characters, males and eggs of different shape and structure, I think it is going too far to fuse them all into one or two species. The animal Dr. Wesenberg-Lund calls *S. pectinata minor* is most probably *S. oblonga*, which may occasionally be seen carrying an egg for a short time.



Figures 1-3. *Chrysomelidae* sp. n.

Fig. 4-6.

up to 408μ ($\frac{1}{82}$ in.) long by 231μ ($\frac{1}{110}$ in.) wide at the auricles. Egg spherical, 98.5μ ($\frac{1}{258}$ in.) in diameter. Lacustrine.

This handsome rotifer, one of the most common and widely distributed species in England, as well as on the Continents of Europe and America, appears to have first been recorded by Ehrenberg in 1831, in a communication to the Berlin Academy of Science, and afterwards in 1838 in his great work on the Infusoria.

In 1870, Dr. C. T. Hudson subjected this species, under the name of *S. mordax*, to a careful study, which was published in the *Monthly Microscopical Journal*, vol. iv. pp. 26-32, with a plate of good figures, showing its various aspects. The animal Mr. Gosse has figured as *S. oblonga* in *The Rotifera* is certainly a *S. pectinata*, swollen and half dead; the two frontal processes are sufficient to identify it as such.

Synchaeta pectinata is a well characterised species, which cannot be mistaken when once seen. Its large sized, white, very transparent, more or less conical body, and large prominent auricles, make it a conspicuous object even with the naked eye. But its special character, which serves best to distinguish it at once from its congeners, are two fleshy setose protuberances, or little horns, on the front of the head; no other species of *Synchaeta* has these organs.

The shape of the body is that of a more or less swollen cone, very broad and convex anteriorly, ending in a short stout foot and two minute conical toes. The exact shape of the body varies a good deal. Young animals have straighter sides than represented in fig. 1, whilst occasionally extra well fed specimens are met with which are more swollen round about the stomach.

The head is very broad, and, with the auricles, forms a wide semicircle; dorso-ventrally it is a little compressed, rising only to a prominence on the dorsal side where the dorsal antenna protrudes. The ciliary wreath consists of two parts: the dorsal part is formed by a nearly straight double cushion of vibratile cilia, interrupted in the centre; the ventral part forms a smaller rounded double cushion of cilia below and at the sides of the mouth, and these cilia are mainly concerned in driving food-particles to the mouth. The prominent auricles are large, semicircular, slightly pendent, and furnished with long, powerful vibratile cilia, all arising on the upper surface of the auricles, from a cushion of dense grey protoplasmic material. The auricles are supplied with a number of muscular bands, arising from the integument of the head and body-cavity, which can retract and also alter the position of these organs, and thereby vary the incidence of the beat of the cilia. This explains the vigorous turning movement and gyrations which the animal performs with such rapidity.

Of sense-organs there are on the head, first of all, two pairs of styles, which are really clusters of long, fine, stiff setæ. The outer pair are the largest and most prominent, arising from a small triangular fleshy flap, and can be followed for some distance within a muscular sheath in the head, to which a nerve-thread is attached. The inner pair is smaller, more dorsal in position, and situated immediately below the ciliary wreath. On the ventral side of the head, on each side of the mouth, there are two setigerous pimples, each bearing two short styles. These are not seen from a dorsal view. Then, right in the middle of the front of the head, are the two characteristic fleshy prominences already mentioned, surmounted by a fan of short, stiff sense-hairs. A nerve-thread with ganglionic enlargement can be seen within the prominences. The dorsal antenna, seated on an eminence just above the eye, is quite large and prominent when seen from the front or side, but is not readily observed when looked at from a dorsal view; it seems to be a double organ fused into one, as two rocket-shaped nerve-threads are seen to converge to it. The lateral antennæ were thought to be absent altogether by all previous observers. For a long time I searched for them in vain up and down the sides of the body, and could not understand why so large a rotifer should be without these sense-organs, so characteristic of the entire class. About two years ago I had received some dried pond mud from Australia, and placing this in water, in a few days a solitary *Synchæta pectinata* made its appearance from some dormant egg, which shows at the same time how rotifers can be transported from one distant continent to another. On examining this pale, very transparent individual with quite a low power under dark-ground illumination, it slowly turned round on its longer axis, when suddenly I noticed a fine brush of long setæ protruding from the side of the body on a level with the stomach. On further investigation of this strange appearance, which I had searched for many times with low and high powers and with the very best optical means, I found that the lateral antennæ are quite obvious, but situated on the *ventral* side of the body, and therefore are quite invisible from a dorsal view, the position in which I, and no doubt everybody else, had always searched for them. In the figure their position at the sides is indicated, but it must be remembered that they are situated just round the corner on the ventral side.

The mouth is not oval, as has been stated, but shield-shaped, and quite straight on the upper side. On the upper, and on each lateral side there is a cushion of grey protoplasm, from which arise a single row of very fine, short, stiff setæ, which curve over the mouth, meeting in the centre, and thus form a screen through which all food-particles must pass. This very fine dome-shaped screen is seen well only in a front view of the head under a high

power. I can see it best with my fine Zeiss apochromatic $\frac{1}{10}$ in. water-immersion.

Dr. Hudson enlarges upon the great difficulty in obtaining a frontal view of *Synchæta*'s head. It is to be regretted that he did not know the effect of a drop of 1 p.c. cocaine solution added to a trough full of water. After a few minutes *Synchæta*, which Dr. Hudson rightly calls "perpetual motion itself," becomes as quiet as a dove, the body fully extended, the cilia moving, but with gradually decreasing vigour until they stop altogether, remaining thus narcotised and nearly motionless for more than an hour before the animal dies. Moreover, some of them frequently fix their heads to the cover-glass of the compressor and remain there for ten or twenty minutes at a time, the cilia beating feebly all the time. In this way I found no difficulty in obtaining ideal views of this and other *Synchætæ*, usually in perpetual motion.

The large mastax of *Synchæta pectinata* has a peculiar pear-shaped form, characteristic of the genus, containing in particular two finely striated V-shaped muscles embracing the base of the long fulcrum. I have taken great pains to dissolve out the jaws of *S. pectinata*, which has proved a difficult task owing to the extreme thinness and lightness of the parts. By mounting a number of these separated jaws without pressure in a shallow cell, I think I have succeeded in obtaining a correct interpretation of their structure, which is shown in figs. 7 and 7*a*, front and side view. The fulcrum *a* is a long narrow rod; the rami *bb* are thin elongated blades, ending in a single sharp tooth, with very thin, curved, wing-like plates fixed to the sides; the malleus consists of a narrow curved manubrium *c*, from which also a very thin plate of chitine projects, and a small triangular plate forming the unci *d*. The edges of the unci are quite smooth, and there are no teeth as is the case in those of *S. tremula*, *oblonga*, *gyrina*, and others. When looking at the unci from the dorsal or ventral side, a side view is obtained, which of course gives the appearance of a single sharp tooth. The shape and position of the parts will best be seen from the figures. The snapping motion often seen in *Synchæta* bears, I think, a different interpretation from that usually given to it. Various authors have thought that the jaws protrude through the mouth and seize their prey; this, I think, is not the case, and the snapping motion seen is due to a sudden opening of the buccal funnel and cavity of the mastax, thus producing a strong sucking action, just as in *Asplanchna*, which draws in the small algæ, infusoria, &c., forming the food of *Synchæta*. I have seen a pair of tubular muscular bands attached to the dorsal side of the mastax, just by the side of the spot where the cesophagus arises, which may produce this action. The thin plates of the unci lie exactly below the mouth, so that everything entering the mouth can be seized by, and must pass between them.

A small rounded opening below the middle of the dorsal side of the mastax leads to a long, thin-walled oesophagus, which is not ciliated internally, and empties in the rounded thick-walled stomach. The cells of the stomach are large, often containing numerous yellow oil-globules, and ciliated internally, keeping the food in continual motion. The food-particles are usually green or brown, and occasionally pink in colour. The intestine is quite inconspicuous; the cloaca is situated dorsally at the root of the foot. The gastric glands attached to the stomach are spherical in shape, and contain a granular centre and some nuclei.

The ovary is rounded and more or less compressed; usually it is of the same size as the stomach, but in some animals I found it twice as large, filling the greater part of the ventral half of the body-cavity, and containing eight to sixteen nucleated germ-cells. Maturing eggs containing a cluster of small, spherical, yellow granules are often seen by the side of the ovary. The eggs, when laid, fall off immediately, and are not carried about; they are spherical in shape, white, transparent, except the small cluster of deep yellow granules mentioned above; their size is 98.5μ ($\frac{1}{258}$ in.) in diameter. The surface of the egg is covered with minute sparsely scattered dots. It is worthy of mention that Dr. O. Zacharias has stated that in the north of Germany *S. pectinata* habitually carries its eggs about, attached to the toes. This is very strange, considering that here in England I have never once, during the many hundreds of times that I have had this species under observation, seen a single *S. pectinata* do anything of the kind.

The eye, seated on the granular brain-sac, is fairly large, spherical in shape and bluish-purple in colour; its structure is that of a hyaline vesicle closely packed with very minute purple granules. There is no sign in this species of a stream of red granules forward or of frontal eyes.

The lateral canals and flame-cells are of normal structure, but reach only to the height of the stomach and gastric glands. The contractile vesicle is small, situated at the base of the foot, and a tubule of the lateral canals can clearly be seen to enter it on each side, after making a loop in its wall.

The muscular system is well developed, particularly in the head, where there is a complicated system of narrow, finely striated muscular bands for regulating the position of the auricles and for the retraction of the head. The long retractors of the head and foot are very narrow and finely striated. The transverse muscular bands are more numerous and more closely set around the head and neck region.

The foot is stout and short, contains two foot-glands and carries two small, acute toes.

Synchaeta pectinata is a most vigorous swimmer, and its course:

is usually that of cork-screw curves, revolving at the same time on its longer axis, but occasionally turning somersaults in rapid succession for a change. More rarely it is seen to hover over one spot with all its cilia in rapid motion, producing a strong current in the water. It does not, however, anchor itself to a thread secreted from the toes as *S. tremula* does habitually. Small as is the body-cavity of this rotifer it is not free from internal parasites of considerable size. I have often observed numerous elongated sausage-shaped bodies, 95μ ($\frac{1}{2} \frac{1}{6} \frac{1}{7}$ in.) in length by 14μ ($\frac{1}{18} \frac{1}{0} \frac{1}{0}$ in.) thick, and also spherical bodies, apparently living on the nutritive fluid it contains, pl. VI. fig. 13. These bodies are not ciliated, have no motion of their own, and consist of a transparent membrane thickly filled with spherical smaller vesicles; they appear to do little harm to the organs of *Synchæta*, and the individuals containing them seem as vigorous as the others.

I am greatly indebted to my friend Mr. F. R. Dixon-Nuttall for the very fine figure of this species, pl. III. fig. 1, which he has drawn for me from life.

The male I have not yet seen, nor have I ever seen any indication of fertilised resting eggs which would indicate the presence of the male; but I should mention that Mr. John Hood has doubtfully reported it to me.

The size of *S. pectinata* varies between 340μ ($\frac{1}{7} \frac{1}{5}$ in.) and 408μ ($\frac{1}{6} \frac{1}{2}$ in.), but very young animals may be smaller.

Synchæta tremula Ehrenberg.

Pl. III. fig. 3.

BIBLIOGRAPHY.

- EHRENBERG, G. F.—Abhandl. der Akad. d. Wissensch. zu Berlin, 1831, pp. 135, 138; 1833, p. 221.
 — Die Infusionsthierchen. Leipzig, 1838, p. 438, pl. 54, fig. 5.
 GOSSE, P. H.—On the Structure, &c., of the Manducatory Organs in the Rotifera. Phil. Trans. of the Royal Soc. of London, 1856, p. 434, figs. 41, 42.
 — On the Diccious Character of the Rotifera. Phil. Trans. of the Royal Soc. of London, 1858, p. 321, figs. 30, 31.
 HUDSON & GOSSE.—The Rotifera. London, 1886, vol. i. p. 128, pl. 13, fig. 2.
 WEBER, E. F.—Faune Rotatorienne du bassin du Léman. Revue Suisse de Zool., Genève, 1898, p. 394, pl. 16, fig. 17.

Spec. Char.—Body top-shaped, truncate and straight in front; often yellowish in colour; auricles small, in line with front of the head; four frontal styles; lateral antennæ situated at extreme base of body; eye red, cervical; foot short, narrow; toes two, small, acute. Size from 212μ ($\frac{1}{1} \frac{1}{2} \frac{1}{0}$ in.) to 292μ ($\frac{1}{8} \frac{1}{7}$ in.) in length by 115μ ($\frac{1}{2} \frac{1}{2} \frac{1}{0}$ in.) to 149μ ($\frac{1}{1} \frac{1}{1} \frac{1}{0}$ in.) wide at the auricles. Male conical, 110μ ($\frac{1}{2} \frac{1}{3} \frac{1}{0}$ in.) in length; lacustrine.

This bright, common, and widely distributed species has been figured best by Dr. Hudson in his monograph, fig. 2, pl. XIII. It was probably seen by most observers in the early days of Microscopy, but Ehrenberg was the first to figure and describe it with sufficient accuracy for future identification.

In the early spring, it is, as a rule, the most abundant Rotifer in nearly all lakes and pools; it is also frequently met with throughout the summer and autumn, and even in winter under the ice many inches thick. Its ubiquitous habitat is made evident by its presence in nearly every list of Rotifers that has been published in England as well as on the Continent of Europe, in America, Australia, and South Africa. I cannot, however, help expressing a suspicion that one or two other species, particularly *S. oblonga*, have sometimes been mistaken for *tremula*.

In size it is decidedly smaller than *S. pectinata* with which it is frequently associated. In colour it often has a slight yellowish tinge which contrasts with the white transparency of *S. pectinata* when seen together. The integument is thin, white, and transparent, and has some slight longitudinal folds along the dorsal side.

In shape the body of *S. tremula* is that of a slender cone, quite straight and flat in front, the small rounded auricles forming a lateral prolongation of the flat frontal surface. In young animals the sides of the body are quite straight also, but in well-fed specimens the sides bulge out more or less. The foot is short, less wide in girth than the apex of the body, and tapers to the two small acute toes.

The front of the head bears two pairs of styles, the larger outer pair arise from very small triangular fleshy flaps. Two pairs of setose pimples are, as usual, situated ventrally on each side of the mouth, each bearing two or three stiff divergent hairs. The ciliary wreath consists of a nearly straight band along the dorsal border of the head, which, however, is interrupted by a dorsal gap in the middle, and ventrally by two strongly ciliated cushions, one on each side of the mouth.

The auricles are thin, small, semicircular, of usual structure, and in line with the front of the head.

The mouth is situated on the ventral half of the head; it is shield-shaped, and surrounded by the usual single row of very small stiff hairs curving over it all round.

The dorsal antenna protrudes from an eminence in the usual position above the eye and is connected by two rocket-shaped enlargements and nerve-threads with the brain. The lateral antennæ are found very low down at the sides of the body, close above the foot.

The eye, seated on a granular brain-sac, is deep red, rounded and of usual structure; the red granules do not always fill up the

whole eye-vesicle, and sometimes, congregating on either side of it, give rise to an appearance of a double eye. From the eye two narrow divergent tubules, as described in the introduction, advance to the front of the head, and these tubules sometimes contain very minute scattered red granules. I have counted ten and twelve of these on each side on a recent occasion.

The characteristic mastax is somewhat smaller in proportion than in *S. pectinata*, whilst in structure it is very much like that which is figured for *S. oblonga*, pl. V. fig. 10. The unci are thin triangular plates with five or six teeth, very irregular in shape and divided in two sets by a deep incision (fig. 3*b*); the first tooth is long and pointed and well separated from the rest, which is characteristic of this type; a very small knob of chitin at the back of this first tooth indicates the spot where the manubrium is fixed. The unci lie immediately below the mouth, and can readily be seen from a frontal view in the living animal. I do not think the jaws can be projected through the mouth as has been stated, and the action of the mastax is the same as I have described in the case of *S. pectinata*. The œsophagus is of moderate length and opens into a saccate thick-walled stomach, the cells of which usually contain yellow oil-globules. A small and densely ciliated intestine opens on the dorsal side of the base of the body. The usual rounded, or more or less pointed, gastric glands are readily seen. The ovary is a fairly large and thick rounded plate on the ventral side, filled with nucleated germ-cells. The lateral canals seem to be attached to the wall of the stomach on each side, where they form some convolutions, from which one branch runs forward and is attached to the body-wall at a height corresponding to the middle of the œsophagus, and there ending in two flame-cells on each side. Two more flame-cells are seen lower down on the canal running by the side of the stomach. No canal or flame-cell has ever been seen in or near the head. The contractile vesicle is fairly large, in its usual position above the foot.

The longitudinal muscles, retractors of the head and foot, are narrow and finely striated; six to eight fine transverse muscular threads run close together round the integument on the anterior part of the body; lower down there are fewer threads and they seem to be confined to the dorsal side.

The male, fig. 3*a*, was first discovered by Mr. Gosse; it is a small conical creature with a bent towards the ventral side close behind the head. The front is truncate, with four styles. The red eye, dorsal antenna, large sperm-sac, and two acute toes are prominent. The mastax and stomach are quite absent, and replaced by the sperm-sac. The size is 110μ ($\frac{1}{2}\frac{1}{30}$ in.) in length. I found the male in some abundance in a gathering in October 1900, and it is not very rare.

Synchæta tremula is a vigorous swimmer, and takes, as a rule,

a more or less straight course. It loves also to spin a fine thread from its toes, and attaching it to any convenient object, remains anchored, spinning round and round on its longer axis for a long time on the same spot, while the vigorous action of the frontal cilia, instead of propelling the animal forward, produces a strong current of water towards the head which brings food to the mouth. *S. pectinata* and *oblonga* never spin round in this way. Contrary to what other observers have reported, I have never seen *S. tremula* carry its eggs about. Dr. Zacharias has stated that in the North of Germany this species, as well as *S. pectinata*, habitually carry their eggs, which seems very strange if there be no error as to species.

I have never seen *S. tremula* in salt water, and have little doubt that when it has been reported as occurring in the sea or in brackish tide pools, one of the marine species must have been mistaken for it.

Its largest size when full-grown I have found to be 292μ ($\frac{1}{87}$ in.) long by 149μ ($\frac{1}{170}$ in.) wide at the auricles. Young animals are, of course, much smaller, and an average size would be about 235μ ($\frac{1}{108}$ in.) long by 124μ ($\frac{1}{205}$ in.) wide.

Synchæta oblonga Ehrenberg.

Pl. III. fig. 2 and Pl. V. fig. 10.

SYNONYMY.

Synchæta neglecta Zacharias.

BIBLIOGRAPHY.

- EHRENBURG, C. G.—Abhandlung der Akad. d. Wiss. Berlin, 1831, p. 135; 1833, p. 221.
 — Die Infusionsthierchen. Leipzig, 1838, p. 438, pl. 53, fig. 4.
 HUDSON & GOSSE.—The Rotifera. London, 1889, vol. i. p. 127.
 ZACHARIAS, O.—Ueber die im Süßwasserplankton vorkommenden Synchæten. Biol. Centralblatt, Bd. ii. 1901, pp. 381-3.

Spec. Char.—Body small, cone-shaped, somewhat oblong and more or less swollen at sides, rounded in front; auricles small; four frontal styles; lateral antennæ very small, situated two-thirds down the sides of the body; eye red, cervical; foot short, narrow;

EXPLANATION OF PLATE V.

- Fig. 8.—*Synchæta grandis* Zach. ♀ Dorsal view. $\times 225$.
 " 9 " *neapolitana* sp. n. Rouss. ♀ Dorsal view. $\times 470$.
 " 9a " " " The toe and spur. $\times 1175$.
 " 9b } " " " The male, dorsal and side views. $\times 680$.
 " 9c }
 " 10 " *oblonga* Ehrbg. The jaws. $\times 550$.
 " 10a " " A separated manubrium. $\times 550$.
 " 10b " " The unci. $\times 875$.

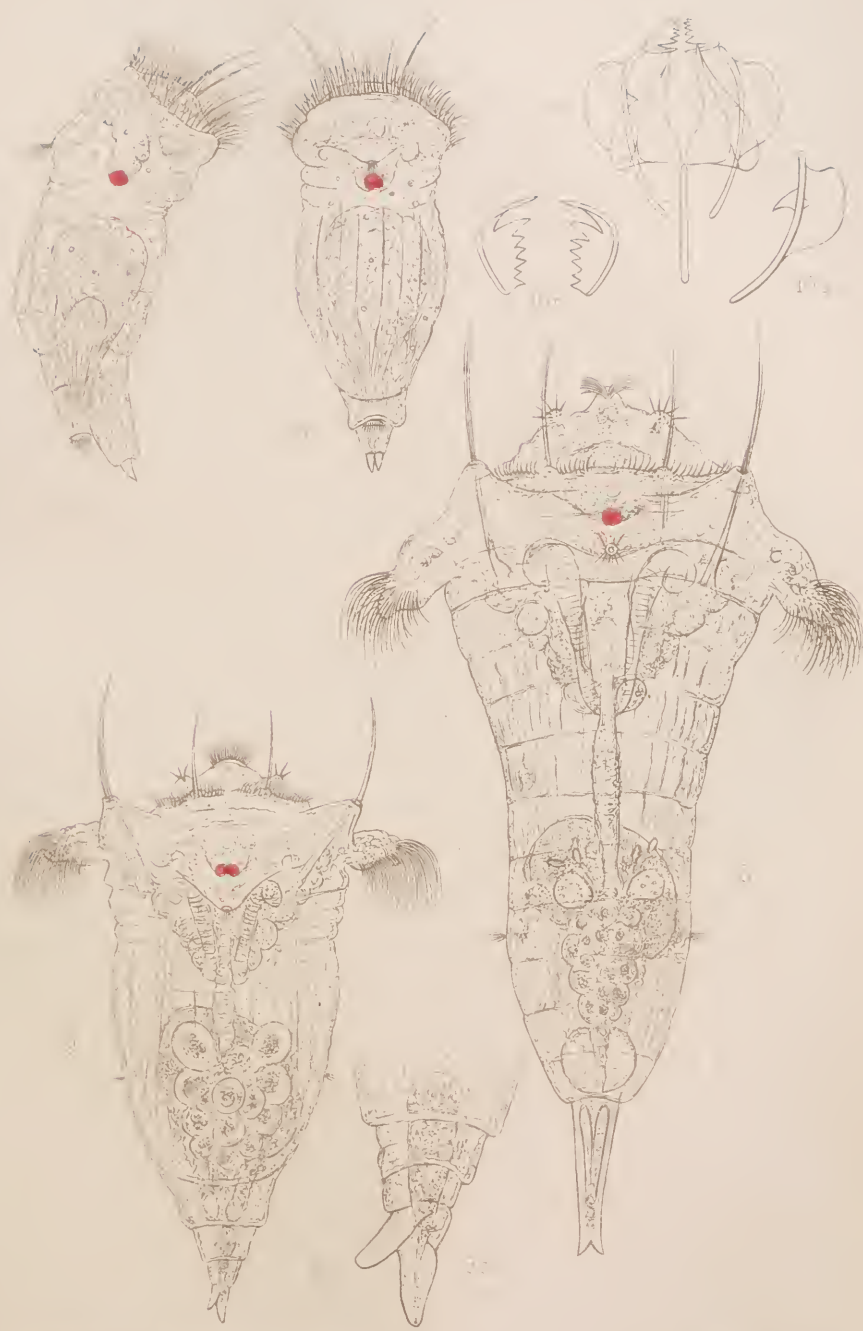

EXAMINED BY THE U.S. DEPARTMENT OF AGRICULTURE

WEST VIRGINIA COLLEGE

By: CHAS. H. HAY

toes two, small, acute, well separated. Size up to 225μ ($\frac{11}{13}$ in.) in length by 115μ ($\frac{1}{20}$ in.) wide at the auricles. Male 102μ ($\frac{1}{30}$ in.) in length. Lacustrine.

Although a very common species everywhere in fresh-water ponds and lakes, I fear this animal has not been clearly recognised until quite lately. One reason possibly is that Ehrenberg gives it a size equal to that of *S. pectinata*, which is obviously not correct; another reason is that Mr. Gosse has figured under this name of *oblonga* an animal which certainly was a sick *pectinata*, the two frontal fleshy little horns being quite sufficient to recognise it as such.

Most workers will have taken this common *Synchæta* for a small *S. tremula*, whilst I have for a considerable time past separated it from *tremula*, but have confounded it with *S. gyrina* of Hood, which I now know is a larger and exclusively marine and brackish water species. In the lists of Rotifers, therefore, found at the Quekett Club's excursions published in the *Quekett Journal*, wherever *S. gyrina* is mentioned, this name should be altered into *oblonga*. Quite recently Dr. Zacharias, recognising its distinctive characters, has given it the new name of *S. neglecta*, while it is represented in his earlier lists under the name of *S. tremula*.

Prof. Ehrenberg in his great work describes *S. oblonga* as the commonest *Synchæta* occurring in his time near Berlin, and usually associated with *pectinata* and *tremula*. This is exactly what I find to be the case here near London at the present time.

At first sight, and when observed with a low power, it has much resemblance in shape and size with a small *S. tremula*. A closer acquaintance, however, shows a number of differences in shape, structure, and habits, which can always be readily recognised. Perhaps it will be convenient if I first clearly state the differences which separate these two species. *S. tremula* has a top-shaped body with the front of the head quite straight and flat, and the auricles in a line with the front. *S. oblonga*, whilst also more or less cone-shaped, is, as a rule, more swollen at the sides and has the front of the head convex, and the auricles are lower down at the end of the convex frontal curve. The lateral antennæ in *S. tremula* are situated low down near the base of the foot; in *oblonga* these organs are much higher up at the sides of the body and slightly ventral in position. On the extreme front of the head, when seen from the dorsal side, *S. oblonga* has two divergent tufts of very fine stiff sense-hairs which are absent in *tremula*. Finally, *S. tremula* is a little, but distinctly, larger in size and more yellowish in colour; it also likes to anchor itself on a thread from the toes and spin round and round on its longer axis on the spot; this habit *S. oblonga* does not possess. The two figs. 2 and 3 on pl. III., drawn from life by Mr. Dixon-Nuttall, will give a clear idea of these differences.

Synchata oblonga is small in size, and the shape of the body is that of an oblong cone, more or less swollen at the sides; it is white, transparent, and the head is distinctly convex in front. The exact shape of the body varies somewhat according to the locality, the age of the individuals, the abundance or scarcity of food, &c. The integument is very thin, white, transparent, and shows numerous very fine longitudinal folds on the dorsal side. The foot is short and narrow and carries two small, conical, well separated toes; the foot is usually slightly enlarged at the base of the toes, and contains two foot-glands.

The front of the head bears the usual two pairs of styles, the longer outer pair arising from triangular fleshy flaps. At the extreme front are seen two divergent bundles of very fine stiff setæ, which arise from a pimple situated immediately above the mouth, and which are not present in *S. tremula* or *gyrina*. The auricles are small, slightly pendent, and situated at the ends of the frontal curve of the head. The mouth is in the usual position on the ventral side of the front of the head, shield-shaped, closely surrounded by a single row of very fine, stiff, curved hairs, and with four larger setigerous pimples a little further off at the four corners.

The dorsal antenna protrudes in the usual position above the eye on a slight eminence, whilst the very small lateral antennæ are situated at the sides of the body, on a level with the stomach, and slightly on the ventral side; frequently they are very difficult to find.

The cervical eye is deep red in colour, often appearing divided in two halves, and sometimes in this species two more or less prominent aggregations of red granules occur on the front of the head, and two streams of very minute red granules connect these with the cervical eye, much like the frontal eyes of *S. triophthalma* and *littoralis*, but much less pronounced.

I have taken considerable trouble to dissolve out the very delicate jaws of this species, and believe fig. 10, pl. V. gives a correct representation of their structure, which is a type different from that of *S. pectinata*, but common to a number of other species. The malleus consists of a long, thin, curved manubrium, having a broad, very thin, wing-like flange on one side, and a triangular projection on the other; the unci are thin triangular plates armed with one large, deeply-cut tooth, well separated from the rest, and five shorter sharp teeth, rather irregular and varying in shape. The incus consists of a long, narrow but deep fulcrum, and very thin, broadly triangular rami. The figs. 10, 10a, and 10b will give a better idea of the shape and position of these organs than any amount of description.

The œsophagus, arising from the dorsal side of the mastax, is of moderate length, and opens in a thick-walled stomach of usual

structure. The intestine is inconspicuous, and opens dorsally above the base of the foot. The gastric glands in this species are more or less divided into lobes. The ovary is large, rounded and flattened, filling nearly the whole of the ventral side of the body-cavity, and contains usually eight nucleated germ-cells, and often a maturing egg lies by the side of it. The egg when extruded may sometimes be seen attached to the toes for a very short time, but soon becomes detached and falls to the bottom; it can hardly be said that *S. oblonga* carries its eggs, though occasionally an individual may be seen with an egg attached.

The lateral canals are distinct on each side of the stomach, and end in a branch with two flame-cells near the top of this organ; posteriorly, they open into the small contractile vesicle.

The muscles of the body are very narrow, striated, and arranged as in *S. tremula*.

The male has often been observed by me, and is represented in figs. 2a and 2b. It is small, elongated, curved ventrally, with two toes and four short frontal styles, has a large red eye and large sperm-sac; its greatest length is 102μ ($\frac{1}{250}$ in.).

Synchæta oblonga is a moderate swimmer when compared with its more vigorous cousins; it swims fairly straight forward or in graceful curves, and has not the habit of anchoring itself to a thread and revolving on its longer axis, which is such a conspicuous habit of *S. tremula*.

In size *S. oblonga* is distinctly smaller than *tremula*, but of course young specimens of *tremula* may be smaller than adult *oblonga*. The usual size is: female up to 225μ ($\frac{1}{13}$ in.) by 115μ ($\frac{1}{220}$ in.) wide at the auricles.

Synchæta grandis Zacharias.

Pl. V. fig. 8.

BIBLIOGRAPHY.

ZACHARIAS, DR. OTTO.—Forschungsberichte aus der Biolog. Station zu Plön, Theil 1, 1893, p. 23, fig. 2.

Spec. Char.—Body very long and slender, broadest at the auricles, compressed in the middle, tapering to an elongated single-jointed foot, bifurcate at the tip; auricles large, pendent; frontal styles four; eye spherical, red, cervical. Size, total length 505μ ($\frac{1}{50}$ in.) by 258μ ($\frac{1}{8}$ in.) wide at the auricles. Lacustrine.

This is probably the largest member of this genus, and was first found by Dr. O. Zacharias in 1893 in the great inland lake of Plön, in Holstein. Five years ago I obtained it from one of the large reservoirs of the East London Waterworks Company at

Tottenham, where I have found it several times since, always in the month of July.

The very clear, white, transparent body is very narrow and elongate, with a distinct waist in the middle, then tapering, and terminating in a fairly long foot, bifurcate at the tip, which, however, does not seem to carry proper toes. The broadest part is the head, which is rounded anteriorly, with a projecting, rounded point at the extreme front, carrying two broad bundles of very fine stiff setæ. This frontal tuft of sense-hairs seems to have been overlooked by Dr. Zacharias, as he makes a point of their absence. The four frontal styles are present as usual, the outer pair emerging from broad triangular fleshy flaps. The sheath of the large styles can be followed for some distance inside the head to a nervous base or ganglion cell, from which two nerve-threads are seen running towards the brain, and a third thread backwards. On either side of the extreme front of the head, and slightly towards the ventral side, are two hemispherical projections, one on each side, which bear bundles of radiating, fairly long, and stiff sense-hairs.

The ciliary wreath has the form usual in other *Synchætæ*, the two ventral cushions on each side of the mouth having exceptionally long and powerful vibratile cilia. The auricles are very prominent, broad, rounded, and more or less pendent.

The dorsal antenna is not very prominent, situated in its usual position over the eye; the lateral antennæ are low down in the lumbar region and quite on the ventral side.

The brain is large, consisting of a broad sac containing greyish granular cells, and carries the spherical deep red eye.

The mastax is very large, of the usual *Synchætata* pattern, but the presence or absence of teeth in the unci has not been ascertained, unfortunately. The œsophagus is a very long, contractile, thin-walled tube, not ciliated internally, leading to a small thick-walled stomach, the large cells of which often contain yellow oil-globules. The gastric glands are rounded and small. The lateral canals are distinct, ending at the height of the stomach in a convolution, to which two or three flame-cells are attached. The contractile vesicle, of fairly large size, is situated at the extreme base of the body-cavity. The ovary is rather small for so large an animal, rounded, and containing eight to sixteen nucleated germ-cells. By the side of the ovary a large egg is often seen, with large nucleus and a number of small, deep yellow oil-globules. The eggs are not carried.

The foot is long and stiff, and has but a single joint containing two narrow elongated foot-glands; at the end it bifurcates more or less, but does not carry proper toes.

The integument of the body is very thin, white, transparent, very finely folded longitudinally on the dorsal side.

The muscles, retractors of the head and foot, are normal, very narrow and finely striated; the transverse muscular bands, encircling the body under the integument, more particularly on the dorsal side, are numerous, and more prominent than usual.

In swimming this fine species is more vigorous and rapid than *S. pectinata*, bending and turning constantly; it is more pliable also and flexible at the waist than any other species. When once seen there is no difficulty in distinguishing it from *S. pectinata* even with a pocket lens. Its food seems to consist mainly of the smaller rotifers, such as *Polyarthra*.

The accompanying fine drawing (fig. 8) has been made by Mr. Dixon-Nuttall from a living specimen I was able to send him.

In size it reaches a total length of 505μ ($\frac{1}{30}$ in.) by 258μ ($\frac{1}{38}$ in.) wide at the auricles; the body a little below the auricles is only 170μ ($\frac{1}{30}$ in.) wide. Dr. Zacharias gives the greatest length as 600μ . The male is as yet unknown.

Synchæta stylata Wierzejski.

Pl. IV. fig. 4.

BIBLIOGRAPHY.

WIERZEJSKI, Prof. Dr. A.—*Rotatoria Galicyi*, Krakau, 1892, p. 62, pl. iv. fig. 5.

Spec. Char.—Body large, elongated, conical, tapering both anteriorly and posteriorly; foot long and styliform, carrying two very small toes. Eye single, cervical, dark red. Egg spherical, covered with very long and thin spines, floating in the water. Habitat fresh-water lakes. Size, 242μ ($\frac{1}{35}$ in.) to 292μ ($\frac{1}{37}$ in.). Lacustrine.

This well marked and fine species was first discovered by Prof. A. Wierzejski in Galicia in 1892, and figured and described by him in his *Rotatoria Galicyi*. I have met with it repeatedly, in the summer months, in canals and lakes round London: Putney, Hanwell, Willesden. The shape of the body is that of an elongated cone, tapering gradually posteriorly to the foot, which is long, and perfectly round and styliform, ending in two very minute, but distinct toes. The head is elongated, and also tapers anteriorly to a rounded point, which bears at its extreme front two bundles of very fine, divergent, stiff setæ. The auricles are of fair size. The head carries the usual two pairs of styles; the outer and larger pair arise from well developed triangular fleshy flaps, and are continued inward as far as the mastax. The mouth is situated on the ventral side of the head, and on each side of it there is a bunch of three or four long stiff setæ, arising from a fleshy knob. The ciliary wreath is situated on a ridge running round the head between the two pairs

of styles, as shown in the figure. The eye is cervical, deep red, small, single, though often showing a line, as if it consisted of two apposed halves. The mastax is large, of the usual *Synchaeta* type, followed by a long œsophagus, not ciliated internally, which leads into a stomach of the usual structure. The body-cavity, being large in proportion to the organs contained in it, looks rather empty. The integument is thin, and often shows many longitudinal folds dorsally.

The dorsal antenna protrudes on an eminence in the usual position; the lateral antennæ are in the lumbar region, slightly on the ventral side.

The egg of this species has a very unusual structure (fig. 4a). It is spherical or slightly oval in shape, and covered all over with very long and very thin spines, by means of which it floats in the water instead of sinking to the bottom. I found these floating eggs in my tank containing this species, and in order to make quite sure that they were the eggs of *S. stylata*, I isolated a number of animals in perfectly clean water and left them over night, when next day these spiny eggs were again there. The size of the egg-shell is 75μ ($\frac{1}{340}$ in.), and the total size to the extremity of the spines 136μ ($\frac{1}{186}$ in.). I am not aware of any other *Synchaeta*, or any other rotifer, having eggs of this structure. These spiny eggs have been seen also by Dr. O. Zacharias and Dr. R. Lauterborn, who have attributed them to *S. pectinata*, which is evidently a mistake, as has already been pointed out recently by Herr Max Voigt.*

The only *Synchaeta* with which this well characterised species could be confounded is *S. pectinata*, from which, however, it is readily distinguished by the absence of the two fleshy horns and the structure of the head and foot, which are quite unlike those of *pectinata*. The drawing (fig. 4) has been made by Mr. F. R. Dixon-Nuttall from my preserved specimens, and it shows the characteristic form and structure very well.

The male has not yet been seen.

* Max Voigt, Beiträge zur Kenntnis des Planktons pommerseher Seen. Forschungsberichte a. d. Biol. Sta. zu Plön, 1902, p. 25.

(Continued on page 393.)

NOTE.

Waddel's Erecting Microscope.

By EDWARD M. NELSON.

IN the *Journal* for 1900, p. 115, I drew attention to the fact that Ahrens' device for erecting the Microscope image by means of Porro prisms had been figured and described in the *Journal* for 1888, p. 1020; but it now appears that priority for this idea must be accorded to Mr. Waddel, of Leith, because Brewster, in his *Edinburgh Encyclopædia* (1830), figures and describes Waddel's method of erecting the image by two right-angled prisms, one being placed in front of the objective, and the other in front of the eye-lens; and what is more remarkable, there is also a figure of a single prism, cut in such a manner as to produce the same effect, thus pre-dating that of Messrs. Zeiss.

I pointed out in the *Journal* for 1898, p. 382, figs. 70 and 71, that this plan of erecting the image by reflection in two planes was as old as the 2nd edition of Zahn's *Oculus Artificialis* (1702), but evidently since then it has been re-invented more than once. On April 5th, 1811, Cornelius Varley took out a patent for a "Graphic Telescope." This consisted of an astronomical telescope, having small power but a large flat field, in which the image was erected by reflection from two plane metal specula. It was by one of these instruments that the sketch of London was made from the top of St. Paul's for the panorama exhibited at the Colosseum, which probably some of us may remember. On December 4th, 1806, Dr. W. H. Wollaston patented his Camera Lucida, and the "Graphic Telescope" may be considered as an effort on Varley's part to improve it.

It is more than probable that the original publication by Zahn, in 1702, of the method of erection by means of reflection had long been forgotten, and it was Wollaston's camera which caused the re-invention of it by Varley in 1811. This gave Waddel the idea of adapting the same principle to the Microscope, and to the publication of Waddel's method in 1830, by Brewster, in a fairly well-known Encyclopædia, may be referred subsequent re-inventions, including that of Porro.

SUMMARY OF CURRENT RESEARCHES
RELATING TO
ZOOLOGY AND BOTANY
(PRINCIPALLY INVERTEBRATA AND CRYPTOGAMIA),
MICROSCOPY ETC.*

ZOOLOGY.

VERTEBRATA.

a. Embryology. †

Progeny of a Tailless Cat. ‡—Prof. J. Kennel points out that the distinction between congenital deviations due to germinal variation and those due to influences on the embryo or fœtus is rather theoretical than actually verifiable. The sporadic occurrence of a kitten with a rudimentary tail may be interpreted as due to foetal amputation, while the repeated birth of curtailed forms in a family would point to germinal variation. The occurrence of an apparently tailless cat may be due to crossing with the Japanese or Manx race, or it may be a mutilation, or it may be an expression of germinal defect. Kennel points out that careful observation (e.g. with X-rays) may make it quite plain whether the taillessness of a parent cat is congenital or acquired, for in the latter case the terminal vertebræ will show the normal configuration of those at the base of the tail.

Kennel discusses a particular case brought under his notice by Dr. E. Thomson, in Helenehof, Esthland. The mother, caught wild in the country, had a rudimentary tail, with a scar-like, hairless, terminal piece. The record of six litters (by normal males) was as follows:—

Litters.	With Tails.	With Rudimentary Tails.	Tailless.
1897. Spring	4	..	2
Autumn	2	..	2
1898. Spring	1	1	3
Autumn	1	..	3
1899. Spring	2	2	..
Autumn	2	1	2

* The Society are not intended to be denoted by the editorial "we," and they do not hold themselves responsible for the views of the authors of the papers noted, nor for any claim to novelty or otherwise made by them. The object of this part of the Journal is to present a summary of the papers as *actually published*, and to describe and illustrate Instruments, Apparatus, &c., which are either new or have not been previously described in this country.

† This section includes not only papers relating to Embryology properly so called, but also those dealing with Evolution, Development, Reproduction, and allied subjects.

‡ Zool. Jahrb., xv. (1901) pp. 219-42.

The inheritance in this case was largely maternal as regards the state of the tail, and it will be noted that the number of kittens which were tailless equals that of those with tails, and exceeds it by four if those with rudimentary tails are included. There is a strikingly rapid and cumulative progressive change in the direction of tail-reduction.

It is, unfortunately, doubtful whether the mother owed her rudimentary tail to a germinal variation, or to foetal or post-foetal amputation. Contact with a specimen of the Manx or Japanese race was out of the question. If we did not know the subsequent history, we should conclude in favour of the amputation hypothesis, for the occurrence of reduction of the tail as a true variation is rare in cats. The alleged scar-like end, the two vertebræ (strong enough to be counted as two), the reported strong musculature of the stump, favour the same view, but Kennel does not press the point. The case is interesting enough without forcing it to bear evidence in favour of the possible hereditary transmission of the results of mutilation. For it points to remarkable maternal prepotency, and to a possibly rapid origin of a race like the Manx cats. It gives some support to the view that saltatory or transilient variations may be of great evolutionary importance. Prof. Kennel concludes his very interesting paper with a description of the structural differences between a rudimentary tail and the so-called tailless condition.

Spermatogenesis in Sparrow.* — G. Loisel, continuing his researches on this subject, reaches the following general results. The spermatozoa appear only in spring, and disappear entirely at the end of summer. During the winter, the epithelium of the seminiferous tubes is formed of elements similar to those which occur before sexual maturity in the testis of all Vertebrates. These are primitive germinative cells, and, derived from these, there are oviform spermatogonia. These elements elaborate an internal secretion. On the foundation of this glandular epithelium there is formed, in the spring, the strictly seminiferous epithelium. At this time the spermatogonia expend their ingesta in successive kinesis, thus forming the zone of proliferation, from which arise continually the seminal cells, strictly so-called. The germinative cells continue to secrete, but their cell-bodies, influenced by the multiplication of seminal cells, lose their boundaries, and form a vast nucleated syncytium. Some—the cells of Sertoli, the nutritive cells, the vegetative cells, &c.—exaggerate the secretory activity seen in winter, and produce a substance which acts with a new intensity, first on the seminal cells, and then on the somatic cells. The others—the reserve spermatogonia, the spore-cells, the indifferent cells, &c.—remain during the summer as a reserve to form the new spermatogonia of the following winter. Loisel's most general conclusion is that in all Vertebrates the seminal cells are derived from a glandular epithelium.

Peculiar Process in Seminal Vesicles of Elk. † — Dr. R. Kolster found that in the seminal vesicles of a specimen of *Cervus alces*, killed shortly before the commencement of the breeding season, there was a

* Comptes Rendus, cxxxiv. (1902) pp. 853-5; and Journ. de l'Anat. Physiol., xxxviii. (1902) pp. 112-77 (4 pls. and 25 figs.).

† Arch. Mikr. Anat., lx. (1902) pp. 100-11 (1 pl.).

remarkable histolytic process. Over a considerable area there was dissolution and degeneration of the epithelial cells, which formed a mass of detritus in the tubules. The fundus portion of the vesicle showed a double stratum of epithelial cells, which is regarded as the normal lining; towards the efferent duct there was a single layer of cubical cells, apparently the result of regeneration; between these was the area of dissolution. It is evident that more specimens must be studied before a secure statement can be made, but there was no sign of disease.

Influence of Diet on Egg-laying in the Fowl.*—F. Houssay found that two hens fed with grain laid, in a given period, 127 + 67 eggs, while two others of similar races, fed with raw flesh, laid 176 + 121. The total for the first two is 194, for the other two 297. There was also a superiority as to weight in favour of the eggs laid by the carnivorous fowls, their average being 58 grm. as against 55 grm. for the vegetarians.

Early Stages in Development of Duck and Tern.†—Prof. P. Mitrophanow finds that these resemble in general the corresponding stages in the fowl. The beginning of morphological differentiation is in the formation of the median ectodermal thickening, which in the above-named aquatic birds is shunted distinctly backwards. The very distinct *Primitivknoten*—the antecedent of the primitive streak—is probably a palingenetic feature; it occurs as a very rare deviation from the norm in the fowl. From the middle of the ectodermal thickening, or from the *Primitivknoten*, the primitive streak begins to grow in the direction of the tail. The primitive groove follows the same path. The anterior end of these structures, which appears first, and is always more pronounced than the posterior end, corresponds to the blastopore of reptiles, and sometimes shows a similar form.

Maternal Impression in a Mare.‡—Le Hello notes that a racing mare, Mascarade, by Mask and Shepherd's Bush, hurt the left side of her head by galloping against a tree. After the wound healed there was left a marked hollow at the level of the lachrymal, and a certain depression of the orbital apophysis. The nutrition of the eye was seriously affected, and the globe is now much atrophied.

More than a month before the accident, Mascarade had been successfully served by Nicham II., and the foal—La Courtille—born in due course, shows on the left side of her head lesions closely resembling those of the mother. The lachrymal depression is less marked; the orbital arcade is even more suppressed; the little cavity called the *salière* is virtually absent, and the eye is not bigger than a lentil. Le Hello regards it as a clear case of maternal impression.

Heredity Studied in Mice.§—Prof. L. Cuénot has verified in mice the law which Gregor Mendel stated in 1865 in regard to peas. If a common grey mouse—male or female—be paired with a white mouse—female or male—the result is, without exception, that grey mice are produced. The pigmented form is, as regards pigmentation, invariably prepotent over the unpigmented form.

* Comptes Rendus, cxxxiv. (1902) pp. 432-3.

† Zeitschr. f. wiss. Zool., lxxi. (1902) pp. 189-210 (2 pls.).

‡ Comptes Rendus, cxxxiv. (1902) pp. 201-2. § Tom. cit., pp. 779-81.

b. Histology.

On the Process of Hair turning White.*—E. Metchnikoff finds that this is due to the intervention of phagocytes of the hair. These cells have a single nucleus and numerous amœboid processes; they are derived from the medullary part of the hair, make their way out into its cortical layer, absorb pigment-granules, and retire to the root. The phagocytes become more and more scarce as the hair whitens, and most frequently disappear entirely. Hair turning white in a single night, or in a few days, may be explained as due to unusual activity on the part of the phagocytes. This mechanism of the whitening of the hair through the agency of phagocytes allows this case of atrophy to be classed under the general laws of atrophy of the solid parts of the organism.

Accessory Lobes on Spinal Cord of Birds.†—P. Lachi refers to a communication by von Kölliker, ‡ on aggregates of nerve-cells on the sides of the spinal cord in birds (Hofmann-Kölliker nuclei). In 1889 § Lachi gave an account of the lumbar and sacral region of the spinal cord in goose, fowl, pigeon, &c., and stated the following conclusions.

The lumbar swelling shows 5–8 pairs of metamericly disposed "accessory lobes." These lobes consist of nerve-cells and of a gelatinous stroma analogous to the gelatinous substance of the rhomboidal sinus. They are derived from the anterior horns and become distinct about the eighth day of incubation. They have counterparts in the accessory lobes of some bony fishes (Ussov) and others observed in the alligator, and they throw some light on somewhat similar aggregates of nerve-cells recognised in the lumbar expansion in man.

Nutritive Channels within the Liver-Cells communicating with the Lobular Capillaries.||—Prof. E. A. Schäfer describes sections from a rabbit's liver, injected with carmine-gelatin from the portal vein, which show within the cytoplasm of the cells—but not within the nucleus—a network of fine varicose canaliculi filled with the red injection and communicating here and there directly with the lobular capillaries, which are also completely injected. The preparations unmistakably demonstrate the existence of what Browicz has inferred, namely, the existence within the liver-cells of canaliculi communicating directly with the blood-vessels. This is important in regard to the mechanism of nutrition of the liver-cells and in regard to pathological conditions. The specimens date from 1886 (the late Prof. Rutherford's collection), and the canals in question were observed by Prof. Carlier, of Birmingham, who showed them to Rutherford. Unfortunately, the publication of the observation was not then accomplished.

Nerve-Endings in Human Muscle.¶—Dr. Grabower has been very successful in demonstrating that the nerve-endings in human muscle show essentially the same form and relations as have been described in amphibians and reptiles by Kühne, Krause, Bremer, and others. The

* Proc. Roy. Soc. London, lxi. (1901) p. 156.

† Anat. Anzeig., xxi. (1902) pp. 7–8.

‡ SB. Acad. Sci. Wien, 5th Dec. 1901. § Atti Soc. Tosc. Sci. Nat., 1889.

|| Anat. Anzeig., xxi. (1902) pp. 18–20 (1 fig.).

¶ Arch. Mikr. Anat., lx. (1902) pp. 1–16 (3 pls.).

result of his investigation is in the main to confirm in regard to the particular case of man what has been observed elsewhere. Attention may be directed, however, to Grabower's description of peculiar oval structures, which look like sensory end-organs and in any case do not at all resemble any of the motor endings.

Supporting-Substances of the Nervous System.*—Dr. H. Joseph has reached the following chief conclusions. (1) In Annelids and in many other Invertebrates, the neuroglia consists of peculiar well-defined fibres, the neuroglial fibres, and shows a remarkable correspondence with the neuroglia of Vertebrates. (2) In both Vertebrates and Invertebrates, the neuroglia is a derivative of the outer germinal layer, the fibres are derivatives of cells with which they probably always retain some persistent connection. (3) Epithelial fibres and neuroglial fibres show a most intimate correspondence, and are phylogenetically related. They are functional structures in the clearest sense and are originally related to simple requirements and functions of the cells. (4) The position of the glia fibres is such that they are apposed to or imbedded in only the external layer of the cell-plasm. They do not pass into the interior protoplasm, as Erik Müller supposed.

Matrix of Vitreous Humour in the Eye of Man and Animals.†—Dr. C. Addario notes that almost all investigators are agreed that the *Grundsubstanz* of the vitreous humour includes (a) firm fibrils forming a narrow-meshed network, and (b) a fluid interfibrillar substance. He has come to the conclusion that the ciliary epithelium lying directly in front of the ora serrata forms and adds to the fibrillar framework of the vitreous humour and must therefore be regarded as a true matrix, by the activity of which a slow, but persistent growth of the vitreous humour is effected.

Skin-Pigment in Man and Monkeys.‡—Dr. B. Adachi finds in the corium two kinds of connective-tissue pigment-cells, (a) small, inconspicuous elements, almost always the more external; and (b) much larger, usually deeper, very conspicuous elements. The former occur in man and in all monkeys; the latter are sometimes absent. In many monkeys the large pigment-cells occur in almost every part of the body, in others they are quite absent; in man (apart from the choroid and meningeal membranes) they are transitory, sometimes occurring before and after birth, sometimes only after birth, rarely in adult life, most abundant in the lumbar, coccygeal, and gluteal regions, and especially in coloured races. In many coloured races they may form blue spots on the regions indicated; in white men they are practically microscopic. They cannot be regarded as racial peculiarities, nor can it be concluded that those races in which they are most abundant are lower.

"Chromatophores"—stellate pigment-figures within the epithelial limits—are often clearly seen in the normal white skin; they are much more distinct in *Hylobates*; they are not cells, however, but cell-like figures formed mainly by intercellular pigment-granules. A connective-tissue pigment-cell, whether of the small or of the large type, never reaches the epithelial boundary, either in (healthy) men or in monkeys.

* Arb. Zool. Inst. Wien, xiii. (1902) pp. 335-400 (4 pls. and 2 figs.).

† Anat. Anzeig., xxi. (1902) pp. 9-12.

‡ Tom. cit., pp. 16-8.

c. General.

Distribution of Marine Mammals.*—Prof. J. Palacký thinks that marine mammals represent decadent groups. The number of extinct forms is usually large in proportion to that of the extant;—Sirenia, 5:1; Pinnipedia, 30:54; Cetacea, 286:112. In Platanistidæ the numbers are 72:3; in Physteridæ, 68:16; in Mystacoceti, 91:36; but in dolphins the fossils are in the minority (18:63).

The older distribution was more uniform than that of to-day; human influence has been very disturbing. Geological facts show that an arctic origin must be excluded, but three distribution-centres may be recognised,—Argentina, N.E. America, and Mid-Europe. It was after the Glacial Periods that the northern immigration occurred, and the peopling of the Antarctic ocean was also recent. The boundaries of the zoo-geographical marine regions are somewhat arbitrary.

Plankton and Abyssal Fauna around Capri.†—Dr. S. Lo Bianco gives an account—full of interesting notes—of the animals captured from the surface and from the deep waters in the vicinity of Capri. The investigations were made in April on Herr F. A. Krupp's 'Maia.' They re-emphasise the richness and variety of the Mediterranean fauna, and the discovery of 27 new species near an area which has been relatively well worked is in itself striking.

New Species of Atherine in Fresh Water.‡—Prof. L. Roule describes as *Atherina riqueti* what he regards as a new species of recent origin, to all appearance a fresh-water derivative of the marine *A. boyeri*, just as *A. lacustris* seems to be derived from the marine *A. hepsetus*. The new form was found in the Canal du Midi which connects the basin of the Garonne with the Mediterranean.

Molluscum Contagiosum in Amphibians.§—P. Mingazzini describes a case of this skin disease in *Discoglossus pictus*. The disease has been hitherto known only in warm-blooded animals (man, sheep, pigeon, fowl), but in spite of differences in the degree of infection and in the dimensions of the parasite, there seems no doubt as to its occurrence in the amphibian mentioned.

Prodromus of Monograph on Chamæleons.||—Dr. Fr. Werner begins by noticing that since Boulenger's "classic catalogue" (1887) the number of known species of chamæleons has been considerably increased. Twenty-six new species of *Chamæleon*, four of *Brookesia*, and three of *Rhampholeon*, have been described. The total is now 82 species.

The first section deals with the classification of the species of *Chamæleon*, which the author arranges in seven groups. The diverse snout appendages—apparently of polyphyletic origin—are arranged on four distinct lines. Then follows a discussion of the markings, of which eight different sorts are distinguished. The geographical distribution

* Zool. Jahrb., xv. (1901) pp. 249-66.†

† MT. Zool. Stat. Neapel, xv. (1901) pp. 413-82 (1 map).

‡ Zool. Anzeig., xxv. (1902) pp. 262-7 (4 figs.).

§ Atti R. Accad. Lincei (Rend.), xi. (1902) pp. 258-63.

|| Zool. Jahrb., xv. (1902) pp. 295-460 (13 pls. and 2 figs.).

is then discussed, and illustrated with maps. The systematic survey follows, and we must at least notice the excellence of the numerous illustrations.

Excretory Organs of Amphioxus.*—E. S. Goodrich finds that the *Fadenzellen* described by Boveri round the funnels of the excretory tubules of *Amphioxus*, are in reality typical *solenocytes*, such as Goodrich has described in the Glyceridæ, Phyllocoidæ, Alciopidæ, and Nephthyidæ. Hitherto these excretory cells have been known only at the inner end of nephridia which end blindly, having no direct communication with the cœlom, and this is true of the excretory organ of an adult *Amphioxus*. It is more or less branched, and the branches bear innumerable solenocytes with narrow thread-like tubes of remarkable length. At the distal end of each tube is situated the cell-body and nucleus, and inside it vibrates a flagellum which passes into the lumen of the excretory canal. It may be concluded that, in their function, segmental arrangement, and detailed histological structure, the excretory organs of *Amphioxus* are essentially identical with the nephridia of certain Polychæt worms.

Monstrosity in a Trout.†—Prof. E. Yung describes a malformation in the head of a rainbow trout (*Salmo iridens*), which, unlike most monstrous trouts, lived a considerable time—22 months, feeding solely on *Tubifex*. It had one eye, situated on the left, and it invariably moved in circles around an imaginary axis on its left side. The mandible was prolonged, the upper jaw greatly reduced. Great abnormalities were found in the brain; the first and third vesicles had been arrested in development and had thereafter suffered degeneration of the nervous tissue to the right side; the second vesicle was confluent with the third and was also very degenerate.

Questions of Nomenclature.‡—Dr. C. W. Stiles discusses certain questions of nomenclature as applied to parasites and with special reference to the work of Looss. We cannot do more than quote the headings of a few sections:—The law of priority, at what date should the law of priority become operative? the rule of homonyms, is there any disgrace connected with synonyms? method of proposing a new genus or species, are patronymic names to be censured?

Occurrence of Compounds of Phosphorus in Invertebrates.§—Jean Gautrelet finds that in Crustaceans and Molluscs—many examples—the blood and the shell both contain phosphorus in mineral and in organic compounds. In the crustacean carapace the amount of mineral phosphatic compounds was found to be much less than previous investigators had computed.

Biological Theory of Vision.||—Georges Bohn refers under this title to his speculations in regard to the origin of pigment and the rôle of pigment in vision. Arguing against Pizon, he maintains that the light-waves are translated into intra-molecular movements and that the luminous

* Proc. Roy. Soc., lxi. (1902) pp. 350-1.

† Rev. Suisse Zool., ix. (1901) pp. 307-13 (3 figs.).

‡ Zool. Jahrb., xv. (1901) pp. 157-208.

§ Comptes Rendus, cxxiv. (1902) pp. 186-8. || Tom. cit., pp. 184-6.

energy is transformed into chemical energy in the granules by the pigment. Not only so, but the formation of the eye is "a chemical phenomenon," in which pigmentary and hyaline modifications of tissue occur. In Vertebrates, it is noted, the eye is considered as a metamorphosed branchial cleft. We have not been able to follow the argument.

INVERTEBRATA.

Mollusca.

a. Cephalopoda.

Dichotomy of Arms in Cuttlefish.*—C. Parona describes a case in *Octopus vulgaris*. The divided arm was small and doubtless in process of regeneration. In another case observed in *Eledone aldrovandi*, the dichotomy was not obvious as such, but an extra arm arose between the second and third on the right side, closely apposed to the third. Fishermen report the not infrequent occurrence of specimens of *Eledone* with nine arms.

Synopsis of Cegopsid Cephalopods.† — Dr. G. Pfeffer has made a valuable synopsis of all the known cegopsid cephalopods, with the usual diagnoses and identification tables. It has especial reference to the cephalopods of the German Plankton Expedition—to be treated of in a special report.

β. Scaphopoda.

"Pseudogamy" in *Dentalium Entalis*.‡ — Dr. V. Ariola has followed Loeb's methods in treating the ova of *Dentalium entalis* with various solutions, magnesium chloride, sodium chloride, &c. in sea-water and in distilled water. In no case did the eggs exhibit *osmotic pseudogamy*, as the author calls it. There was no beginning of segmentation. But a comparison of the eggs in the artificial solutions with those in normal sea-water showed that the ions had a deleterious effect.

γ. Gasteropoda.

Reactions of *Limax maximus*.§ — P. Frandsen has studied the locomotor responses of this slug to three kinds of stimuli,—those of touch, gravity, and light. (I.) In ordinary circumstances the animal is negatively thigmotactic,—moving away from the agent that comes in contact with it.

(II.) On an inclined *glass plate*, all slugs give a geotactic response, some positively, others negatively; a few are somewhat indifferent. There is little variation on different days or at different times on the same day. The occasional vagaries in the responses of individual animals are to some extent due to thigmotactic and phototactic influences.

The different geotactic response, on a glass plate, of different individuals is due mainly to two factors: (a) the quantity and quality of

* Boll. Mus. Zool. Univ. Genova, No. 96 (1900) pp. 1-7 (1 pl.). See Zool. Centralbl., ix. (1902) pp. 184-5.

† MT. Nat. Hist. Museum Hamburg, xvii. (1900) pp. 147-98. See Zool. Centralbl., ix. (1902) p. 185.

‡ MT. Zool. Stat. Neapel, xv. (1901) pp. 408-12.

§ Proc. Amer. Acad. Sci., xxxvii. (1901) pp. 185-227 (22 figs.).

the slime secreted; (b) the relative proportions of the length of the anterior and the posterior regions of the animal's body. All the conditions being the same, it is this last factor which determines whether the head end will be directed up or down.

If the ratio of length of the anterior region (from the tip of the head to the posterior edge of the mantle) to the posterior region is 2 : 3, or more, and if the mucus is of good quality and sufficient quantity, the slug will be positively geotactic. If the ratio is 3 : 5, or less, the animal will usually migrate upward, and the nearer the ratio approaches 1 : 2 the more apt is the slug to respond negatively. In a small number of individuals, in which the ratio lies between 2 : 3 and 3 : 5, the response will depend largely on the condition of the mucus and co-operation of other factors.

All slugs have a natural tendency to move towards the earth. This tendency is masked in the animals which are negatively geotactic on a glass plate by the greater pull of gravity on the disproportionately larger and heavier posterior region of the animal. The general downward tendency may vary normally at different times of the day, owing to the animals' habit of remaining in concealment in the daytime and feeding at night.

(III.) The slugs are markedly phototactic, but with individual differences, as in geotaxis. To strong light, they give, on the average, a strong negative response, and the degree of response gradually diminishes with the reduction in the strength of the stimulus. There is a certain strength of light—neutral stimulus—which appears neither to repel nor to attract, and reduction of the intensity beyond this neutral point changes the phototaxis from negative to positive. The positive response becomes stronger up to a certain degree of intensity; it then gradually diminishes with decreasing intensity until absolute darkness, accompanied by no response, is reached. Slugs are responsive to light stimuli covering a wide range of intensities. The principal organ of response is probably the eye. The right side is not as sensitive to stimuli as the left. In the dark, other directive stimuli being eliminated, the slug tends to travel in a spiral of gradually increasing radius, though almost invariably producing one or more loops. There is a slightly greater tendency to right-hand circling.

“These responses of the slug to touch, gravity, and light-stimuli emphasise the fact that it is an animal's normal environmental conditions which chiefly determine its general response to artificial stimuli. The variations in precision and character of this general response are mainly dependent on certain internal factors, such as the food conditions of the animal, its fear of an enemy, and desire to escape captivity.”

Digestive Gland in Molluscs.*—P. Enriques has made a detailed, chiefly microscopical, study of the digestive gland in *Aplysia depilans* and *limacina*, in comparison with *Pleurobranchæa meckelii*, the common snail, the oyster, and various Cephalopods. His results include some details in regard to the structure and relations of the digestive gland, an account of the mechanism of trituration and digestion in *Aplysia*, and a description of the microscopical changes exhibited by the food-particles.

* MT. Zool. Stat. Neapel, xv. (1901) pp. 281-407 (3 pls.).

The alcoholic extract of the liver of *Aplysia* shows the spectrum of acid chlorophyll.

In *Aplysia* there are four kinds of hepatic cells—which are described at length—(1) chlorophyllous absorbing cells, (2) secreting cells with small drops, (3) secreting cells with large drops, and (4) spherular cells which in one stage are characterised by numerous non-calcareous refractive spheres. In *Pleurobranchæa*, the chlorophyllous and spherular cells are not represented; in *Helix*, there are absorbing, secreting, and spherular cells; in Cephalopods (*Octopus*, *Eledone*, *Sepia*) there are secreting cells with drops coloured brown, spherular cells like those of Gastropods, and cells with red granules of unknown import; in *Ostrea edulis* there are only secreting cells with pigmented drops like those of Cephalopods. In none of the forms studied was there evidence of excretory function in the hepatic cells. The epithelial cells of the stomach and cæcum in Cephalopods—though characteristically ciliated—are full of absorbed fat-globules.

Poisoning from Conus.*—R. G. Corney notes that doubt has been cast on the opinion that the “bite” of certain species of *Conus* is poisonous, and reports a case from Fiji which is much to the point. The patient, a European subject, was extracting the animal (*Conus geographicus*) from its shell, and received a puncture which was soon followed by numbness, loss of speech, paralysis, and so on, with recovery in two days. The condition resembled that which might be looked for after poisoning with curare.

Arthropoda.

a. Insecta.

Copulation of House-Fly.†—Prof. A. Berlese gives a fine illustration of the careful scientific analysis of a familiar scene, the copulation of *Musca domestica*. After a description of the male and female reproductive organs, with admirable figures of the complex penis and ovipositor, Berlese discusses the copulatory process, in regard to which the most remarkable fact is perhaps the relatively slight activity of the external organs of the male and the very great activity of those of the female. Apart from preliminaries and the actual mounting on the female, the male is relatively passive in the act. For it is the female that introduces her ovipositor into the genital atrium of the male.

Development of Nerve-Cord.‡—Dr. K. Escherich concludes from his study of the embryos of *Lucilia*, that the ventral nerve-cord arises from two genetically distinct systems—the paired lateral cords and the unpaired median strand. In *Lucilia* and in Muscidæ generally the two systems become intimately combined, but in the larval and imaginal stages of most other insects the distinctness of the median strand is evident, as Leydig and others have pointed out.

Notes on Galls.§—D. Manuel Fernandez de Gatta discusses the Levantine galls on *Quercus infectoria* produced by *Diplolepis gallæ*

* Nature, lxx. (1902) p. 198.

† Rev. P.tol. Vegetale, ix. (1900-1901, published 1902) pp. 345-56 (12 figs.).

‡ Biol. Centralbl., xxii. (1902) pp. 179-81 (4 figs.).

§ Boll. Soc. Espan. Hist. Nat., ii. (1902) pp. 81-6.

tinctoriæ Wild and by *Cynips polycera* Giraud; and also the galls produced on *Rhus semialata* in China and Japan by *Aphis chinensis* Bell.

Notes on South American Termites and their Termitophilous Associates.*—Dr. F. Silvestri communicates descriptive notes on a large collection. The termitophilous forms include Acari, Diplopoda, Thysanura, Hemiptera, Diptera, Hymenoptera, and Coleoptera, which may be arranged according to habit in seven groups proposed by Janet for myrmecophilous forms. The terms are repellent:—alloicoxeni, parasitoxeni, phoresoxeni, cleptoxeni, synecitroxeni, synoicoxeni, and euxeni.

Colours of Butterflies not due to Diffraction.†—W. B. Croft points out that while all scales have fine diffraction rulings, consisting of rows of small points, it is a mistake to attribute the colours to diffraction, such as is familiar on the finely marked feathers of a hummingbird. True diffraction colours are many-coloured iridescent lights varying as they glance off at different angles, but no illustration of this was found in a collection of British Lepidoptera. No doubt some insects show interference colours, but these seem usually to arise from the phenomenon caused by thin plates.

Odoriferous Organ of the Male *Hepialus hectus*.‡—Dr. P. Deegener gives a careful account of this highly developed scent-gland which lies in the swollen tibia. The excessive development of the tibia has been associated with the great reduction of the tarsus, but it is present in rudimentary form. Each glandular cell has two large nuclei rich in chromatin. The secretion probably diffuses out in gaseous form through the delicate walls of the scales which become tense and are erected by internal pressure. It seems likely that the secretion was originally a sexual excitant, and that it now helps the females to find the males. We cannot do more than indicate the general scope of the memoir.

Dermaptera and the Microthorax.§—Dr. K. W. Verhoeff proposes a new and natural system of the Dermaptera, suggests a phylogenetic scheme of the families, and describes twelve new genera. He also devotes particular attention to the microthorax or neck-segment, which he regards as a trace of Chilopod ancestry, more and more completely suppressed in Insecta. It is still well developed in Dermaptera, and fairly distinct in the lower Orthoptera. In Neuroptera it is strongest on the dorsal surface, in Hymenoptera and Coleoptera on the pleural surfaces.

Structure and Classification of Collembola.||—Carl Börner has investigated in considerable detail the antennal sense-organs of Collembola. As in other Insects, these consist essentially of pore-canals in the cuticle, the orifice being closed externally by a sensory appendage of some kind. There is much variation as regards the number and character of these sensory appendages, and the author has studied those especially of "antennal organ iii." in a number of forms. In Collembola

* Boll. Mus. Zool. Univ. Torino, xvii. No. 419 (1902) 29 pp.

† Nature, lxx. (1902) p. 198.

‡ Zeitschr. f. wiss. Zool., lxxi. (1902) pp. 276-95 (1 pl.).

§ Zool. Anzeig., xxv. (1902) pp. 181-208.

|| Tom. cit., pp. 92-116 (18 figs.).

generally they are confined to the ultimate and penultimate segments of the antennæ, and are such that it is easy to trace a transition from the ordinary pointed hairs to the differentiated sense-papillæ. In addition to these hairs and papillæ derived from hairs, there are also integumentary tubercles, non-articulated, but of similar sensory nature to the hair-like structures. The main facts in regard to the components of the antennal sense-organs may be summed up in the following table:—

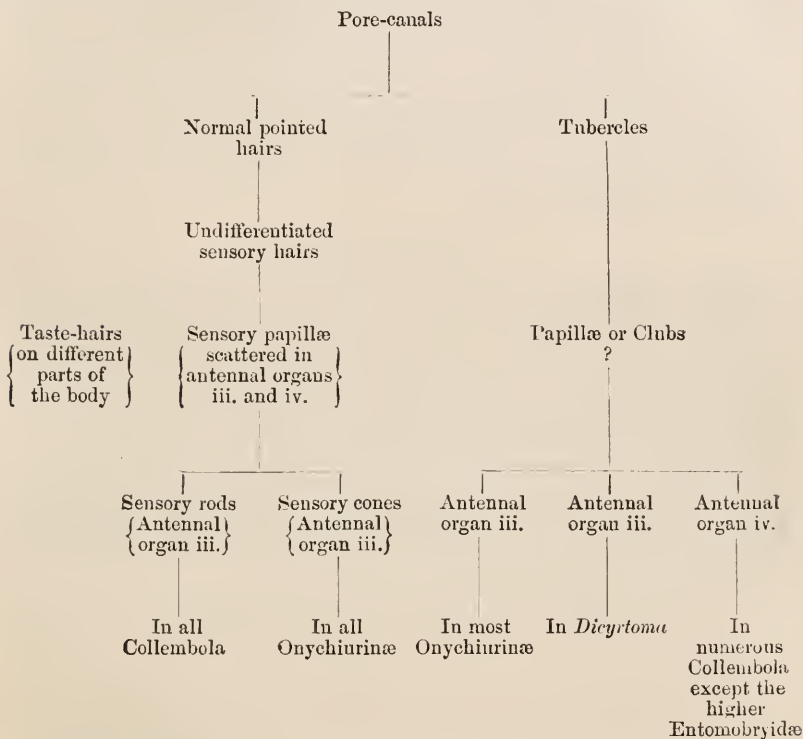

The author describes and figures antennal sense-organ iii. in each of the sub-families. The remainder of the paper is occupied with a discussion of the systematic position of the genera *Tetracanthella* Schött, and *Actaletes* Giard. He finds that the former is most nearly related to the genera *Anurophorus* and *Uzelia*, and should be united with them to constitute the sub-family Anurophorinæ, which is to be regarded as including the most primitive members of the family Entomobryidæ. The genus *Actaletes* is placed in a new sub-family—Actaletinæ—of the Entomobryidæ.

Life-History of *Clythra quadri-punctata*.* — Horace St. John K. Donisthorpe gives an interesting account of the life-history of this beetle, whose larvæ are found in spring in ants' nests (*Formica rufa*). When the beetle has emerged from the pupa in the nest, it escapes with

* Trans. Entom. Soc. London, 1902, pp. 11-24 (1 pl.).

caution, "feigning death," and holding on to twigs, when attacked by the ants. It seeks a mate and copulation occurs. The beetles frequent birch shrubs, eating the young shoots and leaves. The female seeks a tree or shrub above or close to a nest of *F. rufa*, and drops the eggs on the ground beneath. The eggs are covered by an excrementitious case or capsule, each like the end of a birch catkin. The ants carry the covered eggs to the nest, probably mistaking them for vegetable refuse. The young larva, which hatches in about twenty-one days, uses the egg-case as a nucleus on which to build the larval case,—made of the larval excrement mixed with earth. To enlarge the case the larva removes particles from the inside and plasters them on the outside. The larva feeds on vegetable refuse in the nest and may possibly be of some service to the ants in removing useless or decaying stuff. The beetle looks like a mimic of *Coccinella distincta*, which also lives in nests of *Formica rufa*, and it is distasteful on its own account, thus affording an example of Müllerian mimicry.

B. Myriopoda.

Spermatogenesis and Oogenesis in *Lithobius forficatus*.* — Carl Tönninges has reached the following conclusions. (I.) As to spermatogenesis:—In the young male gonads numerous elements unite to form a syncytium; this is due to emigration of indifferent cells from the germinal epithelium which furnishes the specific spermatogonia; most of the syncytium is used as nutrition for the primitive sperm-cells, but some of the spermatogonia are utilised by their neighbours. The nutritive cells of the *Lithobius* testes are really abortive germ-cells.

The spermatogonia proliferate as cell-complexes into the syncytium of the testis. They form long cell-strands with nuclei disposed one behind the other. As the elongation goes on, these nuclei acquire cell-boundaries. All the nutritive cells are absorbed.

The cell-lineage is as follows:—

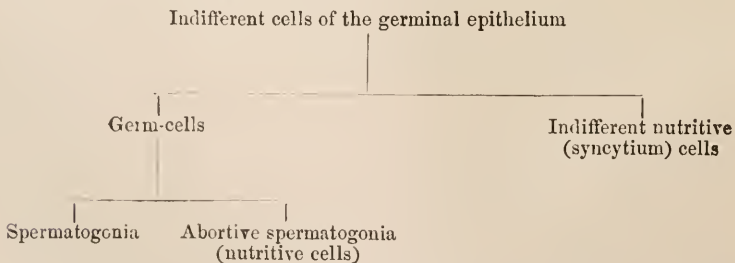

(II.) As to the oogenesis, the general results are as follows:—In the young female gonads, as in the terminal chamber of the insect's ovarian tubes, all the cell-elements form a syncytium. This syncytium is in greater part utilised as nutritive material by the ova which grow over it like parasites. The origin of the syncytium is due to the emigration and separation of indifferent cells from the germinal epithelium. From this indifferent cell-material there arise germ-cells, which become ova and nutritive cells. Besides these it gives rise to follicle-cells. Typical

* Zeitschr. f. wiss. Zool., lxxi. (1902) pp. 328-58 (2 pls. and 3 figs.).

ova are frequently used up as nutritive material by their neighbours, so that the nutritive cells of the *Lithobius*-ovary must be regarded as abortive or unsuccessful ova.

The cell-lineage is as follows :—

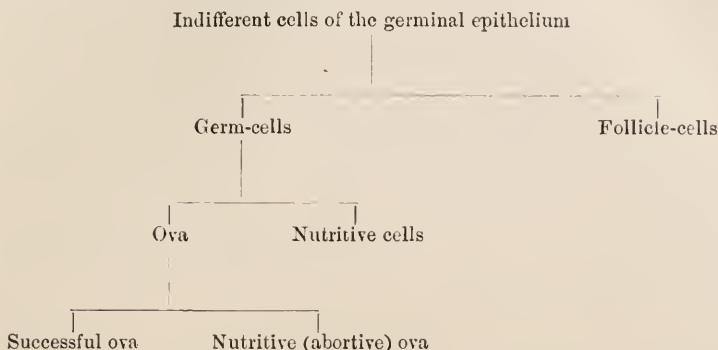

The general result, it will be observed, is to corroborate completely in reference to *Lithobius*, the conclusions which were established by Heymons from his study of *Scolopendra*.

Comparative Morphology of Chilopoda.* — Dr. Karl W. Verhoeff discusses some of the results obtained by Heymons in his recent study of the embryology of *Scolopendra*.† First, in regard to the appendages of the head, he points out the differences between Heymons' nomenclature and his own, and adduces reasons for believing that Heymons' conclusions suffer from the fact that he has confined his observations too exclusively to the early stages of development. Again, in regard to the number of segments in the legs, whilst most authors give seven as the typical number, Verhoeff finds six only, and Heymons eight. But Heymons includes the claw as a distinct segment, although in post-embryonic life it does not contain a cavity, and the other segment is the trochanter which is only present in rudiment in the posterior legs of *Scolopendra*, but is distinct in the anterior. Heymons' results convince Verhoeff that while in *Lithobius* the six-jointed condition is the primary one, in *Scolopendra* it is secondary. Further, he does not agree with Heymons' nomenclature for the newly discovered small segment behind the genital segment. He considers that the name genital segment must be retained for the segment to which it has hitherto been applied, and the name post-genital segment be given to Heymons' newly discovered segment.

Resistance of Myriopods to Asphyxiation.‡ — Dr. G. Rossi has made a number of experiments. It seems that millipedes (*Iulus*) survive prolonged immersion, exhibit no sign of discomfort, and retain for a long time their wonted vigour. Centipedes (*Scolopendra*, *Lithobius*, *Scutigera*, &c.), on the other hand, show plain signs of discomfort when thrown into water, they soon become rigid, and never survive more than

* Zool. Anzeig., xxv. (1902) pp. 118-20. † Cf. this Journal, ante, p. 41.

‡ Ex Bull. Soc. Entomol. Ital., xxxiii. (1901) 31 pp.

three or four hours. The author advances a number of facts suggesting that there is active cutaneous respiration in Millipedes, but none in Centipedes. He also directed attention to the accumulation of gas [CO_2 ?] beneath the cuticle of submerged millipedes. Furthermore he maintains that the respiratory process in Diplopoda is very slow when compared with that in Chilopoda. This is borne out by experiments showing how successfully *Iulus* resists immersion in inert and even deleterious gases, which are rapidly fatal to Chilopoda.

Notes on Myriopods.*—Dr. F. Silvestri criticises the identifications in a recent memoir by Prof. G. Rossi, and various statements as to the development and the hypodermis of *Iulus*. Nor does he agree with what Rossi says as to the possibility of submerged Diplopoda absorbing air through the cuticular pores. In the second part of his paper, Silvestri gives a short account of the integumentary skeleton of *Glomeridesmus*, and of the repugnatory and sericiparous glands. He has also notes on the dorsal glands of *Glomeris*.

γ. Prototracheata.

Oviparous Species of Onychophora.†—Prof. A. Dendy gives the following summary of the principal conclusions arrived at in his memoir.

The genus *Ooperipatus* includes a number of oviparous Onychophora characteristic of Eastern Australia, Tasmania, and New Zealand; distinguished by laying large, heavily yolked eggs with a thick sculptured chorion, and by the presence in the female of a conspicuous muscular ovipositor. The egg at the time of laying contains no recognisably developed embryo, and development takes place afterwards with extreme slowness. The oviparous habit is very ancient, dating back at least to the Cretaceous epoch, as indicated by the geographical distribution of the species. The conclusions of Sedgwick and Sclater as to the loss of yolk in the eggs of certain viviparous species are thereby supported.

Three species are at present known, *O. oviparus*, *O. viridimaculatus*, and *O. insignis*. In the last the eggs have not yet been observed, but the females have the conspicuous ovipositor. The genus is very closely related to Pocock's *Peripatoides*, and may be regarded as representing an ancestral form from which the viviparous Australasian species are descended.

Except as regards the egg-laying habit and structures associated therewith, the genus *Ooperipatus* is, according to the views of Bouvier, very far from primitive in its characters, the number of walking legs being reduced to fifteen or fourteen, the spinous pads being only three in number, and the transverse ridges of the integument being interrupted in the mid-dorsal line by a narrow unpigmented groove.

There is no sufficient reason for supposing that *Ooperipatus insignis* Dendy is identical with *Peripatus leuckartii* Sanger, which last name must be retained for the common viviparous form of New South Wales.

Papillæ of Onychophora.‡—E. L. Bouvier finds in a study of the pedal papillæ some useful hints as to the phylogeny of the Peripatidæ.

* Rev. Patol. Veg., x. (1902) pp. 179-84.

† Quart. Journ. Micr. Sci., xlv. (1902) pp. 363-415 (4 pls.).

‡ Comptes Rendus, cxxxiv. (1902) pp. 55-8.

The number of pedal papillæ is often more than three, and may rise to six (*Peripatus ecuadorensis*). There is a correlation between the number of papillæ and the number of appendages; and the forms with the largest number are the more primitive. The abnormally situated urinary papillæ of the fourth and fifth appendages are regarded as representing "the excretory pores of the sexual nephridia of the aquatic ancestor of the group." Viviparity followed as an adaptation to terrestrial life, and resulted in the displacement of the genital function to the penultimate appendages, leaving the nephridia of the fourth and fifth to reassume their urinary functions. After a long period of viviparity there was a return to oviparity with very large eggs.

δ. Arachnoidea.

Discoarachne brevipes Hoek.* — Leon J. Cole amplifies Hoek's description of this Pycnogonid from Sea Point, Cape Town, where a female specimen was collected during the cruise of the 'Challenger.' Mr. Cole received 11 specimens from Dr. W. F. Purcell, of the South African Museum,—6 females, 3 males, and 2 immature. He notes some secondary adaptations on the ovigerous legs of the males to hold the egg-masses. One of the males bore 8 closely crowded balls of eggs in the same stage of development (the number 8 corresponding to the genital openings of the female), and besides these another set of eggs mostly hatched. This shows that the male had taken eggs from a second female while still carrying eggs he had previously received from another. The "ovigerous" legs in the female are even larger than in the male, and Cole suggests that they may help in the transfer of the eggs to the male.

Hydrachnids of Central Russia. † — A. Croneberg gives a list of the water-mites which he collected in the Gouvernement of Tambow, thirty-three species in all, including *Arrenurus lævis* sp. n., and *Eyllais unisinuata* sp. n.

ε. Crustacea.

Notes on Fauna of Neuenburgersee. ‡ — Dr. Th. Stingelin has studied the littoral fauna at the south-west end of this lake, which he found to include 20 Cladocera, 7 Copepods, and 3 Ostracods. He devotes particular attention to two rare and bizarre forms—*Alona falcata* Sars and *Monospilus dispar* G. O. Sars, the latter new to Switzerland. He has also notes on the limnetic fauna of the north end of the same lake.

Annulata.

Stolonial Growth in Syllidæ.§ — G. Pruvot has made some careful measurements as to stolonial budding in various Syllids, and thinks the following law may be stated. The rapidity and activity of the budding, whether cephalogenic or urogenic, is in proportion to the relative size of the area which exhibits it. The development of cephalic and caudal new formations is thus in inverse ratio in the same animal. More generally, he maintains that the activity of regenerative blastogenesis (here and

* Zool. Jahrb., xv. (1901) pp. 243-8 (1 pl.).

† Bull. Soc. Imp. Nat. Moscow, 1902, pp. 90-101 (1 pl.).

‡ Rev. Suisse Zool., ix. (1901) pp. 315-23 (1 pl.).

§ Comptes Rendus, cxxxiv. (1902) pp. 433-6.

elsewhere) is in proportion to the relation between the total surface of the body in contact with the external medium and the volume of the body.

Prof. E. Perrier* criticises some of Pruvot's interpretations involved in the paper above referred to. Pruvot traces back stolonisation in Syllids to the phenomena of epigamy or epitoky; Perrier points, however, to the fresh-water Naidomorpha where stolonisation is conspicuous without any trace of epigamy. Moreover, stolonisation is associated with the non-sexual periods in *Nais*, *Dero*, &c. It should be traced back to the posterior budding which is the characteristic mode of growth in Annelids.

Pruvot regarded stolonial reproduction as a recent acquisition, mainly because of the diversity in its modes of occurrence even within one genus; Perrier argues that the more legitimate inference is that stolonisation is a survival of primitive conditions. Perrier also refuses to accept Pruvot's "laws," which do not agree with what may be observed in *Myrianida* for instance. Sounder generalisations are to be found in Geoffroy Saint-Hilaire's "balancing of organs," and in Perrier's general theory of the formation of the Annelid body by posterior budding (*Les Colonies Animales*, 1881).

Alimentary Canal of *Lagis koreni*.†—L. Brasil describes the general structure of the gut in this Pectinarian and discusses the regeneration of the intestinal epithelium. Nuclei migrate towards the surface, exhibit mitoses, and then migrate back towards the base. The same was seen in three other Polychæts and has been described by Heymons in the embryo of *Scolopendra*.

Nematohelminthes.

Cystoopsis acipenseri.‡—W. Zykoff confirms Wagner's description of this interesting nematode which occurs beneath the skin of *Acipenser ruthenus* in guinea-worm fashion. The minute male is found along with the female in the same tubercle. This opens eventually like a boil, and the thread-like uterus full of embryos is extruded into the water. Zykoff gives some reasons for supposing that the intermediate host is *Simulia reptans*, on which the sterlet is wont to feed.

Platyhelminthes.

Distribution of Planarians as affected by Temperature.§ — Prof. W. Voigt has made, as formerly reported, a detailed study of the distribution of Planarians in Alpine streams. He now considers the causes of the elimination of *Planaria alpina* in the "Hundrückgebirge" and of *Polycelis cornuta*. His argument rests on the results of laborious collecting and temperature-observations, and does not admit of brief summary, but the outcome shows that *Planaria alpina*, *Pl. gonocephala*, and *Pol. cornuta* are very sensitive to temperature-changes, such as those which ensue in the streams as the result of de-forestation.

New Trematodes from Crocodile.¶—Th. Odhner found in the intestine of the Nile crocodile a new species of the interesting Holostomid

* Tom. cit., pp. 453-6.

† Arch. Zool. Expér., x. (1901) Notes et Revue, pp. i-iv. (6 figs.).

‡ Biol. Centralbl., xxii. (1902) pp. 229-33 (2 figs.).

§ Verb. Nat. Ver. Rheinland, lviii. (1901) pp. 225-46, 1 pl. (map), 2 figs. (maps).

¶ Öfversigt k. Vetensk. Akad. Föreländl., lix. (1902) pp. 19-45 (3 figs.).

genus *Cyathocotyle* Mühl (*C. fraterna*), a new genus allied to *Echinostomum* (*Stephanoprora ornata* g. et sp. n., also *Ech. umbonatum* sp. n., two new species of *Acanthochoasmus*, *Oistosomum caduceus* g. et sp. n., apparently nearest to *Styphlodora*, *Nephrocephalus* g. et sp. n., apparently nearest to *Clinostomum*. He also describes *Telorchis solivagus* sp. n. from *Clemmys caspica*, *Cotylotretus rugosus* g. et sp. n. from Coluber (*Spilotes*) *pullatus*. A discussion of some of the much debated questions concerning the classification of Trematoda concludes the paper.

Zygeupolia litoralis, a new Heteronemertean.* — Dr. Caroline B. Thompson gives a full account of this new form from Wood's Holl. Its habitat, habits, and parasites are discussed, but the bulk of the paper is anatomical. It is a primitive form, having affinities with both Proto- and Heteronemerteans. The position of the lateral nerves, outside the circular muscle-layer; the presence of the cutis and outer longitudinal muscle-layer; the situation of the mouth behind the brain; the absence of stiletts in the proboscis, and of a blind intestine, are among the many characters which entitle *Zygeupolia* to a place among Heteronemerteans. The affinities with the Protonemerteans—and certain Heteronemerteans—are in the absence of lateral slits, in the presence of an inner circular muscle-layer, and of crosses between this layer and the outer circular, and in the lateral grooves, of sense-organs. In fact, it connects the Heteronemertea more closely with the Protonemerteans. In general structure *Zygeupolia* has some affinities with Eupoliidæ, but comes nearest to the Micruran Lineidæ, e.g. *Micrura cæca*, which is hardly distinguishable from it externally except by the presence of lateral slits.

The general view of the authoress as to the relationships of the different orders of Nemerteans is, that "the Heteronemerteans are very closely related to the Protonemerteans, the Lineidæ being connected by forms like *Zygeupolia*, the Eupoliidæ, and *Hubrechia*, and that the Metanemerteans and the Mesonemertean *Cephalothrix* are widely divergent forms."

Notes on *Carinoma armandi*.† — D. Bergendal confirms his previous conclusion, that this is a Palæonemertine, with very slight divergence in the direction of Metanemertines, and with so little resemblance to *Cephalothrix* that it seems impossible to have them in the same family. He describes in particular the remarkable peculiarities in the musculature of the anterior region.

Incertæ Sedis.

Central Nervous System of *Sipunculus nudus* L. ‡ — H. von Mack has added precision to our knowledge of the minute structure of the ventral nerve-strand of this worm,—a difficult subject for modern neuro-histological methods. Special attention is given to the terminal swelling (Leydig's tail-ganglion), the envelope or peridym of the cord with its three layers, the fibres of the cord and the supporting glia, and the autochthonous pigment which seems to be deposited—apart from any

* Proc. Acad. Nat. Sci. Philadelphia, 1901, pp. 657-739 (5 pls. and 7 figs.).

† Öfersigt k. Vetensk. Akad. Förhandl., lix. (1902) pp. 13-8.

‡ Arb. Zool. Inst. Wien, xiii. (1902) pp. 237-334 (5 pls. and 17 figs.).

specific pigment-cells—as a by-product of metabolism, possibly of some respiratory significance. The paper abounds in interesting histological details.

‡ Genera of Enteropneusta.*—Prof. J. W. Spengel discusses the terminology of the genera, and gives a useful systematic list of the known forms.

- | | | |
|--|-----------|--|
| 1. Harrimaniidæ n.f., | including | <i>Harrimania</i>
<i>Dolichoglossus</i>
<i>Stereobalanus</i> |
| 2. Glandicipitidæ
syn. Spengelidæ } | including | <i>Glandiceps</i>
<i>Spengelia</i>
<i>Schizocardium</i> |
| 3. Ptychoderidæ, | including | <i>Glossobalanus</i>
<i>Balanoglossus</i>
<i>Ptychodera</i> |

Plumatella and Vivipara.†—W. Zykoff refers to Kraepelin's description of a "symbiosis" between *Plumatella princeps* Kraep. var. *S. spongiosa* and *Vivipara fasciata* Müll. Zykoff found the same in the Volga; in the majority of cases the mollusc was covered all over with a thick colony of *Plumatella*, and the mass was sometimes as large as a fist. The fishermen regard them as fresh-water sponges.

Cœlentera.

Post-Embryonic Development of Aurelia aurita.‡—O. Friedemann sums up his results in the following terms:—The stages in the development of the tentacles are expressed by the numbers—4, 8, 16, 24; the 12- and 20-stages are intermediate. At the foot of the larva there are glandular cells with pseudopodia. In the stinging-knobs of the tentacles the ectoderm appears at places two-layered; the endoblasts send processes into the supporting lamella and there enter into connection with ganglion-cells; the fully formed nematocysts occur in two sizes.

There is no "septal funnel" in Goette's sense, but in the older Scyphistomas an inter-radial "peristom-funnel" arises as a new invagination—a transitory ectodermal proliferation into the tæniola. Nor is there an ectodermic gullet.

The endoderm cells of the gastral cavity show both extra- and intracellular digestion. In young Scyphistomas the tæniolæ do not extend down more than a third of the central stomach,—in older forms not more than a half. The cell-multiplication on the outermost margin of the tæniolæ is altogether a local differentiation of the endoderm; a growing down of the ectoderm from the mouth does not occur.

In quite early stages there are no stomach-pouches in Goette's sense, but simply grooves due to the tæniolæ. In the eight-armed scyphistoma, four distinct stomach-pouches make their first appearance, clothed inter-

* Zool. Jahrb., xv. (1901) pp. 209-18.

† Zool. Anzeig., xxv. (1902) p. 181.

‡ Zeitschr. f. wiss. Zool., lxxi. (1902) pp. 227-67 (2 pls. and 3 figs.).

nally with true endoderm. As soon as the septal-ostia are established, the eight *Lappentaschen* are formed.

The ectoderm of the tentacles has strong longitudinal muscle-fibrils, the endoderm has fine circular fibrils which are sometimes branched; both are cross-striated.

In the eight-armed stage mesenchyme cells make their appearance in the supporting substance; as the development of the larva proceeds they become more and more abundant, and a typical fibrous connective-tissue results. The cells in question arise from both ectoderm and endoderm.

The degeneration of the tentacles is due partly to basal constriction and detachment, partly to atrophy and shrivelling, helped by phagocytes. The sense-organs are not the modified basal portions of the tentacles, they arise by evagination from the sub-umbrellar margin of the eight *Lappentaschen*, central to the per-radial and inter-radial tentacles. In the free ephyra a connection between optic cells and ganglion-cells may be seen.

Historical Study of the Zoological Investigation of Hydroids.*—M. Bedot gives a list of the works dealing with hydroids up to 1821. He chronicles the chief classifications proposed, and gives a bibliographic index of the genera and species.

Development of *Gonothyræa loveni*.†—J. Wulfert has published the full account of his investigations on the development of this hydroid, very common on the shores of the Baltic. The wandering primitive sex-cells are recognisable soon after the fixing of the planula. They arise from the interstitial cells of the ectoderm, soon pass into the endoderm of the young stem and hydranths, and afterwards migrate into the ectodermal nucleus of the medusoid bud. In older colonies there is a continual process of new formation in the portions of the stem below a gangangium, and a continued migration of primitive sex-cells.

The form and position of the ovum in the gonophore are variable; during its development the egg has no definite orientation. Maturation is typical. Fertilisation may occur by simple apposition of male and female pronuclei, or by a penetration of the compact male chromatin-body into the female pronucleus.

Two types of segmentation occur, connected by transitional modes. In the one case, a multicellular cœloblastula results, and the endoderm arises by multipolar immigration of blastoderm cells. In the other case, blastoderm cells begin to pass into the interior at the 24-cell stage; thus segmentation and endoderm-formation are not rigidly separable.

Sooner or later the segmentation-cavity is filled up with endoderm cells, and the result is a multicellular solid embryo, which was formerly misnamed a morula. Both ectoderm and endoderm include indifferent interstitial cells.

The free-swimming planula fixes itself, and becomes a flat disc, from the centre of which the hydrocaulus arises. When this is several millimetres in height it shows at its tip the primordium of the first hydranth.

* Rev. Suisse Zool., ix. (1901) pp. 379-515.

† Zeitschr. f. wiss. Zool., lxxi. (1902) pp. 296-327 (3 pls.).

Porifera.

New Calcareous Sponge.*—F. Urban describes a new member of the heterocelous calcareous sponges—*Rhabdodermella nuttingi* g. et sp. n., from Monterey Bay, California. As its elongated flagellate chambers do not open directly into the oscular tube, but communicate with it by efferent canal, the new sponge belongs to the family Syllleibidæ, beside the two genera—*Polejna* Ldf. and *Vosmaeria* Ldf., from both of which it differs a little in the nature of its spicules. The skeleton consists of triactine and tetractine megascleres and rhabdon microscleres; the needles are dermal and gastral, not parenchymal, recalling an *Amphoriscus*-like arrangement.

Protozoa.

Significance of Ionisation in Acclimatisation.†—Dr. R. Florentin considers that the part played by ionisation in the acclimatisation of fresh-water organisms to a saline medium has not been sufficiently emphasised. If an Infusorian be placed in a solution of common salt, the regulation of the pressure between the surrounding fluid and that contained within the cell does not take place by simple osmosis. The internal pressure is due to the ions and to the different molecules of the cytoplasmic medium. If a certain number of saline molecules are introduced into the cell the osmotic pressure increases, but at the same time the disassociation of the saline molecules of the same kind, which are already present in the Infusorian, diminishes, because it is known that the proportion of ionised molecules in a solution becomes less as the solution becomes more concentrated. In other words, the numerical augmentation of the particles introduced is compensated in whole or in part by a regression of the ionisation, with the final result that the internal osmotic pressure varies very little. In consequence the internal and external pressures are not equal, and in order to produce equilibrium capillary pressure intervenes and, according as it is greater or less than the elasticity of the cell-membrane, we have or have not changes in the form of the cell. The diminution of ionisation within the interior of the cell when placed in a saline medium, explains Balbiani's experiments with *Paramœcium*. Balbiani found that specimens, removed from a solution of common salt to an isotonic solution of potassium chloride, survived much longer than those removed from fresh water or placed in the potassium chloride. The explanation is, that in the first case the presence in the interior of the cell of Cl ions produced by the disassociation of the NaCl molecules, diminishes the number of Cl ions produced by the disassociation of the KCl molecules, and therefore diminishes the number of K ions as compared with the number in the second case where Cl ions did not previously exist, and it is the K ions which are so harmful. The same fact explains how it is that organisms can be gradually acclimatised to media of progressive salinity.

Heliozoa around Geneva.‡—E. Penard has descriptive notes on a number of forms, including *Actinophrys vesiculata* sp. n., *Actinosphærium*

* Zeitschr. f. wiss. Zool., lxxi. (1902) pp. 268-75 (1 pl. and 1 fig.).

† Ann. Sei. Nat. (Zool.), xiii. (1901) pp. 305-10.

‡ Rev. Suisse Zool., ix. (1901) pp. 279-305 (1 pl.).

eichhorni var. *viride*, *Raphidiophrys glomerata* sp. n., *Acanthocystis longiseta* sp. n. and *A. ludibunda* sp. n.

Multiplication of Herpetomonas.*—Louis Léger finds that *H. jaculum* sp. n., an abundant flagellate parasite in the midgut of *Nepa cinerea*, occurs in two forms connected by intermediate stages. Most abundant are the monad-like forms, with a long flagellum, and very mobile, multiplying by longitudinal fission. But there are also gregarine-like forms of larger size, which occur fixed in rows to the epithelial cells, and also multiplying by longitudinal fission. The existence of gregarine-like forms in a typical Flagellate seems to the author a strong argument in favour of the origin of Sporozoa from a Flagellate stock.

New Sporozoon.†—L. Brasil gives a preliminary account of *Joyeuxella toxoides* g. et sp. n. from the intestinal epithelium of the Pectinarian *Lagis koreni* Malmgren. It shows certain resemblances to other Sporozoon parasites of Annelids, especially to *Gonospora longissima*, *Toxosporidium*, and *Selenidium*; it is however distinct, and must remain at present unattached.

Action of Human Serum on Trypanosoma Brucei.‡—A. Laveran has found that human serum injected into rats and mice infected with Nagana or Tsetse-fly disease destroys the parasites (*Trypanosoma brucei*) in the blood. But there are evidently corners of the organism where the parasites are able to resist with success the microbicidal influence of the serum. Thence they reappear with disappointing persistence. The serum seems also to be in a feeble degree preventive, and Laveran proposes to pursue the inquiry as to possible immunisation of animals. It is probable that the influence of human serum on *Trypanosoma brucei* is associated with the immunity of man to Tsetse-fly disease, but this interpretation remains incomplete until there is some understanding of the defensive process in the human body against this formidable parasite.

Protozoa of the Volga-Plankton.§—W. Zykoff records about 75 species of Protozoa from the Volga at Saratow, including *Tetraedrophrya planctonica* g. et sp. n., a new suctorial form. As autopotamic *Pinaciphora fluviatilis* may be reckoned; various species of *Diffugia* (except *D. planctonica*), *Vorticella*, Suctorina, and Amœbidæ may be regarded as tychopotamic, and characteristic of the potamo-plankton of the Volga is the occurrence of Heliozoa in considerable numbers, e.g. *Actinophrys sol*, *Actinosphærium eichhornii*, *Acanthocystis myriospina*, and *Rhaphidiophrys elegans*.

* Comptes Rendus, cxxxiv. (1902) pp. 781-4 (7 figs.).

† Arch. Zool. Expér., x. (1901) Notes et Revue, pp. v.-vii. (13 figs.).

‡ Comptes Rendus, cxxxiv. (1902) pp. 735-9.

§ Zool. Anzeig., xxv. (1902) pp. 177-80.



BOTANY.

GENERAL,

Including the Anatomy and Physiology of Seed Plants.

Cytology,

including Cell-Contents.

Protoplasmic Continuity in Cryptogams.* — Kienitz-Gerloff has examined a number of the lower plants in relation to this question. The method followed was that of Arthur Meyer. Amongst Liverworts connecting-threads were sought for in vain in *Fegatella*, *Marchantia*, *Riccia*, and *Anthoceros*, but *Reboulia*, *Metzgeria*, *Lepidozia*, and *Jungermannia bicuspidata* were found to be suitable objects. In the leaf of the last-named form the threads (*Plasmodesmen*) were particularly striking. In *Lepidozia* the continuity was observed in the tissue of the sporophyte (seta). Among mosses the threads were found in a number of genera, but in *Polytrichum formosum* they were very striking in the stem and seta, and are described as the finest yet observed in plants. The author considers that in the filamentous algæ the cells are probably quite separate from one another; but though protoplasmic continuity probably exists in the rest of the algæ, he was unable to observe it in *Fucus*, in which it has been described by Kohl. In the case of the Floridæ he was unable to determine that in *Batrachospermum* and *Polysiphonia* connecting-threads existed in the well-marked pit-closing membranes. Various cases in which the *Plasmodesmen* have been observed in Fungi and Lichens are quoted, and the author has also made observation himself; the most striking connection in the latter group was observed in the hypothecium of *Peltigera carina* and *P. polydactyla*.

The question is discussed as to the part the protoplasmic threads play in the conduction of stimuli and the translocation of food-material from cell to cell, and also as to the passage of the protoplasmic contents from one cell to another, which has been described in the fungi.

Protoplasmic Streaming in Plants.†—A. J. Ewart gives an abstract of results of observation on this phenomenon. The energy of movement is generated in the moving layers, which are retarded by friction against the non-moving ectoplasm, and to a much less extent by friction against the cell-sap which is passively carried with the stream. The velocity depends largely on the viscosity of the protoplasm. Gravity exercises little or no influence upon streaming in small cells, and only a very slight action in the case of large ones. As temperature rises the viscosity of the plasma decreases. The author discusses the physics of the movement, and also its relation to external stimuli, such as temperature, light, and mechanical, chemical, and electrical stimuli.

* Ber. Deutsch. Bot. Ges., xx. (1902) pp. 93-117 (1 pl.).

† Proc. Roy. Soc., lxxix. (1902) pp. 466-70.

Scutellarin.* — H. Molisch finds, as a result of heating leaves of *Scutellaria altissima* L. in 1 p.c. hydrochloric acid for a short time, a formation of dendritically branched or needle-like white crystals on the under leaf-surface; and that after longer action of 5 p.c. acid on entire shoots yellow sphaerocrystals are deposited in the epidermis cells. He calls these bodies *Scutellarin*. The substance can be extracted from fresh plucked leaves by 1–2 p.c. hydrochloric acid solution, is easily soluble in alkalies, and can be precipitated from the yellow ammoniacal solution by hydrochloric acid. The author finds the substance in several species of *Scutellaria*, and also in *Galeopsis Tetrahit* and *Teucrium Chamædryis*, but fails to find it in a large number of common Labiates. G. Goldschmidt has analysed the substance and suggests a formula, $C_{21}H_{20}O_{12}$.

Structure and Development.

Vegetative.

The Old Wood and the New.† — D. H. Scott, by a series of examples of fossil genera including *Heterangium*, *Megaloxylon*, *Lygiodendron*, *Calamopitys*, *Poroxylon*, and *Cordaites*, traces the gradual loss of the old centripetally developed wood, the cryptogamic wood of the French palæobotanists. The centrifugal or phanerogamic wood, with its unlimited possibilities of secondary growth, which is insignificant in *Heterangium*, includes everything except the leaf-trace system in *Lygiodendron*. In the leaf where there was not much demand for secondary tissue, the old wood was long able to hold its own, and has persisted to the present day in Cycads and perhaps, in the form of transfusion-tissue, in the Conifers, where it has survived by the help of a change of function.

Development of Stomata in Conifers.‡ — E. Schwabach finds that the development can only be followed for a short time in the spring, as in a few weeks after the first indications can be observed the process is complete, and the stoma-apparatus appears exactly similar to that of a one or several years old leaf. The first indication is found in needles which are still quite enclosed in the bud. The development was followed in transverse sections of *Picea*, *Abies*, *Juniperus*, *Larix*, and *Pinus*; that in *Picea* is described in full; a similar development occurs in the other leaves which were studied. The division lengthwise of the mother-cell of the guard-cells, its gradual sinking below the level of the neighbouring epidermal cells, the thickening of the walls, and the gradual twisting of the young guard-cells through 90° resulting in the formation of the pit above and the upper part of the air-cavity below, are followed in detail and the stages illustrated by figures. Pine-needles afford a very good object for study on account of their relatively large guard-cells, and also from the fact that in one and the same leaf all developmental stages can be followed. The earliest stages are found at the base of the leaf, the latest at its apex. The author was unable to throw any light on the mechanism of opening of the guard-cells as he found

* Sitzungsber. k. Akad. Wiss. Wien, math.-naturw. Cl., ex. Abth. 1 (June 1901). See also Verhandl. k. k. zoolog.-botan. Ges. Wien, lii. (1902) pp. 67–8.

† New Phytologist, i. (1902) pp. 25–30.

‡ Bot. Zeit., xx. (1902) pp. 1–7 (1 pl.).

none open, although in two successive summers he investigated young needles. The thickening on the cells of the stomatal apparatus in old needles is such that any movement is improbable.

Secondary Growth in Thickness in Palms.*—M. Barsickow has investigated this subject in *Phoenix reclinata*, *Phœnicophorium Seychellarum*, *Oreodoxa regia*, and the Coco-nut. He confirms Eichler's view, from all four examples, that the subsequent thickening is caused by enlargement of the cells of the wood-parenchyma. In *Phoenix* the increase is due almost entirely to this, as both here and in *Oreodoxa* and *Phœnicophorium* the sclerenchyma strands accompanying the bundles increase only slightly in diameter. In the two latter, however, the appearance of new intercellular spaces and the broadening of those already present is an important factor. In coco-nut there is also a considerable broadening of the bundle-sclerenchyma. This, however, is due, not as Eichler thought, exclusively to a broadening and thickening of the fibres, but to a sliding growth caused by their growth in length. Thus the lengths of fibres isolated by maceration from sections taken at various heights above the root increased from 1.015 mm. at 14.5 inches above the root to 1.413 at 12 metres and 2.232 at 40 cm. above the root, while their breadth at the same heights was .035, .037, and .047 mm. respectively.

Origin of the Peripheral Stem-Structure.†—F. Tobler concludes that there is no satisfactory evidence that the peripheral layers of the stem are derived from the leaf, but that, on the contrary, in *Elodea* and other objects the cortex can be demonstrated to be an original stem-structure. He maintains that arguments deduced from Conifers with decurrent leaf-bases, in support of a leaf origin of the cortex are untrustworthy. In the Mosses and also in *Equisetum* the arrangement of the cell-division at the growing-point favours the idea of an independent origin. The author also shows that in *Cirsium*, and in *Genista sagittalis* the wing on the stem has no genetic connection with the leaf.

Origin and Differentiation of Vascular Meristems in the Leaf-Stalk.‡—M. Bouygues, as the result of investigations on a large series of plants representing twenty families, concludes that in the majority of leaves there are two sets of meristem which differ in time and place of origin as well as in development. The first, which alone is constant, forms an arc with concave side upwards. The differentiation of procambium strands and subsequently vascular bundles is always effected there, and often there alone, but always before any such development occurs in the other meristem. The bilateral structure of the leaf is therefore primitive and fundamental. The second meristem is a cortical one, situated above the former. The formation of vascular tissue in it is not general; it fails at the base and apex of the leaf, and is absent altogether in a large number of leaves. It frequently forms a plate completing the vascular arc and transforming it into a closed circle resembling that of the stem.

* Verhandl. physik.-medic. Ges. Würzburg, N.F. xxxiv. No. 8 (1901) pp. 213-15 (1 fig.).

† Pringsh. Jahrb., xxxvii. (1901) pp. 99-136 (13 figs. in text).

‡ Compt. Rend., cxxxiv. (1902) pp. 438-41.

Primary Vascular Elements in Roots of Monocotyledons.* — R. Pirotta publishes an abstract of his paper, which will soon be printed in full with plates in the *Annuario del R. Istituto Botanico di Roma*, on the origin and differentiation of the primary vascular elements in the root of Monocotyledons. Nägeli and others have stated that the formation of the vessels and their lignification is centripetal; but they do not agree as to the mode of origin of the vascular elements. There are two kinds of vessels, distinct in origin and structure: the vascular rays and the central vessel or vessels. Several authors have admitted the centripetal origin of the vascular rays. Russow found that from the plerome are formed a peripheral pericambium, which yields the vascular rays and sieve-tubes, and a medullary parenchyma. Van Tieghem at first regarded the central vessels as belonging to the vascular rays, but more lately has admitted that in some cases they may be of medullary origin. Cerulli-Irelli and Chauveaud have established that the central vessels have no connection with the vascular rays. Nicolai found that in some Gramineae the central vessels appear before the rays, but are the last to lignify. The author now states that the apical plerome differentiates into three histogens:—the pericambium, the procambial parenchyma, and the central parenchyma. In the second of these the vascular rays are developed in regular order alternating with the sieve-tubes. In the central parenchyma arise the central vessels, one, a few, or several, without relation to the vascular rays. They are the first to appear, and develop close to the apex of the plerome, and in a centrifugal order if they be several in number. The vascular rays develop more slowly (and always after the sieve-tubes) and *centrifugally*, the largest inside and the smallest outside. But lignification takes place *centripetally*—first the small, then the large vessels of the vascular rays, and finally the central vessels. This is the general rule.

Tubercle of *Tamus communis*.† — L. du Sablon supplements in a short paper the previous work of Bucherer on the morphology of the tuber of black bryony. The young tuber has at its base a growing point and grows vertically downwards with strong positive geotropism. The tubercle of the seedling has below the epidermis a few cortical layers, the cells of which divide radially and not tangentially, and a central cylinder in which cell-division takes place in all directions. A cork cambium is formed at an early stage in the sub-epidermal layer, and in the pericycle a meristematic ring by which growth in thickness is provided for exactly as in *Dracæna*. The direction of the vascular bundles is very variable. The cork cambium goes over the growing point which becomes therefore covered with a cork layer; but in the meristematic ring, as we approach the growing point, cell-division becomes very irregular, and at the growing point itself occurs in all directions as in the apical meristem of a stem. In its exogenous origin, and internal structure the tuber suggests a stem, though the absence of leaves and vertical downward growth are root-characters.

* Atti della R. Accad. dei Lincei, Rendiconti, xi. (1902) pp. 49-52.

† Revue Gen. Botan., xiv. pp. 145-50 (9 figs.).

Study of the Family *Ochnaceæ*, especially of Malayan Species.*—V. Bartelletti gives an account of the external form and internal anatomy, especially of the vegetative organs, of members of the family *Ochnaceæ*. He also describes a number of new species from Prof. Beccari's collection, with notes on other Malayan forms.

Bast-Fibres of Japanese Fibre-Plants.†—K. Saito has made an elaborate investigation of the structure, arrangement, and physical and chemical properties of the bast-fibres in nearly thirty fibre-plants, native or cultivated in Japan. The species investigated represent five orders of monocotyledons and eleven of dicotyledons. The range of variation in length and diameter of the fibre is given in each case, and the author has also elaborated a table by means of which the species of the plant can be diagnosed from the measurement and other characters of the fibre. A copious bibliography forms an appendix.

Secreting Apparatus of *Daniellia*.‡—L. Guignard describes an extensive system of anastomosing secreting canals in the wood of this genus; they arise schizogenously in the cambium. The foliar organs also contain rounded secreting areas, also of schizogenous origin. In the main the secretory system of *Daniellia* resembles that of *Copaifera*, and probably also that of *Eperua*. These three genera belong to the same tribe (*Amherstieæ*) of *Leguminosæ*, and are the only members of the order in which, to the author's knowledge, secretory canals have been observed.

Anatomical Systematic Investigation of Leaf and Axis in the *Hippocrateaceæ*.§—F. E. Fritsch has studied the occurrence of caoutchouc in this family, and at the same time made a comparative investigation of the anatomy of the leaf and axis. The caoutchouc occurs in unsegmented, much elongated, often branched cells recalling the laticiferous elements of *Euphorbia*, and like these already laid down in the embryo and continuing to grow with the growth of the plant. They occur not only in the vegetative organs but also in the flower, fruit, and seed. In the axis the sacs are found both within the phloem and outside the latter in the primary cortex, and often in the secondary cortex at the limit of the primary. They never occur in the pith. In the leaf-stalk a similar distribution obtains. The sacs were not observed to anastomose.

‡ Reproductive.

Morphology of the Pine-Cone.||—C. E. Bessey, as a result of many years' study of the young cones of the pines, has been impressed with the essential identity of the cones bearing stamens and ovules respectively, and suggests a corresponding explanation of the much debated ovuliferous scale. The megasporangia first appear as rounded cell-masses pushing up from the axillary region at the base of the bract of the young cone; later this differentiates into scale and ovule, but there is never

* *Malpighia*, xv. (1902) pp. 105-74 (7 pls.).

† *Journ. Coll. Sci. Imp. Univ. Tokyo*, xv. pt. iii. (1901) pp. 395-450 (2 pls.).

‡ *Journ. de Botan.*, xvi. (1902) pp. 69-97 (19 figs.).

§ *Beiheft. Bot. Centralbl.*, xi. (1901) pp. 80 (1 pl.).

|| *Bot. Gaz.*, xxxiii. (1902) pp. 157-9 (1 pl.).

any line of demarcation between the two, the tissues are continuous and pass insensibly from one to the other. These facts suggested that the scale in the pine-cone is a backward extension of the chalazal tissue of the ovules. The cones in the Cupressinæ and Taxodineæ are normal, i.e. the megasporangia are borne by the bracts or carpels which later become enlarged. In the Araucariæ there is a slight backward ovular growth, but the bract is still so large as to greatly overshadow it. In the Abietinæ the ovules, which at first are secondary to the bracts, soon make so great a backward (or chalazal) growth as to greatly overshadow the bracts. A decreased development of the bract is associated with the enlargement of the ovular tissue, which has assumed more and more the functions elsewhere discharged by the bract. On this view the male and female cones are strictly homologous; and in the latter the sporophyll enlarges or remains small just as the chalazal development of the megasporangium into a scale is more or less pronounced.

Gametophytes and Embryo of Podocarpus.*—W. C. Coker obtains the following results. The pollen-grain contains two prothallial cells, as in the Abietæ; and in all essential points the pollen-grains are similar in the two cases. The second prothallial nucleus persists, and is found later in the tip of the pollen-tube; a behaviour which is unknown in other Conifers and for which a parallel must be sought in *Ginkgo* and the Cycads. The pollen-tube reaches the prothallium before the archeogonium initials can be distinguished; only two cases were found showing the male cells, but these leave no doubt that there is only one functional male cell formed as in *Taxus*. The macrospore arises deep in the nucellus, and is not surrounded by "spongy" tissue such as is general in the Coniferæ, and has often been erroneously described as of sporogenous character. The outer layer of the prothallium is composed of very small regular epidermis-like cells with dense protoplasm, but almost free from the starch-grains which are abundant in other parts. The author regards these surface cells as specially modified for secretion; no such definite layer seems to have been described for other gymnosperms. In one case two prothallia were found in one ovule; neither had formed archeogonia, although the seed had reached its full size. One of them contained a few tracheids; a fact recalling the formation of tracheids in apogamous fern prothallia.

The number of archeogonia was from six to ten. The neck varies greatly both in shape and the number of the cells; in one case more than twenty-five were counted, and sometimes there were only two. The jacket cells are less dense than in many other conifers, and their nuclei do not go to pieces when the archeogonium is mature. The position and behaviour of the ventral canal nucleus agrees closely with that in *Taxodium*. It is not separated from the protoplasm of the egg by a membrane; it persists for some time after fertilisation and probably assists in nourishing the embryo. The pollen-tube penetrates for some distance into the archeogonium and discharges its contents into the egg.

Fertilisation stages were not found, but the author thinks it probable that the fusion-nucleus moves to the base of the archeogonium before

* Bot. Gaz., xxxiii. (1902) pp. 89-107 (3 pls.).

dividing. Four divisions occur before cell-walls are formed. The pro-embryo consists of three tiers of cells, the upper two of fourteen each, the lower of one cell containing two nuclei. A thick plug of cellulose is formed between the cells of the upper tier (rosette-cells) and those of the middle tier (suspensors). The suspensors may separate and several embryos develop from one archegonium. As a general conclusion the Podocarpeæ are considered to be the nearest living relatives of the Abietæ.

Vascular Structure of the Flowers of Gnetaceæ.*—W. C. Worsdell finds traces of the more primitive structure of the older types of Coniferæ and of the Cycads in the floral axes and bracts of some members of Gnetaceæ. In the bract of the female inflorescence of *Ephedra distachya* a tract of centripetal xylem was seen on the ventral side of the collateral bundle. In the peduncle and axis of the female cone of *Welwitschia* the bundles of the central cylinder frequently have an inverted strand attached to their dorsal side, an occurrence previously noted by the author in the peduncle of some Cycadean cones; the inverted strand may be fused with the main strand to form a concentric structure of which the phloem is the centre. There were also a number of strands showing a more or less complete concentric structure forming a second vascular cylinder outside the first. The author also suggests that the very small lignified elements frequently found opposite the protoxylem of the bundles of the central cylinder may represent centripetal xylem, although their structure is rather that of ordinary sclerotic cells.

Anatomy and Morphology of the Flower of Cruciferæ, &c.†—E. Martel gives a comparative account of the floral structure of Cruciferæ, and of representatives of the allied orders Fumariaceæ and Cappari-daceæ. The paper is accompanied by numerous figures illustrating the arrangement of the bundles supplying the members of the various floral whorls.

Development of Pollinium and Sperm-Cells in Asclepias Cornuti.‡—C. S. Gager claims to have settled the question of the identity of the pollen-grain and its ontogeny in *Asclepias*. The individual cells of the pollinium are true pollen-grains which never become free. Numerical reduction of the chromosomes takes place in the primary pollinium cell, the divisions of which are successive, giving rise to a row of four pollen-grains radially arranged. This arrangement of the individual grains is the chief peculiarity in the division. Otherwise the whole course of development is precisely what occurs in other plants that form pollen-grains. The outer membrane of each pollen-grain is composed of the wall of the mother-cell, which does not dissolve, plus the cross-walls formed by the two divisions of the mother-cells. In addition each grain has an inner membrane which it develops about itself.

The generative cell divides, before the formation of the pollen-tube, into two sperm-cells, each of which travels down the pollen-tube, passing the vegetative nucleus on the way.

* Ann. Bot., xv. (1901) pp. 766-72 (1 fig.).

† Mem. R. Accad. Sci. Turin, ser. 2, t. li. (1902) pp. 241-66 (3 pls.).

‡ Ann. Bot., xvi. (1902) pp. 123-48 (1 pl.). Cf. this Journal, 1902, p. 199.

Influence of Pollination on the Development of the Pericarp.*—E. Tschermak gives an account of experiments on the wallflower. He finds that by use of pollen from another individual of the same form or the same variety, the pods were almost twice as long and proportionately broader than when pollination was effected by means of the same flower or another flower of the same plant. The large pods also contained more than a third more seeds, and the seeds were 70 p.c. heavier than in the smaller. The stigmas also behaved somewhat differently in the two cases. The author explains the stronger development of the fruit partly by the increased seed-production, but considers it due in part to the direct vegetative influence of pollination.

The same author † describes some experiments with pea hybrids on the correlation between vegetative and sexual characters. He crossed some red-flowered kinds of *Pisum arvense* having wrinkled cotyledons with white-flowered smooth-seeded kinds of *P. sativum*, but never found any alteration of the cotyledon form in the seeds of the mother-plant. The hybrids were all red-flowered with wrinkled seeds. The second generation of hybrids produced one white-flowered to three red-flowered individuals; the latter bore exclusively wrinkled, the former only smooth seeds. This behaviour is directly opposed to results previously obtained in crossing wrinkled and smooth-seeded forms of *P. sativum*, where the smooth-seed form dominated the wrinkled.

Microscopic Characters of the Fruit-Envelopes in the Acorn.‡—With a view to their recognition as an adulterant in acorn coffee, W. Mitracher describes the minute structure of the cupule and pericarp of *Quercus sessiliflora*. The former consists mainly of parenchyma bearing numerous nests of stone-cells of very different form, and containing sometimes crystals; the outer epidermis is of polygonal cells, and bears very numerous one-celled hairs. The pericarp has below the smooth outer epidermis, in succession, a layer of crystal-bearing cells, a layer consisting of several rows of radially elongated stone-cells, a partly collapsed median layer with solitary crystal sacs, an internal layer of soft parenchyma, and, in the interior, an epidermis bearing numerous one-celled thin-walled hairs.

Development of the Seed in Sapindaceæ.§—P. Guérin has studied the development of the seed-coats and endosperm in species representing a number of genera of this family. The ovule has always two integuments, the outer of which generally forms the bulk of the seed-coat, as in *Cardiospermum*, *Æsculus*, and others. In *Staphylea* the inner integument plays a somewhat more important part, while in *Acer* it is equal in importance to the outer. Endosperm is copious in *Staphylea* and *Melianthus*, but in *Kœlreuteria* and *Xanthoceras* is reduced to a single layer (Guignard's "proteid layer"). In *Cardiospermum* it occurs only as isolated cells, especially near the radicle, as Guignard has previously shown to be the case in *Geraniaceæ*. In *Æsculus* and *Acer* it is quite absent, the nuclei never becoming organised into a tissue within the embryo-sac.

* Bot. Zeit., xx. (1902) pp. 7-16 (1 pl.).

† Tom. cit., pp. 16-21.

‡ Zeitschr. allgem. österr. Apothek.-Verein, 1901, Nos. 1 and 2; and in Verhandl. zool.-botan. Ges. Wien, lii. (1902) pp. 136-7.

§ Journ. de Bot., 1901, pp. 326-62 (24 figs.).

Germination of *Onguekoa* and *Strombosia*.*—E. Heckel, continuing his studies on the seedlings of Olacaceæ, finds that similar methods are followed in the West African genus *Onguekoa*, and in some species of the Malayan *Strombosia*, to that previously described in *Ximenia americana*. The cotyledons remain included in the seed in all three genera. In *Onguekoa* and species of *Strombosia* there is a great elongation of the hypocotyl, and the seed is carried far above the ground; in the African genus, and in *Strombosia javanica*, the cotyledons become separated from the aerial axis at their points of insertion, and fall to the ground with the seed.

Cockscomb Fasciation of Pine-apples. †—J. W. Harshberger describes some striking cases of fasciation in this fruit, the larger of which were apparently composed of a dozen or more individuals. A photographic reproduction is given of one of the largest specimens.

Physiology.

Nutrition and Growth.

Theory of the Shifting of Lateral Organs through Mutual Pressure. ‡—L. Jost maintains that Schwendener's theory of "shifting" of organs during growth, and of stem-torsion, will not explain such alterations in arrangement as he himself now describes in the case of leaves of conifers and florets of the sunflower. Actual shifting, in the sense that in the young condition of a plant other organs are in lateral contact than in an older condition, was never observed, and the author maintains that there are to-day in the province of botany no facts known which render necessary the assumption of a subsequent shifting, in Schwendener's sense, of organs whose position has once been defined.

Influence of Tension and Pressure on the Direction of the Cell-wall.§—L. Kny draws the following conclusions from his investigations on the growth of various members of different plants. The tensions set up in parts of plants which are still capable of growth, and exercising either a pull or a pressure on the individual cells, are responsible for the direction of the prevailing cell-growth and for the position of the division-walls. Growth takes place, in so far as other forces do not prevent, in the direction of the pull and at right angles to the pressure. When cell-division occurs the dividing walls tend to lie in the direction of the pressure and at right angles to the pull. Opposing forces may be external or internal. The most important external forces are represented by mechanical obstacles with which certain tissues and plant organs (e.g. stems of lianes, roots, &c.) have to contend. Light may, as in the case of germinating spores of *Equisetum*, have an important influence on the position of the dividing wall. The author regards as an internal force the course of development prescribed by heredity for the species in question. An example of the overpowering of the action of pull and pressure by such internal forces is found in the early stages of periderm

* Compt. Rend., cxxxiv. (1902) pp. 489-90.

† Proc. Acad. Nat. Sci. Philadelphia, 1901, pp. 609-11.

‡ Bot. Zeit., lx. (1902) pp. 21-43.

§ Pringsh. Jahrb., xxxvii. (1901) pp. 55-98 (2 pls.).

formation, where the first divisions in the initial layer are periclinal in spite of the considerable radial pressure which is exercised in the phellogen cells as a result of increase in thickness in the interior of the stem. The same applies to the periclinal divisions in the cambium of the higher plants. Another instance of the influence of heredity is found in the medullary rays in the wood of *Salix* and *JEsculus*, which generally remain only a single layer in width in spite of the numerous anticlinal divisions occurring in the cambium cells as a result of radial pressure.

Suckers of the Green Rhinanthaceæ.*—A. Sperlich has studied the development, structure, and cell-contents of the haustoria in *Melampyrum*, *Alectorolophus*, *Pedicularis*, *Tozzia*, and other genera of this semi-dependent group of Scrophularineæ. He finds that *Melampyrum pratense*, *silvaticum*, and *nemosorum* live not only saprophytically but also parasitically, the two methods being combined in the nourishment of the same individual. The haustoria attach themselves to living as well as to dead nutritive objects, and differ in this respect from *M. arvense* and the other Rhinanthaceæ. The hyaline tissue which forms the central mass of the sucker originates through growth in the pericambium and endodermis on the side towards the nutritive object; it is limited, except at the place where the haustorial process will be formed, by a row of cells, the membrane of which gives, to a large extent, the reaction of an endodermal membrane. Tracheides are not formed in all the suckers; their appearances seem governed by exigencies of conduction. The suckers of *Melampyrum* produce, when attached to suitable objects, a wedge-like process, the terminal-cells of which elongate often in a hyphal manner and penetrate fungus-like the nutritive object.

Proteid crystalloids were found in the nuclei of the cortical parenchyma and hyaline tissue in *Melampyrum*. The resemblance previously pointed out by Koch of certain structures found in the cell-plasm of the hyaline tissue, to the bacteroids of Leguminous tubercles, was confirmed by the similar behaviour to a series of reagents in both cases. The hyaline tissue is rich in proteid; starch is also common, and in young stages amyloextrin. The presence of glycogen (or a nearly allied body), rhinanthin, phosphoric acid, and nitrates was also demonstrated. Similar contents were found in the other genera investigated.

The author concludes that this tissue of hyaline cells is a centre for the anabolic processes involved in the supply of material for the growth of the plant. After ripening of the fruit this function ceases, and it serves henceforth as a place for deposition of reserve-materials.

Assimilation of Carbon by a Green Alga.†—P. G. Charpentier cultivated *Cystococcus humicola* in a nutrient solution containing sulphate of magnesium, bi-potassic phosphate, nitrates of potassium and calcium, with traces of ferrous sulphate, and 10 grm. glucose to 1000 grm. water. The plant grew well, quite independently of the carbonic acid of the air, at the expense of the sugar contained in the solution. Like other lower Algæ it retained its green colour, due to chlorophyll, in darkness, but light was proved to be very beneficial to the plant; a culture made in the light yielding 330 mgrm., while one

* Beiheft. Bot. Centralbl., xi. (1902) pp. 437-85 (1 pl.).

† Compt. Rend., cxxxiv. (1902) pp. 671-3.

otherwise precisely similar, but in darkness, gave only 27 mgrm. In light the cells are small, in a state of active multiplication, and contain no starch-grains. When living in the dark they are large, with thick walls, and evidently sluggish; they were, moreover, crowded with starch. The absence of starch-grains in the light is explained by the fact that starch being a temporary reserve, the plant was growing too rapidly to be able to store any carbohydrate.

1 Chemauxism of Copper Salts on *Penicillium glaucum*.*—Dr. Le Renard describes the influence exerted by soluble copper salts on the growth of *Penicillium* in the presence of carbohydrates. The writer finds, as did Nägeli in his study of oligodynamics, that the presence of copper salts in infinitesimal quantities in the culture medium is fatal to the organism. A more concentrated solution excites the growth which increases by leaps up to a certain strength; after the maximum is reached the copper again becomes harmful to the growth of the plant.

Resistance to Salt Solution.†—F. Cavara publishes his investigations of the extraordinary physiological resistance offered by *Microcoleus chthonoplastes* Thur. to salt water of varying degrees of concentration. The plant is a cyanophyceous alga, and plays an important part in the separation of pure salt from sea-water. The author gives an account of the process adopted in the evaporation tanks and of the benefits derived from the presence of the alga, which greatly assists in the purification of the brine. He describes the experiments he made for determining the maximum and minimum strengths of solution in which the alga can grow, and his microscopical observation of the changes which result in the filaments and cells. He finds that the plant can even maintain life for a year or two in the heaps of extracted salt.

Irritability.

Action of Temperature on the Absorption of Minerals in Etiolated Plants.‡—G. André experimented with etiolated plants of maize and haricot growing at temperatures of 15° C. and 30° C. He finds a remarkable increase in the proportion of silica in the dry weight at the higher temperature. Calcium carbonate, on the contrary, was absorbed in less quantity, and the amount of potash was not increased. The proportion of phosphoric acid was unchanged. The amount of nitrogen was only feebly influenced by the rise in temperature. Among hydrocarbons, vasculose was present in considerably larger proportions at 30° C. than at 15° C.

Light and Spore-Germination.§—N. Schulz treats of the germination of the spores of Mosses, Ferns, and Equisetaceæ, and shows that in all but a few cases light is indispensable for promoting the assimilation of the food stored in the spores of Mosses and Ferns. The spores of Equisetaceæ contain no food-stores and can only obtain nourishment from carbonic acid in the presence of light.

* Journ. de Bot., xvi. (1902) pp. 97-107.

† Nuov. Giorn. Bot. Ital., nuov. ser. ix. (1902) pp. 59-80 (t. 2).

‡ Compt. Rend., cxxxiv. (1902) pp. 668-71.

§ Beiheft. Botan. Centralblatt, xi. (1901) pp. 81-97 (8 figs.).

Chemical Changes.

Enzyme Action.—A. J. Brown* shows that the enzyme action involved in the alcoholic fermentation of yeast follows approximately the same order of progression as that of inversion of cane sugar. When invertase acts in solutions of cane sugar of varying concentrations, an approximately constant weight of sugar is inverted in unit time, and the yeast-cell under similar conditions, ferments an approximately constant weight of sugar. This apparent independence of mass-action may be due to the existence of a time factor. If the enzyme, as there is reason to believe, combines with the reacting substance, the compound molecule may exist for an interval of time before disruption and change supervene. This will set a limit to the number of changes which a given molecule of the enzyme can effect in unit time. Hence, provided that the quantity of reacting substance present ensures a greater number of molecular collisions in unit time than the possible number of molecular changes, then a constant weight of substance may be changed in unit time in all the actions. The author brings forward experimental evidence in support of this theory.

Horace T. Brown and T. A. Glendinning† find the results of their experiments on starch hydrolysis by diastase to agree with the observations of Adrian Brown and V. Henri on cane-sugar hydrolysis, and suggest that one fundamental law may be found to express the rate of change in all enzyme actions which can be quantitatively studied with sufficient accuracy.

Tryptophane in Proteolysis.‡—S. H. Vines describes further experiments on the subject of proteolysis. These bear out his previously expressed opinion that the proteolytic enzymes of plants in general are essentially "tryptic." The question arises, in view of the accumulating evidence that pepsin itself can effect tryptic proteolysis, as to whether such a thing as a peptic enzyme exists at all; an enzyme, that is, which only hydrolyses the higher proteids to peptones and does not decompose the proteid molecule. The author suggests the following provisional arrangement of plant enzymes from the point of view of the reaction of the medium in which they act.

I. Active in acid liquids.

1. Active *only* in acid liquid.

a. Most active with HCl—Pepsin.

b. Active with HCl or natural acid—Nepenthin.

2. More active in acid than in neutral or alkaline liquid.

a. Equally active with HCl or natural acid—Bromelin, Coco.

b. More active with natural or organic acid—Papain, Cradein, Peptase of barley.

II. Active in neutral or acid liquid—enzyme of yeast.

III. Active in neutral or alkaline liquid.

a. Active in either—enzyme of Bean (?); putrefactive bacteria.

b. More active in alkaline—Trypsin.

* Journ. Chem. Soc., lxxxi. (1902) pp. 373-88. † Tom. cit., pp. 388-400.

‡ Ann. Bot., xvi. (1902) pp. 1-22. Cf. this Journal, 1902, p. 205.

The author also suggests that hydrocyanic acid, which is present in many germinating seeds, may be of importance in facilitating the proteolysis of the reserve-materials of the seed.

Cane-Sugar in the Reserve Food-Substances of Phanerogams.*—E. Bourquelot, as a result of the chemical examination of the roots, rhizomes, bulbs, seeds, and other deposits of reserve food in a number of plants, in almost all of which he is able to demonstrate the presence of cane-sugar, comes to the conclusion that this carbohydrate is a sort of principle necessary to nutritive changes in all phanerogamic plants. The occasional failure to demonstrate its presence is probably due, not to its absence, but to the fact that the action of invertin, by means of which it was recognised, was masked by the existence of another principle.

Conversion of Carbohydrate in the Germination of the Date.†—J. Grüss finds the hydrolysis products of an enzyme action on the reserve-cellulose in the date endosperm to be mannose, galactose, dextrose, and fructose. This carbohydrate nourishment is supplied to the embryo in the form of cane-sugar which constitutes 44 p.c. of the dry weight of the cotyledonary sucker. There is no conversion into transitory starch on its passage to the shoot. The author demonstrates a striking agreement in the action of the enzyme of date-endosperm and of malt-diastrase respectively. Both convert *α*-mannan first into mannin and finally into mannose, and galactan into galactin and finally galactose, and both act on starch, though malt-diastrase is the more energetic agent. Finally, both work the same corrosive action on reserve-cellulose.

General.

Quantitative Study of Variation in the Bracts, Rays, and Disk-florets of Species of Aster.‡—G. H. Shull has studied the variation in the organs mentioned in four species of *Aster* from Yellow Springs, Ohio. After describing his method of work he gives an exhaustive account of his results, which are illustrated by numerous diagrams and tables. A close correlation was found between bracts and rays, which is attributed to the fact that the rays are axillary to the bracts; and the degree of imbrication of the bracts was observed to bear a relation to the number of empty bracts. Curves and "constants" were determined; constants for several individuals of *A. puniceus* growing in identical surroundings showed great variation in the variability "constants." The number of bracts, rays, and disk-florets (in *A. prenanthoides*) was found to decrease continuously from the beginning to the end of the flowering season. The author finds that the suggestion that statistical methods will prove valuable in taxonomic work is not sustained by his results; and also emphasises the importance of an intelligent selection of material for work on variation.

Passage from a Bisexual to a Unisexual Condition by Unilateral Parasitic Castration.§—A. Giard reviews some recent work by Meehan on the action of certain fungi which inhabiting the root of species of *Vernonia* caused remarkable changes in the general habit of

* Compt. Rend., cxxxiv. (1902) pp. 718-20.

† Bot. Zeit., xx. (1902) pp. 36-44.

‡ Amer. Nat., xxxvi. (1902) pp. 111-52 (40 figs.).

§ Compt. Rend., cxxxiv. (1902) pp. 146-9.

the plant, and also a destruction of the pollen in the anthers. The result was the formation of a hybrid as cross-fertilisation was imperative. M. Giard cites a comparable instance of morphological modification by a root-inhabiting cryptogamic parasite, in abnormal specimens of *Pulicaria dysenterica*, and suggests that there probably exist among Composite plants, and even in individual species, parasitic root-inhabiting fungi of different kinds, exercising a different morphological action on their host. The influence of these parasites on the conditions of sexuality of their hosts is equally variable and of great interest in general biology.

Topographical Botany.* — N. Boulay has drawn up a careful and detailed report on the geography and botany of the Saut-du-Bouchot, a cascade in the Department of the Vosges, one of the highest feeders of the River Moselle. It is the result of observations extending over the past 40 years, and it is intended as a record which can be referred to in years to come, when possible changes in the factors which determine the nature of the present flora may have arisen. The cascade is some 1400 ft. above sea-level and has been selected as a typical one and as not likely to be interfered with by the hand of man. A map of the neighbourhood, a geological section, and three photographic views of the cascade are given. First the topography is explained with care, and the measurements of the cascade are set out. Then the vegetation in the immediate vicinity is described, special attention being devoted to the mosses and hepatics since they would be the first to respond to changes of humidity or climate. Lists of these plants, as they occur in the ravine, on submerged rocks, on trees, &c. are supplied. The flora is silicicolous without any calcicolous constituents.

Phyllospadix as a Beach-builder.† — R. E. Gibbs describes the formation from the fruit of this marine monocotyledonous plant of a very effective anchoring apparatus. This is brought about by the persistence of tough fibres permeating the softer substance of the pericarp, after the decay of these softer portions, in a manner similar to that by which the grappers of the water-chestnut are formed. The hard persistent endocarp forms a pair of curving arms lined on the inside by a row of stiff down-curved fibres. These barbed arms are frequently found grasping one or a pair of the nodose stems of a coralline sea-weed (*Amphiroa*), and in this position germination takes place. The stem grows downward till it reaches the rock to which it becomes tightly fixed by numerous adventitious roots, and by repeated branching soon covers the surface with a mat of eel-grass. The author insists on the importance of this growth as a beach-protector and builder.

CRYPTOGAMS.

Pteridophyta.

Prothalli of Ophioglossum and Helminthostachys.‡ — W. H. Lang gives a detailed account of the prothalli of *Ophioglossum pendulinum*

* Rev. Bryol., xxix. (1902) pp. 37-55 (3 pls. and 2 figs.).

† Amer. Nat., xxxvi. (1902) pp. 101-9.

‡ Ann. Bot., xvi. (1902) pp. 23-56 (3 pls.). Cf. this Journal, 1902, p. 77.

and *Helminthostachys zeylanica*, a preliminary account of which has already been published in the *Proceedings* of the Royal Society. He also describes the morphology and anatomy of the young sporophyte of the latter. The young plant remains attached to the prothallus until several leaves are formed; the first leaf has a ternate lamina and reaches the light. For a time a single root is developed below each leaf. The first root is triarch; succeeding ones tetrarch. A mycorrhizal fungus is present in a medio-cortical zone of the first few roots. The stele of the stem is at first endarch and may be solid or have a small pith; it is surrounded by a well-marked endodermis. The first leaf-traces are endarch or mesarch, and do not leave definite leaf-gaps.

The author also discusses the affinity of the Ophioglossaceæ. The form of the prothallus, structure of the sexual organs and embryogeny are such as might be expected in saprophytic forms derived from prothalli of the general type found in the Filicales. On the other hand, there is little to suggest any close affinity between Ophioglossaceæ and the Equisetales. The evidence available points to the origin of the type of prothallus from forms not unlike the gametophyte of existing Marattiaceæ, though possibly belonging to a more primitive group. This is little or nothing to indicate an origin from the type of prothallus found in the homosporous Lycopodiales.

Classification of Ferns.* — L. M. Underwood, in continuing his notices of American Ferns, discusses the Aspidiæ, and blames the different schools of systematists for insisting exclusively on this or that set of characters as of primary importance in the classification of groups of ferns. He classes the values of the plant-characters of the Aspidiæ in the following order:—(1) venation; (2) habit, and growth-characters of stem; (3) position of sori in relation to veins; (4) character of indusium. He devotes by far the greater part of the paper to a rigorous examination of the validity of the generic names in the light of modern rules of nomenclature. In classing the Aspidioid genera according to our present knowledge, he is compelled to reduce to synonymy two such well-known names as *Nephrodium* and *Aspidium*, and to replace them by the older names *Dryopteris* and *Tectaria*, and he exposes the carelessness and the bias which have led authors to muddle the nomenclature of the group so much in the past. He gives a key to twenty genera.

Anatomy of *Ceratopteris thalictroides*.† — S. O. Ford describes the anatomy of this fern, which is an annual aquatic plant, rooting in the mud, or floating freely in deeper water. It is widely distributed through the tropics. The much reduced stem bears both fertile and sterile leaves. At the apex of the stem is a three-sided apical cell. The young stem is monostelic; at a later stage there are two steles, and further division gives rise to the polystelic condition of the mature stem. The steles in both stem and leaves are bi-collateral; the former contains an outer circle of large steles, within which small, feebly developed steles are scattered irregularly. Vegetative buds are formed in large numbers; they arise at the angle of a leaf, and grow by a three-sided apical cell; they are borne by both sterile and fertile leaves. The

* Bull. Torrey Bot. Club, xxix. (1902) pp. 121-36.

† Ann. Bot., xvi. (1902) pp. 95-121 (1 pl.).

large sporangia, which arise from a single cell, are scattered irregularly over the leaves; the annulus may be much reduced.

The position of *Ceratopteris* amongst leptosporangiate ferns is not clear; it shows stronger affinities with the *Polypodiaceæ* than with any other group, but has also well-marked affinities with the *Marsiliaceæ*, and may possibly be intermediate in position between these two orders.

New Type of Fern-Steles.*—A. G. Tansley and R. B. Lulham describe a new type of fern-steel in the creeping rhizomes of species of *Lindsaya*, and in *Davallia repens*. It is a monostele, showing, in cross-section, a central mass of xylem, consisting of scalariform tracheids intermingled with parenchyma and surrounded by a complete ring of phloem, pericycle, and endodermis, as in *Gleichenia* and *Lygodium*, but differing by having, in addition to the external phloem-mantle, a strand of phloem completely imbedded in the xylem near the dorsal surface of the latter. This internal phloem-strand consists of typical sieve-tubes mixed with parenchyma and separated by a layer of similar parenchyma from the surrounding xylem. This type of steel corresponds with the condition found by L. du Sablon in the young stem of *Pteris aquilina*, and a few other cases. Its great interest is, that it appears to furnish a phylogenetic link, hitherto wanting in a mature stem, between the protostelic and the solenostelic structure.

Alga-like Fern-Prothallus.†—A. P. W. Thomas describes the prothallus of an Australasian fern, *Schizæa bifida*, which is quite unlike the ordinary types of fern-prothalli, and strongly suggestive of an Alga. It is composed of branched filaments forming a green cushion which may reach $\frac{1}{4}$ in. to $\frac{1}{2}$ in. in diameter. It differs from the filamentous prothalli known in *Trichomanes*, since the latter are incompletely filamentous, the archegonia being borne on archegoniophores which are masses of meristematic cells; whereas the prothalli of *Schizæa* are completely filamentous archegonia, as well as antheridia, being produced on filaments. The prothalli are monoecious, but male and female organs occur on distinct branches. The archegonium is remarkable in having a free venter, resembling in this respect the archegonia of typical bryophytes; the neck, however, is short. The question arises as to whether this remarkable alga-like prothallus represents a primitive or secondary form. The author prefers Goebel's explanation advanced for *Trichomanes*, namely that *Schizæa* represents even more than the latter a primitive state.

Affinities of Tmesipteris.‡—The same author as a result of the study of the variations of the synangium-bearing structure in this genus, develops the idea, previously suggested by Scott, of an affinity between the *Psilotaceæ* and the extinct group Sphenophyllales. He also brings evidence to show that while the whole fertile structure represents a single leaf, or sporophyll, the synangium, with its axis, corresponds to a ventral sporangiophore (Scott). The variations noted are of three kinds:—(1) Sporophylls with repeated dichotomy and two or three synangia; (2) Sporophylls in which the synangium is raised on a stalk or pedicel; (3) Sporophylls in which the synangium is replaced

* Ann. Bot., xvi. (1902) pp. 157-64 (10 figs.). † Tom. cit., pp. 165-70.

‡ Proc. Roy. Soc., lxi. (1902) pp. 343-50.

by a leaf-lobe of normal appearance. The first is a common variation; the sporophylls are of healthy appearance, and occur in the most vigorous parts of the best shoots. A comparison with the Sphenophyllales seems the most promising way of considering these variations. The leaves of *Sphenophyllum* were often heteromorphic, and among great variety in form we find those with a dichotomously branched blade, and in some forms the bracts were forked. In *S. trichomatosum* the sporophylls were not arranged in sharply delimited cones. The second group of variations recalls the case of *Bowmanites*, where the bracts bore sporangiophores, each with two sporangia. Trilocular synangia may occur in *Tmesipteris*, and this suggests comparison with the elaborate palmately tripartite sporangiophore of *Cheirostrobos*. The third class of variation supports the comparison of the synangium with a ventral leaf-lobe.

The author suggests a parallel between *Tmesipteris* and the Sphenophyllales on the one hand, and a simple Lycopodium such as *L. Selago* and *Lepidodendron* on the other. The contrast in the leaf-arrangement, whorled in Sphenophyllales and scattered in the Psilotæ, is marked, but can hardly outweigh the evidence derived from sporangial characters. In *Psilotum* also instances were found of dichotomy of one or both forks of the sporophyll, with corresponding increase in number of the synangia.

So-called Phloem of *Lepidodendron*.* — A. C. Seward reiterates his opinion as to the absence of any true secondary phloem in *Lepidodendroid* stems. He maintains that his "secretory zone," while probably having phloem functions, does not, as Weiss has recently described, show phloem structure, and we cannot therefore, as suggested by Scott, regard the phloem of *Lepidodendron* as fundamentally similar to that of the recent allies of the genus. The author also shows that the tissue immediately beyond the secondary wood, which Scott regards as phloem, can, by comparison of transverse with longitudinal sections (of which he gives figures), be shown to form a homogeneous band of short thin-walled cells, in which the formation of new cell-walls was in active progress when the plant was killed. Its structure is essentially distinct from that of typical phloem, and there are no elements which can be compared with sieve-tubes. It is, in fact, a broad, meristematic zone of quite a different type from the cambium of recent plants.

Mosses.

Spore Distribution. † — A. J. M. Garjeanne discusses the spore-distribution as it occurs in a few mosses. In *Pottia Heimii* the operculum splits off from the gymnostomous theca in the presence of moisture after dry weather, but remains attached to the columella; and the spores are spread by the slightest currents of air, or by the movements of insects. In *P. truncata* and *Physcomitrium pyriforme*, both gymnostomous, the operculum is completely detached in the former, and partially split off in the latter; and in the latter the spores of different individuals differ in their capacity for germination. The distribution

* New Phytologist, i. pp. 38-46 (2 figs.).

† Beiheft. Botan. Centralbl., xi. (1901) pp. 53-9.

of the spores of certain species of *Orthotrichum* which grow on trees is dealt with; and it is found that they require bark or woody humus for their germination.

Geographical Distribution of Mosses.*—J. Palacký continues his studies on the distribution of the mosses. He divides the Acrocarpous mosses into 23 families, and discusses the geographical distribution of the genera of each in turn.

Peristome of Mosses.†—H. Philibert concludes the tenth article of his studies on the peristome of mosses by discussing the remarkable structures that occur in *Dawsonia* and *Buxbaumia*.

Abnormalities.—W. Mönkemeyer ‡ describes and figures the leaf-buds on a species of *Harpidium* gathered in a pool on the crest of the Riesengebirge. The buds were swollen into galls and infested by colonies of *Anguillula*. The leaves were much broadened and hollowed out, and the character of their areolation was entirely altered.

F. Tobler § gives figures and a description of a singular instance of a plant of *Polytrichum gracile* Menz. bearing two setas capped by one calyptra, the longer one laxly coiled three times round the shorter. Each arose from a separate vaginula; the calyptra was the product of the coalescence of two archegonia.

Lists and New Species.—S. M. Macvicar || records and discusses five hepatics found in Scotland and new to the British Isles.

Th. Herzog ¶ calls attention to the rich and interesting moss-flora of the St. Wilhelm and Oberried valleys of the Black Forest of Baden, where amongst other rarities is found *Hypnum micans*. He discusses the distribution and affinities of this puzzling moss.

F. Matouschek ** gives a list of the hepatics and mosses hitherto discovered in Moravia and Eastern Silesia, together with the localities in which they occur. In an introductory note he records the work of previous collectors in the two districts.

Dr. E. Jäderholm †† gives a list of 31 mosses gathered in the Transcaucasian districts of Lenkoran and Baku by J. Mikutowicz. Six of these are new to the region; and no previous moss-flora of Baku appears to have been published.

Mönkemeyer †‡ describes and figures *Pleuridium nitidum* Rabenh. var. *anomalum* var. nov., a curious and luxuriant variety found growing with the type near Mittweida.

F. Camus §§ publishes a preliminary note upon the Muscineæ gathered by him in Corsica during a month's tour in May and June 1901. Owing to the snow-bound state of the Alpine region and the dried-up condition of the coastal region, he was unable to form a just estimate of their flora; but he intends to return to the island in the full summer, and in the winter to examine them under the best conditions. His attention

* Sitzungsber. k. Böhm. Gesellsch. Wiss., 1901, pt. iv. p. 29.

† Rev. Bryol., xxix. (1902) pp. 10-3.

‡ Hedwigia, xli. (1902) Beibl., pp. 22-3. § Tom. cit., pp. 56-8.

|| Journ. Bot., xl. (1902) pp. 157-9.

¶ Beiheft. Botan. Centralbl., xi. (1902) pp. 546-51.

** Verh. naturforsch. Verein. in Brünn, xxxix. (1901) pp. 19-64.

†† Hedwigia, xli. (1902) pp. 84-88. †‡ Tom. cit., Beibl., pp. 853-4.

§§ Rev. Bryol., xxix. (1902) pp. 17-26.

was mainly directed to the mosses and hepatics of the intermediate or forest zone; and his gatherings have resulted in the addition of more than a quarter to the previously recorded totals of species. He now gives them as 282 mosses, 5 sphagna, 82 hepatics. He adds a freely annotated list of the novelties, and another of the more interesting species which had been recorded previously, but usually without any clue to the locality or altitude at which they had been found.

The same writer* calls attention to a hepatic new to France and to two rare mosses, also French, which have lately been determined by him.

W. Mönkemeyer † publishes a list of the rarer mosses—83 in number—gathered by A. Berger in the vicinity of La Mortola, near Ventimiglia in the Riviera. It appears to be the first published list for the district.

W. Arnell ‡ describes and figures three new hepatics—*Kantia sphagnicola*, *K. suecica*, and *K. submersa*—which have been discovered in Sweden, and points out how they may be distinguished from the well-known *K. trichomanis*.

J. Douin § publishes notes on seven hepatics that occur in the Mont-Dore district of France.

B. Kaalaas || describes two new hepatics of the genus *Cephalozia* gathered in Norway.

J. Douin ¶ notes the occurrence of the minute and fugacious moss *Ephemerum tenerum* C. Muell. in the vicinity of Paris, and expresses his belief that other members of the genus are likely to be found there. He calls attention to the ease with which dehiscence of the capsule takes place when the fresh ripe fruit is subjected to pressure, and alludes to the doubts which have been felt about the dehiscence of *Systegium crispum* by authors who have not examined the plant in the fresh state.

General Paris** continues his lists of mosses and hepatics from various districts of Madagascar, and describes eight new species.

K. Mueller †† records six species of hepatics of the genus *Scapania* gathered in Sikkim and other parts of India. Three of the species and one variety are new.

A. W. Evans ††† has monographed the *Lejeuneæ* of the United States and Canada, and recorded 23 of the species of this subtribe of hepatics as native, 4 being new species and 6 new records for the continent. He describes the confusion caused by the carelessness of previous investigators and the difficulties he has had in unravelling it. Each species is fully discussed, and 15 are illustrated.

R. S. Williams §§ describes and figures *Eurhynchium Tayloræ* sp. nov. from Idaho and *Brachythecium Pringlei* sp. nov. from Arizona.

É. Bescherelle ||| gives a list of 42 mosses and 25 hepatics gathered in Mexico by Maury twelve years ago, and describes four of the former as new species.

* Tom. cit., p. 26.

† Hedwigia, xli. (1902) Beibl., pp. 11-4.

‡ Rev. Bryol., xxix. (1902) pp. 26-32 (figs. in text). § Tom. cit., pp. 32-4.

|| Tom. cit., pp. 8-10.

¶ Tom. cit., pp. 55, 56.

** Tom. cit., pp. 1-8.

†† Beiheft. Botan. Centralbl., xi. (1902) pp. 542-5.

††† Mem. Torrey Bot. Club, viii. (1902) pp. 113-83 (7 pls.).

§§ Bull. Torrey Bot. Club, xxix. (1902) pp. 66-8 (2 pls.).

||| Journ. de Bot., xv. (1901) pp. 380-8.

He also * describes eleven new species of mosses collected in Guadeloupe and Martinique by Prof. P. Duss.

Algæ.

New *Mougeotia*.† — W. West describes *Mougeotia immersa*, a new species collected at Pokharia, Chota Nagpur, by the Rev. A. Campbell. The zygospores vary in size from 30 μ to occasionally 48 μ , and the cells of the thallus are 20–24 μ across.

Sexuality in *Spirogyra*.‡ — E. B. Copeland describes the various degrees of sexuality to be met with in the different species of *Spirogyra*. He gives an account of the conjugation of *S. crassa*, a dioicous species, and calls attention to the effect produced in a cell that attempts to conjugate but fails. The nucleus was found against the wall opposite, but remote from, the conjugating tube. The cell-contents lose their transparency and become slightly granular with what may be oil-globules.

Cladophora Ægagropila.§ — A morphological and systematic account of the Ægagropila group of *Cladophora* is given by F. Brand, who has made a study of this genus for many years. The material, on which his investigations were made, was plentiful, and the species were cultivated by him both at home and in the open, thus allowing careful observations to be made under various conditions and in different stages of growth. His results are described clearly under the following headings:—Structure and growth of the vegetative filaments; Reversal or mutability of polarity; Organs of attachment (Rhizoids and Cirrhoids); Neutral shoots and "stolonids"; Maintenance and propagation; Conditions of life; Aggregated forms. Under these headings many points of interest are brought out, the chief of these being perhaps the following, which have been specially emphasised by the author. (1) The hydrophilous Ægagropila forms are typically rootless plants, without polar division into a cauloidal and rhizoidal portion. (2) Their accessory rhizoids can be developed from any portion of the plant and in any direction. (3) Each species has a more or less constant limit as to size, beyond which any increase is balanced by gradual dying-off below. (4) By means of this regular withering of the oldest cells, the lowest branches become regularly free in acropetal order. This may also occur irregularly in all parts of the plant. (5) The Ægagropilæ have an extraordinarily slow growth and—like the *Sphagna*—an unlimited period of life. (6) They require comparatively little light. (7) The weak shoots, rather poor in chlorophyll, are not always rhizoids; the character of such "neutral shoots" is at first doubtful and their function is only determined by external circumstances. They may become organs of attachment, or they may return to a vegetative condition. The latter alternative may take place directly, or indirectly by the formation of "stolonids."

The morphological part of this paper is followed by a systematic treatment of this group of *Cladophora*. The characteristic features of the group as a whole are detailed, and it is then divided into two sub-

* Journ. cit., xvi. (1902) pp. 6–11. † Journ. Bot., xl. (1902) p. 144.

‡ Bull. Torrey Bot. Club, xxix. (1902) pp. 161–3.

§ Hedwigia, xli. (1902) pp. 34–71 (1 pl.).

divisions, *Euægagropila* and *Cornuta*. A diagnosis of each subdivision is followed by the respective key to the species in each group:—*Euægagropila* containing six species, *C. Linnæi*, *C. Martensii*, *C. profunda*, *C. holsatica*, *C. armeniaca*, and *C. Sauteri*; *Cornuta* contains as yet only *C. cornuta*. Each species is then discussed separately, and two new varieties are described: *C. profunda* var. *Nordstedtiana*, and *C. Sauteri* var. *Borgeana*. Finally lists follow of insufficiently known forms, among which is a new species, *C. Dusenii*, and of species removed from the section. *C. muscoides* Menegh. is shown to be a species founded on insufficient grounds, and is therefore struck out altogether.

Spiral Arrangement in the Rhodomelaceæ.*—Dr. Kolderup Rosenvinge here enters into a full discussion of the views on this subject held by Prof. Schwendener and his pupil H. Seckt, which he pronounces incorrect. Dr. Rosenvinge holds that the spiral position of the “leaves” (as he calls them) in the Rhodomelaceæ is not dependent upon any outside influence, but that the cause must be sought in the interior of the plant. The author thinks that the position of each new “leaf” is determined by the position of the last preceding one, possibly by means of an impulse conveyed through the protoplasm which connects the cells. He notes the correlation between the position of the “side-organs” and that of the first-formed pericentral cell; and he denies any correlation between the direction of the leaf-spiral and the asymmetrical branching of the leaves. The direction of the spiral is usually to the left, and a change of spiral on any single shoot is extremely rare. The divergence is not absolutely regular, but varies between $\frac{1}{4}$ and $\frac{7}{8}$.

Development of the Cystocarp in some Florideæ.†—A detailed account of the development of the fruit in two red algæ, *Heuretella Schousboei*, and *Chylocladia kaliformis*, is given by A. Hassenkamp, illustrated by beautiful figures. The author shows that Prof. Oltmanns' conclusions concerning the absence of double fertilisation in the Florideæ hold good in these two species, and infers that similar results would be obtained from an examination of other Florideæ. Both this author and Oltmanns find that the spores arise from division of purely sporogenous nuclei, and that the auxiliary cell simply serves to nourish the sporogenous cells. The sporogenous nucleus never fuses with the nucleus of the auxiliary cell, and thus the second fertilisation, which was believed to take place in the auxiliary cell, is fictitious. The author regards this stage of development as a parasitism of the sporogenous cell on the auxiliary cell, and likens it to the development of the sporogonium of a moss on the sexual generation. He regards the antheridia and the carpogone-bearing plant as the gametophyte, while the sporophyte is represented by the sporogenous cells and filaments and by the spores. In the same way that the sporogonium of a moss is nourished by the sexual generation, so is the sporogenous cell nourished by means of fusion with the auxiliary cell, since the egg-cell does not contain sufficient food-material for the purpose.

The author also criticises certain statements on the development of

* Pringsh. Jahrb., xxxvii. (1902) pp. 338–64 (1 pl.).

† Bot. Zeit., lx. (1902) pp. 67–86 (1 pl. and 12 figs. in text).

cystocarps, made by Hauptfleisch; and draws comparisons between his own results and those of Phillips on other species.

Algæ of Verona.* — Achille Forti gives a short account of the work published by various authors on the algæ of Verona and the neighbourhood, and this is followed by a list of 173 species of Florideæ, Characeæ, and Chlorophyceæ. The list is to be continued.

Algæ of Jamaica.† — F. S. Collins publishes a list of algæ, including a few fresh-water species, from Jamaica, mainly founded on collections made by Mrs. Pease and Miss Butler, Dr. J. E. Humphrey and Dr. Duerden. The new species here described are:—*Scytonema conchophilum* Humphrey, a shell-boring species, *Diplochæte solitaria* representing a new genus of Chætophoraceæ, *Cladophora intertexta*, *Dictyterpa jamaicensis*, a new genus of the Dictyotaceæ, *Goniotrichum Humphreyi*, *Cordylecladia Peasix*, and *Antithamnion Butlerix*; the new varieties are:—*Oscillatoria princeps* forma *purpurea*, *Sargassum vulgare* forma *ovata*, and *Callithamnion byssoideum* var. *jamaicensis*. Tables are given, comparing the marine flora of Jamaica with the floras of New England, Great Britain, the northern coast of Spain, the coast of Morocco, the Canary Islands, and Puerto Rico. A graphic account is given from notes by Mrs. Pease, of the manner of collecting and the appearance of certain algæ when growing. Notes by the same collector are also inserted occasionally under the species names in the list and add to the general interest of this paper.

Fungi.

Coprophilous Fungi II.‡ — G. Masee and E. S. Salmon describe experiments which prove that the various species of Fungi occurring on dung originate from spores swallowed by the animal along with its food. The enumeration of species, which is arranged systematically, includes several that have occurred on the dung of exotic animals, obtained from the Zoological Society's Gardens. Two new genera are described: *Arachnomyces* (Perisporiaceæ), with two species; and *Gymnodochium*, related to Berkeley's *Endodesmia* (Tuberculariæ). New species have been found in the following genera of Ascomycetes:—*Ascodesmis*, *Arachniotus*, *Myxotrichum*, *Chætomium*, and *Nectria*, and of Hyphomycetes in *Cephalosporium*, *Acremonium*, *Sepedonium*, *Edocephalum*, *Trichothecium*, *Trichosporium*, *Chætostroma*, and *Graphium*. A large number of species new to the British Flora were also recorded.

Fertilisation of *Pythium de Baryanum*.§ — This fungus, which causes the damping-off of seedlings, has been investigated by Kûchi Miyake at Cornell University. He gives a historical sketch of previous researches on the fertilisation process in *Pythium*. The improved methods of the present day have enabled him to arrive at more definite results than was possible to older workers. Nuclear division in the sexual organs he finds is similar to that which takes place in *Cystopus* and *Peronospora*. Of the many nuclei in the oogonium and antheridium,

* Nuov. Notaris., xvii. (1902) pp. 49-68.

† Proc. Amer. Acad. Arts and Sciences, xxxvii. (1901) pp. 231-70.

‡ Ann. Bot., xvi. pp. 57-93 (2 pls.). Cf. this Journal, 1901, p. 680.

§ Ann. Bot., xv. (1901) pp. 653-67 (1 pl.).

one only in each is functional, and their fusion forms the nucleus of the oospore. The author is inclined, as a result of his study, to place *Pythium* in the Peronosporæ rather than in the Saprolegniæ, although it occupies somewhat of an intermediate position between the two.

Bovista ammophila.*—This fungus was originally described and figured by Lévillé. According to N. Patouillard and P. Hariot, the specimen in the Paris Museum is still the only one that is authentic. They have redescribed it, and on account of the sterile base and the form of the capillitium they have placed it in the genus *Bovistella* which now includes three species *B. radicata*, *B. paludosa*, and *B. ammophila*. The plant accepted in this country and in America as *B. ammophila* must, the authors declare, belong to another species. They add some notes on several little known species of *Bovista*.

Mycorrhiza.†—J. Beauverie gives an account of the occurrence of a filamentous fungus in the thallus of a hepatic, *Fegatella conica*. The fungus attacked and entered the rhizoids and spread to the cells of the thallus with which they lived in symbiosis. The plants devoid of fungi were found to be less vigorous and less highly coloured along the nerve. The fungus itself depended on the presence of humus in the soil. M. Beauverie found by experiment that when there was much mycelium present, the chlorophyll was extremely inactive, the plant seemingly drawing some of its carbohydrates from the humus by means of the fungus. The fungus was found to be a species of *Fusarium*, spores being produced both in the cells of the host-plant and also in artificial cultures.

Underground Species of *Urophlyctis*.‡—While describing this new fungus, P. Magnus takes occasion to discuss the systematic position of the genus in relation to *Cladochytrium* and *Physoderma*. There are only a few species of *Urophlyctis*, all of them parasites, either on the roots or on the aerial parts of the plants attacked. The new species *U. Rübsaameni* formed large galls on the roots of *Rumex scutatus*. On examination the galls were found to be full of the brown resting-spores of the fungus. It was collected by E. H. Rübsaamen in the neighbourhood of St. Goar.

Decomposition of Butter-Fat.§—O. Laxa notes, as the most active agents in this process, several varieties of moulds—*Penicillium glaucum*, a *Mucor*, and *Oidium lactis*. Some yeasts and bacteria, although active peptonisers of casein, exerted but slight action on butter-fat, and several varieties of lactic acid bacteria and of *Tyrothrix* were inactive.

By first triturating *Penicillium* and *Mucor* with glass powder, the author was able to obtain a sterile solution containing an enzyme which decomposed monobutyryl and butter-fat in a characteristic manner. The glycerides of the insoluble acids were the first to be decomposed, but those of the soluble acids were most extensively affected.

Duclaux suggested that the decomposition of butter-fat was due to

* Journ. de Bot., xvi. (1902) p. 11-4.

† Comptes Rendus, cxxxiv. (1902) pp. 616-8.

‡ Ber. Deutsch. Bot. Ges., xix. (1902) pp. 145-53 (1 pl.).

§ Arch. Hygiene, xli. (1901) pp. 119-51. See also Journ. Chem. Soc., Feb. 1902, Abstr. ij. p. 97.

the action of ammonia (produced from nitrogenous matter by the life and growth of the organisms), but the author considers this is not so, as solutions of ammonia do not act on the fatty glycerides at the ordinary temperature.

Alcoholic Fermentation of Indian Fig-Must.*—Ulpiani and Sarcoli studied the morphological and biological characters of the *Saccharomyces Opuntiae*, to the action of which the spontaneous fermentation of the Indian fig-must in Southern Italy is due. This yeast does not liquefy gelatin or starch paste, and is non-chromogenic. It ferments dextrose and levulose, but has no action on sucrose, maltose, lactose, raffinose, galactose, manitol, or dulcitol.

Comparative experiments on the fermentation of must by *S. Opuntiae* and *S. Pastorianus II.* show a much greater yield of alcohol as the result of the action of the latter, but if unsterilised must is inoculated with the *S. Pastorianus II.*, the growth and action of the yeast is quickly checked by the rapid multiplication of the *S. Opuntiae* already present.

Puccinia.†—Franz Bubak gives the results of his investigations on the systematic position of several closely allied forms of *Puccinia*. The species described by Schweinitz and named by him *P. Anemonis Virginiana*, is confined to North America; it is a Leptopuccinia, producing only teleutospores. Under *P. De Baryana* the author distinguishes four varieties which grow on various species of *Pulsatilla* in Europe and North America. Teleutospores only are produced, but of the Micropuccinia type. A form found on *Anemone patens* in North America he names *P. gigantispora*; it belongs to Pucciniopsis. The teleutospores somewhat resemble those of *P. De Baryana*, but the occurrence of æidia differentiates it from that species. Outline drawings of the teleutospores are given.

Pure Cultures of a Uredine.‡—Marshall Ward has been engaged in a long series of infection experiments on Bromus grasses with the uredospores of *Puccinia dispersa*. This Uredine grows on the different species of *Bromus* and is, in all cases, morphologically the same. It was found, however, that it was not always possible to infect from one host to another; thus the spores of *Bromus mollis* would infect *B. mollis*, *B. sterilis*, *B. secalinus*, and *B. arvensis*, but not *B. inermis*. Spores taken from *B. sterilis* only infected *B. secalinus* and *B. arvensis*. Every care was taken to obtain pure cultures of both hosts and parasite. Seeds from rusted Bromes purified from external infection, developed healthy plants, proving that no mycelium lurked in the embryo. Seeds were treated antiseptically and grown in tubes successfully for weeks on cotton-wool well charged with a mineral solution used in water cultures. The plants that developed from these seeds were infected with the uredospores, and an absolutely clean and pure culture of the *Puccinia* was obtained. Further experiments were instituted to determine the influence on the growth of the parasite of different mineral ingredients. The results have not yet been decisive, though they indicate that if the

* Gazzetta, xxxi. (1901) 2, pp. 395-413. See also Journ. Chem. Soc., March 1902, Abstr. ii. p. 164.

† Sitzungsber. k. Böhm. Gesellsch. Wissensch., 1901 (1902) Botanika, pp. 1-11.

‡ Proc. Roy. Soc., lxxix. (1902) pp. 451-66.

host-plant is starved, the germ-tube is unable to establish itself. Whatever affects the host affects the parasite also. When plants were deprived of some constituent necessary to healthy growth, infection spots showed corrosion and collapse instead of normal rust-flecks. The paper is enriched by tabulated results of experiments and by figures of the tubes used in growing the grasses.

Rust of Cereals.*—Jakob Eriksson has completed the publication of his studies on rusts. In the first part of the work he gave an account of the disease itself and the results of his many culture experiments, carried on during several years, with the purpose of determining the source of infection. All attempts have failed, he considers, to explain the origin of rust by infection from fungus spores that have survived the winter; nor can it be traced to spores or mycelium in the grain. He finds in the tissue of the host-plants, in the cells bordering on the rust-pustules, special corpuscles, irregular in form, somewhat bent, and simple or branched. These have arisen, he says, from a mycoplasma in the cell, and they produce the mycelium of the fungus. He considers the presence of the mycoplasma in the plants, from the seed onwards, as a case of symbiosis which may not always be hurtful to the development of the host.

In a third part he discusses the papers that have been published since first he announced his mycoplasma theory in 1897. The final part of his paper deals with the best methods of combating the disease. He strongly recommends experimental stations in the countries that are affected by the rust-disease, that the different factors concerned in the propagation of the fungus may be discovered, and that information on such points as soils, manures, &c. may be imparted to the growers; also that experiments should be carried out to test which varieties of grain are likely to be less affected by disease than others.

Diplodia cacaoicola.†—This fungus, parasitic on sugar-cane and cacao in the West Indies, has been thoroughly worked out by A. Howard. It is a rind-fungus and forms colonies of pycnidia containing two-celled, brown spores just under the bark, which it finally ruptures. The author was able to grow the fungus saprophytically from spore to pycnidium, and to reinfect young plants with material produced in his cultures in the laboratory. By comparison and experiment he proved the morphological identity of the fungi causing the rind-disease on sugar-cane and cacao; and by infection experiments from one host-plant to the other, he was able to establish that they were identical biologically. He advises planters as to the best method of combating the disease.

Canker of the Oak.‡—M. C. Potter has found many cankered oaks in the north of England and has traced the injury to the presence of a fungus belonging to the genus *Stereum*. Pure cultures were made of the suspected fungus, and these were used to infect successfully oak branches. Miniature cankers were produced, resembling those found on the diseased oaks. The author discusses the different species of

* Ann. Sci. Nat., ser. 8, xv. pp. 1-155 (5 pls.).

† Ann. Bot., xv. (1901) pp. 683-701 (1 pl.).

‡ Trans. Eng. Arb. Soc., 1901-1902, reprints, 8 pp. and 4 figs.

Stereum and makes a new species, *St. quercinum*, for the fungus causing the canker.

Spore-Distribution in a Lichen.*—M. Miyoshi describes the method of spore-distribution in a tree-inhabiting lichen, discovered and named by himself *Sagedia macrospora*. The fruits are small, round, closed perithecia, which, as they ripen, become detached from the parent plant, and are carried away by some mechanical agent, such as wind. Next comes the action of water, which causes the perithecium to swell, the walls are burst open, the paraphyses are spread out, and the spores are ejected from the asci.

In the same journal T. Inui † has published an account of the manufacture of "Awamori," a kind of whisky, and a description of the fungi that induce the fermentation. Only one species, he finds, is necessary or desirable in the first part of the process, a form of *Aspergillus* with dark spores, that he has named *A. luchuensis*. It can be replaced by *A. perniciosus*, also a new species, of a lighter colour than the other, which is not nearly so effective. A form of *Monilia* also occurs. The yeast-fungus of the fermentation he has described as *Saccharomyces Awamori*, and the peculiar aroma of the spirit is due to another species of yeast, *S. anomalus*. Awamori has been manufactured in the Island of Luchu for about 500 years.

British Mycology. ‡ — The concluding part of vol. i. of the *Transactions of the British Mycological Society* contains an account of the annual fungus foray, held at Exeter, and resulting in a list of over 460 specimens, two of which were new to Britain—*Femsonia luteoalba* and *Helminthosporium obclavatum*. Marshall Ward describes the best means of preserving and examining fungi. Various hardening and fixing fluids are recommended, and section-cutting and staining methods are carefully explained. He advises the student how to obtain pure cultures of fungi, and also how to grow the host-plant free from infection of any but the desired parasite.

C. B. Plowright contributes a note on *Ozonium auricomum*, which he found associated with *Coprinus domesticus*, and of which he considers it to be the vegetative form.

B. T. P. Barker publishes a paper on 'Spore-formation in *Saccharomycetes*.' He conducted a series of experiments to test (1) the effect of external conditions on the spores; (2) the conditions of the cells themselves, i.e. internal conditions. He finds that good aeration is necessary for spore-formation, and that the cells must be in a vigorous state of growth.

A list of the fungi added to the British flora during the year is given; many of the species are new to science. Three new genera of microscopic fungi are recorded.

The Gasteromycetes.§ — C. G. Lloyd has issued a short introduction to the genera of this group. He gives an account of their minute struc-

* Journ. Coll. Sci. Imp. Univ. Tokyo, xv. pt. iii. (1901) pp. 369-70 (1 pl.).

† Tom. cit., pp. 465-76 (1 pl.).

‡ Trans. Brit. Myc. Soc., 1900-1901, pp. 159-217 (1 pl.).

§ The Genera of Gasteromycetes, by C. G. Lloyd, Cincinnati, Ohio, U.S.A., 1902, 24 pp. and 49 figs.

ture, a classified table of the genera, and photographic figures illustrating each genus.

Fungus Flora.*—F. Bataille has drawn up a list of the genera *Amanita* and *Lepiota*, which forms the first part of a contemplated Flora of the larger Fungi of France. The author has invented a series of new terms: he substitutes *Basidiosporés* and *Ascosporés* for *Basidiomycetes* and *Ascomycetes*. The *Basidiosporés* he subdivides into *Gymnobasidiés* and *Angiobasidiés*. The *Gymnobasidiés*, which are exactly synonymous with *Hymenomycetes*, comprise six families: *Polyphyllés*, *Erinacés*, *Clavariés*, *Auriculariés*, and *Tremellines*. The *Amanitas* and *Lepiotas*, along with the other sub-genera of *Agaricus*, fall under the *Polyphyllés*. The author discusses the habit and economic value of the fungi, and gives an analytical table of species. M. Lucien Quélet, since deceased, has furnished a preface.

Fungi of the Netherlands.†—C. A. J. A. Oudemans describes 75 new species of Fungi. The first 13 belong to the *Basidiomycetes*, *Ascomycetes*, and *Phycomycetes*. The others are all in the group of *Fungi Imperfecti*. One species, *Phyllosticta Typhæ*, had been already published under *Phoma Typhæ*. A large number of the species belong to the *Sphærospidiæ*, and grow on branches and leaves of various trees.

Vegetable Pathology.‡—H. von Schrenk contributes a paper on the teaching of vegetable pathology. He would divide the subject, as in animal pathology, into three groups: (1) Diagnosis; (2) Etiology; (3) Therapeutics. The great advantage of vegetable pathology is the possibility of making the study one of continual experimentation on living plants. The author requires in his students a thorough knowledge of physiology, in order that they may appreciate the changes in the organism induced by disease.

Lists and New Species of Fungi.—C. H. Peck§ describes 14 new species of the larger fungi from various States. Of one of these, *Agaricus Sterlingii*, he remarks that it is edible, and richer in flavour than the common mushroom.

W. H. Long|| has described seven new species of *Puccinia* from the neighbourhood of Austin, Texas. In *P. Cooperiæ* and *P. similis* he has found all three stages of the fungus on the same host. In the case of the other species he records only the urodo- and teleutospores. He gives drawings of the spores.

P. Hennings¶ has described the fungi collected in Para by Dr. J. Huber. There are three new species of *Uredineæ*, four new *Ascomycetes*, and four species not hitherto described in the *Deuteromycetes*.

He** also publishes a list of new Japanese rusts, and †† a second list of fungi collected in South Brazil by A. Möller. Those already enumerated belonged to the *Ustilaginæ* and *Uredineæ*; these are all *Ascomycetes*, a group in which South Brazil is especially rich, and many new forms have been discovered. A large number had already

* Flore monographique des Amanites et des Lépiotes, Paris, 1902, 88 pp.

† Beiheft. Bot. Centralbl., xi. (1902) pp. 523-41.

‡ Bull. Torrey Bot. Club, xxix. (1902) pp. 57-65. § Tom. cit., pp. 69-74.

|| Tom. cit., pp. 110-6.

¶ Hedwigia, xli. (1902) pp. 15-8.

** Tom. cit., pp. 18-21.

†† Tom. cit., pp. 1-33.

been published, but the list includes many plants not before described. The new genera are all monotypic; they are:—

Aschersoniopsis, the conidial condition of some *Hypocrella*. The conidiophores rise from a flat, horny stroma, and bear lateral, spicate conidia, which are subglobose and colourless. It grows on bamboo leaves.

Moelleroclavus, a member of the Xylariaceæ, has only the conidial condition fully developed; the ascophorous stroma is subclavate and dark-coloured, with immersed perithecia, which are immature.

Stilbohypoxylon, a neighbouring genus, has a dark-coloured, subglobose stroma, the perithecia are immature. Conidia are acrogenous, subglobose, brownish.

Midotiopsis, placed among the Dermatiaceæ, has erumpent, less or more stalked ascomata; the exterior is slightly tomentose, the spores are globose and colourless.

Bulgariopsis has elongate, continuous, colourless spores; the ascomata resemble those of *Bulgaria polymorpha*.

Moellerodiscus is allied to *Cudoniella*. The spores are subfusiform, colourless, continuous.

Sylloge Fungorum.*—The sixteenth volume of Saccardo's *Sylloge*, which forms part v. of the Supplement, is issued under the joint editorship of P. A. Saccardo and P. Sydow. The book may be divided into three divisions: the first, of 382 pages, is occupied by the Basidiomycetes including the Uredinaceæ. To the Ascomycetes are allotted about 400 pages. The last great group of Fungi Imperfecti extends over nearly 300 pages. Both the Sphærospideæ and the Hyphomycetes are included under one term the Deuteromycetæ. There are 32 new species of Fungi in the volume that have not been published elsewhere. A list of these is given at the beginning. The authors promise at an early date a universal index with the names correctly accentuated.

Protophyta.

Schizophyceæ.

Oscillaria prolifica.†—Isabel F. Hyams and Ellen H. Richards describe the life-history of *Oscillaria prolifica*, as seen and studied in Jamaica Pond, near Boston. The authors have kept records of its occurrence and condition during thirteen years, and they find that a certain regularity is observed with regard to its seasonal appearance. A table of dates is given, taken from notes made in 1901. The various stages of development in the alga are shown in figures, and reproductions of photographs show the masses of *Oscillaria* floating on the surface of the pond. A further contribution to the subject is promised, which will deal with chemical considerations in connection with the food of the plant. ✓

Schizomycetes.

Nitrogen-Assimilating Bacteria in Soils.‡—Neumann prepared extracts of the roots, stems, and leaves of *Vicia faba*, and of peaty soil, ✓

* *Sylloge Fungorum*, Supp. Univ., pars v. (1902) 1291 pp.

† *Technology Quarterly* (Boston), xiv. (1901) pp. 302-10 (8 figs.).

‡ *Landw. Versuchs-Stat.*, lvi. (1901) pp. 203-6. See *Journ. Chem. Soc.*, 1902, Abstr. ii. p. 163.

and inoculated them with extract of bean-roots, of nodules, and of the adhering soil, and carried on observations over a period of two weeks. Assimilation took place in each case, and the results were very similar. The greatest assimilation was noted in the extract of stems and leaves, and the least in the peat extract.

Alinit-Bacillus Beta.*—Fr. Bayer describes a new bacillus, *Alinit-bacillus Beta*, which is found associated with the ordinary *Alinit* bacillus (*Alpha*) in all humous soils that have responded to the application of alinit. The new bacillus does not by itself assimilate free nitrogen, but it increases the assimilating power of the A-bacillus, and the simultaneous action of the two benefits all crops. The author notes the desirability of adding a certain amount of carbohydrate (e.g. solution of molasses) to the soil when applying alinit.

Luminous Bacteria.†—Barnard gives a short résumé of the group of photogenic bacteria, twenty-five species of which have been isolated up to the present time from sea-water. He supports the opinion that the emission of light by these organisms is merely the result of cell-metabolism comparable to the production of heat by other forms of life. The most suitable medium for the cultivation of these bacteria is prepared by adding 2·6 p.c. sodium chloride, 0·75 p.c. magnesium chloride, and 0·3 p.c. potassium chloride to ordinary meat-peptone broth. Free oxygen should be bubbled through the medium during the growth of the organisms, or frequent agitation resorted to, in order to obtain the maximum luminosity. The optimum temperature of photogenic bacteria occurring in the northern latitudes is about 15° C., although they are able to grow and remain luminous at 0° C. Those found in the tropics grow at a somewhat higher temperature, but none require blood-heat for their optimum temperature. The spectrum of luminous bacteria gives a bright band between F and G. The author includes some striking illustrations of cultivations of photogenic bacteria, which have been photographed entirely by their own light.

Variability of Micro-Organisms.‡—Růžička compared and contrasted *B. pyocyaneus* and *B. fluorescens liquefaciens*, bacilli which he considers are very closely allied. Failing in his endeavours to place the *B. fluorescens liquefaciens* under the conditions in which the *B. pyocyaneus* exists in nature, he restricted his observations to pure cultivations incubated in the laboratory for long periods, under such conditions with respect to temperature and moisture as would obtain in wound infections. After this treatment, some of the cultural reactions resembled those of the original strain; others, however, became modified and resembled those of the *B. pyocyaneus* in forming more pigment than at the room temperature, and growing sparingly on glycerin-agar. These new characters were retained for months.

On the other hand, a typical strain of the *B. pyocyaneus* was kept in water, and the conditions varied by exposing the cultivations to, and protecting them from light and air, without the cultural characters undergoing any important change. Those freely supplied with air were

* Bied. Centr., xxxi. (1902) pp. 12-4. See Journ. Chem. Soc., 1902, Abstr. ii. p. 164.

† Nature, lxxv. (1902) pp. 536-8.

‡ Arch. f. Hygiene, xxxvii. p. 1. See Bot. Centralbl., lxxxviii. (1901) p. 122.

enfeebled so far as concerned their capacity for growth at higher temperatures and their colour production.

Although the main results could be confirmed, Ružička found great difficulty in repeating any particular experiment, even when the self-same strain of bacillus was employed.

Detection of Tubercle Bacilli in Milk.*—Sartori examined 255 samples of milk, obtained from different sources, for tubercle bacilli. Microscopical examination demonstrated the presence of acid-fast bacilli in 217 (85 p.c.): of these 6 p.c. when inoculated into animals, gave rise to tuberculous lesions.

The other acid-fast bacilli, which Sartori considered identical with the dung bacillus, are much more easily found in the centrifugalised deposit than in the cream layer of the milk sample. He also mentions the frequent occurrence of *B. coli* and *Streptococcus* in milk.

He states that in his opinion the presence of tubercle bacilli in milk samples can only be demonstrated conclusively by means of animal inoculations.

New Capsulated Bacillus.†—Dr. Fasching describes a bacillus which he isolated from the nasal discharge of cases occurring during the influenza epidemic at Graz during the winter months of 1889–90, and to which he gives the name of *B. capsulatus mucosus*. He describes the bacillus as a short, thick, non-motile rod, a non-sporing facultative-anaerobe, staining well with the ordinary anilin dyes but not by Gram's method, having an optimum temperature of from 18° to 30° C., a maximum of 35° C., and a minimum of 14° C. The growth in gelatin, stab and streak, and upon agar appears identical with that of the Pneumo-bacillus of Friedländer. Upon potato it forms an almost invisible growth and produces no gas. In sugar-gelatin it produces gas and acid, and in litmus- whey it produces first acid, but subsequently the reaction becomes alkaline.

The bacillus is pathogenic for mice, and when inoculated subcutaneously at the root of the tail causes death in 36 to 48 hours from a general septicæmia. The bacillus, 3–4 μ long by 0.75–1 μ thick, being beautifully capsulated, is easily demonstrated in the blood, where it occurs singly, in pairs, or in short chains of about four elements, liver, spleen, and other organs.

The author differentiates it from the Pneumo-bacillus of Friedländer by reason of its smaller size and the fact that it does not produce that browning of the gelatin noticeable in old cultures of Friedländer's bacillus.

Micro-Organisms of Egyptian "Leben Raib."‡—Rist and Khoury describe the results of their examination of Egyptian "Leben," a milk food of pleasant taste and peculiar odour, somewhat similar to kephir. It is prepared by boiling milk, pouring it out into pans to cool, and when the temperature has fallen to about 40° C. adding a small quantity of the previous day's Leben preserved for the purpose, and allowing it to stand for about six hours for fermentation to take place.

* Ann. d'Igiene Sperim., x. (1900) p. 301. See Bot. Centralbl., lxxviii. (1901) p. 396.

† Zeitschr. angew. Mikr., vii. (1902) pp. 281–94.

‡ Ann. Inst. Pasteur, xvi. (1902) pp. 65–84.

Chemical analysis of numerous samples show that its sharp taste is due to the presence of lactic acid, whilst small quantities of alcohol were also noted. Five varieties of micro-organisms, and no more, were invariably detected in the fresh *Leben*, viz. a stout bacillus arranged in chains of 5 to 10 elements, *Streptobacillus lebenis*; a slender bacillus always occurring singly, *Bacillus lebenis*; a diplococcus resembling the gonococcus in morphology, *Diplococcus lebenis*; an ovoid-celled yeast, *Saccharomyces lebenis*; and another yeast with elongated cells, *Mycoderma lebenis*. All these organisms stain by Gram's method. The yeasts were readily isolated by means of serial cultivations on agar, but on account of their luxuriant growth the bacilli and the coccus could not at first be obtained in pure culture; but by planting fresh *Leben* in freshly sterilised milk and incubating anaerobically in Pasteur's tubes at 37° C. for 24 hours through several generations the yeasts, being strict aerobes, were completely destroyed, and the bacilli were then readily isolated by means of aerobic cultivations upon glucose agar, and the diplococcus upon 2 p.c. lactose agar.

These five organisms were then studied in detail and their morphological and biological characters determined, the characteristic features of the bacilli and the coccus, all facultative anaerobes, being their selective preference for sugar media,—glucose or lactose being essential to their growth.

Finally, by planting these five organisms in freshly sterilised milk, in the following order, first the two blastomycetes together with the *B. lebenis*, and after a short interval to allow of their development, adding the streptobacillus and the diplococcus, the authors were able to produce a preparation of milk which was identical in appearance, taste, and chemical composition with true Egyptian *Leben*.

Rist and Khoury conclude that the method of action of these organisms is as follows. The streptobacillus and the diplococcus coagulate the milk by the combined action of the lactic acid and the rennet that they produce, whilst the streptobacillus renders the milk fermentable and enables the two blastomycetes to elaborate the alcohol and also some ill-defined aromatic compounds. The *B. lebenis*, although probably aiding the streptobacillus and the diplococcus in their work, does not appear to be absolutely essential to the process.

Acid-fast Bacilli.*—Dr. A. Moeller emphasises the fact that all acid-fast bacilli are not necessarily tubercle bacilli, and describes and compares the various "named" species of acid-fast organisms.

The Leprosy bacillus, first described in 1877 by Hansen, closely resembles the tubercle bacillus in its staining reactions and also in morphology, but individual bacilli are slightly shorter, while cultivations of the bacillus upon artificial media have not yet been obtained.

The Smegma bacillus, found by Tavel and Alvarez in 1885 in normal preputial secretion, &c., resembles the tubercle bacillus in that it is acid-fast, but differs in being, usually, less alcohol-fast: still, it is quite possible to confuse the two organisms in a secretion such as urine. Morphologically it often resembles a diphtheria-like bacillus found in smegma, but which is not acid-fast. No cultivations of the Smegma

* *Centralbl. Bakt.*, 1^o Abt., xxx. (1901) pp. 513-23.

bacillus have been obtained, but from injections of material containing enormous numbers of the bacilli, it appears to be non-pathogenic.

The well-known bacillus of avian tubercle is probably the *B. tuberculosis* modified by its environment, for the only essential difference it presents is with regard to its pathogenicity: similarly it is highly probable that tuberculosis in cold-blooded animals is due to tubercle bacillus modified somewhat by the conditions of its habitat. Lubarsch, Dubard, and others, by means of passages through frogs and fish, have succeeded in modifying the characteristics of the mammalian tubercle bacillus to a marked extent, whilst Moeller himself, by passing it through the slow-worm, effected such changes that the tubercle bacillus would no longer grow at a higher temperature than 30° C., and this character persisted even after subsequent passage through warm-blooded animals, whilst the cultural appearances closely resembled those of the bacillus of avian tubercle.

Moeller also refers to other acid-fast bacilli,—the Petri-Rabinowitsch butter bacillus, the Timothy grass bacillus (*B. phlei*), and the grass bacillus ii., the dung bacillus, &c., all of which closely resemble the tubercle bacillus in morphology (though individual rods may be somewhat thicker), and when injected into animals produce lesions which to the naked eye simulate true tuberculosis. The author considers that *B. tuberculosis*, like all acid-fast bacilli, belongs to the *Streptotrichiæ*.

Fat Substance of the Tubercle Bacillus.* — K. Kresling prefaces a communication on the fat substance of the tubercle bacillus with a short historical account of the work previously done on this subject.

In his own investigations the tubercle bacillus was cultivated for 4 to 5 months at 37° C. in small broad-bottomed Erlenmeyer flasks, containing 5 p.c. glycerin-broth. The medium when finished, reacted acid

to phenolphthalein to the extent of 0.1 to 0.4 ccm. $\frac{n}{10}$ NaOH per 100 ccm. The resulting growth was killed in the autoclave at 110° C., collected on filter paper, washed with hot distilled water to free it from glycerin, &c., spread upon porous earthen plates, and finally dried at about 40° C. The result was a yellowish spongy mass, which could easily be pulverised, and which, if exposed to the air, took on a reddish tinge.

The result of Kresling's analyses may be summarised as follows:—

(1) *Composition of the Dried Tubercle Bacillus.* Moisture (dried at 100°–110° C.), 3.9375 p.c. (after drying in the H₂SO₄ desiccator, 3.08 p.c.); ash, 2.55 p.c.; nitrogen, 8.575 p.c.; nitrogenous substance, —albumen—excluding the nitrogen of the lecithins, and other substances soluble in alcohol, ether, chloroform, and benzol, 53.59 p.c.; fatty substances, 38.95 p.c.; N-free substances, 0.9725 p.c.

(2) *Fatty Substance obtained by extraction with CHCl₃ presented the following characters:*—Melting-point, 46° C.; acidity, 23.08; saponification value, 60.70. And had the following composition:—Free fatty acid, 14.38 p.c.; neutral fat and residual fatty acids, 77.25 p.c.; fatty acids in general (with a melting-point of 53.5° C., not estimated; lecithine, 0.16 p.c.; cholestrin, not estimated; substances directly

* Centralbl. Bakt., 1^{te} Abt., xxx. (1901) pp. 897–909.

soluble in water, 0.73 p.c.; water-soluble substances, formed by the complete saponification of the fatty substances, 25.764 p.c.

Lactic Ferments in the Arts.*—Martinus Beyerinck describes the ferments employed in the industrial production of lactic acid, as initiating a true catabolic process and not merely an enzymic action. The best results are obtained with pure cultivations of the *Lactobacillus fermentum*, which when grown at its optimum temperature of 41–42° C. (maximum being 50° C. and minimum 25° C.) and freely supplied with air, gives lactic acid only and produces no volatile acids. The *L. fermentum*, according to the author, can be transformed into the *L. delbrücki*, by cultivating at a temperature above the optimum; and the *L. delbrücki* if grown aerobically at the ordinary temperature becomes the *L. fermentum*.

Presence of a Parasite in the Blood of Epileptics.†—M. Bra, as the result of the examination of fresh specimens from 70 patients suffering from epilepsy, states that a feebly staining motile coccus, occurring singly, in pairs, or in chains of six to eight individuals, is constantly present in the blood during the attack and immediately after it, but is absent during the interparoxysmal stage.

With the assistance of M. Chaussé, the coccus was isolated 80 times out of a total of 100 attempts, by receiving the blood into tubes of bouillon and incubating at 34° C. for 48 hours. The coccus thus isolated measured from 0.6 μ to 1 μ ; in cultivations it grew as a streptococcus, forming flocculi in bouillon, produced acid, did not liquefy gelatin, and gave an “invisible” growth on potato, &c. It stained better with acid than with basic anilin dyes, and was decolorised by Gram’s method.

Injected intravenously into the rabbit, it gave rise to appearances similar to those noted in the blood of the epileptics.

Streptococcus Hæmolysin.‡—Dr. Besredka, in endeavouring to isolate the hæmolysin of the streptococcus, first grew the organism in Marmorek’s ascitic-broth at 37° C. for 24 hours, and then filtered the cultivation through a porcelain filter, but the filtrate proved to be destitute of hæmolytic powers. Experiments with cultivations in other media gave similar negative results.

Further experiments, however, using as a medium serum from the rabbit, man, or the sheep (arranged in the order of value), previously heated to 55° C. for half-an-hour, gave highly satisfactory results. Such media were inoculated with a streptococcus taken direct at the autopsy from a rabbit whose blood was hæmolysed; a few drops of normal defibrinated blood were added to the culture, which was then incubated at 37° C. for about 18 hours. Before filtration the cultivation was diluted with an equal bulk of physiological salt solution, and it was noted that when the cultivation passed rapidly through the filter the hæmolytic value of the filtrate was high, and *vice versa*. It was also observed that if about 25 p.c. rabbits’ serum was added to sheep, ox,

* Archiv. Néer. Sci. Exact. Nat., vi. (1901) pp. 212–43. See Journ. Chem. Soc., 1902, Abstr. ii. p. 97.

† Comptes Rend., cxxxiv. (1902) pp. 50–2.

‡ Ann. Inst. Pasteur, xv. (1901) pp. 880–93.

or horse-serum, the mixture formed a medium almost equal in value to the rabbit-serum when alone.

Streptocolysine thus obtained is extremely active, but is in no sense specific; it dissolves, though at somewhat different rates, the red discs of man, rabbit, guinea-pig, sheep, ox, horse, and dog; it resists a temperature of 55–56° C. for half-an-hour, exposure to 70° C. for two hours being necessary to destroy its hæmolytic properties. Prolonged exposure to low temperatures, e.g. 37° C., for some days, or even 15–17° C. for 20 days, will produce the same effect. Having once lost its hæmolytic power, the streptocolysine cannot be reactivated by the addition either of new serum or of new streptocolysine. Curiously enough, its hæmolytic action is feeble at the room temperature, and is most active at 37° C. Streptocolysine is not toxic for animals.

Normal Serum in Pneumo-Enteritis. * — Voges stated that 0·01 mgrm. of a cultivation of the bacillus of pneumo-enteritis of swine (*Schweinseuche*) was the minimal fatal dose for the guinea-pig, whether inoculated subcutaneously or intraperitoneally, and further that the simultaneous injection (subcutaneously) of 0·1 ccm. of normal guinea-pig serum would protect another guinea-pig against the subcutaneous injection of 1000 times the minimal fatal dose, or the intraperitoneal injection of 50 times the minimal fatal dose.

Satykow, who attempted to repeat these experiments, obtained diametrically opposite results. Using a cultivation which had been exalted to the same degree of virulence as that employed by Voges, this observer found that the subcutaneous minimal fatal dose was 200 times as great as the intraperitoneal minimal fatal dose; while those animals injected simultaneously with cultivation and normal serum died as soon as, and sometimes earlier than, the control guinea-pigs. He therefore concludes that the results obtained by Voges depended upon some individual and accidental peculiarity of the serum employed.

Resorption of Bacteria from the Intestines. † — Rogozinski questions the work of Meissner, Hauser, Neisser, Opitz, and others who maintain that the tissues of normal animals are sterile, and details two series of experiments in support of his views. The first series included 27 dogs and 3 cats, the chyle or mesenteric glands, or both, being examined microscopically and by means of cultivations, the result being negative so far as concerned the chyle, but positive in the case of the glands, as out of 26 animals from which samples of gland-substance were removed 21 gave evidence of infection, 18 of them yielding cultivations of bacilli belonging to the *Coli* group. Six strains of cocci (species not specified), two of *Proteus vulgaris*, one of *B. subtilis*, and one of *B. mesentericus vulgatus*, were also observed. The varieties of *B. coli*, 35 in all, were carefully studied on all different media, compared with control cultivations, and their identity established.

In the second series (seven dogs) the blood and mesenteric glands were examined bacteriologically, after feeding three animals with cultivations of *B. prodigiosus*, two with *B. kiliensis*, and two with *B. mycoides*, at each meal for three to five days. The results were positive, the

* Ann. Inst. Pasteur, xvi. (1902) pp. 94–6.

† Bull. Internat. Acad. Sci. Cracovie, 1902, pp. 96–112.

organisms thus introduced into the alimentary tract being subsequently recovered from the mesenteric glands, and occasionally found associated with the *B. coli communis*.

The author lays great stress on the strictly aseptic conditions under which the material for examination was collected: the portions of tissue were removed by means of sterile instruments after searing the surface and surrounding tissues and organs with a red-hot cautery iron. Rogozinski mentions that in seven of his early experiments he employed the Paquelin's thermo-cautery, but as he invariably failed to obtain a positive result, he came to the conclusion that the heat generated was too great, and consequently caused the death of the organisms in the interior of the glands; he therefore discontinued its use.

In microscopical sections of the fresh glands the author was unable to demonstrate the presence of micro-organisms. He therefore adopted the method of transferring portions of gland-substance directly from the animal to tubes of nutrient broth, and allowing them to incubate at 37° C. for from 4 to 24 hours. Occasionally the broth remained clear throughout, but often showed evidence of growth. Microscopical sections of the gland-substance treated in this manner invariably showed the presence of bacteria.

Micro-organisms in the Systemic Circulation.* — Fütterer remarks that although it is quite proved that micro-organisms which have penetrated to the portal vein pass into the systemic circulation within less than a minute, and after the lapse of a very few minutes the liver and kidneys, especially the former organ, have commenced their separation and elimination, this fact so far has not been sufficiently considered.

Plasmoptysis.† — Fischer describes the processes which accompany and precede the granular disintegration of bacteria in serum, chiefly in connection with the *V. cholerae*. First, a distinct but irregular swelling-up of the cell takes place, followed by the extrusion of a small refractile globule of protoplasm from one pole of the cell—usually that bearing the flagellum—and only rarely from the side. He explains this method of extrusion on the assumption that the swollen protoplasm leaves the cell membrane by means of the pore through which the flagellum passes. Fischer terms this process Plasmoptysis, and states that bacteria undergo the process in the serum of the rat, the ox, and the pig; and it may also usually be observed whenever bacteria are transferred from a dilute to a more concentrated solution, as, for instance, from 0.75 p.c. to 2 p.c. or 2.5 p.c. salt solution.

Agglutination of the Tubercle Bacillus.‡ — Beck and Rabinowitsch repeated the experiments of Arloing and Courmont, who as far back as 1898 had stated that the agglutination of cultivations of the *B. tuberculosis* (grown in 6 p.c. glycerin-broth) by means of the blood-serum of the patient, afforded a means of early diagnosis of tuberculous lesions.

* Berlin. Klin. Wochenschr., xxxviii. pp. 58-9. See Bot. Centralbl., lxxxviii. (1901) p. 396.

† Zeitschr. f. Hygiene u. Infekt., xxxv. (1900). See Bot. Centralbl., lxxxviii. (1901) pp. 394-5.

‡ Zeitschr. f. Hygiene u. Infekt., xxxvii. (1901) p. 203. See Bot. Centralbl., lxxxviii. (1901) p. 312.

They applied the test to different strains of the tubercle bacillus, one isolated by themselves from the sputum of a phthisical patient, and another obtained from Courmont, which had been cultivated for a long period upon artificial media. This latter they found had become practically non-pathogenic for the guinea-pig.

The authors tested the serum from 73 subjects, 41 of whom were suffering from some form of tuberculosis, 29 from diseases other than tuberculosis, and 3 normal individuals. The results were so contradictory and unreliable that the authors do not consider the test of any value in the early diagnosis of tuberculosis.

Miquel and Cambier's Bacteriology.*—P. Miquel and R. Cambier have combined to produce an exhaustive treatise on Bacteriology, somewhat similar in its arrangement to that manual by Sternberg which has long been a standard work in all English-speaking countries. The volume is divided into four parts, of which the first, consisting of 238 pages, is devoted to the morphology and biology of bacteria and methods of investigation and technique in general. The second part contains a systematic description of pathogenic bacteria in about 330 pages, whilst the third, of equal size, describes the saprophytic bacteria. The final section is concerned with bacterioscopic analyses and the application of bacteriology to hygiene, and is limited to 150 pages.

The classification of bacteria which the authors have adopted is a good working one, viz. that of Cohn, although we note with regret that the term *Leptothrix* is retained to designate such of the bacilli as occur in long non-motile threads, a connection in which we hoped the word had become obsolete, instead of restricting it as a generic term for a definite group of the higher bacteria; again, *Prodigiosus* is spoken of as a *Micrococcus*, although most workers now prefer to class this micro-organism as a bacillus. The details of the technique adopted in the study of the structure and functions of bacteria in general are precise and the methods themselves for the most part effective, though fewer are mentioned than we should have anticipated in a work of this magnitude, and some apparently can only be carried out by the aid of expensive and cumbersome apparatus.

In view of the increasing importance that is attached, and rightly so, to the preparation of nutrient media, it is somewhat startling to find it stated that nutrient broth should be neutralised with a solution of caustic soda or carbonate of soda until it gives a faintly alkaline reaction, no advice whatever being given as to the most convenient strength of the neutralising solution to employ, nor is the indicator even mentioned. Further, we are told that the sterilisation of nutrient media, such as gelatin and agar, by the discontinuous method (of Tyndall), although "seductive in theory," is unsafe in practice and should be replaced by steaming in the autoclave, under pressure, at a temperature of 105° to 110° C.

In the second and third parts the descriptions of the various pathogenic and saprophytic bacteria are accurate and sound so far as they go, but we are surprised to find that notes of the cultural characteristics

* *Traité de Bactériologie, pure et appliquée à la Médecine et à l'Hygiène* P. Miquel et R. Cambier, Paris (C. Naud), 1902, crown 4to, 1059 pp. and 224 figs. in the text.

upon agar, gelatin, potato, and in broth, and occasionally in milk, are considered sufficient for purposes of identification, especially as we are told in the preface that the book is written in the hope that it "may prove useful to those who, having a general knowledge of bacteriology, seek precise details." The illustrations in this section, the majority of which are in colours, are all good, and a certain novelty is here introduced in that most of the cultivations are represented in Freudreich's flasks, instead of the test-tubes we are accustomed to see.

The fourth section is devoted to the applications of bacteriology to practical hygiene, and in the first chapter, which deals with the bacterial flora of the air analytically and statistically, the information is full and satisfying; on the other hand, those portions dealing with the bacteriological examination of water and soil are inadequate and insufficient. But one method, and that an unsatisfactory and unreliable one, is described for the isolation of the *B. coli* and *B. typhosus* from drinking-water, whilst the method of enumerating the micro-organisms present per cubic centimetre of a water sample appears to us as needlessly complicated and moreover open to numerous fallacies. Food-stuffs generally are not even touched upon, and no methods whatever are described for the bacteriological examination of milk and milk products.

The most valuable feature of the book is undoubtedly the excellent and extensive bibliography which is arranged in footnotes throughout the volume. The type and paper are good, and a well-arranged index renders the work of reference easy.

BIBLIOGRAPHY.

CHESTER, F. D.—**A Manual of Determinative Bacteriology.**

Macmillan, London and New York, 1901, vi. and 401 pp.



MICROSCOPY.

A. Instruments, Accessories, &c.*

(1) Stands.

Two Early Microscopes by Andrew Ross (?)—Mr. E. M. Nelson has sent the following account of the two old Microscopes which Mr. J. C. Webb kindly exhibited at a recent meeting of the Society.

The Microscope shown in fig. 65 is not signed, but we may conclude from the style and finish of the workmanship that it was made by Andrew Ross. It will be noticed that the peculiarly shaped flat tripod foot is precisely similar to that figured by Andrew Pritchard in his *Microscopic Illustrations* (1838), but we know that Microscopes sold by Andrew Pritchard were made by Ross and Powell, both of whom at that time worked for the trade. To this tripod foot is fixed a tubular pillar holding an extension-rod which can be clamped in any position by an ordinary screw-ring; at the top of the rod is a compass-joint to which the limb of the Microscope is attached.

The limb is, in section, an equilateral triangle, the front angle being cut with teeth for stage focussing rackwork; below the stage is a concave mirror. The body is attached to the arm by a screw-clamp, and when a "single" Microscope is required the arm can be turned aside and another arm to hold Wollaston's doublets used in its stead. A fine adjustment is obtained by a direct-acting screw operating on a nose-piece, but without the usual spring; below this nose-piece there is another sprung nose-piece, which is simply a safety device. This separation of the sprung nose-piece from the fine-adjustment screw is a rare form, and at the same time, a very crude idea.

There are two objectives, one a single non-achromatic of the same date as the instrument, the other a French button combination of later date. The eye-piece is Huyghenian with a double eye-lens, a form first introduced by Benjamin Martin and subsequently employed by Coddington. In design this Microscope looks older than it really is, but we know that this kind of solid tripod foot was introduced in 1837, and this probably is the date of the instrument.

The second Microscope (fig. 66), which is smaller, although signed "Carpenter and Westley, Regent Street," was probably made by the same hand and about the same time as the first. The foot, which is a little different in shape, has the same peculiar cut to the front toes; but the instrument differs from the other in having no pillar, the lower end of the limb being attached to the foot by a compass-joint. It, like the

* This subdivision contains (1) Stands; (2) Eye-pieces and Objectives; (3) Illuminating and other Apparatus; (4) Photomicrography; (5) Microscopical Optics and Manipulation; (6) Miscellaneous.

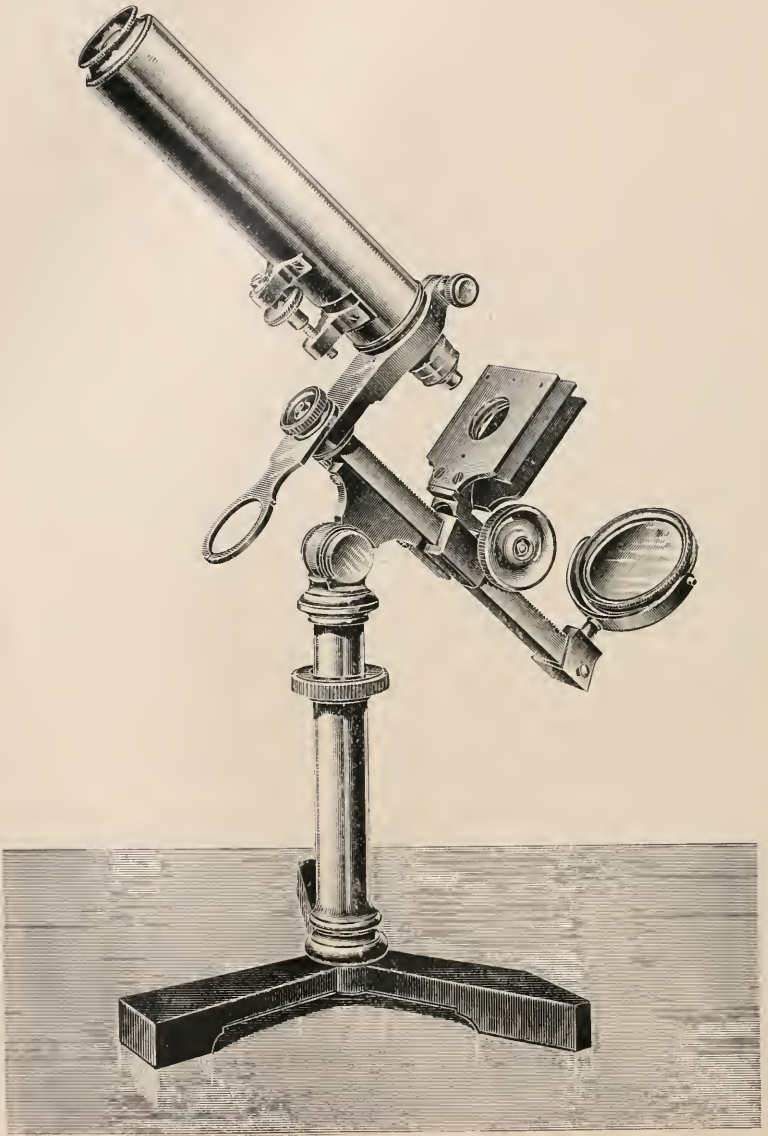

FIG. 65

former, is a stage focusser, and has a concave mirror. Both the objective and the eye-piece are of a much later date.

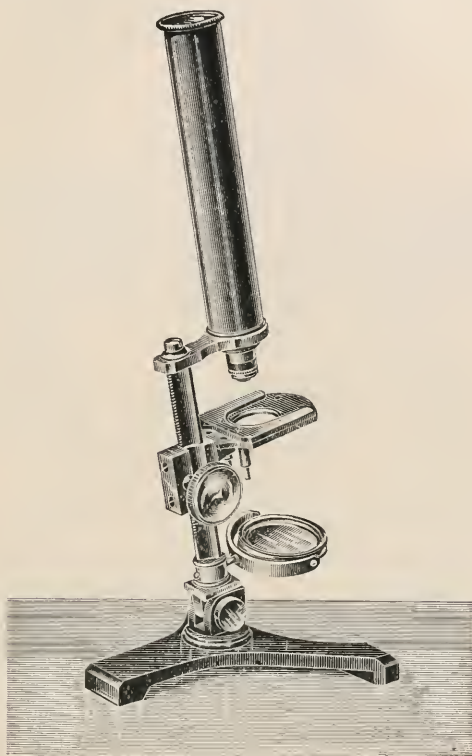

FIG. 66.

Pillischer's "Lenticular Microscope."—Mr. J. Pillischer, of Bona Street, has most kindly presented this very interesting portable, really pocket, Microscope to the Society's Cabinet. It was designed by the late Mr. M. Pillischer, the donor's uncle.

The instrument is figured and described in *Urinary Deposits* by Golding Bird (p. 29, fig. 13, 1857, 5th ed.), but it will be noticed that the figure differs slightly from the original, inasmuch as a second spring to hold the slide has been added, and a semicircular segment cut out at both ends instead of at one end of the base-plate as there shown.

The design of this instrument (fig. 67) is most ingenious: there is neither stand nor limb, the main basis of the instrument being the slide-holder, at one angle of which is a short pillar containing a direct-acting screw fine adjustment, which acts upon a swinging arm carrying the lens. Below the stage is a mirror attached to a jointed arm, and a wheel of diaphragms. The lenses, three in number, are Coddingtons of $\frac{1}{4}$, $\frac{1}{10}$, and $\frac{1}{25}$ -in. foci.

It may be pointed out, says E. M. Nelson, that an instrument of this kind, fitted with achromatic loupes, would be very serviceable to a microscopist for field work.

It will be remembered that three of Dr. Gairdner's Microscopes, made by Bryson of Edinburgh, were exhibited, figured, and described in the *Journal* for 1899, p. 643, fig. 149.

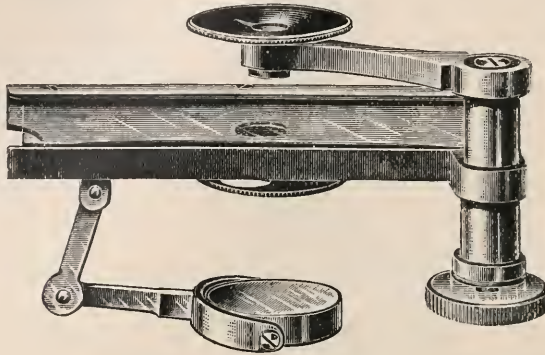

FIG. 67.

These had Coddington lenses, each power having a separate Microscope to itself. Gairdner's Microscope was described in the first edition of Carpenter on the Microscope, 1856, p. 74, fig. 15, and there it is said to be of use in bed-side investigations of urinary deposits.

In design, Gairdner's Microscope is far inferior to that of Pillischer's, inasmuch as there is no possibility of either moving the slide under the lens, or the lens over the slide, so nothing can be seen except the single point in the axis of the lens.

Seibert's Large Model Microscope No. 2.—This stand (fig. 68) closely corresponds to Zeiss' Model 1A; but is sold at a much less price. The fine adjustment, unlike Seibert's largest model, is by a prismatic bar, the micrometer screw being placed on the prism collar. When inclined the Microscope can be clamped by a lever. The stage is circular, graduated on rim, rotatory, and provided with centring screws. It is interesting to note that the horse-shoe foot is replaced by a flat tripod.

Watson's New "Holos Fram" Microscope.—This instrument (fig. 69) is Messrs. Watson and Sons' "Fram" Microscope, fitted with a rigid mechanical stage, and centring rackwork substage.

New Two-speed Fine Adjustment.—Messrs. W. Watson and Sons' new two-speed fine adjustment (fig. 70) is an ordinary single micrometer screw, having the usual larged milled head, and a projecting spindle-head, also milled, and of convenient length. When the latter is made

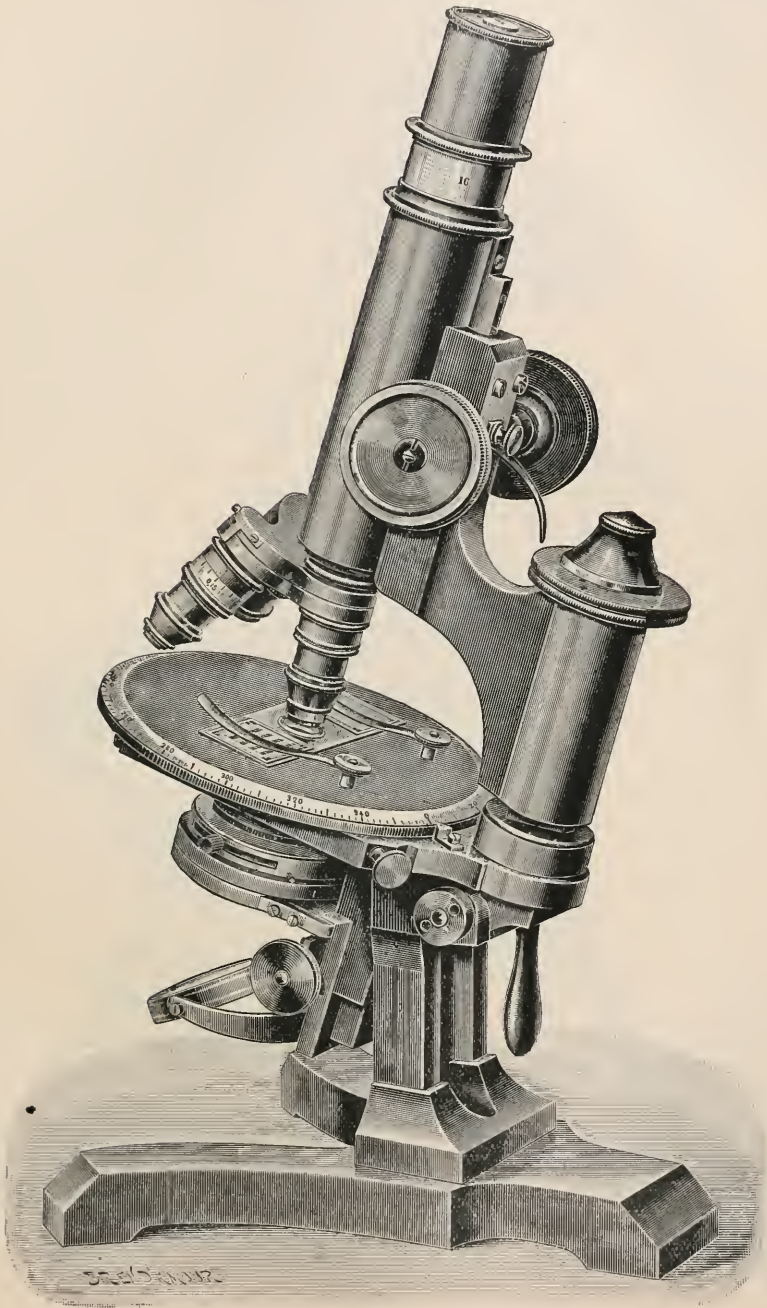

FIG. 63.

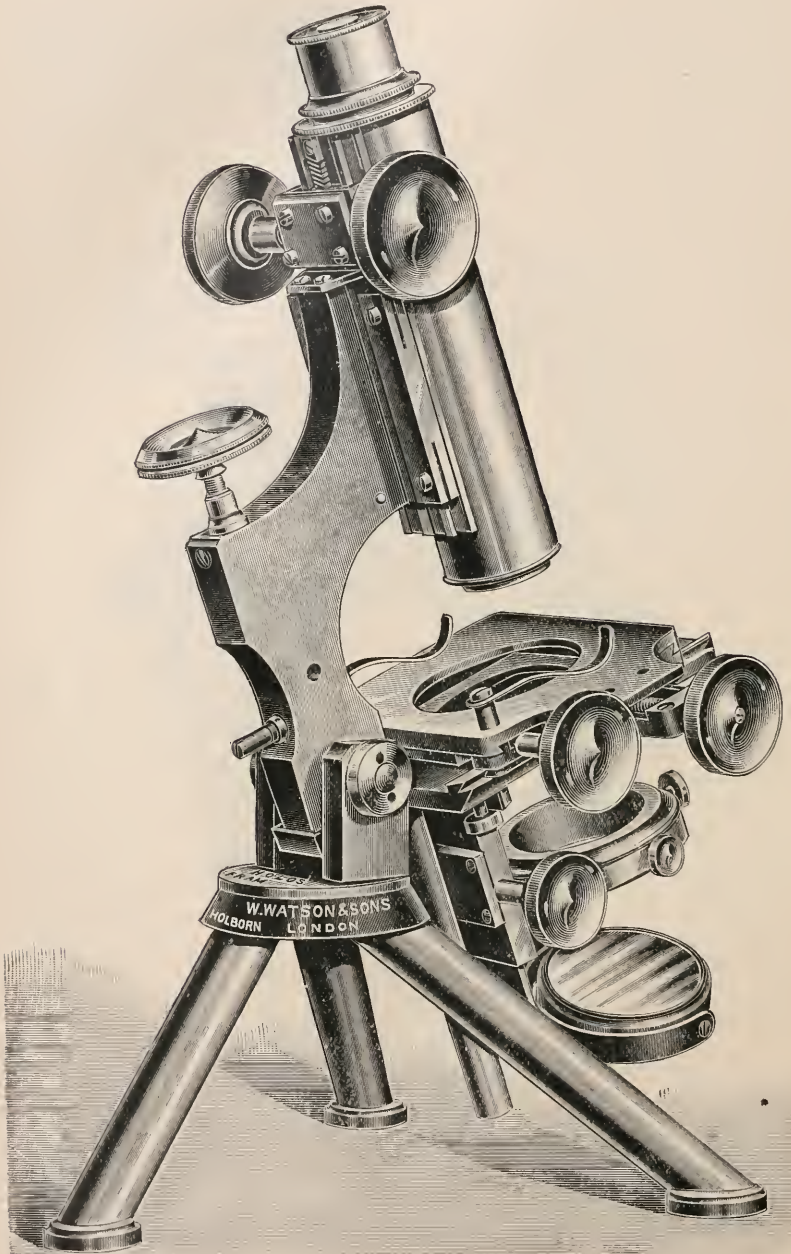

FIG. 69.

to revolve rapidly a quick adjustment, suitable for low powers, is obtained, while the large milled head is available for delicate adjustment and high powers.

Beck's Micrometer Microscope.—This instrument (fig. 71) is intended for the accurate measurement of either opaque or transparent objects. The eye-piece has cross lines, and the whole Microscope is traversed across the object by means of a fine micrometer screw. On the upper portion of the stand is a scale representing the number of turns of the screw, whilst the drum of the milled head records to $\frac{1}{100}$ th of a millimetre. The Microscope has a rack-and-pinion focusing motion, a graduated draw-tube, and carries the standard Royal Microscopical Society screw.

The stand is so made that the entire portion carrying the Microscope and micrometer screw may be removed, and attached in a horizontal position. A telescope object-glass may then be used in place of the

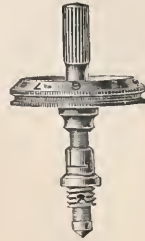

FIG. 70.

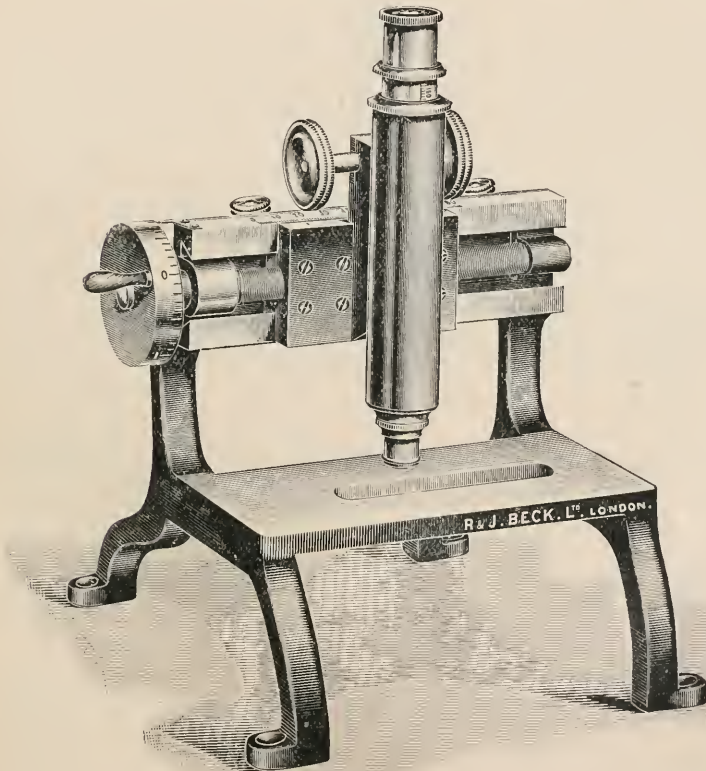

FIG. 71.

Microscope object-glass, and focussed by means of the draw-tube. In this way the instrument may be used for readings at a distance.

Albrecht's Microscope for Measuring Plant-Growth.*—The modern form of this instrument is shown in fig. 72. The tripod base is carried on levelling screws *s*, and the adjustment of the Microscope-tube is controlled by the level *L*. The sleeve *H* forms a part of the heavy base and contains a pillar *S*, which is raised or depressed by the screw

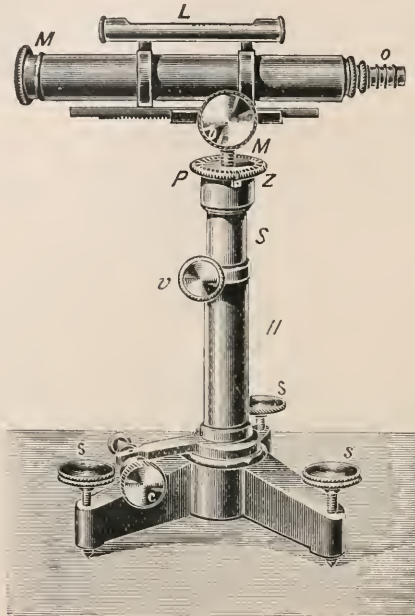

FIG. 72.

v, which thus acts as a coarse adjustment. The finer vertical adjustment is effected by the micrometer screw *M*, an indicator *Z* serving, in conjunction with the graduated plate *P*, to read off the movement. The screw *b* regulates the motion and the direction of the tube-length, and another screw *c* imparts a slight lateral movement of the entire upper part. Dr. Zimmermann considers that an arrangement for adding rotation about a horizontal axis would be a desirable addition. The optical parts are made by Seibert, of Wetzlar.

Pye's Reading Microscope.—Messrs. W. G. Pye and Co.'s reading Microscope (fig. 73) is designed on the geometric slide principle. A steel cylinder, to which is clamped, in any position, the Microscope arm, and forms the carriage, works in a pair of V's cut in the uprights of the base. These V's are parallel to the top plane edge of the base,

* Zimmermann, *Das Mikroskop*, 1895, p. 106, fig. 77.

on which rests a steel pin fixed to the under side of the arm, thus forming a perfect-fitting slide.

The carriage is actuated by a micrometer screw working against one

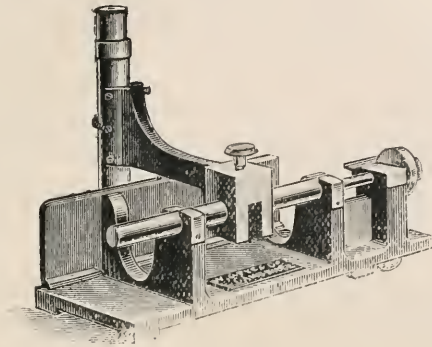

FIG. 73.

end of the steel cylinder, the latter being kept in contact by pressure with the finger on the other end. The screw is of 0.5 mm. pitch, with a head divided into 100 parts, and a traverse of 30 mm.

The instrument is also made without the micrometer screw, in which case a millimetre scale is fixed to the top edge of the base, the carriage being furnished with a vernier reading to 0.05 mm. The Microscope is provided with a Ramsden eye-piece with cross wires. It is held in position against four points by a flexible steel spring, and the vertical cradle that supports it will receive any other Microscope-tube in place of the one supplied.

Short Table Cathetometer.—This instrument (fig. 74), made by Messrs. W. G. Pye and Co., is constructed on the geometric slide principle. The base, provided with three levelling screws, carries a steel rod $\frac{7}{8}$ in. in diameter, with a millimetre scale divided on it, which can be read when the telescope is in any position. A brass ring with V bearings, carrying the telescope cradle and micrometer, fits on the column, and is capable of being revolved without altering its height. The V's in this annular ring are kept against the column by a spring on the opposite side.

The micrometer slide consists of two steel rods carried by the ring. Against one, which is fixed to the ring, one point of the telescope cradle is pressed by a spring. The other is fixed to the telescope cradle, and works in two V's cut in the annular ring. One end of the latter rod

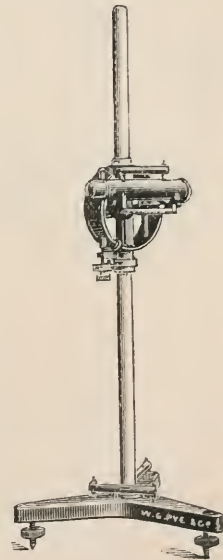

FIG. 74.

rests on the point of the micrometer screw, by means of which it is actuated. The screw has a pitch of 1 mm., and its head is divided into 10 parts.

The telescope rests in V's, and is reversible. It has a Ramsden eye-piece, adjustable diaphragm with cross wires, and a movable object-glass for focussing. Two spirit levels are supplied on the base and one on the telescope.

An Old Rackwork Draw-tube.—Mr. Nelson writes to say that he was shown an old monocular Microscope fitted with a rackwork draw-tube; the tube was graduated in inches and tenths. The milled head on the pinion, which was geared to the rack, was divided into five or six equal portions by small countersunk holes, into which a spring-catch pressed. When the milled head was revolved, so that the spring-catch passed out of one countersunk hole into the next, the draw-tube was moved exactly one-tenth of an inch. Therefore by feeling or hearing the spring click the amount of movement given to the draw-tube would be known, without the necessity of removing the eye from the eye-piece for the purpose of reading the graduated scale.

The legend engraved on the Microscope was "M. Pillischer, 398 Oxford Street, London. 167." Its date is 1847-48.

(2) Eye-pieces and Objectives.

Beck-Steinheil Orthostigmats.—These lenses (fig. 75) were primarily introduced for photography pure and simple, but owing to their exceptional qualities as to their corrections both for colour values (severely tested in connection with the photo-mechanical three-colour work) and also for spherical and astigmatic errors, Messrs. Beck have introduced a number of shorter foci lenses specially for the most difficult photo-micrographical research. Each surface is polished and figured on the principle adopted for the manufacture of large astronomical telescope objectives, and the accuracy of the test employed is such that a surface error not exceeding a fraction of a wave-length may be detected.



FIG. 75.

No mechanical measuring machine has ever been constructed which will measure the errors of curvature with a tithe of the accuracy of the method adopted. The series at present includes three members, whose focal lengths are respectively 1, 2, $3\frac{1}{2}$ in.; their corresponding apertures being $\frac{1}{8}$, $\frac{1}{4}$, $\frac{9}{16}$ in.

Leitz' Spherically, Chromatically, and Astigmatically corrected Objective.*—E. Leitz, of Wetzlar, has taken out a German patent † for the above, and the spherical and astigmatic corrections are accomplished by a pair of reversed combinations separated from one another by a film of air (fig. 76). The outer members form a biconvex lens A, and the inner consist of a pair of plano-concave lenses B, and two positive menisci C. The biconvex A is made out of a highly refractive crown glass and serves for the rectification of the astigmatism. The spherical

* Deutsche Mechaniker-Zeitung, No. 2 (Jan. 1902) p. 19 (1 fig.).

† No. 118433. Cl. 42, 16.7. 1899.

correction depends, as with aplanatics, on the inner surface of the cemented double lens, of which one lens B is made from a negative flint glass lens, and the other is a positive meniscus C of weakly refractive crown glass; the resultant focal length of the double lens being negative.

(3) Illuminating and other Apparatus.

Winkel's Drawing Apparatus for Weak Magnifications.*—A horse-shoe foot supports a pillar S which carries, by means of the screw A, the object-table T and the mirror E (fig. 77). The screw B serves as a clamp. The large perforation of the object-table renders the instrument applicable to large preparations, and the carrier T permits the insertion of a disc of ground glass for uniform illumination of the field. The optical portion is placed at the upper

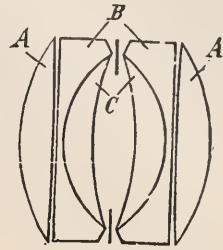

FIG. 76.

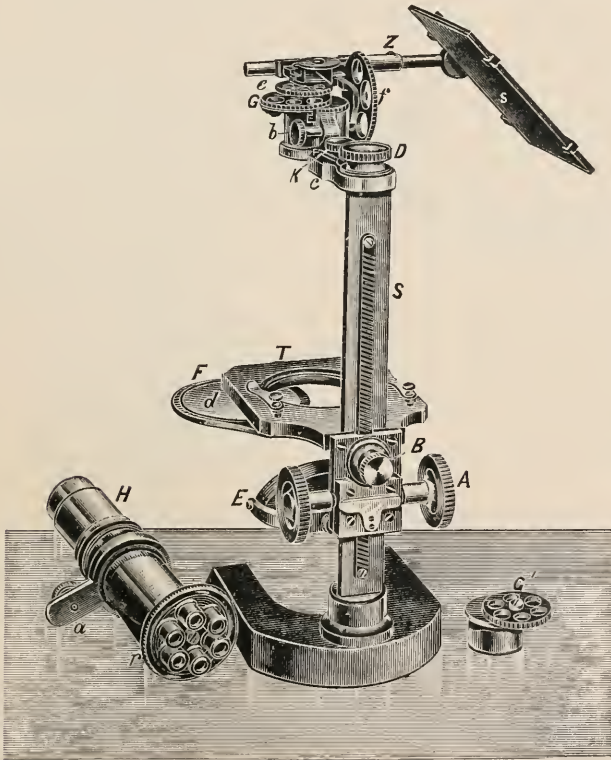

FIG. 77.

* Zimmermann, Das Mikroskop, pp. 138, 9; and Zeitschr. wiss. Mikr., x. (1893) p. 289.

end and is fixed by a dovetailed slide *c*, and clamped by a screw *K*; this part is rotatory about the pillar. Simple loups are placed in the rotatory disc *G*, revolver fashion, of magnifying power 1·7 to 10. For higher magnifications the Microscope-tube *H* with the help of the plug *a* is inserted, and bears at its lower end six objective systems of magnifying powers 12 to 38. The drawing is effected by the arrangement shown, which was fully described in a previous number of the *Journal*.*

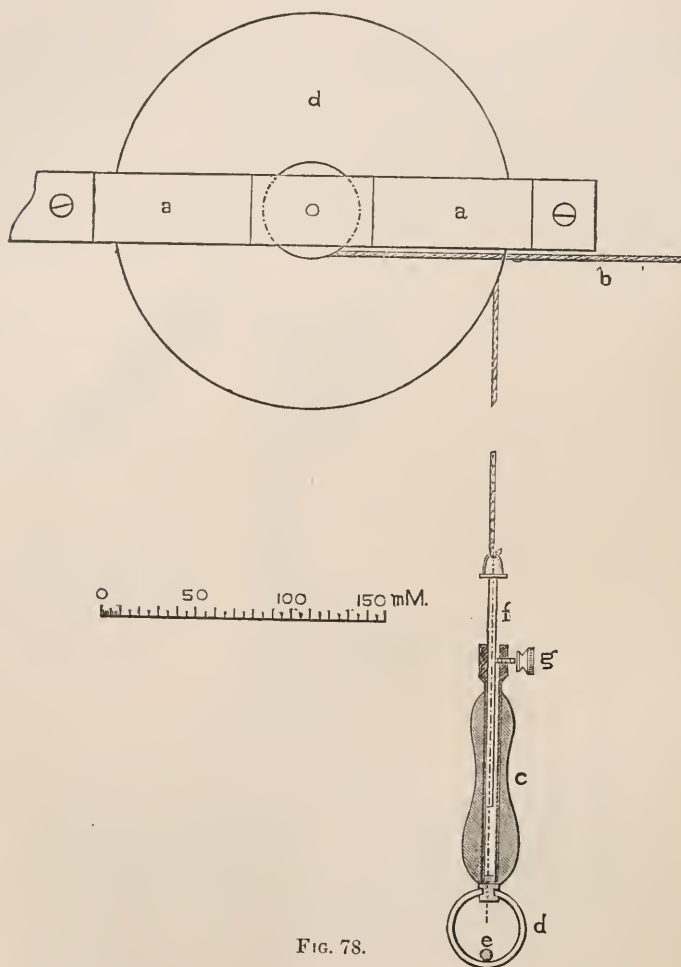

FIG. 78.

Moll's Apparatus for the Adjustment of a Projection Microscope.†—The object of this apparatus is to enable the lecturer, who

* *Journal R.M.S.*, 1892, p. 264.

† *Zeitschr. wiss. Mikr.*, xviii. (1901) pp. 129–37 (2 figs.).

prefers to stand near the screen, to have control over the fine adjustment of the ocular so that he may arrange a sharp definition of any desired part of the image. It is in actual operation at the Botanical Laboratory, Groningen. Dr. Moll has designed a sort of wheel-and-axle arrangement (fig. 78) consisting of two grooved discs of radii 2.1 and 10.5 cm., rotatory about a horizontal axis and firmly fastened together. They are enclosed in a metal frame which is secured to a convenient beam in the ceiling. The cord *b* is fastened at one end to the small disc, and, at the other, to the ocular mount. To the larger disc is fastened the vertical cord terminating in a handle *c*, which is gripped by the lecturer. The size of this larger disc is important as it increases the delicacy of

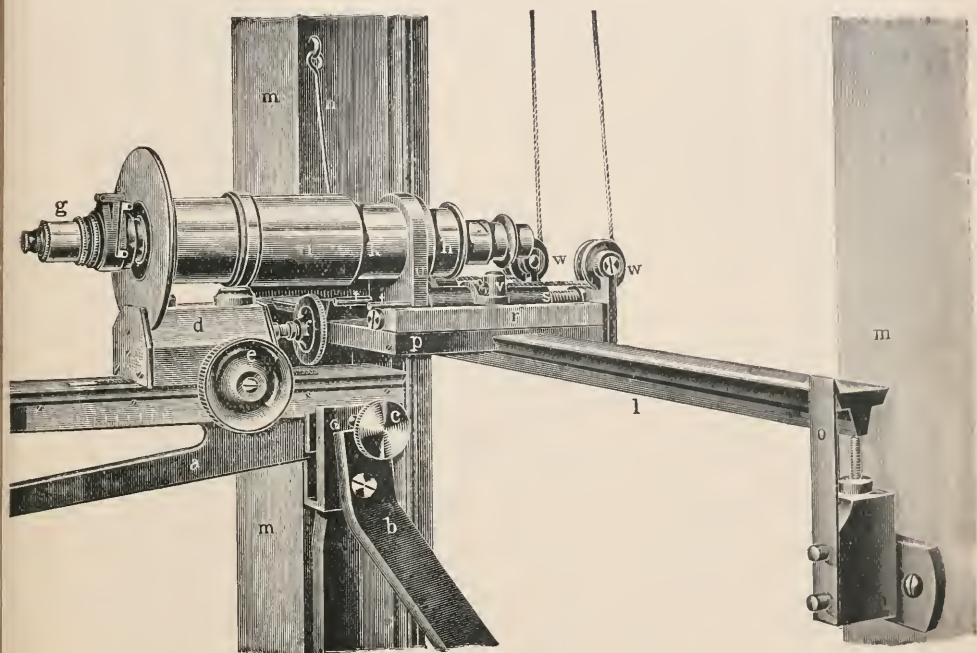

FIG. 79.

the ocular fine adjustment. The range of this latter is 5.5 cm.; but the corresponding stroke of the lecturer's handle is about 26 cm., and the precision attainable in image definition is proportionately increased. In many cases, and especially at the beginning of a demonstration, a medium position would be convenient: this is attained by making the handle terminate in a ring *d*, which may be then secured to a nail *e* in the wall. For better attainment of this medium position an adjustable rod *f* is contrived in the hollow handle, and its suitable length determined by a screw *g*.

To the ocular mount itself (fig. 79) strong spiral springs *s* are attached. These work in a frame at whose extremity are a pair of

pulleys *w* under which pass the limbs of the cord-loop. The ocular part of the Microscope-tube is mounted on a strong metal base-plate which, by means of a dovetailed groove, rests on a cast-iron bar supported by the upright beams *m* of the projection chamber. At the left-hand end of this bar is a hinge (not visible in figure) so that the bar and instrument can be raised, and by means of the hook *n* kept in an oblique position if projection apparatus of another kind should be required. At the right-hand end a strong spring *o* suffices to keep the bar in its place. The lantern is one of Newton's "patent electric lantern Microscope and micropolariscopes."

(4) Photomicrography.

Study of Growing Crystals by Instantaneous Photomicrography.*—Messrs. Richards and Archibald in their experiments used

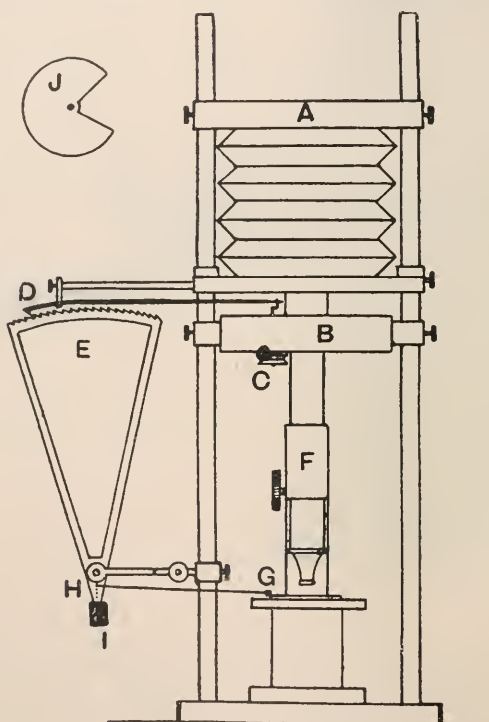

FIG. 80.

Bausch and Lomb's ordinary photomicrographic apparatus with a vertical camera. Between the Microscope *F* (fig. 80) and the camera, in a suitable light-tight box *B*, was placed a revolving shutter, which

* Amer. Chem. Journ., xxvi. (1901) pp. 61-74 (16 figs. and pls.).

allowed an exposure equal to one-fifth of the time of its revolution. Thus, when the shutter made two revolutions in a second, the exposure was one-tenth of a second. A Henrici hot-air motor, combined with speed-reducing double pulleys, enabled the experimenter to use any rate of revolution desired; the power was communicated by the pulley C. The rate was reasonably constant, but no attempt was made to make it absolutely so. The sensitive plate or gelatin film was held above in a suitable holder A, which was put in the place of the ground-glass plate used for focussing just before each series of exposures. In a first series of experiments it was arranged so that the image should be bright on a dark ground, and for this purpose it was found more convenient to move the crystallising solution than to move the photographic plate. For effecting this the slide G bearing the drop of liquid was attached by a wire to a point just below the centre of a segment provided above with saw-teeth E. The segment was moved gradually by the oscillating motion of a connecting-rod D, fastened by a crank to the revolving shutter at one end and playing into the saw-teeth on the other. In order to make the motion certain, the stroke of the connecting-rod slightly exceeded the distance between the saw-teeth. The segment was suspended in such a way that its centre of gravity coincided with its point of support, and the friction of its bearings was so adjusted that it would move easily, and yet remain stationary during the return stroke. I is a weight for balancing the segment. The distance through which the observed object was moved was easily varied by altering the relative lengths of the lever arms: holes H bored at distances varying from one-tenth to one-fiftieth mm. were generally used. The shutter was so arranged that during the exposure the segment and slide were at rest, the shift in position being effected during the four-fifths of the revolution through which the shutter was closed. Fig. 80 represents the apparatus an instant before an exposure begins. J is a horizontal projection of the revolving shutter in detail. The best light-source was found to be sunlight directed by a suitably arranged mirror and condensed by reflectors and lenses. The chief, though not serious, difficulty of this arrangement was the great heat caused by the converging rays, a difficulty which was obviated partially by an absorbent screen. The first trials were taken by reflected light, but were less satisfactory than those obtained by polarised light. The images were now much more clearly defined, but the magnification (30 diameters) was too low to warrant conclusions about the genesis of crystals. Among other substances, sodic nitrate, boric chloride, cupric sulphate, and ferrous ammoniac sulphate were found to give satisfactory images. A photomicrograph shows the crystals of sodic nitrate obtained under a higher magnification of 110 diameters with an exposure of $\cdot 12$ second. Light-ground illumination was now tried, as it was considered that an initial globular condition, if it ever existed, would probably not be visible through the nicols. The slide and crystallising solution were allowed to remain stationary, and a 2.5 in. Eastman cartridge gelatin film was moved as in the common film-carriers. At first a power of 100 diameters was employed, and very satisfactory pictures of the growth of crystals of potassic iodide were obtained. They do not, however, reveal anything new. Higher powers of magnification were used and

the utmost intensification of light obtained, but none of the results favoured the theory that crystals develop from a transitory liquid phase.

Stereo-Photomicrography.*—F. M. Duncan points out that as stereo-photomicrography comes under the head of low-power work the Microscope itself is not required; the Stephenson's prisms and objective being attached directly on to the front of the camera. These prisms obviate

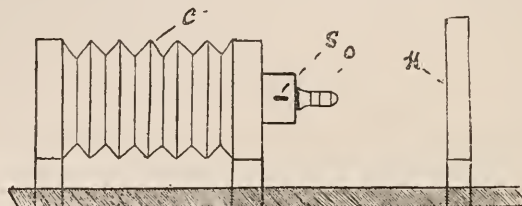

FIG. 81.

the necessity of cutting and transposing the photographs as in the case of ordinary stereoscopic work. The camera should be mounted on a travelling stage of sufficient length and breadth to afford a firm support to the camera when its bellows are racked out to their fullest extension. To the base of this camera-stage two grooved blocks of wood should be

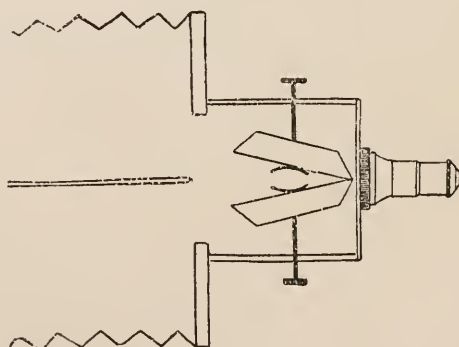

FIG. 82.

firmly attached, the grooves corresponding in angle to the two V-shaped rails which run the whole length of the baseboard. The baseboard to carry the camera, object-holder, &c. should be made of well-seasoned pine, 10 in. wide, 5 ft. long, and 1 in. thick. Fastened on the edge and running the entire length of the baseboard, there should be two V-shaped rails, on which the camera, &c. can be moved into the required position. The object-holder must be so constructed as to bring the specimen

* English Mech. and World of Science, lxxiv. (1901) pp. 354, 5 (2 figs.); and British Journal of Photography (loc. non cit.).

exactly in front of the lens, and in a central position. A small well-made box must be carefully constructed to carry the prisms and objective; or better still, a short wooden cylinder. In either case the interior must be perfectly smooth and painted a dead black, and at one end must be fastened a lens-flange for attaching the box or cylinder in such a manner as to be immediately behind the objective and as near to its back lens as possible. The prisms should be fitted with two adjusting screws capable of being manipulated from the sides of the box or cylinder, so that the angle at which the prisms are inclined to one another may be altered if necessary. Fig. 81 shows the apparatus in position: S is the adjusting screw of prism; O the micro-objective; and H the stage for carrying specimen. Fig. 82 shows the apparatus in place. A telescopic partition must be constructed to run through the length of the camera in an exactly central position. To obtain the best results a full exposure should be given, so as to obtain vigorous negatives full of detail with good contrasts.*

Panoramic View Camera.—In 1850 Andrew Pritchard, on p. 83 of his Appendix to *Optical Instruments*, in *Natural Philosophy*, Library of Useful Knowledge (1832), says, "In taking panoramic views M. Lerabours has ingeniously constructed a camera, the lens of which revolves about a vertical axis; the plate is curved, and a screen is interposed, which revolves with the lens; this screen has a slit opposite the centre of the lens, so that only a small part of the image impinges upon the plate at one time. By properly regulating the time and motion, to suit the varied brilliancy of the different parts of the landscape, and also by making the slit opposite the sky narrowest, a very perfect panoramic view is obtained."

It is needless, says E. M. Nelson, to point out to photographers that this description, now fifty years old, is precisely applicable to one of the latest forms of cameras, thereby proving that "there is nothing new under the sun."

If a similar adaptation were to be made to a microscopic camera, the object would have to be mounted upon a curved slide, while the negative plate remained a plane surface. This might be useful in taking low-power instantaneous photomicrographs of long and narrow objects such as living worms.

(5) Microscopical Optics and Manipulation.

The Black and White Dot Phenomenon.†—J. Rheinberg suggests that the origin of the black and white dot phenomenon in diatoms arises primarily from the fact that the perforations in a diatom form approximately vertical partitions between two media differing in refractive index. A certain portion of the light which impinges from below on the partition from the side of the denser medium, is reflected as at the surface of an ordinary mirror. Such reflected light is that which reaches the plane of partition beyond the critical angle. In consequence darkness is brought about on the less dense side of the partition in the space

* This method is essentially the same as that described by E. R. Turner, *Illustrated Ann. Microscopy*, 1900, p. 52.

† *Journ. Quek. Micr. Club*, viii. (Nov. 1901) pp. 113-8 (6 figs.).

where the light has been unable to get through from the side of greater density; and darkness is also brought about on the denser side of the partition because throughout the whole of a certain solid space a direct and a reflected wave-stream, emanating from the same points of the light-source, meet in opposite phase. Figs. 83-85 represent a diatom denser than the imbedding medium; in figs. 86-88 the imbedding material has the higher refractive index. In figs. 83 and 86 the light impinges at an angle greater than the critical angle; in figs. 84 and 87 at the critical angle; in figs. 85 and 88 at an angle less than the critical angle. The closely shaded portions (when uncrossed by other lines) show where no light has been able to get through; and it will be seen that no light reaches a space in the upper surface plane of the diatom just at or near one of the edges of the vertical walls forming the partition.

FIG. 83.

FIG. 84.

FIG. 85.

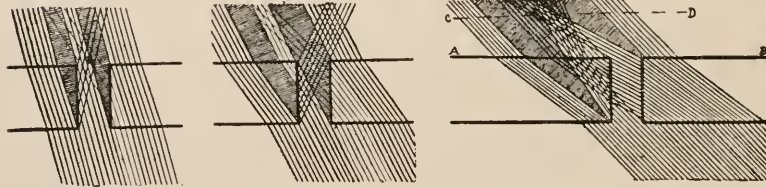
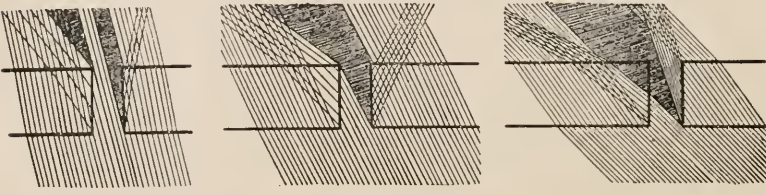

FIG. 86.

FIG. 87.

FIG. 88.

It will further be observed in figs. 83 and 84 and also in figs. 86 and 87, that the rays which impinge on to one of the vertical partitions are thrown back on themselves. A change of phase occurs where they are then reflected, and, if we take any point where one of these rays meets one of the unreflected rays, we find the two have travelled the same length of path and, being now in opposite phase, they cancel one another and produce darkness. Thus darkness is formed in the surface plane of the diatom both sides of the partition, though due to different causes in the two cases. There are, in fact, two bands of darkness which issue upwards from an angle to each other from the horizontal plane in which the top of the vertical partition lies, in the case of a diatom which is studded with perforations—in other words, with vertical positions—there is an immense number of the bands parallel to each other in each of the two directions forming a sort of trellis-work of light and darkness. And, as sections of trellis-work taken one below the other would show

alternately light and dark spaces, so do the diatoms when the focus is adjusted to different planes. Mr. Rheinberg prefers the black dot image, and gives full reasons for his preference, and states also that different effects will be produced, according to the different media in which the objects are mounted; and that the positions which the black and white dots take up are not the same, because careful examination will show that the rows of white dots occupy intermediate positions to those which the black dots previously occupied.

E. M. Nelson,* in discussing this subject, applied the same lens and illumination to diatoms marked with various degrees of fineness. He considers that Mr. Stokes is right in assigning to spherical aberration an important function, for in those cases where there is a white dot both above and below the black dot, the upper or lower white dot can be made the stronger or weaker, or both made alike, by means of screw-collar or tube-length adjustments. He has also reason for thinking that the upper black dots observed by Mr. Stokes with annular illumination must have been images of the stop at the back of the condenser. The examination of a considerable number of specimens has shown that there is more variety in the association of the blackness and whiteness than is commonly supposed. Thus a balsam-mounted *Pleurosigma formosum* generally has the white dot below; but Mr. Nelson has met with a reverse example. He finds, so far as he can measure it accurately, that the distance between the two dots is fairly constant at 3λ .

With regard to Mr. Rheinberg's papers, Mr. Nelson is of opinion, after many careful observations, that the white and black dots are exactly superimposed. This seems to be a fatal objection to the trellis-work theory, notwithstanding its interest and ingenuity.

In a paper read before the Quekett last March, Mr. Rheinberg returns to the study of the subject and admits that the two dots are superimposed. He then sums up the possible theories as four, viz. :—

(1) Spherical aberration by reason of the objective acting in zones, each zone having its own focus within certain limits.

(2) A pinhole effect.

(3) Crossing of bands arising from diffraction.

(4) Crossing of bands (or rather cones) formed by reason of the difference of refractive indices of the media, in accordance with the ordinary laws of total reflection beyond the critical angle.

He gives his reasons why the last should be preferred, and also suggests that "critical angle" rather than "trellis-work" theory is the more suitable short title. It has the following six points in its favour:—

(a) It will explain the appearances without recourse to other than the most ordinary and generally established optical laws.

(b) It accounts for the fact that wide-angled objectives will show the results better than narrow-angled ones; similarly it shows why wide cones are more favourable than narrow ones for the production of the appearances.

(c) It allows for the alteration of appearances due to spherical aberration, tube-length, &c. It can also be shown to harmonise with those changes at different foci caused by diffraction.

* Tom. cit. (April 1902) pp. 261-5 (5 figs.).

(d) It accounts for the appearances of edges of a transparent object, and of transparent isolated objects, as bacilli, &c.

(e) The dimensions of the perforations, particularly the relation of depth to width, account in the simplest way for the fact that sometimes the white dot is seen above and the black below, sometimes *vice versa*. It is simply a matter of an extra reflection at the wall.

(f) Different dimensions of the perforations explain the varying vertical distances between the black and white dots seen in different diatoms on the same slide.

(g) Lastly, the existence of patches on a diatom showing reverse order of the black and white dots can be accounted for by the difference of refractive index of the gum or other medium in which that portion of the diatom forming the patch is immersed.

B. Technique.*

(1) Collecting Objects, including Culture Processes.

Cultivation of Anaerobic Bacteria.†—Dr. Hammerl has elaborated a method for completely eliminating oxygen from anaerobic cultivations, and of obtaining oxygen-free nutrient media. Taking advantage of the fact that solutions of methylen-blue are colourless if every trace of oxygen is removed therefrom, he used this substance as an indicator, and added small quantities to his glucose-formate nutrient media. By prolonged heating in a water-bath or steamer he found he was able to drive off the dissolved oxygen from the depths of the medium in the tubes, although a coloured ring, some 1.5 cm. broad, at the upper part indicated the presence of oxygen at the surface.

On testing the various methods in general use for the production of a condition of anaerobiosis by means of the methylen-blue, all were found to be defective, traces at least of oxygen always being present in the media. He then employed fresh solutions of ammonium sulphate as the deoxidising agent. This substance does not inhibit the growth of bacteria, and if freshly prepared in the manner described by the author, gives highly satisfactory and concordant results.

The method described for preparing the fresh ammonium sulphate is as follows:—Fill 100 to 150 ccm. distilled water into a stoppered measuring cylinder, replace the stopper by a cotton-wool plug, and sterilise in the steamer together with a piece of glass tubing long enough to reach to the bottom of the measure, and some rubber tubing. When cool connect the glass tube to a reservoir of sulphuretted hydrogen gas by means of the rubber tubing, and pass the gas through the sterile water in the measuring cylinder for five or six minutes. Now fill exactly 10 ccm. of the H₂S water into each of several test-tubes (6 or 8), and add to the first tube 2 drops of a 1 p.c. solution of ammonia, to the second 4 drops, and so on, shaking each thoroughly to mix the contents. Finally add 3 drops of a concentrated alcoholic solution of methylen-blue to each tube, and note the length of time required to decolorise the

* This subdivision contains (1) Collecting Objects, including Culture Processes; (2) Preparing Objects; (3) Cutting, including Imbedding and Microtomes; (4) Staining and Injecting; (5) Mounting, including slides, preservative fluids, &c.; (6) Miscellaneous. † Centralbl. Bakt., 1^{te} Abt., xxx. (1901) pp. 658-64.

mixture. That number of drops of ammonia (probably between 4 and 8) which decolorises the methylen-blue in from $\frac{1}{4}$ to 1 minute is taken as the standard, and the necessary quantity calculated on this basis is added to the remainder of the sterile H_2S water in the measuring cylinder. After thoroughly mixing, this NH_4HS solution is added to each of the tubes of nutrient media in the proportion of 1 : 10.

Isolation of the Typhoid Bacillus.*—Dr. A. Moore recommends a modified Elsner agar medium for isolating the typhoid bacillus. 500 gm. of potato are scraped on a grater, and then macerated in a litre of water for 3 or 4 hours, strained and allowed to stand overnight. Next morning the supernatant fluid is decanted off and the volume made up to 1000 ccm. The liquid is then rendered distinctly alkaline and 20 gm. of agar added. The process is then continued as for ordinary agar. When sterile the medium is distributed into test-tubes, 10 ccm. in each, and immediately before use 0.5 of the following solution is added to each tube:—Potassium iodide 10 gm., water 50 ccm. The agar tubes thus contain 1 p.c. of potassium iodide. Plates made with this medium were sown with mixed cultures of the typhoid and coli bacilli and incubated for 24 hours at 37°. After this interval examination under a low power showed that the typhoid colonies were clear, transparent, with irregular clean-cut margins, while the coli colonies were larger, rounded, and opaque. By this procedure typhoid bacilli were isolated in pure culture from numerous artificial mixtures, from old typhoid dejecta, and from cockles suspected of causing an outbreak of typhoid fever.

The author also describes experiments with W-shaped tubes containing Parietti's serum-gelatin. Though successful for isolating any given strain of colon bacillus the method failed when applied to mixtures of different strains, and though possessing a certain value, was abandoned for the method given above.

Medium for Isolating Typhoid Bacilli.†—V. Drigalski and H. Couradi have constructed the following medium for isolating typhoid bacilli. (1) 3 lb. of beef are macerated in two litres of water for 24 hours. The beef extract is then boiled for an hour, and after having been filtered, 20 gm. pepton, 20 gm. nutrose, and 10 gm. salt are added. The mixture is then boiled for an hour, and after filtration 20 gm. of the best agar are added. After boiling for 3 hours the solution is rendered alkaline, filtered, and boiled for $\frac{1}{2}$ hour.

(2) 260 ccm. of litmus solution (Kubel-Tiemann) are boiled for 10 minutes, and then 30 gm. of chemically pure lactic acid are added. This mixture is boiled for 15 minutes.

(3) The two foregoing solutions, while still quite hot, are mixed together, and having been well shaken, 4 ccm. of a hot sterile solution of 10 per. cent. crystalline soda and 20 ccm. of a freshly prepared solution of 0.1 gm. crystal violet B. Höchst, in 100 ccm. of warm distilled water, are added. Plates are then made in the usual way.

The authors claim that a diagnosis of typhoid can be made by means of this medium always within 24 hours, the typhoid colonies being blue and quite transparent while the coli colonies are red and opaque.

* Brit. Med. Journ., 1902, i. pp. 703-4 (1 fig.).

† Zeitschr. Hyg. u. Infekt., xxxix. (1902) pp. 283-300 (1 fig.).

Adhesion-Cultures.*—P. Lindner describes the following method for examining mixed vegetations in artificial or natural media. A thin layer of the cultivation fluid is spread all over the under side of the cover-glass. The slip is then placed over the hollow of a ground-out slide and ringed round with vaselin.

Should it be desired to cut off or diminish the air-supply to this culture, another cover-slip of slightly less size is put over the film so that the medium is shut in between two glass surfaces. Over the drop culture this method has the special advantage of causing the vegetation to spread out in one plane so that the growth can be readily inspected and photographed.

(2) Preparing Objects.

Fixing and Staining Trypanosoma.†—J. R. Bradford and H. G. Plimmer made films by placing a small drop of the infected blood in one corner of a slide or of a slip, spreading it with a piece of goldbeater's skin, held in a pair of forceps. The edge should be quite straight and the width a little less than that of the slip. The best fixative results were obtained from the vapour of a mixture of equal parts of 2 p.c. osmic acid and glacial acetic acid, though 10 parts formalin with 90 parts absolute alcohol give very good results. Fixation by this latter mixture takes 5–10 minutes, after which the film must be well washed and then dried. The stains used were methylen-blue and erythrosin. The methylen-blue was a 1 p.c. M.B. med. pur. (Höchst) to which 0.5 p.c. potassium carbonate was added and the mixture incubated at 37° for 48 hours. When cold it is filtered and is then ready for use. The erythrosin (tetraiodide of fluorescein) was used in 0.001 p.c. solution with 0.25 p.c. formalin to prevent growth of moulds. When required for use, 20 ccm. of distilled water are put into each of two beakers, to one of which are added 20 drops of the erythrosin solution, and to the other 6 to 8 drops of the methylen-blue solution. The solutions are then mixed and poured into a flat dish in which the slides or slips to be stained have been already placed. In about 20 minutes the preparations are washed in distilled water till no more colour comes away, and are then allowed to dry in the air. No heat must be used for drying, otherwise the red colour will entirely disappear. They are then mounted, preferably in turpentine colophonium.

Method for Fixing Blood-Preparations.‡—Lenoble and Dominici expose the films to the vapour disengaged from a solution composed of perchloride of mercury and iodine, and stain with the Ehrlich triacid mixture. The fixative may be used in two strengths:—(1) Saturated solution of sublimate in 40 grm. of alcohol to which 6 grm. of tincture of iodine are added. (2) Saturated solution of sublimate in 35 grm. of alcohol and 15 grm. of tincture of iodine.

Method for Fixing and Staining Hæmatopoietic Tissue.§—Dominici fixes the material in a medium which has for its basis a mixture of alcoholic solution of iodine and aqueous solution of sublimate.

* Wochenschr. f. Brauerei, xviii. pp. 512–4. See Centralbl. Bakt., 2^o Abt., viii. (1902) p. 286.

† Quart. Journ. Micr. Sci., xlv. pp. 449–71 (2 pls.).

‡ C.R. Soc. Biol. de Paris, liv. (1902) pp. 223–5. § Tom. cit., pp. 221–3.

To this stock-fluid may be added formalin, chromic acid, Flemming's fluid, osmic acid, &c.

The stains used are eosin and orange G, 1 grm. each to 200 of distilled water. The preparations are washed in 60 p.c. alcohol, after which they are stained in toluidin-blue, 1 grm. to 200 of water. After decolorising in 60 p.c. alcohol and dehydrating in absolute alcohol, the preparations are mounted in xylol-balsam.

Fixation of Polychæta Embryos.*—A. Soulier when studying the early phases of the embryology of *Serpula*, fixed artificially fecundated ova at various stages of maturation with various fluids. Of those which contain osmic acid, Flemming, Fol's, and Cori's proved to give only moderately successful results. Much more satisfactory were the mixtures known as Gilson's, Roule's, and Ripart et Petit's. Gilson's fluid is composed of nitric acid 78 ccm., glacial acetic acid 22 ccm., sublimate 100 grm., alcohol 60 p.c. 500 ccm., distilled water 4400 ccm. Roule's fluid is a mixture of saturated solution of sublimate 80 ccm., and glacial acetic acid 20 ccm. Ripart et Petit's fluid contains chloride of copper 0.3 grm., acetate of copper 0.3 grm., glacial acetic acid 1 grm., distilled water 150 grm. One volume of any of these fixatives is mixed with three volumes of sea-water containing the ova. Their use does not necessitate a prolonged washing, and they do not interfere with the action of staining solutions.

Examining Nervous System of Sipunculus nudus.†—For examining *Sipunculus nudus* in the fresh condition H. von Mack obtained uncontracted specimens by adding at intervals 75 p.c. alcohol to the sea-water in which the animals were kept. 1 p.c. cocain solution was also very effective. For teasing-out or maceration-preparations Müller's fluid and nitric acid were used. Treatment with the former required several weeks, the tissue being afterwards stained with hæmatoxylin; with the latter in 20 p.c. solution 24 hours were sufficient, the pieces being afterwards washed with distilled water for 24 hours and then, having been mordanted with alum, stained with hæmatoxylin.

For sectioning pieces of tissue 1 cm. long, several fixatives were used, e.g. saturated solution of sublimate in 0.5–0.7 p.c. salt solution (15–20 hours), or Apáthy's sublimate-alcohol (16–24 hours). After either of these, washing in water, then graded alcohols (30 p.c., 50 p.c., 70 p.c.), and Apáthy's alcoholic iodopotassic iodide to 96 p.c. alcohol. This avoids the red precipitate of iodide of mercury which is deposited when the aqueous iodopotassic iodide is employed. Other fixatives used were equal volumes of 1 p.c. osmic acid and the salt-sublimate solution; $\frac{1}{4}$ p.c. osmic acid in sea-water; Flemming's mixture and Tellyesnický's fluid (acetic acid and bichromate of potassium).

The material was stained *en masse* in very dilute Delafield's hæmatoxylin, in Apáthy's hæmatein solution I.A., and by a combination of the two fluids. The first of these was $\frac{1}{10}$ – $\frac{1}{20}$ of the aqueous or alcoholic (30 p.c.) solution of Delafield's hæmatoxylin. Duration 6–8 days, after which distilled water and then dehydration in absolute alcohol. The Apáthy's solution took 5 days; the pieces being afterwards washed in

* Mém. Acad. Sci. et Lett. Montpellier, iii. (1901) pp. 1–7 (4 pls.).

† Arb. Zool. Inst. Wien, xiii. (1902) pp. 237–334 (5 pls.).

distilled water and then dehydrated as quickly as possible in absolute alcohol, as this extracts the colour. The third procedure was to stain first for a few days with Delafield and follow this with Apáthy's hæmatein. The sections were differentiated in 1 per thousand hydrochloric acid-alcohol. The plasma stains used were acid rubin, differentiated or not with acetic acid-alcohol or with picric acid. For double staining, borax-carmin and bleu de Lyon. After fixation with osmic acid the sections are examinable without staining, though safranin was employed in some cases. For differentiating nerve-fibrils Apáthy's gilding method was used.

Preparation of Radulæ.*—K. Diederichs remarks that snails are best killed with boiling water, and after removal of superfluous parts, the head should be boiled in caustic potash solution until the soft tissues can be easily removed from the radula. When thoroughly clean the preparation may be mounted in glycerin or in isinglass jelly. If mounted in balsam the preparation should be stained with some picrocarmin solution, for which the formulæ given in the April number are suitable.†

Fixing and Staining Phycchromaceæ.‡—R. Hegler fixed the material with saturated aqueous sulphurous acid 7 parts; 94 p.c. alcohol 93 parts, and after 12–14 hours washed it in alcohol. If there were much lime, he washed in running water or even fixed with 5 p.c. saturated SO₂ solution, 95 p.c. distilled water.

Formalin-alcohol (40 p.c. formalin 5 p.c. and 94 p.c. alcohol 95 p.c.), afterwards washing with 50 p.c. alcohol, sometimes gave good results.

The fixed material was imbedded in paraffin and sections made, or a small piece was squeezed flat between two cover-glasses. These preparations were placed in 50, 75, and 94 p.c. alcohol, and then after some days the cover-glasses were separated and placed in a mixture of 2 parts absolute alcohol, 1 part glycerin, and 1 part water. A third method was to make cover-glass films and preserve in the above-mentioned mixture.

The following methods gave the sharper staining of the central body:—Dissolve ammonia-alum 75 in water 750, and add glycerin 125, alcohol 100, saturated alcoholic solution of hæmatoxylin 25. Expose to light for several weeks and stain with 10 vols. to 100 vols. 1 p.c. formalin for 24 hours. Wash for 24 hours in running water, and differentiate in saturated alcoholic solution of picric acid 1 vol., water 1 vol., alcohol (94 p.c.) 2 vols. for a few seconds, wash in 75 p.c. alcohol and examine under Microscope. Instead of picric acid, 1 per thousand hydrochloric acid in 60 p.c. alcohol may be used. After differentiation the preparations are washed till they become blue, after which alcohol, toluol, dammar.

Another method is to fix in SO₂ alcohol, immerse for 2–4 hours in 1.5 p.c. iron-alum solution, and then, without rinsing in water, to treat with the following for at least 24 hours:—1 grm. hæmatoxylin, 200 water, 4 ccm. formalin (shake and filter). The preparations are next

* Zeitschr. angew. Mikr., vii. (1901) pp. 29–30 (1 pl.).

† See *ante*, p. 255.

‡ Jahrb. wiss. Bot., xxxvi. (1901) pp. 319–25 (2 pls.).

washed in running water for an hour. Any surface deposit is removed by means of 1 per thousand HCl alcohol. Differentiation with 0.5 p.c. iron-ammonia-alum solution or with hydrochloric acid and alcohol or picric acid and alcohol. Next frequent washing, and mounting as before.

Preparing Liver of Mollusca.* — P. Enriquez experienced much difficulty in fixing the liver of Mollusca, especially in warm weather. Most of the ordinary fixatives have a solvent action on these organs, so that the cells disappear and the hepatic framework only remains. The most satisfactory fixatives appear to have been, saturated aqueous solution of sublimate in 0.5–1 p.c. NaCl and in 5 p.c. acetic acid; chrom-osmic-acetic acid and Müller's fluid. By partially drying in the air fresh tissue, and then imbedding in gum and glycerin or in syrup and glycerin, decent sections were obtained. If these sections had to be treated with aqueous fluids they were stuck on the slide with a solution of gelatin at 50°–60°. The best staining results were given by hæmalum and thionin.

(3) Cutting, including Imbedding and Microtomes.

Standing's Imbedding Microtome. — This microtome (fig. 89), made by Messrs. R. and J. Beck, consists of a ball of wood surmounted by a tube, in the interior of which the object to be cut is imbedded. Over the tube is screwed a small table which is lowered to the requisite amount to cut the section. In the centre of the ball is a plug, by means of which the specimen is located in a convenient position preparatory to cutting. The whole of the upper portion being removable, the imbedding can be filled in from below.



FIG. 89.

Slide-Brake of Jung's Microtome.† — This is an accessory invented by the Heidelberg firm, with the assistance of Prof. Heidenhain, for increasing the stability of the slide-gear. It had been found that, owing to the thickness of the oil-layer or in the case of sections of unusual size or hardness, the section thicknesses were not perfectly uniform and sometimes exhibited variations of 0.5 μ . The contrivance for rectifying this is called the slide-brake (*Schlittenbremse*) and will be understood from the following description:—On each slide-track there is now attached a bar (*a*, fig. 90), and the slide *c* runs along and presses upon this by the interposition of a reel, or roller, *b*. This roller is fastened to the slide, not directly, but in the following way (fig. 91).

* Mittheil. Zool. Stat. Neapel, xv. (1901) pp. 281–407 (3 pls.).

† Zeitschr. f. wiss. Mikr., xviii. (1901) pp. 138–40 (2 figs.).

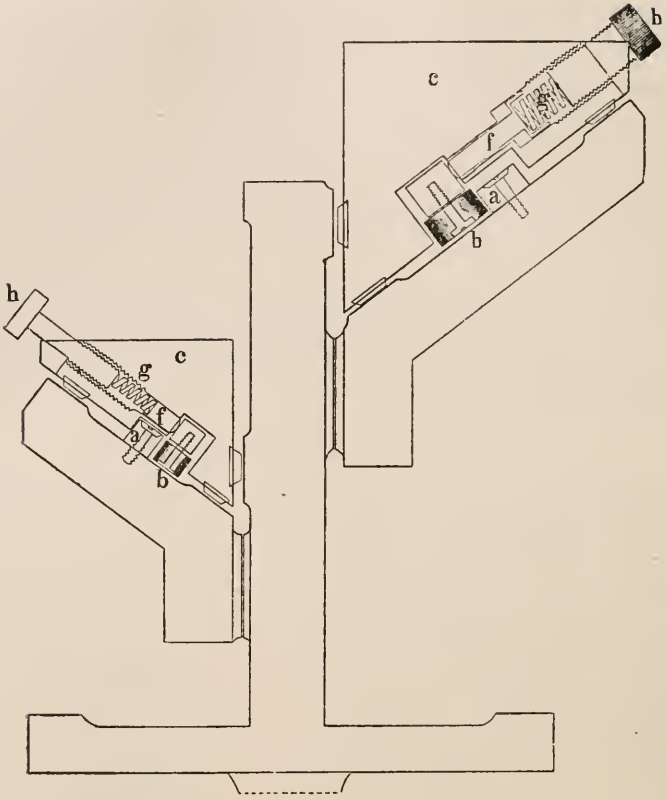

FIG. 90.

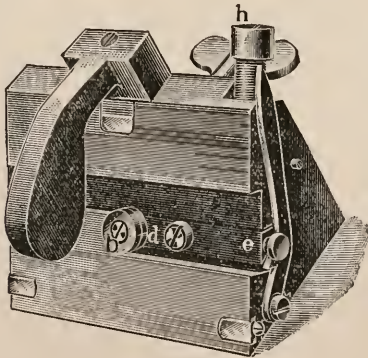

FIG. 91.

A two-armed lever *de* is secured to the underside of the slide, and to one end of the lever the roller is applied; on the other end (fig. 90) acts, by means of a bolt *f*, a strong spiral spring *g*, which can be tightened or relaxed by a screw (*h*, figs. 90 and 91). Screw, spring, and bolt lie in a perforated canal in the lower massive part of the slide. When the spring is tightened by the screw, the roller can therefore be raised and pressed as tightly as desired against the bar. The effect is to totally deprive the slide of anything like loose play. The spring pressure can obviously be varied at pleasure, and the slide can therefore be regulated as circumstances require. A secondary result is an increased pressure on the micrometer screw, which has therefore needed some strengthening. This slide-brake can be applied to existing microtomes of the Jung type.

Apparatus for Imbedding in Paraffin.*—Dr. P. Meissner describes a useful apparatus for imbedding objects in paraffin. It consists of a tank made of copper with a well sunk in at the top. The well is for the reception of a rectangular bath, and into the latter fits a wire cage in which the paper moulds are placed. Level with the bottom of the well is a pipe which connects by means of rubber tubing with a tank containing cold water. After the specimens have been satisfactorily oriented the paraffin is made to set by letting the cold water flow into the well. This device prevents the formation of air-bubbles. The pan or paraffin bath is then lifted out of the well and hung up outside the bath on the arms of two supports fixed to the top of the tank until the paraffin is completely set.

Rapid Method of making Permanent Preparations of Frozen Sections. †—J. H. Wright makes preparations fully equal to paraffin or celloidin sections by the following procedure:—A piece of tissue not exceeding 5 mm. in thickness is placed for 2 hours or more in 10 p.c. formalin, or may be boiled therein for 2 or 3 minutes. The sections made with a freezing microtome are floated on to a slide, and after the superfluous water has been run off are covered with a piece of cigarette paper. On this is placed a pad of filter paper, moistened with 95 p.c. alcohol, and after pressure has been applied the pad and cigarette paper are removed. The section is then flooded with absolute alcohol, and after this has been drained off a very thin solution of celloidin is allowed to run over the surface of the section to adjacent parts of the slide. After draining off any superfluous celloidin solution, the slide is flooded with 95 p.c. alcohol, and then at once plunged in water for 10 seconds. The section may now be stained by any method. It is then dehydrated in 95 p.c. alcohol, followed by a little absolute alcohol, after which it is cleared with oil of origanum and mounted in balsam. Alcohol or Zenker's fluid may be used for fixing instead of formalin, but then the piece of tissue must be thoroughly washed in water to remove the fixative.

This method not only prevents distortion of the section by dehydrating and clearing agents, but it also saves much time, and a diagnosis may be made within a few minutes after the specimen is received.

* Zeitschr. wiss. Mikr., xviii. (1902) pp. 286-8 (1 fig.).

† Mallory and Wright, Pathological Technique, Philadelphia, 1901, p. 417. See Journ. App. Microscopy, v. (1902) pp. 1670-1.

(4) Staining and Injecting.

Staining Malaria Parasites.*—G. Giemsa contends that methylen-azur is the effective agent in the solutions used for staining malaria parasites, and that the part played by the eosin salts of methylen-blue and methylen-violet has been much overrated. He mixes together 19 ccm. of 0.005 p.c. eosin (Höchst) solution and 1 ccm. of 0.08 p.c. solution of agar. The staining takes only a few minutes, and the preparations only require to be washed in water.

Method for Washing, Staining, and Dehydrating Small Specimens.†—The apparatus used by J. R. Slonaker for dehydrating, washing, or staining small objects consists of a circular board about 12 in. in diameter, on the radii of which are fastened a number of trough-like tin pieces for holding suitable sized vials securely. The wheel is made to revolve slowly (about once or twice a minute) in a vertical plane by any desired method, the writer making use of a water motor for the power, and an old clock gear to reduce the speed.

Intra vitam Staining of Fungi.‡—J. Plato and H. Guth record the appearances observed from *intra vitam* staining of *Penicillium brevicaulis* and some *Trichophyta*. The staining solution consisted of neutral red 1 to 50,000—100,000 physiological salt solution; when used so much KHO was added as to impart to the neutral red solution an orange-yellow hue. Pieces cut out of the margin of a 3 to 4 days' old culture were placed in flat capsules containing some of the staining solution. The piece was examined under a low power from time to time, and when the ends of the filaments were found to be stained (10 minutes to 1 hour) the piece of culture was placed on a slide and then a cover-glass applied, some distilled water being run under to prevent the preparation from drying.

New Method for Staining in Bulk.§—A. Spuler uses finely powdered cochineal boiled in distilled water, and after filtering evaporates nearly to dryness. The mass is then treated with alcohol, filtered and evaporated, after which it is dissolved in distilled water. In this solution the pieces are incubated for 24 hours or longer. They are then washed, and mordanted in a dilute iron-alum bath by which the colour is changed from red to black. After having been thoroughly washed the pieces are imbedded and sectioned.

For projection purposes this procedure is extremely suitable as the outlines are well defined and the colour black.

(5) Mounting, including Slides, Preservative Fluids, &c.

Preserving and Mounting Rotifera.||—C. F. Rousselet first isolates the rotifers, picking them up under a dissecting Microscope with a fine teat-pipette and then placing them in a watch-glass half full of perfectly

* Centralbl. Bakt., 1^o Abt. Orig., xxxi. (1902) pp. 429-30.

† Journ. App. Micr., v. (1902) pp. 1645-6 (1 fig.).

‡ Zeitschr. f. Hygiene u. Infekt., xxxviii. (1901) p. 319. See Centralbl. Bakt., 1^o Abt., xxxi. (1902) p. 190.

§ Deutsche Med. Wochenschr., xxvii. (1901) ver.-beil., p. 116.

|| Knowledge, xxv. (1902) pp. 68 and 91.

clean water. The animals are now narcotised with (1) 2 p.c. solution of hydrochlorate of cocain 3 parts, alcohol 1 part, water 6 parts; or (2) 1 p.c. aqueous solution of hydrochloride of eucaïn. The narcotic is added drop by drop until the movements slacken or almost cease, the time varying from 15 minutes to several hours, according to the species. The animals are next killed and fixed with $\frac{1}{4}$ p.c. osmic acid, with Flemming's chrom-aceto-osmic fluid, or with Hermann's platino-aceto-osmic mixture, the preference being given to the last. One drop of the fixative is sufficient. After a few minutes the animals are washed several times in clean water, for marine rotifers sea-water being used. The rotifers are then removed to $2\frac{1}{2}$ p.c. formalin, made by mixing 2.5 ccm. of commercial formaldehyde with 37.5 ccm. of water. In this fluid they may be kept, or mounted therein in ground-out cells or in shallow built-up cells. When mounting, place a drop of the formalin solution in the cell and transfer the rotifers. Place another drop of formalin by the side of the cell, lower the cover-slip on this drop, and then push the slip cautiously and gradually over the cell. The superfluous fluid is removed with blotting-paper and the cell closed with dammar gold-size cement. To do this, first run round a varnish consisting of two-thirds dammar in benzol and one-third gold-size, then two coats of pure shellac dissolved in alcohol, and finally 4 or 5 coats of pure gold-size, with an interval of 24 hours for each coat.

(6) Miscellaneous.

Method of Preserving Museum Specimens.*—H. Galt has found the following solution to give better results than the Kaiserling fluid for preserving museum specimens:—Common salt 5 oz., potassium nitrate 1 oz., chloral hydrate 1 oz., water 100 oz. The preliminary treatment consists in washing the specimen in water, and after properly trimming it immersing it in methylated spirits for a time corresponding to its size. 0.5 p.c. formalin may be added to the spirit.

Method for Demonstrating the Framework of Organs.†—Dr. J. M. Flint describes an extension of Spalteholz's method of demonstrating the framework of organs. The pieces should not exceed 3 mm. in thickness, the other dimensions being immaterial. The tissue from which the piece is taken is first fixed with Van Gehuchten's fluid (glacial acetic acid 10 parts, chloroform 30 parts, absolute alcohol 60 parts), or with graded alcohols. After fixation, the tissue is dehydrated and then transferred to ether, and the fat extracted in a Soxhlet apparatus. When all the free fat has been removed, the tissue is dehydrated in graded alcohols, and then having been again washed with water, is treated with pancreatin. The process of digestion is watched from time to time under the Microscope, and when digestion is complete nothing but the framework remains. When this stage is reached, the tissue is washed in distilled water and cleared with glycerin. The framework can then be studied with the stereoscopic Microscope.

After a study of the framework in the three dimensions, the piece may be cut up for permanent preparations. The glycerin is washed

* *Lancet*, 1901, ii. pp. 1334-5.

† *Johns Hopkins Hosp. Bull.*, xiii. (1902) pp. 48-52 (1 fig.).

out, and after imbedding in paraffin or celloidin, sections are made. These sections may be stained and mounted in various ways.

Burette for Removing Definite Quantities of Sterile Fluids.*—Dr. St. Epstein describes an apparatus for removing measured quantities of sterile fluids. It consists of a flask A (fig. 92), fitted with a cap C. In the cap are two openings, one for a side tube R plugged at Z with cotton-wool, the other D, melted into the cap, carries a burette B, the lower end of which can be closed at N by means of the rod K. The lower end of the burette is protected by the guard M, and its upper end

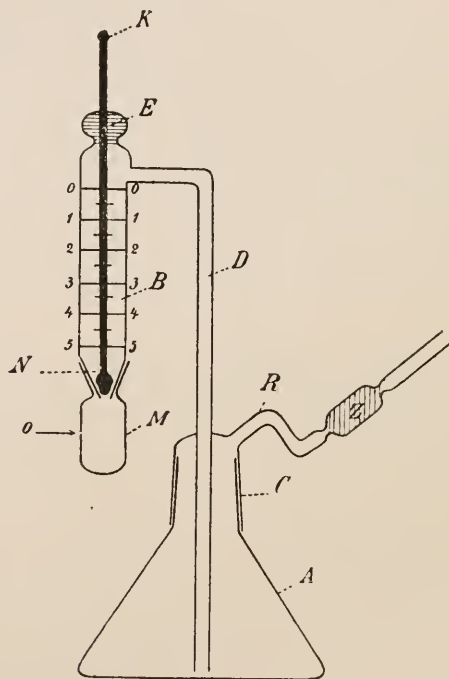

FIG. 92.

is plugged with cotton-wool E. The apparatus may be sterilised with or without fluid. By blowing down the tube R the sterile liquid in A is driven up into the burette B, from which any desired quantity can be removed by raising or turning the rod K. After use the cup-guard M is replaced and pressed against the end of the burette which is vaselined. In M is a minute hole o to let the air escape.

“Hanging-Block” Preparation for observing developing Bacteria.†—A. W. Hill cuts a cube of agar from a Petri dish of solidified jelly. The organism to be examined—taken from emulsions, from solid cul-

* *Centralbl. Bakt.*, 1^o Abt. Orig., xxxi. (1902) pp. 335-6 (1 fig.).

† *Proc. Amer. Soc. Bacteriol.* See *Journ. App. Microsc.*, v. (1902) p. 1713.

tures, or from a liquid culture—is smeared over the surface of the agar. After drying the cube at 37° for 10 minutes, a cover-glass is applied to the inoculated surface and sealed in place by running a little melted agar round the edges. The block and cover-glass are then placed over the opening in a moist chamber, the block lowermost, and the Microscope focussed upon the bacteria.

Ink for Writing on Glass.*—W. R. Hubbert states that the ink used at the University of Berne for writing on glass is very satisfactory. It consists of a mixture of 3 parts of a 13 p.c. solution of shellac in alcohol in the cold and 5 parts of the same strength solution of borax in distilled water. The solutions are mixed a drop at a time, and if a precipitate form the mixture is heated until clear. Methylene-blue is added to colour it a deep blue.

New Reversible Live-Box.—The live-box (fig. 93) exhibited by Mr. T. D. Ersser at the Meeting on April 16th, is specially intended for showing under the Microscope spiders building their webs; it is also adapted for a lantern-slide, the images being clearly defined when thrown on the screen.

The apparatus consists of two brass plates with a circular box

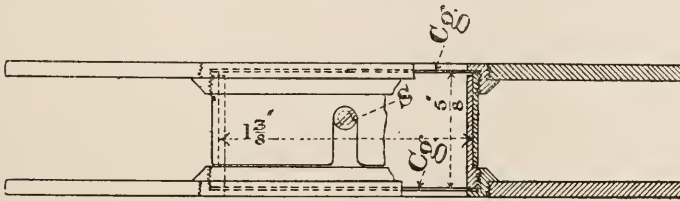

FIG. 93.

attachment to each, the one fitting over the other. A screw S, tapped into the inner box, passes through a slot cut in the outer one, thus keeping the two rings taut and in position. The box attachments when closed in with thin glass form a cell, the diameter of which is $1\frac{3}{8}$ in. and the depth $\frac{5}{8}$ in. They can be unscrewed for the purpose of replacing the cover-glass Cg.

Cattle Plague.†—M. Nicolle and Adil-Bey, continuing their researches on rinderpest, offer some general observations on the factors concerned in the filtration of fluids containing bacteria, such as the thickness and porosity of the filter bougie, the temperature and pressure at which the operation is conducted, the medium in which the organisms are suspended and the degree of concentration, and also the biological characters of the organisms with respect to size and motility. Under the term *Plasmisation* the authors describe an ingenious method of clearing turbid fluid as a preliminary to filtration. Plasmisation consists of the addition to any turbid fluid of one-tenth of its volume of horse's plasma (obtained by refrigerating the blood), mixing the fluids

* Journ. App. Micr., v. (1902) p. 1680.

† Ann. Inst. Pasteur, xvi. (1902) pp. 56-64.

intimately, and allowing coagulation to take place; the resulting clot carries down the suspended particles and allows the clear fluid to be decanted off.

As the result of their numerous experiments with the filtrates of various infective materials, e.g. brain emulsion, peritoneal fluid, fæces, &c., the authors conclude that the specific micro-organism of rinderpest is "invisible"—that it is too minute to be detected with any of the present combinations of microscopical lenses, or to be demonstrated by any known method of staining; and further, that under ordinary conditions the walls of the porcelain filter candle, Berkefeld or Chamberland, do not offer any resistance to its passage.

The authors further suggest that this organism habitually occurs within the bodies of the leucocytes, and cite the observations of Kolle, who centrifuged defibrinated virulent blood, and proved that whilst the serum thus obtained was inactive, the deposit remained virulent.

Trocar for the Aseptic Collection of Portions of Tumours.*—Dr. Cohn has devised what appears to be an extremely useful instrument for the purpose of removing portions of tumours, &c. for bacteriological examination.

It consists of a metal trocar and cannula (see fig. 94), the former having a small cavity *a* with cutting edges, excavated from the metal just above its point, the cavity being concealed in the cannula *e*, which in turn carries a movable disc *b*. The latter is clamped by the screw *c*, to regulate the depth of penetration of the point of the instrument. Sterilisation is easily effected either by boiling or by hot air. In using the instrument the point is plunged into the tumour, a half-turn of the handle releases a small bayonet-catch *d*, running in a slot in the cannula, and allows the point of the instrument to be protruded beyond the end of the cannula sufficiently to expose the cavity (as indicated by the dotted lines), into which some of the tissue naturally finds its way. Drawing back the handle of the instrument and returning the knob to its original position cuts off the enclosed piece of tissue, and at the same

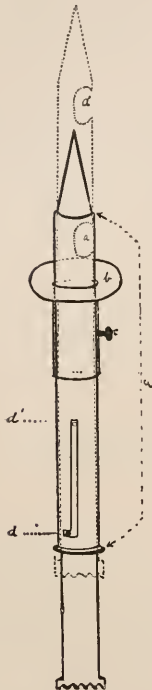

FIG. 94.

time protects it from accidental contamination when the instrument is finally removed from the tumour.

Properties of Steel Castings.†—J. O. Arnold has undertaken researches to ascertain the best standard composition for steel castings, and gives, by way of instalment, the results of his examination of nearly pure carbon-irons. Many specimens of such steels, as cast and as annealed, were tested. He concludes that pure iron and carbon steel is not a suitable material for fulfilling the modern specifications drafted

* Centralbl. Bakt., 1^o Abt., xxx. (1901) pp. 625-6.

† Metallographist, v. (1902) pp. 2-24 (13 figs.).

by engineers for steel castings. With iron and carbon castings the ductility demanded can be ensured with ease, but with such ductility it is impossible to correlate the required tenacity. The latter property, it is true, can be obtained from iron and carbon castings, but at the expense of an almost complete loss of ductility.

Alloys of Copper and Tin.*—W. Campbell, in a paper read before the Institution of Mechanical Engineers,† divides these alloys into seven classes according to their percentage of copper. The paper is illustrated by an excellent series of photographs, from which it appears that the branch *e* in the Roberts-Austen freezing-point curve of copper-tin alloys must be one of change in the solid. When the many and distinct different structures in the series, produced by quenching at different temperatures, and by reheating and then quenching, are considered, it is quite evident that the changes which take place during the cooling of a copper-tin alloy, especially in the neighbourhood of the second eutectic, are even more numerous than those of the carbon-irons.

BIBLIOGRAPHY.

GRUJNS, G.—Eine einfache Vorrichtung, um zu verhindern, dass beim Gebrauch des Brütapparates für konstante niedrige Temperatur, System Lautenschläger, wenn das Eis im Behälter ausgeht, das ungekühlte Wasser in den kalten Schrank fließt.

Centralbl. Bakt., 1^o Abt. Orig., XXXI. (1902) pp. 430-2 (3 figs.).

HUNZIKER, O. F.—Review of existing Methods for Cultivating Anaerobic Bacteria.

Journ. App. Micr., V. (1902) pp. 1694-7, 1741-58, 1800-13 (54 figs.).

KAISER, W.—Die Technik des modernen Mikroskopes. 2. gänzlich umgearbeitete Auflage, 8vo, mit vielen Abbildungen. (Technique of the Modern Microscope. Second and completely revised edition, with numerous illustrations.)

Vienna, Pertes, 1901.

WEISSENBERG, H.—Ein registrierender Bakterien-Spirometer. (An apparatus for registering the evolution of nitrogen by denitrifying bacteria.)

Centralbl. Bakt., 2^o Abt., VIII. (1902) pp. 370-7 (2 figs.).

* Nature, No. 1685, pp. 354-6 (10 figs.).

† December 20, 1901.

PROCEEDINGS OF THE SOCIETY.

MEETING

HELD ON THE 16TH OF APRIL, 1902, AT 20 HANOVER SQUARE, W.
DR. HENRY WOODWARD, F.R.S., PRESIDENT, IN THE CHAIR.

The Minutes of the Meeting of 19th of March, 1902, were read and confirmed, and were signed by the President.

The List of Donations to the Society, exclusive of exchanges and reprints, received since the last Meeting, was read, and the thanks of the Society were voted to the donors.

	From
Miquel & Cambier, <i>Traité de Bactériologie</i> . (8vo, Paris, 1902)..	<i>The Publisher.</i>
Parkinson, S., <i>A Treatise on Optics</i> . (8vo, London, 1859) ..	<i>Mr. E. M. Nelson.</i>
Quarterly Journal of Microscopical Science and Transactions of the Microscopical Society. Vol. iii. (8vo, London, 1855) .. }	<i>Mr. E. M. Nelson.</i>
Bird, Dr. Golding, <i>Urinary Deposits</i> . (8vo, London, 1857) ..	<i>The Publishers.</i>
A "Lenticular Microscope"	<i>Mr. J. Pillischer.</i>

The President, in reference to the old Microscope by Pillischer presented to the Society, regretted the absence of Mr. Nelson, who had intended to say something about it. It appeared to be a most compact little instrument, and most complete, in its way, for the examination of urinary deposits, &c. by a medical man.

Dr. Golding Bird's description of it was then read by Dr. Hebb, as follows:—

"It has often been a matter of regret that a very portable Microscope has not hitherto been contrived, sufficiently small to be easily carried in the pocket, and sufficiently economical to be within the reach of all. Very recently Mr. Pillischer has constructed one, which he terms the "Lenticular Microscope," which seems to me to fulfil this condition entirely, and I cannot too strongly recommend it to the notice of the profession. In the construction of this beautiful little instrument he has made use of the excellent and well-known Coddington lens, which consists of a very thick double-convex lens, excavated at the sides into a kind of dumb-bell shape, by which the extreme lateral rays are cut off, and a very perfect image obtained.

"It consists of a rectangular piece of brass, excavated at one end, furnished with raised sides. To the inner surface of the side a steel spring is fixed, for the purpose of keeping the piece of glass on which the object is placed quite steady. At the under surface a brass arm is fixed bearing a small concave mirror. A perforated diaphragm is fixed to a pin beneath an aperture in the plate, so that by moving it the pencil of rays reflected from the mirror may be lessened, and a clearer definition obtained. A strong arm of brass is capable of being moved horizontally over the aperture in the plate, whilst a fine screw movement enables it to be raised vertically. The lenses, having respectively a

focal length of about $\frac{1}{4}$, $\frac{1}{20}$, and $\frac{1}{25}$ of an inch each, are placed in a split cylinder at the end of the arm. When not in use the arm to which the mirror is attached is folded up flat against the under surface of the plate, and thus the whole apparatus can be carried in the waistcoat-pocket. To use this instrument, a drop of urine containing a deposit is placed on a slip of glass, and covered with a piece of mica or thin glass. It is then placed on the plate, on which the spring firmly retains it. One of the lenses being then placed in the cylinder, the object is brought into focus by means of the screw, illumination being effected by holding up the instrument to the light of the clouds or a candle, or, still better, by reflecting a ray of light through the object by means of the mirror. If the object is very translucent, especially when epithelial cells are searched for, the amount of transmitted light should be diminished by means of the diaphragm. Should the deposit consist of large coarse crystals, it is better placed in a little cavity ground in a plate of glass (which accompanies the instrument), as they will thus escape injury when covered with the piece of thin glass for examination."

Also the following note by Mr. E. M. Nelson:—

"It seems an excellent idea, and would, when fitted with achromatic lenses in place of the Coddingtons, be most useful to diatom gatherers and other searchers after small forms."

The President said their thanks were due to Mr. Pillischer for the gift of this Microscope, which would be a valuable addition to their historical collection, and no doubt would be of great interest to those who had given their attention to the history of the Microscope.

Mr. C. Beck exhibited and described "Standing's Imbedding Microtome." He also called attention to some gratings ruled by Mr. Grayson of Melbourne, which had been brought from Australia by Mr. Wedeles, and were exhibited in the room that evening. He thought those who examined them would agree with him that they were at least equal to anything which had yet been produced. The distinctness with which they could be seen was largely due to the way in which they were mounted, the medium employed being realgar having a refractive index of 2.5. He thought it would be remembered that Mr. Nelson had referred to these at their meeting in June 1898,* and also in his Presidential Address in 1899,† as being the finest he had ever seen.

Mr. Wedeles, in reply to the President, said that these rulings had been so fully described by Mr. Nelson that no further explanation seemed to be necessary. He might, however, mention that the bands were spaced $\frac{1}{20000}$ and that the finest ruling was 120,000 to the inch. Mr. Grayson had been very much engaged lately at the Melbourne University, but had recently made a new machine with which he hoped to do something still better. The great difficulty in the matter was to get a suitable piece of diamond for the purpose. The slides which had hitherto been ruled had not been made with any idea of commercial profit, but entirely from scientific interest. Mr. Grayson had spent any amount of time and money on this work and was now hoping to be able to give some further attention to it.

The thanks of the Meeting were unanimously voted to Mr. Beck and to Mr. Wedeles.

* This Journal, 1898, pp. 690-1.

† Op. cit., 1899, p. 123.

Mr. J. C. Webb, F.E.S., exhibited an old Microscope by Pritchard, which he had purchased from a friend, in whose possession it had been for forty years. Mr. Nelson said he had not seen one like it before, and asked him to bring it down for exhibition. There was nothing about it to indicate the date, but so far as he could judge it was made by Pritchard prior to the date of his Engiscope which was brought out in 1832. Amongst other things it possessed an arrangement for protecting the objective from injury; the eye-piece was triple and gave very good definition; there was a fine adjustment, and the body could be removed so as to use the instrument as a dissecting Microscope. The lenses were not achromatic, but they were fairly good. Taken as a whole the instrument was a fine specimen of mechanical skill, for it must be borne in mind that machine tools were almost unknown at the time it was made.

The thanks of the Meeting were voted to Mr. Webb for his interesting exhibit.

Mr. Ersser exhibited a reversible live-box which was intended to facilitate observations on large living objects, such as spiders whilst spinning their webs.

The President thought this seemed likely to be very useful in the examination of live insects of considerable size, which could not be put into the ordinary live-boxes in common use.

The thanks of the Meeting were, on the motion of the President, voted to Mr. Ersser for this exhibit.

Mr. T. Powell, in replying to an inquiry from the President, said that he was exhibiting on a Microscope in the room one of his new semi-apochromatic objectives of $\frac{1}{2}$ -in. focus and numerical aperture of 1.4. One feature of this series was that they were made of glass which would stand any climate without deterioration, and they were also comparatively inexpensive, the price of the one on the table being 5*l.*

The President said they had no papers to be read that evening, but they would find plenty of interest in the very splendid exhibition of pond life, for which they were indebted to some of the Fellows of the Society and to the Members of the Quekett Microscopical Club, to whom he was sure all who were present would be glad to express their thanks. It was a matter of no small trouble—not only to bring Microscopes there and to arrange them, but also to collect and prepare these living objects, especially so fine a series as they had in the room that night. The exhibition of live objects from a pond took him back to the time when a past President of their Society, the late Mr. H. J. Slack, brought out his book *The Marvels of Pond Life*, and now, after the lapse of forty-one years, they could still turn with interest to the same pursuit, for there was no subject which excited more general interest, either at their own Society or at the Quekett Microscopical Club. He was reminded, also, of a review of Mr. Slack's book by Dr. S. P. Woodward, in which he pointed out how easy it was to visit the suburbs of London and to find in a pond which in itself did not look at all attractive, living objects of the greatest beauty. In those days one need not go very far away for this purpose—to Copenhagen Fields, for instance, where the Cattle Market now stood,

to Blackbeath Common, Highgate, or Hampstead, or to many other places equally near, which had long since fallen a prey to the speculative builder. At the present day they must go farther afield to find the ponds, but wherever they were found, they could still obtain an abundance of beautiful objects. He would now ask those present to examine the exhibits on the tables before them, and he felt sure they would find there was enough of beauty to justify his eulogium.

The Secretary read a letter from the Society of Marine Engineers, inviting the Fellows of the Society to a lecture by Mr. Houghton on "The Microscopic Structure of Iron and Steel."

New Fellow:—Mr. Charles R. Chichester was elected an *Ordinary* Fellow of the Society.

The following Instruments, Objects, &c., were exhibited:—

Messrs. R. and J. Beck:—Standing's Imbedding Microtome. Grayson's Rulings: 1, Test-plate of 10 bands, the rulings ranging from 1000 to 10,000 lines per inch; 2, Micrometer, divided into $\frac{1}{100}$ ths and $\frac{1}{1000}$ ths of an inch, and into $\frac{1}{4}$ ths, $\frac{1}{10}$ ths, and $\frac{1}{100}$ ths of a millimetre; 3, Test-plate of 12 bands, the rulings ranging from 5000 to 60,000 lines per inch.

Mr. T. D. Ersser:—A Reversible Live-box, and a similar box with Web of Spider spun in it.

Messrs. Powell and Lealand:—A new Semi-Apochromatic Homogeneous-Immersion $\frac{1}{2}$ in. Objective of 1.4 N.A.

Mr. J. C. Webb:—An old Microscope by Andrew Pritchard.

Mr. E. Bartlett:—*Chara vulgaris*, showing cyclosis.

Mr. A. Dennis:—*Limnias annulatus*.

Mr. A. J. French:—Larva of May-Fly.

Mr. G. T. Harris:—Cyclosis in Closterium.

Mr. A. Hilton:—Stentors.

Mr. E. Hinton:—*Batrachospermum vagum*.

Mr. J. Hood:—*Stephanoceros Eichhorni*; *Melicerta ringens*; *Limnias Ceratophylli*; *Plumatella repens*, emerging from Statoblast.

Mr. K. J. Marks:—*Philodina megalotrocha*.

Mr. M. Poser:—*Lophopus crystallinus*.

Mr. G. H. J. Rogers:—*Cristatella mucedo*, young colony.

Mr. C. F. Rousselet:—Brachionus, Synchronæ, Anuræa, &c.

Mr. D. J. Scourfield:—*Acroperus harpæ*.

Mr. C. J. H. Sidwell:—Olfactory Setæ on Antennule of *Acroperus harpæ* $\times 400$.

Mr. C. D. Soar:—*Atax ypsilophorus*.

Mr. H. Taverner:—*Atax ypsilophorus*, ventral view.

Mr. W. R. Traviss:—Phantom Larva.

Mr. A. Verinder:—*Stephanoceros Eichhorni*.

Mr. W. Wesché:—*Brachionus quadratus*.

MEETING

HELD ON THE 21ST OF MAY, 1902, AT 20 HANOVER SQUARE, W.,
DR. HENRY WOODWARD, F.R.S., PRESIDENT, IN THE CHAIR.

The Minutes of the Meeting of the 16th of April, 1902, were read and confirmed, and were signed by the President.

The List of Donations to the Society (exclusive of exchanges and reprints), received since the last Meeting, was read, and the thanks of the Society were voted to the donors.

	From
Gerard, John, <i>Herbal</i> (4to, London, 1633)	
Curtis, Wm., <i>Flora Londinensis</i> (2 vols. folio, London, 1777-98)	
Sprengel, C. K., <i>Das entdeckte Geheimniß der Natur</i> (4to, Berlin, 1793)	
Cooke, M. C., <i>Handbook of British Hepaticæ</i> (8vo, London, 1894)	
" " <i>Introduction to the Study of Fungi</i> (8vo, London, 1895)	
Darwin, Chas., <i>Cross- and Self-Fertilisation of Plants</i> (8vo, London, 1876)	
" " <i>Forms of Flowers</i> (8vo, London, 1875)	
" " <i>Insectivorous Plants</i> (8vo, London, 1877)	
Darwin, C. and F., <i>The Movements of Plants</i> (8vo, London, 1880)	The Executors of the late A. W. Bennett.
Harvey, W. H., <i>A Manual of the British Marine Algeæ</i> (8vo, London, 1849)	
Massee, G., <i>British Fungus Flora</i> (4 vols. 8vo, London, 1892-5)	
" " <i>Text-Book of Plant Diseases</i> (8vo, London, 1899)	
Smith, W. G., <i>Diseases of Field and Garden Crops</i> (8vo, London, 1884)	
Tubœuf and Smith, <i>Diseases of Plants induced by Cryptogamic Parasites</i> (8vo, London, 1897)	
Wolle, F., <i>Freshwater Algeæ of the United States</i> (2 vols. 8vo, Bethlehem, Pa. U.S.A., 1887)	
Chase, Dr. H. H., <i>Index Diatomacearum</i> (4to, T-W, Linden, Mich. U.S.A., 1894)	Donald S. Arbutnott, Esq
Photographic Portrait of the late R. Macer	
Two Pieces of Apparatus designed by the late R. Macer for exhibiting Flies, &c. feeding	Mrs. Macer.
Photomicrograph of <i>Pleurosigma angulatum</i>	Mr. F. E. Ives.
Cornelius Varley's Patent Graphic Telescope	Mr. E. M. Nelson.
Cretaceous Deposit from Zululand	Mr. A. W. Cooper.
Braithwaite, R., <i>British Moss Flora</i> , pt. xxi. (4to, London, 1902)	The Author.

Dr. Hebb called attention to several of the donations, particularly to a bequest of 20 volumes left to the Society by the late Mr. A. W. Bennett, which included a copy of Gerard's *Herbal*, 1633, and William Curtis's *Flora Londinensis*, 1777 to 1798. There was also an elaborate

type-written volume, *Index Diatomacearum*, presented by Mr. D. S. Arbuthnot. With the photograph of the late Mr. Macer, there were also two small pieces of apparatus with which he used to exhibit the action of the proboscis of a fly when feeding.

The photograph of *Pleurosigma angulatum* was considered by Mr. Nelson to be a most perfect representation of what was to be seen in that diatom. Varley's Graphic Telescope, presented by Mr. Nelson, would also be an interesting addition to their collection. A quantity of cretaceous deposit from Zululand had been sent to the Society for distribution, samples of which could be obtained on application to the Assistant Secretary.

Messrs. W. G. Pye and Co. sent for exhibition a table cathetometer for observing the torsion of mineral fibres, growth of plants, &c. They also sent two new pattern reading Microscopes, one right and one left hand, each having a traverse of 30 mm., and a vernier reading of 0.05 mm.

Mr. J. C. Webb exhibited an old Microscope bearing the name of "Carpenter and Westley, Regent Street, London," which, he stated, he had recently been fortunate to rescue from oblivion. The Microscope somewhat resembled the "Pritchard" Microscope which he exhibited at the last meeting of the Society, inasmuch as the stage was made to rack up to the body instead of the body racking down to the stage, whilst the stand was capable of being converted into a simple dissecting Microscope by unscrewing the body and inserting a simple lens in its place. The instrument was furnished with one ordinary eye-piece and a dividing objective capable of conversion into 1 in., $\frac{1}{2}$ in., and $\frac{1}{4}$ in. powers. Mr. Webb further stated that he had seen the present representative of the firm of Carpenter and Westley on the matter, and was informed by him that the Microscope was one of those sold by the firm between 1832 and 1840, and was probably made for them by Powell or Ross.

The President, in thanking Mr. Webb for his exhibit, thought that if this Microscope was made in 1832, it must have been considerably in advance of those of that period. He recalled the fact that the Society of Arts had offered a prize for the best Microscope to be produced at the lowest possible price, and that this was awarded to Field, of Birmingham, in or about the year 1858. He was asked at the time to write a short description of this instrument to accompany it as a hand-book. The instrument exhibited by Mr. Webb reminded him of Field's small prize Microscope.

Mr. T. D. Ersser brought for exhibition a new acetylene illuminator for the lantern, which he claimed would give a light of 300 candle-power for 3 hours at a cost of 9d. Unfortunately the demonstration of its utility for the purpose was not successful, owing to some difficulty in manipulating the lantern.

Mr. J. J. Vezey said there was nothing new in the use of acetylene light for lantern work, but he understood Mr. Ersser to say that he

burnt it in an argand burner; if this was correct, he should be sorry to be in the room while the light was going. Most people knew what an unpleasant smell and smoke were given out when a burner was not properly adapted for the consumption of acetylene.

The President said that in giving a lecture some years ago at Peterborough, acetylene was used for the lantern. The light was very excellent, but the heat was so intense that it cracked the cold lens of the lantern, and after this his slides appeared with a black flaw across the object. When staying this year at an hotel in Italy, where acetylene was used, the gas gave an excellent light, but it needed great attention, a man having to clear out the burners almost nightly, the acetylene frequently emitting a quantity of black smoke from imperfect combustion. He believed, also, that great complaints had lately been made about its use by the drivers of the London General Omnibus Company, on account of the powerful odour of garlic emitted from the lamps.

Mr. D. J. Scourfield, being called upon by the President to give some explanation of the exhibition of Fresh-water Entomostraca which he had arranged in the room, said that he had not attempted to make this an exhibition of all the orders of the Entomostraca, neither had he followed a scientific classification in the arrangement of the specimens, but had confined himself to the Cladocera, and to the illustration of the various habits of life and powers of movement shown by these animals, ranging from the free-swimming forms found in lakes to those which simply crawled about in or on the mud. In addition to their transparency the characteristics of the lake or "plankton" forms were: great development of the swimming organs (*Leptodora hyalina* *), or the possession of long spines and other outgrowths (*Daphnia kahlbergensis*, *Bosmina longirostris*, *Bythotrephes longimanus*), or the production of a mass of jelly serving probably as a float (*Holopedium gibberum*). Next to these came the species which might best be described as the continually hopping forms. They could not cling to weeds and yet were not adapted for life in the open water of lakes. They had to maintain themselves in the water by constant and laborious movements of their comparatively weak swimming antennæ (*Daphnia pulex*, *D. magna*). Then followed the species which did not swim unless they were obliged to, for they possessed the means of attaching themselves to weeds, &c., and made full use of their powers. The attachment was brought about in various ways. In some cases (*Simocephalus vetulus*) minute hooks on two of the antennal setæ enabled the animals to cling to solid objects in the water; in others (*Camptocercus rectirostris*, *Pleuroxus aduncus*, *Chydorus sphaericus*), the clinging was brought about by hooked setæ on the feet; and in yet other cases (*Graptoleberis testudinaria*) the attachment was made apparently by the setæ on the ventral margin of the shell. There was one of these clinging species (*Scapholeberis mucronata*), which had even discovered how to make use of the surface film of water for support. Lastly, there were the bottom and mud-loving species, some of which could indeed swim when necessary (*Macrothrix laticornis*,

* The species mentioned are those included in the exhibition; they are of course, as a rule, only representatives of their respective groups.

Leydigia quadrangularis), but others had lost all power of swimming (*Ulyocryptus sordidus*) and only used their large antennæ and post-abdomen for pushing themselves about in the mud. Mr. Scourfield said he feared the exhibition was not a very good one from the "pretty object" point of view, but thought it would be found fairly representative of the various habits of life of the different animals included in the order Cladocera. Most of the living specimens were exhibited in Rousselet live-boxes, but he had also shown a specimen (*Daphnia magna*) in another way to illustrate a method of examining the swimming movements of Entomostraca. In this arrangement the head of the animal was attached to a pin by means of a small drop of sealing-wax varnish, and it would be seen that the creature could carry on all its movements quite freely without being able to get out of the field of view. He should be very glad if the result of an exhibition of this kind were to excite more interest in this class of creature, and to induce other microscopists to take up their study.

The President thought it would be hardly necessary to ask the Fellows to vote their thanks to Mr. Scourfield for this very interesting exhibition which he had taken a great deal of trouble to arrange for their inspection.

The thanks of the Meeting were then unanimously voted to Mr. Scourfield.

Dr. Hebb said he had much pleasure in announcing that the Hon. Walter Rothschild had most kindly invited the Fellows of the Society to visit his Museum at Tring, on Saturday, June 21. Those who desired to go should send in their names, on or before May 31, to the Assistant Secretary, from whom further information relative to the excursion could be obtained. The number of the party was limited to 50, and if more than that number of applications were received a ballot would be taken to decide who should receive cards of invitation. Another excursion, limited to about 30, had also been arranged for Saturday, July 5, to the Zoological Gardens. He should like to add that these invitations were entirely due to the initiative of the President, and also that Mr. Rothschild had promised to provide vehicles for the conveyance of the party to and from the station.

The President said he was sorry they could not go down to Tring 100 or 200 strong, but it was obvious that many might not care about taking part in such a large gathering, which would also be very difficult to arrange for. He thought it probable that Mr. Charles Rothschild, if he had returned home from America by the date named, might be willing to exhibit some of his microscopical collections.

As regarded Dr. Selater's invitation to visit the Zoological Society's Gardens, there was no reason why, although a Microscopical Society, they should not sometimes indulge in macroscopic studies, and that the idea of providing some out-of-door form of recreation for the Fellows would not be considered too frivolous. On some future occasion they might arrange a series of afternoon visits to the Natural History Museum, when their late President, Mr. Carruthers, would no doubt be happy to conduct them through the Botanical department, whilst he himself would gladly do the same in the Geological galleries, where

they might see that the Entomostraca of to-day were the survivors of a very ancient race, as shown by their fossil remains in the rocks, where bivalved forms were abundantly represented, some being of gigantic size. Such visits to the Museum would be found both interesting and instructive, and the place itself a very different one from what it was to people who, wandering aimlessly through the building, seemed only to be trying how many miles they could cover in the course of an afternoon. The late Prince Consort always insisted upon a systematic way of visiting the Museum, and would not allow the Royal family to roam about the galleries, but invariably arranged beforehand what they were to be shown, and they were at once taken to that particular part of the collection, and after having seen it, and had it explained to them, the visit ended. Museum headaches and boredom are thus avoided.

The following Instruments, Objects, &c., were exhibited:—

Mr. T. D. Ersser:—Acetylene Gas as an Illuminant for the Lantern, with Illustrations thrown on the Screen.

Messrs. W. W. G. Pye and Co.:—A pair of New Pattern Reading Microscopes, and a Short Table Cathetometer.

Mr. J. C. Webb:—An Old Microscope by Carpenter and Westley.

Mr. D. J. Scourfield:—*Bythotrephes longimanus* (preserved in formalin); *Leptodora hyalina* (preserved in formalin); *Leydigia quadrangularis* (living); *Daphnia magna* (ephippial female); *Camptocercus rectirostris* (living); *Chydorus sphaericus* (living); *Graptoleberis testudinaria* (living); *Pleuroxis aduncus* (living); *Scapholeberis mucronata* (preserved in alcohol); *Simocephalus vetulus* (living); *Ilyocryptus sordidus* (living); *Macrothrix laticornis* (living).

New Fellows:—Mr. John Edward Lord; Mr. Max Poser.

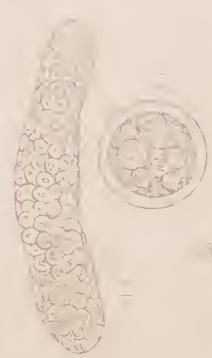
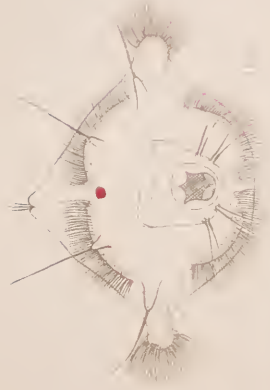

JOURNAL
OF THE
ROYAL MICROSCOPICAL SOCIETY.

AUGUST 1902.

TRANSACTIONS OF THE SOCIETY.

VII. (continued).—*The Genus Synchæta* :
A Monographic Study, with Descriptions of Five New Species.

By CHARLES F. ROUSSELET, Curator and F.R.M.S.

(Read June 18th, 1902.)

Synchæta longipes Gosse.

Pl. IV. fig. 5.

BIBLIOGRAPHY.

- GOSSE, P. H.—Twenty-four new Species of Rotifera. Journ. Roy. Micr. Soc., 1887, p. 5, pl. II. fig. 15.
HOOD, JOHN—Chats about Rotifers. Science Gossip, 1887, p. 220.
HUDSON & GOSSE.—The Rotifera. Supplement. London, 1889, p. 17, pl. 31, fig. 4.

Spec. Char.—Body wide and triangular in front; rounded, almost globular posteriorly, possessing a long foot carrying two acute toes; four frontal styles; broad pendent auricles; eye red, cervical. Largest size 204μ ($\frac{1}{125}$ in.) long by 95μ ($\frac{1}{267}$ in.) wide at the auricles. Lacustrine.

First found by Mr. John Hood near Dundee, this well marked species was described by Mr. P. H. Gosse in one of the last papers he wrote. The figure accompanying the description must unfortunately have been made from a very abnormal specimen, and it

EXPLANATION OF PLATE VI.

- Fig. 11.—*Synchæta baltica* Ehrbg. ♀ Dorsal view. $\times 180$.
" 11a " " " Front view of head. $\times 180$.
" 12 " *monopus* Plate ♀ Dorsal view. $\times 350$.
" 12a " " " Front of head. $\times 350$.
" 13 and 13a.—Parasites from body-cavity of *S. pectinata*. $\times 650$.
August 20th, 1902 2 D

does not give a good idea of the creature. I have met with it three or four times in the middle of the summer round London, at Hanwell, Woking, and near St. Helens in Lancashire, and from these Mr. Dixon-Nuttall has made the accompanying excellent drawing, but it is rather a rare species not often seen.

The body is very rounded and globular behind, not unlike a wine-glass in shape, the stem of which is represented by the long foot. The head is abnormally large, slightly compressed dorso-ventrally and broad at the auricles, advancing to a regular point in front, and thus giving it almost the shape of an equilateral triangle. The front of the head bears the usual four styles, the outer pair being much the larger and protruding from large triangular fleshy flaps. Two more pairs of setose pimples are situated in front and around the mouth as usual, and the extreme pointed front is furnished with a fine and broad brush of sense-hairs.

The ciliary wreath is of the usual *Synchaeta* type, the wide auricles being more or less pendent and further back in position than in *tremula* and *oblonga*. Immediately behind the auricles the body is considerably constricted and then swells out again to a width equal to that of the head.

The foot is very narrow, elongated, about one-quarter the size of the body, terminating in two small acute toes. It may be swollen a little occasionally, but it can hardly be called "rhomboidal" in outline. The foot is moved about and lashed in all directions like a tail.

The dorsal antenna is in the usual position on an eminence above the eye, and the lateral antennæ issue two-thirds down the sides of the body, slightly on the ventral side. The mastax is large, of usual *Synchaeta* type, but, I regret to say, I have omitted to look at the teeth of the unci, and having been unable to find this creature recently, do not know their presence or their number. The œsophagus is short, leading to a stomach of the usual structure with rounded gastric glands. The lateral canals, contractile vesicle as well as the foot-glands, ovary, and muscular system, are all quite normal. The red eye is rounded, not particularly large, and of normal structure.

In the projecting triangular head and narrow foot this species has some superficial resemblance with *S. stylata*, from which it is however quite different in shape, structure, and size.

Synchaeta longipes does not carry its eggs. It is a powerful swimmer, very voracious, and catches its prey, consisting of *Polyarthra* and other similar rotifers, and devours them whilst swimming at full speed. The male has not yet been discovered.

Its greatest total size is 204μ ($\frac{1}{125}$ in.), one-fifth of which is represented by the foot and toes. Smaller young animals are always present also.

***Synchæta kitina* sp. n.**

Pl. IV. fig. 6.

Spec. Char.—Body very small, cup-shaped, truncate anteriorly, much contracted posteriorly, head flat or slightly rounded in front, foot short and tapering, carrying two small conical toes. Eye cervical, red, appearing double, imbedded in semi-opaque granules. Size, up to 136μ ($\frac{1}{85}$ in.) in length by 102μ ($\frac{1}{56}$ in.) wide. Lacustrine.

In a tube of some water from the reservoirs supplying Dundee with water, containing *Notholca longispina* and other rotifers, which Mr. John Hood sent me in July 1898, I found a very small *Synchæta* which proved to be new and to which I have given this name in honour of an enthusiastic friend greatly interested in these minute sparks of life. After having had his attention called to it, Mr. Hood was able to send it me again several times, but it has so far not been obtained in any other locality than the neighbourhood of Dundee, where it makes its appearance at the end of May and usually remains until the beginning of September, associated with *Notholca longispina*, *Anurca cochlearis*, and *Gastropus stylifer*. Its unusual shape, very small size, and mode of swimming at once arrest the attention of anyone familiar with the commoner species of *Synchæta*, but being so small it requires a fairly high power for observation and identification.

The general shape of the body is that of a cup or wine-glass with somewhat stout stem. The posterior cylindrical and constricted part of the body widens again slightly and then terminates; the foot is short, broad at the base and tapering, carrying two small toes at the end. The foot can be retracted within the body so that only the toes protrude. The auricles are comparatively large, broad and semicircular in shape, and are carried on a level with the front of the head; when contracting the auricles fold over the head. The head is very broad and almost flat in front. Two pairs of tactile styles arise from the front, the larger outer pair from fleshy triangular flaps and the inner pair from the dorsal edge as usual. Four more groups of two or three shorter tactile hairs are placed around the mouth. The vibratile cilia are confined to four regions or patches on the frontal part of the head as usual, in addition to the long cilia on the auricles. The mouth is situated in front near the centre of the head, but slightly ventral, surrounded by the projecting circlet of very fine stiff hairs, part of which are visible from a dorsal view. The eye is cervical, situated in the usual position, and consists apparently of two dark red corpuscles, closely apposed and imbedded in a small mass of semi-opaque granules. The mastax is large, filling the anterior part of the body-

cavity ; the jaws are of usual *Synchæta* type, but extremely delicate ; the unci have five or six teeth.

The stomach is small, carrying two pointed gastric glands, and the rounded ovary, lateral canals, and contractile vesicle are present as usual.

The dorsal antenna projects from a dorsal eminence a little below the eye, while the lateral antennæ protrude at the extreme posterior and narrow part of the body, as in *S. tremula*.

The integument is very soft, showing more or less distinct fine longitudinal folds. When held fast in the compressor the animal is very restless, contracts and contorts its body in all manner of shapes, so that it can hardly be recognised under these conditions.

In swimming the motion is slow and steady, the animal revolving on its longer axis as it proceeds, and now and again suddenly changing its direction at right angles to its former course. *S. kitina* does not anchor itself to a thread and revolve on the same spot as does *S. tremula*.

The pretty sketch, fig. 6, has been drawn by Mr. F. R. Dixon-Nuttall from life, and gives a good idea of its usual shape.

In size, this is one of the smallest *Synchætæ* known, being only 136μ ($\frac{1}{185}$ in.) in total length by 102μ ($\frac{1}{250}$ in.) wide at the auricles, whilst smaller individuals are always present also.

Synchæta tavina (Hood).

Pl. VIII. fig. 18.

BIBLIOGRAPHY.

HOOD, JOHN.—*Synchæta tavina*. Inter. Journ. of Microscopy and Nat. Science, 1893, pp. 382-3 (1 pl.).

Spec. Char.—Body markedly cylindrical in shape, truncate in front ; auricles small ; foot short, carrying two small, separated toes ; eye cervical, usually appearing double ; the lateral antennæ situated in the lumbar regions. Size 254μ ($\frac{1}{100}$ in.) by 95μ ($\frac{1}{267}$ in.) wide at the auricles. In brackish water.

Mr. John Hood also discovered this species in the tide pools of the Tay in the early spring of 1893, and published an account of it in the *International Journal of Microscopy and Natural Science* for October of that year.

The shape of the body is conspicuously cylindrical, being scarcely wider in front than at the side and somewhat compressed laterally, then tapering gradually to the short foot and toes. The foot is in a line with the ventral side of the body, and the toes are generally carried turned upwards. At first sight it is hardly recognised as belonging to the genus *Synchæta*, so unlike is it to the characteristic cone-shape of nearly all the other species of this genus.

Mr. Dixon-Nuttall's sketch very well represents its usual shape, which of course varies slightly according as it is filled with food or empty. The integument is thin, white, transparent, and shows a number of fine longitudinal folds on the dorsal side. The auricles are small, and in retraction are folded over the head by a muscular band running from the auricle to near the centre of the head. The front of the head is truncate and slightly rounded, carrying the usual two pairs of styles, the outer pair arising from well-marked triangular fleshy flaps. On the extreme raised front of the head are two bundles of very fine diverging stiff setæ, similar to those found in *S. oblonga*. The mouth is nearly central in position, screened as usual by a row of fine, overhanging setæ, which can be seen from a dorsal view in this species. At some little distance from and around the mouth are the usual four bundles of three or four larger setæ which are rather conspicuous. The vibratile cilia are arranged on four ridges or cushions on the front of the head, as is the case with all other species. The cervical eye consists of a clear vesicle partly filled with white opaque and red granules, the latter often separated into two groups, and thus giving the appearance of a double eye.

The mastax is large and of the usual *Synchaeta* type; the jaws are very delicate and difficult to make out; they are of the same type as those of *S. tremula*, the unci are curved, and have four or five teeth.

The œsophagus arises on the dorsal side of the mastax and leads into an ample stomach which is thick-walled anteriorly and thin-walled posteriorly, and to which two elongated gastric glands are attached. The ovary is large, flat, oval or nearly circular in shape and contains large germ-cells.

The lateral canals and contractile vesicles are of normal structure.

The dorsal antenna is situated on a raised prominence in the usual position, and the lateral antennæ are readily seen in the lumbar region. The foot is stout and the two broad and pointed toes are usually carried turned upwards.

I have found the **male** of this species in March 1895 and several times since. It is a small, soft, conical animal with two minute toes, large sperm-sac, long brain with opaque granules at the tip of which red granules forming a double eye are imbedded. It is usually detected by its more rapid movements among the females.

Synchaeta tavina swims vigorously and steadily in spiral curves and is rarely anchored to a thread, nor does it carry its eggs. Its habitat is brackish water, and I have obtained it many times from Mr. John Hood from the mouth of the Tay near Dundee, and also from Great Yarmouth in water sent by Mr. H. E. Hurrell, generally in the early spring, March and April. In size it reaches up to 254μ ($\frac{1}{10}$ in.).

Synchæta littoralis sp. n.

Pl. VII. fig. 15.

Spec. Char.—Body cone-shaped, convex anteriorly, usually cylindrical in the middle, tapering to a stout foot and well separated acute toes; auricles small; four frontal styles. Eyes three, one cervical, large, red, connected by two streams of red granules with two frontal eye-spots; lateral antennæ prominent in lumbar region. Size up to 238μ ($\frac{1}{107}$ in.) long by 109μ ($\frac{1}{232}$ in.) wide at the auricles. In brackish water.

For some years past I have received this distinctive species from Dundee, Margate, Great Yarmouth, and various places near the sea coast, always in water that was slightly brackish. In general appearance and structure it comes nearest to *S. oblonga*, from which it can, however, be readily distinguished by a much stouter foot, by its three eyes, and a prominent stream of red granules running forward from the cervical eye, which is unusually large, to the two frontal eye-spots, very much resembling *S. triophthalma* in this respect.

The front of the head is convex, and the shape of the body more or less cylindrical, merging posteriorly into a conspicuously stout foot with two fairly thick acute toes, which are always carried well apart. The outer styles emerge from fairly large triangular fleshy flaps, and at the extreme front of the head are two bundles of very fine diverging sense-hairs. The dorsal antenna is situated in its usual position, and the lateral antennæ, which are readily visible, protrude from the sides in the lumbar region and a little on the ventral side.

The integument is white, transparent, folded longitudinally on the dorsal side. The mastax is large, of usual shape and structure, and the unci have five or six teeth. The thick-walled stomach is surmounted by two rounded gastric glands.

The remainder of the anatomy follows that of other *Synchætæ*; the eggs are not carried.

The **male** has been seen several times, and has much analogy with that of *S. oblonga*.

The accompanying fig. 15 has been drawn by Mr. Dixon-Nuttall, and gives a good idea of the animal.

EXPLANATION OF PLATE VII.

- Fig. 14.—*Synchæta triophthalma* Laut. ♀ Dorsal view. × 400.
 „ 14a „ „ „ One unci of the jaws.
 „ 15 „ „ *littoralis* sp. n. Rouss. ♀ Dorsal view. × 375.
 „ 16 „ „ *cecilia* sp. n. Rouss. ♀ Dorsal view. × 500.
 „ 16a „ „ „ Side view of toe. × 750.
 „ 16b „ „ „ The male. × 500.



Fig. 1. Dorsal view of head and thorax.

Wheat, New York, 1892.

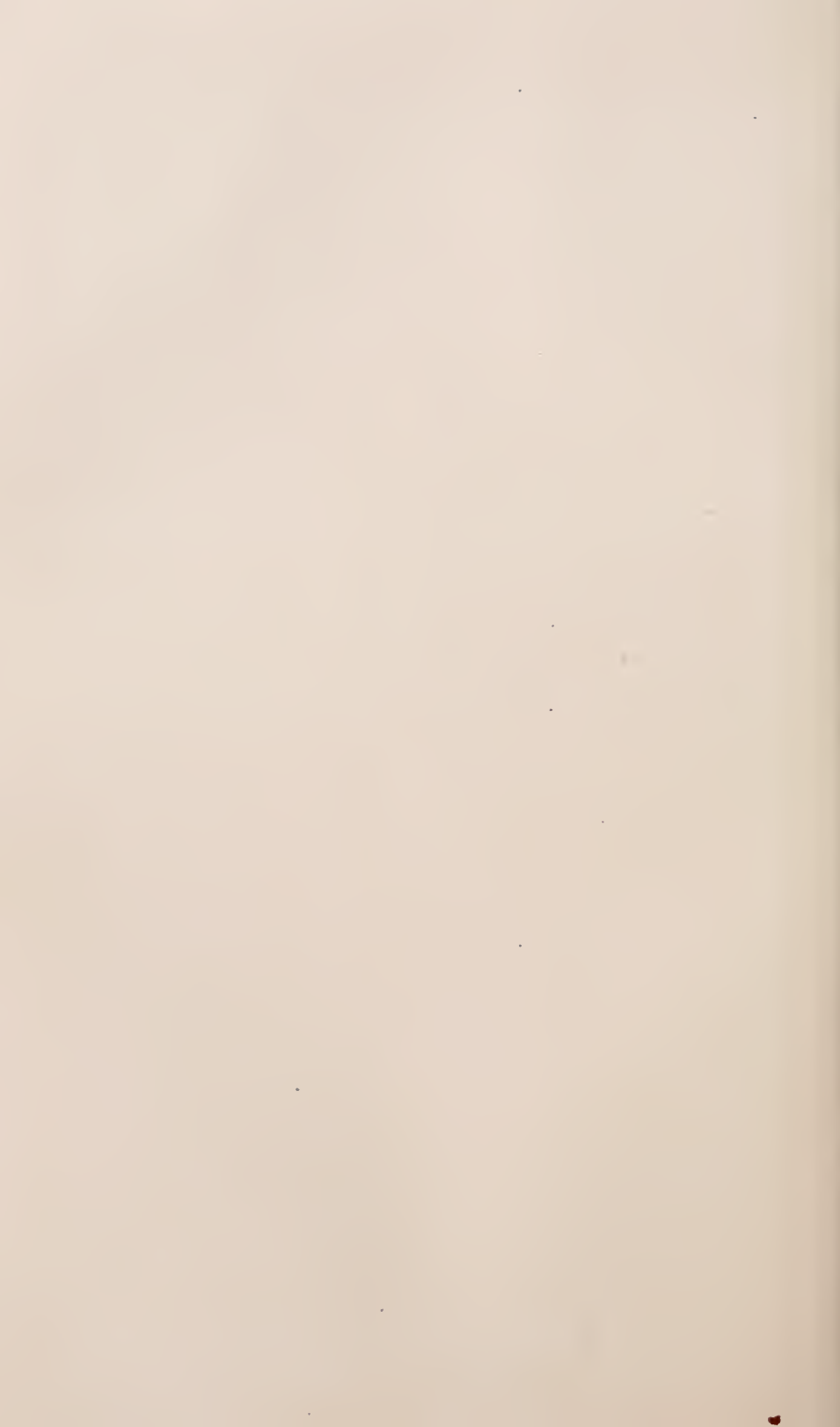

Synchaeta baltica Ehrenberg.

Pl. VI. fig. 11.

SYNONYMY.

Synchaeta apus Plate.

BIBLIOGRAPHY.

- EHRENBERG, C. G.—Das Leuchten des Meeres. Abhandl. der Akad. d. Wissensch. Berlin, 1834, p. 572, pl. 1, fig. 2.
 ——— Die Infusionsthierchen. Leipzig, 1838, p. 437, pl. 53, fig. 5.
 HUDSON & GOSSE.—The Rotifera. London, 1889, vol. i. p. 126, pl. 13, fig. 1.
 PLATE, L. H.—Ueber die Rotatorienfauna des bottnischen Meerbusens, etc. Zeitschr. f. wiss. Zool., Bd. 49, 1890, pp. 1-4.
 LEVANDER, K. M.—Zur Kenntniss der Wasserfauna in der Umgebung von Helsingfors. Acta Societatis pro Fauna et Flora Fennica, Helsingfors, vol. xii. No. 3, 1894, p. 18, pl. 1, fig. 4.

Spec. Char.—Body very large, bell-shaped, rounded in front, constricted below the auricles, tapering to a stout foot and thick obtuse toes; four frontal styles; wide front, and large, broad auricles; eye red, cervical, with a tendency to be cleft in two halves. Size 455μ ($\frac{1}{56}$ in.) to 523μ ($\frac{1}{48}$ in.) long by 245μ ($\frac{1}{104}$ in.) to 270μ ($\frac{1}{33}$ in.) wide at the auricles. Marine, pelagic in the Baltic.

The species to which Ehrenberg gave this name appears to have been first found by a Dr. Michaelis in Kiel harbour in 1830. It was early associated with the luminosity of the sea, because it was found in sea water that was luminous, but according to Ehrenberg's own account, his experiments to prove its luminosity were entirely negative, as *Synchaeta* did not shine when isolated, whilst the water contained other marine organisms, such as *Peridinia*, which undoubtedly were luminous. There is, therefore, no valid reason for the statement that this *Synchaeta*, or any other rotifer, is connected with the luminosity of the sea.

Ehrenberg obtained his specimen from Dr. Michaelis, and communicated his first account and drawings of this species to the Berlin Academy of Sciences in 1834, the description and figures being afterwards reproduced in his great work on the Infusoria in 1838.

Until quite recently the real *S. baltica* does not seem to have been again met with, or to have been searched for in its particular haunts, the Baltic Sea. Mr. Gosse, in his early writings, mentions a marine *Synchaeta* which he often found and supposed was Ehrenberg's *S. baltica*, and figured it in his *Tenby*. This, however, is the animal now known as *Synchaeta gyryna* of Hood. Later Gosse received another, smaller and different marine species from Mr. John Hood of Dundee, which he figured in *The Rotifera*, pl. xiii. fig. 1, under the name of *S. baltica*. It is, however, quite clear now that none of these are identical with Ehrenberg's species, and

I have it from Mr. John Hood that the small marine species he sent to Mr. Gosse in 1888 is the one which is now described in this paper under the name of *S. eccilia*.

Ehrenberg's figure shows a large *Synchaeta*, with very large and broad auricles, and it was not until 1894 that it was again certainly identified by Dr. Levander, who found it in abundance in the open sea and at various places round the coast of Finland, and has given a better drawing of it in his memoir. A few years previously Dr. L. Plate received some spirit material collected by Dr. Nordqvist in the Gulf of Bothnia and in the northern parts of the Baltic. In this material he found a large *Synchaeta* fully contracted into a ball, showing no foot at all. This Dr. Plate named *Synchaeta apus*, and described as a new species. Dr. Levander, however, has proved quite satisfactorily that it is no other than *S. baltica*.

I have considered it necessary to give this short historical sketch of *S. baltica* in order to clear up its identity and separate it from the various species to which this name has been wrongly applied.

Dr. Levander has been good enough to send me some fairly well preserved specimens of *Synchaeta baltica*, yet they are not so perfect and fully extended as one could wish. Fig. 11, pl. VI. has been drawn by Mr. Dixon-Nuttall from one of these, and is sufficiently characteristic, but should be compared with Dr. Levander's sketch of the living animal. Fig. 11a represents a front view of the head, which has been kindly sent me by Dr. Levander.

The shape of the living *S. baltica*, according to Dr. Levander's description, is bell-shaped, rounded in front, constricted below the auricles, then widening again considerably in the middle of the body, whence it tapers gradually to the thick foot. In the preserved specimens the posterior end of the body shows a ring-like thickening of the integument from which the foot emerges; it may be, however, that this is due to the partly retracted foot, and that in the living animal the body merges gradually into the foot, as shown in Dr. Levander's drawing. The foot is stout, of considerable size, and carries two thick obtuse toes, well separated, in which the fine canals of the foot-glands can be readily seen. The toes are not pointed, but distinctly cut off, or truncate and flat at the tip.

The ciliary wreath is of the usual type, but the auricles are particularly large and very broad and clothed with long vibratile cilia as is well represented in Mr. Dixon-Nuttall's figure. Four frontal styles are present as usual, the outer pair emerging from triangular fleshy flaps of skin. On each side of the extreme front is a tuft of fine radiating sense-hairs; around the mouth on the ventral side are the usual four setose pimples carrying each two or three stiff hairs.

The dorsal antenna is situated on an eminence in its usual position above the eye, and the lateral antennæ emerge low down in the lumbar regions and a little on the ventral side.

The eye is large, red, usually cleft in two halves, and seated on the rounded brain mass.

The mouth is shield-shaped and guarded all round by a single row of very small stiff converging hairs. The mastax is large, of the usual *Synchæta* shape and type; the fulcrum seems to be particularly long; the unci have each five pointed teeth. The thin-walled œsophagus arises in the middle of the dorsal side of the mastax, is fairly long and not ciliated in its interior. The stomach is thick-walled, consisting of large rounded granular cells, and carrying the usual gastric glands; the intestine is not very well marked off. The lateral canals appear to be attached to the walls of the stomach and reach forward as far as the gastric glands only. According to Dr. Levander each canal forms here a convoluted knot from which two branches are sent off. One branch goes forward a short distance in the body-cavity, is held in position by a fine thread fixed to the body-wall, and ends in a single flame-cell. The contractile vesicle is large, situated at the base of the foot on the ventral side; the lateral canals make several turns in its walls before opening into it.

The ovary is oval, of usual structure, and lies across the body-cavity on the ventral side. Two foot-glands are very prominent in the stout foot.

The eggs are slightly oval in shape and generally carried about. I found several eggs still attached to the toes by a fine thread in the preserved specimens; their size is $109\ \mu$ ($\frac{1}{2}\frac{1}{33}$ in.) long by $88\ \mu$ ($\frac{1}{2}\frac{1}{89}$ in.) broad.

As far as is at present known *S. baltica* is found only in the Baltic, where it is truly pelagic, occurring in great abundance in the open sea as well as in all the large and small bays. It is well known that the salinity of the water of the Baltic is much less than that of the North Sea, due to its enclosed position, to the absence of tides, and to the great volume of fresh water that is constantly poured into it by numerous rivers.

According to Dr. Levander the greatest total length of *S. baltica* is $523\ \mu$ ($\frac{1}{4}\frac{1}{8}$ in.). The largest preserved specimen I have received measured $455\ \mu$ ($\frac{1}{5}\frac{1}{6}$ in.) long by $245\ \mu$ ($\frac{1}{10}\frac{1}{4}$ in.) wide at the auricles.

The male has not yet been observed.

Synchæta gyrina Hood.

Pl. VIII. fig. 17.

BIBLIOGRAPHY.

- HOOD, JOHN.—Chats about Rotifers: *Synchæta gyrina*. Science Gossip, 1887, p. 149, 2 figs.
HUDSON & GOSSE.—The Rotifera. Supplement. London, 1889, p. 18.

Spec. Char.—Body large, barrel-shaped, not much wider in front, and tapering gradually posteriorly to the short foot and toes; eye cervical, appearing double; auricles comparatively

small but powerful; four anterior styles. Largest size of female 326μ ($\frac{1}{8}$ in.) long by 145μ ($\frac{1}{175}$ in.) wide across the auricles. Marine and in brackish water.

Mr. John Hood, of Dundee, first discovered this marine and brackish water species in the spring of 1886, in tide pools of the estuary of the Tay, and gave a description and rough sketch of it in the July number of *Science Gossip* of 1887.

In the autumn of last year I obtained specimens from Great Yarmouth, and subsequently also from brackish water pools near Exmouth and Worthing, which have enabled me to make this description and Mr. Dixon-Nuttall the accompanying excellent drawing, fig. 17. Both the drawing and the well preserved and mounted animals were identified by Mr. Hood, which was necessary, as his rough sketch is deficient in accuracy.

The body is stout, cylindrical or barrel-shaped, widest in the middle, tapering gradually posteriorly; the foot is distinct, short, tapering, and carrying two distinct broad and acute toes, slightly shouldered on the outer side; two distinct foot-glands are contained in the foot. The head also is cylindrical, hardly wider than the widest part of the body. The auricles are comparatively small but powerful; the head is truncate in front without any conspicuous prominences. Two pairs of styles arise in front, the outer pair from very small fleshy eminences. The vibratile cilia in front have the usual arrangement in four regions. The mouth is ventral in position, surrounded by the usual tactile tufts of setæ and circle of short stiff hairs. The eye is large, cervical, and consists of two dark red closely apposed bodies or clusters of red granules. The mastax is large, of usual *Synchaeta* shape and structure, and of *S. oblonga* type with six broad, lancet-shaped teeth in each uncus. The dorsal antenna protrudes on a dorsal eminence above the eye, and the lateral antennæ are situated at the sides, slightly below the middle of the body.

The stomach is large, of usual shape, as well as the gastric glands, ovary, lateral canals and contractile vesicle, all of which are clearly indicated in Mr. Dixon-Nuttall's excellent figure. The integument is fairly firm, showing more or less prominent transverse and longitudinal folds, particularly on the dorsal side.

In swimming, this *Synchaeta* moves rapidly, almost rolling in the water like a barrel, without apparent aim; it also spins a thread from the toes to which it attaches itself occasionally.

The eggs are nearly spherical, coloured slightly brown, and 78μ ($\frac{1}{328}$ in.) in diameter; when laid they fall off at once, and are not carried about.

The **male** has been seen by Mr. Hood, who describes it as a conical slender creature, 85μ ($\frac{1}{300}$ in.) in length.

Habitat: in sea-water and brackish tide pools, near Dundee, Great Yarmouth, Exmouth, Worthing, and probably all round the coast.

***Synchæta triophthalma* Lauterborn.**

Pl. VII. fig. 14.

BIBLIOGRAPHY.

LAUTERBORN, ROBERT.—Wissensch. Meeresuntersuchungen aus der Biol. Anstalt auf Helgoland, 1894, i. pp. 207-13, 1 fig.

Spec. Char.—Body cone-shaped, very wide and rounded in front; foot indistinct; toe thin, style-shaped, apparently single; eyes three, one large cervical, and two frontal eyes. Lateral antenna asymmetrical, large, single, situated on left side of body. Size 181μ to 265μ ($\frac{1}{16}$ to $\frac{1}{6}$ in.). Marine, pelagic.

In June 1898 Mr. John Hood found this peculiar *Synchæta* in the sea near Dundee, and sent me some living specimens for identification. I recognised it at once as the animal Dr. Robert Lauterborn had discovered off the coast of Helgoland in August 1893, and of which he had given a rough figure and short description in his *Beiträge zur Meeresfauna von Helgoland*. Since his first capture, Mr. Hood has found it repeatedly and has sent it to his correspondents, and I have no doubt it could be obtained at other points along the coast during the summer months. Mr. Dixon-Nuttall has made a fine and accurate portrait of it (fig. 14) which gives a better idea of its appearance than any amount of description. The general outline of this species is cone- or top-shaped, very broad anteriorly and very slender posteriorly, ending in a thin, pointed, style-like toe, which appears to be single. The auricles are very large, and the front of the head is rounded, and so wide as to be, with the auricles, very nearly as broad as the animal is long. The usual pair of large outer frontal styles project from large triangular fleshy flaps, and the two smaller styles are situated on the dorsal edge just above the frontal eyes. A peculiarity of this species is that it has three deep red eyes: a cervical eye which is double, in the usual position, and two frontal eyes situated in front, a short distance below the dorso-frontal edge of the head. Two streams of minute red granules usually connect the dorsal eye with the frontal eyes, as if the latter were connected with the cervical eye by means of very fine tubules. I have noticed a similar tendency in several other species such as *S. oblonga*, and more rarely in *S. tremula*, but only in *S. littoralis* are the frontal eyes so constant and so prominent as in *S. triophthalma*. The dorsal antenna is present in its usual position, but the main and unique feature of this *Synchæta* is that it has a single, very large and asymmetric lateral antenna, protruding from a fleshy prominence low down on the left side of the body near the toe. There is no trace of a lateral antenna on the right side. The

foot is not well marked off, and body, foot, and toe follow each other without much distinctness. The foot-gland is elongated and club-shaped and apparently single.

The mouth is situated in the usual position on the ventral half of the front of the head; around the mouth are four groups of five or six fairly long stiff sense-hairs, and outside these there are the usual four patches of vibratile cilia. The mouth is oval in shape, and guarded by a wreath of short, closely-set, overhanging, stiff hairs. The mastax, cesophagus, stomach, ovary, lateral canals, and rest of the anatomy are quite normal of *Synchæta* type. One uncus of the jaws is represented in fig. 14*a*. The egg, when extruded, is carried about for a time, attached by a thread, but often becomes detached. I have observed an individual carrying two eggs. It is oval in shape, 75μ ($\frac{1}{340}$ in.) long by 58μ ($\frac{1}{440}$ in.) broad.

In swimming this *Synchæta* sails in long graceful curves, without undue haste, and reminds one of the flight of the swallow through the air. When once seen this species can be recognised by this mode of swimming, which is very different from that of the other species.

The **male** has not yet been observed.

I have been very successful in preserving and mounting this animal fully extended, and showing all its characteristic peculiarities.

The size varies a good deal according as the animal is young or full grown, from 181μ to 265μ ($\frac{1}{140}$ in. to $\frac{1}{96}$ in.). The width across the auricles is very nearly the same.

Its habitat, as far as known, is the open sea round Helgoland, near Dundee, and the Bay of Naples, appearing in the summer months from May.

Synchæta monopos Plate.

Pl. VI. fig. 12.

BIBLIOGRAPHY.

- PLATE, L. H.—Ueber die Rotatorienfauna des baltischen Meerbusens, etc. Zeitschr. f. wiss. Zool., Band 49, 1890, pp. 1–42.
 LEVANDER, K. M.—Wasserfauna in der Umgebung von Helsingfors. Acta Soc. pro Fauna et Flora Fennica, Helsingfors, 1894, pp. 1–72, 2 pls.

Spec. Char.—Body a greatly swollen bag, very thin-walled and extremely transparent, terminating in a very small foot with single toe. Head small, with four frontal styles and small auricles. Eye red, cervical. Size 254μ ($\frac{1}{100}$ in.) long by 164μ ($\frac{1}{53}$ in.) broad. Marine, pelagic in the Baltic.

This remarkable pelagic marine species was named by Dr.

L. H. Plate from material collected by Dr. O. Nordqvist in the Bay of Bothnia. The specimens having been killed and preserved in spirit, were all fully contracted, so that only a very imperfect description could be given. Dr. Levander has, however, found this form again in great abundance in the open sea near Helsingfors, and has given a better account of it with a drawing. He has also been good enough to send me some fairly well preserved specimens and two sketches of the dorsal side and front view of the head, which are here reproduced (figs. 12 and 12*a*), so that I owe my acquaintance with this peculiar *Synchronæta* to these. Not having seen it in the living state, however, my account of it must be largely taken from Dr. Levander's description.

The shape of the body is quite unlike that of any other *Synchronæta*, and instead of the usual cone it presents an extremely thin-walled, very transparent, bag-like, rounded vesicle, constricted anteriorly, with a very small head, which, however, has the usual characteristic *Synchronæta* structure. The body terminates in a very small swollen foot carrying a single toe.

The whole structure of all the organs is so fine and delicate that it appears evident the whole organism, in acquiring these characters, has been evolved with a view to render itself as transparent, and therefore as invisible as possible, which is characteristic of many pelagic animals.

The small head, as will be seen from fig. 12*a*, which represents a front view, carries a normal ciliary wreath in two interrupted regions, four frontal styles, and two small but distinct auricles.

The cervical eye is red, seated on the oval brain mass. The dorsal antenna is slightly raised above the eye, while the ventral antennæ emerge very low down close to the foot, somewhat on the ventral side. The mouth is shield-shaped and guarded by the usual screen of fine hairs. The mastax is also small, of *Synchronæta* structure, and the unci have five strong teeth, which I was able to see in some swollen specimens where the unci had been forced through the mouth.

The cesophagus is a very thin, long tube, not ciliated internally, leading to a small thick-walled stomach, to which very small and rounded gastric glands are attached.

The ovary is very small, oval, containing about eight germ-cells.

The muscular system is of normal character; a dorsal and ventral pair of extremely thin and narrow muscular threads originate both in the head and in the foot, and are inserted a little below the middle to the body-walls.

The excretory system is represented by lateral canals, which are attached, on either side, to the wall of the stomach, whence they continue forward for a short distance, being suspended quite freely in the body-cavity by a very fine thread attached to the side

of the body; each canal ends in a single flame-cell. The contractile vesicle is fairly large, and situated below the stomach.

The whole of the internal organs, digestive system, ovary, &c., take up only a very small proportion of the comparatively large body-cavity, so that this *Synchæta* at first sight looks much more like a small *Asplanchna priodonta* than anything else. The dorsal half of the body-cavity is smaller than the ventral half, and sometimes the ventral wall is swollen out to such a degree as to extend much beyond the foot.

Synchæta monopus has not the appearance of being so vigorous a swimmer as its near relatives. Dr. Levander states that it occurs in great abundance, associated with *S. baltica*, from the middle of June to October, in the bays and open sea near Helsingfors, and it is evidently also found in other parts of the Baltic. It has not yet been found on the English coast, or in any other seas. It does not carry its eggs.

Its size is 254μ ($\frac{1}{100}$ in.) long by 164μ ($\frac{1}{35}$ in.) wide. The male is not known.

Synchæta cecilia sp. n.

Pl. VII. fig. 16.

Spec. Char.—Body small, pear-shaped in form, rounded in front; four frontal styles; foot distinct, conical, carrying apparently a single toe. Lateral antennæ situated at extreme base of body. Eye cervical, red, with a tendency to separate in two halves; carries one or more eggs about attached by a thread to the toe. (Greatest size 142μ ($\frac{1}{30}$ in.); width at auricles 82μ ($\frac{1}{30}$ in.); male 78μ ($\frac{1}{26}$ in.) long. Marine.

In November 1895 I first obtained this small and attractive marine species from Mr. F. Daunou, who had found it in a tide pool close to the sea at Margate. Since then I have received it repeatedly, sometimes in large numbers, from Mr. John Hood, of Dundee, and from Mr. Hurrell, of Great Yarmouth. A great peculiarity, which at once attracts attention, is that it habitually carries about its eggs, one, two, or sometimes three in a string, in its restless gyrations.

In size it is one of the smallest *Synchætæ*, and in shape it is cylindric, somewhat pear-shaped, convexly rounded in front, rounded behind, with a distinctly marked-off foot of fair size, bearing a small conical, apparently single, toe. The foot and toe are often bent dorsal-wards. The auricular lobes are small. In front the head bears the usual prominent four styliform bundles of stiff sense-hairs, the outer pair emerging from triangular fleshy flaps. On each side of the shield-shaped mouth there are the

usual four tufts of sense-hairs, but only two of these tufts can be seen from a dorsal view. The crimson eye is in the usual position, and consists of two apposed red bodies. The dorsal antenna protrudes from a conical elevation in the usual situation. The lateral antennæ are situated at the extreme base of the body, where the foot begins. The mastax is fairly large, of normal structure, and of *S. tremula* type, with six teeth in the thin, flat, and broad unci, the first tooth being longer than the others. A short, thin-walled cesophagus leads to a thick-walled, rounded, yellow stomach, the anterior part of which is thin-walled, and having large cells in its wall, and densely ciliated inside. The stomach carries ample gastric glands of irregular shape. The lateral canals, contractile vesicle, and muscular system are distinct and normal. The integument is fine and soft, and with a high power numerous very fine longitudinal folds can be observed in it. The ovary is flat and rounded, and contains a number of large nucleated germ-cells. The egg is large, being estimated at about one-fifth of the total bulk of the animal, and oval in shape; it is attached to the toe by means of a fine mucous thread, which is sometimes lengthened, and the egg then follows the animal at some distance behind. I have seen two and three eggs attached side by side or one behind the other in a string—a peculiar sight. This habit of carrying its eggs is quite uncommon in *Synchætæ*, but with this species it appears to be habitual, and dozens of individuals can be seen with eggs in a fresh gathering, while of course there are also always some without them. Mr. F. R. Dixon-Nuttall has made the attractive drawing, fig. 16, and also fig. 16*a*, which shows a side view of the single toe with a small knob, looking like a rudiment of a second toe.

On comparing this new species with the described forms it seemed to me that it had some resemblance with the marine *Synchæta* Mr. Gosse has figured and described in the Monograph, p. 126, as Ehrenberg's *S. baltica*, though there are some discrepancies in the description, and he does not mention that it carries its eggs. I therefore applied to Mr. John Hood and inquired what animal it was he sent to Mr. Gosse, from which he made the drawing on pl. xiii. fig. 1, as mentioned in the text, and Mr. Hood informs me that it was this *Synchæta* to which I have now given the name of *S. cecilia*. Mr. Gosse has never seen the real *S. baltica* of Ehrenberg, which, as far as is known, is confined to the Baltic, and hence his mistake.

The male.—At the end of October last Mr. Hurrell sent me some sea water in which this species was very abundant, and amongst them I noticed some carrying bundles of two to four small male eggs. By isolating these I soon obtained the male, which is represented in fig. 16*b*. It is a small cylindrical creature 78μ ($\frac{1}{32}$ in.) in length, with a foot and toe turned ventral-wards. The front of the head is conical and carries four styles; the base of the cone

bears a nearly circular wreath of vibratile cilia. The brain-sac carries a red eye imbedded in grey granules, and just above it the large dorsal antenna is seen to emerge, slanting backwards. The lateral antennæ are also conspicuous by their size, protruding low down at the sides of the body. A mouth, jaws, and digestive tract are absent; a large sperm-sac fills the greater part of the body-cavity. The male was seen to attach itself invariably to the side of the female. Although the males became abundant in the water I never observed an egg with thicker walls that could be recognised as a fertilised resting egg, and such eggs are so far quite unknown in any Synchæta.

Size of female: 142μ ($\frac{1}{180}$ in.) in length by 82μ ($\frac{1}{310}$ in.) wide at the auricles; young and smaller animals are always present also. The male: 78μ ($\frac{1}{326}$ in.) in length; the eggs are slightly oval in shape. Female eggs, 61μ ($\frac{1}{415}$ in.) by 47.5μ ($\frac{1}{535}$ in.); male eggs, 42.5μ ($\frac{1}{600}$ in.) by 35.7μ ($\frac{1}{710}$ in.).

Synchæta vorax sp. n.

Pl. VIII. fig. 19.

Spec. Char.—Body stout, more cylindrical in shape rather than conical, pointed anteriorly, with a well-marked, narrow, fairly long, and flexible foot, carrying two distinct toes. Frontal styles four; in addition to usual dorsal and lateral antennæ it has a unique tubular frontal antenna. Cervical eye large, red, appearing double. Size of female, average 272μ ($\frac{1}{93}$ in.) long by 136μ ($\frac{1}{185}$ in.) broad across the auricles. One large specimen measured 340μ ($\frac{1}{75}$ in.) long by 149μ ($\frac{1}{70}$ in.) broad. **Male** with three tubular frontal antennæ and two movable, setose, fleshy processes in front of head; 149μ ($\frac{1}{70}$ in.) long. Marine.

In June 1898, in sea water from the harbour of Dundee sent by Mr. John Hood, I first discovered a few specimens of this new and savage species in company with *S. triophthalma*, and then again in June 1899 Mr. Hood obtained it in the same spot in larger numbers, which I was able to preserve and mount most perfectly. It has not been met with at any other season or place, and seems to be a summer form.

EXPLANATION OF PLATE VIII.

Fig. 17.—	<i>Synchæta gyrina</i>	Hood ♀	Dorsal view.	× 300.
" 18	" <i>tavina</i>	Hood ♀	Dorsal view.	× 325.
" 19	" <i>vorax</i>	sp. n. Rouss. ♀	Dorsal view.	× 275.
" 19a	" " "	" "	The male, dorsal view.	× 300.
" 19b	" " "	" "	One uncus of the jaws.	
" 19c	" " "	" "	One ramus and fulcrum of the jaws.	

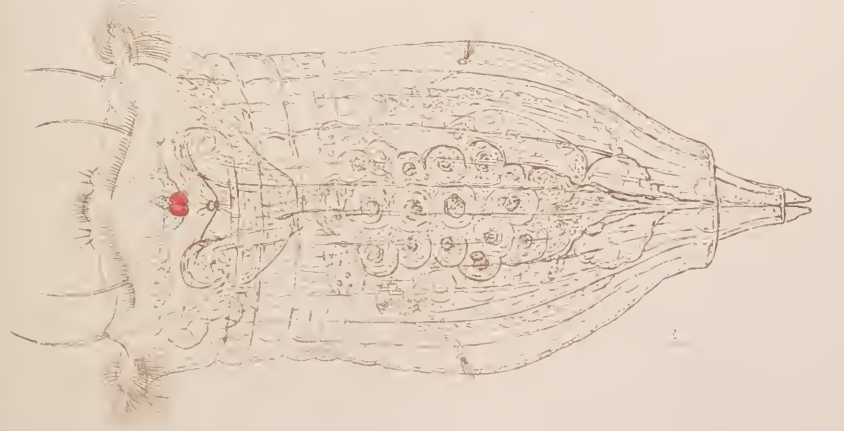

The body is more cylindrical in shape than the other species of the genus, rounding off towards the foot, which is very flexible and distinctly marked off, narrow, fairly long, and terminated by two small pointed toes always carried well apart. The auricles are powerful, but less broad than in some other species; the head is prominently pointed in front, and carries the usual pair of style-like antennæ issuing out of a triangular flap of the integument, and two small styles on the dorsal frontal edge of the head. Below the frontal eye, exactly in the middle of the front and above the mouth, this species has a large tubular antenna of peculiar structure, not known, so far, in any other species of *Synchæta*. It consists of a bundle of fine setæ protruding out of a fairly long, fleshy tubule pointing straight forward. The usual median dorsal antenna above the eye is also present. The mouth is situated immediately below the pointed front, is surrounded by the usual four tufts of stiff setæ and four patches of vibratile cilia. The mouth-opening itself is V-shaped and, as in all other species, is guarded by a single row all round of closely set, short, stiff hairs, all converging over its centre. The lateral antennæ are very small, and situated in the lumbar region, about two-thirds down the side of the body, and slightly on the ventral side. The median eye is large, deep red in colour, looking like two eyes closely apposed. The mastax is large and of usual *Synchæta tremula* type with some variation in the shape of the rami (fig. 19c); the unci have one large tooth and four or five very small teeth, mere serrations (fig. 19b). The large stomach, intestine, lateral canals, and contractile vesicle are of usual structure and call for no particular remark. The ovary is large and roughly oval in shape. The eggs are not carried about, and I have seen an egg lying beside the ovary with a rather stout, smooth shell, measuring 11.5μ by 9.5μ .

This species swims with such impetuosity through the water that its rush cannot be described otherwise than furious; its course is straight forward, then it dashes suddenly round in another direction, lashing its foot up and down and right and left, attacking any other *Synchæta* that may come in its way, and not at all particular as to species. I have seen it seize an unfortunate *S. triophthalma* with its jaws, carry it in its mouth and devour it without a moment's stop in its furious career.

No other *Synchæta* of my acquaintance is so fast in motion and so fierce of temper. In this respect it can only be compared with *Ploesoma hudsoni*, which is equally wild and fierce.

In retraction the auricles are turned in over the head, and a fold of the skin closes over them, while the foot is completely retracted within the body.

The male. The *Synchæta* males are rare, but I observed the male of this species attached to the posterior part of a large female, while at the same time the latter was rushing through

the water at express speed with a *S. triophthalma* in its jaws, which it was devouring. Seizing the opportunity, I secured and mounted all three in a slide. The male is small, conical in shape, has no mouth, mastax, stomach, or intestine; a small rounded sperm-sac takes the place of the stomach. The front of the head carries the usual four styles. The median frontal tubular antenna, which is so prominent and characteristic in the female, is also present, but of small size; in addition to this, the male has on the front two small tubular antennæ, one on each side, which is very strange. Further, it has at the extreme front of the head, but slightly ventral in position, two stout, fleshy, freely movable processes, surmounted by a broad brush of long stiff hairs. In no other male have I seen such organs.

A deep red eye, usually imbedded in a mass of semi-opaque granules, is present. Size of male 149μ ($\frac{1}{170}$ in.).

Mr. Dixon-Nuttall has made excellent drawings of the male and female from living specimens (figs. 19 and 19a), by means of which this species will be readily identified.

Synchæta neapolitana sp. n

Pl. V. fig. 9.

Spec. Char.—Body small, top-shaped, sometimes swollen at sides; head broad, and rounded in front; four frontal styles; auricles fairly large; lateral antennæ very small, situated two-thirds down the sides of the body; eye red, cervical; foot with two distinct joints, the last joint bearing a blunt spur, and carrying a single pointed toe. Size: female up to 163μ ($\frac{1}{55}$ in.) long by 108μ ($\frac{1}{35}$ in.) wide at the auricles; male 75μ ($\frac{1}{40}$ in.) long. Marine.

In June 1897, Mr. H. S. Jennings of U. S. America sent me, from the Zoological Station at Naples, a rough sketch of a *Synchæta* which had just been collected in very large numbers in the open sea in the Bay of Naples, showing a spur-like projection on the foot as its most distinctive feature. At that time I was unable to recognise or diagnose this animal, but having since made a careful study of, and become personally acquainted with, all the known species of *Synchæta*, and having also received some preserved specimens from Mr. Jennings, I can now say that it is undoubtedly a new species, which I have named *S. neapolitana*.

A very few specimens of the somewhat larger *S. triophthalma* I discovered in the same material.

From the Director of the Naples Zoological Station I learn that this new *Synchæta neapolitana* appears in the bay occasionally

in June in immense swarms, when the sea has been very calm for a long time, but not every year. Mr. Jennings' preserved material, prepared for the purpose of studying the segmentation and development in the egg, is not very good as regards the adult *Synchaeta*, the great majority of the animals being badly contracted, but by searching some fairly extended specimens have been secured, of which the following is a description:—

The body is top or cone-shaped, either straight or slightly swollen at the sides. The front part of the head is broad and rounded, and bears four styles, the outer pair arising from triangular fleshy flaps, and auricles of fairly large size. The foot has two distinct joints, and carries a spur-like process at its dorsal end. It is somewhat difficult to decide whether this process is a true spur, an organ otherwise unknown in this genus, or a second toe turned upwards, and to some extent gone out of use. The process is situated on the dorsal side of the second joint of the foot, but to the left of the median line, and originates a little higher than the base of the true toe, which seems to be the only exit for the secretion of the large and apparently single foot-gland. Whatever its true meaning, this structure forms the most prominent distinctive character of this species, and fig. 9*a* gives an enlarged view of the foot and spur-like structure.

The mastax is of usual *Synchaeta* shape and structure, the unci have teeth similar to those of *S. oblonga*, but their exact number could not be ascertained in the preserved specimen. The stomach is not large, of usual structure, and carries two rounded gastric glands. A rounded ovary, contractile vesicle, and lateral canals are present. The cervical eye is single, with occasionally a slight appearance of splitting in two halves, but I could see no trace of frontal eyes such as *S. triophthalma* possesses. The dorsal antenna is situated on a fleshy projection above the eye, and the lateral antennæ are very small and protrude at a point about two-thirds down the side of the body and slightly on the ventral side.

In life the eggs are carried about attached to the toes. I found a large number of both male and female eggs in the preserved material, and also the **male**, which is of usual structure and represented in figs. 9*b* and 9*c*, dorsal and lateral view.

Mr. F. R. Dixon-Nuttall has made a good drawing of both male and female, figs. 9*a*, *b*, and *c*, after looking at and comparing a number of specimens which were not too well preserved.

The size of the female varies considerably, as usual, from 109 μ ($\frac{1}{237}$ in.) to 163 μ ($\frac{1}{155}$ in.) long by 75 μ ($\frac{1}{340}$ in.) to 108 μ ($\frac{1}{235}$ in.) wide at the auricles. The **Male** is 75 μ ($\frac{1}{340}$ in.) long. The eggs are oval in shape and measure:—female eggs, 61 μ ($\frac{1}{415}$ in.) long by 51 μ ($\frac{1}{500}$ in.) broad; male eggs, 44 μ ($\frac{1}{575}$ in.) long by 34 μ ($\frac{1}{750}$ in.) broad.

VIII.—*Undescribed Palpi on the Proboscis of some Dipterous Flies, with Remarks on the Mouth-parts in several Families.*

By WALTER WESCHÉ.

(Read June 18th. 1902.)

PLATES IX. AND X.

BEFORE describing what perhaps in our present knowledge may be considered an abnormality, I propose to give a short account of some more or less well known forms, graduating from those which have nearly all the parts of the typical insect mouth, to those in which many parts are absent, or apparently absent.

Tabanus and Culex have all the mouth-parts present, with the exception of what are usually called the labial palpi. But there is a striking difference between the two, in the structure of the labium.

In the Gnat it is simply a horny sheath for the lancets, with valves at the extremity, and covered with the scales characteristic of the insect, fig. 1.

In the Breeze Fly it is membranous; the tip is tracheated, and the organ has many points of resemblance to the labium in the Muscidæ, generally considered typical of the order, fig. 2. I have said that with the exception of the labial palpi (the usual nomenclature), all the parts of the typical insect mouth are present: the labrum, mandibles, maxillæ with palpi, and the labium. In

EXPLANATION OF PLATES IX. AND X.

The drawings were made from slides in the author's possession, the insects having been cleared in caustic potash and mounted under pressure. Fig. 8 was roughly sketched from a recently killed insect.

- Fig. 1.—Mouth-parts of *Culex pipiens* ♀ (lateral view).
 " 2. Mouth-parts of *Hæmatopota pluvialis* ♀ (lateral view).
 " 2b. Diagram of the same, ventral view with labium removed.
 " 3. Mouth-parts of *Empis chioptera* ♂ (lateral view).
 " 4. Mouth-parts of *Syritta pipiens* ♂ (lateral view).
 " 5. Mouth-parts of *Musca domestica* ♀ (dorsal view).
 " 6. Mouth-parts of *Spilogaster flagripes* ♀ (lateral view).
 " 7. Portion of mouth-parts of *Hyetodesia basalis* ♀ (lateral view).
 " 8. Sketch of mouth-parts of *Hyetodesia perdita* ♀ seen as an opaque object.
 " 9. Mouth-parts of *Dilophus albipennis* ♂ (ventral view).

The letters apply to all the figures. *a*, antennæ. *lr*, labrum. *h*, hypopharynx. *md*, mandibles. *m*, maxillæ. *l*, labium. *p*, palpi. *lp*, labial palpi. *mp*, maxillary palpi. *r*, rudiment.

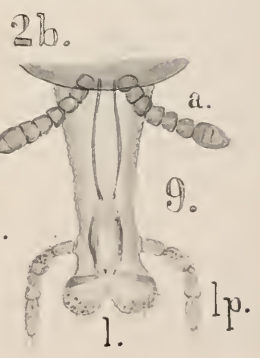
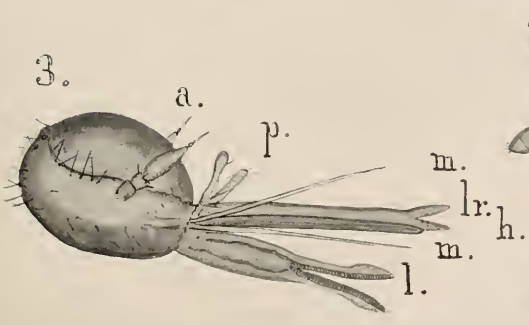
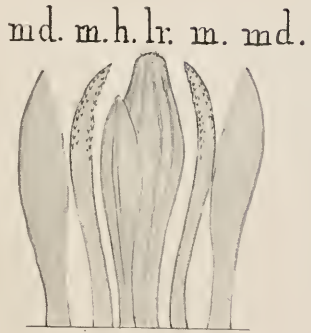
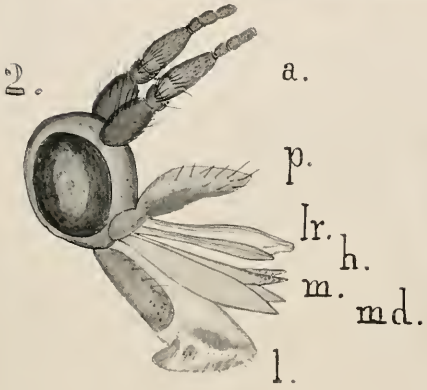
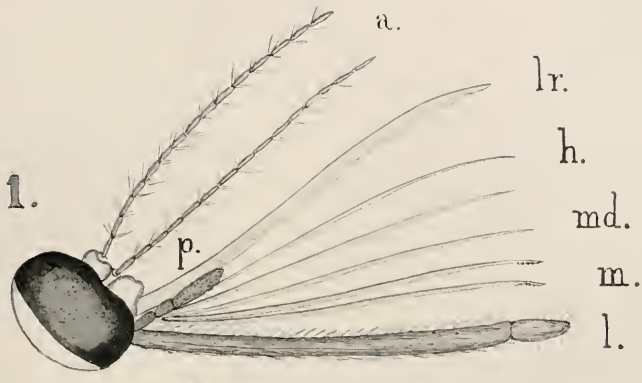

W. Wesché, del.

London Etching Co., eng.

MOUTH-PARTS OF DIPTERA.

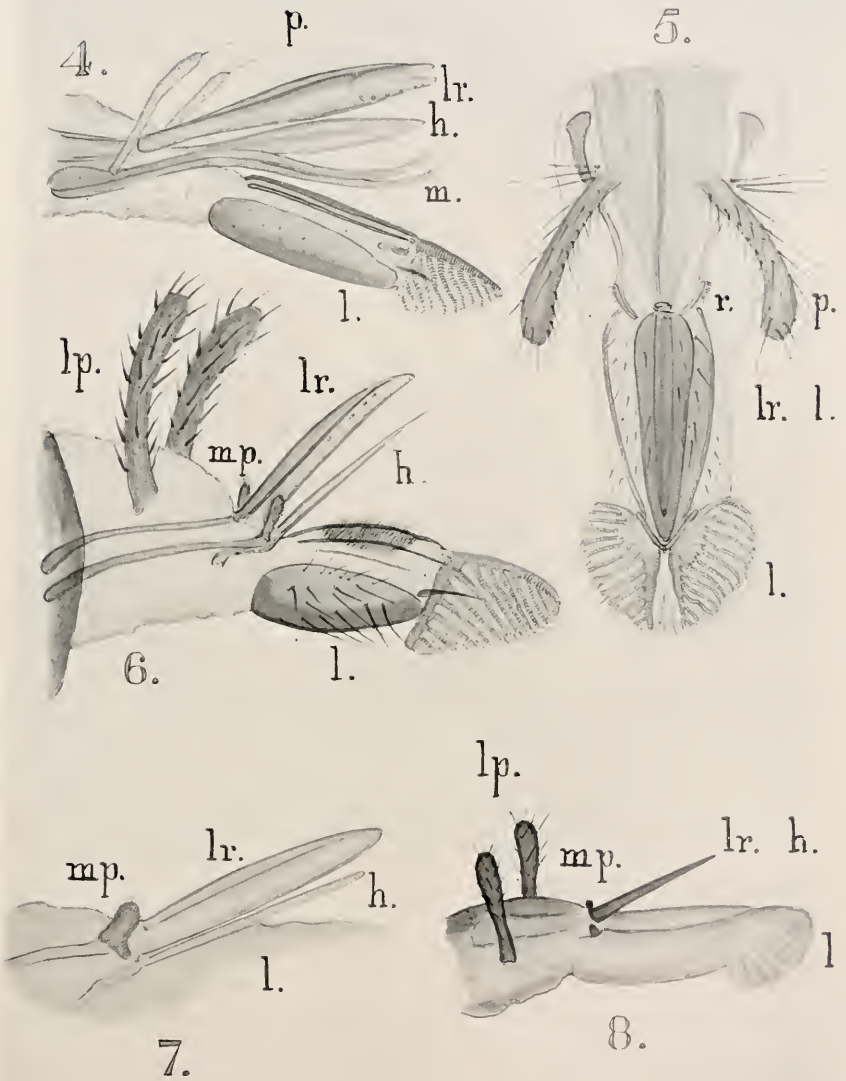

W. Wesché, del.

London Etching Co., eng.

MOUTH-PARTS OF DIPTERA.

addition, immediately below the labrum a hollow lancet is always found, the hypopharynx.

In Empis, fewer parts are present, the mandibles being absent. The labium has tracheæ, and there are traces of rod-like chitinous structures on the dorsal side, which are not seen in *Hæmatopota pluvialis*, fig. 3.

In Syrphus, are identical parts. In the genus Syritta, the maxillæ are ciliated at the tips with fine hairs, while the chitinous rods on the dorsal side of the labium are strongly marked, fig. 4. In both these families, as far as my observations go, the palpi are attenuate, and situated lower down the proboscis than in the Muscidae, well on the bases of the maxillæ.

In Musca, still fewer parts are seen, both mandibles and maxillæ having apparently disappeared. If we now compare those labia which are tracheated with each other, after the soft parts have been dissolved in caustic potash, we may formulate the three following simple rules:—

(1) In flies which have all the armature, with the exception of the palpi, present, the labium has little or no chitinous structure on the dorsal side.

(2) In flies which have only the maxillæ present, chitinous structures are visible on the dorsal side of the labium.

(3) In flies which have both mandibles and maxillæ aborted, the chitinous structure is equally, if not more marked than in the second case.

From these facts and by this "rough-and-ready" method we may infer:—(1) That in the Muscidae, the mandibles and maxillæ are soldered into the labium, and their rudiments may be seen as the chitinous framework on the dorsal side. (2) That the maxillary palpi are rudimentary or have disappeared, and that the palpi always present and generally regarded as maxillary, are labial. (3) That the proboscis is the true labium or lower lip, and that the chitinous shield on the ventral side, the lower labial plate of Kraepelin, is the mentum.

In support of this nomenclature of the palpi, I give a figure of the mouth-parts of *Dilophus albipennis*, which has the palpi right down on the labella, and which seem undoubtedly labial, fig. 9. This traverses the accepted dogma, that the labial palpi are absent in Diptera. But a more convincing argument can be found, in the discovery of several species with well marked palpi on the levers that work the labrum and hypopharynx, and immediately on the bases of the chitinous structures on the dorsal side of the labium, in addition to the two always present. These must be the maxillary palpi, and the higher palpi which spring from a membrane and have no chitinous foundation, the labial.

It may be argued, that if these were labial palpi, that is to say, palpi on the lower lip, they would not be situated on the

dorsal or upper part of the proboscis. This is explained by the assumption, that palpi situated on the lower portion of the proboscis, would in the process of evolution work round to the upper, if advantage were gained by doing so. A parallel case is the well known one of the eye in the flat fishes, which works round from a symmetrical to an asymmetrical position on the upper side, during the transition from the young to the adult stage.*

It remains to describe these mouth-parts of Muscidae that are provided with two palpi in addition to those always present and generally called maxillary.

In several species of the Anthomyia family, in the genera Hyetodesia, Spilogaster, and Hydrotea, are to be found at the base of the labrum and hypopharynx, and connected with the apodemes or levers that work those parts, two hairy processes, one on each apodeme.† These are jointless, chitinous in structure, thickly haired, and have much the appearance of ordinary palpi, fig. 6.

In *Hyetodesia basalis* ♀ they are very well marked, but are shorter in proportion to their breadth than in *Spilogaster duplicata* ♀ and *S. flagripes* ♀ (?), fig. 7.

In *H. basalis* they measure $\frac{1}{300}$ in. in length (.084667 mm.), while in *Spilogaster duplicata*, which is a smaller fly, they are the same length and about half the breadth.

Even in these insects, the organs may be considered rudimentary, but there are many species where only a few hairs on a minute tubercle remain. Such rudiments may be found on *Lasiops ctenoctema* ♂ ♀, *Anthomyia radicum* ♂ ♀, *Phorbia floccosa* ♂ (very small), *Pegomyia bicolor* ♂ ♀, *Homalomyia canicularis* ♂ ♀ (very small), *Hylemyia strigosa* ♂, and *Azelea macquarti* ♂.

In the Sarcophagidae rudiments may be found in *Myiocera carinifrons*, and in *Musca corvina* and *M. domestica* of the Muscidae, so the rudimentary palpi are not restricted to the Anthomyia section of the Muscidae, fig. 5.

I first noticed these organs on a slide of *Spilogaster duplicata*, cleared, mounted under pressure, and with a magnification of over 300 diameters. I have also seen them with an ordinary simple lens on the proboscis of *Hyetodesia perdita*, a rather large fly, about 10 mm. long, fig. 8. If a newly killed fly of this species be procured, the proboscis taken hold of by a fine pair of forceps, drawn out to its fullest length, and examined with a magnification of 10 or 15 diameters, it will be seen that the labrum and hypopharynx are lying flat, in the cavity of the labium hollowed out for their reception, but the rudimentary palpi are not visible.

It is obvious that if the hypopharynx is to be used, it must rise from the cavity in the labium at a more or less acute angle

* Darwin, Origin of Species, chap. vii.

† The palpi have also been found in species in the families Sepsidae, Opomyzidae, and Borboridae.

from its base. I have seen this in Scatophaga, when the insect has used its lancet on prey.

It is also obvious that if these palpi are feeling organs, that they would come into play when the lancet was ready for action. This was very clearly demonstrated when the labrum and hypopharynx were raised with a fine needle, for then the palpi also rose at the base, and being of a darker colour than the labium, were easily seen, fig. 8.

The discovery of these palpi settles the question as to the larger palpi being labial or not, at least in the Muscidæ, and also proves that the proboscis is not formed by a fusion of the labial palpi in the median line. These points have been debated at very considerable length between morphologists, as the ordinary nomenclature agreed with, or differed from their schemes of homologies; but hitherto no convincing proof has been advanced by either side. Several writers have rejected the idea that the labium is homologous with the proboscis, deriving it, especially the labella, from the labial palpi, fused with the maxillæ and mandibles.*

On the other hand, it may be conceded that the palpi present in Syrphus and Empis, from their situation at the base of the maxillæ, are maxillary, and that the labial have aborted.†

How much the presence of the four palpi on the proboscis of a Muscid upsets received ideas, may be gathered from the following extracts.

The late Prof. Westwood in his *Modern Classification of Insects*, gives as the description of the mouth-parts of the order Diptera, "Mouth antliate, with a fleshy proboscis (labium), forming a canal and enclosing several lancet-like organs varying in number but always destitute of labial palpi."

Prof. Packard in describing the house fly (*Musca domestica*) says, "The mandibles and maxillæ so well developed in the mosquito and other piercing or biting flies, are aborted, though the maxillary palpi are present."

Mr. B. F. Lowne (*The Blow-Fly*, p. 130) says, "Robineau-Desvoidy is the only author who, so far as I know, arrived at conclusions which my researches enable me to endorse, but unfortunately he gives no reasons for his statements, which have received little attention. He says, 'The proboscis of the Diptera, in my opinion, is not formed by the lower lip as in the Hymenoptera, but by the maxillæ. In the Muscidæ it is usually membranous, sometimes solid and triarticulate. The more or less

* Chatin, I., 'La mâchoire des Insectes,' Paris, 1897.

Wedde, H., 'Beiträge zur Kenntniss des Rhynchotenrüssels,' Berlin, 1885.

Kräpelin, K., 'Über die systematische Stellung der Puliciden,' 1884; 'Zur Anatomie und Physiologie des Rüssels von Musca,' 1883.

† This can be demonstrated by dissection of the larger species in Syrphus. In *Helophilus* the palpi are attached to the maxillæ.

solid piece which covers the groove on the dorsal surface of the proboscis is the labrum or upper lip.' Desvoidy, however, says in the same paragraph, 'Its base is enveloped by the base of the labium of which the palpi are always present.' He regards the palpi of the Diptera as labial, and not as maxillary, a conclusion which appears to me unwarranted. They are without the slightest doubt, maxillary palpi."

OBITUARY.

WILLIAM MILLER ORD, M.D. F.R.C.P.

1834-1902.

DR. ORD was the son of a medical man residing at Streatham, and received his professional education at St. Thomas's Hospital, to the staff of which institution he was elected in 1871. From this date till 1898, when he retired with the honorary title of Consulting Physician to the Hospital, his time was actively employed in teaching medicine, in clinical observation, and in scientific researches. In the medical profession his name will be remembered in connection with Myxœdema, on which morbid condition he was an authority. To the Pathological Society he made numerous communications, especially on calculi, that on an 'Indigo Calculus from the kidney' being a pioneering observation. His claim to scientific originality is perhaps best supported by his work on 'The Influence of Colloids upon Crystalline Form and Cohesion,' in which he showed that the shape of urinary crystals was in a measure dependent on the presence of albumen and mucus in the urine.

Dr. Ord joined the Royal Microscopical Society in 1879, and some twenty years ago was a frequent attendant at the meetings. To the Transactions of the Society he contributed the following papers:—(1) Studies on the Natural History of the Urates, *Monthly Microscopical Journal*, 1875, p. 108, 1 pl.; (2) On Some Causes of Brownian Movements, *Journ. Roy. Microscop. Soc.*, 1879, p. 656, 2 figs.; (3) On Erosion of the Surface of Glass when exposed to the joint action of carbonate of lime and colloids," *Journ. Roy. Microscop. Soc.*, 1885, p. 761.

SUMMARY OF CURRENT RESEARCHES
RELATING TO
ZOOLOGY AND BOTANY
(PRINCIPALLY INVERTEBRATA AND CRYPTOGAMIA),
MICROSCOPY ETC.*

ZOOLOGY.

VERTEBRATA.

a. Embryology. †

Artificial Parthenogenesis in *Arbacia* induced by the Use of Sea-water concentrated by Evaporation. ‡—S. J. Hunter finds that sea-water condensed until it is isotonic with Loeb's 10 p.c. to 15 p.c. $2\frac{1}{2} n$ sodium chloride solution will induce artificial parthenogenesis in the ova of the sea-urchin *Arbacia*. Sea-water with osmotic pressure perceptibly less or greater than the 10 to 15 p.c. solution of $2\frac{1}{2} n$ sodium chloride will not produce artificial parthenogenesis. Furthermore, it is evident that a certain osmotic index or degree of pressure is essential for artificial parthenogenesis. These observations obviously supply an interesting confirmation of Loeb's osmotic theory of artificial parthenogenesis.

Problem of Fertilisation.§—Th. Boveri has published a terse up-to-date exposition of the processes of fertilisation, with a critical discussion of the meaning of the various steps. Perhaps the most significant part of the lecture is that in which he suggests some modification of the view that one of the chief functions of the spermatozoon is to import a centrosome into the inert ovum. Morgan and others showed that alterations in the saline composition of the sea-water resulted in the appearance of bodies like centrospheres in the ova of sea-urchins, &c.; Loeb showed that in similar conditions (already summarised) artificial parthenogenesis resulted; Wilson noticed that in Loeb's experiments bodies like centrospheres appeared in the unfertilised ova and seemed to initiate the segmentation; Boveri now suggests "that it is not a centrosome as an *organised structure* which is introduced into the egg, and which there starts the segmentation processes, but rather

* The Society are not intended to be denoted by the editorial "we," and they do not hold themselves responsible for the views of the authors of the papers noted, nor for any claim to novelty or otherwise made by them. The object of this part of the Journal is to present a summary of the papers as *actually published*, and to describe and illustrate Instruments, Apparatus, &c., which are either new or have not been previously described in this country.

† This section includes not only papers relating to Embryology properly so called, but also those dealing with Evolution, Development, Reproduction, and allied subjects.

‡ Amer. Journ. Physiol., vi. (1901) pp. 177-80.

§ Das Problem der Befruchtung, Jena, 1902, 8vo, 48 pp.

a chemical substance which, in combination with the ovian cytoplasm, produces the body in question." "Such a view," Prof. Farmer says,* "would reconcile much that has hitherto been difficult of explanation in connection with the diverse behaviour of centrosomes in different organisms, and even in different cells and tissues of the same individual."

Nature of Fertilisation.†—R. Hertwig has made numerous cultures of *Actinosphaerium* in order to get more secure data in regard to "plastogamy" or fusion of cytoplasm apart from fusion of nuclei ("Karyogamy").

In *Actinosphaerium* the process occurs in quite definite conditions,—at the close of intense nutritive periods and also at times when the power of assimilation has ceased. It occurs when there is disproportion between nucleoplasm and cytoplasm. Forms appear which are the results of the plastogamy of perhaps a hundred units, and may be recognised, apart from their large size, by the fact that the different regions of the giant show different phases of nuclear change.

There is a causal relation between the ordinary vital functions and the occurrence of natural death. In opposition to Weismann, it is maintained that natural death is the necessary consequence of life. The Protozoa must come to an end like the Metazoa, but there are processes which counteract the injurious influences of long-continued life. The most effective counteractive is fertilisation, "a process in which, from the material of two units gradually verging towards destruction, a new vitally energetic individual is formed."

Grand-parental Inheritance.‡—N. Blanchard contributes an article on grand-parental inheritance, collecting all known data and supplementing them by the coefficients for grandsires in the case of coat-colour for thoroughbred horses. He emphasises the need for further work on "blending," as distinguished from "alternative" inheritance, and suggests the need for experiments on the grand-parental relation in small mammals or insects.

Numerical Law of the Germ-Cells.§—J. Beard states in particular reference to his studies on the early development of skate-embryos (*Raja batis*) and dog-fish embryos (*Scyllium canicula*), the following law:—"The number of primary germ-cells in any given Metazoan development is 2^n , but with the sacrifice, entailed by the development of one primary germ-cell to form an embryo for the reception of the rest, the greatest actual number of primary germ-cells in any embryo will be $2^n - 1$." One would need to be very sure of one's methods to contradict this!

Spermatogenesis in *Phalangista vulpina*.||—K. von Korff describes the four periods in the development of the spermatozoa of this Marsupial.

The sperm-nucleus is flattened into an oval body lying transverse

* Nature, lxxvi. (1902) p. 74.

† SB. Ak. Wiss. München (Math.-Phys. Classe), 1902, Heft i. pp. 57-73.

‡ Biometrika, i. (1902) pp. 361-4.

§ Anat. Anzeig., xxi. (1902) pp. 189-200.

|| Arch. Mikr. Anat., lx. (1902) pp. 232-60 (2 pls. and 4 figs.).

to the axial filament, but the head undergoes three torsions in the course of development which result in a variety of appearances. The intricate changes of the two central corpuscles are minutely described. A head-cap, formed from a vesicle of the idiozome, is a transitory structure thrown off when the head takes its final form.

Morphology of Teleostean Head Skeleton.*—H. H. Swinnerton has made a study of the developing skull of the three-spined stickleback (*Gasterosteus aculeatus*).

The cranial flexure, together with other features in the shape of the embryonic head skeleton in Teleosts, is probably a mechanical effect due to differences in the degree of distensibility between the dorsal and ventral surfaces of the brain, and to the presence of skeletal structures in close association with the latter.

The presence of an epiphysial bar, with consequent division of the large dorsal cranial fontanelle into two, is a common feature in developing Teleosts. The Ostariophysi differ from others in retaining this early condition of the cranial roof in the adult.

The intra-cranial notochord, so far from undergoing reduction, never at any stage ceases to grow.

In *Gasterosteus* the elements concerned in the support of the jaws and operculum, and in the attachment of the associated muscles, seem to undergo a considerable acceleration in development compared with the rest of the head skeleton.

Three types of palato-ethmoidal relationship exist in Teleosts and the immediately related Ganoids. The study of the structure and development of the head seems to point to a common ancestral stock for Elasmobranchs and Teleosts. The manner of mandibular suspension in Teleosts is insufficiently described by the term hyostylic.

The Lophobranchii and Hemibranchii together constitute a natural group (Thoracostei). To these, through the Gasterosteoides, the Scomberesoces approach more closely than do any other living Physoclysti. As judged by the study of the ethmoid and suspensorial regions, the Zancliæ and Acronuridæ are closely allied to the Plectognathi, but the affinities of these forms must not be sought amongst living Physoclysti.

Development of Inner Ear in Bat.†—P. Denis has made, with particular reference to *Vespertilio murinus*, a detailed study of the development of the external forms of the labyrinth and especially of the changes exhibited by the epithelium at various stages. The successive forms of the inner ear are made evident by photographs of twenty-one models constructed on Born's method.

Migration of Eye of Flat-Fish.‡—S. R. Williams has studied the changes accompanying the migration of the eye in *Pseudopleuronectes americanus*, and has made a number of observations on the tractus opticus and the tectum opticum. The first step in preparation for metamorphosis is the rapid resorption of the part of the supraorbital cartilage bar which lies in the path of the eye. This is probably due

* Quart. Journ. Micr. Sci., xlv. (1902) pp. 503-93 (4 pls. and 5 figs.).

† Arch. Biol., xviii. (1902) pp. 377-493 (7 pls.).

‡ Bull. Mus. Zool. Harvard, xl. (1902) pp. 1-57 (5 pls.).

to pressure from the migrating eye. Correlated with this is an increase in the distance between the eyes and the brain, caused by the growth of the facial cartilages. The migrating eye moves through an arc of about 120 degrees in about three days. The skeletal and nervous changes are carefully described. It may be noted that the only well-marked asymmetry in the adult brain is due to the much larger size of the olfactory nerve and lobe of the ocular side.

Thyroid of Lamprey.*—A. M. Reese gives an account of the structure and development of the thyroid gland in *Petromyzon* (two or three species), from the stage when it appears as a simple pit or groove of the pharynx on to the adult condition. The adult has a paired basilar or salivary gland of which no trace was seen in even the oldest larva, but it seems possible that this is developed from the anterior part of the larval thyroid, or from the pair of deep ciliated grooves which run forward from the opening of the thyroid in the larva, and are not present, as such, in the adult condition. The similarity in the secretion of the larval thyroid to the secretion and function of a salivary gland seems to support this view, but the author hopes soon to find evidence of the existence or absence of this relation.

Reproduction of *Gerardinus decemmaculatus*.†—N. Zolotnisky has made some observations on this viviparous South American Cyprinodont. It seems that the ventral fin is used as a penis; reproduction may occur four times a year, at irregular intervals; the female excitement before parturition is great; there is a pause of 10–15 minutes between the liberation of each pair of larvæ; the male seems to act as a sort of accoucheur. The author's most remarkable report is that the female can bring forth two sets of young in the absence of the male; he urges experts to look into the matter.

Development of Excretory Organs in *Gymnophiona*.‡—A. Brauer, in his third memoir on *Gymnophiona*, describes the development of the pronephros and mesonephros in *Hypogeophis rostratus*, and discusses the difficult morphological questions involved.

Hermaphroditism in the Herring.§—T. Southwell notes this rather rare occurrence. The ovary had two lobes, and was anterior in position; the testis was a single mass, posterior in position. Both bodies were fully matured, and had a healthy appearance.

Argument for the Use-Inheritance Interpretation.||—W. Kidd believes that "certain inherited characters of animals can only be interpreted by considering them to have arisen in ancestors of those animals by use or habit." His argument has reference to the disposition of hair in mammals, which he regards as more adequately interpreted on a dynamical theory of use-inheritance than by the selectionist formula.

* Proc. Acad. Sci. Philadelphia, 1902, pp. 85–112 (4 pls.).

† Arch. Zool. Expér., ix. (1901) Notes et Revue, pp. lxxv.–lxxi. (1 fig.).

‡ Zool. Jahrb., xvi. (1902) pp. 1–176 (20 pls. and 85 figs.).

§ Ann. Nat. Hist., li. (1902) pp. 195–6.

|| Use-Inheritance. Illustrated by the direction of Hair on the bodies of animals. London, 1901. 8vo, 47 pp. and 16 figs.

b. Histology.

Intracellular Canals in Hepatic Cells.*—M. T. Browicz directs attention to his own work, and to that of others, in demonstrating the existence of intracellular canals traversing both cytoplasm and karyoplasm in the cells of the liver.

Brown Fat in Rodents and Insectivores.†—M. Auerbach finds that brown fat occurs in all the typical parts of the body in rats, mice, voles, hares, hedgehogs, moles, &c. and in some of the typical regions in squirrel, rabbit, and guinea-pig. None was found in badger or cat. It appears that the occurrence of brown fat has no special relation to hibernation; it is absent from some hibernators, and it is present in many forms which do not hibernate. It is not reduced to some fibrous strands after hibernation, as Carlier reported, but may persist to a great extent. In *Myoxus muscardinus*, *Arctomys marmota*, and *Mus rattus* there is a distinct transition from brown to white fat. In hedgehog, marmot, and *Myoxus nitela* it is not an absolute necessity that there should be some feeding during the hibernating period. The sinking of the body-temperature, the diminution of heart-beats and inspirations, and the lowering of sensory acuteness, were verified in the marmot. The primordium of a fat-organ was found in embryos of rat, mole, rabbit, and cat.

Evolution of Pyramidal Cells of the Cerebrum.‡—P. Ramón y Cajal has an important short paper—which should be translated—on the phylogenetic changes in the pyramidal corpuscles of the cerebrum. He notes that the idea of the supposed progressive evolution of these elements, based on their diverse appearances throughout the Vertebrate series, must be corrected by the fact that the plastic protoplasm relates itself to the changing plan of cortical cerebral structure. But he has much more to say, which we would summarise if we were more familiar with his language.

Cerebral Degenerations.§—K. Kosaka describes, in reference to dog and monkey, the secondary degenerations which ensue in the mid-brain, pons, and medulla oblongata, after the destruction of the cerebrum, and especially of the motor cortical centre.

Arterio-Venous Anastomoses in Man and Mammals.||—O. Grosser has made a detailed study of the anastomoses of arteries and veins at the end of the extremities in bats, rabbit, rat, mouse, cat, and man. The histological relations are noted, and the possible physiological interpretations are discussed.

Lympho-myeloid Connective Stroma in Testes of Young Rays.¶—A. Pollicard notes that the immature testis has in great part a lympho-myeloid structure. This connective stroma is probably the seat of leucocyte-formation, and it probably has a nutritive function in relation

* Bull. Internat. Acad. Sci. Cracovie, 1902, pp. 130-6.

† Arch. Mikr. Anat., lx. (1902) pp. 291-338 (2 pls.).

‡ Boll. Soc. Espan. Hist. Nat., ii. (1902) pp. 179-50 (2 figs.).

§ M.T. Med. Fac. Univ. Tokio, v. (1901) pp. 77-160 (4 pls.).

|| Arch. Mikr. Anat., lx. (1902) pp. 191-216 (2 pls. and 2 figs.).

¶ Comptes Rendus, cxxxiv. (1902) pp. 297-9.

to the spermatic ampullæ. It does not seem to have any hæmatopoietic significance.

Interstitial Cells of the Testis.*—P. Stephan agrees with Loisel that these elements are sister-cells of the germinative elements, but he differs from Loisel in regarding their secretory or nutritive rôle as entirely secondary,—a falling away from the primary germinative path.

Nerves of Lorenzini's Ampullæ.†—A. Coggi has studied the development of these ampullæ in *Torpedo*, *Pristiurus*, *Mustelus*, and *Raja*, and comes to the conclusion that the mode of development and the details of structure show that the ampullary nerves are in their nature somewhat different from those of the lateral organs. They seem to be sensory nerves of a more general character.

In another paper ‡ Coggi discusses the number and arrangement of the ampullæ, the time and place of their formation, and the various stages in their development.

Spines of Spinax.§—H. Koppen has made a study of the minute structure and the development of the fin-spines in *Spinax niger*, with especial reference to the epithelial cells in the protective cap of the spine, which are arranged in a network. This is compared to the cells in the enamel-pulp in mammalian teeth, and to similar tissue beneath the horny teeth of *Myxine*, and elsewhere.

c. General.

Chemical Organisation of the Cell.||—F. Hofmeister seeks to explain what must be the organisation of the living cell in order that protoplasm—the functions of which are chemical—may do its work. The manifold activities of liver-cells are discussed in illustration. Hydrations, oxidations, reductions, condensations,—all are accomplished through the activity of catalytic agents, colloidal in nature, which are the important agents in the chemical transformations of the cell. There is no necessity for calling upon other than well-known forces for an explanation of the work done.

Practical Course of Zoology.¶—W. Kükenthal has published a second edition of his useful outlines of a practical course in Zoology. Some additions, e.g. as to parasites, have been made, and new illustrations have been added or substituted.

Story of Animal Life.**—B. Lindsay has written a terse and yet interesting introduction to the study of animals. It might be described as a bird's-eye view of the animal kingdom, supplemented by more detailed pictures of particular corners, e.g. of sea-shore life. Most of the booklet is devoted to an illustrated survey and classification of

* Comptes Rendus, cxxxiv. (1902) pp. 299-302.

† Atti (Rend.) R. Accad. Lincei, xi. (1902) pp. 338-40.

‡ Tom. cit., pp. 289-97.

§ Zool. Jahrb., xiv. (1901) pp. 477-522 (3 pls. and 1 fig.).

|| Die Chemische Organisation der Zelle, Braunschweig, 1901, 8vo, 29 pp. See Review Amer. Journ. Sci., xiii. (1902) pp. 241-2.

¶ Jena, 1902, 8vo, 304 pp. and 169 figs.

** The Story of Animal Life (Newnes' Library of Useful Stories), London, 1902, viii. and 208 pp. and 47 figs.

animals, and there are special chapters on adaptation to circumstances, man, and zoological work. For a little book of this sort there seem to us to be too many technicalities, but the authoress has not taken her work lightly and deserves congratulation for successfully avoiding the misleading suggestion of false simplicity. The illustrations are not up to the level of the text.

Variations in Vascular System of *Rana temporaria*.*—E. Warren has noticed in four years five cases (out of about 200) in which a blood-vessel connected the apex of one of the lungs with the rectal vein of the hepatic portal. He refers to other striking abnormalities, and asks Continental workers to notice if similar variations occur in *Rana esculenta*.

Variations in Human Vertebral Column.†—P. Ancel and L. Sencert discuss the numerical variations in the human vertebral column, propose four categories embracing the recorded variations, and discuss the possible interpretations.

The most frequent variations are of a compensatory character, due to accommodation, others are referable to difficulties connected with the movements of the pelvis; a few, notably cervical, imply some change in the primitive segmentation.

There is an evident relation between the appearance of cervical ribs and the reduction of the number of pre-sacral vertebræ; but which change is primary remains obscure.

Variation in Snakes.‡—E. C. Eckel, in a systematic catalogue of the snakes of the north-eastern United States, has a few notes on variation. Notable examples are the common garter snake (*Eutænia sirtalis*) and the milk snake (*Oseola dolia*). In regard to melanism, it is noted that in *Heterodon platyrhinus* the black coloration has no systematic importance, while in *Natrix fasciata sipedon* it seems that the darker coloration in New York and New England specimens is general and not merely individual in its occurrence.

Teeth of Hag and Lamprey.§—E. Warren has made sections through young forms, and does not confirm the conclusion of Dr. Beard that the teeth show odontoblasts. The cone of "odontoblasts" is purely epidermal in origin, and is, in fact, a successional tooth developing beneath the functional tooth.

The structure of the teeth does not lend support to the idea that they are degenerate derivatives of calcified teeth. If they actually are degenerate they must be regarded as having reverted to a condition that probably preceded the placoid scale of an Elasmobranch—a horny wart with a pulp-cavity

Excretory Organs of Amphioxus.||—E. S. Goodrich adds a little to the preliminary paper in which he pointed out that in their segmental arrangement, in their function, and in their histological structure, the excretory organs of *Amphioxus* and the nephridia of *Phyllococe* are in all essentials identical.

* Zool. Anzeig., xxv. (1902) pp. 221-2.

† Journ. de l'Anat. Physiol., xxxviii. (1902) pp. 217-58 (2 pls.).

‡ Bull. New York State Museum, li. (1902) pp. 356-88 (24 figs.).

§ Quart. Journ. Micr. Sci., xlv. (1902) pp. 631-6 (1 pl.).

|| Tom. cit., pp. 493-501 (1 pl. and 1 fig.).

Amount of Dissolved Oxygen in Water required by Young Salmonidæ.*—D. Noël Paton finds that a fall in the amount of dissolved oxygen in water to below one-third of the normal amount, 2 ccm. per litre, is prejudicial and generally fatal to young Salmonoids. When the surface of the deoxygenated water is exposed to an atmosphere containing oxygen, the fish frequently seem able to live by constantly coming to the thin layer of more oxygenated water at the surface. Some individuals are able to sustain life for very prolonged periods in water containing only minimal traces of dissolved oxygen. Such fish are seen to lie very quietly at the bottom of the bottle.

Action of Spurge on Salmonoid Fishes.†—H. M. Kyle has studied the fatal effect of *Euphorbia hiberna* on fishes—an effect well known to the Irish peasantry. The plant cut into small pieces and pounded with stones, or simply trampled upon at some convenient spot on a river, forms an emulsion in the water which, being swept downward into the pools, carries death to all fishes in its course. Even in small quantities the spurge extract is almost as fatal as corrosive sublimate.

Chemical analysis of the extract shows tannic acid, about 1 p.c. it has been calculated, but on this estimation the spurge extract is fatal within a shorter time than a corresponding quantity of tannic acid. Hence the percentage of tannic acid has been under-estimated, or some other substance or substances in the extract also aid in producing fatal effects. 20 p.c. of the fresh extract is fatal within 5 minutes, whilst 0·1 p.c. takes 4–6 hours, and seems to be the smallest percentage that has fatal results. In the case of fishes death is considered to ensue from the inflammation of the gills and consequent stasis of the circulation.

Electrical Properties of Nerves.‡—V. Grandis communicates the results of 150 experiments, which go to show, if we understand aright, that a nerve is to be regarded rather as a dielectric than as a conductor.

Function of the Thyroid Gland.§—E. Roos tries to combine the two views, (a) that the thyroid produces and exudes a special substance, and (b) that the thyroid acts as a neutraliser of auto-toxins.

By its iodothylin, the thyroid increases the renal elimination of solid uric-substances, which accumulate in myxœdema when the thyroid has degenerated. Tetanus, after extirpation of the thyroid, is due to a retention of these uric substances. Tetanic convulsions correspond to uræmic cramps. Normally, the thyroid secretion antagonises the uric poisons. But this is only a hint of a learned lecture.

European Wild Cattle.||—R. Lydekker sums up an interesting discussion by noting that the aurochs and the Pembroke and park cattle belong to one and the same species, and since the latter do not appear specifically separable from the domesticated cattle of Scandinavia, which probably formed the type of the *Bos taurus* of Linnæus, it is clear that the aurochs has no right to a distinct species name. Instead of *Bos primigenius*, it should be called *Bos taurus primigenius*.

* Proc. R. Soc. Edin., xxiv. (1902) pp. 145–50.

† Proc. R. Soc. London, lxx. (1902) pp. 48–66.

‡ Atti Accad. Sci. Torino, xxxvii. (1902) pp. 341–6.

§ Ber. Nat. Ges. Freiburg, xii. (1902) pp. 119–33.

|| Knowledge, xxv. (1902) pp. 100–2.

Biogeographical Regions.*—A. Jacobi has made an important contribution to biogeography. He accepts the fundamental idea that the present distribution does not correspond, in many cases, to the present conditions of life, but has often its origin in the past, and indicates conditions prevailing in former geological periods.

He finds in Lydekker's Arctogæa, Neogæa, and Notogæa, the most appropriate division applicable to the distribution of mammals and birds since the beginning of Tertiary times.

But there are numerous facts which show in certain parts of the earth a faunal and floral distribution which is inexplicable by the present conditions. Thus Jacobi distinguishes fifteen "areas of dispersal" (*Ausbreitungsgebiete*), which demand a former land-connection between areas now more or less separated.

"In the demonstration that such conditions must have existed in former times, and in the collection of known facts as well as in the introduction of new ones, which tend to support this assumption, lies the chief value of Jacobi's paper, which will be of great use to any one who proposes to study these highly interesting zoogeographical questions."

Plankton of the Lake of Maria-Laach.†—O. Zacharias reports on the Algæ, Flagellata, Rotatoria, Crustacea, and Hydrachnida of this lake in the Coblenz district. The most interesting fact is, that some Crustacea, e.g. *Diaptomus cæruleus* and Hydrachnids, e.g. *Atax crassipes*, showed degeneracy as regards size—which may be reasonably correlated with the continual ascent of bubbles of carbonic acid gas from the floor. No effect on Rotifers was noticed, but *Diatoma tenue* was more slender and delicate than in any other water-basin investigated.

Tunicata.

New Giant Pyrosoma.‡—J. Bonnier and C. Perez observed in the Indian Ocean an immense shoal of gigantic specimens of *Pyrosoma indicum* sp. n., all swimming in the same direction but at different depths. The smallest, 40–50 cm. in length, were almost on the surface; the largest, 2·50 m. in length, with a diameter of 20–30 cm., were swimming about 2 m. from the surface. The ascidizoids were bright red, with remarkable development of a powerful spindle-shaped lateral muscular band (200 μ broad by 1500 μ long). The gut contained a monocystic Gregarine, doubtless allied to *Lankesteria*; the cavity of the colony included commensal fishes and a Penæid.

INVERTEBRATA.

Mollusca.

γ . Gasteropoda.

New Parasitic Gasteropod in Holothurian.§—Kristine Bonnevie describes a very interesting new form—*Enteroxenos östergreni* g. et sp. n.—found by Hjalmar Östergren in 1896, as a parasite in *Stichopus tremulus*.

* Zeitschr. Ges. Erdkunde Berlin, xxxv. (1900) pp. 147–238 (2 pls.). Review by A. E. Ortman, Amer. Nat., xxxvi. (1902) pp. 157–9.

† Zool. Anzeig., xxv. (1902) pp. 395–6.

‡ Comptes Rendus, cxxxiv. (1902) pp. 1238–40.

§ Zool. Jahrb., xv. (1902) pp. 731–92 (5 pls. and 6 figs.).

It occurs on the outside of the gut, ensheathed in layers of endothelium and connective tissue formed by its host. Occasionally one was found free in the cœlom. Apart from the epithelium and musculature of its body-wall, the parasite has no organs except the gonads. These occupy the central cavity which has a "ciliated canal" as its only communication with the exterior.

The development occurs within the mother, and the segmentation and larvæ are Gasteropod-like. The larva has velum, otoliths, foot-glands, a shell, an operculum, &c. The post-embryonic development occurs within the connective tissue of the wall of the gut, and there is a gradual protrusion into the cœlom.

What intervenes between the stage when the minute larva is within its parent and the stage when it occurs in the wall of the gut, is uncertain. There are some reasons for believing that the larva must be liberated from its first host before the post-larval changes occur.

The new parasite is compared in detail with *Entoconcha mirabilis* and *Entocolax ludwigi*.

Crystalline Style and Style-Sac in *Turritella communis*.*—W. B. Randles finds that the stomach of this gasteropod contains a crystalline style and style-sac, and has on the inner wall of the posterior chamber a short crescentic groove somewhat similar to that in *Trochus*, and probably representing a vestigial spiral cæcum. If so, it indicates the retention of a very primitive character in this genus.

Paryphanta hochstetteri Pfr.†—B. Beutler gives an account of the structure of this rare New Zealand snail, which does not however show any remarkable peculiarity. Its affinities are with *Testacella* which in many ways it closely resembles; as it has a relatively large shell it is probably ancestral to the Testacellids where the shell becomes rudimentary.

'Talisman' Opisthobranchs.‡—A. Vayssière reports on the small collection made by the 'Talisman' in 1883. As Opisthobranchs are notably littoral, it was not surprising that only seven forms were obtained in the deep dredgings. Although they had lain many years in spirit, they admitted of dissection, and the author has obtained some interesting results. In this preliminary note he directs particular attention to *Phyllidiopsis berghi* sp. n.

Arthropoda.

Last Joint of the Limbs in Arthropods.§—J. C. H. de Meijere has made a detailed comparative study of the terminal joint in the appendages of insects, Crustaceans, Arachnoids, Pycnogonids, *Limulus*, *Peripatus*, &c. From the nature of the subject it is not easy to make an intelligible summary.

Ventral Integument of Trilobites.||—C. E. Beecher has especially studied *Triarthrus becki* Green, but refers also to *Asaphus megistus*

* Anat. Anzeig., xxi. (1902) pp. 200-3 (3 figs.).

† Zool. Jahrb., xiv. (1901) pp. 369-416 (4 pls.).

‡ Comptes Rendus, cxxxiv. (1902) pp. 296-7.

§ Zool. Jahrb., xiv. (1901) pp. 417-76 (8 pls.).

|| Amer. Journ. Sci., xiii. (1902) pp. 165-74 (4 pls.).

Locke and *Ptychoparia striata* Emmer. The ventral integument is a thin uncalcified membrane, which may be divided into pleurosternites and mesosternites, corresponding to the mesotergites and pleurotergites of the dorsal test, and like them connected segmentally by an inter-articular membrane. The mesosternites are usually marked by five longitudinal ridges, or buttresses, representing thickenings of the membrane, which may be homologised with apodemal structures in (other) crustaceans, and not with the appendicular system. These buttresses, or apodemes, include a single median one for each mesosternite, with two others on each side extending forward and obliquely inward, and enclosing subtriangular or rhombic spaces. The presence and disposition of these buttresses apparently afford information regarding the ventral musculature of the Trilobites. A pair of flexors is indicated, together with lateral strands attached to each mesosternite and extending forward and inward to their union with the main bundles within the cavity of the next anterior somite.

a. Insecta.

Artificial Parthenogenesis of Silk-Moth Ova.*—A. Tichomirow refers to his experiments in 1885 in which he showed that unfertilised ova of the silk-moth (*Bombyx mori*) dipped in dilute sulphuric acid exhibited parthenogenetic development in response to the extraordinary stimulus. He has since experimented with similar results with dilute sulphuric and hydrochloric acid. His conviction is that the induced development is very different from the normal. The embryos have little vitality, the cells have exceedingly little coherence, the relations of the germ-layers is abnormal, and so on. In short, the artificial parthenogenetic development is a *Krüppelentwicklung*.

Prothoracic Respiratory Apparatus in Dipterous Pupæ.†—J. C. H. de Meijere finds that, except in *Chironomus*, this apparatus is a modification of the *Tüpfelstigmata* which are of wide occurrence in simpler form in Dipterous larvæ and on the abdomen of pupæ. He discusses the development and the possible homologies and the many different forms.

Some British Hemiptera.‡—E. A. Butler writes a useful popular paper on what he calls "stilt-walkers"—*Metatropis rufescens* from the Euchariter's Nightshade, *Metacanthus punctipes* from the rest-harrow, *Neides tipularius*, *Ploiaria vagabunda*, *Hydrometra stagnarum*, and *Ranatra linearis*.

Index to North American Orthoptera.§—S. H. Scudder has completed an index, which has been forty years in the making, of all known definite references to the Orthoptera of North America and the West Indies from the time of Linné to the close of the last century. The list of literature cited is practically a complete bibliography of North American Orthoptera.

* Zool. Anzeig., xxv. (1902) pp. 386-91 (3 figs.).

† Zool. Jahrb., xv. (1902) pp. 623-92 (4 pls.).

‡ Knowledge, xxv. (1902) pp. 97-100 (6 figs.).

§ Occasional Papers Boston Soc. Nat. Hist., vi. (1901) vi. and 436 pp.

Monograph on Coccidæ occurring in Britain.* — Robert Newstead has completed the first volume of an important monograph on the Coccidæ which are found living in Britain. It deals with the sub-family Diaspinæ, and includes a very valuable general introduction. The author's illustrations are worthy of the series, and the text is the outcome of many years of work well known for its thoroughness.

Studies on Thysanura.† — F. Silvestri discusses, in the first place, some of the characters of *Projapyx*, e.g. two glands which he has discovered opening at the ends of the cerci. In the second place, he describes 13 species of *Japyx* in his collection of which eight are new. He then describes three new species of *Nicoletia* and one of *Lepisma*. His communication ends with a brief account of South American Thysanura, of which 29 species are now known. Of the ten genera, *Eutrichocampa* and *Trinemophora* are probably characteristic of the neotropical region. The genera *Japyx*, *Campodea*, *Lepisma*, *Grassiella*, *Machilis*, and *Nicoletia* seem to be cosmopolitan; *Lepidocampa* is also represented in the Malay Archipelago, and *Projapyx* in East Africa.

New Agricultural Ant from Texas.‡ — W. M. Wheeler describes *Pogonomyrmex imberbiculus* sp. n., a small and inconspicuous form, of a timid disposition, living under stones. It collects grass-seeds, which it shells and treats in some singular manner, so that they have all a glistening yellow colour like the animal itself. The myth that *Pogonomyrmex molifaciens* sows, guards, and weeds the "ant-rice" (*Aristida oligantha*) is regarded as a joke even by the Texan schoolboy. The seeds which have sprouted too far to be fit for food are carried out, but there is neither sowing nor weeding. The special ring of grass about the nest is an unintentional and inconstant by-product of the activities of the colony. A key to the species is appended.

New Moravian Cave-Insect.§ — C. Absolon describes a new member of the Collembola, *Heteromurus hirsutus* sp. n., from Moravian caves, and discusses the other species of the interesting genus.

Insects Injurious to Elm-Trees.|| — E. P. Felt describes the elm-leaf beetle (*Galerucella luteola*), the bag or basket-worm (*Thyridopteryx ephemeraformis*), the fall web-worm (*Hyphantria cunea*), the spiny elm caterpillar (*Euvanessa antiopa*), the elm-borer (*Saperda tridentata*), the elm snout beetles (*Magdalis*), and the elm-bark louse (*Gossyparia ulmi*). The coloured plates of these insects have unusual excellence.

Honey of Bees.¶ — H. Jimero has made a number of saccharometric and polarimetric observations on different kinds of honey from various parts of Spain.

B. Myriopoda.

Annectant Type of Chilopod.** — R. I. Pocock has had the pleasure of receiving, through G. M. Thomson, of Dunedin, a consignment of

* Ray Society, 1901, xii. and 220 pp. and 39 pls.

† Bull. Soc. Entomol. Ital., xxxiii. (1901) pp. 204-49 (48 figs.).

‡ Amer. Nat., xxxvi. (1902) pp. 85-100 (8 figs.).

§ Verh. Nat. Ver. Brünn, 1901, pp. 6-14 (1 pl.).

|| Reprint from 5th Ann. Rep. Fisheries, Game, Forest Commission, State of New York, 1902, pp. 352-79 (3 pls. and 7 figs.).

¶ Boll. Soc. Espan. Hist. Nat., ii. (1902) pp. 98-102.

** Quart. Journ. Micr. Sci., xlv. (1902) pp. 417-48 (1 pl. and 1 fig.).

Myriopods from the summit of Mount Rumney, Hobart, Tasmania, "which completely falsified the opinion that the Antipodes hold nothing peculiar or primitive in the way of centipede-life, and are wholly given over to the occupation of widely distributed and well-known forms. The collection in question contained a couple of centipedes representing a species which proves to be comparable in interest, from a morphological standpoint, to either of its compatriots, *Ceratodus* or *Ornithorhynchus*, inasmuch as it unmistakably represents an archaic type which has survived in this isolated corner of the world—a type which possesses the twofold interest of exhibiting certain unique structural peculiarities of its own, coupled with others that serve to link together three of the best-known and most diversified sections of the class; and also of showing the true, but previously unknown and unsuspected, nature of the connection between the metamerism of the Scolopendromorpha and that of the Lithobiomorpha."

After describing the new Centipede—*Craterostigma* g. n.—and comparing it with existing orders, Mr. Pocock explains its significance in testifying to the transformation of the Scolopendroid into the Lithobioid type. "It may be stated with confidence, and without fear of contradiction, that the true nature of the connection between the metamerism of the Lithobioid and Scolopendroid types would never have been guessed had it not been for the fortunate survival of this intermediate form, with the six additional somites of the last-named type in process of excalation."

The interesting and important essay concludes with a discussion of the general characters and classification of the Chilopoda. The classification may be summed up:—

- Sub-class Pleurostigma
 - Order 1. Geophilomorpha
 - Geophilidæ, Oryidæ, &c.
 - Order 2. Scolopendromorpha
 - Scolopendriidæ, Newportiidæ, &c.
 - Order 3. Craterostigmomorpha
 - Craterostigma*
 - Order 4. Lithobiomorpha
 - Lithobiidæ, Hemipidæ, and
 - Cermatobiidæ
- Sub-class Notostigma
 - Order Scutigermomorpha
 - One family Scutigeridæ.

δ. Arachnida.

Development of *Admetus pumilio* Koch.*—L. H. Gough has been able to study some stages in the development of this Pedipalp. On the whole the development of the Pedipalps follows the types seen among other Arachnids, sometimes leaning towards one, sometimes more towards another.

It resembles that of spiders—in the first cleavages (probably), in the egg-envelopes, in the general build of the blastoderm, in the de-

* Quart. Journ. Micr. Sci., xlv. (1902) pp. 595-630 (2 pls.).

velopment outside the mother, and in the development of the lungs, heart, alimentary canal, and coxal gland. It resembles that of Solpugidæ and Pseudoscorpionidæ in the development of the lateral organ, and that of scorpions as regards central nervous system, accessory brain, median and lateral eyes, and also as to lungs, heart, coxal gland, and parts of the alimentary canal and Malpighian tubes.

Hibernating Cyst of a Mite.*—A. C. Oudemans describes a peculiar scale-like cyst, with anterior and posterior hairs or hair-like processes, which contained a fully formed *Erythræus* (= *Rhyncholophus*) with its food-canal filled with black particles. He finds it impossible to explain the process (of ecdysis and encystation?) whereby the described structure arose.

British Tyroglyphidæ.†—A. D. Michael has increased the debt which zoology already owes him by adding to his monograph on British Oribatidæ the first part of a companion work on Tyroglyphidæ. After discussing general characters, practical importance to man, parasitism and mutualism, &c., he gives a history of the literature, and a discussion of the classifications proposed. Then follow two important chapters on structure and development. The rest of volume i. is systematic. The whole will be an achievement to be proud of.

Arctic Halacaridæ.‡—E. Trouessart makes a preliminary report on the Acarina of Arctic seas, collected by the Prince of Monaco. He raises the number of known Arctic species from three to nine, and four of the additions are new species. Two of these *Halacarus alberti* and *H. princeps* are remarkable for their large size.

ε. Crustacea.

Regeneration in Hermit Crab and Crayfish.§—T. H. Morgan shows that regeneration of the leg of the hermit crab can take place at a number of different regions lying outside of the breaking-joint, and presumably, therefore, at all levels. It is thence argued that there can be no connection between regeneration and liability to injury, for the legs can rarely or never be broken off outside of the breaking-joint under natural conditions without the leg being thrown off at the base.

The author gives five cases showing that the crayfish has the same power as the hermit crab and can regenerate the distal portions of its legs when they are cut off outside of the breaking-joint. The crayfish can also regenerate a new leg when the old one has been cut off inside of the breaking-joint. There is no necessary connection between the process of autotomy and the power of regeneration.

Larval Stages of the Shrimp.||—H. C. Williamson confirms Ehrenbaum's arrangement of the larval forms of *Crangon vulgaris* in five stages, which form a complete series all connected by observed moults. He traces and very carefully figures the development of the nine pairs of appendages from stage to stage. The gills, it is noted, are in all

* Zool. Anzeig., xxv. (1902) pp. 218-9.

† Ray Society, 1901, xiii. and 290 pp. and 22 pls.

‡ Bull. Soc. Zool., xxvii. (1902) pp. 66-70.

§ Anat. Anzeig., xx. (1902) pp. 598-605 (17 figs.).

|| 19th Ann. Rep. Fishery Board Scotland, 1901, pp. 92-119 (6 pls.).

cases originally appendages of the limb, and pass from being podobranchs to become arthrobranchs and pleurobranchs.

Relict Crustaceans in North German Lakes.* — M. Samter and W. Weltner have studied the distribution of *Mysis relicta*, *Pallasiella quadrispinosa*, and *Pontoporeia affinis*, and furnish a list of numerous North German lakes in which the "relicts" are at home. They are now distributed over a wide area of the northern plain, which was land and not sea during the Glacial Period. Lovén's interpretation that these relicts in South Swedish lakes are referable to an ancient extension of the sea will not serve for North Germany.

Observations on Young Stages of *Balanus improvisus*.† — E. Filatowa notes, in the first place, that the nauplii and later stages of this acorn-shell swim about without indications of heliotropism, but they seek shady nooks to rest in.

Secondly, the author maintains on the basis of experiments with pigments, that the large cells, with large nuclei and granular cytoplasm, on the dorsal wall of the stomach of the nauplius and metanauplius, have an excretory function. Other excretory structures are unknown.

Thirdly, he gives his reasons for believing that the larval nervous system is simply represented in the nauplius by the ectodermic cells. After noticing what he calls "acid cells," the author briefly describes a pair of glandular organs in the basal segments of the second pair of antennæ.

Decapods of Celebes.‡ — E. Schenkel reports on the collection made by the brothers Sarasin, which included fourteen new species mostly belonging to the genera *Potamon*, *Sesarma*, *Palæmon*, and *Caridina*, so characteristic of the Indo-Pacific fresh waters. The author briefly alludes to some of the zoogeographical riddles which the new facts seem rather to accent than to solve.

New Genus of Blind Isopods.§ — O. A. Sayce describes *Hypimetopus intrusor* g. et sp. n., a new blind Isopod belonging to the interesting and peculiarly Australian family Phreatoicidæ. The new form was found in Tasmania in the burrows of the land crayfish, *Engæus cunicularius*. In all fundamental characters it agrees with the genus *Phreatoicus*, but is a quite distinct representative of the very ancient family of Phreatoicidæ.

New and little-known Victorian Decapods.|| — S. W. Fulton and F. E. Grant describe—*Platydromia thomsoni* g. et sp. n., a new crab of the family Dromiidae, and two little-known species—*Axius plectro-rhynchus* Strahl, and *Upogebia simsoni* Thomson. They also record the occurrence at Port Philip of the common European shore-crab, *Carcinus mænas*,—probably introduced in the shipping.

Reproduction of Limnetic Crustacea.¶ — V. Haecker has studied in the Titi lake near Stuttgart the reproductive phases of *Heterocope saliens*, *Diaptomus denticornis*, *D. laciniatus*, and *Cyclops strenuus*.

* Zool. Anzeig., xxv. (1902) pp. 222-4. † Tom. cit., pp. 379-85 (6 figs.).

‡ Verh. Nat. Ges. Basel, xiii. (1902) pp. 485-585 (7 pls.).

§ Proc. R. Soc. Victoria, xiv. (1902) pp. 218-24 (2 pls.).

|| Tom. cit., pp. 55-64 (1 pl.).

¶ Ber. Nat. Ges. Freiburg, xii. (1902) pp. 1-33 (6 figs.).

The species of *Diaptomus* show monocyclic reproduction, the others show alternation of reproductive periods. While *D. laciniatus* shows a continuous development and winters in a differentiated stage, the other species (*D. denticornis*) probably winters in an embryonic stage.

The females seem to be more uniformly distributed than the males—which are more sensitive to changes in light and heat, and alter their vertical distribution more markedly.

Lateral Hermaphroditism in *Palinurus frontalis*.* — O. Bürger describes an interesting asymmetrical specimen of this lobster, which in its appendages and other hard parts was distinctly female-like on the left side and male-like on the right.

Annulata.

Regeneration in *Enchytræidæ*. † — J. Nusbaum has studied regeneration-processes in *Fridericia ratzeli* Eisen and *Enchytræus buchholzii* Vejd. Some of the processes, e.g. formation of the proctodæum, follow the ontogenetic mode; others, e.g. the ectodermal renewal of the musculature, especially the circular musculature, follow a simplified, more primitive plan.

Circulation in *Lumbricus*. ‡ — J. B. Johnston and Sarah W. Johnson find that the circulation in each segment behind the hearts of the earthworm is as follows:—the branches of the lateral neurals and parietals collect blood from the body-wall; the parietals take blood to the dorsal from the sub-neural body-wall and nephridia; the dorso-intestinals give blood to the dorsal from the intestine; all of this blood goes forward in the dorsal to the hearts; through them nearly all of it is given to the ventral vessel, which sends it to the intestine through the ventro-intestinals and to the body-wall through the ventro-tegmentaries. The head-region is supplied with blood by the dorsal and ventral vessels, while the neurals and laterals carry blood from it. The dorsal and ventral vessels carry mixed blood: the neurals carry oxygenated blood only; the laterals carry backward mixed blood.

Two new Earthworms. § — F. E. Beddard describes *Octochætus beatrix* sp. n. and *Benhamia tanganyikæ* sp. n., Acanthodriloid earthworms of the family Megascaloidæ.

Peritoneal Elements of *Phascolosoma vulgare*. || — M. A. Hérubel describes the chlorogogen elements and the ciliated urns in the ascending coil of the intestine of this worm. He discusses the relation of the urns to the chlorogogen cells which they always have as their neighbours; and he also points out that there are never urns apart from membranous connective tissue. The urns rapidly remove injurious solid bodies from the cavity of the gut; the chlorogogen cells act more slowly as "microphagous" peritoneal cells. The urns seem to digest, as far as possible, the bodies which they capture.

* Zeitschr. wiss. Zool., lxxi. (1902) pp. 702-7 (4 figs.).

† Biol. Centralbl., xxii. (1902) pp. 292-8.

‡ Amer. Nat., xxxvi. (1902) pp. 317-28 (3 figs.).

§ Ann. Nat. Hist., ix. (1902) pp. 456-63.

|| Bull. Soc. Zool. France, xxvii. (1902) pp. 105-14 (4 figs.).

Nematohelminthes.

New Nematodes.* — O. von Linstow describes new species of *Ascaris*, *Heterakis*, *Physaloptera*, *Spiroptera*, *Filaria*, *Agamonema*, *Gordius*, and *Echinorhynchus*; and also furnishes notes on a number of previously recorded forms.

Platyhelminthes.

New Rhabdocæl.† — F. F. Laidlaw describes *Typhlorhynchus nanus* g. et sp. n. living on the body of the Polychæt *Nephtys scolopendroides*. Its affinities are with the Mesostomidæ and Proboscidæ; perhaps it may be ranked most conveniently among the latter and in the neighbourhood of *Pseudorhynchus*. It is the only member of either of the related families that has adopted an epizoic habit. The character of the parenchyma should be specially marked, for in the way it merges into the endoderm it shows a distinct approach to the condition found in the Alloiocœla.

Notes on a Planarian.‡ — X. Raspail has made some interesting observations on an undetermined species of *Planaria*, whose generations he has watched since 1892, in a vessel holding about two litres. He notes their changes of colour — often harmonising with that of the objects on which they live, and due to the fluid in the gastric ramifications. They fed greedily on flies which got entangled on the surface of the water, and on the common earthworm whose presence in the vessel they noticed with extraordinary rapidity, while the introduction of *Lumbricus fetidus* passed unnoticed. They were also seen devouring *Gammarus puteanus*.

Distomum duplicatum in Fresh-water Mussels.§ — H. Reuss describes the abundant occurrence of sporocysts and cercariæ of this Trematode inside *Anodonta mutabilis* Cless. var. *cellensis*. The sporocysts filled up the space between the coils of the gut and the gonads; they were seen as shining white spots through the epidermis of the foot; some occurred on the mantle and in the pericardium. The liberation of the cercariæ from the exhalant aperture and the changes which followed in the water are described, but the life-history was not discovered.

Maturation and Fertilisation in Distomum hepaticum.|| — L. F. Henneguy briefly describes the appearance of the immature ovum and the vitelline cells which surround it. He notes the interesting fact that many spermatozoa are absorbed, and probably digested, by the vitelline cells.

After the entrance of the spermatozoon, and before its transformation into a male pronucleus, the seminal vesicle loses its contour; in its place there appears a maturation spindle with two punctiform centrosomes at each end; the chromosomes—few in number and very unequal in size—are irregularly distributed in the equatorial region.

Two bodies like polar bodies were seen, but their actual expulsion was not observed. The oocyte remains with male and female pronuclei quiescent and independent until the liberation of the egg.

* Arch. Mikr. Anat., lx. (1902) pp. 217-32 (1 pl.).

† Quart. Journ. Micr. Sci., xlv. (1902) pp. 637-52 (1 pl.).

‡ Bull. Soc. Zool. France, xxvii. (1902) pp. 119-23.

§ Zool. Anzeig., xxv. (1902) pp. 375-9.

|| Comptes Rendus, cxxxiv. (1902) pp. 1235-8.

Incertæ Sedis.

Development of *Phoronis*.* — M. de Selys Longchamps gives a full account of his investigations on material from Helgoland and from Naples. Total almost equal segmentation results in a blastula, ciliated in the Helgoland form; the gastrulation is by embole, a typical invagination in the Helgoland form, by a modified "incurving process" in the other species; the circular blastopore, which is very large, closes from behind forwards, leaving an anterior entrance to the archenteron. At the posterior end, on the ventral surface, a median ectodermic diverticulum insinuates itself into the blastocœl between the ventral surface of the archenteron and the ectoderm. The mesoblast arises from endoderm cells, liberated from the archenteric wall, but most actively from the anterior region surrounding the persisting portion of the blastopore.

Larval characters begin to appear; the stomodæum is formed, the pre-oral lobe is transformed into a cephalic hood with the central ganglion at its summit, the tentacles originate, the anal papilla becomes distinct. Within this great internal changes go on, the posterior part of the archenteron becomes the intestine, an anus is formed without a proctodæum, the ectodermic diverticulum seems to form the posterior cavity of the body (cœlomic?), while the anterior cavity is blastocœlic. But the history of this diverticulum and the excretory structures remains very vague. In a second part of his memoir the author describes the actinotrocha, and his results are closely similar to those of Ikeda, which he did not know of until after his work was done.

Notes on *Actinotrocha*.† — K. R. Menon describes this larva with particular reference to the epistome (a new structure, an outgrowth of the collar region, and *not* a remnant of the pre-oral lobe), the body-cavities, the nephridia, the "notochords," the sub-neural gland, the tubular nerve-ganglion, and the sense-organ in front of the ganglion.

"If *Actinotrocha* is related to the Chordata at all, as the presence of three divisions of the body with their corresponding cavities, of collar nephridia, of a dorsal diverticulum of the anterior part of the gut, and of a dorsal tubular nerve-ganglion renders probable, the absence of such important structures as the gill-slits, and of the proboscis pores, shows that the relationship is to be traced through a form like *Rhabdopleura*."

A. T. Mastermann ‡ reviews Iwaji Ikeda's § observations on the development, structure, and metamorphoses of *Actinotrocha*. He notes their confirmatory value in reference to his own work, and points out that the discrepancies are mostly due (a) to differences of interpretation; (b) to specific variation; and (c) to unintentional misunderstanding of his (Mastermann's) statements.

Rotifera.

New Rotifers. — F. R. Dixon-Nuttall and R. Freeman || describe *Diglena rostrata* sp. n., which they have found in the large lake of

* Arch. Biol., xviii. (1901) pp. 495-597 (3 pls.).

† Quart. Journ. Micr. Sci., xlv. (1902) pp. 473-81 (1 pl.).

‡ Tom. cit., pp. 485-92.

§ Journ. Coll. Sci. Tokyo, xiii. (1901) pt. 4.

|| Journ. Quek. Micr. Club, viii. (1902) pp. 215-6 (1 pl.).

Knowsley Park, Lancs. The body is elongated and narrow; the face long and prone, and has a projecting hook anteriorly with two red frontal eyes; the toes are long and blade-shaped. Two very good figures accompany the text. Size 240 μ .

A. Seligo* describes *Tubicolaria natans* sp. n., which is really a *Conochilus*, resembling *C. dossuarius* in its habits. It was found in the lakes of Stuhm in East Prussia, is free swimming, without tube, occurs singly, and does not form colonies, but carries 1-3 eggs attached to the posterior end. It has two long ventral antennæ, which are separate to their base. Size 140-200 μ .

Max Voigt† describes *Anuræa aculeata* var. *divergens*, a new variety with rather long anterior and posterior spines.

Echinoderma.

Calcareous Plates of *Synapta* and *Ankyroderma*.‡—Ed. Herouard expounds the theory that the anchor-plate of *Synapta* is derived from a theoretical hexagonal honeycomb. Some interesting abnormalities are figured in support of the theory. The law is stated that the meshes in the calcareous plates decrease in size in precise relation to the order of their formation. The homology between the plates in *Ankyroderma* and in *Synapta* is pointed out.

Minute Structure of Cuvierian Organs.§—Ph. Barthels returns to a subject which he discussed in 1896, and points out, in criticism of Russo, that in *Holothuria helleri*, &c. the wall of the Cuvierian organs always shows the following layers:—internal epithelium, internal connective tissue, circular and longitudinal musculature, external connective tissue, and external epithelium.

New Holothurian from New Zealand.||—A. Reiffen describes *Ludwigia ocnoides* g. n. (= *Colochirus ocnoides* Dendy). The body is elongated and curved, without a ventral sole, with ten tentacles of which the two ventral ones are smaller than the others. There are well-developed tube-feet, with distinct suctorial discs dorsally as well as ventrally on the radii,—but rudimentary towards both ends of the body; the calcareous bodies (plates, rods, &c.) differ considerably in different regions of the body; retractors and longitudinal muscles are undivided, except where the latter adjoin the pharynx; the radialia of the calcareous ring consist of one piece, narrow, thin, and brittle; the interr radialia are short and thick; the elastic membrane of the water vascular system is distinctly recognisable; the cloaca occupies the whole of the posterior third of the body; the respiratory trees open separately into the cloaca; to the right and left there is a tuft of unbranched genital tubules, and the opening is on a minute papilla between the two dorsal feelers.

An abnormal six-rayed specimen is described. A sixth radius and interradius have been interpolated between the right dorsal and right ventral radius, that is, on the right dorsal interradius.

* Untersuchungen in den Stuhmer Seen, Danzig, 1900, pp. 1-60 (1 fig.).

† Beitr. zur Kenntniss des Planktons pomm. Seen, Forschungsberichte Plön, Teil 9 (1902) pp. 72-86 (2 figs.).

‡ Bull. Zool. Soc. France, xxvii. (1902) pp. 46-51 (8 figs.).

§ Zool. Anzeig., xxv. (1902) pp. 392-5.

|| Zeitschr. wiss. Zool., lxi. (1901) pp. 598-621 (1 pl.).

The probable systematic position of the genus is interesting; it represents in certain respects a transition from the *Dendrochirota* to the *Molpadiidæ*.

Maturation in *Asterias glacialis*.* — M. Hartmann finds that in the growing period of the ovarian egg, there are "vegetative nuclear changes," consisting in the distribution of the chromatin in the nucleus and its accumulation in the nucleolus.

At the end of this period all the chromatin and plastin is united in the nucleolus, from which after liberation into the water and after the radiation and dissolution of the germinal vesicle there arise the chromosomes of the first directive-division.

This is confirmatory of the work of O. Hertwig (1878) and of what Carnoy and Lebrun observed in *Urodela*. It cannot be readily harmonised with the assumption of the individuality and qualitative diversity of the chromosomes.

Echinoderms from Puget Sound. † — H. L. Clark reports on collections which include some interesting new species:—*Pteraster multi-spinosus*, *Cribrella spiculifera*, *Psolus chitonoides*, and *Cucumaria lubrica*.

Function of Sphæridia in Sea-Urchins. ‡ — Yves Delage has made a number of experiments to test the theory that the sphæridia are equilibrating organs. He experimented with *Strongylocentrotus lividus* and *Echinus esculentus*, watching the behaviour of the animals after the removal of the sphæridia. His results were negative, for the urchins operated on moved and turned themselves and climbed up vertical surfaces almost as effectively as uninjured specimens. They were slow and hesitating in righting themselves when inverted, but they did it. Delage concludes cautiously that the sphæridia are not the exclusive organs of orientation.

Genital Pores of Male *Antedon rosacea*. § — W. S. Marshall describes pores penetrating nearly through the wall of the pinnules. As many as four pores were found on a single pinnule, with no very definite position other than being in the neighbourhood of the sacculi. Many were full of spermatozoa and in one specimen the pore was ruptured.

New Crinoid. || — O. Follmann describes a new form *Hystricrinus schwerdtii* from lower Devonian strata near Coblenz. It is related to those Hexacrinids which have a tripartite basis (*Hexacrinus* Aust. and *Arthracantha* Williams = *Hystricrinus* Hinde), but is distinguished by the cirri on the stalk, the three different kinds of joints occurring in the stalk, the numerous small polygonal plates composing the calyx lip, and so on.

Cœlentera.

Relationships of the Rugosa to Living Zoanthæ. ¶ — J. E. Duerden finds from a study of sections of *Lophophyllum proliferum* that the tip

* Zool. Jahrb., xv. (1902) pp. 792-812 (2 pls.).

† Proc. Boston Soc. Nat. Hist., xxix. (1901) pp. 323-37 (4 pls.).

‡ Comptes Rendus, cxxxiv. (1902) pp. 1030-3.

§ Zool. Anzeig., xxv. (1902) pp. 209-11 (2 figs.).

|| Verh. Nat. Ver. Preuss. Rheinl., lviii. (1901) pp. 66-76 (1 pl.).

¶ Johns Hopkins Univ. Circ., xxi. (1902) pp. 19-25 (12 figs.); Ann. Nat. Hist., x. (1902) pp. 381-98 (12 figs.).

of the corallum displays the median dark lines of six primary septa, separated by six interseptal spaces. There is no doubt as to the primary hexamerous character.

"So far as *Lophophyllum* can be taken as a representative, the peculiar septal plan of the Rugosa introduces no new conception into Anthozoan studies, and any other peculiar features which the order possesses, such as tabulæ and vesicular endotheca, are of very subordinate morphological importance compared with the septal scheme."

If the manner of mesenterial development be taken as the index of natural relationships, the bilateral Zoanthids, primarily hexamerous, but with their metacnemic development restricted to two exocœlic regions, are, more than any other Anthozoan type, the modern representatives of the Rugosa.

The following arrangement indicates the different fundamental types of metacnemic sequence now known within the Actinaria and Madreporaria, and the position amongst them of the Rugosa. With the exception of the Cerianthæ all possess a primary hexamerous stage, consisting of six pairs of mesenteries with six primary entocœlic chambers and six primary exocœlic chambers. Calcareous septa may appear within only one or in both series of chambers. It is in the succession of the later mesenteries and septa—metacnemes and metasepta—that the divergences are introduced.

I. The metacnemes arise as unilateral pairs at one, three, seven, &c. regions within all the six primary exocœles, and become arranged in one, two, three, or more cycles:—

- | | |
|---|---|
| (a) <i>Non-skeletal.</i>
Most Actinians. | (b) <i>Skeleton-forming.</i>
Most recent Madreporarian corals. |
|---|---|

II. The metacnemes arise as bilateral pairs at only one region within two or more of the primary exocœles:—

- | | |
|--|--|
| (a) <i>Non-skeletal.</i>
Zoanthids. | (b) <i>Skeleton-forming.</i>
<i>Lophophyllum</i> and probably other Rugosa. |
|--|--|

III. The metacnemes arise as bilateral pairs at one region within one or both of the axial entocœles:—

- | | |
|--|--|
| (a) <i>Non-skeletal.</i>
Cerianthids. | (b) <i>Skeleton-forming.</i>
<i>Porites, Madrepora.</i> |
|--|--|

Protozoa.

Conjugation of *Dendrocometes paradoxus*.*—S. J. Hickson, assisted by J. T. Wadsworth, has made a study of conjugation of this Acinetarian which commonly occurs on the gills of *Gammarus pulex*. The phenomena may be briefly stated as follows:—Two individuals in proximity on a gill of *Gammarus* send out simultaneously blunt lobe-like processes, which may be called the conjugative processes. These meet but do not completely fuse, a distinct membrane delimiting the process of each individual throughout the conjugation. This membrane does not prevent the fusion of the meganuclei nor of the conjugative micronuclei in

* Quart. Journ. Micr. Sci., xlv. (1902) pp. 325-62 (2 pls.).

the later stages, nor does it prevent a certain amount of mixture of the cytoplasm of the conjugating individuals.

In contrast to ciliate Infusorians, the difference between the migratory or male germ-nucleus and the stationary or female germ-nucleus is in *Dendrocometes* reduced to a minimum. It is possible that in all cases one germ-nucleus traverses the membrane and the other does not, so that the distinction remains, but the two nuclei are as nearly neuters as can be. Moreover, the fusion of the germ-nuclei takes place during a resting and not in a mitotic state. The ordinary vital processes are not affected by the conjugating act.

Plate's observation of the occasional occurrence of a conjugation of three individuals is confirmed. The mixing of the cytoplasm in the conjugative process is also confirmed. It seems probable that the sexual stimulus affects the two individuals simultaneously and that there is no differentiation of sex.

Hickson gives a detailed account of the two or more, usually three, micronuclei and their mitosis.

Whatever difficulties there may be in finding an explanation of the fact, there can be no doubt that the meganuclei do, during conjugation, meet and become continuous. The junction lasts a very short time and it is probably followed immediately by disintegration. The new meganucleus is formed from one of the four nuclei produced by the second division of the germ-nucleus. In this formation there are remarkable processes of elimination and recovery of chromatin.

The paper concludes with an interesting chapter of general considerations, leading on to the conclusion that the body of *Dendrocometes* is no more a single independent cell than is the embryo-sac of an angiosperm.

Osmotic Phenomena in Infusorians.*—P. Enriques has experimented with *Opalina ranarum*, *Vorticella nebulifera*, *Halteria*, *Chilodon*, and *Gastrostyla steinii*, and finds that when these Infusorians are transferred from one medium to another of different tonicity, they exhibit at first a change of volume due to the passage of water through their cell-wall, osmotically impermeable to salts; and then a change in the opposite direction due to the non-osmotic reception of water and salts (absorbed or excreted) which may temporarily more than counteract the initial changes. Infusorians without mouth and gullet, e.g. *Opalina*, are impermeable by endosmosis to sodium chloride dissolved in the water.

Foraminifera.†—F. Chapman has made students of zoology his grateful debtors by this excellent account of the Foraminifera—well illustrated and printed, and reasonably cheap. After some introductory chapters on the position, structure, reproduction, and classification of Foraminifera, the author gives a systematic survey of the ten well-established families. Then follow chapters on geological range and geographical distribution, on collecting and mounting. The book ends with a bibliography. We have had the pleasure of using the book in the laboratory, and can testify to its convenient utility and clearness.

* Atti (Rend.) R. Accad. Lincei, xi. (1902) pp. 340-7.

† The Foraminifera: An Introduction to the Study of the Protozoa, London, 1902, 8vo, xv. and 354 pp., 14 pls. and frontispiece, and 42 figs.

Trypanosoma brucei.*—J. R. Bradford and H. G. Plimmer describe the adult form of this organism found in Nagana or Tse-tse fly disease, its multiplication by longitudinal division and from a plasmodial mass by detachment of buds, its conjugation, its "amœboid" and "plasmodial" forms, and its "micronucleus" ("blepharoplast," "nucleolus," "centrosome," &c. of other authors) which seems to come off from the macronucleus and which fuses with the corresponding body in another individual. The "micronucleus" has this in favour of its being a centrosome that it nearly always divides before the macronucleus does in the longitudinal division.

The authors also discuss the distribution of the parasite, its variations in different animals, and their resistance to it. The noticeable differences between it and the *Trypanosoma lewisi* found in sewer rats are noted.

The probable sequence of the life-history is:—(1) longitudinal division, which is very common, seen more or less in the blood of all the organisms examined; (2) conjugation, the essential of which is the fusion of the micronuclei of the conjugates, and (3) the fusion of the adult forms in "tangles" or plasmodia which give off flagellated amœboid forms from the margin.

New *Trypanosoma*. †—A. Laveran discusses *Trypanosoma theileri* sp. n., called after its discoverer Theiler,—a veterinarian in Pretoria. It seems a specific parasite of cattle, and injections into horse, dog, rabbit, &c. proved ineffective. The disease induced in cattle is a pernicious anæmia with or without fever, and with some striking features, such as the rapid destruction of red blood-corpuscles. Laveran points out that the number of species of *Trypanosoma* is rapidly mounting up.

Terminology for Various Stages of the Malaria Parasite. ‡—E. Ray Lankester proposes a clearer terminology than that in vogue for describing the stages in the life-history of the malaria parasite and similar forms. The life-cycle may be written as below, the sign \times being used to indicate fissile multiplication, $+$ to indicate fusion, and \longrightarrow to indicate merely continuity.

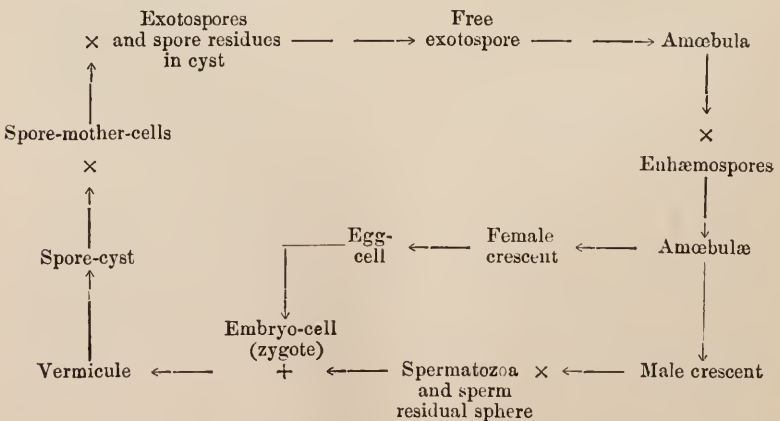

* Quart. Journ. Micr. Sci., xlv. (1902) pp. 449-71 (2 pls.).

† Comptes Rendus, cxxxiv. (1902) pp. 512-4.

‡ Proc. Roy. Soc. London, lxx. (1902) pp. 74-9.

Life-History of Lankesterella minima.*—R. Hintze has investigated this hæmospore parasite of the frog's blood, perhaps better known as *Drepanidium*. He describes the structure, mode of life, the schizogony, the sporogony, the formation of micro- and macro-gametes, the maturation of the latter and their fertilisation by the former. He also discusses the mode of infection and the different species. Many gaps in our knowledge of this common form are removed by this research.

Progressive Movement of Gregarines.†—H. Crawley has studied the gliding movements of *Stenophora juli* and *Echinomera hispida*. One kind of movement, which consists of contractions of the body, is readily explained by the existence of "the muscular layer," but the other kind of movement, in which the animal glides along, usually, it is said, "without the slightest bodily movement," has been for many years a riddle.

In 1894 Schewiakoff advanced the theory, supported by careful studies, that Gregarines progress by means of the extrusion of gelatinous fibres, derived from a layer between the cuticle and the ectoplasm. He supposed that they form a hollow cylinder behind the animal and acquire a certain amount of rigidity, that the posterior end of this cylinder impinging upon some resistant body, becomes fixed, and that the Gregarine is pushed passively forward as the extrusion continues and the cylinder lengthens.

Crawley cannot accept Schewiakoff's theory. The progression of Gregarines is effected in a manner somewhat as follows:—The muscular impulse, starting backward from the region of the septum, necessarily causes the contact of the Gregarine (with the cover-glass) to be different in this region from what it is in the more posterior parts. Further, since the transverse movement takes place at the same time as the backward movement, that part of the Gregarine's surface where the contact relations are temporarily different moves not only backward, but from side to side as well. It is not difficult to see how movements of this sort may produce locomotion, when it is recollected that Gregarines are sticky.

This explanation is based on the fact that Gregarines possess a well-developed muscular system, while the theory of a passive locomotion by means of the extrusion of gelatinous threads is without parallel in the animal kingdom.

Cabbage and Cancer.‡—L. Feinberg describes the peculiarities especially as regards nucleus, of the amœboid organism—*Plasmodiophora brassicæ*—causing cabbage-hernia; and hints at the possible occurrence of a similar organism at work in human carcinomata.

* Zool. Jahrb., xv. (1902) pp. 693-730 (1 pl.).

† Proc. Acad. Nat. Sci. Philadelphia, 1902, pp. 4-20 (2 pls.).

‡ Ber. Deutsch. Bot. Ges., xix. (1901) pp. 533-6.



BOTANY.

GENERAL,

Including the Anatomy and Physiology of Seed Plants.

Cytology,

including Cell-Contents.

Permeability of Protoplasm.* — Van Rysselberghe, working in Pfeffer's laboratory, has made observations on the influence of temperature on the permeability of living protoplasm; a field of work almost untouched except for the observations of Krabbe in 1896. The chief methods of observation were the study of the contraction and expansion of living elder pith under various conditions, and the direct observation under the microscope of cells of the epidermis of *Tradescantia*. The author shows, as Krabbe found, that the permeability increases with the rise of temperature (at 30° C. the protoplasm being eight times more permeable than at 0° C.); the increase of permeability is different from that found in a precipitated membrane of copper ferrocyanide, but it is shown that this is no reason for believing with Krabbe, that this change is due to a vital action of the protoplasm. Contrary to the general opinion the permeability was found to be only reduced, not in complete abeyance, at 0° C., and this applied not only to the passage of water but also to that of dissolved substances. The passage of water was found to take place under very reduced osmotic pressures (probably at 0·0023 of an atmosphere) so that probably there is no minimum force of filtration, as Krabbe believed, below which no passage of water takes place. It was further found that a cell, the cell-sap of which is isotonic with a certain solution at one temperature, remains isotonic with the same solution at all temperatures, provided that changes in the cell-sap have not had time to take place by adaptation. It is thus clear that the changes in the osmotic pressure in the cell is the same as that in a solution, namely, $\frac{1}{273}$ for every degree of temperature.

Aleurone-Grains in Oily Seeds.† — Bille Gram has examined the character and reactions of all the elements of the grain — tegument, fundamental mass, globoid, crystal, and crystalloid. He confirms the refractory character of the coat, manifested in its insolubility in 5 p.c. solution of caustic potash. The fundamental mass consists mainly of albuminoids, which in different grains show different degrees of solubility in dilute caustic potash; various other substances are present. He finds in the globoid not only the acid phosphates of calcium and magnesium signalled by Pfeffer but also succinic acid. From their behaviour with solvents globoids would appear to have, generally

* Recueil de l'Institut Botanique Université de Bruxelles, v. (1902) pp. 209-49 (6 pls.).

† Mém. Acad. Roy. Sci. &c. Danemark, sér. 6 (Section d. Sciences) ix. (1901) pp. 303-36 (4 pls.).

speaking, a uniform composition. As to the presence in them of alkaloïds, as Tschirch and Kritzel maintained, the author's researches gave no certain indication. From the crystals he obtains succinic acid, oxalic acid, and the metals magnesium, calcium, and potassium. The greater or less resistance of the crystalloïds to different reagents is due to differences in chemical composition, which probably find expression in the differences in form. The form of the crystalloïd is of great importance for determination of the grain and can be studied in the pulverised grain better than in sections. The author concludes that crystalloïds are in a great number of cases complex bodies. He recommends a solution of potassium borotartrate for clearing the grain and manifesting the form of the crystalloïd. This solution generally dissolves the fundamental mass entirely and also the globoid. On placing the powdered grain, from which the fat has been removed by ether, into this solution, the crystalloïd generally appears standing alone and surrounded by the tegument.

Constitution of Hæmatoxylin.* — W. H. Perkin jun. and J. Yates have carried out a number of experiments on the colouring matter of the heart-wood of *Hæmatoxyton campechianum*, the well-known logwood, the results of which indicate its close relationship with brazilin and also enable the authors to assign a formula to hæmatoxylin.

Colouring Matters of Green Ebony.† — A. G. Perkin and S. H. C. Briggs have investigated the colouring matters of a sample of green ebony, a yellow dye-wood formerly employed to some extent in this country, and a native of Jamaica or the West Indies. They isolated crystals of two distinct colouring matters which they name excecacin and jacarandin respectively. The former has the composition $C_{13}H_{12}O_5$ and crystallises in glistening lemon-yellow needles, sparingly soluble in cold alcohol or ether and insoluble in benzene or chloroform. The latter is represented by the formula $C_{14}H_{12}O_5$ and forms glistening yellow plates or leaflets sparingly soluble in alcohol and the usual solvents to form pale yellow liquids having a green fluorescence. The former does not dye calico with or without mordants, but the latter gives good full shades of yellow, brown, or olive varying with the mordant. The chemical and physical properties of the substances are fully discussed. The dye-wood is obtained from *Excecacia glandulosa* or *Jacaranda ovalifolia*, but the name of the specimen used was not determined.

Colouring Matter from Flowers of Delphinium consolida.‡ — A. G. Perkin and E. J. Wilkinson have extracted from the blue flowers of this plant a yellow colouring matter differing in composition from that present in *Delphinium Zaiti*. It consists of pale yellow needles resembling quercetin in appearance, melting at 276° – 277° , readily soluble in boiling alcohol and also in alkaline solution to which it gave a pale yellow colour. It is represented by the formula $C_{15}H_{10}O_6$. Its reactions agree closely with those of kampherol prepared by Gordin from the monomethyl ether, kampheride, contained in galanga root.

* Journ. Chem. Soc., lxxx. (1902) pp. 235-46.

† Tom. cit., pp. 210-20.

‡ Tom. cit., pp. 585-91.

Structure and Development.

Vegetative.

Anatomy of Ranunculaceæ.*—H. Lonay has studied the anatomical structure of the pericarp and seed-coat in a large number of genera and species of this family. In the first part of his paper he describes the detailed structure of the walls of the carpels, ovules, and seeds, and the character of the albumen, at various stages of development in six types, namely *Ranunculus arvensis*, *Thalictrum flavum*, *Clematis Vitalba*, *Helleborus fœtidus*, *Delphinium Ajacis*, and *Pœonia officinalis*. These represent types of organisation about which it is possible to group the species of Ranunculaceæ.

In the second part he gives a general account of the structure of ovary wall, pericarp, and seed-coat, in these and other genera; as many species as could be obtained were examined. An anatomical diagnosis of the genera follows. The author then criticises previous tribal divisions of the order and suggests six tribes, as follows, giving the anatomical characters of the ovary, &c. as based on his work.

(1) Ranunculæ, including *Ranunculus*, *Ceratocephalus*, *Ficaria*, *Oxygraphis*, and *Myosurus*.

(2) Thaliectræ, including *Thalictrum* and *Adonis*.

(3) Anemoneæ, including *Knowltonia*, *Anemone*, *Hepatica*, and *Clematis*.

(4) Helleboreæ, including *Helleborus*, *Trollius*, *Caltha*, *Eranthis*, and *Aquilegia*.

(5) Delphinicæ, including *Isopyrum*, *Garidella*, *Nigella*, *Aconitum*, and *Delphinium*.

(6) Pœonicæ, including *Actæa*, *Cimicifuga*, and *Pœonia*.

The author concludes by giving a clavis for the determination of genera and one for the determination of the species which he has studied.

Anatomy of the Leaves in the Ranunculaceæ.†—J. Goffart arrives at the following conclusions from the study of the development and structure of the leaf (including bracts and bud-scales) in a large series of species. The genera are characterised not only by their floral, but also by their vegetative organs, especially by the leaves. Some genera resist more than others the influence of their present environment, and it is these genera that present fewer intermediate forms, and are consequently best characterised by vegetative organs. Study of the leaf-anatomy supplies additional material for deciding on the suppression or maintenance of disputed genera. For instance, *Hepatica* is not sufficiently characterised by its vegetative organs to justify a separation from *Anemone*, and the same holds for *Nigella* and *Garidella*, *Actæa* and *Cimicifuga*, and *Ficaria*, *Oxygraphis*, and *Ranunculus*. The study of anatomical characters confirms generally recognised systems of classification. In most of the genera anatomy is a help to the arrangement and determination of species.

* Archiv. de l'Institut. Bot. de l'Univ. de Liège, iii. (1901) pp. 164 (21 pls.).

† Tom. cit., pp. 190 (14 pls.).

Anatomy of the Euphorbiaceæ.*—L. Gaucher has investigated 375 species, representing 126 genera and all the tribes except Ricinodendrineæ. He concludes that there is, in spite of the extent of the family, its wide distribution, and its polymorphism, an aggregate of anatomical characters sufficiently constant to define the Euphorbiaceous type. They are as follows:—In the stem the phellogen is sub-epidermal, the pericycle forms in front of the vascular bundles fibrous islands or masses of fibres, intermingled with sclerotic cells, the vascular system forms a ring scarcely interrupted by medullary rays which are composed of a single row of cells; these cells are sclerotic in the region of the wood; the pith is also often sclerotic. Tannin sacs and calcium oxalate (except in *Euphorbia*) occur in the stem, in cortex, pericycle, phloem, and pith; they are especially abundant in the bast rays, where they mark very sharply the limit of the bundles. In the leaf the epidermal cells have a very uniform structure. The cuticle is generally quite plain, and the stomata are always on a level with the epidermis, and very rarely surrounded by subsidiary cells. As regards the subdivision of the order, anatomical characters bear out the generally recognised grouping. The Phyllanthoidæ are remarkable for the presence of water-reservoirs formed by epidermal cells or cells immediately below the epidermis. Laticiferous tissue and internal phloem are absent. The Crotonoidæ have no water-reservoirs, but often show a well-developed hairiness. They have also laticiferous tissue and internal phloem. The Stenolobæ have laticiferous tissue, but no internal phloem; they approach the two other tribes in that some have a water-storing apparatus, while others are hairy.

The internal bast of the Crotonoidæ occurs in four principal forms. In the *Euphorbia* type it forms a narrow zone around the pith, and consists of elongated cells with brightly shining walls, but with no trace of sieves. In the *Tragia* type it forms islands opposite the vascular bundles. The cells resemble those of the *Euphorbia* type, but some of the transverse walls, thicker and more refractive than others, are perforated in places. In the *Croton* type the phloem islands are more extensive, and have true sieve-tubes. The type of *Lepidoturus* is characterised by a girdle of sclerenchyma in addition to the phloem.

The latex receptacles are unicellular or multicellular, and never anastomose. The unicellular are sometimes surrounded by a sheath of parenchymatous cells (reserve tissue), giving the appearance of a secretory canal. The multicellular comprise two well-defined types. In one a number of elongated cells is placed in series, which is more or less regular according to the persistence or absorption of the transverse cell-walls. In the second type a number of cells irregularly arranged form by their union the latex-carrying tissue. Latex-carriers of very different form occur in different parts of the same organ. The author gives a table showing the distribution of the various forms in the family.

The latex-carriers pass from the stem into the leaf, where they spread through the mesophyll and surround closely the assimilatory tissue. The latex is for the most part composed of substances of a high nutritive value, of the same nature as the contents of the reserve

* Ann. Sci. Nat., ser. 8. xv. (1902) pp. 161-309 (81 figs.).

parenchyma; these substances also occur in the assimilatory tissue of the leaf. An exchange of material seems to occur between the reserve parenchyma and the latex-carriers on the one hand, and between the latter and the assimilatory tissue on the other. The latex tissue of the Euphorbiaceæ, which is generally regarded as purely excretory, should, in the author's opinion, be regarded rather as a conducting system for the transport of a part at least of the material elaborated in the leaves.

Many of the Euphorbiaceæ have tannin-carriers composed of equal cell-elements, which, like the latex-carriers, are continued from the stem into the leaf. By absorption of their transverse walls they may be transformed into tubes often of considerable length. Their development is most marked in the Phyllanthoideæ.

Morphology and Anatomy of *Azorella Selago*.*—C. Ternetz gives an exhaustive account of this interesting little Umbellifer, which forms a characteristic feature of the flora of Kerguelen's Land and other islands of the Southern Ocean, where it forms dense low-growing cushions. In growth and structure it is a well-marked xerophyte. The climate is remarkably damp, but owing to the constant low temperature, absorption of water from the soil is checked, while owing to the almost uninterrupted strong winds, rapid transpiration is favoured. In its stem-structure it differs remarkably from the description given by Drude for the genus in that it possesses a cambial secondary growth (which in the older plants is anomalous), while the vascular system forms a loose ring, not limited by a phloëterma; moreover crystal-sacs are absent from the pith, and there are no woody hard-bast strands in the cortex.

Air-roots of *Avicennia tomentosa*.†—W. Brenner has studied in detail the anatomical structure of the vertical air-roots of this mangrove in material from West Africa. The structure demonstrates to the full their respiratory function, and the alteration with increased age and size of the roots represents the response of the plant to increased need for gaseous interchange. For instance, while the young roots have a smooth exterior and show but little phellogen development, the older show this in a marked degree, and their surface is rendered uneven by the formation of numerous lenticels.

Origin of the Seed-leaf in Monocotyledons.‡—E. Sargent has examined the course of the vascular bundles in a number of seedlings representing a series of typical Liliaceous genera, and concludes that the most primitive form is that represented in *Anemarrhena*. The arrangement is a symmetrical one. The bundles run the whole length of the cotyledon, and are placed approximately at the foci of the elliptical transverse section of the organ. The transition stage in the short hypocotyl is also a perfectly symmetrical one. Each xylem group gives off three branches of protoxylem, and each phloem group divides into two. The four lateral branches of protoxylem fuse in pairs, to form the regular tetrarch stele of the root. If this be compared with *Eranthis*, a genus of Ranunculaceæ, the resemblance of the ground plan

* Bot. Zeit., lxx. (1902) pp. 1-20 (1 pl. and 8 figs.).

† Ber. Deutsch. Bot. Ges., xx. (1902) pp. 175-95 (3 pls.).

‡ New Phytol., i. (1902) pp. 107-13 (1 pl.).

of structure is very striking. The blades of the two cotyledons of *Eranthis* are distinct, but the long petioles are united to form a slender cylinder, a transverse section of which shows two bundles in exactly the same position as in *Anemarrhena*. The arrangement in the thickened hypocotyl is also comparable with that in the monocotyledonous genus. The author concludes that in *Eranthis* we have a plant which is in the way to become a monocotyledon; we have only to imagine the blades of the cotyledons united to complete the resemblance. The complete union of the cotyledons in Monocotyledons may be due to their common specialisation as a sucking organ. The fact that the apex of the cotyledon in this group often remains within the endosperm throughout its existence might lead in course of time to the fusion of the cotyledons within the seed. On this view the Monocotyledons are the more recent group.

Stipular Structures of Monocotyledons.* — H. Glück shows that true paired stipules (stipulæ laterales) occur in *Hydrocharis*, *Naias*, *Potamogeton*, *Ruppia*, *Althenia*, *Pothos*, and *Smilax otigera*, and that these structures are not so rare in Monocotyledons as has been supposed. Of special interest are those of certain species of *Potamogeton*, where only the leaves immediately succeeding the cotyledon have typical lateral stipules. In the following leaves the stipules gradually pass into a sheath-like appendage united with the leaf-base (stipula adnata) and ending in a ligule, and then by gradual shortening of the sheath-like portion into an apparently axillary ligule (stipula axillaris). The author regards this series as of phylogenic importance. The stipulæ laterales represent the oldest type (I.) from which have developed in succession the stipulæ adnatæ (II.) and the stipulæ axillares (III.). The ligule-bearing leaf-sheath of the grasses belongs to the second type, as also do similar structures in *Potamogeton*, *Calla palustris*, *Zingiber*, and others. To types II. and III. belong also all those appendages in which the stipular sheath is a closed tube, like the tubular liguled leaf-sheath in *Allium Ampeloprasum*, *Pontederia*, &c. The simple leaf-sheaths in grasses and orchids are regarded as further reduced stipular structures.

In the second part of the paper, the author discusses the biological function of the stipules which may act exclusively for the protection of young undeveloped members, or in addition as assimilating organs. In some cases the stipules serve mainly as protective organs for winter buds, in others they protect inflorescences or flowers, in others they serve mainly as stores of reserve material.

Subterranean Plants of *Epiphegus*.† — R. G. Leavitt describes dwarf specimens of *Epiphegus virginiana* completely buried 1 or 2 in. deep in the soil and bearing several fruits with good seed.

Regeneration of Leaf-Blade in *Cyclamen*.‡ — H. Winkler confirms Hildebrand's statement that on removal of the leaf-blade from the primary leaf of *Cyclamen persicum* and *africanum* new growths appear

* Verh. naturhist.-med. Ver. Heidelberg, N.F. vii. Heft 1, pp. 96 (5 pls.). See Botan. Zeit., lx. (1902) p. 43.

† Bot. Gaz., xxxiii. (1902) p. 376 (1 fig.).

‡ Ber. Deutsch. Bot. Ges., xx. (1902) pp. 81-7.

laterally upon the leaf-stalks, resembling in colour and structure the original leaf and performing its functions. Winkler finds that in the majority of cases if the blade be removed, two, more rarely one and still more rarely several, lateral outgrowths arise from the wing-like edge of the stalk and form as many new leaf-blades. The new development appears usually 5-6 days after the operation and directly below the cut end of the stalk, wherever the cut has been made. The new blade arises chiefly from the epidermal and subepidermal layer of the petiole; subsequently a procambial strand is formed connecting with the vascular bundle system of the stalk, and forming the conducting tissue of the new leaf-structure. The author finds that similar blade-regeneration ensues in the case of any of the other leaves of the first vegetative period.

Cork-formation in the Interior of the Leaf-stalk of *Nuphar luteum*.*—O. Amberg describes the formation of a protective layer of cork in the parenchymatous cells of the leaf-stalk of this water lily as a result of the destruction of tissue by an insect, which had eaten out a great part of the internal tissue, forming hollow chambers communicating with the outside air by narrow openings.

Union of Branch and Stem of the same Tree.†—O. Leneček describes such a union in a pine of about 50 years of age and 20 metres high. The branch springs from just above the base of the main axis and makes rather more than one complete turn round it; in the lower part the branch is closely flattened to the stem but not coherent with it, but for about 2 metres of its length the two are closely coherent, the branch being imbedded in the cortex of the stem. The free end of the branch was dead. The occurrence is explained by the death of the terminal bud of the young plant, when its place was taken by two lateral branches one of which grew more strongly to form the main axis while the other formed the branch which has become in part coherent with the main axis. The lower portion of the branch showed growth in thickness, which however ceased in the portion united with the stem.

Reproductive.

Notes on Living Cycads—The *Zamias* of Florida.‡—G. R. Wieland has examined a number of specimens from the Miami region. One is figured, and shows remarkably the disproportion in size between the ovulate cone and the plant on which it is borne, the cone being often much larger than the underground stem on which it is produced. The free branching is also well shown; a male plant is reported with as many as 39 cones; and when a trunk is cut off below the crown of leaves several new crowns may form. In one of the female cones a pinnule of normal structure had grown out from beneath the tip of one of the upper abortive sporophylls. This recalls the much more striking case of reversion described by Thiselton-Dyer in *Encephalartos villosus* § and emphasises the statement that the carpophyll is merely a transformed foliage leaf and capable of being replaced by it.

* Vierteljahrsschr. Naturforsch. Ges. Zürich, xlv. (1902) pp. 326-30 (1 pl.).

† Verh. zool.-bot. Ges. Wien, lii. (1902) pp. 165-8 (1 fig.).

‡ Amer. Journ. Sci., xiii. (1902) pp. 331-8 (5 figs.).

§ See this Journal, ante, p. 65.

Development of Pollen in *Zostera*.*—O. Rosenberg finds that in quite young anther rudiments the archesporial cells are very elongated, lying obliquely to the anther wall and stretching from one wall to the other. From both ends of the archesporial cells isodiametric tapetal cells are cut off, which divide several times and are finally dissolved. The inner cells continue to elongate and divide longitudinally to form numerous long cells, the pollen-mother-cells, which pass through a long resting period. Other cells divide transversely to form the sterile cells of the archesporium, which become crushed by the pollen-mother-cells and gradually disorganised. The nuclei which are found later between the pollen-cells are derived mainly from these sterile cells, but in part from the dissolved tapetal cells. A long period of development is passed before the pollen-mother-cells form tetrads, at this period the proportion between length and breadth is 60 : 1, and the number of the chromosomes is reduced to six. The first spindle is often sickle- or S-shaped; the nuclear membrane persists to the time when the daughter chromosomes have reached the poles, a phenomenon which recurs in the nuclear divisions in the root-apex of the same plant. The spindle and also the cell-plate stand obliquely to the long axis of the pollen-mother-cell; the cell-plate becoming more and more parallel with the latter. The second cell-division is also longitudinal, as might be expected from the characteristic packet of four thread-like cells.

Finally the author discusses previously described instances of sterile cells in archesporia; he suggests that herein may lie the explanation of differences in form of the pollen-grains in one and the same anther-chamber.

Embryology of *Zostera marina*.†—The same author finds that the origin and development of the embryo-sac follow the course typical for most angiosperms. From the embryo-sac mother-cell is formed a series of four cells the lowest of which becomes the embryo-sac. The embryo lies usually near the micropyle, rarely near the middle of the embryo-sac. It is borne as a remarkably large one-celled pear-shaped suspensor which contains a very large nucleus. The nucleus increases in size until it almost fills the cell; its appearance suggests an active nutritive function. In formation of endosperm the nuclei lie free in the parietal cytoplasm.

The author also discusses the structure of the root, especially the epidermis which shows well the arrangement into long and short cells. From the peculiar structure of the nucleus of the short cells, which recalls that of the nuclei of nutritive cells, the author concludes that these short elements are passage cells, whereas owing to their richness in tannin the long cells probably cannot subserve this function.

Development of Embryo-sac and Embryo in *Castalia* and *Nymphæa*.‡—M. T. Cook has investigated *Castalia odorata* and *Nymphæa advena* with a view to reaching some satisfactory conclusion on the

* Meddel. fr. Stockholms Högskola Bot. Inst., 1901, pp. 21 (9 figs.). See Bot. Zeit., lx. 2 (1902) pp. 132-3.

† Op. cit.; Nr. 211 (1901) pp. 24 (2 pls. and 6 text figs.). See Bot. Zeit., l. c., pp. 131-2.

‡ Bull. Torr. Bot. Club, xxix. (1902) pp. 211-20 (2 pls. and 2 figs.).

debated systematic position of the *Nymphæaceæ*. He finds nothing unusual in the formation of the megaspore—the archesporium is a single hypodermal cell, and the tapetal cells are irregularly formed. In one case two functional megaspores were observed side by side. The embryo-sac contains abundance of starch when in the two- and four-celled stages. The antipodal cells are very small and disappear about the time of the conjugation of the polar nuclei. One of the synergids persists for a very long time. Shortly after the conjugation of the polar nuclei and fertilisation of the egg the endosperm nucleus divides and a very delicate wall is formed across the sac similar to that described by Schaffner for *Sagittaria*. The upper nucleus forms the endosperm at the upper part of the sac; the endosperm persists until the embryo is fully formed.

From the lower cell is formed a long tube which grows towards the chalazal end of the ovule, forming a passage by the absorption of the nucellus. The author compares this nutritive function of the lower part of the embryo-sac with the presumed similar physiological significance of the antipodal cells in those plants (e.g. *Ranunculaceæ*, *Sparanium*, &c.) in which they are prominent. The embryo is at first spherical and later forms a single cotyledon which was not observed to bifurcate as Lyon describes for *Nelumbo*. The suspensor is late in forming and apparently without function. The formation of the plumule and primary root agree with the processes described by Lyon for *Nelumbo*. The embryo shows no marked resemblance in its development to any of the monocotyledonous plants of the *Helobieæ* series; but the development of the embryo-sac and the formation of tapetal cells and megaspores are very similar to what obtains in *Potamogeton* and *Naias*, while the formation of the wall across the sac recalls the same process in *Sagittaria*. Hence the author agrees with Lyon in placing *Nymphæaceæ* in or near the series *Helobieæ* (*Naiadales*).

Embryogeny of Araliaceæ.*—L. Ducamp describes the formation of the ovule and of the embryo-sac and the development of the embryo in this family. Of the two ovules which begin to be formed in each carpel, one, the ascending, becomes aborted, while an embryo-sac is produced only in the other, descending ovule. The embryo-sac is generally the lowest of a row of three cells formed by transverse division of a spore-mother-cell. Frequently four daughter-cells were formed by successive transverse divisions of the mother-cell—this is regarded as a primitive condition.

The course of division in the embryo-sac follows the general plan as described by Strasburger. The nucellus becomes absorbed except beneath the embryo-sac, and the internal epidermis of the integument forms a digestive layer, the cells of which are cutinised on the surface. The cells of the integument become disorganised, and finally the epithelial layer disappears, its place being taken by the superficial layer of endosperm which becomes differentiated as a digestive sac. The seed-coat is a membranous layer formed from the persistent outer epidermis of the integument, outside which the endocarp forms a layer of sclerotic elements.

In the formation of the embryo the initial cells of the central

* *Ann. Sci. Nat.*, ser. 8. xv. (1902) pp. 312-402 (8 pls.).

cylinder in the radicle mark the limit of suspensor and embryo, the lower cortex and root-cap are derived from the suspensor. In the Ivy secretory canals are found in the pericycle, appearing first in the hypocotyl, while tracheids arise only in the cotyledons. The embryos of other members of this order show neither canals nor tracheids.

Parthenogenesis in *Thalictrum purpurascens*.* — J. B. Overton describes this phenomenon and discusses parthenogenesis in seed-plants generally.

He finds the development and germination of the megaspore in *Thalictrum* to be that usual among angiosperms. The antipodal cells are remarkably large, and their nuclei multiply by fragmentation. Fusion of the polar nuclei occurs before fertilisation in normal material, and before the division of the egg in parthenogenetic material; the definitive nucleus is remarkably large. Fertilisation is not necessary either for embryo or endosperm development. Embryos were produced parthenogenetically under all conditions. Parthenogenesis is very general; the development of the embryo is the same as in the case of embryos formed from a fertilised egg. Loeb's work on eggs of echinoderms showing that unfertilised eggs may be made to develop into normal embryonic forms through increase in osmotic pressure, suggested an explanation of the present case. The egg is invested in early stages by a dense sheath of cytoplasm, and later becomes surrounded by an area much resembling a vacuole, which may affect the osmotic pressure and indicate a withdrawal of water causing the oosphere to divide. The author discusses previously described cases of parthenogenesis in angiosperms and suggests that it is of more common occurrence than at present supposed.

Physiology.

Nutrition and Growth.

Green Hemiparasites.† — E. Heinricher supplements his previous observations on *Euphrasia*, *Odontites*, and *Alectorolophus*. He describes culture experiments made with *Euphrasia* with a view of ascertaining whether the chemical properties of the cell-sap were prejudicial to a plant serving as a host. He finds that species of *Euphorbia* and *Oxalis* served admirably as host plants in spite of the peculiar chemical qualities of their cell-sap. The culture of *Euphrasia minima* confirmed the previous suggestion that this plant was relatively independent—many of the specimens reached the flowering stage without becoming parasitic.

With regard to *Alectorolophus*, he shows that Koch's statement, that monocotyledons exclusively could serve as host plants, is wrong since, as in *Euphrasia*, dicotyledons also will serve. He cultivated three species of the parasite on widely different hosts, such as *Origanum vulgare*, *Polygonum aviculare*, *Veronica*, *Lotus*, *Stellaria media*, &c., obtaining perfect development in each case. He also shows that with *Alectorolophus*, as in the case of *Euphrasia*, the same individual may attach itself at the same time to the roots of very different hosts. A series of cultures was also

* Bot. Gaz., xxxiii. (1902) pp. 363-75 (2 pls.).

† Pringsh. Jahrb. Bot., xxxvii. (1902) pp. 264-337 (2 pls.).

made with species of the same genus to investigate the relation of nutrition to the general habit of the plant. Investigations with *Odontites verna*, undertaken to decide the question as to how far parasitism was replaceable by saprophytism, showed that while a proportion of plants grown in river sand (4 out of 7) came to flower, a much larger proportion (11 out of 12) reached the same stage in humus cultures. The tendency to form haustoria for humus-feeding was a very slight one.

Germination of Potato Tubers.*—H. Vöchting finds that the manner of development of shoots on a tuber is closely related to temperature. At a temperature which only slightly exceeded the lower limit at which germination begins, only tuber-bearing shoots were produced, while at the optimum temperature leaf-shoots were exclusively developed; in the former case the root-development was small, in the latter copious. The amount of water in the soil is also closely related to the mode of growth. If little or no water be added then almost no roots and no leaf-shoots are formed, but only tubers. On the other hand, with a plentiful supply of water, numerous roots and subsequently leaf-shoots, but no tubers, appear. The amount of water in the atmosphere is also of importance. If insufficient, the shoots, whether etiolated or arising under the influence of light, creep on the damp soil; they are hydrotropic. An increase in the supply of moisture in the air also favours the development of leaves on the shoots, with insufficient moisture only scales are formed. Variations in the amount of oxygen in the atmosphere, on the contrary, exert no such formative influence on the course of germination. The place at which a bud will develop can be determined by incidence of light rays. Finally the author theorises on the mode of action of the various factors.

Cultivation of Beet-root.†—P. P. Deherain and C. Dupont report on the experiments on beet-root cultivation at Grignon in the years 1900 and 1901. Suggestions are made as to the variety most suited to the soil, and the best distances apart for planting the roots. The results also show that a permeable soil attains a high state of fertility when it is kept damp either by summer rains or by watering; under these conditions a high ferment activity is reached and a very considerable quantity of nitrogen is converted into nitrates capable of being assimilated.

Leucine and Tyrosine as Food-stuffs.‡—E. Schulze concludes from the fact that they disappear during growth, that both of these substances are assimilated by seed-plants. Loew and Bokorny had previously shown that algæ can utilise leucine.

Yield of Leguminous Plants.§—O. Pitsch has ascertained the amounts of total crop and of nitrogen yielded by various leguminous plants. Vetches and peas gave greater yields than blue lupins, but the roots of the latter penetrate the soil to a greater depth and thus prepare the subsoil for future crops.

* Bot. Zeit., lx. 1 (1902) pp. 87-114 (2 pls.).

† Comptes Rendus, cxxxiv. (1902) pp. 953-8.

‡ Landw. Versuchs-Stat., lvi. (1901) pp. 97-106. See Journ. Chem. Soc., lxxxii. (1902) ii. p. 165.

§ Ann. Agron., xxviii. (1902) pp. 59-61. See Journ. Chem. Soc., l. c., p. 286.

Influence of Nitrogenous Manures on the Form of Cereals.*—H. Clausen finds that nitrogenous manures tend to increase the length of the lower portions of the stems of cereals, whilst the upper portions are relatively shortened. Nitrates have much more effect than ammonium salts. The elongation of the lower internodes renders the stems weaker, hence, although more grain is produced when ammonium salts are used, the crop is less liable to be laid than when nitrates are employed.

Soils suitable for Chestnuts.†—L. Piccioli concludes from examination of the soils and subsoils of Italian chestnut forests, that the trees require a moderate amount of lime, but that as much as 8 p.c. is very injurious. The injurious action may to some extent be neutralised by application of potash. The author recommends a manure suitable for chestnut forests.

Nutrition of Hops.‡—T. Remy and O. Englisch find the maximum growth to occur during flower and fruit production. In the spring the perennial portions of the plants contain 30 to 40 p.c. of the total nitrogen, potassium, and phosphoric acid required; assimilation from the soil is at first slow but afterwards increases, reaching a maximum when the fruit develops; when the hops are ripe assimilation ceases. The assimilation of calcium and magnesium seems to continue after the ripening period. The hop requires very considerable amounts of these two minerals, more even than red clover; large amounts of potassium are also necessary. Nitrogen, potassium, and phosphoric acid migrate from the stems and leaves before their death to the fruit; but there is at the same time a gain of calcium and magnesium in the leaves. The roots also acquire more nitrogen, potassium, and phosphoric acid.

Value of Green Manures.§—F. Hanusch made plot experiments on a large scale to determine the relative value of the crop. The nitrogen and ash content, both in the portions above ground and in the roots, were determined. The most remunerative crop was found to be white clover, followed in order of diminishing value by vetches, horse-beans, and field-peas.

Value of Kainite.||—M. Gerlach finds, experimenting with barley in soil poor in potassium, that kainite produced far better results than high per cent. "potassium salts" containing the same amount of potassium. This is due to the fact that the kainite contained twice as much sodium chloride as the "potassium salts," and the author agrees with Wagner, that sodium economises potassium partly by liberating the latter from the soil and partly by satisfying the mineral requirements of the crop. In the case of potatoes, "potassium salts" have the advantage, as compared with kainite, that they contain less chlorides.

Shifting in Heads of Sunflower during Development from Flowering to Ripening.¶—B. Leisering states that the alterations in

* Journ. Landw., xlix. (1902) pp. 365-88. See Journ. Chem. Soc., l. c., p. 283.

† Bied. Centr., xxxi. (1902) pp. 75-6. See Journ. Chem. Soc., l. c., p. 285.

‡ Bl. Gersten-, Hopfen- u. Kartoffelbau, 1900, p. 457. See Journ. Chem. Soc., l. c., p. 168.

§ Zeit. Landw. Versuchswes. Oesterr., 1901, p. 772. See Journ. Chem. Soc., l. c., p. 169.

|| Fühling's landw. Zeit., 1901, pp. 11, 12. See Journ. Chem. Soc., l. c., p. 170.

¶ Flora, xc. (1902) pp. 378-432 (3 pls.).

relative position of the florets, the existence of which has been denied by C. de Candolle, Schumann, and Jost, do actually exist. By aid of photography he has been able to demonstrate in a given flower-head, between times of flowering and ripening, an alteration in the angle of imbrication amounting to 34° . The angle at first decreases, the organs becoming pushed in towards the centre, causing the head to be bent in a convex manner at the beginning of the flowering period; later the angle increases again, and the head gradually reassumes its flat form. Evident alterations in divergence accompany these changes, which may even cause contact alterations in the florets. Such photographic results set beyond dispute the truth of Schwendener's theory of "shifting."

On the Separation of Characters in Hybrids of the Pea Type.*—C. Correns discusses the highly theoretical question of the method and time of separation of the "Anlagen" of characters which obey Mendel's law (of which the best known case is that of pea-hybrids), especially in relation to the criticism passed on his views by Strasburger. Correns believes that the separation of characters in the gametes of the hybrids is brought about by a nuclear division, physiologically of the nature of Weismann's reducing division, though not necessarily by a cross division of the chromosomes. This, in the case of the female gametes, is the first division of the embryo-sac mother-cell, and in the case of the male gametes, probably the division which gives origin to the vegetative and generative nuclei.

Irritability.

Rheotropism of Roots.† — F. C. Newcombe has experimented with thirty-two species of plants belonging to widely different families; twenty have proved positively rheotropic, and fourteen were insensitive. Rheotropism cannot therefore be regarded as a general phenomenon. Sensitive species differ greatly in degree of sensitiveness to a stimulating water current. The fourteen insensitive species are distributed through nine families, and the twenty sensitive through six; there is an indication that the roots of genetically related plants behave alike toward a water current. The watercress, and four other aquatic plants tested, were not sensitive; hence it is improbable that rheotropism stands in any biological relation to water-plants. As regards the effect of velocity of water-current on the response, the author finds that velocities above 1000 cm. per minute give general negative (mechanical) curves, that the optimum velocity lies between 100 cm. and 500 cm. per minute, and that velocities below 50 cm. bring fewer and slower responses with smaller angles. As regards latent period, species differ greatly in time of response, though the latent period in every case is relatively long as compared with that for geotropism. In the competition between geotropism and rheotropism some roots attain only a small deviation from the vertical, some reach 45° , and some 90° , the last seeming to overcome entirely their geotropism. The author finds that the rheotropic sensitiveness occurs over at least 15 mm. of the length of the root-apex, and also that the extreme apex is rheotropic. Rheotropism is not confined

* Bot. Zeit., lx. (1902) pp. 65-82.

† Bot. Gaz., xxxiii. (1902) pp. 177-98, 263-83, 341-62 (15 figs.).

to the primary root, and the author concludes that the secondary roots behave in a corresponding manner to the primary. As far as his experiments go, he finds that rheotropism is neither gained nor lost in the development of a plant from seedling to near maturity.

Influence of X-Rays on the Plant Organism.*—H. Seckt has investigated the action of these rays on the streaming movement of protoplasm, and on leaf-movements of *Mimosa* and *Oxalis*. For the former purpose he used objects such as staminal hairs of *Tradescantia*, in which, under normal conditions, there is a well-marked circulation. He finds that exposure to the rays distinctly favours the movement, a result previously attained by Lopriore. Movement which had been slow, or even non-existent, before exposure became rapid after $\frac{1}{4}$ to $\frac{3}{4}$ of an hour's exposure to the rays. The radiation also exerted a favourable influence on the duration of the movement, which often persisted with undiminished activity for 2 to 3 hours. When the tube of the apparatus was placed too close to the object a greater or less tendency to plasmolysis appeared. This, the author suggests, may be due to the harmful action of other electric waves, a supposition which was strengthened by the behaviour of *Spirogyra*, which shows great susceptibility to electric currents, and in which plasmolysis rapidly appeared (in 5 to 10 minutes) when the tube was placed 10 to 20 cm. from the specimen.

In experiments with *Mimosa* and *Oxalis corniculata* the distance of the tube from the object was not an essential factor; generally the distance was from $\frac{1}{4}$ to $\frac{1}{2}$ metre. The influence of the rays was generally remarked after 20 to 30 minutes, when in the case of *Mimosa* the leaf had assumed the position as usual after stimulus. In 20 to 25 minutes more the normal position was resumed.

Chemical Changes.

Reaction and Nature of Oxidising Ferments.†—J. H. Kastle and O. M. Shedd suggest that phenolphthalin, from the fact that it is readily oxidised to phenolphthalein, a substance readily lending itself to colorimetric measurements, might prove a valuable reagent in the study of the oxidising ferments. They have investigated its action on the oxidising ferment of the potato, and find that it operates in a manner similar to tincture of guaiacum. They also show that extract of potato, on standing at ordinary temperature, rapidly loses its power to oxidise either phenolphthalin or guaiacum, owing to the instability of the oxidase in aqueous solutions. They find that the oxidase is distributed throughout the substance of the potato, occurring in small quantities even in the skin. The oxidation of the phthalin proceeds much more slowly than that of guaiacum, and it has one advantage over many of the reagents hitherto proposed from the fact that the rate of oxidation can be easily and accurately determined by colorimetric comparisons with alkaline solutions of phenolphthalein of known strength; the amount oxidised is found to be proportional to the time of its remaining in contact with the oxidase. The colour ranges from light pink to dark red. The authors find the same or a similar oxidase present in a

* Ber. Deutsch. Bot. Ges., xx. (1902) pp. 87-93.

† Amer. Chem. Journ., xxvi. (1901) pp. 526-39.

number of other plant structures, such as sweet potato, pulp of banana, cherry-tree and other gums.

J. H. Kastle and A. S. Loevenhart* have also investigated the nature of the oxidising ferment, and arrive at the following conclusions:—Oxygen is absolutely essential to the production of the guaiacum-bluing ferment of the potato, and this so-called oxidising ferment is in all probability not a free soluble ferment, but an organic peroxide. They suggest that the oxidation phenomena occurring in the plant, and probably in the animal organism also, can be satisfactorily explained upon the supposition that the readily autoxidisable substances which they contain are oxidised to the peroxide condition by molecular oxygen, and that the peroxides thus formed in turn give up part of their oxygen to other less oxidisable substances present in the cell.

Action of Sunlight on Enzymes.†—O. Emmerling has studied the action of sunlight on 1 per cent. solutions of invertase, yeast-maltase, maize-glucase, lactase, emulsin, and diastase. The solutions were exposed for six hours, and their fermenting properties then tested, when it was found that, with the exception of yeast-maltase, the enzymes had suffered but very little deterioration. Toxins, on the contrary, appear to be very susceptible to light.

Transformation of Proteids during Germination.‡—G. André has studied the nitrogenous metabolism in the haricot bean, comparing the total amount of nitrogen, and of nitrogenous substances in the dry seed, and at various stages in the young seedling, up to the time when the dry weight of the latter equals that of the dry seed. Of the proteids, the albumin, which in the seeds used represents only 2·5 p.c. of the total weight, disappears most rapidly, in fact directly germination and loss of dry weight begin. Legumin, which represents one-fourth of the total nitrogen of the resting seed, also diminishes rapidly, but without completely disappearing. The amide nitrogen (asparagin and allied bodies) which remains in solution after separation of the albumin and legumin, increases considerably as germination proceeds, from 4·2 p.c. in the resting seed to 55·5 p.c. of the total nitrogen, but rapidly diminishes in the later stages.

The nitrogen of the proteids insoluble in water, consisting chiefly of the substance called by Ritthausen conglutin, diminishes at first continuously during germination, but shows a marked increase when the plant begins to take in nitrogen from the soil. This period is characterised by the formation of new albuminoids, derived partly from the transformation of nitrogen taken from the soil, but especially from the conversion of the soluble amides into albuminoids.

Changes in Nitrogenous Substances in Ripening of Cereals.§—N. K. Nedokutschaeff has estimated the total nitrogen, and the nitrogen in the form of proteids, asparagin and amides, in grains of rye, wheat, barley, and oats, at different periods in the course of ripening of the

* Tom. cit., pp. 539-64.

† Ber. Deutsch. Chem. Ges., xxxiv. (1901) pp. 3811-4. See Journ. Chem. Soc., lxxxii. (1902) i. p. 195.

‡ Comptes Rendus, cxxxiv. (1902) pp. 995-8.

§ Landw. Versuchs-Stat., lvi. (1902) pp. 303-10. See Journ. Chem. Soc., lxxxii. (1902) ii. p. 281.

grain. He finds that the percentage of proteid nitrogen increases as ripening proceeds, but that nitrogen in other forms, especially asparagin, diminishes. In wheat and rye the percentage of total nitrogen diminishes, but increases in oats and barley.

Changes during Ripening of Apples.*—R. Otto finds that the percentage of water increases during ripening. The starch diminished from about 4 p.c. (Sept. 7) to 1.6 (Oct. 5), and disappeared entirely when the fruit was stored; the ash decreased, whilst the cellulose remained constant. There was an increase in nitrogen during ripening on the trees, but afterwards a decrease.

Composition of Proteids and Cell-Membranes in Bacteria and Fungi.†—K. S. Iwanoff finds the proteids to be nuclei-proteids containing in bacteria 16.3 p.c. nitrogen and 1.8–2.2 p.c. phosphorus, in fungi 15.1–16.2 p.c. nitrogen and 0.7–1 p.c. phosphorus. The author also confirms the existence in the cell-membranes of chitin apparently identical with animal chitin.

Proteid Formation in Plants.‡—F. Czapek emphasises the importance of amino-compounds in the synthesis of proteids in plants.

General.

Colours of Northern Polypetalous Flowers.§—J. H. Lovell continues his studies on the colours of flowers. He finds that throughout the Choripetalæ conspicuousness is generally correlated with insect fertilisation. In many genera the species can be arranged in a progressive series showing an advance from inconspicuousness, few visitors, and self-fertilisation to many visitors, great conspicuousness, and loss of power of self-fertilisation. While green flowers are small and frequently apetalous, white and yellow vary from small to large, are most common, and contrast more strongly with the foliage than purple or blue. Of the 71 polypetalous families, 43 contain white, 41 yellow and 29 both kinds of flowers. White flowers are most common in families or genera containing shrubs and trees, in the case of small flowers aggregated in a dense inflorescence and in nocturnal flowers. Yellow flowers are more commonly associated with a herbaceous habit, and are most abundant in the same families as white flowers, unless the species are shrubs or trees.

There is no evidence of the preference of beetles for flowers of any particular colour. They are most common in connection with small white clustered flowers with easily accessible pollen and honey. Diptera visit most frequently white and yellow flowers, but as they become more specialised and restrict themselves to flowers the percentage of visits to red and blue flowers increases. They appear to find a particoloured or dotted inflorescence, as in Cruciferæ and Saxifragaceæ, attractive. Carrion flies prefer malodorous, lurid purple or flesh-coloured flowers. The changes of colour and their sequence in individual flowers are noteworthy. Green changes to white, yellow, red, purple, or violet; white to green, yellow, red, or blue; yellow to white, red, or blue; red to blue.

* Bied. Centr., xxxi. (1902) pp. 107–8. See Journ. Chem. Soc., 1. c.

† Beitr. Chem. Physiol. Path., 1902, pp. 524–37. See Journ. Chem. Soc., 1. c.

‡ Tom. cit., pp. 538–60.

§ Amer. Nat., xxxvi. (1902) pp. 203–42.

The tendency of green, white, and yellow to change to red or blue is much stronger than the reverse. The floral colours are often correlated with that of the stem and leaves, as in *Sedum*. The foliage of plants with white flowers is as a rule paler than when the flowers are coloured. The development of bright colours in autumn leaves presents a series of colour changes which are in part parallel to those which occur in flowers.

The formation of pigments is affected by the chemical composition of the soil, by altitude, or the intensity of light, by latitude, and by absence or presence of moisture, as well as other ecological factors.

Anchoring of Plantain-Seed. * — D. Griffiths discusses the process of burying which is effected by a drying and contraction of the mucilaginous layers in the seeds of *Plantago fastigiata*. This plant grows profusely in the deserts of southern Arizona. As in other species, the seeds have a compact glossy or white coating which absorbs water, expanding and becoming mucilaginous when an opportunity offers. After a shower of rain, when the surface of the ground had dried, isolated seeds were plentifully found, each sunken in a little pit in the ground, the walls and bottom of which were made rigid by the hardened mucilage. In the succeeding dry months it would become buried by the natural abrasion of the soil.

Burmanniaceæ from Brazil. † — Eug. Warming describes two new genera of saprophytes, *Glaziocharis* and *Triscyphus*, belonging to this interesting little group of monocotyledons. They were collected by P. Glaziou in the dark, damp, humus rich virgin forests of the State of Rio Janeiro, especially in the region, Alto Macahe, from which Miers described a number of saprophytic Burmanniaceæ. The author also describes a new species of *Thismia* and offers remarks on the floral biology of several species previously described by Miers, belonging to the genera *Dictyostegia* and *Apteria*.

Vegetation of the Mountainous Districts North of Lake Nyasa. ‡ — A. Engler describes the character of the vegetation of North Nyasaland as shown by the collections made by a recent expedition. The mountains reach nearly 3000 metres in height. The botanical features of the following plant zones are successively described—the alluvial land, the wet mountain forests, the steppe formations of the lowlands, the xerophilous highland formation, the mountain steppes, the high woods, the high-lying meadows, and the alpine vegetation. In spite of their southern position there are numerous points of relationship with the Abyssinian flora, while on the other hand several well marked South African types occur.

History and Development of Applied Botany. § — A report of an address by O. Warburg to the botanical section of the German "Naturforscher-Versammlung," in September 1901.

* Bull. Torr. Bot. Club, xxix. (1902) pp. 164-9.

† Oversigt k. Danske Videnskab. Selsk. Forhandl., 1901, No. 6 (1902) pp. 173-88 (2 pls. and 6 figs.).

‡ Sitzungsber. k. Preuss. Akad. Wiss. Berlin, xii. (1902) pp. 215-36.

§ Ber. Deutsch. Bot. Ges., xix. (1902) Generalversammlungs-heft, pp. 153-83.

CRYPTOGAMS.

Pteridophyta.

Vegetative Propagation in *Angiopteris evecta*.* — M. Raciborski describes a very effective method of vegetative propagation in this Marattiaceous fern. The leaves, as in other members of the order, are differentiated into leaf-base and upper leaf. The former forms a cushion rhombic in section, reaching 2 dm. in length and bearing on its flanks the fleshy lobes of the stipules. The upper leaf, consisting of leaf-stalk and blade, usually lives for 2-3 years, and then withers and falls after a separating cork layer has been developed between it and the leaf-base. The old leaf-stalks remain many years, ten or more, on the stock. They are covered with a thick brown layer; the stipules slowly perish, while the internal parenchymatous tissue functions as a water reservoir, and contains the numerous gum or mucilage passages characteristic of Marattiaceæ. Ultimately the leaf-cushion becomes separated from the stem. These separated leaf-cushions, often partially decomposed, are found in considerable quantities rolled about on the steep slopes of the wooded volcanic mountains in Java. They bear strong adventitious buds on their flanks which rapidly take root and thus form an efficacious means of plant distribution.

Spore-casting Mechanism of *Selaginella* Sporangia.† — C. Steinbrinck, following Goebel's work, has investigated the structural details associated with the opening of the macro- and micro-sporangia and the ejection of the spores. Goebel suggested that the mechanism was supplied either by a shrinking or was of the nature of a cohesion mechanism. The author finds that a cohesion mechanism is not only a plausible explanation, but also the only one possible.

Mosses.

Irish Mosses.‡ — J. Hunter publishes a large annotated list of the mosses gathered by him in the neighbourhood of Londonderry and Lough Swilly. Some of the localities in this region appear to be particularly adapted for a rich growth of these plants.

E. Armitage§ gives a list of 107 mosses collected in July and August of last year in the northern part of County Limerick.

British Moss-Flora.|| — R. Braithwaite publishes part xxi. of his moss-flora, of which only two more parts remain to be issued. He figures thirty species, and describes some thirty-four species in the text. The genera included are *Helicodontium* and *Habrodon* of the subfamily Hypnææ, and nine others belonging to the subfamily Stereodontæ, viz. *Myurella*, *Heterocladium*, *Hylocomium*, *Campylium*, *Ctenidium*, *Hyocodium*, *Ptilium*, *Sematophyllum*, and *Stereodon*.

Notes on American Hepaticæ.¶ — M. A. Howe contributes critical notes on several North American hepatics. *Cephalozia connivens* has

* Bull. Internat. Acad. Sci. Cracovie, 1902, pp. 48-51.

† Ber. Deutsch. Bot. Ges., xx. (1902) pp. 117-28 (3 figs.).

‡ Journ. Bot., xl. (1902) pp. 191-6. § Tom. cit., pp. 226-8.

|| R. Braithwaite, The British Moss-Flora, part xxi. April 1902, pp. 129-68 (pls. cix.-cxiv.). ¶ Bull. Torr. Bot. Club, xxix. (1902) pp. 281-9.

been much confused with the nearly allied *C. lunulæfolia*, and the synonymy was also obscure. *Telaranea* Spruce, a small genus nearly allied to *Lepidozia* and others. A synopsis of species and varieties is given. The author also notes the close resemblance which exists between the Californian *Riccia Campbelliana* and the Mediterranean *R. macrocarpa*, but maintains their specific distinction.

Mosses of South-western Switzerland.*—W. E. Nicholson publishes notes on the more interesting of the mosses gathered by him in July 1901 in the alpine zone above Zermatt, the sub-alpine zone about Gliou and Diablerêts, and down near the Lake of Geneva where certain species of the Mediterranean type occur. In all more than 200 species were gathered. The paper is in English.

Mosses of West Tropical Africa.†—General Paris, with the co-operation of some other experts, describes sixteen new species of mosses from Senegal, Fouta Djallon, the Ivory Coast, and Dahomey, and adds the names and localities of several other species of mosses and hepatics gathered in the same territories but already described.

Algæ.

Structure and Division of *Polytoma*.‡—Dr. S. Prowazek dissents from the view put forward by Dangeard that in *Polytoma* the flagellum is connected by means of a fibrillar structure, the "rhizoplast," with a granular structure in connection with the nucleus which he calls the "condyle." On this view Dangeard draws a comparison between the structure of *Polytoma* and that of the spermatozoid of such a form as *Helix*. The author's view is that the "rhizoplast" stops short at some distance from the apex and that the structure, of doubtful nature, which has been called the "condyle" lies just inside the nuclear wall, on the side which is directed away from the rhizoplast, and seems to have no connection with it. He confirms Dangeard's statement that eight chromosomes are present at the nuclear division of this form.

Atlas of Diatoms.§—The latest part of this publication, for which Dr. F. Fricke is responsible, contains notes and figures of various genera and species, including a new species *Stephanodiscus Pontocseki*.

Growth of *Cladophora cornea* in the Form of Balls.||—Lederbauer describes plants of this species, which he dredged up at Rovigno, forming balls as in *C. Sauteri*. He attributes this occurrence to their position on a gently sloping shore, on which they would be constantly rolled about by waves. The centre of the ball consists of a fragment of *Lithothamnion* or large grains of coral sand, to which the alga clings by means of short branches or holdfasts. These are of three kinds:—(1) Outgrowths from the basal cell forming rhizoidal attachments; (2) holdfasts arising from the side of a cell; and (3) those which arise at the end of the branches.

* Rev. Bryol., xxix. (1902) pp. 57-62.

† Tom. cit., pp. 63-72.

‡ Österreich. Botan. Zeitschr., li. (1901) p. 400 (2 figs.).

§ Adolf Schmidt, Atlas der Diatomaceen-kunde, Heft 58 (ser. v. tt. 229-32) Reissland, Leipzig.

|| Verhandl. k. k. zool.-bot. Ges. Wien, lii. (1902) pp. 155-9 (4 figs.).

The first are much-branched outgrowths from the basal cell, from which they are not cut off by any cell-wall. They become closely adherent to the substratum and do not penetrate in any way. They are poor in chlorophyll and very thick-walled.

The second kind of holdfasts arise sideways from a plant, at the base of a cell, not, as in the case of an ordinary branch, from its upper end. A thin branch cell grows out bearing at its end the holdfasts which are much branched and poor in chlorophyll.

The third kind is formed on the ends of thin, many-celled branches; and they have the appearance of helicoid tendrils. These are rare.

Although no description of these holdfasts is given for *C. cornea*, the author places his ball-like plant temporarily under that species until such time as he can further examine material of his plant and settle on its position in the genus. The manner of ball-formation is the same in *C. cornea* as in *C. Sauteri*, but the centre of the former is solid, while the centre of *C. Sauteri* is hollow.

Variation in *Fragilaria crotonensis*.*—C. Schröter and P. Vogler give statistics as to the variation of this diatom, dredged in the Lake of Zürich at the rate of once or twice a month continuously from 1896–1901. They describe the methods of examination and give tables of their results. Four distinct forms of the species are recognised and described. Their occurrence in the lake is variable.

Fresh-water Algæ of Switzerland.†—R. Chodat publishes a considerable contribution to our knowledge of fresh-water algæ and of the cryptogamic flora of Switzerland. It is mainly the result of much personal experience and study of the polymorphism of this group of plants. The book is divided into four parts:—(A) Collection and preservation of fresh-water algæ. (B) Morphology, in which the author treats under separate headings of:—Protoplasm, Vacuoles, Flagella, Stigma, Chromatophores, Pyrenoid, Nucleus, Membrane, Pluricellular thallus, Hairs and bristles, Rhizoids and organs of attachment, Organs of multiplication. (C) Biology, under the headings of Light, Temperature, Nutrition, Tropism, Classification according to biology, Parasitism, Symbiosis, Holophytes, Aquatic limnophils, Plankton, Cryoplankton, Dispersal. (D) Classification. This last part occupies 264 pages of the book and deals with the Pleurococcoideæ, including the Schizogonioideæ, and with the Chroolepoideæ. The families Palmellaceæ, Volvocineæ, Protococcoideæ, and Pleurococcaceæ are treated with the completeness of monographs, and throughout the classificatory part of the book the descriptions, the very full notes, and the keys are of great value.

Marine Algæ of Iceland.‡—Helgi Jonsson publishes a list of the marine algæ of Iceland, founded on collections made by himself and others, and preserved for the most part in the Copenhagen Museum. Seventy-one species are recorded with certainty, of which *Chantransia Alariæ* and *Rhodocorton repens* are new species. Both are figured and

* Vierteljahrschr. Naturforsch. Ges. Zürich, xlvi. (1902) pp. 185–206 (5 figs.).

† Algues vertes de la Suisse. Pleurococcoïdes—Chroolépoides. Beiträge z. krypt. Fl. Schweiz, i. (1902) pp. 373 (264 figs.).

‡ Botan. Tidsskrift, xxiv. (1901) pp. 127–55.

described; and both occur on *Alaria esculenta*. Many of the species-names are followed by critical notes and remarks.

Flora of Koh Chang.*—The Messrs. West publish a list of 124 fresh-water algæ from this island, of which nine species and seven varieties are new. A complete description is also given here for the first time of *Micrasterias Möbii* West and G. S. West. The paper is illustrated by three plates.

Major Reinbold gives a list of 62 marine algæ other than Corallinaceæ, for this district. The new species described are: *Boodlea (coacta) var. ?) siamensis* and *Rhabdonia Schmidtii*; a new forma *major* of *Asperococcus fastigiatus* is described, and a forma *prolificans* of *Gracilaria dura*. A plate is given of *Rhabdonia Schmidtii*.

Mons. Gomont records 27 species of Myxophyceæ, of which *Scytonema Schmidtii* and *Brachytrichia maculans* are new. Both are figured on one plate.

The number of Peridinales recorded by J. Schmidt is 44, containing the description of a new genus *Ostreopsis*, represented by the species *O. siamensis*, and a new form and a new variety of other species. The paper includes eight figures in the text.

Mycetozoa and Fungi.

Notes on Mycetozoa.†—Arthur Lister and G. Lister have established a new species *Chondrioderma asteroides* from a specimen collected by Miss A. Fry at Ventimiglia. The outer dark-coloured wall of the sporangium, which is marked by dark lines or furrows, dehisces in a stellate manner into about eight to twelve reflexed lobes, which are snow-white on the inner side. The subglobose columella is also white or pale cream-coloured. The spores are purple brown. The authors consider it to be most nearly allied to *C. radiatum* Rost., but quite sufficiently distinct to be worthy of specific rank. A note is given on *Physarum gyrosum* Rost. The original specimen grew in a hot-house in Berlin, and the writers held it at one time to be identical with *Fuligo septica*. An interesting series of specimens sent by Dr. Jahn from South America have led them to the conclusion that *P. gyrosum* is a distinct species.

A careful study of Dr. Ladislav Celakovsky's *Die Myxomyceten Böhmens*, and a comparison of his specimens with types in their possession, have enabled them to make a number of corrections with which Dr. Celakovsky fully agrees. A number of new species were found to be merely variations of forms already described. They now publish the result of this examination.

The Acrasieæ.‡—A monograph of this group is in preparation by Edgar W. Olive, and in the meantime he has published a preliminary enumeration of the Acrasieæ and their allies under the general term Sorophoreæ. The author has discovered a new genus *Guttulinopsis* with three species. The genus is characterised by the lobose pseudopodia of the myxamœbæ; the fructifications of all the species are yellowish

* Botan. Tidskrift, xxiv. (1901) pp. 157-221.

† Journ. Bot., xl. (1902) pp. 209-13 (1 pl.).

‡ Proc. Amer. Acad. Arts and Sci., xxxvi. (1901) pp. 333-44.

white. He has added three new species to the genus *Dictyostelium*: *D. brevicaule*, which has a persistently short stalk and a large sorus, and *D. purpureum* and *D. aureum*, which are distinguished by their bright coloration. *Polysphondylium pallidum* and *P. album* are also additions to the flora of the Acrasieæ. Only one member had been reported from America before Mr. Olive began his study of the group. The paper is a contribution from the Cryptogamic Laboratory of Harvard University.

Genus *Mucor*.*—W. Schostakowitsch has added seven new species to the genus *Mucor* from the neighbourhood of Irkutsk. *M. proliferus*, which is very common round Irkutsk, has two kinds of sporangia; one large and strongly incrustated, which terminates the main hyphæ; the other, smaller and smooth, is borne at the tops of the branches. In old cultures one or more processes grow out of the columella and develop a branched mycelium, which bears the smaller type of sporangium. *M. irkutensis* has but one type of sporangium, which is globose, and attains to the large size of 1 mm. in diameter. The spores are also rather large, 28 μ by 10.5 μ . *M. cinereus* has somewhat grey globose sporangia on strong stalks 30–40 μ in width and 1–4 cm. long. *M. agglomeratus* is characterised by a racemose branching of the ordinary type, and further by cushion-like swellings on the main stem and branches, from which arise a number of sporangiophores (5–20) bearing very small sporangia. In *M. angarensis* the hyphæ are much branched and circinate at the tops. The sporangia are globose and black. The columella and spores when massed are slate-blue in colour. *M. de Baryanus* forms dark coloured masses. After ripening, the sporangia bend down towards the substratum and form from the stalk beneath the columella a series of outgrowths which grow into a branching mycelium and give rise to new sporangiophores. Gemmæ are abundant as in *M. racemosus*. *M. heterosporus sibiricus* becomes brown when mature. The hyphæ are richly branched, the sporangia globose and rather small. Gemmæ are produced in great numbers on the hyphæ. In none of the species have zygospores been observed.

The same author† has described a new species of *Mucor* from Siberia. It was found growing on cooked rice. The sporangiophores are usually unbranched, and reach a height of 10–12 cm.; the sporangia are 0.5 mm. in diameter. In old cultures, the sporangiophores that have remained sterile swell out near the tops, and from this portion arise a series of unbranched sporangiophores with somewhat smaller sporangia. These and other peculiarities serve to differentiate this species.

He also describes the changes induced in *Mucor proliferus* by bacteria. So great was the influence of the bacteria on the form of the *Mucor* that another species seemed to have been formed. The sporangiophores were differently branched and prostrate, the sporangia much smaller, most of them sessile and without spores, the columella from conical or pear-shaped had become globose, the spores more round in shape and olive-green instead of colourless.

Parasitic Fungi of the Diatomaceæ.‡—Under the general title Archimyceten Marpmann has described the one-celled fungi that infest

* Zeitschr. f. angew. Mikr., vii. (1902) pp. 311–5.

† Op. cit., viii. (1902) pp. 5–10.

‡ Tom. cit. pp. 1–5 (1 pl.).

Diatoms and other Algæ. He divides them into two groups: (I.) The Myxochytridinæ with two families, the Monolpidiaceæ (Olpidiaceæ) and Merolpidiaceæ (Synchytriaceæ). (II.) The Mycochytridinæ also with two families, the Holochytriaceæ (Ancylistaceæ) and the Sporochytriaceæ (Rhizidiaceæ or Polyphagaceæ). The writer gives a general description of the fungi and the methods found to be most serviceable for examining them. He also gives a more particular account of those found on Diatoms.

Coemansiella alabastrina.^{*}—This microscopic fungus was discovered in Belgium in 1862 by Coemans. Van Tieghem and Le Mounier met with it again in France in 1873, and now it has been discovered in this country by Rudolf Beer who found it on horse-dung in Kent. Mr. Beer cultivated the fungus with success and was able to follow all the stages described by the French writers. The conidiophore of the fungus bears at the tip a verticil of converging hyphæ forked at the tips. The upper surfaces of these branches except the tips are studded with the conidia. Mr. Beer found in his cultures that some of the hyphæ formed chlamydospores, but he was not able to establish absolutely the connection between these hyphæ and the conidiophores of *Coemansiella*. He was also unable to find any connection with a higher form of fructification.

Rabenhorst's Cryptogamic Flora of Germany, &c. (Fungi Imperfecti).[†]—Parts 82 and 83 of this important work have just been issued by Andreas Allescher. The genus *Glæosporium* occupies almost the whole of the first part. It is a parasitic fungus, the perithecia occurring on discoloured spots of the leaves of the host-plants. There are 149 species recorded from Germany and Western Europe. The genus *Myxosporium* follows next. It is very similar to *Glæosporium*; but it is always found on branches. *Melanostroma*, *Næmospora*, *Hypodermium*, *Myxosporella*, *Blennoria*, *Agyriella*, *Trullula*, *Myxormia*, *Bloxamia*, *Colletotrichum*, and *Pestalotiella* are all fully described. These all belong to the group of Melanconiceæ with colourless spores. A second division is commenced of forms with brown spores beginning with the large genus *Melanconium*. The author tabulates his species under an alphabetical arrangement of the plants on which they are habitually to be found. There are numerous figures in the text.

New *Gymnoascus*.[‡]—Alb. Klöcker found the new species of *Gymnoascus* which he describes on the body of a fly. He made successful cultures of the fungus and was able to watch the growth both of the conidial and the ascus form. He has named it *G. flavus* on account of the yellow colour of the hyphæ. In a nutrient solution the ascospores produced branching hyphæ with chains of small oval-shaped conidia; these were never formed in the air. The author describes the conidial forms of *Gymnoascus* that have already been observed.

Studies on *Urnula* and *Geopyxis*.[§]—In order to clear up the confusion which existed as to the systematic position of the genus *Urnula*,

^{*} Journ. Bot., xl. (1902) pp. 169-72 (1 pl.).

[†] Leipzig, 1902, pp. 449-576.

[‡] Hedw., xli. (1902) pp. 80-3 (1 pl.).

[§] Bull. Torr. Bot. Club, xxix. (1902) pp. 137-44 (1 pl.).

Elsie M. Kupfer has made a careful anatomical study of three species of the genus, *U. craterium* Fr., *U. terrestris* Sacc., and *U. Geaster* Peck. The first which was the original type of the genus had been transferred by Rehm to the genus *Geopyxis*. Miss Kupfer proves that it is quite distinct from *Geopyxis* and should probably be placed in the Cenangiaceæ. The structure of the excipulum is prosenchymatous. *U. terrestris* Sacc. has a parenchymatous excipulum which differentiates it entirely from *Urnula*. Following Schröter the writer calls it *Podophacidium xanthomelan*. The remaining species has been made the type of a new genus *Chorioactis*. It is a large leathery fungus narrowed to a stem about 3 cm. long; both disc and stem are covered with a dense tomentum of soft brown hairs. The parenchymatous nature of the tissue places it among the Pezizaceæ near *Plectania* and *Sarcoscypha*. The author retains the specific name *Geaster* given by Peck.

Notes on the Erysiphaceæ.* — E. S. Salmon has followed up his monograph of the Erysiphaceæ by a series of important notes. He reviews the additions to the genera made by P. Hennings in his *Fungi Javanici* and also the new species described by Neger from the Argentine Republic, all of which he considers may be referred, for morphological reasons, to previously known plants. He further discusses Neger's recent articles on Erysiphaceæ and criticises adversely some of his conclusions.

In a further contribution,† he adds fuller details of habit and occurrence to many of the species already described in the monograph, and gives important economic information as to the ravages of the disease caused by the parasites. He gives counsel as to the best methods of spraying, &c. He adds a special note on the American gooseberry mildew *Sphærotheca mors-uvæ*, recently introduced into Ireland, and which reappeared a second year in the same garden still more extensively. He warns fruit-growers against allowing the fungus to spread.

In a continued series of notes ‡ on several species, *Erysiphe Polygoni*, *E. Cichoracearum*, *E. Galeopsidis*, &c., Mr. Salmon gives many new hosts and localities for the fungi in addition to those already published by him. He again discusses several new species and refers them to existing types. Under *E. graminis* he describes the conidial form *Oidium monilioides* Link., and its synonyms *Torula bulbiger* Bon. and *T. rubella* Bon. A lengthy account of the penicillate cells of the perithecium is given under *Phyllactinia corylea*. These cells, which are outgrowths from the cells at the apex of the perithecium, become mucilaginous. When the perithecium is ripe it becomes detached from the leaf and is conveyed by the wind to some new habitat. The mucilage of the penicillate cells causes it to adhere firmly to the new substratum in a reversed position. Many hosts have been thus erroneously recorded for this fungus, and they are often found fastened firmly to the upper surface of leaves, though originally they always grow on the under surface.

The same author § considers that the name *Erysiphe album* Fries. must be allowed to drop. There are no specimens of the fungus and

* Bull. Torr. Bot. Club, xxix. (1902) pp. 1-22.

† Tom. cit., pp. 81-109.

‡ Tom. cit., pp. 181-210 (3 pls.).

§ Tom. cit., pp. 302-16.

the description is too imperfect to allow of identification. *E. Lathyri* Merat, *G. Saxifragæ sibericæ* Merat, *E. Liliæ* Merat are not fungi but the work of some insect. Several other species are dealt with, and reasons given why they should not be included in the flora. A copious bibliography, a host-index, and a species-index of the whole group are printed at the end of the notes.

New Species of *Venturia*.*—By observation and culture experiments, R. Aderhold finds the species *Venturia Cratægi* to be distinct from *V. chlorospora* in which it was formerly included. The conidial form belongs to the genus *Fusicladium*, and to it he has also given the specific name *Cratægi*. The perithecia of *Venturia* are to be found in groups on the underside of the leaves of *Cratægus Oxycantha*, and ripen in winter or during the early spring months. *Fusicladium* appears on the fruits of the hawthorn where it produces abundant conidia and may outlive the winter. The fruit is filled with fungus hyphæ and dark crusty specks are formed on the exterior. In suitable conditions of moisture, &c. these produce crops of spores in autumn and spring and possibly also in summer.

“Benikoji” Fungus.†—Y. Uyeda gives a detailed account of the fungus used in the making of “Anchu,” a Chinese fermented drink prepared from rice in Formosa. Several fungi take part in the process, but the chief agent of fermentation is a species of *Monascus*. In cultivation the fungus produces sporangia or asci, which become reddish in colour, and which are surrounded by an envelope of loose hyphæ. The spores are elliptical or oval, and number from 20 to 40.

Two types of conidia are also produced: macroconidia, which are formed singly or in short chains on the ends of the hyphæ: and microconidia, which are much smaller and grow in chains. Intercalary gemmæ are also formed. The “Benikoji” is of a dark red colour, becoming purple with age. Besides the *Monascus* fungus there are two kinds of yeast formed. The one that most frequently occurs is produced by the budding of the microconidia, and is near akin to *Saccharomyces rosaceus*. The author considers that the “Benikoji” fungus is identical with *Monascus purpureus* described by Went.

New Uredineæ.‡—J. C. Arthur, of the Lafayette University, has described several new rusts, all with one exception from the United States. In one species, *Uromyces Rickerianus*, he found both the æcidia and the teleutospores. In the others he found only the *puccinia* or *uredo* forms. One species, *Puccinia aspera*, was described by Dietel and Holway, and is published here for the first time. *Uromyces Rottbælliz* was detected on herbarium specimens of *Rottbællia speciosa* collected in India. It was found to possess amphispores and teleutospores.

Uredineæ Cultures.§—H. Klebahn gives the results of his experiments on rusts, carried on in the Hamburg Botanical Gardens. He has proved the relationship between three *Melampsora* species on willows and poplars and the *Cœoma* species on *Allium*. With the spores of

* Ber. Deutsch. Bot. Ges., xx. (1902) pp. 195–200.

† Bot. Mag. Tokyo, xv. (1901) pp. 160–3; and xvi. (1902) pp. 7–9 (1 pl.).

‡ Bull. Torr. Bot. Club, xxix. (1902) pp. 227–31.

§ Hedw., xli. (1902) pp. 17–44.

Melampsora Allii-fragilis collected on *Salix fragilis* he infected *Allium vineale*, *A. ursinum*, and others, and got an abundant growth of the *Cœoma* form. *Melampsora Allii-Salicis* nov. nom. (syn. *M. Salicis albæ*) was also transferred to similar species of *Allium* with a like result. *Melampsora Allii-populina* sp. n. produced *Cœoma* spores on *Allium ascalonicum*.

A second series of experiments was made with the species of *Melampsora* of willows which form *Cœoma* spores on species of *Ribes*. Many experiments were also successfully made with the *Melampsora* of the larch, the uredo-forms of which are to be found on species of *Salix* or *Populus*. The *Cœoma* spores of *Mercurialis perennis* produced a rich growth of *Melampsora* on *Populus tremula*, with a slighter growth on other species of *Populus*. Klebahn concludes that though fungi can be induced to grow on allied species of the host-plant, their continuance depends always on the chief host-plant. The paper is illustrated by some figures in the text.

West American Fungi.*—The fungi described by David Griffiths belong with one exception (a species of *Claviceps*) to the Ustilagineæ and Uredineæ. The paper is intended to supply additional information to that contained on the labels distributed with the specimens. The species described are mostly new. *Ustilago Mulfordiana* and *Tilletia fusca* are rare in herbaria; they are constantly found together on the same host, *Festuca octoflora*. The paper is illustrated by figures in the text.

Paraphyses of the Uredineæ.†—The biological significance of these paraphyses has been studied by P. Dietel. In form they are frequently globose or club-shaped at the tips, and capable of retaining moisture for some time. They thus act as a protecting covering for the developing spores. The paper is illustrated by figures in the text.

The Nidulariaceæ of North America.‡—V. S. White has examined a large amount of material of this group, and has revised the species so far as they occur in North America. There are four genera—*Cyathia*, *Crucibulum*, *Nidula*, and *Granularia*. He describes one new species of *Cyathia*, which he has called *C. dura*, from the hard and brittle peridium. The genus *Crucibulum* contains one species, the well-known *C. vulgare*, which White records under an older specific name, *C. crucibuliforme*. *Nidula* is a new genus with two species, *N. candida* and *N. microcarpa* Peck sp. n. *Granularia* contains three species, two of them, *G. castanea* and *G. rudis*, being new to science. A very full description is given of each plant, and there is a table of the distribution in Canada, the States, and West Indies. The paper is fully illustrated.

Lichens.—*Lichens of Minnesota*.§—Bruce Fink has studied the lichen flora over a region in Minnesota, including a great variety of substrata, and varying greatly in moisture and other conditions. He gives a sketch of the different hunting grounds, and divides the lichens into groups according to their habitat. He notes the increase of lichens on the

* Bull. Torr. Bot. Club, xxix. (1902) pp. 290-301.

† Hedw., Beibl., xli. (1902) pp. 58-61.

‡ Bull. Torr. Bot. Club, xxix. (1902) pp. 251-80 (5 pls.).

§ Minn. Bot. Studies, ii. (1902) pp. 657-709.

rocks as the country becomes more settled, and fires are less frequent. Another note he makes is that in areas that are poor as regards the number of lichens to be found in them, the rarer plants are altogether wanting, these being found in neighbourhoods with a richer flora. He found a large number of species of *Calicium*, a genus that was once thought to be peculiar to the Atlantic region; his opinion is that the *Calicium* follows the conifers regardless of slight climatic changes. He concludes with a systematic list of the genera and species of the region. There are a few species new to science or new to North America.

M. H. Olivier* gives a further account of rocks bearing lichens collected by the late Dr. Goulard in the Pyrénées-Orientales. He gives detailed notes of some of the species of *Dirina*, *Bacidia*, *Biatorella*, and *Lecidea*.

E. Monguillon† continues his list of lichens collected in the departments of the Sarthe. The lists are arranged in the form of a key to the different species. He deals with the genera from *Cladonia* to *Leptogium*—altogether 50 genera. He gives no authorities and no extended description of genera or species.

A. Zahlbruckner‡ publishes his sixth list of the lichens of the Netherlands. The new species are *Lecidea Baumgartneri* found on gneiss and *Thelocarpon Strasseri* on pine wood. The author has appended critical notes to many of the species described.

Servian Fungus Flora.§—A first contribution to the fungus flora of Servia is published by N. Ranojević. Most of the specimens he collected himself, and many of the parasitic forms he records from new hosts. With the exception of the Peronosporæ the list includes as yet only members of the Basidiomycetes.

Spanish Fungi.||—D. B. Lázaro has published a short list of fungi new to Spain. The writer has described two new species of *Dictyolus*, a genus formerly included under *Cantherellus*, and one new species of *Scleroderma* very near to *vulgare*, *S. hemisphæricum*, so called from the shape of the sporiferous part of the fungus.

Fungi from Java.¶—O. Penzig and P. A. Saccardo publish a third series of Javanese fungi. They nearly all belong to two groups, the Ascomycetes and the Deuteromycetes. More than 100 of the species are new. There are 4 new genera of Discomycetes, *Arenæa* with 2 species is near to *Pirotæa*, *Davincia* also has 2 species, the ascospores are 2-many septate, otherwise the genus resembles *Cyathicula*. *Delpontia* is a new genus of Stictidiaceæ; the spores are hyaline, multi-septate, and muriform. *Moutoniella* belongs to the Phacidiaceæ; it is near to *Stegia* but with filiform spores. In the Pyrenomycetes the authors describe two new genera. *Rinia*, a member of the Sphæriaceæ, has elliptical one-celled colourless spores, the ostiole of the perithecium is large and stellate. *Fleischeria* forms a stroma on living branches, the spores are filiform and colourless; it is one of the Hypocreaceæ. The authors.

* Bull. Acad. Intern. Geog. Bot., 1902, pp. 55-6.

† Tom. cit., pp. 33-40, 113-28.

‡ Verhandl. k. k. Zool.-bot. Gesellsch. Wien, lii. (1902) pp. 257-70.

§ Hedw., xli. (1902) pp. 89-96.

|| Bol. Soc. Esp. Hist. Nat., 1902, pp. 117-9 and 152 (2 pls.).

¶ Malpighia, xv. (1902) pp. 201-60.

record many new species but no new genera among the Sphærospideæ. Among the Hyphomycetes there are 7 described. *Xenopus*, one of the Mucedineæ, is near to *Rhinotrichum*, but the hyphæ are entirely verrucose. *Trichobotrys* is one of the Dematiaceæ, it somewhat resembles a conidial form of *Ascotrichum* or *Chætonium*. *Neomichelia* has brightly coloured hyphæ and dark-coloured spores which are multi-septate and borne on toothed projections on the hyphæ. The spores of *Xenosporium* are borne on short sporophores; they are large, erect, and subreniform, of a dark shining colour and septate-muriform. *Volutina* resembles the genus *Volutella*, but the spores are catenulate; *Listeromyces* (named for our English botanist Mr. Arthur Lister), is somewhat near *Exosporium*; the sporodochia are erect and cylindrical, the spores are ovoid, septate, and dark coloured. *Bonordoniella* is also a member of the Tuberculariæ, with catenulate brown spores.

Some new Fungi.* — P. Hennings publishes a list of fungi from various localities from Norway, South America, Japan, New Guinea, &c. All of them are microscopic and belong mostly to the Uredineæ and the Ascomycetes with a few Hyphomycetes.

The same author † has published the list of Fungi japonici III. They include species belonging to a large number of genera of the Peronosporæ, Protomycetæ, Ustilagineæ, Uredineæ, Basidiomycetes, and Ascomycetes with a small number of Sphærospideæ and Hyphomycetes. The collection was made in Japan by some of the Professors in Tokyo. The larger Agarics and Pezizas had been carefully prepared and preserved, and were accompanied in many cases by coloured drawings and photographs.

P. Dietel ‡ gives a list of Japanese Uredineæ. There are a considerable number of new species, but no genera new to science.

Tycho Vestergrén § has issued a series of critical notes and diagnoses to accompany his exsiccata of Micromycetes. The fungi dealt with are all microscopic. Some of them are new species, others were found on hitherto unrecorded host plants. He records under *Cœoma Alliorum* that the fungus was the product of a culture obtained from the spores of *Melampsora populina* on *Allium oleraceum* and *A. vineale*.

Plant Diseases. Black Rot of the Vine.—M. A. Prunet || publishes a note on the development of the fungus *Guignardia Bidwellii*, which causes this disease. A stroma is formed on the grapes, which persists through the winter. In the early spring pycnidia are formed in the stroma, the spores of which reinfect the young shoots of the vine. Pycnidia are again formed on the vine-shoots, and the spores which they produce originate a second infection; this M. Prunet calls the secondary invasion. The development of the parasite depends largely on the condition of the atmosphere. A continuous rain and high temperature are the most favourable conditions for the germination and growth of the spores. A period of drought or too cold a season may stop altogether the formation of the pycnidia.

* Hedw. Beibl., xli. (1902) pp. 61-6.

† Engler's Bot. Jahrb., xxxii. (1902) pp. 35-46.

‡ Tom. cit., pp. 47-52.

§ Botan. Notis., 1902, pp. 113-28.

|| Comptes Rendus, cxxxiv. (1902) pp. 1072-5.

N. N. von Speschnew* (Tiflis) has examined grapes affected with Black Rot, from Trans-Caucasia. He finds not only the fungi *Guignardia reniformis* and *G. Bidwellii* on the fruit, but also the perithecia of *Diplodia uvicola*.

A disease of clover is caused also by a member of the Sphærospidiæ, *Glæosporium*. It has been examined by O. Kirchner.† The seat of the malady is on the stalk where there occur elongate brown spots. The spots are studded with the perithecia of the fungus, which has hitherto been considered identical with *G. Trifolii* Peck. The author finds, however, that this stem fungus varies somewhat from *G. Trifolii*, which always attacks the leaves, and he considers it to be a new species. He has named it *G. caulivorum*. The parts of the plant above the point of attack all die off.

P. Hennings‡ records two new parasitic leaf-fungi from Brandenburg. *Septoria Caraganæ* sp. n., the perithecia of which are scattered over the under side of the leaf of *Caragana arborescens*, the Siberian Pea-tree, causing somewhat yellowish spots. The other, which grew on the leaves of *Robinia Pseudo-Acacia*, was named by him *Fusarium Vogelii*. It forms roundish dark-brown spots on the leaves and kills the tissue so that the leaves look as if eaten by caterpillars.

The same author§ contributes a note on the American Gooseberry mildew, *Sphærotheca mors-uvæ*. He found the fungus on some gooseberry leaves from the neighbourhood of Moscow. He considers it to be indigenous in Russia and almost certainly identical with *Sphærotheca tomentosa*, which is very common on species of *Euphorbia*. The latter fungus is morphologically very similar to the gooseberry mildew. This disease appeared in Ireland in 1900. E. Salmon,|| who first noted the fungus on this side of the Atlantic, gives notes of the further progress of the disease. He warns gardeners against allowing the fungus to spread, and recommends spraying the plants attacked.

A résumé is given of six lectures on fungal diseases of plants by G. Masee.¶ A discussion of the conditions favouring disease is followed by a detailed account of several specific cases of attack. The history of *Botrytis cinerea* on snowdrop is given, and the disease of tomatoes caused by *Cladosporium fulvum* is described. Some injuries to fruit and other trees caused by members of the higher groups of fungi are explained. Advice is given as to methods of watering, spraying, mulching, and planting, and in a summary at the close the lecturer has given an account of the dissemination of fungus spores and the best way for the planter to prevent the further spread of the parasites. The lectures are illustrated by figures in the text.

Disease of Maize.**—V. Peglion has described the injury induced in grasses by the attack of the false mildew of maize *Sclerospora graminicola*. In the plants attacked a proliferation of the vegetative axis takes place, with a thickening of the stalk and the leaves lose colour.

* Zeitschr. f. Pflanzenkr., xii. (1902) p. 10. † Tom. cit., pp. 10-4.

‡ Tom. cit., pp. 14-6. § Tom. cit., pp. 16-7.

|| Journ. Roy. Hort. Soc., xxvi. (1902) pp. 778-9.

¶ Tom. cit., pp. 724-44.

** Le Stazioni sperimentali agrarie italiane, xxxiv. (1901) pp. 506-32 (3 pls.). See also Centralbl. Bakt., viii. (1902) pp. 652-3.

If infection takes place at a later stage when the grass is coming into bloom, hypertrophy and abnormal developments of the various parts occur, and the flowering is much delayed. The action of the disease is described in grasses of the genera *Triticum*, *Avena*, *Agropyrum*, *Glyceria*, *Phalaris*, *Lolium*, *Agrostis*, *Holcus*, and *Phragmites*. The author recommends the burning of all diseased grasses to prevent the spread of infection.

Fungus Pests of the Carnations.*—M. C. Corbie gives an account of fungal diseases of carnations. Leaf-spotting is due to the attacks of various species of Sphærospideæ belonging to the genera *Ascochyta*, *Sep-toria*, *Glaeosporium*, *Marsonia*, and *Cylindrosporium*. These render the plant unsightly and weaken the development. Gathering and destroying all spotted leaves would stop the spread of the fungi. Two species of *Peronospora* have also attacked the leaves of *P. Dianthi* (not yet recorded in Britain) and *P. Arenariæ*. A Hyphomycete, *Ramularia lychnicola*, has appeared on wild *Lychnis*. *Heterosporium echinulatum*, a black mould, is very destructive to carnations. *Macrosporium nobile*, a nearly allied mould, has been noted in the West of England, but is comparatively rare. Ustilagineæ and Uredineæ are also frequent pests, and a form of disease is caused by Bacteria. It is as yet confined to the United States. The author gives a list of the fungal parasites.

Coprophilous Fungi.†—George Masee has chosen for the subject of his presidential address to the members of the Quekett Club the fungi that are to be found growing on dung. He considers the habitat to be adaptive, as the fungi existed before the animals, though now many of the species are never found on any other substratum. A general sketch is given of the groups likely to occur on dung, and figures in the text illustrate a number of the more interesting forms.

Influence of Irritation on the Growth of Unicellular Plants.‡—M. J. Trzebinski has carried out a series of experiments and observations on the growth of *Phycomyces nitens* under the influence of various irritants. Mechanical injury, such as cutting the growing filaments, lowered the turgescence of the hyphæ, and markedly retarded growth. A very slight injury was found to act injuriously. Irritation of the sporangium by means of slender glass rods or some similar agent causes increased growth of the stalk. Ether vapour introduced in an open vessel into the culture-chamber also induced more rapid growth. If the vapour were too condensed growth was entirely stopped. The experiments were held to show that between the higher plants and unicellular plants of the type of *Phycomyces* there is a great similarity in the response to irritation.

Resistance to Temperature of Fungi.§—Abigail O'Brien has tested the comparative resistance to high temperature of the spores and mycelium of delicate fungi. She finds that the mycelium resists heat equally with the spores. The fungus was placed in beet decoction and heated in a boiler to the desired temperature, and then grown in drop-

* Journ. Roy. Hort. Soc., xxvi. (1902) pp. 649-56 (2 pls.).

† Journ. Quek. Mier. Club, 1902, pp. 253-60.

‡ Bull. Internat. Acad. Sci. Cracovie, 1902, pp. 112-30.

§ Bull. Torr. Bot. Club, xxix. (1902) pp. 170-2.

cultures. The spores and mycelium of *Penicillium* both grew after exposure to 60° C. The mycelium alone grew after exposure to 65° C.

Resistance of some Moulds to Metal Poisoning.* — In order to test the influence of metal poisons on the development of fungi, Carl Pulst made use of cultures of four common moulds, *Mucor mucedo*, *Aspergillus niger*, *Botrytis cinerea*, and *Penicillium glaucum*. He employed various mineral salts, as for instance, the sulphates of copper, zinc, iron, &c., which he mixed with the substratum, and graded his solutions so that the organisms should not be killed, but only retarded in growth. Both microscopic and macroscopic methods were used to measure the rate of increase of the plants. The results showed that *Penicillium glaucum* possessed the greatest power of resistance; that the other three moulds were extremely sensitive to the influence of the poisons; that moulds, especially *Penicillium*, have a power of accommodating themselves to the medium in which they are grown, and the limit of resistance is therefore not fixed, but rises with each generation of the fungus. The paper is accompanied by a series of tables giving the effect of the different salts on the growth of the moulds.

Germicides.†—G. Wesenburg has conducted a series of experiments with a variety of substances manufactured and offered for sale as disinfecting media. Antigermin is a copper salt combined with a weak organic acid. It is an odourless, greenish, somewhat treacle-like substance, requiring 200 parts of hot water to effect complete solution. Mikrosol is a greenish paste, also a compound of copper. It has a very strong odour. Afral, an organic compound, a nitro-product of phenol. The two latter are more easily soluble. Mycelicid is somewhat akin to Afral. Antiformin is a chlorine compound similar to eau de Javelle.

The effect of the mixtures was tested on various fungi: *Saccharomyces*, *Oidium lactis*, *Penicillium glaucum*, dry-rot of wood, &c., as also on the eel-worms of vinegar. Antigermin was found to be the best preservative against attacks of dry-rot. Antigermin and Mikrosol are almost equally effective in killing yeasts. The action of Afral and Mycelicid was found to be much slower.

Spore-Germination in the Higher Fungi.‡ — M. A. de Gomont de Lesparre gives first a *résumé* of reasons for and against the sexual development of the higher fungi. A historical account of the truffle follows, and an account of the various speculations of scientists and authors, from 380 B.C. to the present day, as to the origin and nature of the organism. The question of the parasitism of truffles on the roots of trees comes under discussion, and the author's final word on the matter is, that though the truffles may sometimes live as parasites on the roots of trees, yet that is not necessary, and they grow frequently as saprophytes in the soil.

Then follows a detailed anatomical account of the fungus, and of the asci and spores. The writer finds that the spores germinate on the leaves of trees, on Oaks, Walnuts, Conifers, &c., and usually near the central nerve of the leaf. They are transported to the leaves by insects

* Jahrb. Wiss. Bot., xxxvii. (1902) pp. 205-63.

† Centralbl. Bakt., viii. (1902) pp. 627-38.

‡ Étude sur la reproduction sexuelle de quelques champignons supérieurs, Paris-Paul Klinksieck, 1902, xx. and 61 pp., 3 pls. and 16 figs.

or by some mechanical agent such as wind. The most favourable time for germination is December, and the leaves may be fresh and green and still on the tree, or they may lie withering on the ground.

He discusses at great length the germination and sexuality of the spores, and gives the results of his experiments with the spores of *Coprinus* and other Hymenomycetes. The paper is enriched by coloured plates of the germinating spores and by many figures in the text.

Predisposition and Immunity in Plants.*—Marshall Ward discusses this question in the light of his experience gained in the culture of Rusts on Brome grasses. He rehearses the present position of our knowledge of Uredineæ, which as yet is one of great perplexity, and he then gives a series of tables which record the results of his experiments in infection. He was dealing with only one form of Rust, the uredospores of *Puccinia dispersa*. The results led to the conclusion that the source from which the spores are taken and the specific peculiarities of the grass inoculated have both to be taken into account if infection was to be successful. Certain Bromes were readily infected by spores taken from individuals of the same species, but were immune to those of other Bromes in an increasing degree as the species was further removed systematically. It was not easy to inoculate from one specific group to another. The author made a careful examination of the grasses to determine where the difference lay. The number and size of the stomata and hairs were calculated, the thickness of the leaves, &c. He came to the conclusion that the capacity for infection is independent of the anatomical structure. The reason must be found in some unknown biological distinction.

Technical Mycology.†—Franz Lafar has published a second instalment of his great work. The first volume dealt with Bacteria. The newly issued part, which is to form the first third-part of the second volume, deals with the general Morphology and Physiology of fungi. Under Morphology he gives only the data necessary to the understanding of the succeeding chapters. Special attention is devoted to the work on Physiology and Biology that has been done within the last ten years on fungi: as for instance, the chemistry of the cell-wall, the necessity for mineral food, the reaction to light, &c. A chapter is devoted to the fermentation process induced by Zygomycetes, with an account of the Mucorini. A necessarily large amount of attention is devoted to the yeasts, especially to the Saccharomycetes; to the form and chemistry of the yeast-cell; the morphology and development of yeasts; the anatomy and chemistry of the cells; their nourishment and reproduction, and finally their requirement of organic and inorganic material, and their need of oxygen. Emil Chr. Hansen writes a preface to the work. The part is illustrated by 68 figures in the text and one plate.

Schizophyta.

Structure and Affinities of the Schizophyta.‡—J. Massart has taken up again the question of the presence of a nucleus in the Bacteria and

* Proc. Camb. Phil. Soc., xi. (1902) pp. 307-28.

† Technische Mykologie, ii., Jena (Gustav Fischer) 1901. See Centralbl. Bakt. viii. (1902) pp. 648-9.

‡ Recueil de l'Inst. Bot. Univ. de Bruxelles, v. (1902) pp. 251-82.

Schizophyceæ. His observations were chiefly made on living material stained with very dilute methylen-blue. A large number of different forms were investigated, with the conclusion that there are present a number of stainable granules in many Bacteria and in Schizophyceæ a peripheral pigmented layer and a colourless central body. The author believes, however, that, contrary to the opinion of Bütschli, there is not the least evidence that the granules of bacteria have any connection with a nucleus; they are of varying number, can be seen to arise in the protoplasm, and never divide. The pigmented layer, he concludes, cannot be considered as a true plastid on account of its indefinite limits towards the inside, and the fact that it may contain both gas and liquid vacuoles; there is no doubt, however, that it functions as a plastid. Massart further considers that there is no reason to consider the central body, in which he has never seen any trace of karyokineses, as of nuclear nature. The fact that it has no definite outline, is sometimes vacuolated, and that it becomes greatly increased in size when the cell becomes a spore, all militate against the view that it is a nucleus. The author believes that there are two types of cells, those with cytoplasm and a nucleus, and simple cells such as are found in the Schizophyta. The paper concludes with a discussion of the relation of the various groups of the Schizophyceæ and the relation of the Schizophyta to other low forms of life. The conclusion is reached that the latter forms must be considered as an isolated group of doubtful origin and with no known affinities.

Schizomycetes.

Experimental Production of Parasitic Races of Bacteria.* — Lepontre attempted to show that the micro-organisms responsible for bacterial diseases in plants need not necessarily be "specific," but that ordinary saprophytic bacteria might acquire parasitic properties. In the course of this work he endeavoured to so modify the *B. fluorescens liquefaciens*, *B. mycoides*, and *B. mesentericus vulgatus*, as to enable them to lead a parasitic existence in various vegetable tissues. An experimental field (the same one Laurent employed in 1898 when working at the same subject) used for growing carrots, potatoes, turnips, &c., was divided into five plots numbered I. to V., and each year plot I. was treated with an excessive dose of nitrogenised manure; plot II. with potash manure; plot III. with superphosphates; plot IV. with lime; and plot V. with chloride of sodium.

Discs from carrots grown in each of these five plots were inoculated with pure cultures of each of the bacilli and incubated at 30° C. Those obtained from plots I. and IV. gave the most luxuriant growth, those from III. the most scanty. Successive passages of the bacilli, from carrot to carrot, resulted in increased ease and luxuriance of growth, and finally the carrots from plot III. were attacked as readily as those from the other plots; the growth of the *B. fluorescens* in about 24 hours converting the vegetable tissue to the depth of 5 mm. into a brownish alkaline fluid. The organisms were now transferred from carrots to turnips with analogous results. Of artichokes inoculated

* Comptes Rendus, cxxxiv. (1902) pp. 927-9. See also Ann. Inst. Pasteur, xvi. (1902) pp. 301-12.

with the *B. fluorescens*, only those from plot IV. were attacked, and those but feebly, and further passages did not appear to increase the virulence of the bacilli, whilst the beetroot appears to be quite immune. In default of potatoes from the experimental plots, some grown in neighbouring fields were next used, but no growth could at first be obtained upon them. If, however, the resistance of the potatoes was previously reduced by soaking in soda solution (1 in 1000) for 60 minutes, growth, especially marked in the case of the *B. fluorescens liquefaciens*, was obtained, and destruction of the potato tissue to a depth of 8–15 mm. resulted in two days. Successive passages again exalted the virulence of these organisms, so that finally they would attack all varieties of potato.

Microscopically, the tissues of the potatoes infected with the *B. fluorescens*, which, it should be noted, was isolated in the first instance from a rotten potato and possessed an appreciable initial virulence, showed disintegration of the parenchyma and coagulation of the internal protoplasm associated with the production of an alkaline reaction. The juice expressed from potato and turnip cultivations and filtered contained a diastase *pectinase*, which dissolved pectose: this enzyme is destroyed at 62° C. The substance which coagulates the protoplasm appears to be a mixture of acetic and lactic acids and resists exposure to a temperature of 100° C.

The author concludes from his experiments that an excess of nitrogenised manure or of lime predisposes the tubercles to bacterial invasion, while phosphates tend to increase the natural resistance of carrots and turnips.

Bacterial Flora of Mont Blanc.* — Binot undertook a study of the bacterial flora of (1) the glaciers; (2) water; and (3) air, at several points on Mont Blanc during the months of August and September 1900. He found that organisms were chiefly limited to the surface of the glaciers, 1 or 2 per ccm., chiefly organisms of slight resistance; in the depths were found sporing bacteria, streptotricheæ, and sporing moulds. The author states that he isolated a virulent race of the *B. pyocyaneus* from the ice of the summit. At the foot of the glacier the number of surface bacteria is larger, e.g. Mer de Glace, 6–65 per ccm. The numbers were distinctly smaller on surfaces exposed to the sun's rays than in situations protected from the sun. Fresh snow is practically sterile, as much as 8 ccm. of material failing to yield a single colony.

The waters from the glaciers contained extremely few bacteria, some only 3–8 per ccm. The air also contains but few micro-organisms, the numbers per cubic metre diminishing progressively as the valleys are left behind, and average 6 on the Grand Plateau. One experiment at least failed to demonstrate a single germ in that volume of air.

As a result of this research, the author isolated about 300 either new or undetermined species of bacteria, of which he has already worked out about one-third.

Retting of Flax.† — Hauman communicates a preliminary note on the bacteriological study of the factors concerned in the aerobic retting of flax. His observations lead him to conclude that the air retting (dew

* Comptes Rendus, cxxxiv. (1902) pp. 673–6.

† Tom. cit., pp. 1163–6.

retting) of flax is a purely biological process accomplished by the action of the common saprophytic bacteria and moulds of the air. Ordinary methods of isolation demonstrated the presence of the following organisms upon the flax stalks retted in the open air:—*B. coli communis*, *B. mesentericus fuscus*, *B. fluorescens liquefaciens*, *B. mycoides*, *B. subtilis*, *Micrococcus roseus*, *Streptothrix Forsteri*, *Penicillium glaucum*, *Mucor mucedo*, *Cladosporium herbarum*. Of these organisms the *B. coli*, *B. mesentericus*, and the *Cladosporium herbarum* are the most numerous and most active in the process of retting. The author placed stalks of flax in large glass tubes (50 cm. long), together with a few centimetres of dilute broth or beer wort, sterilised tubes and contents by repeated heatings at 110° C., and inoculated with pure cultivations of these different organisms (a higher temperature than 110° C. was found to produce a partial disassociation of the flax fibres). At the end of about twelve days retting was complete, but Hauman found that in general the moulds were much more energetic in their action than the bacteria, attacking the cellulose of the fibres and destroying their solidity.

That the process of retting is due to microbial activity was shown by exposing two handfuls of flax, side by side, to atmospheric influences for about a month. The one was not interfered with, the other was placed in an atmosphere of formaldehyde every two or three days to destroy bacterial life. At the end of the experiment the first bundle was completely retted, whilst the process had not even started in the second.

Source of Acid Organisms of Milk.*—R. Burr details the investigations he pursued in order to determine whether the acid organisms found in milk exist in the cow's udder, or are present in the dust and air and only contaminate the milk during or after milking.

The technique adopted was to draw small quantities of milk from a single cow into sterile 10 ccm. tubes at the beginning and close of milking, taking every precaution against air-borne contamination, at the same time filling a sterilised litre jar with the same milk but without observing such precautions. He then plated the milk samples, using plain gelatin with 3 p.c. lactose and coloured with litmus, that being the most suitable medium. The milk in the sterile tubes contained 500 micro-organisms per ccm., and did not include the *B. acidi lactici*; it did not curdle for 8 or 10 days. Unripened cream from the milk drawn in the sterile pail contained about 161 million organisms, and when ripened, about 268 millions, including the *B. acidi lactici I.*, the *B. acidi lactici II.*, and *B. lactis aerogenes*.

In a second series of experiments, specimens of milk were collected as in the previous experiments, and in addition gelatin plates were exposed under the cow for varying short periods during the process of milking. All the plates contained the *B. acidi lactici* and *B. lactis aerogenes*, showing that the acid organisms are probably an outside contamination.

Further experiments comprised the collection of samples of milk on three successive days from seventy different cows under conditions calculated to prevent accidental contamination, the results similarly point-

* Centralbl. Bakt., 2^{te} Abt., viii. (1902) pp. 236-41.

ing to the conclusion that acid organisms are not in the milk when freshly drawn, but are a contamination from without.

The author further examined bacteriologically the udders of two cows, both derived from animals which had been condemned on the result of the tuberculin test: neither cow was milked for some hours previous to slaughter, a process which might have washed out micro-organisms from the lacteal ducts. Inoculations were made into sterile milk, on to serum, agar-agar, and gelatin tinted with litmus, from three separate situations,—the upper glandular portion of the udder, the milk cistern, and the beginning of the teat. In no case were either of the three chief lactic bacteria found: an organism probably identical with Conn's *Micrococcus varians lactis*, which does not appear to play an important rôle in the souring of milk, was, however, isolated.

Bacillus caseolyticus.*—Lochmann isolated a previously undescribed bacillus belonging to the Coli group from the organs of a guinea-pig which had succumbed to general tuberculosis after injection with a cultivation of the *B. tuberculosis*. This organism, which he designates *B. caseolyticus*, appears as small actively motile rods with rounded ends, resembling the *B. typhi abdominalis*, and provided with 4–8 peritrichous flagella. It stains readily with the usual anilin dyes but does not retain the colour when treated by Gram's method. In artificial cultivations it is pleomorphic, sometimes grows out into long threads, and is frequently vacuolated when old. It is a facultative anaerobe, growing well at the room temperature, but better at 37° C., on all the ordinary media. The bacillus is killed by exposure to 70° C. for five minutes. Gelatin is not liquefied by its growth, which in stab culture assumes the form of a nail with a flat head. Cultivations in broth become uniformly turbid in a few hours, and after some days a deposit is thrown down, whilst occasionally there is a suggestion of pellicle formation. Indol is not formed. On potato a thick heaped-up layer forms, which later becomes brownish in colour and spreads out laterally. Milk is not coagulated by its growth, but a large amount of alkali is formed, and after about four weeks the milk appears to be peptonised, although no peptones can be demonstrated by chemical tests. Gas production is observed in media containing 2 p.c. of grape or cane-sugar or lactose, and occasionally in media to which no sugar has been added.

Forty-eight hour old broth cultivations of the bacillus are pathogenic for mice and guinea-pigs in from 20 hours to 5 days when injected subcutaneously, and in 4–5 days when introduced into the alimentary canal [by feeding]. Introduction of the bacillus into the healthy conjunctival sac produces no pathogenic effect. In rabbits subcutaneous inoculation merely provokes local suppuration not followed by general infection. The author was unable to demonstrate the formation of any soluble toxin. He differentiates the *B. caseolyticus* from the *B. enteritidis* Gärtner by the absence of toxin formation and the luxuriant anaerobic growth.

Efficiency of Pasteurisation.†—Russell and Hastings studied the destruction of bacteria in milk by means of heat, employing in their

* Centralbl. Bakt., 1^{te} Abt., xxxi. (1902) pp. 385–8.

† Op. cit., 2^{te} Abt., viii. (1902) pp. 462–9.

experiments milk inoculated with a coccus which possessed the unique property of retaining its vitality at temperatures considerably above 60° C., and concluded that the efficacy of the method depends upon the conditions under which the exposure is made: if pasteurisation at 80° C. is carried on whilst the milk is exposed to the air, a "scalded layer" pellicle formation occurs, and the organisms caught up in this layer acquire greater powers of resistance than such organisms as remain suspended in the milk below, a result partly due to the lower temperature existing at the surface, but depending chiefly upon the nature of the enclosing membrane. An interesting fact observed in the course of these experiments was that if the membrane was removed from the milk after an interval of about 10 minutes after formation, a second membrane then formed, which proved to be perfectly sterile, although the first membrane contained living organisms at the time of removal.

Decomposition of Lactose by *Bacillus acidi lactici*.*—P. Haacke states that when milk-sugar is decomposed by the *B. acidi lactici*, the resulting products consist of lactic acid, acetic acid, and alcohol, together with a gas which was not analysed. The amount of sugar decomposed by 1000 bacilli varies according to the conditions from 0.008 mg. to 0.00001 mg. The quantity of lactic acid obtained never exceeds one-third of the sugar decomposed, whilst the amount present at any given moment is not strictly proportional to the quantity of sugar decomposed, as a portion of the acid is probably acted upon still further.

***Bacillus tuberculosis* in Cheese.**†—Harrison carried out a careful series of experiments to determine the length of time the *B. tuberculosis* would remain alive and virulent in Cheddar cheese manufactured from infected milk. In all twenty-seven guinea-pigs were inoculated with curd or cheese at intervals of about one week: up to the 112th day after the commencement of the experiment, with the result that the presence of the *B. tuberculosis* could not be demonstrated after 62–70 days. As compared with similar experiments carried out in 1900 at Berne with Swiss Cheddar; this shows a difference of about 34 days in favour of Canadian Cheddar; and Harrison suggests that the difference may be due to the higher acidity, the intimate admixture with salt, and the closer texture of the Canadian cheese.

***Bacillus tuberculosis* in Buda-Pesth Butter.**‡—Anjeszky examined twenty samples of butter obtained from different sources, in order to determine the presence or absence of the tubercle bacillus. Three or four healthy guinea-pigs of 350–450 grm. weight were injected intraperitoneally with 0.5 to 2 ccm. of the fat-free centrifugalised deposit from each sample. The animals inoculated with three of the samples died within a few days from infection by the *Streptococcus pyogenes*, *Staphylococcus aureus*, and the *B. coli communis* respectively. Of the remainder, three only (17.6 p.c.) developed general tuberculosis, to which they succumbed in from 35–80 days. Some of the animals inoculated from each of the other fourteen samples of butter were killed 4 or 6 weeks after inoculation and carefully examined, but with negative

* Arch. Hygiene, xlii. (1902) pp. 16–47.

† Centralbl. Bakt., 1^o Abt., xxxi. (1902) pp. 250–4. ‡ Tom. cit., pp. 132–4.

results. The others were observed up to the end of about three months without any signs of tuberculosis being observed. The author remarks on the fact that he did not succeed in demonstrating the presence of acid-fast bacilli other than the tubercle bacilli in the organs of any of the animals examined post-mortem, and he attributes this fact to the freedom of the inoculated material from fat.

Tuberculosis in Cold-blooded Animals.*—Herzog investigating experimental tuberculosis in cold-blooded animals, showed that the pathological manifestations produced in the body of the frog as the result of infection by the bacillus of mammalian tuberculosis were identical, both naked-eye and microscopically, with those initiated by the bacillus of fish tuberculosis, the seat of inoculation usually employed being one of the lymph-sacs or the peritoneal cavity. Microscopical sections of tuberculous nodules from the frog's kidney demonstrate this point in a most striking manner. He further states that the bacilli introduced soon disappear from the seat of inoculation, and may finally be demonstrated in all the internal organs. The bacillus of mammalian tuberculosis after passage through cold-blooded animals loses its virulence for warm-blooded animals, so that fatal infection of guinea-pigs can no longer be produced even when large doses are employed. A list of the literature of the subject is appended to the paper.

Pseudo-Tuberculosis (Streptobacillary) of the Grey Rat.†—At the post-mortem of an experimental rat, killed by the administration of terebinthine, Sabrazes observed suppurative lesions limited to the liver and lungs. In the liver these consisted of a lenticular granulation filled with greyish pus, and in the lungs and pleuræ of small tubercles filled with greenish-yellow pus. The pus contained numerous rods (8–11 μ by 0.35 μ) arranged end to end, slightly curved, not branched, non-motile, staining well with the ordinary anilin dyes, but decolorised when treated by either the Ziehl-Neelsen or Gram's methods. Planted on agar at 37° C., the pus gave a pure culture of this streptobacillus, which in plates formed circular colonies, yellowish by transmitted light, attaining a maximum diameter of 1 mm. Agar streak, a slightly raised transparent streak of the colour of the medium, with sinuous borders showing a more or less well-marked double contour. Inspissated blood-serum and glycerin-agar show similar appearances. Broth becomes uniformly turbid, reaction unchanged; later a light pellicle is formed, which eventually breaks up and sinks with the rest of the growth to the bottom of the vessel, the bulk of the medium again becoming clear. Milk is not coagulated. Upon potato a scanty growth consisting of a greyish-white layer takes place. On gelatin at the room temperature there is no liquefaction of the medium. The bacillus does not ferment sugar, form indol or spores, or possess flagella; its virulence is lost and its vitality is slight, subcultivation is necessary about every eighth day to ensure growth; it does not grow well anaerobically. In culture it forms filaments from 5–60 μ in length, composed of unequal rods or even cocco-bacillary forms. In old cultures granular and swollen involution forms appear.

* Centralbl. Bakt., 1^o Abt., xxxi. (1902) pp. 78–85.

† Ann. Inst. Pasteur, xvi. (1902) pp. 97–105.

The streptobacillus is pathogenic for the white mouse and the rat, death taking place in the case of the former in a few days, in the latter in about three weeks, from a general infection. Rabbits and guinea-pigs only give a slight local reaction and a transitory adenitis.

The author points out several points of similarity possessed by this organism and that described by Kutscher.

Lesions produced by Acid-resisting Bacilli.*—Abbott and Gildersleeve communicate some observations which they believe constitute additional evidence that the members of the acid-fast group are closely allied botanically to members of the *Actinomyces* family. They observed that when rabbits were injected intravenously with cultivations of the *B. phlei*, Grass bacillus II., and Butter bacillus, certain peculiar structures were occasionally present in the resulting lesions. The animals were killed in from 12 to 15 days after inoculation, and at the post-mortem a variable number of yellowish-grey spherical nodules were detected in the kidneys, not elevated above the surface, but intimately connected with the capsule, and only rarely extending from the surface of the kidney into its cortex. Occasionally nodules were found in the lungs almost indistinguishable from genuine miliary tubercles. Microscopically they were indistinctly rosette-shaped, and had a structure suggestive of mycelium. Stained by Gram's method or with hot carbol-fuchsin, and subsequently decolorised with alcohol containing 5 p.c. acetic acid, preparations were obtained showing mycelium similar to that produced by *Actinomyces*. Occasionally areas were encountered containing longer and shorter beaded threads matted together, which more nearly approached the appearance of *B. tuberculosis* in artificial culture, and the authors state that this mycelial development is a constant accompaniment of the growth of the organism in tissues, and they consider the short beaded rods to be usually merely fragments of the longer, convoluted, clubbed, mycelial threads. Occasionally they observed mycelium in which only a very few hyphæ could be stained. In this connection the authors cannot say with certainty that branching forms have yet been observed.

Etiology of Acute Dysentery.†—Vedder and Duval investigated several outbreaks of dysentery occurring in the Eastern States of America in asylums and almshouses. From all their cases they isolated a non-motile bacillus, which was indistinguishable from the Shiga-Kruse-Flexner bacillus. They further note that the *B. dysenterix* does not develop so rapidly in plate cultivations as the *B. coli communis*. In making agglutination tests the authors find that positive reactions are not obtained simultaneously with the appearance of clinical symptoms; again, after having been demonstrated, agglutinins sometimes disappear from the blood with startling rapidity. They conclude that sporadic and institutional dysentery are both due to the same organism, which is itself identical with that responsible for the production of acute epidemic dysentery—the *B. dysenterix* of Shiga.

Resistance of the Bacillus dysenterix to Cold.‡—G. Schmidt, in an attempt to explain the recrudescence of epidemics of dysentery in con-

* Centralbl. Bakt., 1^o Abt., xxxi. (1902) pp. 547-50.

† Tom. cit., pp. 134-5.

‡ Tom. cit., pp. 522-4.

secutive summers, investigated the resisting powers of the Shiga-Flexner dysentery bacillus against winter frost. The method he adopted was to inoculate samples of garden earth mixed with urine and fæces, slices of potato, tap water, sterile water, coffee, coffee with milk, coffee with sugar, &c., with pure cultures of the *B. dysenterix*, and to expose this infected material, together with pure cultivations on agar and in broth, in an open wooden box in the open air every frosty night from Dec. 19, 1901, to Feb. 24, 1902. Control series of cultures were maintained during this period at the ordinary room temperature.

Exhaustive observations were carried out on Dec. 29, and on the 27th of the following February, with the result that from the agar and broth cultures and from the infected coffee and milk, whether exposed to the cold or kept at the room temperature, pure cultivations of typical dysentery bacilli were recovered, and their identity carefully confirmed by subcultivation on the various media. In the garden earth, potato slices, and various coffee preparations, the *B. dysenterix* was, however, so overgrown by the multiplication of ordinary saprophytic bacteria, even at the first observation (Dec. 29), that it could not be detected, and was considered to have already died out.

*Diphtheria Toxins in Serum Media.**—C. Wood, by cultivating the *B. diphtherix* in natural unchanged albumen (e.g. blood-serum) derived from the horse (homeoplasma), prepares a toxin which, when injected into horses, provokes a rapid rise in the antitoxic value of their serum. In the author's method of preparing the toxin he inoculates ordinary alkaline peptone broth with a virulent *B. diphtherix* and incubates at 37° C. for a week or more; then adds 15 to 30 p.c. of its bulk of sterile horse-serum, and again incubates at 37° C. for a month or six weeks; then raises the temperature of the cultivation to, and maintains it at, 65° C. for one hour, and finally filters it through a Chamberland filter candle. If, however, the serum from some other species of animal (heteroplasma), such as the sheep, ox, or man, is employed in the culture medium, no such rise in antitoxic value takes place.

The author next extended his experiments to the ordinary laboratory animals—rabbits, guinea-pigs, and pigeons—and found that preliminary injections of rabbits and pigeons with toxines obtained from media containing guinea-pig's serum, so far from protecting the animals against a lethal dose of toxin, appeared to render them more susceptible; but guinea-pigs were rendered more resistant or entirely protected. When rabbit serum toxin was used, only the rabbit was rendered more resistant. On the other hand, pigeon serum toxin appeared to increase the resistance of rabbits and guinea-pigs as well as pigeons, although this anomaly might be explained as a matter of dosage.

Bacillus diphtherix in Simple Rhinitis.†—Neumann, from a study of five cases of what proved to be nasal diphtheria, concludes that the occurrence of virulent diphtheria bacillus in cases of apparently simple rhinitis is much more common than is generally supposed. The fact that these cases are so frequently overlooked is due to the want of uniformity of the symptoms and the mildness, as a rule, of the attack.

* Centralbl. Bakt., 1^o Abt., xxxi. (1902) pp. 241-5.

† Tom. cit., pp. 34-41.

Etiologically, however, these cases are identical with those of rhinitis fibrosa—both varieties, in the opinion of the author, should be called nasal diphtheria, and should be differentiated only by the addition of the words “with membrane formation” or “without.” Both are active sources of infection, consequently all doubtful cases of rhinitis, especially those which under treatment prove refractory, should be examined bacteriologically as to the presence of the *B. diphtheriæ*, in order that therapeutic injections of serum may be administered at an early stage. In many of the cases the “pseudo-bacillus” was associated with the true *B. diphtheriæ*, without, however, exercising any influence on the disease. Indeed, Neumann states as his opinion that the pseudo-diphtheria bacillus is a harmless saprophyte.



MICROSCOPY.

A. Instruments, Accessories, &c.*

(1) Stands.

Zeiss' Stand for Brain Sections.†—This stand is shown in fig. 95. The upper part is fitted with Berger's micrometer movement and with a very wide external tube. The draw-out tube is worked by hand motion, and has a collar which serves as a handle. The crane-like tube-carrier

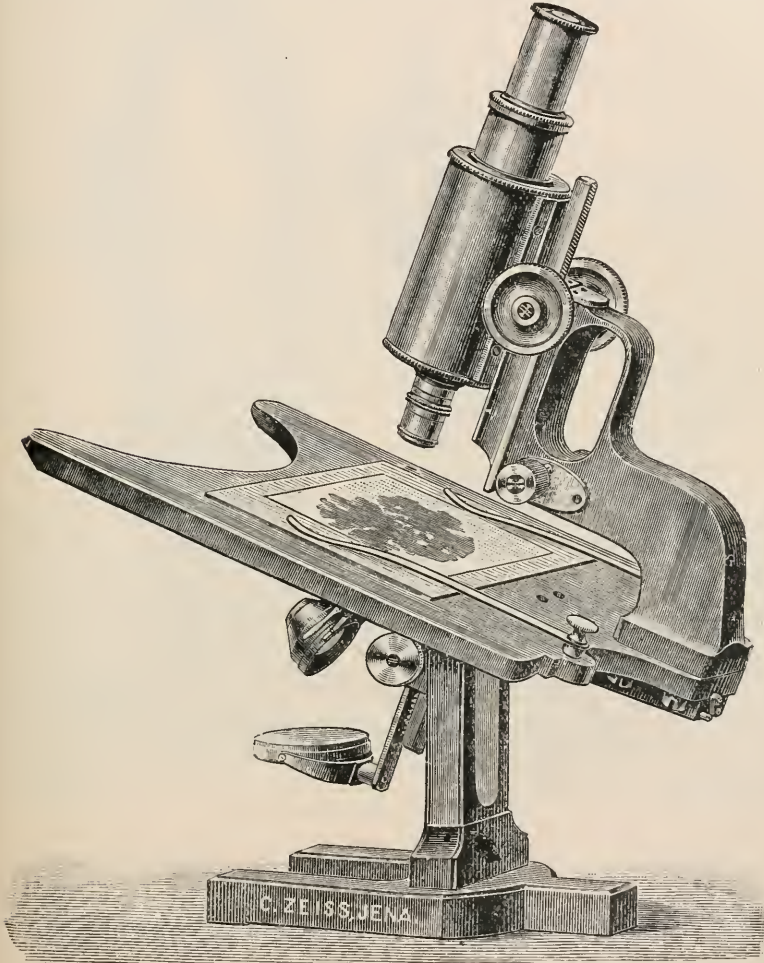

FIG. 95.

* This subdivision contains (1) Stands; (2) Eye-pieces and Objectives; (3) Illuminating and other Apparatus; (4) Photomicrography; (5) Microscopical Optics and Manipulation; (6) Miscellaneous.

† Zeiss' Catalogue, 1902, No. 70, fig. 26, p. 56.

is unusually deeply cut out, so that the optical axis of the tube can lie over the centre of a 250 by 250 mm. object-stage. The form of stand especially adapts it for the examination of brain sections or other such extensive preparations.

Czapski's Cornea-Microscope.*—Fig. 96 shows this instrument with its base-plate and Everbusch chin-holder. The Greenhough binocular

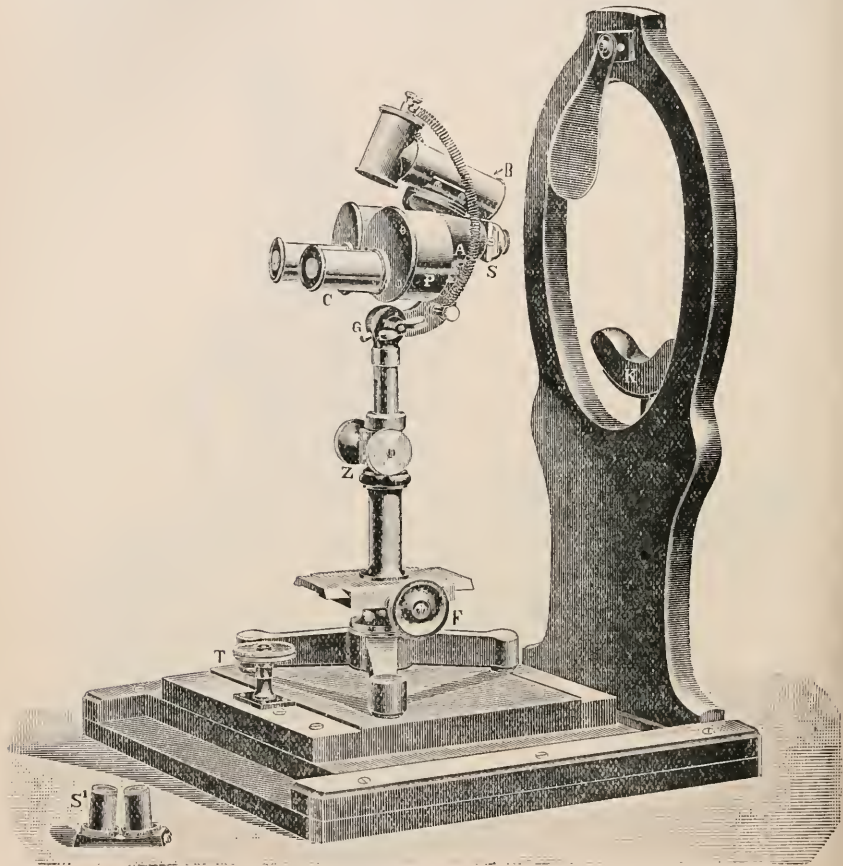

FIG. 96.

is, in this case, provided over the centre line between the double tubes, with an illuminating tube, whose axes converge to the same point as the axes of the two Microscopes. In this tube is an incandescent electric lamp with a two-strand illuminating system so that the most favourable light for the examination of the patient's eye can be found. The whole of the upper part can rotate and be clamped in a vertical plane about a

* Zeiss' Catalogue, 1902, No. 98, fig. 37, p. 76.

horizontal axis formed by a hinge. The instrument is also rotatory about a vertical axis. A rack-and-pinion adjusts the height and a second rack-and-pinion the horizontal distance from the object. The base-plate, on which the whole is mounted, can also be moved in two horizontal directions mutually perpendicular. The movement from front to rear is freehand and from left to right by the milled head T.

Zeiss' Preparation Stand and Drawing Apparatus for Weak Magnifications.* — This apparatus (fig. 97) not only satisfies all the

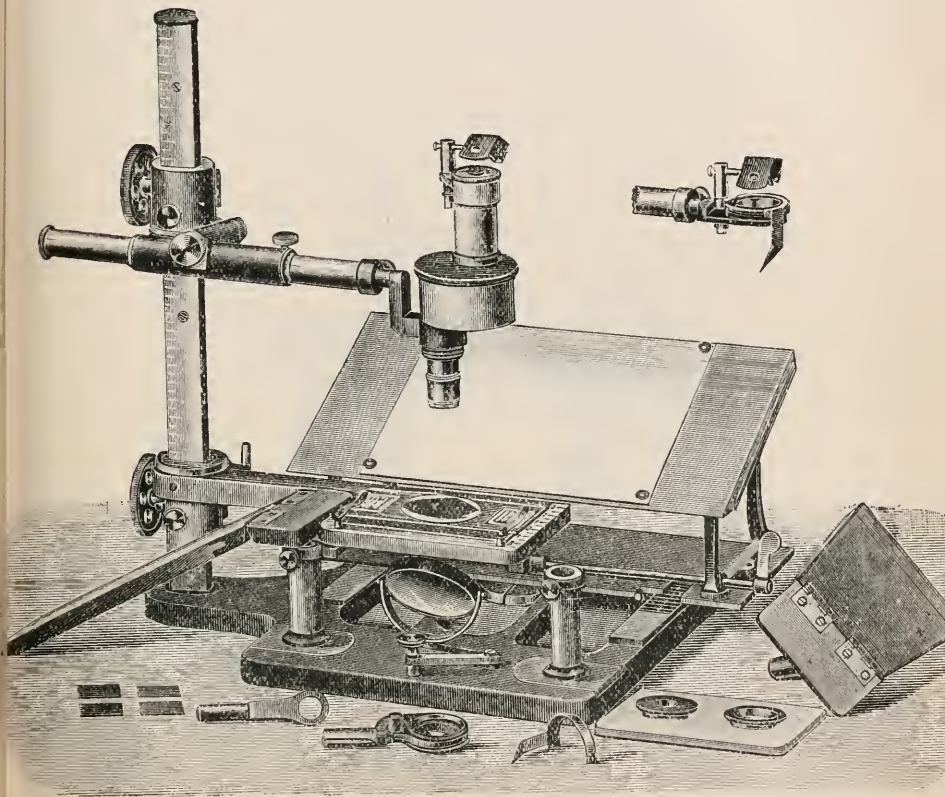

FIG. 97.

requirements of a preparation Microscope, but also serves for the drawing of objects within increased limits of scale-selection. Two horizontal arms are movable up and down on the strong brass pillar to the left. The upper one bears at its extremity a perforation for receiving the various holders for loupes, spectacle-glasses, or an erecting Microscope. The lower arm is a frame-shaped object-table for receiving a plate of glass, metal, or wood. Illumination is obtained by transmitted light

* Zeiss' Catalogue, 1902, No. 102, fig. 39, p. 79.

from a mirror set in a universal joint in the base-plate. The drawing-board is pushed up and down on a desk-shaped stand at an angle of 25° . This frame can be slid backwards and forwards in a groove of the base-plate. Scales are set on both sides of the object-table, and, in connection with the scale on the base-plate, have the effect of preserving the same magnification in a drawing of any part of a large preparation. It is also possible to draw in reduced measure, if the preparation is set on the drawing-board and the paper on the object-table.

Photo-measuring Micrometer. — A. Hilger's photo-measuring micrometer (fig. 98), though specially designed for accurate and rapid

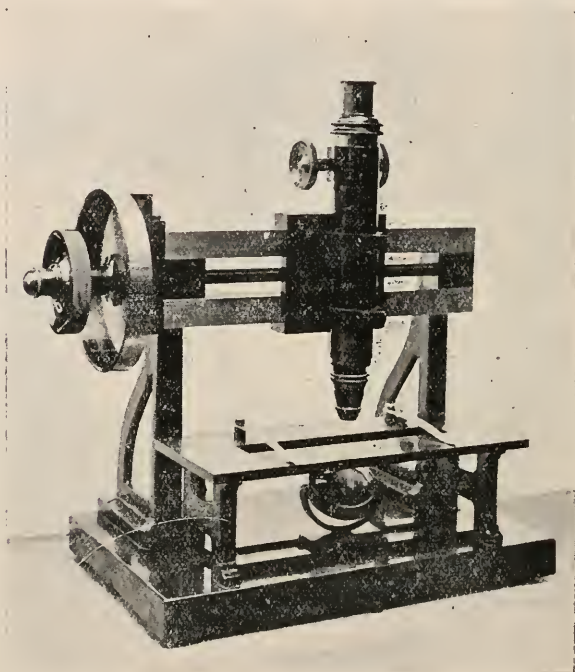

FIG. 98.

measurements of spectrum photographs, is adapted for general laboratory work. The accuracy of the instrument is attained by the careful manufacture of the steel screw, its nut, and the gun-metal Microscope-slide. Its durability is ensured by simplicity of design, by the provision of adequate surface-bearings on the screw and on the Microscope-slide, and by the deep thread of the screw and its substantial diameter of $\frac{1}{2}$ in. As the pitch of the screw is 1 mm., and there is a large divided drum-head, the whole traverse of 6 in. can be rapidly worked over and exceedingly accurate measurements taken. The base of the instrument is of cast iron, and the Microscope-slide is mounted on two cast iron standards.

(2) Eye-pieces and Objectives.

Zeiss' Objectives.*—The Zeiss firm guarantee that their achromats and apochromats may now be classed among durable objectives, and may, without hesitation, be used even under such unfavourable climatic conditions as obtain in maritime and tropical districts.

In the achromats E and F the guaranteed minimum value of the numerical aperture has been raised from 0·85 to 0·90, and in the case of the $\frac{1}{2}$ -in. homogeneous-immersion from 1·25 to 1·30.

Demonstration Eye-piece.†—L. Murbach thinks that the well-known difficulty of leading a pupil to identify objects (especially when moving) under the Microscope may be got over by some kind of demonstration eye-piece, whereby both teacher and pupil may view the object at the same time. The principle of his idea is shown in fig. 99. The

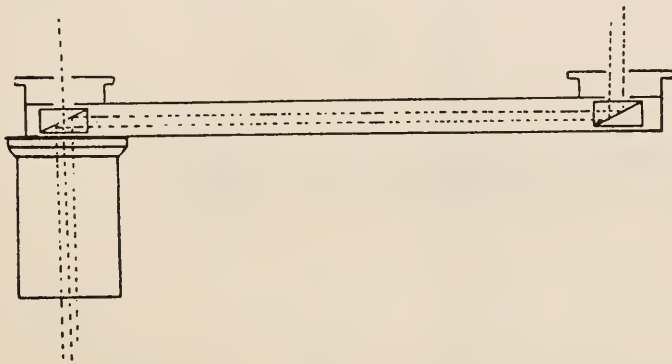

FIG. 99.

device consists of an ordinary eye-piece with cross-hairs for pointing out the object. A prism above the eye-piece is so placed as to reflect the image through a tube at right angles to the eye-piece to another prism at the end of the tube. This prism will reflect the image upward into the eye.

Oculars for General Laboratory Work.‡—J. H. Schaffner says that Microscopes intended for general laboratory work, as for example, the Bausch and Lomb BB4, are usually fitted with the 2-inch and 1-inch eye-pieces; but he recommends that the inch should be replaced by a $\frac{3}{4}$ -inch, the 2-inch being retained.

PULFRICH, C.—Ueber neuere Anwendungen der Stereoskopie und über einen hierfür bestimmten Stereo-Komparator.

[Discusses, *inter alia*, the principles of the Microscope-Stereoscope.]

Zeit. f. Instrumentenkunde, XXII. (1902) pp. 65-81 (4 figs.).

STREHL, K.—Ueber die Gauss-Bedingung bei Mikroskopobjektiven.

[Explains the principles on which apochromatic lenses are made, and how the conditions for colour-correction are determined.]

Central-Zeit. f. Opt. u. Mech., XXIII. (1902) pp. 76-7.

* Zeiss' Catalogue, 1902, and special circular.

† Journ. App. Micr., v. (1902) p. 1648 (1 fig.).

‡ Tom. cit., p. 1646.

(3) Illuminating and other Apparatus.

Giltch's Drawing Stand.*—This simple apparatus (fig. 100) is intended for use with a drawing-prism (camera lucida) or the large Abbe drawing apparatus. Ordinary pocket-loups or spectacle-glasses may be used.

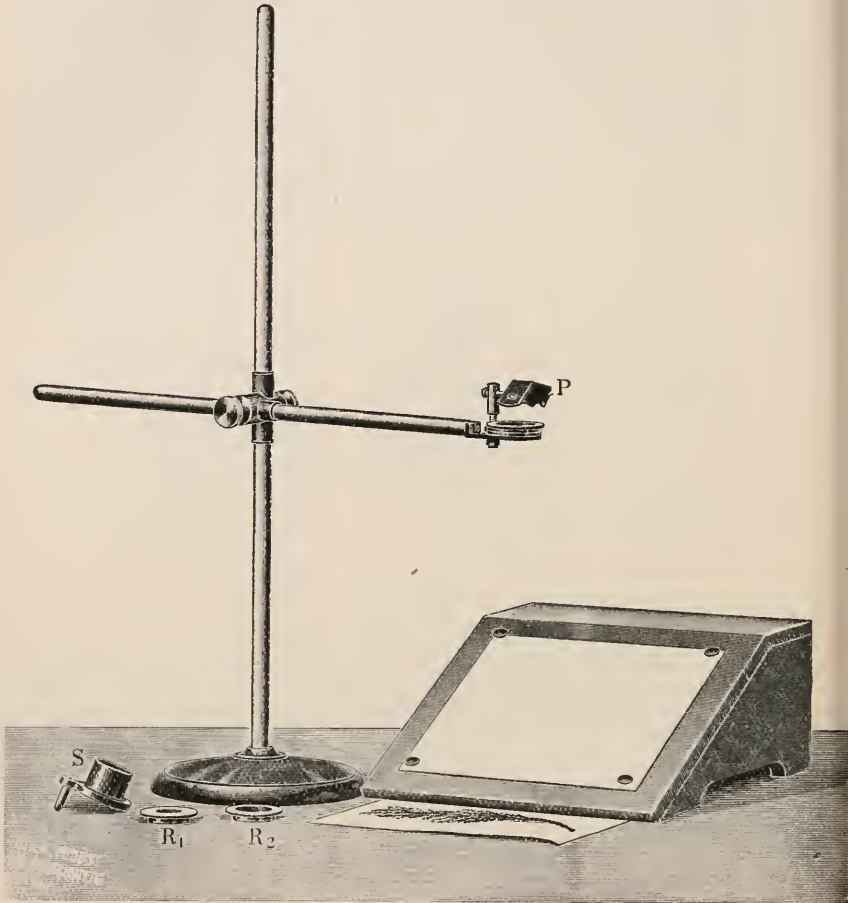

FIG. 100.

The Apertometer and its Use.†—H. F. Augus argues against the neglect of the apertometer and its supposed limited range of usefulness. He also points out that the objection on the score of expense vanishes if either of the two following simple forms be used, and that, except for immersion lenses, these simple instruments are amply sufficient.

* Zeiss' Catalogue, 1902, No. 116, fig. 50, p. 91.

† Journ. Quek. Micr. Club, viii. (1902) pp. 209-15 (1 fig.).

The first, which he calls the protractor apertometer (fig. 101), consists essentially of an ordinary semicircular protractor mounted on a base and supplied with two pointers, easily adjustable to indicate any angle, and an object placed at the centre on which to focus the objective under examination. In practice, a silvered cover-glass mounted on a piece of glass of the thickness of an ordinary slip, with an aperture of about 1 mm., is found the best object on which to focus. The objective is focussed in the usual manner on the edge of the aperture in the silvered surface; the protractor is then moved slightly, so that the edge

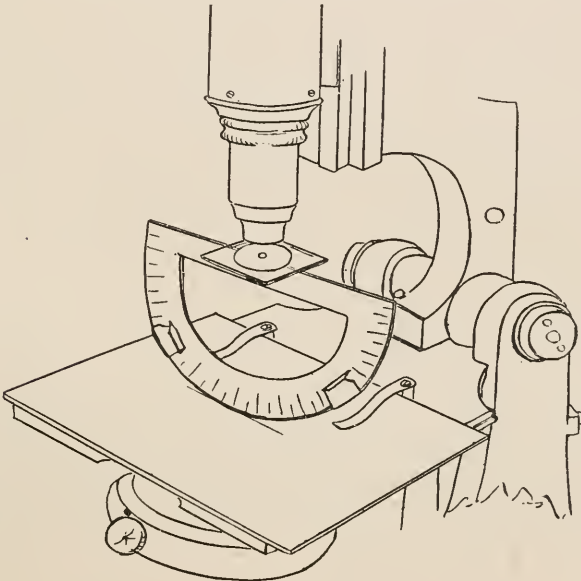

FIG. 101.

on which the focus was obtained moves out of the field, and the centre of aperture in the silver film becomes coincident with the optic axis of the Microscope; then, on removing the eye-piece and looking down the tube, the whole of that part of the protractor which the objective takes in will be found to be visible, and the pointers can be adjusted so as to touch the opposite edges of the field, the reading indicating the angular aperture. Except with very low powers, however, the image of the protractor as seen when looking down the tube is so small that some difficulty will be experienced in adjusting the pointers. To obviate this the draw-tube can be converted into an auxiliary Microscope, thus magnifying the original image. This is effected by replacing the eye-piece and screwing into the lower end of the draw-tube a very low-power objective, such as the posterior half of a 2-in. objective. Having thus obtained a reading of the actual angle embraced by the objective, it can be converted to N.A. by reference to some such table as that in Dallinger's *Carpenter*.

The second simple form is the *substage-scale* apertometer, which was
August 20th, 1902

suggested to the author by F. T. Cheshire, of the Birkbeck Institute. It consists essentially of a glass disc of such diameter that it can be dropped into the stop-carrier of the condenser with which it is used, ruled with equidistant lines (a millimetre scale will be found as suitable as any). To use this piece of apparatus it is first necessary to find the value of the scale when used with any given condenser. This is effected by means of an objective of known aperture in the following manner:—The condenser and objective having been focussed on an object, the disc is inserted below the condenser, the eye-piece removed, and the number of divisions of the scale visible in the field duly noted. As in the case of the protractor apertometer, it will usually be necessary to magnify the image so obtained in order to read the scale with accuracy. When set up in this manner the scale will appear sharply defined right up to the edge of the field, provided that the aperture of the lens measured does not exceed the aplanatic aperture of the condenser. Thus, suppose the objective of known aperture to be a $\frac{1}{2}$ -in. of N.A. 0·34, and the condenser to be the Abbe chromatic pattern N.A. 1·20 (this is the total aperture, the aplanatic aperture is, of course, very much less, approximately N.A. 0·50), then, proceeding as above, it will be found that $8\frac{1}{2}$ divisions are visible in the field, and that consequently 1 mm. of the scale with this condenser has a value of N.A. 0·04. If now another objective, say a $\frac{1}{4}$ -in., be taken and 5 divisions be found visible, then the aperture will be N.A. 0·20.

The author gives a number of examples in which the apertometer is used to obtain the conditions for good dark-ground illumination.

Acetylene Gas for the Lantern.—T. D. Ersser states that he has used acetylene gas for lantern purposes for the past two years. He finds that the best apparatus is the Imperial cold generator which when worked on the gasometer principle is perfectly safe. With 20 oz. of the best calcium carbide and an argand burner, a light of over 300 candle-power, free from smoke and smell, and lasting for two hours, can be obtained at a cost of ninepence.

(4) Photomicrography.

New Method of Focussing in Photomicrography.*—Katharine Foot and Ella C. Strobell use a very simple form of vertical camera. The Microscope (an ordinary Continental model with a direct-acting screw fine adjustment) stands upon a base-board, 12 by 12 by $\frac{3}{4}$ in. thick, to which wooden uprights, which hold a bellows camera, are attached.

In the new focussing method all need for a focussing rod, or other appliance, to carry the movement of the fine adjustment screw to the sensitive plate end of the camera is obviated, neither is it necessary to project the image on to the ground-glass screen, for the correct focus is obtained even before the camera is applied to the Microscope by the simple expedient of using a spectacle lens of a certain negative strength when focussing the instrument.

The powers of the spectacle lenses suitable for given extensions of camera, and other conditions, were experimentally determined and

* Zeitschr. wiss. Mikr., xviii. (1902) pp. 421-6 (1 pl.).

recorded. Thus a Zeiss 2 mm. objective, with projection ocular 4, and a camera length of $29\frac{3}{4}$ in., measured from the Microscope stage to the sensitive plate, required a - 5 D lens.

Different planes in a thick object are photographed by focussing the Microscope upon the same point in the object, and employing spectacles of various negative strengths.

In illustration of the paper, there is a plate containing nine photomicrographs of one section of an egg of *Allolobophora fætida*, showing the lower pole of the first maturation spindle, and two and a half of the eleven chromosomes.

The following passage, which is extracted verbatim, throws a curious side light upon the efficiency of the Continental model Microscope, with its direct-acting screw fine adjustment, when used for rough and ready cytological photomicrographic work.

"It is a waste of time to expose the plate unless the stability of the focus is assured, for the slightest change of focus during exposure destroys the sharp outlines of the image, giving that blurred effect so familiar in many photomicrographs. This slipping of the focus we have found the most troublesome factor in photography, and this danger must exist whether the vertical or horizontal camera is used, or with any method of focussing.

"A worn or an imperfect micrometer screw is not the sole cause of this trouble, for we have tested a new Zeiss Microscope and we found the focus changed so radically that after a half hour's wait, the centrosome (on which the test was made) was completely lost sight of. We are inclined to think that changing of the focus is due rather to variations of temperature to which the Microscope may be subjected, for example, in bringing it from a warm part of the laboratory and placing it close to a window, though this would seem hardly adequate to account for all the vagaries of a changing focus. Sometimes a wait of an hour or more is needed to ensure a stable focus, but fortunately these are rare occasions, as a rule ten or fifteen minutes test is all that is needed."

Photomicrographic Device.* — F. E. Ives describes a simple home-made arrangement for securing a photograph of the microscopic image without any readjustment and even without interfering with the inclination of the instrument.

A half-inch mahogany box-lid 10 in. wide and 12 in. long served as a base for the Microscope, which was held securely in place by means of stops against which it was pressed. A small shelf-bracket was fixed on each side of the Microscope so that one of the screw-holes in the bracket came exactly opposite the centre of the Microscope joint. The brackets were so separated as to just sufficiently clear all the working parts of the Microscope. The screw-holes are the points of attachment for the camera device and must occupy such a position in order that the camera may swing from the same centre as the Microscope body, and thus be adjustable by a single movement for any desired inclination. On a double-pillar Microscope the camera attachment could be adapted to swing from the centres on the Microscope itself, and the brackets could be therefore dispensed with. The camera was a simple box with a lens at one end and a plate-holder at the other—the lens of 10-in.

* Journ. Franklin Institute, cliii. (1902) pp. 371-6 (2 figs.).

focus and the distance from lens to plate 10 in. Monochromatic light is recommended. The camera has rack-and-pinion movement on a base-board having two rigidly attached arms extending forward and carrying pins to engage in the screw-holes of the brackets. Slots were cut into the screw-holes so that the pins dropped into place and an automatic lock prevented the pins from being lifted out except when the camera was swung below the horizontal plane. An adjustable telescopic strut

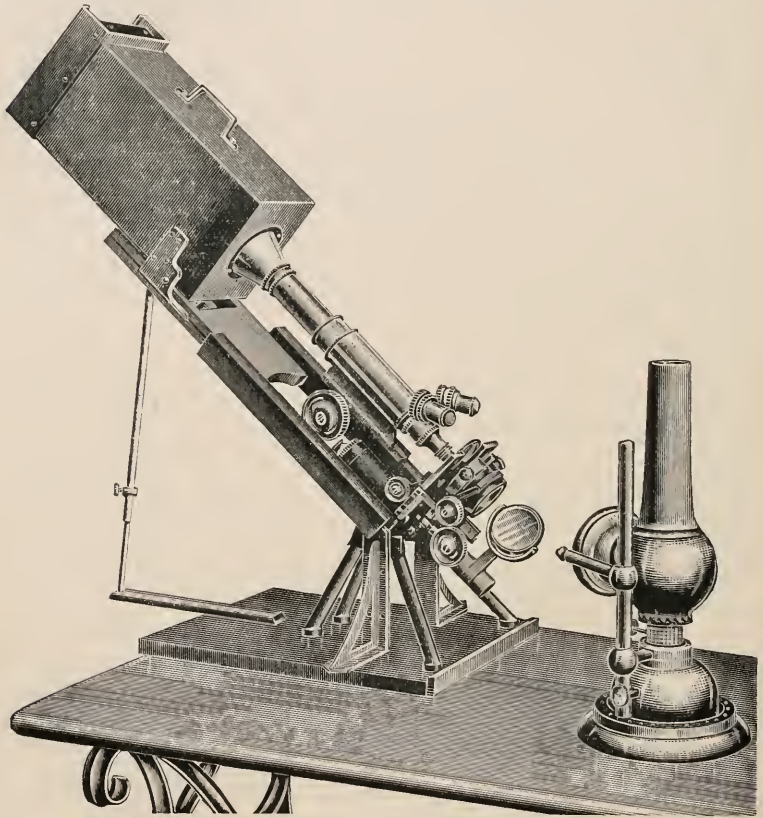

FIG. 102.

and detachable extension to the base-board supported the camera and fixed it at any desired inclination. Fig. 102 shows the device as fitted to a Swift folding Microscope, and the author seems to have been very well pleased with his results.

Photomicrography with Simple Apparatus.*—Katherine E. Golden obtains good results with the following "home-made" apparatus (fig. 103). An inch board about 40 in. long and 12 in. wide carries near the lower

* Journ. App. Micr., v. (1902) pp. 1681-3 (3 figs.).

end a shelf for supporting the Microscope. Near the upper end is a sliding-piece to which is attached the box or bellows of an ordinary camera. Under the shelf another piece of board is fastened to the first at right angles: this assists in supporting the shelf and also serves as a leg to help keep the apparatus in an upright position. The lens of the camera is removed and a washer of felt is glued to the edge of the collar, so as to make a light-tight connection with the eye-piece of the Microscope. A slit is made in the side of the collar, and through this slit is fitted an elliptic-shaped piece of metal having a round opening in one side, the other side being left entire, and also having a piece of the metal projecting on one side of the ellipse to be used as a handle. The elliptic piece is the shutter for admitting or cutting off the light, and is manipulated by the projecting handle. Specimens of the results obtained are given.

Photomicrographs on Gelatino-bromide Films.* — W. Forgan, in a lecture before the Edinburgh Photographic Society, narrates how he cleared up the doubt as to the suitability of collodion or gelatino-bromide plates for photographing eclipses. Microscopical examination showed that the grains of silver in the two plates were of practically equal size, viz. about $\frac{1}{19000}$ th of an inch in diameter. The method of preparation, however, of a collodion plate has the

effect of covering only the surface with a film of silver; whereas, in the other plate, the silver is thoroughly dispersed throughout the whole medium. This fact seems to account for the superior rapidity of the gelatino-bromide. But the more rapid the action of the plate, the coarser was the granulation. In the ordinary plates the silver grains are in a more scattered form, and the granulation, therefore, finer. Hence, the maker's advice to use ordinary plates wherever possible, is based on sound principles. For astronomical photography, especially for negatives where delicate measurements afterwards require to be made, a slow ordinary plate is an essential requisite.

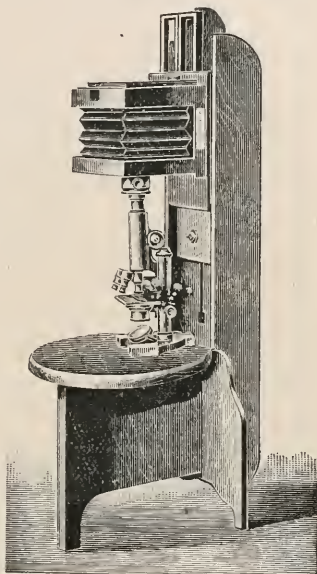

FIG. 103.

(5) Microscopical Optics and Manipulation.

Prisms and Plates for showing Dichromatism.† — R. W. Wood describes how to observe the property of dichromatism, i.e. the change of colour of an absorbing medium with increase of thickness. Thus thin

* Eng. Mech., lxxv. (April 18, 1902) p. 203.

† Nature, lxi. (1902) p. 31.

layers of such a medium might be bright green and thick layers blood-red. The principle is that the medium should transmit two distinct regions of the spectrum, the absorption coefficient for one being greater than for the other. Mr. Wood's method is to boil a quantity of Canada balsam in an evaporating dish until a drop placed on a cold surface becomes quite hard. A dye is made of commercial "brilliant green" but must not be added until the balsam has cooled almost to the point of becoming thick, otherwise it will be decomposed and produce a very muddy green. Enough brilliant green must be dissolved in the balsam to make it appear deep red in layers 1.5 cm. thick. This layer will be found to be blue. It is desirable to add some naphthol yellow in quantity sufficient to change the tint of thin layers from blue to green. A hollow prism is now made by fastening two pieces of thin plate glass between two grooved strips of wood. The base of the prism should be about 2 cm. thick if the strips are 4 cm. long. The plates are warmed with a flame and the coloured balsam poured between them. After the balsam has cooled it is a good plan to run a quantity of melted sealing-wax upon the top of it, which strengthens the prism. An incandescent lamp or gas flame viewed through the prism is seen divided into a green and a red image, the former gradually fading away as the eye is moved towards the base of the prism. If a larger amount of the colouring matter be added to the balsam and the fluid be pressed out between pieces of plate glass, screens can be made which transmit a very good secondary yellow. Through these screens a sodium flame is absolutely invisible, though a gas flame appears of a colour very closely resembling the soda flame. The colour of the transmitted light depends also on the original composition of the light. By a suitable adjustment of the dyes a screen can be made which appears red by lamplight and green by daylight, illustrating very well the peculiarity of the alexandrite crystals.

Stopping Down the Lens of the Human Eye.* — W. Andrews suggests that the optical properties of the human eye may be improved by using a metal plate with a perforation one-fiftieth of an inch in diameter. This acts like a stop in a compound lens and renders unnecessary the use of spectacles.

Gerald Molloy points out that a pair of spectacles on the above principle was made and used by the late Lord Sherbrooke, who was an albino, and had no pigment in his iris. These spectacles consisted of two convex metal cups closely resembling in size and shape the bowl of an ordinary tea-spoon. In the centre of each was a small pin-hole which was the only aperture through which light could enter.

MERLIN, A.—On the Critical Employment of the Microscope for Ordinary Working Purposes.

[A very useful paper, full of practical and valuable hints.]

Journ. Quek. Micr. Club, VIII. (1902) pp. 195-209.

(6) Miscellaneous.

Holder for Metallurgical Work.—This apparatus (Fig. 104), made by W. Watson & Sons, consists of two rotating jaws attached to the end

* *Nature*, lxvi. (1902) pp. 31 and 56.

of screws which work through arms mounted on a base, so as to raise them above the surface of the stage.

It will be seen that the metal substance which is to be examined can be set at any desired angle to the objective and also rotated, thus obviating the necessity of mounting specimens on glass slips, and rendering unnecessary the use of a levelling surface to the stage.

The apparatus shown in the illustration is intended to be used with a Microscope having a large central aperture, but another design is in use for square stages, the outer edges of which are gripped by a frame carrying the screws and jaws.

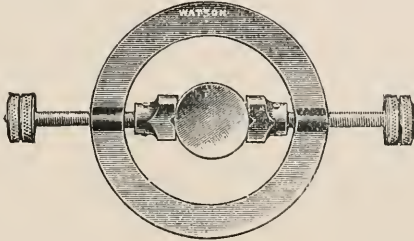

FIG. 104.

Certain Minute Structure observed in some forms of *Triceratium*.*—A. A. Merlin notes that a variety of *Triceratium parallelum* from the Oamaru deposit, resembling the ordinary form in size, shape, and general appearance, but not identical in detail, has been found to possess a delicate lacework structure apparently covering the whole of the siliceous surface of the valve, and extending to and closely surrounding the primaries. Subsequently a similar but even finer network was observed on the outer surface of a typical *T. parallelum*. This is an excessively faint and difficult object and is close to the limit of visibility with a fine Zeiss 3 mm. apochromat of N.A. 1.426, illuminated by the full cone of Powell's dry adjustable apochromatic condenser. The existence of an identical network has also been noticed on a *T. glandiferum* (Grun), which could only be resolved and held for brief intervals, after long rests to the eyes in the dark, by the employment of the above objective and a solid axial cone of about N.A. 1.3 from Watson's oil-immersion condenser. All the specimens were mounted in styrax, and the author believes the appearances really existent and not ghostly diffraction effects.

Opto-Technics.†—In a paper read before the Society of Arts, Prof. Silvanus Thompson eloquently pleads for the better organisation of optical instruction in all its branches in London. He deprecates the establishment of *poly*-technics, believing that *mono*-technics would be of greater industrial service. Institutions devoted to the culture of special subjects should be developed. Dr. Thompson considers that the Bolt Court Institute, which is exclusively devoted to the technology of the printing trades, is the most successful centre of technical education in

* Journ. Quek. Micr. Club, viii. (1902) p. 267.

† Journ. Soc. Arts, I. (1902) pp. 518-30.

London. In a similar manner an Optotechnical Institute, either at the Northampton Polytechnic in Clerkenwell or elsewhere, should be organised. He sketches a scheme of studies, and dwells upon the importance of the project.

B. Technique.*

(1) Collecting Objects, including Culture Processes.

Media for distinguishing *B. coli*, *B. typhosus*, and related Species.†—A. S. Grünbaum and E. H. Hume have found that for ordinary working purposes MacConkey's medium with neutral red gives the best results, but for demonstration purposes a medium containing both neutral red and crystal violet gives very striking and instructive pictures. The medium recommended has the following composition:—agar 2 gm.; peptone 2 gm.; water 100 ccm.; made alkaline to the extent of 0.4 ccm. normal NaOH beyond the neutral (litmus) point. To this, when filtered and sterilised, are added, sod. taurocholate 0.5 gm.; lactose 1 gm.; $\frac{1}{2}$ p.c. neutral red solution 1 ccm. The whole is sterilised for 15 minutes. In this medium *B. coli* and other lactose fermenters grow as red colonies; all other similar forms (*B. typhosus*, *B. paracolon*) are white, and impart to the surrounding medium an amber or orange tint. The authors also find that on lactose-agar to which both neutral red and crystal violet (1–100,000) have been added *B. coli* is red and *B. typhosus* blue to purple.

Method for the Detection of the Typhoid Bacillus in the Blood.‡ —A. Castellani advocates the use of large quantities of nutrient broth for isolating the typhoid bacillus from blood, on the ground that not only the blood, but also the agglutinins it contained, would be greatly diluted, and at the same time the bactericidal properties of the blood-serum would be weakened. The technique merely consists in obtaining aseptically a few cubic centimetres of blood and at once transferring to large flasks (five or six) each containing at least 300 ccm. of faintly alkaline beef-broth. The flasks are then incubated at blood heat. In practice this method has been found to be very successful, not only by the author, but by several other investigators.

Polythermostats.§ —G. Gabritchewsky advocates the adoption of combining in one apparatus several thermostatic chambers heated to different temperatures by one and the same source of heat. The idea is ingenious, and has been successfully carried out in Moscow, Berlin, and Paris.

Hanging-drop Cultivation.||—G. C. Karop describes the following convenient method for making hanging-drop cultures. The materials required are millboard, slides, 1 in. square covers, a soup-plate and bell-glass to fit it, white blotting-paper, and a strip or two of perforated zinc.

* This subdivision contains (1) Collecting Objects, including Culture Processes; (2) Preparing Objects; (3) Cutting, including Imbedding and Microtomes; (4) Staining and Injecting; (5) Mounting, including slides, preservative fluids, &c.; (6) Miscellaneous. † Brit. Med. Journ., 1902, i. pp. 1473-4 (1 fig.).

‡ Centralbl. Bakt., 1^o Abt., xxxi. (1902) pp. 477-9. § Tom. cit., pp. 814-6.

|| Journ. Quek. Micr. Club, viii. (1902) pp. 265-7.

Cut the millboard into pieces 1 in. square, and punch out the centres with a $\frac{3}{4}$ or $\frac{5}{8}$ gun-wad punch. Take a strip of perforated zinc 6 in. by $2\frac{1}{2}$ in., and bend down 1 in. of the ends to a right angle to make rests for the slides while in the moist chamber. When required for studying, say, the spores of a coprophilous fungus, place one or more of the punched-out squares of millboard between two pieces of glass, with a weight on top, and soak in water for some hours. According to the size of the drop required take one or more of the squares, and after squeezing out the excess of water place in the centre of a slide. Then take a cover and ring a very thin smear of soft paraffin or vaselin just a shade smaller than the aperture in the millboard. In a clean capsule put a little of the nutrient medium and mix therein the spores; from this remove with a glass rod or dropper sufficient to form a drop and place in the centre of the ring, and then invert over the perforation in the millboard. Next place three or four layers of blotting-paper on the bottom of the soup-plate with sufficient water to saturate them, on these the zinc support, on the latter the slide with the hanging-drop, and over all the bell-jar. The foregoing procedure affords a satisfactory and easy method for studying the growth and development of the lower organisms, more particularly algæ and fungi.

Simple Apparatus for Cultivating Anaerobes in Test-tubes.* — W. Omelianski has devised a simple and handy apparatus for anaerobic tube-cultures. It consists of two parts (fig. 105), a cylindrical vessel A and a cap B. The upper end of A is choke-bored, and its base expanded to ensure stability. The height of the whole apparatus is 20 cm.; the diameter of A in the middle is 1.8 cm., and at the base 8 cm. The cap B is ground so as to fit accurately over the narrowed

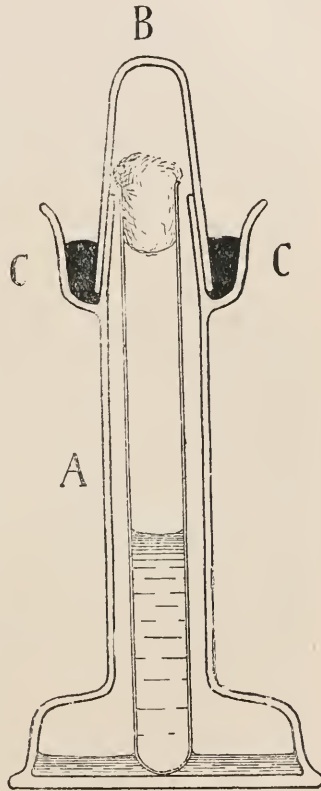

FIG. 105.

upper end of A. The upturned collar with everted rim C C, which forms a sort of cup or receptacle for mercury, has a diameter of 5.5 cm. When required for use, the ground surface of the cap is smeared with a mixture of 1 part wax and 2 parts vaselin, and then a mixture of 10 cm. of 12.5 p.c. caustic potash and 10 cm. of 5 p.c. pyrogallol solution is poured into the bottle. The test-tube (diameter 16 mm., length 16 cm.) containing the culture is then inserted, and the cap put firmly on. The cup C is then filled with mercury in quantity sufficient to

* Centralbl. Bakt., 2^o Abt., viii. (1902) pp. 711-3 (1 fig.).

cover the lower end of B. The oxygen is completely absorbed in from $1\frac{1}{2}$ to 2 hours. When the cultivation is finished and it is required to take out the tube, the mercury must be poured off before the cap is removed.

Method for examining Nutrient Media.*—S. Weissbein examined ten different substances with nutrient properties (plasmon, galactogen, Heyden's medium, and others) by the aid of Pappenheim's panoptic tri-acid solution. Some of the powdered medium was mixed with distilled water, to which ten drops of the staining solution were added. This mixture was then centrifuged for about two minutes and then the stained sediment was examined under the Microscope. To estimate the amount of starch, about two drops of tincture of iodine were added to the sediment, and this again centrifuged. Owing to the selective action of the components and constituents of the media, different stainings of the powdered substances were obtained. As the different colourings indicate different chemical constitution, the method adopted gives much information as to the nature of a nutrient substance and its value as an artificial medium.

(2) Preparing Objects.

Simple Method of Fixing Bacteria to the Slide or Cover-Slip without Drying.†—G. von Wendt takes a loopful of a bacterial culture and mixes it with a drop of water in a watch-glass. If desired, the bacteria may be fixed by using 1–3 p.c. nitric acid or $\frac{1}{2}$ –3 p.c. sublimate, &c. instead of pure water. A very thin layer of Meyer's albumen-glycerin is smeared on slides or slips, and the films moistened with a few drops of water. A loopful of the bacterial suspension is then deposited in the water lying on the films. The slide or slip is then covered with a sufficiently large watch-glass. In 20–30 minutes the bacteria will have settled down, and then the covering watch-glass is removed to allow a few drops of water to be deposited on the film. The watch-glass is then replaced, and the whole is placed in an incubator at 75° for 8–10 minutes. In this way the albumen is coagulated and the bacteria fixed to the slide or slip. The watch-glass must fit tight over the slide to prevent evaporation, and must not be removed until the preparation is cooled down sufficiently, after which the films may be stained, passed through graded alcohols, and mounted in balsam.

(3) Cutting, including Imbedding and Microtomes.

Simple Method for Making Bone Sections.‡—J. F. Burkholder cuts transverse slices of bone 2–3 mm. thick with a fine saw. One surface is polished on a dry whetstone and then gummed on to a smooth piece of wood 1 by 1 by 2 cm. in size. When thoroughly dry most of the slice may be sawn off, and the rest rubbed down on the wetted whetstone until it is so thin that the grain of the wood can be clearly seen through it. By the aid of a little hot water the bone is easily separated from the wood block. Then place the section on the wetted whetstone and

* Deutsch. Med. Wochenschr., xxviii. (1902) pp. 24–6.

† Centralbl. Bakt. Orig., 1^o Abt., xxxi. (1902) pp. 671–2.

‡ Journ. App. Micr., v. (1902) p. 1781.

rub to and fro with the ball of the finger until the papillæ are distinctly visible. Then after drying and cleaning by rubbing between the fingers, mount in balsam. Put some very thick balsam on the centre of the slide, and also on the cover-slip, then place the section on the slide and press the slip firmly down.

Improved Method of Sectioning Carbonised Wood.*—L. Wittmack and J. Buchwald saturated the material with Canada balsam or with paraffin, and then made sections of the prepared mass. Some of the sections were incinerated on platinum foil and the ash transferred to xylol or balsam. Their best results were obtained by first incinerating the wood and then working up the ash into microscopical sections. A piece of carbonised wood of suitable size was incinerated, and the residue amalgamated with hot liquid paraffin. The blocks thus obtained were sectioned. The sections, after having been straightened on the slide, were treated with xylol and mounted in balsam.

(4) Staining and Injecting.

Influence of High Temperatures on the Stainability of Bacteria.†
—G. Gabritschewsky records some interesting observations on the behaviour of bacterial films to staining solutions at different high temperatures. The first series relates to acid-fast bacteria. After staining for 5 minutes with carbol fuchsin, these bacteria, *B. tuberculosis hominis*, *avium*, *piscium*, *B. mölleri* (grass), *B. korn* (butter), *B. marpmann* (urine), were decolorised by 5 p.c. sulphuric acid if the preparations had been previously heated to 180° C. They still retained the Gram staining, but lost it at 190°, though up to 200° they would stain by simple solutions. In the second series were *B. anthracis*, *B. subtilis*, and *B. pseudo-anthraxis*. Up to 160° *B. anthracis* with spores stained well with carbol-fuchsin. By Gram's method both bacilli and spores stained up to 180°, but at 190° the spores only retained the dye. In the third series cultures of diphtheria and pseudo-diphtheria showed the Ernst-Neisser granules up to 170°. By Gram's method diphtheria bacilli did not stain at 180°, while the pseudo-diphtheria retained it up to 190°.

New Method of Staining Neuroglia.‡—D. Anglade and C. Morel state that the following method gives sharper details, and is more easily managed, than the ordinary procedures. The material is hardened in a mixture composed of Fol's fluid 3 parts, and sublimate solution 7 p.c. 1 part. The preparations are placed in an autoclave at 37° for 45 hours. On removal they are washed, and then dehydrated in alcohol. After saturating in acetone (24 hours) the material is imbedded in paraffin (3 hours). The sections are stained in warm saturated aqueous solution of Grüber's Victoria-blue and heated until it vaporises. They are next treated with Gram's solution, and afterwards with a mixture of xylol 1 part, anilin oil 2 parts, after which they are imbedded in balsam, or better still, in amber-lac.

* Ber. Deutsch. Bot. Ges., xx. (1902) p. 21. See Zeitschr. wiss. Mikr., xviii. (1902) p. 508.

† Centralbl. Bakt., 1^{te} Abt., xxxi. (1902) pp. 813-4.

‡ Rev. Neurol., ix. (1901) pp. 157-8.

Staining the Grey Matter of Spinal Cord after Mordanting with Metallic Salts.*—Kadyi states that after hardening in formalin and mordanting with the acetates of uranium, lead or copper, staining with carmin is very successful. Four variants of the method are given. In the first the grey matter only is stained, the white remaining unstained. After removal from the formalin the pieces are washed and then transferred to a mixture of uranium acetate 1 p.c. and acetic acid 1 p.c., wherein they remain for a few hours to a few days according to their size. The sections are stained in 0.2–0.5 p.c. solution of carminate of soda or in ammoniacal carmin. The second procedure imparts staining to the neuroglia. The sections after having been mordanted in uranium acetate are transferred to a solution of potassium nitrate. By the third method a deep staining of the white matter is obtained, the grey remaining almost colourless. In this case the sections are treated with potassium nitrate before they are mordanted. The fourth imparts a stain to the axis-cylinders only. For this the pieces of spinal cord are hardened in neutral or alkaline formalin solution (distilled water 100; bicarbonate of soda 2; formalin 5). The 1 p.c. copper acetate mordant must not contain any free acetic acid. After the sections have been mordanted they are washed in 2 p.c. potassium nitrate, and after having been stained are differentiated in a solution composed of distilled water 100 parts; carminate of soda 1 part; potassium nitrate 2 parts. When sufficiently decolorised, the sections are washed in 2 p.c. potassium nitrate until the pigment is no longer given off, after which they are treated with absolute alcohol and chloroform and then mounted in balsam.

Staining the Medullary Sheath of Nerve-Fibres.†—W. H. Wynn fixes and hardens the material in 5 p.c. formalin, and sections it on a freezing microtome, using no gum. The sections are mordanted for 24 hours in the cold in 2 p.c. ammonium molybdate, iron-alum or uranium acetate or they may be incubated at 40° C. for a few hours. After washing, they are stained for some hours in acid hæmatoxylin, or for two hours in the incubator. They are again washed and afterwards differentiated by Pal's method: the sections are first placed in potassium permanganate solution and next in Pal's solution, the baths being alternated until the required differentiation is obtained. They are again washed, after which they are mopped up and then transferred to absolute alcohol. After draining off the alcohol they are passed through chloroform and xylol successively and mounted in balsam.

Instead of Pal's solution, Bolton's method may be used for differentiating. This consists in immersing the sections in a moderately dilute solution of ammonia by which the unattached lake is quickly dissolved out, leaving differentiation complete.

Staining the Neuro-fibrils in the Ganglion-cells of the Cerebral Cortex.‡—S. Paton immerses the material for 24 hours in a saturated solution of sublimate containing 5 p.c. acetic acid. It is then transferred to 95 p.c. alcohol which should be changed at least once a day

* Neurol. Centralbl., xx. (1901) pp. 687–8.

† Journ. Anat. Physiol., xiv. (1900) pp. 381–97 (2 pls.).

‡ Journ. Exp. Med., v. (1900–1901) pp. 21–5 (1 pl.).

during the first week and afterwards once a week. It is better to remove the sublimate in this way than to use iodine. The material is then imbedded in paraffin or in celloidin. If paraffin be selected, chloroform must be used as a solvent. When fixed to the slide the sections are treated with tinctura ferri Rademacheri for 1 or 2 hours. The preparations are then washed and stained in Apáthy's hematin solution for 24 hours. For differentiation a mixture of anilin oil 1 part and 70 p.c. alcohol 9 parts is used. After having been washed the sections are dehydrated and mounted in chloroform-balsam.

Methods of rendering Golgi-Sublimate Preparations permanent by Platinum Substitution.*—W. F. Robertson and J. H. Macdonald each worked out a separate process for replacing the mercurial deposit in Cox-preparations by platinum.

Robertson's method.—(1) Place the sections in a saturated solution of lithium carbonate for 15 minutes. (2) Wash in water. (3) Place in equal parts of 1 p.c. chloroplatinate of potassium and 10 p.c. citric acid for 1–2 days: keep in the dark. (4) Wash for 1 or 2 hours. (5) Place in equal parts of (a) saturated solution of iodine in 1 p.c. potassium iodide, and (b) water, for 5 minutes. (6) Wash. (7) Place for 5 minutes in a bowl of water to which 2 or 3 drops of strong ammonia have been added. (8) Wash. (9) Dehydrate in absolute alcohol. (10) Clear in benzol. (11) Mount in benzol-balsam.

Macdonald's method.—Wash the tissue which has previously been treated by Cox's method in a large quantity of water, overnight. Transfer to rectified spirit for half an hour. Cut on a Cathcart's microtome by Coat's method. Transfer the sections to rectified spirit, and when a sufficient number have been obtained proceed as follows:—(1) Transfer to distilled water for a few minutes. (2) Place for 24 hours in (? mixture of) solution i. η 120; solution ii. η 30. Solution i. is 1 p.c. chloroplatinate of potassium. Solution ii. consists of sodium hypophosphite $1\frac{1}{2}$ oz.; sodium sulphite $\frac{3}{4}$ oz.; sodium chloride $\frac{1}{4}$ oz.; water 10 oz.. (3) Transfer to one in eighty hydrochloric acid for 2 minutes and repeat the bath twice. (4) Transfer to solution ii. for 10 minutes. (5) Then to equal parts of (a) 1 p.c. iodine in rectified spirit; (b) distilled water, until the sections are of the same colour as the solution. (6) Clear, and fix in solution ii. for 10 minutes. (7) Wash for 2 hours. (8) Dehydrate and then clear in benzol and mount in benzol-balsam.

The sections must be manipulated with a brush or quill as metal lifters and needles are inadmissible. For washing the sections and making the solutions distilled water must always be used.

Acid-fuchsin Staining for Degenerated Nerve-Fibres.†—R. Kolster who has made careful investigation as to the value of acid-fuchsin for staining degenerated nerve-fibres, a method invented by Hovén of Copenhagen in 1884, remarks that to obtain good results the material must be exposed to the influence of chromic acid solutions for a long time, e.g. five months in Müller's fluid. The after-hardening in alcohol should not take more than about two weeks. After this the material is imbedded in celloidin and the sections stained with saturated aqueous

* Journ. Mental Sci., xlvii. (1901) pp. 327–30.

† Deutsche Zeitschr. f. Nervenheilk., xx. (1901) pp. 29–34 (1 pl.).

solution of acid-fuchsin (Weigert's) for 1-24 hours. After washing in water they are differentiated in alcoholic solution of caustic potash. The decoloration is continued until the grey substance becomes clearly visible, after which the sections are washed in water, dehydrated, cleared in xylol, and mounted in balsam. The axis-cylinders of the degenerated fibres are clearly traceable by their dark red colour, while the healthy fibres are almost unstained.

The author's results differ somewhat from those obtained by Hovén, possibly owing to slight differences in the composition of the pigments employed.

New Method of Flagella Staining.*—A. J. Kendall describes the following procedure for staining flagella. The bacteria are properly diluted on the cover-glass by adding to a tube containing 5 ccm. of sterile water enough of an 18-24 hours agar culture to produce a faint turbidity in the upper half of the water. The tube is then placed in an incubator run at the optimum temperature for the particular species for one hour. Two or three drops are then placed on a cover-glass and allowed to dry spontaneously at the temperature of incubator. The film is fixed in the flame and stained by Pitfield's method. Pitfield's mordant consists of 10 p.c. aqueous solution of tannic acid 10 ccm., saturated aqueous solution of corrosive sublimate 5 ccm., saturated aqueous solution of alum 5 ccm., carbol fuchsin 5 ccm. The stain is composed of saturated aqueous solution of alum 10 ccm., saturated aqueous solution of gentian-violet 2 ccm. The film is hot-mordanted for about a minute, after which it is washed, then hot-stained, dried, and mounted.

Staining Mast-Cells and the Chromatin of Malaria Parasites.†—L. B. Goldhorn gives three methods for staining mast-cells. (1) Saturate wood-alcohol with dahlia or methylen-blue and pour the solution on a freshly made blood-smear without previous fixation. (2) Methylen-blue is rendered polychrome and then acidulated with glacial acetic acid. The polychrome solution is made by dissolving 4 grm. of the pigment and 4 grm. of lithium carbonate in 300 ccm. of warm water and heating for 15 minutes in a water-bath. The solution is poured into a bottle and after a lapse of several days is rendered faintly alkaline by adding some 4-5 p.c. acetic acid. Next add 5 p.c. eosin solution, and then filter. Dry the mass on filter in a hot-air oven, and then dissolve in wood-alcohol. (3) Saturate wood-alcohol with methylen-blue, and stain the film for about 15 seconds. Wash in water, and stain in 0.1 p.c. aqueous eosin for from 15 to 30 seconds.

The author also gives a method for staining the malaria parasite. Dry the films and fix in methyl-alcohol for 15 seconds, wash. Stain in 0.1-0.2 p.c. aqueous solution of eosin for 7-30 seconds, wash. Stain in polychrome methylen-blue solution for 30 seconds to 2 minutes, wash thoroughly. Dry in air.

(6) Miscellaneous.

Improved Method of Making Collodion Sacs.‡—N. M. Harris describes a method of making collodion sacs which is an improvement on

* Journ. App. Micr., v. (1902) p. 1836. † Tom. cit., pp. 1635 and 1867.

‡ Bull. Johns Hopkins Hosp., xiii. (1902) pp. 112-5 (3 figs.).

those of Trudeau and McCrae. The materials employed are empty gelatin capsules, glass tubing, celloidin or collodion solution, a drying rack, blow-pipe flame, and a small file.

The end of the glass tubing is heated in the burner and while still hot is passed through the lid of the capsule. When cool the capsule is plunged in the celloidin solution and afterwards placed on the rack to dry. The coated capsule is then filled with broth by means of a Pasteur pipette and then immersed, glass tube end downwards, in a broth culture tube and autoclaved at 1 atmosphere for 5 minutes at 120°. By this procedure the gelatin becomes dissolved in the broth. The gelatin may, however, be removed by washing out the sac with hot water.

After inoculating the medium in the sac by the aid of a Pasteur pipette the glass tube is sealed up, a procedure requiring considerable care and skill.

Method for Cleaning Slides.*—L. Jones recommends a washing powder known as "Gold Dust" for cleaning old and dirty slides. A strong solution is heated to boiling and then removed from the fire. As many slides as the vessel will hold are at once dumped in and left there for half an hour or so, but should be moved about occasionally. On removing the slides they should be washed in water and then dried or passed through alcohol and then wiped. Usually one bath is quite sufficient.

Bottle for Cedar-Wood Oil.—F. Tiesen, of Breslau, makes a bottle for cedar-wood oil, which has some useful features. An ordinary glass phial (fig. 106) is fixed to a circular leaden base: this ensures stability. The stopper is a sphere of hard rubber or vulcanite. This ball is perforated to allow the passage of a long stem, the upper end of which serves as a handle and the lower end as the dropper. As the stem is not fixed in the ball it can be pushed up and down so as to regulate the length for the quantity of oil in the bottle.

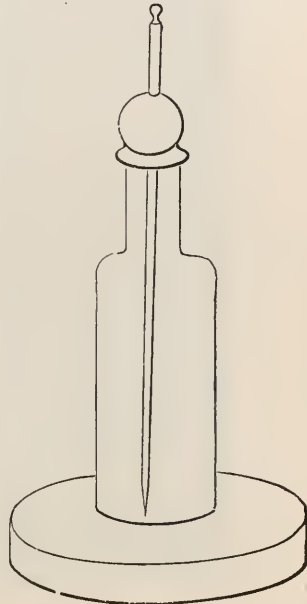

FIG. 106.

Germ- and Water-tight Stopper for Flasks.†—Dr. H. Schottmüller describes a stopper which is air- and water-tight and also prevents the entrance of germs. The stopper proper is fixed to the inside of a cap which goes over the neck of the bottle. The outer surface of the stopper and the inner surface of the neck are ground to fit accurately. The neck of the bottle has a double lip to prevent the layer of cotton-wool which is wound round the neck from getting wetted when fluid is poured out.

* Journ. App. Micr., v. (1902) p. 1781.

† Centralbl. Bakt., 1^o Abt., xxx. (1901) pp. 875-7 (3 figs.).

The layer of cotton-wool prevents the entry of germs from without. The apparatus is sterilised in the usual way (figs. 107-109).



FIG. 107. .



FIG. 108.



FIG. 109.

Micro-Crystalline Structure of Platinum.*—T. Andrews obtained a satisfactorily developed crystalline structure of a polished platinum ingot after boiling it for 45 seconds in aqua regia composed of 4 parts of hydrochloric acid (sp. gr. 1·2) to 1 part of nitric acid (sp. gr. 1·42). The general micro-crystalline structure was observed to be allotriomorphic in character, and derived from a system of interfering cubes and octahedra, the cubic and hexagonal forms being frequently noticeable. The size of the large crystal grains varied from 0·002 in. to 0·04 in. in size, and the smaller crystals ranged from about 0·0002 in. to about 0·007 in. There were indications that the smaller crystals

* Proc. Roy. Soc., lxi. (1902) pp. 433-5 (1 pl. of 6 photos).

were each built up of even more minute crystalline ramifications. The crystalline structure of platinum appears to generally resemble that of gold and silver.

HOUGHTON, S. A.—The Microscopic Structure of Metals.

[Two interesting lectures before the Institute of Marine Engineers.]

Shipping Gazette and Lloyd's List, March 6 and 13, 1902.

” ” **The Internal Structure of Iron and Steel, with special reference to defective material.**

[A lecture before the Institute of Marine Engineers, April 21, 1902. The author gives a very complete *résumé* of our present knowledge on this subject, but avoids the discussion of controversial points. More than thirty of the photographs are original, and deal with cases of failure in metalwork.]

Shipping Gazette and Lloyd's List, April 24, 1902;

also as a pamphlet issued by the Institute of Marine Engineers.

STEAD, J. E.—Metallic Alloys.

[A lecture before the Cleveland Institution of Engineers, Dec. 10, 1900. A full investigation of the subject.]

Metallographist, v. (1902) pp. 110-44 (19 figs.).

Nomenclature of Metallography.

[A preliminary glossary of technical terms, with their French and German equivalents, has been drawn up for the consideration of the International Committee of Metallurgists, which has been appointed to consider this question.]

Metallographist, v. (1902) pp. 145-65.

PROCEEDINGS OF THE SOCIETY.

MEETING

HELD ON THE 18TH OF JUNE, 1902, AT 20 HANOVER SQUARE, W.
DR. HENRY WOODWARD, F.R.S., PRESIDENT, IN THE CHAIR.

The Minutes of the Meeting of the 21st of May, 1902, were read and confirmed, and were signed by the President.

The List of Donations to the Society (exclusive of exchanges and reprints) received since the last Meeting was read, and the thanks of the Society were voted to the donors.

	From
Catalogue of Scientific Papers, 1800-1883. Vol. xii. (4to, London, 1902)	} <i>The Royal Society.</i>
Duncan, Martin F., First Steps in Photomicrography. (8vo, London, 1902)	} <i>The Publishers.</i>
Petit et Borne, Manuel pratique de Bactériologie. (8vo, Paris, 1902)	} <i>The Publisher.</i>
Records of the Egyptian Government School of Medicine. (4to, Cairo, 1901)	} <i>The Director of the School of Medicine.</i>
Zoological Record. Vols. xxii, xxiii, and xxiv. (8vo, London, 1895, 6, and 7	} <i>Mr. P. E. Radley.</i>

The Secretary read a note from Mr. Nelson on some high-power photomicrographs taken by Mr. F. E. Ives, three examples of which were shown upon the screen by Mr. Poser.

Mr. Hilger exhibited a new photo-measuring micrometer attached to a Microscope with an objective giving a magnifying power of $\times 55$ and designed specially for accurately measuring the distances between the lines of the spectrum.

Mr. Watson Baker described a new two-speed fine adjustment sent for exhibition by Messrs. Watson and Sons. The adjustment was shown fitted to a Microscope, and its construction was further illustrated by a working sectional model and detail drawings.

The same firm exhibited also a Microscope fitted with a new arrangement for holding pieces of metal whilst under examination, by means of which the specimen could be gripped firmly and held in any required position or plane.

The thanks of the Meeting were voted to Mr. Hilger and Mr. Baker for their exhibits.

Mr. Max Poser exhibited for Messrs. Zeiss their Epidiascope, an elaborate form of projection apparatus, by means of which large pictures of opaque and transparent objects can be shown on the screen.

Not only lantern slides of any size up to 9 in. square, but solid objects such as photographs, drawings, description on a page of a book,

bones, butterflies, &c., can be thrown on the screen in their natural colours by simply placing them on the table inside the apparatus. A simplified Microscope is also attached to the epidiascope so that the microscopic preparations (ordinary micro-slides, &c.) can be projected.

The details of construction were explained by sectional drawings shown on the screen, and a variety of objects, such as bones, medals, butterflies, &c. were projected in illustration of the instrument's capabilities. The illuminant is a remarkably steady and silent electric search-light of 3000 candle-power, and microscopic slides were shown under high magnifying powers giving pictures of about 5 ft. diameter with great brilliancy and sharpness of definition. At the close of the Meeting a further demonstration was given, when a large number of miscellaneous objects, including some live tadpoles, entomostraca, &c. were projected on the screen with excellent effect.

The thanks of the Society were cordially voted to Messrs. Zeiss for their exhibit.

Prof. Marcus Hartog gave a short account of the structure of Acinetines from observations on a species (*Choanophrya infundibulifera*) epizoid on *Cyclops*: he demonstrated (1) that the spiral marking of the tentacles was due to a double-threaded constriction; (2) that in protrusion and retraction there was no torsion, but only an opening and closing of the spiral; and (3) that the tentacles were continued deep into the endosarc of the creature. He illustrated his remarks by drawings on the board, and by the exhibition of living specimens and sections under Microscopes, and thought the observations afforded an explanation of the process of absorption carried out in the Suctorial Infusoria. He mentioned that this species, though apparently seen only by Zenker in 1866 and himself, was very common, as it was to be found adherent to adults of species of *Cyclops*, but must be looked for upon the ventral surface among and on the circum-oral appendages.

The President expressed the thanks of the Society to Prof. Hartog for his kindness in bringing these objects to the Meeting, and for the very interesting remarks made concerning them.

Mr. C. F. Rousselet read a paper "On the genus *Synchaeta*, with a description of five new species," the subject being well illustrated by drawings shown on the screen by means of Zeiss's Epidiascope, and by numerous preserved and mounted specimens under Microscopes kindly lent for the occasion by Mr. Pillischer.

The President and Secretary being obliged to leave early, their places were occupied respectively by Dr. Braithwaite and Mr. Karop.

Dr. Braithwaite felt sure that all who had heard this paper would heartily join in thanking Mr. Rousselet for it. It could not fail to be regarded as a valuable contribution to their knowledge of this genus, and it showed also what could be done by a person who, like Mr. Rousselet, persistently followed up the same subject instead of deviating into a variety of orders and adding but little to our knowledge of them.

The thanks of the Society were, on the motion of the Chairman, unanimously voted to Mr. Rousselet for his paper.

Mr. W. Wesché gave a brief *résumé* of his paper on "Undescribed palpi on the mouth-parts of Diptera." Drawings in illustration of the subject were shown upon the screen by the kindness of Mr. Poser. Specimens, showing the palpi on several species, and in a more rudimentary state in other species, were exhibited under Microscopes in the room.

The Chairman regretted that owing to the lateness of the hour Mr. Wesché had been unable to read his paper *in extenso*, but the thanks of the Society were due to him for bringing this new observation before them, and his communication would no doubt be read with much interest when it appeared in the *Journal*.

Mr. Karop thought, that in addition to thanking the authors of the several communications which had been brought before the Meeting, the Fellows would desire to express their thanks to Mr. Poser for his most effective manipulation of the instrument by which the illustrative figures were thrown on the screen, and also to Mr. Pillischer for the loan of the Microscopes under which Mr. Rousselet's rotifers were being exhibited.

The thanks of the Society were voted to these gentlemen by acclamation.

Mr. Karop announced that the Rooms of the Society would be closed on August 16th and reopened on September 15th, and that the next Meeting of the Society would take place on Wednesday, October 15th.

The following Instruments, Objects, &c., were exhibited:—

Prof. Marcus Hartog:—*Choanophrya* (g.n.) *infundibulifera* on *Cyclops brevicornis* ($\frac{1}{8}$ in. objective), showing funnel-bearing tentacles. *Choanophrya infundibulifera* ($\frac{1}{3}$ in. objective) on *Cyclops*, oblique section *in situ*.

Mr. A. Hilger:—New Photo-measuring Micrometer.

Mr. F. E. Ives:—Lantern slides of *Pleurosigma anguatum*, *Surirella gemma*, and *Coscinodiscus asteromphalus*.

Mr. C. F. Rousselet:—*Synchæta tremula*, *S. triophthalma*, and *S. vorax* (alive), and mounted specimens of *S. pectinata*, *S. tremula*, *S. oblonga*, *S. grandis*, *S. stylata*, *S. longipes*, *S. kitina*, *S. tavina*, *S. littoralis*, *S. baltica*, *S. gyrina*, *S. triophthalma*, *S. monopus*, *S. cecilia*, *S. vorax*, *S. neapolitana*, also jaws of *S. pectinata* and eggs of *S. stylata*.

Messrs. Wm. Watson and Sons:—New Two-speed Fine-adjustment. Holder for Metallurgical Specimens.

Mr. Walter Wesché:—Maxillary Palpi on proboscis of *Hyetodesia basalis* ♀; Maxillary and Labial Palpi on the proboscis of *Hydrotæa occulta* ♂; Fly, from which the proboscis, shown mounted, has been cut (*Hyetodesia perdita* ♀).

Messrs. Zeiss:—The Epidiascope.

New Fellow.—The following was elected an *Ordinary* Fellow: Mr. James Alexander Martin.



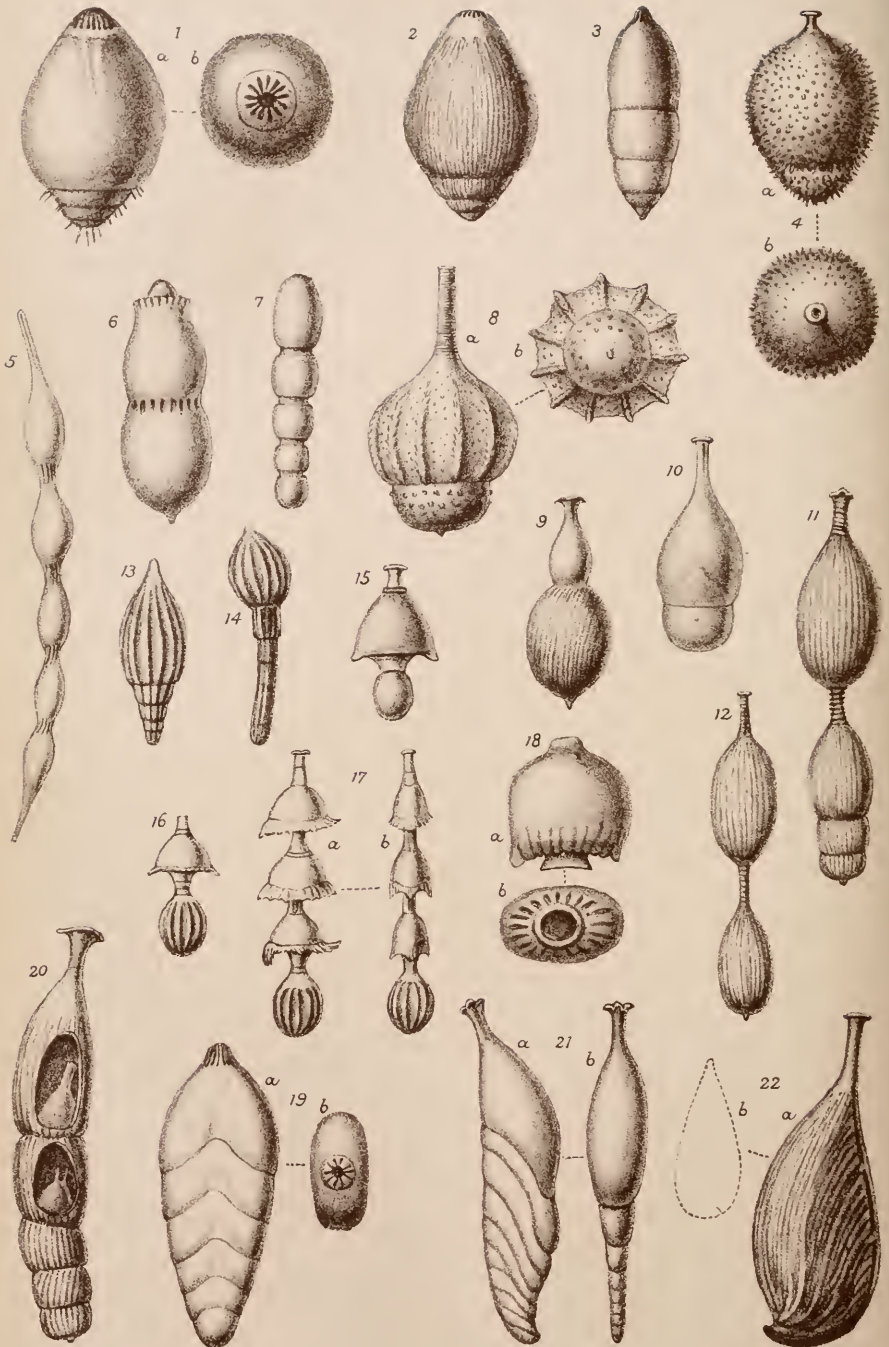

F.W. Millett del. ad. nat.

Hanhart lith & imp.

JOURNAL
OF THE
ROYAL MICROSCOPICAL SOCIETY.

OCTOBER 1902.

TRANSACTIONS OF THE SOCIETY.

IX.—*Report on the Recent Foraminifera of the Malay Archipelago
collected by Mr. A. Durrand, F.R.M.S.—Part XIII.*

By FORTESCUE WILLIAM MILLETT, F.R.M.S.

(Read March 19th, 1902.)

PLATE XI.

Sub-Family **Nodosarinæ.**

Nodosaria Lamarek.

Nodosaria (Glandulina) lævigata d'Orbigny, plate XI. fig. 1.

“Cornu Hammonis erectum globosius,” Plancus, 1739, Conch. Min., p. 16, pl. ii. fig. 3. *Nodosaria (Glandulina) lævigata* d'Orbigny, 1826, Ann. Sci. Nat., vol. vii. p. 252, pl. x. figs. 1–3. *Glan-*

EXPLANATION OF PLATE XI.

- Fig. 1.—*Nodosaria (Gl.) lævigata* d'Orbigny. × 90. *a*, lateral aspect; *b*, oral aspect.
 “ 2. “ “ *comata* Batsch sp. × 90.
 “ 3. “ “ *æqualis* Reuss. × 90.
 “ 4. “ “ *echinata* sp. n. × 65. *a*, lateral aspect; *b*, oral aspect.
 “ 5.—*Nodosaria semirugosa* d'Orbigny. × 60.
 “ 6. “ *capitata* Boll. × 65.
 “ 7. “ *limbata* d'Orbigny. × 90.
 “ 8. “ *bicamerata* F. W. O. R. Jones sp. × 90. *a*, lateral aspect
 b, aboral aspect.
 “ 9. “ *proxima* O. Silvestri. × 90.
 “ 10. “ *scalaris* Batsch sp. var. × 75.
 “ 11, 12. “ “ var. *separans* Brady. × 60.
 “ 13, 14. “ (?) *obscura* Reuss. Fig. 13 × 65; fig. 14 × 90.
 “ 15.—*Lingulina limbata* sp. n. × 100.
 “ 16, 17. “ *pagoda* sp. n. × 75. *a*, lateral aspect; *b*, peripheral aspect.
 “ 18. “ sp. indet. × 100. *a*, lateral aspect; *b*, aboral aspect.
 “ 19.—*Frondicularia nitida* Terquem. × 80.
 “ 20.—*Marginulina costata* Batsch sp. × 60.
 “ 21.—*Vaginulina legumen* Linné sp. var. × 75. *a*, lateral aspect; *b*, peripheral
 aspect.
 “ 22. “ *formosa* sp. n. × 90. *a*, lateral aspect; *b*, horizontal section.

October 15th, 1902

2 M

dulina lævigata var. *inflata* (Born.) Andreae, 1884, Abhandl. geol. Special Karte Elsass-Loth., vol. ii. p. 206, pl. vii. fig. 12; and var. *elliptica* (Reuss), p. 206, pl. x. fig. 22. *G. lævigata* (d'Orb.) Gumbel, 1885, Geol. Bayern, p. 422, fig. 266, 4. *Nodosaria (Glandulina) abbreviata* (Neug.) Sherborn and Chapman, 1886, Journ. R. Micr. Soc., p. 746, pl. xiv. fig. 20. *G. lævigata* Haeusler, 1887, Neues Jahrb. für Min., p. 189, pl. v. fig. 29. *Nodosaria (Gland.) lævigata* (d'Orb.) Burrows, Sherborn, and Bailey, 1890, Journ. R. Micr. Soc., p. 556, pl. ix. figs. 14, 15. *G. lævigata* (d'Orb.) Haeusler, 1890, Abhandl. schweiz. Pal. Gesell., vol. xvii. p. 91, pl. xiii. figs. 61-63; and pl. xiv. fig. 2. *G. lævigata* (d'Orb.) Crick and Sherborn, 1891, Journ. Northamp. Nat. Hist. Soc., vol. vi. p. 209, pl. vi. fig. 4. *G. lævigata* (d'Orb.) Beissel (Holzapfel), 1891, Abhandl. k. Preuss. geol. Landesanst., N.F., Heft 3, p. 29, pl. vi. figs. 7-9. *G. lævigata* (d'Orb.) Hosius, 1892, Verhandl. Nat. Ver. Preuss. Rheinlands Westphal., Jahrg. xlix. p. 152, pl. ii. figs. 1, 2. *G. lævigata* (d'Orb.) Egger, 1893, Abhandl. k. bayer. Akad. Wiss., Cl. II. vol. xviii. pp. 336 and 339, pl. xi. fig. 31. *Nodosaria lævigata* (d'Orb.) Der-vieux, 1893, Boll. Soc. Geol. Italia, vol. xii. p. 597, pl. v. figs. 1, 2. *Nodosaria lævigata* (d'Orb.) Goës, 1894, K. Svenska Vet.-Akad. Handl., vol. xxv. p. 71, pl. xiii. figs. 702, 703, 706, 707, 709. *G. cuspidata* Franzenau, 1894, Glasnik Hrv. Nar. Društva, p. 259, pl. v. fig. 5. *G. lævigata* (d'Orb.) Jones, 1895, Palæont. Soc., p. 207. *G. lævigata* var. *chilostoma* Rzehak, 1895, Ann. k. k. Naturh. Hof-museums, vol. x. part 2, p. 219, pl. vii. fig. 6. *Nodosaria lævigata* (d'Orb.) Silvestri, 1896, Mem. Pontif. Acad. Nuovi Lincei, vol. xii. p. 122, pl. iii. fig. 11 (anomalous). *Nodosaria lævigata* (d'Orb.) Flint, 1899, Rep. U.S. Nat. Mus. for 1897 (1899) p. 308, pl. lv. fig. 3. *G. lævigata* (d'Orb.) Egger, 1899, Abhandl. k. bayer. Akad. Wiss., Cl. II. vol. xxi. p. 81, pl. v. fig. 31. *G. lævigata* (d'Orb.) Silvestri, 1900, Mem. Pontif. Acad. Nuovi Lincei, vol. xvii. p. 248, pl. vi. figs. 41, 49. Idem, 1900, Atti e Rendic. Acad. Sci. Lett. e Arti dei Zelanti e P.P. dello Studio di Acireale, vol. x. p. (1) pl. figs. 1-5, 9, 16. *G. lævigata* (d'Orb.) var. *subornata* Fornasini, 1901, Mem. R. Acad. Sci. Ist. Bologna, ser. 5, vol. ix. p. 56, fig. 9.

This form is very abundant and exhibits the usual variations, the chambers sometimes being almost entirely exposed; at other times nearly concealed by the embracing latest chamber. The sutures are of various degrees of obliquity, and the aperture is frequently entosolenian.

It is found at most of the Stations in both Areas, and is very evenly distributed.

Nodosaria (Glandulina) rotundata Reuss.

Glandulina rotundata Reuss, 1849, Denkschr. K. Akad. Wiss. Wien, vol. i. p. 366, pl. xlvi. fig. 2. *Nodosaria (Gl.) obtusissima* (Reuss) Sherborn and Chapman, 1886, Journ. R. Micr. Soc., ser. 2,

vol. vi. p. 746, pl. xiv. fig. 21. *Nodosaria (Gl.) obtusissima* (Reuss) Burrows, Sherborn, and Bailey, 1890, Journ. R. Micr. Soc., p. 556, pl. ix. fig. 16. *G. rotundata* (Reuss) Fornasini, 1896, Rivista Ital. di Paleont., fig. 1. *Nodosaria rotundata* (Reuss) Flint, 1899, Rep. U.S. Nat. Mus. for 1897 (1899) p. 308, pl. liv. fig. 6. *G. laevigata* A (d'Orb.) (*rotundata*) Silvestri, 1899, 1900, Atti e Rendic. Accad. Sci. Lett. e Arti dei Zelanti e P.P. dello Studio di Acireale, vol. x. pl. figs. 7, 8, 10-15.

This variety with the rounded base is almost as abundant as the foregoing, and is just as evenly distributed. The aperture likewise is often entosolenian, but there is not quite so much variation in the form of the test.

In treating of the fauna of an extensive region it is hardly desirable to enter into the controversy with regard to the dual forms, and it must be left to other investigators to determine if *G. laevigata* and *G. rotundata* are respectively the microspheric and megalospheric states of the same species, but it may be pointed out that their almost equal abundance in the Malay Archipelago is rather against the theory.

Nodosaria (Glandulina) echinata sp. n., plate XI. fig. 4.

Test subovate; broadest near the centre and tapering towards each end, the base being either acute or rounded. Sutures indistinct. Aperture situated in a short neck with an everted lip. Surface of the shell beset with minute spines which are longest at the primordial end of the test. Length 0.38 mm.

This may be described as a spinous variety of both *N. laevigata* and *N. rotundata*. In the present state of uncertainty as to the nature of the relations between the *Nodosariae* differing in character only in having the base either acute or rounded, it is here considered inadvisable to follow the hitherto accepted rule of treating the two forms as representing different species, and giving them distinctive names, consequently the more simple course has been adopted of associating them under one heading.

Their intimate relationship is shown by their both possessing the phialine aperture, which is an unusual feature in *Glandulina*.

There are numerous examples of a variety of *N. laevigata*, in which the spines are confined to the base. This form has the aperture invariably mammillate with radiating striæ; and the base is always acute or apiculate.

The three spinous varieties here described are by no means uncommon in the Malay Archipelago, being found at several Stations in both Areas and are about equal in number.

Nodosaria (Glandulina) æqualis Reuss, plate XI. fig. 3.

Glandulina æqualis Reuss, 1863, Sitzungsber. k. Akad. Wiss. Wien, vol. xlviii. p. 48, pl. iii. fig. 28. *G. æqualis* (Reuss) Fornasini

sini, 1886, Boll. Soc. Geol. Italia, vol. v. p. 337, pl. vii. figs. 1-12. *Nodosaria candela* (Egger) Burrows, Sherborn, and Bailey, 1890, Journ. R. Micr. Soc., p. 556, pl. ix. fig. 18. *Nodosaria aequalis* (Reuss) Fornasini, 1894, Mem. R. Accad. Sci. Ist. Bologna, ser. 5, vol. iv. p. 202, pl. i. fig. 1. *Nodosaria aequalis* (Reuss) Goës, 1894, K. Svenska Vet.-Akad. Handl., vol. xxv. p. 72, pl. xiii. figs. 704, 705, 708, 710, 711. *G. aequalis* (Reuss) Egger, 1899, Abhandl. k. bayer. Akad. Wiss., Cl. II. vol. xxi. p. 84, pl. v. fig. 22. *G. aequalis* (Reuss) Silvestri, 1900, Mem. Pontif. Accad. Nuovi Lincei, vol. xvii. p. 249, pl. vi. figs. 58, 59.

This cylindrical variety is rounded at the base typically, and in that condition may be regarded as an elongate form of *N. rotundata*. In the Malay Archipelago the examples are invariably acutely pointed at the primordial end, thus indicating an affinity with *N. laevigata*. For the reasons given in treating of *N. echinata* the two forms are again associated.

It is very rare in the Malay Archipelago, and occurs only in Area 1.

Nodosaria (Glandulina) comata Batsch sp., plate XI. fig. 2.

Nautilus (Orthoceras) comatus Batsch, 1791, Conch. Seesands, p. 2, pl. i. fig. 2 a-d. *Nodosaria (Glandulina) glans* d'Orbigny, 1826, Ann. Sci. Nat., vol. vii. p. 252, No. 2; and Modèle No. 51. *N. (Gland.) glans* (d'Orb.) Jones and Parker, 1860, Quart. Journ. Geol. Soc., vol. xvi. p. 453, pl. xix. fig. 7. ? *Glandulina glans* (d'Orb.) Fornasini, 1883, Boll. Soc. Geol. Italia, vol. ii. pl. ii. fig. 6. *Nodosaria comata* (Batsch sp.) Fornasini, 1891, Foram. Plioc. del Ponticello di Savena, pl. ii. fig. 18. *Nodosaria cornuta* (sic) (Batsch sp.) Grzybowski, 1895, Rozprawy Wydz. mat.-Przyr. Akad. Umiej-Krakowie, vol. xxx. p. 293, pl. x. fig. 8. *Nodosaria comata* (Batsch sp.) Flint, 1899, Rep. U.S. Nat. Mus. for 1897 (1899) p. 311, pl. lvii. fig. 3. *Glandulina comata* (Batsch sp.) Fornasini, 1900, Mem. R. Accad. Sci. Ist. Bologna, ser. 5, vol. viii. p. 380, fig. 29.

This, in its more compact form, is nothing more nor less than a typical *Glandulina laevigata*, having its surface covered with delicate striæ, and has been well represented by d'Orbigny under the name of *Glandulina glans*. Amongst a multitude of specimens from the Malay Archipelago, passage forms are to be found in abundance leading gradually and insensibly from this Glanduline to the elongated Nodosarian form, which may be considered to represent *Nodosaria radícula* with a striated surface.

In his 'Challenger' Report,* Brady has so thoroughly dealt

* Brady, Chall. Rept., 1884, p. 509.

with the subject and so well explained the affinity of the apparently dissimilar forms figured by Batsch, that to attempt to add anything to his statement would be a mere waste of time.

As a recent form, it has been recorded from only a very few Stations, but these are wide apart, extending from the West Indies to Mauritius, at depths not exceeding 450 fathoms.

In the Malay Archipelago, it occurs in great abundance all over the region.

Nodosaria radricula Linné sp.

Cornu Hammonis erectum Plancus, 1739, Conch. Min., p. 14, pl. i. fig. 5, A, B, C. *Nautilus radricula* Linné, 1767, Syst. Nat., p. 1164. *Nodosaria radricula* (Linn.) Sherborn and Chapman, 1886, Journ. R. Micr. Soc., ser. 2, vol. vi. p. 746, pl. xiv. fig. 24. *N. radricula* (Linn.) Malagoli, 1887, Boll. Soc. Geol. Italia, vol. vi. p. 520, pl. xiii. fig. 4. *N. radricula* (L.) Idem, 1887, Atti Soc. Nat. Modena, ser. 3, vol. iii. p. 109, pl. i. fig. 8. *N. radricula* Mariani, 1889, Boll. Soc. Geol. Italia, vol. vii. p. 286, pl. x. fig. 7. *N. radricula* (Linn.) Haeusler, 1890, Abhandl. schweiz. pal. Gesell., vol. xvii. p. 92, pl. xiii. figs. 41-45, 47, 48, 50, 53. *N. radricula* (Linn.) Crick and Sherborn, 1891, Journ. Northamp. Nat. Hist. Soc., vol. vi. pl. i. fig. 5. *N. radricula* (Linn.) Terrigi, 1891, Mem. R. Com. Geol. Italia, vol. iv. p. 78, pl. ii. fig. 4. *N. radricula* (Linn.) Haeusler, 1893, Abhandl. schweiz. pal. Gesell., vol. xx. p. 23, pl. ii. figs. 36-46. *N. radricula* (Linn.) Grzybowski, 1897, Rozprawy Wydz. Przyr. Akad. Umiej-Krakowie, vol. xxxiii. p. 296, pl. xii. fig. 18. *N. radricula* (Linn.) Flint, 1899, Rep. U.S. Nat. Mus. for 1897 (1899) p. 309, pl. lv. fig. 1. *N. radricula* (Linn.) Egger, 1899, Abhandl. k. bayer. Akad. Wiss., Cl. II., vol. xxi. p. 67, pl. v. fig. 40.

This is a widely distributed form, but Brady states that it has not been found in the North Pacific.

Nodosaria calomorpha Reuss.

Nodosaria calomorpha Reuss, 1865, Denkschr. k. Akad. Wiss. Wien, vol. xxv. p. 129, pl. i. figs. 15-19. *N. bistegia* Dunikowski, 1879, Kosmos (Lemberg) vol. iv. p. 106, pl., fig. 4. *N. calomorpha* (Reuss) Brady, Parker, and Jones, 1888, Trans. Zool. Soc., vol. xii. p. 223, pl. xlv. figs. 1, 4. *N. calomorpha* (Reuss) Haeusler, 1890, Abhandl. schweizer Pal. Gesell., vol. xvii. p. 95, pl. xiii. figs. 35-37. *N. calomorpha* (Reuss) Burrows, Sherborn, and Bailey, 1890, Journ. R. Micr. Soc., p. 566, pl. ix. fig. 21. *N. calomorpha* (Reuss) Terrigi, 1891, Mem. R. Com. Geol. Italia, vol. iv. p. 78, pl. ii. fig. 5. *N. calomorpha* (Reuss) Chaster, 1892, First Rept. of the Southport Soc. of Nat. Sci., 1890-1891 (1892) p. 63, pl. i. fig. 12. *N. calomorpha* (Reuss) Haeusler, 1893, Abhandl. schweizer Pal. Gesell.,

vol. xx. p. 27, pl. i. fig. 73; pl. iii. fig. 47. *N. calomorpha* (Reuss) Egger, 1893, Abhandl. k. bayer. Akad. Wiss., Cl. II. vol. xviii. p. 340, pl. xi. figs. 21, 26. *N. calomorpha* (Reuss) Goës, 1894, K. Svenska Vet.-Akad. Handl., vol. xxv. p. 72, pl. xiii. figs. 712, 713. *N. calomorpha* (Reuss) Grzybowski, 1895, Rozprawy Wydz. mat.-Przyr. Akad. Umiej-Krakowie, vol. xxx. p. 293, pl. x. fig. 31. *N. calomorpha* (Reuss) Morton, 1897, Proc. Portland Soc. Nat. Hist., vol. ii. p. 118, pl. i. fig. 6.

This delicate little *Nodosaria*, with its thin transparent chambers resembling a string of bubbles, is common in the Malay Archipelago, and widely distributed in both Areas. Usually the test consists of two or three segments only, and these, from the formation of the last added chamber, appear to be complete in themselves, but there are examples which possess four and even five segments. Some of the two-chambered specimens differ from *N. simplex* Silvestri only in wanting the mucro at the base of the initial chamber. Goës suggests that *N. calomorpha* may be the megaspheric form of *N. radicularis* or *N. pauperata*.

The area of distribution of the species is very wide; whilst bathymetrically its range according to Brady is from 6 fathoms to 2200 fathoms, and it is recorded by Dr. Egger from depths of 17 to 677 metres.

Nodosaria pyrula d'Orbigny.

Nodosaria pyrula d'Orbigny, 1826, Ann. Sci. Nat., vol. vii. p. 253, No. 13. *Lagena laevis* (W. and J.) Clarke, 1849, Ann. and Mag. Nat. Hist., ser. 2, vol. iii. p. 382, fig. *Nodosaria pyrula* (d'Orb.) Williamson, 1858, Rec. Foram. Gt. Britain, p. 17, pl. ii. fig. 39. *N. pyrula* (d'Orb.) Balkwill and Wright, 1885, Trans. R. Irish Acad., vol. xxviii. (Sci.) p. 343, pl. xii. fig. 23. *N. pyrula* (d'Orb.) Brady, Parker, and Jones, 1888, Trans. Zool. Soc., vol. xii. p. 223, pl. xlv. fig. 2. *N. pyrula* (d'Orb.) Formasini, 1890, Mem. R. Accad. Sci. Ist. Bologna, ser. 4, vol. x. p. 468, pl. fig. 11. *N. pyrula* (d'Orb.) Terrigi, 1891, Mem. R. Com. Geol. Italia, vol. iv. part 1, p. 89, pl. ii. fig. 29. *N. pyrula* (d'Orb.) Haeusler, 1893, Abhandl. schweizer Pal. Gesell., vol. xx. p. 28, pl. v. figs. 25, 26. *N. pyrula* (d'Orb.) Egger, 1893, Abhandl. k. bayer. Akad. Wiss. Cl. II. vol. xviii. p. 345, pl. xi. figs. 14, 15. *N. pyrula* (d'Orb.) Dervieux, 1893, Boll. Soc. Geol. Italia, vol. xii. fasc. 4, p. 603, pl. v. fig. 15. *N. pyrula* (d'Orb.) Silvestri, 1896, Mem. Pontif. Accad. Nuovi Lincei, vol. xii. p. 134, pl. iii. fig. 21. *N. pyrula* (d'Orb.) Flint, 1899, Rep. U.S. Nat. Mus. for 1897 (1899) p. 309, pl. lv. fig. 4.

This fragile variety is represented by both the straight and the curved form *D. guttifera* d'Orbigny. At no Station is it abundant, but it occurs in both Areas.

Nodosaria hispida d'Orbigny.

"Orthoceratia quasi hispida" Soldani, 1798, Testaceographia, vol. ii. p. 15, pl. ii. fig. p. *Nodosaria hispida* d'Orbigny, 1846, For. Foss. Vienne, p. 35, pl. i. figs. 24, 25. *N. hispida* (d'Orb.) Balkwill and Wright, 1885, Trans. R. Irish Acad., vol. xxviii. (Sci.) p. 343, pl. xii. fig. 31. *N. hispida* (d'Orb.) Sherborn and Chapman, 1886, Journ. R. Micr. Soc., ser. 2, vol. vi. p. 748, pl. xiv. fig. 32. *N. hispida* (d'Orb.) Brady, Parker, and Jones, 1888, Trans. Zool. Soc., vol. xii. p. 223, pl. xlv. figs. 3, 5. *N. hispida* (d'Orb.) Mariani, 1889, Boll. Soc. Geol. Italia, vol. vii. p. 286, pl. x. fig. 6. *N. hispida* (d'Orb.) Terrigi, 1891, Mem. R. Com. Geol. Italia, vol. iv. p. 81, pl. ii. fig. 13. *N. hispida* (d'Orb.) Egger, 1893, Abhandl. k. bayer. Akad. Wiss., Cl. II. vol. xviii. p. 343, pl. xi. fig. 16. *N. hispida* (d'Orb.) Chapman, 1893, Journ. R. Micr. Soc., p. 591, pl. ix. fig. 5. *N. hispida* (d'Orb.) Silvestri, 1893, Atti e Rendic. Accad. Sci. Lett. e Arti dei Zelanti e P.P. dello Studio di Acireale, vol. v. p. 13, pl. ii. figs. 8-11. *N. hispida* (d'Orb.) Fornasini, 1894, Mem. R. Accad. Sci. Ist. Bologna, ser. 5, vol. iv. p. 208, pl. i. figs. 16-18. *N. hispida* (d'Orb.) Rhumbler, 1895, Zool. Anzeiger, No. 474, fig. 6. *N. hispida* (d'Orb.) Perner, 1897, Česká Akad. Císarè Františka Josefa (Palæont. Bohemiæ No. 4) p. 24, pl. iii. fig. 31. *N. hispida* (d'Orb.) Fornasini, 1897-98, Rendic. R. Accad. Sci. Ist. Bologna, n.s. vol. ii. p. 4, pl. i. fig. 1. *N. hispida* (d'Orb.) Egger, 1899, Abhandl. k. bayer. Akad. Wiss., Cl. II. vol. xxi. p. 79, pl. ix. figs. 23, 24. *N. hispida* (d'Orb.) Flint, 1899, Rep. U.S. Nat. Mus. for 1897 (1899) p. 311, pl. lvii. fig. 1. *N. hispida* (d'Orb.) Fornasini, 1901, Mem. R. Accad. Sci. Ist. Bologna, ser. 5, vol. ix. p. 53, fig. 6.

N. hispida in its typical form may be regarded as a variety of *N. pyrula* with its surface beset with spines. There is great diversity in the form as well as in the disposition of the chambers; usually these are connected by a long stoloniferous tube, but frequently this is wanting, and the test, composed of sessile chambers, differs only from *N. radícula* or *N. scalaris* in having the surface hispid. Sometimes both forms appear in one test, the later chambers only having the stoloniferous tubes.

It is found at several Stations in both Areas, but is by no means common, and the examples are small.

Nodosaria semirugosa d'Orbigny, plate XI. fig. 5.

Nodosaria semirugosa d'Orbigny, 1846, For. Foss. Vienne, p. 34, pl. i. figs. 20-23. *Nodosaria* No. 35, Von Schlicht, 1870, Foram. Septarienthones von Pietzpuhl, p. 24, pl. vii. fig. 20. *N. stipitata* var. *costulata* Reuss, 1870, Sitzungsber. k. Akad. Wiss. Wien, vol. lxii. Abth. i. p. 471. *N. costulata* (Reuss) Brady, 1884, Chall. Rept., p. 515, pl. lxiii. figs. 23-27. *N. (cf.) semirugosa* (d'Orb.)

Hosius, 1892, Verhandl. Nat. Ver. Preuss. Rheinl. Westphal., Jahrg. xlix. p. 156, pl. ii. fig. 5. *N. costellata* (Reuss) Perner, 1897, Česká Akad. Čišeř Františka Josefa (Palæont. Bohemiæ No. 4) p. 29, pl. iii. fig. 18. *N. costulata* (Reuss) Flint, 1899, Rep. U.S. Nat. Mus. for 1897 (1899) p. 312, pl. lviii. fig. 1.

This variety of the *N. pyrula* group differs from the last described only in having the base of the chambers marked by short costæ. The remarks on the diversity of shapes in the hispid variety apply equally to the partially costate form, and in the Malay Archipelago the distribution is similar.

It is difficult to understand why Reuss should have failed to identify Von Schlicht's figure with d'Orbigny's *N. semirugosa*, and why Brady, on the faith of Reuss, should have accepted it as a new variety. D'Orbigny states that *N. semirugosa* differs from *N. pyrula* only in the partially costate condition of the base of the chambers; whilst Brady gives as the differences between the two forms that "the walls are thick and the basal aspect of each chamber is decorated externally with raised costæ."

Elsewhere it is by no means so common nor so widely distributed as *N. hispida*. The 'Challenger' Stations are three in the North Atlantic and one near the Philippine Islands, at depths ranging from 95 to 450 fathoms. Flint records two 'Albatross' Stations, both in the Gulf of Mexico, 210 and 227 fathoms respectively.

Nodosaria (Dentalina) soluta Reuss.

Dentalina soluta Reuss, 1851, Zeitschr. deutsch. geol. Gesell., vol. iii. p. 63, pl. iii. fig. 4. *Nodosaria soluta* (Reuss) Andreae, 1884, Abhandl. geol. Special Karte Elsass-Loth., vol. ii. p. 201, pl. x. fig. 8. *N. soluta* (Reuss) Sherborn and Chapman, 1886, Journ. R. Micr. Soc., ser. 2, vol. vi. p. 746, pl. xiv. figs. 25, 26. *N. (D.) soluta* (Reuss) Burrows, Sherborn, and Bailey, 1890, Journ. R. Micr. Soc., p. 557, pl. ix. fig. 26. *Dentalina soluta* (Reuss) Wisniewski, 1890, Pamiętnik Wydz. iii. Ak. Umiej-Krakowie, vol. xvii. p. 20, pl. viii. figs. 37, 38. *N. soluta* (Reuss) Fornasini, 1890, Mem. R. Accad. Sci. Ist. Bologna, ser. 4, vol. x. p. 469, pl. fig. 8. *N. soluta* (Reuss) Fornasini, 1891, Foraminiferi Pliocenici del Ponticello di Savena, pl. ii. figs. 14, 15. *N. soluta* (Reuss) Terrigi, 1891, Mem. R. Com. Geol. Italia, vol. iv. p. 80, pl. ii. fig. 10. *N. (D.) soluta* (Reuss) Chapman, 1893, Journ. R. Micr. Soc., p. 587, pl. viii. fig. 26. *N. soluta* (Reuss) Goes, 1894, K. Svenska Vet.-Akad. Handl., vol. xxv. p. 70, pl. xii. fig. 690. *N. soluta* (Reuss) Egger, 1895, Naturh. Ver. Passau, Jahresber., xvi. p. 21, pl. ii. figs. 6, 15, 16. *N. soluta* (Reuss) Perner, 1897, Česká Akad. Čišeř Františka Josefa (Palæont. Bohemiæ No. 4) p. 26, pl. iii. fig. 10. *N. soluta* (Reuss) Egger, 1899, Abhandl.

k. bayer. Akad. Wiss., Cl. II. vol. xxi. p. 59, pl. vi. fig. 23, and pl. vii. fig. iii. *N. soluta* (Reuss) Flint, 1899, Rep. U.S. Nat. Mus. for 1897 (1899) p. 310, pl. lvi. fig. 3. *N. soluta* (Reuss) Chapman, 1900. Proc. California Acad. of Sci., ser. 3, Geol., vol. i. p. 248, pl. xxix. fig. 14. *N. soluta* (Reuss) Silvestri, 1900, Mem. Pontif. Accad. Nuovi Lincei, vol. xvii. p. 252, pl. vi. figs. 67, 68.

The difference between the slender *N. pyrula* and the more compact *N. soluta* is only one of degree, and that chiefly in the length and thickness of the stoloniferous tubes. In the original figures by Reuss these are almost as long and as slender as in *N. pyrula*, and one of the examples figured has the later chambers only connected by the tube, which, as before mentioned, is a common feature in *N. hispida*.

In the Malay Archipelago *N. soluta* is of great rarity and has been observed only in Area 1.

Nodosaria capitata Boll, plate XI. fig. 6.

Nodosaria capitata Boll, 1846, Geogn. deutsch. Ostseeländer, p. 177, pl. ii. fig. 13. *Dentalina antennula* d'Orbigny, 1846, For. Foss. Vienne, p. 53, pl. ii. figs. 29, 30; and *D. semicostata*, p. 53, pl. ii. figs. 26, 28. *D. Buchi* Reuss, 1851, Zeitschr. deutsch. geol. Gesell., vol. iii. p. 60, pl. iii. fig. 6; and *D. Philippi*, p. 60, pl. iii. fig. 5. *D. capitata* (Boll) Reuss, 1855, Sitzungsber. k. Akad. Wiss. Wien, vol. xviii. p. 223, pl. i. fig. 4; and 1864 (1865) vol. i. p. 454, pl. i. figs. 8-10. *Nodosaria tholigera* Schwager, 1866, Novara-Exped., Geol. Theil, vol. ii. p. 218, pl. v. fig. 41. *Dentalina* Nos. 149 and 150 Von Schlicht, 1870, Foram. Sep-tarienthones von Pietzpuhl, p. 27, pl. viii. figs. 9, 11. *D. capitata* (Boll) Hantken, 1875 (1876), A magy. kir. földt. int. evkönyve, vol. iv. p. 29, pl. iii. fig. 16. *Nodosaria aciculata* (d'Orb.) Fornasini, 1891, Foraminiferi Pliocenici del Ponticello di Savena, pl. ii. fig. 17. *N. soluta* (Reuss) Silvestri, 1893, Atti e Rendic. Accad. Sci. Lett. e Arti dei Zelanti e P.P. dello Studio di Acireale, vol. v. p. 13, pl. iii. figs. 16, 17. *N. plicosuturata* Dervilleux, 1894, Boll. Soc. Geol. Italia, vol. xii. fasc. 4, p. 613, pl. v. fig. 43.

N. capitata, as interpreted by Reuss and other authors, seems to be nothing more nor less than *N. soluta* with the sutures or base of the chambers costate or plicate. *N. capitata*, when so named, is always figured as a test with few chambers, the initial one being larger than those which immediately succeed it; but there is another form composed of numerous chambers and tapering almost to a point at the base. This is well represented by one of Soldani's figures, to which d'Orbigny has given the name of *Dentalina aciculata*.* This form also has the con-

* Ann. Sci. Nat., vol. vii. 1826, p. 255, No. 41.

stricted portions between the chambers costate, and may be considered to represent the microspheric condition of the species. To this latter form may be assigned the *Orthocerata vitrea*, &c. Soldani;* *Nodosaria intermittens* Roemer;† *Dentalina semicostata* d'Orbigny;‡ *Nodosaria aciculata* (d'Orb.) Fornasini;§ and *Nodosaria* (indet.) Franzénau.¶

There is no previous record of this form in the living condition, and the only example from the Malay Archipelago is the fragment figured: this is from Station 25 in Area 2.

Nodosaria limbata d'Orbigny, plate XI. fig. 7.

Nautilus (Orthoceras) radicle Batsch, 1791, Conch. Seesands, pl. iii. fig. 10. *Nodosaria limbata* d'Orbigny, 1840, Mém. Soc. Géol. France, sér. 1. vol. iv. p. 12, pl. i. fig. 1. *N. antipodum* Stache, 1864, Novara-Exped., Geol. Theil, vol. i. p. 194, pl. xxii. fig. 19; and *Dentalina pomuligera*, p. 204, pl. xxii. fig. 31. *Dentalina tecta* (Terquem) Tate and Blake, 1876, Yorkshire Lias, p. 459, pl. xviii. fig. 25. *N. limbata* (d'Orb.) Burrows, Sherborn, and Bailey, 1890, Journ. R. Micr. Soc., p. 557, pl. ix. fig. 23. *N. limbata* (d'Orb.) Egger, 1899, Abhandl. k. bayer. Akad. Wiss., Cl. II. vol. xxi. p. 62, pl. xxiv. fig. 41.

In this form the stoloniferous tubes of *N. pyrula* are reduced to a mere collar or band, but the propriety of placing them in the same group can hardly be questioned.

Although d'Orbigny restricts the number of chambers to three or four, there are frequently five in the straight specimens, and a still larger number in the curved examples.

The form is represented by but one example from the Malay Archipelago, and this is from Station 5 in Area 1. This, with Batsch's specimens from an unknown locality, are the only records of the species in the living condition.

Nodosaria bicamerata F. W. O. R. Jones sp., plate XI. fig. 8.

Lagena vulgaris (Will.) var. *bicamerata* F. W. O. R. Jones, 1872, Trans. Linn. Soc., vol. xxx. p. 65, plate xix. figs. 60-62.

Under this name Rymer Jones lumps together several forms which appear to have nothing in common beyond being composed of two chambers. He describes the primordial chamber as "being more or less globular and sometimes compressed," and in some

* Sagg. Critt., 1780, p. 107, pl. v. fig. 41 r.

† Neues Jahrb., 1838, p. 382, pl. iii. fig. 2.

‡ For. Foss. Vienne, 1846, p. 53, pl. ii. figs. 36-38.

§ Foram. Plice. del Ponticello di Savona, 1891, pl. ii. fig. 17.

¶ Glasnik Hrvatsko Naravnoslov Društvo, vol. vi. 1894, p. 273, pl. vi. fig. 48.

instances these compressed chambers are provided with a marginal keel.

In the Malay Archipelago examples the exposed portion of the primordial chamber is hemispherical; it is studded with minute tubercles, and bears a small mucro. The terminal chamber is disk-shaped and ornamented with from nine to eleven longitudinal costæ. The neck of this chamber bears a delicate spiral coil, whilst the surface of the body, including the costæ, is minutely aculeated and perforated. In Rymer Jones's fig. 62, which most nearly resembles the Malay examples, the number of costæ is stated to be fourteen.

Probably some of the specimens described by Rymer Jones are really double-celled *Lagenæ*, as the individual chambers have the characters of known species of that genus with which they are associated in the same locality: but in the Malay Archipelago there have been found no *Lagenæ* having cells identical with those of the form here described, hence it may be treated as a true *Nodosaria*.

In the Malay Archipelago it is very rare, and has been observed only at Station 13 in Area 1.

Ry. Jones's specimens were obtained from a sounding ten miles south of Sandalwood Island in the Java Seas at a depth of 1080 fathoms.

Nodosaria proxima O. Silvestri, plate XI. fig. 9.

Nodosaria proxima O. Silvestri, 1872. Atti Accad. Gioenia Sci. Nat., n.s. vol. vii. p. 63, pl. vi. figs. 138-147. *N. proxima* (Silvestri) Terrigi, 1891, Mem. R. Com. Geol. Italia. vol. iv. p. 82. pl. ii. fig. 17. *N. mutabilis* (Terquem) Crick and Sherborn, 1891, Journ. Northamp. Nat. Hist. Soc., vol. vi. p. 214, pl. vi. figs. 7, 8. *N. proxima* (Silvestri) Fornasini, 1894, Mem. R. Accad. Sci. Ist. Bologna, ser. 5, vol. iv. p. 206, pl. i. figs. 33-35. *N. proxima* (Silvestri) Jones, 1896, Palæont. Soc., p. 219, pl. vii. fig. 15 and (1866) pl. iv. fig. 8. *N. scalaris* (Batsch) var. *proxima* (Silv.) A. Silvestri, 1896, Mem. Pontif. Acad. Nuovi Lincei, vol. xii. p. 159, pl. iv. figs. 12-15.

The specimens of this variety are all bilocular and the initial chamber is always larger than that which follows it, in this respect being exactly the reverse of the bilocular form of *N. scalaris*. The examples of *N. proxima* differ from one another in little more than the character of the ornamentation, the costæ of some being few and strong, as in *Lagena sulcata*, whilst in others they are very delicate as in *L. striata*.

It is not uncommon in the Malay Archipelago, being found at several Stations in both areas.

Nodosaria scalaris Batsch sp. var., plate XI. fig. 10.

Nautilus (Orthoceras) scalaris Batsch, 1791, Conch. Seesands, No. 4, pl. ii. fig. 4. *Nodosaria longicauda* d'Orbigny, 1826, Ann. Sci. Nat., vol. vii. p. 254, No. 28. *N. intersita* Franzenau, 1888, Földt. Közlöny, vol. xviii. p. 172, pl. ii. figs. 1, 2. *N. scalaris* (Batsch) Brady, Parker, and Jones, 1888, Trans. Zool. Soc., vol. xii. p. 223, pl. xlv. figs. 6, 19. *N. scalaris* (Batsch) Fornasini 1889, Minute forme Rizopod. Retic., pl. fig. 24. *N. scalaris* (Batsch) Terrigi, 1891, Mem. R. Com. Geol. Italia, vol. iv. p. 82, pl. 2, fig. 15; and *N. raphanus* (Linné) p. 82, pl. ii. fig. 16. *N. scalaris* (Batsch) Egger, 1893, Abhandl. k. bayer. Akad. Wiss., Cl. II. vol. xviii. p. 344, pl. xi. figs. 40, 41. *N. scalaris* (Batsch) A. Silvestri, 1893, Mem. Pontif. Accad. Nuovi Lincei, vol. ix. p. 203, pl. v. fig. 4. *N. scalaris* (Batsch) Goës, 1894, K. Svenska Vet.-Akad. Handl., vol. xxv. p. 73, pl. xiii. figs. 716-718. *N. scalaris* (Batsch) A. Silvestri, 1896, Mem. Pontif. Accad. Nuovi Lincei, vol. xii. p. 156, pl. iv. figs. 5-11; pl. v. fig. 1. *N. scalaris* (Batsch) Fornasini, 1902, Mem. R. Accad. Sci. Ist. Bologna, ser. 5^a, vol. x. p. 34, figs. 27, 28.

Bilocular examples of this species are common in the Malay Archipelago, and on some of these the costæ are very faint whilst on others they are entirely wanting; in this state the form is not to be distinguished from *N. simplex* Silvestri, and this latter may well be regarded as the smooth condition of *N. scalaris*.

As before mentioned, the embryonal chamber of these bilocular forms of *N. scalaris* is always the smaller, as opposed to the arrangement characteristic of *N. proxima*; but this distinction may after all be purely artificial, for taking these bilocular forms, they are assigned to one or other of the species according as one or other of the chambers is the larger, whilst both forms are to be found embodied in the multilocular *N. scalaris* in which the second chamber is usually larger than the embryonal, but is often smaller as in *N. proxima*.

It is one of the commonest of the *Nodosariæ* in the Malay Archipelago and is found at several Stations in both Areas.

Nodosaria scalaris Batsch sp. var. *separans* Brady,
plate XI. figs. 11, 12.

Nodosaria separans Batsch sp. var. *separans* Brady, 1884, Chall. Rept., p. 511, pl. lxiv. figs. 16-19. *N. scalaris* var. *separans* (Brady) A. Silvestri, 1893, Mem. Pontif. Accad. Nuovi Lincei, vol. ix. p. 203, pl. iv. fig. 4.

In *N. scalaris* as in *N. hispida* there is a tendency to have some of the chambers separated by a stoloniferous tube.

This variety appears to be very local. It was found only in one

'Challenger' sounding, off the west coast of New Zealand, 275 fathoms; and Brady says that good examples have been dredged on the coast of Kerry. It has been recorded by Joseph Wright at three stations off the south west of Ireland at depths of from 110 to 120 fathoms and is stated by him to be common at one of these Stations. Silvestri's examples were dredged off the east coast of Sicily, 22 to 700 metres.

In the Malay Archipelago it is represented by a few samples from Station 6 in Area 1 and from Station 25 in area 2.

Nodosaria obscura (?) Reuss, plate XI. figs. 13, 14.

Nodosaria obscura Reuss, 1845, Verstein. böhm. Kreide, part I, p. 26, pl. xiii. fig. 7. *N. obscura* (Reuss) Reuss, 1874, Palæontographica, vol. xx. part 2, p. 81, pl. xx. figs. 1-4. *N. obscura* (Reuss) Berthelin, 1880, Mém. Soc. Géol. France, sér. 3, vol. i. p. 31, pl. xxiv. fig. 17.

Here are two somewhat anomalous specimens which appear to be related to *N. scalaris*. Under the name of *N. obscura* Reuss has described and figured a variable form which in some examples shows no constriction at the sutures throughout the whole of the growth, whilst in other instances the septation of the earlier chambers is indistinct although in the succeeding ones the sutures are deeply sunk. An exaggerated example of this latter form is shown in one of the Malay specimens, fig. 14.

It is with some hesitation that these examples are ascribed to *N. obscura*, but whatever they may be they are interesting forms, and therefore worthy of being recorded.

The only Malay Archipelago Station is No. 22 in Area 2.

Nodosaria raphanus Linné sp.

"Cornu Hammonis erectum striatum" Plancus, 1739, Conch. Min., p. 15, pl. i. fig. 6. *Nautilus raphanus* Linné, 1767, Syst. Nat., 12th ed. p. 1164, No. 283. *Nodosaria raphanus* (Linné), Parker and Jones, 1859, Ann. and Mag. Nat. Hist., ser. 3, vol. iii. p. 477. *N. raphanus* (Linné) Balkwill and Wright, 1885, Trans. R. Irish Acad., vol. xxviii. (Sci.) p. 342, pl. xii. fig. 26. *N. raphanus* (Linné) Sherborn and Chapman, 1886, Journ. R. Micr. Soc., ser. 2, vol. vi. p. 749, pl. xiv. figs. 36, 37. *N. raphanus* (Linné) Fornasini, 1890, Mem. R. Accad. Sci. Ist. Bologna, ser. 4, vol. x. p. 470, pl. figs. 24, 25. *N. scalaris* (Batsch) Haeusler, 1890, Abhandl. schweiz. pal. Gesell., vol. xvii. p. 101, pl. xiii. fig. 91; and *N. multicostrata* (d'Orb.) p. 102, pl. xiii. fig. 92. *N. raphanus* (Linné) Crick and Sherborne, 1891, Journ. Northamp.

Nat. Hist. Soc., vol. vi. p. 205, pl. i. fig. 11. *N. raphanus* (Linné) Silvestri, 1893, Atti e Rendic. Accad. Sci. Lett. e Arti dei Zelanti e P.P. dello Studio di Acireale, vol. v. p. 13, pl. ii. figs. 4-7. *N. raphanus* (Linné) Fornasini, 1894, Mem. R. Accad. Sci. Ist. Bologna, ser. 5, vol. iv. p. 204, pl. i. figs. 41-45. *N. raphanus* (Linné) Jones, 1896, Palæont. Soc., p. 213, pl. vi. figs. 9, 10. *N. raphanus* (Linné) Burrows and Holland, 1897, Proc. Geol. Assoc., vol. xv. p. 35, pl. ii. fig. 8. *N. raphanus* (Linné) Perner, 1897, Česká Akad. Císare Františka Josefa (Palæont. Bohemiæ No. 4) p. 27, pl. ii. fig. 19.

The Malay examples of this form show little variation. It is common at Station 13 in Area 1, and occurs at a few other Stations in both Areas.

Nodosaria (D.) communis d'Orbigny.

Nodosaria (Dentalina) communis d'Orbigny, 1826, Ann. Sci. Nat., vol. vii. p. 254, No. 35. *Dentalina communis* d'Orbigny, 1840, Mém. Soc. Géol. France, sér. 1, vol. iv. p. 13, pl. i. fig. 4. *Nodosaria (D.) communis* (d'Orb.) Burrows, Sherborn, and Bailey, 1890, Journ. R. Micr. Soc., p. 557, pl. ix. fig. 27. *N. communis* (d'Orb.) Fornasini, 1890, Mem. R. Accad. Sci. Ist. Bologna, ser. 4, vol. x. p. 469, pl. figs. 14-16, 19, 21. *N. (D.) communis* (d'Orb.) Haeusler, 1890, Abhandl. schweiz. pal. Gesell., vol. xvii. p. 99, pl. xiii. figs. 97, 100, 108. *D. communis* (d'Orb.) Crick and Sherborn, 1891, Journ. Northam. Nat. Hist. Soc., vol. vi. p. 4, pl. i. fig. 13. *N. (D.) communis* (d'Orb.) Chapman, 1893, Journ. R. Micr. Soc., p. 590, pl. ix. fig. 1. *N. (D.) communis* (d'Orb.) Egger, 1893, Abhandl. k. bayer. Akad. Wiss., Cl. II. vol. xviii. p. 342, pl. xi. figs. 22-24. *N. communis* (d'Orb.) Goës, 1894, K. Svenska Vet.-Akad. Handl., vol. xxv. p. 67, pl. xii. figs. 667-671. *N. communis* (d'Orb.) Fornasini, 1894, Mem. R. Accad. Sci. Ist. Bologna, ser. 5, vol. iv. p. 211, pl. i. figs. 8, 9; and p. 214, pl. ii. fig. 2. *D. legumen* (Reuss) = *communis* (d'Orb.) Perner, 1897, Česká Akad. Císare Františka Josefa (Palæont. Bohemiæ No. 4) p. 35, pl. iii. fig. 5. *N. communis* (d'Orb.) Fornasini, 1898, Mem. R. Accad. Sci. Ist. Bologna ser. 5, vol. vii. p. 209, pl. figs. 11, 13, 14. *N. communis* (d'Orb.) Egger, 1899, Abhandl. k. bayer. Akad. Wiss., Cl. II. vol. xxi. p. 65, pl. vi. fig. 4. *N. communis* (d'Orb.) Flint, 1899, Rep. U.S. Nat. Mus. for 1897 (1899) p. 310, pl. lvi. fig. 2.

This species occurs in various forms, those with oblique sutures predominating and partaking of the characters of *N. Roemeri* and *N. mucronata*.

It is moderately common in the Malay Archipelago and pretty evenly distributed over the whole of the region.

Nodosaria (D.) farcimen Soldani sp.

"*Orthoceras farcimen*" Soldani, 1791, Testaceographia, vol. i. part 2, p. 98, pl. cv. fig. o. *Dentalina farcimen* (Sold.) Reuss, 1863, Bull. Acad. Roy. Belg., sér 2, vol. xv. p. 146, pl. i. fig. 18. *Nodosaria (D.) farcimen* (Sold.) Howchin, 1888, Journ. R. Micr. Soc., p. 543, pl. ix. fig. 21. *N. (D.) farcimen* (Sold.) Haeusler, 1890, Abhandl. schweiz. pal. Gesell., vol. xvii. p. 100, pl. xiii. fig. 109; pl. xiv. figs. 24, 25. *N. farcimen* (Sold.) Fornasini, 1890, Mem. R. Accad. Sci. Ist. Bologna, ser. 4, vol. x. p. 463, pl. fig. 13. *N. farcimen* (Sold.) Mariani, 1891, Boll. Soc. Geol. Italia, vol. x. fasc. 2, p. 173, pl. vi. fig. 5. *Dentalina monile* (Hag.) Beissel (Holzapfel) 1891, Abhandl. k. preuss. geol. Landesanst., N.F. Heft 3, p. 31, pl. vi. fig. 31. *N. (D.) farcimen* (Sold.) Haeussler, 1893, Abhandl. schweiz. pal. Gesell., vol. xx. p. 31, pl. iv. figs. 17-21. *N. farcimen* (Sold.) Fornasini, 1894, Mem. R. Accad. Sci. Ist. Bologna, ser. 5, vol. iv. p. 211, pl. i. figs. 6, 7. *N. farcimen* (Sold.) Flint, 1899, Rep. U.S. Nat. Mus. for 1897 (1899), p. 309, pl. lv. fig. 5.

This form occurs in both Areas, but is very rare; the specimens are typical and well developed.

Nodosaria (D.) filiformis d'Orbigny.

"*Orthoceratia filiformia aut capillaria*" Soldani, 1798, Testaceographia, vol. ii. p. 35, pl. x. fig. c. *Nodosaria filiformis* d'Orbigny, 1826, Ann. Sci. Nat., vol. vii. p. 253, No. 14. *Dentalina* sp. de Folin, 1887, Le Naturaliste, vol. ix. p. 140, fig. 20 a. *N. filiformis* (d'Orb.) Fornasini, 1889, Foram. Mioc. di San Rufillo, pl. i. fig. 14. *N. (D.) filiformis* (d'Orb.) Haeusler, 1890, Abhandl. schweiz. pal. Gesell., vol. xvii. p. 97, pl. xiii. figs. 105, 107. *N. (D.) filiformis* (d'Orb.) Terrigi, 1891, Mem. R. Com. Geol. Italia, vol. iv. p. 79, pl. ii. fig. 7. *N. filiformis* (d'Orb.) Flint, 1899, Rep. U.S. Nat. Mus. for 1897 (1899) p. 310, pl. lv. fig. 6.

This also is a very rare form in the Malay Archipelago, and is represented mainly by fragments. The majority of the examples have oblique sutures, resembling plate lxiii. fig. 4 of Brady's 'Challenger' Report.

Lingulina d'Orbigny.*Lingulina limbata* sp. n., plate XI. fig. 15.

Primordial chamber oval, surmounted by an expanding neck; surface smooth. Succeeding chamber triangular, compressed, base limbate with a short process on either margin. Aperture oval, in a phialine neck. Length 0.20 mm.

This is one of an aberrant group of *Lingulina* in which the chambers, in place of being equitant as in the type, are connected by stoloniferous tubes of more or less slenderness. The test is composed of two or more lageniform chambers arranged in a linear series, the primordial chamber being of a character different from the others.

One of this group was described and figured by Dr. Chester under the name of *L. herdmanni*.* This was a solitary specimen from shore mud at Southport.

In one of the examples of *L. carinata* figured by Brady † the primordial chamber is armed with a pair of marginal spines at the oral end.

Amongst the abnormal forms of *Nodosaria rutilicula* figured by Haensler, two bear a resemblance to this group of *Lingulina*. ‡

From my friend Mr. H. Sidebottom, of Cheadle Hulme, I have specimens and drawings of a form closely allied to *L. limbata*, but not identical. Of this he writes, "About 150 specimens were found in the material from off the coast of the Island of Delos (Grecian Archipelago), depth 8 to 14 fathoms, by my brother-in-law Mr. C. H. Nevill and myself. In six cases there is a third chamber similar to the second, only rather larger. The species occurs at other parts of the Mediterranean very rarely, also from the Seychelles Islands."

L. limbata is very rare in the Malay Archipelago, and has been found only at Station 6 in Area 1.

Lingulina pagoda sp. n., plate XI. figs. 16, 17.

Test linear. Primordial chamber flask-shaped with longitudinal costæ. Succeeding chambers pyriform, compressed, broad at the base, which is encircled by a tubuliferous fringe. Aperture oval, in a phialine neck. Length 0·50 mm.

This curious form may be said to be compounded of an initial cell resembling *Lagena sulcata*, from which proceeds a series of cells each of which has somewhat of the characters of *L. fimbriata*, the base of each being attached to the phialine neck of the preceding, and each successive chamber increasing slightly in size.

This form also is very rare in the Malay Archipelago, and has been observed only at Station 6 in Area 1.

Fig. 18 represents a detached chamber found at Station 30 in Area 2, which indicates a species distinct from those described. The length of the chamber is 0·15 mm.

* First Rept. of the Southport Soc. of Nat. Sci., 1890-91 (1892) p. 63, pl. i. fig. 9.

† Chall. Rept., 1884, p. 517, pl. lxxv. fig. 17.

‡ Abhandl. schweiz. pal. Gesell., vol. xvii. 1890, p. 92, pl. xiii. figs. 56-59.

Frondicularia DeFrance.*Frondicularia nitida* Terquem, plate XI. fig. 19.

Frondicularia nitida Terquem, 1858, Mém. Acad. Imp. de Metz, vol. xxxix. p. 592, pl. i. fig. 9. *F. cf. nitida* (Terq.) Uhlig, 1883, Jahrb. k. k. geol. Reichs., vol. xxxiii. p. 756, pl. ix. fig. 19. *F. nitida* (Terq.) Burbach, 1886, Zeitschr. Naturw. Halle, vol. lix. p. 45, pl. i. fig. 7. *F. spathulata* (Brady) Egger, 1893, Abhandl. k. bayer. Akad. Wiss., Cl. II. vol. xviii. p. 346, pl. xi. fig. 32.

Of this almost extinct genus Mr. Durrand's collection yields but a single individual; this is from Station 30 in Area 2.

This form, with slight variations, is common in the lias, and has received a variety of names. Its nearest living representative appears to be the *F. spathulata* of Brady.* The solitary specimen found by Dr. Egger in the 'Gazelle' Soundings, and attributed by him to *F. spathulata*, seems to correspond in all respects with the Malay Archipelago example.

Rhabdogonium Reuss.*Rhabdogonium tricarinatum* d'Orbigny sp.

Vaginulina tricarinata d'Orbigny, 1826, Ann. Sci. Nat., vol. vii. p. 258, No. 4; Modèle, No. 4. *Rhabdogonium tricarinatum* (d'Orb.) Brady, 1884, Chall. Rept., p. 525, pl. lxvii. figs. 1-3. *R. tricarinatum* (d'Orb.) Sherborn and Chapman, 1886, Journ. R. Micr. Soc., ser. 2, vol. vi. p. 752, pl. xv. fig. 16. *R. tricarinatum* (d'Orb.) Brady, Parker, and Jones, 1888, Trans. Zool. Soc., vol. xii. p. 223, pl. xlv. fig. 3. *R. tricarinatum* (d'Orb.) Schrodt, 1890, Zeitschr. deutsch. geol. Gesell., vol. xlii. p. 411, pl. xxii. fig. 2. *R. tricarinatum* (d'Orb.) Burrows, Sherborn, and Bailey, 1890, Journ. R. Micr. Soc., p. 558, pl. x. fig. 7. *R. tricarinatum* (d'Orb.) Egger, 1893, Abhandl. k. bayer. Akad. Wiss., Cl. II. vol. xviii. p. 355, pl. xi. figs. 49, 50; pl. xii. figs. 36-38. *R. tricarinatum* (d'Orb.) Jones, 1895, Palæont. Soc., p. 232, pl. vii. fig. 16. *R. tricarinatum* (d'Orb.) Egger, 1895, Naturhist. Ver. Passau, Jahresber. xvi. p. 23, pl. ii. figs. 18, 19. *R. tricarinatum* (d'Orb.) Silvestri, 1896, Mem. Pontif. Accad. Nuovi Lincei, vol. xii. p. 194, pl. i. fig. 8 (vol. xv. 1899).

This form occurs sparingly at a few Stations in both areas. All the examples are twisted and have a produced neck.

Brady states that it has not been noticed at any point in the North Pacific.

* Quart. Journ. Micr. Sci., n.s. vol. xix. 1879, p. 270, pl. viii. fig. 5.

Marginulina d'Orbigny.*Marginulina glabra* d'Orbigny.

Marginulina glabra d'Orbigny, 1826, Ann. Sci. Nat., vol. vii. p. 259, No. 6; Modèle, No. 55. *M. attenuata* (Neug.) Sherborn and Chapman, 1889, Journ. R. Micr. Soc., p. 487, pl. xi. fig. 27. *M. glabra* (d'Orb.) Burrows, Sherborn, and Bailey, 1890, Journ. R. Micr. Soc., p. 558, pl. x. fig. 1. *M. glabra* (d'Orb.) Haeusler, 1890, Abhandl. schweiz. pal. Gesell., vol. xvii. p. 106, pl. xiv. figs. 35-40, 42, 43. *M. glabra* (d'Orb.) Fornasini, 1890, Mem. R. Accad. Sci. Ist. Bologna, ser. 4, vol. x. p. 470, pl. figs. 20, 26-30. *M. glabra* (d'Orb.) Mariani, 1891, Boll. Soc. Geol. Italia, vol. x. p. 173, pl. vi. fig. 6. *M. elongata* (d'Orb.) Perner, 1892, Česká Akad. Císarè Františka Josefa (Palæont. Bohemie No. 1) p. 61, pl. v. figs. 13, 14. *M. glabra* (d'Orb.) Egger, 1893, Abhandl. k. bayer. Akad. Wiss., Cl. II. vol. xviii. p. 346, pl. xi. figs. 28, 29. *M. glabra* (d'Orb.) Chapman, 1894, Journ. R. Micr. Soc., p. 160, pl. iv. fig. 11. *Vaginulina glabra* (d'Orb.) Goës, 1894, K. Svenska Vet.-Akad. Handl., vol. xxv. pl. xi. figs. 659-661. *M. glabra* (d'Orb.) Jones, 1896, Palæont. Soc., p. 233, pl. i. fig. 26 (1866). *M. glabra* (d'Orb.) Flint, 1899, Rep. U.S. Nat. Mus. for 1897 (1899), p. 313, pl. lx. fig. 1.

This form is moderately common in the Malay Archipelago and appears at several Stations in both Areas. The examples are short and inflated, and in most cases have but two chambers.

Marginulina costata Batsch sp., plate XI. fig. 20.

Nautilus (*Orthoceras*) *costatus* Batsch, 1791, Conch. Seesands, pl. i. fig. 1. *Marginulina raphanus* (Linné) d'Orbigny, 1826, Ann. Sci. Nat., vol. vii. p. 258, No. 1, pl. x. figs. 7, 8; Modèle, No. 6. *M. costata* (Batsch) Terrigi, 1891, Mem. R. Com. Geol. Italia, vol. iv. p. 92, pl. iii. fig. 4. *Cristellaria* (*Marginulina*) *costata* Hosius, 1892, Verhandl. Nat. Ver. Preuss. Rheinl. Westph., Jahrg. xlix. p. 184, pl. ii. fig. 22; and *ravicosta*, p. 124, pl. ii. fig. 23. *M. costata* (Batsch) Fornasini, 1893, Mem. R. Accad. Sci. Ist. Bologna, ser. 5, vol. iii. p. 434, pl. ii. fig. 6; and 1894, ser. 5, vol. iv. pp. 213, 214, 217, pl. ii. figs. 18-21. *Nodosaria raphanus* (Linné) Dervieux, 1893, Boll. Soc. Geol. Italia, vol. xii. p. 621, pl. v. figs. 56, 57. *M. costata* (Batsch) Egger, 1895, Naturhist. Ver. Passau, Jahresber. xvi. p. 23, pl. ii. fig. 17. *M. costata* (Batsch) Jones, 1896, Palæont. Soc., p. 235, pl. i. fig. 21 (1866, *M. raphanus*) (d'Orb.). *M. costata* (Batsch) Silvestri, 1896, Mem. Pontif. Accad. Nuovi Lincei, vol. xii. p. 200, pl. i. fig. 9. *M. costata* (Batsch) Fornasini, 1897-98, Rendic. R. Accad. Sci. Ist. Bologna, n.s. vol.

ii. p. 5, pl. i. fig. 3. *M. costata* (Batsch) Silvestri, 1900, Mem. Pontif. Accad. Nuovi Lincei, vol. xvii. p. 273, pl. vi. fig. 22.

This species occurs in two forms, one short and inflated with a few strong ribs; the other elongate with numerous and delicate costæ as shown in the illustration.

It is moderately common at Station 30 in Area 2, and appears at a few stations in Area 1.

Brady states that with the exception of a few small examples from off the coast of New Zealand, it has not been observed in either the North or South Pacific, the Southern Ocean, or the Red Sea

Vaginulina d'Orbigny.

Vaginulina legumen Linné sp. var., plate XI. fig. 21.

Nautilus legumen Linné, 1767, Syst. Nat., 12th ed. p. 1164, No. 288. *Vaginulina legumen* (Linné) d'Orbigny, 1826, Ann. Sci. Nat., vol. vii. p. 257, No. 2. *V. legumen* var. *lævigata* (Röm.) Jones, 1884, Quart. Journ. Geol. Soc., vol. xl. p. 769, pl. xxxiv. fig. 5. *V. legumen* (Linné) Sherborn and Chapman, 1886, Journ. R. Micr. Soc., ser. 2, vol. vi. p. 753, pl. xv. fig. 19; and Ibid., 1889, p. 487, pl. xi. fig. 25. *V. legumen* (Linné) Burrows, Sherborn, and Bailey, 1890, Journ. R. Micr. Soc., p. 559, pl. x. fig. 16. *V. legumen* (Linné) Hæusler, 1890, Abhandl. schweiz. pal. Gesell., vol. xvii. p. 107, pl. xiv. fig. 49. *V. legumen* (Linné) Crick and Sherborn, 1891, Journ. Northamp. Nat. Hist. Soc., vol. vi. p. 4, pl. vi. fig. 15. *V. legumen* (Linné) Terrigi, 1891, Mem. R. Com. Geol. Italia, vol. iv. p. 94, pl. iii. fig. 6. *V. lævigata* (Röm.) Goës, 1894, K. Svenska Vet.-Akad. Handl., vol. xxv. p. 65, pl. xi. figs. 648-655. *V. lævigata* (Röm.) Jones, 1896, Palæont. Soc., p. 227, pl. v. fig. 8. *V. legumen* (Linné) Bagg, 1898, Bull. U.S. Geol. Survey, No. 88, p. 53, pl. iv. fig. 4. *V. legumen* (Linné) Flint, 1899, Rep. U.S. Nat. Mus. for 1897 (1899), p. 314, pl. lx. fig. 2. *V. legumen* (Linné) Egger, 1899, Abhandl. k. bayer. Akad. Wiss., Cl. II. vol. xxi. p. 98, pl. ix. figs. 29, 30; and *V. denudata* (Reuss) p. 100, pl. ix. figs. 29, 30.

A very rare form in the Malay Archipelago and has been found only in Area 2.

Most of the examples are normal, but the variety figured approaches *Cristellaria crepidula*, whilst the inflated terminal chamber suggests an affinity with the dimorphous genus *Amphicyræne*.

Vaginulina formosa sp. n., plate xi. fig. 22.

Test oblong, tapering towards the apertural end; aboral end broad and rounded; dorsal margin thin and carinate; ventral

margin broad and inflated; chambers few in number, triangular, radiating from a point at the aboral extremity of the test. Sutures obscure; surface covered with costæ parallel with the sutures. Aperture in a produced neck. Length 0.47 mm.

This is a passage form from *Vaginulina* to *Cristellaria* and is interesting as being a survival from the mesozoic period. In the lias and more especially in the oolite, types similar in character were extremely abundant, and a multitude of them has been figured by Terquem in his various works on the foraminifera of those formations.

There is but a single specimen from the Malay Archipelago, and this is from Station 25 in Area 2.



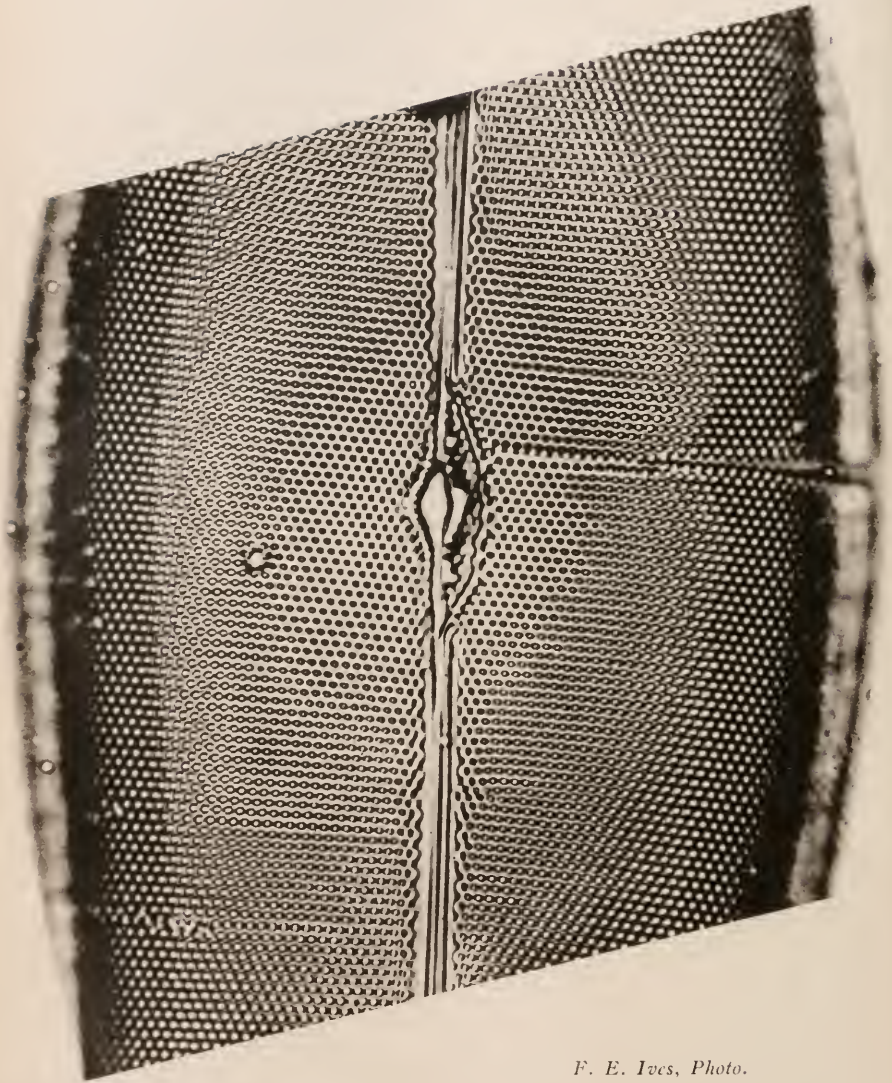

F. E. Ives, Photo.

PLEUROSIGMA ANGULATUM.

NOTE.

Photograph of Pleurosigma angulatum by F. E. Ives.

PLATE XII.

At the June Meeting were exhibited a photograph of *Pleurosigma angulatum* and lantern slides of *Coccolithus asteromphalus*, *Surirella gemma*, and *Pleurosigma angulatum*. With regard to these exhibits, which are not only beautiful in themselves, but important from an optical point of view, Mr. Ives writes as follows:—"This negative (referring to *Pleurosigma angulatum*) is an enlargement from a smaller one made direct. The original negative was made on a lantern slide plate, with Zeiss 3 mm. apochromatic objective, N.A. 1.30, 18 compensation eye-piece, Abbe achromatic condenser, on a Swift portable histological stand, Welsbach light in ground-glass chimney, and the camera described on pp. 371-8 of the Journal of the Franklin Institute, May 1902. The mount is one of Möller's, dry, the valve in cover-glass contact. Illumination, cone of about .80 or .90 N.A., very carefully centered. Tube-length adjusted with great care. The objective is marked for a tube-length of 160 mm., but when adjusted most carefully by the eye, on objects mounted in cover-glass contact or in balsam, always stands within 2 mm. of 150. Quite incapable of giving the result shown in this photograph with a 160 mm. tube.

Direct amplification $\times 1320$; enlargement to $\times 2375$.

With first-class *achromatics*, and with valves mounted in styrax or monobromide, *Pleurosigma angulatum* presents to my eye the appearance shown in this photograph, and is so reproduced by photography, though not quite so perfectly and brilliantly as with the dry mount and apochromatic objective.

The lantern slides of *Coccolithus*, *Asteromphalus*, and *Surirella gemma* are contact prints from negatives made under the same kind of conditions, from valves mounted in liquid-amber. The *Surirella* shows, on one part, a suggestion of the white dot growing up within the black dot, which is so well shown in the photograph of *Pleurosigma angulatum*."

OBITUARY.

RICHARD LEACH MADDOX.

1816-1902.

RICHARD LEACH MADDOX was born at Bath on August 4, 1816. He received his early education at a public school in Somersetshire, and in 1837 entered University College, London, to study medicine. While still a student he took a voyage round the world for the sake of his health, leaving England in 1839 and returning in 1840. In 1842 he obtained the diploma of the Royal College of Surgeons, and in the following year the Licence of the Apothecaries' Society. In 1844 he went over to Paris to pursue his medical studies at the Hôpital de la Charité. In 1847 he visited Smyrna, proceeding thence to Constantinople where he practised his profession until 1850 when he returned to England. In 1851 he took his M.D. degree at Aberdeen. In the following year he went back to Constantinople where he again set up in practice, and during the latter part of the Crimean war held an appointment as Civil Surgeon at the Hospital at Scutari.

Compelled to return to England on account of his health, Maddox set up in private practice for a time at Islington, afterwards at Ryde, Isle of Wight, eventually settling at Woolston, near Southampton, in 1859. Here he remained till 1874, and it was during this period that he did so much of the work which was to render his name conspicuous. In 1875 he again went abroad, proceeding first to Ajaccio and afterwards to Bordighera and Cornigliano, at which places he practised medicine among the English residents. He was also at different times resident physician to the Duke of Montrose, Sir Watkin Williams Wynne, and Lady Katharine Bannerman.

Still later, Maddox lived for some years at Gunnersbury, but from 1887 onwards resided at Greenbank, Portswood, Southampton, till his death on May 11th.

Dr. Maddox was twice married, and left two sons and a daughter.

For a great part of his life Maddox was subject to periodical attacks of ill-health which sometimes caused him to leave England for a more congenial climate, and which frequently prevented him from pursuing those avocations to which he was inclined. These break-downs were attributable to overwork, for he never spared himself, and also to the vitiated atmosphere, tainted with ether vapour, in which he was accustomed to work. Yet it was the

supposition that the deterioration of his health was due to the poisonous influence of ether vapour which induced him to try for a substitute for the wet collodion, and led to the invention of the gelatino-bromide dry-plate method.

Throughout his life he was devoted to scientific pursuits, and in the early part of his career was much occupied with electricity, but afterwards abandoned this for photography, and still later became much interested in the rising fortunes of bacteriology.

In connection with the gelatino-bromide method he justly gained a great reputation, for he was the principal pioneer of this procedure which has done so much to advance the technique of photography. Of photomicrography he was always much enamoured and was one of the first to grasp its potentialities for reproducing pictures of microscopical preparations. Even as far back as 1865 Lionel Beale published some of his photomicrographs as the frontispiece to *How to Work with the Microscope*. His photomicrographs are too well known to need more than this passing reference.

This Society has the credit of being the first prominent body to recognise the scientific claims of Maddox, for in 1871 he was elected Hon. F.R.M.S., on account of his eminence in science and for his valuable contributions to the Transactions of the Society.

Later, however, he became the recipient of numerous distinctions, the most important being, the Gold Medal at the Inventions Exhibition, Dublin, 1885; the John Scott Legacy Medal and Premium from the Franklin Institute, Pennsylvania, U.S.A., 1889; the Progress Medal of the Royal Photographic Society, 1901. The John Scott Medal was awarded on the recommendation of a committee, among the members of which were J. Carbutt and F. E. Ives. Their advisory report, quoted below, sums up most aptly the exact position of Maddox to the "invention which has revolutionised the whole science and practice of photography."

The committee report that they "have carefully considered the subject and examined into the merits of the invention claimed by Dr. Maddox. They find that although gelatin had been employed photographically in a variety of ways, and although silver haloid salts had been emulsified successfully with collodion in photographic practice prior to the publication by Dr. Maddox of his gelatino-bromide process, nevertheless the successful emulsification by him of silver haloids with gelatin, and the perfecting of a working process founded upon it, involved so much painstaking experimentation and investigation, and was such a departure from old methods, that it merits recognition on account of its marked influence on the progress of photography, on the enlargement of its practice, and the multiplication of its applications in technical and purely scientific directions. The process, though affording negatives of good quality, was soon improved in regard to the quality and sensitiveness of the plates by different individuals, by

the removal of the soluble salts, by heating to higher temperatures, by prolonged digestion, by the addition of ammonia, and by changes in minor details. In consideration, therefore, of the novelty of the process and its value, and of the publication of it without any reservation of rights, your committee recommend the award of the Scott Legacy medal and premium to Dr. Richard Leach Maddox for the substitution of gelatin for collodion in photography as accomplished by him."

The following is a list of the more important papers by the late R. L. Maddox, Hon. F.R.M.S.

An Experiment with Gelatino-Bromide. *British Journal of Photography*, Sept. 8, 1871.

On the Apparent Relation of the Nerves to the Muscular Structures in the Aquatic Larva of *Tipula crystallina* of De Geer. *Proc. Roy. Soc.*, xvi. 1868.

On the Photographic Delineation of Microscopic Objects. *Trans. Microscop. Soc.*, 1863, pp. 9-12.

A Contribution to the Minute Anatomy of the Fungiform Papillæ, and Terminal Arrangement of Nerve to Striped Muscular Tissue in the Tongue of the Common Frog (*Rana temporaria*); with Drawings and Photomicrographs. *Monthly Microscop. Journ.*, i. 1869, pp. 1-14, 1 pl.

Heliostat for Photomicrography. *Monthly Microscop. Journ.*, i. 1869, pp. 27-29, 1 pl.

Observations on *Mucor Mucedo*. *Monthly Microscop. Journ.*, ii. 1869, pp. 140-147, 1 pl.

Cultivation, &c. of Microscopic Fungi. *Monthly Microscop. Journ.*, iii. 1870, pp. 14-24, 1 pl.

Experiments on Feeding some Insects with the Curved or "Comma" Bacillus, and also with another Bacillus (*B. subtilis*?). *J.R.M.S.*, 1885, pp. 602-7 and pp. 941-52.

And many others in various scientific periodicals, Transactions of Societies, &c.

SUMMARY OF CURRENT RESEARCHES
RELATING TO
ZOOLOGY AND BOTANY
(PRINCIPALLY INVERTEBRATA AND CRYPTOGAMIA),
MICROSCOPY, ETC.*

ZOOLOGY.

VERTEBRATA.

a. Embryology.†

Variation: Germinal and Environmental.‡—J. Cossar Ewart uses the phrase *germinal variation* for the variation which inevitably flows from the blending of two highly specialised germ-cells; all the variations in the germ-cells up to the moment of conjugation, together with the variations during development and growth, are referred to as *environmental variations*.

Environmental variation is considered under several heads. (I.) There are those environmental variations which occur during development, e.g. dwarfing and arrestments; and it is pointed out that many are "congenital," but neither inherited nor transmitted. (II.) There are environmentally produced changes occurring from the end of development to the end of the reproductive period, including changes in the germ-cells during their growth and maturation. (a) None of his results favour belief in the transmission of acquired somatic variations; on the contrary, some of them indicate that such transmission is highly improbable. (b) There is evidence of the influence of nutrition and somatic well-being on the germ-cells. (c) There is some evidence that age, seasonal condition of parents, &c. influence the progeny: thus, as a female increases in age and vigour her germ-cells may increase in prepotency. (d) The influence of the age of the parents, and of the ripeness of the germ-cells, is then illustrated. Some interesting evidence is adduced to show that inter-breeding is a cause of variation. Mating before and after the normal time is also provocative of changes, some of which (in rabbits, &c.) seem to occur with some degree of definiteness.

* The Society are not intended to be denoted by the editorial "we," and they do not hold themselves responsible for the views of the authors of the papers noted, nor for any claim to novelty or otherwise made by them. The object of this part of the Journal is to present a summary of the papers as *actually published*, and to describe and illustrate Instruments, Apparatus, &c., which are either new or have not been previously described in this country.

† This section includes not only papers relating to Embryology properly so called, but also those dealing with Evolution, Development, Reproduction, and allied subjects.

‡ *Scient. Trans. R. Dublin Soc.*, vii. (1901) pp. 353-78.

In interpreting germinal variation, the author agrees in the main with Weismann, and accepts the idea of germinal selection.

The combined results of germinal and environmental variation are then illustrated by giving the results of a number of inter-crossing and inter-breeding experiments, which are of great interest and value.

The following are some of the more striking results of inter-crossing:—

(1) The offspring may, down to the remotest details, be all but intermediate between the two parents, but this is not very common.

(2) The offspring often resembles one of the parents—the prepotent one.

(3) Some of the offspring may resemble one of the parents, some the other. Thus, in a litter of four kittens, two may be pure white like the sire, and two tabby like the mother.

(4) The offspring may combine, almost unimpaired, the more striking characters of both breeds. Though the engrafting of the characters of one breed on another may not be common, it certainly occurs.

(5) Sometimes new, or at least unexpected, characters appear in the offspring, e.g. a grey tailless rabbit, “spinning” rabbits, reddish-brown or chestnut rooks.

(6) The offspring of half-breeds are, as a rule, extremely variable—a fact long recognised by breeders, fanciers, and horticulturists.

(7) Sometimes the offspring, instead of resembling the immediate ancestors, i.e. the parents, resemble former ancestors.

We have not been able to do more than outline the plan of a very interesting paper, full of concrete detail of great value.

Determination of Sex in Animal Development.*—J. Beard has been led by certain discoveries to a theory of the determination of sex. Enumerations showed him that the primary germ-cells of *Raja batis* approximated to 256 or 512; “from evidences to be given elsewhere, it was established that the larger number of primary germ-cells related to the future female embryos, the smaller to potential males;” it was found that during the cleavage there are germinal discs of two sizes.

Beard suggests that the “sterilised metazoan person” which we call a female produces two kinds of functional gametes, viz. eggs which may develop into males, and eggs which may develop into females. Similarly, the male typically bears two forms of spermatozoa, one of which is never of functional value, and may be never more than initiated. In more than three dozen species two kinds of sperms are known.

Since it is the egg that develops, and not the sperm, the burden of providing for the continuance of the race is borne by the female metazoan, or rather, by the germ-cells of which it is the host. They make provision not only for a new batch of “female-eggs,” but also for one of “male-eggs.” “*The determination of sex for the next generation thus lies with the germ-cells of the female metazoan organism.*”

In all dioecious Metazoa there are thus three kinds of functional gametes, two in the female, one in the male. “The faculty of becoming hermaphrodite is confined to the female.” From “male-eggs” she is able on occasion, by anticipation, to form spermatozoa. Hermaphroditism

* Anat. Anzeig., xx. (1902) pp. 556-61.

is associated with the partial or complete suppression of one form of gamete, the male *eg.*. Parthenogenesis, on the other hand, entails the occasional, or the cyclical, arrestment of one or other of the two gametes of the female. If it become acyclical (Weismann) with the consequent disappearance of the males, with these there vanish the male-eggs which produce them, and the spermatozoa. In such instances the only form of gamete left is the female-egg, which, as is well known, undergoes an isogamous union with a rudimentary sister, the polar body.

The problems of the origin, the determination, and the regulation of sex should be more carefully distinguished. "Of its origin no absolutely certain knowledge is possible." "The actual determination is initiated at the division of the primary germ-cells into secondary ones; it is completed at the formation of the oocytes and spermatocytes, and its manifestation is accomplished by the numerical reduction of the chromosomes in these."

The experiments of Yung, Born, &c. were really experiments in the regulation of sex, and only prove what percentage of either sex will survive under given, usually utterly abnormal, conditions. The so-called self-regulation of the proportions of the sexes is mainly due to the preponderance of the males in the earlier, and of the females in the later offspring. An increment in the race is effected by increasing the number of offspring, and with these the number of females. The adjustment begins to manifest itself in the third generation.

Determination of Sex.*—A. Van Lint expounds a new theory of the determination of sex, which seems to be in part a rejuvenescence of Starkweather's. The theory is that the offspring has the sex of the weaker parent, but the weaker parent comes to mean the parent whose sex-cells were relatively less vigorous at the time, and this, unfortunately, cannot be readily tested.

In the first part of the little book, Van Lint frankly and lucidly expounds the five hypotheses involved in his theory:—(1) The ovum and spermatozoon are antithetic, they express opposite extremes of cellular differentiation, or it may be that they differ like right-handed and left-handed crystals. (2) There is also a somatic antithesis between the masculine body and the feminine body, often conspicuous in secondary sexual characters, often inconspicuously expressed in minute contrasts throughout the soma. (3) There is also a contrast between the germ-cells produced by an individual organism and the soma of that organism; they are complementary expressions of an original hermaphroditic unity; the characters of the sex suppressed in the development of the gonads are reflected, as it were, in saturating influence on the soma. (4) So strong is this contrast that the male's somatic cells—which the author calls *parova*—may be regarded as sexually equivalent to ova, while the female's somatic cells—which the author calls *paraspermatozoids*—may be regarded as sexually equivalent to spermatozoa. (5) The properties of the somatic cells may modify the properties of the sex-cells in embryonic as well as in adult life, and this in such a precise way that they determine the sex of the offspring into which the germ-cells will develop.

* *Qu'est-ce qui détermine le sexe?* Paris, 1902, 77 pp.

From what has been said it will be plain that Van Lint believes in the origin of the unisexual state from a primitive hermaphrodite one, traces of which persist; that he attaches great importance to the dependence of the soma on the gonads, and to the dependence of the sex-cells on the state of the soma; and that he does not believe in the germ-plasm concept.

The theory, which is a co-ordination of the five hypotheses above summarised, may be made quite clear by taking a particular case. If a relatively feeble ovum is fertilised by a relatively vigorous spermatozoon, the result will be a female offspring. What are the steps that lead to this remarkable conclusion? The fertilised ovum in question will have the spermatozoon's qualities dominant; the embryo will therefore have a masculine soma (of paraspermatozoid cells); to balance this dominant masculinity the gonad must be female.

The author proceeds to explain what is meant by the relative vigour of a cell, and the vital force of an organism (which involves a complete medical examination under six heads), but he explains that the *certain* sign of a man's being more vigorous than his wife is his having a daughter. "Le sexe de l'enfant tranchera la question."

It is next pointed out that "crossed inheritance"—the son taking after his mother, the daughter after her father—is readily interpreted by the theory expounded. The son is the result of a more vigorous ovum fertilised by a less vigorous spermatozoon, the somatic cells must balance the gonads, therefore they must be feminine, and therefore the boy is his mother's image.

In the eighth chapter the author seeks to show that the available statistical and experimental results, many of which are summed up in *The Evolution of Sex* by Geddes and Thomson (4th edition, 1901), are in harmony with his theory, or may be harmonised with it. He concludes by showing that the so-called auto-regulation of the proportions of the sexes is readily explicable on his theory, for it is the more feeble which nature insists on replacing.

External Phenomena of Fertilisation.*—A. H. R. Buller has particularly studied Echinoid ova and spermatozoa. His chief results are the following. The meeting of the spermatozoa with the outer surface of the gelatinous coat (zona pellucida) is a matter of chance, and not due to chemotaxis. In passing through the gelatinous coat the spermatozoa follow a more or less radial direction, but this is not due to any chemotactic substance being excreted from the egg; it is possibly due to stereotaxis, but a purely mechanical explanation seems to the author more probable. The spermatozoa do not respond to tonotactic or heliotactic stimuli, and are probably not chemotactically sensitive.

On coming in contact with a surface bounding their medium, the spermatozoa cling to it, and usually continue for a time to revolve upon it in (from their point of view) a counter-clockwise direction. This statement applies to all the groups of Echinoderma. The spermatozoa easily become attached to glass and other surfaces by the tips of their conical heads. This phenomenon doubtless plays a rôle in causing the spermatozoa to bore through the gelatinous coat after having come in

* Quart. Journ. Micr. Sci., xlv. (1902) pp. 145-76 (4 figs.).

contact with its outer surface, and also in their becoming attached to the living egg.

The vast number of eggs, and the still vaster number of spermatozoa produced, together with the motility of the latter and the action of sea-currents, quite suffices to bring the male sexual cells into contact with the zona pellucida.

Many writers have supposed that chemotaxis is a constant factor in the fertilisation of animal eggs. This generalisation, which has been made by arguing from the attraction of the spermatozoa to the eggs of certain plants, is as yet entirely without experimental justification. The author's results in regard to Echinoids, which are in accordance with those obtained by Masart in the case of the frog, and with the work of Dewitz on the fertilisation of the eggs of certain insects, lead him to suppose that chemotaxis, at least for a great number of animal species, plays no rôle whatever in bringing the sexual elements together.

Dispensability of Gravity in Development of Toad's Egg.*—T. H. Morgan has subjected the toad's eggs to rotation in water from the moment of their removal from the animal, and before fertilisation.

The cleavage of the rotating eggs progressed normally, as was determined by removing a few of the eggs at intervals. Those removed at the 2-cell stage (after 5 hours) and kept outside developed normally. Eggs removed after 25 and 36 hours also produced normal embryos. After 48 hours the eggs that were still rotating also showed the dorsal lip of the blastopore. The eggs were kept rotating for several days longer, and produced normal embryos.

The results show that gravity *need not be* a determining factor in the development of a bilateral plane in the apparently radially symmetrical egg.

The critical points that now remain to be determined are:—(1) does the point of entrance of the spermatozoon determine the bilaterality of the egg? (2) does the grey crescent develop in a pre-organised part of the egg, and if so, does the egg rotate after fertilisation so that this part turns uppermost? or (3) does the grey crescent appear at any point on the egg that happens to lie uppermost? But the results of the experiments on the toad's eggs show conclusively that when gravity is excluded as a factor acting in a constant relation to the egg, a bilateral plane still appears in the egg.

Early Stages in Oogenesis and the Synaptic Phases.†—A. Giardina has studied these in *Dytiscus*, *Mantis*, *Helix*, &c. During the growth of the oocytes there is a twice repeated characteristic stage of repose, with a reticular nucleus, and between these a synaptic phase is interposed. But it seems necessary to distinguish the synapsis of growth from a synapsis of differentiation, which also occurs in the course of oogenesis.

Experimental Parthenogenesis in Amphibians.‡—E. Bataillon finds that the unfertilised ova of *Rana fusca* and *R. esculenta* are made active by heat as well as by plasmolytic solutions, and that the two stimuli may be advantageously combined. In these conditions the eggs

* Anat. Anzeig., xxi. (1902) pp. 313-6.

† Tom. cit., pp. 293-308 (21 figs.).

‡ Comptes Rendus, cxxxiv. (1902) pp. 918-20.

show nucleated blastomeres and cytotblastomeres. In the areas of full activity there are normal or abnormal karyokineses, cytasters, and divisions of cytasters. Apart from the absence of defined centrosomes in the asters, and the origin and number of the chromosomes, the essential phenomena agree with those described by Wilson in the unfertilised ova of *Toxopneustes*.

Disruptive Processes in Ovarian Ova of *Lacerta agilis*.* — J. A. Meyer finds that appearances suggestive of cleavage are really disruptive. The plasmic masses are irregular; they are without nuclei; the germinal vesicle disappears; the yolk becomes fluid; leucocytes wander into the egg; the follicular epithelium first proliferates and then breaks up.

Internal Secretion of Testis.† — G. Loisel has studied the testes of birds and mammals in embryonic and adult life, and distinguishes what he calls a primary, chemical, internal secretion from the secondary, morphological, external secretion (that of spermatogenesis). In its internal secretion the testis is a great destructor of fat; hence the frequently greater thinness of males, their emaciation during the breeding period, and the fattening of castrated individuals.

Spermatogenesis in Newt.‡ — J. A. Janssens describes the various stages, and emphasises some new points. Of especial importance is the comparison between the phenomena of spermatogenesis and those of oogenesis, and the theory that the successive "resolutions" of the nucleoli in the ova may correspond to the successive divisions of the spermatogonia. The author also makes a point of insisting on the intimate relations between the chemical processes of metabolism and nutrition on the one hand, and the physical processes of cell-division on the other.

Spermatozoon of Rat.§ — A. A. Merlin has made a detailed examination of a fine preparation of rat spermatozoa, and describes the apparently somewhat complex minute organisation of the "head."

Two-tailed Spermatozoa.|| — E. Ballowitz refers to Bromann's recent description of two-tailed spermatozoa in the normal spermatic fluid of man, salamander, and dog-fish, but recalls his own paper of 1891, in which the occurrence of similar forms was carefully noted.

Alleged Peritubular Lymphatic Tubes of the Testis.¶ — M. A. Capurro believes that the free peritubular spaces seen on section of the testes and often described, are really artefacts, due to the effect of the mode of preparation on the glandular material.

Development of Layers of Retina.** — J. Cameron notes that the inner wall of the retinal cup in a fourth-day chick has exactly the same structure as the wall of the embryonic cerebral vesicles or spinal cord

* Anat. Hefte (Merkel and Bonnet), 1901, pp. 71-96 (4 pls.). See Zool. Centralbl., ix. (1902) p. 153.

† Comptes Rendus. cxxxv. (1902) pp. 250-2.

‡ Anat. Anzeig., xxi. (1902) pp. 129-38 (15 figs.).

§ Journ. Quekett Micr. Club, viii. (1902) pp. 189-94 (2 figs.).

|| Anat. Anzeig., xx. (1902) pp. 561-3.

¶ Tom. cit., pp. 563-9 (4 figs.).

** Proc. Roy. Soc. London, lxx. (1902) pp. 84-6.

at the same stage of development. Thus all the structures which His has described in the wall of the embryonic spinal cord can also be recognised in the inner wall of the retinal cup, and may therefore receive similar names. He goes on to describe the differentiation of the myelospongioid network, &c., and the progress from day to day.

Hofmann's Nuclei (Kölliker) in Spinal Cord of Chick.*—K. Berliner proved independently of Kölliker and at the same time the occurrence of segmentally arranged nerve-cell nuclei, appearing in the earliest stages of development in organic connection with the spinal cord of the chick, and retaining this connection throughout life.

Branchial Clefts in Ophidia.†—A. Prenant and G. Saint-Remy find that three kinds of structures arise from the branchial clefts of *Coluber æsculapii* and *Tropidonotus natrix*.

(1) There are solid buds produced by a thickening of the wall of a dorsal evagination, appearing transitorily in connection with clefts I., II., and III., and possibly related to thymus elements.

(2) There are hollow primordia produced by a development of the whole wall of the cul-de-sac forming the base of the branchial pouch, which in IV. and V. form a thymus properly so-called, while in III. they form a homologous gland, quite different in structure from the thymus.

(3) There are hollow primordia arising from a small segment of the median region of the fourth branchial pouch, forming little glands. They are represented in rudimentary form in connection with pouch V.

Pseudothyroid of Frog.‡—H. N. Norris finds that the so-called "ventraler Kiemenrest" of Maurer in the frog is not derived from any part of the wall of the branchial chamber. It may be appropriately described as "Pseudothyreoidea" (Mayer). This pseudothyreoidea and the corpus propericardiale have essentially the same structure, and develop simultaneously. The arterial supply of the two is from the same branch of the external carotid artery, the ramus musculo-glandularis; their chief venous outlet is the vena pseudothyreoidea. Both originate in regions previously occupied by portions of the basihyobranchialis muscle of the tadpole.

Eye-Muscles of Acanthias.§—A. B. Lamb shows that the necessary mechanical relations between eyeball and muscles are secured:—(1) by a forward growth of processes from the second and third somites, and the development of muscle-fibres in them; (2) by a spreading out of the first somite around the eyeball and the development of muscles in its distal portions.

Evidence is adduced to show that the original direction of all the eye-muscles is longitudinal, which seems to represent an originally flexible condition of the head and to be an additional support for a belief in the homology of head and trunk somites.

* Anat. Anzeig., xxi. (1902) pp. 273-8 (1 pl.).

† Comptes Rendus, cxxxiv. (1902) pp. 614-6.

‡ Anat. Anzeig., xxi. (1902) pp. 434-42 (7 figs.).

§ Tufts College Studies, No. 7 (1902) pp. 275-92 (9 figs.); Amer. Journ. Nat., i. pp. 185-202.

The author uses three arguments showing that it is improbable that the present musculature of the eye in *Acanthias* is the primitive one. Two stages in the phylogenetic evolution are hinted at by the ontogeny, —(1) a stage where if any eye musculature existed it was furnished by the anterior somite, and (2) a stage at which four radially arranged muscles moved the eye.

Notes on Development of Liver.*—G. Hunter gives the results of a number of observations on the development of the liver in Urodela, chick, hare, man, &c. He considers the origin and morphology of the primary hepatic cylinders, of the bile capillaries and ducts, and of the blood-corpuseles and the vascular channels. From the numerous erythroblasts seen in the sections at all stages of development, it is impossible to come to any other conclusion than that the liver is the chief seat of blood formation during embryonic life, and perhaps also for some time after birth.

Development of Ventral Pancreas in *Lacerta muralis*.†—Ch. Tecqmenne finds that the pancreas in this lizard arises from two distinct lobes, one distal, the other proximal. The former is in relation with the spleen and may be called juxta-splenic; it is ontogenetically older, and is wholly a dorsal pancreas. The proximal mass may be called juxta-choledochus, for it has a mixed origin, partly from the dorsal pancreatic outgrowth and partly from a ventral outgrowth. Between the two portions and uniting them, but free from all pancreatic tissue, there extends a long portion of the duct of the dorsal pancreas. Thus, in general, the development of the pancreas in *Lacerta muralis* is similar to that described in other reptiles by Gianelli, Glas, Choronshtitzky, and Laguesse.

Comparative Anatomy and Embryology of the Malpighian Bodies.‡—P. T. Herring sums up a useful general discussion of this theme in the following general conclusions. There is an analogy between the organs of excretion of Craniata. We observe that the author does not, even with his data, say that there is a *homology*. The simplest form of Malpighian body is found in the pronephros during embryonic life. It is at first part of the peritoneal cavity, and the pronephros at that stage shows a close resemblance to the organs of excretion of *Amphioxus*. Later on, the glomerulus appears in a specially formed part of the peritoneal cavity. In the mesonephros, a peritoneal connection is usually present at first, but becomes imperfect. In the metanephros, according to the author, the cavity of Bowman's capsule may be considered to correspond to part of the body-cavity specially differentiated for purposes of excretion. The development of the Malpighian body lends support to this view, especially if we are to consider it, as Braun does, as formed from the peritoneal epithelium. The layer of endothelial cells lining Bowman's capsule corresponds to the lining cells of the general peritoneal cavity, and helps to complete the resemblance.

* Proc. Scot. Micr. Soc., iii. (1901) pp. 114-21 (4 pls.).

† Anat. Anzeig., xxi. (1902) pp. 278-92 (3 figs.).

‡ Proc. Scot. Micr. Soc., iii. (1901) pp. 109-13.

Precocious Sexual Development.*—W. Roger Williams has published a careful essay on developmental anomalies of this kind, with abstracts of over one hundred authentic cases. His classification for females runs:—I. Precocious sexual development, (a) at birth or thereabouts, (b) birth to the sixth month, (c) sixth month to one year, (d) one to two years, (e) two to three years, (f) three to four years, and so on to seven years—altogether 59 cases; II. Precocious sexual development with concomitant intra-abdominal tumour (13 cases); III. Precocious pregnancy, 15 cases, at 8, 9, 10, 11, 12, 13 years. Then follow 20 cases of precocious sexual development in males, e.g. of boys who were parents at 13 years and 3 months and at 14 years, “believed to be the earliest examples of precocious paternity extant.”

Recent Teratological Work.†—B. C. A. Windle has issued the twelfth of his valuable reports on recent teratological investigations, arranged under the heads,—(1) experimental, (2) general, (3) duplicity, (4) various parts of the body.

b. Histology.

Studies on the Retina.‡—H. M. Bernard discusses in the third part of his studies on the retina the migration of the retinal nuclei. The fourth part is devoted to the vesicular swellings at the tips of the “cones,” and some earlier form-phases in rod-production in the Amphibians. The fifth part discusses the removal of the absorbed pigmentary matter from the rods,—an explanation of “Müller’s fibres.”

The conclusion which of all others now arrived at is of widest significance from a general point of view, is that the retina can no longer be regarded as built up of so many separate “cells,” each with some definite and permanent morphological value. The functional retina is really a continuous cytoplasmic reticulum in which nuclei are suspended, and these nuclei are not stationary. With reference to the retina itself as the specific organ of vision, by far the most important result obtained by the author is the discovery of some new details relating to the origin and structure of the rods, that is, of those structures which are peculiar to the retina as the visual organ. The parallel between the rods and cuticular formations does not work out; the “cones” are not always analogous structures; the striation of the rods is due to strands in the walls of the rod-vesicles; the refractive matter which fills the outer limbs of the rods is absorbed pigment, which is usually, but not always, clarified during the process of absorption; Müller’s fibres are merely streams of the pigment matter which have been absorbed by the rods, and which pass inwards through the retina, eventually to join the vitreous humour.

Retina of Hatteria.§—Hs. Virchow has been able to make a satisfactory study of well-preserved retinae, and although he has found nothing essentially different from what occurs in the retinae of other Reptiles, there is interesting evidence of detailed differentiating peculiarities.

* Brit. Gynæcol. Journ., May 1902, pp. 85-114.

† Journ. Anat. Physiol., xxxvi. (1902) pp. 296-308.

‡ Quart. Journ. Micr. Sci., xlvi. (1902) pp. 27-75 (3 pls).

§ SB. Ges. Nat. Freunde Berlin, 1901, pp. 42-62.

Neurofibrillar Theory.*—C. K. Mills holds that the elementary fibrils in which is stored neural energy not only conduct or transmit nervous impulses, but by means of the special manner in which they are arranged in the nerve-centres as well as in the periphery, determine the intensity and character of the discharge. The fibrillar coils and bundles are regarded as representing a complicated induction apparatus. Localisation of function is brought about by means of special arrangements of intracellular and intercellular neurofibrillary coils and plexuses in the particular regions called centres. As only an abstract of the paper is before us, we have no means of appreciating the evidence on which these conclusions are based.

Minute Structure of the Muscle-Fibril.†—E. A. Schäfer refers to previous investigations in which he showed that the sarcoms elements or principal discs of the fibrils of the wing-muscles of insects are traversed by longitudinal pores. He brought forward evidence that the process of contraction of the fibril is accompanied by a transference of (fluid?) isotropous substance into the anisotropous disc or sarcoms element. He has recently found in a leg-muscle fibre of *Harpalus ruficornis* a good object for demonstrating the porous structure of the sarcoms elements, and he re-affirms his conviction as to the existence of fine longitudinal pores in the anisotropous substance, into which the isotropous fluid may pass during contraction.

Muscularisation of Capillary Vessels.‡—S. Mayer gives in an interesting paper a statement of the evidence which has led him to the conclusion that there are smooth muscle-cells on the walls of the capillary vessels.

Cæca of Birds.§—C. Calleja gives a preliminary account of his researches on the structure of the cæcal appendages in birds. He describes four layers,—connective, muscular, lymphatic, and epithelial.

c. General.

Concept of Species.||—K. Möbius says that we are bound to a double outlook on Nature, (a) when we perceive its infinitely rich variety and heterogeneity, (b) when we perceive it as a harmonious universe. The second outlook leads the naturalist to group organisms, to detect recurrent characters transmitted from parents to offspring, and the concept of *species* results.

Our concepts of species are necessarily imperfect inductions; no one can verify them exhaustively. They are necessarily affected by the naturalist's personal equation; what are true species to one may not appear so to another. Nature has no ill-defined and well-defined species, but naturalists have.

Species are only logical unities, quite abstract; they do not change or adapt themselves; only the individuals do so. Indeed, the formation of species-concepts is quite independent of questions as to the origin of the real organisms.

* Proc. Nat. Sci. Philad., 1902, p. 113.

† Anat. Anzeig., xxi. (1902) pp. 474-7 (4 figs.).

‡ Tom. cit., pp. 442-55.

§ Boll. Soc. Españ. Hist. Nat., ii. (1902) pp. 250-2 (1 fig.).

|| SB. Ges. Nat. Freunde Berlin, 1901, pp. 267-9.

Pathogenic and Teratogenic Agents.*—E. Rabaud seeks to give precision to this contrast. A teratogenic agent induces modifications such that the living matter loses none of its essential qualities; there is a novel distribution of histological differentiations, and there is local variation in the rapidity of growth. A pathogenic agent induces destructive processes; there is at least a tendency to total or partial destruction of certain protoplasmic elements, or to their transformation into inert substances. The vital processes are hindered or bereft of their completeness.

Growth and Auto-Intoxication.†—F. Houssay has plotted out the progressive changes in the weights of a brood of chickens, and compared the curves with those of Deschamps expressing the growth of Protozoa limited by inanition or auto-intoxication. As inanition could hardly be supposed in the conditions observed, Houssay thinks that it is auto-intoxication which restricts the rate of growth. He maintains that auto-intoxication is a constantly present check on the growth of Metazoa.

Biological Test for Blood.—G. H. F. Nuttall has described the preparation of so-called specific anti-sera.‡ To obtain an anti-serum for human blood, the blood is injected intraperitoneally into rabbits. After about five injections, given at intervals of three or more days, the rabbit is bled to death, and its blood-serum is collected. This serum has acquired the remarkable property of producing a precipitation immediately on its being added in small quantity to human blood-serum.

Nuttall has discovered the interesting fact§ that the anti-serum above described has no effect upon the blood of other mammals and other vertebrates (230 different kinds), *with the single exception of monkey bloods*. Similarly, if rabbits are treated with the blood of the horse, dog, ox, sheep, &c., anti-sera are formed which produce precipitations only in the bloods of the animals whose blood was used for treatment, or, to a less extent, in the bloods of nearly allied animals.

Thus the blood-test comes to be a physiological criterion of relationship. The new world monkeys give a less marked reaction with the anti-serum for human blood than do the old world monkeys; and the test gave a negative result when applied to the blood of two species of *Lemur*.

In a subsequent paper|| Nuttall notes that anti-dog serum yielded positive results only with bloods of other Canidæ; anti-horse serum only produced a reaction with the blood of horse and donkey; the bloods of Tragulidæ and Camelidæ gave no indication of relationship with the true ruminants, and so on.

Anti-pig serum produced marked clouding (remote relationship?) in a number of mammalian bloods, but only once a (very slight) clouding in a non-mammalian blood (experimental error?).

* Comptes Rendus, cxxxiv. (1902) pp. 915-7.

† Tom. cit., pp. 1233-5 (1 fig.).

‡ Brit. Med. Journ., 11th May, 1901, p. 1141; 14th September, 1901, p. 669; Journ. of Hygiene, 1st July, 1901, pp. 367-87.

§ Proc. Roy. Soc. London, lxxix. (1901) pp. 150-3.

|| Proc. Cambridge Phil. Soc., xi. (1902) pp. 334-6.

Anti-fowl serum produced a reaction in bloods of widely divergent birds, but only once in mammalian blood (experimental error?).

Anti-lobster serum reacted with lobster serum dilutions; produced slight reactions or marked clouding with blood dilutions of five kinds of crabs; produced marked clouding with blood of crayfish; but exerted no effect whatever on any of the 250 non-crustacean bloods examined.

Minute Traces of Arsenic in Animals.* — A. Gautier re-expounds the delicate method which enabled him (1899) to demonstrate the normal presence of arsenic in minute quantities in some organs of animals,—the skin, the thyroid, the thymus, the bones, &c. Those who have not been able to confirm this have not been careful enough. There are, however, some confirmations, e.g. the observations of G. Bertrand. Gautier finds that at certain times the arsenic seems to pass from the internal organs to epidermic structures, such as the hair.

Experiments on Pigeons in relation to the Semicircular Canals.† — L. Boutan refers to the fact that when the semicircular canals of a pigeon or other bird are cut, there is a constant bending of the head towards the injured side. This phenomenon has been interpreted by E. de Cyon and by Laborde as a direct consequence of the lesion of the semicircular canals. By means of a delicate operation, Boutan has been able to show that the lesion of the semicircular canals is not the real cause of the phenomenon,—from which, it may be noted, the pigeon may react to vital normality.

Reactions to Anisotonic Solutions.‡ — P. Enriques has studied the processes of osmosis and absorption in the reactions of Protozoa (*Oikomonas*, &c.), and of *Limnæa stagnalis* to anisotonic solutions. The problem is rather a difficult one, but, so far as we understand, the author seems to have shown that the passage by osmosis and the passage by absorption are completely independent processes.

Hæmolytic Action of Cobra Poison.§ — A. Calmette discusses the remarkably strong dissolving effect of cobra poison on the red blood-corpuscles of horse, dog, rabbit, guinea-pig, and rat. The corpuscles of ox, fowl, pigeon, and frog are more resistant.

But the subject is somewhat complicated, for Calmette finds that the red blood-corpuscles of an animal hyper-vaccinated against cobra poison, and furnishing a strongly anti-toxic and anti-hæmolytic serum, are still perfectly hæmolysable when, after being separated from the serum by a series of washings and centrifugal operations, they are put in contact with feeble doses of cobra-venom, with the addition of a little normal serum heated to 62°.

Calmette asks biologists interested in the problem of cellular immunity to correlate his results with those noted by Wassermann and Takaki in regard to the fixation of tetanic toxin by nerve-cells, and those noted by Roux and Borrel in regard to cerebral tetanus in vaccinated animals.

Hæmolytic Effect of Viper's Venom.|| — C. Phisalix finds that the effects on the dog are very different from those on the rabbit. In the

* Comptes Rendus, cxxxiv. (1902) pp. 1394-9. † Tom. cit., pp. 1417-9.

‡ Atti R. Accad. Lincei (Rend.), xi. (1902) pp. 495-9.

§ Comptes Rendus, cxxxiv. (1902) pp. 1446-7.

|| Op. cit., cxxxv. (1902) pp. 237-9.

rabbit the red blood-corpuscles are more resistant than the white corpuscles, and the serum contains in excess a very active anti-hæmolytic agent. The red blood-corpuscles of the dog are less resistant than the white corpuscles, and more fragile than those of the rabbit. In the serum the "sensibilatrice" predominates over the "antihémolysine." The transformation of the hæmoglobin into methæmoglobin is due to the oxidising action of the echidnase in the venom.

Long Fast of Python.*—J. Pellegrin recalls some cases of prolonged fasts in snakes,—49 months in *Pelophilus*, 29 months in *Python sebae*,—and records a new case. On the 17th November, 1899, the collection of reptiles at the Museum of Natural History in Paris received a superb specimen of *Python reticulatus*, measuring 6.45 metres, and weighing 75 kilogrammes. It refused all food, remained almost quite inert, slowly lost in weight, and after prolonged local death succumbed on the 20th April, 1902, after a fast of 2 years 5 months and 3 days. It had lost about two-thirds (48 kilogrammes) of its original weight.

Ciliated Grooves in Brain of Ammocœte.†—A. Dendy has found in the New Zealand lamprey (*Geotria australis*) and in *Petromyzon* a pair of conspicuous ciliated grooves lying in the roof of the brain in the neighbourhood of the posterior commissure, extending from the recessus sub-pinealis to the hinder margin of the posterior commissure. They are most conspicuous beneath the commissure itself, in which region they are lined by a sharply defined epithelium of very long columnar cells, totally different in appearance from the epithelium which lines the remainder of the brain-cavity. Their function is probably to promote the circulation of the brain-fluid.

Cranial Nerves of Amphiuma.‡—J. S. Kingsley has made a study of the topographical relations of the cranial nerves in this Amphibian.

Systematic Position of Cæcilians.§—J. S. Kingsley discusses the whole question, comparing the different suggestions that have been made by various authorities. He thinks the facts justify us in accepting Huxley's conclusion, as true to-day as when it was published in 1878, that none of the Gymnophiona present the slightest indication of an approximation towards the Anura or the Urodela.

It is admitted that there are certain superficial resemblances to *Amphiuma*, but the Gymnophiona are certainly not Urodela, and *Amphiuma* is not a neotænic Cæcilian. The Gymnophiona form a distinct order, and the only point of union between them and the others must be sought, where Wiedersheim looked for it in 1879, in the extinct group of Stegocephali.

All evidence of structure, as well as the significant fact of discontinuous distribution, tends to show that the Gymnophiona are an extremely old group, though no fossil forms are known. They are the most stegocephaline of existing Amphibians, and deserve far more study than has as yet been given to them.

* Bull. Soc. Zool. France, xvii. (1902) pp. 164-6.

† Proc. Roy. Soc. London, lxi. (1902) pp. 485-94 (6 figs.).

‡ Tufts College Studies, 1902, pp. 293-321 (3 pls.).

§ Tom. cit., pp. 323-44 (1 fig.).

Homology of Selachian Ampullæ.*—J. B. Johnston differs entirely from the argument of Allis that the nerve-sacs of Ganoids and the ampullæ of Selachians are the homologues of the end-buds of Teleosts, rather than of the lateral line or pit-organs. He criticises the bases of the arguments which Allis advanced, and emphasises the constancy of the chief divisions of the nervous system, and the inseparable and unchangeable unity of the central and peripheral elements of each functional division.

Homologue of Infundibular Organ in Amphioxus.†—J. Boeke finds on the ventral wall of the cerebral ventricle of the larval lancelet (1.5–4.8 cm. in length), at a definite spot, a well-defined organ-like differentiated portion of the ventricle-epithelium, which he regards as the homologue of the infundibular organ in higher Chordates. The infundibular organ would thus be older than the infundibular evagination, which appears contemporaneously with the brain-curvatures.

Note on Additions to Fresh-water Fauna.‡—C. Vaney and A. Conte report the appearance in the fresh water of Lyons of *Emea lacustris* or *Tetrastemma lacustre*,—a Nemertean discovered by du Plessis on the Savoy side of Lake Geneva. It exhibits a natural scissiparity.

Another recent addition to the Lyons fauna is *Blennius alpestris*, first found by Blanchard in the Lake of Bourget. Like *Emea*, it has probably reached Lyons viâ the Rhone.

The authors go on to discuss the adaptability of various fishes to change of habitat; thus *Blennius pavo* and *Gobius niger* can stand abrupt change to fresh water, sticklebacks require more gradual transition, while *Crenilabrus masso* is at once killed if taken from the shore and put into fresh water. There seems no doubt that *Blennius alpestris* is a variety of *Bl. cagnota*, adapted long ago to a fresh-water habitat.

Fossil Faunas and Geological Formations.§—H. S. Williams submits a series of statistics from which he deduces the following "laws."

A geological fauna may be defined as an aggregation of species living together, the several species of which hold a definite value in relation to each other.

The relative value of the constituent species is expressed in terms of the abundance or rarity of the individuals of each faunal ("faunule") sample, viz. bionic value.

The purity or integrity of the fauna may be recognised by the list of its dominant species. The geographical distribution of the fauna may be recognised by the presence of the dominant species and their holding their standard dominance in the list of species with which they are associated in the "faunule." The region, over which the bionic equilibrium of the fauna is expressed by occurrence of the same dominant species, is the metropolis of the fauna. The geological range of a fauna is recognised by the persistence of the bionic equilibrium of the species.

Two faunas may coexist in time in distinct geographical areas; but in the same area, the two faunas can appear in their integrity only by

* Anat. Anzeig., xxi. (1902) pp. 308-13. † Tom. cit., pp. 411-4 (3 figs.).

‡ Comptes Rendus, cxxxiv. (1902) pp. 115-7.

§ Amer. Journ. Sci., xiii. (1902) pp. 417-32.

displacement by which the bionic equilibrium will be disturbed. Hence two faunas in their purity will always appear in succession in any single section.

As the geological changes are, in general, in one direction for any particular region, the *shifting of faunas* is likely to be in the same direction for long periods of time, and thus the recurrence of two distinct faunas is rare. Occasionally, oscillation of two faunas can be recognised in a single section; this fact may be interpreted as migration back and forwards over the same region. The occurrence of two faunas each occupying a distinct metropolis will thus rarely ever show itself in lapping of the faunas; but occasionally evidence of the coexistence of the faunas will be seen in the intercalation of a colony of one of the faunas in the midst of the other. The *lapping of faunas*, stratigraphically, is the necessary interpretation of the coexistence of two faunas at the same period of time.

Dolphin Carp.*—M. Jaquet has made a careful analysis of that strange malformation of the carp's head which is known as "carpe dauphin" or "Mops Karpf." The most deformed parts are the ethmoid, the vomer, the prefrontal, and the upper jaw. There is a reduction in the number of bones in the periorbital chain, and the superior maxillary is formed of two pieces instead of only one as in the normal carp.

Carboniferous Cestracionts and Acanthodians.†—C. R. Eastman notes that coincident with the marked increase of Pelmatozoa and certain families of Brachiopods during the Lower Carboniferous all over the world, a race of sharks armed with crushing teeth suddenly acquired dominance, became exceedingly diversified, and finally all but passed away towards the close of the Palæozoic. Of the very extensive group represented by the Coclilodonts and Cestracionts, which is at least as ancient as the Devonian, only one genus, the so-called Port Jackson shark, survives at the present day. With this all the fossil forms agree in having similar but more or less specialised dentition, so that this creature stands in the same relation to the host of Carboniferous sharks with crushing teeth that *Nautilus* does to fossil Cephalopods. He goes on to discuss *Edestus* and *Campyloprion*, *Ctenacanthus* and *Acanthodes*.

Lamarek, Life and Work.‡—A. S. Packard has executed a labour of love in this study of Lamarek's life and work. In spite of the meagre materials, the author has constructed an interesting biography. This is followed by an estimate of Lamarek's many labours, a discussion of the appreciation and depreciation of these, a history of evolution-theory, and a chapter on neo-Lamarekism. No small part of the value of this interesting work lies in the translation of carefully selected passages from Lamarek's works.

Introductory Text-book of Zoology.§—D. S. Jordan and H. Heath have added another to many introductory text-books of zoology. After briefly discussing the characteristics of living things, and of animals as

* Bull. Soc. Sci. Bucarest, x. (1902) pp. 542-7 (2 pls.).

† Bull. Mus. Comp. Zool. Harvard, xxxix. (1902) pp. 55-99 (7 pls. and 14 figs.).

‡ Lamarek, the Founder of Evolution, his Life and Work, New York, 1901. 8vo, xii. and 451 pp. and 10 pls.

§ Animal Forms, London, 1902, 8vo, vi and 258 pp. and 140 figs.

contrasted with plants, and giving a short account of protoplasm and the cell, the authors take a wide and interesting survey of the chief classes of animals. The structural aspect predominates, but considerable attention is paid to habits and life-history, and the particular feature of the book is the great excellence of the half-tone illustrations, many of which are from photographs of the real animals.

Tunicata.

Ovum within Testes of *Fragarium elegans*.* — W. Redikorzew found inside some of the vesicles which compose the male gonad of this (of course, hermaphrodite) composite Ascidian, a large cell,—unmistakably an ovum. He recalls cases of an ovum within the testis of unisexual animals,—lobster (G. Hermann), crayfish (von la Valette St. George), and cockroach (Heymons).

Heart of *Molgula manhattensis*.† — G. W. Hunter, jun., finds that the heart proper of *Molgula* is made up of three different elements, so far as the selective agency of methylen-blue shows: first, cross-stripped muscle-cells which do not take the stain; second, connective tissue elements which are closely applied to the heart musculature in a somewhat regular manner; and third, nerve-cells and fibres. In the preserved material an extremely delicate pavement epithelium seems to form the endothelial lining.

Ascidians of Bermudas.‡ — W. G. Van Name gives a monographic account of the Bermudian Ascidians, which have hitherto received but little attention. Four new genera are described, and 21 new species, out of a total of about 46.

INVERTEBRATA.

Fauna of a Mountain Stream.§ — F. Zschokke gives an account of the characteristic fauna of a rocky torrential stream near Säckinggen. It exhibits a marked resemblance to the fauna of high Alpine streams. Very typical are the larvæ and pupæ of the Diptera—*Liponeura brevisrostris*, *Simulia*, and *Chironomus*, the young stages of Ephemeroidea (*Epeorus*, *Baëtis*, and *Ecdyurus*), certain Phryganidæ, besides *Perla bipunctata* Pictet and *Nemura nitida* Pictet. Among the submerged moss there are minute Hydrachnids unable to swim, various forms of *Aturus*, *Feltria*, *Sperchonopsis*, *Hygrobates*, and *Atractides*. The list also includes *Gammarus pulex*, *Limnæa truncatula*, *Ancylastrum fluviatile*, and the three stream Turbellarians—*Planaria gonocephala*, *Polycelis cornuta*, and *Planaria alpina*, which succeed one another in that order upstream, as Voigt has described elsewhere.

Mollusca.

Fauna of the Gulf of Triest.|| — E. Graëffe continues his admirable faunistic account of the Gulf of Triest, the last published portion

* Zool. Anzeig., xxv. (1902) pp. 484-6 (1 fig.).

† Anat. Anzeig., xxi. (1902) pp. 241-6 (3 figs.).

‡ Trans. Conn. Acad. Sci., xi. (1902) pp. 325-411 (19 pls.).

§ MT. Bad. Zool. Ver., No. 11-2 (1902) pp. 27-41. See Zool. Centralbl., ix. (1902) pp. 42-3.

|| Arbeit. Zool. Inst. Univ. Wien, xiv. (1902) pp. 89-136.

dealing with the Molluscs. We record it particularly because of the notes on the occurrence, mode of life, and breeding season of the forms catalogued.

γ. Gasteropoda.

Classification of Neomenians.*—G. Pruvot divides the Neomenians into four families, of which he gives diagnoses:—(1) *Lepidomenidæ*, the most primitive family, represented by the genera *Lepidomenia*, *Ismenia*, *Stylomenia*, *Dondersia*, *Nematomenia*, *Myzomenia*; (2) *Neomenidæ*, represented by the single genus *Neomenia*; (3) *Proneomenidæ*, represented by *Proneomenia*, *Amphimena*, *Echinomenia* (3), *Notomenia*, *Strophomenia*, *Rhopalomenia*, and *Pruvotia*; (4) *Paramenidæ*, represented by *Marcellomenia*, *Paramenia*, and *Pararhopalia*, three genera which respectively connect this family with the three other families in the order given above.

The Clætodermidæ are regarded as derived from a Neomenian stock which *Proneomenia* and *Notomenia* most nearly represent. Perhaps the Neomenians and the Annelids both diverged from a Turbellarian stock. The Neomenians and the Solenogastres, as a whole, convey the impression of being a debilitated race, perhaps handicapped by the close and inhibiting structural relations between the heart and the genital apparatus. The Placophora, freed from this imperfection—"une tare originelle"—have progressed, but the Solenogastres represent a cul-de-sac in evolution.

Development of *Paludina vivipara*.†—Isabella M. Drummond has studied this subject with special reference to the urinogenital organs, and to the theories of Gasteropod torsion.

The functional kidney of the adult belongs morphologically to the definitive left side of the body, as von Erlanger has pointed out; but the definitive right kidney is not lost, as that authority described; it persists as the genital duct.

An indication of the original cœlomic connection between gonad and kidney is found in the course of development as a thickened ridge of pericardial epithelium, which finally becomes indistinguishable from the gonad, and, after it has acquired a lumen, communicates with the definitive left kidney close to the reno-pericardial aperture. The gonad arises as a solid proliferation of the morphologically dorsal wall of the pericardium. It arises from the original left side only, and shows no sign of a paired origin.

Theories of Gasteropod torsion may be divided into two classes:—
(a) Those which view the present position of the pallial complex as due to a forward movement along the right side of the body, which resulted from greater growth of the left side of the body than of the right; and
(b) Those which view the present position of the pallial complex as due to a ventral flexion followed by a vertical rotation of the whole visceral hump upon the head.

The evidence for the second of these views seems greater than that for the first, in that—

(1) A vertical displacement through 180° of all the organs contained in the visceral hump takes place in the course of ontogeny;

* Arch. Zool. Expér., x. (1902) Notes et Revue, pp. xvii.-xxvii.

† Quart. Journ. Micr. Sci., xlvi. (1902) pp. 97-143 (3 pls.).

(2) There is some evidence, both from comparative anatomy and embryology, for believing that the œsophagus has undergone an actual twist;

(3) Monstrosities which retain the pallial complex in a ventral position show a tendency to form an exogastric coil.

The innervation of the mantle is shown to be equally difficult to interpret on either hypothesis. Against the first view is also urged the insufficiency of the evidence upon which Bütschli bases his conclusions with regard to zones of unequal growth.

With regard to the phylogenetic cause of the vertical twist, embryology can only give negative evidence; while in considering the ontogenetic cause we are thrown back upon unsolved problems of heredity, and must confess our ignorance.

Relations of Kidney in *Haliotis*.*—H. J. Fleure finds that *Haliotis tuberculata* has two separate kidneys right and left of the pericardium, opening externally by separate apertures; that the gonaduct opens into the right kidney, which is the functional excretory organ, while the left kidney is partly degenerating into lymphatic tissue, and is becoming connected with the efferent branchial vein by direct blood-channels; and that the right or functional kidney communicates with the pericardium, while the left one does not. The author discusses generally the difficult question of the kidney homologies in Vertebrates, and supports the view that the kidney which is reduced is that of the pretorsional right (post-torsional left) side.

Purple of *Purpura lapillus*.†—A. Letellier refers to the conclusion of Dubois in regard to the purple of *Murex brandaris*,—that the chromogenic substances produced the purple colour only under the combined influence of light and a ferment. Letellier has made careful experiments, but finds no evidence of a ferment in the case of the dog-whelk. The chromogenic substance becomes purple under the action of light only. A similar transformation is known in other cases, whereas we have no knowledge of a ferment which acts in presence of absolute alcohol, and is not sterilised in the heating chamber at 120°. The author concludes that if Dubois is right in regard to *Murex*, his results do not apply to *Purpura*.

Structure of *Limnæa emarginata*.‡—F. C. Baker has made a careful study of this species (var. *mighelsi*), comparing his results with those reached in regard to the few others that have been studied anatomically. The extraordinary variability of the shell is well illustrated; the animals themselves are wonderfully uniform.

Bivalves with Red Blood-Corpuscles.§—L. Cuénot notes that in a number of Lamellibranchs there are numerous corpuscles with hæmoglobin. This has been recorded for *Arca tetragona*, *A. (Argina) pexata*, *A. trapezia*, and two undetermined species of *Arca*, for *Pectunculus glycimerris*, *Tellina (Gastrana) fragilis*, *Tellina planata* (doubtfully), and for *Solen (Pharus) legumen*. Cuénot tested *Pectunculus glycimerris* from

* Quart. Journ. Micr. Sci., xlvi. (1902) pp. 77-96 (1 pl.).

† Arch. Zool. Expér., x. (1902) Notes et Revue, pp. xxxiii.-xxxvi.

‡ Bull. Chicago Ac. Sci., ii. (1900, received 1902) pp. 191-211 (6 pls.).

§ Zool. Anzeig., xxv. (1902) pp. 543-4.

Roscoff and Arcachon without any success, but found the red corpuscles in specimens from Naples. It turns out that the species so named at Naples is really *Pectunculus violascens* Lam.

Arthropoda.

Epithelial Regeneration in Mid-gut of Arthropods.*—L. Léger and O. Duboscq have studied the mitotic regeneration of the epithelium in Decapod Crustaceans, in *Lithobius*, and in various insects. In general their results confirm the theory of Ziegler and Vom Rath of variously distributed loci of regeneration where mitosis occurs.

Collection of Microscopic Marine Arthropods.†—E. Trouessart gives directions in fourteen paragraphs in regard to the collecting of minute Halacaridæ, Crustacea, &c. in marine exploration. We cannot condense them, but the reference may be of service to explorers interested in having a complete survey.

a. Insecta.

General Course of Entomology.‡—J. H. Comstock and V. L. Kellogg have published a new edition of a work that "represents the fundamental laboratory course in the chief centre of entomological instruction in America." J. G. Needham, in reviewing it, says: "For a simple, straightforward, condensed guide to the laboratory study of elementary insect anatomy, there is no such book elsewhere."

Habits of Larvæ of *Sciara medullaris*.§—A. Giard has studied the habits of these larvæ, which are very common on the dried stems of *Senecio jacobæa* at Wimcreux. They feed on the pith of the ragwort, and there was no evidence of a diet of animal matter, as is sometimes described. Like some other Dipterous larvæ (Syrphidæ), they have a marked power of surviving desiccation. If a piece of stem containing them be dried in a warm chamber, the larvæ become inert, and development stops; when the stem is replaced in a moist chamber, after three weeks or more the larvæ return to their normal activity. They are positively hydrotropic, but at the approach of pupation the hydrotropicism becomes negative. The gregarious instinct, more marked in the army-worm, *Sciara militaris*, is briefly discussed, and further evidence is given of the extent to which the habits are dominated by the conditions of humidity.

Expulsion of Spermatozoa in *Sciara*.||—A. Giard has a remarkable story to tell of the genesis, liberation, and behaviour of the spermatozoa in this Dipterous insect. The phenomena of emission are as complicated as in Hirudinea and Cephalopoda, though there is not, in the strict sense, any spermatophore. The "synandry," or aggregation of the spermatozoa, is especially remarkable.

Studies on Ants.¶—Adele M. Fielde continues her study of ants, and finds that *Stenamma fulvum piceum* is the bearer of three distinct

* Arch. Zool. Expér., x. (1902) Notes et Revue, pp. xxxvi.-xlii.

† Bull. Soc. Zool. France, xxvii. (1902) pp. 23-7.

‡ The Elements of Insect Anatomy, Ithaca, 1901, 8vo, 145 pp. and 11 figs. See Amer. Nat., xxxvi. (1902) pp. 500-1.

§ Comptes Rendus, cxxxiv. (1902) pp. 1179-85. || Tom. cit., pp. 1124-7.

¶ Proc. Acad. Sci. Philadelphia, 1901, pp. 521-44 (2 figs.).

odours, perceived through the three distal segments of her antennæ:— (a) There is a scent deposited by her feet, forming an individual trail, whereby she traces her own steps, discerned through her tenth segment. (b) There is an inherent and inherited odour, manifested over her whole body, identical in quality for queens and workers of the same lineage. It forms a means for the recognition of blood-relations, and is discerned by contact of the eleventh segment. (c) There is a nest-smell, consisting of the commingled odours of all animate members of the colony, diffused by them in air or ether, constituting an aura whereby they distinguish their nest from those of aliens. It is discerned through the twelfth, the distal, segment.

The behaviour of the ant is influenced by a sensory memory. Without experience or instruction, she capably constructs the dwellings of her species and tends the young. Her criterion of a nest-aura is established solely by association, and may be changed many times during her life. Her care of the young is a reflex from the eighth and ninth segments of her antennæ, and she receives an immediate reward for her labour in the sustenance thereby obtained. The gregarious habit of the ant is the conjoint result of the reflexes from the five distal segments of the antennæ.

Sense of Taste in an Ant.*—R. Cobelli has experimented with specimens of *Lasius emarginatus* Oliv., and finds the sense of taste slightly developed. The ants refused solutions of bisulphate of quinine and sulphuric acid, whether by themselves or when mixed with equal parts of honey. On the other hand, they partook indifferently of pure honey, and of honey mixed with equal parts of sulphate of magnesia, tincture of gentian, quassia, salt, naphthaline, &c. &c. These substances were refused by themselves when not disguised by honey.

Morphology of Labial Parts in Hydrocoridæ.†—N. Leon distinguishes two types of labium, one with three joints (e.g. *Appasus*), the other with four joints, e.g. *Halobates*, and discusses the morphological significance of the parts.

Life-History of *Ulula hyalina* Latreille.‡—J. F. McClendon has had an opportunity of observing the life-history of this interesting member of the family Ascaphidæ. The eggs hatch after nine to ten days; the young larva remains quiet for a day or two, after which it seeks the ground and behaves very much like an ant-lion. The larval life lasts about 62 days, with two moults. There is a third moult inside of the cocoon, when the larva changes to the pupa. When full grown, the larva seeks some hidden place where it spins a web, covering it with sand and other small objects. It then gets inside the web and spins a cocoon during three successive nights. McClendon describes the eggs which are fixed in tiers on a branch, the "repagula" (abortive eggs placed in circles below the tiers of eggs), the larva, the pupa, and the cocoon. In an interesting paragraph he compares the habits of *Ulula*-larva with those of the not very remotely related ant-lions (Myrmeleonidæ).

* Verh. Zool.-Bot. Ges. Wien, lii. (1902) pp. 254-7.

† Jassy, 1901, 13 pp. and 4 figs.

‡ Amer. Nat., xxxvi. (1902) pp. 421-9 (15 figs.).

Setæ on the Legs of Flies.* — W. Wesché gives illustrations of the various uses of setæ on the legs of Diptera:—(1) as brushes to clean the antennæ, &c. (fore tarsi of *Musca domestica*); (2) as adhesive pads for holding the female (tarsi and tibiæ of *Platychirus*); (3) as floats, e.g. in *Dolichopus*, where the tomentum or down on the tarsi is so fine that it holds the air and enables the insect to glide on the surface-film of water; and (4) as arrangements for grasping prey, as in *Tachydromia arrogans*. His general thesis is one which is being persistently corroborated, that even minute details of structure, such as the disposition of setæ, have adaptive significance. This becomes more and more evident as our knowledge of habits becomes more intimate.

Hermaphroditism in Species of Chermes.†—N. Cholodkovsky finds that in *Ch. strobilobius* at least there is a frequent occurrence of females with two oviducts which are all hermaphrodites.

Scale-Insects of Japan.‡—S. I. Kuwana has collected no fewer than 76 species of Japanese scale-insects, twenty of which are described as new. The total list for Japan is now 116 species.

β. Myriopoda.

Anterior or Cephalic Glands of Diplopoda.§ — F. Silvestri has discovered in *Pachyulus communis* anterior or cephalic glands certainly homologous with the buccal, mandibular, and maxillary glands of Chilopoda.

Locomotion of Myriopods.|| — G. Rossi discusses three problems,—(1) the order in which the appendages move in progression, (2) the rapidity of movement, and (3) the movement on a vertical surface. Both in order of movement and in rate, the appendages of Diplopoda work rather differently from those of Chilopoda, but we must refer to the paper for a statement of the differences. Progression on a vertical surface is possible only when there are slight roughnesses which can be gripped by the setæ and claws.

Alimentary Tract of *Julus communis*.¶ — G. Rossi has descriptive notes on the buccal dilatation, the relatively delicate ectodermic œsophagus, the anterior glands, the peri-œsophageal "adipose tissue" so-called, the peri-intestinal reticular tissue, and the four Malpighian tubules.

δ. Arachnida.

Peculiar Phytoptid Galls.**—C. Rechner describes the work of a species of *Phytoptus* parasitic on *Artemisia campestris* which gives its host a most deceptive resemblance to *Filago arvensis*. This, he thinks, may have some adaptive significance, perhaps protecting the Phytoptid galls.

* Journ. Quekett Micr. Club, 1902, pp. 245-50 (2 pls.).

† Zool. Anzeig., xxv. (1902) pp. 521-2 (3 figs.).

‡ Proc. California Ac. Sci., iii. pp. 43-98 (7 pls.).

§ Lab. Zool. Scuola Sup. Agric. Portici, June 1902, 2 pp.

|| Ex Att. Soc. Ligustica, xii. (1901) 17 pp.

¶ Ex Bull. Soc. Entomol. Ital., xxxiv. (1902) 7 pp. (1 pl.).

** Verh. Zool.-bot. Ges. Wien, lii. (1902) pp. 152-3.

New Uropodinæ.*—E. Trouessart discusses the family Uropodinæ, and describes (1) four new species of *Uropoda*, (2) *Uropoda* (*Glyphopsis*) *riccardiana*, as a representative of the sub-genus *Glyphopsis* Berlese, and (3) three new species of *Discopoma*.

New British Hydrachnid.†—C. D. Soar describes *Ecpolus papillosus* sp. n., an unrecorded Hydrachnid found in Britain. The specimen (a female) was discovered by Taverner in the New River. Its nearest relative seems to be Koenike's *Ecpolus tuberatus*, described and figured in his Hydrachnidæ of Madagascar and Nossi Bé.‡ Koenike reports that the animal is new to him, but thinks that it belongs to the genus *Ecpolus*.

Arrangement of a Spider Collection.§ — Fr. Dahl utilises three methods:—(a) preservation of the entire animals in alcohol, &c.; (b) exhibition of dried specimens; and (c) permanent preparations of the important diagnostic parts. The paper includes many practical hints of value to museum workers.

Classification of Spiders.|| — Fr. Dahl discusses the value of the cribellum and calamistrum in the classification of spiders, and takes a systematic survey of the Zoropsidæ in particular. The new genus *Calamistrula* is described.

e. Crustacea.

Ephippia of the Lynceid Entomostraca.¶ — D. J. Scourfield has made a detailed study of many of these, and submits a number of general conclusions.

The ephippium is usually composed of a large portion of the original shell, in the majority about three-fourths, and in *Alona tenuicaudis* the whole. The dorsal margin of the ephippium is always specially strengthened by a more or less copious deposit of chitin. The anterior margin is formed by the ordinary line of junction between the head-shield and the valves.

The line of separation between the ventral portions of the valves to be detached and the ephippium is traced out, at least anteriorly, before the ephippium is thrown off, and it appears to be always due to the special formation of a row or rows of easily separated pieces of chitin, of variable but usually minute size.

The chitin of the valves of the ephippium is always more or less darkened and probably thickened, but it is not usually much modified, except that the ordinary shell sculpture becomes at times intensified, and a minutely pitted structure is often developed. Between the outer valves of the ephippium and the egg there are always certain membranes or pieces of tissue, probably forming in most cases a perfectly closed inner envelope for the egg. The ephippium contains but one resting egg, except in the genus *Eurycercus*, where numerous eggs occur, and in Weismann's case of *Camptocercus macrurus*, which has sometimes, but not always, two eggs.

* Bull. Soc. Zool. France. xxvii. (1902) pp. 29-45 (3 figs.).

† Journ. Quekett Micr. Club, 1902, pp. 251-2 (1 pl.).

‡ Abh. Senckenberg Nat. Ges., xxi. p. 368 figs. 73-9.

§ SB. Ges. Nat. Freunde Berlin, 1901, pp. 1-8.

|| Tom. cit., pp. 177-99 (6 figs.).

¶ Journ. Quekett Micr. Club, 1902, pp. 217-44 (3 pls.).

New Rhizocephalid Type.*—H. Coutière found under the abdomen of three species of *Alpheus* a new Rhizocephalid parasite, remarkable in being gregarious. A hundred or more occurred together, forming a mass like a bunch of eggs. The new form, for which the name *Thylacoplethus* is proposed, approaches *Thompsonia globosa* Kossmann. It seems certain that the larvæ fasten themselves directly on the place where the adults are found.

Structure of Thylacoplethus.†—H. Coutière describes some of the remarkable features in the internal structure of this new Rhizocephalous parasite which infests species of *Alpheus*,—*T. haddoni* on *A. avarus*, *T. edwardsi* on *A. edwardsi*, and *T. heurteli* on *A. macrochirus*. In its mode of fixation, in its simple structure, in its gregarious character, the genus *Thylacoplethus* may be taken as representing a very primitive type, one of the first essays in parasitism on the part of these Crustaceans.

Scottish Crustacea.‡—T. Scott describes the Isopod *Pleurocrypta longibranchiata* obtained on a species of *Galathea* from the Clyde, and *Pl. patiencei* sp. n. from a specimen of *Caridion gordonii*. The new form is called after Alexander Patience who has done much good work in collecting Clyde Crustaceans and who sent the author a new Bopyrid, *Pleurocrypta cluthæ* sp. n. The communication includes a note on *Tryphana malmii* Boeck, a somewhat rare Amphipod obtained on the deep water about nine or ten miles off Aberdeen.

Commensal Schizopod.§—J. Bonnier and C. Pérez describe *Guathomyxis gerlachei* g. et sp. n., type of a new family of Schizopods, found at Massaouah on the Red Sea. It is perhaps more remarkable in habit than in structure, for it occurred (four specimens) within the topmost turn of the spire of gastropod shells inhabited by *Pagurus brevipes*.

Early Development of Lepas ||—M. A. Bigelow discusses the maturation, fertilisation, cleavage, and germ-layer formation. His research is mainly a study in cell-lineage on to the 62-cell stage.

Lepas resembles most other Crustacea (a) in respect to the position of the blastopore, which is ventral and posterior; (b) in the extension of the entoblast and mesoblast from the blastopore as a starting-point; and (c) in the mode of formation of the organs of the larva.

In *Lepas*, as in most other Crustacea, the mesoblast and entoblast originate in the region of the blastopore from cells which, speaking in general terms, at first lie in the blastoderm and later migrate into the cleavage-cavity.

Among the migrating mes-entoblastic cells one can distinguish in *Lepas* the individual cells of the entoblast and of two varieties of mesoblast. Representatives, if not precise homologues, of these kinds of cells are probably present both in other Entomostraca and in the higher Crustacea.

The origin, relative position, and fate of all the cells of all the cleav-

* Comptes Rendus, cxxxiv. (1902) pp. 913-5. † Tom. cit., pp. 1452-3.

‡ Ann. Nat. Hist., x. (1902) pp. 1-5 (1 pl.).

§ Comptes Rendus, cxxxiv. (1902) pp. 117-9.

|| Bull. Mus. Zool. Harvard, xl. (1902) pp. 61-144 (12 pls.).

age stages are shown to be constant, definite, and "determinate," so far as the formation of germ-layers is concerned. In later stages specific areas of cells, known to be of definite origin, enter into the formation of particular organs. It is therefore probable that the cells in cleavage stages bear a definite and constant relation to future organs. A clear table of the lineage is given. In an addendum, E. L. Mark and W. E. Castle maintain that *Lepas* is a good example of modified "quartet" cleavage.

So-called Hepatico-Pancreatic Glands of Isopods.*—L. H. Huie has made some observations on the changes which these cells (in *Oniscus* and *Porcellio*) undergo owing to functional activity. Their size renders them a favourable subject for physiological investigations. The livers are tubular glands composed of two kinds of cells in a single layer:—(a) large cone-shaped cells projecting conspicuously into the lumen in transverse sections of the glands; and (b) small, more or less stellate cells, inconspicuous in transverse sections. Both usually contain two nuclei. The large cells contain a great quantity of yellow oil, and the small cells are normally filled by minute brownish-yellow globules. Fasting for not less than five days causes a diminution of the oil in the large cells and the granules in the small ones, and finally the total or almost total disappearance of both. The cells and nuclei shrink, the oil-cavities are obliterated, and the plasma stains deeply all over, but especially towards the periphery of the cell bordering the lumen. The lumen of the livers of *Oniscus* is very generally infested with bacteria.

Mysis in the Volga.†—W. Zykoff reports finding in the Volga at Saratow both males and females of *Mesomysis ullskyi* Czern. This seems to be the third case in Europe of a representative of the Mysidæ occurring in rivers. In 1828 Vaughan Thompson recorded *Mysis chamæleon* and *M. vulgaris* from the Lee in England; in 1875 Pengo found *Potamomysis pengoi* Czern. in the river Udy at Charkow. Zykoff has had the good fortune to add a third case, and he has for the first time seen the male of this species. He regards the form as a relict from the Aralo-Caspian basin.

Annulata.

Vascular System of Hirudinea.‡—A. Oka maintains that a body-cavity occurs in all Hirudinea. It is much more distinct in Glossiphonidæ and Ichthyobdellidæ than in Gnathobdellidæ and Herpobdellidæ. In the two last-named families it is much restricted by proliferation of connective-tissue, &c.

A true blood-vascular system is represented only in the Glossiphonidæ and Ichthyobdellidæ. It is quite closed, and is in general features comparable to that of Chaetopods. What are called blood-vessels in Gnathobdellidæ and Herpobdellidæ are simple vessel-like channels of the body-cavity.

The Ichthyobdellidæ represent to some extent a transition between the Glossiphonidæ and the Gnathobdellidæ, for they exhibit, besides a true blood-vascular system, vessel-like lateral channels.

* Proc. Scot. Micr. Soc., iii. (1901) pp. 85-8 (2 pls.).

† Zool. Anzeig., xxv. (1902) pp. 275-6.

‡ Annot. Zool. Japon., iv. (1902) pp. 49-60 (5 figs.).

Early Development of Mesoblast in *Thalassema*.*—J. C. Torrey notes that the mesoblast in *Thalassema mellita* has a twofold origin, as entomesoblast—derived from the posterior member of the fourth quartet, and as ectomesoblast—derived from all of the first three quartets of ectomeres, instead of from one alone as has hitherto been described to be the case. A considerable number of these cells, however, are rudimentary, and quickly disappear. It is, however, very difficult to make the lineage at all clear without the author's figures.

Nematohelminthes.

Fermentation of Glycogen in *Ascaris*.†—E. Weinland notes that *Ascarids* kept without food or oxygen for 5–7 days in 1 p.c. salt solution at the temperature of their host, show a marked diminution in their rich store of glycogen. This is not due to a combustion, but to a fermentation, resulting in carbonic acid gas and valerianic acid.

New Nematodes.‡—O. von Linstow describes two new parasites from the iguana, *Metopoceros cornutus*, the one a species of *Atractis* (*A. cruciata* sp. n.), the other *Oxyuris monhytera* sp. n.

Platyhelminthes.

Fertilisation in Cestodes.§—O. Fuhrmann discusses the various modes of fecundation in Cestodes. In *Dioicocestus* Fuhrmann, where the sexes are separate, there is ordinary copulation. In tapeworms with well-developed penis, which occur in numbers together, e.g. *Tænia inflata* and *T. cirrhosa*, there is cross-fertilisation, or at least fertilisation between different proglottides of one strobila. Where the cirrus is relatively ill-developed or very short, as in *Davainea* and *Acoleinae*, auto-copulation occurs, though cross-fertilisation is still possible. In *Aporina* g. n. (*Aporina alba* from *Pyrrhua*) cross-fertilisation is quite impossible, for the vagina and the cirrus do not open to the exterior, but are connected in the internal parenchyma.

New Species of *Caryophyllæus* ||—G. Schneider found in 29 specimens of *Leuciscus erythrophthalmus* three cases of abundant infestation with *Caryophyllæus fennicus* sp. n., a new example of an interesting genus. Somewhat notable is its firmness of fixation in spite of a very simple attaching apparatus, apparently a mere depression of the anterior end. But this anterior end bears fine stiff "Härchen," is very mobile, and strongly innervated. The new parasite is intermediate between *C. mutabilis* and *C. tuba*; it has no proper cirrus, but a large pyriform seminal vesicle. Like *C. mutabilis*, it probably has some limicolous *Oligochæt* as its intermediate host.

Schneider also describes *Bothrimonus nylandicus* sp. n. from the flounder (*Pleuronectes fjesus*). In its contracted state especially, this Cestode has a very marked resemblance to *Diplocotyle*, and this genus

* Anat. Anzeig., xxi. (1902) pp. 247–56 (3 figs.).

† Zeitschr. Biol., xlii. (1901) pp. 55–90. See Zool. Centralbl., ix. (1902) pp. 451–2.

‡ Centralbl. Bakt., 1^o Abt., xxxi. (1902) pp. 28–32 (1 pl.).

§ CR. Soc. Neuchatel Sci. Nat. in Arch. Sci. Nat., xiii. (1902) pp. 516–7.

|| Arch. Naturges., lxviii. pp. 65–78 (1 pl. and 3 figs.). See Centralbl. Bakt., 1^o Abt., xxxi. (1902) pp. 720–1.

should be absorbed in *Bothrimonus*. The author indicates that *Bothrimonus* leads from the Cestodaria, on the one hand to the Bothriocephaloidæ, on the other hand to the Cyathocephalidæ.

Unusual Human Parasite.*—F. Zschokke substantiates the occurrence of *Hymenolepis (Drepanidoteenia) lanceolata* Bloch as a parasite in man. Two specimens from a boy of twelve years of age were transmitted by Kükenthal, from Breslau. It will be remembered that this parasite is widely distributed in aquatic birds, e.g. in ducks and geese, and that it is believed to cause epidemics among them. The young stages occur in common Copepods—*Cyclops scerrulatus* and *Diaptomus spinosus*, and might thus readily infect man from unsuitable drinking-water. The author notes that *Davainea madagascariensis* Lkt., a representative of another characteristically avian genus, also occurs in man.

New Distomids.†—Th. Odhner gives a diagnosis of a proposed new sub-family, Zoogoninæ, including the genera *Zoogonus* Lss. and *Zoogonoides* g. n. To the former the author adds the species *Zoogonus rubellus* from *Labrus berggylta*; the new genus is represented by *Zoogonoides viviparus* from numerous flat-fishes.

The second part of the paper discusses the flukes found in the urinary bladder of fishes; four new species of *Phyllodistomum* are described, and a new genus and species is established for *Lepidophyllum steenstrupi* from the cat-fish.

Fasciolid Parasites of Birds.‡—M. Braun has published a valuable account of the flukes which occur in birds. It includes a description of 72 species, many of which are new.

Fecampia.§—M. Caullery and F. Mesnil describe *F. erythrocephala*, which Giard discovered in 1886,—a Rhabdocœl parasitic in crabs and hermit-crabs. They have found another species, *F. xanthocephala*, in small specimens of *Carcinus mœnas* and in *Idotea neglecta*. It may be said that *Fecampia* represents the most degenerate type of Turbellarian; there is no mouth, no pharynx, no functional digestive apparatus, no excretory system; the gonads and their ducts exhibit the maximum simplicity. When adult, the parasite leaves its host, secretes a cocoon, and is sacrificed in the production of embryos, as Giard described. The development, which is outlined, is not remarkably different from that observed by Metchnikoff, Hallez, Ijima, and others, in various Tricelads and Rhabdocœls. After some free life, the larvæ penetrate into their crustacean hosts, losing eye-spots, mouth, pharynx, &c., and exhibiting an active proliferation of the mesenchyme.

Nemertean Parasites of Crabs.||—W. R. Coe gives a diagnosis of a new genus *Carcinonemertes*, and describes in particular *C. epialti* sp. n. His observations lead on to the following general conclusions:—That the nemerteans infesting crabs are distributed throughout the North

* Zool. Anzeig., xxv. (1902) pp. 337-8.

† Centralbl. Bakt., 1^{te} Abt., xxxi. (1902) pp. 58-69 (3 figs.).

‡ Zool. Jahrb., xvi. (1902) pp. 1-162 (8 pls.).

§ Comptes Rendus, cxxxiv. (1902) pp. 911-3.

|| Amer. Nat., xxxvi. (1902) pp. 431-50 (9 figs.).

Atlantic and into the Pacific Ocean; that the New England form is identical with the long-known European species (*C. carcinophila*); that all the species recorded are closely related, and the several European forms are perhaps the same species; that the worms are true parasites, spending practically their whole existence on the crab—in the gills when young, on the egg-masses when mature; that in different regions the same species may occur on different crab hosts; that they crawl about on the bodies of the crabs, and are thus easily transferred from host to host; and that by means of the free-swimming embryos the species may be distributed widely, although the young usually remain among the egg-masses until they are past the free-swimming stage.

Incertæ Sedis.

Habits of *Lingula*.*—Naohidé Yatsu supplies some interesting information in regard to the habits of this Brachiopod. It occurs in every suitable mud-flat along the coast of southern Japan, never in deep water. It is sometimes abundant enough to be sold by the peck for food. It lives fixed to the hard sandy mud, not to rock or stone; it retires deep into its burrow at low tide, so that no trace can be seen from the surface.

In making the burrow the water is at first forcibly gushed out of the central funnel formed by the mantle-edge and the setæ. By the above action, coupled with the sliding lateral motion of the shell, the burrow is soon formed, and its walls are made smooth by the secretion of the gland-ridge ("Drüsenwall"), and by the up-and-down gliding of the valves. The contractility and regenerative power of the stalk is remarkable. Only the comb-like row of cirri of the largest whorl of the arm can be protruded out of the shell, and the tip of the arm-apparatus is always kept within the mantle-cavity.

It seems probable that at Misaki *Lingula* lives for five years or more on an average. They have extraordinarily great powers of surviving disadvantageous conditions, as is illustrated circumstantially in the paper.

The author refers to the fact that Morse took living specimens to America, and had the satisfaction of placing them upon a ledge of Cambrian limestone among the primeval, but hardly different, shells of their ancestors. "*Lingula* had already acquired, as long ago as the Cambrian period, an organisation most favourable for facing all the ambient conditions, physical as well as chemical, that have taken place since that time, and there seems to have been no necessity for improving their adaptations to the environment."

New Enteropneust. † — Hisato Kuwano describes *Balanoglossus misakiensis* sp. n., a new Japanese Enteropneust, found in the vicinity of Misaki.

It is distinguished by the following features:—(1) definite arrangement of the longitudinal stems of the dermal capillaries in the anterior portion of the proboscis wall; (2) occurrence of an alveolar structure in the connective tissue of the proboscis cœlum; (3) occurrence of

* Annot. Zool. Japon., iv. (1902) pp. 61, 7 (2 figs.).

† Tom. cit., pp. 77-84 (6 figs.).

another circular vessel at the anterior portion of the trunk, immediately behind that which lies between the collar and the trunk; (4) confluence of the four most anterior pairs of gill-pouches into a common cavity on each side, discharging to the exterior through a common gill-pore, with the collar-pores distinct at the anterior wall of the common cavities; (5) communication of the lateral vessels with the dorsal vessel immediately behind the last gill-slits; (6) occurrence of circular muscle-fibres at the anal region, just external to the longitudinal muscle-fibres upon the gut-wall; (7) dorso-terminal position of the anus.

Though the species is to be ranked, from its general structure, under the genus *Balanoglossus* Delle Chiaje among the Ptychoderidæ, it has some features characteristic of other groups of the Enteropneusta.

Variation in *Platystrophia* Lynx.* — E. R. Cumings and A. V. Mauck have made a quantitative study of variation in this fossil Brachiopod. The species is extremely variable, exceptionally abundant and well-preserved, and thus well suited for quantitative study. Such an investigation is more warranted because of the different opinions current as to the taxonomic importance of several of the forms under which *Platystrophia* presents itself.

Echinoderma.

Extraordinary Animal.† — H. L. Clark reports, under the above title, on a strange specimen dredged by the "Albatross" in 1588 fathoms off the Queen Charlotte Islands. It is probably a monstrosity, but of what? It has a firm external skeleton, which completely encloses it, and two parts with no internal communication. The smaller upper part is nearly cylindrical, bounded by a calcified membrane, strengthened by seven transverse rib- or hoop-like thickenings, which are lighter in colour than the membrane. At the posterior end are two very short longitudinal ribs of similar appearance. The skeleton of the lower part is made up of numerous small, closely united plates of unequal size, and of no definite arrangement, each bearing a blunt spine about 1 mm. in length. Similar spines occur on the upper part of the animal, like Echinoid spines microscopically, but not jointed to the skeleton. Apart from the spines, the whole external appearance of the lower part is like the Holothurian, *Sphærothuria* or *Echinocucumis*.

The upper chamber contained a much-branched gland, resembling the gonad of a Holothurian. The lower chamber is almost wholly filled with what appears to be part of a digestive-tube with a large lumen. There is no evidence of mouth, anus, locomotor organs, water-vascular system, nerves, or sense-organs, so far as macroscopic observations show. The specimen, light brown in colour, is about 15 mm. in length, and the greatest height is about the same. Such an extraordinary animal gives one pause, and makes one feel as if there were something wrong in Nature or in man's device. The author is inclined to call it a monstrous Holothurian, allied to *Sphærothuria*.

Body-Wall and Gut-Wall in Echinoderms.‡ — E. Hérouard gives an account of the body-wall in Holothuroids, and compares it with that

* Amer. Journ. Sci., xiv. (1902) pp. 9-16 (3 pls.).

† Zool. Anzeig., xxv. (1902) pp. 509-11 (1 fig.).

‡ Bull. Soc. Zool. France, xxvii. (1902) pp. 131-8 (1 fig.).

in other Echinoderms. The wall of the body and the wall of the gut in Echinoderms is formed of three layers, of which the median one represents the schizocoel and is composed of lacunar tissue; calcareous formations are confined to the other two. The hæmal system is not a closed system apart from the schizocoel, but remains freely in communication with it.

Cœlentera.

Free-Swimming Hydroid. *— A. Dendy found on the beach near Christchurch a living specimen of what must be called a free-swimming hydroid,—perhaps an aberrant Tubularian, related to *Corymorpha* and its allies. Dendy calls his prize *Pelagohydra mirabilis* g. et sp. n., and gives this diagnosis:—Hydroid solitary, free-swimming; the proximal part of the body modified to form a float, supported internally by a system of radiating membranes of endodermal origin; the distal portion forming a flexible proboscis, with the mouth at its extremity. Gastral cavity continued from the proboscis into the float in the form of endodermal canals, from which arise branching stolons. Tentacles filiform, scattered over the surface of the float and in whorls around the mouth. Medusæ developed on stolons between the tentacles of the float; quadri-radiate, symmetrical, probably with gonads in the wall of the simple manubrium; tentacles in four per-radial groups of five (possibly more in the adult).

The adaptation of a hydroid type to free-swimming life, such remarkable structural features as the endodermal canals from the gastral cavity and the float with its extraordinary supporting membranes, and the high degree of histological differentiation, make *Pelagohydra* a remarkable interesting organism.

Budding in Larvæ of *Gonionema murbachii*. †— H. F. Perkins describes a very interesting and quite unique case—a process of non-sexual multiplication by budding in the solitary larvæ of a Hydro-medusan. The buds are produced singly and become detached as planulæ. From the planula stage onward, the asexually produced larvæ repeat the ontogeny of the sexually produced forms. The author also reports an instance of apparent transverse fission, in which the cœlenteron had undergone complete division.

Aggregated Colonies in Madreporarian Corals. ‡— J. E. Duerden discusses the occurrence of colonies, which von Koch called "aggregated," formed through the secondary fusion of individuals which were originally distinct, as apart from most Anthozoan colonies which are produced by the budding or fission of a single individual. Von Koch's example was found in specimens of *Balanophyllia verrucaria*, a Mediterranean coral which usually retains a simple habit; Lacaze-Duthiers described and figured a similar aggregated state in *Caryophyllia*; certain forms of the rugose coral *Streptelasma* (*Palæophyllum*) *divaricans* Nicholson seem also to be aggregated colonies. Duerden has found in the common West Indian coral, *Siderastræa radians* Pallas, actual instances of colony formation by the fusion of originally free, distinct

* Quart. Journ. Micr. Sci., xlvi. (1902) pp. 1-24 (2 pls.).

† Johns Hopkins Univ. Circ., xxi. (1902) pp. 87-9 (11 figs.).

‡ Amer. Nat., xxxvi. (1902) pp. 461-71 (3 figs.).

larvæ. The process of growth was followed from the time of fixation of the free-swimming individuals as far as the production of the early skeleton.

Actinians of Porto Rico.*—J. E. Duerden describes the structure of a collection of (13) Actinians from Porto Rico, including a new species *Bunadosoma spherulata*.

Dispersal of *Sagartia lucia*.†—G. H. Parker makes a report on the multiplication and dispersal of this New England sea-anemone, which seems to have migrated eastward from New Haven and northward to Salem with relatively great rapidity. It has probably covered the distance between these extremes in ten years. Like the introduced periwinkle, *Littorina littorea*, this species will probably gain an extended distribution both north and south of Cape Cod, though in this instance the invasion comes from the south instead of from the north, as with the periwinkle.

Porifera.

Asexual Origin of the Ciliated Sponge Larva.‡—H. V. Wilson has previously published certain observations which led him to believe that in monaxonid sponges, e.g. *Esperella fibrecilis*, free-swimming larvæ identical in structure with those developing from eggs are sometimes produced asexually. He still holds to this interpretation of what he observed, answers some criticisms of Maas, and finds confirmation in Ijima's description of the congeries or groups of "archæocytes" (undifferentiated cells) which occur in Hexactinellids. After recalling Wilson's observations, Ijima says: "I conceive the mode of origin and growth of the archæocyte congeries in the Hexactinellida to be just the same, and it seems to me not impossible that in the hexactinellid larvæ which I have seen we have simply a new case of the 'gemmule-larva' or bud embryo."

Algerian Sponges.§—E. Topsent gives a faunistic account of the sponges (62 in number) of the Algerian coasts (La Calle), and compares them with those of the French and Italian coasts.

Protozoa.

Yeast-eating Amœboid Organism.||—T. Cürzäszcz gives a graphic description of the powers possessed by *Physarum leucophæum ferox* in devouring yeast-cells (*Mycoderma cerevisiæ*, *Saccharomyces apiculatus*, &c.) and digesting them. A struggle with the bacteria of acetic acid was also witnessed; the microbes were ingulfed, "jedoch nicht gerne," and they were soon expelled again. The amœboid organism in question is a myxomycete, closely allied to *Physarum leucophæum*.

Digestion in Amœbæ.¶—H. Mouton has carefully isolated an amœba and studied its multiplication, encystation, and digestive pro-

* Bull. U.S. Fish Commission for 1900, pp. 323-74 (13 pls.).

† Amer. Nat., xxxvi. (1902) pp. 491-3. ‡ Tom. cit., pp. 451-9.

§ Arch. Zool. Expér., ix. (1901) pp. 327-70 (2 pls.).

|| Centralbl. Bakt., 2^{te} Abt., viii. (1902) pp. 431-41 (1 pl.).

¶ Ann. Inst. Pasteur, xvi. (1902) pp. 457-509 (1 pl.).

cesses. He kept his species in company with *Bacterium coli*, on which it feeds. By means of the secretion of its contractile vacuole it agglutinates the microbes and ingests them. Their changes within the Amœba are described.

From the cultures of amœbæ the author obtained a proteolytic ferment, approaching trypsin, and this seems to be the digestive agent within the food-vacuoles.

Parasites of Rotifers.*—A. M. Przesmycki divides the parasitic organisms found inside Rotifers into two groups. The first group includes forms which attack living Rotifers and gradually kill them; their nature remains obscure, but they seem to correspond to the "parasitic vesicles" described by Bertram and compared by him to Chytridiaceæ.

The second group includes forms which find entrance only into moribund Rotifers. Thus the author describes (1) *Endophrys rotatoriorum* g. et sp. n.—a Heliozoon—nor unlike *Nuclearia*; (2) *Dimœrium hyalinum* g. et sp. n., a plastic form, occurring in flagellate, amœboid, and encysted phases. These two new forms and a third less fully discussed are facultative parasites, and are not peculiar to dying Rotifers.

New Parasitic Infusorian.†—M. Siedlecki describes *Herpetophrya astoma* g. et sp. n. found as a parasite in the body-cavity fluid of *Polymnia nebulosa*. The structure, movements, and transverse fission are described. The position of the new form is in the family Opalinidæ, near *Anoplophrya* Stein and *Monodontophrya* Vejdovsky.

Two new Dinoflagellata.‡—O. Zacharias describes two new representatives of the genus *Glenodinium*—*Gl. apiculatum* sp. n. from the Eckbergsee near Plön, and *Gl. lemmermanni*—commemorating the work of a most industrious algologist—from the great lake of Plön.

Action of Blood-Serum on Paramœcium.§—Ledoux-Lebard has made numerous experiments on the effect of the blood-serum of various animals on Paramœcium. The movements of the Infusorians are weakened, and they soon cease altogether. The individuals give off faecal particles which adhere together and to their producers, which then become agglutinated in radiating or irregular aggregates.

Marine Phosphorescence.||—Fr. Weitlauer gives a graphic description of five different types of marine illumination—mainly due to Noctiluca.

Observations on Protozoa.¶—J. Y. Simpson has made a number of observations on the ultimate structure of Protozoa, e. g. of the macronucleus of Ciliata, as exhibited by intravital staining. He also discusses protective encystment in the case of the Ciliata, and has obtained the cysts of *Paramœcium* and *Spirostomum* which were not previously known to encyst. His opinion is that all the Ciliata would be found to possess

* Bull. Acad. Sci. Cracovie, 1901, pp. 358-408 (3 pls.).

† Tom. cit., pp. 356-32 (1 pl.).

‡ Zool. Anzeig., xxiv. (1901) pp. 307-8.

§ Ann. Inst. Pasteur, xvi. (1902) pp. 510-21.

|| Verh. Zool.-bot. Ges. Wien, lii. (1902) pp. 270-7.

¶ Proc. Scot. Micr. Soc., iii. (1901) pp. 90-108 (2 pls.).

the faculty of protective encystment, if only the suitable conditions could be discovered.

A precise account is given of the process of encystment in *Paramecium* and *Spirostomum ambiguum*; and there are many other detailed observations of interest.

New Trypanosoma.*—D. Bruce describes *T. theileri* sp. n. discovered by A. Theiler in blood taken from a young ox which had just recovered from rinderpest. It is nearly twice as large as the Trypanosoma of Surra, Tse-tse fly disease, or of rat, but agrees with them in its oval protoplasmic body, longitudinal fin-like membrane, and single flagellum.

It only infects cattle; horses, dogs, goats, rabbits, and guinea-pigs are all immune. When inoculated into calves it causes an acute pernicious anæmia with grave blood changes; or a general anæmia without deformation of the elements of the blood; or, lastly, only a slight fever, but there is a relative natural immunity in cattle against it. The disease is probably that which Kolle described as bovine malaria.

Multiplication of Trypanosoma in Fishes.†—A. Laveran and F. Mesnil describe the binary fission (equal or sub-equal) of *Trypanosoma remaki* and *Trypanoplasma borreli* in the blood of fishes, where the presence of these parasites seems only slightly, if at all, pathogenic. They have also shown that these parasites may be readily inoculated from one fish to another of the same species.

Sexual Phenomena in Ptercephalus.‡—L. Léger and O. Duboseq find that in the Gregarine, *Ptercephalus nobilis* A. Schn., parasitic in *Scolopendra*, there are sexual elements, as in the Stylorhynchids, differentiated as ova and spermatozoa.

The so-called conjugation is anisogamous in a high degree. But, while in *Stylorhynchus* the very large spermatozoa bear with them the larger portion of nutritive reserve, those of *Ptercephalus* are very minute, and the nutritive vitellus is in the ova.

Sarcocystis tenella in Man.§—P. Vuillemin has found in preparations made by Hoche conclusive evidence that *Sarcocystis tenella*, common in the sheep, occurs in man's muscles. He notes that the membrane surrounding the parasite is two layers thick. The external layer is composed of an achromatic, flexible, compressible "fundamental substance," and a stainable substance, disposed in irregular prisms, simulating a ciliary covering when the fundamental substance is destroyed. The units, which are at first quite uniform, become differentiated into fertile and sterile forms.

* Proc. Roy. Soc. London, lxxix. (1902) p. 496.

† Comptes Rendus, cxxxiv. (1902) pp. 1405-9.

‡ Tom. cit., pp. 1148-9.

§ Tom. cit., pp. 1152-4.



BOTANY.

GENERAL,

Including the Anatomy and Physiology of Seed Plants.]

Cytology,

including Cell-Contents.

Nature and Function of the Nucleolus.*—E. Paratore publishes some further researches upon the radical tubercles of the Leguminosæ, with regard to the structure and alteration of the nucleus of the tubercular cell in *Vicia Faba*. By the use of new reagents he has confirmed his results of last year and has arrived at some new ideas about the nature and function of the nucleolus. He quotes the views of Cavara and of Busealioni and others, and calls attention to the frequent difficulty of distinguishing nucleoli from macrosomes, to the inconstancy of the reaction of nucleoli and chromatin to differential stains, to the identity of coloration of both in various physiological and pathological conditions, and to the appearance of many granules more or less easily identifiable with the nucleolus. He thinks that the nucleolus may be a hypertrophic and differentiated chromosome, and that it may be a metabolic centre of the nucleus and especially of the chromatin, an element of nutrition and of respiration.

Cytological Changes accompanying the Secretion of Diastase.†—J. C. Torrey has studied the place, mode, and time of origin of the diastatic enzyme in seeds of maize and barley. He finds that the enzyme arises in the nuclei of the columnar epithelium of the scutellum, in the form of dark staining granules which exude in small streams through breaks in the membrane and collect at the end of the cell next to the endosperm, where they are ultimately dissolved. Immediately after their disappearance the first signs are observed of the destructive action of a ferment on the cells of the endosperm, and starch-grains soon appear in greater abundance on the cells of the scutellum. The formation of the ferment begins in the nuclei before the commencement of the resting period. The process of secretion is at first intermittent, but after the third day of germination until the final exhaustion of the cells the secretion is more continuous.

Crystals of Calcium Oxalate in Seedlings of Alsike.‡—J. Percival describes the distribution and first appearance of crystals of calcium oxalate in *Trifolium hybridum* in plants grown under various conditions. Plants grown in distilled water in paraffin-lined flasks show development of crystals, first in the petioles of the cotyledons, and then near the tips of the vascular bundles in the primary leaf. They very rarely occur in the hypocotyl or root. Similar development along the track of the vas-

* Malpighia, xv. (1902) pp. 178-87.

† Bull. Torr. Bot. Club, xxix. (1902) pp. 421-35 (1 pl.).

‡ Journ. Linn. Soc. (Bot.), xxxv. (1902) pp. 396-402 (6 figs.).

cular bundles of the petiole and primary leaf-blades occurs in plants grown with free supply of calcium in the dark, and in an atmosphere free from carbonic acid gas. When transpiration is reduced fewer crystals appear, and when allowed to grow in a crowded state on filter-paper in covered Petri dishes, crystals do not form for a long while. The crystals are attached to or imbedded in a matrix of some pectic substance, and occur in the first row of parenchymatous cells next to the fibres in the bundles of the leaf-blades and petioles. They are always on the side next to the wall of the fibre and not in the middle of the cells. Where few fibres are present, or where they are poorly developed, as in plants grown in the dark and under reduced transpiration, crystals are correspondingly diminished in number. They also decrease in number when the petioles are subjected to gradually increasing tension.

Cyanogenesis in Plants.*—W. R. Dunstan and T. A. Henry have investigated the nature of the poison contained in young plants of the guinea corn (*Sorghum vulgare*), an important food-grain of the tropics. The authors find that the young plant, but not the seeds or old plants, when crushed with water yields prussic acid (about 0.2 p.c. of the dried plant). The acid is not present in the free state but is due to the action of a hydrolytic enzyme, apparently identical with the emulsin of bitter almonds, on a cyanogenetic glucoside which has been named dhurrin from *dhurra*, the Arabic name for the plant. A formula is given for the glucoside which differs from the other two known cyanogenetic glucosides, the amygdalin of bitter almonds and the lotusin found by the authors in *Lotus arabicus*, in being derived from dextrose and not from maltose.

Composition of Orchid Tubers.†—K. Rammelberg finds invert sugar, sucrose, amylose, and cellulose in young and old tubers of eleven different orchids. The old tubers contained the most cellulose, but generally less invert sugar, sucrose, and amylose than the young tubers. The predominating constituent is amylose.

Composition of Bananas.‡—E. Leuscher publishes analyses of the green and ripe husks, the unripe and ripe fruit without the husk, the preserved fruit and the banana meal. The meal contains 6.98 p.c. of crude protein.

Chemical Demonstration of Nectaries in Pollen Flowers and Anemophilous Flowers.§—R. Stäger has employed the chemical method suggested and used by Paul Knuth, namely, use of Fehling's solution, to determine presence of sugar-containing tissue in various flowers. The flower was laid intact in the reagent for about 24 hours, the solution with the flower was then boiled, and the flower washed with cold water. Presence of sugar is indicated by a reddish precipitate of cuprous oxide. By these means the author has demonstrated the presence of nectar or a sugar-containing tissue, in some so-called pollen flowers,

* Proc. Roy. Soc., lxx. (1902) pp. 153-4.

† Bied. Centr., xxxi. (1902) pp. 256-7. See also Journ. Chem. Soc., lxxxii. (1902) ii. p. 420.

‡ Zeit. öffentl. Chem., viii. (1902) pp. 125-34. See also Journ. Chem. Soc., lxxxii. (1902) ii. p. 421.

§ Beih. Bot. Centralbl., xii. (1902) pp. 34-43.

that is, flowers visited for sake of their pollen, as well as in certain anemophilous flowers. Among the former are *Helianthemum vulgare*, *Hypericum perforatum*, and *Papaver Rhœas*, while in others, e.g. *Solanum nigrum*, no trace of sugar was found. *Chenopodium album* and *Plantago lanceolata* were also examined as examples of plants affording a transition between pollen flowers and wind flowers. In both cases sugar was indicated by the cuprous precipitate. Of well-marked wind flowers, the hop showed no trace of sugar; but sugar was found in the anthers of the male flowers of the nettle, the female were not investigated. The stigmas and anthers of several common grasses also showed a well-marked red coloring when heated with the reagent indicating presence of sugar, and the author is convinced that insects play a more important part than generally supposed in the pollination of grass flowers.

Sugars and Organic Acids in certain Fruits.* — A. Borntraeger has estimated the invert sugar, sucrose, and acidity in a number of generally cultivated fruits including species of *Diospyros*, the banana, medlar, *Eriobotrya*, and others. All contained invert sugar, varying in amount in the ripe fruit from 4.7 to 16.2 p.c. Sucrose occurred only in unripe fruit of *Arbutus Unedo* (7.34 p.c.), in ripe banana (7.24 p.c.), and in both ripe and unripe fruit of *Eriobotrya japonica* (from 2.47 to 4.9 p.c.). Malic acid was universally present, but other organic acids such as oxalic, tartaric, and citric were not found except in *Eriobotrya*, the juice from the unripe fruit of which contained on the average 1.24 p.c. of citric acid. Tannin occurred in *Diospyros Kaki* and *D. Lotus*.

Two new Sugars extracted from Manna.† — C. Tauret has isolated two new sugars from manna. One, manneotetrose, has the formula $C_{24}H_{42}O_{21}$, forms minute clinorhombic crystals in aqueous solution, and does not reduce Fehling's solution. It, however, takes up water readily and then becomes a reducing agent. It undergoes partial fermentation by yeast. The other, manninotriose, has the composition represented by the formula $C_{18}H_{32}O_{16}$; is deposited from boiling absolute alcohol in the form of slightly birefractive globules; it has not been obtained in crystalline form.

Constituents of Pith of Maize and Elder.‡ — C. A. Browne, jun. and B. Tollens find pentose to be present in the pith of both maize and elder, and there was also evidence of a sugar resembling dextrose in maize-pith. Xylose and arabinose were also prepared from the pith of both plants by hydrolysis with sulphuric acid.

Colouring Matters obtainable from Isatis tinctoria.§ — L. Marchlewski describes the action of isatin on extract of woad prepared in different ways, and shows that the chemical compositions of dried and fresh leaves of the plant vary very considerably, thus explaining the cause of the differences in the results obtained by Schunk on the one hand and Beijerinck on the other.

* Zeit. Nahr.-Genussm., v. (1902) pp. 145-55. See also Journ. Chem. Soc., lxxxii. (1902) ii. p. 347.

† Comptes Rendus, cxxxiv. (1902) pp. 1586-9.

‡ Ber. Deutsch. Chem. Ges., xxxv. (1902) pp. 1457-67. See also Journ. Chem. Soc., lxxxii. (1902) ii. p. 420.

§ Bull. Internat. Acad. Sci. Cracov. Cl. Sci. Math. et Nat., 1902, pp. 227-30.

Constituents of *Acacia* and *Gambier Catechus*.* — A. G. Perkin and E. Yoshitake report the results of analysis and study of the catechus extracted from *Acacia Catechu* and *Uncaria Gambier*. They prove the existence of at least three catechins with melting-points 30 degrees apart from each other.

Lecithin in Plants.† — M. Schlagdenhauffen and Reeb describe their method of estimating lecithin in terms of phosphoric acid, and the amounts obtained in the various plants with which they experimented.

Saponarin.‡ — G. Barger has prepared this new glucoside from *Saponaria*, and describes its properties. It resembles scutellarin, which has recently been prepared from *Scutellaria*.§

Taxine.|| — T. E. Thorpe and G. Stubbs have investigated the alkaloid of yew, extracted from autumn-gathered leaves of male and female trees, by digesting with 1 p.c. sulphuric acid for 5 or 6 days. The acid liquid was strained and pressed from the leaves, rendered alkaline and extracted with ether. Taxine was obtained in the form of very fine glistening particles, by crushing down the residue from the ether extract; it is very susceptible to change. Several salts were prepared and analysed, and the figures deduced are in substantial agreement with the formula $C_{37}H_{52}NO_{10}$, given by Hilger and Brande. The authors, however, are not of opinion that this formula is definitely established.

Structure and Development.

Vegetative.

Leaf-Anatomy of *Rutaceæ*.¶ — H. Schulze has studied the leaf-anatomy of a number of species, representing 34 genera of this family. He finds as great a variety in internal structure as in external form, so that it is impossible to define any general type. The presence of secretory spaces affords a constant character, an exception occurring only in *Fagara Pterota*, which has oil-cells. Considerable agreement is found between the members of the subdivisions of the order, especially in the *Diosmeæ*. Leaf-structure is in the great majority dorsiventral, but sometimes isobilateral, more rarely almost centric. The cells of the epidermis vary very much in size, the radial walls are straight, so the cells appear polygonal in surface view. The occurrence of an epidermal mucilage is very frequent, and specially characterises the *Diosmeæ*, in which it was found in 40 out of 41 species. It was also observed in the *Xanthoxyleæ*, *Flindersiææ*, and *Toddaliææ*. Stomata in the dorsiventral leaves are found mostly only on the under face; in some *Diosmeæ* they are limited to two narrow zones on the under face; they belong to no definite type, and generally show no subsidiary cells. Hairs are generally present; they vary in form, but one-celled, often very short, hairs are common. In the dorsiventral leaf the mesophyll is

* Journ. Chem. Soc., lxxxii. (1902) pp. 1160-73.

† Comptes Rendus, cxxxv. (1902) pp. 205-8.

‡ Ber. Deutsch. Chem. Ges., xxxv. (1902) pp. 1296-8. See also Journ. Chem. Soc., lxxxii. (1902) i. p. 387.

§ See this Journal, ante, p. 315.

|| Proc. Chem. Soc., xviii. (1902) pp. 123-5.

¶ Beih. Bot. Centralbl., xii (1902) pp. 55-98 (2 pls.).

generally sharply distinguished into palisade and spongy layers, the former often one layer thick. Calcium oxalate was generally present; hesperidin was frequently observed in the epidermis.

The author does not consider that a sufficient number of genera was investigated in the subdivisions of the order to draw definite conclusions as to the systematic value of the anatomical characters. He, however, indicates the following points of interest:—The almost constant occurrence of mucilage in the epidermis of the Diosmææ. In other groups it was less constant or not observed in the genera investigated. The structure of the palisade parenchyma showed some agreement in individual groups. In the Toddaliæ it was always one-layered, as also in the Boroniææ, except in *Bornia* (two-layered), in the Aurantiææ always several-layered, and of almost cubical cells. In other tribes the number of layers was variable.

Dischidia with Double Pitchers. *—H. H. W. Pearson describes the occurrence of double pitchers in four species of *Dischidia*, from the Philippines and Borneo. The second or inner pitcher is formed by the involution of the leaf-apex, which, in the simple pitcher of *D. Rafflesianum*, hangs free in the pitcher. The outer pitcher contains solid matter and roots; in two cases ants were found. The opening into the outer pitcher being only 2 mm. in diameter, is not large enough to allow of the washing in of solid matters by rain; and the author suggests, therefore, that the material is carried in by the ants, indicating a degree of myrmecophily which is an advance upon that shown by *D. Rafflesianum*. There were no roots in the inner pitcher. In one species, *D. pectinoides*, a large number of small, irregular-shaped sweet masses were found in the inner pitcher; these arise from gummosis of the tissue above the opening of the inner pitcher. On the surface of the inner wall of the outer pitcher a fungus mycelium was present, the hyphæ of which abstrict gemmæ, which perhaps serve as food for the ants.

Precursors of Sieve-tubes in Gymnosperms. †—G. Chauveaud describes elements which precede the sieve-tubes in order of development, and are in their position and character intermediate between the cells of the pericycle and the first-formed sieve-tubes. The first are tubular in form, with a thin wall, and no appreciable modification. These are followed by elements, tubular like the first, but also provided at certain points in their walls with a little sieve-area. Other elements show a still higher degree of differentiation. The limit between pericycle and bast is not therefore abrupt, as in the angiosperms; we pass from the cells of the pericycle to the first sieve-tubes through a series of forms showing increasing differentiation. These intermediate forms, which are transitory, give a primitive character to the bast which corresponds with the ancient origin of the group. These precursory elements are best seen in the seedling before the cotyledons have completely spread. Their differentiation can be followed from the radicle into the cotyledons, and they can be found also at the origin of each young rootlet.

Botanical Origin of Kinkeliba. ‡—E. Perrot and G. Lefèvre have investigated the histology and external morphology of this tropical

* Journ. Soc. (Bot.) Linn., xxxv. (1902) pp. 375-89 (1 pl.).

† Comptes Rendus, cxxiv. (1902) pp. 1605-6. ‡ Tom. cit., pp. 1154-6.

African plant, the leaves of which have febrifuge properties. They find, as previously suggested by Engler, that the source of the drug is *Combretum altum* Guill. and Perrot (= *C. micranthum* Don). The divergence of views held by systematists as to the nature of the plant is explained by its polymorphism. It may be a liane almost deprived of leaves or a densely leaved bush. In anatomical character, the absence of phloem islands in the wood, it agrees with *Combretum micranthum*, but differs from *C. glutinosum* in which this tissue occurs. This is an important point, as Heckel, working with inadequate material, has described the plant as a new species, *C. Raimbaulti*, allied to *C. glutinosum*.

Reproductive.

Development of *Hamamelis virginiana*. *—D. N. Shoemaker describes the development of the flower, the course of pollination, and the embryology in this species. He finds the floral development to be as described by Baillon, except that only in one instance were there two ovules in a carpel. At the time of flowering the ovule is small and incomplete, and the macropore indifferenciated. The pollen-grains show great resistance to low temperature. Fertilisation takes place about the middle of May, that is, from 5 to 7 months after pollination. The mature embryo-sac is typical. The endosperm uses up all the nucellus except the epidermal layer. The embryo has a suspensor, and at maturity has used up about one-third of the endosperm, when it lies straight in the axis of the seed.

Development of the Embryo-sac in *Piper* and *Heckeria*. †—D. S. Johnson has studied the development and germination of the megaspore in two species of each of the above genera. The megaspore is directly derived from the lower half of a hypodermal cell, and the whole course of development is like that of typical angiosperms.

Embryology of *Limnocharis*. ‡—J. G. Hall has studied the embryology of the South American species, *Limnocharis emarginata*. He finds that the development of the ovules closely follows that in *Butomus umbellatus* as described by Ward. They arise as emergences from the walls of the carpels without definite placental arrangement. Except in the history of the embryo-sac the subsequent development is of the usual angiospermous type. The hypodermal cell which forms the arche-sporium is very early distinguishable; a tapetal cell is cut off from it but has no wall and is pushed towards the apex of the sac where it subsequently disappears. The remaining large cell becomes the embryo-sac without further division. The subsequent history of the nuclear changes differs considerably from the usual course. The megaspore nucleus forms two daughter nuclei, one of which passes to the micropylar end of the sac and forms the egg-apparatus and upper polar nucleus, while the other goes to the antipodal end and remains undivided. The upper polar nucleus migrates towards the antipodal end of the sac where it divides transversely. The lower daughter nucleus remains in position, being cut off by a wall across the sac, and forming

* Johns Hopkins Univ. Circulars, xxi. (1902) pp. 86-7.

† Tom. cit., pp. 85-6.

‡ Bot. Gaz., xxxiii. (1902) pp. 214-9 (1 pl.).

a large cell which does not divide further, but finally disappears through the encroachment of the endosperm. The upper daughter nucleus travels back toward the egg-apparatus and by further division forms the endosperm, which at an early stage consists of only a single layer of granular protoplasm lining the sac, in which are imbedded free nuclei, but later walls are formed although not easily distinguishable.

Fertilisation occurs before the first division of the polar nucleus; actual fusion of sperm-cell and oosphere was not observed. The first division of the egg is into suspensor and embryo-cell. The original suspensor cell increases much in size but never divides except in cases of polyembryony, when an embryogenic mass is formed from which several embryos bud out somewhat as in *Erythronium americanum* and *Tulipa Gesneri*. In the older embryo the suspensor consists in addition of some of the cells derived from the first terminal segment, and may comprise four to five cells. The first division of the embryo-cell is always transverse, but the next may be vertical, transverse, or oblique. When vertical or oblique the growing point of the stem and the cotyledon both arise from terminal segments, thus agreeing with *Zannichellia* but differing from *Naias*. The author concludes that there is no regular order of division in the formation of the young embryo after the first two walls are formed. In the older stages of the embryo the growing point was apparently always of lateral origin.

Structure of Achenes.*—E. Villari calls attention to the confusion arising from the terms employed in systematic botany to denote various kinds of fruits, one and the same term being used to include a diversity of fruits which in their morphological origin have but little in common with one another. In order to contribute towards a better classification, he has studied the structure of the achenes of *Anemone hortensis*, *Ranunculus muricatus*, *Delphinium halteratum*, *Daucus Carota*, *Senecio vulgaris*, *Sonchus tenerrimus*, *S. oleraceus*, *Tolpis quadriaristata*, *Carthamus lanatus*, *Helianthus annuus*, *Rumex glomeratus*, *Mirabilis Jalapa*, *Oxybaphus viscosus*, and *Parietaria lusitanica*. He often found it impossible to make out in the mature fruit the number of carpels of which it was composed. At other times the sutures were quite apparent. He considers that not only the number of the carpels, but also the superior or inferior position of the ovaries, ought to be taken into account, and that epiachenes (including periachenes) should be distinguished from hypoachenes. The distinction of achene from caryopsis is of slight importance, as in *Urticaceæ*, *Nyctagineæ*, and *Ranunculaceæ*, he has found achenes with the pericarp more or less adherent to the seed.

Germination in Piperaceæ.†—D. S. Johnson has studied the germination of the seeds of *Peperomia pellucida*. The bulk of the ripe seed is made up of perisperm rich in starch; a thin layer of endosperm surrounds the globular embryo. The seed-coat is burst by increase in size of embryo and endosperm. The endosperm pushes out of the seed continuing to surround the embryo until the radicle and cotyledons are well formed. The radicle and later the bases of the cotyledons push out through the sac of the endosperm, which remains as a cap tightly

* Malpighia, xv. (1902) pp. 188-99.

† Johns Hopkins Univ. Circulars, xxi. (1902) p. 86.

covering the tips of the cotyledons and surrounded by the perisperm. The seed is raised by the elongating hypocotyl and clings to the tips of the cotyledons till all the food is absorbed. The endosperm, which is never more than one or two layers thick, never contains any appreciable amount of starch. In the ripe seed it is full of aleurone-grains which gradually disappear as germination proceeds, the starch in the perisperm disappearing at the same time from the endosperm outwards. It is suggested that the function of the endosperm is to digest the starch stored in the perisperm, by the aid probably of a ferment prepared from the proteid granules, and then to absorb and pass on the digested material to the embryo. In *Heckeria umbellata* the process is almost identical with that found in *Peperomia*. In *Canna*, *Dianthus* and *Cerastium*, *Polygonum* and other cases, the thin layer of endosperm about the cotyledons apparently serves the same purpose as in *Peperomia*. The author believes that the sporophyte of the second generation is nourished by that of the first generation always through the intermediate gametophyte.

Germination of Seeds of *Carapa guianensis*.*—J. W. Harshberger has studied the germination of the seeds of this tropical forest tree (natural order Meliaceæ). The capsule is about the size and shape of a coco-nut, and is filled with angular seeds, ten to twelve of which are packed within the woody pericarp. Germination begins before the seeds leave the capsule; they are held in place by the interwoven mass of secondary roots. The stem elongates some 4 to 6 in. and emerges from the interior of the partially opened seed-vessel. The seeds lose their vitality if allowed to remain for some time in a dry place. They are an inch to an inch and a half in diameter, with woody coats; the interior is filled with the fleshy conferruminate cotyledons. The cotyledons contain no starch, the reserve material consisting of oil and proteid bodies. In germination the hard coat cracks, the radicle first protrudes and develops numerous secondary roots; the plumule follows. The rapidly elongating stem bears at first closely appressed scale-leaves; after a time there arises a pair of opposite abruptly pinnate bijugate leaves. *Carapa guianensis*, which is a land plant, differs from *C. moluccensis*, which is a mangrove plant, in not having the tuber-like radicle and the pneumatodes which characterise the latter.

Physiology.

Nutrition and Growth.

Observations on Transpiration.†—C. C. Curtis describes the results of numerous experiments on the apparently irregular variations in the rate of transpiration. He finds that on dull days when the intensity of the light is uniform or at least not in keeping with the time of day, the transpiration curve shows a pronounced maximum near midday and is also characterised by minor fluctuations which occur independently of climatic changes. Illumination by an electric light of 900 candle-power under uniform external conditions showed a periodicity in the transpiration of several plants corresponding in the main with the curves

* Proc. Acad. Nat. Sci. Philadelph., 1902, pp. 122-5.

† Bull. Torr. Bot. Club, xxix. (1902) pp. 359-73.

determined on cloudy days. The harmonising of the rhythms of absorption, exudation and tension of fluids, and the rate of growth is suggestive of the vital character of transpiration. Variations of a few per cent. in the humidity of the atmosphere produced no sensible change in the amount of transpiration, but an increase of 8 per cent. resulted in a marked drop in the rate. The curve in the dark was sometimes in keeping with the rhythm found under constant illumination, but was more frequently characterised by variations quite out of keeping with the periodicity of light. There is evidently a cessation of the vital action of the plant, and the retardation of the rate and its greater regularity accords with the loss of tone manifest in the plant. The considerable volume transpired in the dark indicates that the stomata may be sufficiently open to allow the escape of vapour. Only in the case of *Cycas revoluta* was the amount of transpiration in keeping with the ratios determined for cuticular transpiration. The physiological character of transpiration is also indicated by the periodicity of the opening and closing of the stomata. They are more responsive to the stimulus of light in the morning than in the afternoon.

Transpiration of Evergreen Trees in Winter.*—Shunsuke Kusano gives an account of a large series of experiments on the transpiration of evergreen plants at the latitude of Tokyo, during winter. Details of the experiments which were made under various external conditions of temperature, light, time of day, &c. are tabulated. The author shows that not only is transpiration continued, but also that photosynthesis takes place without intermission in winter, though much feebler than in summer. The time of minimum transpiration coincides with that of minimum temperature (end of January). The amount of water transpired by foliage evergreen trees was in average cases one and a half to twice as great as that transpired by conifers. The author concludes that many of the evergreen trees in Japan have their stomata more or less open even in the depth of winter; a condition which is probably the most important factor in winter transpiration.

Relations of Calcium and Magnesium to Plant-Growth.†—W. May experimented with various plants grown in water, sand, and ordinary soil, and manured with calcium and magnesium as sulphates, nitrates, and carbonates. A great excess of magnesium was found to be very injurious, while excessive amounts of calcium check the growth. The best relations of calcium to magnesium are 7 : 4.

Accumulation of Mineral and Organic Matter in Woody Plants.‡—G. André has studied the variation in the amount of mineral and organic matter in the branches of the current year in the horse-chestnut, starting from the time when the branch has finished its elongation to the fall of its leaves. The nutritive materials accumulated serve to nourish the terminal bud which will develop next year. He finds a gradual increase through the period of experimentation (from July 29 to November 16) in the phosphoric acid, potash, and nitrogen. The amounts of carbohydrate saccharifiable by dilute acids, and the cellulose

* Journ. Coll. Sci. Imp. Univ. Tokyo, xv. pt. 3 (1901) pp. 313-66 (1 pl.).

† U.S. Dept. Agr. Bull., 1901, No. 1, pp. 37-53. See also Journ. Chem. Soc., lxxxii. (1902) ii. p. 347.

‡ Comptes Rendus, cxxxiv. (1902) pp. 1514-7.

increase from July to September; from this time, when the weight of dry matter remains constant, the former regularly diminish and are replaced almost exactly by cellulose.

Irritability.

Effect of Sunshine on Plants.*—N. Passerini publishes some observations upon the results of growing thirteen different species of plants in direct sunshine and in diffused light respectively. By analysis he determined the relative percentages of water, organic matter, and mineral ash of the two sets of plants. The highest gain was found in *Cucurbita Pepo*, where the plant grown in sunshine was twenty-seven times as heavy as the shaded plant; and the next were *Hordeum vulgare* and *Zea Mays* where the gain was about nine times. As to gain in organic substance, the greatest gains were shown by *Brassica Rapa*, *Hordeum vulgare*, and *Anagallis arvensis*. The conclusions drawn by the author are that in every case the plant exposed to direct sunlight is heavier than the shaded plant; that the failure of direct radiation limits the growth of the plant, and retards the vegetative phases, especially the inflorescence and the complete development of the fruit; that the sun-grown plants are much greener than the shaded; that the shaded plants have a larger proportion of water and less of solid substance; that the higher percentage of solid substance in the sun-grown plants is chiefly due to organic matter; and that the difference in the proportion of mineral matter is less notable.

Electrical Phenomena in Plants.†—A. Tompa has studied electromotive effects in dead and living seeds. He finds that there is no essential difference of intensity in manifestation of electric polarisation in living and in dead seeds respectively. The polarisation currents in both living and dead seeds may reach considerable intensity, but are of small tension. The amount of intensity and the direction of the current vary according to variations in the internal resistance of the seeds. A criterion of the life of the seed is supplied by the "lesion"-current; in the case of living seeds, as a result of superficial injury on one side, an electromotive force with a potential exceeding 0.005 volt is experienced, while dead seeds show no potential, or at any rate one of less than 0.005 volt. Hence a lesion-current whose potential exceeds 0.005 volt may be considered a criterion of life in a seed.

Electric Response in Plants under Mechanical Stimulus.‡—J. C. Bose describes apparatus and experiments on numerous plants, which prove that plants and their different organs give precisely the same electric responses to stimuli as does animal tissue, indicating that vital phenomena are identical in the animal and plant kingdoms. That the responses are physiological, and not merely mechanical, in character is shown by the fact that whatever tends to exalt or depress the physiological activity, tends also to increase or diminish the electric response. The effect of anæsthetics and poisons, organic variations, fatigue, modification by high and low temperatures, corresponds strictly to similar

* Bull. Soc. Bot. Ital., 1902, pp. 13-24.

† Beih. Bot. Centralbl., xii. (1902) pp. 99-136 (3 figs.).

‡ Journ. Linn. Soc. (Bot.), xxxv. (1902) pp. 275-304 (25 figs.).

phenomena in muscle and nerve. The author emphasises the importance of this unity between plants and animals, as owing to the simpler conditions which obtain in plant life, the electro-physiological investigation in plants may be found to throw much light on the subject generally. There is no longer any room for the explanation that the response in plants is due to movement of water, as suggested by Kunkel. In a work to be shortly published, entitled *Response in the Living and Non-living*, the author will treat fully of the subject of irritability and response.

Method of Investigating the Gravitational Sensitiveness of the Root-tip.*—F. Darwin describes a method giving additional confirmation of the truth of the theory that sensitiveness to the stimulus of gravity is confined to the root-tip. A piece of apparatus was devised by means of which the weight of the heavy cotyledons of leguminous plants (which are especially suitable for experiment) could be supported, but at the same time allowed to move freely, the tip of the root being inserted in a tube. Besides glass tubes, straws and quills were used, and also nectaries of *Tropæolum*, corolla-tubes of various flowers, and the hollow scape of the dandelion.

Action of Alcohol on Germination of some Seeds.†—I. Sukatschew finds, in agreement with Dixon, that seeds of lupine and pea can remain some time in alcohol of various strengths without losing capacity for germination. On the other hand, he concludes from experiments with *Lupinus luteus* and *Lepidium sativum*, that wounding of the seed, or removal of the testa, does not lead to so rapid a loss of germination capacity as the results of Dixon and Schmid tend to show.

Chemical Changes.

Chemical Studies of the Coco-nut.‡—J. E. Kirkwood and W. J. Gies have studied the chemical composition of the coco-nut, and the changes which occur during germination. In the case of the ungerminated nut the composition of the milk and of the endosperm is considered in detail. The fresh endosperm contains 46 p.c. water to 54 p.c. solids, the latter consisting, except for 1 p.c., of organic matter. The organic matter comprises 37 p.c. fat, 3.4 p.c. cellulose, 4 p.c. proteid. Water, salt-solution, and glycerin all failed to extract appreciable quantities of either proteolytic or adipolytic enzymes from the endosperm, though an active amylolytic ferment was extracted in every case. The morphological changes accompanying germination are described, and the general composition of the parts of the seedling and germinated nut.

Investigation and Presence of Rennet-ferment in Plants.§—M. Javillier describes the extraction and experiments on the action of the rennet ferment obtained from the taro, under rigorous aseptic conditions, which have not been observed by previous workers. He finds the ferment to be widespread in plants, occurring chiefly in the leaves.

* Journ. Linn. Soc. (Bot.), xxxv. (1902) pp. 266-74 (10 figs.).

† Beih. Bot. Centralbl., xii. (1902) pp. 137-8.

‡ Bull. Torr. Bot. Club, xxix. (1902) pp. 321-59 (1 pl. and 5 figs. in text).

§ Comptes Rendus, cxxxiv. (1902) pp. 13-3-4.

Action of Ungerminated Barley Diastase on Starch.*—J. L. Baker finds that when the diastase is allowed to act at 50° on a solution of soluble starch, hydrolysis proceeds for an hour to an hour and a half, when a stage is reached beyond which the reaction is comparatively slow. After 1½ to 2 hours dextrin and maltose were the sole products; after 24 hours evidence of the presence of glucose was obtained, the amount of this sugar apparently increasing in proportion to the time of conversion. Since barley diastase is without action on maltose, the glucose which occurs at the later stage must be derived from the dextrin. This dextrin differs markedly from Nägeli's amylo-dextrin, and in consideration of its general behaviour and close relation to the parent starch, the author proposes to call it *α*-amylo-dextrin.

Mosaic Disease of Tobacco.†—A. F. Woods gives an historical summary of the facts relating to this disease, and an account of the results of his own investigations. The leaves of plants attacked by the disease show a more or less sharply defined differentiation into light and dark green areas, giving a mosaic appearance. The light green areas are, as a rule, between the larger vascular bundles, the darker green portions forming a border along the larger bundles. Occasionally, however, the dark and light green patches occur indiscriminately. Where the contrast is more marked the light-coloured areas grow slowly, while the dark green grow more rapidly, and thus the leaf becomes badly distorted. The disease is not due to parasites of any kind, but results from the defective nutrition of the young dividing and rapidly growing cells, due to a lack of elaborated nitrogenous reserve food, accompanied by an abnormal increase in activity of oxidising enzymes in the diseased cells. The unusual activity of an enzyme prevents the proper elaboration of reserve food, so that a plant once diseased seldom recovers. On the decay of the plant the enzyme is set free, and remains active in the soil. It is very soluble in water, and appears to pass readily through plant-membranes. If young plants take it up in sufficient quantity to reach the terminal bud, they become diseased in the characteristic way. Under field conditions there is little danger from infection in this way, but in the seed-bed the danger is much greater owing to the greater susceptibility of the young plants to disease, and the greater amount of free-oxidising enzymes likely to be in the soil due to the decay of roots and plants. New or steam-sterilised soil should therefore be used for the seed-bed. There is evidence that rapid growth, caused by too much nitrogenous manure or too high temperature, is favourable to the disease.

Action of Hydrogen peroxide on Carbohydrates in presence of Ferrous Sulphate.‡—R. S. Morrell and J. S. Crofts have continued the investigations of Cross and others, and have shown that dextrose, lævulose, arabinose, and rhamnose are transformed by hydrogen peroxide in presence of the iron salt into osones.

General.

Phyllobiologic Types in some Orders of Seed-Plants.§—Prof. Hansgirg, who has already published an account of his investigations

* Proc. Chem. Soc., xviii. (1902) pp. 134-6.

† U.S. Dept. Agric. Bureau of Plant Industry, Bull. No. 8 (1902) pp. 1-24 (6 pls.).

‡ Journ. Chem. Soc., lxxxi. (1902) pp. 666-75.

§ S.B. k. böhm. Ges. Wiss. Math.-naturw. Cl., 1901, No. 24, pp. 33.

on the relation between the form, texture, and structure of the leaf and its environment, now gives a systematic review of the various climato-ecological types of leaves found in a number of natural orders of dicotyledons and monocotyledons.

Study of the Genus *Serapias*.*—G. Zodda describes a new variety *maculata* of *Serapias lingua* from Messina, and adds remarks on the floral structure of this and the other species of the genus. He also discusses their phylogeny.

Malformations of the Flower of Orchids.†—Gustav Stenzel, of Breslau, gives a detailed and classified description of the abnormalities which he himself has noticed and which have been recorded by other workers, in endemic species of orchids. In an introductory chapter he discusses the value, from a general morphological point of view, of the phenomena presented by teratology. He regards them as a useful aid to the solution of problems in morphology. He then reviews the cases, noted by himself and others, of abnormal female cones in Abietinæ, by study of which Alexander Braun was led to suggest the view now generally accepted of the morphology of the ovule-bearing structures.

In the case of orchids only those cases are included which were found on plants growing under natural conditions. The majority are the result of an alteration in the number of the parts of the flower; a smaller division contains those caused by replacement of an organ by one of a different character, such as lip by normal petal, or lateral petals by lip-like structures, in fact, mainly cases of peloria. The observations afford an excellent example of teratological variety in one type of flower, but do not throw any new light on its morphology.

North American *Carices*.‡—Theo. Holm contributes another article to his series, entitled *Studies in the Cyperaceæ*. He discusses the small section *Physocephalæ* of L. H. Bailey, to which a few species with an inflated utricle have been referred. As a result of a morphological and anatomical examination of the species he concludes that the section is an unnatural one and cannot stand. The well-marked *Carex Fraseri* he places in a new section of its own which he calls *Leucocephalæ*.

Tertiary Plants from the Himmelsberg.§—H. Engelhardt gives a descriptive list of fossil plants from this locality in central Germany. He enumerates more than one hundred species belonging to 46 families and 69 genera; they include four new leaf-fungi. The flora of the Himmelsberg, like other tertiary European floras, contains a large proportion of plant-types which are not included in the recent flora. In the present case, American types are most strongly represented, being twice as many as the Asiatic, three times as many as the European, and seven times as many as the Australian and African.

Botany of Tasmania.||—L. Rodway gives a short general review of the botany (flowering plants and ferns) of Tasmania, and also ¶ records a few additions to the flora of the island.

* Nuovo Giorn. Botan. Ital., nuov. ser. ix. (1902) pp. 173-89.

† Bibliotheca Botanica, Heft 55 (1902) pp. 136 (6 pls.).

‡ Amer. Journ. Sci., ser. 4, xiv. (1902) pp. 57-63 (1 pl.).

§ Abhandl. Senckenb. Naturf. Gesell., xx. (1902) pp. 251-306 (5 pls.).

|| Papers and Proc. Roy. Soc. Tasmania, 1900-1901 (1902) pp. 85 bis-9.

¶ Tom. cit., pp. 107-8.

Ecological Sketch of the Flora of Santo Domingo.*—J. W. Harshberger gives a short account of the topography, climate, and vegetation of this island which he describes as the geographic centre of the Greater Antilles. The vegetation is rich and most luxuriant, and the writer describes its characteristic features under ecological headings:—Hydrophytes, mesophytes, forest vegetation, savanna vegetation, epiphytes, parasites, and xerophytes. On the slopes of the higher mountains inland the native flora has been undisturbed.

CRYPTOGAMS.

Pteridophyta.

Analytical Key for the Ferns of the North-eastern States, based on the Stipes.†—C. E. Waters has revised and enlarged his previously published key, which is designed as an aid to identifying ferns when they cannot be obtained in fruit. It includes 59 species which are arranged primarily according to the number of the bundles in the leaf-stalk, and secondarily according to the shape, regular or irregular arrangement, and relative size of the bundles. A description of the leaf is also given under each species.

Filmy Ferns of South America.‡—E. G. Britton discusses the so-called *Trichomanes radicans* of the southern United States, and is of opinion that the plant is quite distinct from that species and should be called *T. Boschianum* Sturm. She claims that the Linnæan type of *T. radicans* requires re-examination, and that its synonymy ought to be revised; that the type of *T. scandens* ought also to be re-studied; and finally that diligent search should be made in Florida for *T. Petersii*, the specimens of which are lost and its locality doubtful.

New Species of Selaginella.§—G. Hieronymus makes a second contribution to his descriptions of new or insufficiently known species of *Selaginella*, the names of most of which he has already published in Engler and Prantl's *Pflanzenfamilien*. In the present paper he confines himself to the subgenus *Heterophyllum*, describing 20 species and adding critical remarks.

Bryophyta.

Forcible Discharge of Antherozoids in Asterella californica.||—G. J. Pierce describes the forcible ejection of the antherozoids in this liverwort, better known as *Fimbriaria californica*. The antherozoids are discharged while enclosed in mucilage, the main mass of which breaks up during its flight into smaller masses, so that finally the male cells fall to the ground in little groups, the enveloping mucilage then dissolves in the dew or rain, thus liberating the antherozoids which are then free to swim off. The mechanism of ejection consists of two parts: (1) the water-absorbing matrix consisting of gelatinised mother-cells and thin walls, in which the antherozoids lie, and which distends the

* Proc. Acad. Nat. Sci. Philadelph., liii. (1902) pp. 554-61.

† Johns Hopkins Univ. Circular, xxi. (1902) pp. 83-5.

‡ Bull. Torr. Bot. Club, xxix. (1902) pp. 475-7.

§ Hedwigia, xli. (1902) pp. 170-202.

|| Bull. Torr. Bot. Club, xxix. (1902) pp. 374-82 (6 figs. in text).

ripe antheridium; and (2) the thin-walled and large-celled water-absorbing tissue composing the cushion on the thallus, in chambers of which the antheridia develop. The expansions of the tissue and the mucilage as they absorb water tend respectively to decrease and increase the size of the antheridial chambers. As the chambers are open above the distending and compressing strains result in the rupture of the antheridium and the discharge of its contents through the mouth of the chamber.

Red-coloured Hepatics.*—A. Casares Gil records a few observations as to the reddish coloration of certain hepatics. He inclines to the opinion that its purpose is not to absorb a greater amount of light or heat but to act as a shield to regulate the intensity of the more refrangible rays that penetrate the plant. Some frondose hepatics such as *Targionia hypophylla* and *Grimaldia dichotoma* are deeply coloured on the under surface and grow in dry sunny spots. In the early morning they remain expanded while the dew is on them, and then fold in their coloured margins so as to cover and protect the green upper surface. In *Reboulia hemisphærica* the distribution and depth of the red colour of the lower surface is proportional to the intensity of light which the plant has to live in. The red antheridia of some genera and the reddish-violet root-hairs of others have yet to be explained.

Genus Thamnium.†—N. C. Kindberg begins a monograph of the genus *Thamnium*, as emended by himself, importing into it the whole of *Porotrichum* and a large number of species from various other genera. In all, he includes 96 species and treats of 20 in the present contribution. Many so-called species he reduces to mere synonyms. In the introduction he supplies lists of characteristics which he finds to be, or not to be, trustworthy for discriminating the species. He also adds a bibliography. He divides the genus into *Eu-Thamnium*, *Porotrichum*, *Camptolepis*, and *Lembophyllum*; and subdivides the first three of these sections into *Leiophylla* and *Trachyphylla*; and by further manipulations he reduces the ultimate groups of species to conveniently small dimensions.

French Muscinæ.—E. Levier ‡ describes *Riccia Crozalsii*, a new species belonging to the ciliate section of the genus; and shows how it may be readily distinguished from its allies. It was found in the south of France near Montpellier, by A. Crozals, who has also discovered fertile plants of three other species,—*R. macrocarpa* Levier, *R. papillosa* Moris, and *R. Gougetiana* Mont.—which are additions to the French flora.

G. Dismier § publishes a note on some mosses and hepatics new to the French Ardennes, or at least rare, which he gathered during a trip in that district last Whitsuntide. To his surprise he found the exclusively calcicolous moss *Eucladium verticillatum* growing on a slaty rock, and supposes it to have derived sufficient carbonate of lime for its existence from the water percolating down from some houses situated overhead.

* Bolet. Soc. Españ. Hist. Nat., ii. (1902) pp. 217-220.

† Hedwigia, xli. (1902) pp. 203-24.

‡ Rev. Bryolog., xxix. (1902) pp. 73-6 (figs. in text).

§ Tom. cit., pp. 89-90.

The same author * records the discovery of *Cephalozia catenulata* at Cherbourg by A. Martin, the chief interest being that this hepatic, which is very rare in France and had been found only in high mountain forests in the Vosges, Jura, Pyrenees, and Auvergne, gains at Cherbourg a connecting link with the distribution of the species in the British Isles, where it occurs as far south as Tunbridge Wells. The author draws up in tabular form the characters by which the species is distinguished from its two nearest allies, *C. lunuleifolia* and *C. connivens*.

Mosses of Central Europe. † — W. Migula publishes part v. of his *Kryptogamen-Flora*, a continuation of Thomé's *Flora von Deutschland, Österreich und der Schweiz*. Each part contains thirty-two pages of text and six plates of figures, in black and white and in colours. Key to the species, &c. are provided, and the descriptions are sufficiently short. The present part deals with the Grimmiaceæ and Orthotrichaceæ. The work is in German and the instalments appear at intervals of about one month.

Bohemian Species of Bryum. ‡ — J. Podpěra writes on the geographical distribution and natural grouping of the species of the genus *Bryum* which occur in Bohemia, adding critical remarks on the comparative distribution and development of the same groups throughout the whole of Europe. The two great subgenera, *Cladodium* and *Eubryum*, are mainly northern and southern in their distribution, attaining their greatest variability in the Baltic and Mediterranean regions respectively. Nearly four-fifths of the species of *Cladodium* (50 in number) are exclusively northern, and nine are confined to the Alps. Only five are found in Bohemia. On the other hand *Eubryum* is richly represented in Bohemia. Nearly 72 of its species occur in Europe, and half of these reach their highest development in the Mediterranean region, while only twelve are purely northern. The author groups the species in a synoptical table according to their natural affinities, adds an artificial key, and deals with the individual species in detail, discussing their variability and distribution.

Mosses of Madagascar. § — E. G. Paris publishes a third contribution to the moss-flora of Madagascar in collaboration with Renauld and Cardot. The list contains 35 mosses, including 13 new species and 4 new varieties; also five hepatics, three of which are new, determined by Stephani. The plants were gathered in the following districts, — Sakalave, Ankazobe, Betafo, and Moramanga. Critical notes are added.

Australian Mosses. || — K. Müller's third and last posthumous contribution to the biology of Australasia consists of 39 descriptions of new species, gathered for the most part in Victoria and New Zealand, and for the rest in Tasmania, New South Wales, Queensland, and New Guinea, by various collectors.

Bryological Notes. ¶ — E. S. Salmon continues his bryological notes, his chief point being that the Burmese genus *Thiamea* cannot be main-

* Tom. cit., pp. 86-8.

† Thomé's *Flora von Deutschland*, v. Lfg. 5 (July 1902) Gera, Reuss j. L. (F. von Zeschwitz). ‡ Beih. Bot. Centralbl., xii. (1902) pp. 1-33.

§ Rev. Bryolog., xxix. (1902) pp. 76-86.

|| Hedwigia, xli. (1902) pp. 119-34.

¶ Journ. Bot., xl. (1902) pp. 273-9 (1 pl.).

tained as distinct, but must be merged in *Wilsoniella*, its one species becoming *W. Hampeana*. The genus *Wilsoniella* he thinks should be removed from the Bryaceæ into the Dieranaceæ or Tortulaceæ. For the rest, he shows that a var. *Maclellandii* can be separated from the type of *Syrrhobodon Gardneri*; and re-describes the little-known Indian moss *Pogonatum nudiusculum*.

British and Irish Mosses.—G. B. Savery* gives a list of 144 mosses collected near Pool, in the Wharfe Valley, &c., on the Millstone Grit in a district polluted by smoke.

T. Barker † states his reasons for believing that *Hypnum Sendtneri* Schimp. and *Trichostomum inclinatum* Dixon have been wrongly recorded as occurring in Derbyshire. He also calls attention to Correns's studies of the variability of the bulbils of *Webera annotina*, which led Correns to distinguish four forms of the plant. All four forms occur near Whaley Bridge; and Prof. Barker calls upon bryologists to search for them in other parts of the country.

E. Armitage ‡ supplies a list of mosses gathered in Co. Limerick in July and August 1901.

H. W. Lett § claims *Dicranella curvata* Schimp. and *Hypnum umbratum* Ehrh., found in Co. Mayo, as new to Ireland.

Algæ.

Plankton.—P. T. Cleve publishes the result of his examination of various collections from the Indian Ocean and Malay Archipelago. Except the Malay specimens all the organisms were collected in winter. Silicoflagellata are represented by 2 species, Chlorophyceæ by 1, Cyanophyceæ by 2, Muræcystæ and Cystæ by 6, Peridinales by 64, and Diatomaceæ by 121. Among the "systematic notes" which follow, are descriptions of new species of plankton:—*Chaetoceras Aurivillii*, *C. calvus*, *Fragilaria Aurivillii*, *Streptotheca maxima*, *Thalassiosira Aurivillii*; from the coast collections *Fragilaria (?) rhombica*, *Licmophora Aurivillii*, and *Sceptroneis Aurivillii*.

The same author ¶ also publishes some notes on Atlantic plankton organisms, based on collections received after his former work had gone to press. Among Peridinales, a new species is described *Dinophysis intermedia*; *Peridinium spinulosum* Murr. et Whitt. is shown to be *Protoceratium reticulatum* Schütt, and *Protoceratium reticulatum* (Clap. and Lach. = *P. aceros* Bergh) is a distinct and more northern form.

The report ** on the plankton of the North Sea and Skagerak in 1900 by the same author has also appeared. The occurrence of certain forms at certain seasons and the variation in distribution both as to form and abundance are dealt with. The specimens were collected at two stations on the west coast of Sweden, in the North Sea by various steamers, in the Skagerak by steamer, and in the Shetlands.

* The Naturalist, 1902, pp. 229-34.

† Tom. cit., pp. 234-6.

‡ Journ. Bot., xl. (1902) pp. 226-8.

§ Irish Naturalist, xi. (1902) p. 149.

¶ Handl. K. Svensk. Vet.-Akad., xxxv. (1902) No. 5, 58 pp. (8 pls.). See Bot. Centralbl., lxxxix. (1902) p. 685.

** Gothenburg, 1902, 51 pp. See Bot. Centralbl., tom. cit., p. 686.

Handl. K. Svensk. Vet.-Akad., tom. cit., No. 7, 49 pp. See Bot. Centralbl., tom. cit., p. 715.

Edogonium.*—F. E. Fritsch describes the germination of the zoospores in *O. capillare* Kütz., and his observations do not altogether agree with those of Kützing or of Poulsen. He finds that the first cap is not thrown off in *O. capillare*, nor in other undetermined species which he has examined.

Ida A. Keller † describes and figures a peculiar condition of a species of *Edogonium*, which was kept in a jar of water at a window from autumn to early summer. The alga, which at first was green and luxuriant, was found in May to have lost its chlorophyll, and many of the cells were closely packed with starch; the plants were, however, perfectly healthy and had remained rooted to pieces of rock. Since no oogonia had been formed during the previous autumn, it is probable that the food-material stored up for their formation had remained in the cells in the form of starch.

Characeæ from Co. Monaghan.‡ — G. R. Bullock-Webster describes his researches among the numerous pools and lakes of Co. Monaghan in August 1901. His most interesting finds were the following (both new to Ireland): *Nitella mucronata* Kuetz. in plenty near Carrickmacross, and *N. flexilis* var. *nidifica* Wallm. in Co. Cavan. He points out the similarity of the black peat and shell-marl in Ireland with those found in the fens of Cambridgeshire, and quotes a theory that this shell-marl may be due largely to the decay of Characeæ.

Observations on *Pterygophora californica*.§ — Conway McMillan describes this alga as being larger than has hitherto been supposed and attaining a length of 10 ft. with trunks of 3 in. in diameter. He places it, as regards systematic position, between Laminariæ and Alariideæ. The holdfasts show distinct rings of growth due to differences in the cell-contents, produced by the varying amount of polysaccharids, allied to mucine. Rings of growth are also visible in the stipe, produced in some cases by the same condition as that described for the holdfast, and in others by the larger or smaller lamina of the cells. Polysaccharid idioblasts are abundant in the cortex of the lamina, and these often become exhausted during the formation of sori. The sori, which are here described for the first time, are formed in December in irregular patches towards the base of the pinnae; the paraphyses resemble those of *Lessonia* in the disposition of the cuticular caps.

Recent Publications on Diatoms.|| — P. T. Cleve makes critical remarks upon Karsten's *Die Diatomen der Kieler Bucht* (1899) and corrects some of the specific determinations, while C. Mereschkowsky criticises the information about the cell-contents. Cleve also corrects several of the species names in Mereschkowsky's *Études sur l'Endochrome des Diatomées* (1901); Heiden-Rostock's *Diatomeen des Conventer Sees bei Doberan* (1900); Schütt's *Centrifugale und simultane Membranverdickungen* (1900); Schröder's *Das Phytoplankton des Golfes von Neapel*.

* Ann. Bot., xvi. (1902) pp. 412-7 (fig. in text).

† Proc. Acad. Nat. Sci. Philadelphia, liii. (1901) pp. 598-601 (figs. in text).

‡ Irish Naturalist, xi. (1902) pp. 141-6.

§ Minnesota Bot. Stud., ser. ii. xli. (1902) pp. 723-41 (6 pls.).

|| Ann. Mag. Nat. Hist., x. (1902) pp. 27-38.

S. C. Stow* supplies a list of twenty-one diatoms collected at Cleve in March 1902.

F. E. Burbury† gives a list of ninety-one species of diatoms found in Tasmania, including *Eumotia transylvanica*, *Hyalosira whampoensis*, and *Nitzschia Clevei*.

Development of Tetrasporangium in Florideæ.‡—F. Heydrich continues his observations on this subject and draws an analogy between the development of the tetrasporangium and the fertilised carpogonium. In the case of the carpogonium the sporogenous energid penetrates into the auxiliary cell, and drives the nucleus of that cell into a remote corner, where it perishes. As the result of this usurpation, the production of carpospores becomes possible.

Heydrich here describes a similar process in the tetrasporangium of *Polysiphonia variegata*. Two cells are given off from a pericentral cell, the lower one being designated the stalk-cell or karyoplastic-cell, the upper one the protospore-cell. The karyoplastic-cell puts forth a small tube towards the protospore-cell, and as soon as a connection is established between them, the nucleus of the lower cell divides into two and the upper one of the daughter nuclei passes into the protospore-cell. The nucleus of the protospore-cell retires upwards and eventually perishes, and the protospore-cell becomes the tetrasporangium mother-cell. The analogy between the two processes is obvious.

The author describes the development of the tetrasporangium in *Faucheia repens*, *Callithamnion*, *Ceramothamnion*, *Hypnea*, *Dudresnaya*, and others.

Structure and Development of the Desmarestiæ.§—Although so much attention has been given to *Desmarestia aculeata*, there yet remained certain points of interest in the genus to be worked out, and this has been done by B. Jönsson. He has watched the different stages of growth in *D. aculeata* and their duration, and gives an account of the manner of development of the branches. The differentiation of the tissue and the formation of secondary "central cylinders" is described, and the functions of the various tissues are deduced from the cell-structure. The other species of *Desmarestia* are dealt with shortly, the principal work having been done on *D. aculeata*.

The Rhodomelaceæ.||—R. Falkenberg gives in this quarto book of xvi. and 754 pages the results of many years of study on this group of Florideæ. It is published as one of the monographs of the Zoological Station at Naples, and though the species found in that region are treated with special detail, the work embraces the whole Order. The anatomical development of the thallus, the morphology of the vegetative organs and the reproductive organs are treated at length in a section of 109 pages. In the special part, consisting of 588 pages, detailed studies of many species are given. Then follows 'Systematic Results,' dealing

* The Naturalist, London, July 1902, p. 236.

† Papers and Proc. Roy. Soc. Tasmania, 1902, pp. 4-8.

‡ Bibliotheca Botanica, Heft 57 (1902) pp. 1-9 (1 pl.).

§ Kongl. Fysiograf. Sällskap. Handling., Bd. 12, No. 6, pp. 1-42 (3 pls.).

|| Flora und Flora des Golfes von Neapel. 26. Die Rhodomelaceen. Berlin, 1901, xvi. and 754 pp., 24 pls. See also Amer. Naturalist, xxxvi. (1902).

with the relationship between Rhodomelaceæ and other Orders, and containing a synoptical view of the genera, as well as notes on many points of interest. The general outline of the systematic treatment is the same as that in Engler and Prantl's *Natürlichen Pflanzenfamilien*, which was drawn up by Falkenberg, but in this work we have the details of the system which till now has been only treated generally. The new genera are founded as the result of definite views regarding the importance of certain characters throughout the Order, occurring mainly in the vegetative parts of the thallus. Since the classification of the present work is based more on developmental characters than on mature structure, it differs considerably from the Agardhian classification, and is at variance with the conclusions of various other authors.

Corallinæ from Port Renfrew, Vancouver.*—A critical list by K. Yendo, of nine species of *Amphiroa*, *Cheilosporum*, and *Corallina*, with a synoptical key. *Amphiroa tasmanica* Sond. is reduced to a form of *A. cretacea* Endl.; the diagnosis of *Amphiroa californica* Decne is considerably amplified and the species transferred to *Cheilosporum*; *Corallina frondescens* Post. et Rupr. is also transferred to *Cheilosporum*, and three new forms of it are described. Amplified diagnoses are also given of *Corallina planiuscula* Kütz. and *C. officinalis* var. *chilensis* Kütz., the former species being transferred to *Cheilosporum*. Three new species are described,—*Cheilosporum MacMillani*, *Corallina vancouveriensis* in two forms, and *C. aculeata*. Details are given concerning the habitat of all these plants at Port Renfrew, and the whole paper is fully illustrated, in part by photographs.

Japanese Corallinæ.†—K. Yendo publishes a critical list of thirty-two species of Corallinæ from the coasts of northern and middle Japan. Of these twenty are new, consisting of eight species of *Amphiroa*, three of *Cheilosporum*, and nine of *Corallina*. Four new varieties are also described, two of these being of already existing species. They are well figured on seven plates, of which four are reproductions of photographs.

Notes on some Fresh-water Algæ.‡—W. Schmidle here publishes corrections of what he considers errors of nomenclature in works of Chodat and others. He also describes several new species: *Stipitococcus Lauterbornei*, *Askenasyella chlamydropus* new genus and species, *Cephaleros Henningsii*, *Schizothrix guadeloupeana*, and *Oodesmus Doederleinii* new genus and species. *Askenasyella chlamydropus* had been already seen and figured by Hermann, as Schmidle adds in a final note. A diagnosis is given of Lemmermann's genus *Tetrasporopsis*, till now a nomen nudum.

Fresh-water Algæ of Ceylon.§—William West and George S. West publish a list of 395 fresh-water algæ, including 49 diatoms, collected in Ceylon by Mr. Freeman. Other species than those recorded were also observed, but the specimens were too fragmentary to identify. A new genus, *Desmatractum*, is described, to receive one species founded on a single specimen. It is most nearly allied to *Rhaphidium* in the family

* Minnesota Bot. Stud., ser. ii. xl. (1902) pp. 711-22 (6 pls.).

† Journ. Coll. Sci. Imp. Univ. Tokyo, xii. part 2, article 3 (1902) 38 pp. (7 pls.).

‡ Hedwigia, xli. (1902) pp. 150-63 (2 figs. in text).

§ Trans. Linn. Soc., 2nd ser. (Bot.), vi. (1902) pp. 123-215 (6 pls.).

Palmellaceæ. Including *Desmatractum plicatum*, the authors describe 65 new species and a considerable number of new varieties of already existing species. A relatively large number of the same species occur in Ceylon and Madagascar, and a great resemblance is also found between the fresh-water algæ of Ceylon and that of North Queensland. *Phymatodocis irregulare* Schmidle, which has hitherto only been found in East Africa, is here recorded from Ceylon. The paper is illustrated with six quarto plates, containing numerous figures.

British Marine Algæ.*—E. A. L. Batters is publishing a list of British Marine Algæ, including the latest records and the result of his own examination of the national and other herbaria. He gives the distribution of each species, and a note as to the rarity or otherwise of their occurrence. Only such synonymy is given as is necessary for the recognition of a species or variety. Up to the present time the Orders Myxophyceæ, Chlorospermeæ, and part of Fucoideæ have appeared.

Marine Flora of the Gulf of Naples.†—A. Mazza publishes a list of 99 marine algæ, collected at various points in the Gulf of Naples. Critical notes are given on many of the species, and the list shows several additions to the record of Falkenberg and Berthold.

Algæ of the Verona District.‡—Achille Forti makes a fourth contribution to his list of the Verona algæ, including 176 Bacillariæ, 6 Peridiniæ, 16 Flagellata, and 71 Myxophyceæ.

Algæ of the Harriman Alaska Expedition.§—De Alton Saunders publishes a list of 380 species collected during this expedition, giving the locality of each species, and in many cases critical notes. Nine new species are described:—*Streblonema minutissima*, *S. pacifica*, *S. irregulare*, *Homocostroma lobata*, *Coilodesme linearis*, *Myelophycus intestinalis*, *Mesogloia simplex*, *Alaria fragilis*, and *Pleurophycus Gardueri*.

Mycetozoa and Fungi.

Studies in Myxomycetes.||—A descriptive list of species from Brazil has been published by E. Jahn on material collected by Alfred Möller during his stay in Blumenau. Tropical forms had already been recorded from the Old World by Raciborski, Penzig had described species from Java, Lister from Antigua and Domenica, and Macbride had included the species of Central America in his North American Slime-moulds. Möller's collections are the first gatherings of Myxomycetes from Brazil. Jahn has distinguished 37 different species. Many of them were already known from the tropics of Asia and from North America. They are either absent from Europe, or occur there only rarely. Climatic reasons scarcely account for such a distribution, as they are found far to the north in America. He considers that the wide dissemination of species is practically unhindered over the whole Western continents, while in the Eastern hemisphere the broad steppes

* Journ. Bot., xl. (1902) Supplement.

† Nuova Notarisa, ser. xiii. (June 1902) pp. 125-52.

‡ Tom. cit., pp. 97-124.

§ Proc. Washington Acad. Sci., iii. (1901) pp. 391-486 (20 pls.).

|| Ber. Deutsch. Bot. Ges., xx. (1902) pp. 268-79 (1 pl.).

of Asia and Russia and the Sahara desert in Africa form a natural and efficient barrier between the warm countries and the forests of Europe. The writer has followed Lister's *Monograph of the Mycetozoa* in his classification. There is one new species recorded, *Didymium excelsum*, determined by Lister.

Plasmodiophora Brassicæ.* — Feinberg has studied the origin of "finger and toe," the diseased outgrowths on the roots of members of the genus *Brassica*, in order to throw light on the cause of tumours in the animal kingdom. In sections cut from a diseased cabbage-root he found cells full of masses of spores, others with the amœbæ, and in some cases the plasmodium developing into spores. The spores were small round bodies, rather larger than the nucleoli of the host-cell. They were surrounded by a double membrane. The amœbæ presented a fine protoplasm, with a more or less characteristic nucleus, which was formed of a nucleolus surrounded by a sharp clear zone resembling, according to v. Leyden, the eye of a bird. Feinberg found these nuclei also in malaria parasites, and considers them characteristic of one-celled animal organisms. He did not find the parasites nor the spores in tumours from the human body.

Streptothrix farcinica.† — Carl Feistmantel has communicated the results of his observations after a long series of experiments on the staining properties of various species of the lower fungi. He discusses the causes that enable stained specimens to resist discoloration by acids and alcohol, and the systematic value of this property. He finds that *S. farcinica* occupies a position midway between the Actinomycetes (the Streptotrichaceæ) and the fungi that resist decoloration by acids. He would, however, use the term *Streptothrix* for the whole group.

Urophlyctis. — In a recently published paper, P. Magnus gave a sketch of the genus and species of *Urophlyctis*. He describes in the present paper ‡ a disease causing galls on the roots of lucerne, ascribed by Lagerheim to *Cladochytrium Alfalfæ*, but which Magnus considers to belong also to the genus *Urophlyctis*. The galls occur as small excrescences on the main roots of *Medicago sativa*. The interior is divided into irregular chambers, which are filled with the resting-spores of the fungus. The disease occurs only in damp soil, and is fatal to lucerne plants. It was first described by Lagerheim from Ecuador. It has also been found frequently in Alsace, into which country it has been imported from the former region.

Fr. Bubak § has discovered in Bohemia *Urophlyctis bohémica*, a new fungus on plants of *Trifolium montanum*. The plants attacked fail to flower, and the leaves and petioles become covered with yellow spots and warts caused by the parasite. On the petioles the warts are much larger than on the lamina of the leaf, attaining a diameter of 1 mm. The resting spores are found in the abnormally large parenchyma cells, the walls of which disappear as the fungus ripens. As many as 200 resting-spores may be contained in each wart. They are convex-

* Deutsche Med. Wochenschr., No. 3 (1902).

† Centralbl. Bakt., 1^{te} Abt., xxxi. (1902) pp. 433-44.

‡ Ber. Deutsch. Bot. Ges., xx. (1902) pp. 291-6 (1 pl.).

§ Centralbl. Bakt., 2^{te} Abt., viii. (1902) pp. 817-21

concave, almost boat-shaped, and are of an intense yellow-brown colour. No other spore form was found. The paper is illustrated by photographs of the diseased plants and of a microscopic section through one of the warts, showing the resting spores in position.

Energy of Assimilation in Fungi.*—T. Bokorny finds that the assimilation energy measured by the relative increase in weight per unit of time, is much greater for moulds and yeasts than for green plants. A mould nourished with glycerol and ammonium sulphate increased in weight one thousand times in twenty-eight days. Yeast yields the largest crop in presence of cane-sugar when its nitrogenous food is peptone, asparagine is less favourable, and ammonium sulphate is least of all. *Spirogyra* can assimilate its carbon from sodium formaldehyde sulphonate in absence of carbon dioxide, starch being formed in the cells; 0.07 grm. of the dried alga gave about 0.11 grm. in 5 days.

Zymase in Fungal Hyphæ.†—M. Mazé has experimented with the hyphæ of *Eurotiopsis Gayoni*, in order to decide the presence of zymase in the cells that are largely exposed to the air, and to prove that the quantity of this substance in a given weight of mycelium diminishes with the age of the fungus. His method was, by the employment of ether and alcohol, to kill the mycelium while at the same time he fixed the diastase. He then pounded the mycelium and tested it in a solution of glucose. He found that aerobic life was necessary for the production of zymase and that it is rapidly destroyed as the filaments become old.

Pleomorphism and Chlamydospore Formation among Filamentous Fungi.‡—O. Brefeld discusses at some length the evolution of the higher fungi from the lower. He traces the development of conidia and sporangia, the latter through the Hemiasci to the fully developed Ascomycetes, the former to the Basidiomycetes. He describes the growth of a new form of *Chlamydomucor* which appeared in a culture of *Ptychogaster* spores. After a period of luxuriant growth the contents of the filaments centred in definite small areas, which were cut off by cell-walls from the rest of the mycelium. These enriched portions acted as resting-spores and after a quiescent period of four to six weeks they produced sporangiophores and sporangia, or, if they were very small, a new vegetative growth. Brefeld compares this type of development with the well-known *Mucor racemosus* and classes them both in *Chlamydomucor*. He claims also that he finds an exactly similar chlamydospore formation among the higher fungi. He reiterates his frequently expressed opinion that sexuality exists only among the lower alga-like fungi, that the higher are derived from the non-sexual conidia and sporangia of the lower fungi, and that sexuality is therefore not to be found in such. He refuses to recognise any connection between them and the Floridææ.

The Saprolegnieæ.§—M. V. Minden publishes a general account of this family. He compares them with the nearly related groups of algæ, and notes the points of resemblance, as, for instance, between *Mono-*

* Pflüger's Archiv, lxxxix. (1902) pp. 454-74. See also Journ. Chem. Soc., lxxxii. ii. p. 345. † Comptes Rendus, cxxxv. (1902) pp. 113-6.

‡ Jahresber. Schles. Ges., lxxix. II. Abt., pp. 4-22.

§ Centralbl. Bakt., 2^o Abt., viii. (1902) pp. 805-10.

blepharis and *Ædlogonium*. A somewhat full description is given of the genus *Rhipidium*. Many of the forms have been found in the neighbourhood of Breslau.

In a further instalment,* the same author gives an account of *Araiospora*, under which genus Thaxter has placed *Rhipidium spinosum*. *Araiospora* possesses two kinds of sporangia, one simple, procumbent, ovate; the other strongly built and provided with a varying number of stiff horn-like processes round the opening, which are spreading, upright, or bent-back, and are probably protective against different animals. The oospores of *Araiospora* have been rarely found, in this respect differing from *Rhipidium* in which the sexual generation is easily cultivated. V. Minden also discusses the systematic position of *Blastocladia*. It is still imperfectly known, as no one has succeeded in finding the sexual spores. He records a new genus *Macrochytrium* with one species *botrydioides*. It has a large, broadly elliptical or globose sporangium, in which are developed innumerable uniciliate spores resembling those of *Chytridium*. The sporangium opens by a lid which remains attached as by a hinge on one side. The genus differs from *Chytridium* in its abundant mycelium and well-developed rhizoids. The author places it under the group Hypochytriaceæ near *Tetrachytrium triceps*. These fungi are all rather rare, but this is largely due to oversight on the part of fungologists.

Sporodinia grandis.†—Georg Klebs recapitulates the work he has done on zygospore formation in *Sporodinia* in answer to Falck and Brefeld, who have denied the correctness of his statements as to the factors influencing the production of zygospores. These two writers lay special stress on nutriment as the determining cause. Klebs' contention is that other influences come into play such as atmosphere (the amount of moisture and of oxygen), quality and quantity of nutriment, light and temperature. The presence of moisture in the air and the absence of light were found by him to be very powerful agents in inducing the formation of zygospores. He made a new series of experiments, the results of which he gives in two tables. A number of cultures of the fungus were started in a mixture of grape-sugar and gelatin. Some of these were grown in a dry atmosphere, exposed to a clear northern light, and produced only sporangia; others were kept in a moist chamber in the dark and zygospores alone were formed. The whole matter is discussed at length, and further proofs are given by Klebs in support of his theories.

Mucor as an Alcohol Yeast.‡—W. Winkler discusses the opinions of various fungologists as to the autonomy of the yeast fungus, *Saccharomyces*. Pasteur's idea that alcohol yeast was a form of some Hyphomycete has, he thinks, much to recommend it. He himself has proved the connection between *Torula* and one form of *Saccharomyces*. In order to throw more light on the question he cultivated several typical yeasts in various media, to induce, if possible, an advance in growth or a reversion to some other form. At the same time he selected several

* Tom. cit., pp. 821-5.

† Bot. Zeit., ix. (1902) pp. 177-99.

‡ Centralbl. Bakt., 2^o Abt., viii. (1902) pp. 721-8 and 753-60 (2 pls.).

species of *Mucor* which he cultivated with a view to their ultimately forming yeasts. The first of these methods has given as yet no certain results. With the cultivation of *Mucor* he has been more successful. By growing the fungus in successive liquid cultures he produced an *Oidium* from the hyphæ, and from the *Oidium* he obtained yeast-cells which grew plentifully, and induced considerable fermentation. Winkler found that a solution containing honey was best adapted for the final growth of the yeast-cells. He did not, however, succeed with all the species of *Mucor* that he experimented with. He concludes with a comparison of the *Mucor-oidium* spores and the resting spores of yeast, which he considers bear a strong resemblance to each other.

Actinomucor repens.* — Wl. Schostakowitsch has discovered and described this new fungus, a genus of the Mucoraceæ. It is characterised by "runners," which resemble somewhat those of *Rhizopus* and *Alsidia*, but it differs from these genera in the formation of the columella and sporangiophore. At the end of the runners there rise groups of sporangiophores; these branch usually twice in a verticillate manner, each branchlet terminating in a sporangium. In addition there are formed occasionally sporangiophores on the "runners," which are single, or terminate in a crown of short branches. The sporangia terminating the main branches are larger than the others; the columella is conical, that of the smaller sporangia is almost round. The spores are globose, about $7\ \mu$ in diameter. They are colourless, but appear black in the mass. The fungus was found on pigeon's dung. Its form varies somewhat on different substrata.

Clasterosporium carophilum (Lév.) Aderh. † — R. Aderhold publishes the results of his studies and researches on the fungi that cause gummosis of trees with stone-fruit. He finds that the various species of *Clasterosporium* found on these trees are identical. Cultures were made of the fungus, and every means tried to find some higher form of development, but in vain. The parasite evidently passes the winter in the wounds caused by gummosis, and on the young twigs. The writer considers it to be identical with *Coryneum Beijerinckii*. He discusses the probability of *Clasterosporium* being the cause of gummosis. The malady was always induced by infection with the spores of the fungus, though other causes might also be at work. After infection the cambium-cells were excited to abnormal growth. Aderhold concludes that the fungus secretes a ferment which acts on the cells of the host-plant, thereby inducing unnatural activity. The fungus was rarely found in the swollen tissue or in the cambium.

Erysiphe Graminis. ‡ — Em. Marchal gives the results of his experiments on the spores of this fungus. He desired to find out if the spores collected from one host would infect indiscriminately any of the other plants on which that species is recorded. He selected plants of wheat, and on these he planted *Oidium* spores of *E. graminis*, taken respectively from plants of wheat, barley, rye, and oats. The first only

* Zeitschr. angew. Mikr., viii. (1902) pp. 35-8.

† Arb. aus der biolog. Abt. für Land- u. Forstwirthsch. am Kaiserl. Gesundheits., ii. (1902) p. 515 (2 pls.). See also Bot. Zeit., lx. (1902) p. 203.

‡ Comptes Rendus, cxxxv. (1902) pp. 210-2.

of the series was successful, those collected from wheat and transferred to other wheat plants. The others gave only negative results. He made a further series of experiments with wild grasses. He took the *Oidium* spores from barley and infected a large series of pasture and other grasses. The spores grew on the species of wild barley, but failed entirely on all the other genera selected. There is no morphological difference in *Erysiphe graminis* from these different hosts, but he concludes that there are distinct physiological or biological races evolved within the genus by gradual specialisation on the various hosts. He hopes in future to make further experiments with the ascospores.

Parasitism of *Botrytis cinerea*.*—Ralph E. Smith gives an account of this fungus, usually a saprophyte, but also very frequently a mischievous parasite. Instances are given of the direct infection of a living leaf by the *Botrytis* conidia; but the writer considers that they grow more readily when saprophytic nourishment is first supplied. After infection, the neighbouring tissue is found to have been killed by the action of the fungus, which then feeds on the dead cells. Smith considers that there are two effects to be distinguished: first, the killing of the tissue by some poisonous substance secreted by the fungus; and secondly, the disintegration of the cells by a variety of enzymes. *Botrytis* was grown on a very large variety of substances. It was found to grow well on sugars in general, on dextrin, cellulose, glycerin, gum arabic, vegetable oils, tartaric and malic acids, asparagin and several glucosides. An account is given of the changes induced in several of these media by the growth of the fungus. The writer concludes that the poison given off by the *Botrytis* is oxalic acid formed by the fungus as a by-product of its metabolism. The conidia require saprophytic nourishment to start them on their career as parasites, because they are thus enabled to form a sufficient quantity of oxalic acid to attack the host-tissue. It is pointed out that where infection has taken place from conidia alone, these are always unusually large.

Some North American Discomycetes.†—Elias J. Durand has found a number of species hitherto only recorded from Europe. He gives full descriptions from the fresh material. He has discovered two species new to science. One of these, *Ciboria americana*, grows on the inside of decaying husks of Horse-chestnuts. It is very like the European *C. echinophila*, and may prove to be the American form of that species. The other, *Sclerotinia Smilacinx*, resembles *S. tuberosa*. It grows from small sclerotia which are attached to the decaying rhizomes of *Smilacina racemosa*.

Kryptogamen-Flora.‡—The latest issue of this work, under the editorship of Andreas Allescher, continues the account of the genus *Melanconium*. It also includes the genera *Cryptomela*, *Thyrsidium*, and *Basiascum*, all with one-celled spores. The Hyalodidymæ come next in order with the genera *Marsonia*, *Septomyxa*, and *Glaeosporiella*. The Phæodidymæ are represented by *Didymosporium* and *Bullaria*, the latter with only one species. *Rhopalidium*, also monotypic, *Septoglæum*,

* Bot. Gaz., xxxiii. (1902) pp. 421-36 (2 figs.).

† Bull. Torrey Bot. Club, xxix. (1902) pp. 458-65.

‡ Rabenhorst's Krypt. Flora, i. Abt. vii. Leipzig (1902) pp. 577-640.

Prostemiella, *Psamminta*, and *Pestalozzina* belong to the Hyalophragmiæ. A beginning has also been made with the Phæophragmiæ. The genus *Stilbospora* is completed, and a few of the species of *Coryneum*. The genera are well illustrated. In the small genus *Thyrsidium* there are drawings of no fewer than four species.

Yeasts.*—G. Marpmann confirms Wager's results as to the presence of nuclei in the cells of yeast. He gives a careful account of his methods of fixing and staining for determining the presence of nuclei. He has applied the same treatment to the larger bacteria and has proved the existence of nuclei in their cells also. He gives, further, an account of his prolonged cultures of yeasts, and recommends nuclei-staining as a help to diagnosing the different species. Wild yeasts, he finds, grow at a lower temperature than the forms under cultivation, but in time they develop into culture yeasts. As yeasts differ in form, contents, nuclei, &c., so do they differ probably in the results they produce in the fermentation process. He gives a list of the *Saccharomyces* species he has studied. The different forms are classified as white, grey, yellow-brown, yellow, red, and black yeasts. The writer gives also some account of his work on *Schizosaccharomyces*.

Observations on the Vitality of the Yeast Plant.†—H. Will has found that after 15 years and 2 months yeast-cells developed from the charcoal and asbestos used in connection with brewing. Cells of wild yeast were also frequently found, especially in the asbestos. The vitality of wild yeast is very great when unfavourable conditions such as high temperature, &c. are excluded, and the experiments made prove the great risk of infection from that plant in the brewing process.

Smut of Cereals.‡—Tubouff gives the results of many experiments undertaken with a view to further our knowledge of the fungus causing smut and the best means of combating the disease. As a method of prevention he recommends treating the seed with Bordeaux mixture. In order to test predisposition to disease, eight varieties of maize seed were dusted with smut spores before being planted. The results as to infection were very varied, and the experiment is still being carried on.

The writer states, among other interesting results, that infection does not take place through wind-borne spores. He finds also that the spores of *Tilletia* cannot persist during winter in the soil and that they are harmless for horses, cattle, sheep, and pigeons. Low temperatures are unfavourable to the development of the fungus, so that to delay sowing corn until the season is advanced is to increase the risk of disease.

Biological Phenomena in the Cultivation of *Ustilago Maydis*.§—When spore-formation takes place in *Ustilago Maydis*, the spore-forming hyphæ become mucilaginous. J. Grüss has investigated this in order to determine the possible presence of an enzyme. He finds, after long

* Zeitschr. angew. Mikr., viii. (1902) pp. 57-62.

† Zeitschr. ges. Brauerw., xxv. (1902) pp. 49-50. See Centralbl. Bakt., 2^m Abt., ix. (1902) p. 60.

‡ Arb. aus biolog. Abt. für Land- u. Forstwirthsch. am Kais. Gesundheits, ii. (1902) pp. 179-349 (1 pl. and 19 figs.). See also Bot. Zeit., lx. (1902) pp. 204-5.

§ Ber. Deutsch. Bot. Ges., xx. (1902) pp. 212-20 (1 pl.).

experimentation, that an aminoxydase is present in the fungus similar to that found in the yeast of beer, and is located, as in yeasts, in the vacuoles of the cell. As soon as the formation of mucilage begins in *Ustilago*, the production of the oxydase ceases. The enzyme is most active when there is a maximum of metabolism in the cell, and the resting stage of the fungus follows the period of mucilaginous formation. The author states various theories as to the function of the mucilage. He concludes with an account of spore-germination in this fungus.

Rust of *Andropogon Sorghum*.*—Walter Busse has studied the occurrence of this fungus in German East Africa where it sometimes causes very great loss in the crops of millet. He came to the conclusion that it was the same fungus as that described by Cooke about 25 years ago as *Puccinia purpurea*. The æcidium form is unknown. Uredospores and teleutospores are to be found simultaneously in the same sorus, usually on the under surface of the leaf parallel with the leaf-nerves. The spore-bed is surrounded by paraphyses; they are somewhat club-shaped and are brownish-yellow or of a deep red colour at the tips. The writer considers that this Uredine is the same as that described by Barclay as a sorghum rust in India and named by him *P. Penniseti*. It is said to be "the peculiar indigenous rust of Indian cereals," and is found on a great number of the native grasses.

Witch's Brooms on the Barberry.†—Jakob Eriksson has proved by experiment that the abnormal branch development of the barberry is due to *Æcidium graveolens* of which the *Puccinia* form is produced on *Avena elatior*. The region of attack is the central bud of the tender rosettes of leaves, although an unfolded leaf is also liable to infection by the *Puccinia*. According to Eriksson the tissue entered by the fungus is not suppressed, but rather it is excited to a quick and strong branch development. Later arrives a condition of weakness which renders the abnormal branches unfit to resist the cold of winter, and these parts are liable to be killed. The photographic reproductions show a barberry branch with a broom in three stages of growth induced by artificial infection of teleutospores from the *Avena* host.

Rust of Timothy Grass.‡—The same author has arrived at the conclusion that the rust found on *Phleum pratense* is a separate and distinct species. It has been named *Puccinia Phlei-pratensis* Er. and Hen. Many infection experiments were tried by the author to trace the complete life-history of the fungus. Once he succeeded in inducing germination on the barberry, spermogonia and æcidia being sparsely produced, after a considerable delay. Somewhat similar results were obtained in the attempts to grow the fungus on rye, wheat, oats, and barley. Only in one case, on oats, did any growth take place. It was found that the uredospores germinated and grew on *Festuca elatior*, many of the experiments yielding positive results. Eriksson is of opinion that *P. Phlei-pratensis* was originally identical with *P. graminis*,

* Ber. Deutsch. Bot. Ges., xx. (1902) pp. 281-91 (1 pl.).

† Cohn's Beiträge zur Biologie der Pflanzen, viii. pp. 3-127 (3 pls.). See also Centralbl. Bakt., 2^o Abt., ix. (1902) pp. 75-6.

‡ Öfvers. af Kongl. Vet.-Akad. Förh., lix. (1902) pp. 189-98.

but that it has become specialised on timothy, and can only rarely be induced to grow on oats and rye, and also that it has quite lost the æcidium form.

Relation between Host and Parasite.*—Marshall Ward has worked out this problem in connection with the brome grasses and the Rust *Puccinia dispersa* that grows freely on all bromes. The paper is divided into sections each dealing with some special aspect of the case. After a general introduction, he discusses the different Rusts that have been found on bromes. He then passes on to a description of the different species of the host plants used in this research, with an account of the sterilisation and germination of the seeds in order to secure a plant free from all trace of previous rust infection. Tests were made as to the temperature of the leaves and the conditions generally affecting the germination of uredospores. Methods of infection and the progress of the various experiments are given in careful detail. Pot-plants were used and the results were found to be very different for different species of brome. The spores taken from one species would not infect others unless they were closely allied forms. In discussing these phenomena the writer takes into account the varying conditions of the different hosts. He describes the leaf anatomy, the number of the stomata, the leaf-hairs, &c. He draws a comparison between the germination of uredospores and that of pollen-grains as observed in attempts at cross-breeding, and he considers that it might be possible to grow species of grasses immune from rust infection.

Monograph of the Uredineæ.†—P. and H. Sydow have issued the first part of their important work on the Uredines. The whole of the first volume will include only the genus *Puccinia*. The authors have not followed the usual division into sub-genera, such as *Eupuccinia*, *Heteropuccinia*, &c. They consider that in the present condition of defective knowledge as regards exotic species, it is impossible to so classify the specimens. In order to lighten the labour of finding species in their book, they have followed an alphabetical arrangement of host-plants. They begin with the natural order Compositæ, and the first host cited is *Achillea*; the last is *Zoegea*, on which are recorded species from Persia and Brazil. This first part is almost entirely occupied with the one natural order. Two pages only at the end are devoted to Calyceraceæ.

Rare or little known species are illustrated by outline drawings of the spores. The diagnoses, where possible, have been made from original material.

Geastræ.‡—C. G. Lloyd has recently issued in pamphlet form a monograph of this family of Gasteromycetes. He includes the two genera *Geaster* and *Myriostoma*. The latter is monotypic, and has been usually included as a sub-genus of *Geaster*. It is distinguished by having several orifices and several pedicels to the fruiting body.

There are 22 American species of *Geaster*. Those exclusively American are *G. Morganii* Lloyd, *G. delicatus* Morg., and *G. radicans*

* Ann. Bot., xvi. (1902) pp. 233-315.

† Leipzig, Borntraeger, 1902, vol. i. fasc. 1, 192 pp. and 172 figs.

‡ The Geastræ, Cincinnati, Ohio, U.S.A., 1902, 43 pp. and 80 figs.

Rad. Lloyd has found in the States and in Samoa the plant that was figured and described by W. G. Smith under *G. striatus* D.C. After examining and comparing the different specimens, he concludes that it is altogether different from the typical *G. striatus*, and he has re-named it *G. Smithii*. The species are all illustrated by photographs.

European Agarics.*—G. Masee has just published a classified list of these fungi, with a short description of each species. It is a handy compilation, and is intended to widen the outlook of home systematists, and give them a better grasp of species as a whole. The work includes descriptions of 2750 species, of which 1553 are British. The species not yet recorded for Britain are indicated by brackets. A scanty bibliography is given at the end of the book.

Rhizomorpha.†—Jules Goffart has studied the form and development of the rhizomorpha of *Armillaria mellea*. It grows usually in long strands under the bark of dying trees, and passes out into the soil to a considerable distance. A strand that had grown into a stream was also examined and compared with those that grow in the ground. He finds in the rhizomorpha a medulla of primary hyphæ, along with secondary hyphæ. This central portion increases in diameter, and the hyphæ grow outwards and form the cortex, which is thus continually renewed from the interior. The author finds in the structure reserve hyphæ and vascular hyphæ. These latter were fewer in number in the aquatic specimen.

American Mycology.—After an interval of several years, the *Journal of Mycology* ‡ is now being reissued under the editorship of W. A. Kellerman, of the Ohio State University. The contents of the June number include a paper on the Morchellæ, by A. P. Morgan. He groups all the specimens he has found under two species, *Morchella esculenta* and *M. patula*. The editor publishes a new species, *Rhizisma concavum*, found growing on leaves of *Ilex verticillata*, and characterised by the concavity of the stroma on the under side of the leaf. J. C. Arthur gives a further instalment of his work on the cultures of Uredineæ. He has been dealing with *Carex* rusts, and for three of them he proposes new names. The æcidia grow on various Dicotyledons. Kellerman gives a list of the plants included in Fascicle IV. of his *Ohio Fungi*, with a descriptive note appended to each species. J. B. Ellis and B. M. Everhart publish a long list of new Alabama fungi, collected by George W. Carver. They are all small fungi, and belong to the Sphæröpsideæ, the Pyrenomycetes, Hysteriaceæ, Discomycetes, and Hyphomycetes. A considerable part of the number is occupied by an alphabetical list of articles, authors, subjects, new species, and hosts, all pertaining to the subject of Mycology. The frontispiece to the number is a portrait of J. B. Ellis.

C. L. Shear § publishes comments on various American species of fungi, and a considerable number of new species belonging to many

* European Fungus-Flora: Agaricaceæ, London, 1902, vi. and 274 pp.

† Bull. Classe Sci. Acad. Roy. Belg. No. 5 (1902) pp. 313-5.

‡ Journ. Myc., viii. (1902) pp. 45-104.

§ Bull. Torr. Bot. Club, xxix. (1902) pp. 449-57.

different genera. *Polyporus volvatus* Peck is made the type of a new genus *Cryptoporus*. In this plant a "thick volva-like extension of the margin of the pileus covers the pores, with the exception of a small circular aperture." The author records a new genus of Hyphomycetes, *Plectrothrix*, near to *Monosporium*. The spores are borne on spinose branches near the tops of the fertile hyphæ. They grew on leaves of *Vaccinium macrocarpon* which were kept in a moist chamber, and which had previously developed *Pestalozzia Gupini*.

Vegetable Pathology.*—F. P. Brzezinski publishes the result of his research on fruit-trees injured by canker and gummosis. The canker of apple-trees has been hitherto ascribed to the action of a fungus, *Nectria ditissima*. The writer has conducted a long series of experiments, and has come to the conclusion that the nectria is merely saprophytic on the damaged tissue, and that the canker is primarily due to the action of bacteria. He invariably found microbes in the diseased parts, and with these he inoculated healthy trees and reproduced the canker. Brzezinski considers canker to be a contagious malady, and one which may be latent for years in a seemingly healthy tree. So long as the surroundings are conducive to healthy growth the tree shows no sign of canker, but if unfavourable conditions occur, or if the tree is old, the disease at once becomes manifest. The canker bacterium has the form of short rods divided in two twin globules. It is easily cultivated on nutritive media. High temperatures are fatal to it, but it thrives and multiplies in the cold down to 0° C.

The bacterium of Pear canker cannot be distinguished from that of the Apple, though in artificial cultures there is a slight difference. Gummosis of the Peach, Apricot, Plum, and Cherry has much analogy with canker; it also is due to the action of bacteria. The writer is of opinion that the Cherry bacterium differs from that of the other fruit-trees; it is similar in form, but quite distinct in artificial cultures. Gummosis commences with discoloured streaks in the tissue penetrating the wood of the branches, which soon thereafter begin to secrete gum from open wounds. The young twigs and the fruits are also liable to the disease.

Fungi on *Andromeda polifolia*.†—P. Hennings has described a new species, *Godronia Andromedæ*, which he found growing on *Andromeda*. It is closely related to *G. urceoliformis* and *G. Ledi*, which grow on *Vaccinium Myrtillus*. He also found, growing along with *Godronia*, a new species of the Melanconia, *Septomyxa Andromedæ*. He is of opinion that the latter is the pycnidial form of *Godronia*. Several other pycnidial forms have been observed in association with species of *Godronia*. Schröter found *Sphærocista schizothecioides* Preuss. growing with *Godronia Ericæ*. *Dothichiza Viburni* Karst. and *Sphæronema Viburni* Fusk. are associated with *Godronia Viburni*, and Brefeld noted in his cultures a series of conidial forms pertaining to *G. urceolus*. Hennings found also on *Andromeda* specimens of *Mollisia cinerea* var. nov. *Andromedæ* and of *Lachnum virgineum*.

* Comptes Rendus, cxxxiv. (1902) pp. 1170-3.

† Verh. Bot. Prov. Brandenb., xliii. (1902) pp. 102-4. See also Centralbl. Bakt. 2^o Abt., viii. (1902) p. 813.

Fungal Parasites of Tropical Cultivated Plants.*—A. Zimmerman gives a further list of injurious fungi on the plants of our greenhouses, &c. There is one member of the Hymenomycetes, *Corticium javanicum* Zim. The others are all microscopic, mostly found on the leaves or twigs of the host-plant.

Black Rot of Oranges.†—N. B. Pierce describes as a new species *Alternaria Citri*, a fungous disease of navel oranges which has attracted attention in the orange-growing districts of California for some years past. The fungus hyphæ enter through cracks in the peel, and destroy the cells of the pulp-sacs, which become black and bitter. Conidia are formed upon the surface of affected tissues.

Disease of Cultivated Chrysanthemums.‡—P. Voglino has made an extended study of the fungus causing this disease. It appeared first in July, and several plants were entirely killed. In August and September there was not much spread of the disease, but in the two following months it increased with great rapidity. The leaves were disfigured by irregular brown spots which gradually extended over the whole lamina. On these spots small pycnidia of a *Phoma* were formed, called by Voglino *P. Chrysanthemi*. Examples of *Phyllosticta leucanthemi* were also formed occasionally on greyish spots. At a later stage the *Phoma* was replaced by *Septoria Chrysanthemi*, which continued to develop and was, during the remainder of the season, the chief form of the disease. By culture and infection experiments the writer proved that the *Phoma* and *Septoria* were successive stages of the same fungus, and that while the spores of *Phoma* had only a short existence, the *Septoria* spores germinated after long intervals, and were able to resist low temperatures.

Black Rot.§—A. Prunet has published a note giving the result of his treatment of Black Rot, a disease of the vine. The spores are formed in pycnidia and are liberated by the action of water. The first formation of these should be watched and the vines protected from the first invasion of spores. He considers that they should be sprayed, say ten days from the first unfolding of the leaves until the tree has bloomed. It is not a wide-spread malady like mildew, and treatment need be applied only where the disease has actually broken out.

Some Fungus Cultures.||—Karl Holborn has been successful in cultivating some of the fungi that cause diseases on hairs. His aim was to transfer the parasite to other hairs. In a case of *Trichorrhexis nodosa* that occurred in the hairs of a man's beard, he made a pure culture of the fungus and developed a *Mucor* with its sporangia. From the culture he induced a typical growth of the *Trichorrhexis* on hairs from a horse's tail; and from these hairs he again grew the *Mucor*.

He applied the same methods to the culture of some of the Uredineæ. He failed to make a growth from spores on artificial media, but he was more successful with the mycelium of the same fungi. He was prevented

* Centrabl. Bakt., 2^e Abt., viii. (1902) pp. 803-5.

† Bot. Gaz., xxxiii. (1902) pp. 234-5.

‡ Malpighia, xv. (1902) pp. 329-41 (1 pl.).

§ Comptes Rendus, cxxxv. (1902) pp. 120-3.

|| Tom. cit., pp. 479-80.

from pursuing the research further and could not attempt the infection of plants from his cultivated mycelium as he had intended.

Schizophyta.

Schizophyceæ.

Flora of Hot Springs.*—G. S. West publishes a list of 56 species and varieties collected in hot springs in Iceland. *Aulosira thermalis* is a new species, and *Calothrix parietina* has a new variety *thermalis*. *Oscillatoria proboscidea* and *O. numidica* occur there. Three species are also recorded from a hot spring in the Malay Peninsula, two of which, *Simploca Yappii* and *Phormidium orientale*, are new.

Observations on *Aphanochæte*.†—F. E. Fritsch gives the results of observations on *A. polychæte* Fritsch, taken at intervals for a period of over six months. He describes and figures various stages in its life-history, but can give no details as to its reproduction. He considers his plant identical with *Herpoteiron polychæte* Hansg., and transfers it, together with *H. confervicola* Näg., to the genus *Aphanochæte*. The genus *Herpoteiron* should be dropped, according to this author, who finds that the septate hairs described for this genus do not really occur; neither do the hairs have a sheath at their base. An account of work already published on *Aphanochæte* and the neighbouring genera is given, and a scheme of classification, based on the author's own observations. The frequent occurrence of cells with red granular contents is described in connection with *A. polychæte*, but as yet no clue has been found to the part they play in the life-history of the alga. The author has found similar cells while examining young plants of *Stigeoclonium*.

Schizomycetes.

Fermentation of Cellulose.‡—V. Omelianski finds two species of bacilli which effect fermentation of cellulose, and are widely distributed in soil, manure, sewage deposits, river mud, &c. One species effects a hydrogen fermentation of cellulose, yielding hydrogen, carbon dioxide, and butyric and acetic acids. The other effects methane fermentation, yielding methane, carbon dioxide, and the same fatty acids. Neither of the species is identical with *Bacillus amylobacter*, which, according to van Tieghem, is the chief organism which attacks cellulose.

Parasitism of *Pseudomonas destructans*.§—M. C. Potter describes the action of this bacterium on living cells of the turnip. The cells were rapidly killed by the toxin secreted by the parasite, which then penetrated the walls and entered the cell-cavities. The bacterium had no power of penetrating or destroying the fully developed cuticle of the epidermis, but can readily effect an entrance through the young undeveloped epidermis.

Infection by *Paracolon Bacillus*.||—Strong describes a case of infection occurring at Santa Cruz, simulating and diagnosed as typhoid

* Journ. Bot., xl. (1902) pp. 241-8 (1 pl.).

† Ann. Bot., xxi. (1902) pp. 403-12 (7 figs.).

‡ Centralbl. Bakt., 2^{te} Abt., viii. (1902) pp. 193-201, 225-31, 257-63, 289-91, 321-6, 353-61, 385-91 (1 pl. and 1 fig.).

§ Proc. Roy. Soc., lxx. (1902) pp. 392-7 (2 figs.).

|| Rep. Surg.-Gen. on Prevalent Diseases among Troops in the Philippines, 1901. See Bull. Johns Hopkins Hosp., xiii. (1902) pp. 107-8.

fever. At the autopsy a paracolon bacillus only was isolated from the spleen, and no lesions such as are usually associated with infection by the *B. typhosus* could be demonstrated. The bacillus presented the following characteristics:—motile, decolorised by Gram; surface colonies on gelatin plates resembled those of the *B. typhosus* or delicate colon colonies; agar streak, moderately heavy growth; broth, uniform turbidity at first, later a sediment is deposited and sometimes pellicle formation is observed, no indol is formed; litmus milk after 14–24 hours becomes reddened, after 48 hours has again become blue, and later still the colour of the litmus may be completely discharged. Glucose and saccharose are fermented by the bacillus in the course of its growth, but not lactose. Unfortunately no blood was collected at the autopsy, so there was no opportunity of testing for the presence of agglutinins. The bacillus was pathogenic for mice in doses of 0·5 ccm. (? broth culture) and was recovered post-mortem from the blood and organs. This makes the fourth recorded case of primary infection by paracolon bacilli.

Differential Diagnosis of Coli and Typhoid.*—Wolff eulogises the neutral red method of differentiating the *B. typhosus* from the *B. coli communis*, and definitely states that it never fails. He points out that when grown in neutral-red agar plate cultivations, the colonies of the typhoid and colon bacillus become coloured, due to vital staining of the individuals of which they are composed. If such bacilli are examined in water they are seen to be motile, but the stain is quickly washed out, but if examined in weak neutral-red solution the preparation appears to consist of cocci, not bacilli, owing to the presence of one or two neutral-red spots visible in each bacillus, although the motility is not affected.

The author also discusses whether or no the *B. typhi abdominalis* can assume a pyogenic role, and whilst not giving a decided opinion inclines to the belief that under certain conditions it may do so.

Unity of Pathogenic Streptococci.†—Marmorek, after critically studying 42 strains, maintains the unity of streptococci pathogenic to man, and disregarding minor morphological differences—referable to variations in environment or the composition of nutrient media, symbiotic life or the like—points out that several vital characteristics are common to all, no matter what their source.

The first of these is the power possessed by the virulent streptococcus of hæmolysing the blood of the rabbit *in vivo*, a character which constitutes a direct index of the virulence of the streptococcus; the second, its inability to grow in filtered cultivations of the same or other virulent streptococci; and finally, all pathogenic streptococci from whatever source agree in that they are capable of being exalted in virulence to a definite fixed standard.

The author further states that the streptococci isolated from scarlet fever anginas possess but slight hæmolytic powers, which, moreover, are not increased by exalting the virulence of the organism, and are also able to develop to a certain extent in filtered cultures. These, however, are merely differences of degree and not of kind.

* Centralbl. Bakt., 1^o Abt., xxxi. (1902) pp. 69–72.

† Ann. Inst. Pasteur, xvi. (1902) pp. 172–8.

Actinomyces asteroides.*—MacCallum defends the generic name of *Actinomyces* for the group of organisms to which the *Actinomyces asteroides* belongs, and points out that it is the only appropriate title, and that with the exception of the term *Streptothrix* (which had already been applied to a genus of the Hyphomycetes group), it has the additional claim of priority. The organism the author describes was isolated in pure culture, post-mortem, from some caseous masses in the peritoneum of a negro child, and was identical with that described by Eppinger as *Cladothrix asteroides*. The organism, which was definitely branched, was easily cultivated; on agar plates it forms discrete, round, opaque, shaggy colonies, which are firm and hard and of a yellow colour, with moist, dull, roughened surface raised and sometimes umbilicated, sometimes attaining a diameter of 3-4 mm. On gelatin and on inspissated blood-serum similar colonies are produced; the medium is not liquefied in either case. In broth a thin pellicle, resembling dust scattered over the surface, appears in 24 hours, and a deposit forms consisting of a coherent filamentous mass entangling minute opaque yellowish-white balls. The bulk of the medium remains clear. In litmus milk a yellowish granular sediment forms, accompanied by the production of a marked alkaline reaction; no peptonisation of the medium occurs. On potato a dull greyish-red film appears after 24 hours, which becomes thicker and more nodular in appearance, and after a time on the upper drier portions of the potato a chalky-white bloom appears on the elevated points of the cultivation which may ultimately extend over the whole surface. The organisms stained by Gram's method and showed distinct granules when treated by Neisser's method. Filamentous growth with distinct branching, also clubbed and coccus forms were noted, but no evidence of spore formation could be obtained by staining methods. This *Actinomyces* is a strict aerobe, does not produce gas, optimum temperature appears to be about 37° C., thermal death-point for coccus forms 65° C. for 10 minutes, and for the thread-forms 70° C. for a similar period.

Rabbits and guinea-pigs are susceptible to intravenous, intraperitoneal, or subcutaneous inoculation of this actinomyces, dying in from a few hours to 10 days. Dogs and mice are also susceptible. The pathogenic effects of the organism were studied most fully on the rabbit, in which animal it produces widely disseminated focal lesions containing characteristic ray-fungus forms, consisting of elongated cylindrical structures with laterally radiating clubs which are probably degenerating forms.

The metastatic abscesses begin with a focal degeneration and necrosis of tissue, associated with an extensive accumulation of leucocytes, all of which in turn undergo necrosis and are walled off by a capsule of vascular granulation tissue in which giant-cells often occur.

Botryomycosis.†—Galli Valerio reviews the work of previous observers on the subject of botryomycosis, and describes a recent case (which came under his own observation) occurring in a farm labourer, in the form of a pedunculated tumour some 2.5 cm. in diameter, situated on and involving the skin of the right forearm.

* Centralbl. Bakt., 1^{te} Abt., xxxi. (1902) pp. 529-47. † Tom. cit., pp. 508-21.

Cultivations from the depths of the tumour gave rise to cultivations of a non-motile coccus occurring in pairs and in staphylococcus-like masses, individual elements measuring from 0.6 to 0.8 μ . Occasionally zooglæa formation is noticed. The coccus stains well with anilin dyes and also by Gram. In gelatin plates at 20° C. yellowish-orange colonies appear in 24 hours which liquefy the gelatin; in gelatin stabs growth takes place on the surface and in the depths, liquefaction proceeds in the shape of a cone, and the entire contents of the tube are liquefied in about 17 days. It grows well upon agar at 37° C., and on inspissated ox-serum without liquefying the medium. A golden-coloured layer appears upon potato, and in broth at 37° C. pellicle formation is observed in 24 to 48 hours, with universal turbidity and considerable yellowish deposit at the bottom of the tube after 3 days. No indol formation occurs: milk is coagulated in 4 days.

Of two guinea-pigs inoculated subcutaneously with broth cultivations, one died in less than 48 hours; in this case the post-mortem appearances resembled those produced by inoculation with the *B. anthracis*, with the exception that the staphylococcus was recovered from the heart blood. The other guinea-pig suffered from a local abscess, the pus being crowded with the cocci, but the author does not state that the animal succumbed. A grey rat inoculated subcutaneously died in 48 hours with sero-hæmorrhagic exudation at the site of inoculation, the cocci being present in its heart blood. Inoculations of rabbits and guinea-pigs with portions of the excised tumour provoked local suppuration which apparently did not produce death. In summarising his observations the author states that there exists among animals and in man an affection known by the name of botryomycosis, in which is found a micrococcus that occasionally presents slight differences from the typical form of the *Staphylococcus pyogenes aureus*.

Bacterium phasianicida.* — E. Klein describes a new species belonging to the hæmorrhagic septicæmia group, which he considers responsible for a severe and fatal epidemic among the pheasants on an English game-farm. He describes the lesions observed in the birds post-mortem.

Post-mortem examination of the bodies of the birds shows injected intestines, enlarged dark red spleen, engorged liver, with hæmorrhage in the capsule and on the surface, the heart-cavities filled with coagulated blood. Smear preparations of the blood show small numbers of short oval bacilli; preparations from the spleen, however, are found to be crowded with the bacilli. They correspond in size to those of chicken cholera, and resemble them further in taking up the ordinary anilin dyes most deeply at the poles, and in not retaining the stain when treated by Gram's method. Surface colonies on plates resemble those of members of the *Coli* group. On gelatin it grows more quickly than the bacillus of fowl cholera; it produces a thin colourless layer on potato; the bacillus does not liquefy gelatin, form acid, produce indol or gas, and does not coagulate milk.

Inoculation experiments show that the chicken and the guinea-pig are insusceptible to infection by the bacillus. Rabbits die about 48 hours

* Centralbl. Bakt., 1^o Abt., xxxi. (1902) pp. 76-7.

after subcutaneous inoculation. Pigeons are readily infected, and show post-mortem lesions identical with those found in the pheasant.

Cultivations of Gonococcus.*—Wildbolz, in a preliminary communication, comments upon the unanimity of observers who record their failure to obtain a growth of the gonococcus on ordinary nutrient media, and states that in only four strains out of twenty did he fail to obtain a growth on ordinary agar and in broth. He attained this result by cultivating the gonococcus, isolated from early acute cases of gonorrhoeal urethritis, through a number of generations upon serum-agar, and at each generation inoculating tubes of ordinary agar; he then found that although he seldom obtained a growth from the second or third generation, he was usually successful after the fourth or fifth. In one instance he only obtained a growth on ordinary agar after sixty-two generations on serum-agar.

The growth from early generations was always scanty, but became better after ten to twenty, and he was then usually able to cultivate the coccus on ordinary agar through 15–20 generations. With increased capacity for saprophytic growth the vitality increased, and sub-cultures could be obtained from four-week-old cultivations. The virulence under these conditions was not tested. The author further remarks that all batches of agar, although prepared in the same manner (watery extract of beef plus 1 p.c. peptone, 0.5 p.c. salt, and 1.5 p.c. agar, rendered feebly alkaline in reaction), were not equally suitable for the growth of the gonococcus, but that he has not yet determined the factors concerned in the production of this difference.

New Pyogenic Bacillus.†—Stefansky describes a new pus-producing bacillus which he isolated from the pus aspirated from an abscess of the leg. Microscopically numerous organisms, apparently cocci, were observed, many being contained in the pus-cells. Cultures on agar, after 24 hours, showed a pure growth of a short, fairly thick rod, with rounded or pointed ends. The organism was extremely pleomorphic, short rods, globular and flask-shaped forms, also short and long threads showing irregular swellings, together with branched and Y-shaped forms, being frequently met with in artificial cultures of all ages from 24 hours onwards. It stains well with ordinary dyes, but not by Gram; is a facultative anaerobe, optimum temperature 37° C.; thermal death-point 70° C. after exposure for 30 minutes. It grows well upon all ordinary media, whether acid or alkaline, even at 10° C., and retains its vitality for at least six months; produces indol, ferments grape, cane, and milk sugars; does not liquefy gelatin; produces acid in milk, but does not coagulate the medium. When injected subcutaneously into guinea-pigs, rabbits, cats, and dogs, produces local suppuration, not followed, however, by generalised infection. It is extremely pathogenic to pigeons, producing death after intramuscular injection in 20–40 hours, the bacillus being recovered in pure culture from the blood. Toxines obtained from week-old broth were also fatal to the pigeon in doses of 1–2 ccm. in 5–6 days.

* Centralbl. Bakt., 1^o Abt., xxxi. (1902) pp. 128–32.

† Tom. cit., pp. 86–92.

The author designates this bacillus *Bacterium pyogenes ramosum*, and considers it as belonging to the Proteus group.

Bacillus Pathogenic to Rats.*—Issatschenko records some further experiments with a bacillus pathogenic to the grey rat, previously described by him.† This organism was fatal in 431 out of a total of 443 rats experimented upon,—when injected in pure culture death usually taking place from the seventh to the tenth day after infection. Domestic animals appear to be totally insusceptible to the bacillus. The author fed 2 cats, 1 dog, 2 hens, and 4 pigeons with highly virulent cultivations of the bacillus in doses varying from 20 ccm. to 200 ccm. No ill effects followed, whilst control rats provided with infected food died 7, 8, 10, and 11 days after feeding. The author also quotes Feoktistoff's experiments, in which the horse, ox, pig, sheep, dog, cat, turkey, hen, goose, and duck were fed with varying doses, ranging from 500 ccm. in the case of the horse down to 20 ccm. for the duck, without a fatal result being produced in any of the experimental animals. The author also states that large quantities of broth cultivations have been sent out from his laboratory to be employed for the purpose of destroying rats on farms, and in granaries and dwelling-houses, and the reports of its action testify to its value.

Heat-resisting Micrococcus.‡—Russell and Hastings describe a micrococcus which is capable of retaining its vitality in milk heated to 60° C., and which they isolated in large numbers from samples of pasteurised milk. The organism occurs usually in pairs or bunches of four, individual elements having their adjacent sides flattened, and showing a clear bright line between. The coccus stains easily with anilin dyes, and is not decolorised when treated by Gram's method. Its optimum temperature is from 20° C. to 25° C., growth at 38° C. being but very scanty. It grows well on all ordinary media; on agar it produces a dull lemon-yellow coloured layer, confined to the needle-track. In broth growth begins at the bottom of the tube, and creeps up the side, old cultures showing a thin pellicle. In milk no change is observed, the bright yellow growth being deposited at the bottom of the tube. Gelatin is not liquefied. The organism does not ferment dextrose, lactose, or saccharose. In thermal death-point determinations, 48-hour cultures in standard nutrient broth were exposed at various temperatures in thin-walled tubes of 6 mm. diameter, the results showing that although many individuals are killed at 72° C., exposure to 76° C. for fully 10 minutes is necessary to ensure the death of all.

Association of Amylomyces and a Micrococcus.§—Vuillemin in cultivating *Mucor Rouxianus* upon potato in association with an unnamed micrococcus, found that the coccus developed at the expense of the sugar produced from the potato starch by the fungus. Further, that the large amount of yellowish-orange pigment elaborated by the *Mucor* is due to the consumption of maltose by the micrococcus.

* Centralbl. Bakt., 1^o Abt., xxxi. (1902) pp. 26-8.

† Cf. this Journal, 1898, p. 467.

‡ Centralbl. Bakt., 2^o Abt., viii. (1902) pp. 339-42.

§ Comptes Rendus, cxxxiv. (1902) pp. 366-8. See Journ. Chem. Soc., Abstr. ii. 1xxxii. (1902) p. 343.

Alinit.*—C. Schulze states that the alinit bacillus requires organic nitrogenous matter for its growth, and fails to develop in non-nitrogenous solutions. Wheat was grown in pots containing a mixture of (a) Ellenbach soil and ground sandstone, (b) sandstone and dextrose. Three sets of pots were used for each experiment which had been:—

- (1) Sterilised and inoculated with a pure culture of the alinit bacillus.
- (2) Sterilised but not inoculated.
- (3) Neither sterilised nor inoculated.

At the conclusion of the experiments it was found that although all the pots contained moulds and extraneous bacteria, the alinit bacillus predominated. No fixation of free nitrogen had taken place and there was a distinct loss of nitrogen. Similar results were obtained in pots exposed to air. Negative results were also obtained in a second set of experiments to determine the effects of carbohydrates, and in field experiments with barley and oats.

Gas Vacuoles in Thiothrix.†—Wille after recurring to Winogradsky's definitions of the groups *Beggiatoa* and *Thiothrix*, describes his own observations on the *Thiothrix tenuis* Winogr. which he obtained in September 1901, associated with a felted mass of *Vaucheria*. In this *Thiothrix* he observed that the bodies usually described as sulphur granules had all the optical appearances of bubbles of air or gas, e.g. they possessed dark edges and the central portions were reddish in tint,—appearances totally unlike those produced by the refraction of light from solid particles: furthermore, on warming the preparation these bodies disappeared at a temperature much below the melting-point of sulphur. On running in caustic potash under the cover-glass of this preparation, the walls of the *Thiothrix* became more transparent and the enclosed vacuoles stood out more sharply, and in some situations two or more coalesced, showing that the vacuoles did not contain CO_2 , which would have been absorbed by the caustic. The application of a solution of picric acid to the *Thiothrix* did not cause the formation of sulphur crystals, but a few of the vacuoles ran together and coalesced, although not to the same extent as occurred on the addition of potash. Lead acetate did not yield a precipitate of lead sulphide, nor did the vacuoles disappear. Iodine and iodide of potash solution had no effect; on the addition, however, of iodine and alcohol or alcohol alone, the gas vacuoles disappeared very quickly and completely and the threads of the *Thiothrix* became smaller in diameter. At this point unfortunately the *Thiothrix* was lost as a result of an accident to the glass containing the mixed *Vaucheria* and *Thiothrix*.

Handbook of Bacteriology and Pathology.‡—This little book is intended for the use of students preparing for the practical part of the third examination for the Doctorate of Medicine. It is obvious, however, that it is impossible to do more than give the salient points of each subject in a small book which only occupies 235 pages in summarising

* Bied. Centralbl., xxxi. (1902) pp. 145-7. See Journ. Chem. Soc., Abstr. ii. lxxxii. (1902) p. 344.

† Biol. Centralbl., xxii. (1902) pp. 257-62.

‡ Petit et Borne, Manuel pratique de Bactériologie, Parasitologie, Urologie et Anatomie Pathologique, Paris, C. Naud, 1902, crown 8vo, 235 pp. and 47 figs.

the present-day knowledge of the pathogenic bacteria and the methods of demonstrating their presence in various lesions; serum therapy; the animal and vegetable parasites of man; the microscopical examination and chemical analysis of urine; the methods of examining sputum, blood, and gastric secretion; performing autopsies; together with a *résumé* of the naked-eye and microscopical appearances of the lesions most frequently shown the candidates at this examination. The notes are as far as possible arranged in tabular fashion, a method which, in conjunction with a good index, renders it an easy matter to refer to any given section; but in consequence of the mass of material to be dealt with, the details concerning each subject are few. Owing to this undesirable brevity much valuable information has been omitted, thus for example, under the heading of urogenital tuberculosis no hint is given of the existence of the *Smegma bacillus*, which has so often been confused with the *B. tuberculosis*. But notwithstanding its deficiencies the work is well arranged and accurate in all its details—so far as it goes.



MICROSCOPY.

A. Instruments, Accessories, &c.*

(1) Stands.

Zeiss' Smaller Mechanical Stage.†—In this apparatus, the leading idea of which was first worked out by a Fellow of the Society, the late

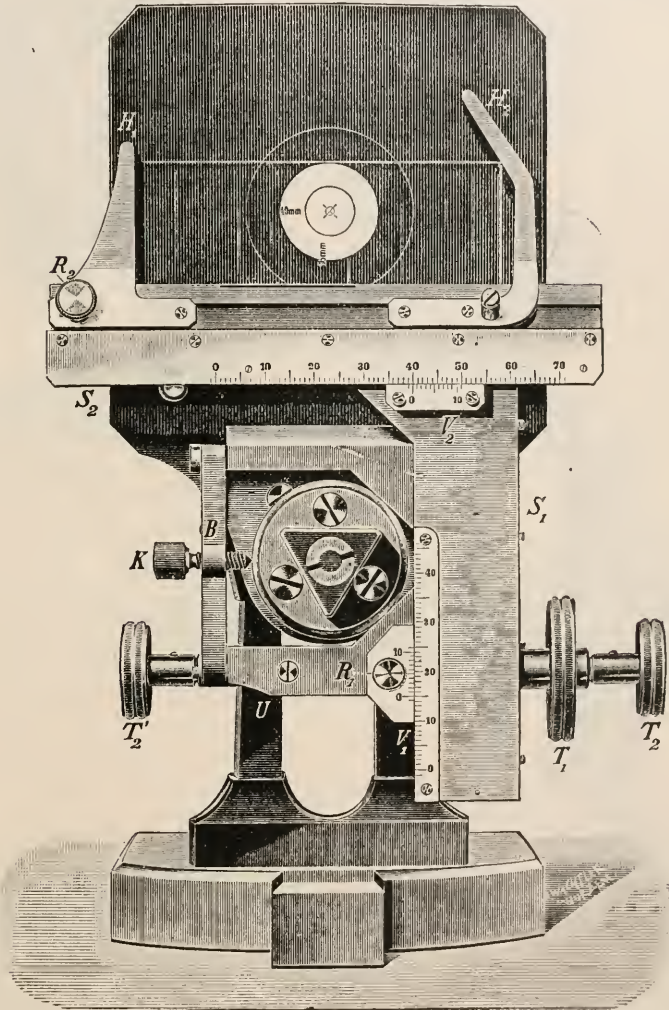

FIG. 110.

* This subdivision contains (1) Stands; (2) Eye-pieces and Objectives; (3) Illuminating and other Apparatus; (4) Photomicrography; (5) Microscopical Optics and Manipulation; (6) Miscellaneous. † Zeiss' Cat., 1902, No. 47, fig. 18.
 October 15th, 1902 2 s

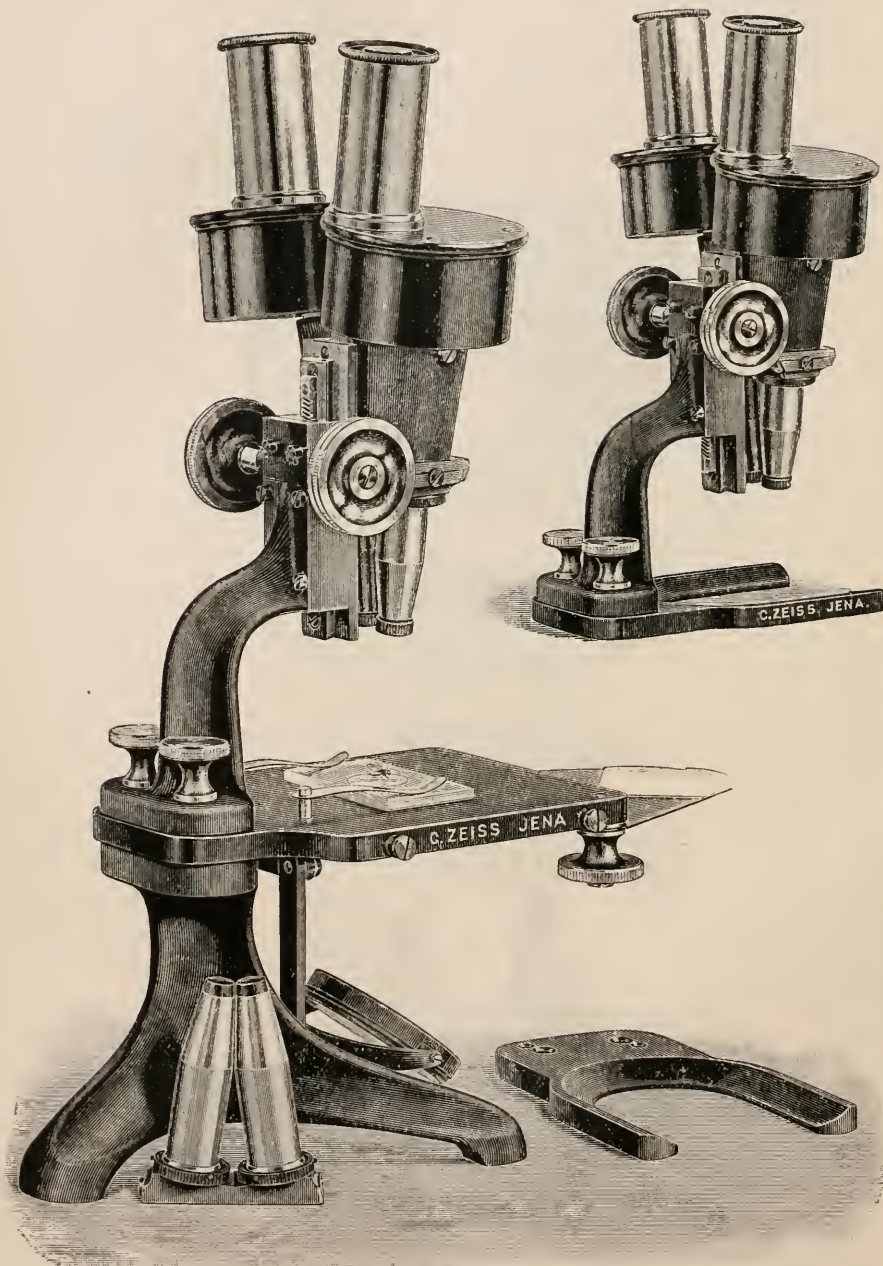

FIG 111.

Mr. J. Mayall, jun.,* some improvements have been recently introduced. The milled heads for the movements of the two slides are set co-axially, and preserve their position during rotation. The horizontal movement can be effected by either the right or the left hand. The range of the movements has been slightly increased and now extends to 60 by 30 mm. An accurately gauged centring glass, on which are engraved the distances of the cross-strokes from two edges of the object-carrier, is supplied with each stage. Fig. 110 shows the stage as applied to Stand IVa.

Greenough's Binocular.†—The Zeiss firm now make the upper part of this instrument with the double tube removable; after the removal of this upper portion the stand can be replaced by a vulcanite fork to which the tube-carrier is screwed (fig. 111). Thus a portable instrument is formed which can be applied to the examination of objects of any kind: it may, for instance, be used as a dermatoscope for skin investigations.

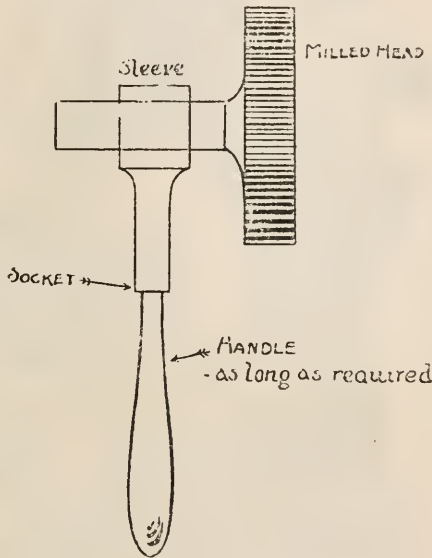

FIG. 112.

Microscope Adjustment.‡—A correspondent, "Treadle," to the *English Mechanic*, after noticing the tendency of Microscope makers to reduce cost by omitting the fine and by improving the coarse adjustment, suggests a revival of the following old device (fig. 112) in use some forty years ago, but now apparently forgotten. It consists of a sleeve fitting loosely on the shank of either of the coarse-adjustment milled heads, with a socket attached into which can be fitted a handle of

* This Journal, 1885, p. 122.

† Zeiss' Catalogue, 1902, No. 95, fig. 35b, p. 73.

‡ Eng. Mech., lxxv. (1902) pp. 207-8 (1 fig.).

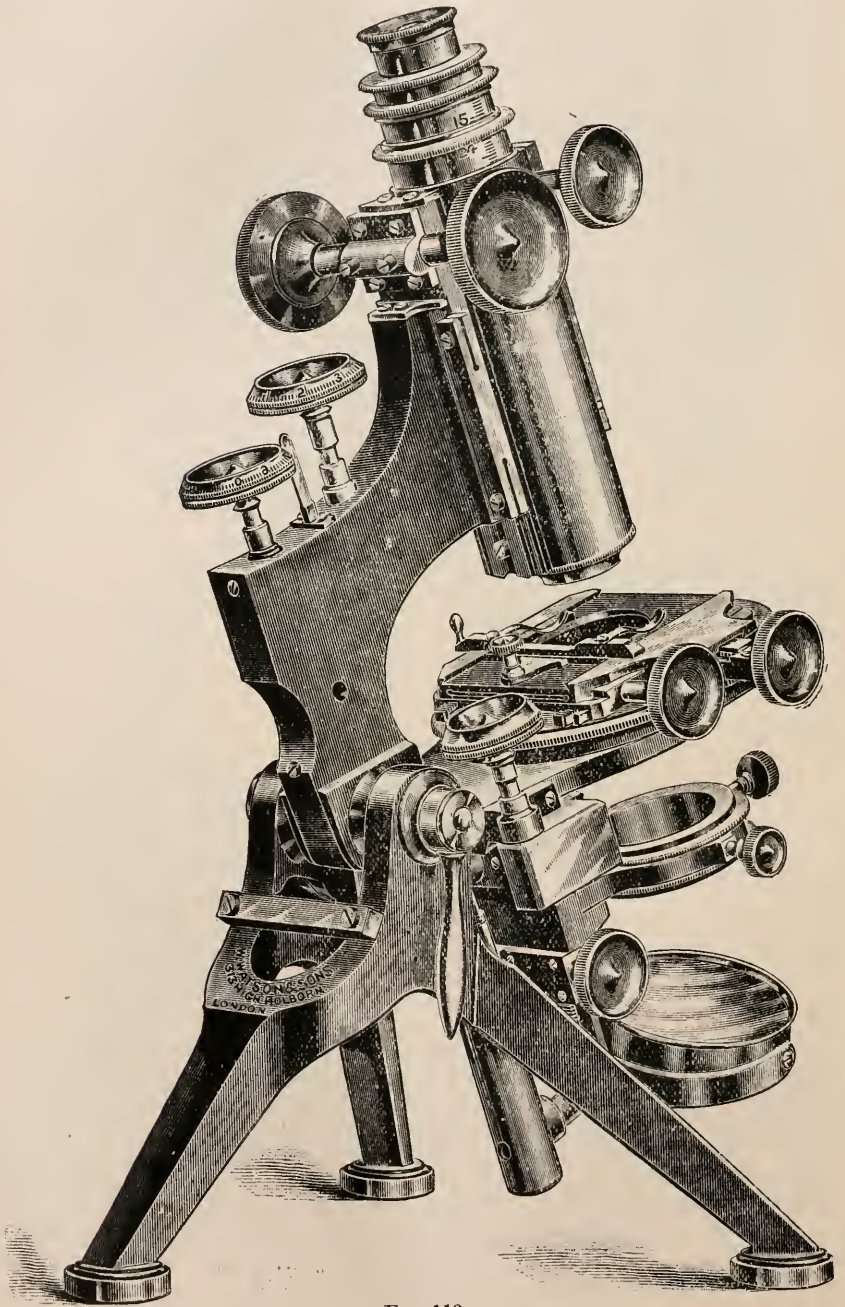

FIG. 113.

any convenient length. By moving the handle sideways the sleeve is made to seize upon the shank of the milled head, and the long handle allows of a very delicate motion being imparted to the pinion. With a well-cut rack the author finds even high-power objectives can be satisfactorily focussed.

This form of fine adjustment by means of a loose lever attached to the coarse adjustment pinion, was described by Messrs. Smith and Beck at the Microscopical Society of London on October 9th, 1861.* A very similar construction by Ladd is also figured in the third edition of *Carpenter*, p. 81, fig. 27 (1862). Mr. Beck states in a foot-note that Mr. Brookes (Charles Brooke?) was the first to recommend this kind of slow motion.

Males-Watson Two-speed Fine Adjustment.—The essential feature in this new two-speed fine adjustment is a lever similar to that regularly

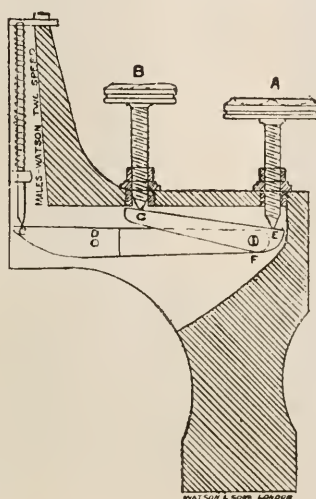

FIG. 114.

fitted to Watson's Microscopes. The fulcrum of this is at D, and the lever is worked by the milled head A on the point E. By using a coarse thread for the screw a speed of $\frac{1}{150}$ th of an inch for each complete rotation is produced. The second and slower speed is obtained by another lever fitted to the first at the point F, which is acted on by the screw B at the point G. A somewhat finer screw is used for this, and the combination of the levers yields a movement as slow as $\frac{1}{450}$ th of an inch for each complete turn of the milled head. Any desired ratio of speed can be obtained by altering the pitch of the threads of the micrometer screws. Fig. 113 shows the adjustment fitted to a Watson's Van Heurck Microscope, and Fig. 114 gives a sectional view of the working parts.

* Trans. Mic. Soc., x. (1862) p. 11, pl. 5.

Berger's Fine Adjustment.—Fig. 115, from Messrs. Zeiss'* new Catalogue, shows the action of this fine adjustment more clearly than the illustration previously published in the *Journal* for 1898, p. 585, fig. 99.

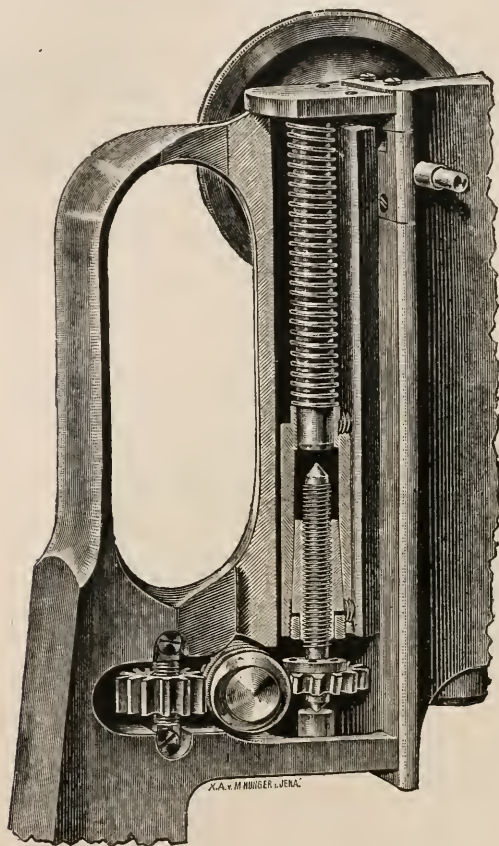

FIG. 115.

Zeiss' Small Mineralogical Stand.†—This model (fig. 116) is numbered IX^b in the Catalogue; it is not inclinable, and possesses rack-and-pinion coarse adjustment. The tube, which is not provided with draw-tube, carries on its upper extremity a divided circle and a removable analyser. At the lower end are two sliding carriers and a centring appliance. One of these carriers bears a second analyser, while the other is available for a quartz or other crystal plate for insertion above the objective. The polariser is combined in a sliding sleeve with a condenser system of 1.0 N.A. The upper lens of this

* Fig. 19, p. 44, of Zeiss' Catalogue.

† Catalogue, English edition, 1902, pp. 68-71, fig. 34.

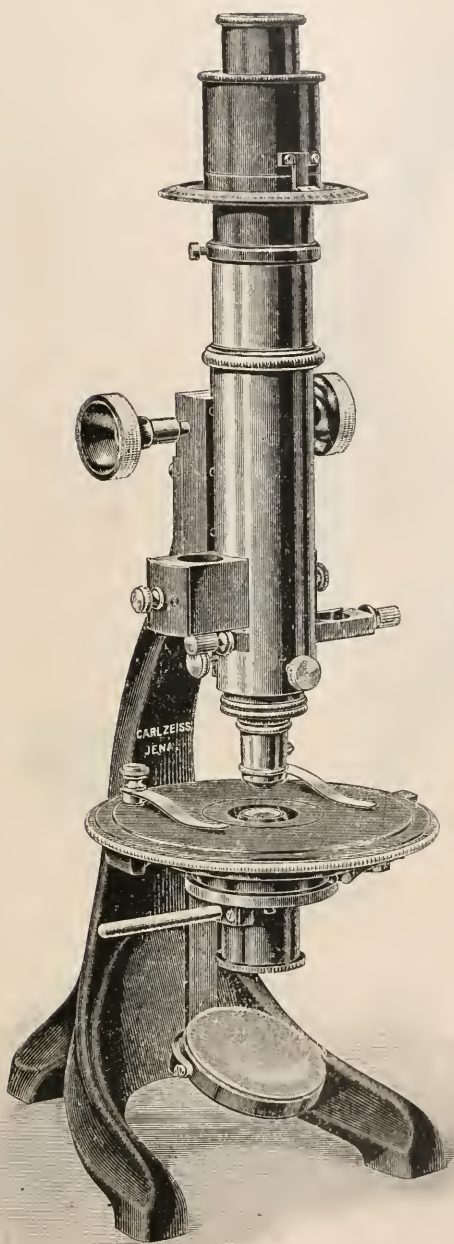

FIG. 116.

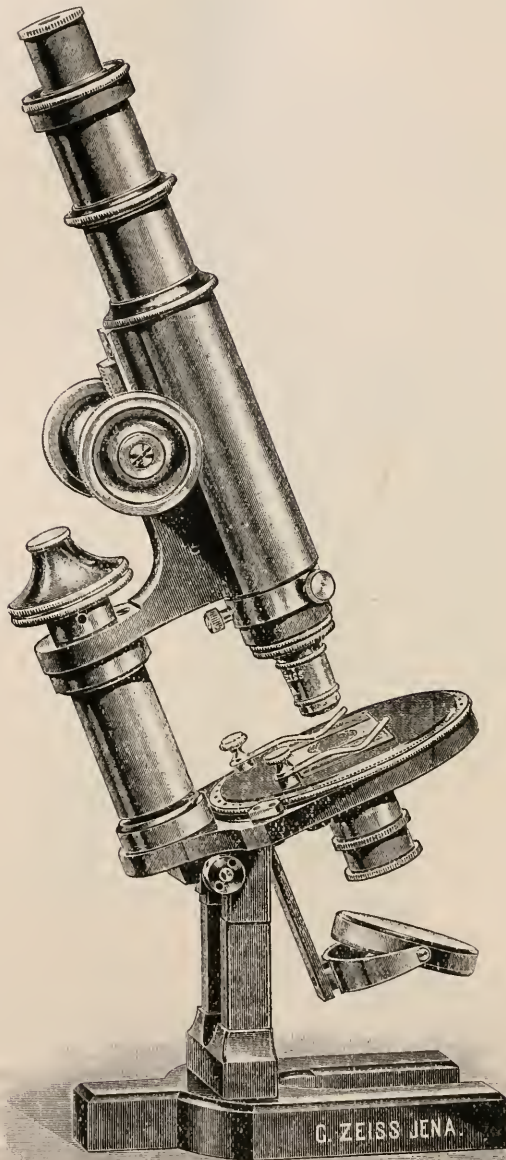

FIG. 117.

condenser is easily removable, as, when using low magnifications, it is advisable to work with the lower condenser lens only. A sliding sleeve, within which the polariser may be revolved by means of a lever, is situated below the revolving and graduated stage.

Zeiss' Small Model Polarising Microscope.*—This stand (fig. 117), indexed as VI^b, is one of Zeiss' smaller models adapted for work with polarising apparatus. It bears a revolving stage (diam. 80 mm.) with a graduated peripheral scale. A centring appliance for objectives is situated on the lower extremity of the tube. Objectives of the highest power can be used, and the stage can be completely rotated.

Messter's Attachable Mechanical Stage.†—M. Marpmann highly praises this accessory for its cheapness and convenience. The object-slide, which fits into a space of suitable size, is secured by two clamps. The stage itself is easily attached to any Microscope: the upper screw fits into a hole of the table and the trigger-shaped part on the right is secured to the pillar, so that the stage is rigid in all positions. Of the two screws which control the stage motions the lower imparts a perpendicular movement from front to rear within limits of 30 mm., and the front one a lateral movement within a range of 50 mm. These dimensions serve for preparations of large size. Positions are noted by means of two scales which are easily read to 0.1 mm.

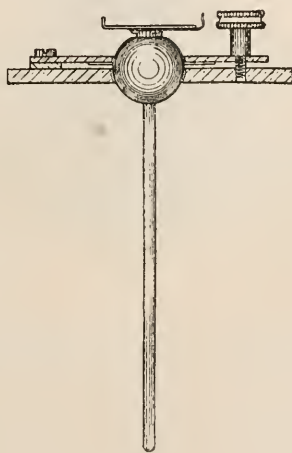

FIG. 118.

Huntingdon's Tilting-stage for Holding and Adjusting Minerals.—This apparatus (fig. 118), made by Messrs. R. and J. Beck, consists of a pair of brass plates which grip a ball, held in two circular holes cut in the plates. The ball is surmounted by a small stage, and from its inferior aspect projects a rod by which the specimen is oriented. By

* Catalogue, English edition, 1902, pp. 62-5.

† Zeitsch. f. angew. Mikr., ii. (1901) pp. 230-4 (1 fig.).

means of a screw-clamp the pressure on the ball may be adjusted. The tilting-stage is placed on the Microscope-stage, and the specimen, roughly mounted on a glass plate 1 in. wide, is placed in the holder. The apparatus is then adjusted so that the surface to be examined is exactly at right angles to the optic axis.

When the Microscope upon which it is used has a mechanical stop, an adjustable plate may be placed at the base of the Microscope, so that it may be used for temporarily fixing the long rod. In this case the ordinary movements of the mechanical stage form a fine adjustment for levelling the object. When the object is levelled the plate may be released, and then the stage-movements are used in the usual manner for moving the object.

(2) Eye-pieces and Objectives.

Zeiss' A* Objective.*—This useful objective, in which there is an arrangement for separating its component lenses by rotating a collar, for the purpose of increasing its magnifying power, has had its mechanism altered, so that now it is in its original form.

When it was first introduced, the rotation of the collar caused the

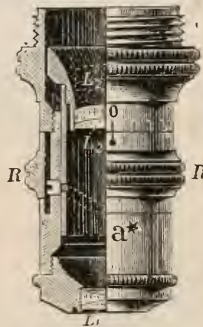

FIG. 119.

back positive lens to move away from the front negative lens, which was fixed; but in 1880 the motion was changed, so as to make the front lens move while the back remained fixed.† The reason for this was, that the back lens, in its excursion up the tube, should not foul the diaphragm, usually placed by Messrs. Zeiss at the end of their draw-tubes. Fig. 119, which is taken from this year's catalogue, shows that Messrs. Zeiss have reverted to their original form in making the back lens the movable one.

An interesting account of the theory of this lens will be found in the *Journal* for 1884, p. 450.

Assorted Pairs of Objectives for Binocular Microscopes.‡—These are now supplied by Zeiss in a special form of setting, and mounted in pairs on slides, and are well adapted for Greenough's binocular. They

* Catalogue, English edition, p. 14, fig. 6. † Journ. R.M.S., 1880, p. 524.

‡ Catalogue, English edition, 1902, p. 18.

are designated (55), (a_0), (a_2), (a_3), and ($P1$), and are respectively of working distances 70, 54, 40, 30, 35 mm. The combination ($P1$) is recommended as a plankton searcher.

Zeiss' Orthomorphic Eye-piece.*—A Ramsden eye-piece is made by the Jena firm specially for use with Greenough's binocular Microscopes. The name "orthomorphic" is applied to it because of the original design of combining it with small diaphragms in the region of the upper microscopic nodal point in order to satisfy Mr. Greenough's "orthomorphic" requirements. The magnifications obtained by combinations of this eye-piece and any of the objectives in last paragraph, range between 15 and 72 diameters.

(3) Illuminating and other Apparatus.

Zeiss' Centring Apparatus for Microscope Objectives when used as Condensers.†—In many instances it appears desirable to use achromatic, or apochromatic, objectives as illuminators instead of ordinary condensers. For this purpose a sliding sleeve is supplied with centring

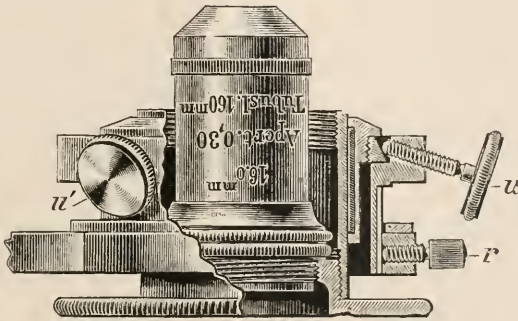

FIG. 120.

collar into which such objectives may be screwed, and which fits into the sleeve of the illuminating apparatus. The arrangement is seen in fig. 120, where $u u'$ are the centring screws, and r the screw for clamping the condenser in the sliding sleeve.

Solar Projection Apparatus and its Adjustment.‡—A. H. Cole recommends a solar projection apparatus fitted with a *porte-lumière*, instead of a heliostat, as being a cheap, manageable, and effective arrangement. A *porte-lumière* and a heliostat are both intended for reflecting sunlight: but the *porte-lumière* is hand-regulated, whereas the other is clockwork-regulated. The author mounts his apparatus on a wide board of sufficient length to exactly fit into any desired window. The window-sash should be raised, the board then placed *in situ*, and the sash then drawn down close on to the board. Any supplementary fixing

* Catalogue, English edition, 1902, pp. 19 and 72.

† Tom. cit., p. 32 and fig. p. 31.

‡ Journ. Applied Microscopy, v. (1902) pp. 1795-7 (1 fig.).

should be added as required. The board is perforated by a hole large enough for the mirror and base rods to be passed through, but smaller than the brass plate to which the water-cell and mirror-adjuster are attached. This plate is firmly screwed to the board. The various items of apparatus slide on the base rods, and ordinary objectives are used. A sufficient darkening of the room is obtained by very dark opaque blinds on spring-rollers, their edges being boxed up.

(4) Photomicrography.

Observing Prism for Photomicrography.—This apparatus, fig. 121, devised and made by Messrs. R. and J. Beck, consists of a right-angle prism fitted in a tube of the same length as and at right angles to the

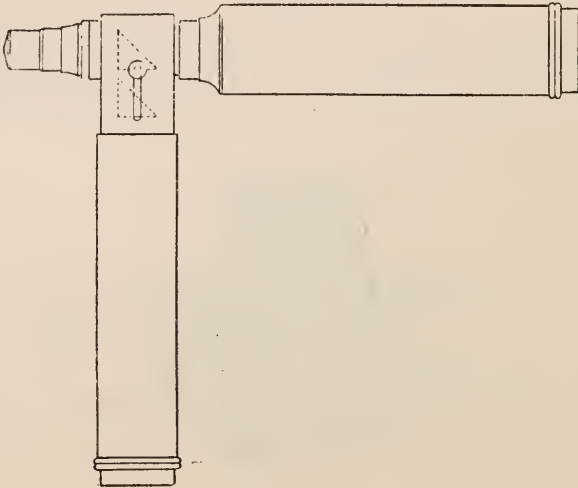

FIG. 121.

ordinary Microscope-body. The tube screws on to the object-glass end of the instrument. When the Microscope is in a horizontal position the tube may be connected with the photomicrographic camera and all the observing done through the supplementary body through the observing prism. To take a photograph, the prism may be instantly displaced by pressing a milled head, and the light then passes directly up the Microscope-tube into the camera. So accurately are the parts constructed and adjusted that there is no loss of definition and *Amphipleura pellucida* can be perfectly resolved.

Photomicrography.* — F. M. Duncan's *First Steps in Photomicrography*, which only claims to be a handbook for novices, consists of a simple and almost non-technical account of the methods and apparatus employed in the production of photomicrographs. It deals with low, medium, and high-power work, developing, printing, preparation of

* London, Hazell, Watson & Viney, 1902, 104 pp., with illustrations.

suitable objects, and with stereo-photomicrography.' The booklet, which forms one of a series ("Amateur Photographer's Library") should have a ready vogue.

(5) Microscopical Optics and Manipulation.

GULLSTRAND, A.—Allgemeine Theorie der monochromatischen Aberrationen und ihre nächsten Ergebnisse für die Ophthalmologie.

[Very fully discusses the general mathematical questions involved in passage of light-rays through the eye, and deduces their special applications in ophthalmology.]

Nova Acta Reg. Soc. Sci. Upsaliensis, XX.
fasc. 1 (1901) 204 pp. and 51 figs.

(6) Miscellaneous.

Zeiss' Crystal Films and Plates for Double Refraction.* — (i.) *Selenite and Mica Films*. These are now supplied in four different thicknesses which, when placed between crossed Nicol prisms, show red of the i., ii., iii., and iv. orders; there are also four different mica films, which are graduated so as to produce differences of phase equal to $\frac{1}{8}\lambda$, $\frac{1}{4}\lambda$, $\frac{3}{8}\lambda$, $\frac{1}{2}\lambda$. These eight films compose the set of selenite and mica films originally proposed by H. v. Mohl for the examination of plant cells in polarised light.

(ii.) *Bravais' Double Selenite Film*. In this case two semicircular films for red of the i. order are so arranged side by side that the equal angles of optical elasticity are at right angles to each other, and form angles of 45° to the boundary line.

(iii.) *Biot-Klein's Quartz Plate*. This is a plate of quartz 3.75 mm. thick, and cut perfectly perpendicularly to the axis.

(iv.) *Bertrand's Quadruple Quartz Plate*. Four quadrant-shaped quartz plates, cut perpendicularly to the axis, are cemented together so that their dividing lines form the shape of a cross. Two of the plates are composed of quartz with rotatory power directed to the right, the other two of crystals having the opposite rotation.

(v.) *Stauroscopic Calc-spar Plate*. This is a plate of calc-spar, cut perpendicularly to the axis, mounted so as to be readily inserted between eye-piece and analyser.

B. Technique.†

(1) Collecting Objects, including Culture Processes.

Flask for Storing Culture Media.‡—A. Robin describes a simple device for storing fluid culture media. It consists of a flask A plugged with cotton-wool and sealed with a mixture of equal parts of paraffin and vaselin, a bent tube *d*, and a siphon tube *abc* (fig. 122). The end of the tube *d* is loosely filled with cotton. The whole is sterilised, and then the plug is pushed down the neck, leaving about one-half inch space from the brim. The surface is dusted with powdered sulphate of copper, and then the space in the neck above the stopper is filled in with a

* Catalogue, English edition, 1902, pp. 104-5.

† This subdivision contains (1) Collecting Objects, including Culture Processes; (2) Preparing Objects; (3) Cutting, including Imbedding and Microtomes; (4) Staining and Injecting; (5) Mounting, including slides, preservative fluids, &c.; (6) Miscellaneous.

‡ Journ. Applied Microscopy, v. (1902) pp. 1876-7 (1 fig.).

mixture of paraffin and vaselin. The siphon is started by blowing through the tube *d*. Once started the flask is inclined in the direction opposite the outlet, when the fluid will run back into the tube *b*. The level of the fluid in *b* will be the same as in *A*. The end of *c* is then sealed as well as the end of *d*. To pour out the medium, the end of *c*, after careful flaming, is broken off at one of the narrowed points, and the flask inclined in the direction of *c*. The rapidity of the flow can be made to vary from a drop to a stream according to the inclination of the flask. Hence this flask is suitable not only for storage purposes, but may be used as a dropping-bottle or used in the bacteriological examination of water when fractions of a cubic centimetre are required.

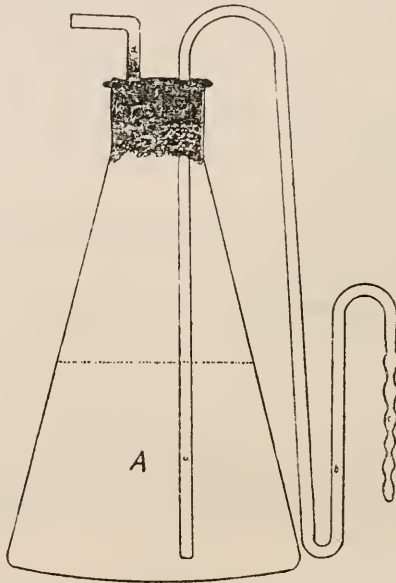

FIG. 122.

New Method of Cultivating Tetanus Bacillus.*—L. Debrand, who had previously demonstrated the identity of the toxin produced in anaerobic cultures of the tetanus bacillus and the toxin found in air-cultures of *B. tetanus* associated with *B. subtilis*, has recently made experiments which tend to show that with the toxin obtained from the symbiosis of these bacilli cultivated aerobically there can be produced a serum just as active as with the toxin raised by the ordinary methods. This new cultivation method may replace the old procedure for preparing anti-tetanus serum.

Cultivation of Nitrite-formers on Paper Disks.†—W. Omelianski sews numerous pieces of filter paper together and fits them in the bottom

* Ann. Inst. Pasteur. xvi. (1902) pp. 427-32.

† Centralbl. Bakt., 1^o Abt., xxxi. (1902) pp. 785-7 (1 pl.).

of a Petri's capsule. Some carbonate of magnesia is sprinkled over the bottom underneath the filter-paper. The usual inorganic solution for cultivating nitrite-formers is then poured in, care being taken that the fluid does not reach the topmost layer. The fluid should reach about half up the clump of paper disks. The capsule is then sterilised, and when cool inoculated. When the nitrification process is set up, the fluid is tested for ammonia and nitrous acid. When all the ammonia has disappeared a few drops of sterilised 10 p.c. ammonium sulphate are introduced. Colonies are just visible to the eye by the 10th to 15th day as yellowish points, which gradually become brown.

(2) Preparing Objects.

Methods for Use in the Study of Infusoria.*—A. W. Peters obtains clean specimens of many kinds of Infusoria by the following "yarn-siphon" method. From the culture-jar a quantity of the liquid is removed with a pipette to a Stender dish. The organisms are distributed by sucking up the liquid into, and forcing it out of, the pipette a few times. A few pieces of woollen yarn about 10 cm. long are then laid parallel in a single strand, held in water and pressed together until thoroughly wet. This yarn-siphon is then placed with one end in the Stender dish, the other hanging over into a receiving vessel. Ciliated organisms soon pass over the siphon into the receiving-vessel. From time to time fresh water is added to replace that lost by siphoning.

To concentrate the organisms in a small amount of water, to remove the culture, or to change the medium, the author devised an apparatus termed a "tube-filter." One end of a short piece of wide glass tubing is closed by a piece of filter-paper held in position by a rubber band. The process essentially depends on the quality and area of the filter-paper employed; for rapid work with about 50 ccm. of fluid a tube of about 3 cm. in diameter and 6 cm. in length is used. The tube is held in a vertical position on a ring-stand, and under it is placed a Stender dish or other vessel containing the organisms. The tube is lowered until its paper diaphragm comes within a few millimetres of the bottom of the dish. In the tube is hung a filled glass siphon with the lower end of the outer arm bent upwards to prevent its running empty. As the water rises through the filter-paper and into the tube, it is removed by the siphon. More culture-water with organisms or fluid desired as medium may be added from time to time. The process of upward filtration leaves nearly all the organisms in the dish when the tube is removed.

Another device, called the U-cell, serves much the same purpose as the tube-filter, but on a smaller scale. To make this U-cell (fig. 123) there are necessary two slides, some rubber bands, and coarse, tough darning-cotton. A piece of the cotton one-and-a-half times the length of the slides is saturated with water and then laid upon a slide in the form

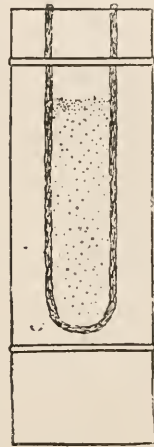

FIG. 123.

* Amer. Natural., xxxv. (1901) pp. 553-9 (2 figs.)

of a U, the two ends only just projecting beyond the edge of the slide. The other slide is laid on top, and the pair are secured by means of rubber bands. This arrangement constitutes the U-cell. It is filled by standing it in a nearly vertical position, and then injecting the fluid containing the organisms with a pipette through the open end of the U. Or it may be filled by siphoning by means of a piece of woollen yarn thrust through the U-aperture to a depth of 5-10 mm.

The U-cell may also be used for a circulating medium, as shown in fig. 124. The cells are placed at an angle in a glass dish, and lean against an inner vessel placed in the centre of the first. The dimensions of the two vessels should be so selected that the upper ends of the

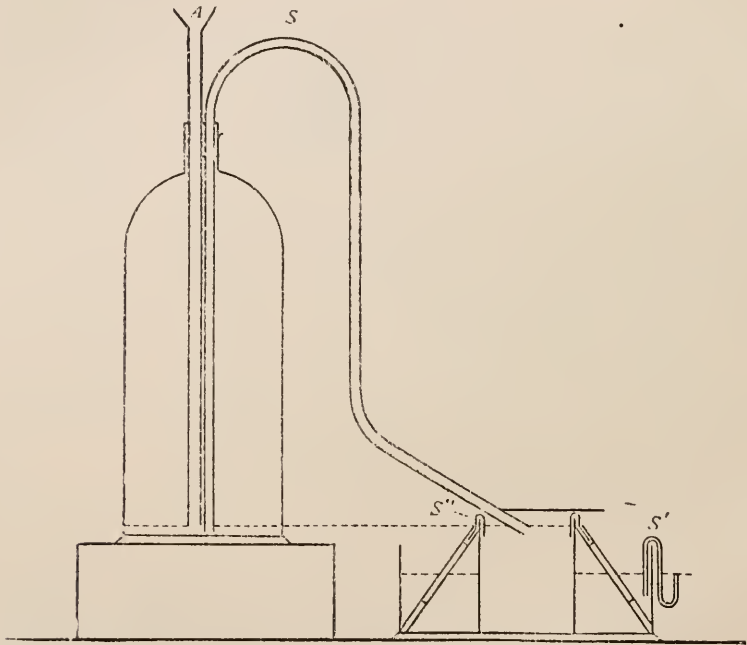

FIG. 124.

cells come in contact with the inner vessel at about 5 mm. below its upper end. From the inner vessel water is led by cotton-yarn siphons S'' into the cells. A constant-level siphon S' is hung over the wall of the outer vessel. The inner vessel is supplied from a bottle fitted with an air-tube A and a siphon-tube S . The inner vessel and its yarn-siphons should be protected from dust by a glass plate, the edge of which is notched to admit the siphon-tube. Woollen yarn is used when a rapid flow is desired, cotton for a slower rate.

In the preparation of microscopical specimens requiring change of fluids under the cover-glass, the author uses cotton-wool. A small quantity of dry absorbent wool is placed on a slide and moistened with

a drop or two of water containing Infusoria. The cotton is then spread out into a thin layer about the size of the cover-glass to be used. The cover is then placed on the cotton layer and secured in position by means of rubber bands. The slide is placed in a sloping position, and the fluids introduced by adding them in drops at the top side of the slip. The excess fluid streams out on the lower side, or may be guided down by strips of filter-paper.

When the latter device is adopted, the rubber bands may, if desired, be removed after the passage of the fixing fluid. The cotton acts as a mechanical obstruction, the organisms being caught in the meshes. The procedure is safe and rapid, and also convenient, as the preparations may be inspected at any stage or stored up for future examination.

Preparation of Metal Specimens for the Microscope.*—In preparing specimens of metal, the principal object, says M. I. Cross, is to obtain a perfectly level surface, free from all scratches and marks, with the highest degree of polish. The surface of the sample is first carefully filed or ground. The marks made by this procedure are then taken out with a very smooth file or with emery cloth, the coarseness of the cloth being gradually diminished until the finest grade is reached. From this stage the polishing must be done on parchment or chamois leather stretched very tightly on wood; the leather being sprinkled with fine crocus powder or rouge moistened with a little water. At this stage the metal should be frequently examined under the Microscope. This is easily done by clamping it in a metal-holder. When the requisite degree of polish is attained the preparation is ready to be etched, by which process the structure is further developed. Etching is effected by various reagents, such as dilute mineral acids, but best by infusion of liquorice root and tincture of iodine. The method of applying the reagent is as follows: the specimen is either coated with some protective varnish,—leaving the surface to be acted on free,—and immersing the whole in a bath; or a few drops may be applied to the surface and then spread by means of a glass dipping rod. The solution should be allowed to act, say, for 20 seconds; the specimen is then carefully washed in methylated spirit, the surface being gently rubbed with the little finger, after which it is washed in water and then dried with a soft piece of linen. If the etching be not satisfactory, the process should be repeated. Owing to the advent of the metal-holder it is no longer necessary to fix the piece of metal to a glass slide, as this apparatus is fitted with jaws which grip the preparation tightly and allow it to be set in any plane.

(3) Cutting, including Imbedding and Microtomes.

Born and Peter's Orientation Plate.†—This appliance, named after its inventors, is made by Messrs. Zeiss, and is designed to mark the position of objects contained in hardening paraffin, and at the same time to impress so-called lines of direction upon the paraffin blocks. For the latter purpose one side of the plate has several parallel grooves, of equal width and with sharp edges, cut into it. A pair of glass set-squares is generally supplied with the instrument.

* Knowledge, xxv. (1902) pp. 189-90.

† Catalogue, English edition, 1902, p. 114.

(4) Staining and Injecting.

Staining Biliary Canaliculi.*—St. Ciechanowski recommends Weigert's nerve-staining method for demonstrating biliary canaliculi. Small pieces of liver are fixed for not less than 24 hours in 2-4 p.c. formalin, and after-hardened in alcohol. The sections are mordanted in 0.5 p.c. chromic acid solution for 2 hours, and then stained in Weigert's hæmatoxylin solution. When sufficiently stained the sections are differentiated in the ferridcyanide solution, and having been thoroughly washed are mounted in the usual way.

Glycogen Staining.†—Best publishes a method for staining glycogen in the liver, tumours, &c., by means of lithium-carmin. The procedure is as follows. The sections are first stained with Delafield's or Böhmer's hæmatoxylin, and after having been washed in water are immersed for 15-20 minutes in a freshly made mixture consisting of carmin solution 2, liq. ammon. caust. 3, and methyl-alcohol 6.

The carmin solution is prepared by boiling a mixture of carmin 1, ammon. chloratum 2, lithium carbonicum 0.5, and 50 water. To this, when cold, 20 ccm. of liq. ammon. caustici are added. After the carmin staining the preparations are decolorised in the following mixture, frequently renewed:—methyl-alcohol 2, absolute alcohol 4, water 5, or in liq. ammon. caustic. 1, absolute alcohol 2. Dehydration in 80 p.c. and 100 p.c. alcohol, oil, balsam.

The tissue should be fixed in absolute alcohol and imbedded in celloidin.

(5) Mounting, including Slides, Preservative Fluids, &c.

Sodium Silicate as a Mounting Medium for Microscopical Preparations.‡—Schürhoff recommends silicate of sodium mixed with 10 p.c. glycerin and 10 p.c. water for mounting microscopical preparations. 80 parts of commercial silicate of sodium solution are added to a mixture of 10 parts glycerin and 10 parts previously mixed. The medium hardens well in the course of a few hours.

Simple Method for Preserving Urinary and other Deposits.§—R. Rohnstein says that the deposit or sediment from secretions or discharges may be preserved in the following simple manner. In the case of urine the sediment is first treated with an equal bulk of 2 p.c. formalin, and the deposit therefrom mixed with an equal volume of the following solution:—formalin 20, glycerin 125, distilled water up to 200. When the material to be preserved is of a more solid character such as vomit or fæces, it is thoroughly mixed with an equal bulk of the solution.

(6) Miscellaneous.

Micrometer Gauge.||—This micrometer gauge (fig. 125), made by Elliott Brothers, is excellently adapted for ascertaining the thickness of cover-glasses. The instrument is fitted with a ratchet head to prevent

* Anat. Anzeig., xxi (1902) pp. 426-30.

† Deutsch. Med. Wochenschr., 1902, No. 5, Vereins-Beil., p. 36.

‡ Deutsch. Apoth.-Zeit. See Zeitschr. angew. Mikr., viii. (1902) p. 54.

§ Fortschr. d. Med., xx. (1902) pp. 41-4.

|| Elliott Bros.' Catalogue, 1902, p. 18, fig. 3550.

undue straining of the contact points, and is made in sizes to take $\frac{1}{4}$ in. to 1 in. measurement in steps of $\frac{1}{1000}$ in. The pitch of the screw-shaft is 50 to the inch, and the circumference of the cylinder carried by the shaft is divided into 20 parts, so that each division on the cylinder equals

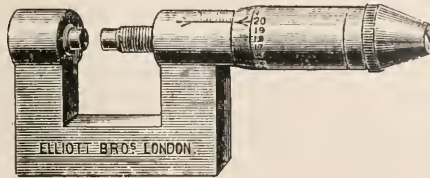

FIG. 125.

0.001 in. By slightly enlarging the cylinder, a reading of $\frac{1}{10000}$ in. is obtained by subdividing the 20 divisions into 10 parts. These gauges are also made to read in metric measure to 0.01 and 0.001 mm.

Lee and Henneguy's *Histological Technique*.* — The well-known treatise on the technique of microscopical anatomy by Bolles Lee and Henneguy has reached its third edition. In the present issue the work has been practically recast and is considerably enlarged. While numerous obsolete methods have been omitted, fifty pages of entirely new matter have been added. The additions include chapters on the theory of fixation, setting of microtome knives, principles of histological staining, methods for making series of sections, &c. The chapters on coal-tar colours and on cytological methods have been practically re-written, and that on neurological methods has not only been entirely recast but has been remodelled on a scheme suggested by van Gehuchten. The authors acknowledge also assistance from P. Mayer in the selection of new matter in the chapters on zoological methods.

Dictionary of Photography.† — E. J. Wall's *Dictionary of Photography* has just reached its eighth edition. The present issue, enlarged to 656 pages, has been revised and brought up to date by T. Bolas. Nearly 100 pages of new matter and many diagrams have been added, but owing to concentration and elimination the bulk of the volume is not unduly increased. The work presents the same general features as have rendered its success so marked.

Re-crystallisation of Platinum.‡ — W. Rosenhain points out that platinum, when used as foil or as crucible, is in a condition of severe strain, having been bent, drawn, rolled, &c. either in the cold or at temperatures far below its annealing temperature. When submitted to a prolonged exposure at a high temperature it undergoes re-crystallisation, and then becomes brittle.

* *Traité des Méthodes techniques de l'Anatomie Microscopique, Histologie, Embryologie et Zoologie*, par A. Bolles Lee et L. F. Henneguy, avec une préface par Prof. L. Ranvier, 3^{me} édition, Paris, Octave Doin, 1902, ix. and 553 pp.

† Hazell, Watson and Viney, London, 1902, 656 pp.

‡ *Proc. Roy. Soc.*, lxx. No. 462 (1902) pp. 252-4 (1 fig.).

Microscopic Effects of Stress on Platinum.*—Messrs. T. Andrews and C. R. Andrews prepared an ingot of pure platinum, carefully machined into a cube 0.30 in. square. This was microscopically polished and subjected to a compression stress of 12.82 tons per square inch, thereby reducing its height by 10 p.c. of the original dimension. The result was to produce a great number of "slip-bands," roughly inclined at an angle of 45° to the line of the compression force on the crystal sectional facets. The experiment is confirmatory of the observations of Ewing and others, that stress alone, without etching, sometimes renders manifest the lines of inter-crystalline junction of the large or primary crystal grains of a stressed metal, providing that the stress is of sufficient intensity.

RICHARDS, B. R.—System of Recording Cultures of Bacteria genealogically for Laboratory Purposes.

[This system furnishes a convenient means of recording all data relating to the study of individual laboratory cultures of bacteria.]

Journ. Applied Microscopy, 1902, pp. 1877-83.

SPARROW, F. W., R.N.—Principles of Simple Photography.

[A manual embodying the ruling principles of elementary photography.]

London, Hazell, Watson & Viney, 1902, 130 pp.,
with illustrations by the author.

* Proc. Roy. Soc., lxx. No. 462 (1902) pp. 250-2 (3 figs.).

JOURNAL
OF THE
ROYAL MICROSCOPICAL SOCIETY.
DECEMBER 1902.

TRANSACTIONS OF THE SOCIETY.

X.—*Electrical Method of Taking Microscope Measurements.*

By PHILIP E. SHAW, B.A., D.Sc.

(Read November 19th, 1902.)

Two years ago* I described a method of taking very small measurements by a new process, that of electric touch. Since then considerable advance has been made on the same lines, and now it is possible to measure one-millionth of a mm. with accuracy, and the method has been used in a variety of physical problems.†

By simplifying the original instrument a small apparatus, called the Simple Electric Micrometer, has been produced giving measurements of one-thousandth of mm. or less. It has a great number of uses in the physical laboratory, including one application to the Microscope about to be described.

This method of measuring is novel in two respects. Firstly, it is electrical; secondly, it is a direct method, which is in its favour.

Description.—In the diagram (fig. 126) the essential parts for the measurement are shown.

The slide *sl* is mounted on the stage *s*, *o* being the Microscope objective. A screw *sc* is brought up to nearly touch the edge of the slide. This screw is carried by a nut *n*, and has a graduated disc *d* and milled head *m* attached to it. If the screw have two threads to a mm., and the graduated disc have 500 divisions, then a movement of the screw-disc by one division corresponds to a movement of the screw-point *t* by one-thousandth of a mm. (i.e. 1 micron). The micrometer-screw is supported on a stand quite separate from the Microscope, so that it can be removed and packed in a separate box for preservation. There is a universal joint *j* between the screw and the stand, so that we can raise or lower the screw, point it in any direction whatever, and then rigidly clamp it there. Suppose the screw and stage are brought

* Phil. Mag., Dec. 1900.

† Phil. Mag., March 1901; Electrician, March 1901 and March 1902.

into contact, an electric circuit is completed through a battery b , a resistance r , a telephone receiver te , a nut n , and thence through the screw sc and the stage s to the battery. At each make or break of circuit at the point t the telephone "speaks."

In order to measure any object seen in the Microscope slide, move the stage by the rack-and-pinion or other adjustment, till the cross-wire is on one side of the object. Bring the screw sc into contact with stage s , and when the telephone speaks observe the

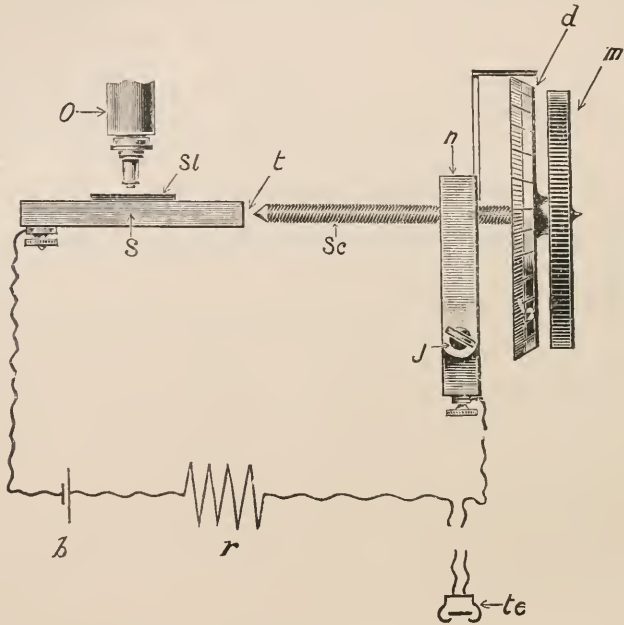

FIG. 126.

reading R_1 of the disc d . Now move the stage till the other side of the object coincides with the cross-wire. Bring the screw into contact again, and obtain a new reading R_2 of the disc d . Then the diameter of the object is $(R_2 - R_1)$.

As an example, three sets of readings were taken for *Bacillus tuberculosis*, and were as follows:—

R_1 .	R_2 .	Length = $R_2 - R_1$.	
411	414	3 microns	} mean 3.1 microns
410.7	414	3.3 "	
411	414	3 "	

As an instance of another class of measurement the following is given. If it be desired to accurately measure the number of lines in a diffraction grating used to produce a normal spectrum, place the grating on the stage and proceed as before. A table of results is given.

EVERY 50 LINES IN A DIFFRACTION GRATING.

Micrometer Reading.	Difference in Term of μ .
225	} 454
679	
1134	} 455
1593	
2040	} 459
2498	
2953	} 453
3410	
	} 458
	} 455
	} 457

Mean 456μ for 50 lines.

Fig. 127 shows the micrometer by itself.

Fig. 128 shows the whole apparatus for Microscope measurements.

Details.—This method of measuring by electric contact has been exhaustively tested for several years and is quite reliable. Consistent results can be obtained if two conditions are observed:— (1) Both the contact surfaces of the screw and the stage must be metallically clean; fine emery cloth should be used on them till they are quite free from lacquer, oil, &c. (2) Vibrations should be avoided. Mount the apparatus on a steady table not subject to vibrations, and handle the screw delicately when taking a measurement. Any cell will do for the circuit, and any telephone receiver will act, though a "loud speaker" is most convenient. For resistance I have used a few hundred ohms. The object in having resistance is to keep the current small, but it is not an essential. In completing the circuit through the Microscope, I have used any spare screw on the Microscope and brought the joining wire to it. If there is no screw convenient, the wire may be simply lashed firmly on the instrument, but of course to an unlacquered surface. It should be observed that the method works equally well whether immersion is adopted or not.

Other Methods of Measuring.—(1) *The Ramsden Eye-piece Micrometer.*—This is a convenient and sensitive method, but every measurement taken by it has to be divided by the magnifying power of the objective, a quantity which is only known to a certain degree of accuracy. Hence, besides the error due to the micrometer reading, a second one is introduced into the measurement. Moreover, the magnifying power must be known for every objective. Again, in most cases the Ramsden eye-piece is mounted in the tube of the Microscope, so that movement and oscillations of the tube take place each time the Microscope is handled, thus introducing errors. To avoid this, the eye-piece should be on a separate stand.

(2) Less sensitive than the former is the *Jackson eye-piece*

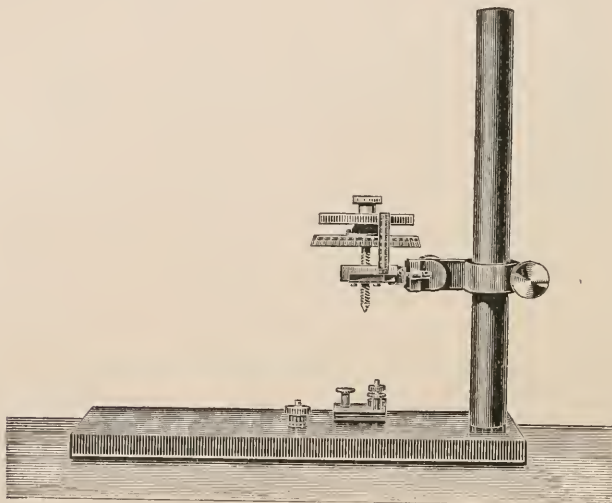

FIG. 127.

micrometer. It is convenient, as with it the eye-piece is not handled, and the difficulty in the Ramsden form is avoided. But it labours under the other disadvantages mentioned.

(3) *The stage micrometer method.*—Whilst the ruled scale is the standard of length it cannot be used directly on the object to be measured, but either we (*a*) use the camera lucida method of sketching, which is clumsy, or (*b*) calibrate the eye-piece micrometer by means of the ruled surface, and then proceed henceforward to use the eye-piece micrometer. The stage micrometer rulings are not perfectly uniform.* Thus the methods in common use at present are all *indirect*, for at least two steps have to be

* See Carpenter's book on the Microscope, 7th edition, p. 231.

taken in any measurement made. Each step involves errors and expenditure of time.

On the other hand, the electric micrometer is a direct method; only one measurement is required, thus making for accuracy, whilst at the same time the instrument used is very sensitive.

If one specially wishes to work by means of an eye-piece micrometer, it is easy to see how the electric method can be used in place of the stage micrometer to give a very accurate calibration of the eye-piece. But this does not seem a desirable course.

(4) Some modern Microscope stages are moved by a screw which has a graduated head. In this way a measurement may be taken directly (as with the electrical method). In principle this micrometer is good, but in practice it has three disqualifications:—

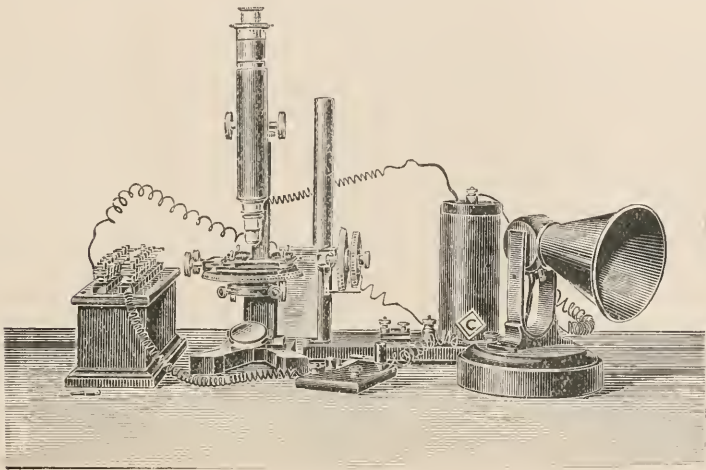

FIG. 128.

(i.) The measuring-screw is given the work of carrying the stage with it when it turns; supposing no looseness or backlash occur at first, these will probably be set up in time from the wearing action, and so errors will arise. (ii.) It is inconvenient to have such a large graduated disc attached near the stage as will give readings of 1 micron; but the disc is generally small, and hence the readings cannot be very fine or the instrument delicate. (iii.) The micrometer screw being fixed on the stage will be liable to be knocked and damaged, and so spoiled for accurate measurement. Any fine measuring-screw should be put away when not in use.

The Electric Micrometer is like the above in being direct-acting, but it does not suffer from the disqualifications mentioned. It can be used with any Microscope having a movable stage (and

if a movable stage does not exist a temporary one could be easily made by having a brass plate moved by the screw itself), no other micrometer at all being needed.

I have used it on two laboratory Microscopes for a variety of measurements. It takes only a minute or two to set up the apparatus.

Given delicacy of touch, measurements can be made of anything visible. I have found no difficulty in reading to $\frac{1}{4}$ micron.

If a capstan-pin be inserted into the edge of the milled head of the screw, a more delicate angular movement may be given to the screw, and readings of $\frac{1}{10}$ micron obtained.

SUMMARY OF CURRENT RESEARCHES
RELATING TO
ZOOLOGY AND BOTANY
(PRINCIPALLY INVERTEBRATA AND CRYPTOGAMIA),
MICROSCOPY, ETC.*

ZOOLOGY.

VERTEBRATA.

a. Embryology.†

Influence of Temperature on Development of Fowl's Egg.‡—C. L. Edwards has made a careful study of this question. His data are based on 238 incubated and 59 unincubated eggs.

The physiological zero, or the temperature below which there is no development, is given by most authors at 28°; it is established at the degree included between 20° and 21°. The index of development between 20° and 30°·75 is given; the normal average diameter of the blastoderm and of the area pellucida is calculated. The average volume of the egg is also considered. We cannot summarise the tables, but the general result shows a direct dependence of ontogenetic organisation upon warmth.

Retrogressive Changes in Ovarian Follicles.§ — A. Bühler first describes the retrogressive changes in the burst follicle of Cyclostomes (lamprey) and Teleosts. There is an almost complete degeneration, well seen in *Coregonus*; the epithelium and the theca connective-tissue degenerate *pari passu* and almost equally. At the beginning of the process in *Coregonus* there is in the theca a certain progressiveness in the formation of a few large connective-tissue cells, and this is much more marked in the lamprey, where the theca holds out till after the degeneration of the epithelium. The residue of the theca becomes an inseparable part of the connective-tissue of the superficial ovarian lamina. There is no formation of new tissue,—no corpus luteum.

Bühler then discusses the degeneration of the unburst follicle. This is more complex since it involves the absorption of the ovum, partly

* The Society are not intended to be denoted by the editorial "we," and they do not hold themselves responsible for the views of the authors of the papers noted, nor for any claim to novelty or otherwise made by them. The object of this part of the Journal is to present a summary of the papers as *actually published*, and to describe and illustrate Instruments, Apparatus, &c., which are either new or have not been previously described in this country.

† This section includes not only papers relating to Embryology properly so called, but also those dealing with Evolution, Development, Reproduction, and allied subjects.

‡ Amer. Journ. Physiol., vi. (1902) pp. 351-97.

§ Morphol. Jahrb., xxx. (1902) pp. 377-452 (2 pls. and 2 figs.).

by chemical and physical disintegration, partly by the active agency of the elements of the follicular envelopes. This is described at length. The result is the same as before—the specific epithelium of the follicle is wholly lost and the remains of the connective-tissue pass into the lamina ovarii superficialis.

Albuminoid Crystals in Ova of Roe Deer.*—V. von Ebner describes the remarkable occurrence of crystalline bodies in the ova of the roe deer. The reactions point to an albuminoid body, insoluble in water, soluble in salt solution,—a globulin in the strict sense. The crystals occurred only in ova already surrounded by a zona.

Ovary and Menstruation.†—J. Halban has made experiments on Pavian monkeys which have led him to the conclusion that menstruation is definitely stopped after removal of the ovaries. The experiments show that menstruation is dependent on the ovary; and that the cause of menstruation is to be found in a chemical, not directly nervous, nexus, since the persistence of menstruation depends on the presence of the ovary in the body irrespective of its position, whether subcutaneously between muscle and fascia, or in the mesentery.

Pseudochromosomes in Ova of Birds.‡—F. d'Hollander describes "pseudochromosomes" ("Balbiani's nucleus," "vitelline nucleus") in the ova of *Parus major*, *Muscicapa grisola*, and the fowl. These bodies occur in varied form (as granules, rods, filaments, vesicles with chromatic walls, &c.), distinct from the germinal vesicle. He regards these enigmatical bodies as equivalent to the "pseudochromosomes" of Heidenhain and Fürst, the ergastoplasmic structures of Prenant and the brothers Bouin, the spicules found by von Winiwarter in the human ovum, and the pseudochromosomes observed by Van der Stricht in the ovum of the bat.

Atypical Spermatozoa.§—I. Broman has studied the atypical forms of spermatozoa occurring in man, salamander, and dog-fish. He distinguishes three sets:—(I.) Giant and dwarf spermatozoa occur which are typical except in size. They probably arise from spermatocytes whose chromosomes have been unequally divided between the two daughter-cells. (II.) Spermatozoa occur with 2–4 tails but one head, which arise from spermatocytes with bipolar or multipolar mitoses. (III.) Spermatozoa with two or three heads also occur, and arise in man when nuclear division of spermatocytes is not followed by plasmic division. In the forms of this type which occur in the salamander the behaviour of the idiozome is of particular interest.

A fourth category of atypical spermatozoa is elsewhere || discussed. It includes those (often occurring in man) which have an abnormal form. The abnormality may affect the form of the head, the attachment of the tail, the spiral sheath of the connecting-piece, or the sheath of the main tail-piece, or several of these at once. The origin of these abnormalities is unknown,—perhaps they may be classed as pathological variations.

* SB. Akad. Wiss. Wien, ex. (1901) pp. 5–12 (2 figs.).

† Tom. cit., pp. 71–92.

‡ Verh. Anat. Ges., xvi. Vers. in Anat. Anzeig. Ergänzungshft., xxi. (1902) pp. 168–71 (5 figs.).

§ Anat. Hefte, xviii. (1902) pp. 509–47 (11 pls.).

|| Anat. Anzeig., xxi. (1902) pp. 497–531 (107 figs.).

In the more speculative part of his paper, Broman expresses his belief that these atypical sperms may function in fertilisation. He attaches particular importance to those with one head and two tails, which, he suggests, may be responsible for twins from one ovum.

Fertilisation in the Bat.*—O. Van der Stricht has had the good fortune to be able to study the behaviour of the spermatozoon in the act of fertilising the ovum of *Vespertilio noctula*. The entire spermatozoon penetrates into the interior of the vitellus; it may enter at the pole where the polar globules are detached, or at the opposite pole, and probably at any spot. The tail persists a very long time beside the head, after the latter is transformed into the pronucleus, even on to the formation of the first cleavage spindle. A spermatid is formed around a central corpuscle—the spermocentrum, and reaches to the anterior end of the portion which connects to the tail of the spermatozoon. No rotation of the head through 180° was observed.

Epithelial Structures on Parrots' Beaks.†—A. Ghigi has examined a series of embryos of *Melopsittacus undulatus*. The epitrichium is most developed on the dorsal surface, and least ventrally; comparison with other birds shows that its distribution is very variable, as is also the distribution and quantity of ceratohyalin in the individual epitrichial elements.

The "egg-tooth" consists of many superposed strata of denticulate cells with very distinct and stainable nuclei and granular cytoplasm.

The papillæ of the beak are dermal and epidermal elevations, extending the surface which forms the horny investment of the beak and thereby affording greater strength.

The dentition is represented, as Röse, Carlsson, and others have shown, by epithelial laminae on the jaws, and that of the upper jaw in parrots attains a notable degree of development, and persists some time after the bird is hatched.

Regeneration of the Lens in Chick Embryos.‡—D. Barfurth in co-operation with O. Dragendorff has shown that the embryo of the fowl shows characteristic regenerative processes on the internal wall of the optic cup and can form a new lens. The regenerated lens is closely connected with the margin of the optic cup, therefore with the subsequently formed iris margin. The operations destroyed the normal ectodermic primordium of the lens and injured the subjacent portion of the developing optic cup. It seems most probable that the margin of the optic cup affords the formative tissue for the new lens.

It appears from the above that the embryo-bird has a regenerative capacity which the adult almost entirely loses, which corresponds with what Barfurth has previously observed in regard to Amphibians. Barfurth inclines to say that regenerative capacity is an original and intrinsic power of organisms, and he does not think that this view is

* Verh. Anat. Ges., xvi. Vers. in Anat. Anzeig. Ergänzungshft., xxi. (1902) pp. 163-8 (1 fig.).

† Anat. Anzeig., xxi. (1902) pp. 145-63 (8 figs.).

‡ Verh. Anat. Ges., xvi. Vers. in Anat. Anzeig. Ergänzungshft., xxi. (1902) pp. 185-99 (13 figs.).

inconsistent with what Weismann has maintained in regard to its adaptive significance.

Branchial Clefts in Lizard and Slow-worm.*—Prenant and Saint-Remy corroborate on the whole the conclusions of Maurer.

The first cleft does not develop as such, but is at its first appearance a dorsal sensory organ; the second cleft gives rise to the anterior thymus; the third is associated with the posterior thymus and a parathymic glandule; the fourth gives rise to a structure like a parathymic glandule, but this degenerates completely; the fifth, developed in *Laerta*, is quite transitory in the slow-worm. There is a paired post-branchial evagination, but that on the left retrogresses and usually disappears, while that on the right becomes a gland which is at its maximum in young forms, and retrogressive in adults.

Skull and Nervous System of *Ceratodus*.†—A. N. Sewertzoff has studied the development of the primordial cranium of *Ceratodus* and the nervous system. In its development the cranium of this Dipnoan shows a greater resemblance to that of Urodela than to that of any other group. On the other hand, there are not a few distinctive features which do not occur in Amphibia. Moreover, as one would expect, the resemblance to Amphibia decreases as development proceeds.

The distribution of the nerves in *Ceratodus* is in general the same as in *Protopterus*, as described by Pincus, while some peculiarities, e.g. as to the nervus præopticus, distinguish it sharply from that of other Vertebrata.

Structural Feature connected with Mating of *Diemyctylus viridescens*.‡—W. A. Hilton describes the quaint mating habits in this Urodele. After excitation, in which the male touches the female with the sides of his head, the male leaves the female but is closely followed by her. The male moves slowly forward and throws his body into serpentine undulations, and a spermatophore is emitted which may come to the cloaca of the female as she follows her mate farther along. What is the nature of the attraction which leads the female to follow?

Hilton's suggestion is that it may be in part due to the secretion of three or four quite large, deep glandular pits which extend from the back of the male's eye along the side of the head. They are represented by small pin-prick-like minute depressions in the female. Adult males taken at any time except the breeding season show the gland tubules associated with the pits in a resting state; when breeding the gland lumens are filled with secretion. No pits or glands were found in *D. torosus*, whose breeding habits are dissimilar.

Palæontology and Evolution.§—E. Koken expounds a number of conclusions which command general assent. The palæontologist has to deal with the most direct "evidences of evolution,"—there are fossil-series, there are extinct links between modern types, there is an unmistakable progress, and so on.

* Comptes Rendus, exxxv. (1902) pp. 62-3.

† Anat. Anzeig., xxi. (1902) pp. 593-608 (5 figs.).

‡ Amer. Nat., xxxvi. (1902) pp. 643-51 (11 figs.).

§ 'Palæontologie und Descendenzlehre,' Jena, 1902, Svo, 33 pp. See Zool. Centralbl., ix. (1902) pp. 432-5.

He emphasises the necessity of assuming "reiterated species-formation" (*iterative Artbildung*), namely, the repetition of similar variations at different epochs, as if there were a "predisposition towards certain lines of variability." This is a very interesting inquiry, which few have pursued, as to parallelism in evolutionary processes.

The author is not a Darwinian, but a frank Lamarckian. Not only do changes in the earth and its climate bring about changes in species, in part directly and in part by influencing instincts, but the instinct and the will of the organisms are the most important factors in evolution, whether in the formation of the Ichthyosaurian paddle or in the establishment of the feet of *Diprotodon*. But the difficulty is to harmonise such psychological formulæ as "will," with biological factors of a more objective sort.

b. Histology.

Artificially induced Anomalies in Cell-Division.*—R. Werner has experimented on the effects of ether spray. The cold brings about proliferation and cell-lesions; and abnormal modes of cell-division ensue. Most are amitotic, but sometimes the mitotic character is preserved. The amitotic process is a traumatic, in a certain sense simplified, mitosis. There is an unsymmetrical and incomplete rearrangement of the chromatin before the metakinesis, and on this other phenomena depend. Although not of equal value to mitosis, the amitosis gives rise to viable cells. Giant cells of unicellular origin arise either by stimulation of the centres and paralysis of the periphery (Weigert), or by a hindering of cell-wall formation through the persistent activity of the centres (His).

Direct Division in Artificial Conditions.†—W. Schimkewitsch directs attention to a number of experiments which he has made on the eggs of *Loligo* and the fowl, which show that unnatural conditions of a chemical nature induce direct division where indirect division should occur. The variety of conditions when this occurs is great, but it seems as if they might all be included in the statement that an unnaturally intensified metabolism tends to induce the direct mode of division. An interesting survey is taken of the numerous and very varied instances where this relapse to amitosis has been observed.

Reticular Apparatus in Spinal Ganglion Cells.‡—M. Jaworowski has found in the spinal ganglion cells of birds and amphibians the same "reticular apparatus" as Golgi has described in mammals. It is quite different from Apáthy's nerve-fibrils or Holmgren's canaliculi; it is a closed structure, composed of threads, confined to the inner plasmic region, and in no connection with the surface.

Pituitary Body of Amphibians.§—A. Bochenek finds that a nerve-strand from the under part of the infundibulum enters the hypophysis and ends in the glandula infundibuli. In Urodela the glandula infundibuli consists of a single segment, and is almost exclusively formed of a dense meshwork of nerve-fibres. In Anura there are two segments,

* Arch. Mikr. Anat., lxi. (1902) pp. 85-122 (1 pl.).

† Biol. Centralbl., xxii. (1902) pp. 605-8.

‡ Bull. Acad. Internat. Sci. Cracovie, 1902. pp. 403-13 (1 pl.).

§ Tom. cit., pp. 397-403 (2 figs.).

—the anterior one corresponding exactly to the glandula infundibuli of Urodela, the posterior one being a new structure altogether. Boeke's view that the infundibulum is to be regarded as a sensory organ finds fresh support in Bochenek's demonstration of the nerve-strand above mentioned.

Structure and Function of Thymus in Teleosteans.*—T. Prymak has studied this in *Gobio fluviatilis*, *Carassius auratus*, *Corvina nigra*, and *Stromateus fiatola*. He supports Beard's conclusion that the thymus is the first and original source of the leucocytes. In every case he found that leucocytes passed in large numbers from the thymus, through the thin epithelial layer, into the branchial cavity. Quantities of leucocytes were likewise found on the gills or in their immediate vicinity. It seems plausible to conclude, with Beard, that the emigrant leucocytes act as phagocytes, dealing with the numerous micro-organisms about the gills.

The degeneration of the thymus is characterised by the appearance of empty spaces vacated by the leucocytes, which have passed into the blood-vessels or migrated from the thymus, or changed into red blood-corpuseles which by-and-by break up into finely granular substance. Another characteristic is the appearance of concentric (Hassal's) corpuscles. These are not due to remains of epithelial cells, but arise, according to the author, from obliterated blood-vessels.

Supra-renal Bodies of Plagiostomes.†—E. Grynfeldt has examined these bodies in twenty-four species, and finds the same general structure throughout. They consist of an epithelial mass of chromaffine cells surrounded by a delicate capsule, and traversed solely by capillaries and terminal nerve-fibres. The nerve-fibres penetrate into the parenchyma among the chromaffine cells, in contact with which they end freely.

Inter-renal Body of Plagiostomes.‡—E. Grynfeldt communicates some details in regard to this puzzling body. It is typically a paired organ. Its structure is that of a blood-gland, consisting of flexuous cellular strands, anastomosing in a kind of network with voluminous capillaries in the meshes. The cellular strands are enveloped in a delicate membrane; they are usually solid, but have internal spaces in *Myliobatis*. The cells of the inter-renal body are remarkable for their abundant content of fat.

Plasmic Appearance of Metaphosphate of Calcium.§—A. L. Herrera gives descriptions and photomicrographs of the cell-like appearances obtainable from emulsions of metaphosphate of lime in salt water. He suggests that living matter may have metaphosphate of lime as its foundation.

c. General.

Classification.||—J. Stanley Gardiner criticises adversely Bernard's proposal to classify by localities. The specimens of a collection are to be divided into the *forms* for each locality, and each *form* is to be termed X. loc. 1, 2, 3, 4, 5, &c. in accordance with the number of *forms* in that locality.

* Anat. Anzeig., xxi. (1902) pp. 164-77 (2 figs.).

† Comptes Rendus, cxxxv. (1902) pp. 373-4. ‡ Tom. cit., pp. 439-41.

§ Mem. Soc. Cient. Antonio Alzate, xvii. (1902) pp. 201-13 (8 figs.).

|| Proc. Cambridge Phil. Soc., xi. (1902) pp. 423-7.

The author remarks, after criticising the proposed scheme, that, "Zoology as a science commenced with the doctrine of evolution, a generalisation of facts. Species in the older sense are not, but the meaning of the term is clear to all. It is not unscientific to call each twig of our tree by a separate name. In nature each twig is different from its neighbour, and is many times reduplicated. Each replica varies somewhat, but the main characters of the twig are repeated in all. New twigs may perhaps be formed by the splitting of old twigs, but the more general method—certainly in corals—is by the bursting of buds."

Physical Coloration.*—H. Mandoul discusses the iridescent coloration of shells, fish-scales, insects' wings, birds' feathers, &c. Gadow, Krukenberg, and others attribute the colours to dispersion phenomena (caused by prisms or fine lines); Brücke and others have referred them to the action of fine lamellæ; but neither interpretation has been proved. Careful investigation has led Mandoul to the conclusion that the colours are due to interference phenomena caused by delicate lamellæ.

Copper in the Animal Organism.†—R. Dubois has examined about a score of types, and finds a general occurrence of copper, as in plants. It occurs in terrestrial, fresh-water, and marine forms, in very varied proportions even in the same species. Fishes contain less than Invertebrates, and the latter have much more than the higher Vertebrates. The proportions in different parts of the same animal differ greatly, thus the muscles of *Palinurus vulgaris* only contain $4\frac{1}{2}$ mgrm. in 100 grm., the blood has 23 mgrm. in 100 grm., and the eggs show no trace. The absence of copper in the eggs of *Palinurus* shows that this element is not essential to the development of the animal, as its abundance in the adult might suggest.

Lesion of the Semicircular Canals.‡—L. Boutan has made experiments on pigeons and concludes that the destruction of the membranous canals implies at once a temporary excitation and a paralysis of the organ. Immediately after the operation, the bird experiences false sensations of rotation, due to the section of the sensory nerves, and at the same time, as the result of the definitive paralysis of the organ, it is incapable of adjusting the movements of rotation which it actually exhibits. Thus when it is forced to walk, it turns and tumbles on the injured side.

Brain of *Macroscelides proboscideus*.§—G. Elliot Smith gives a brief description of the brain of this Insectivore, and shows that Parker's remark concerning the skeleton, that "we have a curious mixture of marsupial (metatherian) and eutherian characters," might with equal truth be applied to the brain.

Anatomy of Giant Salamander of Japan.||—Gakutaro Osawa gives a detailed account of the skeletal, muscular, nervous, and vascular system of *Cryptobranchus japonicus*, the giant salamander of Japan.

* Comptes Rendus, cxxxv. (1902) pp. 65-6.

† Ann. Soc. Linn. Lyon, xlvii. (1901) pp. 93-7.

‡ Comptes Rendus, cxxxiv. (1902) pp. 1601-3.

§ Journ. Linn. Soc. (Zool.), xxviii. (1902) pp. 443-8 (2 figs.).

|| MT. Med. Fac. Univ. Tokio, v. (1902) pp. 221-427 (44 pls.).

Toxic Properties of the Saliva of certain Non-poisonous Colubrines.*—A. Alcock and L. Rogers have experimented with *Cerberus rhyncops*, *Dipsas forstenii*, *Dryophis mycterizans*, *Zamenis mucosus*, and *Tropidonotus piscator*, and have found, even from a few experiments, strong reason to believe that the difference between poisonous and "non-poisonous" Colubrines is not a radical one, but is only one of degree, and that the parotid secretion of some of the "harmless" Colubrines is to a certain extent poisonous when injected subcutaneously.

Venom of Snakes.†—C. Delezenne finds that the venom of snakes (cobra, *Bothrops*) contains a diastase having the same properties as enterokinase, or the kinase of leucocytes and microbes. He asks whether it may have digestive importance, and whether it is distinct from the principle which gives the venom its toxicity.

Systematic Position of Pleuronectidæ.‡—G. A. Boulenger proposes the establishment of a division of the suborder Acanthopterygii, under the name of Zorhombi, defined as aberrant, strongly compressed Perciformes, with very short præcaudal region, modified in the direction of the flat-fishes, and characterised by the combination of an increased number (7-9) of ventral rays, with absence of hypural spine (by which Berycidæ are excluded), or by asymmetry of the skull in the forms in which the spine of the ventral fin has been lost. This division would include Zeidæ, Amphistiidæ, and Pleuronectidæ. In short, the author seeks to derive the Pleuronectidæ from an ancestral type to which Zeidæ and Amphistiidæ are related.

Vertebræ of Terrestrial Carnivores.§—E. Stromer von Reichenbach has made a monographic study of the morphology and systematic significance of the vertebræ of terrestrial carnivores, including some extinct forms. The atlas—which has the most complex functions—gives the best clue to systematic relations; the other vertebræ seem to be relatively insignificant in this respect.

Zoologischer Jahresbericht.||—We have received the last volume of the Naples Zoologischer Jahresbericht (for 1901), conforming in plan, excellence, and punctuality, to its predecessors.

Bonelli, an early Italian Lamarckian.¶—L. Camerano gives an interesting account of Franco Andrea Bonelli, who professed zoology at Turin from 1811 to 1830, and maintained, as documentary evidence shows, what would now be called a well-defined Lamarckian position in regard to evolution.

Tunicata.

Heart of Diplosomidæ.**—A. Pizon has made some interesting observations on the extraordinary vitality of the heart in these com-

* Proc. Roy. Soc. London, lxx. (1902) pp. 446-54.

† Comptes Rendus, cxxxv. (1902) pp. 328-9.

‡ Ann. Nat. Hist., x. (1902) pp. 295-304.

§ Zoologica, xv. (1902) pp. 1-276 (5 pls. and many tables of measurements).

|| Berlin, Svo, viii. and about 400 pp. not consecutively paginated.

¶ Atti Accad. Sci. Torino, xxxvii. (1902) pp. 455-64.

** Comptes Rendus, cxxxiv. (1902) pp. 1528-30.

posite Ascidians. He has previously referred to similar phenomena in Botryllids. The beating goes on after all the organs of the ascidizoids have undergone advanced degenerative histolysis, and it begins precociously in the young zooids before these (which have an interesting triple origin) are as yet integrated into a continuous whole.

Development of Molgulidæ.* — D. Damas has studied the embryos of *Lithonephyra eugyrida*, *Molgula echinosiphonica*, and *Anurella bleizi*. In connection with the cleavage of the ovum, he notes the occasional occurrence of multiple division-figures, most numerous towards the periphery, within an undivided protoplasmic mass. An account is given of the development of the notochord, "muscle"-plates, and neural tube in the early embryo; and the author corroborates what Lacaze-Duthiers observed in regard to the remarkable caudal degeneration which leads to the "anurous" embryo.

The larval nervous system, well developed in many Ascidians, does not advance far in the Molgulidæ studied. It begins to dwindle after the outlining of three chief divisions,—the cerebral vesicle, the visceral region, and the caudal portion. There are never any sense-organs in the anurous larvæ, but the urodelous forms have a single pigmented cerebral organ. The greater part of the primitive neural canal is destroyed in the retrogressive metamorphosis. The relations of the hypophysis with the epiblastic portion of the mouth, and the communication of hypophysial tube and neural canal, are very distinct.

There is a simultaneous formation of two pairs of branchial stigmata. The parietal wall of the peribranchial cavity is formed by the epiblastic layer, while the visceral wall includes, on the one hand, the lips of the stigmata formed by hypoblastic diverticula, and on the other hand, an interposed cellular column of epiblastic origin.

A solid rudiment, median and symmetrical, gives origin to the renal vesicle. The pericardium passes in its development through a stage when it appears as a compact mass. These two organs are both formed at the posterior end of the endostyle, and their development extends through a considerable period of embryonic life.

INVERTEBRATA.

Variations of Plankton in Lake Geneva.†—E. Yung, in continuing a previous investigation, indicates very strongly that the methods in vogue for measuring quantitative variations in plankton are inadequate. Hasty generalisations as to seasonal variation, based on insufficient data, are doing much more harm than good.

Mollusca.

a. Cephalopoda.

Amphitretus from the Sagami Sea.‡—I. Ijima and S. Ikeda describe a specimen of this remarkable Octopod—a member of a rare and interesting genus—perhaps identical with the single species as yet known *A. pelagicus*, described by Hoyle.

The authors agree with Hoyle in regarding *Amphitretus* as a repre-

* Arch. Biol., xviii. (1902) pp. 599-664 (4 pls.).

† Arch. Phys. Nat., xiv. (1902) pp. 119-31 (1 pl.).

‡ Annot. Zool. Japon., iv. (1902) pp. 85-101 (1 pl. and 3 figs.).

sentative of a distinct family, the Amphitretidæ. This family probably has its nearest ally in the genus *Alloposus*, the only essential distinctive character being the presence of a ventro-median connection of the mantle with the siphon in *Amphitretus*. Apart from *Alloposus*, which Verrill made the representative of a special family Alloposidæ, the Amphitretidæ seem more nearly related to the Octopodidæ than to any other of the eight-armed Dibranchiata.

γ. Gasteropoda.

Blood of the Snail.*—E. Couvreur has made a physiological study of the blood of *Helix pomatia*. It does not coagulate, which is difficult to explain. Perhaps the globulin, which is precipitated by sulphate of magnesium and is otherwise different from the fibrinogen of mammals, is entirely combined with a cupriferous substance and incapable of behaving like fibrinogen.

The blood of this mollusc contains no glucose either during hibernation or immediately afterwards. It contains a large proportion of urea or of compounds of urea. The colouring matter ("hæmocyamin"), which turns bluish on exposure to air, seems to be due to the combination of an albuminoid with a cupric substance, and is only remotely analogous with hæmoglobin.

Tanganyika Gastropods: *Chytra* and *Limnotrochus*.†—Lettice Digby discusses the structure and affinities of *Chytra kirkii* and *Limnotrochus thomsoni*. The former shows an obvious combination of characters distinctive of several well-known Prosobranchiate forms,—*Capulus*, *Xenophorus*, *Aporrhais*, *Trochus*, *Pleurotomaria*, *Nassopsis*, &c. It is suggested that in *Chytra* we are probably dealing with the direct ancestor of the families Hipponycidæ and Capulidæ, since the genus combines the nervous system of the one and the radula of the other, i.e. two of the most salient features of Prosobranchiate structure.

Like *Chytra*, *Limnotrochus* has scattered affinities, and it is more difficult to place than even *Chytra* itself. It is undoubtedly allied both to *Chytra* and to *Typhobia*, as well as to the Stromboid group represented by the genera *Strombus* and *Aporrhais*; and it is perhaps more nearly allied to these genera than to any other living types. But on the other hand, it is quite distinct from them all, and must, at any rate for the present, be regarded as unique.

δ. Lamellibranchiata.

Artificial Parthenogenesis in *Maetra*.‡—C. Kostanecki has made numerous experiments with the ova of *Maetra stultorum* and *M. helvacea*, which lead him to conclude that the beginnings of artificial parthenogenetic development may be induced by increasing the concentration of the sea-water or by adding various chlorides, &c. The unfertilised ova under these conditions exhibited, but with considerable variability of result, the protrusion of the polar bodies and a cleavage as far as the 12-cell stage. It is possible, he thinks, that with more experience

* Ann. Soc. Linn. Lyon, xlvi. (1901) pp. 85-91.

† Journ. Linn. Soc. (Zool.), xxviii. pp. 434-42 (3 pls.).

‡ Bull. Internat. Acad. Cracovie, 1902, pp. 363-87 (9 figs.).

in regard to the degree of concentration requisite, the development might be carried further.

Systematic Position of the Solenogastres.*—J. Thiele contributes a detailed discussion of this problem, and comes to the conclusion that the Solenogastres represent a group of worms most nearly related to Gordiidae and Annelids. The relation of the uterus to the heart and the beginnings of a radula-formation bring them in contact with the Molluscan stock, among which the Chitonidae with their persistent lateral cords are nearest to them. The memoir includes a lengthy anatomical description of the Solenogastres,—*Notomenia clavigera*, *Proneomenia australis*, *P. sluiteri*, *Neomenia carinata*, and *Chætoderma nitidulum*.

Variation in Position of Adductors in *Anodonta grandis* Say.†—E. R. Downing has measured a large number of specimens and reached the following results. (1) The distance of the adductor muscle from the umbo, measured along the line of migration, varies considerably in its relation to the distance to the shell margin, measured along the same line produced. (2) While the range of variation is comparatively large, the frequencies are well concentrated at or near the mode. In 93 p.c. of the cases the position of the muscle would not vary 3 mm. in either direction from the mean position. (3) Roughly speaking, we may say that the muscle is situated two-thirds of the way from the umbo to the margin. Accurately, the mean ratios are 0.6757 for the anterior muscle, and 0.6608 for the posterior. (4) The anterior adductor tends to move toward the margin at a more rapid rate than the posterior, although there is a tendency in both to lag behind the rate of growth of the shell margin. We seem to have in this form a species that is stable, rather than one that is in process of rapid evolution.

Structure of Gills of Lamellibranchs.‡—W. G. Ridewood has examined 215 species, belong to 118 genera, and finds that, except in a very broad way, the minute structure of the gill, like the grosser structure, cannot be taken as an indication of genetic affinity.

Three main types of gill structure can, however, be recognised, representing apparently three successive grades of complexity. Nuculidae and Solenomyidae (Pelseneer's Protobranchia) are marked by the mutual freedom of the gill-leaflets or platelets into which the embryonic gill papillae expand. In the two other types the embryonic papillae elongate into filaments, which are held in juxtaposition by interlocking cilia disposed in circular patches on the anterior and posterior sides of the filaments (*cleutherorhabdic*), or by regularly arranged horizontal bars of cellular tissue, which put the adjacent filaments into organic connection the one with the other and convert the interfilamentar spaces into rows of fenestræ (*synaptorhabdic*).

Pelseneer's order Pseudolamellibranchia is regarded as ill-founded. Evidence is also adduced to show that Pelseneer's Septibranchia are degenerate forms of the *Lyonsiella* type, and the suppression of Septibranchia as a distinct order is advocated.

* Zeitschr. wiss. Zool., lxxii. (1902) pp. 249-466 (10 pls. and 21 figs.).

† Amer. Nat., xxxvi. (1902) pp. 395-400 (6 figs.).

‡ Proc. Roy. Soc. London, lxx. (1902) pp. 499-500.

In *Avicula argentea* a very interesting condition is noted, there are both ciliated discs (*eleutherorhabdic*) and organic interfilamentar junctions (*synaptorhabdic*). In *Anomia aculeata*, as in the rare *Dimya*, the gill-filaments are not reflected, i.e. they have no ascending portions.

Ligament of Bivalves.* — O. M. Reis has studied this structure with such extraordinary detail and thoroughness that he must surely have finished off the subject. His communication extends over more than a hundred pages, and his summary over sixteen. The ligament is a modification of shell-formation, it includes a non-elastic portion, hardly distinguishable from the periostracum, and an elastic portion, distinctly laminated or layered, traversed usually by calcareous fibres running transverse to the layers. The action of the ligament depends upon its elasticity, the elastic portion is always bent postero-ventrally, the non-elastic portion has no function and is indefinite as to position.

Arthropoda.

Eurypterid Remains in Cambrian. † — C. E. Beecher describes *Strabops thacheri* g. et sp. n. from the Cambrian of Missouri,—an interesting discovery as almost the only instance of Eurypterid-remains older than the Upper Silurian. *Strabops* is nearly related to *Eurypterus*.

a. Insecta.

Interesting Case of Mimicry. ‡ — H. Osborn describes a case discovered by C. W. Mally in Cape Town. A Jassid in the group Acocephalidæ—*Cephaletus infumatus* Percheron—lives on the twigs of *Dovea tectorum* Masters on which there are numerous thorn-like abortive bracts. These the insect, which has a long thorn-like frontal process, “mimics” not only in form, but in colour, size, and position, so that even the eye of the practised entomologist finds it difficult to distinguish animal from plant.

Metamorphosis of Sisyra. § — Maude H. Anthony gives an account of the metamorphosis of this obscure little fly—one of the Hemerobiidæ—which passes its larval existence as a parasite on fresh-water sponges, clinging to their surfaces or descending into the open ostioles, piercing the tissue with its long decurved jaws. The food obtained is so pure that there is no residuum, and at least a fourth of the posterior portion of the stomach is atrophied, leaving no opening from the stomach at that end. Carnivorous habits and piercing mouth-parts are common to other hemerobian larvæ, but the decurved position of the mouth-parts and the tracheal gills are peculiar to this insect and *Olimacia*, its nearest ally, which has similar habits. Very remarkable, too, is the silk-secreting apparatus, which is formed from a modification of the Malpighian tubules, and not, as usual in insects, from the salivary glands.

The mouth-parts are not in the usual opposed position, but are approximated in pairs to form two sucking-tubes, excessively elongated,

* Jahreshefte Ver. Nat. Württemberg, lviii. (1902) pp. 179-291 (4 pls.). See Zool. Centralbl., ix. (1902) pp. 573-5.

† Amer. Journ. Sci., xii. (1901) pp. 364-6 (1 pl.).

‡ Psyche, ix. (1902) p. 327. See Zool. Centralbl., ix. (1902) p. 532.

§ Amer. Nat., xxxvi. (1902) pp. 615-31 (18 figs.).

and decurved. The brain is in the prothorax in old larvæ. The stomach is closed in the larva. Three Malpighian tubules are attached at both ends, and two are attached at one end,—all metamorphosed into silk-glands in their middle portion. The small intestine is modified as an outlet for the silk secretion. The spinneret is formed from the terminal part of the alimentary canal.

A completer account than has hitherto appeared is given of the late stages of wing development, and the variations in the venation of fifty wings are tabulated.

So-called Microthorax of Insects.* — F. Silvestri concludes from a study of *Japyx*, *Campodea*, &c. that the "microthorax" or "Nackensegment" distinguished by Verhoeff, is nothing more than a part of the labial segment.

The segment which in Chilopods bears the maxillipedes is homologous with the prothorax of insects. Verhoeff's "microthorax," if it be regarded as part of the labial segment, is homologous with the first limbless segment of Diplopoda,—the neck-shield with its sternum.

Sense-Hairs of Lepidopterous Larvæ.† — W. A. Hilton finds that Lepidopterous larvæ are clothed with hollow hairs, each of which is supplied by a bipolar nerve-cell, a process of which penetrates a short distance into the hair and probably terminates before reaching the tip. In most species all body-hairs are sensory; large hairs are supplied by large bipolar nerve-cells, and small ones by smaller bipolar cells.

Under the hypodermis of caterpillars there is a system of multipolar cells more or less intimately connected with nerve-cells and fibres, which (a) stain lighter than the larger nerves, and (b) are closer to the hypodermis than the other cells and fibres. Nerves from bipolar sensory nerve-cells go to the central nervous system, run to the ganglia, leaving at once to follow on the outside of the connectives towards the head, forming a well-marked sensory tract. Motor nerves—going to muscles—seem to come directly from the central cell areas of the ganglia. Almost the only sensory termination of nerves on the body of insects is by means of the hairs.

Culicidæ of Algiers.‡ — H. Soulié has made a number of observations on the Culicidæ of Algiers, which show that malarial regions are rich in *Anopheles*, and that the genus *Culex* is not an agent in diffusing the disease.

Oogenesis in *Hydrophilus piceus*.§ — Fr. Megušar finds that the ovarian tubes are not terminally united to the heart region by a common strand, as is generally supposed. The terminations of the tubes are connected with the diverticula of branched glands which stretch towards the pericardial region and form there a funnel-like structure suggestive of the funnel of a nephridium. From this structure numerous ramifications and diverticula proceed, and it is here that the germ-cells are primarily formed. The seat of the formation of the ova is not really in the blind ends of the ovarian tubules, nor in their prolongations—

* Zool. Anzeig., xxv. (1902) pp. 619-20.

† Amer. Nat., xxxvi. (1902) pp. 561-78 (23 figs.).

‡ Comptes Rendus, cxxxv. (1902) pp. 118-20.

§ Zool. Anzeig., xxv. (1902) pp. 607-10.

the so-called terminal threads—it is in the germinal epithelium which Megušar has discovered in the pericardial region.

Nerve-Endings in Striped Muscle of Insects.*—A. Aggazzotti has demonstrated by a new method the existence of Doyère's "colline" with its nuclei, and the relation of the nerve-fibrils to the isotropic lines of the muscle-fibre. He finds, in regard to the fibrils emerging from the nerve-fibre preterminally or from the plate, that the axis-cylinders of a nerve-fibre have not their final termination in Doyère's "colline," but in greater part are prolonged into numerous subdivisions ending in little granular aggregations in the muscle-fibre, or resolving into fine fibrillar endings which lose themselves in the substance of the muscle.

Influence of Temperature during Pupation.†—M. von Linden gives a valuable critical exposition of the results of about forty papers on this subject, and comes to the conclusion that the stable results sufficiently prove that characters acquired by parents are transmissible to offspring. In her opinion the Lamarckian interpretation is justified by the facts.

Receptacula seminis in Culicidæ.‡—M. Neveu-Lemaire describes the position, structure, and function of the receptacula seminis in females of *Anopheles coustani*, *Culex pipiens*, *Mansonia uniformis*. In copulation the sperms follow canals leading to the receptacula, where they may remain vital for a more or less prolonged period,—a fact of importance in the life-history of these insects. In *Anopheles* there is but one receptacle and one canal.

Testis of Tenebrio.§—K. Demokidoff found, at the blind end of the testicular follicles of *Tenebrio*, a lens-like body of fibrous structure with few nuclei, from which a strand passed into the follicle. He regards this body as homologous with the terminal chamber of the ovarioles.

Exuvial Glands.||—E. Verson refers to a recent paper by W. L. Tower describing peculiar unicellular skin-glands in the larvæ of *Leptinotarsa decemlineata*, which secrete an exuvial fluid between the old cuticle and the new. But in 1890 Verson described these exuvial glands in the silkworm, where there are 15 pairs of them, secreting a fluid between the hypodermis and the cuticle. They become specially active before a moult, and their secreted products doubtless help in the removal of the old cuticle. But they are probably at the same time excretory; from the first to the fourth larval moult the secretion contains oxalic acid salts, and subsequently uric acid.

B. Myriopoda.

Chilopoda in Bronn's 'Tierreich.' ¶—K. Verhoeff has begun what will be a welcome contribution—a general account of the Chilopoda.

* Atti Accad. Sci. Torino, xxxvii. (1902) pp. 724-32 (1 pl.).

† Zool. Centralbl., ix. (1902) pp. 581-99.

‡ Bull. Soc. Zool. France, xxvii. (1902) pp. 172-5 (4 figs.).

§ Zool. Anzeig., xxv. (1902) pp. 575-8 (3 figs.).

|| Tom. cit., pp. 652-4.

¶ Bronn's Klassen und Ordnungen des Tierreichs. Bd. 5, Abth. ii. Lief. 63-5, 42 pp. (6 pls.).

He discusses the literature and history of the subject, and the structure of the skeleton, skin, skin-glands, and sense-organs.

Myriopods are regarded as a phylogenetic unity, and the contrast between Progoneata and Opisthgoneata is emphasised.

δ. Arachnida.

Tracheæ of Spiders.*—E. Lamy has made a detailed study of the tracheal system in spiders. In *Epeira*, taken as type, there are four tubes, invaginations of the integument, ending in tendinous extremities attached in the internal tubes to the median tendons of the abdomen, and in the external tubes to the dorsal integumentary insertions of the fibres of the abdominal connective sac.

In all spiders the tracheal orifices are formed by the same pair of stigmata (belonging to the third abdominal segment), fused or not into one, which may be displaced to the posterior end of the body. Similarly, the tracheæ—however modified—are throughout the same in origin. Similar modifications seem to have occurred concurrently in different families, and their degree of development does not give a clue to general genetic rank, or afford a basis of classification.

The tracheæ of spiders are homologous with those of insects, and also with lung-books. Both tracheæ and lung-books are ectodermic invaginations, elongated and ramifying in the one case, internally plaited in the other. They have evolved concurrently, and illustrate in their degree of development a physiological balancing. But the bulk of the author's paper is taken up with a concrete description of the tracheæ of a long list of genera.

Studies on the Arachnid Entosternite.†—R. I. Pocock discusses the structure of the entosternite in Xiphosuræ, Scorpiones, Pedipalpi, Araneæ, and Solifugæ. In a second chapter he discusses the homologies of this difficult structure in different orders; they seem fairly obvious in the case of Pedipalpi and Araneæ, and Pocock shows that they can be to some extent detected over a wider range. Thirdly, the author inquires into the origin of the entosternite, and finds overwhelming evidence in favour of Lankester's view (1881) that it may be regarded as an enlargement and interlacing of the respective tendons of the muscles which are attached to it.

Spiders of Germany.‡—W. Bösenberg continues his valuable monograph on the spiders of Germany, giving a systematic account of the genera *Theridium*, *Ero*, *Steatoda*, *Teutana*, *Enoplognatha*, &c.—forty-six genera in all.

Limbless Acarid.§—I. Trägårdh describes as *Pimelobia apoda* g. et sp. n. a limbless Sarcoptid occurring under the elytra of a species of beetle (*Pimelia* sp.) from the desert near Cairo. The parasite is very degenerate, and its entire suppression of extremities is unique among Acarids. All the specimens were females, fixed by the mouth to the

* Ann. Sci. Nat. (Zool.), pp. 148-280 (4 pls. and 71 figs.).

† Quart. Journ. Micr. Sci., xlv. (1902) pp. 225-62 (2 pls.).

‡ Zoologica, xiv. (1902) pp. 97-192 (9 pls.).

§ Zool. Anzeig., xxv. (1902) pp. 617-8 (3 figs.).

skin of the host. They were full of minute hexapod larvæ, which develop directly into the limbless adults without trace of nymph stages. From the absence of males parthenogenesis is inferred.

ε. Crustacea.

Dwarf Males and other Sexual Peculiarities in Cirripedia.*—A. Gruvel finds that the dwarf males of the older species of *Scalpellum* have a more complete structure than in the newer species. On the other hand, as the general somatic organs atrophy, the reproductive organs become more developed, e.g. in the muscular investment of the seminal vesicle, which violently expels the seminal matter.

In the dwarf male of *Scalpellum peronii* some abortive ovarian cells were found—residues of an ancestral hermaphroditism.

Cirripeds are typically hermaphrodite. They may then exhibit autogamy, or they may be *directly* cross-fertilised by other hermaphrodites. An *indirect* cross-fertilisation, by sperms from other forms conveyed through the water, seems extremely unlikely.

In *Scalpellum* the original form was hermaphrodite, and the dwarf males are derived from hermaphrodites which have become fixed to other hermaphrodites. In certain species, instead of being fixed on other hermaphrodites, they occur on individuals which have become wholly female.

New Victorian Decapods.†—S. W. Fulton and F. E. Grant describe three new species of shrimps belonging to the genus *Pontophilus*, and a new crab—*Cryptodromia wilsoni*. They record the occurrence of a fresh-water form (from Lake Colac), apparently identical with *Hymenosoma lacustris*, recorded from New Zealand and Norfolk Island.

New Parasitic Copepod in Intestine of Mussel.‡—A. Steuer describes from *Mytilus galloprovincialis* Lam. a remarkable new Copepod, which he calls *Mytilicola intestinalis* g. et sp. n. The parasite is very common in the mussels of the Bay of Trieste, occurring in almost every specimen, and sometimes about half a hundred in one. It is of a reddish colour, worm-like in appearance, the male measuring 4 mm., the female about twice as much in length. The thoracic segments have paired dorsal processes; the segmentation of the abdomen is imperfect. There is a median eye.

Steuer gives a short description of the four-jointed first antennæ, the three-jointed hooked second antennæ, the short knob-like mandibles, the first maxillipede, hooked in the male, reduced to a small chitinous thickening in the female. The position of the second maxillipede is marked (in the male only) by a slight chitinous thickening. The other appendages are very small. The genital aperture is paired.

Nauplii with intense positive heliotropism are succeeded by cyclopid stages, which probably enter the mussel. The new form belongs to the family Dichelesteiidæ.

New Victorian Amphipods.§—O. A. Sayce describes the following new species,—*Chiltonia subtenuis*, *Atyloides fontana*, *Gammarus haasei*,

* P.V. Soc. Sci. Phys. Nat. Bordeaux, 1901. pp. 93-4.

† Proc. R. Soc. Victoria, xv. (1902) pp. 59-68 (3 pls.).

‡ Zool. Anzeig., xxv. (1902) pp. 635-6 (2 figs.).

§ Proc. R. Soc. Victoria, xv. (1902) pp. 47-58 (4 pls.)

and *Neoniphargus fultoni*. The third of these is of especial interest, inasmuch as, although an inhabitant of surface-waters, it is totally without eyes, and is comparable in this respect to *Niphargus pulchellus*.

Annulata.

Respiration in Polychæta.*—J. Bounhiol has made a detailed study of the respiratory system and functions in Polychæta. We can only give some of his general results.

The branchiæ of annelids are pectinate or branched organs, sometimes situated on the various segments of the body (Eunicidæ, Arenicolidæ), sometimes exclusively cephalic (Terebellidæ), always very vascular, and of considerable respiratory activity, discharging three-quarters or more of the total respiration, while the skin is responsible for about a quarter. There is always cutaneous respiration, undoubtedly the primitive mode. The organs called branchiæ in Cirratulidæ and Serpulidæ are not gills, but prehensile organs. The organs called lymphatic or cœliac branchiæ in forms with colourless blood have no particular respiratory rôle.

The fluid of the body-cavity has a respiratory significance far inferior to that of coloured blood, and it has none unless it contain some coloured corpuscles. The species with colourless blood are physiologically in the same position as those with only a cœlomic fluid.

Regeneration of Alimentary Canal in Rhynchelmis limosella.†—G. Winkler removed 5–10 segments from the anterior end and observed the formation of a new mouth (from ectodermic invagination) and of a new pharynx (from the old gut). He gives a detailed account of the regeneration process, and describes a number of experiments. It is interesting to notice the close correspondence in this case between the regenerative and the embryonic development.

Sense-Organs of the Polychæt Proboscis.‡—Adele Oppenheimer gives an account of certain sense-organs of the proboscis of *Rhynchobolus dibranchiatus*, which take the form of well-differentiated papillæ, occurring over almost the entire surface of the everted proboscis, elevated above the surrounding surface, and covered by a cuticle which is reduced to about two-thirds of the thickness it has elsewhere.

There are two or three spindle-shaped cells in a papilla, each terminating—either below the cuticle or more probably at the very apex of the papilla—in what is clearly a sensory structure. Moreover, each of these cells tapers gradually at its base into a nerve-fibre. These nerve-fibres are connected either directly or indirectly—through the intervention of a peripheral nerve-plexus—with the eighteen longitudinal nerves of the proboscis. There are two basal nuclei belonging to cells which probably have the function of cover-cells. Into each papilla there enter, besides nerve-fibres, connective-tissue fibres in close connection with a finely granular substance, of which there is a particularly dense and deeply staining layer immediately under the cuticle.

* Ann. Sci. Nat. (Zool.), xvi. (1902) pp. 1–80.

† SB. Böhm. Ges. Wiss., 1902, No. 12, 34 pp. (2 pls.).

‡ Proc. Amer. Acad., xxxvii. (1902) pp. 553–62 (6 pls.).

Observations on Swiss Oligochæta.*—K. Bretcher communicates some notes on the freezing of *Heulea ventriculosa* and on the desiccation of *Psammoryctes plicatus* and *Lumbriculus variegatus*. He also gives an account of the distribution of Enchytræids and other families, and discusses the systematic characters of Enchytræid species.

Chloragogen of Oligochæta.†—D. Rosa concludes that the typical chloragogen is a modified peritoneum. Its elements are not derived from leucocytes and do not give rise to them. The bases of the chloragocytes always adhere to the matrix of the inner cuticula of the walls of the blood-vessels. In the main the chloragogen is an excretory tissue, but it may also serve as a deposition-area for reserve materials; and this second function is the dominant one in Enchytræidæ. The reserves consist essentially of fat-globules; the excretions, usually yellowish, consist of semi-fluid elastic spherules (*chloragosomes*) formed within the chloragocytes from the blood. The occurrence of chloragosomes in the body-cavity is due to the more or less accidental liberation or bursting of the chloragocytes, and is not necessarily bound up with the function of the chloragogen.

Function of Chloragogen Cells.‡—C. Bartolotti gives a preliminary account of observations which he has made, independently of those by Rosa, on the function of the chloragogen cells in *Lumbricus* and *Allolobophora*. Their function is predominantly excretory, but they also accumulate reserve materials. He believes that the excretory granules consist in great part, if not exclusively, of uric acid, while the reserve materials seemed to be glycogen.

Spermatozoa of *Allolobophora fœtida*.§—Katharine Foot and Ella Church Strobell have demonstrated in these three centrosome-like structures—one at the base of the spine, one at the anterior, and one at the posterior end of the middle-piece. They discuss the complications which their discovery discloses, and direct attention to the following facts—among others—(1) the complete disappearance of both male and egg attraction-spheres at a definite stage of the egg's development; (2) the lack of decisive evidence that the rays of the male aster focus at any one point in the middle-piece, or that the rays of the cone focus at the base of the spine; (3) an inconstancy in both size and form of the egg centrosome at a given stage of the development of the spindle, and a lack of evidence of any division of either egg or sperm aster. They conclude that the centrosomes of *Allolobophora* present conflicting evidence that demands rigid cross-examination.

Development of *Clepsine*.||—O. Bürger finds that *Clepsine* shows in its development, as in its structure, a closer resemblance to typical Annelids than is exhibited by *Nepheleis*, *Hirudo*, or *Aulastomum*.

The lateral cavities of *Clepsine* correspond to the primitive segmental cavities of Chætopods, for they originate in the same way. Bürger observed their dorsal as well as their ventral coalescence; they form a dorsal cavity corresponding in origin to the ventral cavity. In *Hirudo*

* Rev. Suisse Zool., x. (1902) pp. 1-29.

† Mem. Accad. Torino, lii. (1902) pp. 117-44 (1 pl.).

‡ Rend. Accad. Lincei Roma, xi. (1902) pp. 449-51.

§ Amer. Journ. Anat., i. (1902) pp. 321-7 (1 pl.).

|| Zeitschr. wiss. Zool., lxxii. (1902) pp. 525-44 (3 pls.).

medicinalis there is a dorsal sinus, which Bürger regards as cœlomic and comparable to the dorsal cavity in *Clepsine*.

‡ *Clepsine* has a pair of blood-vessels, dorsal and ventral, which are both inclosed in cœlomic spaces, corresponding to similar vessels in Chaetopods, but apparently not represented in the other leeches named above. As in Chaetopods these vessels arise in *Clepsine* in connection with the process of coalescence which unites the primitive segmental cavities above and below the gut. Peculiar to *Clepsine* are the "cardio-blasts,"—two rows of mesoderm cells arising in connection with the primitive segments, and shunted from left and from right towards the middle line both ventrally and dorsally.

The cells which in other leeches form the "botryoidal tissue" become in *Clepsine* "excretophores," fat-cells, and *Stapelzellen*. The nephridia arise as in other leeches, as Bergh has described, in a manner comparable to that observed in Chaetopods. Bürger shows further that the origin of the reproductive system in *Clepsine* is similar to that in the Gnathobdellidæ.

Brain of *Phascolosoma*.*—Marcel A. Herubel gives an account of the minute structure of this brain which lies between the two dorsal retractor muscles, enveloped in a fibrous—muscular and connective—sheath. Three regions are distinguishable and are minutely described.

The most interesting result is, that the brain in question seems to consist of a syncytium of nuclei within an anastomosing network, the punctated substance of which seems to be the immediate centripetal element. It is, therefore, in the network and not in the "cell," that we must look for the seat of the essential nervous function. In short, Herubel's results are against attaching importance to the individuality and fixity of nerve-cells. Nervous function implies correlation.

Development of *Sagitta*.†—L. Doncaster has confirmed Hertwig's account, except that in *S. bipunctata* the head-cavities are formed as Bütschli described (1873). Hertwig probably studied a species with minute head-cavities.

Sections of the embryo show that in its early stages the nuclei lie at the free ends of the cells, but as development proceeds those of the ventral ectoderm sink into their bases, and in the ventro-lateral areas a great proliferation of nuclei takes place giving rise to the lateral nuclear bands of the ventral ganglion. The cavities of the embryo disappear entirely, the endoderm becomes reduced to a thin septum, the mesoderm to two solid strands, in which most of the nuclei become aggregated dorsally and ventrally, and the cell-protoplasm beneath them becomes converted into the longitudinal muscles.

The larva is as described by Hertwig, but he failed to observe the mode of formation of the posterior transverse septum, which arises between the genital cells of each side as they migrate from the splanchnic mesoderm across the body-cavity to the body-wall. This migration takes place at the time of the reappearance of the cœlom, and the septum is probably formed from the mesodermic envelopes of the genital cells.

* Comptes Rendus, cxxxiv. (1902) pp. 1603-5.

† Proc. Cambridge Phil. Soc., xi. (1902) p. 267.

The ectoderm of the larva in the neck region and at the front end of the fins is thickened and consists of vacuolated cells like those composing the epidermis of *Spadella draco*. No trace of excretory organs nor of genital ducts was found in the larva; the latter appears only as maturity approaches. There is no cœlomic epithelium, but the muscles are formed from the basal ends of the cells which line the cœlom, as in Nematodes. This fact, combined with the mode of origin of the transverse septa and the absence of many Annelid characters, supports the view that the Chætognatha are not related to the Annelida.

In a subsequent paper* L. Doncaster describes the complete and equal cleavage, the blastula with its nuclei at the outer ends of its cells, the gastrula arising by invagination, and the early appearance of the primitive genital cells (at first 2, then by division 4), which are separated from the inner layer of the gastrula at the opposite pole from the blastopore. Soon after their appearance a pair of folds arise at the anterior pole, which, growing backward, divide the archenteric cavity into three divisions,—a median alimentary canal and two lateral cœlomic cavities.

The folds push before them the genital cells for some distance, and the latter ultimately come to rest in the cœlomic cavities, two in each side. At about this stage the front ends of the cœlomic spaces become separated off as head-cavities, and the ectoderm, invaginating till it meets and fuses with the endoderm, forms the mouth. The blastopore comes to lie a little in front of the posterior end before it closes, and by the lengthening of the embryo in the shell and the general compression caused thereby, all cavities become obliterated. The origin of the cerebral and ventral ganglia by ectodermic thickening and in-sinking is then described, as well as the four longitudinal aggregations of the mesoderm.

The larva, which escapes from the shell, usually not more than two days after the eggs are laid, is a little tapering rod about 1 mm. in length, solid and without cavities. Doncaster describes the differentiation of the ganglia, the musculature, the cœlomic cavities, the gut, and so on, till the definitive structure is reached.

"In the present state of our knowledge it seems safest to regard the Chætognatha as descended from a primitive cœlomate stock, from which the Annelida have arisen on the one hand; while, on the other, the Nematoda probably branched off, but lost many of their original characters owing to their parasitic habit."

Nematohelminthes.

Largest of known Nematodes.†—J. F. Gemmill and O. von Linstow describe *Ichthyonema grayi* sp. n., found by Gemmill in the body-cavity of *Echinus esculentus* from the Firth of Clyde, and also by Shipley at Plymouth. The female measured 1500 mm., the male 60 mm. in length. The authors compare the new form with the other (7) species of the genus.

* Quart. Journ. Mier. Sci., xlvi. (1902) pp. 351-98 (3 pls.).

† Arch. Naturges., lxxviii. (1902) pp. 113-8 (1 pl.).

New Filaria.*—O. von Linstow describes *Filaria cingula* sp. n. from the skin of the giant salamander of Japan, *Cryptobranchus maximus*. The specific title refers to the prominent annuli on the cuticle.

Platyhelminthes.

Maturation and Fertilisation in Cerebratulus marginatus.†—C. Kostanecki describes the processes of maturation and fertilisation in this Nemertine. One of the outstanding results is the clear proof that the centrosomes of the first cleavage-spindle originate in the spermatozoon. In a subsequent paper ‡ the author discusses the remarkable and suggestive anomalies in the formation of the polar bodies in this species.

Regeneration of Pharynx in Planaria maculata.§—Henrietta F. Thacher has sought to find out if there is any marked difference between the formation of the pharynx in the new tissue of an anterior piece and in the old tissue of a posterior piece. It appears that the regeneration of the pharynx in the new and in the old tissue is much the same, (1) as to the origin and migration of the cells, (2) as to the formation of the two cavities (the chamber and the lumen of the pharynx), and (3) as to the differentiation of the cells into the normal tissues.

They differ (a) in the length of time that elapses before the pharynx thickening shows itself (about twelve hours more being required for its appearance in the old tissue than in the new), (b) in the position of the developing pharynx with regard to the central digestive cavity, and (c) in the size of the pharyngeal chamber as shown by its early irregularities in the posterior piece. The last two differences are probably due to the disposition of the digestive branches in the two cases.

New Species of Monostomum — L. Cohn describes *Monostomum oculobium* sp. n., from the eye of *Vanellus melanogaster*, an exceedingly hyaline form, as transparent as a Medusa, showing its internal organs through a thick cuticle. One of the peculiarities observed was the frequent occurrence of a situs inversus of the gonads, and this leads Cohn to a discussion of similar conditions elsewhere, e.g. in *Hæmato-loechus variegatus* Rud.

Incertæ Sedis.

Structure of Cheilostomata.¶—S. F. Harmer finds that a large number of Cheilostomata are provided with a "compensation"-sac, a structure described by Jullien, which opens at the proximal border of the operculum, or by a "median pore." Muscles usually run from the lateral walls of the zoëcium to the floor of the sac, dilate it by their contraction, thereby helping to force out the polypide. The constant change of water in the compensation-sac probably has a respiratory

* Zool. Anzeig., xxv. (1902) pp. 634-5 (1 fig.).

† Bull. Internat. Acad. Sci. Cracovie, 1902, pp. 270-7 (10 pls.).

‡ Tom. cit., pp. 278-89.

§ Amer. Nat., xxxvi. (1902) pp. 633-41 (8 figs.).

¶ Zool. Anzeig., xxv. (1902) pp. 712-8 (9 figs.).

¶ Quart. Journ. Micr. Sci., xlvi. (1902) pp. 263-350 (4 pls.).

importance. The sac is frequently found in zoëcia whose polypides have undergone histolysis.

The floor of the compensation-sac corresponds in whole or in part with the membranous frontal surface ("frontal membrane") of a *Membranipora*; and its muscles are homologous with the parietal muscles of the same genus. It appears to have been evolved in more than one way.

In *Cribrilinidæ* a calcareous wall ("frontal shield") is developed as a series of marginal spines, which overarch the frontal membrane. This leads to the condition found in some *Escharine* forms, in which, as in *Umbonula*, the calcareous frontal shield similarly overarches the frontal membrane.

The frontal shield of the *Microporidæ* and *Steganoporellidæ* is of the nature of a "cryptocyst," i.e. a calcareous lamella which grows horizontally across the body-cavity beneath the frontal membrane. This has, perhaps, led to the condition found in *Lepralia*, *Schizoporella*, &c. in which the compensation-sac is developed as an invagination at the base of the operculum, and passes to the deeper side of the frontal shield, which is on this view a cryptocyst.

The epitheca, or layer of living tissue, bounded by a cuticle, which covers the frontal shield, may represent the entire frontal membrane (*Microporidæ*, &c.), or only a part of that membrane (*Lepralia*, &c.), or it may have been derived from the outer calcareous layer of the frontal bars of a *Cribrilina*-like form (*Umbonula*). The epitheca is frequently responsible for the addition of secondary calcareous matter to the frontal shield, and in some cases (*Cellepora*, &c.) for the formation of new generations of zoëcia which are superposed on the older ones.

The operculum, in its more primitive condition, is merely part of the frontal membrane strengthened by a semicircular marginal flange. It acquires a firmer texture and a more elaborate arrangement of its thickened parts as the result of its articulation with calcareous portions of the zoëcium. While ocluser muscles may be regarded as an essential adjunct of the operculum, definite divaricators seem to have been evolved as a modification of the distal pair of parietal muscles.

The consideration of the relations of the frontal surface involves some rearrangements in the classification of the *Cheilostomata*.

The results of the study of the compensation-sac and frontal surface generally are confirmed by an examination of the primary zoëcium or "ancestrula" (Jullien).

Contributions to the Anatomy of *Rhabdopleura normani*.*—A. Conte and C. Vaney have studied well-preserved specimens of this interesting animal, colonies of which were found by Prof. R. Kœhler in *Lophohelia prolifera*.

Their most important results are the following:—(1) the testis and the ovary arise from differentiations of the two extremities of the stalk; (2) the space enclosed between the wall of the body and the internal organs is occupied by a trabecular connective tissue; it is not subdivided by septa, and it cannot be regarded as homologous with a body-cavity; (3) there is not really any notochord.

* Comptes Rendus, cxxxv. (1902) pp. 63-5.

Rotatoria.

Parasites of Rotatoria.* — O. Zacharias discusses the "sausage-shaped parasites" of Rotifers. He gives a list of the forms in which they occur (species of *Brachionus*, *Asplanchna*, *Synchaeta*, *Conochilus*, and *Polyarthra*). Various observers have noted and named them, but their position remains uncertain. Zacharias thinks that the name he proposed in 1893—*Ascosporidium blochmanni*—may be conveniently adhered to.

New Rotifers from Scotland.† — James Murray, in a short communication, figures and describes the following seven new species of Bdelloida, most of which he has obtained among Sphagnum from Blantyre Moor in Scotland: *Philodina brevipes*, *acuticornis*, *decurvicornis*, and *obesa*; *Callidina ornata*; *Rotifer quadrioculatus* and *spicatus*.

Key to the Rotifera for the Amateur.‡ — A friend, H. S. M., of the late Thos. S. Stevens has published this revised and extended Key to the Rotifera, which includes some of the new species described since Hudson and Gosse's monograph appeared, but by no means all of them. This Key is, no doubt, useful, but it will not be easy, and hardly safe, to determine species by it alone.

Echinoderma.

Structure and Hermaphroditism of *Cucumaria lævigata*.§ — A. Ackermann gives a general description of this Holothurian, but the chief interest of his investigation is in regard to the reproductive system. The genital tubes arise as diverticula from a "budding zone," which occupies the upper portion of the "genital-basis," and consists of many canals abstracted off from the main canal. All these tubes are hermaphroditic. Both in young and old animals a first portion forms ova, a second portion is used up in follicle-formation, a third portion becomes ultimately spermatogenetic.

At the most posterior portion of the "genital-basis" only male organs occur, which arise from the hermaphrodite tubes by a peculiar process—the female elements being removed by the activity of phagocytes. Their place is taken by spermatogenetic cells, which arise from an abundant multiplication of the indifferent sex-cells of the hermaphrodite tube.

The animals function first as males, the male elements reaching maturity first. Ripe eggs occur in the larger specimens, after a destruction of the previously developed male tubes. After the ova are removed from the tubes and any remnants are destroyed by phagocytes, the tubes become exclusively male gonads. From the first oviposition onwards there is a continuous absorption of the oldest male tubes, and therewith an absorption of the posterior "genital-basis." The absorption of ova and of tubes is due to phagocytes—all of similar character—plasma-cells with large nuclei.

* Zool. Anzeig., xxv. (1902) pp. 647-9.

† Ann. Scot. Nat. Hist., July 1902, pp. 162-7 (2 pls.).

‡ Amer. Mon. Micr. Journ., May 1902, pp. 89-114.

§ Zeitschr. wiss. Zool., lxxii. (1902) pp. 721-49 (1 pl. and 2 figs.).

In short, as age increases there is a diminution of the hermaphroditism, and a predominance of maleness. Perhaps in course of time *Cucumaria lævigata* will become dioecious.

Red Pigment of *Asterias rubens*.*—R. Dubois finds that maceration of this starfish in fresh water yields a fine blood-red liquid. This does not contain hæmoglobin, nor does it fix the atmospheric oxygen. Addition of ether produces a change of colour to strong yellow and separates an albumin. The pigment is ferruginous, but does not show the characteristic spectrum.

Natural Parthenogenetic Development.†—C. Viguier reasserts his conviction that parthenogenetic development may occur *naturally* in sea-urchins—*Sphærechinus*, *Toxopneustes*, and *Arbacia*. He has obtained parthenogenetic plutei from *Toxopneustes*, and gastrulæ from *Arbacia*; and he emphasises the fact that the parthenogenetic development differs in some details from that which follows fertilisation. He also gives the results of experiments which show that temperature has its influence on the alleged natural parthenogenetic development.

Maturation in *Echinus esculentus*.‡—T. H. Bryce has made an important contribution to our knowledge of this process, and some of his results help to harmonise the discrepancies of other accounts. His comparison of his results with those of other observers is very interesting, but we must confine ourselves to the summary of observations.

The chromatin thread or threads, derived only from a portion of the mass of chromatin in the germinal vesicle, are found split longitudinally and segmented into sixteen bodies—half the number of the chromatin rods in the nuclei of the cleavage divisions. These bodies consist of two short rods placed side by side, and each rod is composed of two spheres united by a less deeply stained portion of the thread. The two rods are intimately associated so as to form a tetrad-like mass, and the whole figure is to be considered as a compound chromosome.

After a relatively long prophase each of these is resolved in the first polar metaphase in such a manner that while the body is opened up along the original cleavage plane, another longitudinal cleft is effected, which is completed in the anaphase, and the final result is another compound chromosome like the original from which it sprang except in size. Each of the sixteen double rods which remain in the ovum after the extrusion of the first polar body is resolved in the second polar spindle into its two elements without further cleavage taking place.

In the telophase of the second division the elements which remain in the ovum after the extrusion of the second polar body elongate into rods which become bent on themselves, while those in the second polar body remain condensed as small bilobed rods.

The maturation phases differ from the ordinary cleavage mitoses in respect of (a) the thickening and condensation of the chromatin rods, (b) the second longitudinal splitting which occurs in the first metaphase, and (c) the absence of longitudinal cleavage in the second metaphase. The second mitosis thus merely distributes the grand-daughter

* Ann. Soc. Lyon, xlvii. (1901) pp. 139-41.

† Comptes Rendus, cxxxv. (1902) pp. 60-2.

‡ Quart. Journ. Mic. Sci., xlvi. (1902) pp. 177-224 (3 pls. and 3 figs.).

chromosomes formed by the second longitudinal splitting in the first mitosis.

There is thus no "reducing division." The only reduction which occurs is effected in the germinal vesicle, and the chromatin destined to form the chromosomes of the polar divisions is diminished in bulk merely.

Coelentera.

Increase of Mesenteries in *Madrepora*.*—J. E. Duerden finds that in most of the polyps of *Madrepora* only the six bilateral pairs of primary mesenteries are developed, four pairs complete, two incomplete. On any colony a few enlarged polyps may have more. The new mesenteries beyond the primary six pairs are added in complete or incomplete bilateral pairs at only the two axial extremities, the entocœle of the dorsal and ventral directives. Like *Porites*, *Madrepora* illustrates the bilateral entocœle type; the cyclic disposition is never assumed; the directives form isocnemic pairs, but the other pairs are all anisocnemic.

The pinnate method of mesenterial increase is distinct from that characteristic of most recent corals; in these the metacnemes are added in isocnemic pairs all round the periphery of the polyp, within the six primary exocœles, and in the end constitute one or more distinct alternating cycles. In *Porites* the same method of increase is characteristic, except that in any one polyp of *Porites* the new mesenteries are disposed at either the one or the other extremity, not at both.

Six new bilateral pairs of mesenteries appear practically simultaneously in *Madrepora*, but only later do they all extend down the polypal wall. In *Porites* the new pairs follow one another in regular succession.

In *Madrepora* the mesenterial increase is early associated with fission of the stomodæum, and in the end probably with complete polypal fission, in which half the mesenteries of each fission are derived from the primary twelve of the original polyp, and the other half are new formations. The resulting paired arrangement of the mesenteries, including the presence of two pairs of directives, is exactly as in primary polyps. Fission of the stomodæum appears very late in *Porites*, after full establishment of six new pairs of mesenteries.

Regeneration in *Tubularia*. †—E. Godlewski gives an interesting description of the regeneration of *Tubularia mesembryanthemum* when the stem is cut in two longitudinally. The hydranth may re-develop simultaneously at both ends, or only at one end (which may be aboral), or in the middle of the stem (in pieces cut lengthwise unsymmetrically).

Regeneration in *Hydra*. ‡—H. T. Rowley has sought to discover whether, during the period of regeneration, the old cells go over without change into the tissue of the new animals, or whether new cells are formed, and if so, in what part or parts. The answer given is that the new cells which appear during the regeneration are formed by division

* Johns Hopkins Univ. Circ., xxi. (1902) pp. 59-66 (12 figs.); Ann. Nat. Hist., x. (1902) pp. 96-115 (12 figs.).

† Bull. Internat. Acad. Sci. Cracovie, 1902, pp. 387-96 (11 figs.).

‡ Amer. Nat., xxxvi. (1902) pp. 579-83.

of the old cells throughout the entire piece, as in the normally growing animal, and that the tentacles are formed from old cells and from cells that have arisen by division of the already differentiated cells of the old part.

Japanese Scyphomedusæ.*—Kamakichi Kishinouye has in the past few years been studying the Scyphomedusæ of Japanese waters, and has come to know 22 species, most of which are new to science. Some are very remarkable.

The new family Stenoscypthidæ (among the Stauromedusæ) is established for *Stenoscypthus* g.n.—a medusa which stands between Tesseridæ and Lucernaridæ, closely allied to Depastridæ on the one hand and to Haliclystidæ on the other; it has a four-chambered peduncle and eight separate gonads. It hangs down from the fronds of *Sargassum*, able to detach itself, but without swimming power. As the body has adhesive apparatus at both its extremities, it can effect a locomotion very much like that of a leech.

Very interesting, also, is *Schizodiscus* g.n.—a Lucernarid without mesogonial pouches and without adhesive anchors. The Pelagidæ are enriched by *Kuragea* g.n., the Rhizostomæ (Cepheidæ) by *Microstylus* g.n., and *Perirhiza* g.n.

Porifera.

Studies on Hexactinellids.†—Isao Ijima has studied the old types of *Corbitella speciosa* Quoy Gaimard, *Heterotella corbicula* Bowerbank, and *Eudictyum elegans* Marshall.

Gray's genera *Corbitella* and *Heterotella* should be kept up as distinct, the former to comprise not only Quoy and Gaimard's species *C. speciosa*, but also Marshall's *Eudictyum elegans* as well as F. E. Schulze's *Tægeria pulchra*, and the latter to stand represented by the single original species *H. corbicula* of Bowerbank.

Ijima gives a definition of the Euplectellid subfamily Corbitellinæ, and diagnoses of the species mentioned above.

Protozoa.

Variations of *Nodosaria scalaris*.‡—A. Silvestri discusses, particularly from the systematic side, the occurrence of numerous aberrant forms of this Foraminifer, which cannot be regarded as accidental or teratological anomalies, but seem to be quite definite variations from the type.

Dimorphism of Foraminifera.§—A. Silvestri discusses the marked dimorphism of *Siphogenerina columellaris*, which occurs in a rarer microspheric and a commoner megalospheric form.

Discoloration of the Sea by Dinoflagellata.||—H. B. Torrey describes the occurrence of enormous swarms of a species of *Gonyaulax* at San Pedro, on the Californian coast. The water was red (muddy ver-

* Journ. Coll. Sci. Univ. Tokyo, xvii. (1902) article 7, 17 pp. and 2 pls.

† Tom. cit., article 9, 34 pp. and 1 pl.

‡ Atti Pont. Accad. Rom. Nuovi Lincei, lv. (1902) pp. 49-58.

§ Tom. cit., pp. 101-4 (1 fig.).

|| Amer. Nat., xxxvi. (1902) pp. 187-92 (3 figs.).

million) by day and unusually phosphorescent at night. The redness occurred for at least two hundred miles along the coast, from Santa Barbara to San Diego, and extended several miles to sea. It lasted from July to September. Wherever it was seen the fishermen reported a scarcity of food fishes; the small harbour fishes seemed unaffected, the tiny invertebrates of the plankton were abundant in it, but the general effect was most disastrous. The beach was strewn with dead fishes, crustaceans, holothurians, &c. It seems that *Gonyaulax* produces these harmful effects by dying in enormous numbers, the putrefactive changes thus occasioned polluting the water and giving rise to a horrible stench. It died most rapidly along the water's edge, thus affecting the littoral animals especially. The cause of the extremely rapid reproduction remains obscure.

Infusoria in Cuckoo-Spit.*—O. Zacharias finds that the cuckoo-spit formed by the larvæ of the Cicad *Aphrophora spumaria* is often (especially in June and July) tenanted by large numbers of the ciliate Infusorian *Chilodon cucullulus* Ehrb.—probably carried there by the wind. A minute form of *Monadina* was also present.

Coccidium of Frog's Kidneys.†—A. Laveran and F. Mesnil have worked out the life-history of *Isopora lieberkühni*, a parasite characteristic of the kidneys of *Rana esculenta*.

The frog ingests the sporocyst stages; the sporozoites become free in the alimentary canal, and pass quickly into the vascular system. Thence they pass into the kidneys, where the capillary system is so well developed.

In the kidneys the parasites accumulate in the glomeruli, rupture the delicate boundary which separates capillaries from canaliculi, and become free in the canaliculi. The infection of the renal epithelium is doubtless due to young merozoites, and it seems probable that this intra-epithelial parasitism is not an essential feature in the life-history.

Hæmosporidia of Alpine Birds.‡—B. Galli-Valerio has shown that Alpine birds are in no way exempt from the parasitism of Hæmosporidia. He examined 101 specimens (36 species, 29 genera, mostly Passeres), and found 29 cases (18 species, 16 genera) of infection with Hæmosporidia. But the particular parasites are not identified.

Myxosporidia of Coregonus.§—O. Fuhrmann describes in particular *Henneguya zschokkei* Gurley (= *H. kolesnikovi* Gurley and *Myxobolus bicaudatus* Zschokke) which is the cause of frequent disease in species of *Coregonus*.

* Biol. Centralbl., xxii. (1902) p. 608.

† Comptes Rendus, cxxxv. (1902) pp. 82-7 (11 figs.).

‡ Centralbl. Bakt., xxxi. (1902) pp. 162-5.

§ C.R. Soc. Neuchatel, in Arch. Phys. Nat., xiv. (1902) pp. 172-3.



BOTANY.

GENERAL,

Including the Anatomy and Physiology of Seed Plants.

Cytology,
including Cell-Contents.

Poison of *Lotus arabicus*.*—W. R. Dunstan and T. A. Henry give an account of the chemical and physical properties of the glucoside *lotusin* which they have isolated from this plant. The plant has proved fatal to many domestic animals in Egypt. *Lotusin*, like amygdalin, gives prussic acid as a decomposition product.

Structure and Development.

Vegetative.

Germination of *Carapa guianensis*.†—J. W. Harshberger describes the germination of seeds of this member of the order Meliaceæ. The seeds begin to germinate before they fall out of the capsule. The cotyledons are conferruminate and never leave the seed, and the course of germination is that which is usually observed in the case of seeds containing a large store of reserve material. The protrusion of the radicle is followed by that of the plumule, the stem elongates and develops at first only scale-leaves, and then in succession leaves which gradually assume the character of the adult form. The author contrasts the germination of this species with that of *C. moluccensis* which is a mangrove plant, while *C. guianensis* is a land plant. The germination is somewhat similar in the two cases; the chief difference lies in the formation of a tuber-like radicle and pneumatode in *C. moluccensis* in association with its littoral mode of life.

Peculiar Stages of Foliage in the Genus *Acacia*.‡—C. E. Preston discusses the development of the bipinnate leaf and of the phyllode in species of *Acacia*, and suggests that the appearances described favour Reinke's view of the existence of a great variety in the mode of origin of the phyllode.

Precocious Branching.§—D. G. Fairchild describes the production of an early branch on a poplar, which arose from a wound. The wound had healed and the branch originated near the callus. The author suggests the possible importance of the phenomenon in the production of earlier developing varieties of shade or fruit trees.

Subterranean Organs of Californian Liliacæ.||—A. Rimbach has studied the method of penetration of the soil adopted by various species

* Phil. Trans. B, exciv. (1901) pp. 515-83.

† Proc. Acad. Nat. Sci. Philad., liv. (1902) pp. 122-6 (1 pl.).

‡ Amer. Natural., xxxvi. (1902) pp. 727-34 (10 figs.).

§ Bot. Gaz., xxxiii. (1902) pp. 461-2 (1 fig.).

|| Tom. cit., pp. 401-20 (1 pl.).

of Liliaceæ, all perennial herbs. In species of *Clintonia*, *Prosartes*, and *Fritillaria* the rhizome alone by its movement of growth determines the position of the plant. It grows horizontally and is influenced as to its position by the roots which are not contractile. In species of *Lilium*, *Scoliopus*, and *Trillium*, on the other hand, the roots are contractile and mainly determine the position of the horizontally developing rhizome. In *Zygadenus*, *Chlorogalum*, *Calochortus*, and *Brodiaea* the rhizome develops vertically and the contractile roots determine almost exclusively the position of the plant. In the first seven genera mentioned the roots are of the same kind, but in the last three there is a morphological and physiological differentiation of labour into nutritive and contractile roots. The age of the roots amounts to years in *Clintonia*, *Prosartes*, *Scoliopus*, and *Trillium*, but to a few months only in *Fritillaria*, *Zygadenus*, *Chlorogalum*, *Calochortus*, and *Brodiaea*. Contractility occurs not only in long-lived roots but also, and in a very high degree, in short-lived ones. Long-lived roots assume also the function of storing reserve material, they may be contractile as in *Scoliopus* and *Trillium*, or not contractile as in *Prosartes* and *Clintonia*.

Rejuvenescence as a Result of Grafting.* — L. Daniel describes the result of grafting an herbaceous annual *Scopolia carniolica* on a young tomato plant. *Scopolia carniolica* is one of the earliest spring flowering plants. On May 1st, its aerial shoots, which were beginning to dry up and perish, were grafted on a young tomato which at that time was at the beginning of its development and growing actively. The graft succeeded, and renewed its growth, producing in succession buds and leafy branches, and in one case an inflorescence and fruit. The plants are both members of the same order, Solanaceæ, but belong to different tribes, viz. Hyoseyameæ and Solaneæ respectively. The experiment shows that likeness of habit between stock and graft is not essential to success, and also the possibility of a rejuvenescence of shoots which are already in a state of senility. The operation has moreover profoundly modified the habit of the graft, so that a second flowering has occurred.

Structure of the Wood in Deciduous and Evergreen Trees.† — S. Simon formulates the following results of his investigations in the distribution of tissue in woody plants of the temperate zone. In the case of nearly allied plants growing under the same climatic conditions, the one deciduous and the other evergreen, there is a greater tendency in the former, owing to its more limited period of assimilation, to develop storage tissue. This tendency is checked only when the deciduous plant has some compensating contrivance which acts as a complete or partial equivalent for the evergreen leaf. Corresponding to the less extent of storage tissue is a greater development of mechanical tissue in the evergreen plant. This is correlated with the general xerophytic character of these plants, which for the same reason have less conducting tissue. As regards distribution of tissue, the conducting elements occur fairly evenly throughout the annual ring in evergreen trees, corresponding with the more even distribution of activity

* Comptes Rendus, cxxxv. (1902) pp. 481-2.

† Ber. Deutsch. Bot. Ges., xx. (1902) pp. 229-49 (1 pl. and 3 figs.).

throughout the whole vegetation period. On the contrary, the large conducting elements preponderate in the spring wood in deciduous trees, corresponding with the rapid development of a large leaf area at that season. Similarly the mechanical tissue is also very evenly distributed in the evergreen wood, forming generally the groundwork of the wood. On the other hand, in deciduous trees the mechanical tissue is formed mainly in the autumn wood when the need for conducting tissue is lessened.

Increase in Diameter of Trees.*—A. W. Borthwick has compared results obtained by means of Pressler's increment-borer with those obtained by actual measurements of circumference of trees extending over a series of years. The experiments were carried out in the Royal Botanic Gardens, Edinburgh. The results obtained by the two methods closely coincided. By means of the increment-borer narrow cylinders of wood can be extracted from the tree-trunk and the breadth of the annual rings can then be measured.

Abnormal Secondary Thickening in Kendrickia.†—A. M. Clark describes this process in *K. Walkeri*, a tropical climbing epiphyte belonging to the Melastomaceæ. The anatomy of the young stem is typical of the family. At a fairly early stage numerous small patches and several large wedge-shaped areas of thin-walled unligified wood-parenchyma are cut off from the inner side of the completely circular cambium ring. Later the cells at the central margin of the wedge areas start new growth and cell-division; the product of this growth splits the axial woody ring into a varying number of portions. Later on the quiescent cambium lying between the original internal phloem and the axial woody ring resumes growth and proceeds to form xylem on the one side and phloem on the other.

Pericycle of Angiosperms.‡—J. Pitard has made extensive studies on the evolution and the anatomic and taxonomic value of the pericycle in this group. His communication is divided into five parts:—(1) Historical methods. (2) Evolution of the principal types of pericycle in Angiosperms. (3) General phenomena of the evolution of the pericyclic zone. (4) Taxonomic and anatomical value of the pericycle. (5) Conclusions. As regards the evolution of the pericycle, the author describes five methods by which the zone may follow the tangential growth of the axis, viz.:—(a) By tangential increase in size of the cells often followed by (β) radial division of the cell. (γ) Mere stretching, a tangential increase accompanied by a radial decrease in diameter. (δ) Crushing; the layer becoming flattened and killed by the centrifugal pressure. (ε) Rupture in the sclerenchyma when the zone is a ring of sclerenchyma, as in heterogeneous pericycles where parenchyma alternates with groups of sclerenchyma.

Considerable variation in the radial diameter of the zone may occur at different ages of the axis; and the contour may also become altered during the course of development. As regards function, the parenchymatous cells may contain chlorophyll and be assimilative; later,

* Report Brit. Ass., 1901 (1902) p. 831.

† Tom. cit., pp. 842-3.

‡ Mém. de la Soc. des Sci. Bordeaux, ser. 6, i. (1901) pp. 173-360 (7 pls.).

however, the chlorophyll disappears, starch is deposited, and the layer becomes a reservoir of reserve food-stuff. The cells may also become rich in deposits of tannin and calcium oxalate, i.e. are excretory, and finally, by the sclerosis of the cell-walls, the layer plays an important mechanical function.

The duration of the zone is very variable. It may perish a few weeks after its formation or may remain for many years at the surface of great trunks. There seems little or no relation between the nature of the zone and its duration. The author also discusses the influence of the pericycle on the development of the cortex and the central cylinder. Thus a sclerotic pericycle may offer considerable resistance to the development of bast and be an important obstacle to the formation of vessels. As regards its taxonomic value, the pericycle of the young stem is a character of the first importance, but owing to the modifications to which it is liable in later stages, varying with age and even in one and the same tree, it becomes very difficult to draw conclusions of taxonomic value. As an autonomous zone, from an anatomical point of view, the pericycle does not exist in woody axes even relatively young, nor in many herbaceous stems. It is merely a conception. The study of the evolution of the axis shows this region to be a mixture of elements of the most diverse origin. As a definite tissue also the pericycle has no existence. It is a pseudo-tissue subject to continual additions, destructions, and modifications. Owing to the continual intrusion of new elements the pericycle has no definite limits or contour, and cannot be regarded as "exactly delimiting the position and constitution of the bast."

Reproductive.

Polyembryony in Ginkgo.*—M. T. Cook records a single case of polyembryony from Washington D.C. Two embryos were present, each as complete in every respect as the single embryos except in size; their length was about three-fourths the average length of single embryos.

Histology of the Endosperm.†—W. Gardiner and A. W. Hill have investigated the histology of the endosperm during germination of the seed in *Tamus communis* and *Galium tricornis*. A description with figures of the macroscopic characters of the germination in *Tamus* is given, illustrating the early production of an epicotyledonary tuber in which the reserve materials of the seed are in part re-stored as starch. The thick endosperm walls are, judging from their reactions to stains, probably composed of a reserve cellulose like that described by Gruss from seeds of the date palm and other plants. Connecting threads occur in groups throughout the walls which are unpitted. The progress of the ferment action is centrifugal with reference to the embryo; the ferment which proceeds from the cotyledon along a few of the threads, affects first those walls of the endosperm cells which are in immediate contact with it, and as the cotyledon enlarges *pari passu* with the disorganisation of the endosperm, extends its sphere of action into deeper layers.

* Bot. Gaz., xxxiv. (1902) pp. 64-5 (1 fig.).

† Proc. Cambr. Philosoph. Soc., xi. (1902) pp. 445-54 (1 pl.).

The seed of *Galium tricornis* affords a different type of ferment action. The thick and irregularly pitted walls of the endosperm are richly provided with connecting threads which are usually arranged in barrel-shaped groups. No distinction can be drawn between the groups of threads which occupy the pit-closing membranes and those which occur in thick parts of the walls, since every gradation from one to the other occurs. The walls are apparently composed of a substance of the nature of pecto-cellulose. The progress of the ferment action is not centrifugal as in *Tamus*, as the ferment appears to originate in the endosperm and inwards towards the embryo in a centripetal manner. The relation between the progress of the ferment action and distribution of the connecting threads is not always clear, as in many cases the dissolution of the walls appears to take place without any obvious connection with the threads. The authors conclude that although the ferments can attack and dissolve the thick walls of the endosperm without any necessary relation to the connecting threads, yet that in the initial stages the penetration of the enzyme may be effected by means of the threads which thus afford a means of reaching the internal parts of the wall. Secondly, that the connecting threads are concerned mainly and primarily with the conduction of food and stimuli from the parent plant to the developing embryo and endosperm of the seed, and that any further use to which they may be put during germination must be regarded as only of secondary importance.

Comparative Embryology of the Rubiaceæ.*—F. E. Lloyd formulates the following conclusions from a study of twenty-three species representing nine genera of the Rubiaceæ. The ovules have a single integument and a greatly reduced nucellus, which can be distinguished only at an early age when it forms a cap of a single layer of cells crowning the archesporium. In the Spermaceæ there is, in addition to the integument, a second outgrowth, derived from the funicle,—a strophiole; it contains the vascular supply of the ovules and includes also numerous special excretory cells which become loaded with raphides. Similar cells occur in some Galieæ near the embryo-sac for some time before and after fertilisation; the calcium oxalate may, the author suggests, be of some positive value. *Houstonia* differs from the other genera studied in that each loculus contains a number of ovules, not a solitary one; the ovules are relatively very small and borne on a club-shaped placenta. They have no integument, and the archesporium, which consists of but one functional embryo-sac mother-cell, becomes deeply buried in the nucellar tissue by the growth of the capping cells. The author points out that the belief that a single naked ovule is correlated with the parasitic habit must be rejected. Except in *Houstonia* the archesporium contains 7 to 15 megaspore mother-cells, each of which, except the arrested ones at the side of the archesporium, divides to form four megaspores which are generally not separated by walls. This condition is comparable to that described as occurring in *Eichhornia* and *Avena*. All the megaspores are both morphologically and physiologically equivalent. The author refers to Koernicke's view of the fact that the embryo-sac cell in the great majority of seed plants

* Mem. Torr. Bot. Club, viii. (1902) pp. 1-112 (15 pls. and 11 figs.).

is derived from the lowest megaspore, i.e. the one at the chalazal pole, because the divisions which give rise to the megaspores are such as to give the larger proportion of plasma to that cell owing to its more favourable position with reference to the source of nutriment. This view is supported by the Rubiaceæ in so far that the larger number of megaspores and undivided megaspore mother-cells form a nutritive tissue, surrounding more or less completely the embryo-sac cell which arises near the longitudinal axis of the mass. The fact that in forms in which a pluricellular sporangium is present any or all of the megaspores can develop into embryo-sacs proves their morphological equality, and the regular division of each of the megaspore mother-cells into four must be regarded as a true tetrad division.

The author compares Murbeck's results in *Alchemilla*, where the archesporium is multicellular; some of the mother-cells never divide and never give rise to embryo-sacs, the others divide once or twice, forming megaspores, two or more of which may develop into young embryo-sacs, and in the same sporogenous cell-row two or more may commence their development into embryo-sacs. This is precisely comparable with *Crucianella* in Rubiaceæ. The pluricellular archesporium, which has been shown to occur in widely separated families, has no phylogenetic significance; the meaning is purely physiological. The archesporial tissue not directly concerned in the formation of the embryo-sac takes actively or passively a nutritive rôle, either gradually disintegrating and becoming absorbed, or growing, chiefly in length, and forming a transporting tissue connecting the embryo-sac with the vascular supply of the ovule. The embryo-sac may develop *in situ* or break through the nucellar cells and pass along the micropylar canal, deriving nutriment from the adjacent disintegrating cells. The antipodal cells in the Galieæ are three in number, one being much elongated, its free end plunging into the mass of disintegrating megaspores and acting as an absorbent organ. In *Crucianella* they are short-lived and show no special development. In *Diodia virginiana* there are from 4 to 10, arranged in a long series and physiologically equivalent to the single long antipodal in the Galieæ. The author points out that the form and cytological structure of the antipodals, the changes in their food content, their tending to multiply and form a special conductive or nutritive tissue, supports Westermaier's conclusion that the antipodals form an anatomical-physiological apparatus, and not a useless rudimentary structure which may be understood only from the view of comparative morphology.

The embryo in the Galieæ has a highly developed suspensor, the cells of which elongate laterally, forming haustoria which penetrate between the cells of the endosperm; the suspensor therefore acts as a temporary embryonic root. This condition is analogous to that described by Dickson in *Tropeolum*, where the branches from the base of the suspensor penetrate the pericarp. Similar organs have been described by Treub in Orchidaceæ, and by Hofmeister and Guignard in Leguminosæ. In the Spermaceæ and *Houstonia* there is a complete absence of these adaptive characters; the suspensor is a very simple structure. The peripheral cells of the endosperm, from their cytological character and the behaviour of the adjacent tissues, may be

regarded as secreting an enzyme and absorbing the food derived by digestion of the reserve food-substances in the integument.

During growth of the embryo-sac mother-cell a large number of coarse fibres occur in the cytoplasm, and persist through diakinesis of the first division. The spindle in both pollen and embryo-sac mother-cell is of multipolar origin, and there is no trace of centrosomes. A reduced number of chromosomes appears in the prophase of the first division of the pollen and embryo-sac mother-cells, ten in *Crucianella*, twelve in *Asperula*. These numbers are maintained throughout subsequent divisions. From the mode of division the author concludes that they are true tetrad divisions, and the four resultant cells are spores. The author also refers to the question—at what point in the life cycle does the gametophyte start? The two periods of development have been merged into one another to different degrees in different plants. In extreme cases, as *Lilium*, the gametophyte appears to begin histologically with the embryo-sac mother-cell, and where four spores are produced it may be regarded as an individual by coalescence, having its origin in four like vegetative cells whose primitive function has been lost. As Juel and Murbeck have shown in *Antennaria* and *Alchemilla*, true tetrad mitoses do not occur in parthenogenetically reproduced plants.

In view of the fact that the course of the pollen-tube may be intercellular, or pass through the ovary cavity in related species, the author infers that its behaviour is of no practical significance from the point of view of phylogeny. Chemotropism is assumed to be the important factor in guiding the pollen-tube, and the suggestion is made that the synergidæ are the source of the stimulant.

Development of Ovule and Seed in Rosaceæ.* — F. Péchoutre has studied the development of ovule and seed in a large number of species representing the different tribes of the order. He finds, contrary to the assertions of Baillon, who considers the ovules of most indigenous Rosaceæ to be monochlamydeous, that almost all are dichlamydeous; *Geum*, *Fragaria*, *Potentilla*, and *Alchemilla* alone of the genera studied having only an external integument, the internal being absorbed. The development of the integuments shows great homogeneity throughout the order. The internal originates from four epidermal cells, which generally arise by tangential division of a single epidermal cell, or sometimes of two neighbouring cells. They appear at the level of the base of the nucellar projection, after the differentiation of the embryo-sac mother-cells. The external tegument originates from a subepidermal cell behind and close to the dividing epidermal cell. Later on cell-division extends to neighbouring subepidermal cells and the covering epidermal cells. The external tegument generally appears after the internal. Hence the development of the ovular teguments in Rosaceæ conforms to the rule general to all Dialypetalæ. Even in the most pronounced cases of conerescence there is never any confusion of the initials. The variations which appear depend solely on the relative position of the respective initials. In Pireæ, where a distance of about two epidermal cells separates the initials, the teguments arise as two

* Ann. Sci. Nat., xvi. (1902) pp. 1-158 (166 figs.).

distinct protuberances and remain distinct throughout from chalaza to micropyle. In the *Amygdalæ* two forms occur. In *Armeniaca*, *Persica*, and *Amygdalus* the initial of the external tegument appears behind that of the internal at a distance of about half the length of an epidermal cell. Only one protuberance is formed, but the two integuments, though in contact, remain distinct throughout. In *Cerasus* and *Prunus* the subepidermal cell in which the outer originates immediately precedes the epidermal from which the inner tegument arises. There is a single protuberance in which the two teguments are conrescent; later, however, the external acquires an epidermis of its own, so that in the micropylar region the two teguments are distinct. In the *Spirææ* both the forms found in *Amygdalæ* occur, while in *Spiræa filipendula* the conrescence is complete from chalaza to micropyle. The same complete conrescence occurs in the *Sanguisorbæ* (except *Alchemilla*), in the *Rosæ* and *Rubææ*. In *Alchemilla* and in the *Potentillæ* studied (*Geum*, *Fragaria*, *Potentilla*) except *Dryas*, where there are two integuments, the internal tegument is absorbed, and the ovule is monochlamydeous. The subepidermal initial of the outer tegument is beneath the epidermal initial of the inner. Both initials divide at first in the usual way, but the epidermal cells are carried up by the developing external tegument, and are thus prevented from forming an internal.

The number of layers comprising the two teguments at the time of fertilisation varies considerably from three to ten or more for the outer, and two to four or more for the inner. The time at which the full number of layers is formed also varies. The seed generally being well protected by the pericarp, and sometimes by a receptacular envelope, the modifications undergone by the ovular integuments in their conversion into seed-coats are generally in the sense of a simplification. In all cases with two teguments the inner takes a part, though a feeble one, in the constitution of the seed-coat, sometimes being represented only by a membranous layer without cellular structure, and never showing any sclerosis. The modifications of the external tegument are subject to numerous variations. There is always a more or less abundant albumen applied to, and intimately united with, the inner face of the seed-coat.

The sporogenous tissue always arises from several axial sub-epidermal cells, which divide transversely, the upper forming a transitory tapetum, the lower forming the macrospore mother-cell, which always divides transversely to form three or four daughter-cells, one of which forms the embryo-sac. The primary tapetal cell divides by both transverse and longitudinal walls. In each vertical row all the products of division of the macrospore mother-cell are equivalent in their capacity of forming an embryo-sac. Only one embryo-sac forms in each rank, but several cells belonging to separate ranks may commence development, and one may find in the adult nucellus several perfect embryo-sacs; generally only a single one arrives at maturity. Any one of the daughter-cells in a series may become the embryo-sac; the selection depends apparently merely on mechanical causes. When one of the upper cells is selected, the lower (generally only one) form anticlinal, which show a higher vitality than their sister cells above the embryo-sac, which early become crushed against the tapetal cells.

The epidermis of the nucellus divides to form an epidermal cap above the tapetum. Below the embryo-sac and during its development the nucellus shows several threads of cells extending towards the chalaza, which are crushed and in course of absorption. After fertilisation the nucellus is very slowly absorbed; in the ripe seed of *Pireæ* it is still represented by a narrow layer of crushed cells, and sometimes by a recognisable epidermis.

Development in the embryo-sac immediately following fertilisation is very slow, especially in the *Amygdaleæ*, but when the albumen is formed it is, on the contrary, very rapid. The embryo always has a suspensor, which is massive and short in the *Amygdaleæ*, larger and formed of a double or simple thread in all the other tribes. The lower cells of the suspensor generally make a notch in the radicular extremity of the embryo. In favourable cases (*Pirus*, *Sanguisorba*, &c.), where the limit between the cells of suspensor and embryo is well defined, the suspensor seems to play no part in the formation of the organs of the embryo. The early development of endosperm is uniform throughout the order, commencing with a layer of free nuclei round the sac, which is then transformed into a cell-layer by formation of cell-walls. Later the cavity of the sac becomes filled, the *Amygdaleæ* differing from the rest of the order in that only the upper part of the sac is filled. The nucellus is crushed and generally completely absorbed by the albumen, which is in turn in great part absorbed by the embryo. A portion of the albumen always persists, though variously distributed around the seed. The outermost layer is always remarkable by its abundant proteid contents, but only in *Rhodotyppus*, where the greatest quantity of albumen is found, does it show marked differential characters from the rest of the albumen. Owing to the generally small development of albumen, and its intimate association with the seed-coat, the author considers its function to be protective rather than nutritive. In contrast with the passive and mechanical protection afforded by the seed-coat, it supplies an active physiological protection regulating osmotic exchanges and preventing the intrusion of germs.

The author considers that the ovule and seed show variations which support the subdivision of the *Rosaceæ* into a number of distinct families.

Existence of a Hypostase in the Ovule and Seed of *Rosaceæ*.*—Ph. Van Tieghem refers to his discovery of a small structure in the pistil of seed-plants below the female prothallus, the object of which is to arrest towards the base the longitudinal growth of the prothallus, and which he calls the hypostase. It consists generally of a cupule of isodiametric cells which have strongly lignified but not much thickened membranes. When the pistil is inovulate, whether a nucellus is present or not, it forms in the parenchyma of the carpel a single structure common to all the female prothalli. When the pistil is ovulate, whether the nucellus is permanent or transitory, it forms in each ovule a small individual hypostase. Owing to its strong lignification it resists all the various diastatic agencies which are at work during formation of embryo and albumen; and for the same reason is incapable of growth. Hence

* *Ann. Sci. Nat.*, xvi. (1902) pp. 159-60.

it appears in the ripe fruit exactly as it was in the pistil, but being relatively much smaller is difficult to perceive. In the Perpariceteæ, it sometimes occupies a more or less elevated position in the persistent nucellus. By arresting the basal development of the albumen it protects from destruction the region of the nucellus between itself and the chalaza: this region is found in the ripe seed intercalated between the tegument and the albumen, or the tegument and the embryo. Hence in these cases there is a more or less voluminous perisperm. The author insists on the necessity of looking for the hypostase and the perisperm in future studies of pistil and ovule, and complains that M. Péchoutre has, in the preceding memoir on the Rosaceæ, a member of the group Perpariceteæ, completely ignored its existence. M. Van Tieghem asserts that he has himself observed it in a good number of cases situated sometimes at the very base of the nucellus, sometimes higher up in its mass. He gives as a special case the strawberry, in which the little woody cupule can be seen immediately beneath the endosperm, and below it a small disc of rudimentary perisperm.

Development of Flower and Embryo of *Spiræa*.*—J. E. Webb has studied the organogeny of the flower and the development of the embryo mainly in *Spiræa japonica*. He finds that the members develop in the following order:—sepals, inner stamens, carpels, outer stamens, and finally petals. The microsporangia are mature before the megasporangia. In the former there is never any trace of archesporial cell or plate. The peripheral layer of the hypodermal cells divides periclinally to form two cell-layers, below which is a tapetal layer. The tapetum is merely the outer layer of the sporogenous mass, and is distinguished from the sporogenous cells merely by its position and nutritive function. The author remarks that, although such an explanation of the tapetal layer is impossible for many microsporangia, e.g. *Cnicus*, yet its possibility has been suggested by Coulter in *Ranunculus*. By gradual changes the tapetal is clearly differentiated from the spore-mother-cells, to form a thick surrounding layer rich in food material. The inner of the two layers between tapetum and epidermis is absorbed by the tapetum for the benefit of the sporogenous tissue, and the tapetum itself becomes ultimately disorganised and absorbed. The outer of the two layers becomes the endothecium with large cells and thickened walls. In the megasporangia, at a very early stage, several hypodermal cells at the tip become enlarged, to form a mass of archesporial cells comparable to that found in *Rosa livida* by Strasburger. By periclinial divisions a hypodermal tapetal mass becomes separated from an inner sporogenous mass. Successive periclinial divisions in the tapetum add much to the length of the ovule and the distance from the sporogenous tissue to the epidermis, and periclinial divisions in the latter also add to the length of the ovule. Usually, one only of the megaspore-mother-cells enlarges for division, but often two or three begin to divide and then all but one break down. The successful megaspore is the one nearest the chalazal end of the sac. It is very seldom that a megaspore nearer the micropyle shows any signs of reaching maturity. The embryo-sac follows the normal course of development, and at an early stage there occurs a

* Bot. Gaz., xxxiii. (1902) pp. 451-60 (28 figs.).

thickening of the cells in the chalazal region adjacent to the megaspore. The development of the embryo is regular and normal; the suspensor, unlike that of Leguminosæ but in accordance with typical illustrations, consists of a single row of cells. Their function is evidently to direct the food supply derived from the embryo-sac to the embryonic root region.

Physiology.

Nutrition and Growth.

Influence of Varying Amounts of Carbon Dioxide in the Air on Photosynthesis and Plant Growth.*—H. T. Brown and F. Escombe show that a living leaf is able within certain limits to respond to increased amounts of carbon dioxide in the surrounding air, in such a manner as to indicate an approximate proportion between the photosynthetic work and the partial pressure of the gas. But further experiments show that this power of responding to increased amounts of carbon dioxide is not correlated with increase in dry weight of the plant. The leaf area of plants grown for a long period in excess of CO_2 was generally much reduced in comparison with control plants grown in a normal atmosphere, and in many cases there was a marked inward curling of the leaves. The excess of CO_2 in several cases induced a deeper green colour; and the leaves showed a much larger accumulation of starch than in those of the control plants. The most striking differences were in the development of the reproductive organs; flowering was almost entirely inhibited on plants exposed to air containing 11.4 parts per 10,000 of CO_2 . Hence it is evident that the transformation, translocation, and general metabolism of the leaf-reserves under the altered conditions cannot keep pace with the increased tendency to produce an extra amount of plastic material from the atmosphere. The slight increase in the amount of CO_2 in the surrounding air which favours increased photosynthesis, destroys the adjustment of the various parts and results in a more or less abnormal development of the plant, the reproductive functions being especially modified. The authors suggest that the facts recorded by them indicate that the composition of our atmosphere, as regards the carbon dioxide, has remained practically constant for a long period.

J. B. Farmer and S. E. Chandler † have made a comparative study of the internal structure of the plants of several species used by Brown and Escombe in the above experiments. They find that the results which follow an increase in the amount of carbon dioxide normally present to about three and a half times the amount are as follows:—

- (1) Growth of the internodes is checked, and the period of growth as measured by the elongation of successive internodes is lengthened.
- (2) Growth in surface of the leaves is arrested at a more or less early stage.
- (3) The absolute number of stomata per unit area of leaf surface is considerably increased, largely or entirely as the result of the non-attainment by the epidermal cells of their normal size. The guard-cells,

* Proc. Roy. Soc., lxx. (1902) pp. 397-412 (6 pls.).

† Tom. cit., pp. 413-23 (5 figs. in text).

however, do not diminish, and are found to be gorged with starch; the stoma remains open. The relative proportion of stomata to the number of epidermal cells in a given area remains approximately constant in the two cases.

(4) The anatomical structure of the internal tissue of the leaves is not materially altered.

(5) The anatomical structure of the stem usually differs in the direction of the formation of less lignified xylem elements, fewer vessels, and often also in the imperfect development of mechanical tissue. The phloem shows no alteration. No alteration could be detected in the roots.

Duration of Germinating Power of Seeds.*—Jules Poisson cites certain observations which point to the retention of germinating power for many years in marsh plants. In these cases the seeds have been able to resist the action of moisture which is generally found to be prejudicial to the retention of germinating power.

Irritability.

Nature of the Stimulus causing the Change of Form and Structure in an Amphibious Plant.†—W. B. McCallum has tried to ascertain the real factors which determine the type of leaf produced by heterophyllous water plants. The subject of his experiments was *Proserpinaca palustris*, which grows in low swampy places usually flooded in spring and early summer, and subject to occasional submergence throughout the season. He has studied seriatim as far as possible the effects of each external factor, and concludes that the stimulus to the development of the water form is not involved in the light relation, in the nutritive conditions, temperature, the gaseous content of the water, nor the contact stimulus of the water. The only factor which is constant in all cases where the water form develops is the checking of transpiration, and the consequent increased amount of water in the protoplasm. When the latter is in that condition of dilution which accompanies the absorption of a large amount of water, the nature of the growth is such as to produce the water form, while those physical and chemical conditions resulting from a partial withdrawal of water by evaporation (i.e. an increased density of the protoplasm) result in the production of the aerial form.

Electrical Conductivity of Plant Juices.‡—F. D. Heald describes apparatus and methods for the determination of the above. He finds as the result of examination of the beet, potato, onion, radish, and four other species, that plant juices are good conductors, the conductivity being due largely to the dissolved mineral substances, while the organic compounds play a minor part. The specific conductivity of the juice obtained from the roots is always considerably less than that of the juice from subaerial parts. The specific conductivity generally increases progressively from the root upward, although in some cases the sap from the stem has a higher conductivity than that from the leaves. In the majority of cases the specific conductivity is a rough measure of the relative amounts of ash present in different parts of the plant.

* Comptes Rendus, cxxxv. (1902) pp. 333-5.

† Bot. Gaz., xxxiv. (1902) pp. 93-108 (10 figs.).

‡ Tom. cit., pp. 81-92 (2 figs.).

Chemical Changes.

Enzymes of the Tea-leaf.*—H. H. Mann has investigated the nature of the changes which occur during the preparation of the tea-leaf and comes to the following conclusions:—(1) That an oxidase occurs in the leaf. (2) That this oxidase is the chief agent in bringing about the fermentation and colouring of the leaf. It is most active below 55° C. and is destroyed about 80° C., is very sensitive to acids and also to alkalis, but not to quite the same extent. There is distinct evidence that part of it usually occurs as a pro-enzyme in the leaf. (3) That it occurs in greatest quantity in the unopened tip-leaf of the shoot, and that the quantity decreases as the leaves get older, but that the stalk contains at least the same amount as the tip-leaf. (4) That leaf which contains the most enzyme makes the most highly flavoured tea. The increase of enzyme in the leaf seems in some way connected with the amount of phosphates in the soil. (5) The amount of enzyme in the leaf materially increases during withering, a fact which throws a new light on the nature of the process, and makes it probable that the enzyme performs much more important functions in the manufacture than has hitherto been supposed. Other enzymes occur in the leaf, but there is at present no evidence that they play an important part in tea manufacture.

General.

Liparis Loeselii and *Teucrium Scordium*.†—A. Bennett gives notes of the occurrence and distribution of these two East Anglian marsh plants, which are becoming gradually rarer as drainage and cultivation extend.

Variations in Perianth of *Ranunculus Ficaria*.‡—W. A. Nicholson gives a table of statistics showing the variation in the numbers of the sepals and petals in 2116 flowers of *R. Ficaria* from Norfolk, and works out the standard deviation from the mean by the method recommended by Prof. Pearson. That for the sepals is 0·4776, for the petals 0·9538. He finds that as the sepals increase the petals decrease in number.

Albinism in Plants.§—E. Pantanelli publishes some researches into the meaning of albinism in plants. After reviewing the papers of previous authors he proceeds to the anatomical side of the subject, and considers first the relation between the white patches and the nervation and deformation caused by albinism; and secondly, the distribution of the chromatophores in the white leaves. He has studied some eighteen species. In summing up his results he finds that the diversely coloured areas are always bordered by nerves; that the palisade cells are the first to turn white; that the thickness of the leaf is usually as great in the white patches as in the green; that the distribution of the chromatophores is subject to great specific variation; that in white patches the chromatophores are absent, in yellow patches they

* Journ. Asiat. Soc. Bengal, lxx. pt. ii. (1902) pp. 154-66.

† Trans. Norf. and Norw. Nat. Soc., vii. (1902) pp. 333-8.

‡ Tom. cit., pp. 379-82.

§ Malpighia, xv. (1902) pp. 363-415 (1 pl.).

are present, and it is only in yellow patches that recovery of the green colour can occur in old age; that where the chromatophores do occur they are smaller than usual.

British Dye-plants.*—C. B. Plowright has examined and tested the tinctorial properties of about 70 plants, using only the simpler mordants (such as alum, ammonia, iron sulphate, &c.), with a view of ascertaining what shades and colours were available for former inhabitants of our islands. About 150 different shades were produced, all essentially sombre in hue. The author gives a list of the plants and the results obtained in each case.

Relationships of American and Old World Birches.†—M. L. Fernald after a comparative study of the North American and old world forms of *Betula*, concludes that some forms hitherto regarded as endemic in the new world are identical with old world forms, thus emphasising the community between the floras of the eastern and western north temperate areas.

CRYPTOGAMS.

Pteridophyta.

Pollen and Male Prothallia from the Coal Measures.‡—B. Renault gives figures and descriptions of various preparations on which he bases the following conclusions. Many pollen-grains of the coal period contained a male prothallium perfectly well defined, the compartments in which enclosed the antherozoid-mother-cells. This prothallium might send out a pollen-tube as in *Stephanospermum*, or allow the antherozoids to escape directly into the pollen-chamber as in *Ætheotesta*. In cases where the grain was too large to penetrate the micropylar canal to the pollen-chamber, it threw off its extine, and the prothallium penetrated alone; the perforations in the cell-walls allowed the antherozoids to pass into the pollen-chamber, into which the necks of the archegonia opened.

Fossil American Ferns: Fertile Fronds of *Crossothea* and *Myriothea*.§—E. H. Sellards describes fertile fronds of species of these Carboniferous ferns from Mazon Creek, Illinois. He points out that although both genera are included by Zeiller in the Marattiaceæ, the large size of the spores and the comparatively small output to the sporangium are characters not met with in the living representatives of that group. The position of the sporangia is also unusual. He also examined spores from a large number of fronds of two species of *Pecopteris* from the same locality and finds no indication of heterospory, and does not accept Renault's suggestion of the existence of this condition in the genus.

The same author,|| as the result of examination of additional material, concludes that Lesquereux's fern genus *Idiophyllum* is merely a synonym of *Neuropteris rarineris* Bunt.

* Trans. Norf. and Norw. Nat. Soc., vii. (1902) pp. 383-94.

† Amer. Journ. Sci., xiv. (1902) pp. 167-94 (2 pls.).

‡ Comptes Rendus, cxxxv. (1902) pp. 350-3 (7 figs.).

§ Amer. Journ. Sci., xiv. (1902) pp. 195-202 (1 pl.).

|| Tom. cit., pp. 203-4 (2 figs.).

"Structure and Affinities of Dipteris.*—A. C. Seward and Elizabeth Dale give a general account of the synonymy and characters of the four species of this genus, which is mainly of Indian and Malayan distribution. They also give an elaborate description of the anatomy of rhizome, root, and leaf in *Dipteris conjugata*, and then proceed to a discussion of the systematic position of the genus. "The anatomical features, taken in conjunction with the sporangial characters and the characteristic form and venation of the fronds, afford ample reasons for the removal of the genus from the Polypodiaceæ, and its inclusion in a separate family, of which it represents the solitary surviving type." The family had a wide European distribution in the early Mesozoic period. The authors give a tabular account of the distribution in space and time of the probable members of the Dipteridinea.

Danish Pteridophyta.†—C. Christensen publishes a revised list of the Danish Pteridophytes, with a few critical notes. He recognises 46 species.

Brazilian Ferns.‡—H. Christ concludes his study of the ferns of South Brazil and treats of the species falling under the following genera—*Osmunda*, *Gleichenia*, *Schizæa*, *Aneimia*, *Danæa*, *Ophioglossum*, *Botrychium*, *Lycopodium*. The total number of species in the paper is 288. Eight of these are described as new in the concluding instalment, and with them are some new varieties.

Hybrid Origin of *Asplenium ebenoides*.§—M. Slosson has been endeavouring for some years to obtain plants of *Asplenium ebenoides* by experimenting with the prothallia of *A. platyneuron* and *Camptosorus rhizophyllus*, and has now obtained young plants so like those produced naturally that she claims to have proved her case. She describes the methods followed in dealing with the prothallia and the precautions adopted.

Nature of the Stele of *Equisetum*.||—D. T. Gwynne-Vaughan finds that the usual comparison of the vascular bundles of *Equisetum* with those of a monostelic phanerogam cannot be satisfactorily maintained. The xylem of the so-called vascular bundle of *Equisetum* consists of three strands, two of which are lateral and cauline, while the median or carinal strand is common to stem and leaf. The fact that only a small part passes out as a leaf-trace, and not the bundle as a whole, is an essential point of difference from the bundle of a seed-plant. The development of the tracheids in the leaf-trace and the carinal strand are not exarch but endarch or perhaps slightly mesarch on the adaxial side. The lateral strands are differentiated later than the carinal strand, but do not seem to be a continuation of its centrifugal development. It is suggested that the lateral xylem strands in the vascular bundles of existing *Equisetums* may perhaps be taken to represent the last remnants of a primitive central mass, and that this

* Phil. Trans. B, exciv. (1901) pp. 487-513 (3 pls.).

† Bot. Tidskr., xxiv. (1902) pp. 369-76.

‡ Bull. Herb. Boiss., ii. (1902) pp. 689-708.

§ Bull. Torr. Bot. Club, xxix. (1902) pp. 487-95 (with figs. in text).

|| Rep. Brit. Ass., 1901 (1902) p. 850.

would be entirely in agreement with their apparently centripetal development and in particular with their cauline course.

Mosses.

Leaf-Anatomy of the Leucobryaceæ.*—J. Carlot publishes the results of his researches into the anatomy of the Leucobryaceæ and illustrates them with 19 plates containing abundant sketches of leaf sections. The transverse section of the leaf is an all-important character of both species and genus. It varies according to the height at which it is taken in a given leaf, but this variation is constant in a given species, and hence is of systematic importance. The author claims that he has put our knowledge of the leaf-structure on a firmer footing; that Lindberg's view that the leaf of *Leucobryum* is chiefly composed of an expanded nerve is correct; that the affinities of the Leucobryaceæ are with the Dicranaceæ on the one hand and with *Syrphopodon* on the other; that the anatomical characters of the leaf afford natural and satisfactory means for discriminating the genera. He divides his subject into four tribes:—Leucobryeæ, Leucophaneæ, Octoblephareæ, Arthrocormeæ—according to the elements composing the cross-sections of the leaves; and the genera comprised are:—I. *Ochrobryum*, *Schistomitrium*, *Cladopodanthus*, *Leucobryum*; II. *Leucophanes*; III. *Cardotia*, *Octoblepharum*; IV. *Arthrocormus*, *Exodictyon*.

British Moss Flora.†—W. E. Nicholson notes the occurrence in Britain (near Crowborough in Sussex, and Bedgbury Park Woods, Kent) of *Ephemerum stellatum*, a moss hitherto known only from France. The author gives a description and figure, and refers to the species as "perhaps the smallest of all British mosses."

Mosses of Jutland.‡—A. Mentz discusses the nature and composition of the moss vegetation of the heaths and bogs of Jutland. The paper is in Danish. A bibliography is appended.

European Species of Sematophyllum.§—Elizabeth G. Britton discusses the synonymy of this genus, its European species, and the geographical distribution of the latter.

Preliminary List of Montana Mosses.||—R. S. Williams gives a list of species collected between 1886 and 1897 in various portions of the State chiefly in the Missouri watershed. A new species of *Dicranum* and of *Barbula* are described.

Species Hepaticarum.¶—F. Stephani resumes his revision of the hepatics of the world by issuing the first half of the difficult genus *Plagiochila*. In an introduction he discusses the importance of the leaves and especially of the leaf-base as characters in the classification of the species. Coming to the species, he enumerates and classifies

* Mém. Soc. Nat. des Sci. Nat. et Math. de Cherbourg, xxxii. (1901-2) pp. 1-84 (19 pls.).

† Journ. Bot., xl. (1902) pp. 337-8 (1 pl.).

‡ Bot. Tidsskr., xxiv. (1902) pp. 303-22 (5 figs in text).

§ Journ. Bot., xl. (1902) pp. 353-5.

¶ Bull. New York Bot. Gard., ii. (1902) pp. 351-80 (6 pls.).

¶ Bull. Herb. Boiss., ii. (1902) pp. 657-88 (with 6 figs. in text).

121 from tropical America, all belonging to the section *Patulæ*, and 52 of these he describes in full. There are 27 new species.

Petalophyllum Ralfsii.* — S. Sommer, who previously discovered the rare British hepatic *Petalophyllum Ralfsii* in the Tuscan island Pianosa, has found it again on the mainland of Italy between Monte Argentaro and Orbetello, being led to search for it closely through noticing that the soil and plants (especially *Ophioglossum lusitanicum*) were just such as conceal the plant on the island of Pianosa.

Siamese Hepatics.† — F. Stephani describes four new hepatics and names thirteen other species collected in the island of Koh Chang in the Gulf of Siam by the Danish expedition (1899–1900).

Riella cultivated from dried Mud.‡ — M. P. Porsild describes a new species of hepatic—*Riella Paulsenii*, cultivated from spores in dried mud brought from brackish lakes in Bokhara in central Asia, two years previously. The genus is remarkable for its submerged existence, its structure, rarity, and distribution. The author institutes a new sub-genus, *Trabutiella*.

Hepatics of Puerto Rico.§ — A. W. Evans describes fully and figures the four species of *Leptolejeunea* found in the island of Puerto Rico. These are minute and epiphyllous. The author carefully compares the genus with its ally *Drepanolejeunea* and brings out the points of difference. He includes an account of the vegetative reproduction.

Priority of the Name *Calypogeia*.|| — E. Levier discusses the history and systematic values of the debated generic names *Calypogeia* Raddi (1818), *Kantia* [or *Kautius*] S. F. Gray (1821), *Cincinnulus* Du Mortier (1822), and *Gongylanthus* Nees (1836). Appealing to Raddi's clear description and figures of the original species *Jungermannia calypogeia* in 1808—the earliest demonstration of a subterranean marsupiod perichæetium in a hepatic, he claims this species to be the type of Raddi's genus *Calypogeia*, under the later name *C. fissa* Raddi (1818), and approves Nees' transference of Raddi's two other species to *Gongylanthus*. As to *Kantia* Gray and *Cincinnulus* Du Mort., he finds them to be unwarranted, though the former was revived by Lindberg—in inadequate grounds.

Algæ.

1 Coccospheres and Cocoliths.¶ — H. Lohmann publishes the results of his researches on these organisms and adds much to what had previously been known on the subject. His paper is divided into six sections, preceded by a general introduction. Section I. deals with the history of Cocolithophoridae, as the group is here termed, with the literature and views already published; it is divided into several subsections; II. deals with the structure of the cell and of the two coverings, gelatinous and calcareous; III. the reproduction and development; IV. the

* Bull. Soc. Bot. Ital., 1902, p. 73.

† Bot. Tidsskr., xxiv. (1902) pp. 277–80.

‡ Tom. cit., pp. 323–7 (3 figs. in text).

§ Bull. Torr. Bot. Club, xxix. (1902) pp. 496–510 (3 pls.).

|| Bull. Soc. Ital., 1902, pp. 92–8.

¶ Arch. f. Protistenkunde, i. (1902) pp. 89–165 (3 pls.).

systematic position; V. the classification; VI. the distribution, occurrence, and significance, including the author's methods of capture, preservation, and examination.

This author regards Cocospheres as true Flagellatæ, probably forming a family in the division Chrysomonadina. He shows that the name *Coccosphæra* must be dropped as having been previously used for another organism; and he therefore proposes instead the name *Coccolithophora*. His method of capture of these minute bodies is most ingenious. Hitherto nets have been used of the finest silk gauze, but Lohmann catches them by means of the filtering apparatus of species of *Appendicularia* which feed on them. An examination of the carefully constructed apparatus provided by nature in these organisms has revealed a large number of species of Coccolithophoridæ which were small enough to slip through the finest meshes of a net, and the author has thereby been able to form satisfactory estimates as to their distribution and occurrence. It has also been possible to study their minute structure in a manner unknown before, and the results are given in section II. The work was carried on in the Mediterranean, and the author shows that these organisms are much more common in the upper layers of the sea than had been supposed. As regards the systematic treatment, the author divides them into two main groups: Syracosphærinæ having unperforated Coccoliths, and Coccolithophorinæ with perforated Coccoliths. Five new genera are described and seventeen new species.

Plankton of Alpine Lakes.* — Carl v. Keissler has continued his investigations on the plankton of the Aber- or Wolfgang-See in Salzburg. The author gives a list of both the phyto- and zoo-plankton met with in the lake from June to September. The Chlorophyceæ number five, among which *Botryococcus Braunii* Kütz. is described in some detail with the aid of a plate; the diatoms number fourteen; the Schizophyceæ present include four forms, among which a new variety *Chroococcus minor* Naeg. var. *dispersus* is described and figured as a new variety; the phyto-plankton further includes three Peridineæ and six Flagellata. Of the zoo-plankton, two Protozoa, five Rotatoria and six Crustacea are mentioned. Tables are given, indicating the relative number of the forms at various times of the year, and also comparing the plankton of this lake with that of two other Alpine lakes, the Neuenberger See and the Ottersee, for the months of August and September. Tables are also provided to show the vertical distribution of the various organisms, and also the total quantity of plankton present at various depths.

Pond Plankton.† — In May 1898 a pond in the palm-garden at Frankfort a. M. was seen to be coloured a deep green, and Otto Zacharias found that this was caused by the excessive multiplication of a desmid, *Polyedrium papilliferum* var. *tetragona* Br. Schröder. The cells were 12 μ long and about the same breadth, except at the girdle where they measured 8 μ . There was also with it a small quantity of *Scenedesmus opoliensis* Richt. and *Synedra delicatissima* W. Sm. In July of the same year the author found a similar luxuriant growth of cœnobia of *Pediastrum boryanum*, which gave a light green colour to the water of a

* Verhandl. k. k. zool.-bot. Gesell. Wien, lii. pp. 305-27 (1 pl. and 1 text fig.).

† Biol. Centralbl., xxii. (1902) pp. 535-6.

pond at Marburg. These cells measured 25–45 μ in diameter. Associated with this species was *Synedra acus* Grun.

Diatoms of Lake Cotronia.*—Matteo Lanzi finds that the species most abundantly represented belong to *Cyclotella*; then follow *Cocconeis* and *Synedra*, *Colletonema* and *Cymbella*. More rarely are found species of *Navicula*, *Pleurosigma*, *Surirella*, and *Cymatopleura*, *Achnanthes lanceolata*, *Campylodiscus*, and *Odontidium*.

Phyto-plankton of the Erlaufsee, and the Caspian Sea.†—V. Brehm and E. Lederbauer record *Anabæna flos aquæ* Bréb., *Ceratium hirundinella* Müll., *Asterionella formosa* var. *gracillima* Grun., *Tabellaria fenestrata* var. *intermedia* Grun., and *Botryococcus Braunii* Kütz. The phyto-plankton of this lake is much more rarely to be found than the zoo-plankton, and there is no one form which occurs sufficiently often in the nets as to be in any way characteristic. The least rare form is *Ceratium hirundinella*, which is not found below 5 m.

C. H. Ostenfeld ‡ gives the result of his examination of plankton collected in the Caspian Sea by the Danish Expedition to Central Asia. The three samples taken showed that a similarity exists between the phyto-plankton of the Caspian and that of the Baltic, but that endemic species constitute the larger part. The following new species and varieties are described:—*Amphorella borealis* var. *caspica*, *Diplopsalis caspica*, *Gonyaulax Clevei*, *Exuviella cordata*, *Chaetoceras caspicum*, *C. delicatulum*, *C. Paulsenii*, *C. rigidum*, *C. simplex*, *Anabæna caspica*, *Oocystis socialis*.

Diatoms of the River Olona.§—Benedetto Corti publishes a list of the diatoms found by him in this Italian river. Some years ago he published a paper 'On the Terraces of the Olona,' and the subject made him desirous of studying the fossil diatoms of the terraces. His researches among certain strata were without any but a negative result. He was then led to examine those still living in the river, and found 58 different species, of which he gives a list. In the glacial peat of the Olona he had found 18 species, and of these only three are found among the species still living in the river—*Cocconeis helvetica* Brun., *Gomphonema acuminatum* Ehr., and *Cymbella lanceolata* Ehr. The marked difference of species between the fossil and the living diatoms of the same region is, in the author's opinion, of importance for the micropalæontologist.

Diatoms in Agar-Agar.||—E. Senft gives a short list of the diatoms most commonly found in agar-agar, after the substance has been calcined and reduced to a white ash and then treated with hydrochloric acid. Four species of *Grammatophora*, *Arachnoidiscus ornatus* Ehr., species of *Cocconeis*, especially *C. scutellum* and its variety *parva*, and *Campyloneis Grevillei* Grun. are the species which the author regards as characteristic.

* Atti Pont. Accad. Rom. d. Nuov. Line., lv. (1902) pp. 145–7.

† Verh. k. k. zool.-bot. Gesell. Wien, lii. (1902) pp. 388–402.

‡ Vedensk. Medd. Naturhist. Foren. Copenhagen, 1901, pp. 129–39 (10 figs. in text)

§ Rendiconti Real. Ist. Lomb., xxxiv. (1901) pp. 764–7.

|| Zeitschr. f. angew. Mikr., viii. (1902) pp. 85–8 (9 figs. in text).

Extrusion of Gametes in *Fucus*.* — George J. Peirce gives the result of his experiments in connection with the fruiting tips of *Fucus evanescens* Ag. He shows that the gametes effect their escape from the conceptacles while still under water; and the contraction of the external cells of the thallus, as a result of being left half dry at low tide, is not necessary to the ejection of the sexual organs, though such contraction may hasten the process. The extrusion of the gametes is effected by mechanical pressure which is developed within the plant, and the contraction and compression as a result of drying merely supplement this pressure.

The Genus *Trentepohlia*.† — F. Brand treats of the structure of *Trentepohlia* under various headings and compares his own results with those of previous writers. The sections of his paper are entitled Cell-wall, Cellulose caps, Cross-walls and Pore-formation, Growth and Branching, Sporangia, Physiological and biological conditions, Polymorphism, Method of preparation and staining, and New forms. Under "Cell-wall" the author refers to the characteristic roughnesses on the outer wall of mature cells and to the lamellate structure of the walls. In the main he is able to confirm the statement of Correns concerning the formation in *T. iolithus* of funnel-shaped lamellæ. He finds the same thing in his new species *T. Negeri*.

The development of the cellulose caps has been traced by the author from an early stage, and they are shown to be the remains of dead terminal sporangia or of end cells. The manner of their formation is described.

The cross-walls of *Trentepohlia* are said to arise without preliminary thickening or folding, and it is impossible to detect any division of the cross-wall into layers such as is commonly seen in *Cladophora*—the septum is simple. As regards the pores in the cross-walls, the author quotes the results of Karsten and others, and gives his own experience on dried material; he hopes that comparative examination on living plants may lead to interesting results with regard to delimitation of species. The growth of *Trentepohlia* is unlimited, although it may appear to be terminated by the formation of sporangia, for after the shedding of the spores the basal cell of the sporangium grows up through the empty sporangium to form new vegetative shoots or reproductive cells. The method of branching is fully dealt with.

The sporangia may arise from the base of the plant or on the filaments, and in the latter case they may be either terminal, intercalary or grow from the side of the filament. The form of the sporangium may also vary, being either round, bottle-shaped, or hooped; and the author describes here a new shape which he has found on a new species, *T. annulata*. This he describes as having funnel-shaped sporangia, which when ripe are obliquely oval and are distinguished from the round sporangia by having two short, funnel-shaped rings of cellulose close to each other, between the sporangium and the stalk-cell. The author was unable to study the development of these rings as fully as he could have wished owing to lack of fresh material.

The section containing the author's views from a biological stand-

* Torrey, ii. (1902) pp. 134-7.

† Beih. z. Bot. Centralbl., xii. (1902) pp. 200-25 (1 pl.)

point deals with the effect of outside influences on the growth of the plant and the distribution of its spores. The round sporangia are said by Karsten to flourish most in damp surroundings and the hooked sporangia to prefer the air, and this author finds that species bearing round sporangia grow more constantly on vertical surfaces, those with hooked or funnel-shaped sporangia preferring a horizontal surface. He adds that further study on these points is to be desired.

Under Polymorphism the author deals with the changes in form brought about in the same species by varying conditions, and deprecates the view that a change in the outward form of the sporangia indicates a transition from one species to another. His method of preparation in examining dried material is given and the effect of various reagents on the specimens.

Two new species are described, *T. Negeri* from Chile and *T. annulata* from Bavaria; and a new form *punctata* of *T. aurea* Mart., found near Partenkirchen in Bavaria. A list of literature on the subject is given.

Chondrus crispus.* — Otto V. Darbishire publishes a detailed account of this alga, containing all that had been previously known about it, together with the results of his own observations. In the Introduction, methods of collecting algæ are described, and instructions are given concerning their preparation for the herbarium and the Microscope. Then follows a section devoted to the external morphology, anatomy, and histology of the vegetative organs, physiology of the vegetative organs, the reproductive organs, and ecology. Concluding remarks contain a full diagnosis of the plant. The author succeeded in germinating tetraspores of *C. crispus* on small strips of parchment paper, which were first soaked in running water in order to remove any acid present. These strips were laid at the bottom of small glass troughs, filled with fresh filtered sea-water, and kept cool in a fairly dark place. On these strips was placed a fresh plant bearing a nemathecium. The tetraspores escaped on to the parchment, and it was then possible to observe the stages of germination by placing the parchment, with certain precautions, under the Microscope.

In the section headed Ecology the author gives the results of his investigations as to the vertical distribution of certain species of marine algæ in Port Erin Bay.

The Genus *Halimeda*.† — Ethel S. Barton gives here a structural and systematic account of this genus. It is shown that the manner of communication between the filaments of the central strand of the thallus forms a good specific distinction, and the author is thus enabled to reduce the number of species from twenty-one to seven. Certain of the former species represent types of variation within the limits of one species. Communication takes place between the filaments of the central strand when these reach the apex of a joint or internode; this communication may take place either by means of large open pits in the walls, or the filaments may fuse in twos or threes. In order to ascertain the manner of communication it is necessary to decalcify the apex of a

* Liverpool Mar. Biol. Committee Memoirs, ix. (1902) pp. viii. and 42 (7 pls.).

† Siboga Expeditie, Monogr. lx. (Leiden, 1901) 32 pp. (4 pls.).

joint in Peronyi's fluid; and, if the filaments are not then sufficiently clear, the preparation may be treated with eau-de-Javelle and stained.

Japanese Marine Algæ.*—K. Okamura continues his illustrations of the marine Algæ of Japan. The author describes and figures the cystocarps and tetraspores of *Lomentaria catenata* Harv., and shows that it is a distinct species related to *L. articulata* Lyngb. A new species, *Phacelocarpus japonicus*, is described. The cystocarps and tetraspores are axillary and pedicellate, and the species is placed in the sub-genus *Euctenodus*, near *P. Labillardieri*. Another new species, *Cutleria cylindrica*, is interesting as showing a new type of structure for the genus; the symmetry is radial, instead of bilateral. *Cladophora Wrightiana* Harv. is described and figured; and the last plate is of *Rhipidiphyllon reticulatum* (Ask.) Heydr. Comparisons are drawn between *Anadyomene*, *Microdictyon* and *Rhipidiphyllon*, the differences between the two latter genera being confined to differences in the shape of the cells of the veins and veinlets, and in the habit.

Marine Algæ of the Mediterranean.† — In a note on the algæ of this region Francesco Ardissonne gives a few critical remarks on the genus *Rodriguezella*, the species *R. Strafforellii* Schmitz, *R. Bornetii* Schmitz, *Constantinea grandifolia* Ardis., *Sphærococcus rhizophylloides* Rodrig., *Halymenia patens* J. Ag., and *H. decipiens* J. Ag. He also describes a new species, *Halymenia coccinea*, but he has not seen the fruit. A few remarks on nomenclature close the paper.

The same author ‡ publishes the first part of a Supplement to his *Phycologia Mediterranea*. He deals with the question of classification according to the system of Agardh, or of Schmitz, and gives as his opinion that the Schmitzian system is not a natural or a logical one, and therefore he cannot follow it. He gives a synopsis of the orders, and a list of genera and species recorded from the Mediterranean. Then follow notes on *Callithamnion*, treating of the genera into which it has been divided by various authors, with a key to the species; and notes on *Constantinea*, *Meredithia*, *Chylocladia*, and *Lomentaria*. The paper closes with a list of figures of genera represented in the Mediterranean.

Stichococcus bacillaris Naeg.§ — L. Matruchot and M. Molliard publish the conclusion of their studies on the variations of structure of a green alga under the influence of a nutritive medium. They describe their experiments on *Stichococcus bacillaris*, which they find does not behave like an anaerobic organism, though it requires but little oxygen for its development. Glucose acts as by far the most favourable medium, and after that dextrin and gum, glycerin and mannite. Saccharose, lactose, maltose, peptone, inuline, and starch have but little effect. These substances also affect variously the colour of the alga. The action of certain mineral substances is also described. The various changes obtained artificially help to explain the dimorphism found in members of one and the same colony. The authors have distinguished

* Illustr. Mar. Alg. Japan. i. No. vi. (Tokyo 1902) pp. 475-93 (5 pls.).

† Rendicanti Real. Ist. Lombard., xxxiv. (1901) pp. 122-7.

‡ Tom. cit., pp. 1013-44.

§ Revue Gen. Bot., xiv. (1902) pp. 316-32 (3 pls.).

in the cells of *Stichococcus* (1) a single nucleus, (2) three kinds of granules, two of which are visible in the living plant.

Salt-water Aquarium.*—Rina Scott describes an aquarium in which successful experiments have been carried on for some years. The sea-water can be kept fresh for years without being changed, the salinity being tested by means of specific gravity balls, and regulated accordingly. The water must be well syringed daily, and all dead or decaying matter must be removed at once. Periwinkles are introduced in order to devour the superfluous green spores. It is possible to watch the germination of spores of Florideæ or other algæ, by allowing such spores to settle on mica plates $\frac{1}{2}$ in. square; these plates are suspended among the fruits and can be removed and placed under a Microscope at will.

Fungi.

Mucors of East Siberia.†—Wlad. Schostakowitsch has devoted special attention to the genus *Mucor* in the neighbourhood of Irkutsk. During his three years' residence there he found eight different species, all of which he cultivated, and watched their development. The following are new to science: *M. irkutensis*, *M. heterosporus sibiricus*, *M. de Baryanus*, and *M. angarensis*.

Dematophora in Fruit.‡—Ed. Prillieux has discovered the Ascomycetous fruit of the fungus *Dematophora necatrix*, which attacks and destroys the roots of fruit trees, but of which the perfect form has not hitherto been known. Some roots infested by the fungus were kept in a suitably moist condition for several years, and the mature perithecia were at last produced. Careful examination proved them to belong to the genus *Rosellinia*, and the author has given them the specific name *necatrix*. When Prof. Hartig first described *Dematophora* he was impressed by the resemblance of the hyphæ to those of species of *Rosellinia*, and he was then of opinion that the mature fruit form would be one of that genus. The perithecia are globose, brown, about 1.5 mm. in diameter. The spores are very dark coloured when mature.

The Genus Aspergillus.§—C. Welmer has published an account of the above genus, with special reference to the forms that occur in central Europe. The ascus fruit is known in only three or four species, and the author does not think these should be placed in another genus, *Eurotium*. He decides also that the genus *Sterigmatocystis* cannot stand. He finds that the branching conidiophores, by which it is distinguished, occur simultaneously with simple conidiophores on the same individual. He has arranged the classification according to colour: green, white, black, and yellow or brown.

Fruit Yeasts.||—W. Rommel found two wild yeasts growing in flask beer that had been kept for some time, and, in order to discover their

* New Phytologist, i. (1902) pp. 124-6.

† Zeitschr. angew. Mikr., viii. (1902) pp. 62-5.

‡ Comptes Rendus, cxxxv. (1902) pp. 275-8.

§ Mém. Soc. phys. et hist. nat. Genève, xxxiii. (1901) pt. 2, No. 4 (5 pls.). Cf. Centralbl. Bakt., ix. (1902) pp. 173-5.

|| Wochenschr. f. Brauerei, xix. No. 12, pp. 176-8. See also Centralbl. Bakt., ix. (1902) pp. 170-1.

origin, he instituted a series of cultures with many different kinds of fruits. He failed to find the yeasts that he sought, but he made interesting notes of the various fungal organisms that developed in his media, and he gives an account of them. They comprise several species of yeast, *Torula*, *Mucor*, and other filamentous fungi.

New Pathogenic Yeast (Klein's Yeast).* — This yeast on which E. Cohn has conducted a series of researches, was found by Klein along with other pathogenic organisms in milk. He proved its injurious nature on various small animals, and sent a pure culture to the Hygienic Institute at Halle, where a further study was prosecuted by Cohn. The yeast grew in a large variety of liquid media, and when planted on a firm substratum it covered it over with a greyish shining layer. The best culture medium of all was beer-wort with its natural acid reaction. In it the yeast formed thick masses of the consistency of butter of a yellow or brownish tinge. Experiments were made by Cohn as to its effect on various animals.

New Uredineæ.† — J. T. Lindroth has published a list with diagnoses of 30 new species of rusts from various countries. He thinks that *Æcidium thysselini*, found on *Thysselinum palustre*, has probably its telentospore form on *Carex*; of *Æcidium selini*, which grows on *Selinum linearis*, the uredo- and telentospore stages grow on *Polygonum viviparum*. The other species recorded are single stages of the rust, mostly the telentospore stage.

Relationship between Pleospora and Helminthosporium.‡ — H. Diedicke has been engaged in tracing the connection between the conidial and ascus forms of these fungi found growing on the same host. He has conducted a series of culture and infection experiments on different grasses. He finds that the *Helminthosporium* species parasitic on *Bromus asper* and *Triticum repens* are distinct from each other, and that they are the conidial forms of *Pleospora*. The author considers that the *Pleospora* is identical with *Pl. trichostoma* Wint, but that form species have developed on *Bromus* and on *Triticum*. The conidial form belongs to *Helminthosporium gramineum* Rabenh., which has also developed form species on the different hosts.

Infection Experiments with Uredineæ.§ — Tubeuf has infected plants of *Epilobium angustifolium* successfully with ædiospores of the fir. The spores of *Cæoma Abietis pectinatæ* grew on *Salix capræa*. The witch's broom æidium of the fir had been proved by Fischer to be connected with the fungus on *Stellaria nemorum*. Tubeuf infected also *Stellaria media* and *Cerastium semi-decaudrum* with the same fungus, and in each case reproduced another stage in the life-history of the parasite.

Rusts of the Umbelliferæ.|| — J. J. Lindroth has published his study of the Uredineæ found on the above plants. In determining the

* Centrabl. Bakt. 1^o Abt., xxxi. (1902) pp. 737-48.

† Meddel. fr. Stockholms Högskolas botaniska Institut, iv. (1901) p. 8. See also Centrabl. Bakt., 2^o Abt., viii. (1902) pp. 812-3.

‡ Centrabl. Bakt., ix. (1902) pp. 317-29 (9 figs.). § Tom. cit., p. 241.

|| Acta Soc. pro Fauna et Flora Fennica, xxii. No. 1, 224 pp. See also Hedwigia Beiblatt, xli. (1902) pp. 151-3.

species he relies strongly on the number of germ-pores in the uredo- and telentospores. Such comprehensive species as *Puccinia bullata* are now divided up into a number of smaller species. He also lays stress on the warts and reticulations of the epispore. He divides *Puccinia* into five groups—*Reticulatae*, *Psorodermæ*, *Bullatae*, and two other groups which are not so exactly defined. There are 70 species of *Puccinia* recorded on Umbelliferae, but only 11 species of *Uromyces*. There are also some *Æcidium*, *Uredo*, and *Cœoma* forms. The author records several new species.

Function of Paraphyses in the Uredineæ.*—P. Magnus accepts the conclusions arrived at by P. Dietel† as to the protective function of the paraphyses; but he considers they serve yet another purpose; they raise and burst the epidermis of the host-plant and make room for the growing spores. Magnus gives in this connection an account of several species of *Coleosporium*. He finds that the paraphyses there serve both for protection and for the lifting of the epidermis. In *Coleosporium paraphysatum* the development is somewhat different. The epidermis is not burst, and the germinating teleutospores push their sterigma between the epidermal cells and bear the sporidia on reaching the open. This species of *Coleosporium* forms a transition to other genera, more especially to *Coleopuccinia*. The author hopes to pursue the subject further.

Experiments with Rusts.‡—Klebahn continues the account of his various culture experiments with the rusts of Conifers. He has established satisfactorily the connection between various life-stages of the fungi. He also made successful experiments with *Æcidium Pastinacæ*, *Puccinia Angelicæ-Bistortæ*, the rusts of *Ribes* and *Carex*, and the Puccinias of various grasses.

Amanita ovoidea.§ —Matteo Lanzi has examined the so-called "meal" of this fungus, which is found on the stalk below the ring, and which is composed of white cells mostly elliptical in form.

Germination of Basidiospores.||—Margaret C. Ferguson has studied the conditions most favourable to the germination of spores of various forms of Basidiomycetes, more especially those of *Agaricus campestris*. She gives an account of the methods employed, the different media used, the conditions of temperature, &c. It was found that the presence of a bit of the mycelium of *Agaricus campestris* made possible the germination of all the spores in the culture. The writer closes with a historical account of previous work.

Hydnaceæ.¶—Howard J. Banker publishes a historical review of this natural order of Hymenomycetes. He discusses each genus in turn, and proposes some changes in nomenclature. *Radulum* is untenable, as there is already a genus *Radula* in the Jungermanniaceæ; he therefore proposes to replace it with *Tyloclon*. *Hericium* he also considers untenable, but

* Ber. Deutsch. Bot. Ges., xx. (1902) pp. 334-9.

† Cf. Hedwigia, Beiblatt xli. (1902) pp. 58-61.

‡ Zeit. f. Pflanzenk., xii. (1902) pp. 129-51.

§ Atti Acc. Pontif. N. Lincei, lv. (1901-1902) pp. 97-100.

|| Bull. No. 26, U.S. Dept. of Agr., 1902, 43 pp. (3 pls.).

¶ Bull. Torr. Bot. Club, xxix. (1902) pp. 436-48.

the species composing the genus require further examination. *Odontia* is preoccupied by *Odontia* Pers., and the name *Etheirodon* is chosen as a substitute. *Neokneiffia* is now used instead of *Kneiffia*, the latter name having been given to a genus of Epilobiaceæ. *Pycnodon* was also proposed for this genus. The writer thinks that there are several names of genera that, with more advanced knowledge, will be found to be synonyms.

Crystalloids of the Basidiomycetes.*—Ch. Van Bambeke discovered crystalloids in the mycelium of *Lepiota meleagris*, and at a later date in *L. cepæstipes*. He then proceeded to examine all the sections of the higher fungi that were within his reach, and came to the conclusion that the presence of crystalloids is the rule in the Hymenomycetes and Gasteromycetes. They occur in the vegetative part as well as in the carpophore, and are more or less numerous according to the genus or species. They are usually in large numbers in the stalk and in the vegetative parts. They become fewer in the hymenial tissue. The crystalloids have the appearance of a regular rhomb, but they are sometimes spherical and also intermediate in form. The author considers them to be reserve material rather than products of degeneration. This view is supported by the fact of the gradual diminution in size of these bodies in the tissue bordering on the hymenium, as if this substance were being gradually used up in spore-production. A series of tables give the results of his examination in graphic form, and the hyphæ containing the crystalloids are figured.

Silver-leaf Disease.†—J. Percival finds that this disease of *Prunus* is due to a fungus in the roots. It is characterised by a peculiar grey appearance of the leaves, though no fungus is present in the leaves, nor, as a rule, in the stem or branches. In all the cases of disease examined the tissues of the root were found to be permeated with fine hyphæ, and in one case the fruiting bodies of *Stereum purpureum* were found on a branch of a tree affected with silver-leaf. On inoculating healthy trees with *Stereum* the disease was again produced. The author is of opinion that the fungus secretes an oxidase which in a short time pervades the branches and leaves, and causes by its action the silvery look on the leaves. The affected trees produce little or no fruit, and are always sickly and unprofitable.

Spanish Lichens.‡—M. Llenas y Fernández publishes a list of lichens (58 species and 9 varieties) gathered in the environs of Barcelona, and calls attention to the neglect with which the Spanish Cryptogams, and especially the Lichens, have been treated.

Contribution to the Lichen Flora of Emilia.§—Carlo Zanfregnini gives a first instalment of his list of lichens from Emilia, that district in the north of Italy which includes the provinces of Piacenza, Parma, Reggio, Modena, Bologna, Forli, Ferrara, and Ravenna, representing a very varied country of mountain and plain. The *Sylloge Lichenum Italicorum*, published in 1900 by A. Jatta, embraces the whole of Italy;

* Bull. Classe Sci. Acad. Roy. Belg., No. lv. (1902) pp. 227-50 (1 pl.).

† Journ. Linn. Soc. (Bot.), xxxv. (1902) pp. 390-5 (1 pl. and 5 figs.).

‡ Bolet. Socied. Españ. Hist. Nat., ii. (1902) pp. 207-11.

§ Nuov. Giorn. Bot. Ital., ix. (1902) pp. 190-211.

but while some districts are well represented in that work, others, and of these Emilia is one, have very poor records. The writer proposes in this list to fill up the blanks left in the larger work. In general, he has followed Jatta's system of classification, and this first publication includes genera and species of Ramalinaceæ, Cladoniaceæ, Sphærophoraceæ, and Parmeliaceæ.

A further instalment* contains species belonging to the genera *Umbilicaria*, *Gyrophora*, and *Endocarpon*. The crustaceous lichens follow in order, and those belonging to the Lecanoracei are included.

Compounds from Lichens. † — W. Zopf describes the properties of various acids and other chemical compounds obtained from different lichens. Some of the compounds are new to science.

Kryptogamen-Flora. ‡ — Andreas Allesen has issued another part which continues the account of the *Fungi imperfecti*. He concludes the genus *Coryneum*. Then follow the small genera *Scolecosporium*, *Asterosporium*, *Sciridium*, and *Seiridiella*; the two latter being very closely allied. The two genera *Monochætea* and *Pestalozzia* occupy the remaining pages. The former genus has been hitherto regarded as a sub-genus of *Pestalozzia*. Allesen raises it to generic rank, in order to make the work of arrangement easier. The species are tabulated on an alphabetical list of host plants—and the author found it simpler to place all the forms of *Monochætea* by themselves. The spores differ from those of *Pestalozzia* in having only one appendage.

Contributions to Fungus Floras. — N. Ranojević § completes his list of Servian fungi, 247 in all. There is one new species, *Ascobolus serbicus*, included in this last contribution.

P. Hennings ¶ describes the fungi collected by Puttemans and A. Hammar at Sao Paulo during the years 1900 and 1901. They are all microscopic and grow on leaves or branches of various plants. Many new species are described, and three new genera, *Puttemansia*, a member of the Pezizaceæ with erumpent, globose and then cupulate, hairy ascomata; the spores fusiform—three-septate and yellowish—hyaline, found on leaves of a member of Lauraceæ. *Pseudomelasmia* near to the genus *Melasmia*, one of the Leptostromataceæ; the conidia are oblong, hyaline, and one-septate. *Tetracrium*, a Hyphomycete, bears four radiate conidia at the tips of the conidiophores; they are elongate-fusiform, pluri-septate and colourless.

Hennings ¶ also publishes his *Fungi Costaricensis I.* received from H. Pittier. There are a few Myxomycetes. There are no new genera. Most of the species of fungi are microscopic; many of them are new to science. They have been collected at or near Costa Rica.

Under mycological notes, A. Scherffel** describes several new Chytridinae which he has found growing on green algæ. They are

* Tom. cit., pp. 355-77.

† Anmal., cccxxi. (1901) pp. 37-61. See also Journ. Chem. Soc., lxxxii. (1902) i. pp. 465-6.

‡ Rabenhorst's Kryptogamen-Flora, vii. Lief. 85 (Leipzig, 1902) pp. 641-704.

§ Hedwigia, xli. (1902) pp. 97-103.

¶ Tom. cit., pp. 104-18.

¶ Hedwigia, Beiblatt, xli. (1902) pp. 101-5.

** Tom. cit., pp. 105-7.

Chytridium gibbosum on *Cladophora*, *Lagenidium Œdogonii* found in the vegetative cells of *Œdogonium* and *Aphelidium Melosiræ* in *Melosira*.

P. Dietel* reviews the genus *Uropyxis* and allied genera. With the exception of *U. Steudneri*, which is found in Abyssinia, all the species of the genus are from the American continent. The genus is characterised by the presence of two germinating pores in each spore-cell and by a sheath which envelopes the teleutospore.

Fungi Javanici.†—A list of fungi from Java, all of them new to science, has been issued by P. Hennings. They were collected by Zimmermann. There are several new genera:—*Zimmermaniella* in the family Dothideaceæ, the asci of which contain three oblong continuous spores; this genus is also distinguished by the form of the stroma; *Discomycopsella*, one of the Leptostromataceæ; *Didymostilbe*, nearly allied to *Stilbum*, but with septate spores; and *Didymobotryopsis*, also a member of the Stilbaceæ, but distinguished by the form of the stroma.

The same author ‡ describes some new Pezizaceæ found in Germany. These are a variety *Raatzii* of *Pyronema domesticum*, *Pyronema Buchsii* and *Sarcoscypha pseudomelastoma*.

He publishes § still another series of species of *Cordiceps* from Surinam. There are six new forms all found growing on insects. One of them, *C. Michaelisii*, was found on a chrysalis.

A new Hymenomycete, *Phlebia Kriegeriana*, is also described by Hennings.|| It was collected by Krieger at Königstein, and differs from other European species in colour and form.

Fungus Flora of the Sonntagberg.¶—P. Pius Strasser gives a second contribution of fungi from this region of Austria. The numbers here published are 738–856. There are several new species, one new genus in the Sphærospideæ, namely *Strasseria* near *Neottiospora*, and one new Hyphomycetous genus *Höhneliella*, a member of the Phæostilbeæ. Brodadola and Saccardo have determined the new forms.

Fungus Flora of Piedmont.**—Teodoro Ferrario publishes a second list of fungi collected in Piedmont. He has already recorded 112 species from the same neighbourhood; the present contribution brings the number up to 218. The larger number belong to the Deuteromycetæ, and the new species or varieties, of which there are 21, are all microscopic, most of them Sphærospideæ. The author has been assisted by Saccardo in determining several of the new species. They are all illustrated.

North American Mycology.††—F. S. Earle contributes notes on the following. (1) Synonymy of *Ascocorticium*—*A. albidum* Brefeld is identical with *Ascomyces anomalus* Ell. and Hark. (2) A synopsis of North American species of *Periconia*, with description of several new species. (3) New Florida Fungi. (4) New California Fungi. (5) New Fungi from various localities.

* Tom. cit., pp. 107–13. † Hedwigia, xli. (1902) pp. 140–9.

‡ Tom. cit., pp. 164–6. § Tom. cit., pp. 167–9.

¶ Hedwigia, Beiblatt, xli. (1902) pp. 146–7.

|| Verh. k. k. zool.-bot. Ges. Wien, lii. (1902) pp. 429–37.

** Malpighia, xvi. (1902) pp. 2–46 (2 pls.).

†† Bull. New York Bot. Gard., ii. (1902) pp. 331–50.

Diseases of Plants.*—An account is given of *Plasmodiophora Brassicæ*, the way in which it is propagated, and the best means of preventing or curing the disease.

A paper † on Larch and Spruce Fir canker, by G. Masee, gives the results of the observations and experiments of many years. He discusses the various stages of the diseases and the probable manner of infection. He considers them to be entirely wound parasites, all infection experiments having failed on uninjured bark. The Larch canker is caused by *Dasyctypha calycina*; the fungus causing the spruce disease is *D. resinaria*. The latter is frequently enabled to enter the tissue of the host through wounds made by a small parasitic fungus *Exosporium* sp. Methods of prevention and cure are suggested. The paper is well illustrated.

Another paper ‡ deals with Cucumber and Melon-leaf blotch, due to a parasitic fungus *Cercospora Melonis*. It occurs only in green-houses where the air is hot and moist. Preventive measures are recommended.

Canker in Apple-Trees.§—Hasselbring has discussed the various diseases affecting the bark of apple-trees popularly described as canker. The most common instance of the disease in Illinois, U.S., is due to a fungous parasite, *Nummularia discreta*. It is a wound parasite and gains entrance to the tree through openings in the bark caused by pruning or by accidental injuries. It produces extended blackened areas, and the bark cracks and finally crumbles away. The affected branch is always killed by the fungus. Badly diseased limbs should be cut and burned, and wounds in the tree should be painted with some antiseptic solution.

Economic Fungi.||—There is a considerable number of the smaller fungi that are used in the manufacture of various articles of commerce, and Prof. Wehner has given an account of some of the most important. He cites some of the forms of yeast used in brewing, in the East, as well as *Aspergillus Oryzæ*, which is employed in Japan in the making of Soja sauce. *Aspergillus niger* is used for the production of oxalic acid; *Citromyces Pfefferianus* is employed in the manufacture of citric acid. He takes note also of *Penicillium glaucum* which is mixed with the cheese curds to form the green veins of Roquefort and Gorgonzola. The Chinese make a red colouring matter from *Monascus purpureus*, but the method employed remains a secret. The author also mentions some other fungi which are used as colouring agents.

Pathogenic Fungi.¶—L. Gedoelst calls this book a technical guide to vegetable parasitology. His aim has been to provide a manual that can be consulted alike by the physician and the botanist. He gives descriptions of the various fungi that have been found to cause diseases of the animal body and gives the best methods of isolating and culti-

* Journ. Board of Agric., ix. (1902) pp. 145-9 (1 fig.).

† Tom. cit., pp. 176-88 (3 pls.).

‡ Tom. cit., pp. 196-8 (1 pl.).

§ Bull. No. 70 Univ. of Ill. Agr. Station. See also Gard. Chron., xxxii. (1902) p. 60.

|| Zeitschr. angew. Mikr., viii. (1902) pp. 89-90.

¶ 'Les Champignons Parasites de l'Homme et des Animaux Domestiques,' par L. Gedoelst (Brussels, 1902) pp. vi. and 199 and 124 figs.

vating the parasites, with an account of inoculation experiments employed to verify the identity of the fungus with the origin of the disease. The fungi are all minute species. In the group of Phycomycetes he describes several forms of the Mucorinæ. Among the pathogenic Ascomycetes he includes forms of Saccharomycetinae and Plectascinae, and under *Fungi imperfecti* he describes the diseases due to *Discomyces*, *Oidium*, &c.

Fungal Disease in Horses.*—J. de Haan has investigated a disease of horses in Batavia. He found that it was caused by the presence of a fungus in the skin, more especially in the mucous membrane of the mouth, lip, and nose. In the later stages the bones of the head are also attacked. An examination showed the presence of yellowish-grey lumps of a somewhat hard formation varying in size from the head of a pin to an egg; and traversed in all directions by a well-developed mycelium which also penetrated the surrounding tissue. The writer has named the fungus *Hyphomycosis destruens equi*, and he is of opinion that it is the sole origin of the malady. Infection comes from the food, and the fungus gains entrance to the tissue through some small wound in the mucous membrane caused by the grasses, &c. that compose the fodder. In the external skin the fungus would similarly find entrance through some abrasion. De Haan made cultures of the fungus, and with these he re-infected the mouth and neck of healthy horses. The experiment was unsuccessful.

Continuity of Protoplasm in Fungi.†—Arthur Meyer reviews the work already done on this subject by Chmielewsky, Wahrlich, and others, and gives an account of the different fungi in which this phenomenon had already been noted. He devotes special attention to the mode in which the perforating protoplasmic strands are formed between the cells. There are two possible ways in which this could take place: that the closed membrane should be pierced by the protoplasmic strand, or that the opening should be left in the wall at its original formation. He finds that the latter is the process followed in the fungi. Meyer discusses also the fusion of hyphæ and the occurrence of clamp connections with reference to the subject of continuity between cells. Fusion of hyphæ has been demonstrated by various observers in many Basidiomycetes and Ascomycetes, and in the promycelial cells of the Ustilagineæ. It has been noted in the germinating tube of the uredospores of *Uromyces Poæ*, but not as yet in any other member of the Uredineæ. The author discusses at some length the bearing of these facts on the phylogeny of the group. The paper is followed by a large and complete bibliography of the subject.

Influence of Light on the Respiration of the Lower Fungi.‡—N. A. Maximow gives the results of his researches on two species of fungi, *Mucor stolonifer* and *Aspergillus niger*. He used direct sunlight or the light from an electric lamp for the illumination of the plants, and he grew them on various media. He found that the influence of the light varied with the age of the cultures: at a young stage light had no effect

* Centralbl. Bakt., 1^o Abt., xxxi. (1902) pp. 758-63 (2 figs.).

† Bot. Zeit., ix. (1902) pp. 139-78 (1 pl.).

‡ Centralbl. Bakt., ix. (1902) pp. 193-205 and 261-73.

on the respiration. On older plants there was a marked increase, especially on those cultures where nourishment was scanty. The influence of the light made itself felt in about 30 minutes, but if the plant was exposed to alternate light and dark the effect of the light was altogether feebler.

Respiration of Fungi.* — S. Kostytschew gives the results of his research on respiration which was undertaken to determine if there were any connection between intramolecular respiration and the alcoholic fermentation of yeast fungi. He experimented with *Mucor stolonifer* and *Aspergillus niger*, growing them on various media in an atmosphere free from oxygen. He concludes that intramolecular respiration is not identical with the fermentation process.

Weather and Parasitic Fungi.† — Karl Sago has collected facts and statistics on the appearance and disappearance during certain seasons of various fungal diseases, especially those that occur on the vine. He finds that the direction and force of the wind has a great influence on the spread of disease, and that hail showers render the host-plant more liable to attack. More work is required to determine the weather conditions that affect special forms. *Alternaria solani* spread with great rapidity in dry weather that supervened on a rainy season. During a warm damp summer it was noticed that there was very little disease.

Decomposition of Compounds of Selenium and Tellurium by Moulds.‡ — O. Rosenheim gives a *résumé* of his results which confirm those recently published by Maassen. The biological test for arsenic consists in the formation of gaseous organic arsenic compounds with a characteristic garlic odour produced by the growth of certain moulds (*Aspergillus*, *Penicillium*, *Mucor*) in media containing arsenic. When applying this test to beer and sugar which contained selenium and arsenic, the author noticed a pronounced faecal odour different from that produced by arsenic alone. Experiments with soluble selenium compounds showed that this was due to the presence of selenium. It was also found that tellurium compounds were decomposed by *Penicillium brevicaulis*, producing a very characteristic odour. The odour produced by decomposition of selenium compounds is very disagreeable, being something like skatol or mercaptan, whilst the gases formed by tellurium compounds have a strong garlic odour. The test is extremely sensitive; 0.01 mgrm. in 1 ccm. of liquid is easily demonstrated by a vigorous growth of the mould. Unlike arsenic, pure selenium and tellurium are not attacked by the mould.

Influence of Sulphocyanic Acid on Growth of *Aspergillus niger*.§ — A. Fernbach finds that the presence of sulphocyanate of ammonia in a liquid in which the mould is growing has no sensible effect on the development of the mycelium, but causes arrest of the fructification which only begins to develop when the sulphocyanate has disappeared, probably as a result of oxidation. This effect is remarkable as it is contrary to what we might expect from the general behaviour of

* Ber. Deutsch. Bot. Ges., xx. (1902) pp. 327-34.

† Zeit. Pflanzenkr., xii. pp. 151-7.

‡ Proc. Chem. Soc., xviii. (1902) pp. 138-9.

§ Comptes Rendus, cxxxv. (1902) pp. 51-2.

compounds which are prejudicial to the growth of lower organisms, especially in the case of moulds. The general result is a diminution of the weight of the mycelium and a speedy assumption of the spore-forming stage.

New Pathogenic Blastomyces.*—E. Klein, in addition to a new bacillus (*Bacterium diphtheroides*, which morphologically resembles the *B. diphtheriæ*, grows only at 37° C., slowly liquefies inspissated blood-serum, produces acid, and causes clotting of litmus-milk), describes a new pathogenic blastomyces which he isolated from a sample of country milk. This yeast is a strict aerobe, grows readily between 20° and 37° C. on all ordinary media, liquefies gelatin slowly, does not form gas in sugar media, the growth on solid media being whitish at first, but afterwards becoming yellow. The organism stains well with the anilin dyes, and also by Gram's method.

When inoculated into the peritoneal cavity of guinea-pigs, this yeast provokes the formation of a tumour or tumours, followed by the death of the infected animal. Subcutaneous and intravascular inoculation also yield similar results, and from the tumours the yeast may be recovered in pure culture. The blastomyces is pathogenic to rabbits and mice.

Protophyta.

Schizophyceæ.

Cytology of Cyanophyceæ.†—H. Wager describes the "central body" of the cell as resembling the nuclei of higher organisms in that it is composed of a chromatic network, but differing in the absence of a nuclear membrane and nucleolus. Chromatin is present, but generally only in small quantities. Presence of phosphorus was also shown. In the process of division the cell begins to divide and new cell-walls are formed independently of the division of the nucleus. Some of the division stages in the nucleus resemble true stages of karyokinetic division. The colouring-matter of the cell occurs in the form of granules or fibrils in the peripheral layer, the structure of which recalls that of the chromatophores of other organisms.

Schizomycetes.

Unusual Bacterial Grouping.‡—Mary Hefferan describes the unusual bacterial grouping occurring in a cultivation of the *B. rosaceus metaloides*, obtained from the Král Laboratory. The bacillus in question is a slender rod 1.2 μ to 2 μ long, actively motile, and possessing polar flagella. When grown in ordinary broth and examined microscopically, either stained or in a hanging-drop preparation, the individual elements show a peculiar grouping, being bound together in the form of rosettes or asters of varying sizes. These rosettes were observed in practically all fluid media, including cultivations in broth, milk, nitrate solution, asparagin solution, &c. When cultivated upon solid media, however, the growth on agar is the only one which shows this peculiar rosette formation, none whatever being observed in cultures upon gelatin or potato.

* Local Gov. Board Repts., 1900-1901 (1902) pp. 328-52.

† Report Brit. Ass., 1901 (1902) p. 830.

‡ Centrabl. Bakt., 2^e Abt., viii. (1902) pp. 689-99.

Observations were made as to the rate of growth and the time occupied in the formation of the rosettes, by inoculating from rosette-free potato cultures into a hanging-drop of broth and observing microscopically. For the first two hours after inoculation no rosette formation was noted, but from this time onwards up to 24 hours the rosettes increased in numbers, reaching their maximum at the last-named point, the time required for the appearance of the rosettes corresponding apparently to that required for cell-multiplication to take place. The author is of opinion that the formation of the rosettes is too regular and perfect to be explained as a passive agglomeration caused by some agglutinating substance, whilst observations upon cell-division under conditions unfavourable to the bacillus, e.g. pressure and lack of oxygen, still showed the tendency of the dividing cells to form rosette groups, a fact which strongly supports the theory that the phenomenon must be closely connected with the vital processes.

Intestinal Bacteria of *Chironomus Larvæ*.* — Leger, during the course of some researches upon the parasitology of the *Diptera*, observed three micro-organisms present in the intestinal canal of the larvæ of *Chironomus plumosus*, with such constancy as to constitute them true parasites. These three bacteria were, in order of frequency, a streptothrix, a bacillus, and a spirillum or spirochæta.

The streptothrix occurred as hyaline filaments, 1.5μ long, forming bundles or interlacing tresses, also ovoid conidia, 2.8μ in length, in the posterior, and, but rarely, in the middle intestine. Occasionally it is present in such masses in the rectum as to lead to great distension.

The bacillus was less frequently observed than the streptothrix, although sometimes the two organisms were associated; it was a short, straight, or slightly curved motile rod, 6 to 8μ in length, sometimes free in the intestinal canal, but usually attached by one extremity to the surface of the epithelial cells. It forms ovoid spores, 1.7μ long, at the free extremity, which becomes somewhat swollen.

The third organism, the spirillum, rarer than either of the above-mentioned species, closely resembles the *Spirillum Obermeyerei*. It occurs as long filiform threads, 15 to 20μ in length, and containing in such a length four or five very pronounced curves. Like the bacillus, it is attached by one extremity to the intestinal wall, the unattached portion exhibiting constant rapid undulatory movements. The author concludes that these spirochæta are the structures that previous observers (e.g. P. Vignon) have described as the cilia of the epithelial cells of the intestine.

Bacillus Lacto-rubifaciens.† — Gruber isolated a bacillus from milk, which produces a red coloration of that fluid, and possesses the following characters. It is a short rod with parallel sides and rounded ends, occurring singly, in pairs, and short threads, 1.75μ to 14μ long, by 0.4μ to 0.6μ . Occasionally diplo-bacilli are found, and sometimes more or less oval single rods, many of the rods showing distinctly refractile granules, and from old cultivations the stained preparations show distinct central granules, which are not, however, true spores. The organism is motile, with peritrichous flagella. The bacillus grows well

* Comptes Rendus, cxxxiv. (1902) pp. 1317-9.

† Centralbl. Bakt., 2^e Abt., viii. (1902) pp. 457-62.

at 18° to 22° C., forming upon gelatin plates flat spreading surface colonies, which in two days attain a diameter of 1 to 2 mm., slightly heaped up in the centre, with a sharply defined outline. Deep colonies are small and punctiform, round, with a sharp contour, light edges and dark centre. Stab and streak cultivations upon gelatin closely resemble those of the *B. coli*; the organism does not liquefy gelatin. Cultivations upon agar are by no means characteristic. Broth at 24 hours becomes uniformly turbid; later the growth sinks to the bottom as a sediment, and leaves the bulk of the medium clear. Potato cultivations grow well in about 24 hours. Cultivations in milk grow well at 20° to 22° C., and in about four days show distinct red coloration, associated with a marked acid reaction. The consistence of the milk is altered, and becomes somewhat slimy, but does not undergo subsequent peptonisation; the depth of rose tint increases up to about the tenth day. The addition of grape sugar to the milk causes the earlier development of a deep red coloration (in two days); the addition of milk-sugar, however, does not cause so marked a change.

This bacillus is differentiated from the *B. lactis erythrogenes* by its white growth upon gelatin and agar (as compared with the yellow coloration and wine-red staining of the nutrient medium by the erythrogenes), and by its intense slime formation in milk, associated with the production of a red colour and an acid reaction without disintegration of the casein. the *B. lactis erythrogenes* coagulating milk with an alkaline reaction, producing a blood-red colour of the milk, and later peptonisation. *B. prodigiosus* and *Sarcina rubra* are easily differentiated from the *B. lacto-rubifaciens* by reason of the coloured character of their growth upon gelatin, agar, &c.

Black Dry-rot in Swedes.*—Middleton and Potter describe a bacterial disease attacking swedes, which they term "black dry-rot." This disease takes the form of a dark, almost black, spot in the centre of the turnip, which gradually increases in size till only a shell of normal tissue may be left in the root. The organism responsible for the disease was isolated by means of cultivations upon neutral turnip broth rendered solid by gelatin, and when transplanted upon sterile blocks of healthy swede produced a disease identical with that from which it was originally obtained. The organism is a short, motile rod, 3 μ by 1 μ . It is an aerobe and liquefies gelatin, and possesses a single polar flagellum, but no further specific characters have as yet been worked out for this organism.

New Syphilis Bacillus.†—De Lille and Jullien have isolated upon ordinary nutrient media a new bacillus, both from the blood-serum of a syphilitic patient, and from the serum obtained from blisters (raised by means of cantharides plaster). This organism is a pleomorphic motile bacillus, 5–8 μ long by 0·015 μ to 0·03 μ broad, which retains the colour when stained by Gram's method, and which in old cultures grows out into threads, and later on becomes granular. When grown upon agar it forms a creamy moist greenish layer, and it liquefies gelatin, forming a light greenish pigment.

* Journ. Board Agric., ix. (1902) pp. 25–32.

† Centralbl. Bakt., 1^a Abt., xxxi. (1902) Ref., p. 6; also Deutsch. Med. Woch., 1901, No. 29.

The bacillus is pathogenic to guinea-pigs and frogs, the former dying in 10–15 days after intraperitoneal injection. At the site of inoculation an ulcerating papule forms, with swelling of the neighbouring glands. The bacillus is agglutinated by the serum of syphilitic patients.

Bacilli in Syphilitic Semen.* — Max Joseph and Piorkowski examined bacteriologically the semen of 22 syphilitic patients, employing pieces of fresh normal placental tissue as their culture-medium; these were previously observed in sterile Petri dishes and contaminated portions rejected. Sterile pieces were inoculated with freshly ejaculated semen and incubated at 37° C. In every case transparent dewdrop-like colonies of bacilli appeared on the first day, which later became grey and confluent. The bacilli were broad and granular, clubbed at one or both ends like the Klebs-Löffler bacillus, and of about the size of the *B. subtilis*. The bacillus stained best with carbol-fuchsin or gentian-violet, also by Gram, but were not acid-fast. Polar staining involution forms were noted in old cultivations. Sub-cultivations in broth failed, but succeeded on solid agar or better still on serum-agar, the growth appearing as a greyish-white waxy layer. In gelatin stab there was a luxuriant whitish growth, and on potato a moist, glistening, whitish layer. Milk was coagulated with the production of an acid reaction, but no gas formation was noted.

The bacillus was not pathogenic to guinea-pigs, rabbits, or mice. No growth could be obtained from the semen of healthy non-syphilitic men. The bacilli appeared to be related in some way to the spermatozoa, for if the semen was kept a few hours until the spermatozoa were dead, no growth could be obtained, and further, if no spermatozoa were present in the seminal fluid, even when such was derived from cases of recent syphilis, no bacilli could be demonstrated.

Transmissibility of Plague to Bats.† — Gosio remarks that many species of animals have been studied with regard to their susceptibility to bubonic plague, rats and mice exhibiting spontaneous infection in countries where plague is epidemic: whilst the field-mouse, guinea-pig, rabbit, ape, cat, fowl, and sparrow have been infected experimentally. The pigeon is susceptible when fasting, and the lizard and snake if kept at a high temperature. The dog, ox, and hedgehog have so far proved immune. At the time of the small epidemic of plague at Naples, when the author was placed in charge of the sanitary department, no public health statistics were available, but by instituting such statistics the origin of the infection was traced to the warehouses of the Punto Franco, where both rats and bats abounded, and although high walls and an isolated drainage system prevented the egress of the former, these precautions were obviously useless if the infection could be conveyed by the bats. Gosio therefore inoculated the common bat (*Vesperugo noctula*), which is found throughout the greater part of Italy, with plague bacilli isolated from the Naples epidemic and retained in a virulent condition by passages through white rats. Subcutaneous inoculations were practised, the dose at first employed being 0·5 ccm. of a 24-hour old broth

* Med. Rev. Reviews, v. (1902) pp. 420–1. See also Berlin Klin. Woch., 1902, pp. 257 and 282.

† Atti Reale Accad. Lincei, xi. (1902) pp. 448–9.

cultivation. As these were found to give positive results, smaller doses were tried, and it was eventually found that from 0·05 to 0·1 of a 24-hour old broth culture invariably infected the bats and caused death within a relatively short time. Post-mortem, the spleen showed the typical appearance and all the internal organs contained plague bacilli. Further, as it has been shown that the common flea carries plague bacilli, all the varieties of parasites found on the dead bats were examined and found to contain the *B. pestis*.

Shell-fish and Typhoid.* — E. Klein shows by a series of careful experiments that both cockles and mussels are able to take up from polluted sea-water the specific organisms of both typhoid and cholera, at any rate when presented to them in large quantities and under laboratory conditions, and to retain them in their interior for some days after removal from the source of contamination. Further, under these conditions the author was able to demonstrate that the *B. typhosus* actually multiplied in the interior of the cockle.

Klein also investigated the value of the cooking processes usually employed for these shell-fish in destroying the specific germs, and found that when boiling water was applied to the infected molluscs in bulk, the organisms in the interior of the shell-fish were not necessarily killed, although those on the surface were destroyed.

Pathogenic Bacillus in Cockles.† — Galeotti and Zardo, who were interested in some fatal cases of food-poisoning, resulting apparently from the ingestion of cockles (*Murex bradatus*) gathered from the oyster-beds at Isola (Austria), obtained from the mayor of that town samples of the molluscs collected from the same situation. These they examined bacteriologically, and isolated from them a bacillus which they could not identify with any existing described bacterium, although it obviously belonged to the hæmorrhagic septicæmia group. Their bacillus is a thick, sluggishly motile rod, 1·6 μ to 1·7 μ by 0·7 μ , with rounded ends. It stains evenly throughout, is neither alcohol- nor acid-fast, and does not retain the stain when treated by Gram's method. It is usually arranged in pairs, and thread formation was not observed, nor could involution forms be detected, even in old cultures. It does not form spores, nor could the presence of flagella be demonstrated by staining methods. It grows well at 25° C. and 37° C., is a facultative ærobie, and grows well in whatever anaerobic method is adopted for its cultivation, and in the absence of oxygen produces a fair amount of gas. Gelatin plate cultivations show small, rounded, sharply-defined, greyish, iridescent colonies, which do not liquefy the medium. Cultures upon agar and inspissated blood-serum show similar discrete colonies, which do not coalesce. Broth cultivations soon become universally turbid, but no pellicle formation can be observed. The bacillus is pathogenic to mice, guinea-pigs, and rabbits, whether introduced into the system by way of the stomach, peritoneal cavity, subcutaneous tissue, or intravenously. The anatomical changes occurring in the animals which died after injection of cultivations of the bacillus consisted chiefly of hæmorrhages and infarcts, and closely resembled those noted at the

* Local Gov. Board Reps., 1900-1901 (1902) pp. 561-71.

† Centralbl. Bakt., 1^o A bt., xxxi. (1902) pp. 593-614.

post mortem examination of the bodies of those who had died after eating the shell-fish from the same beds.

The authors remark that the actual proof that the bacillus they isolated from the shell-fish was the cause of the fatal illness in people who had eaten similar bivalves is wanting, as none of the morbid secretions from the bodies direct were used for inoculation experiment; but in view of the fact that careful chemical analysis excluded the possibility of simple poisoning, and having due regard to the pathogenic effects of the bacillus they isolated, they consider they are justified in ascribing the deaths to infection by their bacillus. The authors give a critical analysis of 31 recorded instances of poisoning after ingestion of various contaminated food-stuffs, and append a bibliography of the subject.

Streptococcus of Scarlet Fever.*—M. H. Gordon describes the *Streptococcus scarlatinæ*, and gives the points which differentiate it from the ordinary *Streptococcus pyogenes*. He specially mentions the marked tendency to the formation of oval and rod-shaped individuals as compared with the strictly spherical shape of the *S. pyogenes*. The *S. scarlatinæ* upon gelatin and agar also grows more slowly, and has a somewhat different appearance; it clots milk, producing a strongly acid reaction in the course of its growth, and finally it is less virulent to white mice.

The author bases his description upon ten strains isolated from the tonsillar mucus of ten cases of scarlet fever; in three cases the organism was also associated with the *S. pyogenes*. He considers that the streptococcus of Baginsky and Sommerfeld, and also that isolated by Class, may simply be varieties of this *S. scarlatinæ*.

Bacteriology of Scarlatina.†—M. H. Gordon details his investigations into the bacteriology of scarlet fever, during which he isolated an organism, the *Streptococcus scarlatinæ*, from each of the ten cases he examined between the 2nd and 34th days of the disease. The streptococcus isolated from five of these cases was virulent for the mouse, and in three cases examined on the 2nd, 3rd, and 4th days respectively it was associated with a virulent strain of the *S. pyogenes*. In four cases of suspected scarlatina investigated by the writer, two yielded evidence of the presence of the *S. scarlatinæ*, and later, desquamation proved their nature; the two remaining cases, in which the bacteriological examination yielded negative results, were not followed by desquamation.

The author isolated the *S. pyogenes* from the nasal discharge of five out of twelve cases of scarlatina, and from the aural discharge of five out of twelve cases of scarlatinal otorrhœa, and he therefore concludes that this organism plays an important rôle.

The technique adopted in isolating the organism was to collect tonsillar secretion in a calibrated loop holding about $\frac{1}{500}$ ccm. Two such loopfuls of the secretion were added to 2 ccm. sterile salt solution and varying quantities of the dilution, equivalent to from $\frac{1}{300000}$ ccm. to $\frac{1}{3000000}$ ccm. inoculated on to inspissated horse's serum.

In concluding his paper, Gordon suggests that the *S. scarlatinæ* occupies a position in the bacteriological kingdom between *S. pyogenes* and *B. diphtheriæ*.

* Brit. Med. Journ., 1902, ii. p. 445.

† Local Gov. Board Repts., 1900-1901 (1902) pp. 353-404.

Bacteria and Hemp.*—V. Peglione refers to a paper published in 1896, in which he described a diseased condition of the stalk of the hemp, characterised by disorganisation of the cuticle and the cortical testa, and by the presence in the altered tissues of a micro-organism resembling the *B. cubonianus*. The specificity of this pathological manifestation has been since doubted, chiefly on account of the fact that the macroscopical appearances of the lesion may be confused with those produced by hail, and the author regrets that he has had no opportunities of settling this particular point.

He has observed numerous hemp plants, grown in unfavourable conditions (e.g. imperfect preparation of the soil or late sowing, followed by bad climatic conditions), in which numerous leaves, and sometimes the top or tuft of the plant, exhibit a condition termed by the peasants "*brusone*." These leaves are marked with spots of irregular form, at first yellowish, afterwards becoming black, and in a few days affecting the greater part of the surface of the leaf, and at the same time the leaf-tissue becomes dry and fragile. When this stage is reached, some of the leaf-veins may become wrinkled or warped; the peripheral part of the spot presents a light colour and an indistinct edge, as is observed in the spots produced by moulds. When the spots reach a certain size, the dry tissues split and separate, producing perforations. Placing the diseased leaves upon discs of blotting-paper, enclosed in Petri's dishes, a slight moisture is observed in those parts of the paper under the spots on the leaves in a few hours, and soon after large yellow drops appear, which microscopically show pure colonies of diplococci.

Sections of the leaves, hardened in alcohol and treated for a time with dilute solution of caustic potash (afterwards neutralised by lactic acid), show colonies of micro-organisms in the intercellular spaces of the tissue, especially abundant in the peripheral parts of the spots and on the limits of sound tissue. The bacteria are found principally in hemp of stunted growth, especially when the soil has been insufficiently prepared, and it is frequent in plants grown in "crude" soil. Climatic conditions also exert a decisive influence on the spread and severity of the infection, this year the condition being quite common. The author has not yet determined the behaviour of the microbe outside the plant, or whether it is identical with the *B. cubonianus*.

Bacteriology of Human Fæces.†—A. Klein records some of the results of his researches to determine the total number of bacteria present in the human fæces. His conclusions may be briefly summed up as follows:—

(1) Healthy adults excrete much greater numbers of bacteria in the fæces every 24 hours than had hitherto been suspected, amounting to 8800 milliards, responsible for 0·31 p.c. of the solid matter of the fæces.

(2) Of these, however, only about 1 p.c. are living and capable of multiplication if transferred to suitable media: the remainder are dead.

(3) Anti-bacterial action can be demonstrated in most fæces, the bacterial power, even outside the body at 37° C., often diminishing the number of living germs, or at least inhibiting their growth.

* *Atti Reale Accad. Lincei*, xi. (1902) pp. 32-4.

† *Proc. K. Akad. Wetenschappen te Amsterdam*, May 25th, 1901.

Bacillus Coli in Dysentery.*—M. Lesage draws attention to the rarity of the *B. coli* in the fæces during the early stage of dysentery, a fact first noted by Le Dantec. He distinguishes three stages in typical dysentery, and states that out of 26 cases examined in the first stage he was only able to detect typical *B. coli* in 6, and from 63 cases in the second stage he isolated the organism 18 times. On the other hand, from every case in the third stage he obtained cultivations of the colon bacillus. The organisms isolated from cases in the first two stages were usually members of the *paracoli* group, and characterised by their inability to coagulate milk, and absence of odour from the cultures. He further states that by cultivating the paracolon bacillus upon potato through a number of generations,—the number of sub-cultures varying with the variety of potato,—the power of coagulating milk was regained, and the peculiar odour of the *B. coli* again made its appearance in the cultures.

Cereal Products and Bacteria.†—E. Klein and A. C. Houston, who showed in a previous report that some grains, also cereal products such as wheat-flour, contained not only saprophytic bacteria but also members of the coli group and spores of the *B. enteritidis sporogenes*, have continued their researches in this direction by cultivating various pathogenic microbes (*B. typhosus*, *B. diphtheriæ*, *B. pyocyaneus*, and the *Staphylococcus aureus*) in a medium composed of wheat-flour, rice-flour, and oatmeal respectively, to which sterilised water had been added in the proportion of 9 ccm. to one gram of flour. As the result of numerous experiments the authors state that the *B. typhosus* could be recovered as late as 25 days, and the *B. pyocyaneus* 29 days, after sowing in rice-flour and water. When planted in wheat-flour and water the respective figures were 5 days and 14 days. The *Staphylococcus aureus* was recovered as late as the 24th day from oatmeal and water. The *B. diphtheriæ* appears to die out rapidly in these media, and is not recovered later than the third day, whilst the *V. cholerae* did not appear to survive beyond the sixth day.

Antagonism of the Soil to the Bacillus typhosus.‡—S. Martin has investigated the factors concerned in the destruction of the *B. typhosus* when that organism is introduced into the soil. The method he adopted was to isolate a common non-putrefactive bacillus from the soil,—*B. ramificans*,—and to inoculate it simultaneously with a *B. typhosus* recently isolated from a human source, into sterilised soil; incubate portions at 22° C. and at 37° C., and examine at frequent intervals to ascertain the result of the mixed infection. Control experiments were made in which diluted peptone broth was inoculated with these two organisms and similarly incubated. In this series of experiments it was found that in the soil the *B. typhosus* had undergone considerable diminution in 26 days, and could no longer be recovered after about 33 days: in the liquid medium, diminution of the *B. typhosus* was noted in 45 days, and its extinction in 72 days. This latter observation was repeated in a slightly different manner. The peptone broth was first inoculated with the *B. typhosus* and was incubated at 37° C. for several

* Comptes Rendus, cxxxv. (1902) pp. 403-5.

† Local Gov. Board Repts., 1900-1901 (1902) pp. 310-27.

‡ Tom. cit., pp. 487-511.

days before the *B. ramificans* was added to the medium: the final result, however, was unaltered, as 52 days later the *B. typhosus* was extinct.

Martin further cultivated the *B. ramificans* alone and in association with the *B. typhosus* in flasks of dilute peptone broth for about 10 weeks: the cultivations were then filtered through porcelain filters and each sterile filtrate inoculated with the *B. typhosus*. Three days later, however, the *B. typhosus* was extinct. The filtrates from cultivations prepared by inoculating fluid media with ordinary soil were likewise inoculated with the *B. typhosus* with identical results.

Manual of Determinative Bacteriology.*—Determinative Bacteriology is the title chosen by F. D. Chester to designate a collection of short descriptions, obtained from the original sources, of over seven hundred recorded species of bacteria. The work is intended to serve as a laboratory manual to aid in the identification of unfamiliar organisms, and in the preface it is stated that "with the use of the present manual it is believed that the teacher can place a given culture in the hands of his pupil and expect him to determine it."

In the first 42 pages of the book the author briefly summarises what is known of the cell-structure of bacteria, and elaborates a scheme of terminology to be employed in describing the naked-eye characters of artificial cultivations, which if universally adopted would not only simplify and condense but would also lead to a much-to-be-desired accuracy and uniformity in such descriptions.

He also discusses the important subject of nutrient media, their preparation, composition, and, more important still, their reaction, a few standard methods of staining, and some points in the observation of the chemical functions of bacteria. Two pages are devoted to an outline scheme for the complete study of any given organism, adapted from the report of the Laboratory Committee of the American Public Health Association, the author urging upon the student the necessity for the careful, systematic, and complete study of species.

Chapter III. is devoted to the classification of bacteria, and insensibly glides into the main portion of the book,—the descriptions of species. Of the compilation of descriptions, scanty though they of necessity are, having regard to the paucity of detail in many of the original descriptions, we must express unqualified admiration, whilst the full synonymy and the excellent index render the work a handy reference book for the laboratory bookshelf.

BIBLIOGRAPHY.

- ERNST, P.—Ueber den Bau der Bakterien.
Centrabl. Bakt., 2^o Abt., VIII. (1902) pp. 1-7, 34-6, 65-73, 97-107.
- JENSEN, O.—Studien über das Ranzigwerden der Butter.
Centrabl. Bakt., 2^o Abt., VIII. (1902) pp. 11-6, 42-6, 74-80, 107-14,
 140-4, 171-4, 211-6, 278-81, 309-12, 342-6, 367-9, 406-9.
- WILL, H.—Die Farbe des Bieres und die Hefe.
Centrabl. Bakt., 2^o Abt., VIII. (1902) pp. 7-11, 36-42.

* F. D. Chester; Macmillan and Co, London and New York, 1901, 8vo, 401 pp. and 13 figs.

MICROSCOPY.

A. Instruments, Accessories, &c.*

(1) Stands.

Swift's "Ariston" Fine Adjustment.—J. Swift and Son claim that their new fine adjustment (fig. 129) entirely eliminates the side-movement which occurs in so many instruments when the micrometer-screw is put in motion. The accompanying illustration, which gives a

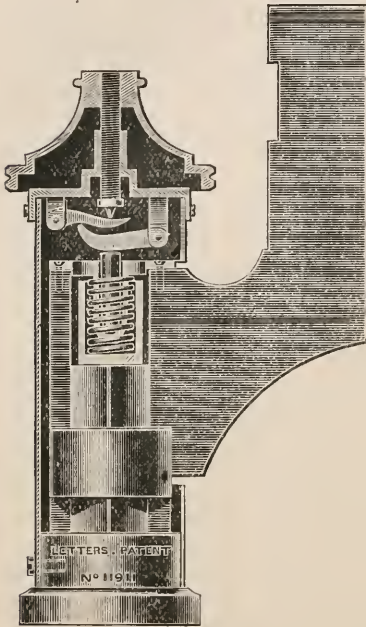

FIG. 129.

sectional view, shows how the principle of the apparatus has been worked out. The milled head of the screw is isolated and supported on an independent tube fixed to the base-piece. The only point of contact of the micrometer-screw is its fine point bearing upon the top of the fine adjustment. The advantages claimed for the Ariston fine adjustment are that even with a coarse screw a very slow rate of speed and extremely delicate focussing are obtained; that it is practically impossible for it to get out of order, and that the micrometer-screw is entirely disconnected from any of the fittings likely to produce movement when the milled head is touched.

SCHAEFFER, W.—Mikroskope.

[A popular introduction to the instrument.]

Forms Bändchen 35 of the series "Aus Natur und Geisteswelt," B. G. Teubner, Leipzig.

(2) Eye-pieces and Objectives.

Berger's Stereoscopic Loups. †—E. Berger has arranged a combination of stereoscopic loups which seems likely to be of considerable service to miniature painters, lithographers, microscopists, watchmakers, and others who are interested in delicate handicraft. The author thinks it offers many advantages over the present watchmaker's lens. In the construction two of Berger's decentric lenses inclined to one another in the horizontal meridian are used. The inclination is so arranged that the light rays do not fall at too great an angle on the strongly prismatic

* This subdivision contains (1) Stands; (2) Eye-pieces and Objectives; (3) Illuminating and other Apparatus; (4) Photomicrography; (5) Microscopical Optics and Manipulation; (6) Miscellaneous.

† Central. Zeit. f. Opt. u. Mech., xxiii. (1902) pp. 145-6 (3 figs.).

parts of the lenses. The loupes are fitted up in a sort of camera, which may be worn over the eyes and secured by a band behind the head.

Zeiss' Improved Algascope.*—A "No. 1 Combination Lens" is fitted to a sliding sleeve, to which a small stage with spring object-holders is attached. In this form the lens is known as the "improved Algascope."

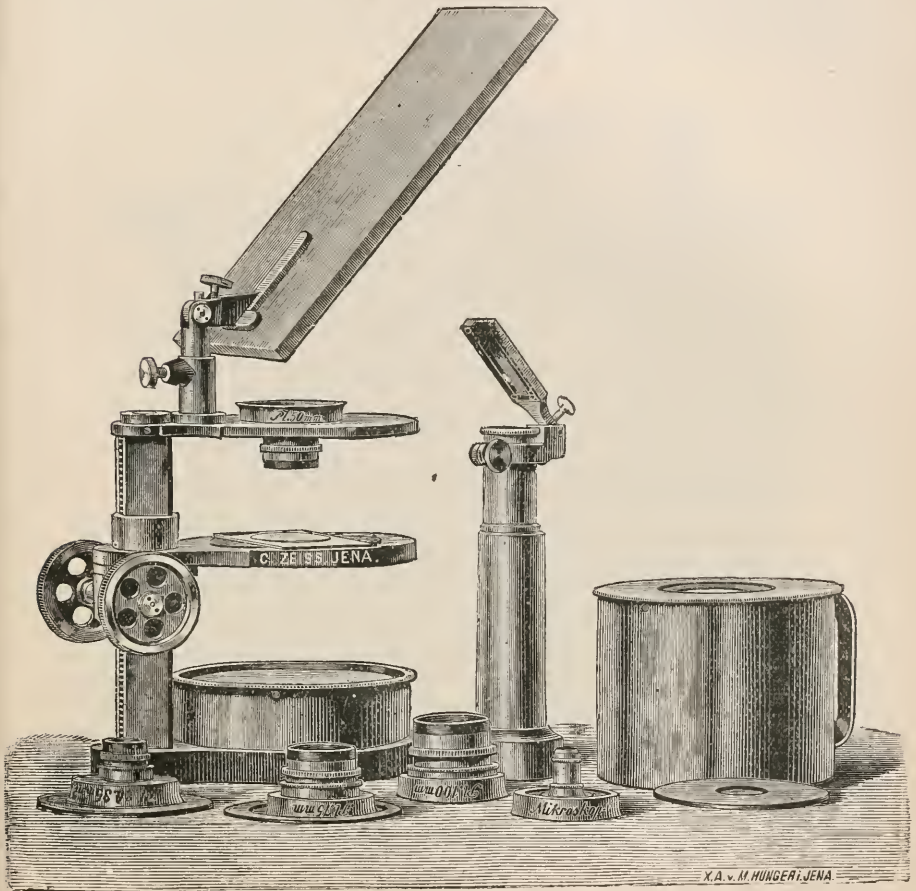

FIG. 130.

The "combination lens" consists of three achromatic lenses combined with an achromatic dispersion lens, which also serves as an eye-piece. The magnifications obtainable from different members of the series vary between 11 and 100 diameters.

(3) Illuminating and other Apparatus.

Zeiss' Epidiascope.†—This is an apparatus for the projection of objects lying in a horizontal position. It employs reflected light in

* Catalogue, English edition, 1902, p. 23.

† Special Catalogue.

the case of opaque, and transmitted light with transparent (or at least translucent) objects. As compared with Zeiss' projection apparatus with an optical bench (Catalogue, No. 249) it possesses the following characteristic advantages:—(1) Greater latitude in the shape and size of objects; (2) when reflected light is used, the illumination is more perfect; (3) transition from operation with reflected to transmitted light is effected with greater speed and convenience; (4) the apparatus is easily adjusted for projection obliquely upwards; (5) the several com-

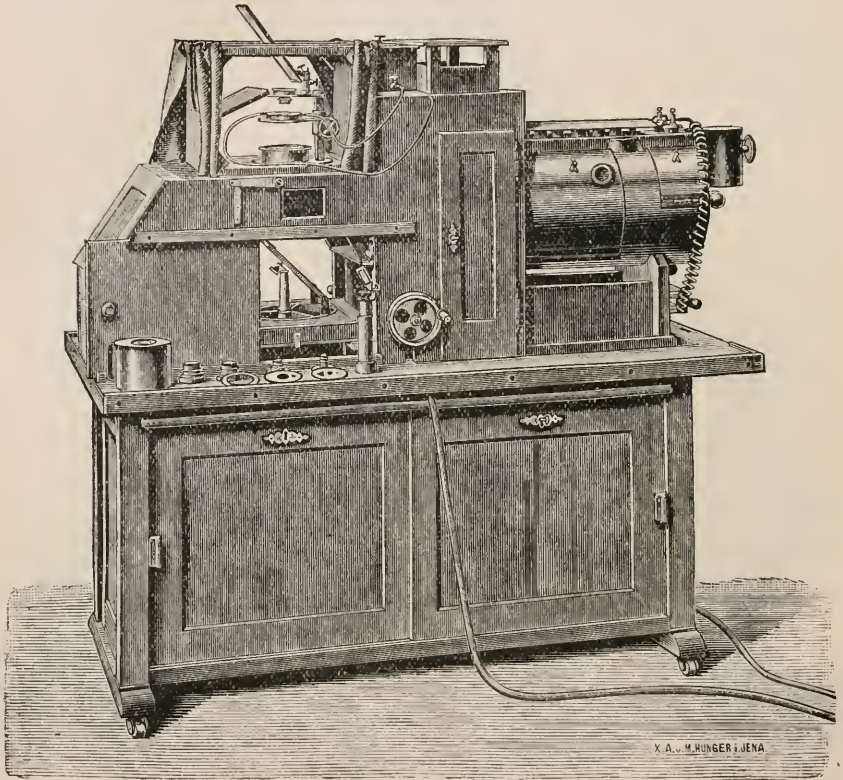

FIG. 131.

ponent parts are better protected against dust and improper usage. On the other hand, owing to the absence of the optical bench, the epidiascope lacks somewhat the manysidedness of application so characteristic of Zeiss' other projection apparatus. The epidiascope is about 4 ft. 11 in. in length, 2 ft. 6 in. in width, and about 4 ft. 11 in. high. The height is so calculated that a person standing on the floor at the side of the apparatus may be able to work it with ease and comfort. The source of light used is a search-light lamp adjusted for a current of 30 or 50 amperes. The objective supplied cannot be exchanged for one of differ-

ent focus without special adaptation. Hence the degree of magnification can only be varied by altering the distance between the apparatus (which is placed on casters) and the screen. With the small search-light the magnification of a uniformly illuminated area of 9 sq. in. is magnified 9 diameters; but smaller objects may be magnified up to 25 diameters. With the larger lamp the magnification varies from 14 to 37 diameters. An opaque screen is recommended for the projection and may be prepared as follows:—A wall space, or a paper or linen screen, is painted

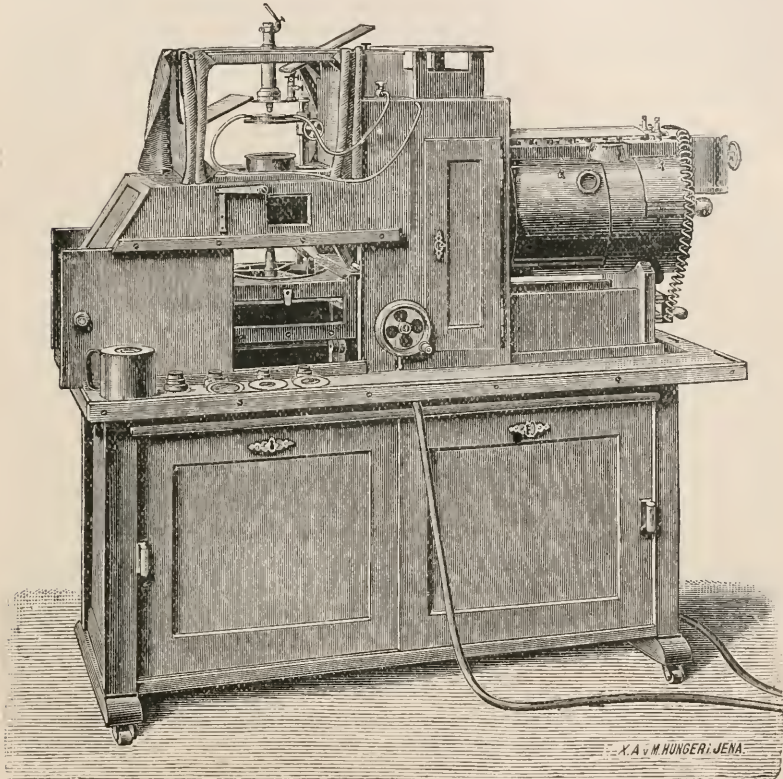

FIG. 132.

with white zinc, prepared with water and size, and dusted over with powdered chalk just before the coat of paint becomes dry. Such a colouring can be easily renewed when necessary.

When reflected light is used the light emitted by the crater of the positive carbon falls upon the parabolic mirror of the lamp and is thence reflected in the shape of a nearly cylindrical pencil. It next passes through the cooling chamber (which is filled with water and performs the function of absorbing heat rays), then strikes a mirror and is by it reflected obliquely through the diaphragm and upon the object imme-

diately below. From the object the light is diffusely reflected upwards. Of the reflected rays, only those which are confined in their passage to the space marked off by the dotted lines reach the objective. The cone of rays travelling upwards through the objective meets the erecting mirror and is finally reflected upon the screen.

When transmitted light is used the mirror previously employed is turned back so as to allow the pencil of rays to pass to a second mirror. From there it is reflected obliquely downwards upon a third mirror, which again reflects it vertically upwards into the condensing lens situated below the object-stage. On leaving the condenser, the rays of light pass through the transparent object and form a reduced image of the search-light reflector near the projection objective. They next pass through the objective and meet the erecting mirror. The latter is fitted with a regulator. The position of the mirror is that required for projecting the picture obliquely upwards.

Fig. 130 represents the simplified Microscope with a planar lens in use. Fig. 131 shows the whole epidiascope and the simplified Microscope attached to it when used with a planar lens. Fig. 132 gives the epidiascope with the simplified Microscope provided with an ordinary microscopical objective and ocular.

Projection Microscopes using Electric Arc or Oxyhydrogen Light.*—A. H. Cole points out that the utility of projection Microscopes depends upon the degree of success with which three practical problems are solved:—(1) A light of intense brilliancy must be produced and kept in the optical axis; (2) the system of condensers must collect the largest possible percentage of light rays from the luminous point and deliver them at the proper angle of convergence for each of the objectives used; (3) the apparatus must not be too cumbersome or complicated, or too expensive for ordinary use. Fig. 133 shows the author's attempt to solve these problems, the body being rotated upwards on the top of the plate and held in position by a slender support so as to give a clear view of the 90° arc lamp and electrical connections. The base-board is cut away under the lamp so as to permit the use of long vertical carbons. At the rear end and right side of the board is placed the switch in the most convenient position for use. On the opposite side of the board is the fuse-block. At the right of the fuse-block, as seen in the illustration, are two binding-posts connected with the fuse-block by two twisted flexible wire cables. From the other end of the fuse-block two similar cables connect with the binding-posts of the knife-switch. When the electricity is turned into the lamp by closing the switch, it passes to each carbon through the cables connected with the right-hand binding-posts of the switch. The arc is formed between the proximate ends of the carbons, which are shown on an alternating current of 110 volts, and in about the proper adjustment to develop the maximum power of the lamp. The carbons are fed together or singly by turning both feed-wheels at the end of the horizontal shaft below the horizontal carbon at the same time, or either one alone, as needed. The entire lamp may be elevated, or lowered, and rotated to the right or left, and moved along the base-rods and clamped in any position.

* Journ. App. Micr., v. (1902) pp. 1892-3, 2012-3 (1 fig.).

The available light is derived from the end of the horizontal carbon and falls directly into condenser number one, then passes through condenser number two, both of which are in the condenser-cell attached to the front of the plate. The light next passes through the water-tank, then through condenser number three, which is attached to the tank, then passes to the substage condenser if high-power objectives are being used, next through the object mounted on the stage of the Microscope, then through the objective, and, lastly, through the amplifier and falls upon the screen. The substage condenser is not used with low-power objectives, as it produces a cone of rays with too wide an angle. The amplifier is a single plano-concave lens of 5 or 6 in. focal length and may be used with any objective to increase the magnification of the

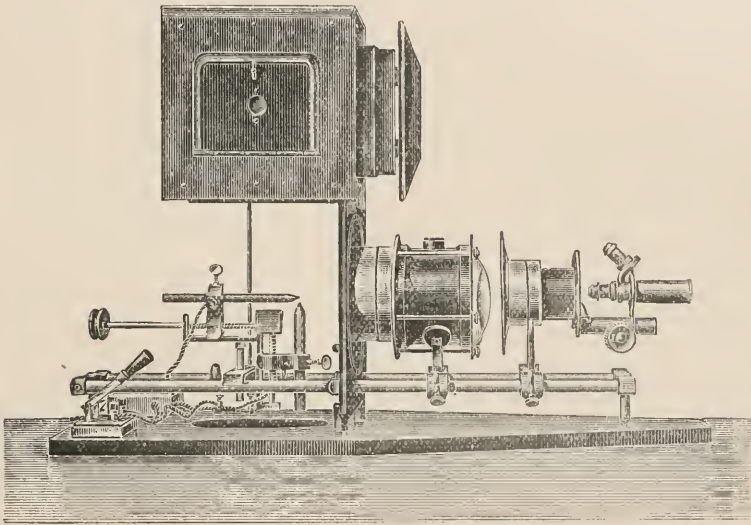

FIG. 133.

image on the screen. It is preferable to a regular microscopic ocular, as it intercepts less light.

In working with high-power objectives it is necessary to bear in mind that the field is sometimes only one-fiftieth of an inch in diameter, and that perfectly uniform illumination is essential for successful work. By observing an arc through smoked glass, or through a combination of two plates of deep ruby and blue glasses, it is readily seen that the arc creeps about on the ends of the carbons as they are slowly consumed. The luminous point consequently varies in position. This difficulty may be overcome in three ways:—(1) By using soft-cored carbons; (2) by using as small a horizontal carbon as possible in combination with a larger vertical carbon; (3) by moving the luminous point into the optical axis by a slight vertical or lateral movement of the arc. To accomplish the last, the vertical supporting rod of the lamp should not

be clamped rigidly, and a slight lateral push on the feed-wheels will rotate the lamp on its support. Small carbons burn away more rapidly than large ones, and the feed requires more frequent attention. The carbons shown in the engraving are $\frac{7}{16}$ and $\frac{9}{16}$ in. in diameter, "Nürnberg soft-cored Electra brand." In the highest power work which the author has done with the electric light, a very steady light was obtained by using a $\frac{9}{16}$ in. cored vertical and a $\frac{5}{16}$ in. solid horizontal carbon. The light from a 110-volt alternating incandescent current was sufficient to give a strong picture of a stained transverse section of an earthworm having a magnification of 8800 diameters by measurement. The objective used was a B and C $\frac{1}{2}$ -in. oil-immersion in connection with an amplifier. The conditions just described will indicate the reason for the use of hand-fed 90° arc lamp rather than for other types of hand-fed lamps or for any of the automatic-fed. The automatic-fed lamp is convenient in very low power and lantern slide projection, but here also the 90° lamp gives as good results. Concerning the field of illumination on the screen, it should be noted that, if the Microscope is pushed too close to the lamp, the field will be blue and will not give satisfactory results. As the Microscope is moved to a greater distance from the lamp, the centre of the field will be strongly illuminated, and at a still greater distance the entire field will be evenly illuminated, and this is the best position for all objects except the most difficult, which may require the strong central illumination. The system of condensers is of the utmost importance, and the best combination consists of three plano-convex condensers, each $4\frac{1}{2}$ in. in diameter, and arranged as follows:—No. 1, a plano-convex lens of about 5 in. focal length with its plane side next to the light; No. 2, a plano-convex lens of $6\frac{1}{2}$ in. focal length with its convex side facing the convex side of No. 1, and enclosed in the same cell with it; No. 3, a plano-convex lens of about 11 in. focal length and attached to the water-tank with its convex side facing the Microscope. A simple plano-convex substage condenser of $\frac{3}{8}$ in. focal length is a necessity in high-power work with the above condensers, but its efficiency varies with its distance from the object. The correct distance for each objective should be determined by experiment and recorded for reference. All the above directions for the electric light apply equally well to the oxyhydrogen, in which the luminous point is constant: but the less intense light materially reduces the available magnification.

Method of Measuring Objects in the Microscope.* — F. E. Ives proposes a simple arrangement for stage measurement. In fig. 134, A represents the foot of the Microscope; B is a block of wood notched to fit against the foot and project in a particular direction; C is a rider with set-screw and a post, and spring-clamp D to hold a jeweller's saw having sixty-four teeth to the inch; E is the Welsbach light diffused by a ground-glass chimney and shielded from the eyes by a hood open only on the side towards the Microscope. The source of light being on a level with the Microscope, the jeweller's saw is supported in a vertical plane directly between the light and the Microscope mirror, and in this position its image can be focussed in the field of the Micro-

* Journ. Franklin Inst., cliv. (1902) pp. 73-6 (3 figs.).

scope by slightly racking back the condenser. The image of the saw-teeth constitutes the measuring scale which can be given any desired value, within limits, by adjusting its distance from the Microscope mirror and comparing the focussed image with the scale on a stage micrometer. When the scale is not wanted the block is pushed aside and can be replaced in an instant. An engraved scale on glass, or celluloid, could be substituted for the saw.*

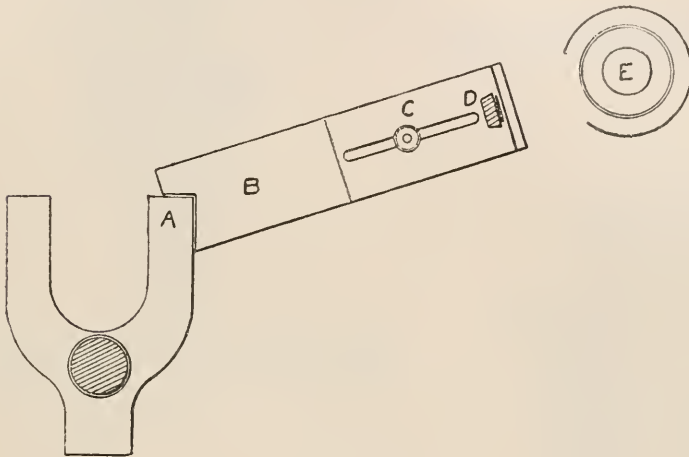

FIG. 134.

Form of Vertical Camera and its Uses.† — J. Reighard has arranged an apparatus for photographing such objects as the eggs of *Amia*, which are some 2 mm. in diameter, spherical and opaque, and must be photographed under liquid with a vertical camera. He used Zeiss' larger photomicrographic camera, which is made in two sections so that the front section alone may be employed where a short bellows is desired. The camera was attached by means of clamps to an iron frame consisting of two iron rods held together by cross bars at the ends and middle, and the length of the bellows could be varied by the adjustment of the clamps. The frame could be slid backwards and forwards in four grooved supports screwed to the top of an iron stand: this top was a heavy I-shaped casting bolted to the rest of the stand. A fine adjustment was secured by the following device:—Alongside the camera frame (on the left) at a distance of 5 cm. from it runs a vertical wooden rod 3 to 4 cm. in diameter (fig. 135); this rod is pivoted at its upper end to the ceiling near the first pulley wheel, and at its lower end it is pivoted on a wooden bracket which extends from the wall just below the board to which the iron base-plate is attached; the rod is thus within easy reach of a person focussing the camera, and turns freely; its upper end for about 6 cm. is formed into a spool and

* This is a variant of the ghost micrometer described by Dr. Goring in 'Micrographia,' 1837, p. 51. It has since been re-invented many times.

† Journ. App. Micr., v. (1902) pp. 1782-90 (7 figs.).

about it the rope running to the counterpoise makes one turn; the remainder of the rod is octagonal; by turning the rod with the hand the camera may be moved up or down with great delicacy, while the rod offers no hindrance to the direct and more rapid movement of the camera by hand.

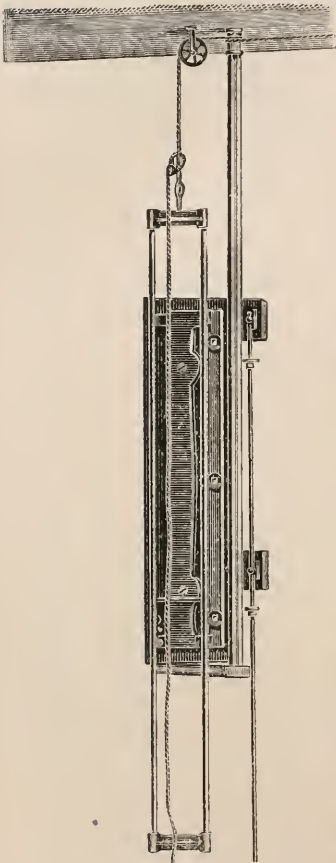

FIG 135.

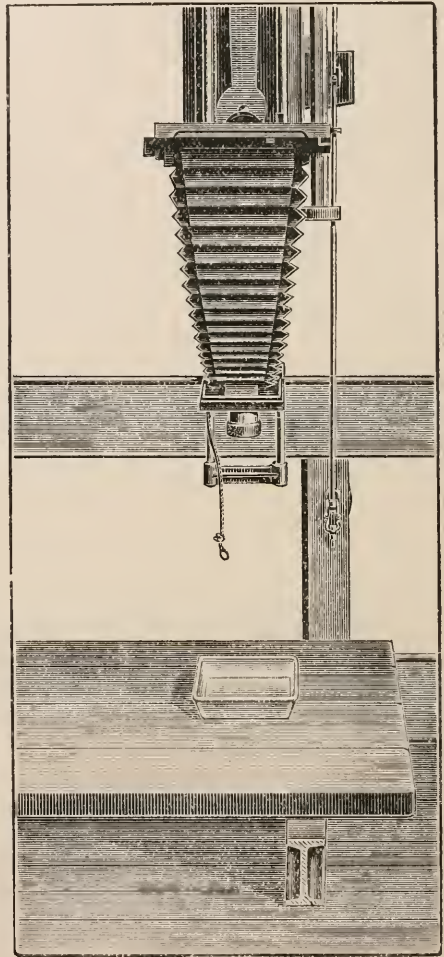

FIG. 136.

Fig. 137 shows the apparatus fitted to the Microscope, the illumination being provided in this case by a Thomson 90° arc lamp, lantern-condenser, and alum-cell. The Microscope must be attached to a levelling plate which is a cast-iron slab 17 by 25 mm. and 6 mm. thick.

with truncated rectangular pyramidal feet 8 mm. high at the corners; these feet are pierced by levelling screws. The slab is provided with ear-like projections extending from either end through which the plate may be screwed to small iron plates set into the floor. The upper surface of the levelling plate is provided with stops against which the base of the Microscope fits, with felt pads for the instrument to rest on; it has also a binding-screw by means of which a metal strip is clamped across the base of the Microscope to hold it to the plate (fig. 138). To the end of the plate at the back of the Microscope is attached a socket from which rises an iron rod 12 mm. in diameter, and vertically adjustable by a thumb-screw in the socket. At the top of this rod is a cross bar for bearing a pair of pulley-wheels, which may be set at any point on the backwardly projecting limb of the cross bar. An iron rod 11 cm. long and 5 mm. in diameter is attached to one end of the axis of the pulley by means of a Hooke's joint. Supported from the wall by two brackets alongside the camera is a vertical metal rod which extends from the level of the coarse-adjustment screws to the uppermost camera support (fig. 137). This rod is provided with two adjustable milled heads, which may be set at any point so as to be within easy reach. At the lower end of the vertical rod is a third bracket which supports a bevel gear whose cog-wheels are each about 3 cm. in diameter (fig. 138). The upper wheel is attached to the vertical rod, while to the lower is attached, by means of a Hooke's joint, an iron rod like that attached to the axis of the pulley-wheel, but only 3 cm. in length. When the levelling plate is in position these two iron rods may be united by means of a brass sleeve in which there are two screws (fig. 138). The Hooke's joints give this connection a certain degree of flexibility, and so permit of considerable movement of the levelling plate and of adjustment of the pulley-wheels on the cross bar. When the connections have been made, the coarse adjustment of the

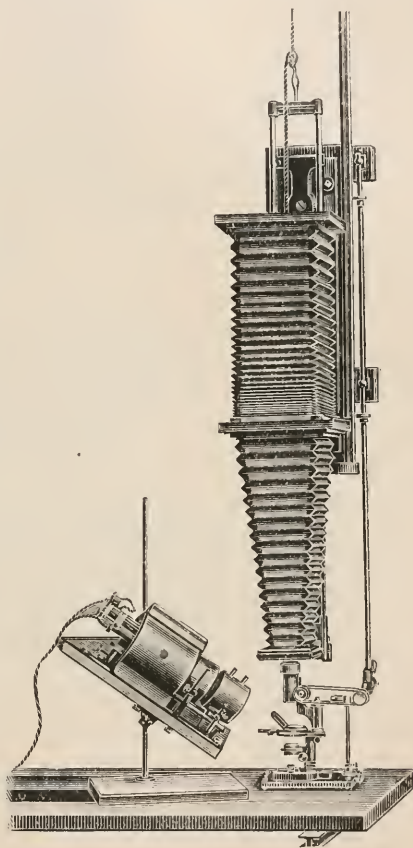

FIG. 137.

Microscope may be manipulated by an operator looking at the ground glass of the fully extended camera. The coarse adjustment is to be

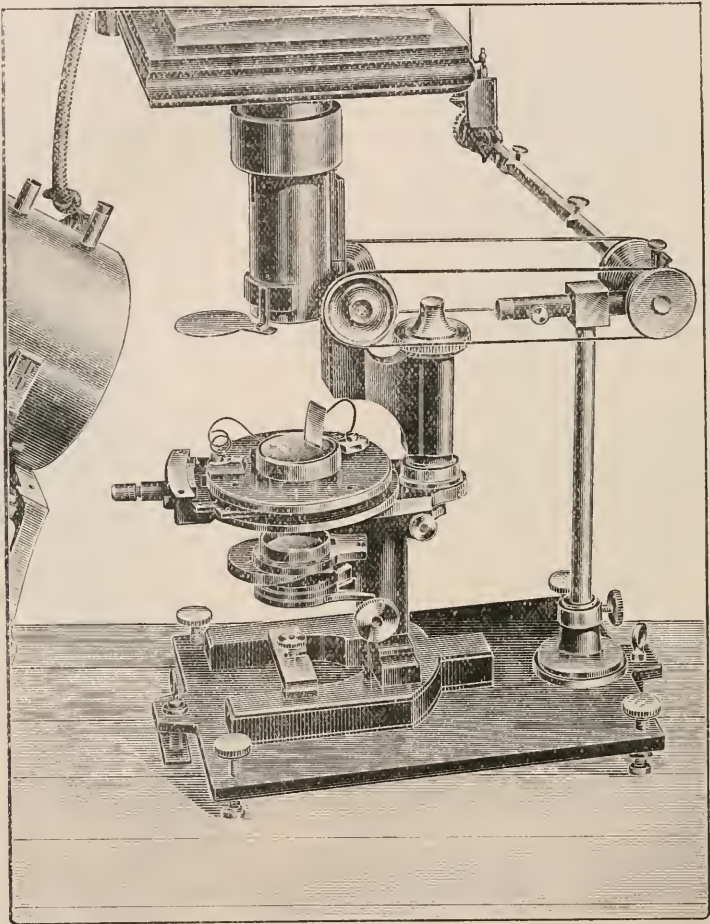

FIG. 138.



FIG. 139.

preferred for all work with very low powers. If high powers are to be used the focussing rod and Hooke's joint may be attached to the limb

of the cross bar, opposite that which carries the pulleys, and by means of these the fine adjustment may be turned from a distance.

A flat opaque object, such as a chick blastoderm, may be brought into the focal plane of the objective by the following device (figs. 138 and 139):—To the centre of a brass plate of the size and form of the Microscope stage is soldered a flat brass ring 40 mm. in diameter and 9 to 10 mm. high, thus forming a shallow pan in the centre of the brass plate; to the centre of one face of a small brass disc 30 mm. in diameter, a brass ball of about 6 mm. in diameter is attached by a stem 2 mm. long; this ball is received into a socket between the lower face of the brass pan and a small brass disc screwed to it, and this socket is packed with oiled leather; the small metal plate then forms a sort of false adjustable bottom within the pan, which is filled with alcohol and placed on the Microscope stage; the specimen is then placed on the false bottom which is tilted until the specimen lies as nearly as possible in the focal plane of the objective. The brass plate may be provided with holes by means of which it may be attached by pins inserted into the clip-holes of the Microscope stage.

(4) Photomicrography.

BAGSHAW, W.—*Elementary Photomicrography*. London, 1902, 70 pp. and 6 pl.
 MARKTANNER-TURNERETSCHER, G.—*Wichtigere Fortschritte auf dem Gebiete der Mikrophotographie und des Projektionswesens*.

[Gives a very complete *résumé* of international progress in photomicrography.]
Jahrb. f. Photographie und Reproduktionstechnik für das Jahr 1902, Halle;
 also in pamphlet form, 21 pp. and 5 figs.

(5) Microscopical Optics and Manipulation.

KRAFT, C.—*Études expérimentales sur l'échelle des couleurs d'interférence*.

[The author describes the mapping out of the colours of various spectra in connection with the corresponding wave-lengths.]
Bull. Int. Acad. Sci. Cracovie, No. 5 (1902) pp. 310-53 (4 pls.).

(6) Miscellaneous.

Chambers and Inskeep's Improved Ophthalmometer.*—This instrument, for measuring the curvature of the cornea, possesses, as its special characteristics, stationary and luminous mires and adjustable prisms. These features give it, say its inventors, a distinct superiority over other forms of ophthalmometer.

Fig. 140 gives a rear side view of the instrument, and shows the adjustments for focussing, for perpendicular adjustment, and for moving the prisms. Fig. 141 presents the stationary mires and head-rest. The construction will be understood from fig. 142, which is a vertical section of the instrument. *d* is the outer tube mounted to rotate in sleeve or collar *s*, supported by standard *t*, the standard being swivelled in tubular support *g*; *k* is a diaphragm; *l* is the eye-piece, with suitable lenses *a* and *b*; *n* is a stationary disc borne on collar *s*, graduated to indicate angles of meridional deviation of plane of mires; *i* is a

* Chambers, Inskeep & Co.'s Special Catalogue.

pointer, or index finger, carried on angular bridge q of telescope-tube to point out angle on graduated scale; u is a black concave disc rotating with the tube d ; wv are the mires, made of translucent material; 12, 12 are hemispherical shells containing the light, connected with

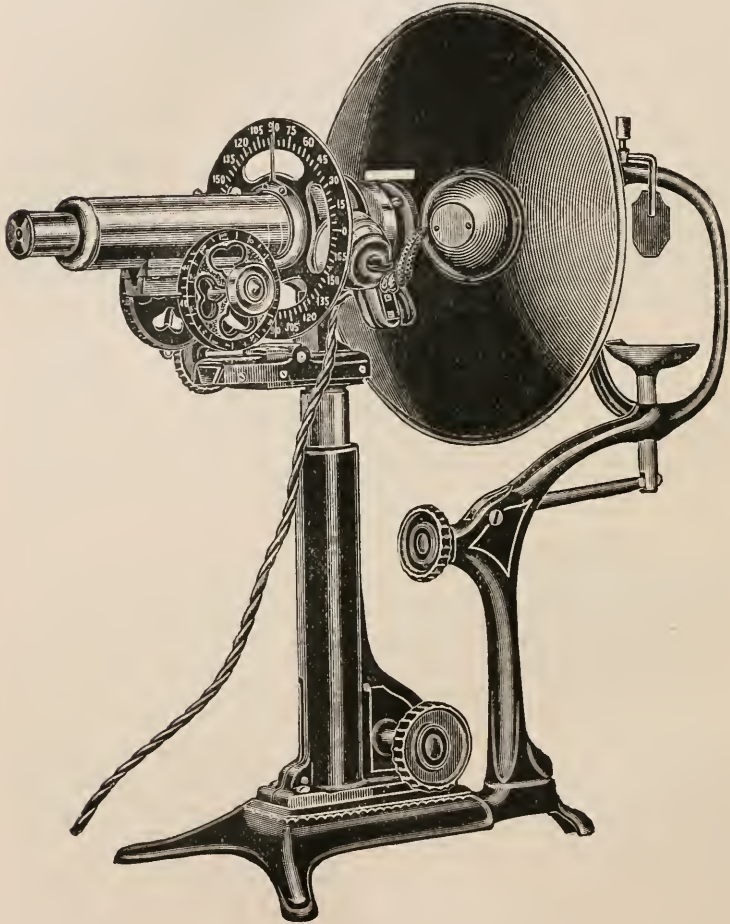

FIG. 140.

wires running from insulated rings in the hollow stem t ; f is the inner or sliding tube of telescope, carrying a prism hh , whose refractive plane is in the plane of the mires: this tube has a rack o attached thereto for moving it; this rack projects through a slot m , and is engaged by a pinion p , by which the inner tube is carried back and

forth in the outer tube. On the axis of the pinion is a milled head, for turning the pinion and discs in duplicate, graduated on outer edge and face with a scale in millimetres of radii and their equivalent in dioptries. The effect of moving the prisms longitudinally is to approximate or separate the images of the mires as seen on the cornea.

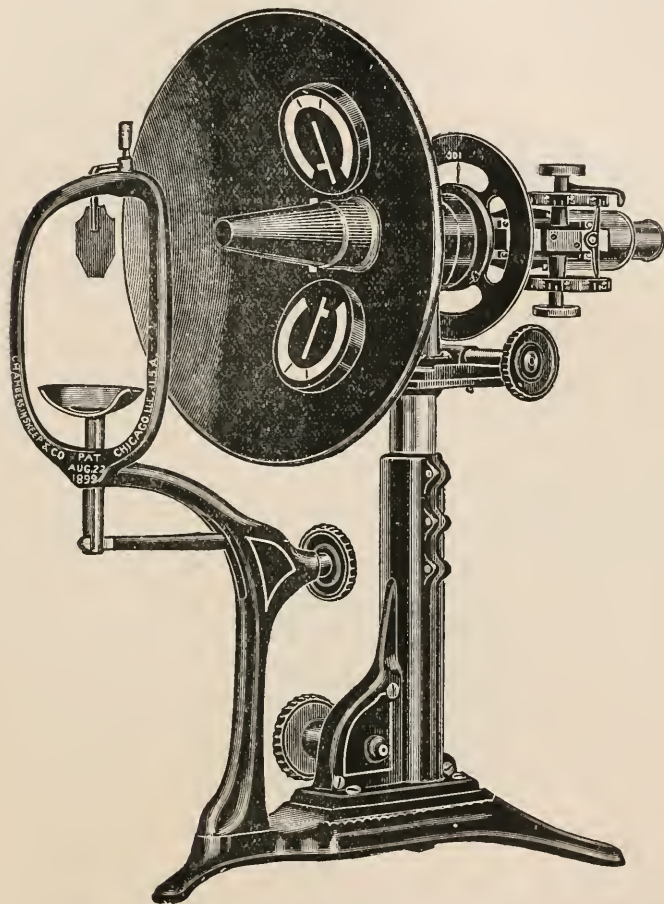

FIG. 141.

In using the ophthalmometer, the operator, after the necessary adjustments for height, obtains a clear image in the patient's eye of the mires by the focussing adjustment. He then turns the tube horizontally slightly to right or left until two images of the mires are seen in close proximity (fig. 143). An outer image may be seen on either side of the field of view, but these are always widely separated from the inner ones,

and are to be disregarded. The instrument is now revolved until the long meridian lines of the images show a single straight and unbroken one. If there is no astigmatism this condition will be seen at all axial

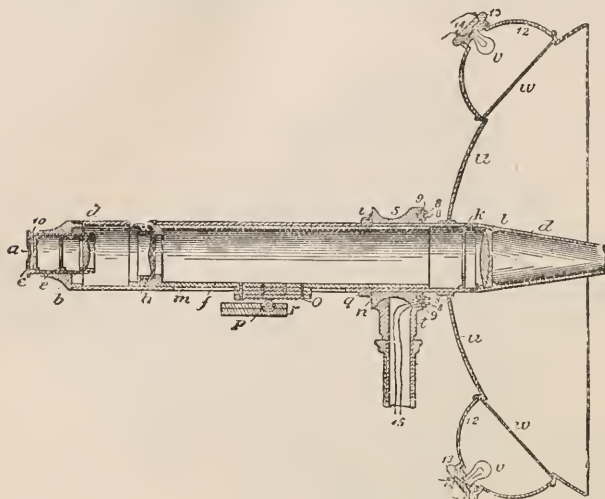

FIG. 142.

positions; if astigmatism, at but two positions. Directions are given for reading the variation of cornea curvature in dioptries and fractions.

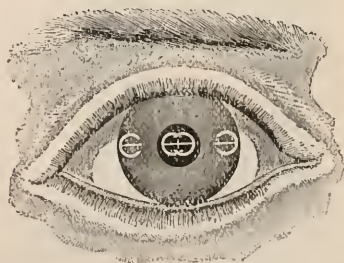

FIG. 143.

Interesting Extracts from Borelli. — The following passages, of which a literal translation is subjoined, occur in Borelli's Treatise on the Telescope and other magnifying glasses, viz. *De vero Telescopii inventore cum brevi omnium Conspiciliorum Historia. Authore Petro Borello. Hagæ-Comitum, 1655.* The copy of this work in our library is in fair condition, though two pages, including the portrait of the author, are wanting.

Book i. p. 10:—"And lastly the Microscope, or the fly or flea spy-glass, by which the flea and the fly rise to (the size of) the camel and the elephant, is made of two glasses included in a tube; the glass nearest

the eye is convex, and made out of a minute segment of a spherule, the diameter of which should be two inches; the other is a flat glass: it may also be made out of two convex (glasses), and this is better."

Book ii. p. 43:—"The third kind of tube is the Microscope for greatly increasing the size of small objects, as fleas, &c. This consists of two glasses and a tube of one inch (? long) or thereabouts, in which small bodies are placed. One glass, that nearest the eye, is convex (and) ground out of a minute segment of a sphere, the diameter of which is at most equal to two inches; the lower one near the bottom, on which the things to be looked at are placed, is merely a simple piece of glass flat on both sides.

"Or Microscopes are made of two convex glasses, reduced to the shape of the tube; one, which is directed towards the things to be looked at, is highly convex, and should be made from the segment of a small sphere; the other, which is applied to the eye, is somewhat flatter; of course the proportion to the things to be seen in it must be carefully considered."

B. Technique.*

(1) Collecting Objects, including Culture Processes.

Physical Properties of Gelatin, in reference to its use in Culture Media.†—G. C. Whipple made experiments which show that the character of the gelatin used in culture media has a most important influence upon quantitative and qualitative bacteriological work, and that for different observers to obtain results which may be fairly comparable, it will be necessary to use culture media made from one and the same lot of gelatin. It will be necessary also to follow a most rigid system in the preparation, sterilisation, and use of nutrient gelatin, in order that its physical condition may be the same in all cases. The chemical characteristics of different gelatins with reference to their use in culture media are not discussed, as investigations in that direction are not completed, but the effect of the physical condition of the culture medium on bacterial growth is pointed out. The viscosity, melting-point, and spissitude (jelly strength) of gelatin solutions are described, and a new form of spissimeter and a new method of stating the results of spissitude measurements are suggested.

Method of Cultivating Anaerobic Bacteria.‡—F. C. Harrison describes a method of growing anaerobes which is a combination of the pyrogallol method and a vacuum. Plates or tubes are placed in a bell-jar with stopcock at the top (fig. 144), and this connected with a vacuum pump. The bell-jar is sealed to the dish with paraffin. Pyrogallic acid is placed on the floor of the dish, and the apparatus shown in fig. 145 is inserted after having been filled with KOH or NaOH. The vacuum

* This subdivision contains (1) Collecting Objects, including Culture Processes; (2) Preparing Objects; (3) Cutting, including Imbedding and Microtomes; (4) Staining and Injecting; (5) Mounting, including slides, preservative fluids, &c. (6) Miscellaneous.

† Technol. Quart., xv. (1902) pp. 127-60 (14 figs.).

‡ Journ. App. Micr., v. (1902) p. 1974 (2 figs.).

causes the NaOH in the tube to siphon off, and the last remaining trace of oxygen is absorbed.

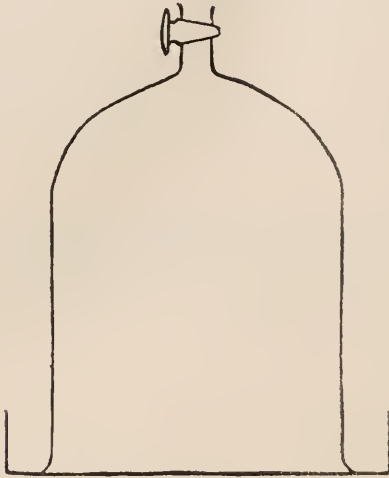

FIG. 144.



FIG. 145.

Eggs as a Medium for the Cultivation of *Bacillus tuberculosis*.*
M. Dorset finds that coagulated egg-albumen is an excellent medium for cultivating the tubercle bacillus. The white and yolk are mixed together and then distributed in tubes. The tubes are incubated at 70° C. for two successive days for four hours and simultaneously sterilised. A couple of drops of sterilised water are poured into each tube, and then the surface of the slope is inoculated with the tuberculous material. The cotton-wool plugs are saturated with paraffin, and the ends of the tubes filled in with paraffin.

Apparatus for Removing Pieces of Tissue for Microscopical Examination.†—T. L. Webb has devised an apparatus for removing pieces of tissue for histological examination by means of suction. The apparatus consists of a glass tube about $\frac{3}{8}$ in. in diameter, which is attached to an aspirator. When the aspirator is turned on some tissue is drawn up into the tube and then it is easy to snip off a piece.

(2) Preparing Objects.

Simple Method of Preparing Bone Sections.‡—H. G. Rosenberger first cuts rough sections with a saw and then inserts them in a cavity hollowed out of a piece of soft pine. The block is then held against a revolving grindstone, so that wood and bone are ground down together. As soon as the first side is well smoothed, the section is turned and the

* Amer. Med., iii. (1902) pp. 555-6. See Centralbl. Bakt., 1^{te} Abt. Ref., xxxii. (1902) p. 114.

† Journ. Brit. Dental Assoc., xxiii. (1902) pp. 438-40 (1 fig.).

‡ Journ. App. Micr., v. (1902) p. 1996.

other side ground until the desired thickness is nearly reached. The section is then removed and finished off on an oilstone or hone, and finally mounted in thick balsam.

Neurological Technique.*—A monograph containing the approved methods of examining nervous tissue has long been a desideratum. This want has been supplied by Irving Hardesty, whose work entitled *Neurological Technique* will be found of the greatest service by those who are engaged in studying or in teaching the histology of the nervous system. The sub-title (Some special histological methods employed for the study of the nervous system, together with a laboratory outline for the dissection of the central nervous system and the neurological nomenclature (BNA) arranged in a classified list) more closely indicates the general scope of this useful work.

The first part of the work deals with general considerations as to the need and action of reagents, and with general instructions in procedure. Then come fifteen methods for demonstrating the histological appearances of the central nervous system. These are followed by two methods for museum preparations, after which is a chapter on the fixation and preservation of human embryos and fetuses. The last two chapters deal with the application of formalin and with the dissection of the central nervous system. There is an adequate index.

(3) Cutting, including Imbedding and Microtomes.

Marble Blocks for Celloidin Tissues.†—E. C. Streeter recommends marble blocks instead of wood or cork for celloidin masses. He has given them a year's trial and is satisfied that they are very advantageous.

SLONAKER, J. R.—An Attachment to the Minot Microtome for cutting Sections of 1 micron thickness. *Journ. App. Micr.*, V. (1902) pp. 1994-6 (4 figs.).

(4) Staining and Injecting.

Rapid Method of Staining the Morphotic Elements of Blood.‡—Marino uses two solutions:—(i.) A saturated solution of acid fuchsin; (ii.) Brilliant kresyl-blue 1 to 1000-4000 water, or kresyl-blue 1, absolute alcohol 200. The preparations are stained for one minute in the acid-fuchsin solution, and then having been washed with water are treated for 15-20 minutes with the kresyl-blue.

Staining Axis-Cylinders of Fresh Spinal Cord.§—H. L. Osborn finds that spinal cord may be stained sufficiently well for demonstration purposes by placing a small piece in 30 p.c. alcohol and incubating at 56° for six hours. Small pieces are teased out in distilled water on a slide and irrigated with an aqueous solution of acid-violet.

New Alcoholic Carmin Solution.||—N. Loewenthal prepares a carmin solution in the following way. The first step is to make a sodium

* University of Chicago Press, Chicago, and Wesley and Son, London, 1902, xii. and 183 pp. and 4 figs. † *Journ. App. Micr.*, v. (1902) p. 1970.

‡ *C.R. Soc. Biol. de Paris*, liv. (1902) p. 457.

§ *Journ. App. Micr.*, v. (1902) p. 1987 (1 fig.).

|| *Zeitschr. wiss. Mikr.*, xix. (1902) pp. 56-60.

picro-carmin mixture by heating together 0.4 grm. carmin, 100 ccm. water, and 0.8 ccm. 10 p.c. caustic soda. While still hot, 25 ccm. of 0.5 p.c. aqueous solution of picric acid are added gradually. When cold this sodium picro-carmin is mixed with half its bulk of 1 p.c. HCl. The red precipitate which forms is then washed until the water is no longer yellow. The dark red deposit on the filter is then dissolved in 70 p.c. alcohol acidulated with HCl (about 1 p.c.). The solution is quite clear and gives good results after any method of fixation. The immersion time is from a half to several hours. The after-treatment is simple and consists of changes of alcohol from 70 p.c. up to absolute. The author states that the solution is an effective nuclear stain, that by its use aqueous media can be avoided, and that it does not colour celloidin.

Flagella Staining.*—W. Kuntze describes the procedure he adopts for staining flagella. The medium recommended for cultivating the bacteria is the ordinary 1 p.c. meat-pepton-agar but without salt. The tubes need not be fresh. The cultures used for inoculating should be from a few days to several weeks old and have been kept at the room temperature for some time. The freshly sown tubes are incubated and are ready for use in from 8 to 10 hours. An essential for success is that the cover-slip should be perfectly clean, and though a decent result may be attained by wiping, washing in ether and flaming, it is safer to follow the procedures of van Ermengem and Hinterberger. On the clean cover-slip is placed a drop of tap-water. This is effected by means of a loop $\frac{1}{2}$ – $\frac{3}{4}$ mm. in diameter and made by bending a piece of glass rod. From this drop of water a droplet about the size of a pin's head is removed and placed on another cover-glass. To the latter is added a minute trace of the bacterial culture and the suspension distributed into a thin layer by means of the glass loop-rod. This must be performed without rubbing or pressing lest the flagella be torn off or damaged. The film should dry in a few seconds; it is then fixed in the flame in the usual way. When the film has cooled it is mordanted with van Ermengem's fluid made about a week before. The mordant consists of 1 vol. 2 p.c. osmic acid and 2 vols. 25 p.c. tannic acid with four drops of acetic acid to 100 ccm. The mordanting takes from $\frac{1}{2}$ to $\frac{3}{4}$ hour according to the temperature of the room. As it is important that the preparations should not come in contact with metallic substances, the cover-slips are held in glass-bladed forceps during the rest of the manipulation. The films are next washed with distilled water, and while still damp some 1 p.c. alcoholic solution of silver nitrate is dropped on. After a few seconds they are treated with the developer (5 grm. gallic acid, 3 grm. tannin, 10 grm. acetate of soda, 350 grm. distilled water). After a short action, silver nitrate solution is again dropped on until the black precipitate, which forms at first, is washed away. The films are then washed with distilled water, and if it be found that they are clean and free from precipitate may be at once passed through absolute alcohol and dried in the flame. If, however, any precipitate still remain they must be treated with gold chloride solution (1–2000 or 3000). Should it be necessary to use gold chloride the

* Centralbl. Bakt., 1^{te} Abt. Orig., xxxii. (1902) pp. 555–60 (1 fig.).

preparation should be previously exposed to the light for a short time, and in any case the treatment must be of short duration. If, after using gold chloride, the resulting picture is found to be good, it is advisable to expose the preparation to the light for a few days, as gold is reduced much more slowly than silver.

Staining Sections of Spinal Cord with Cœrulein S.*—B. Rawitz recommends Cœrulein S (Höchst) for staining sections of spinal cord. The following solution gives good results:—Cœrulein S 0.1 grm., potassio-tartrate of antimony 1.0 grm., distilled water 100 ccm. The potassio-tartrate is dissolved in lukewarm water, the pigment is then added, and the mixture boiled in a sand-bath. When cold, the clear dark-green fluid is decanted off and kept as stock. When required for use, one part of the stock solution is mixed with ten to twenty times its volume of distilled water. The time required is 24–48 hours, and it may be necessary to incubate at 37°–40°. The sections are afterwards washed in distilled water, dehydrated in 96 p.c. alcohol, and after clearing in bergamot oil mounted in balsam.

Simplified Method of Staining with Polychrome Methylen-Blue.† B. Rawitz gets excellent results by means of the following simplified procedure. The sections are placed for 24–48 hours in dilute polychrome blue (1–50 Aq dest.), and then after a short washing with water are immersed for 24, 48–72 hours in 96 p.c. alcohol or until they become quite light blue. They are then cleared up in dark-green bergamot oil (the yellow is too acid) and mounted in xylol.

Staining the Reticulum of Spinal Ganglion-cells.‡—F. Kopsch demonstrates the reticulum in ganglion-cells of the spinal cord in the following manner. Not more than six ganglia are immersed in 2 ccm. of 2 p.c. osmic acid solution for about eight days. The acid must be renewed if there be any reduction. The reticulum begins to stain about the fifth day, but does not attain its maximum till the eighth or even later. Though this method is not successful with cells of the central nervous system it gives good results with cells from other regions, e.g. salivary gland.

ZANGGER, H.—*Histologisch-Färbetechnische Erfahrungen im allgemeinen und speziell über die Möglichkeit einer morphologischer Darstellung der Zell-Narkose (vitale Färbung)*. (A discussion on histological staining technique and intra vitam staining.)

Vierteljahrschrift Naturf. Ges. Zürich, XVII. (1902) pp. 43–72.

(5) Mounting, including Slides, Preservative Fluids, &c.

Double Mounting for Whole Objects.§—H. F. Perkins suggests the following device for mounting objects to be studied from both surfaces. The object is mounted on a large cover-glass with a smaller slip for cover. The larger slip is then laid on an ordinary slide and one end fixed by means of gummed paper or sticking-plaster. This

* *Anat. Anzeig.*, xxi. (1902) pp. 554–5.

† *Tom. cit.*, p. 555.

‡ *S.B. Königl. Preuss. Akad. Wiss. Berlin*, xxxix. (1902) pp. 929–35 (1 fig.).

§ *Journ. App. Micr.*, v. (1902) p. 1926 (1 fig.).

acts as a hinge and allows the large slip to be turned over. A small wire clip is used to hold the covers firmly to the slide in either position.

(6) Miscellaneous.

New Counting Apparatus for Plate Cultures.* — R. Thiele describes a counting apparatus which is intended to avoid counting the colonies twice over. It consists of a tripod stand having a loup attached to the upper end of the pillar. This loup has a diameter of 10 cm., gives a magnification of six to eight, and can be used with both eyes. The plate is borne on a carrier which can be moved up and down the pillar. The carrier is marked out in squares or in sextants. The distance between the loup and the carrier is such that a pencil can be used to indicate the colonies.

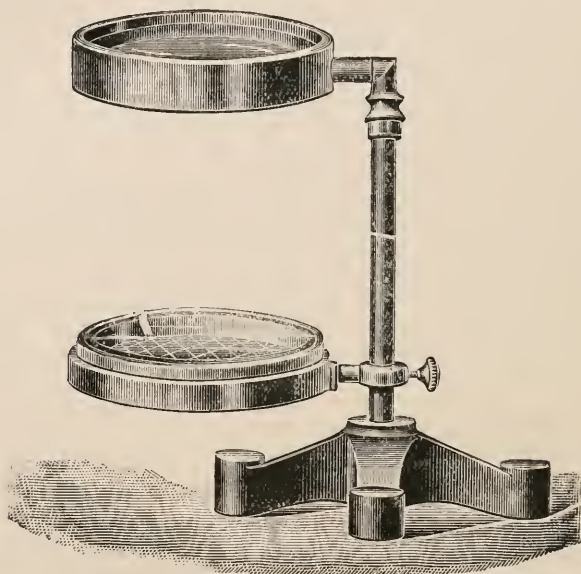

FIG. 146.

Effect of Reheating upon Overheated Steel.† — K. F. Göransson concludes that the destruction of the coarse network of cementite is caused by its carbon being dissolved in the martensite, and that the network surrounding the new grains is formed by the expulsion of cementite from the martensite as it is being cooled.

Steel Rails: Relation between their Structure and Durability.‡ R. Job has undertaken a long series of microscopic observations on

* *Centralbl. Bakt.*, 2^e Abt., ix. (1902) pp. 332-3 (1 fig.).

† *Metallographist*, v. (1902) pp. 216-28.

‡ *Tom. cit.*, pp. 177-91 (13 microphotos).

steel rails which have fractured or duly worn in use, as well as on other rails which have shown especial durability. His conclusions are corroborative of other investigators' results and show the importance of giving to steel rails a fine-grained structure throughout—not merely as a surface layer. The rail should be fine-grained even at the centre of the head, and practically amorphous at the surface. Reliance upon chemical analysis is quite untrustworthy.

S. S. Martin's* experiments point to the same conclusion, and he argues that since no change of structure can result from finishing below the critical point, a rail must be rolled as near the critical point as possible to get the best structure, or in the case of rail steel between 700° C. and 725° C.

A. Sauveur,† after discussing theories of present methods, points out that, in order to confer a fine-grained structure upon steel rails, there seem to be three courses of manufacture open:—(1) To shorten the crystallising period, i.e. the time during which the rail is allowed to cool undisturbedly above the critical temperature (say about 700° C.). (2) To cause a part of the crystallising period to occur previous to the final pass through the mill. (3) To finish the rail at the temperature most desirable for easiness and speed of manipulation in rolling, and then to reheat it to a temperature slightly above the critical, a treatment which would result in the breaking up of the pre-existing coarse structure and replacing it by a much finer one.

S. S. Martin ‡ also shows by the comparison of fine micro-sections the difference between hot and cold sawing upon steel. It follows that in studying the structure of rails care should be taken that the polished sections are sufficiently removed from the hot sawn side to be unaffected by the action of the saw; otherwise seriously misleading observations might result: a coarsely crystalline rail might be made to appear fine-grained.

Effects of Strain on the Crystalline Structure of Lead.§—J. C. W. Humfrey experimented with some exceptionally favourable lead crystals. The effect of tensile strain was to produce slip-bands, and it appeared that, when a slip had been produced in any part, there was a tendency for it to continue there rather than in other parts of the specimen. Thus the effect was rather to localise the strain. If the originally uniformly oriented crystal showed signs of recrystallisation after straining, it was found that moderate heating (up to 100° C.) very much facilitated the process. Experiments were specially carried out to determine whether the recrystallisation, which is apparent immediately after re-etching a severely strained crystal, is a direct and instantaneous effect of the strain, or is a growth which occurs during the interval of time that has elapsed during the straining and the examination. The author's opinion is clearly in favour of the latter hypothesis, and he considers it ought to be classed with the progressive growth demonstrated by Ewing and Rosenhain in their observations on the crystals of ordinary lead after straining.

* Tom. cit., pp. 191-6 (4 microphotos); and *Iron Age*, Dec. 26, 1901.

† Tom. cit., *supra*, pp. 197-202.

‡ Tom. cit., pp. 245-7 (5 microphotos).

§ *Proc. Roy. Soc.*, lxx. (1902) pp. 462-4.

Structure of Copper-Antimony Alloys.* — J. E. Stead contributes a microphotograph showing the value of the "superposing" method for the preparation of alloys to be studied under the Microscope. The method consists of first melting the metal of highest specific gravity and then pouring on top of this, in a molten condition, the other, lighter metal. The two metals will alloy in such a manner that a vertical cross-section will show crystals of a pure metal at one end and crystals of the other metal at the other end, while between these the metals will be found alloyed in all proportions.

C. H.—The Microscope and the Metallurgy of Steel.

Railroad Gazette, June 13, 1902; and
Metallographist, V. (1902) pp. 240-4 (4 figs.).

CAMPBELL, W.—Structure of Metals and Binary Alloys.

[A valuable practical treatise, with many original illustrations.]

Journ. Franklin Inst., CLIV. (1902) pp. 1-16, 131-42 (32 microphotos).

HORNES, A. H.—Metallography: an Introduction to the Study of the Structure of Metals, chiefly by the aid of the Microscope.

Macmillan & Co, London, 1902. xiv. and 158 pp. and 96 figs.

* *Metallographist*, v. (1902) pp. 247-8 (1 fig.).

PROCEEDINGS OF THE SOCIETY.

MEETING

HELD ON THE 15TH OF OCTOBER, 1902, AT 20 HANOVER SQUARE, W.
DR. HENRY WOODWARD, F.R.S., PRESIDENT, IN THE CHAIR.

The Minutes of the Meeting of the 18th of June last were read and confirmed, and were signed by the President.

The List of Donations to the Society was submitted, amongst which special mention was made of the Manual of Bacteriology; British Association Reports for 1901, from Mr. Frank Crisp; a Microscope from Mr. Jackson; and another from Mr. Waters.

Chester, F. D., A Manual of Determinative Bacteriology. } (Svo, New York and London, 1901) }	From <i>The Publishers.</i>
Hinton, A. Horsley, "P.O.P.": A Simple Book of Instruction in the Use of Silver Printing Out Paper. (Svo, London, 1902) }	<i>The Publishers.</i>
Sparrow, F. W., The Principles of Simple Photography. } (Svo, London, 1902) }	<i>The Publishers.</i>
Wall, E. J., The Dictionary of Photography. 8th ed., revised by Thos. Bolas. (Svo, London, 1902) }	<i>The Publishers.</i>
Board of Agriculture. Reports of Proceedings under the Diseases of Animals Acts, &c., 1901. (Svo, London, 1902) }	<i>The Secretary to the Board of Agriculture.</i>
British Association. Report 1901. (Svo, London, 1902) .. }	<i>Mr. Frank Crisp.</i>
Microscope by Cary, with Varley Stage }	<i>Mr. A. W. Waters and Miss Celia Waters.</i>
An old Microscope which belonged to Mr. Geo. Jackson, a former President of the Society }	<i>Mr. John Jackson.</i>

Mr. C. F. Rousselet said that the old Microscope presented by Mr. John Jackson, of Torquay, was interesting as having been made by his father, the late Dr. George Jackson, who was one of the Founders and a former President of the Society (in 1852-3), and as being the prototype of what was known as the Jackson-Lister Model. It would be noticed that the brass limb was in one piece, which was grooved down the centre, having been ploughed in one cut, and the body, stage, and substage all moved in this groove. The motion of the body and substage was effected by rack-and-pinion by milled heads placed vertically at the back of the limb, whilst the stage was moved by a fine micrometer screw which acted as the fine adjustment. It was fitted with a mechanical stage, and had three object-glasses, two eye-pieces, a micrometer eye-piece, and other accessories. Though the instrument itself

December 17th, 1902

3 c

was made by Dr. George Jackson, the optical portion, object-glasses, and eye-pieces were the work of Mr. James Smith. The Society was greatly indebted to Mr. John Jackson for this very interesting present.

Dr. Hebb said the Microscope which had been presented to the Society by Mr. Waters and his sister, Miss Celia Waters, was made by Cary, and was believed by Mr. Waters to be at least 60 years old. It was fitted with Varley and Sons' Lever Stage, the upper plate of which had its movement controlled by an ingenious parallel motion placed below it. A Varley Microscope, having a stage constructed on this principle, is figured in *Quekett on the Microscope*, 1848.

Messrs. Elliott Bros. sent a Class Microscope for exhibition, which was passed round for the inspection of the Fellows present.

On the Motion of the President, a cordial vote of thanks was passed to the donors of these instruments and of the other presents to the Society, and to Messrs. Elliott Bros. for their exhibit.

The President said they were to be favoured that evening with what he was sure would be a most interesting demonstration by Prof. Bonney 'On Rock Changes in Nature's Laboratory,' and the Society was much indebted to Prof. Bonney for giving them his valuable time on that occasion.

Prof. Bonney said he would commence his remarks by a few explanatory words, because he thought that the subject upon which he was going to speak might perhaps lie a little outside the range of those which usually came under the notice of the Society. The changes which took place in nature were brought about by the operation of three great agencies, water, pressure, and heat, only here their action went on much more slowly than any process which we were obliged to adopt, Nature not being cramped for time or limited to threescore years and ten. We could apply heat, for instance, and could melt a portion of rock, and by its fusion produce a glass, but Nature, working slowly, could crystallise these substances in a way which we could not. The three forces seldom acted entirely apart from each other, often two, and sometimes all three, working together. For example, a layer of ordinary mud depressed to a considerable depth, and covered up with similar material, is subjected to pressure. The weight of about 12 ft. of average rock is roughly that of one atmosphere, whilst the earth temperature is known to increase at the rate of about 1° for every 60 ft. of descent. So that a layer of Thames mud when buried under 3000 ft. of similar material would be subject to a pressure of 250 atmospheres, and have its temperature raised 50° , or twice its present average amount. Commonly, however, some one of these forces was dominant, but in other cases each has dominated in its turn. In the district of Skiddaw, for instance, the slaty rock has been heated by intrusive granite, but at Glendalough, in Wicklow, the granite came first, and then pressure acted and forced the altered rock to assume a slaty condition. The subject he had chosen was a rather wide one, and he there-

fore proposed to limit his remarks to three kinds of rocks—the Sandy, the Muddy, and the Calcareous. To begin quite at the outset, he ought to show them the materials themselves—sand, mud, and pounded shell; but he proposed to pass over these, and give some illustrations of the rocks formed from them by means of sections of such rocks shown upon the screen. It would have made these sections more conclusive if they had been shown by polarised light, the effect of which might be compared to that of a coloured map as contrasted with the same only in outline. This, however, involved so much loss of light, that he had decided not to use it.

In illustration of the effects of water, a section was shown of indurated organic sand from the Torres Straits—probably a comparatively modern rock—in which the various materials comprising it were cemented together by very small crystals of calcite; this was followed by a section of a more ancient limestone rock. A section of sandstone, consisting of grains of quartz, was then exhibited, showing how the material was cemented by the deposition of minutely crystalline quartz, probably brought about by the action of water. Next he exhibited a piece of hardened mud-stone of great age.

As regarded the effects of pressure, it was pointed out that when a quantity of flakes were pressed together they arranged themselves parallel, and gave rise to cleavage, but if a solid body consisting of fair-sized grains, like a granite, was thus acted upon, it was either crushed or sheared. The solvent power of water was also increased by pressure, so that when felspar was crushed, water partially dissolved it, and when the pressure was removed some of the constituents went back into mineral form, but as it had generally lost some of its alkalies, it then commonly took the form of mica. In illustration of the effects of pressure, a large number of sections were shown, and the special features in each pointed out. These included granite from Wicklow, an uncrushed rock formed of two kinds of felspar and two kinds of mica; granite from Brittany which had been subjected to greater pressure, and two specimens considerably more crushed; hard felspathic sandstone from N.W. Scotland, which had been exposed to various degrees of pressure, and quartzite from the same under similar conditions; slate from the Ardennes, consisting of mud blackened by carbonaceous matter; and slate from the Isle of Man, exhibiting, secondary, or “strain-slip” cleavage. As illustrating the changes chiefly due to heat, a further series of sections was exhibited, including specimens with Chiastolites, Andalusites, brown mica, &c., from Skiddaw and Brittany. Other sections showed examples of changes produced by heat in calcareous rocks, including two from Montreal, in one of which the remains of fossils could be traced, while from the other they had disappeared in the re-crystallisation of the calcite.

The series was concluded by the exhibition of a set of three specimens of rocks, the past history of which was not at present perfectly clear, the first of these showing the effect of puckering by pressure, and the others exhibiting secondary cleavage structure, with re-crystallisation. Prof. Bonney expressed the hope that he had been able to show, by the action of the three influences referred to, that the nature of rocks might be entirely changed, and that a rock which began from mud

might be changed into crystalline rock like mica schist, and that the process had been, and indeed was still, going on with exceeding slowness. The rock sections with which the demonstration was illustrated were shown upon the screen with great brilliancy and sharpness, although very highly magnified, by means of Messrs. Zeiss' "Epidiascope."

The President said that after the applause which followed the conclusion of Prof. Bonney's remarks, it was hardly necessary to assure the author of their appreciation and their thanks. Nothing could have been more delightful than to see such a beautiful series of slides, and to have them explained so intelligibly. It must certainly lead those who had been present to think and observe for themselves, and desire to know more about the microscopic structure of rocks. They had been shown how those who were able to prepare and study rock sections for themselves could, by this means, trace the changes which had taken place from the effect of greater and greater pressure, heat, and contortion. He did not know anything more likely to impress them than what they had seen and heard that evening, and they desired to express their indebtedness to Prof. Bonney for the able manner in which he had explained the meaning of these very beautiful slides.

A hearty vote of thanks to Prof. Bonney was unanimously passed.

The following Objects, Instruments, &c., were exhibited :—

The Society :—An Old Microscope made by Cary, fitted with Varley and Sons' Stage. An Old Microscope, made by Dr. Geo. Jackson, seventh President of the Society.

Dr. R. G. Hebb :—A German "Class" Microscope, lent by Messrs. Elliott Bros.

Prof. Rev. Canon T. G. Bonney :—Slides of Rock Sections projected on the screen, illustrating his Demonstration.

New Fellow.—The following was elected an *Ordinary* Fellow :
Mr. Josiah Beddow.

MEETING

HELD ON THE 19TH OF NOVEMBER, 1902, AT 20 HANOVER SQUARE, W.
DR. HENRY WOODWARD, F.R.S., PRESIDENT, IN THE CHAIR.

The Minutes of the Meeting of the 15th of October, 1902, were read and confirmed, and were signed by the President.

The List of Donations to the Society (exclusive of exchanges and reprints), received since the last Meeting, was read, and the thanks of the Society were voted to the donors.

	From
Bagshaw, Walter, Elementary Photomicrography. (Svo, London, 1902)	The Author.
Hardesty, Irving, Neurological Technique. (Svo, Chicago and London, 1902)	The Directors of the University of Chicago Press.
Mann, Gustav, Physiological Histology. (Svo, Oxford, 1902)	The Delegates of the Clarendon Press.
Board of Agriculture. Report on Distribution of Grants, 1901-2. (Svo, London, 1902)	The Board of Agriculture.
Internationale Monatschrift für Anatomie und Physiologie. Bd. xix. Heft 1-12. (Svo, Leipzig, 1902)	The Editor.

The President said they were to be favoured that evening with a demonstration on 'The Microscope in Fossil Botany,' and he could not say how much he felt indebted to Dr. Scott for coming there to give them this, which he was quite sure would prove to be a paper of very great interest.

Dr. D. H. Scott said that when the President asked him to give to the Society some account of the structure of fossil plants he was proud to agree to do so, but when he remembered that a paper had been read by their late President on a similar subject he felt himself in a somewhat difficult position in having to follow one who was so high an authority on these questions. He thought, however, that he might also congratulate himself on the fact that after so able an exposition on that occasion, those who were then present already had some acquaintance with the subject, so that there would be no need for him to touch on the general history of fossil botany. The particular department of palaeontological research concerned with the *structure* of plants was one of comparatively modern origin. Of course fossil wood, which was the most familiar example of vegetable remains with structure preserved, had been known for a long time, but anything like a scientific study, with the idea of investigating the organisation of fossil plants, was scarcely attempted until the beginning of the nineteenth century. Among the earliest specimens to attract attention were those curious examples from Saxony, the "Staarsteine" or Psaronii, which are the silicified stems of tree-ferns. Bernard Cotta in 1832, and Witham of Lartington in 1833 almost simultaneously published accounts of what they had discovered: in Witham's work great assistance was given by Nicol, who cut the sections, and by Macgillivray, who acted as artist. Later on Brongniart in France, who had already begun his classical investigation of fossil plants, turned his attention to this branch of the subject. His monograph on *Sigillaria elegans* (1839) is a model of what such a work should be; he placed the whole subject on a sound basis, and did more for fossil botany than any one previously.

In England, Sir Joseph Hooker and, at a later date, Binney likewise made important contributions to structural fossil botany, while no one had done more for the subject than Renault in France, or Solms-Laubach in Germany. He hardly needed to refer to the work of the late President of the Society, or to that of Prof. Williamson who had published so magnificent a series of researches on the fossil plants of the coal measures. It was perfectly plain to anyone who knew anything of botany, that there was a wide difference between a knowledge of the

external forms of plants and a study of their internal structure. Those fossil remains of plants with which the casual observer was most familiar, showed little or nothing of their internal structure, and it was only when we came to the petrified remains, where the plants had their tissues thoroughly impregnated with lime or other mineral matter, that the structure could be studied. Broadly speaking, specimens exhibiting external form showed no structure, and *vice versa*. Most of the British coal-measure material which was of value in these investigations occurred in the form of calcareous nodules imbedded in certain mines in the coal itself; these concretions were simply crammed with vegetable remains which had been prevented by petrification from becoming reduced to coal. In the French Carboniferous deposits the preserving agent had for the most part been silica.

Dr. Scott then proceeded to demonstrate the structure of some Carboniferous plants by the exhibition of a fine series of photographs shown on the screen by the Epidiascope, first showing, in each family dealt with, some examples of external habit, and then going on to sections exhibiting the internal structure. The first group taken was the Calamariæ, which have much in common with the modern Horse-tails. In sections of the cones the spores were well seen in the sporangia. The heterosporous nature of the fructification was pointed out in some examples, from which and from various other points in their organisation it was concluded that these plants attained a higher grade of differentiation than their present representatives. The series further included examples of stems and cones of the Sphenophylleæ, a group in some respects intermediate between Horse-tails and Clubmosses; also of the Palæozoic Lycopodiaceæ (*Lepidodendron* and *Bothrodendron*), in which the cell-structure and details of the fructification were remarkably well shown. He also exhibited under a number of Microscopes on the table many of the actual sections, from some of which the lantern photographs had been taken, and mentioned that the chief difficulty he had experienced in the matter was in making a selection from the large amount of material available. He had purposely limited himself to a few groups of Palæozoic plants.

The President said he was sure it would be unnecessary, after the way in which they had received Dr. Scott's communication, to ask if they desired to thank him for it. He (Dr. Scott) had very wisely given them an account of two extinct types of fossil plants, in which the external form and the internal structure, both of which had been preserved in a fossil state, had been shown on the screen and explained, and it would no doubt be the opinion of the Meeting that this had been done in a very complete manner by the author. A point which was of great interest to them was that the specimens they had been looking at were the actual sections of fossil plants, and not things which were what was called "faked up"; and therefore they could not fail to afford the greatest interest. He was quite sure that Dr. Scott could give them a dozen evenings of this kind, as there were many other formations beside the coal measures in which the microscopic structure of plants has been met with, all of which were very familiar to him. He desired to convey, on behalf of the Fellows of the Society, their very best thanks to Dr. Scott for his interesting and instructive demonstration.

Mr. Edmund J. Spitta then gave a demonstration on "An Apparatus for obtaining Monochromatic Light with a Mixed Jet." He commenced by reminding the Fellows that resolution of minute structure depended upon two functions,—the numerical aperture of the objective and the wave-length of the light employed; and since numerical aperture had now reached its limit, at least so far as existing knowledge led us to see, it was clear that any further advance for increasing resolution must be looked for in the direction of the quality of the light, which must be monochromatic and of the shortest possible wave-length. Attempts to obtain monochromatic blue light by means of glass screens had failed because blue glass of whatever quality he had tried always allowed other colours also to pass, usually red, and so prevented the light being purely monochromatic.

Though this was considered by some as not so very important in photography, if the plates used were not orthochromatic, still it was sufficiently disturbing to prohibit the accuracy of focus for the demands of study, when the Microscope was visually used. Screens consisting of liquid solutions had also been tried, but though by this means it was possible to obtain monochromatic blue light, it was found to be too faint for use when employing a mixed jet. A portion of the spectrum from a prism seemed more promising; but this required the apparatus to be arranged in a semicircular fashion and so rendered it unsuitable, in addition to which the amount of light available was very small and the beam very narrow—too narrow indeed to fill the field of a homogeneous one-twelfth.

The diffraction spectrum reflected from a grating—a series of fine lines ruled on a metal surface—was open also to the objection that the light could not be used "direct." About four years ago, however, Mr. Thorpe showed at the Royal Society's soirée some replicas of diffraction gratings made by coating the metal with a thin film of celloidin or some such substance, which when removed exhibited an exact reproduction of the rulings, and consequently of the diffraction colours, but with this very great advantage, viz. that the spectrum could be seen through the replica as it was so transparent. At that time it was difficult to get a perfect film off a large enough grating to be of any service for the subject in hand, but now Mr. Thorpe was able to make them $1\frac{1}{4}$ in. square. Moreover, he had lately achieved mounting them on corrective glass prisms cut to the proper angle, so that any single colour of special wave-length could be used "direct," which at once did away with the objection of having to arrange the apparatus in a semicircular fashion.

Mr. Spitta then explained by a diagram on the screen how he arranged his apparatus, pointing out the position of the collective condenser, the use of the collimator, and how the Microscope was placed. He also spoke of the importance of using critical light and how it was to be obtained. It was pointed out from the study of Abbe's law of resolution to be an obvious conclusion, that as red light consisted of about 30,000 waves to the inch and blue light of about 60,000, the resolving power of an objective used with the latter would be just double that obtainable by the use of the former wave-length.

Three photographs of *Amphipleura pellucida* were then thrown on

the screen, the first to show the ordinary transverse lines, the second taken with a Gifford's F line (green) screen to try and resolve the dots which were only faintly visible, and the third with the use of monochromatic blue light obtained with the apparatus in question, which showed the same diatom clearly resolved in dots. Mr. Spitta considered further remarks were unnecessary seeing the hour they had reached, save perhaps that the apparatus was on view in the adjoining room where the *Amphipleura* would be shown resolved in the manner he had explained.

The President said they were extremely indebted to Mr. Spitta for this demonstration, and intimated that the apparatus which he had described would be exhibited in the adjoining room at the close of the Meeting.

Mr. Conrady said that having had the pleasure of seeing the apparatus, and the result obtained by its means, he should like to congratulate Mr. Spitta on the successful result of the perseverance with which he had followed up the problem of *Amphipleura pellucida* until he had at last succeeded in resolving it into clear unmistakable dots.

A hearty vote of thanks to Mr. Spitta was then unanimously passed.

A paper by Dr. P. E. Shaw on 'An Electrical Method of Taking Microscopic Measurements' was on the Agenda, but in the absence of the author it was not read *in extenso*. A diagram of the apparatus drawn on the board was briefly explained by Dr. Hebb, and the thanks of the Meeting were voted to Dr. Shaw for his communication.

On the motion of the President, a vote of thanks was also cordially accorded to Messrs. Watson and Sons for the loan of a large number of Microscopes, by means of which Dr. Scott's preparations were shown in the room.

The following Instruments, Objects, &c., were exhibited:—

Dr. Dukinfield H. Scott:—The following sections of Fossil Plants illustrating his paper. *Calamites communis*, young stem, transv. sect. showing pith, wood, remains of phloem, and cortex; *Calamites* sp., minute twig, transv. sect. showing ring of vascular bundles and cortex; *C. communis*, long. sect. of stem showing wood and diaphragms at nodes; *C. communis*, tang. sect. of wood, near pith, showing node and base of a branch; *Calamites* sp., showing leaves of small twigs in transv. sect.; *Calamites* sp., minute rootlet, transv. sect. showing young stele, double endodermis, and lacunar cortex; *Calamostachys Binneyana*, transv. sect. showing axis, peltate scales, sporangia, and spores; *C. Binneyana*, transv. sect. of cone showing whorl of bracts; *C. Binneyana*, long. sect. of cone showing bracts alternating with peltate scales, bearing sporangia; *C. Binneyana*, long. sect. of cone showing axis, bracts, peltate scales, sporangia, and spores; *Sphenophyllum plurifoliatum*, transv. sect. of stem showing primary and secondary wood, phloem, periderm, and remains of cortex; *S. plurifoliatum*, long. sect. of stem showing structure of wood and periderm; *S. Dawsoni*, long. sect. of cone showing

bracts, pedicels, sporangia, and spores; *S. Dawsoni*, long. sect. showing axis, bracts, &c.; *Lepidodendron selaginoides*, transv. sect. of stem showing wood, phloem, inner and outer cortex, periderm, and leaf-bases; *L. selaginoides*, transv. sect. of stem showing primary and secondary wood, cortex, and periderm; *L. selaginoides*, long. sect. of advanced stem showing same features as previous slide; *Bothrodendron mundum*, transv. sect. of bifurcating stem showing the two steles already separated by the cortex; *Lepidostrobus Veltheimianus*, transv. sect. of cone through microspore region, showing axis surrounded by microsporangia; *L. Veltheimianus*, transv. sect. of cone through megaspore region, showing axis surrounded by megasporangia; *L. Veltheimianus*, long. sect. of cone, almost complete, showing microsporangia only; *Spencerites insignis*, transv. sect. of cone showing axis surrounded by sporangia containing winged spores; *Lepidocarpon Wildianum*, section of "seed," the interior of which is partly filled by the prothallus; *Lepidocarpon Lomaxi*, section of "seed," the interior of which is occupied by the prothallus; Fern-sporangia, sorus consisting of many sporangia showing annulus and containing spores; *Lyginodendron Oldhamium*, transv. sect. of stem showing pith, primary and secondary wood, phloem, leaf-trace bundles, and cortex.

Mr. Edmund J. Spitta:—Apparatus for obtaining Monochromatic Light with an ordinary mixed jet; *Amphipleura pellucida* shown under the Microscope with monochromatic light obtained by above apparatus.

New Fellows:—The Right Hon. Lord Rayleigh was elected an *Honorary* Fellow. The following were elected *Ordinary* Fellows:—Messrs. George Chandler Whipple and J. Hilliard Johnson.

INDEX OF NEW BIOLOGICAL TERMS, OR OLD TERMS WITH
NEW MEANINGS, RECORDED IN THIS VOLUME.

ZOOLOGY.

- | | |
|---|---|
| <p>Accessory chromosome, McClung, 41
Adiaphorogenetic, Hallez, 51
Amœbula, Lankester, 440
Ancestrula, Jullien, 652
Apobatic phototaxis, Rothert, 31
Archæocytes, Ijima, 562
Bionic value, Williams, 546
Chloragosomes, Rosa, 648
"Chromatophores," in a new sense, Adachi, 296
Compensation-sac, Harmer, 651
Cryptocyst, Harmer, 652
Diplosomes, Zimmermann, 170
Eleutherorhabdic, Ridewood, 641
Enhæmospore, Lankester, 440
Environmental variations, Ewart, 533
Exeretophores, Bürger, 649
Exotospore, Lankester, 440
Faunule, Williams, 546
Female eggs, Beard, 534
"Forms," in classification, Bernard, 636
Gemmule-larva or Bud-embryo, Ijima, 562
Gynandromorphy, Kohl, 40
Itomere, Blackman, 182
Karyotaxis, Broman, 162</p> | <p>Male eggs, Beard, 534
Matricidal epitoky, Bohn, 49
Metamp, Bidder, 190
Microcentrotaxis, Broman, 162
Microthorax, Verboeff, 643
Monochorial twins, Rosner, 159
Osmotic pseudogamy, Ariola, 299
Paraspermatozoids, Van Lint, 535
Parova, Van Lint, 535
Peristome-funnel, Friedemann, 310
Photokinetic, Nagel, 32
Phototropism and Phototaxis, more precise use, Nagel, 31
Primitivknoten, Mitrophanow, 294
Pseudogamy, Ariola, 299
Pseudochromosomes, d'Hollander, 632
Pseudothyroidea, Mayer, 539
Renovation, Wahl, 42
Reticular apparatus, Golgi, 635
Solenoocytes, Goodrich, 298
Stereotaxis, Buller, 536
Synandry, Giard, 551
Synaptorhabdic, Ridewood, 641
Vermicule, Lankester, 440</p> |
|---|---|

BOTANY.

- | | |
|--|--|
| <p>Achroocyst, Arbaumont, 62
Amylogen, Syniewski, 63
Apolar, Bertrand and Cornaille, 78
Archimycetes, Marpmann, 463
Boletol, Bertrand, 222
Chlorite, Arbaumont, 62
Cyanocyst, Arbaumont, 62
Dhurin, Dunstan and Henry, 566
Endochlorite, Arbaumont, 62
Epiachenes, Villari, 571
Excœcarin, Perkin and Briggs, 443
Gymnochlorite, Arbaumont, 62
Heterodynamic, Correns, 200
Homodynamic, Correns, 200</p> | <p>Homöogonous, Correns, 201
Hypoachenes, Villari, 571
Jacarandin, Perkin and Briggs, 443
Karyoplastic-cell, Heydrich, 583
Lotusin, Dunstan and Henry, 658
Manncotetrose, Tauret, 567
Manninotetrose, Tauret, 567
Periachenes, Villari, 571
Plasmoptysis, Fischer, 348
Protospore-cell, Heydrich, 583
Saponarin, Barger, 568
Schizöogonous, Correns, 201
Scutellarin, Moliseh, 315
Spherulin, Petit, 194</p> |
|--|--|

INDEX.

A.

- Abbe Drawing Camera, 105
 Abbott, —, Lesions produced by Acid-resisting Bacilli, 480
 Absolon, C., New Moravian Cave-Insect, 429
 Abyssal Antarctic Fauna, 35
 Abyssal and Plankton Fauna around Capri, 297
 Acacia, Peculiar Stages of Foliage, 658
 Acanthias, Eye-Muscles, 539
 Acanthodians and Cestracionts, Carboniferous, 547
 Acarid, Limbless, 645
 Acarids, South American, 183
 Acetylene Gas for the Lantern, 490
 — Illuminator for the Lantern, 389
 Achalme's Bacillus of Acute Rheumatism and the *Bacillus enteritidis sporogenes*, Probable Identity, 93
 Achenes, Structure, 571
 Achromatic Combination, the Lister, 17
 Acid-fuchsine Staining for Degenerate Nerve-Fibres, 501
 — -resisting Bacilli in Gangrene, 226
 Acids, Carbonic and other, Reactions of Infusorians to, 191
 — Distribution in Plants, 63
 Acinetines, Structure, 507
 Ackermann, A., Structure and Hermaphroditism of *Cucumaria levigata*, 653
 Acorn, Microscopic Characters of Fruit-Envelopes, 321
 Acrasiæ, 462
 Actinians of Porto Rico, 562
Actinomucor repens, 589
Actinomyces asteroides, 599
 Actinotrocha, Notes, 435
 Adachi, B., Skin Pigment in Man and Monkeys, 296
 Addario, C., Matrix of Vitreous Humour in the Eye of Man and Animals, 296
 Adductors in *Anodonta grandis*, Variation in Position, 641
 Adee, A. A., Hastings Apochromat, 236
 Aderhold, R., *Clasterosporium carpophilum*, 589
 — New Species of *Venturia*, 466
 Adhesion-Cultures, 372
 Adil-Bey, Cattle Plague, 381
 Adjustment, Fine, Berger's, 610
 — — Males-Watson Two-speed, 609
 — — New Two-speed, 506
 — — Swift's "Ariston," 698
 — for Microscope, 607
 — of Projection Microscope, Moll's Apparatus for, 362
Admetus pumilio, Development, 430
Eolosoma tenebrarum, Notes on, 186
 Agarics, European, 594
 "Ageing" of the Embryo of Grasses, 204
 Aggazzotti, A., Nerve-Endings in Striped Muscle of Insects, 644
 Agglutination of Bacteria, 89
 — of Tubercle Bacillus, 348
 — of Vibrios, 228
 — Reaction Results, Interpretation, 228
 Agglutins, Formation, 227
 Ahrens, F. B., Fermentation without Cells, 75
 Aigner, A., Epithelium of Epididymis in Mammals, 163
 Air-roots of *Avicennia tomentosa*, 446
 Albinism in Plants, 670
 Albrecht's Microscope for Measuring Plant-Growth, 358
 — Objective-Carriers, 237
 Albugo, Gametogenesis and Fertilisation, 83
 Aleock, A., Toxic Properties of Saliva of certain Non-poisonous Colubridæ, 638
 Alcohol, Action on Germination of some Seeds, 575
 — Influence on Natural Immunity, 91
Alcyonium digitatum, Structure, 189
 Aleurone-Grains in Oily Seeds, 442
 Allen, C. E., Middle Lamella of Cells, 61
 Algae, British Marine, 585
 — Fresh-water, of Ceylon, 584
 — — — of Switzerland, 461
 — from Caroline Islands, 213
 — Japanese Marine, 679
 — Marine, of Iceland, 461
 — — of the Mediterranean, 679
 — New Genus, *Pseudencyonium*, 82
 — Nitrates and the Carbon-Assimilation of, 204
 — Notes on some Fresh-water, 584
 — of Jamaica, 335

- Algae of Harriman Alaska Expedition, 585
 — of Verona, 335
 — — — District, 585
 —. See CONTENTS, xxvii
 Alga-like Fern-prothallus, 329
 Algascope, Zeiss' Improved, 699
 Alimentary Canal in Decapoda, Glands,
 46
 — — in *Rhynchelmis limosella*, 647
 — — of *Lagis Koreni*, 305
 — System of Birds, Modifications induced
 by Diet, 172
 Alinit, 603
Alinit-Bacillus Beta, 342
 Allen, E. J., Fauna of Exc Estuary, 174
 Allescher, A., Rabenhorst's Cryptogamic
 Flora of Germany, &c. (Fungi Imper-
 fecti), 86, 461, 590, 684
 Allis, E. P., jun., Ophthalmic Nerves of
Mustelus laevis, 29
Allolobophora fatida, Spermatozoa, 648
 Alloys, Copper-Iron, 261
 — of Copper and Tin, 383
 — Structure of Copper-Antimony, 720
 Alpine Plants, Means of Distribution, 76
 Alsike, Crystals of Calcium Oxalate in
 Seedlings, 565
Amanita ovoidea, 682
 Amaryllideae, Bulbiform Seeds, 66
 Amberg, O., Cork-formation in Interior of
 Leaf-stalk of *Nuphar luteum*, 448
 Amberg, S., Staining Dysenteric Amœbæ,
 254
 Amblystoma and Axolotl, 34
Ameiurus nebulosus, Breeding Habits, 34
 Ammœete, Ciliated Grooves in Brain, 545
 Ammœetes, Development of Olfactory
 Organ, 29
 Amniota, Development of Pancreas, 165
 Amœbæ, Digestion, 562
 — Methods for Rearing, 107
 Amphibians, Experimental Parthenogene-
 sis, 537
 — Mollusum Contagiosum in, 297
 — Pituitary Body, 635
 Amphibious Plant, Nature of Stimulus
 causing Change of Form and Structure,
 669
 Amphipods, New Victorian, 646
 Amphicarpous Plants, 65
 Amphineura and Cephalopoda, Relation-
 ship, 38
 Amphioxus and Higher Craniota, Relation
 of Metameric Segmentation in, to
 that in Petromyzon, 29
 — Excretory Organs, 298, 424
 — Homologue of Infundibular Organ, 546
 Amphitretus from Sagami Sea, 639
 Amphiuma, Cranial Nerves, 545
 Ampullæ, Lorenzini's, Nerves, 423
 — Selachian, Homology, 546
 Aplymyces and a Micrococcus, Associa-
 tion, 602
 Anaerobes, Simple Apparatus for Culti-
 vating in Test-tubes, 497
 Anaerobic Cultures, Apparatus, 250
 Anatomy, General, Outlines of, 32
 — Leaf, of Rutaceæ, 568
 — of Seed Plants. See CONTENTS, xxi
 Ancel, P., Skin-Glands of Amphibians, 30
 — Variations in Human Vertebral Column,
 424
 Anchoring of Plantain-Seed, 458
 Anderson, A. P., Fungal Diseases of
 Plants, &c., 220
 André, G., Accumulation of Mineral and
 Organic Matter in Woody Plants,
 573
 — Action of Temperature on Absorption
 of Minerals in Etiolated Plants, 324
 — Distribution of the Acids in Plants, 63
 — Nutrition of the Seedling at the Expense
 of its Cotyledons, 203
 — Transformation of Proteids during Ger-
 mination, 456
 Andrews, T., Micro-Crystalline Structure
 of Platinum, 504
 Andrews, T. and C. R., Microscopic Effects
 of Stress on Platinum, 624
 Andrews, W., Stopping down the Lens of
 the Human Eye, 494
Andromeda polifolia, Fungi, 595
 Andropogon Sorghum, Rust, 592
Angioperis evecta, Vegetative Propagation,
 459
 Angiosperms, Pericycle, 660
 Anglade, D., New Method of Staining
 Neuroglia, 499
 Angus, H. F., The Apertometer and its Use,
 448
 Animal, Extraordinary, 560
 — Morphology, Microtechnique, 257
 Anisotonic Solutions. Reactions, 544
 Anjeszky, —, Bacillus Tuberculosis in
 Buda-Pesth Butter, 478
 Ankyroderma and Synapta, Calcareous
 Plates, 436
 Annual Address, 127
 — Meeting, 122
 Annulata. See CONTENTS, xvi
Anodonta grandis, Variation in Position of
 Adductors, 641
 Ant, New Agricultural, from Texas, 429
 — Sense of Taste in, 552
 Antagonisms, Bio-chemical, 228
Antedon rosacea, Genital Pores of Male,
 437
 Antherozoids in *Asterella californica*,
 Forceful Discharge, 578
 Anthoceros, Apospory, 79
 Anthony, M. H., Metamorphosis of Sisyra,
 642
 Anthrax, Does it form Spores under Anaer-
 obic Conditions? 107
 Ants, Senses of, 39
 — Studies on, 557

- Anoplopterus platycheir*, Distribution, 173
 Aortic Arches and the Origin of Arteries in Reptiles. Variations, 27
 Apáthy, S., Microtechnique of Animal Morphology, 257
 Apertometer and its Use, 488
 Aphanochaete, Observations on, 597
 Apochromat, Hastings, 236
 Apospory in Anthoceros, 79
 Apparatus for Removing Pieces of Tissue for Microscopical Investigation, 714
 Apple Trees, Canker, 686
 Apples, Changes during Ripening, 457
 Aquarium, Salt-water, 680
 Arachnid Entosternite, Studies, 645
 Arachnida. See CONTENTS, xv
 Araliaceæ, Embryogeny, 450
 — Formation of the Ovule and Embryosac, 71
 Arbacia, Artificial Parthenogenesis induced by the Use of Sea-water concentrated by Evaporation, 418
 Arbaumont, J. d', Evolution of Chlorophyll and Starch in the Stem, 62
 Arber, A. E. N., Nitrates and the Carbon-Assimilation of Algæ, 204
 — Type-Specimens of *Lyginodendron Oldhamium*, 208
 Archibald and Richards, Study of Growing-Crystals by Instantaneous Photomicrography, 364
 Ardissone, F., Marine Algæ of the Mediterranean, 679
 Argutinsky, P., Demonstrating the Malaria Parasite, 251
 — Examining Blood-plates, 253
 Ariola, V., "Pseudogamy" in *Dentalium Entalis*, 299
Arisæma triphyllum and *A. Dracontium*, Seeds and Seedlings, 198
 Arker, J., Influence of the Surrounding Medium on the Growth of Roots, 74
 Armitage, E., Irish Mosses, 459, 581
 Arndt, G., Saw for making Microscopic Preparations of Hard Objects, 112
 Arnell, W., New Hepatics, 332
 Arnold, J. O., Properties of Steel Castings, 382
 Arnoldi, W., Embryogeny of the Sequoiaceæ, 70
 Arsenic, Minute Traces in Animals, 544
 Arterio-Venous Anastomoses in Man and Mammals, 422
 Arthropoda. See CONTENTS, xiii
 Arthropods, Collection of Microscopic Marine, 551
 — Epithelial Regeneration in Mid-gut, 551
 Arthur, J. C., New Uredinæ, 466
 — Uredinæ, 217
 Ascaris, Fermentation of Glycogen, 557
 Ascidians of Bermudas, 548
 Asclepiadæ, Formation of Pollen, 199
Asclepias Cornuti, Development of Pollinium and Sperm-Cells, 320
 Ashby, E., Fossil Polyplacophora, 177
 Ashe's Two-speed Fine Adjustments, 232
 Aspergillus, The Genus, 680
Aspergillus niger, Influence of Sulphocyanic Acid on Growth, 688
 Asphyxiation, Resistance of Myriopods to 305
Asplenium ebenoides, Hybrid Origin, 672
 Assimilation, Chlorophyll, 72
 — of Carbon by a Green Alga, 323
 Aster, Quantitative Study of Variation in Bracts, Rays, and Disk-florets, 326
Asterella californica, Forceful Discharge of Antherozoids, 578
Asterias glacialis, Maturation, 437
 — *rubens*, Red Pigment, 654
 Astruc, A., Distribution of the Acids in Plants, 63
 Atherine, New Species in Fresh Water, 297
 Auditors, Appointment, 121
 Auerbach, M., Brown Fat in Rodents and Insectivores, 422
Aurelia aurita, Post-Embryonic Development, 310
 Auto-Intoxication and Growth, 543
 Autotomy in Marine Invertebrates, 174
 Avian Diphtheria, 225
Avicennia tomentosa, Air-roots, 446
 "Awamori," 339
 Axial Skeleton in Amphibia, Development, 27
 Axis-Cylinders of Fresh Spinal Cord, Staining, 715
 Axolotl and Amblystoma, 34
Azorella Selago, Morphology and Anatomy, 466
- B.
- Bacilli, Acid-fast, 344
 — Acid-resisting in Gangrene, 223
 — Cholera, Spore-formation, 90
 — in Syphilitic Semen, 692
 — Lesions produced by Acid-resisting, 480
 — Pseudo-diphtheria, 226
Bacillus anthracis, Capsule and Flagella, 226
Bacillus, Capsulated New, 313
Bacillus caseolyticus, 477
 — *coli communis*, Medium for Isolating *Bacillus typhosus* in presence of, 250
 — — in Dysentery, 696
 — — — Variability of Gas-formation, 92
 — *diphtheriæ* in Simple Rhinitis, 481
 — *dysentericæ*, Resistance to Cold, 480
 — *enteritidis sporogenes* and Achalmé's *Bacillus* of Acute Rheumatism, Probable Identity, 93

- Bacillus acidilactici*, Decomposition of Lactose by, 478
 — *Lacto-rubifaciens*, 690
Bacillus, New Capsulated, 343
 — — Pyogenic, 601
 — Pathogenic to Rats, 602
 — New Syphilis, 691
 — Pathogenic, in Cockles, 693
Bacillus raditicola, Polymorphism, 225
 — *tuberculosis*, Eggs as a Medium for Cultivation, 714
 — — in Buda-Pesth Butter, 478
 — — in Cheese, 478
 — *typhosus*, Antagonism of the Soil to, 696
 — — *Bacillus coli*, and related Species, Media for distinguishing, 496
 — — Medium for Isolating in the presence of *Bacillus coli communis*, 250
 Bacteria Agglutination, 89
 — Anaerobic Cultivation, 370
 — — Method of Cultivating, 713
 — and Cereal Products, 696
 — and Fungi, Composition of Proteids and Cell-Membranes, 457
 — and Hemp, 695
 — and the Disintegration of Cement, 89
 — Chlamydo-spores, 224
 — Decomposition of Nitrates and Nitrites, 224
 — Effect of Nitrates on the Shapes of Certain, 88
 — Enumeration of Water, 229
 — Experimental Production of Parasitic Races, 474
 — Fixing to Slide or Cover-Slip without Drying, Method, 498
 — Gram-Staining, in the Intestines of Infants, 229
 — “Hanging-Block” Preparation for observing developing, 380
 — Intestinal, of Chironomus Larvæ, 690
 — Luminous, 342
 — Nitrogen-Assimilating, in Soils, 341
 — Proteolytic Power, 88
 — Reaction to Stimuli, 88
 — Resorption from Intestines, 347
 — Sporiferous, Metachromatic Granules in, 89
 — Stability of, Influence of High Temperatures on, 499
 Bacterial Disease of the Potato, 223
 — Flora of Mont Blanc, 475
 — Grouping, Unusual, 689
 Bacteriological Examination of Potable Water, 91
 — Purposes, New Injection Syringe, 259
 Bacteriology and Pathology, Handbook, 603
 — Manual of Determinative, 697
 — Miquel and Cambier's, 349
 — of Human Fæces, 695
 — of Scarlatina, 694
 Bacteriosis of Kohlrabi, 90
Bacterium phasianicida, 600
 — *pyogenes ramosum*, 602
 Bacteroids, Formation in Artificial Nutrient Media, 226
 Baker, F. C., Structure of *Limaxa emarginata*, 550
 Baker, F. W. W., Exhibition of Microscopic Slides illustrating Eye Structure, 119, 121
 — New Two-speed Fine Adjustment, 506
 Baker, J. L., Action of Ungerminated Barley on Starch, 576
 Baker's Portable Diagnostic Microscope, 98
Balanus improvisus, Observations on Young Stages, 432
 Ballowitz, E., Two-tailed Spermatozoa, 538
 Bamberke, V., Mycology in France, 221
 Bananas, Composition, 566
 Banchi, A., Parafibula in Marsupials, 33
 Banker, H. J., Hydnaceæ, 682
 Baranetzky, J., Causes of the Direction of Branches, 66
 Barbadoro, L., Development of Frog's Retina, 28
 Barbagallo, —, Preserving Intestinal Worms, 258
 Barberry, Witch's Brooms, 592
 Barbier, M., Mycology in France, 221
 Barfurth, D., Regeneration of the Lens in Chick Embryos, 633
 Barger, G., Saponarin, 568
 Barker, B. T. P., Spore-formation in Saccharomycetes, 339
 Barker, T., British Mosses, 581
 Barnard, —, Luminous Bacteria, 342
 Barrett-Hamilton, G. E. H., Origin of Colour in Animals, 173
 Barsickow, M., Secondary Growth in Thickness in Palms, 316
 Bartelletti, V., Study of the Family Och-naceæ, especially of Malayan Species, 318
 Barthels, P., Minute Structure of Cuvierian Organs, 436
 Bartolotti, C., Function of Chloragogen Cells, 648
 Barton, E. S., The Genus Halimeda, 678
 Basidiomycetes, Crystalloids, 683
 Basidiospores, Germination, 682
 Bast-Fibres of Japanese Fibre-Plants, 318
 Bat, Development of Inner Ear, 420
 — Fertilisation, 633
 Bataille, F., Fungus Flora, 340
 Bataillon, E., Experimental Parthenogenesis in Amphibians, 537
 Bats, Copulation, 164
 — Hibernation, 33
 — Transmissibility of Plague, 692
 Battelli, F., Rheotactic Properties of Spermatozoa, 161
 Batters, E. A. L., British Marine Algæ, 585

- Bayer, F., *Alinit-Bacillus Bcta*, 342
Bdellostoma dombeyi, Vascular System, 174
 Beard, J., Determination of Sex in Animal Development, 534
 — Numerical Law of Germ-Cells, 419
 Beauverie, J., Influence of Osmotic Pressure on the Form and Structure of Plants, 76
 — Mycorrhiza, 336
 Beck, —, Agglutination of Tubercle Bacillus, 348
 Beck, C., Microscope with observing Prism and Eye-piece for Photomicrography, 266
 — New Micrometer Microscope, 119, 121
 — Prof. Hnntingdon's new Stage, 266
 — Standing's Imbedding Microtome, 385
 Beck, R. and J., Exhibition of Typical Bacteria, 264
 — Observing Prism for Photomicrography, 616
 Beck's Imperial Microscope, 95
 — Micrometer Microscope, 357
 Beck-Steinheil Orthostigmats, 360
 Beddard, F. E., "Chestnuts" of Horse, 172
 — Two New Earthworms, 433
 Bedot, —, Historical Study of the Zoological Investigation of Hydroids, 311
 Beecher, C. E., Eurypterid Remains in Cambrian, 642
 — Ventral Integument of Trilobites, 427
 Beer, —, *Coemansiella alabastrina*, 464
 Beetles, British, Coloration, 180
 Beet-root, Cultivation, 452
 Beggiaoa, 223
 Bell, F. J., Occurrence of *Squilla desmaresti* in North Sea, 185
 Bending of Mature Wood in Trees, 66
 Benham, W. B., Platyhelms, Mesozoa, and Nemertini, 186
 "Benikoji" Fungus, 466
 Bennett, A., *Liparis Loeselii* and *Teucrium Scordium*, 670
 Bennett, A. W., 120
 — Death, 264
 — the late, 155
 Bentler, B., *Paryphanta hochstetteri*, 427
 Berg, E., Biology of *Ranunculus Ficaria*, 73
 Bergendal, D., Notes on *Carinoma armandi*, 309
 Berger, E., Stereoscopic Loups, 698
 Berger's Fine Adjustment, 610
 Bergh, R. S., Origin of Blood-Vessels, 160
 Berlese, A., Copulation of House-Fly, 301
 — South American Acarids, 183
 Berliner, K., Hofmann's Nuclei in Spinal Cord of Chick, 539
 Bernard, H. M., Studies on the Retina, 541
 Berry, E. W., Stipules of *Liriodendron*, 67
 Berthelot, M., Distribution of the Acids in Plants, 63
 Bertrand, C. E., Fibrovascular Bundles in the Stem and Leaf of Filicineæ, 78
 — — Chains of Filicineæ, 207
 Bertrand, G., Blue Colour in Fungi, 222
 Bescherelle, E., Lists of Mosses and Hepatics, 332, 333
 Besredka, —, *Streptococcus Hæmolysin*, 346
 Bessey, C., Morphology of the Pine-Cone, 318
 Best, —, Glycogen Staining, 622
 Bettmann, —, Neutral Red for Staining Nucleated Red Blood-Corpuscles, 114
 Bevan, E. J., Researches on Cellulose, 61
 Beyerinck, M., Lactic Ferments in the Arts, 346
 Bibliography, 94, 230, 236, 237, 247, 263, 350, 383, 487, 494, 505, 697, 698, 709, 715, 717, 720
 — of Works dealing with the Microscope and other Optical Subjects, 20
 Bidder, G., Modifications of Metamorphosis in *Halichondria panicea* and in *Suberites domuncula*, 190
 — *Sycon compressum*, 190
 Bigelow, M. A., Early Development of Lepas, 555
 Bild, A., Development of Teeth in *Sus domestica*, 162
 Binot, —, Bacterial Flora of Mont Blanc, 475
 Bio-chemical Antagonisms, 228
 — Studies on the Tubercle Bacillus, 92
 Biogeographical Regions, 426
 Biology and Medicine in Nineteenth Century, History, 170
 Birches, American and Old World, Relationship, 671
 Birds, Cæca, 542
 Bisexual Condition, Passage from to Unisexual Condition by Unilateral Parasitic Castration, 326
 Bisulphide of Carbon in Paraffin Imbedding, 111
 Bites of *Latrodectus 13-guttatus*, 45
 Bitter, G., *Parmelia*, 85
 — Variability of Lichens under different external conditions, 84
 Bivalve, Inferior Backward Current in, 39
 Bivalves, Ligament, 642
 — with Red Blood-Corpuscles, 550
 Black and White Dot Phenomenon, 367
 Blackman, F. F., Reaction of Leaves to Traumatic Stimulation, 74
 Blackman, M. W., Spermatogenesis of *Scolopendra*, 182
 Blanchard, N., Grand-parental Inheritance, 419
 Blastomyces, New Pathogenic, 689
 Blenny, Montagu's, Young of, 167
 Bliesener, —, Spore-formation in *Cholera Bacilli*, 90

- Blood, Biological Test, 543
 — of Snail, 640
 — Rapid Method of Staining the Morpho-
 logical Elements, 715
 Blood-Corpuscles, Bivalves with Red, 550
 Blood-Films, Handy Method of Preparing
 Slides and Slips, 108
 Blood-Plates, Examining, 252, 253
 — — What are they? 170
 Blood-Preparations, Method for Fixing,
 372
 Blood-Vessels, Origin, 160
 Blumentritt, F., Fungal Diseases of Plants,
 &c., 220
 Bochenek, A., Pituitary Body of Amphibi-
 ans, 635
 Boeke, J., Homologue of Infundibular Or-
 gan in Amphioxus, 546
 Boekhout, F. W. J., Cultivation Medium
 for Cheese Bacteria, 108
 Bohn, G., Biological Theory of Vision, 298
 — Marine Intoxications and the Life of
 Burrowers, 34
 — Seasonal Histolysis in Polychætes, 48
 Bokorny, T., Energy of Assimilation in
 Fungi, 587
 Bombicei, —, Apparatus for Cultivating
 Anaerobes, 251
 Bone-Sections, Simple Method of Making,
 498, 714
 Bonelli, an early Italian Lamarekian, 638
 Bonnevie, K., Chromatin-Reduction in So-
 matic Cells, 50
 — New Parasitic Gasteropod in Holothu-
 rian, 426
 Bonney, T. G., On Rock Changes in
 Nature's Laboratory, 722
 Bonnier, J., Commensal Schizopod, 555
 — New Giant Pyrosoma, 526
 Boodle, L. A., Anatomy of the Gleicheni-
 aceæ, 207
 Bordas, L., Bites of *Latrolectus 13-gutta-
 tus*, 45
 Borelli, Interesting Extracts from, 712
 Born and Peter's Orientation Plate, 621
 Börner, C., New Collembola, 44, 181
 — Structure and Classification of Collemb-
 ola, 302
 Borotraeger, A., Sugars and Organic Acids
 in certain Fruits, 567
 Borthwick, A. W., Increase in Diameter
 of Trees, 660
 Bose, J. C., Electric Response in Plants
 under Mechanical Stimulus, 574
 Bösenberg, W., Monograph on Spiders of
 Germany, 45
 — Spiders of Germany, 645
 Bosse, B., Experiments with Deycke's
 Media, 229
 Bossiæ and Lipariæ, Anatomical Investi-
 gation of Leaf and Axis, 195
 Botany, Applied, History and Develop-
 ment, 458
 Botany of Tasmania, 577
 — The Microscope in Fossil, 725
 — Topographical, 327
 Botzat, E., Nerve-Endings in Taste Me-
 nisci, 168
 Botryomycosis, 599
Botrytis cinerea, Parasitism, 590
 Bottle for Cedar-Wood Oil, 503
 Bouchard, M., Fungal Diseases of Plants,
 &c., 221
 Boulay, N., Topographical Botany, 327
 Boulenger, G. A., Systematic Position of
 Pleuronctidæ, 638
 Bonhiol, J., Respiration in Polychæta,
 647
 Bourquelot, E., Cane-Sugar in Reserve
 Food-Substances of Phanerogams, 326
 — Determination of the Presence of Cane-
 Sugar in Plants, 63
 Boutan, L., Experiments on Pigeons (in
 relation to the Semicircular Canals, 544
 — Lesion of the Semicircular Canals,
 637
 Bouvier, E. L., Papillæ of Onychophora,
 306
 Bouyguès, M., Origin and Differentiation
 of Vascular Meristems in Leaf-Stalk,
 316
 Boveri, T., Problem of Fertilisation, 418
Bovista ammophila, 336
 Boyer, G., Vitality of Leaves after their
 Fall, 73
 Bra, M., Presence of a Parasite in Blood
 of Epileptics, 346
 Brachiopods, North Atlantic, 187
 Braddon, W. L., Handy Method of Pre-
 paring Slides and Slips for taking Blood-
 Films, 108
 Bradford, J. R., Fixing and Staining Try-
 panosoma, 372
 — *Trypanosoma brucei*, 440
 Brain of Ammocete, Ciliated Grooves, 545
 — of *Macrosclides proboscideus*, 637
 — of Phascolosoma, 649
 — Sections, Zeiss' Stand for, 483
 Braithwaite, R., 127
 — British Moss-Flora, 459
 Branch and Stem of same Tree, Union, 448
 Branches, Causes of Direction, 66
 Branchial Clefts in Lizard and Slow-worm,
 634
 — — in Ophidia, 539
 Branching, Precocious, 658
 Brand, F., Cladophora, 82
 — *Cladophora Agagropila*, 333
 — The Genus *Trentepohlia*, 677
 Brasil, L., Alimentary Canal of *Lagis
 koreni*, 308
 — New Sporozoon, 313
 Brasseur, —, A Notable Advance in Co-
 lour Photography, 241
 Brauer, A., Development of Excretory Or-
 gans in Gymnophiona, 421

- Braun, M., Fasciolid Parasites of Birds, 558
 Braus, H., Dorsal Groove and Dorsal Suture in Gastrula of Triton, 28
 Breathing Organs of Pseudoscorpionidae, 184
 Breeding Habits of *Ameiurus nebulosus*, 34
 Brefeld, O., Pleomorphism and Chlamydo-spore Formation among Filamentous Fungi, 587
 — Sexual and Non-Sexual Reproduction in the Zygomycetes, 213
 Brehm, V., Phyto-plankton of the Erlaufsee and the Caspian Sea, 676
 Brenner, W., Air-roots of *Avicennia tomentosa*, 446
 Bretcher, K., Observations on Swiss Oligochaeta, 648
 Bretscher, K., Life of Earthworms, 186
 Briggs, S. H. C., Colouring Matters of Green Ebony, 443
 Britain, New Mosses, 209
 Britton, E. G., European Species of Sema-tophyllum, 673
 — Filmy Ferns of South America, 578
 Broman, I., Atypical Spermatozoa, 632
 — Movements of Spermatis and their Parts, 162
 Bronn's 'Tierreich,' Chilopoda in, 644
 Brothems, V. F., Lists and New Species of Mosses, 210
 Browicz, M. T., Intracellular Canals in Hepatic Cells, 422
 Brown, A. J., Enzyme Action, 325
 Brown, H. T., Enzyme Action, 325
 — Influence of Varying Amounts of Carbon Dioxide in the Air on Photosynthesis and Plant Growth, 668
 Browne, C. A., jun., Constituents of Pith of Maize and Elder, 567
 Bruce, D., New Trypanosoma, 564
 Brun, J., Fresh-water Diatoms from the Island of Jan Mayen and the East Coast of Greenland, 212
 Bryce, T. H., Maturation in *Echinus esculentus*, 654
 Bryological Notes, 580
 Bryum, Bohemian Species, 580
 Brzezinski, F. P., Vegetable Pathology, 595
 Bubak, F., Puccinia, 337
 — *Urophlyctis bohemiaea*, 586
 Bühler, A., Retrogressive Changes in Ovarian Follicles, 631
 Bulbiform Seeds of Amaryllidæ, 66
 Bulbils of *Lysimachia terrestris*, 67
 Buller, A. H. R., External Phenomena of Fertilisation, 536
 Bullock-Webster, G. R., Characeæ from Co. Monaghan, 582
Bupestris sanguinea, Sexual Dimorphism, 180
 Burbury, F. E., List of Tasmanian Diatoms, 583
- Burette for removing Definite Quantities of Sterile Fluids, 380
 Burgenstein, A., Germination of Fern-Spores, 78
 Bürger, O., Development of Clepsine, 648
 — Lateral Hermaphroditism in *Palinurus frontalis*, 433
 Burgerstein, A., Germinating Power of the Seeds of Cereals, 204
 Burkholder, J. F., Simple Method of Making Bone Sections, 498
 Burmanniaceæ from Brazil, 458
 Burne, R. H., Innervation of Supra-orbital Canal in *Chimæra monstrosa*, 168
 Burr, R., Source of Acid Organisms of Milk, 476
 Burrows, Life of, and Marine Intoxications, 34
 Buscalioni, L., New Mode of Measuring Transpiration, 75
 Busse, W., Rust of Andropogon Sorghum, 592
 Butler, E. A., Some British Hemiptera, 428
 Butter, *B. tuberculosis* in Buda-Pesth, 478
 Butter-Fat, Decomposition, 336
 Butterflies, Colours not due to Diffraction, 302
 Byrne, L. W., Young of Montagu's Blenny, 167

C.

- Cabbage and Cancer, 441
 Cacace, E., Proteolytic Power of Bacteria, 88
 Cæca of Birds, 542
 Cæcilians, Systematic Position, 545
 Cahn, —, Gram-staining Bacteria in the Intestines of Infants, 229
 Cajal, P. R. y, Evolution of Pyramidal Cells of the Cerebrum, 422
 Calcium and Magnesium, Relations to Plant-Growth, 573
 — oxalate, Function, 63
 Caliper Gauge, 117
 Calleja, C., Cæca of Birds, 542
 Calman, W. G., Affinities of Uronectes, 185
 Calmette, A., Hæmolytic Action of Cobra Poison, 544
 Calypogeia, Priority of the Name, 674
 Cambarus, Structure of Male in Genus, 48
 Cambier and Miquel, Bacteriology, 349
 Cambier, R., Medium for Isolating *Bacillus typhosus* in presence of *Bacillus coli communis*, 250
 Camera, Abbe Drawing, 105
 — Ordinary, Simple Means of producing Microphotographs with, 246
 — Panoramic View, 367
 — Vertical, Form of, and its uses, 705
 Camerao, L., Bonelli, an early Italian Lumarckian, 638
 — Statistical Study of Organisms, 171

- Cameron, J., Development of Layers of Retina, 538
- Camichel, —. Blue and Green Coloration in Skin of Vertebrates, 33
- Campbell, W., Alloys of Copper and Tin, 383
- Crystallisation produced in Solid Metal by Pressure, 261
- Camus, F., Lists of Hepatics and Mosses, 331
- Cancer and Cabbage, 441
- Cane-sugar in Plants, Determination of the Presence, 63
- — in Reserve Food-Substances of Phanerogams, 326
- Canker in Apple Trees, 686
- of the Oak, 338
- Cannon, W. B., Reaction of Daphnia to Light, 47
- Capillary Vessels, Muscularisation, 542
- Capsule and Flagella of *B. anthracis*, 226
- of Anthrax, Staining, 257
- Capurro, M. A., Alleged Peritubular Lymphatic Tubes of the Testis, 538
- Carapa guianensis*, Germination of Seeds, 572, 658
- Carbohydrate, Conversion in the Germination of Date, 326
- Carices, North American, 577
- Cardot, J., Leaf-Anatomy of *Leucobryaceae*, 673
- Carcinoma armandi*, Notes on, 309
- Carmin Solution, New Alcoholic, 715
- Carnations, Fungus Pests, 471
- Carnivores, Vertebrate of Terrestrial, 638
- Carp, Dolphin, 547
- Carpenter, G. H., Arctic Pantopoda, 184
- Collenbolla from Franz-Josef Land, 182
- Carpophyll of Enecephalartos, 65
- Carr, Rev. Canon, 125
- Carruthers, W., 265
- President's Address, 129
- Caryophyllæus, New Species, 557
- Cassiope, Anatomy of, 68
- Castalia and Nympheæ, Development of Embryo-sac and Embryo, 449
- Castellani, A., Method for Detection of Typhoid Bacillus in Blood, 496
- Cat, Tailless, Progeny, 292
- Catechus, Acacia and Gambier, Constituents, 568
- Cathetometer, Short Table, 359
- Table, 389
- Cattle Plague, 381
- Wild, European, 425
- Caullery, M., Fecampia, 558
- Free Phase in the Life-Cycle of Orthonectids, 53
- Cavara, F., Resistance to Salt Solution, 324
- Cave-Insect, New Moravian, 429
- Cedar-Wood Oil Bottle, 503
- Cell, Chemical Organisation, 423
- Cell Contents. See CONTENTS, xxi
- Cell-Division, Artificially induced Anomalies, 635
- Cell-nucleus of Saccharomyces, Demonstration, 113
- Celloidin Tissues, Marble Blocks for, 715
- Cells, Binucleate, in certain Hymenomyces, 217
- Living, Action of Copper on the Growth, 203
- Sertoli's, Function, 161
- Cellulose, Fermentation, 597
- Researches, 61
- Centipedes, Luminosity, 182
- Centring Apparatus, Zeiss', for Microscope Objectives when used as Condensers, 615
- Cephalopoda and Amphineura, Relationship, 38
- Development of Radula, 36
- See CONTENTS, xiii
- Ceratodus, Skull and Nervous System, 634
- Ceratopteris thalictroides*, Anatomy, 328
- Cercopithecus cynomolgus*, Chondrocranium, 163
- Cereals, Changes in Nitrogenous Substances in Ripening, 456
- Germinating Power of the Seeds, 204
- Influence of Nitrogenous Manures on the Form, 453
- Rust, 338
- Smut, 591
- Cerebral Degenerations, 422
- Hemispheres, Origin, 26
- Cerebratulus marginatus*, Maturation and Fertilisation, 651
- Cerebrum, Evolution of Pyramidal Cells, 422
- Cestoda, Germinal Layers, 50
- Cestodes, Avian, 50
- Fertilisation, 557
- Cestracion, Reminiscence of Holoblastic Cleavage in Ovum, 29
- Cestracionts and Acanthodians, Carboniferous, 547
- Chætoderma, 38
- Chamæleons, Prodrumus of Monograph, 297
- Chambers and Inskeep's Improved Ophthalmometer, 709
- Champion, G. C., Sexual Dimorphism in *Buprestis sanguinea*, 180
- Chandler, S. E., Influence of Varying Amounts of Carbon Dioxide in the Air on Photosynthesis and Plant Growth, 668
- Chapman, F., Foraminifera, 439
- Characeæ from County Monaghan, 582
- Characters, Acquired, Alleged Case of Transmission, 164
- Charpentier, P. G., Assimilation of Carbon by a Green Alga, 323
- Charrin, A., Influence on Offspring of Injecting Toxins into Parents, 29

- Cheauvand, G., Precursors of Sieve-tubes in Gymnosperms, 569
- Cheese, *B. tuberculosis* in, 478
- making, Use of Tyrogen, 226
- Cheilostomata, Structure, 651
- Chemauxism of Copper Salts on *Penicillium glaucum*, 324
- Chemical Changes in Seed Plants. See CONTENTS, xxv.
- Chermes, Hermaphroditism in Species of, 553
- Chester, F. D., Manual of Determinative Bacteriology, 697
- “Chestnuts” of Horse, 172
- Soils suitable for, 453
- Chevalier-Euler Achromatic Doublet, 16
- Chick, Hofmann's Nuclei in Spinal Cord, 539
- Chilopod, Annectant Type, 429
- Chilopoda, Comparative Morphology, 305
- in Bronn's 'Tierreich,' 644
- Chimera monstrosa*, Innervation of Supra-orbital Canal, 163
- Chironomus Larvæ, Intestinal Bacteria, 690
- Chlamydo-spores of Bacteria, 224
- Chloragogen Cells, Function, 648
- of Oligochæta, 648
- Chlorophyll and Starch in Stem, Evolution, 62
- Assimilation, 72
- — of Cut Leaves, 73
- Contributions to Chemistry of, 206
- Chodat, R., Fresh-water Algæ of Switzerland, 461
- Cholera Vibrios, Demonstration of, 110
- — Effect of Human Gastric Juice on, 224
- Cholodkovsky, N., Hermaphroditism in Species of Chermes, 553
- Chondocranium of *Ceropithecus cynomolgus*, 163
- Chondrus crispus*, 678
- Christ, H., Brazilian Ferns, 672
- Christensen, C., Danish Pteridophyta, 672
- Chromatin-Reduction in Somatic Cells, 50
- Chromatophores of Fresh-water Diatoms, 80
- Chromosome, Accessory, in Insect Spermatogenesis, 41
- Chromosomes in *Larix leptolepis*, Reduction, 60
- Reduction in the Number in the Embryo-sac Mother-cell, 68
- Chroococccæ, New Genus, Pilgeria, 88
- Chrysanthemums, Cultivated, Disease of, 596
- Chrzaszcz, T., Yeast-eating Amœboid Organism, 562
- Church, A. H., Phyllotaxis, 67
- Chytra and Limnotrochus, Tanganyika Gastropods, 640
- Chytridineæ, New, 84
- Ciechanowski, S., Staining Biliary Canaliculi, 622
- Ciliata, New, 192
- Cirripedia, Dwarf Males and other Sexual Peculiarities, 646
- Citron, E., Multicellular Sense-Organs in *Syncoarpe sarsii*, 55
- Cladocytrium Alismatis*, 214
- Cladonema, Occurrence in the Bahamas, 188
- Cladophora, 82
- Cladophora Agagropila*, 333
- cornea, Growth in Form of Balls, 460
- Clark, A. M., Abnormal Thickening in Kendrickia, 660
- Clark, F., On the Toxic Properties of some Copper Compounds, 222
- Clark, H. L., An Extraordinary Animal, 560
- Echinoderms from Puget Sound, 437
- Classification, 636
- Clasterosporium carpophilum*, 589
- Clausen, H., Influence of Nitrogenous Manures on the Form of Cereals, 453
- Cleistogamy of *Stellaria pallida*, 72
- Clepsine, Development, 648
- Cleve, A., Contributions to the Flora of Bear Island, 212
- Cleve, P. T., Plankton, 581
- Recent Publications on Diatoms, 582
- Clinton, G. P., *Cladocytrium Alismatis*, 214
- Clos, D., Cross-Pollination and Self-Pollination, 71
- Clupea sprattus*, Life-history, 166
- Clythra quadripunctata*, Life-history, 303
- Coal Measures, Pollen and Male Prothallia, 671
- Cobelli, R., Sense of Taste in an Ant, 552
- Cobra Poison, Hæmolytic Action, 544
- Coccidæ occurring in Britain, Monograph, 429
- Coccidium of Frog's Kidneys, 657
- Coccoliths and Coccospheres, 674
- Coccospheres and Coccoliths, 674
- Cockerell, T. D. A., Pigments of Nudi-branches, 38
- Cockles, Pathogenic Bacillus in, 693
- Coco-nut, Chemical Studies, 575
- Fruit, 65
- Coe, W. R., Nemertean Parasites of Crabs, 558
- Cœlentera. See CONTENTS, xviii
- Cœlom, Homologies, 175
- Coemansiella alabastrina*, 464
- Cœrulein S, Staining Sections of Spinal Cord, 717
- Coggi, A., Nerves of Lorenzini's Ampullæ, 423
- Cohn, —, Trocar for the Aseptic Collection of Portions of Tumours, 382

- Cohn, E., New Pathogenic Yeast, 681
 Cohn, F., Function of Corpus Luteum in Relation to Insertion of Ova in Uterus, 25
 Cohn, L., New Species of Monostomum, 651
 Coker, W. C., Gametophytes and Embryo of Podocarpus, 319
 Cole, A. H., Projection Microscopes using Electric Arc or Oxyhydrogen Light, 702
 — Solar Projection Apparatus and its Adjustment, 615
 Cole, L. J., *Discoarachne brevipes*, 307
 Coli and Typhoid, Differential Diagnoses, 598
 Collapsible Tubes, Immersion Oil in, 116
 Collecting Objects. See CONTENTS, xxxvi
 Collembola from Frauz-Josef Land, 182
 — New, 44, 181
 — Structure and Classification, 302
 Collins, S. F., Algæ of Jamaica, 335
 Collodion Sacs, Improved Method of Making, 502
 Colonies, Aggregated, in Madreporian Corals, 561
 Coloration, Blue and Green, in Skin of Vertebrates, 33
 — of British Beetles, 180
 — Physical, 637
 Colour in Animals, Origin, 173
 — Photography, Notable Advance, 241
 — Photomicrography, 243
 Colouring, Correlation, in Liver, Skin, and Hairs, 32
 Colours of American Crayfish, 46
 — of Northern Polypetalous Flowers, 457
 Colubrinæ, Toxic Properties of certain Non-poisonous, 638
 Comber, Thomas, the Late, 158
 Commensal Oligochaete in New England, 49
 Comstock, J. H., General Course of Entomology, 551
 Conifers, Development of Stomata, 315
 Conjugation, Abnormal, in Spirogyra, 80
 Conn, H. W., Ripening of Cream, 90
 Conradi, H., Medium for Isolating Typhoid Bacilli, 371
 Conrady, A. E., 728
 Constantineanu, J. C., New Chytridinae, 84
 Conte, A., Contributions to Anatomy of *Rhabdopleura normani*, 652
 — New Microsporidian, 58
 — Note on Additions to Fresh-water Fauna, 546
 Conus Poisoning, 301
 Cook, M. T., Development of Embryo-sac and Embryo in *Castalia* and *Nymphæa*, 449
 — Methods for Rearing Amœba, 107
 — Polyembryony in Gingko, 661
 Copeland, E. B., Sexuality in Spirogyra, 333
 Copepod, New Parasitic, in Intestine of Mussel, 646
 Copepods of Faroë Channel and Shetlands, 185
 Copper, Action on the Growth of Living Cells, 203
 — Compounds, Toxic Properties of some, 222
 — in the Animal Organism, 637
 — Antimony Alloys, Structure, 720
 — Tin Alloys, Results of Chilling, 261
 Coprophilous Fungi II., 335
 Copulation of Bats, 164
 — of House-fly, 301
 Copulatory Apparatus of Male Trichoptera, 43
 Corallinacæ, New Genus, Perispermum, 212
 Corallinae from Port Renfrew, Vancouver, 584
 — Japanese, 584
 Corals, Madreporian, Aggregated Colonies, 561
 — Rugose, Relationships, 189
 Corbie, M. C., Fungus Pests of the Carnations, 471
 Cord, Fresh Spinal, Staining Axis-Cylinders of, 715
Cordylophora lacustris, Development, 188
 Coregonus, Myxosporidia, 657
 Cork-formation in Interior of Leaf-stalk of *Nuphar luteum*, 448
 Cornaille, F., Fibrovascular Bundles in the Stem and Leaf of Filicineæ, 78
 Cornet's Forceps, Modification, 258
 Corney, R. G., Poisoning in Conus, 301
 Corpus Luteum, Function in Relation to Insertion of Ova in Uterus, 25
 Correns, C., Hybridism and Xenia, 200
 — On the Separation of Characters in Hybrids of Pea Type, 454
Corynebacterium lymphæ vaccinalis, 94
 Corti, B., Diatoms of the River Olona, 676
 Cotte, J., *Suberites domuncula*, 56
 Cotyledons, Nutrition of the Seedling at the Expense of, 203
 Council, New, 122
 Counting Apparatus, New, for Plate Cultures, 718
 Coutière, H., New Rhizocephalid Type, 555
 — Structure of Thylacoplethus, 555
 Couvreur, E., Blood of Snail, 640
 Cover-glass Forceps, New, 260
 Cover-slips, Substitute, 115
 Crabs, Nemertean Parasites, 558
 Crawley, H., Progressive Movement of Gregarines, 441
 Crayfish and Hermit Crab, Regeneration, 431
 — Colours of American, 46

- Cream, Ripening of, 90
 Crinoid, New, 437
 Crocodile, Trematodes, 308
 Croft, W. B., Colours of Butterflies not due to Diffraction, 302
 Crofts, J. S., Action of Hydrogen peroxide on Carbohydrates in presence of Ferrous Sulphate, 576
 Croneberg, A., Hydrachnids of Central Russia, 307
 Crosby, J. H., Reaction of Bacteria to Stimuli, 88
 Cross, C. F., Researches on Cellulose, 61
 Cross-Pollination and Self-Pollination, 71
 Cruciferae, Anatomy and Morphology of Flower, 320
 Crustacea, Limnetic, Reproduction, 432
 — New Blind, 48
 — Scottish, 555
 —. See CONTENTS, xvi
 Crustaceans, Relict in North German Lakes, 432
 Cryptogamic Flora of Germany, Rabenhorst's, 86, 210, 464
 Cryptogams, Lists and New Species, 210
 — Protoplasmic Continuity, 314
 —. See CONTENTS, xxvi
 Crystalline and Crystalloid Substances in Plants, 61
 — Structure of Metals, 262
 Crystallisation produced in Solid Metal by Pressure, 261
 Crystalloid and Crystalline Substances in Plants, 61
 Crystalloids of Basidiomycetes, 683
 Crystals, Albuminoid, in Ova of Roe Deer, 632
 — of Calcium Oxalate in Seedlings of Alsike, 565
 Cuckoo-spit, Infusoria in, 657
Cucumaria lævigata, Structure and Hermaphroditism, 653
 Cuénot, L., Bivalves with Red Blood-Corpuscles, 550
 — Heredity Studied in Mice, 294
 — Physiology of Echinoderms, 54
 Culicidæ of Algiers, 643
 — Receptacula seminis, 644
 Cultivating Anaerobes, Apparatus, 251
 — Anaerobic Bacteria, Method, 713
 — in Test-tubes, Simple Apparatus for, 497
 Cultivation Medium for Cheese Bacteria, 108
 — of *Bacillus tuberculosis*, Eggs as a Medium, 714
 — of *Rhizobium leguminosarum*, 108
 Culture-media, Physical Properties of Gelatin, in reference to its use in, 713
 — Processes. See CONTENTS, xxxvi
 Cumings, E. R., Variation in Platystrophia, 560
 Current, Inferior Backward, in Bivalve, 39
 Curtis, C. C., Observations on Transpiration, 572
 Cutting Objects. See CONTENTS, xxxvii
 Cuttlefish, Dichotomy of Arms, 299
 Cuvierian Organs, Minute Structure, 436
 Cyanogenesis in Plants, 566
 Cyanophyceæ, Cytology, 689
 — New Genus, *Richelia*, 88
 Cycads, Living, Notes on—The *Zamia* of Florida, 448
 Cyclamen, Regeneration of Leaf-Blade, 447
 Cystocarp, Development in some Floridææ, 334
Cystoopsis acipenseri, 308
 Cytology. See CONTENTS, xxi
 — of Cyanophyceæ, 689
 Czapek, F., Proteid Formation in Plants, 457
 Czapski's Cornea Microscope, 484
- D.
- Dahl, F., Arrangement of a Spider Collection, 554
 — Classification of Spiders, 554
 Dale, E., Structure and Affinities of Diptera, 672
 — Tubers of *Dioscorea*, 68
 Damas, D., Development of *Molgulidæ*, 639
 Dangeard, P. A., Zoospore and Spermatozoon, 57
 Daniel, L., Grafting, Pinching, and Annular Decortication, 73
 — Rejuvenescence as a Result of Grafting, 659
 Daniellia, Secreting Apparatus, 318
 Dantec, F. Le, Two States of Living Matter, 31
 Daphnia, Reaction to Light, 47
 Darbshire, O. V., *Chondrus crispus*, 678
 Dark-Ground Illumination, Lens, 237
 Darwin, F., Method of Investigating the Gravitational Sensitiveness of the Root-tip, 575
 Dassonville, C., Mycology in France, 221
 Date, Conversion of Carbohydrate in Germination, 326
 Davenport, C. B., Reaction of *Daphnia* to Light, 47
 Davis, T. J., New Cover-glass Forceps, 260
 Dean, B., Notes on Living *Nautilus*, 36
 — Reminiscence of Holoblastic Cleavage in Ovum of *Cestracion*, 29
 Dearness, J., Magnifiers, 237
 Debrand, L., New Method of Cultivating Tetanus Bacillus, 618
 Decapoda, Glands of Alimentary Canal, 46
 Decapods, New and Little-known, Victorian, 432
 — of Celebes, 432
 — New Victorian, 646

- Decortication, Annular, Grafting and Pinching, 73
- Deegener, P., Odoniferous Organ of the Male *Hepialus hectus*, 302
- Deep-Sea Fauna, 35
- Deetjen, —, Examining Blood-plates, 252
- Deherain, P. P., Cultivation of Beet-root, 452
- Formation of Starch in the Grain of Wheat, 63
- Dekhuysen, M. C., Examining Blood-plates, 252
- Delacroix, G., Bacterial Disease of the Potato, 223
- Delage, Y., Function of Sphæridia in Sea-Urchins, 437
- Delamare, G., Influence on Offspring of Injecting Toxins into Parents, 29
- Delépine, S., Human and Bovine Tuberculosis, 92
- Delezenne, C., Venom of Snakes, 638
- De Lille, —, New Syphilis Bacillus, 691
- Delphinium consolida*, Colouring Matter from the Flowers, 443
- Dematophora in Fruit, 680
- Demokidoff, K., Testis of *Tenebrio*, 644
- Deudrocometes paradoxus*, Conjugation, 438
- Dendy, A., Free-Swimming Hydroid, 561
- Ciliated Grooves in Brain of Ammocoete, 545
- Oviparous Species of Onychophora, 306
- Denis, P., Development of Inner Ear in Bat, 420
- Dennis, D. W., Photomicrography, 240
- Dennis' High-power Photomicrography, 242
- Dentalium Entalis*, "Pseudogamy," 299
- Dentaria bulbifera*, Staminode-like Structures in, 198
- Dermaptera and Microthorax, 302
- Descent, Present Position of the Theory, 171
- Desmarestiæ, Structure and Development, 583
- Development of Duck and Tern, Early Stages, 294
- of Hypodermal Imaginal Discs in Larval Diptera, 42
- of *Polystomum integerrimum*, Early Stages, 51
- Deycke's Media, Experiments, 229
- Dewitz, J., Hindering Pupation, 180
- Diameter of Trees, Increase, 660
- Diastase, Cytological Changes accompanying the Secretion, 565
- Ungerminated Barley, Action on Starch, 576
- Diatom Frustules, Capillary Absorptive Action, 212
- Structure, Images, 248
- Diatomaceæ, Parasitic Fungi, 463
- Diatomaceen-Kunde, Schmidt's Atlas, 82
- Diatoms, Atlas, 460
- Classification, 211
- Colourless, 81
- Fresh-water, Chromatophores of, 80
- — — from the Island of Jan Mayen and the East Coast of Greenland, 212
- in Agar-Agar, 676
- Marine, of France, 82
- New Genus, *Stauronella*, 81
- of Lake Cotronia, 676
- of the River Olona, 676
- Recent Publications, 582
- Dichotomy of Arms in Cuttlefish, 299
- Dichromatism, Prisms and Plates for showing, 493
- Dickel, F., Life-history of Hive Bee, 180
- Didymozone, New Species, 187
- Diederichs, K., Formol as a Preservative and Fixative, 109
- Picro-carmin Solutions, 255
- Preparation of Radulæ, 374
- Diedicke, H., Relationship between Pleospora and Helminthosporium, 681
- Diemyctylus viridescens*, Structural Feature connected with Mating, 634
- Diet, Modifications in Alimentary System of Birds induced by, 172
- Diétel, P., Contributions to Fungus Floras, 685
- New Fungi, 469
- Paraphyses of Uredineæ, 467
- Storing up of Water in the Spores of Uredineæ, 85
- Digby, L., Tanganyika Gastropods: *Chytira* and *Limnotrocha*, 640
- Digestive Gland in Molluscs, 300
- Dimorphism of Foraminifera, 656
- Seasonal, Experiments in, 41
- Sexual, in *Bupestris sanguinea*, 180
- Dingler, H., Floating Organs of Plants, 66
- Dinoflagellata, Discoloration of the Sea, 656
- Two New, 563
- Dioscorea, Tubers, 68
- Diphtheria and Pseudodiphtheria Bacilli. Indol-like Reaction given by Cultures of, 93
- Avian, 225
- Diplopoda, Anterior or Cephalic Glands, 553
- Diplodia cacaoicola*, 338
- Diplosomidae, Heart, 638
- Dipteris, Structure and Affinities, 672
- Dipterous Flies, Undescribed Palpi on the Proboscis of Some, with Remarks on Mouth-parts in several Families, 412
- Pupæ. Prothoracic Respiratory Apparatus, 428
- Direction of Branches, Causes of, 66
- Dischidia with Double Pitchers, 569
- Discoarache brevipes*, 307
- Discomycetes, Some North American, 590

- Discs, Hypodermal Imaginal, Development in Larval Diptera, 42
- Disease in Plants, 76
- Silver-leaf, 683
- Diseases, Fungal, of Plants, 219
- of Plants, 469, 686
- Disinfection, &c., Preparation of Spores for Testing Methods of, 227
- Dismier, G., French Muscineæ, 579
- Distomids, New, 558
- Distomum duplicatum* in Fresh-water Mussels, 431
- *folium*, Life-history, 51
- Distomum from the Duckmole, New Species, 187
- Distomum hepaticum*, Maturation and Fertilisation, 434
- Distribution of Alpine Plants, Means of, 76
- of the Sexes in the Compositæ, 64
- Diverticulum of Duct of Spermatheca in *Helix aspersa*, 176
- Division, Direct, in Artificial Conditions, 635
- Dixon-Nuttall, F. R., New Rotifers, 435
- Dodge, C. W., Immersion Oil in Collapsible Tubes, 116
- Dominici, —, Method for Fixing and Staining Hematopoietic Tissue, 372
- Method for Fixing Blood-Preparations, 372
- Doncaster, L., Development of Sagitta, 649, 650
- Donisthorpe, H. St. J. K., Coloration of British Beetles, 180
- Life-History of *Clythra quadripunctata*, 303
- Dorset, M., Eggs as a Medium for the Cultivation of *Bacillus tuberculosis*, 714
- Double Flowers and Parasitism, 65
- Double-Image Discs and Complementary Interference Colours, 249
- Doublet, Chevalier-Euler Achromatic, 16
- Donin, J., *Ephemerum tenerum*, 332
- List of Hepatics, 332
- Downing, E. R., Variation in Position of Adductors in *Anodonta grandis*, 641
- Dragendorff, O., Regeneration of the Lens in Chick Embryos, 633
- Dragon-Flies of Illinois, 181
- Drawing-Apparatus for Weak Magnifications, and Preparation Stand, Zeiss', 485
- — Winkel's, for Weak Magnifications, 361
- Camera, Abbe, 105
- Stand, Giltsch's, 488
- Draw-tube, an Old Rackwork, 360
- Drigalski, V., Medium for Isolating Typhoid Bacilli, 371
- Dropper for Sterile Fluids, 116
- Drummond, I. M., Development of *Paludina vivipara*, 549
- Drüner, L., Musculature of Urodela, 35
- Dry-rot, Black, in Swedes, 691
- — Micro-chemical Reactions of Wood affected with, 118
- Dubois, R., Copper in the Animal Organism, 637
- Formation of Pearls, 38
- Red Pigment of *Asterias rubens*, 654
- Duboseq, O., Epithelial Regeneration in Mid-gut of Arthropods, 551
- Sexual Phenomena in Pterocephalus, 564
- Ducamp, L., Embryo of Hedera, 71
- Embryogeny of Araliaceæ, 450
- Formation of the Ovule and Embryosac in the Araliaceæ, 71
- Duck and Tern, Early Stages in Development, 294
- Duerden, J. E., Actinians of Porto Rico, 562
- Aggregated Colonies in Madreporian Corals, 561
- Increase of Mesenteries in Madrepora, 655
- Relationship of Rugosa to Living Zoanthæa, 437
- Relationships of Rugose Corals, 189
- Dumée, P., Mycology in France, 221
- Duncan, F. M., Stereophotomicrography, 366
- Photomicrography, 616
- Duncan, J. B., Mosses New to Britain, 210
- Dunstan, W. R., Cyanogenesis in Plants, 566
- Poison of *Lotus arabicus*, 658
- Dupont, C., Cultivation of Beet-root, 452
- Dupont, E., Formation of Starch in the Grain of Wheat, 63
- Durand, E. J., Some North-American Discomycetes, 590
- Durrand, A., Report on the Recent Foraminifera of the Malay Archipelago collected by, 509
- Dusén, P., Lists and New Species of Cryptogams, 210
- Lists of New Species of Hepatics, 210
- Duval, —, Etiology of Acute Dysentery, 480
- Dybowski, B., Life-History and Young Stages of the "Fat-Fish" of Lake Baikal, 167
- Dye-plants, British, 671
- Dysenteric Amœbæ, Staining, 254
- Dysentery, Acute, Etiology, 480
- Etiology of, 91

E.

- Ear in Man, Development, 163
- Inner, in Bat, Development, 420
- Earland, A., Exhibition of Foraminifers 266

- Earle, F. S., North American Mycology, 685
- Earthworms, Life of, 186
— Two New, 433
- Eastman, C. R., Carboniferous Cestracionts and Acanthodians, 547
- Ebner, V. v., Albuminoid Crystals in Ova of Roe Deer, 632
- Ebony, Green, Colouring Matters, 443
- Echinodermæ. *See* CONTENTS, xviii
- Echinoderms, Body-Wall and Gut-Wall, 560
— from Puget Sound, 437
— Physiology, 54
- Echinus esculentus*, Maturation, 654
- Eckel, E. C., Variation in Snakes, 424
- Edwards, C. L., Influence of Temperature on Development of Fowl's Egg, 631
- Egg, Fowl's, Influence of Temperature on Development, 631
- Egg-laying in the Fowl, Influence of Diet, 294
- Elastic Tissue, Modifications of Weigert's Method of Staining, 113
— — New Method of Staining, 256
- Electric Lobes, Staining Nerve Fibrillæ of Neurons, 254
- Electrical Conductivity of Plant Juices, 669
- Electrical Lamp, Microscopist's, 239
- Electricity, Paraffin Bath heated by, 111
- Electrothermal Paraffin Bath, 111
- Elk, Peculiar Process in Seminal Vesicle, 293
- Elliott Bros., Class Microscope, 622
— Micrometer-Gauge, 722
- Elm-Trees, Insects Injurious to, 429
- Embryo and Flower of Spiræa, Development, 667
- Embryo of Hedera, 71
- Embryo-sac and Ovule, Formation in the Araliaceæ, 71
— — in Piper and Heckeria, Development, 570
- Embryogeny of the Sequoiaceæ, 70
- Embryological Methods, 30
- Embryology, Comparative, of Rubiaceæ, 662
— of Vertebrates. *See* CONTENTS, viii
- Emmerich, —, Bio-chemical Antagonisms, 228
- Emmerling, O., Action of Sunlight on Enzymes, 456
- Encephalartos, Carpophyll, 65
- Enchytræidæ, Regeneration, 433
- Endosperm, Histology, 661
- Engelhardt, H., Tertiary Plants from the Himmelsberg, 577
- Engler, A., Vegetation of Mountainous Districts North of Lake Nyasa, 458
- Englisch, O., Nutrition of Hops, 453
- Enriques, P., Digestive Gland in Mollusc, 300
- Enriques, P., Histolysis in Metamorphosis of Flies, 42
— Osmotic Phenomena in Infusorians, 439
— Preparing Liver of Mollusca, 375
— Reactions to Anisotonic Solutions, 544
- Enteropneust, New, 559
- Enteropneusta, Genera, 310
- Entomology, General Course, 551
- Entosternite, Arachnid, Studies, 645
- Enzyme Action, 325
— of Nepenthes. Proteolytic, 205
- Enzymes, Action of Sunlight on, 456
— Demonstration of, 108
— of Tea-leaf, 670
— Oxidising, 205
- Eolidæ, Papillæ, 176
- Ephippia of the Lynceid Entomostraca, 554
- Epidiascope, Zeiss', 506, 699
- Epididymis in Mammals, Epithelium, 163
- Epileptics, Parasite in Blood, 346
- Epiphegus, Subterranean Plants, 447
- Epithelial Structures on Parrots' Beaks, 633
- Epstein, S., Burette for Removing Definite Quantities of Sterile Fluids, 380
- Equisetum, Nature of Stele, 672
- Eriksson, J., Parasitic Fungi, 87
— Rust of Cereals, 338
— — of Timothy Grass, 592
— Witch's Brooms on Barberry, 592
- Ersser, T. D., Acetylene Gas for the Lantern, 490
— New Acetylene Illuminator for the Lantern, 389
— — Reversible Live-Box, 381, 386
- Erysiphaceæ, Contributions to the Biology, 215
— Notes, 465
- Erysiphe Graminis*, 589
- Escherich, K., Development of Nerve-cord, 301
- Escombe, F., Influence of Varying Amounts of Carbon Dioxide in the Air on Photosynthesis and Plant Growth, 668
- Esten, W. M., Ripening of Cream, 90
- Ether Freezing Apparatus for the Microtome, New, 110
- Etiolated Plants, Action of Temperature on Absorption of Minerals, 324
- Euphorbiaceæ, Anatomy, 445
- Eurypterid Remains in Cambrian, 642
- Evans, A. W., Hepatics from Puerto Rico, 674
- Evans, A. W., List of Hepatics, 332
- Evolution and Heterogenesis, 75
— and Palæontology, 634
- Ewart, A. J., Protoplasmic Streaming in Plants, 314
- Ewart, J. C., Variation, Germinal and Environmental, 533
- Ewing, —, Crystalline Structure of Metals, 262

- Excretory Organs in Gymnophiona, 421
 — — of Amphioxus, 298
 Excursions, Announcement, 391
 Exhibition of Foraminifera, 266
 — of Fresh-water Entomostraca, 390
 — of Malaria Parasites, 122
 — of Pond-life, 386
 — of Typical Bacteria, 264
 — Illustrating the Structure and Development of the Eye, 119
 Eycleshymer, A. C., Breeding Habits of *Aneides nebulosus*, 34
 Eye-muscles of Acanthias, 539
 — of Flat-Fish, Migration, 420
 Eye-piece, Demonstration, 487
 — — for Use in Photomicrography, 266
 — — Zeiss' Orthomorphic, 615
 Eye-pieces for the Microscope. *See* CONTENTS, xxxiv
- F.
- Fæces, Human, Bacteriology, 695
 Fairchild, D. G., Precocious Branching, 658
 Falkenberg, R., The Rhodomelaceæ, 583
 Farmer, J. B., Influence of Varying Amounts of Carbon Dioxide in the Air on Photosynthesis and Plant Growth, 668
 Fashing, —, New Capsulated Bacillus, 343
 Fasciation of Pine-Apples, 322
 Fat, Brown, in Rodents and Insectivores, 422
 Fat-fish, of Lake Baikal, Life-history and Young Stages, 167
 Fat-staining Pigment, New, 112
 — Substance of Tubercle Bacillus, 345
 Fauna, Abysmal Antarctic, 35
 — British, Additions, 175
 — Deep-sea, 35
 — Fresh-water, Note on Additions to, 546
 — of a Mountain Stream, 548
 — of Exe Estuary, 174
 — of Neuenburgersee. Notes, 307
 — of Switzerland and the Glacial Period, 35
 — of the Gulf of Triest, 548
 Faunas, Fossil, and Geological Formations, 546
 Fecampia, 558
 Feinberg, —, *Plasmodiophora Brassicæ*, 586
 Feinberg, L., Cabbage and Cancer, 441
 Feistmantel, C., *Streptothrix farcinica*, 586
 Felt, E. P., Insects Injurious to Elm Trees, 429
 Ferguson, M. C., Development of the Oosphere and Fertilisation in *Pinus Strobus*, 70
 — Germination of Basidiospores, 682
 Fermentation, Alcoholic, of Indian Fig-Must, 337
 — without Cells, 75
 Ferments, Oxidising, Reaction and Nature, 455
 Fernald, M. L., Relationships of American and Old World Birchies, 671
 Fernández, M. L. y, Spanish Lichens, 683
 Fernbach, A., Influence of Sulphocyanic Acid on Growth of *Aspergillus niger*, 688
 Fern-Prothallus, Alga-like, 329
 Fern-Stele, New Type, 329
 Ferns, Brazilian, 672
 — Classification, 328
 — Filmy, of South America, 578
 — Fossil American: Fertile Fronds of *Crossotheca* and *Myriothecca*, 671
 — — Heterosporous, 79
 — of the North-eastern States, Analytical Key based on the Stipes, 578
 Ferrario, T., Fungus Flora of Piedmont, 685
 Fertilisation and Development of Oosphere in *Pinus Strobus*, 70
 — and Gametogenesis in Albugo, 83
 — Double in Nadas, 69
 — — in Solanaceæ and Gentianaceæ, 199
 — External Phenomena, 536
 — in the Bat, 633
 — Nature of, 419
 — of *Pythium de Baryanum*, 335
 — Problem, 418
 Fibrovascular Bundles in the Stem and Leaf of Filicinæ, 78
 Fickler, —, *Corynebacterium lymphæ vaccinalis*, 94
 Fielde, A. M., Senses of Ants, 39
 — Studies on Ants, 551
 Fig-must, Indian, Alcoholic Fermentation, 337
 Filaria, New, 651
 Filatova, E., Observations on Young Stages of *Balanus improvisus*, 432
 Filicinæ, Fibrovascular Bundles in the Stem and Leaf, 78
 — — Chains, 207
 Films and Plates for Double Refraction, Zeiss' Crystal, 617
 — Blood, Handy Methods of Preparing Slides and Slips, 108
 Filtering Apparatus, Practical, 260
 Fine-Adjustment, New Two-speed, 267, 354
 — — Swift's "Ariston," 698
 — Adjustments, Ashe's Two-speed, 232
 Fink, B., Lichens of Minnesota, 467
 Fischer, —, Plasmoptysis, 348
 Fischer, E., Chondrocranium of *Cercopithecus cynomolgus*, 163
 — Parasitic Fungi, 219
 — Phalloidæ, 87
 Fischler, G., Formation of New Stems from Old Willows, 197

- Fish, Bony, Development of Mid-brain, 165
 — Mounting for Museums, 258
 — Parasites, 52
 Fish-scales, Periodic Growth, 173
 Fishes, Two New Hæmogregarines, 59
 Flagella and Capsule of *B. anthracis*, 226
 — Staining, 716
 — — New Method, 502
 Flask for Storing Culture Media, 617
 Flat-fish, Migration of Eye, 420
 Flax, Retting, 475
 Fleissig, P., Oil in *Vaucheria*, 83
 Fleure, H. J., Relations of Kidney in *Haliotis*, 550
 Flexner, S., Ætiology of Dysentery, 91
 Flies, Histolysis in Metamorphosis, 42
 — Setæ on Legs, 553
 Flint, J. M., Method of Demonstrating the Framework of Organs, 379
 Floating Organs of Plants, 66
 Flora, Fungus, of Tyrol, 222
 — Marine, of the Gulf of Naples, 585
 — of Bear Island, Contributions, 212
 — of Hot Springs, 597
 — of Koh Chang, 462
 — of San Domingo, Ecological Sketch, 578
 Florentin, R., Significance of Ionisation in Aclimatization, 312
 Floresco, N., Correlation of Colouring in Liver, Skin, and Hairs, 32
 Floridæ, Development of Cystocarp in some, 334
 — — of Tetrasporangium, 583
 Flower and Embryo of *Spiræa*, Development, 667
 — Origin, 198
 Flowers, Abnormal, of *Forsythia viridissima*, 199
 — Double, and Parasitism, 65
 — Pollen and Anemophilous, Chemical Demonstration of Nectaries, 566
 — Polypetalous, Colours of Northern, 457
 — Position with respect to Light, 204
 — Strengthening and Nourishing System, 198
 Focussing Attachments to Photomicrographic Cameras, Stringer's, 246
 — in Photomicrography, New Method, 490
 Foliage in the Genus *Acacia*, Peculiar Stages, 658
 Folli, —, Acid-resisting Bacilli in Gangrene, 226
 Follmann, O., New Crinoid, 437
 Foot, K., New Method of Focussing in Photomicrography, 490
 — Spermatozoa of *Allolobophora fetida*, 648
 Foraminifera, 439
 — Dimorphism, 656
 — Exhibition, 266
 — of the Malay Archipelago collected by Mr. A. Durrand, Report on, 509
 Ford, S. O., Anatomy of *Ceratopteris thalictroides*, 328
 Forgan, W., Photomicrographs on Gelatinobromide Films, 493
 — Simple Means of Producing Microphotographs with an ordinary Camera, 246
 Formaldehyde, Use for Preventing Liquefaction in Glycerin-jelly Mounts, 258
 Formalin, Raising Melting-point of Gelatin by means of, 116
 Formol as a Preservative and Fixative, 109
Forsythia viridissima, Abnormal Flowers, 199
 Forti, A., Algæ of the Verona District, 335, 585
 — Use of Formaldehyde for Preventing Liquefaction in Glycerin-jelly Mounts, 258
 Fossil-Botany, The Microscope in, 725
 Fossil Heterosporous Ferns, 79
 Fouilland, R., Paraffin Bath heated by Electricity, 111
 Fowls'-Eggs, Influences of Injections into the Albumen, 160
 Fraenkel, L., Function of Corpus Luteum in Relation to Insertion of Ova in Uterus, 25
Fragarium elegans, Ovum within Testes, 548
Fragillaria crotonensis, Variation, 461
 'Fram' Microscope with Mechanical Stage, 267
 Framework of Organs, Method of Demonstrating, 379
 Frandsen, P., Reactions of *Limax maximus*, 299
 Freeman, R., New Rotifers, 435
 Fresh-water Entomostraca, Exhibition, 390
 Freudenreich, E. v., Use of Tyrogen in Cheese-making, 226
 Fricke, F., Atlas of Diatoms, 460
 Friedmann, O., Post-Embryonic Development of *Aurelia aurita*, 310
 Fricke, H., North-Atlantic Brachiopods, 187
 — — — Molluscs, 176
 Friedel, J., Chlorophyll Assimilation of Cut Leaves, 73
 Fritsch, F. E., Anatomical Systematic Investigation of Leaf and Axis in the Hippocrateæ, 318
 — Observations on Aphanochètæ, 597
 — (Edogonium), 582
 Frog, Pseudothyroid, 539
 Frog's Retina, Development, 28
 Frozen Sections, Rapid Method of making Permanent Preparations of, 377
 Fruits, Sugars and Organic Acids in, 567
 Fry, T. C., Formation of Pollen in Asclepiadæ, 199

- Fucus, Extrusion of Gametes, 677
 Fuhrmann, O., Avian Cestodes, 50
 — Fertilisation in Cestodes, 557
 — Myxosporidia of Coregonus, 657
 Fulton, S.W., New and Little-known
 Victorian Decapods, 432, 646
 Fungal Disease in Horses, 687
 — of Plants, &c., 219
 Fungi and Bacteria, Composition of Pro-
 teids and Cell-Membranes, 457
 — Blue Colour in, 222
 — Continuity of Protoplasm, 687
 — Coprophilous, 471
 — Economic, 686
 — Energy of Assimilation, 587
 — Filamentous, Pleomorphism and Chla-
 mydospore Formation, 587
 — from Java, 468
 — Intra vitam Staining, 378
 — Javanici, 685
 — Lists and New Species, 340
 — Lower, Influence of Light on the Re-
 spiration, 687
 — of the Netherlands, 340
 — on *Andromeda polifolia*, 595
 — Parasitic, 86, 219
 — Parasitic, and Weather, 688
 — — of Diatomaceæ, 463
 — — of Tropical Cultivated Plants, 596
 — Pathogenic, 686
 — Preserving and Examining, 339
 — Resistance to Temperature, 471
 — Respiration, 688
 —. See CONTENTS, xxviii
 — "Shot-hole," 216
 — Some New, 469
 — South American, 222
 — Spanish, 468
 — Spore-Germination in Higher, 472
 — West American, 467
 Fungus Cultures, 596
 — Flora, 340
 — — of Piedmont, 685
 — — of Tyrol, 222
 — — Servian, 468
 — — of the Sonntagberg, 685
 — New Marine, *Pyrrhosorus*, 213
 — Pests of Carnations, 471
 — Floras, Contributions, 684
 Fütterer, —, Micro-organisms in Systemic
 Circulation, 348
- G.
- Gabritschewsky, G., Influence of High
 Temperatures on the Stainability of
 Bacteria, 499
 — Polythermostats, 496
 Gage, S. H., 'The Microscope,' 118
 Gager, C. S., Development of Pollinium
 and Sperm-Cells in *Asclepias Cornuti*,
 320
- Gain, E., "Ageing" of the Embryo of
 Grasses, 204
 Galaxaura, 79
 Galeotti, —, Pathogenic Bacillus in
 Cockles, 693
Galeus antarcticus, Development, 166
 Gallardo, A., Change of Sexuality in
 Plants, 71
 Galli-Valerio, B., Hæmosporidia in Alpine
 Birds, 657
 Galls, Notes on, 301
 — Peculiar Phytoptid, 553
 — Study, 181
 Galt, H., Method of Preserving Museum
 Specimens, 379
 Gametes, Extrusion in Fucus, 677
 Gametogenesis and Fertilisation in Albu-
 go, 83
 Gametophytes and Embryo of Podocarpus,
 319
 Gammarus, New, 185
 Ganglion-cells, Spinal, Staining Reticulum,
 717
 Garbini, A., New Gammarus, 185
 — — Species of Peridinium, 192
 Gardiner, J. S., Classification, 636
 Gardiner, W., Histology of the Endosperm,
 661
 Garjeanne, A. J. M., Spore Distribution,
 330
 Gasteromycetes, 339
 Gas-formation by *Bacillus coli communis*,
 Variability of, 92
 Gastric Juice, Human, Effect on Cholera
 Vibrios, 224
 Gastropod, New Cave, 177
 — New Parasitic, in Holothurian, 426
 Gastropoda. See CONTENTS, xiii
 Gastropods, Tanganyika: *Chytra* and
Limnotrochus, 640
 Gastrotricha, New Species, 187
 Gatin, C. L., Structure of the Tuberos
 Roots of *Thrinicum tuberosa*, 196
 Gatta, D. M. F. de, Notes on Galls, 301
 Gatta, M. F. de, Studies on Galls, 181
 Gaucher, L., Anatomy of Euphorbiaceæ,
 445
 Gauge, Micrometer, 622
 Gautier, A., Chemical Basis of Variation,
 31
 — Minute Traces of Arsenic in Animals,
 544
 Gautrelet, J., Occurrence of Compounds
 of Phosphorus in Invertebrates, 298
 Geastræ, 593
 Gedoelst, L., Pathogenic Fungi, 686
 Gelatin as a Substitute for Glass, 257
 — Physical Properties, in reference to its
 use in Culture Media, 713
 Gemmill, J. F., Largest of known Nema-
 todes, 650
 Genau, K., Development of *Sauromatum*
guttatum Schott, 202

Genera, New, Acompsomyces, 215

- — Aporina, 557
- — Arachnomyces, 335
- — Arenæa, 468
- — Aschersoniopsis, 341
- — Aturellus, 183
- — Bonordoniella, 469
- — Bulgariopsis, 341
- — Carcinonemertes, 558
- — Celænogamasus, 183
- — Chorioactis, 465
- — Cotyloretus, 309
- — Davincia, 468
- — Delpontia, 468
- — Desmatractum, 584
- — Diarthra, 151
- — Dictyera, 335
- — Didymobotryopsis, 685
- — Didymostilbe, 685
- — Dimœrium, 563
- — Dioicomyces, 215
- — Diplochæte, 335
- — Discomycopsella, 685
- — Endophrys, 563
- — Enteroxenos, 426
- — Euhaplomyces, 215
- — Eumonoicomyces, 214
- — Fleischeria, 468
- — Gnathomysis, 555
- — Gomontiella, 223
- — Guttulinopsis, 462
- — Gymnodochium, 335
- — Joyeuxella, 313
- — Kainomyces, 215
- — Hapalophragmium, 217
- — Helostroma, 221
- — Herpetophrya, 563
- — Heterostroma, 221
- — Hjärtadalia, 183
- — Höhneliella, 685
- — Hyalospora, 217
- — Hypimetopus, 432
- — Kuragea, 656
- — Listeromyces, 469
- — Ludwiglia, 436
- — Macrochytrium, 588
- — Mesobates, 183
- — Micraurida, 181
- — Microstylus, 656
- — Midotiopsis, 341
- — Moelleroclavus, 341
- — Moellerodiscus, 341
- — Moutoniella, 468
- — Mytillicola, 646
- — Neomichelia, 469
- — Nephrocephalus, 309
- — Nidula, 467
- — Oistosomum, 309
- — Ostracolethe, 177
- — Ostreopsis, 462
- — Pelagohydra, 561
- — Perirhiza, 656
- — Perispermum, 212

Genera, New, Pilgeria, 88

- — Pimelobia, 645
- — Planoventer, 151
- — Platydromia, 432
- — Plectothrix, 595
- — Pleistophora, 58
- — Postclausa, 151
- — Pseudenclonium, 82
- — Pseudœcistes, 150
- — Pseudomelasmia, 684
- — Puttemansia, 684
- — Rhabdodermella, 312
- — Richelia, 88
- — Rinia, 468
- — Schizodiscus, 656
- — Spelæconcha, 177
- — Stauronella, 81
- — Stenoscypus, 656
- — Stephanoprora, 309
- — Stereotydeus, 183
- — Stichomyces, 215
- — Stilbohypoxyton, 341
- — Strabops, 642
- — Strasseria, 685
- — Tetracrium, 684
- — Tetraedrophrya, 313
- — Tetramastix, 152
- — Trichobotrys, 469
- — Trypanoplasma, 58
- — Typhlorhynchus, 434
- — Urozercon, 183
- — Volutina, 469
- — Xenopus, 469
- — Xenosporium, 469
- — Zimmermaniella, 685
- — Zoogonoides, 558
- — Zoogonus, 558

Genital Apparatus, Female, in Microlepidoptera, 40

Geographical Distribution of Priapulid, 186

Geopyxis and Urnula, Studies, 464

Geotaxis of *Paramacium aurelia*, Changes, 191

Gerardinus decemmaculatus, Reproduction, 421

Gerassimov, J. J., Influence of the Nucleus on the Growth of the Cell, 60

Gerlach, M., Value of Kainite, 453

Germany, Monograph on Spiders of, 45

Germ-cells, Numerical Law, 419

Germicides, 472

Germinal Layers in Cestoda, 50

Geminating Power of Seeds, Duration, 669

Germination of Basidiospores, 682

— of *Carapa guianensis*, 658

— of Fern-Spores, 78

— Transformation of Fatty Matters into Sugars in Oily Grains during, 206

— of Proteids during, 456

Germinative Cells, So-called, in Medullary Canal of Man, 167

Germ-layers of Vertebrates, 26

- Gessard, C., Melanogenic Variety of *Bacillus pyocyaneus*, 92
- Geum, Integument of the Ovule and Seed, 66
- Ghigi, A., Epithelial Structures on Parrots' Beaks, 633
- Giard, A., Determination of Sex in Lepidoptera, 41
- Expulsion of Spermatozoa in *Sciara*, 551
- Habits of Larvæ of *Sciara medullaris*, 551
- Note on the History of Merogony, 26
- Passage from Bisexual to Unisexual Condition by Unilateral Parasitic Castration, 326
- Giardina, A., Early Stages in Oogenesis and the Synaptic Phases, 537
- Gibbs, R. E., Phyllospadix as a Beach-builder, 327
- Giemsa, G., Staining Malaria Parasites, 378
- Gies, W. J., Chemical Studies of Coconut, 575
- Giesenhagen, K., Leaf-Movements in *Polytrichum*, 209
- *Nipholobus*, 79
- Giglio-Tos, E., So-called Germinative Cells in Medullary Canal of Man, 167
- Gil, A. C., Red-coloured Hepatics, 579
- Gildersleeve, —, Lesions produced by Acid-resisting Bacilli, 480
- Gillot, V. and X., Mycology in France, 221
- Gills of Lamellibranchs, Structure, 641
- Giltch's Drawing Stand, 488
- Gingko, Polyembryony, 661
- Girdwood, G. F., On Stereomicrography, 12
- Glands, Anterior or Cephalic, of Diplopoda, 553
- Cervical, of Marsupials, 33
- Exuvial, 644
- of Alimentary Canal in Decapoda, 46
- Skin, of Amphibians, 30
- So-called Hepatico-Pancreatic of Isopods, 556
- Glass-rod Substage, 240
- Gleicheniaceæ, Anatomy, 207
- Glendinning, T. A., Enzyme Action, 325
- Glück, H., Stipular Structures of Monocotyledons, 447
- Glycerin-jelly Mounts, Use of Formaldehyde for preventing Liquefaction, 258
- Glycogen, Fermentation of, in *Ascaris*, 557
- Gnetaceæ, Vascular Structure of Flowers, 320
- Godlewski, E., Regeneration in *Tubularia*, 655
- Goebel, —, Homologies in the Development of Male and Female Sexual Organs, 206
- Goffart, J., Anatomy of Leaves in Ranunculaceæ, 444
- Rhizomorpha, 594
- Goldberg, —, Interpretation of Agglutination Reaction Results, 228
- Goldberg, S. J., Influence of Alcohol on Natural Immunity, 91
- Golden, K. E., Photomicrography with Simple Apparatus, 482
- Goldforn, L. B., Staining Mast-Cells and the Chromatin of Malaria Parasites, 502
- Golenkin, M., Mycorrhiza in the Marchantiaceæ, 219
- Golowin, E. P., Phagocytic Organs in Nematodes, 49
- Gomout, —, Flora of Koh Chang, 462
- Gomontiella, a new Genus of Schizophyceæ, 223
- Gonionema murbachii*, Budding in Larvæ, 561
- Gonococcus, Cultivation, 601
- Gonothyræa loveni*, Development, 55, 311
- Gonyaulax, Discoloration of Water by, 57
- Goodrich, E. S., Excretory Organs of Amphioxus, 298, 424
- Göransson, K. F., Effect of Reheating upon Overheated Steel, 718
- Gordon, M. H., Bacteriology of Scarletina, 694
- Streptococci of Scarlet Fever, 694
- Gosio, —, Transmissibility of Plague to Bats, 692
- Gough, L. H., Development of *Admetus pumilio*, 430
- Grabower, —, Nerve-Endings in Human Muscle, 295
- Graeffe, E., Fauna of the Gulf of Trieste, 548
- Grafting, Hybridisation by, 73
- Pinching, and Annular Decortication, 73
- Rejuvenescence as a Result, 659
- Gram, B., Aleurone-Grains in Oily Seeds, 442
- Grandis, V., Electrical Properties of Nerves, 425
- Grant, F. E., New and little-known Victorian Decapods, 432, 646
- Grasses, "Ageing" of the Embryo, 204
- Gratings ruled by Mr. Grayson, 385
- Gravity, Dispensability in Development of Toad's Egg, 537
- Grayson's ruled Gratings, 385
- Green Alga, Assimilation of Carbon, 323
- Greenough's Binocular Microscope, 607
- Gregarines, Progressive Movement, 441
- Grew, Nehemiah, Life and Work of, 129
- Grieg, J. A., North Atlantic Brachiopods, 187
- — — Molluses, 176
- Griffiths, D., Anchoring of Plantain-Seeds, 458
- West American Fungi, 467
- Groove, Dorsal, and Dorsal Suture in *Gastrolula* of Triton, 28

- Grosser, O., Arterio-Venous Anastomoses in Man and Mammals, 422
 Growing-Crystals, Study by Instantaneous Photomicrography, 364
 Growth of Seed Plants. See CONTENTS, xxiii
 Gruber, —, *Bacillus Lacto-rubifaciens*, 690
 Grünbaum, A. S., Media for distinguishing *B. coli*, *B. typhosus* and related Species, 496
 Grüss, J., Biological Phenomena in the Cultivation of *Ustilago Maydis*, 591
 — Conversion of Carbohydrate in the Germination of Date, 326
 Gruvel, A., Dwarf Males and other Sexual Peculiarities in Cirripedia, 616
 Grynfeltt, E., Inter-renal Body of Plagiostomes, 636
 — Supra-renal Bodies of Plagiostomes, 636
 Guérin, C., Avian Diphtheria, 225
 Guérin, P., Development of Seed in Sapindaceæ, 321
 Guignard, L., Double Fertilisation in Naias, 69
 — — — in the Solanaceæ and Gentianaceæ, 199
 — Secreting Apparatus of Daniellia, 318
 Guilliermond, A., Sexuality of certain Yeasts, 216
 Gurwitsch, A., Filamentous Tufts of Epithelial Cells in Vas epididymis of Man, 170
 — Rapid Method of Iron-Hæmatoxylin Staining, 256
 Guth, H., Intra vitam Staining of Fungi, 378
 Gwynne-Vaughan, D. T., Nature of the Stele of Equisetum, 672
 Gymnoascus, New, 464
 Gymnophiona, Development of Excretory Organs, 421
 Gymnosperms, Precursors of Sieve-tubes, 569
 Gynandromorphy in a Wasp, 40
- H.
- Haacke, P., Decomposition of Lactose by *B. acidi lactici*, 478
 Haan, J. de, Fungal Disease in Horses, 687
 Haas, G. C. F., Some Evidences of Unscientific Conservatism in the Construction of Microscopes, 248
 Haberlandt, G., On Fibrillar Structure of Protoplasm, 194
 Haecker, V., Reproduction of Limnetic Crustacea, 432
 Hæmatopoietic Tissue, Method of Fixing and Staining, 372
 Hæmatoxylin, Constitution, 413
 Hæmogregarines from Fishes, Two New, 59
 Hæmolymp Glands in Man and Mammals, 169
 Hæmolysin of Streptococcus, 346
 Hæmosporidia of Alpine Birds, 657
 Hair turning White, 295
 Hairs, Examination for Medico-legal purposes, 115
 Halacaridæ, Arctic, 431
 Halban, J., Ovary and Menstruation, 632
Halichondria panicea and *Suberites domuncula*, Modifications or Metamorphosis in, 190
 Halimeda, The Genus, 678
 Haliotis, Relations of Kidney, 550
 Halkin, H., Early Stages in Development of *Polystomum integerrimum*, 51
 Hall, J. G., Embryology of Limnocharis, 570
Hamamelis virginiana, Development, 570
 Hammar, A., Development of Ear in Man, 163
 Hammar, J. A., Development of Tongue in Man, 26
 Hammerl, —, Cultivation of Anaerobic Bacteria, 370
 "Hanging-Block" Preparation for Observing Developing Bacteria, 380
 Hanging-drop Cultivation, 496
 Hansgirg, —, Phyllobiologic Types in some Orders of Seed-plants, 576
 Hansgirg, A., Biology of Leaves, 67
 Hanusch, F., Value of Green Manures, 453
 Haptera of Lichens, 218
 Hard Objects, Saw for making Microscopic Preparations of, 112
 Harden, A., Microscopical Appearances of Pressed Yeast after Liquefaction, 85
 Hardesty, J., Neurological Technique, 715
 Hariot, P., *Bovista ammophila*, 336
 Harmer, S. F., Structure of Cheilostomata, 651
 Harper, —, Binucleate Cells in certain Hymenomycetes, 217
 Harris, H. F., New Method of Staining Elastic Tissue, 256
 Harris, J. A., Structure of Male in Genus *Cambarus*, 48
 Harris, N. M., Improved Method of Making Collodion Sacs, 502
 Harrison, —, *B. tuberculosis* in Cheese, 478
 Harrison, F. C., Method of Cultivating Anaerobic Bacteria, 713
 Harroy, M., Chlorophyll Assimilation of Cut Leaves, 73
 Harshberger, J. W., Cockscomb Fasciation of Pine-apples, 322
 — Germination of *Carapa guianensis*, 658
 — — of Seeds of *Carapa guianensis*, 572

- Harshberger, J. W., Limits of Variation in Plants, 75
 — Ecological Sketch of the Flora of San Domingo, 578
 Hart, A. C., Dragon-flies of Illinois, 181
 Hartlaub, Cl., Revision of Genus *Sertularia*, 55
 Hartmann, M., Maturation in *Asterias glacialis*, 437
 Hartog, M., Structure of Acinetines, 507
 Hasselbring, —, Canker in Apple Trees, 686
 Hassenkamp, A., Development of the Cystocarp in some Floridææ, 334
 Hastings Apochromat, 236
 Hastings, —, Efficiency of Pasteurisation, 477
 Hastings, —, Heat-resisting Micrococcus, 602
 Hatai, S., Efferent Neurons in Electric Lobes of *Torpedo occidentalis*, 168
 — Staining Nerve-Fibrillæ of Neurons in Electric Lobes, 254
 Hata, S., Relation of Metameric Segmentation in Petromyzon to that in Amphioxus and in Higher Craniota, 29
 Hatteria, Retina, 511
 Hauman, —, Retting of Flax, 475
 Head Skeleton, Teleostean, Morphology, 420
 Heald, F. D., Electrical Conductivity of Plant Juices, 669
 Heart of Diplosomidæ, 638
 — of *Molgula manhattensis*, 548
 Heath, H., Introductory Text-book of Zoology, 547
 Hebb, R. G., 120—Announcement of Excursions, 391
 — Microscope by Cary, 722
 Hecke, L., Bacteriosis of Kohlrabi, 90
 Heckel, E., Germination of *Onguekoa* and *Strombosia*, 322
 Hedera, Embryo, 71
 Hefferan, M., Unusual Bacterial Grouping, 689
 Hegler, R., Fixing and Staining Phycochromaceæ, 374
 Heidenhain, M., Carbon Bisulphide in Paraffin Imbedding, 111
 Heim, L., Demonstration of Cholera Vibrios, 110
 Heinricher, E., Green Hemiparasites, 451
 — Parasitic Fungi, 219
 Heinricher, H., Green Hemi-Parasites, 197
 Hélier, F., Mycology in France, 222
 Heliozoa around Geneva, 312
Helix aspersa, Diverticulum of Duct of Spermotheca, 176
 Helix, Free Intra-epithelial Nerve-Endings, 176
 Helly, K., Circulation in the Spleen, 169
 Helminthosporium and Pleospora, Relationship, 681
 Helminthostachys and Ophioglossum, Prothalli, 327
 Helminthostachys, Ophioglossum, and Psilotum, Prothallus of, 77
 Hemi-Parasites, Green, 197, 451
 Hemiptera, Some British, 428
 Hemispheres, Cerebral, Origin, 26
 Hemp and Bacteria, 695
 Henneguy, L. F., Maturation and Fertilisation in *Distomum hepaticum*, 434
 Hennings, P., Contributions to Fungus Floras, 684
 — Fungi Costaricensis, 684
 — Fungi on *Andromeda polifolia*, 595
 — Fungi Javaici, 685
 — Japanese Rusts, 340
 — List of New Fungi from Para, 340
 — New Fungi, 469
 — New Hymenomycete, 685
 — New Pezizaceæ, 685
 — Parasitic Fungi, 86
 — Plant Diseases, 470
 — South-American Fungi, 222
 — Species of *Cordiceps* from Surinam, 685
 Henry, T. A., Cyanogenesis in Plants, 566
 — Poison of *Lotus arabicus*, 658
 Hepatic Cells, Intracellular Canals, 422
 Hepaticæ, American, Notes, 459
 Hepaticarum Species, 673
 Hepatics from Puerto Rico, 674
 — Red-coloured, 579
 — Siamese, 674
Hepialus lectus, Odoriferous Organ of the Male, 302
 Herbst's Corpuscles in Sparrow and Fowl, Structure, 31
 Heredity Studied in Mice, 294
 Hermaphroditism and Structure of *Cucumaria levigata*, 652
 — in Herring, 421
 — in Species of *Chermes*, 553
 — Lateral, in *Palinurus frontalis*, 433
 Hermit Crab and Crayfish, Regeneration, 431
 Hérouard, E., Body-Wall and Gut-Wall in Echinoderms, 560
 — Calcareous Plates of Synapta and Ankyroderma, 436
 Herrera, A. L., Plasmic Appearance of Metaphosphate of Calcium, 636
 Herpetomonas, Multiplication, 313
 Herring, Hermaphroditism, 421
 Herring, P. T., Comparative Anatomy and Embryology of the Malpighian Bodies, 540
 Hertwig, O., Germ-layers of Vertebrates, 26
 Hertwig, R., Nature of Fertilisation, 419
 Hérubel, M. A., Brain of *Phascolosoma*, 649
 — Peritoneal Elements of *Phascolosoma vulgare*, 433

- Herzog, —, Tuberculosis in Cold-blooded Animals, 479
- Herzog, J., Strengthening and Nourishing System in Flowers, 198
- Herzog, T., Lists of Mosses, 331
- Heterodera schachtii*, 50
- Heterogenesis and Evolution, 75
- Heteromertean, new, *Zygeupolia litoralis*, 309
- Hewlett, R. T., Indol-like Reaction given by Cultures of Diphtheria and Pseudodiphtheria Bacilli, 93
- Probable Identity of Achalmé's Bacillus of Acute Rheumatism and the *Bacillus enteritidis sporogenes*, 93
- Hexactinellids, Studies, 656
- Heycock, —, Results of Chilling Copper-Tin Alloys, 261
- Heydrich, F., Development of Tetrasporangium in Floridæ, 583
- Perispermum, a New Genus of Coral-linacæ, 212
- Heymons, R., Development of Scolopendra, 44
- Hibernation of Bats, 33
- Hickson, S. J., Conjugation of *Dendrocometes paradoxus*, 438
- Structure of *Aleyonium digitatum*, 189
- Hieronymus, G., New Species of Selaginella, 578
- Hilger, A., New Photo-measuring Micrometer, 506
- Photo-measuring Micrometer, 486
- Hill, A. W., "Hanging-Block" Preparation for Observing Developing Bacteria, 380
- Histology of the Endosperm, 661
- Histology of the Sieve-tubes of Pinus, 195
- Hilton, W. A., Sense-hairs of Lepidopterous Larvæ, 643
- Structural Feature connected with Mating of *Diemyctylus viridescens*, 634
- Hinterberger, —, Capsule and Flagella of *B. anthracis*, 226
- Hintze, R., *Life-History of Lankesterella minima*, 441
- Hinze, G., Beggiatoa, 223
- Hippocrataceæ, Anatomical Systematic Investigation of Leaf and Axis, 318
- Hirschfeld, H., Examining Blood-plates, 252
- Hirudinea, Vascular System, 556
- Hirudo troctina*, 186
- Histological Technique, Lee and Henne-guy's, 623
- Histology. See CONTENTS, x
- Histolysis in Metamorphosis of Flies, 42
- Seasonal, in Polychæts, 48
- Hitchcock, R., Capillary Absorptive Action of Diatom Frustules, 212
- Live Bee, Life-History, 180
- Hochstetter, F., Variations in the Aortic Arches and the Origin of Arteries in Reptiles, 27
- Hoffmeister, C., Demonstration of the Cell-nucleus of Saccharomyces, 113
- Hofmeister, F., Chemical Organisation of Cell, 423
- Höhlke, D. F., Resin-Receptacle in the Polypodiaceæ and in some Phanerogams, 64
- Holborn, K., Some Fungus Cultures, 596
- Holder for Metallurgical Work, 494
- Hollander, F. d', Pseudo-chromosomes in Ova of Birds, 632
- Holm, T., North-American Carices, 577
- Holmgren, N., Chitin-Formation, Muscle-Insertion, and Cell-Connections in Insects, 178
- Holoblastic Cleavage, Reminiscence in Ovum of Cestracion, 29
- Holothurian, Hermaphrodite, 54
- New, from New Zealand, 436
- Parasitic Gasteropod in, 426
- Holzappel, K., Stand for Holding Slides, 259
- Holtzapffel's Microscope, 19
- Homarus europæus*, Observations on, 185
- Honey of Bees, 429
- Hops, Nutrition, 453
- Horrell, —, Mosses New to Britain, 209
- Horses, Fungal Disease, 687
- Host and Parasite, Relation between, 593
- Hot Water, Animals in, 171
- House-Fly, Copulation, 301
- Housser, G. H., Brain of Mustelus, 30
- Houssay, F., Growth and Auto-Intoxication, 543
- Influence of Diet on Egg-laying in the Fowl, 294
- Modifications in Alimentary System of Birds induced by Diet, 172
- Houston, A. C., Bacteriological Examination of Potable Water, 91
- Cereal Products and Bacteria, 696
- Howard, A., *Diplodia cacaoicola*, 338
- Howe, M. A., Notes on American Hepaticæ, 459
- Hubbert, W. R., Ink for Writing on Glass, 381
- Huie, L. H., So-called Hepatico-pancreatic Glands of Isopods, 556
- Hume, E. H., Media for distinguishing *B. coli*, *B. typhosus*, 496
- Humfrey, J. C. W., Effects of Strain on the Crystalline Structure of Lead, 719
- Hunter, G., Notes on Development of Liver, 540
- Hunter, G. W., Heart of *Molgula manhattensis*, 548
- Hunter, J., Irish Mosses, 459
- Hunter, S. J., Artificial Parthenogenesis in Arbacia induced by the Use of Seawater Concentrated by Evaporation, 418

- Huntingdon's New Stage, 266
 — Tilting-stage for Holding and Adjusting Minerals, 613
 Hyams, I. F., *Oscillaria prolifica*, 341
 Hybridisation by Grafting, 73
 Hybridism and Xenia, 200
 Hybridity, Laws of, 72
 Hydnaceæ, 682
 Hydra, Regeneration, 655
 Hydrachnid, New British, 554
 Hydrachnids, New Genera, 183
 — of Central Russia, 307
 Hydrocoridæ, Morphology of Labial Parts, 552
Hydrodictyon utriculatum, Starch-formation in, 205
 Hydrogen peroxide, Action on Carbohydrates in presence of Ferrous Sulphate, 576
 Hydroid, Free-Swimming, 561
 Hydroids, Historical Study of the Zoological Investigation, 311
Hydrophilus piceus, Oogenesis, 643
 Hymenomyces, Binucleate Cells in, 217
 Hyphæ, Fungal, Zymase in, 587
 Hypopterygiaceæ, 79
 Hypostase, Existence in Ovule and Seed of Rosaceæ, 666
 Hypotrichous Infusoria, Comparative Morphology, 192

I.

- Ijima, J., Amphitretus from Sagami Sea, 639
 — Studies on Hexactinellids, 656
 Ikeda, I., Development of *Phoronis ijimai*, 52
 Ikeda, S., Amphitretus from Sagami Sea, 639
 Illuminating Apparatus. *See* CONTENTS, xxxv
 Illumination, Lens for Dark-Ground, 237
 Imbedding in Paraffin, Apparatus, 377
 — — — in Vacuo, 112
 — Objects. *See* CONTENTS, xxxvii
 Immersion Oil in Collapsible Tubes, 116
 Immunity, 171
 — and Predisposition in Plants, 473
 — Natural, Influence of Alcohol on, 91
 Index of New Biological Terms, or Old Terms with New Meanings, recorded in this Volume, 730
 Indol-like Reaction given by Cultures of Diphtheria and Pseudodiphtheria Bacilli, 93
 Infusoria, Adaptability to Concentrated Solutions, 192
 — Hypotrichous, Comparative Morphology, 192
 — in Cuckoo-Spit, 657
 — Methods for Use in Study of, 619
 Infusorian, New Parasitic, 563
 Infusorians, Osmotic Phenomena, 439
 — Reactions to Carbonic and other Acids, 191
 Inghilleri, F., New Injection Syringe for Bacteriological Purposes, 259
 Inheritance, Grand-parental, 419
 Injecting Objects. *See* CONTENTS, xxxvii
 Injection Syringe, New, for Bacteriological Purposes, 259
 Ink for Writing on Glass, 381
 Innervation of Supra-orbital Canal in *Chimæra monstrosa*, 168
 Inorganic Salts, Action on the Structure and Development of Plants, 72
 Insecta. *See* CONTENTS, xiv
 Insects, Aquatic, in the Adirondacks, 179
 — Chitin-Formation, Muscle-Insertion and Cell-Connections, 178
 — Injurious to Elm-trees, 429
 — Nerve-Endings in Striped Muscle, 644
 — So-called Microthorax, 643
 — Spermatogenesis, 178
 Instruments, Accessories, &c. *See* CONTENTS, xxxiv
 Integument of the Ovule and Seed of Geum, 66
 — Ventral, of Trilobites, 427
 Interference Colours, Complementary, and Double-Image Discs, 249
 Inter-renal Body of Plagiostomes, 636
 Intestinal Worms, Preserving, 258
 Intestine in Vertebrates, Vascularisation, 172
 — Pig's, Development, 27
 Intoxications, Marine, and the Life of Burrowers, 34
 Intracellular Constituents of Typhoid Bacillus, 225
 Inui, T., Yeast Fungi used in Manufacture of "Awamori," 339
 Invertebrata. *See* CONTENTS, xii
 Involution Forms of some Plague-like Bacteria, 91
 Ionisation in Acclimatisation, Significance, 312
 Iris in Man, Development, 164
 Iron and Steel, Report of a Demonstration of Methods used in Photomicrography of, 1
 Iron-Hæmatoxylin Staining, Rapid Method, 256
 Iron Impregnation of Nerve Fibrillæ, 254
 Irritability of Seed Plants. *See* CONTENTS, xxiv
 — of the Higher Plants, 74
 Irritation, Influence on Growth of Unicellular Plants, 471
Isatis tinctoria, Colouring Matters obtainable from, 567
 Ishikawa, C., Reduction of Chromosomes in *Larix leptolepis*, 60
 Isopods, Blind, New Genus, 432

- Isopods, So-called Hepatico-Pancreatic Glands, 556
- Issatschenko, —, Bacillus Pathogenic to Rats, 602
- Issel, R., Animals in Hot Water, 171
- Ives, F. E., Method of Measuring Objects in the Microscope, 704
- Ives, F. E., Photograph of *Pleurosigma angulatum*, 529
- Photomicrographic Device, 491
- Iwanoff, K. S., Composition of Proteids and Cell-Membranes in Bacteria and Fungi, 457
- J.
- Jaccard, P., Distribution of Plants in the Alps and Jura Mountains, 206
- Jackson, C. M., Vascular System of *Bdellostoma dombeyi*, 174
- Jacobi, A., Bio-geographical Regions, 426
- Jäderholm, E., List of Mosses, 331
- Jahn, E., Studies in Myxomycetes, 585
- Janda, V., Notes on *Æolosoma tenebrarum*, 186
- Janssens, J. A., Spermatogenesis in Newt, 538
- Jacquet, M., Dolphin Carp, 547
- Javillier, M., Investigation and Presence of Rennet-ferment in Plants, 575
- Jaworowski, M., Reticular Apparatus in Spinal Ganglion-Cells, 635
- Jeffrey, E. C., Stem of Pteridophytes and Gymnosperms, 194
- Jennings, H. S., "Artificial Protoplasm," 190
- Reaction of Bacteria to Stimuli, 88
- Reactions of Infusorians to Carbonic and other Acids, 191
- Jimero, H., Honey of Bees, 429
- Job, R., Steel Rails: Relation between their Structure and Durability, 718
- Joel, H. O., *Pyrrhosorus*, a New Marine Fungus, 213
- Johnson, D. S., Development of the Embryo-sac in Piper and Heckeria, 570
- Germination in Piperaceæ, 571
- Johnson, S. W., Circulation in Lumbricus, 433
- Johnston, J. B., Circulation in Lumbricus, 433
- Homology of Selachian Ampullæ, 546
- Johnston, S. J., New Species of Distomum from the Duckmole, 187
- Johnstone, J., Cervical Glands of Marsupials, 33
- Protozoan Parasite in Plaice, 193
- Joint, Last, of Limbs in Arthropods, 427
- Jones, —, Mosses New to Britain, 209
- Jones, L., Method for Cleaning Slides, 503
- Jönsson, B., Structure and Development of the Desmarestiæ, 583
- Jonsson, H., Marine Algae of Iceland, 461
- Jordan, D. S., Introductory Text-Book of Zoology, 547
- Joseph, H., Abnormalities in Veins of Salamander, 35
- Supporting-Substances of the Nervous System, 296
- Joseph, M., Bacilli in Syphilitic Semen, 692
- Jost, L., Theory of the Shifting of Lateral Organs through Mutual Pressure, 322
- Jourdain, S., Formation and Diseases of Pearls, 39
- Jullien, —, New Syphilis Bacillus, 691
- Julus communis*, Alimentary Tract, 553
- Jurie, A., Hybridisation by Grafting, 73
- K.
- Kaalaas, B., New Hepatics, 332
- Kadyi, —, Staining Grey Matter of Spinal Cord after Mordanting with Metallic Salts, 500
- Kaestner, S., Embryological Methods, 30
- Kainite, Value, 453
- Kane, W. F. de V., *Mysis relicta* in Ireland, 46
- Kapelkin, W., Development of Axial Skeleton in Amphibia, 27
- Karop, G. C., 128—Hanging-drop Cultivation, 496
- Karsten, G., Colourless Diatoms, 81
- Kastle, J. H., Reaction and Nature of Oxidising Ferments, 455, 456
- Kedrowski, W. J., Cultivation of the Leprosy Bacillus, 249
- Keissler, C. v., Plankton of Alpine Lakes, 675
- Plankton of Attersee, 36
- Keller, I. A., *Ædogonium*, 582
- Kellerman, W. A., American Mycology, 594
- Kellog, V. L., General Course of Entomology, 551
- Kendall, A. J., New Method of Flagella-Staining, 502
- Kendrickia, Abnormal Secondary Thickening, 660
- Kennel, J., Progeny of a Tailless Cat, 292
- Kent, W. J., Colours of American Crayfish, 46
- Kerr, J. G., Relationship between Amphineura and Cephalopoda, 38
- Khouri, —, Micro-Organisms of Egyptian "Leben Raib," 343
- Kidd, W., Argument for Use-Inheritance Interpretation, 421
- Kidney in Haliotis, Relations, 550
- Kienitz-Gerloff, —, Protoplasmic Continuity in Cryptogams, 314
- Kindberg, N. C., Genus *Thamnum*, 579
- Hypopterygiaceæ, 79

- Kineses, Spermatocytic, in Orthoptera, 43
 Kingsley, J. S., Cranial Nerves of Amphiuma, 545
 — Systematic Position of Cæcilians, 545
 Kinkeliba, Botanical Origin, 569
 Kirchner, D., A Disease of Clover, 470
 Kirkwood, J. E., Chemical Studies of Coco-nut, 575
 Kishinouye, K., Japanese Scyphomedusæ, 656
 Kjellman, F. R., Galaxaura, 79
 Klebahn, —, Experiments with Rusts, 682
 — Fungal Diseases of Plants, &c., 219
 — Uredinæ Cultures, 466
 Klebs, G., *Sporodinia grandis*, 588
 Klein, A., Bacteriology of Human Fæces, 695
 Klein, E., *Bacterium phasianicida*, 600
 — Cereal Products and Bacteria, 696
 — New Pathogenic Blastomyces, 689
 — Shell-fish and Typhoid, 693
 Klein, J., Staminode-like Structures in *Dentaria bulbifera*, 198
 Klöcker, A., New Gymnoascus, 464
 Klos, R., Life-history of *Tephroclystia virgaureata*, 180
 Kny, L., Influence of Tension and Pressure on Direction of Cell-wall, 322
 Kodis, T., New Method for Staining Nervous Tissue, 114
 Kohl, F. F., Gynandromorphy in a Wasp, 40
 Kohlbrugge, —, Agglutination of Vibrios, 228
 Köhler, A., Tape Measure for Adjustment of Projection Oculars, 248
 Kohlrabi, Bacteriosis, 90
 Koken, E., Palæontology and Evolution, 634
 Kolster, R., Acid-fuchsin Staining for Degenerated Nerve-Fibres, 501
 — Paraffin-Imbedding in Vacuo, 112
 — Peculiar Process in Seminal Vesicles of Elk, 293
 Koppen, H., Spines of Spinax, 423
 Kopsch, F., Examining Blood-plates, 253
 — Staining the Reticulum of Spinal Ganglion-Cells, 717
 Korff, K. v., Spermatogenesis in *Phalangista vulpina*, 419
 Korschinsky, S., Heterogenesis and Evolution, 75
 Kosaka, K., Cerebral Degenerations, 422
 Kostanecki, C., Artificial Parthenogenesis in *Macra*, 640
 — Maturation and Fertilisation of *Cerebratulus marginatus*, 651
 Kostytschew, S., Respiration of Fungi, 688
 Kövessi, F., Relation of the Supply of Water to the Ripening of Woody Plants, 73
 Kowalevsky, A., The Genus *Chætoderma*, 38
 Kraemer, H., Crystalline and Crystalloid Substances in Plants, 61
 Krembrow, E., Papillæ of Eolidæ, 176
 Kresling, K., Fat Substance of Tubercle Bacillus, 345
 Kresylecht Violet, 112
 Krompecher, E., Metachromatic Granules in Sporiferous Bacteria, 89
 Kryptogamen-Flora, 86, 210, 464, 590, 684
 Ksope or Tanghin de Menabé (Menabea venenata), a Poison Plant of the Sakalaves, 194
 Kükenenthal, W., Practical Course of Zoology, 423
 Kuntze, W., Flagella Staining, 716
 Kupfer, E. M., Studies on Urnula and Geopyxis, 465
 Kusano, S., Transpiration of Evergreen Trees in Winter, 573
 Kuwana, S. I., Scale-Insects of Japan, 553
 Kuwano, H., New Enteropneust, 559
 Kyle, H. M., Action of Spurge on Salmonoid Fishes, 425
- L.
- Laboulbeniaceæ, New Genera and Species, 214
Lacerta agilis, Disruptive Processes in Ovarian Ova, 538
 — *muralis*, Development of Ventral Pancreas, 540
 Lachi, P., Accessory Lobes on Spinal Cord of Birds, 295
 Lactéal Secretion, 169
 Lactic Ferments in the Arts, 346
 Lactose, Decomposition by *B. acidi lactici*, 478
 Lafar, F., Technical Mycology, 473
 Lagerheim, G., Contributions to the Flora of Bear Island, 213
Lagis koreni, Alimentary Canal, 308
 Laidlaw, F. F., New Rhabdocœl, 434
 Lamarek, Life and Work, 547
 Lamb, A. B., Eye-Muscles of Acanthias, 539
 Lamella, Middle, of Cells, 61
 Lamellibranchiata. See CONTENTS, xiii
 Lamellibranchs, Structure of Gills, 641
 Lamp, New Microscope, 104
 Lamprey, Thyroid, 421
 Laney, E., Tracheæ of Spiders, 645
 Lang, W. H., Apospory in *Anthoceros*, 79
 — Prothalli of Ophioglossum and Helminthostachys, 327
 — Prothallus of Ophioglossum, Helminthostachys, and Psilotum, 77
 Langley, S. P., The New Spectrum, 247
 Lankester, E. R., *Okapia johnstoni*, 172

- Lankester, E. R., Terminology for Various Stages of the Malaria Parasite, 440
Lankesterella minima, Life-History, 441
 Lanzi, M., *Amanita ovoidea*, 682
 — Diatoms of Lake Cotronia, 676
Larix leptolepis, Reduction of Chromosomes, 60
 Larva, Ciliated, of Sponge, Asexual Origin, 562
 Larvæ of *Gonionema murbachii*, Budding, 561
 — of *Sciara medullaris*, Habits, 551
 — Lepidopterous, Sense-hairs, 643
Latrodectus 13-guttatus, Bites of, 45
 Laurent, E., Influence of Mineral Salts on the Production of Root-tubercles in *Pisum*, 203
 — Poisonous Principle in the Mistletoe, 64
 Laveran, A., Action of Human Serum on *Trypanosoma brucei*, 313
 — Coccidium of Frog's Kidneys, 657
 — Methods for Examining *Trypanosoma lewisi*, 117
 — Multiplication of *Trypanosoma* in Fishes, 564
 — New *Trypanosoma*, 440
 — *Trypanosoma* in Fishes, 58
 — Two New Hæmogregarines from Fishes, 59
 Laza, O., Decomposition of Butter-fat, 336
 Lázaro, D. B., Spanish Fungi, 468
 Lead, Effects of Strain on the Crystalline Structure, 719
 Leaf-Anatomy of Lencobryaceæ, 673
 Leaf-Blade in Cyclamen, Regeneration, 447
 — Movements in Polytrichum, 209
 — Stalk, Origin and Differentiation of Vascular Meristems, 316
 — Traces, Persistence, 64
 Leaves, Biology, 67
 — Reaction to Traumatic Stimulation, 74
 Leavitt, R. G., Subterranean Plants of Epiphegus, 447
 "Leben Raib," Egyptian, Micro-organisms of, 343
 Leche, W., Alleged Case of Transmission of Acquired Characters, 164
 Lecithin in Plants, 568
 Lederbauer, —, Growth of *Cladophora cornea* in form of Balls, 460
 Lederbauer, E., Phyto-plankton of the Erlaufsee and the Caspian Sea, 676
 Ledoux-Lebard, —, Action of Blood-Serum on Paramecium, 563
 Lee and Henneguy's Histological Technique, 623
 Lefevre, G., Botanical Origin of Kinkeliba, 569
 Leger, —, Intestinal Bacteria of Chironomus Larvæ, 690
 Léger, L., Epithelial Regeneration in Mid-gut of Arthropods, 551
 Leger, R., Multiplication of Herpetomonas, 313
 — Sex-Elements in Stylorhynchus, 58
 — Sexual Phenomena in Pterocerphalus, 564
 Leggett, F. W., Glass-rod Substage, 240
 Leguminous Plants, Yield, 452
 Le Hello, —, Maternal Impression in a Mare, 294
 Leisering, B., Shifting in Heads of Sunflower during Development from Flowering to Ripening, 453
 Leitz's Spherically, Chromatically, and Astigmatically Corrected Objective, 360
 Lemmermann, E., Silicoflagellate Protozoa, 57
 Leneček, O., Union of Branch and Stem of Same Tree, 448
 Lenoble, —, Method for Fixing Blood-Preparations, 372
 Lens for Dark-ground Illumination, 237
 — in Chick Embryos, Regeneration, 633
 — Measurement of the Focus, 146
 — of Human Eye, Stopping down, 494
 Leon, N., Morphology of Labial Parts in Hydrocoridæ, 552
 Leonardi, G., South American Acarids, 183
 Lepas, Early Development, 555
 Lepeophtheirus and Lernæa, Structure, 185
 Lepidodendron, So-called Phloem, 330
 Lepidoptera, Determination of Sex, 41
 Lepontre, —, Experimental Production of Parasitic Races of Bacteria, 474
 Leprosy Bacillus, Cultivation, 249
 Lernæa and Lepeophtheirus, Structure, 185
 Lesage, M., *Bacillus coli* in Dysentery, 696
 Leshure, —, Modification of Cornet's Forceps, 258
 Lesieur, C., Pseudo-diphtheria Bacilli, 226
 Leslie, C. de, Influence of Spermatotoxin on the Fertilising Power of Spermatozoa, 26
 Lesparre, M. A. de G. de, Spore-Germination in Higher Fungi, 472
 Letellier, A., Purple of *Purpura lapillus*, 550
 Lett, H. W., Irish Mosses, 581
 Leucine and Tyrosine as Food-stuffs, 452
 Leucobryaceæ, Leaf-Anatomy, 673
 Leuscher, E., Composition of Bananas, 566
 Levene, P. A., Biochemical Studies on the Tubercle Bacillus, 92
 Levier, E., French Muscineæ, 579
 — Priority of the Name of Calypogeia, 674
 Levy, —, *Corynebacterium lymphæ vac-cinalis*, 94
 Lewton-Brain, L., Parasitic Fungi, 87
 Lichen Flora of Emilia, Contribution to, 683

- Lichen, Spore-Distribution, 339
 Lichens, 218, 467
 — Compounds from, 684
 — Haptera, 218
 — Spanish, 683
 — Variability of, under Different External Conditions, 84
 Life, Animal, Story of, 423
 Ligament of Bivalves, 642
 Light and Spore-Germination, 324
 — Effect on Animals, 31
 — Influence on the Respiration of Lower Fungi, 687
 — Monochromatic, Apparatus for obtaining with a Mixed Jet, 727
 — Position of Flowers with respect to, 204
 Lignières, J., Classification of Hæmorrhagic Septicæmia, 93
 Ligula, Position, 51
 Liliaceæ, Californian, Subterranean Organs, 658
Limax maximus, Reactions, 299
 Lime, Necessity of, for Plants, 203
Limnæa emarginata, Structure, 550
 Limnocharis, Embryology, 570
 Limnotrochus and Chytra, Tanganyika Gastropods, 640
 Limon, M., Lactéal Secretion, 169
 Limpricht, K. G., Rabenhorst's Cryptogamic Flora of Germany (Musci), 210
 Linden, M. v., Influence of Temperature during Pupation, 644
 Lindner, P., Adhesion-Cultures, 372
 Lindroth, J. J., Rusts of the Umbelliferae, 681
 Lindroth, J. T., New Uredineæ, 681
 Lindsay, B., Story of Animal Life, 423
Lineus gesserensis, Structure, 187
 Lingula, Habits, 559
 Linko, A., An Interesting Medusoid, 188
 Linsbauer, K., Anatomy of Cassiope, 68
 Linstow, O. v., Largest of known Nematodes, 650
 — New Filaria, 651
 — New Nematodes, 434, 557
 — Position of Ligula, 51
 Lint, A. v., Determination of Sex, 535
 Linton, E., Fish Parasites, 52
 Lipariæ and Bossiææ, Anatomical Investigation of Leaf and Axis, 195
Liparis loeselii and *Teucrium scordium*, 670
 Liriodendron, Stipules, 67
 Lister, A. and G., Notes on Mycetozoa, 462
 Lister Achromatic Combination, 17
Lithobius forficatus, Oogenesis and Spermatogenesis, 304
 Littorina, Experiments on, 37
 Live-Box, New Reversible, 381
 Liver-Cells, Nutritive Channels communicating with Lobular Capillaries, 295
 Liver, Notes on Development, 540
 — of Mollusca, Preparing, 375
 Lizard and Slow-worm, Branchial Clefts, 634
 Lloyd, C. G., Geastræ, 593
 — The Gasteromyces, 339
 Lloyd, F. E., Comparative Embryology of the Rubiaceæ, 662
 Lo Bianco, S., Plankton and Abyssal Fauna around Capri, 297
 Lochmann, —, *Bacillus caseolyticus*, 477
 Loevenhart, A. S., Reaction and Nature of Oxidising Ferments, 456
 Loew, —, Bio-chemical Antagonisms, 228
 Loew, E., Cleistogamy of *Stellaria pallida*, 72
 Loewenthal, N., New Alcoholic Carmin Solution, 715
 Lohmann, H., Coccospheres and Coccoliths, 674
 Loisel, G., Function of Sertoli's Cells, 161
 — Internal Secretion of Testis, 538
 — Spermatogenesis in Sparrow, 293
Lolium temulentum, Poisonous Properties, 64
 Lonay, H., Anatomy of Ranunculaceæ, 444
 London, E. S., Examination of Hairs for Medico-legal Purposes, 115
 Long, W. H., List of New Fungi, 340
 Longchamps, M. de S., Development of Phoronis, 435
Loranthus aphyllus, Sucker, 196
 Lorch, W., Anatomy and Biology of Mosses, 79
Lotus arabicus, Poison, 658
 Loups, Berger's Stereoscopic, 698
 Lovell, J. H., Colours of Northern Petalons Flowers, 457
 Loyetz, M., Germinal Vesicle of Reptiles, 161
 Lubosch, W., Development of Olfactory Organ of Ammocoetes, 29
 Lubowski, —, Formation of Agglutins, 227
 Lulham, R. B., New Type of Fern-Stele, 329
 Lumbricus, Circulation, 433
 Luminosity in Centipedes, 182
 Lydekker, R., European Wild Cattle, 425
Lyginodendron Oldhamium, Type-Specimens, 208
 Lynceid Entomostraca, Ehippia, 554
 Lyon, F. M., Sporangia and Oophyte of Selagiella, 76
Lysimachia terrestris, Bulbils, 67

M.

- Maas, O., Gemmation of *Tethya*, 55
 Maassen, A., Decomposition of Nitrates and Nitrites by Bacteria, 224
 McAlpine, D., "Shot-hole" Fungi, 216
 MacCallum, —, *Actinomyces asteroides*, 599

- MacCallum, J. B., Development of Pig's Intestine, 27
- McCallum, W. B., Nature of the Stimulus causing the Change of Form and Substance in an Amphibious Plant, 669
- Macchiati, L., Chlorophyll Assimilation, 72
- McClendon, J. F., Life-History of *Ulula hyalina*, 552
- McClung, C. E., Accessory Chromosome in Insect Spermatogenesis, 41
— Spermatogenesis in Insects, 179
- Macdonald, J. H., Methods of rendering Golgi-Sublimate Preparations permanent by Platinum Substitution, 501
- MacDougal, D. T., Bulbils of *Lysimachia terrestris*, 67
- Macfadyen, A., Intracellular Constituents of the Typhoid Bacillus, 225
- Mack, H. v., Central Nervous System of *Sipunculus nudus*, 309
— Examining Nervous System of *Sipunculus nudus*, 373
- McMillan, C., Observations on *Pterygophora californica*, 582
- Macroergates in *Pheidole commutata*, 40
- Macroscetides proboscideus, Brain, 637
- Mactra, Artificial Parthenogenesis, 640
- Macvicar, S. M., Lists and New Species of Mosses, 331
- Madan, Henry George, 24
- Maddox, Richard Leach, Obituary, 530
- Madrepora, Increase of Mesenteries, 655
- Magalhães, P. S. de, Microbe of Piedra, 87
- Magnesium and Calcium, Relations to Plant-Growth, 573
- Magnifiers, 237
- Magnus, F., Function of Paraphyses in Uredineæ, 682
— Parasitic Fungi, 219
— Underground Species of Urophlyctis, 336
— Uredineæ, 217
— Urophlyctis, 586
- Maige, A., Structure of the Tuberos Roots of *Thrinicia tuberosa*, 196
- Mainardi, A., Cross-Pollination and Self-Pollination, 71
- Maire, R., Mycology in France, 221
- Maize, Disease of, 470
- Malaquin, A., Life-History of Monstrilidæ, 46
- Malaria Parasite, Demonstrating, 251
— — Terminology for Various Stages, 440
— Parasites, Staining, 378
— — — Chromatin of, and Mast-Cells, 502
- Malay Archipelago, Recent Foraminifera, 509
- Male in Genus Cambarus, Structure, 48
- Males-Watson Two-speed Fine Adjustment, 609
- Malpighian Bodies, Comparative Anatomy and Embryology, 540
- Mandoul, —, Blue and Green Coloration in Skin of Vertebrates, 33
- Mandoul, H., Physical Coloration, 637
- Mangin, L., Staining Woody Tissue, 113
- Manipulation, Microscopical. See CONTENTS, xxxv
- Manu, H. H., Enzymes of Tea-leaf, 670
- Manna, Two new Sugars extracted from, 567
- Manures, Green, Value, 453
— Nitrogenous, Influence on the Form of Cereals, 453
- Marchal, E., *Erysiphe Graminis*, 589
— Influence of Mineral Salts on the Production of Root-Tubercles in Pisum, 203
- Marchantiaceæ, Mycorhiza, 219
- Marchlewski, L., Colouring Matters obtainable from *Isatis tinctoria*, 567
- Mare, Maternal Impression, 294
- Marine Mammals, Distribution, 297
- Marino, —, Rapid Method of Staining the Morphologic Elements of Blood, 715
- Marmorek, —, Unity of Pathogenic Streptococci, 598
- Marpmann, G., Distinguishing between *Pleurosigma angulatum* and *balticum* under Low Powers, 257
— Micro-chemical Reactions of Wood affected with Dry Rot, 118
— New Fluid Medium for Preserving Zoological Objects, 258
— Parasitic Fungi of Diatomaceæ, 463
— Preparation and Preservation of Urinary Sediment, 115
— Yeasts, 591
- Marshall, G. A. K., Experiments in Seasonal Dimorphism, 41
- Marshall, W. S., Genital Pores of Male *Antedon rosacea*, 437
- Marsupials, Cervical Glands, 33
— Parafibula, 33
- Martel, E., Anatomy and Morphology of Flower of Crucifere, 320
- Martin, S., Antagonism of the Soil to *Bacillus typhosus*, 696
- Martin, S. S., Steel Rails: Difference between Hot and Cold Sawing, 719
— Steel Rails: Relation between their Structure and Durability, 719
- Massart, J., Structure and Affinities of Schizophyta, 473
- Massart, M. J., Irritability of the Higher Plants, 74
- Masseé, G., Coprophilous Fungi, 471
— — Fungi II., 335
— European Agarics, 594
— Larch and Spruce Fir Canker, 686
— Plant Diseases, 470
- Masterman, A. T., Notes on Actinotrocha, 435
- Mateos, M. R., *Hirudo troctina*, 186
- Maternal Impression in a Mare, 294

- Mating of *Diemycylus viridescens*, Structural Feature connected with, 634
- Matousehek, F., List of Hepatics and Mosses, 331
- Matruelot, L., Mycology in France, 221
— *Stichococcus bacillaris*, 679
- Matter, Organic and Mineral, Accumulation in Woody Plants, 573
- Matthaei, G. L. C., Reaction of Leaves to Traumatic Stimulation, 74
- Maturation in *Echinus esculentus*, 654
- Maximow, N. A., Influence of Light on the Respiration of the Lower Fungi, 687
- Matzschita, T., Effect of Salt in Nutrient Media on the Growth of Micro-organisms, 89
- Mauck, A. V., Variation in *Platytophia*, 560
- May, W., Relations of Calcium and Magnesium to Plant-Growth, 573
- Mayer, S., Muscularisation of Capillary Vessels, 542
- Mazé, M., Zymase in Fungal Hyphae, 587
- Mazé, M. P., Transformation of Fatty Matters into Sugars in Oily Grains during Germination, 206
- Mazza, A., Marine Flora of the Gulf of Naples, 585
- Mazzarelli, G., Affinities of *Phyllaplysia*, 38
- Measuring Objects in the Microscope, Method, 704
- Measurements, Electrical Method of Taking Microscope, 625, 728
- Media for distinguishing *B. coli*, *B. typhosus*, and related Species, 496
— Nutrient, Method for examining, 498
- Medicine and Biology in the Nineteenth Century, History, 170
- Medico-legal Purposes, Examination of Hairs for, 115
- Medium for Cheese Bacteria, Cultivation, 108
— Influence of the Surrounding, on the Growth of Roots, 74
- Medullary Canal of Man, So-called Germi-native Cells, 167
— Sheath of Nerve-Fibres, Staining, 500
- Medusoid, Interesting, 188
- Meehan, T., Bending of Mature Wood in Trees, 66
- Meek, S. E., Mounting Fish for Museums, 258
- Megastoma entericum*, 58
- Megušar, F., Oogenesis in *Hydrophilus piceus*, 643
- Mehner, —, Fungal Diseases of Plants, &c., 219
- Meierhofer, H., Bladders of *Utricularia*, 196
- Meijere, H. de, Prothoracic Respiratory Apparatus in Dipterous Pupæ, 428
- Meijere, J. C. H. de, Last Joint in the Limbs of Arthropods, 427
- Meissner, P., Apparatus for Imbedding in Paraffin, 377
- Melanogenic Variety of *Bacillus pyocyaneus*, 92
- Melting-point of Gelatin, Raising by means of Formalin, 116
- Membrane, Limiting, in Human Serosa, 169
- Mendel, G., Laws of Hybridity, 72
- Menier, M., Mycology in France, 222
- Menon, K. R., Notes on *Actinotrocha*, 435
- Mentz, A., Mosses of Jutland, 673
- Mereschkowsky, C., Classification of Diatoms, 211
— *Okedenia*, 81
— *Staurouella*, a New Genus of Diatoms, 81
- Merlin, A. A., Certain Minute Structure observed in some Forms of *Triceratium*, 495
— Spermatozoon of Rat, 538
- Merogony, Note on the History, 26
- Merrett, W. H., Report of a Demonstration of Methods used in Photomicrography of Iron and Steel, 1
- Mesenteries in *Madrepora*, Increase, 655
- Mesnil, F., Coccidium of Frog's Kidneys, 657
- Mesnil, F., *Fecampia*, 558
— Free Phase in the Life-Cycle of *Orthonectids*, 53
— Methods for Examining *Trypanosoma Levisi*, 117
— Multiplication of *Trypanosoma* in Fishes, 564
— *Trypanosoma* in Fishes, 58
— Two New *Hæmogregarines* from Fishes, 59
- Mesoblast, Early Development in *Thalassema*, 557
- Mesozoa, Nemertini, and *Platyhelminia*, 186
- Messter's Attachable Mechanical Stage, 613
- Metachromatic Granules in Sporiferous Bacteria, 89
- Metal, Crystallisation produced in, by Pressure, 261
— Specimens for the Microscope, Preparation, 621
- Metallurgical Work, Holder, 494
- Metals, Crystalline Structure, 262
- Metamorphosis of *Sisyra*, 642
- Metamphy, or Modifications, in *Halichondria panicea* and in *Suberites domuncula*, 190
- Metaphosphate of Calcium, Plasmic Appearance, 636
- Metchnikoff, E., Immunity, 171
— On the Process of Hair turning White, 295
- Metzner, R., *Megastoma entericum* Grassi, 58

- Meyer, A., Chlamydo-spores of Bacteria, 224
 — Continuity of Protoplasm in Fungi, 687
 — New Microscope Lamp, 104
 Meyer, J. A., Disruptive Processes in Ovarian Ova of *Lacerta agilis*, 538
 Meyer, S., Iron Impregnation of Nerve Fibrilla, 254
 Miani, D., Action of Copper on the Growth of Living Cells, 203
 Mice, Heredity Studied in, 294
 Michael, A. D., British Tyroglyphidæ, 431
 Michaelis, L., New Fat-staining Pigment, 112
 Micheletti, L., Poisonous Properties of *Lolium temulentum*, 64
 Micro-chemical Reactions of Wood affected with Dry Rot, 118
 Micrococcus and Amylomyces, Association, 602
 — Heat-resisting, 602
 Microlepidoptera, Female Genital Apparatus, 40
 Micrometer Gauge, 622
 — New Photo-measuring, 506
 — Photo-measuring, 486
 Micro-organisms in Systemic Circulation, 348
 — — of Egyptian "Leben Raib," 343
 — — Variability, 342
 Microphotographs, Simple Means of Producing with an ordinary Camera, 246
 Microscope Adjustment, 607
 — and other Optical Subjects, Bibliography of Works dealing with, 20
 — Baker's Portable Diagnostic, 98
 — Beck's Imperial, 95
 — — Micrometer, 357
 — by Carpenter and Westley, 389
 — Czapski's Cornea, 484
 — for Measuring Plant-Growth, Albrecht's, 358
 — Greenough's Binocular, 607
 — Holtzapffel's, 19
 — Lamp, New, 104
 — Method of Measuring Objects, 704
 — New Micrometer, 119
 — Old, by Pillischer, 384
 — — by Pritchard, 386
 — Pillischer's "Lenticular," 353
 — Pye's Reading, 358
 — Ross' New, 231
 — Seibert's Laboratory, 101
 — — Large Model No. 2, 354
 — — — No. 3, 101
 — — New Dissection, 101
 — — — Projection with Electric Light, 103
 — — Travelling, 98
 — The, S. H. Gage's, 118
 — Waddel's Erecting, 291
 — Watson's New "Holos Fram," 354
 — Work, New Methods, 142
 Microscope, Zeiss' Small Mineralogical, 610
 — — — Model Polarising, 613
 — — — Stand for Brain Sections, 483
 Microscopes, New Pattern Reading, 389
 — Projection, using Electric Arc or Oxygen-hydrogen Light, 702
 — Some Evidences of Unscientific Conservatism in Construction, 248
 — Two Early, by Andrew Ross (?) 351
 Microscopic Effects of Stress on Platinum, 624
 Microscopical Manipulation. See CONTENTS, xxxv
 — Optics. See CONTENTS, xxxv
 Microscopical Preparations, Method of Making, for Photographic Purposes, 253
 — Technique. See CONTENTS, xxxvi
 Microscopy. See CONTENTS, xxxiv
 Microsporidian, New, 58
 Microtechnique of Animal Morphology, 257
 Microthorax and-Dermoptera, 302
 Microthorax, So-called, of Insects, 643
 Microtome, Jung's, Slide-Brake, 375
 — New Ether Freezing Apparatus, 110
 Microtomes. See CONTENTS, xxxvii
 — Standing's Imbedding, 375
 Mid-brain in Bony Fish, Development, 165
 Middleton, —, Black Dry-rot in Swedes, 691
 Migula, W., Mosses of Central Europe, 580
 Milk, Detection of Tubercle Bacilli in, 343
 — Source of Acid Organisms, 476
 Millett, F. W., Report on the Recent Foraminifera of the Malay Archipelago collected by Mr. A. Durrand, 267, 509
 Mills, C. K., Neurofibrillar Theory, 542
 Mimicry, Interesting Case, 642
 Mimicry of a Moss by a Larva and Pupa, 43
 Minden, M. V., The Saprolegniæ, 587
 Minervini, R., Modifications of Weigert's Method of Staining Elastic Tissue, 113
 Mingazzini, P., Molluscum contagiosum in Amphibians, 297
 — Superficial Secretion of Tapeworms, 187
 Minkiewicz, R., Adaptability of Infusoria to Concentrated Solutions, 192
 Miquel and Cambier's Bacteriology, 349
 Mistletoe, Poisonous Principle, 64
 Mite, Hibernating Cyst, 431
 Mites, Myrmecophilous, 183
 Mitlacher, W., Microscopic Characters of Fruit Envelopes of Acorn, 321
 Mitosis and Cell-division, 160
 Mitrophanow, P., Early Stages in Development of Duck and Tern, 294
 Mitsukuri, K., Experiments on Littorina, 37
 Miyake, K., Fertilisation of *Pythium de Baryanum*, 335
 Miyoshi, M., Spore-Distribution in a Lichen, 339

- Möbius, K., Concept of Species, 542
 Moeller, A., Acid-fast Bacilli, 344
 Mohr-Laubenheim, K., Fungal Diseases of Plants, &c., 220
Molgula manhattensis, Heart of, 548
 Molgulidae, Development, 639
 Molisch, H., Scutellarin, 315
 Molliard, M., Double Flowers and Parasitism, 65
 — *Stichococcus bacillaris*, 679
 Moll's Apparatus for the Adjustment of a Projection Microscope, 362
 Mollusca. See CONTENTS, xiii
 Molluscs, Digestive Gland, 300
 — North Atlantic, 176
 Molluscum Contagiosum in Amphibians, 297
 Monguillon, E., Lichens of the Sarthe, 468
 Mükemeyer, W., Abnormalities in Mosses, 331
 — List of Mosses, 332
 — New Variety of Moss, 331
 Monnier, U., Mycology in France, 222
 Monochromatic Light, Apparatus for obtaining with a Mixed Jet, 727
 Monocotyledons, Origin of Seed-leaf, 446
 — Stipular Structure, 447
 Monostomum, New Species, 651
 Monstrillidae, Life-History, 46
 Monstrosity in a Trout, 298
 Montemartini, L., Abnormal Conjugation in Spirogyra, 80
 Montgomery, T. H., Larva of *Plethodon cinereus*, 28
 Moore, A., Isolation of Typhoid Bacillus, 371
 Moore, E. M., Reactions of Infusorians to Carbonic and other Acids, 191
 Morandi, E., Hæmolymp Glands in Man and Mammals, 169
 Morel, C., New Method of Staining Neuroglia, 499
 Morgan, T. H., Dispensability of Gravity in Development of Toad's Egg, 537
 Morgenstern, P., Development of *Cordylophora lacustris*, 188
 Morrell, R. S., Action of Hydrogen peroxide on Carbohydrates in presence of Ferrus Sulphate, 576
 Morse, R. L., Kresylecht Violet, 112
 Moss-Flora, British, 459, 673
 Mosses, Abnormalities, 331
 — Anatomy and Biology, 79
 — Australian, 580
 — British and Irish, 581
 — Geographical Distribution, 331
 — Irish, 459
 — Lists and New Species, 331
 — new to Britain, 209
 — of Central Europe, 580
 — of Jutland, 673
 — of Madagascar, 580
 Mosses of Montana, Preliminary List, 673
 — of South-western Switzerland, 460
 — of West Tropical Africa, 460
 — Peristome, 331
 Mougeotia, New, 333
 Moulds, Decomposition of Compounds of Selenium and Tellurium, 688
 — Resistance of some to Metal Poisoning, 472
 Mounting, Double, for Whole Objects, 717
 Mounting Medium, Sodium Silicate as, for Microscopical Preparations, 622
 — Objects. See CONTENTS, xxxviii
 Mouton, H., Digestion in Amoebæ, 562
 Mucor as an Alcohol Yeast, 588
 — Genus, 463
 Mucors of East Siberia, 680
 Mudge, G. P., Aid to the Study of Zoology, 171
 Mueller, K., List of Hepatics, 332
 Müggenburg, —, Mimicry of a Moss by a Larva and Pupa, 43
 Müller, F. C., History of Medicine and Biology in the Nineteenth Century, 170
 Müller, J., Assimilating Roots of Tæniophyllum, 68
 Müller, K., Australian Mosses, 580
 Müller, P. T., Agglutination of Bacteria, 89
 Murbach, L., A Demonstration Eye-piece, 487
 Murbeck, S., Amphicarpous Plants, 65
 Murray, J., New Rotifers from Scotland, 653
 Muscinæ, French, 579
 —. See CONTENTS, xxvi
 Muscle-Fibril, Minute Structure, 542
 Musculature of Urodela, 35
 Museum Specimens, Method of Preserving, 379
 Mussel, New Parasitic Copepod in Intestine, 646
 Mussels, Spawning Period, 178
 Mustelus, Brain, 30
Mustelus lævis, Ophthalmic Nerves, 29
 Mycetozoa, Notes, 462
 —. See CONTENTS, xxviii
 Mycology, American, 594
 — British, 339
 — in France, 221
 — North American, 685
 — Technical, 473
 Mycorrhiza, 336
 — in Marchantiaceæ, 219
 Myriopoda. See CONTENTS, xv
 Myriopods, Locomotion, 553
 — Notes on, 306
 — Resistance to Asphyxiation, 305
 Myrmecophilous Mites, 183
 Mysis in the Volga, 556
Mysis relicta in Ireland, 46
 Myxomycetes, Studies, 585
 Myxosporidia of Coregonus, 657

N.

- Nagel, W. A., Effect of Light on Animals, 31
- Naias, Double Fertilisation, 69
- Name, W. G. v., Ascidians of Bermudas, 548
- Nautilus, Notes on Living, 36
- Navas, R. P. L., Lichens, 218
- Nectaries in Pollen Flowers and Anemophilous Flowers, Chemical Demonstration, 566
- Nedokutschaeff, N. K., Changes in Nitrogenous Substances in Ripening Cereals, 456
- Needham, J. G., Aquatic Insects in the Adirondacks, 179
- Dragon-flies of Illinois, 181
- Neger, F. W., Contributions to the Biology of the Erysiphaceae, 215
- Fungal Diseases of Plants, &c., 220
- Neisser, —, Formation of Agglutins, 227
- Nelson, E. M., An Old Rackwork Draw-tube, 360
- Bibliography of Works dealing with the Microscope and other Optical Subjects, 20
- Holtzapffel's Microscope, 19
- New Methods in Microscope Work, 142
- Panoramic View Camera, 367
- Polarisising with the Microscope, 264
- The Black and White Dot Phenomenon, 369
- The First English Achromatic Objectives, 16
- Two Early Microscopes, by Andrew Ross (?) 351
- Wadde's Erecting Microscope, 291
- Nematodes, Largest known, 650
- New, 434, 557
- Phagocytic Organs, 49
- Nematohelminthes. *See* CONTENTS, xvii
- Nemertini, Platyhelminia and Mesozoa, 186
- Nencki, L., Differential Staining for Tubercle and Smegma Bacilli, 256
- Neobeliscus, Affinities of Genus, 37
- Necmenians, Classification, 549
- Neostroma, Position, 189
- Nepenthes, Proteolytic Enzyme, 205
- Nerve-cord, Development, 301
- Nerve-endings, Free Intra-epithelial, in Helix, 176
- — in Human Muscle, 295
- — in Peritoneum of Mammals, 168
- — in Striped Muscle of Insects, 644
- — in Taste Menisci, 168
- Nerve-fibres, Acid-fuchsin Staining for Degenerated, 501
- Nerve-fibrillæ, Iron Impregnation, 254
- — of Neurons in Electric Lobes, Staining, 254
- Nerves, Cranial, of Amphiuma, 545
- Electrical Properties, 425
- Nerves, Ophthalmic, of *Mustelus lævis*, 29
- Nervous System and Skull of Ceratodus, 634
- — Central, Platinum Method, 256
- — of *Sipunculus nudus*, Examining, 373
- — Supporting Substances, 296
- Tissue, New Method of Staining, 114
- Neumann, —, *Bacillus diphtheriæ*, in Simple Rhinitis, 481
- Nitrogen-Assimilating Bacteria in Soils, 341
- Neuro-fibrillar Theory, 542
- Neuro-fibrils in Ganglion Cells of Cerebral Cortex, Staining, 500
- Neuroglia, New Method of Staining, 499
- Neurological Technique, 715
- Neurons, Efferent, in Electric Lobes of *Torpedo occidentalis*, 168
- Neutral Red for Staining Nucleated Red Blood-corpuscles, 114
- Neuville, H., Vascularisation of Intestine in Vertebrates, 172
- Neveu-Lemaire, M., Receptacula Seminis in Culicidæ, 644
- Neville, —, Results of Chilling Copper-Tin Alloys, 261
- Newcombe, F. C., Rheotropism of Roots, 454
- Newstead, R., Monograph on Coccidæ occurring in Britain, 429
- Newt, Spermatogenesis, 538
- Newton, C. R., Oxidising Enzymes, 205
- Nichols, M. L., Spermatogenesis of *Oniscus asellus*, 47
- Nicholson, W. A., Variations in Perianth of *Ranunculus Ficaria*, 670
- Nicholson, W. E., British Moss Flora, 673
- Mosses of South-western Switzerland, 460
- Nicolle, M., Cattle Plague, 381
- Nicotra, L., Origin of the Flower, 198
- Nidulariaceae of North America, 467
- Niphobolus, 79
- Nishikawa, T., Discoloration of Water by Gonyaulax, 57
- Nitrates and Nitrites, Decomposition by Bacteria, 224
- Effect on the Shape of certain Bacteria, 88
- Nitrite-Formers, Cultivation on Paper Disks, 618
- Nitrogen-Assimilating Bacteria in Soils, 341
- Noack, F., Fungal Diseases of Plants, &c., 219
- Nodosaria scalaris*, Variations, 656
- Noll, A., New Ether Freezing Apparatus for the Microtome, 110
- Nomenclature, Questions, 298
- Normal Serum in Pneumo-Enteritis, 347
- Norris, H. N., Pseudothyroid of Frog, 539
- North, Right Hon. Sir Ford, 120

- Nuclei, Hoffmann's, in Spinal Cord of Chick, 539
 Nucleolus, Nature and Function, 565
 Nucleus, Influence on Growth of Cell, 60
 Nudibranchs, Pigments, 38
Nuphar luteum, Cork-formation in Interior of Leaf-stalk, 448
 Nusbaum, J., Regeneration in Enchytraëidae, 433
 Nussbaum, M., Cell-divisions and Mitosis, 160
 Nutrition of Seed Plants. *See* CONTENTS, xxiii
 Nuttall, G. H. F., Biological Test for Blood, 543
 Nymphæa and Castalia, Development of Embryo-sac and Embryo, 449
- O.
- Oak, Canker, 338
 Objective-carriers, Albrecht's, 237
 Objective, Leitz', Spherically, Chromatically, and Astigmatically corrected, 360
 — Zeiss' A*, 614
 Objectives, Assorted Pairs, for Binocular Microscopes, 614
 — First English Achromatic, 16
 —. *See* CONTENTS, xxxiv
 — when used as Condensers, Zeiss' Centring Apparatus, 615
 — Zeiss', 487
 O'Brien, A., Resistance to Temperature of Fungi, 471
 Ochnaceæ, Study of the Family, 318
 Oculars for General Laboratory Work, 487
 Odbner, T., New Distomids, 558
 — New Trematodes from Crocodile, 308
 Odoriferous Organ of the Male *Hepialus lectus*, 302
 Edogonia, with Semicircular Foot-cell, 210
 Edogonium, 582
 Edopsid, Cephalopods, Synopsis, 299
 Oil in Vaucheria, 83
 Oka, A., Vascular System of Hirudinea, 556
 Okamura, K., Japanese Marine Algæ, 679
Okapia johnstoni, 172
 Okedenia, 81
 Olfactory Organ in Vertebrates, 164
 — — of Ammocetes, Development, 29
 Oligochæta, Chlorazogen, 648
 — Swiss, Observations, 648
 Oligochæte, Commensal, in New England, 49
 Olive, E. W., The Acrasiæ, 462
 Olivier, M. H., Lichens of the Pyrénées-Orientales, 468
 Omelianski, V., Fermentation of Cellulose, 597
 Omelianski, W., Cultivation of Nitrite-formers on Paper Disks, 618
 — Simple Apparatus for Cultivating Anaerobes in Test-tubes, 497
 Onguekoa and Strombosia, Germination, 322
Oniscus asellus, Spermatogenesis, 47
 Onychophora, Oviparous Species, 306
 — Papillæ, 306
 Oogenesis and Spermatogenesis in *Lithobius forficatus*, 304
 — Early Stages in, and the Synaptic Phases, 537
 — in *Hydrophilus piceus*, 643
 Oophyte and Sporangium of Selaginella, 76
 Oosphere, Development and Fertilisation in *Pinus strobus*, 70
 Ophidia, Branchial Clefts, 539
 Ophioglossum and Helminthostachys, Prothalli, 327
 — Helminthostachys, and Psilotum, Prothallus of, 77
 Ophthalmometer, Chambers and Inskeep's Improved, 709
 Opisthobranchs, "Talisman," 427
 Oppenheimer, A., Sense-Organs of Polychaet Proboscis, 647
 Optics, Microscopical. *See* CONTENTS, xxxv
 Opto-Technics, 495
 Oranges, Black Rot, 596
 Orchids, Malformations of the Flower, 577
 Ord, William Miller, the late, 417
 Organism, Yeast-eating Amoeboid, 562
 Organisms, Statistical Study, 171
 Organs of Plants, Floating, 66
 Orientation Plate, Born and Peter's, 621
 Orthoectids, Free Phase in Life-Cycle, 53
 Orthoptera, Index to North American, 428
 — Spermatocytic Kiuses, 43
 Orthostigmata, Beck-Steinheil, 360
 Osawa, G., Anatomy of Giant Salamander of Japan, 637
 Osborn, H., Interesting Case of Mimicry, 642
 Osborn, H. L., Axolotl and Amblystoma, 34
 — Staining Axis-Cylinders of Fresh Spinal Cord, 715
Oscillaria prolifica, 341
 Osmotic Pressure, Influence on Form and Structure of Plants, 76
 Ostensfeld, C. H., Phyto-plankton of the Caspian Sea, 676
 Ott, E., Chromatophores of Fresh-water Diatoms, 80
 Otto, R., Changes during Ripening Apples, 457
 Oudemans, A. C., Hibernating Cyst of a Mite, 431
 Oudemans, C. A. J. A., Fungi of the Netherlands, 340
 Ova of Birds, Pseudo-chromosomes, 632
 — of Roe Deer, Albuminoid Crystals, 632

- Ova, Ovarian, of *Lacerta agilis*, Disruptive Processes, 538
 Ovarian Follicles, Retrogressive Changes, 631
 Ovary and Menstruation, 632
 Overton, J. B., Parthenogenesis in *Thalictrum purpurascens*, 451
 Oviparous Species of Onychophora, 306
 Ovule and Embryo-sac, Formation in the Araliaceæ, 71
 — and Seed in Rosaceæ, Development, 664
 Ovum within Testes of *Fragarium elegans*, 548
- P.
- Packard, A. S., Lamarek, Life and Work, 547
 Pakes, W. C. C., Effect of Nitrates on the Shape of Certain Bacteria, 88
 Palacky, J., Distribution of Marine Mammals, 297
 — Geographical Distribution of Mosses, 331
 Palæontology and Evolution, 634
Palinurus frontalis, Lateral Hermaphroditism, 433
 Palms, Secondary Growth in Thickness, 316
 Palpi, Undescribed, on the Mouth-parts of Diptera, 508
 — — on the Proboscis of some Dipterous Flies, with Remarks on the Mouth-parts in several Families, 412
Paludina vivipara, Development, 549
 Pancreas in Amniota, Development, 165
 — Ventral, Development in *Lacerta muralis*, 540
 Pantanelli, E., Albinism in Plants, 670
 Pantopoda, Arctic, 184
 Papillæ of Eolidæ, 176
 — of Onychophora, 306
 Pappenheim, A., New Triple Stain, 257
 Paracolon Bacillus, Infection, 597
 Paraffin, Apparatus for Imbedding in, 377
 — Bath, Electrothermal, 111
 — — heated by Electricity, 111
 — Imbedding, Carbon Bisulphide in, 111
 — — in Vacuo, 112
 Parafibula in Marsupials, 33
 Paramecium, Action of Blood-Serum on, 563
Paramæcium aurelia, Changes in the Geotaxis, 191
 Paraphyses in Uredineæ, Function, 682
 Paraphyses of Uredineæ, 467
 Parasite, An unusual Human, 558
 — and Host, Relation between, 593
 — in Blood of Epileptics, 346
 Parasites, Fish, 52
 — Nemertean, of Crabs, 558
 — of Birds, Fasciolid, 558
 — of Rotatoria, 653
 Parasitic Fungi, 86
 Paratore, E., Nature and Function of the Nucleolus, 565
 — Polymorphism of *Bacillus radicolica*, 225
 Parenchyma of Leaves, Refrangent Globules, 194
 Paris, —, Lists of Mosses and Hepatics, 332
 — Mosses of West Tropical Africa, 460
 Paris, E. G., Mosses of Madagascar, 580
 Parker, G. H., Dispersal of *Sagartia lucie*, 562
 Parmelia, 85
 Parona, C., Dichotomy of Arms in Cuttlefish, 299
 Parrots' Beaks, Epithelial Structures, 633
 Parsons, E. A., Exhibition of Slides of Malaria Parasites, 122, 128
 Parthenogenesis, Artificial, in *Arbacia* induced by the Use of Sea-water concentrated by Evaporation, 418
 — Artificial, in *Macra*, 640
 — Development, Natural, 654
 — — of Silk-Moth Ova, 428
 — in Amphibians, Experimental, 537
Paryphanta hochstetteri, 427
 Passerini, N., Effect of Sunshine on Plants, 574
 Pasteurisation, Efficiency, 477
 Pathogenic and Teratogenic Agents, 543
 Pathology and Bacteriology, Handbook, 603
 — Vegetable, 340, 595
 Paton, D. N., Amount of Dissolved Oxygen in Water required by Young Saimonidæ, 425
 Paton, S., Staining Neuro-fibrils in Ganglion-Cells of Cerebral Cortex, 500
 Patouillard, M., Mycology in France, 221
 Patouillard, N., *Bovista ammophila*, 336
 Patterson, —, Segmentation of the Vertebrate Body, 32
 Pea Hybrids, Experiments, 321
 — Type, On Separation of Characters in Hybrids, 454
 Pearls, Formation, 38
 — — and Diseases, 39
 — Origin, 39
 Pearson, H. H. W., Dischidia with Double Pitchers, 569
 Péchoutre, F., Development of Ovule and Seed in Rosaceæ, 664
 Péchoutre, L., Integument of the Ovule and Seed of Geum, 66
 Peck, C. H., List of Fungi, 340
 Pedaschenko, D., Development of Mid-brain in Bony Fish, 165
 Peglione, V., Bacteria and Hemp, 695
 — Disease of Maize, 470
 — Parasitic Fungi, 219
 Peirce, G. J., Extrusion of Gametes in Fucus, 677

- Pellegrin, J., Long Fast of Pythou, 545
 Penard, E., Heliozoa around Geneva, 312
 Penicillate Tubes of Phyllactinia, 84
Penicillium glaucum, Chemauxism of Copper Salts, 324
 Penzig, O., Fungi from Java, 468
 Peragallo, H. and M., Marine Diatoms of France, 82
 Percival, J., Crystals of Calcium Oxalate in Seedlings of Alsike, 565
 — Silver-leaf Disease, 683
 Pérez, C., Commensal Schizopod, 555
 — New Giant Pyrosoma, 426
 Perianth of *Ranunculus Ficaria*, Variations, 670
 Pericycle of Angiosperms, 660
 Peridinium, New Species, 192
 Periodic Growth of Fish-Scales, 173
 Perispermum, a New Genus of Corallinaceæ, 212
 Peristome of Mosses, 331
 — Structure, 209
 Perkin, A. G., Colouring Matter from Flowers of *Delphinium consolida*, 443
 — — Matters of Green Ebony, 443
 — Constituents of Acacia and Gambier Catechus, 568
 Perkin, W. H., jun., Constitution of Hæmatoxylin, 443
 Perkins, H. F., Budding in Larvæ of *Gonionema murbachii*, 561
 — Double Mounting for Whole Objects, 717
 — Occurrence of *Cladonema* in the Bahamas, 188
 Perrier, E., Stolonial Growth in Syllidæ, 308
 Perrot, E., Botanical Origin of Kinkeliba, 569
 — On the Ksopo or Tanghin de Menabé (*Menabea venenata*) a Poison Plant of Sakalaves, 194
Petalophyllum Ralfsii, 674
 Peter and Born's Orientation Plate, 621
 Peters, A. W., Methods for Use in the Study of Infusoria, 619
 Pethybridge, G. H., Action of Inorganic Salts on the Structure and Development of Plants, 72
 Petit et Borne, Handbook of Bacteriology and Pathology, 603
 Petit, L., Refracting Globules in the Parenchyma of Leaves, 194
 Petri, L., Stigmata of *Sericaria mori*, 180
 Petromyzon, Relation of Metameric Segmentation in, to that in Amphioxus and in Higher Craniota, 29
 Pfeffer, G., Synopsis of Cægopsid Cephalopods, 299
 Phagocytic Organs in Nematodes, 49
Phalangista vulpina, Spermatogenesis, 419
 Phalloidæ, 87
 Phanerogams and Polypodiaceæ, Resin-
 Receptacle in, 64
 — Cane-Sugar in Reserve Food-Stuffs, 326
 Pharynx in *Planaria maculata*, Regeneration, 651
 Phascosoma, Brain, 649
Phascosoma vulgare, Peritoneal Elements, 433
Pheidole commutata, Macroergates in, 40
 Philibert, H., Peristome of Mosses, 331
 — Structure of the Peristome, 209
 Phisalix, C., Hæmolytic Effect of Viper's Venom, 544
 Phloem, So-called, of *Lepidodendron*, 330
 Phoronis, Development, 435
Phoronis ijimai, Development, 52
 Phoronis, New Species, 53
 Phosphorescence, Marine, 563
 Phosphorus Compounds in Invertebrates, 298
 Photograph of *Pleurosigma angulatum*, by F. E. Ives, 529
 Photographic Purposes, Method of Making Microscopical Preparations, 253
 Photography, Dictionary, 623
 — Notable Advance in Colour, 241
 Photo-measuring Micrometer, 486
 Photomicrographic Cameras, Stringer's Focussing, 246
 — Device, 491
 Photomicrographs on Gelatino-bromide Films, 493
 Photomicrography, 240, 616
 — Colour, 243
 — Dennis' High-power, 242
 — New Method of Focussing in, 490
 — Observing Prism, 616
 — of Iron and Steel, Report of a Demonstration of Methods used in, 1
 — See CONTENTS, xxxv
 — Seibert's Vertical Apparatus, 106
 — Study of Growing Crystals by Instantaneous, 364
 — with Simple Apparatus, 492
 Photosynthesis and Plant Growth, Influence of Varying Amount of Carbon Dioxide in the Air, 668
 Phycochromaceæ, Staining and Fixing, 374
 Phyllactinia, Penicillate Tubes of, 84
 Phyllaplysia, Affinities, 38
 Phyllospadix as a Beach-builder, 327
 Phyllotaxis, 67
 Phylogeny of Protists, 57
 Phyloglossum, Prothallium, 208
 Physiology of Seed Plants. See CONTENTS, xxi
 Phyto-plankton of the Erlaufsee and the Caspian Sea, 676
 Piccioli, L., Soils suitable for Chestnuts, 453
 Picro-carmin Solutions, 255
 Piedra, Microbe of, 87

- Pierce, G. J., Forceible Discharge of Antherozoids in *Asterella californica*, 578
 Pierce, N. B., Black Rot of Oranges, 596
 Pigment, Red, of *Asteria rubens*, 654
 Pigments of Nudibranchs, 38
 Pig's Intestine, Development, 27
 Pillischer's "Lenticular Microscope," 353
 Pilsbry, H. A., Affinities of Genus *Neobeliscus*, 37
 Pinching, Grafting, and Annular Decortication, 73
 Pine-apples, Cockscomb Fasciation, 322
 Pine-Cone, Morphology, 318
Pinus strobus, Development of the Oosphere and Fertilisation in, 70
 Piorkowski, —, Bacilli in Syphilitic Semen, 692
 Piperaceæ, Germination, 571
 Pirota, R., Primary Vascular Elements in Roots of Monocotyledons, 317
 Pitard, J., Pericycle of Angiosperms, 660
 Pitchers, Double, in *Dischidia*, 569
 Pith of Maize and Elder, Constituents, 567
 Pitsch, O., Yield of Leguminous Plants, 452
 Pituitary Body of Amphibians, 635
 Pizon, A., Heart of Diplosomidæ, 638
 — Mechanical Theory of Vision, 32
 Plagiotomes, Inter-renal Body, 636
 — Supra-renal Bodies, 636
 Plague, Transmissibility to Bats, 692
Planaria maculata, Regeneration of¹Pharynx, 651
 Planarian, Notes on a, 434
 Planarians, Distribution as affected by Temperature, 308
 Plankton, 581
 — and Abyssal Fauna around Capri, 297
 — in Lake Geneva, Variations, 639
 — of Alpine Lakes, 675
 — of Attersee, 36
 — of Lake of Maria-Laach, 426
 — Pond, 675
 Plant Diseases, 469
 — Growth and Photosynthesis, Influence of Varying Amount of Carbon Dioxide in the Air, 668
 — Juices, Electrical Conductivity, 669
 Plantain-Seed, Anchoring, 458
 Plants, Albinism, 670
 — Diseases, 686
 — Distribution in the Alps and Jura Mountains, 206
 — Effect of Sunshine on, 574
 — Electric Response under Mechanical Stimulus, 574
 — Electrical Phenomena, 574
 — Investigation and Presence of Rennet-ferment, 575
 — Necessity of Lime for, 203
 — Predisposition and Immunity, 473
 — Proteid Formation in, 457
 Plants, Protoplasmic Streaming, 314
 — Tertiary, from the Himmelsberg, 577
 — Woody, Accumulation of Mineral and Organic Matter, 573
Plasmodiophora Brassicæ, 586
 Plasmoptysis, 348
 Plate Cultures, New Counting Apparatus, 718
 Platinum Method for the Central Nervous System, 256
 — Micro-Crystalline Structure, 504
 — Microscopic Effects of Stress, 624
 — Re-crystallisation, 623
 — Substitution, Golgi-Sublimate Preparations, Methods of rendering Permanent, 501
 Plato, J., Intra vitam Staining of Fungus, 378
 Platyhelminthes, Mesozoa, and Nemertini, 186
 Platyhelminthes. See CONTENTS, xvii
 Platystrphia, Variation, 560
Plethedon cinereus, Larva, 28
 Pleospora and Helminthosporium, Relationship, 681
 Pleuronectidæ, Systematic Position, 638
Pleurosigma angulatum and *balticum*, Distinguishing under Low Powers, 257
 — — Photograph by F. E. Ives, 529
 Plimmer, H. G., Fixing and Staining Trypanosoma, 372
 — *Trypanosoma brucei*, 440
 Plowright, C. B., British Dye-Plants, 671
 — *Ozonium auricomum*, 339
 Plumetella and Vivipara, 310
 Pneumo-Enteritis, Normal Serum in, 347
 Poche, F., Distribution of *Anoplopteris platychir*, 173
 — — of Siluroids, 173
 Pocock, R. I., Annectant Type of Chilopod, 429
 — Studies on the Arachnid Entosternite, 645
 Podczaski, T., Differential Staining for Tubercle and Smegma Bacilli, 256
 Podocarpus, Gametophytes and Embryo, 319
 Podpěra, J., Bohemian Species of Bryum, 580
 Poirault, M., Mycology in France, 221
 Poisoning in Conus, 301
 Poisonous Principle in the Mistletoe, 64
 — Properties of *Lolium temulentum*, 64
 Poisson, J., Duration of Germinating Power of Seeds, 669
 Polarising Apparatus, Seibert's Large, 104
 — with the Microscope, 142, 264
 Polarisation-Microscopes, Seibert's, 234
 Pollacci, G., New Mode of Measuring Transpiration, 75
 Pollen and Male Prothallia from *Ceal* Measures, 671
 — Formation in the Asclepiadæ, 199

- Pollen of *Zostera*, Development, 449
 Pollicard, A., Lympho-myeloid Connective
 Stroma in Testes of Young Rays, 422
 Pollination, Influence on the Development
 of the Pericarp, 321
 Polychæt Proboscis, Sense-Organs, 647
 Polychæta Embryos, Fixation, 373
 — Respiration, 647
 Polychæts, Sensory Cells in Proboscis, 49
 — Seasonal Histolysis, 48
 Polychromism of Flowers, 64
 Polychrome Methylen-Blue, Simplified
 Method of Staining, 717
 Polyembryony in Ginkgo, 661
 Polymorphism of *Bacillus radicola*, 225
 Polymacophora, Fossil, 177
Polystomum integerrimum, Early Stages in
 Development, 51
 Polythermostats, 496
 Polytoma, Structure and Division, 460
 Polytrichum, Leaf-movements, 209
 Porifera. See CONTENTS, xix
 Porsild, M. P., *Riella* cultivated from
 Dried Mud, 674
 Portheim, L. R. v., Necessity of Lime for
 Plants, 203
 Potable Water, Bacteriological Examina-
 tion of, 91
 Potato, Bacterial Disease, 223
 — Tubers, Germination, 452
 Potter, —, Black Dry-rot in Swedes, 691
 Potter, M. C., Canker of Oak, 338
 — Parasitism of *Pseudomonas destructans*,
 597
 Powell, T., Semi-apochromatic Objective
 of $\frac{1}{12}$ -in. Focus, 386
 Pranter, V., Substitute for Cover-slips,
 115
 Predisposition and Immunity in Plants,
 473
 Preisz, H., Practical Filtering Apparatus,
 260
 Prenant, —, Branchial Clefts in Lizard
 and Slow-worm, 634
 Prenant, A., Branchial Clefts in Ophidia,
 539
 Preparing Objects. See CONTENTS, xxxvii
 Preservative Fluids. See CONTENTS, xxxviii
 Preserving Zoological Objects, New Fluid
 Medium, 258
 President, The, 119, 122, 384, 722, 725
 President's Address: Life and Work of
 Nehemiah Grew, 129
 Pressure and Tension, Influence on Direc-
 tion of Cell-wall, 322
 — Mutual, Theory of the Shifting of
 Lateral Organs, 322
 Preston, C. E., Peculiar Stages of Foliage
 in the Genus *Acacia*, 658
 Priapulid, Geographical Distribution, 186
 Prillieux, E., Dematophora in Fruit, 680
 Prism, Observing, 266
 — — for Photomicrography, 616
 Progeny of a Tailless Cat, 292
 Projection Apparatus, Solar, and its Ad-
 justment, 615
 — Microscope, Moll's Apparatus for Ad-
 justment of, 362
 — Microscopes, using Electric Arc or Oxy-
 hydrogen Light, 702
 — Oculars, Tape Measure for Adjustment,
 248
 Proteid Formation in Plants, 457
 Proteids, Formation, 74
 — Transformation during Germination,
 456
 Proteolysis and Tryptophane, 325
 Proteolytic Power of Bacteria, 88
 Prothalli of Ophioglossum and Helmintho-
 stachys, 327
 Prothallia, Male, and Pollen from *Coa*
 Measures, 671
 Prothallium of *Phylloglossum*, 208
 Prothallus of Ophioglossum, Helmintho-
 stachys, and *Psilotum*, 77
 Protists, Phylogeny, 57
 Protoplasm, Artificial, 190
 — Continuity in Fungi, 687
 — Fibrillar Structure, 194
 — Permeability, 442
 Protoplasmic Continuity in Cryptogams,
 314
 — Streaming in Plants, 314
 Prototracheata. See CONTENTS, xv
 Protozoa, Observations on, 563
 — of the Volga-plankton, 313
 —. See CONTENTS, xix
 — Silico-Flagellate, 57
 Protozoon Parasite in *Plaice*, 193
 Protz, A., New Hydrachnids, 183
 Prowasek, S., Bladders of *Utricularia*, 197
 Prowazek, S., Structure and Division of
Polytoma, 460
 — Tetrads in Spermatogenesis, 162
 Prunet, A., Black Rot, 596
 Prunet, M. A., Black Rot of Vine, 469
 Pruvot, G., Classification of Neomenians,
 549
 — Stolonial Growth in Syllidæ, 307
 Prymak, T., Structure and Function of
 Thymus in Teleostæans, 636
 Przesmycki, A. M., Parasites of Rotifers,
 563
 Przi bram, H., Observations on *Homarus*
europæus, 185
 Pseudo-chromosomes in Ova of Birds, 632
 Pseudodiphtheria and Diphtheria Bacilli,
 Indol-like Reaction given by Cultures
 of, 93
 — Bacilli, 226
 "Pseudogamy" in *Dentalium Eutalis*, 299
Pseudomonas destructans, Parasitism, 597
 Pseudoscorpionidæ, Breathing Organs, 184
 Pseudothyroid of Frog, 539
 Pseudo-tuberculosis (Streptobacillary) of
 Grey Rat, 479

- Psilotum, Ophioglossum, Helminthostachys, Prothallus of, 77
 Pteridophyta, Danish, 672
 — See CONTENTS, xxvi
 Pteroccephalus, Sexual Phenomena, 564
Pterygophora californica, Observations, 582
 Puccinia, 337
 Pulst, C., Resistance of some Moulds to Metal Poisoning, 472
 Punnett, R. C., Structure of *Lineus gessnerensis*, 187
 Pupation, Hindering, 180
 — Influence of Temperature, 644
Purpura lapillus, Purple of, 550
 Pye, W. G. & Co., New Pattern Reading Microscopes, 389
 — Reading Microscope, 358
 — Short Table Cathetometer, 359
 — Table Cathetometer, 389
 Pyrosoma, New Giant, 426
 Pyrrhosorus, a new Marine Fungus, 213
Pythium de Baryanum, Fertilisation, 335
 Python, Long Fast, 545
- Q.
- Quensel, U., New Method of Examining Sputum, 254
- R.
- Rabaud, E., Pathogenic and Teratogenic Agents, 543
 Rabenhorst's Cryptogamic Flora of Germany, &c. (Fungi Imperfecti), 86, 464, 590, 684
 — Cryptogamic Flora of Germany (Musci), 210
 Rübiger, —, Staining the Capsule of Anthrax, 257
 Rabinowitsch, —, Agglutination of Tubercle Bacillus, 348
 Raciborski, M., Vegetative Propagation in *Angiopteris evicta*, 459
 Rackwork Draw-tube, Old, 360
 Radiolarians of Farö Channel and Shetlands, 191
 Radula in Cephalopoda, Development, 36
 Radula, Preparation, 374
 Rammelberg, K., Composition of Orchid Tubers, 566
Rana temporaria, Variations in Vascular System, 424
 Randles, W. B., Crystalline Style and Style-sac in *Turritella communis*, 427
 Ranojević, N., Contributions to Fungus Floras, 684
 Ranojević, N., Servian Fungus Flora, 468
 Ranunculaceæ, Anatomy, 444
 — — of Leaves, 444
Ranunculus Ficaria, Biology of, 73
Ranunculus Ficaria, Variations in Perianth, 670
 Raspail, X., Notes on a Planarian, 434
 Ravenel, M. P., Virulence of Bovine and Human Tubercle Bacilli, 92
 Rawitz, B., Simplified Method of Staining with Polychrome Methylen-Blue, 717
 — Staining Sections of Spinal Cord with Cœruleïn S, 717
 Rays, Young, Lympho-myeloid Connective Stroma in Testes, 422
 Receptacula seminis in Culicidæ, 644
 Reehinger, C., Peculiar Phytoid Galls, 553
 Re-crystallisation of Platinum, 623
 Red, Neutral, for Staining Nucleated Red Blood-Corpuscles, 114
 Redikorzew, W., Ovum within Testes of *Fragarium elegans*, 548
 Reeb, —, Lecithin in Plants, 568
 Reese, A. M., Thyroid of Lamprey, 421
 Refrangent Globules in the Parenchyma of Leaves, 194
 Regaud, C., Paraffin Bath Heated by Electricity, 111
 Regaud, C. O., Demonstrating the Seminal Tubules of the Rat by means of Renaut's Fluid, 114
 Regeneration, Epithelial, in Mid-gut of Arthropods, 551
 — in Hermit Crab and Crayfish, 431
 — in Hydra, 655
 — in Tubularia, 655
 Regions, Bio-geographical, 426
 Reichenbach, E. S. v., Vertebrae of Terrestrial Carnivores, 638
 Reiffen, A., New Holothurian from New Zealand, 436
 Reighard, J., Form of Vertical Camera and its Uses, 705
 Reinbold, —, Algæ from the Caroline Islands, 213
 — —, Flora of Koh Chang, 462
 Reinke, F., Outlines of General Anatomy, 32
 Reis, O. M., Ligament of Bivalves, 642
 Remy, T., Nutrition of Hops, 453
 Renard, —, I.e., Chemauxism of Copper Salts on *Penicillium glaucum*, 324
 Renaut, B., Fossil Heterosporous Ferns, 79
 — Pollen and Male Prothallia from the Coal Measures, 671
 Renaut's Fluid, Demonstrating the Seminal Tubules of the Rat by means of, 114
 Rendle, A. B. Bulbiform Seeds of Amaryllidæ, 66
 Renilla, Regeneration and Regulation, 54
 Rennert, R. J., Seeds and Seedings of *Arisæma triphyllum* and *A. Dracontium*, 198
 Rennet-ferment, Investigation and Presence in Plants, 575

- Report, Annual, 123
 Reproduction, Sexual and Non-Sexual, in
Zygomycetes, 213
 Reptiles, Germinal Vesicle, 161
 Resin-Receptacle in the Polypodiaceæ
 and in some Phanerogams, 64
 Resorption of Bacteria from Intestines,
 347
 Respiration of Fungi, 688
 — of Lower Fungi, Influence of Light,
 387
 Respiratory Prothoracic Apparatus in Dip-
 terous Pupæ, 428
 Retina, Development of Frog's, 28
 — Development of Layers, 538
 — of Hæteria, 541
 — Studies, 541
 Retting of Flax, 475
 Reuss, H., *Distomum duplicatum* in Fresh-
 water Mussels, 434
 Reuter, K., Preparation of Pure Roman-
 owsky-Nocht Stain, 112
 Rhabdocel, New, 434
Rhabdopleura normani, Contributions to
 Anatomy, 652
 Rhabdospora, Arctic-Alpine, 216
 Rheinberg, J., Double-Image Discs and
 Complementary Interference Colours,
 249
 — The Black and White Dot Phenome-
 non, 367
 Rheotropism of Roots, 454
 Rhinanthaceæ, Green, Suckers, 323
Rhizobium leguminosarum, Cultivation,
 108
 Rhizocephalid Type, New, 555
 Rhizomorpha, 594
 Rhizopods, British Fresh-water, 56
 Rhodmelaceæ, 583
 — Spiral Arrangement, 334
Rhynchelmis limosella, Regeneration of
 Alimentary Canal, 647
 Richards and Archibald, Study of Grow-
 ing Crystals by Instantaneous Photo-
 micrography, 364
 Richards, E. H., *Oscillaria prolifica*, 341
 Richardson, F. L., Colour Photomicro-
 graphy, 243
 Ricciardi, S., New Species of Didymozoon,
 187
 Ridewood, W. G., Structure of Gills of
 Lamellibranchs, 641
 Riella Cultivated from dried Mud, 674
 Riggenbach, E., Autotomy in Marine In-
 vertebrates, 174
 Rimbach, A., Subterranean Organs of Cali-
 fornia Liliaceæ, 658
 Rings and Brushes, 143
 Ripening of Cream, 90
 — of Woody Plants, Relation of the Sup-
 ply of Water to, 73
 Rist, —, Micro-Organisms of Egyptian
 "Leben Raib," 343
 Robertson, W. F., Methods of rendering
 Golgi-Sublimate Preparations Perma-
 nent by Platinum Substitution,
 501
 — Platinum Method for the Central Nerv-
 ous System, 256
 Robin, A., Flask for Storing Culture
 Media, 617
 Rodway, L., Botany of Tasmania, 577
 Rogers, L., Toxic Properties of Saliva of
 certain Non-poisonous Colubrines, 638
 Rogozinski, —, Resorption of Bacteria
 from Intestines, 347
 Rohnstein, R., Simple Method for Pre-
 serving Urinary and other Deposits, 622
 Rolland, M. L., Mycology in France, 221
 Romanowsky-Nocht Stain, Pure, Prepara-
 tion of, 112
 Romell, L., South American Fungi, 222
 Rommel, W., Fruit Yeasts, 680
 Roos, E., Function of Thyroid Gland, 425
 Roots, Assimilating, of *Tæniophyllum*, 68
 — of Monocotyledons, Primary Vascular
 Elements, 317
 — Rheotropism, 454
 — Tuberosus, of *Thrinicia tuberosa*, Struc-
 ture, 196
 Root-tip, Method of Investigating the
 Gravitational Sensitiveness, 575
 Root-tubercles in Pisum, Influence of
 Mineral Salts on the Production, 203
 Rosa, D., Chlorogogen of Oligochæta, 648
 Rosaceæ, Development of Ovule and Seed,
 664
 — Existence of a Hypostase in Ovule and
 Seed, 666
 Rosenberg, O., Development of Pollen in
Zostera, 449
 — Embryology of *Zostera marina*, 449
 Rosenberger, H. G., Simple Method of
 Preparing Bone Sections, 714
 Rosenfeld, A., Involution Forms of some
 Plague-like Bacteria, 91
 Rosenhain, —, Crystalline Structure of
 Metals, 262
 Rosenhain, W., Re-crystallisation of Plat-
 inum, 623
 Rosenheim, O., Decomposition of Com-
 pounds of Selenium and Tellurium by
 Moulds, 688
 Rosenvinge, K., Spiral Arrangement in
 Rhodmelaceæ, 334
 Rosner, A., Monochorial Twins, 159
 Ross, Andrew, Two Early Microscopes
 by (?) 351
 Ross, Messrs., Lens for Dark-Ground Il-
 lumination, 237
 Ross' New Microscope, 231
 Rossi, G., Alimentary Tract of *Julus com-
 munis*, 553
 — Locomotion of Myriopods, 553
 — Resistance of Myriopods to Asphyxia-
 tion, 305

- Rot, Black, 596
 — — of Oranges, 596
 Rotatoria, Parasites, 653
 —. See CONTENTS, xviii
 Roth, J., Variability of Gas-formation by
 Bacillus coli communis, 92
 Rotifer, New, 187
 Rotifera, Preserving and Mounting, 378
 — Key for the Amateur, 653
 Rotifers, New, 435
 — New, from Scotland, 653
 — — Third List since 1889, 148, 267
 — Parasites of, 563
 Rottman, G., Development of Radula in
 Cephalopoda, 36
 Roule, L., New Species of Atherine in
 Fresh Water, 297
 Rousselet, C. F., New Rotifer, 188
 — On the Genus Synchrona, 507
 — Preserving and Mounting Rotifera, 378
 — The Genus Synchrona: A Monographic
 Study with Descriptions of Five New
 Species, 269, 393
 — The Jackson Microscope, 721
 — Third List of New Rotifers since 1889,
 148, 267
 Rowland, S., Intracellular Constituents of
 the Typhoid Bacillus, 225
 — Microscopical Appearances of Pressed
 Yeast after Liquefaction, 85
 Rowley, H. T., Regeneration in Hydra,
 655
 Rubiaceæ, Comparative Embryology, 662
 Rugosa, Relationships of, to Living Zoan-
 theæ, 437
 Rulot, H., Hibernation of Bats, 33
 Russell, —., Efficiency of Pasteurisation,
 477
 — Heat-resisting Micrococcus, 602
 Rust of *Andropogon Sorghum*, 592
 — of Cereals, 338
 — of Timothy Grass, 592
 Rusts, Experiments, 682
 — Japanese, 340
 — of the Umbelliferae, 681
 Rutaceæ, Leaf-Anatomy, 568
 Růžička, —., Variability of Micro-Orga-
 nisms, 342
 Rysseberghe, Van —., Permeability of
 Protoplasm, 442
- S.
- Sablon, L. du., Tubercle of *Tamus com-
 munitis*, 317
 Sabrazes, —., Pseudo-Tuberculosis (Strep-
 tobacillary) of Grey Rat, 479
 Saccardo, P. A., Fungi from Java, 468
 — Sylloge Fungorum, 341
 Saccharomyces, Demonstration of the Cell-
 nucleus, 113
 Saccharomycetees, Spore-formation, 339
Sagartia luciae, Dispersal, 562
 Sagitta, Development, 649
 Sago, K., Weather and Parasitic Fungi,
 688
 Saint-Remy, G., Branchial Clefts in Lizard
 and Slow-worm, 634
 — — — in Ophidia, 539
 — Germinal Layers in Cestoda, 50
 Saito, K., Bast-Fibres of Japanese Fibre-
 Plants, 318
 Sala, G., Structure of Herbst's Corpuscles
 in Sparrow and Fowl, 31
 Salamander, Abnormalities in Veins, 35
 — Giant, of Japan, Anatomy, 637
 Saliva of certain Non-poisonous Colubrines.
 Toxic Properties, 638
 Salmon, E., Plant Diseases, 470
 Salmon, E. S., Bryological Notes, 580
 — Coprophilous Fungi II., 335
 — Notes on Erysiphaceæ, 465
 Salmonidae, Young, Amount of Dissolved
 Oxygen in Water required, 425
Salmo fario, Yolk-organ, 166
 Salmonoid Fishes, Action of Spurge on,
 425
 Salt, Effect in Nutrient Media on the
 Growth of Micro-organisms, 89
 — Solution, Resistance to, 324
 Salts, Inorganic, Action on the Structure
 and Development of Plants, 72
 Salvi, G., Copulation of Bats, 164
 Sampolo, —., Notable Advance in Colour
 Photography, 241
 Samter, M., Relict Crustaceans in North
 German Lakes, 432
 Sanchez, D., Diverticulum of Duct of
 Spermatheca in *Helix aspersa*, 176
 Sapindaceæ, Development of Seed, 321
 Saponaria, 568
 Saprolegniæ, 587
Sarcocystis tenella in Man, 564
 Sarcoli, —., Alcoholic Fermentation of
 Indian Fig-Must, 337
 Sargent, E., Origin of Seed-leaf in Mono-
 cotyledons, 446
 Sarnthein, Count v., Fungus Flora of
 Tyrol, 222
 Sartori, —., Detection of Tubercle Bacilli
 in Milk, 343
 Saunders, De A., Algæ of the Harriman
 Alaska Expedition, 585
Sauromatum guttatum, Development, 202
 Sauvageau, M. C., Sphacelariaceæ, 211
 Sauveur, A., Steel Rails, Relation between
 their Structure and Durability, 719
 Savery, G. B., British and Irish Mosses,
 581
 Saw for making Microscopic Preparations
 of Hard Objects, 112
 Sayce, O. A., New Blind Crustacea, 48
 — — Genus of Blind Isopods, 432
 — New Victorian Amphipods, 646
 Scale-Insects of Japan, 553

- Scaphopoda. See CONTENTS, xiii
- Scarlatina, Bacteriology, 694
- Scarlet Fever, Streptococcus, 694
- Schäfer, E. A., Minute Structure of Muscle-Fibril, 542
- Nutritive Channels within the Liver-Cells communicating with the Lobular Capillaries, 295
- Schaffner, J. H., Oculars for General Laboratory Work, 487
- Schenkel, E., Decapods of Celebes, 432
- Scherffel, A., Contributions to Fungus Floras, 684
- Phylogeny of Protists, 57
- Remarks on (Edogonia with Semicircular Foot-cell, 210
- Schinkewitsch, W., Direct Division in Artificial Conditions, 635
- Influences of Injections into the Albumen of Fowls' Eggs, 160
- Schizomyces. See CONTENTS, xxxi
- Schizophyceæ, Gomontiella, a new Genus, 223
- See CONTENTS, xxxi
- Schizophyta, Structure and Affinities, 473
- Schizopods, Commensal, 555
- Schlagdenhauffen, M., Lecithin in Plants, 568
- Schmidle, W., Algæ from the Caroline Islands, 213
- Notes on some Fresh-water Algæ, 584
- Pilgeria, a new Genus of Chroococcaceæ, 88
- Schmidt, G., Resistance of *B. dysenteriae* to Cold, 480
- Schmidt, J., Flora of Koh Chang, 462
- Richelia, a new Genus of Cyanophyceæ, 88
- Schmidt's Atlas der Diatomaceen-Kunde, 82
- Schneider, A., Function of Calcium oxalate, 63
- Schneider, G., Gelatin as a Substitute for Glass, 257
- Life-History of *Clupea sprattus*, 166
- New Species of Caryophyllæus, 557
- Schniewind-Thies, J., Reduction in the Number of Chromosomes in the Embryonic Mother-cell, 68
- Schostakowitsch, W., *Actinomucor repens*, 589
- Genus Mucor, 463
- Mucors of East Siberia, 680
- Schottmüller, H., Germ and Water-tight Stopper for Flasks, 503
- Schouten, S. L., Demonstration of Enzymes, 108
- Schrenk, H. v., Vegetable Pathology, 340
- Schroeder, A., Anatomical Investigation of the Leaf and of the Axis in the Lipariæ and Bossiææ, 195
- Schröter, C., Variation in *Fragillaria crotonensis*, 461
- Schulz, N., Light and Spore-Germination, .. 324
- Schulze, C., Alinit, 603
- Schulze, E., Leucine and Tyrosine as Food-stuffs, 452
- Schulze, H., Leaf-Anatomy of Rutaceæ, 568
- Schultz-Schultzenstein, —, Effect of the Human Gastric Juice on Cholera Vibrios, 224
- Schumacher, S. v., Yolk-organ of *Salmo fario*, 166
- Schunck, —, Contributions to the Chemistry of Chlorophyll, 206
- Schürhoft, —, Sodium Silicate as a Mounting Medium for Microscopical Preparations, 622
- Schwabach, E., Development of Stomata in Conifers, 315
- Schwalbe, E., What are "Blood-plates?" 170
- Sciara, Expulsion of Spermatozoa, 551
- Sciara medullaris*, Habits of Larvæ, 551
- Scolopendra, Development, 44
- Spermatogenesis, 182
- Scott, A., Additions to British Fauna, 175
- Spawning Period of Mussels, 178
- Structure of Lepeophtheirus and Lernæa, 185
- Scott, D. H., The Microscope in Fossil Botany, 725
- The Old Wood and the New, 315
- Scott, R., Salt-water Aquarium, 680
- Scott, T., Scottish Crustacea, 555
- Scourfield, D. J., Ephippia of the Linceid Entomostraca, 554
- Exhibition of Fresh-water Entomostraca, 390
- Scudder, S. H., Index to North American Orthoptera, 428
- Scutellarin, 315
- Scyphomedusæ, Japanese, 656
- Sea-Urchins, Function of Sphæridia, 437
- Seekt, H., Influence of X-rays on Plant Organism, 455
- Seed and Ovule² in Rosaceæ, Development, 664
- in Sapindaceæ, Development, 321
- Seed-leaf in Monocotyledons, Origin, 446
- Seedling, Nutrition of, at the Expense of its Cotyledons, 203
- Seed-Plants, Phyllobiologic Types in some Orders, 576
- Seeds, Action of Alcohol on Germination, 575
- and Seedlings of *Arisæma triphyllum* and *A. Dracontium*, 198
- Bulbiform, of Amaryllideæ, 66
- Duration of Germinating Power, 669
- of *Carapa guianensis*, Germination, 572
- of Cereals, Germinating Power, 204

- Seeds, Oily, Aleurone-Grains, 442
 — Resistance to Low Temperatures, 204
 Seeliger, O., Deep-Sea Fauna, 35
 Segmentation of the Vertebrate Body, 32
 — Metamerie, Relation in Petromyzon to that in Amphioxus and in Higher Craniota, 29
 Seibert's Apparatus for Vertical Photomicrography, 106
 — Laboratory Microscope, 101
 — Large Model Microscope No. 2, 354
 — — — — No. 3, 101
 — — — — Polarising Apparatus, 104
 — — Mineralogical Stand, 234
 — — New Dissection Microscope, 101
 — — Projection Microscope with Electric Light, 103
 — — Travelling Microscope, 98
 Selaginella, New Species, 578
 — Sporangia and Oophyte, 76
 — Sporangia, Spore-casting Mechanism, 459
 Selby, A. D., Resistance of Seeds to Low Temperatures, 204
 Selenium and Tellurium Compounds, Decomposition by Moulds, 688
 Self-Pollination and Cross-Pollination, 71
 Seligo, A., New Rotifers, 436
 Sellards, E. H., Fossil American Ferns: Fertile Fronds of *Crossothea* and *Myriothea*, 671
 Sematophyllum, European Species, 673
 Semicircular Canals, Experiments on Pigeons in relation to, 544
 — — Lesion, 637
 Seminal Vesicles of Elk, Peculiar Process in, 293
 Sencert, L., Variations in Human Vertebral Column, 424
 Sentf, E., Diatoms in Agar-Agar, 676
 Sense-Hairs of Lepidopterous Larvæ, 643
 Sense-Organs, Multicellular, in *Syncoryne sarsii*, 55
 — — of the Polychæt Proboscis, 647
 Sensory Cells in Proboscis of Polychæts, 49
 Septicæmia, Hæmorrhagic, Classification, 93
 Sequoiaceæ, Embryogeny of, 70
 Serapias, Study of the Genus, 577
Sericaria mori, Stigmata, 180
 Serander, R., Haptera of Lichens, 218
 Sertoli's Cells, Function, 161
 Sertularella, Revision of Genus, 55
 Serum Media, Diphtheria Toxins in, 481
 Setæ on Legs of Flies, 553
 Seurat, L. G., Origin of Pearls, 39
 Seward, A. C., So-called Phloem of *Lepidodendron*, 330
 — Structure and Affinities of Dipteris, 672
 Sewertsoff, A. N., Skull and Nervous System of *Ceratodus*, 634
 Sex, Determination, 535
 — — in Animal Development, 534
 Sex-Elements in *Stylorhynchus*, 58
 Sex in Lepidoptera, Determination, 41
 Sexes in the Composite, Distribution, 64
 Sexual Development, Precocious, 541
 — Organs, Male and Female, Homologies in the Development, 206
 Sexuality, Change of, in Plants, 71
 — in *Spirogyra*, 333
 — of certain Yeasts, 216
 Shaw, P. E., Electrical Method of Taking Microscope Measurements, 625, 728
 Shear, C. L., American Fungi, 594
 Shedd, O. M., Reaction and Nature of Oxidising Ferments, 455
 Shell-fish and Typhoid, 693
 Shifting of Lateral Organs through Mutual Pressure, Theory, 322
 Shipley, A. E., Abysmal Antarctic Fauna, 35
 Shoemaker, D. N., Development of *Huamanelis virginiana*, 570
 "Shot-hole" Fungi, 216
 Shrimp, Larval Stages, 431
 Shull, G. H., Quantitative Study in Bracts, Rays, and Disk-florets of Species of *Aster*, 326
 Siedlecki, M., New Parasitic Infusorian, 563
 Sieve-tubes of Pinus, Histology, 195
 — — Precursors of, in Gymnosperms, 569
 Silicoflagellate Protozoa, 57
 Siluroids, Distribution, 173
 Silver-leaf Disease, 683
 Silvestri, A., Dimorphism of Foraminifera, 656
 — Variations of *Nodosaria scalaris*, 656
 Silvestri, F., Anterior or Cephalic Glands of Diplopoda, 553
 — Notes on South American Termites and their Termitophilous Associates, 302
 — So-called Microthorax of Insects, 643
 — Studies on Thysanura, 429
 Simon, S., Structure of the Wood in Deciduous and Evergreen Trees, 659
 Simpson, J. Y., Observations on Protozoa, 563
 Simroth, H., New Genus of Stylommatophora, 177
 Sinéty, R. de, Spermatocytic Kineses in Orthoptera, 43
Sipunculus nudus, Central Nervous System, 309
 — Examining Nervous System, 373
 Sisto, P., HæmolympH Glands in Man and Mammals, 169
 Sisyra, Metamorphosis, 642
 Skeleton, Axial, in Amphibia, Development, 27
 Skin of Vertebrates, Blue and Green Coloration, 33
 Skin-Pigment in Man and Monkeys, 296
 Skorikow, A. S., Geographical Distribution of Priapulus, 186

- Skull and Nervous System of *Ceratodus*, 634
- Slide-Brake of Jung's Microtome, 375
- Slides, Cleaning, Method, 503
- See CONTENTS, xxxviii
- Stand for Holding, 259
- Slonaker, J. R., Method for Washing, Staining, and Dehydrating Small Specimens, 378
- Slosson, M., Hybrid Origin of *Asplenium ebanoïdes*, 672
- Slow-worm and Lizard, Branchial Clefts, 634
- Slupski, R., Does Anthrax form Spores under Anaerobic Conditions? 107
- Small Specimens, Washing, Staining and Dehydrating, Method, 378
- Smegma Bacilli and Tubercle, Differential Staining, 256
- Smidt, H., Free Intra-epithelial Nerve-endings in *Helix*, 176
- Smith, G. E., Brain of *Macroscelides proboscideus*, 637
- Smith, R. E., Parasitism of *Botrytis cinerea*, 590
- Smith, R. G., Bacteria and the Disintegration of Cement, 89
- Cultivation of *Rhizobium leguminosarum*, 108
- *Vibrio denitrificans*, 93
- Smut of Cereals, 591
- Snail, Blood, 640
- Snakes, Variation, 424
- Venom, 638
- Soar, C. D., New British Hydrachnid, 554
- Sodium Silicate as a Mounting Medium for Microscopical Preparations, 622
- Solenogastres, Systematic Position, 641
- Solutions, Concentrated, Adaptability of Infusoria to, 192
- Sommier, S., *Petalophyllum Ralfsii*, 674
- Sosnowski, J., Changes in the Geotaxis of *Paramecium aurelia*, 191
- Soulié, H., Culicidæ of Algiers, 643
- Soulier, A., Fixation of Polychæta Embryos, 373
- Southwell, T., Hermaphroditism in Hermit, 421
- Sparrow, Spermatogenesis, 293
- Spawning Period of Mussels, 178
- Species, Concept of, 542
- Spectrum, The New, 247
- Spengel, J. W., Genera of Enteropneusta, 310
- Sperlich, A., Suckers of Green Rhinanthaceæ, 323
- Spermatids and their Parts, Movements, 162
- Spermatogenesis and Fecundation of *Zamia*, 201
- and Oogenesis in *Lithobius forficatus*, 304
- in Insects, 178
- Spermatogenesis in Newt, 538
- in *Phalangista vulpina*, 419
- in Sparrow, 293
- Insect, Accessory Chromosome, 41
- of *Oniscus asellus*, 47
- of Scelopendra, 182
- Tetrads, 162
- Spermatozoa, Atypical, 632
- Expulsion in *Sciara*, 551
- of *Allolobophora fetida*, 648
- Rheotactic Properties, 161
- Two-tailed, 538
- Spermatozoon and Zoospore, 57
- of Rat, 538
- Spermatotoxin, Influence on Fertilising Power of Spermatozoa, 26
- Speschnew, N. N. v., Black Rot of Vine, 470
- Sphaclariaceæ, 211
- Sphæridia, Function in Sea-Urchins, 437
- Spider Collection, Arrangement, 554
- Spiders, Classification, 554
- of Germany, 645
- — — Monograph, 45
- Tracheæ, 645
- Spinal-cord, Membranes, 169
- of Birds, Accessory Lobes, 295
- — Staining Grey Matter after Mordanting with Metallic Salts, 500
- — — Sections with Cœruleïn S, 717
- Ganglion-Cells, Reticular Apparatus, 635
- Spinax, Spines, 423
- Spiræa, Development of Flower and Embryo, 667
- Spirogyra, Abnormal Conjugation, 80
- Sexuality, 333
- Spitta, E. J., An Apparatus for obtaining Monochromatic Light with a Mixed Jet, 727
- Spleen, Circulation in, 169
- Sponge, New Calcareous, 312
- Sponges, Algerian, 562
- from New South Wales, 190
- Sporangia and Oophyte of Selaginella, 76
- Spore-casting Mechanism of Selaginella Sporangia, 459
- Spore-Distribution, 330
- in a Lichen, 339
- Spore-formation in Cholera Bacilli, 90
- Spore-Germination and Light, 324
- in Higher Fungi, 472
- Spores for Testing Methods of Disinfection, &c., Preparation, 227
- of Ferns, Germination, 78
- of the Uredinæ, Storing up of Water in, 85
- Sporodinia grandis*, 588
- Sporozoon, New, 313
- Spuler, A., New Method for Staining en masse, 114
- — — of Staining in Bulk, 378
- Spurge, Action on Salmonoid Fishes, 425

- Sputum, New Method of Examining, 254
- Squilla desmaresti*, Occurrence in the North Sea, 185
- Ssinitzin, D. T., Life-history of *Distomum folium*, 51
- Stage, Mechanical, Zeiss' Smaller, 605
- Messer's Attachable Mechanical, 613
- Stäger, R., Chemical Demonstration of Nectaries in Pollen Flowers and Anemophilous Flowers, 566
- Staining Biliary Canaliculi, 622
- en masse, New Method, 114
- Flagella, 717
- Glycogen, 622
- in Bulk, New Method, 378
- Nervous Tissue, New Method, 114
- Sections of Spinal Cord with Cœrulein S, 717
- Objects. See CONTENTS, xxxvii
- the Morphotic Elements of Blood, Rapid Method, 715
- with Polychrome Methylen-Blue, Simplified Method, 717
- the Reticulum of Spinal Ganglion-cells, 717
- Staminode-like Structures in *Dentaria bulbifera*, 198
- Stand for Holding Slides, 259
- Preparation and Drawing Apparatus for Weak Magnifications, Zeiss', 485
- Standing's Imbedding Microtome, 375, 385
- Stands, Microscope. See CONTENTS, xxxiv
- Starch and Chlorophyll in Stem, Evolution, 62
- Starch-formation in *Hydrodictyon utriculatum*, 205
- Starch, Formation in the Grain of Wheat, 63
- Structure, 62
- Stassano, H., Conjugation in *Trypanosoma* of Rat, 193
- States, Two, of Living Matter, 31
- Statistical Study of Organisms, 171
- Stead, J. E., Copper-Iron Alloys, 261
- Structure of Copper-Antimony Alloys, 720
- Steel and Iron, Report of a Demonstration of Methods used in Photomicrography of, 1
- Castings, Properties, 382
- Effect of Reheating upon Overheated, 718
- Rails, Relation between their Structure and Durability, 718
- Steen, R. H., Electrothermal Paraffin Bath, 111
- Stefansky, —, New Pathogenic Bacillus, 601
- Steinbrinck, C., Spore-casting Mechanism of Selaginella Sporangia, 459
- Stele of Equisetum, Nature, 672
- Stellaria pallida*, Cleistogamy, 72
- Stem and Branch of same Tree, Union, 448
- of Pteridophytes and Gymnosperms, 194
- Stem-structure, Origin of Peripheral, 316
- Stems, New, Formation from Old Willows, 197
- Stenta, M., Inferior Backward Current in Bivalves, 39
- Stenzel, G., Malformations of the Flower of Orchids, 577
- Stephan, P., Interstitial Cells of the Testis, 423
- Stephani, F., Lists and New Species of Hepatics, 210
- Siamese Hepatics, 674
- Species Hepaticarum, 673
- Stereomicrography, 12
- Stereophotomicrography, 366
- Stereoscopic Loups, Berger's, 698
- Sterzi, G., Membranes of Spinal Chord, 169
- Steuer, A., New Parasitic Copepod in Intestine of Mussel, 646
- Stevens, F. L., Gametogenesis and Fertilisation in *Albugo*, 83
- Stevens, T. S., Key to the Rotifera for Amateurs, 653
- Stichococcus bacillaris*, 679
- Stigmata of *Sericaria mori*, 180
- Stiles, C. W., Questions of Nomenclature, 298
- Stimuli, Reaction of Bacteria to, 88
- Stimulus causing Change of Form and Structure in an Amphibious Plant, Nature of, 669
- Stingelin, T., Notes on Fauna of Neuenburgersee, 307
- Stipular Structures of Monocotyledons, 447
- Stipules of *Liriodendron*, 67
- Stitz, H., Female Genital Apparatus in Microlepidoptera, 40
- Stokes, W. B., Images of Diatom Structure, 248
- Stolonial Growth in Syllidae, 307
- Stomata, Development in Conifers, 315
- Stopper, Germ and Water-tight, for Flasks, 503
- Stow, S. C., List of Diatoms, 583
- Strasburger, E., Formation of the Pollen in the Asclepiadææ, 199
- Strasser, H., Olfactory Organ in Vertebrates, 164
- Strasser, P. P., Fungus Flora of the Sonntagberg, 685
- Streeter, E. C., Marble Blocks for Celluloid Tissues, 715
- Streptococci, Unity of Pathogenic, 598
- Streptococcus Hæmolyisin*, 346
- of Scarlet Fever, 694
- Streptothrix farcinica*, 586
- Stringer's Focussing Attachments to Photomicrographic Cameras, 246
- Strobell, E. C., New Method of Focussing in Photomicrography, 490
- Spermatozoa of *Allolobophora fætida*, 648
- Strombosia and Onguckoæ, Germination, 322

- Strong, —, Infection by Paracolon Bacillus, 597
- Strong, R. P., *Strongyloides intestinalis*, 50
- Structure and Development of Seed Plants, Reproductive. See CONTENTS, xxii
- — — — — Vegetative. See CONTENTS, xxi
- Stschelkanovzeff, J. P., Breathing Organs of Pseudoscorpionidæ, 184
- Stubbs, G., Taxine, 568
- Studnická, F. K., Origin of Cerebral Hemispheres, 26
- Stunay, R., New Cave Gasteropod, 177
- Stutzer, A., Formation of Bacteroids in Artificial Nutrient Media, 226
- Stylommatophora, New Genus, 177
- Stylorhynchus, Sex-Elements, 58
- Suberites domuncula*, 56
- — — *Halichondria panicea*, Modifications or Metamorphosis in, 190
- Substage, Glass-rod, 240
- Substitute for Cover-slips, 115
- Subterranean Organs of Californian Liliaceæ, 658
- Sucker of *Loranthus aphyllus*, 196
- Suckers of Green Rhinanthaceæ, 323
- Sugars and Organic Acids in certain Fruits, 567
- Two new, extracted from Manna, 567
- Sukatscheff, L., Action of Alcohol on Germination of some Seeds, 575
- Sulphocyanic Acid, Influence on Growth of *Aspergillus niger*, 688
- Sunflower, Shifting of Heads during Development from Flowering to Ripening, 453
- Sunshine, Effect on Plants, 574
- Supra-renal Bodies of Plagiostomes, 636
- Sus domestica*, Development, 162
- Sutton, W. S., Spermatogenesis in Insects, 178
- Suture, Dorsal, and Dorsal Groove in Gastrula of Triton, 28
- Swift, J., and Son, "Ariston" Fine Adjustment, 698
- Swinnerton, H. H., Morphology of Teleostean Head Skeleton, 420
- Sycon compressum*, 190
- Sydow, H. and P., Monograph of the Uredineæ, 593
- Uredineæ, 217
- Sydow, P., Sylloge Fungorum, 341
- Syllidæ, Stolerial Growth, 307
- Sylloge Fungorum, 341
- Synapta and Ankyroderma, Calcareous Plates, 436
- Synchaeta, The Genus, 269, 393, 507
- Syncozyne sarsii*, Multicellular Sense-Organs, 55
- Syniewski, W., Structure of Starch, 62
- Syphilitic Semen, Bacilli, 692
- Szili, A., Development of Iris in Man, 164
- T.
- Tæniophyllum, Assimilating Roots, 68
- Taliew, W., Polychroism of Flowers, 64
- Tammes, T., Microscopist's Electrical Lamp, 230
- Tamus communis*, Tubercle, 317
- Tansley, A. G., New Type of Fern-Stele, 329
- Tape Measure for Adjustment of Projection-Oculars, 248
- Tapeworms, Superficial Secretion, 187
- Taste, Sense of, in an Ant, 552
- Tauret, C., Two new Sugars extracted from Manna, 567
- Taxine, 568
- Tea-leaf, Enzymes, 670
- Technique, Microscopical. See CONTENTS, xxxvi
- Teeqmenne, C., Development of Ventral Pancreas in *Lacerta muralis*, 540
- Teeth, Development in *Sus domestica*, 162
- of Hag and Lamprey, 424
- Teleostean Head Skeleton, Morphology, 420
- Teleosteans, Structure and Function of Thymus, 636
- Tellurium and Selenium Compounds, Decomposition by Moulds, 688
- Temperature, Action on Absorption of Minerals in Etiolated Plants, 324
- Distribution of Planarians affected by, 308
- Influence during Pupation, 644
- — on Development on Fowl's Egg, 631
- Tenebrio, Testis, 644
- Tension and Pressure, Influence on Direction of Cell-wall, 322
- Teodoresco, E. G., Gomontiaella, a new Genus of Schizophyceæ, 223
- Tephroclystia virgaureata*, Life-history, 180
- Teratogenic and Pathogenic Agents, 543
- Teratological Work, Recent, 541
- Termites and their Termitophilous Associates, South American, Notes, 302
- Termitoxenia, 43
- Terms, Index of New Biological, or Old Terms with New Meanings, recorded in this Volume, 730
- Teru and Duck, Early Stages in Development, 294
- Ternetz, C., Morphology and Anatomy of *Azorella selago*, 446
- Testis, Alleged Peritubular Lymphatic Tubes, 538
- Internal Secretion, 538
- Interstitial Cells, 423
- of Tenebrio, 644
- Tetanus Bacillus, New Method of Cultivating, 618
- Tethya, Gemmation, 55
- Tetrads in Spermatogenesis, 162
- Tetrasporangium in Floridææ, Development, 583

- Teucrium Scordium* and *Liparis Loeselii*, 670
- Thacher, H. F., Regeneration of Pharynx in *Planaria maculata*, 651
- Thalassema, Early Development of Mesoblast, 557
- Thalictrum purpurascens*, Parthenogenesis, 451
- Thamniun, Genus, 579
- Thaxter, R., New Genera and Species of Laboulbeniaceæ, 214
- Théel, H., Hermaphrodite Holothurian, 54
- Thickening, Abnormal Secondary, in *Kendrickia*, 660
- Thiele, J., Homologies of Cœlom, 175
— Systematic Position of the Solenogastres, 641
- Thiele, R., New Counting Apparatus for Plate Cultures, 718
- Thiothrix, Gas Vacuoles, 603
- Thiselton-Dyer, Sir W. T., Carpophyll of *Encephalartos*, 65
— Persistence of Leaf-traces, 64
— Sucker of *Loranthus aphyllus*, 196
- Thomas, A. P. W., Affinities of *Tmesipteris*, 329
— Alga-like Fern-Prothallus, 329
— Prothallium of *Phylloglossum*, 208
- Thomas, R. H., Luminosity in Centipedes, 182
- Thompson, C. B., *Zygeupolia litoralis*, a new Heteronemertean, 309
- Thompson, S. P., Opto-Technics, 495
- Thomson, J. S., Periodic Growth of Fish-Scales, 173
- Thor, —, New Genera of Hydrachnids, 183
- Thorpe, T. E., Taxine, 568
- Thrinicia tuberosa*, Structure of the Tuberosous Roots, 196
- Thymus in Teleosteans, Structure and Function, 636
- Thylacoplethus, Structure, 555
- Thyroid Gland, Function, 425
— of Lamprey, 421
- Thysanura, Studies, 429
- Tichomirow, A., Artificial Parthenogenesis of Silk-Moth Ova, 428
- Tiessen, F., Bottle for Cedar-Wood Oil, 503
- Tilting-stage, Huntingdon's, for Holding and Adjusting Minerals, 613
- Timberlake, H. G., Starch-formation in *Hydrodictyon utriculatum*, 205
- Timofejew, D. A., Nerve-endings in Peritoneum of Mammals, 168
- Timothy Grass, Rust, 592
- Tmesipteris, Affinities, 329
- Toad's Egg, Dispensability of Gravity in Development, 537
- Tobacco, Mosaic Disease, 576
- Tobler, F., Abnormalities in Mosses, 331
— Origin of Peripheral Stem-Structure, 316
- Todd, R. A., Fauna of Eze Estuary, 174
- Tollens, B., Constituents of Pith of Maize and Elder, 567
- Tomba, A., Electrical Phenomena in Plants, 574
- Tongue, Development in Man, 26
- Tönninges, C., Spermatogenesis and Oogenesis in *Lithobius forficatus*, 304
- Topsent, E., Algerian Sponges, 562
- Tornquist, A., Position of Neostroma, 189
- Torpedo occidentalis*, Efferent Neurons in Electric Lobes, 168
- Torr, W. G., Fossil Polyplacophora, 177
- Torrey, H. B., Discoloration of the Sea by Dinoflagellata, 656
— New Species of *Phoronis*, 53
— Regeneration and Regulation in *Renilla*, 54
- Torrey, J. C., Cytological Changes accompanying the Secretion of Diastase, 565
— Early Development of Mesoblast in *Thalassema*, 557
- Toxic Properties of some Copper Compounds, 222
- Toxins, Diphtheria, in Serum Media, 481
— Injecting into Parents, Influence on Offspring, 29
- Tracheæ of Spiders, 645
- Trägårdh, J., Limbless Acarid, 645
- Transpiration, New Mode of Measuring, 75
— Observations on, 572
— of Evergreen Trees in Winter, 573
- Traumatic Stimulation, Reaction of Leaves to, 74
- Treasurer's Account for 1901, 126
- Trees, Increase in Diameter, 660
- Trematodes, New, from Crocodile, 308
- Trentepohlia, The Genus, 677
- Triceratium, Certain Minute Structure observed in some Forms, 495
- Trichoptera, Copulatory Apparatus of Male, 43
- Triple Stain, New, 257
- Triton, Dorsal Groove and Dorsal Suture in *Gastrula*, 28
- Trocar for the Aseptic Collection of Portions of Tumours, 382
- Trotter, A., Parasitic Fungi, 219
- Trouessart, E., Arctic Halacaridæ, 431
— Collection of Microscopic Marine Arthropods, 551
— New Uropodinae, 554
- Trout, Monstrosity, 298
- Trypanosoma brucei*, 440
— — Action of Human Serum on, 313
- Trypanosoma*, Fixing and Staining, 372
— in Fishes, 58
- Trypanosoma Levisi*, Methods for Examining, 117
- Trypanosoma*, Multiplication in Fishes, 564
— New, 440, 564

Trypanosoma of Rat, Conjugation in, 193
 Tryptophane and Proteolysis, 325
 Trzebiuski, M. J., Influence of Irritation on Growth of Unicellular Plants, 471
 Tschermak, E., Experiments with Pea Hybrids, 321
 — Influence of Pollination on the Development of the Pericarp, 321
 Tubercle and Smegma Bacilli, Differential Staining, 256
 — Bacilli in Milk, Detection, 343
 — — Virulence of Bovine and Human, 92
 — Bacillus, Agglutination, 348
 — — Biochemical Studies on, 92
 — — Fat Substance, 345
 — of *Tamus communis*, 317
 Tuberculosis, Human and Bovine, 92
 — in Cold-blooded Animals, 479
 Tubers of Dioscorea, 68
 — Orchid, Composition, 566
 Tubeuf, —, Infection Experiments with Uredineæ, 681
 — Smut of Cereals, 591
 Tubularia, Regeneration, 655
 Tulley, W., First English Achromatic Objective, 16
 Tunicata. See CONTENTS, xii
Turritella communis, Crystalline Style and Style-sac, 427
 Turro, R., Apparatus for Anaerobic Cultures, 250
 Twins, Monochorial, 159
 Two-speed Fine Adjustment, New, 354
 Typhoid and Coli, Differential Diagnosis, 598
 — and Shell-fish, 693
 — Bacilli, Medium for Isolating, 371
 — Bacillus, Intracellular Constituents, 225
 — — Isolation, 371
 — — Method for Detection in Blood, 496
 — — New Method of Isolating from Water, 249
 Tyrogen, Use in Cheese-making, 226
 Tyroglyphidæ, British, 431
 Tyrosine and Leucine as Food-stuffs, 452

U.

Uexhüll-Gyllenband, M. v., Distribution of the Sexes in the Compositæ, 64
 Ulpiani, —, Alcoholic Fermentation of Indian Fig-Must, 337
Ulula hyalina, Life-history, 552
 Umbelliferæ, Rusts, 681
 Underwood, L. M., Classification of Ferns, 328
 Unisexual Condition, Passage from Bisexual Condition by Unilateral Parasitic Castration, 326
 Urban, F., New Calcareous Sponge, 312
 Uredine, Pure Cultures, 337
 Uredineæ, 217
 — Cultures, 466

Uredineæ, Function of Paraphyses, 682
 — Infection Experiments, 681
 — Monograph, 593
 — New, 466
 — Paraphyses, 467
 — Storing up of Water in the Spores, 85
 Urinary and Other Deposits, Simple Method for Preserving, 622
 — Sediment, Preparation and Preservation, 115
 Urnula and Geopyxis, Studies, 464
 Urodela, Musculature, 35
 Uroneetes, Affinities, 185
 Urophlyctis, 586
 — Underground Species, 336
 Uropodina, New, 554
 Use-Inheritance Interpretation, Argument for, 421
Ustilago Maydis, Biological Phenomena in the Cultivation, 591
 Utricularia, Bladders, 196
 Uyeda, Y., "Benikoji" Fungus, 466

V.

Valerio, G., Botryomycosis, 599
 Vallet, G., New Method for Isolating the Typhoid Bacillus from Water, 249
 Van Bambeke, C., Crystalloids of the Basidiomycetes, 683
 Van der Stricht, O., Fertilisation in the Bat, 633
 Vaney, C., Contributions to Anatomy of *Rhabdopleura normani*, 652
 — New Microsporidian, 58
 — Note on Additions to Fresh-water Fauna, 546
 Van Tieghem, P., Existence of a Hypostase in the Ovule and Seed of Rosaceæ, 666
 Variability of Micro-organisms, 342
 Variation, Chemical Basis, 31
 — Germinal and Environmental, 533
 — in Plants, Limits of, 75
 Vas epididymis of Man, Filamentous Tufts of Epithelial Cells, 170
 Vascular System of *Bdellostoma dombeyi*, 174
 Vaucheria, Oil in, 83
 Vayssière, A., 'Talisman' Opisthobranchs, 427
 Vedder, —, Etiology of Acute Dysentery, 480
 Vegetable Pathology, 340
 Vegetation of Mountainous Districts North of Lake Nyasa, 458
 Veins of Salamander, Abnormalities, 35
 Velenovsky, M., Abnormal Flowers of *Forsythia viridissima*, 199
 Venom of Snakes, 638
 Ventura, New Species, 466
 Verhoef, K., Chilopoda in Bronn's 'Tierreich,' 644

- Verhoeff, K. W., Comparative Morphology of Chilopoda, 305
 — Dermoptera and Microthorax, 302
 Versou, E., Exuvial Glands, 644
 Vertebræ of Terrestrial Carnivores, 638
 Vertebral Column, Human, Variations, 424
 Vertebrata. See CONTENTS, viii
 Vestergren, T., An Arctic-Alpine Rhabdosporea, 216
 — New Fungi, 469
 Vezey, J. J., 119, 125
Vibrio denitrificans, 93
 Vibrios, Agglutination, 228
 Viguier, C., Natural Parthenogenic Development, 654
 Villari, E., Structure of Achenes, 571
 Vincenzi, L., Limiting Membrane in Human Scrota, 169
 Vines, H. S., Proteolytic Enzyme of Nephthyes, 205
 — Tryptophane and Proteolysis, 325
 Violet, Kresylecht, 112
 Viper's Venom, Hæmolytic Effect, 544
 Virchow, H., Retina of Hatteria, 541
 Vision, Biological Theory, 298
 — Mechanical Theory, 32
 Vitality of Leaves after their Fall, 73
 Vitreous Humour in the Eye of Man and Animals, Matrix, 296
 Vivipara and Plumatella, 310
 Vöchting, H., Germination of Potato Tubers, 452
 Vogel, P., Means of Distribution of Alpine Plants, 76
 Voges, —, Normal-Serum in Pneumo-Enteritis, 347
 Vogler, P., Variation in *Fragillaria crotonensis*, 461
 Vogliano, P., Disease of Cultivated Chrysanthemums, 596
 Voigt, M., New Ciliata, 192
 — — Rotifer, 187, 436
 — — Species of Gastrotricha, 187
 Voigt, W., Distribution of Planarians as affected by Temperature, 308
 Völker, —, Development of Pancreas in Amniota, 165
 Vriens, J. G. C., Raising the Melting-point of Gelatin by means of Formalin, 116
 Vuillemin, —, Association of Amylomyces and a Micrococcus, 602
 Vuillemin, P., Penicillate Tubes of Phylactinia, 84
 — Sarcocystis tenella in Man, 564
- W.
- Waddell's Erecting Microscope, 291
 Wadsworth, J. T., Conjugation of *Dendrocometes paradoxus*, 438
 Wager, H., Cytology of Cyanophyceæ, 689
 Wahl, B., Development of Hypodermal Imaginal Discs in Larval Diptera, 42
 Waite, E. R., Development of *Galeus antarcticus*, 166
 Walbaum, —, Enumeration of Water Bacteria, 229
 Wallengren, H., Comparative Morphology of Hypotrichous Infusoria, 192
 — Glands of Alimentary Canal in Decapoda, 46
 — Sensory Cells in Proboscis of Polychæts, 49
 Wall's, E. J., Dictionary of Photography, 623
 Warburg, O., History and Development of Applied Botany, 458
 Ward, H. M., Disease in Plants, 76
 — Parasitic Fungi, 86
 — Predisposition and Immunity in Plants, 473
 — Preserving and Examining Fungi, 339
 — Pure Cultures of a Uredine, 337
 — Relation between Host and Parasite, 593
 Warming, E., Burmanniaceæ from Brazil, 458
 Warren, E., Teeth of Hag and Lamprey, 424
 — Variations in Vascular System of *Rana temporaria*, 424
 Wasmann, E., Genus Termitoxenia, 43
 — Myrmecophilous Mites, 183
 Wasp, Gynandromorphy in, 40
 Water Bacteria, Enumeration, 229
 — Relation of the Supply to the Ripening of Woody Plants, 73
 — Storing up in the Spores of the Uredineæ, 85
 Waters, C. E., Analytical Key for the Ferns of the North-eastern States, based on the Stipes, 578
 Watson and Sons, 'Fram' Microscope with Revolving Top-plate, 267
 — Holder for Metallurgical Work, 494
 — New 'Holos Fram' Microscope, 354
 — — Two-speed Fine Adjustment, 267, 354
 Webb, J. C., Microscope by Carpenter and Westley, 389
 — Old Microscope by Pritchard, 386
 Webb, J. E., Development of Flower and Embryo of Spiræa, 667
 Webb, T. L., Apparatus for Removing Pieces of Tissue for Microscopical Examination, 714
 Webber, H. J., Spermatogenesis and Fecundation of Zamia, 201
 Wedeles, —, Grayson's ruled Gratings, 385
 Wehmer, C., The Genus Aspergillus, 680
 Wehner, —, Economic Fungi, 686
 Weigert's Method of Staining Elastic Tissue, Modifications, 113
 Weil, R., Preparation of Spores for Testing Methods of Disinfection, &c., 227

- Weinland, E., Fermentation of Glycogen in *Ascaris*, 557
- Weissbein, S., Method of Examining Nutrient Media, 498
- Weitlauer, F., Marine Phosphorescence, 563
- Wendt, G. v., Method of making Microscopical Preparations for Photographic Purposes, 253
- Simple Method of Fixing Bacteria to the Slide or Cover-slip without Drying, 498
- Werner, F., Prodrômus of Monograph on Chamæleons, 297
- Werner, R., Artificially induced Anomalies in Cell-Division, 635
- Wesché, W., Setæ on Legs of Flies, 553
- Undescribed Palpi on the Proboscis of some Dipterous Flies, with Remarks on the Mouth-parts in several Families, 412, 508
- Wesenberg, G., Dropper for Sterile Fluids, 116
- Germicides, 472
- West, G. S., British Fresh-water Rhizopods, 56
- Flora of Hot Springs, 597
- West, W., New Mougeotia, 333
- West, W. and G. S., Flora of Koh Chang, 462
- Fresh-water Algæ of Ceylon, 584
- Wheeler, W. M., Macroergates in *Phaiæole commutata*, 40
- New Agricultural Ant from Texas, 429
- Whipple, G. C., Physical Properties of Gelatin in reference to its Use in Culture Media, 713
- White, V. S., Nidulariaceæ of North America, 467
- Whitelegge, T., Sponges from New South Wales, 190
- Wieland, G. R., Notes on Living Cycads—The *Zamia* of Florida, 448
- Weisner, J., Position of Flowers with respect to Light, 204
- Wildbolz, —, Cultivation of *Gonococcus*, 601
- Wilkinson, E. J., Colouring Matter from Flowers of *Delphinium consolida*, 443
- Will, H., Observations on the Vitality of the Yeast-plant, 591
- Yeast-water for Biological Analysis, 107
- Willecox, M. A., Commensal Oligochæte in New England, 49
- Wille, —, Gas Vacuoles in *Thiothrix*, 603
- Williams, H. S., Fossil Faunas and Geological Formations, 546
- Williams, R. S., *Eurhynchium Tayloræ* and *Brachythecium Pringlei*, 332
- Migration of Eye of Flat-fish, 420
- Preliminary List of Montana Mosses, 673
- Williams, W. R., Precocious Sexual Development, 541
- Williamson, H. C., Larval Stages of Shrimp, 431
- Willie, N., *Pseudoclonium*, a New Genus of Algæ, 82
- Willot, —, *Heterodera schachtii*, 50
- Willows, Old, Formation of New Stems from, 197
- Wilson, H. V., Asexual Origin of the Ciliated Sponge Larva, 562
- Wiltner, W., Relict Crustaceans in North German Lakes, 432
- Windle, B. C. A., Recent Teratological Work, 541
- Winkel's Drawing Apparatus, for Weak Magnifications, 361
- Winkler, G., Regeneration of Alimentary Canal in *Rhynchelmis limosella*, 647
- Winkler, H., Regeneration of Leaf-blade in Cyclamen, 447
- Winkler, W., *Mucor* as an Alcohol Yeast, 588
- Winton, A. L., Fruit of the Cocoa-nut, 65
- Witch's Brooms on the Barberry, 592
- Wittmack, L., Improved Method of Sectioning Carbonised Woods, 499
- Wolfenden, R. N., Copepods of Faroë Channel and Shetlands, 185
- Radiolarians of Faroë Channel and Shetlands, 191
- Wolf, —, Differential Diagnosis of Coli and Typhoid, 598
- Wood, C., Diphtheria Toxins in Serum Media, 481
- Wood, Carbonised, Improved Method of Sectioning, 499
- in Deciduous and Evergreen Trees, Structure, 659
- Mature in Trees, Bending, 66
- Old, and the New, 315
- Wood, R. W., Prisms and Plates for showing Dichromatism, 493
- Woods, A. F., Mosaic Disease of Tobacco, 576
- Woodward, Dr. H., 266
- Woody Tissue, Staining, 113
- Worsdell, W. C., Vascular Structure of the Flowers of *Gnetaceæ*, 320
- Wright, J. H., Rapid Method of making Permanent Preparations of Frozen Sections, 377
- Wróblewski, A., Buchner's Yeast Extract, 85
- W.R., W.A., and N.A., Measurement of, 143
- Wulfert, J., Development of *Gonothyræa loveni*, 55, 311
- Wynn, W. H., Staining Medullary Sheath of Nerve-Fibres, 500

X.

- Xenia and Hybridism, 200
- X-Rays, Influence on Plant Organism, 455

Y.

- Yates, J., Constitution of Hæmatoxylin, 443
 Yatsu, N., Habits of *Lingula*, 559
 Yeast Extract, Buchner's, 85
 — New Pathogenic, 681
 — Plant, Observations on the Vitality, 591
 — Pressed, Microscopical Appearances after Liquefaction, 85
 Yeasts, 591
 — Fruit, 680
 — Sexuality, 216
 Yeast-Water for Biological Analysis, 107
 Yendo, K., Corallinæ from Port Renfrew, Vancouver, 584
 — Japanese Corallinæ, 584
 Yolk-organ of *Salmo fario*, 166
 Yung, E., Monstrosity in a Trout, 298
 — Variations of Plankton in Lake Geneva, 639

Z.

- Zacharias, O., Infusoria in Cuckoo-Spit, 657
 — Parasites of Rotatoria, 653
 — Plankton of Lake of Maria-Laach, 426
 — Pond Plankton, 675
 — Two new Dinoflagellata, 563
 Zahlbruckner, A., Lichens, 218
 — Lichens of the Netherlands, 468
 Zaleski, W., Formation of Proteids, 74
 Zamia, Spermatogenesis and Fecundation, 201
 Zamias of Florida—Notes on Living Cycads, 448
 Zander, E., Copulatory Apparatus of Male Trichoptera, 43
 Zanfagnini, C., Contribution to the Lichen Flora of Emilia, 683
 Zardo, —, Pathogenic Bacillus in Cockles, 693
 Zeiss' A* Objective, 614
 — Assorted Pairs of Objectives for Binocular Microscopes, 614
 Zeiss' Centring Apparatus for Microscope Objectives when used as Condensers, 615
 — Crystal Films and Plates for Double Refraction, 617
 — Epidiascope, 506, 699
 — Improved Algascop, 699
 — Small Mineralogical Stand, 610
 — — Model Polarising Microscope, 613
 — Smaller Mechanical Stage, 605
 — Objectives, 487
 — Orthomorphic Eye-piece, 615
 — Preparation Stand and Drawing Apparatus for Weak Magnifications, 485
 — Stand for Brain Sections, 483
 Ziegler, H. E., Present Position of the Theory of Descent, 171
 Zimmerman, A., Parasitic Fungi of Tropical Cultivated Plants, 596
 Zoanthæa, Living, Relationships of the *Rugosa* to, 437
 Zodda, G., Study of the Genus *Scrapias*, 577
 Zolotinsky, N., Reproduction of *Gerardinus decemmaculatus*, 421
 Zoologischer Jahresbericht, 638
 Zoology, Aid to the Study, 171
 — Introductory Text-book, 547
 — Practical Course, 423
 Zoospore and Spermatozoon, 57
 Zopf, W., Compounds from Lichens, 684
 Zostera, Development of Pollen, 449
Zostera marina, Embryology, 449
 Zschokke, F., An unusual Human Parasite, 558
 — Fauna of a Mountain Stream, 548
 — — of Switzerland and the Glacial Period, 35
Zygeupolia litoralis, a new Heteronemertean, 309
 Zygomycetes, Sexual and Non-Sexual Reproduction, 213
 Zykoff, W., *Cystopsis acipenseri*, 308
 — Mysis in the Volga, 556
 — Plumatella and Vivipara, 310
 — Protozoa of the Volga—Plankton, 313
 Zymase in Fungal Hyphæ, 587





