

948
1878

57

PROCEEDINGS

OF THE

ROYAL SOCIETY OF EDINBURGH.

PROCEEDINGS

OF

THE ROYAL SOCIETY

OF

EDINBURGH.

VOL. XXVI.

NOVEMBER 1905 TO JULY 1906.

EDINBURGH:

PRINTED BY NEILL AND COMPANY, LIMITED.

MDCCCXVII.

CONTENTS.

	PAGE
Office-Bearers, Session 1905-6,	1
Some Electrical Measurements on Metals. By Charles E. Fawsitt, D.Sc., Ph.D. <i>Communicated by</i> Professor A. Crum Brown. Issued separately February 12, 1906,	2
The Tarpan and its Relationship with Wild and Domestic Horses. By J. C. Ewart, M.D., F.R.S. (With Three Plates.) Issued separately February 12, 1906,	7
The Horse in Norway. By Francis H. A. Marshall, M.A. (Cantab.), D.Sc. (Edin.) (With Two Plates.) Issued separately February 12, 1906,	22
Notes on the Effect of Electric Oscillations (co-directional and transverse) on the Magnetic Properties of Iron. By James Russell. Issued separately February 8, 1906,	33
On a Theorem in Hypercomplex Numbers. By J. H. Maclagan-Wedderburn, Carnegie Research Fellow. Issued separately February 9, 1906,	48
Library Aids to Mathematical Research. By Thomas Muir, LL.D. Issued separately February 14, 1906,	51
<i>Bathydraco Scotiae</i> , Poisson abyssal nouveau recueilli par l'Expédition Antarctique Nationale Écossaise. Note préliminaire, par Louis Dollo, Conservateur au Musée royal d'Histoire naturelle, à Bruxelles. <i>Présentée par</i> M. R. H. Traquair, M.D., F.R.S., V.P.R.S.E. Issued separately March 29, 1906,	65
Some Further Results obtained with the Spectroheliometer. By Dr J. Halm. Issued separately March 29, 1906,	76
Preliminary Note regarding an Experimental Investigation into the Effects of Varying Diets upon Growth and Nutrition. By Chalmers Watson, M.D. (<i>From the Physiological Laboratory of the University of Edinburgh.</i>) <i>Presented by</i> Professor E. A. Schäfer, F.R.S. Issued separately February 22, 1906,	87
A Contribution to the Study of the Excretion of Allantoin in Thymus Feeding. By W. M'Lachlan, M.D. (<i>From the Research Laboratory of the Royal College of Physicians, Edinburgh.</i>) <i>Communicated by</i> Dr D. Noël Paton. Issued separately March 29, 1906,	95

	PAGE
On the Formation of Certain Lakes in the Highlands. By Dr Léon W. Collet, F. Swiss Geol. S., Assistant to Sir John Murray, K.C.B., and Dr T. N. Johnston, F.R.S.E. With a Note on Two Rock Basins in the Alps, by Dr Léon W. Collet. Issued separately April 16, 1906,	107
On the Distribution of the Proper Fractions. By Duncan M. Y. Sommerville, D.Sc. <i>Communicated by</i> Professor Chrystal. Issued separately April 16, 1906,	116
On Vibrating Systems which are not subject to the Boltzmann-Maxwell Law. By Dr W. Peddie. Issued separately May 24, 1906,	130
Some Experimental Results in connection with the Hydrodynamical Theory of Seiches. By Peter White, M.A., and William Watson. Issued separately June 11, 1906,	142
On the Methods of Standardising Suprarenal Preparations. By I. D. Cameron, M.B., D.P.H., Assistant to the Lecturer on Physiology, Edinburgh School of Medicine for Women. (<i>From the Laboratory of the Royal College of Physicians, Edinburgh.</i>) <i>Communicated by</i> Dr D. Noël Paton. Issued separately May 21, 1906,	157
<i>Neobythites Brucei</i> , Poisson abyssal nouveau recueilli par l'Expédition Antarctique Nationale Écossaise. Note préliminaire, par Louis Dollo, Conservateur au Musée royal d'Histoire naturelle, à Bruxelles. <i>Présentée par</i> M. R. H. Traquair, M.D., F.R.S., V.P.R.S.E. Issued separately June 14, 1906,	172
The Relation between Normal Take-up or Contraction and Degree of Twist in Twisted Threads. By Thomas Oliver, B.Sc. (Lond. & Edin.), Carnegie Research Fellow. <i>Communicated by</i> Dr C. G. Knott. Issued separately June 19, 1906,	182
A New Form of Harmonic Synthetiser. By J. R. Milne, B.Sc., Carnegie Research Fellow. (With Plate.) Issued separately July 12, 1906,	207
Preliminary Note on the Conductivity of Concentrated Aqueous Solutions of Electrolytes. By Professor J. Gibson. Issued separately August 29, 1906,	234
Recherches sur la Glauconie. Par les Drs Léon W. Collet et Gabriel W. Lee, assistants de Sir John Murray, K.C.B. <i>Communiqué par</i> Sir John Murray. (Avec 12 planches et 1 carte.) Issued separately August 30, 1906,	238
Notes:—1. On a Human Skeleton, with Prehistoric Objects, found at Great Casterton, Rutland. 2. On a Stone Cist containing a Skeleton and an Urn, found at Largs, Ayrshire. By Dr Robert Munro. With a Report on the Urn, by the Hon. John Abercromby; and on the Skulls, by Professor D. J. Cunningham. Issued separately August 31, 1906,	279
Note on a rare Dolphin (<i>Delphinus acutus</i>), recently stranded on the Coast of Sutherland. By Sir William Turner, K.C.B., F.R.S. (With Plate.) Issued separately August 29, 1906,	310

	PAGE
Contributions to the Craniology of the People of the Empire of India. Part III. : Natives of the Madras Presidency, Thugs, Veddahs, Tibetans, and Seistanis. By Sir William Turner, K.C.B. <i>Title only</i> ,	320
Note on the Smolt to Grilse Stage of the Salmon, with Exhibition of a Marked Fish recaptured. By W. L. Calderwood. Issued separately October 12, 1906,	321
Two Lecture Experiments in illustration of the Theory of Ionization. By Dr W. W. Taylor. <i>Communicated by</i> Professor Crum Brown. Issued separately October 12, 1906,	325
A Dietary Study of Five Halls of Residence for Students in Edinburgh. By I. D. Cameron, M.B., D.P.H. <i>Communicated by</i> D. Noël Paton, M.D. Issued separately November 9, 1906,	327
Further Study of the Two Forms of Liquid Sulphur as Dynamic Isomers. By Alexander Smith and C. M. Carson. Issued separately November 12, 1906,	352
The Theory of Alternants in the Historical Order of Development up to 1860. By Thomas Muir, LL.D. Issued separately November 16, 1906,	357
The Theory of Circulants in the Historical Order of Development up to 1860. By Thomas Muir, LL.D. Issued separately November 16, 1906,	390
Initiation of Deep-Sea Waves of Three Classes: (1) from a Single Displacement; (2) from a Group of Equal and Similar Displacements; (3) by a Periodically Varying Surface Pressure. By Lord Kelvin. Issued separately November 17, 1906,	399
"Scotia" Collections. On <i>Echinorhynchus antarcticus</i> , n. sp., and its Allies. By John Rennie, D.Sc., University of Aberdeen. <i>Communicated by</i> Wm. S. Bruce, Esq. (With a Plate.) Issued separately January 4, 1907,	437
Electrolysis through Precipitation Films. Part I. By W. S. Millar, M.A., B.Sc., Carnegie Research Scholar, and Dr W. W. Taylor. <i>Communicated by</i> Professor Crum Brown. Issued separately January 4, 1907,	447
Nematodes of the Scottish National Antarctic Expedition, 1902-1904. By Dr v. Linstow, Göttingen. <i>Communicated by</i> W. S. Bruce. (With Two Plates.) Issued separately January 4, 1907,	464
Scottish National Antarctic Expedition. "Scotia" Collections. Collembola from the South Orkney Islands. By George H. Carpenter, B.Sc., M.R.I.A., Professor of Zoology in the Royal College of Science, Dublin. (With Two Plates.) <i>Communicated by</i> William Evans, Esq. Issued separately January 14, 1907,	473
Statistical Studies in Immunity: The Theory of an Epidemic. By John Brownlee, M.D. (Glas.). <i>Communicated by</i> Dr R. M. Buchanan. Issued separately January 14, 1907,	484

	PAGE
On a Simple Way of Obtaining the Half-Shade Field in Polarimeters. By James Robert Milne, B.Sc., Carnegie Research Fellow. Issued separately January 14, 1907,	522
On an Exception to a Certain Theorem in Optics, with an Application to the Polarimeter. By James Robert Milne, B.Sc., Carnegie Research Fellow. Issued separately January 14, 1907,	527
The Hessians of Certain Invariants of Binary Quantics. By Thomas Muir, LL.D. Issued separately January 16, 1907,	529
The Sum of the r -line Minors of the Square of a Determinant. By Thomas Muir, LL.D. Issued separately January 16, 1907.	533
OBITUARY NOTICES,	540
Meetings of the Royal Society—Session 1905–1906,	552
Abstract of Accounts for Session 1905–1906,	561
INDEX,	572

PROCEEDINGS

OF THE

ROYAL SOCIETY OF EDINBURGH.

VOL. XXVI.

1905-6.

THE 123RD SESSION.

GENERAL STATUTORY MEETING.

Monday, 23rd October 1905.

The following Council were elected :—

President.

THE RIGHT HON. LORD KELVIN, G.C.V.O., P.C., LL.D., D.C.L., F.R.S.

Vice-Presidents.

The Hon. Lord M'LAREN, LL.D.	RAMSAY H. TRAQUAIR, M.D., LL.D., F.R.S., F.G.S.
The Rev. Professor FLINT, D.D.	ALEXANDER CRUM BROWN, M.D., D.Sc., F.R.C.P.E., LL.D., F.R.S.
ROBERT MUNRO, M.A., M.D., LL.D.	
Sir JOHN MURRAY, K.C.B., D.S.C., LL.D., D.C.L., Ph.D., F.R.S.	

General Secretary—Professor GEORGE CHRYSAL, M.A., LL.D.

Secretaries to Ordinary Meetings.

DANIEL JOHN CUNNINGHAM, M.D., LL.D., D.C.L., F.R.S., F.Z.S.
CARGILL G. KNOTT, D.Sc.

Treasurer—PHILIP R. D. MACLAGAN, F.F.A.

Curator of Library and Museum—ALEXANDER BUCHAN, M.A.,
LL.D., F.R.S.

Ordinary Members of Council.

ANDREW GRAY, M.A., LL.D., F.R.S.	JAMES COSSAR EWART, M.D., F.R.C.S.E., F.R.S., F.L.S.
ROBERT KIDSTON, F.R.S., F.G.S.	BENJAMIN NEEVE PEACH, LL.D., F.R.S., F.G.S.
DIARMID NOËL PATON, M.D., B.Sc., F.R.C.P.E.	JAMES JOHNSTON DOBBIE, M.A., D.Sc., F.R.S.
JOHN CHIENE, C.B., M.D., LL.D., F.R.C.S.E.	GEORGE A. GIBSON, M.A., LL.D.
JOHN GRAHAM KERR, M.A.	JOHANNES P. KUENEN, Ph.D.
WILLIAM PEDDIE, D.Sc.	
LEONARD DOBBIN, Ph.D.	

Some Electrical Measurements on Metals. By Charles E. Fawsitt, D.Sc., Ph.D. Communicated by Professor A. CRUM BROWN.

(MS. received November 7, 1905. Read November 20, 1905.)

There are many isolated records of facts showing that the physical properties of (pure) metals alter when the metals are subjected to hammering, rolling, heat-treatment, and other processes.

Somewhat recently Beilby has shown* that the differences in all the various states of metals are explained by the fact that solids exhibit two distinct *phases*: these are the amorphous or vitreous, and the crystalline. The properties of a metal in any given state are due to the metal being made up either of one or other of these phases, or both.

The amorphous or vitreous quality is produced by the various processes of "working" a metal; such are hammering, rolling, forging, or polishing. The crystalline condition is obtained by heat-treatment or annealing.

The difference in the physical properties between a metal in the crystalline, and the same metal in the vitreous condition, is often very great, and it appeared to me that it might be worth while to examine the difference in potential which the two phases of a metal have, when placed in an electrolyte.

When two metals are placed in an electrolyte, their potential with regard to the electrolyte is in general different, and the electro-motive force of the cell is easily measured. The E.M.F. of such a cell is given by the expression

$$0\cdot000198T\left(\frac{1}{n_1}\log_{10}\frac{P_1}{p_1}-\frac{1}{n_2}\log_{10}\frac{P_2}{p_2}\right)$$

where T is the absolute temperature, n_1 and n_2 the valency of the metals in the ionic condition, P_1 and P_2 the solution pressure of the two metals, and p_1 and p_2 the osmotic pressure of the ions of the two metals. If the solution pressure of two different phases

* *The Electro-Chemist and Metallurgist*, 1904, p. 806.

of the same metal is different, then the expression for the E.M.F. becomes $\frac{0.000198T}{n} \log_{10} \frac{P_1}{P_2}$.

It is a fact that two different "kinds" of the same metal, when placed in an electrolyte, give an E.M.F. Such results as have been recorded are however often contradictory, and for this, I think, two reasons can be given. In the first place, a very thin layer of oxide or other substance on the surface of a metal alters its potential very much; and secondly, the potential of a metal in contact with an acid or an electrolyte which does not contain the ion of the metal is a very variable quantity.

The following cases are, however, of considerable interest. Rolled copper is negative as compared with soft copper, and hammered copper is negative as compared with rolled copper.* Hard steel is negative against tempered steel.† Lüdtke ‡ found that finely-divided precipitated silver is negative against ordinary silver in a solution of silver nitrate. Gallium§ is liquid at a temperature above 30° C., but also at a temperature below this if undercooled; a measurement of the E.M.F. of the solid against liquid gallium in solution of gallium sulphate showed that the liquid gallium is the negative pole. The liquid condition is a special case (kinetic) of the amorphous phase.

These are instances of what I believe to be a general condition, namely, that the potential of the metal in the amorphous phase is negative, and in the crystalline phase positive, when the two kinds of metal are placed in a solution of a salt of the metal.

The metal I have found most suitable for experimenting upon is *silver*. With regard to the electrolyte, the most suitable is a solution of a silver salt, as we are here dealing with an equilibrium between silver and silver ion. The concentration of silver salt in solution does not matter at all in theory, and within certain limits does not matter in practice. I have used $\frac{1}{4}$ -normal, $\frac{1}{10}$ -normal, and $\frac{1}{100}$ -normal silver nitrate solutions with identical results. When the electrolyte is a salt of some other metal than silver, or if the concentration of silver ion is very small, some silver from the

* Wiedemann, *Elektrizität*, i. 723.

† Wiedemann, *ibid.*, i. 738.

‡ *Wied. Ann.*, 1893, 50, 678-695.

§ Wiedemann, *Elektrizität*, i. 739.

electrode dissolves; and, owing to the variable amount which dissolves, the potential between metal and electrolyte is thus a variable quantity.

The silver used was in the form of stout wire and was pure. Two silver rods which had received different treatment were inserted in silver nitrate solution, and this cell was then inserted along with a Weston cell in a circuit arranged for the measurement of E.M.F. by the compensation method.*

The silver rods were first of all kept at a red heat for several hours. In this condition the surface of the rods had a crystalline frosted appearance, and the rods were quite soft. The cell $Ag_I - AgNO_3 - Ag_{II}$, where Ag_I , Ag_{II} represent the two rods of silver, had no E.M.F. One of the rods (Ag_I) was then polished with emery-papers of different degrees of fineness, and then wiped with a clean cloth. The surface of the polished rod, when examined under the microscope, appeared smooth and unbroken, save for a few scratches, which are hard to avoid in polishing such soft material. The cell $Ag_I - AgNO_3 - Ag_{II}$ now showed an E.M.F., the polished rod, Ag_I , being the negative pole. The polished metal has evidently a greater tendency to dissolve than the annealed rod. The average E.M.F. of the cell is 0.013 volt. It is difficult to obtain always exactly the same value; the smallest I have obtained is .008 volt, and the largest .020 volt.

The E.M.F. remains practically constant; if the cell be short-circuited for a day and then released, the E.M.F. rises in a few minutes from zero to within .002 volt of its former value.

I have used sodium nitrate solution ($\frac{N}{100}$) and sulphuric acid (.05 per cent.) as electrolytes instead of silver nitrate; in both cases the E.M.F. was in the same direction and of approximately the same magnitude as in the case of silver nitrate, but the values obtained varied a great deal.

Returning to the case where silver nitrate is used as an electrolyte, the polished rod of silver (Ag_I) was treated with nitric acid for a few seconds; it was then washed with water, and warmed to about 200° C. for a short time. The vitreous skin was thus dissolved away, and the E.M.F. of the cell $Ag_I - AgNO_3 - Ag_{II}$ was zero.

* Ostwald-Luther, *Physiko-chemische Messungen*, 2nd ed., p. 367.

Instead of removing the polished layer by nitric acid, the rod was next heated for several hours at a red heat; on inserting in the cell again along with Ag_{II} the E.M.F. was found to be zero.

Beginning again with the two rods in an annealed condition, one was then hammered (Ag_I) until reduced to the state of thin foil, which was quite elastic in comparison with the annealed rod. The E.M.F. of the cell $\text{Ag}_I\text{—AgNO}_3\text{—Ag}_{\text{II}}$ was .012 volt, Ag_I being the negative pole. This shows that polishing and hammering induce a similar change in the condition of the metal as measured by E.M.F. methods. On heating the hammered silver rod (Ag_I) red hot, it became soft again, and the E.M.F. of the cell was reduced to zero.

Experiments on other Metals.

Experiments on gold and platinum were carried out in the same manner as on silver. One rod was kept throughout in the annealed condition. Two rods of pure gold were annealed by heating for several hours at a red heat, and were then introduced into gold chloride solution (16 grams per litre). The E.M.F. of this cell was measured as in the case of silver: no matter how long the gold was heated it was not possible to get the E.M.F. to zero as expected; however, by short-circuiting it was possible to reduce the small E.M.F. to zero.

The effect of polishing or hammering one of the gold rods was such as to make it the negative pole of the cell; the E.M.F. in this case is about twice as great as in the case of the silver cell, but the results of separate experiments varied so greatly that a definite figure can scarcely be given. The effect of dissolving the polished layer in aqua regia, or of annealing the hammered rod, was to reduce the E.M.F. of the cell to zero.

With two rods of platinum in platinum chloride solution, similar results were obtained; the polished or hammered rod is negative as measured against the annealed rod.

Summary of Results.

1. If two rods of the same metal be inserted in a solution of a salt of that metal, and if one of the rods be in the soft or annealed

condition, and the other in the hardened condition, then the hardened rod is the negatively, and the soft the positively, charged element of the cell.

2. Similar results are obtained by using other electrolytes than a salt of the particular metal, but their use is not to be recommended.

3. The results of these experiments corroborate previous experimental work and theory in connection with the existence of two phases of metals.

I desire to express my thanks to the Executive Committee of the Carnegie Trust for the Universities of Scotland, for a grant to defray the expenses of this research.

THE UNIVERSITY,
GLASGOW.

(Issued separately February 12, 1906.)

The Tarpan and its Relationship with Wild and Domestic Horses. By J. C. Ewart, M.D., F.R.S.,
Regius Professor of Natural History, University of Edinburgh.
(With Three Plates.)

(Read November 6, 1905.)

In December 1902, I communicated to the Society a preliminary note "On a New Horse from the Western Islands,"¹ and six months later submitted the results of experiments made with a view to ascertaining whether Prejvalsky's horse is a true wild species, or, as suggested by Flower and others, a chance hybrid between a kyang and an escaped Mongol pony.

The new horse (now commonly known as the Celtic Pony) described in the first paper is characterised by a small head, large prominent eyes, short ears, and narrow nostrils; by a long tail, mane, and forelock, and, during winter, by a thick, light yellow-dun woolly undercoat and a remarkable tail-lock (Pl. II. 7); by having, like Prejvalsky's horse, only 23 dorso-lumbar vertebræ, and also by the complete absence of callosities from the inner aspect of the hocks and from the region of the fetlocks—*i.e.* by the absence of the hind warts or chestnuts, and of the four ergots invariably present in typical specimens of the common horse. In speed and staying power, intelligence and docility, the Celtic pony takes after high-caste, fine-tempered Arabs.

This new horse I provisionally named *Equus caballus celticus*; but as it—apart from its coat—more profoundly differs from the common horse than either asses or zebras, it will probably be eventually regarded as a true species. The results of the experiments with the wild Asiatic ass submitted in the second paper² made it sufficiently evident that Prejvalsky's horse is not a hybrid between a kyang (*E. hemionus*) and a Mongol or other Eastern pony. Further observations have made it equally evident that while some of the horses found running wild amongst the Great Altai Mountains may count strayed domestic horses amongst

¹ *Nature*, vol. lxxvii. p. 239, 1903.

² *Proc. Royal Soc. Edin.*, 1903, pp. 460-8.

their recent ancestors, the majority of them probably have an unbroken chain of true wild ancestors.

The existence in North-Western Europe of the Arab-like Celtic pony and in Central Asia of the long-headed Prejvalsky's horse—forms quite distinct from the *Equus caballus* of Linnæus, Gray, and other systematists—led me to feel less certain of the view provisionally adopted, well-nigh half a century ago, by Darwin, that all the existing races had descended “from a single dun-coloured more or less striped primitive stock.”¹

The discovery, two years ago, in a remote part of the Western Highlands of Scotland of the remnant of a variety or species adapted for a forest life, made it impossible any longer to entertain the view that domestic breeds had all descended from a single post-glacial species.

The conclusions arrived at during 1903 were in due time published in a paper entitled “The Multiple Origin of Horses and Ponies.”² In this paper I enumerated the chief characteristics of Prejvalsky's horse and the Celtic pony, and indicated in what respects these types differed from the forest variety,³ which,

¹ *Animals and Plants under Domestication*, vol. i. p. 65, 1875.

² *Trans. Highland and Agri. Soc. Scot.*, vol. xvi., 1904.

³ In a typical forest horse (Pl. III. 9) the coat is of a dark yellow dun colour decorated by a broad dorsal band, remnants of stripes on the face, neck, shoulders, body, and loins, spots over the hind quarters and bars across the legs to a short distance below the knees and hocks, beyond which the legs are black; the mane, forelock, and tail heavy, consisting of long dark coarse wavy hair—the tail having no tail-lock; the hind as well as the front chestnuts large, prominent, and generally oval in form, and the fetlock callosities long and often curved; the hoofs broad, rounded in front, and wide behind; the head massive but well proportioned, the forehead broad with ridges extending from the prominent orbits towards the occipital crest, the profile convex from below the eyes to the level of the nostrils; the upper lip long and prehensile, and the lower lip thick and often seen projecting beyond the upper; the ears wide, of medium length, and usually carried upright; the neck short and thick; the shoulders straight, ending in broad flat withers; the back hollow and long, owing to the presence of 24 dorso-lumbar vertebrae (18 dorsal and 6 lumbar); the hind quarters rounded so as to form a semicircle between the croup and the feebly-developed second thigh, with the tail inserted near the centre of the half circle; the limbs short and strong with thick fetlock and knee-joints, the forelegs tied in at the elbow and back at the knee, the hind limbs straight and the hocks during action kept well apart. This horse is specially adapted for living in or near forests—for frequenting narrow paths, feeding on coarse grasses, leaves, twigs, and roots, and at need readily crossing swamps and clearing obstacles—by having prominent eyes, large teeth set in powerful

because it presents all the points of the common horse of Europe, I designated the *E. caballus typicus*. I also in this paper mentioned that I regarded the Celtic pony as a member of a variety "which at a very remote period branched off from the main stem and possibly reached Europe and North Africa long before the advent of the Neoliths—to become the progenitors, not only of occidental, but also of African races,"¹ and I added that, apart from its coat, mane, and tail, it is almost identical with the smaller kinds of Arabs. While in this country an effort has been made to prove that the domesticated horses have had a multiple origin, the conclusion has been arrived at in the United States that several species of horses flourished in America at or about the beginning of the Glacial Epoch. In a recent address Professor Osborn states: "It was formerly believed, for example, that the modern horse had a single line of ancestors extending back into the Eocene period; now it appears that in North America there were always four to six entirely different varieties of the horse family living contemporaneously, including slow-moving forest-living horses with broader feet, and very swift plains-living horses with narrow feet fashioned more like the deer."²

So much progress has been made during recent years in working out the origin and history of domesticated horses that the time has now come when enquiries may be profitably pursued along certain definite lines.

In the first place (assuming that horses have had a multiple origin), enquiries should be instituted with a view to ascertaining as far as possible the characteristics of the post-glacial species and varieties which have taken part in forming the present domestic races and breeds; in the next place, enquiries should be instituted with a view to ascertaining to which of the lower Pleistocene species the more immediate ancestors of the living horses are most intimately related; and in the third place, an attempt should be made to determine the characteristics of the extinct species, such as their jaws, and broad hoofs, and by having a conformation eminently suitable for leaping and sufficient speed to enable it in times of danger to rapidly take cover in scrub or forest. The forest horse, though a clever leaper, has no great speed, but given time and sufficient food, it can undertake long journeys. Though often timid and spiritless, he is intelligent and docile, moves well, and is capable of carrying heavy burdens.

¹ *Trans. Highland Soc.*, 1904, p. 259.

² *Science*, N. S., vol. xxi., February 24, 1905.

made to determine from which of the ancestral forms the various domesticated breeds have inherited their more striking characters, *i.e.* to ascertain to which ancestral types the Shire, Clydesdale, Percheron, and other heavy breeds, the Barb, Arab, Thoroughbred, Kattiawar, and other slender-limbed breeds, are indebted for their chief peculiarities.

In this paper I shall not attempt to show that either Prejvalsky's horse, the Celtic pony, or the Libyan variety recently described by Professor Ridgeway¹ is genetically related to pre-glacial species, or entitled to be regarded as an ancestor of one or more domestic breeds.

Sufficient data for a discussion of this kind is not yet available. I propose now, by way of clearing the ground for the investigations mentioned above, to enquire whether the Tarpan (long regarded as the wild progenitor of the common horse of Europe) deserves a place amongst the ancestors of living races and breeds.

Up to a certain period the only horses in Europe were wild horses; but in course of time the horse was domesticated and utilised for various purposes, and, as one area after another was settled, the districts suitable for herds of wild horses became gradually circumscribed, with the result that except in the wild wastes of the Gobi Desert and in the vicinity of the Great Altai Mountains true wild horses no longer exist.

Where, and by whom, horses were first domesticated will probably never be known; but this much is certain that in Europe, and doubtless also in Asia, tame horses from time to time ran wild, either to join wild herds, or to give rise to feral herds, such as were once common in America.

Had all domestic breeds sprung from a single wild ancestor, the individuals which ran wild would have been rapidly reabsorbed without in any way modifying the original wild stock—as tame rabbits are rapidly reabsorbed by the common wild rabbit. If, however, the escaped individuals had sprung from several perfectly distinct species, the result would be that, in addition to pure wild herds, one might have come across herds having a distinct infusion of tame blood, and also herds consisting of the mixed offspring of several domesticated breeds.

¹ *Origin and Influence of the Thoroughbred Horse*, Cambridge, 1905.

The multiple origin of the domesticated breeds being assumed, it follows that, in the case of the Tarpan herds once numerous in the east of Europe, it is necessary to enquire whether they consisted of a wild species, were the offspring of escaped domestic breeds, or were crosses between domestic and wild varieties.

The first account of the Tarpan¹ we owe to Gmelin, who came across a troop near Bobrowsk during his journey through Russia between 1733 and 1743. He describes them as mouse-coloured, with a short crisp mane; the tail always shorter than in domestic horses, sometimes full, sometimes only furnished with short hair;



The Tarpan from Vogt and Specht's *Natural History of Animals*. This, like Hamilton Smith's drawing, has the mane and tail of a young foal. In no adult horse, wild or tame, is the tail as short as in the conventional drawings of the Tarpan found in modern as well as old works on natural history.

the legs dark from the knees and hocks to the hoofs; and the head thick, with the ears sometimes long, sometimes short.

Since this description appeared, some Continental naturalists have regarded the Tarpan as a true wild species; others, like Dr Nehring, considered it the last survivor of the ancient prehistoric horses of Europe modified by an infusion of domestic blood; while not a few agreed with Pallas that the Tarpan herds might very well be the offspring of escaped domestic horses.

¹ By the Tarpan I mean the mouse-dun horse of Russian and other Continental naturalists, not the so-called "true" Tarpan of Hamilton Smith (*Naturalists' Library*, vol. xii., 1841).

English naturalists have as a rule adopted the view of Pallas. Sir William Flower regarded the Tarpan of the Steppe country, north of the Sea of Azov, as the nearest approach to true wild horses, while Lydekker is inclined to believe that the Tarpan of Pallas might very well be the ancestral form of the common horse, *E. caballus*.¹ Beddard, in support of this view, pointed out that in its general build and appearance the Tarpan is highly suggestive of the wild horses sketched by primitive man upon ivory.²

Notwithstanding all that has been written on the subject since Gmelin's time, hippologists agree with Salensky that the relationship of the Tarpan with wild and domestic horses has not yet been cleared up.³

During the nineteenth century very little was done towards determining the systemic position of the Tarpan; in fact, since the Tarpan was first described, the statements of one writer (for reasons which will appear later) have often contradicted those of another. But in 1866 a Tarpan foal was captured in the Zagradoffe Steppe on the property of Prince Katschubei, and reared by a domestic mare. When about eighteen years old this specimen was sent to the Moscow Zoological Garden, and eventually described in a paper published by Schatiloff.

This, like Gmelin's specimen, had a somewhat coarse head, was of a mouse colour, with legs black below the knees and hocks. The mane, however, instead of being short and crisp, as in Gmelin's specimen, was 48 cm. (over 18 inches) in length and hanging to one side of the neck. Unfortunately the description of the tail of the Moscow specimen is somewhat meagre; but as a full mane is invariably accompanied by a forelock and a full tail in the Equidæ, it may be safely assumed that the tail resembled that of the common horse.

As clearly realised some years ago by Gray of the British Museum, certain vestigial structures, known as callosities, warts, or chestnuts, are of considerable taxonomic value. Warts or chestnuts, as already mentioned, are present on both the fore and hind limbs of

¹ *Nature*, vol. lxx. p. 103.

² Beddard's *Mammalia*, p. 241.

³ The chief papers on the Tarpan are mentioned in Salensky, *Monograph on Prejvalsky's Horse*, St Petersburg, 1902.

the common horse, and they also occur on the hind as well as the fore limbs of Prejvalsky's horse; while in the Celtic pony, as in asses and zebras, the hind chestnuts are completely absent. It is especially worthy of note that though the hind chestnuts were not invariably present in Tarpan (they were absent in a Tarpan described by Krymsch), they were present in the Moscow specimen.

It thus appears that the Moscow Tarpan agreed in its colour with the specimens referred to by Gmelin and Pallas, but differed in the mane and tail, in both of which, as in its callosities, it resembled the common horse, *E. caballus*. Two Tarpan skeletons have been preserved—one in the Museum of the University of Moscow, the other in the Museum of the Academy of Sciences, St Petersburg. The chief point of interest about these skeletons is, that as in the kyang and Prejvalsky's horse and in certain Arabs there are only 5 lumbar vertebræ.

In having only 5 lumbar vertebræ these Tarpan differed from the common horse of Europe, at least from the forest variety *E. caballus typicus*, in which I have invariably found 18 pairs of ribs and 6 lumbar vertebræ.

From this striking difference in the skeleton it follows that, even should the Tarpan turn out to be a true wild species, it cannot be regarded as the sole ancestor of the common horse of Europe.

As to the skull of the Moscow skeleton, Czerski came to the conclusion that it has, on the one hand, all the characteristics of Oriental horses, while on the other it approaches the Scottish breed to which belongs the pony; in other words, the skull of the Tarpan preserved in the Moscow Museum resembles that of the Celtic pony, and its near relative, the Libyan horse.

The skull of the Tarpan in the St Petersburg Museum, as Salensky points out, resembles skulls of immature specimens of *E. prejvalskii*, but the bones of the limbs and limb girdles are decidedly more slender, and have less pronounced muscular ridges than in the wild horse of Central Asia.

It may here be mentioned that for over a century all the horses living in a wild state in Europe, which happened to be of a mouse-dun colour, seem to have been regarded as Tarpan. If these wild horses were the offspring of several varieties, it will

not be difficult to account for the remarkable difference in the characters between the Tarpan of Gmelin and Pallas and the Tarpan of the Moscow Zoological Garden. It is hardly necessary to point out that were we to find in one and the same herd adult horses with an erect or semi-erect mane and a short bushy tail, and others with a long flowing mane and a full tail, long enough to reach the ground, we should hesitate, even if they happened to be of the same colour, to regard them as intimately related; and if in addition some of them retained, while others had completely lost, the hind chestnuts, we should unhesitatingly look upon them as belonging to two different varieties, if not different species. Such differences, coupled with a want of agreement in the number of the lumbar vertebræ or in the ribs, would make in favour of adopting the view that the herd in question consisted of the feral descendants of domesticated horses, or had resulted from the intercrossing of a true wild horse with members of one or more domesticated varieties.

Seeing that herds of mouse-dun wild horses no longer occur in Europe, and have not during recent years been met with in even the most remote parts of Central Asia, it might perhaps be assumed that the Tarpan's place in Nature must for ever remain a mystery.

This was the conclusion I arrived at when my attention was first directed to the subject. But having ascertained that, by crossing carefully selected forms, remote types are sometimes restored in all their original purity, I thought it worth while to make some experiments. In the case of pigeons, by mixing the blood of two well-marked breeds (such as the owl and archangel breeds of fanciers) and crossing the mongrels with a white fantail, I at once obtained birds which closely resembled *Columba livia*, the recognised wild ancestor of all the tame pigeons.

Bearing this and like experiments with zebras, dogs, rabbits, etc. in mind, I selected for my Tarpan experiments a mouse-dun Shetland pony mare, which seemed to me to be a blend of at least three varieties—in its head (Pl. I. 1) it suggests the wild horse;¹ in

¹ The wild horse (*E. przewalskii*), like Grevy's zebra (*E. grevyi*), has a very long head, the distance between the eye (inner canthus) and the nostril being decidedly longer than in a forest horse eight inches higher at the withers, and

its mane, tail, and trunk it takes after the forest variety (Pl. III. 9); while in the limbs and hoofs it approaches the Celtic pony. This mare was crossed with a black Welsh pony, which belongs to an ancient British race and doubtless has in its veins not a little Celtic blood.

The first foal, black like the sire but Celtic in make, failed to throw any fresh light on the question at issue; it however supported the view that, notwithstanding the large, heavy head, there was Celtic blood in the Shetland mare. Though in the first foal the Celtic blood prevailed, the second foal by the same sire has developed into an animal, now three years old, which, though bred in Scotland, will, I believe, be regarded by Continental naturalists as typical a Tarpan as ever roamed the Russian steppes (Pl. I. 2, 3; Pl. II. 5).

This Scottish Tarpan, a mouse-dun with black points, has a distinct dorsal band (10 to 15 mm. in width) and faint bars above the knees and hocks, a somewhat heavy head, but a short body and well-formed limbs. The mane, of a light colour along each side but dark in the centre, is semi-erect, some of the hair arching to the right, some to the left, and some forwards between the ears to form an imperfect forelock. The mane, which

relatively still longer than in the Celtic pony, while owing to the forehead being decidedly convex, from side to side as well as from above downwards, the eyes look outwards rather than forwards. Like the Celtic pony, Prejvalsky's horse is of a yellow-dun colour, with dark points and only vestiges of stripes—the dorsal band being narrow and the leg bars faint, especially during winter. Unlike the Celtic pony and the forest horse, the mane is upright during at least autumn and winter; in spring it may be only semi-erect; in young individuals out of condition it may, however, arch to one side of the neck. The distal end of the dock carries relatively few long hairs, the basal portion short hairs, while the middle section consists of hairs long enough to form a fringe around the hairs growing from the end of the dock (Pl. II. 4). As in the forest horse there are four chestnuts and four ergots, but the hoofs are relatively longer and decidedly more contracted at the "heels." The ears are long and usually project obliquely outwards. In the skeleton it is especially noteworthy that there are only five lumbar vertebrae, and that owing to the sacrum being nearly horizontal the croup droops but little and the tail is set on unusually high, as in many Arabs. The description of the Asiatic "true" Tarpan given by Hamilton Smith fits fairly well with Prejvalsky's horse. This agreement between the wild horse now living in the Gobi and the Tarpan of the Tahtars has been specially dwelt on by Professor Ridgeway. It is, however, well to bear in mind that Hamilton Smith's drawing of the Tarpan is about as unlike Prejvalsky's horse as any drawing well could be.

resembles that of zebra-horse hybrids, conforms to the description of the mane given by Pallas, but differs from the short crisp mane of Gmelin's specimen, and still more from that of the Moscow Tarpan, which, it will be remembered, reached a length of 45 cm., and hung to one side of the neck. In the dun Shetland dam, the mane lies close to the right side of the neck, but never exceeds a length of 35 cm. In the Scottish Tarpan the mane, from 15 to 27.5 cm. in length, is either nearly upright, or, as already mentioned,

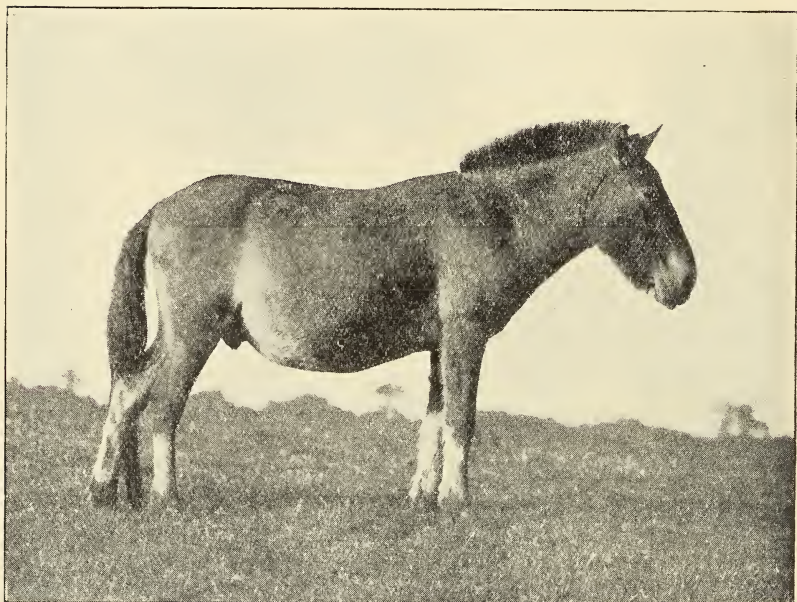

[G. A. Ewart.

A three-year-old wild horse (*E. przewalskii*) from the Great Altai Mountains, photographed September 1904; note erect mane and that the tail reaches the ground.

arches outwards well clear of the neck (Pl. II. 2, 3), whereas in a Fetlar (Shetland-Arab) pony of the same age, the mane reaches a length of 45 cm. and clings to the side of the neck.¹ The tail

¹ Whether the mane is long or short depends on two things: first, on the rate of growth of the hair; and second, on how long the individual hairs persist. In the Celtic pony the mane hairs grow at the rate of nearly one inch per month; in the forest variety they may persist until they reach a length of several feet; even in Prejvalsky's horse they may continue to grow until they are long enough to arch to one side of the neck, but eventually in the wild horse, as in zebras, these long hairs give place to short ones.

of the new Tarpan (Pl. II. 5) is even more remarkable than the mane. The dock, which is 27·5 cm. in length, is furnished with three kinds of hair. The basal portion for 6·5 cm. carries fine hair nearly circular in section, which, except in the part continuous with the dorsal band, is almost colourless; the middle portion of the dock—about 13·75 cm.—carries thicker hair, slightly oval in section, with a thick cortex containing in some cases a considerable amount of pigment; from the terminal part of the dock—about 7·5 cm.—spring coarse black hairs which are now long enough to reach the ground. These long hairs are oval in section, have a very thick cortex, and only a small central axis or medulla.

The fine, short, light-coloured hairs (7·5-15 cm. in length) at the base of the tail form a conspicuous somewhat lozenge-shaped bunch (Pl. II. 5); the thicker hairs growing from the middle section of the dock reach a length of 30 cm. They emerge from under the light-coloured root hairs and expand to form a sort of fringe, from which escape the relatively few long black hairs of the distal part of the dock.

In having a limited number of long hairs growing from the distal end of the dock, this cross-bred pony decidedly differs from the Celtic as well as from the forest types of horses. The interest of the tail in the Scottish Tarpan is not so much that it suggests a mule, as that it has a very striking resemblance to the tail of Prejvalsky's horse (Pl. II. 4). The only difference is that in the true wild horse the upper or light-coloured section of the tail is longer than in the Shetland-Welsh cross, which has, in fact, the kind of tail one would expect in a Prejvalsky hybrid in which the wild blood was dominant.

I may here mention that I have had under observation for some time two imported Mongol ponies, and a half-bred Mongol colt. In both ponies and colt the tail is peculiar—is about intermediate between that of the restored Tarpan and a forest horse (Pl. III. 9). Further, in the colt, the mane, though of the usual length, keeps clear of the neck.¹

I may also mention that in a dark brown pony from the Outer

¹ This condition of the mane is not unknown in cross-bred horses, and it was specially noticeable in two dun ponies, probably of Spanish descent, which I saw last winter in Mexico.

Hebrides with a massive head, and long mane like the Moscow Tarpan, the tail consists of three distinct sections; and that in a mare (Pl. III. 10) obtained by crossing an Arab with a yellow-dun Norwegian (fjord) stallion, and in a colt out of a half Arab mare by a similar stallion, the tail forcibly reminds one of the Tarpan obtained by crossing a Shetland mare with a Welsh stallion.¹

A study of the mane and tail of the Shetland-Welsh cross, and of certain other crosses and breeds, strongly suggests that we must include amongst the ancestors of our domestic horses a species having a mane and tail such as we find in the wild horse still living in Central Asia. In the body hair and the foot-locks the Scottish Tarpan closely resembles the wild horse. Further, it resembles the wild horse in having a very short flank feather, but differs in having the face whorl (Pl. I. 3) situated above the level of the eyes, as in the Celtic pony: in Prejvalsky's horse as in the kyang this whorl lies well below the level of the orbits.

In the Shetland mare the dorsal band is nearly as narrow as in the Celtic pony (Pl. II. 6); the right hind chestnut measures 1.5 cm. by .4 cm., while the left is only .5 cm. in diameter; the front ergots are absent, and the hind ergots are very small. In all these points the Shetland mare approaches the Celtic type. In the Scottish Tarpan the front ergots are small, the hind normal; the front chestnuts are oval as in the wild horse, but decidedly smaller, while the hind chestnuts are only one-fifth the length of those in the wild horse. Finally, in the head, ears, form of the limbs and hoofs, the Tarpan-like Shetland-Welsh cross is as nearly as possible intermediate between a wild horse and a Celtic pony. Of the skeleton it is, of course, impossible to speak, but judging by the shortness of the trunk, the form of the head, and the conformation of the limbs, the probability is that there are only five lumbar vertebræ, as in the Moscow and St Petersburg skeletons, and that the skull and limb bones resemble those of a young Prejvalsky horse. After very full consideration, Salensky came to the conclusion that the Tarpan is a type

¹ Seeing that the mane and tail in various breeds, in the Old World and also in the New, often suggest the Tarpan, it may be inferred that the ancestors of the Tarpan were intimately related to the ancestors of some of the domesticated breeds.

specialised more to the side of *E. caballus* than to *E. prejavskii*. Doubtless Salensky, in coming to this conclusion, was influenced not a little by the long mane and the full tail of the Moscow Tarpan.

GENERAL CONCLUSIONS.

When all the available facts are taken into consideration there seems no escape from the conclusion that the Tarpan, once common in the east of Europe, cannot be considered as a true wild species.

Further, it may be assumed that the Tarpan herds were derived from at least three primitive stocks, viz.: (1) From a variety or species identical with or closely related to the wild horse (*E. prejavskii*) still surviving in Central Asia; (2) from a variety having the characteristics of the Celtic pony—*E. c. celticus*; and (3) from a variety resembling the forest horse—*E. c. typicus*. It is only by assuming the multiplex origin of Tarpan that it is possible to account for some of them having a heavy head, long ears, a nearly upright mane, a mule-like tail, and five lumbar vertebræ, thus suggesting *E. prejavskii*; for others, wanting the hind chestnuts and possessing a skull like that of certain Scottish ponies, thus suggesting *E. c. celticus*; and for others having a thick head, full mane and tail, and hind as well as front chestnuts, thus suggesting *E. c. typicus*.

By experiments now in hand I hope to settle what part Prejavsky's horse has taken in forming the Tarpan. If I succeed in showing that crosses between Prejavsky's horse, and either the forest, Celtic, or Libyan variety are practically identical with the cross between the Shetland mare and the Welsh pony stallion, I shall prove that at least certain of the domesticated breeds are indebted to Prejavsky's horse for some of their characteristics, and at the same time bring additional evidence in support of my view that domesticated races have had a multiple origin, and include plain as well as striped forms amongst their less remote ancestors—have not, in fact, as Darwin thought, descended from a single dun-coloured more or less striped primitive stock.

[Towards the cost of this investigation contributions were received from the Carnegie Trustees, and from the Earl of Moray Research Fund of the University of Edinburgh.

DESCRIPTION OF FIGURES.

PLATE I.

Fig. 1.—Head and shoulders of the mouse-dun Shetland dam of the Scottish Tarpan. In the form of the head, position of the eyes, and distance between the eyes and the nostrils this mare resembles Prejvalsky's horse. A yearling filly, out of this mare by a Hebridean pony, instead of resembling a Tarpan, strongly suggests a Celtic pony.

Figs. 2 and 3.—The mouse-dun Tarpan-like cross between the Shetland mare (fig. 1) and a black Welsh pony. This pony, though a cross, looks as if it belonged to an old-established race. It has a striking, well-formed, massive head, well-placed ears, full eyes, good quarters, and excellent limbs. The mane is, however, short and semi-erect, while the tail consists of three kinds of hair which differ in structure, thickness, colour, and arrangement. From photographs taken September 1905.

PLATE II.

Fig. 4.—Hind quarters and tail of a three-year-old wild mare (*E. prejvalskii*) from a photograph taken in September 1905. The hind quarters and limbs are better formed than in the male wild horse (page 9) and the dorsal band is more distinct. In the upper part of the tail the hair, light in colour and relatively fine, grows obliquely outwards from the caudal portion of the dorsal band; the hair of the middle part of the tail, darker and stronger than that of the root, lies nearly parallel with the dock and reaches to the level of the hocks; the hair of the tip, black, coarse and scanty, but long enough to reach the ground, emerges from within the hair forming the middle part of the tail. Like the hair of the mane, the light hair at the root of the tail is shed annually.

Fig. 5.—Tail and hind quarters of the Scottish Tarpan from a photograph taken at the same time as fig. 4. As in the wild mare the hair of the tail consists of three portions. The basal portion only essentially differs from the corresponding portion in fig. 4, by being of less extent and lighter in colour, the middle portion is also lighter in colour and more plentiful than in the wild mare, while the hair growing from the end of the dock in the Tarpan very closely agrees in colour and amount with the terminal portion of the tail in Prejvalsky's horse.

Fig. 6.—Tail of a typical yellow dun Celtic pony, from a photograph taken in August.

Fig. 7.—Tail of the same pony, from a photograph taken in January.

In fig. 7 the tail-lock is seen at its maximum growth; in fig. 6 a new crop of hair is growing to take the place of the long winter hairs which were gradually shed during the summer.



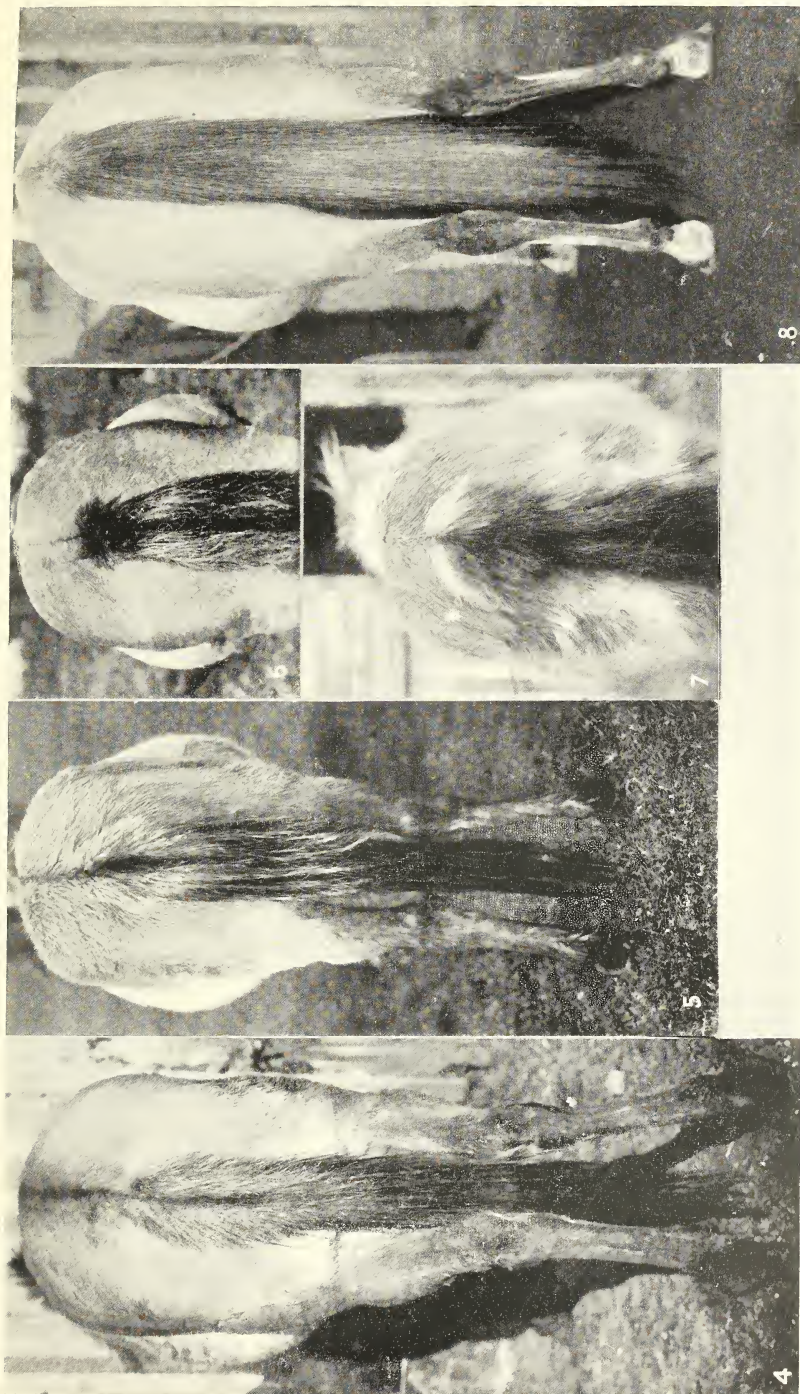

[G. A. Ewart.

4. E. prejavalskii. 5. The Scottish Tarpan. 6-7. Celtic Pony, Summer and Winter. 8. Arab Mare.

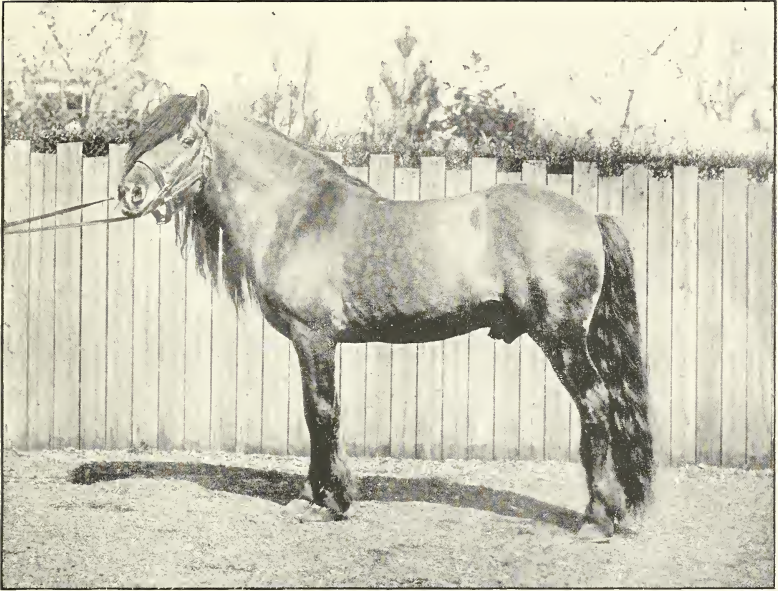

FIG. 9.



FIG. 10.

[*G. A. Ewart.*]

Fig. 8.—The tail of a grey Arab taken at the same time as figs. 4 and 5. There is no marked difference between the middle and terminal parts of the tail as in the Tarpan, but a few hairs at the root of the tail are short and shed annually; in the most proximal part of the tail this Arab agrees with a half-bred Celtic pony in my stud.

PLATE III.

Fig. 9.—Photograph of a typical dark yellow dun forest horse from Western Ross-shire. The mane, forelock and tail, long and heavy, consists of strong wavy hair. The tail, which shows no vestige of a tail-lock, instead of looking a continuation of the vertebral column, looks as if it had been inserted between the rounded hips. This horse bears a close resemblance to the Gudbrandsdal breed of Norway, and it seems to have entered largely into the formation of the Norwegian Fjord horse. Figures of these Norwegian breeds will be found in Dr Marshall's paper, p. 32 of this volume.

Fig. 10.—Photograph of a cross between a grey Arab (fig. 8) and a light yellow dun Fjord stallion from Trondhjem. This cross has the long body of a forest horse, a small head, uniting the points of the Celtic and Libyan varieties, and a tail which in some respects resembles the Tarpan (fig. 5). In a cross out of a well-bred Connemara mare by a similar Fjord stallion there is a typical Celtic taillock, and the hind chestnuts are absent. A study of crosses obtained by Fjord stallions has led me to conclude that the more typical Fjord horses are a blend of the Celtic and forest varieties.

(*Issued separately February 12, 1906.*)

The Horse in Norway. By Francis H. A. Marshall, M.A. (Cantab.), D.Sc. (Edin.), Carnegie Fellow and Lecturer on the Physiology of Reproduction in the University of Edinburgh. (With Two Plates.)

(Read November 6, 1905.)

Writers on the origin of the horse and its different breeds have been accustomed to refer to the horses of Norway as though they belonged to a single type. Thus Sanson, in his *Zootechnie*, includes the horses and ponies of that country in his sub-species *Equus caballus hibernicus*, to which he also refers the various ponies of the British Isles, the Breton in France, and the horses of Iceland and Sweden. The late Captain Maurice Hayes, in his well-known work on the *Points of the Horse*, refers collectively to Norwegian and Swedish horses as though they belonged to one natural group. Professor Ewart, in describing a typical representative of what he calls the Forest type, which, as he shows, differs essentially from the newly discovered "Celtic pony," alludes provisionally to the former as the "Norse horse," because it is common in Norway. Moreover, Professor Ridgeway, in his recently published book on the *Origin and Influence of the Thoroughbred Horse*, appears to regard the Norse horse as representing a single type which has undergone greater or less alteration through the introduction of Libyan or other foreign blood.

As a result of a recent visit to Norway, during which I did not neglect opportunities for studying the native breeds of horses and ponies and their history, it has become evident to me—what indeed is well recognised by all horse-breeders in that country—that the Norwegian horses at the present day belong to two quite distinct types, which, however, have intermixed to a considerable extent. These two types are represented by the "pure" fjord horse * and the Gudbrandsdal horse.

* It is doubtful whether any of the existing fjord horses are really pure, *i.e.* unaltered by admixture of Gudbrandsdal or foreign blood.

It will be remembered that Professor Ewart, in his original paper on the "Celtic Pony," read before this Society in 1902, described this animal as a small-headed horse with short ears, prominent eyes, slender legs, small joints, and a fringe of short hairs on the upper part of the tail, and without hock callosities (chestnuts on the hind limbs) or ergots (fetlock callosities). The most typical colour was light dun. The Celtic pony, as thus described, was stated to occur at the present day in certain of the Western Isles of Scotland, in the north of Ireland, and in the Faroes and Iceland. It was regarded as the living representative of a primitive small horse, whose range extended over North-West Europe, and whose fossil remains are found in the Brighton Elephant Bed.

Living contemporaneously with this ancient Celtic pony, but having perhaps a far more extensive distribution, there was a robust, large-jointed "forest" horse, from which, according to the same authority, the cart-horses and other heavily built horses are largely derived.

It will be well to state at the outset that I regard the Fjordhest as having been partly descended from the same stock as Professor Ewart's "Celtic pony,"* and the Gudbrandsdal horse as representing the "forest" or "cart-horse" type.

The "pure" fjord horse is found in all the fjord districts of Western Norway. The largest specimens are said to occur in the Romsdal and in the neighbourhood of Laerdalsören. These may reach about thirteen hands high. The Fjordhest of Northern Norway is considerably smaller and more roughly coated.

So far as I have observed, "Celtic" characters predominate in all the existing fjord horses. The forehead is flat, and the ears are relatively short, while the limbs are much slenderer, and the joints much smaller than in the Gudbrandsdal horse. The hoofs are generally wide at the heels, and almost circular in outline.

Among the suggestions and regulations drawn up for the guidance of judges at the horse show at Lillehammer in 1857,

* Stejneger appears to regard the Fjordhest, the Celtic pony, and also the Tarpan as representing one sub-species, but the evidence he adduces in support of this view is not very substantial.

it was recommended that in the fjord horse "the head should be comparatively small, with well-shaped and well-placed ears, the eyes should be large and the nostrils wide, and the neck must have a suitable arch, and be broad, but it should be fine at its junction with the head." "The colour should be preferably light dun (borkede) or light brown (blak), with black mane and tail, the legs black below the knees and hocks, and the ear-tips black, with cross stripes on the knees and hocks, and with an eel-mark down the centre of the back."* This colour is probably the commonest amongst fjord horses at the present day. Other colours—browns and greys—and a darker shade of dun, are not infrequent, and I have also seen mouse-coloured ponies. Black fjord horses are said to be extremely rare, and it is doubtful whether any pure ones exist. Nearly all the light-coloured ponies have a black dorsal stripe, and a large proportion of pure and partly bred fjord ponies (probably considerably over 50 per cent. of those which I saw) have cross stripes on the legs. Shoulder stripes are also occasionally present, at any rate in certain of the partly bred fjord horses. Professor Ridgeway, however, says that Dr Venn, F.R.S., and Mr J. A. Venn, who, on a visit to Norway in 1904, examined for him a large number of ponies at various coast towns, did not meet with a single instance of striping.

In typical specimens of the Fjordhest, there is, in winter time, a well-marked caudal fringe or tail-lock. This is not shown in the pony in the photograph (fig. 1), which was taken in the month of August, since the fringe is shed in the summer time, leaving only a bunch of very short hairs in the upper part of the tail. I was informed, however, that in this particular individual a tail-lock consisting of hairs about six inches in length was present in the preceding winter. This pony, like several other fjord horses which I have seen, had no trace of ergots, but a small callosity was present on each hind leg. In numerous other fjord horses which I examined, the hock callosities were extremely small, being frequently scarcely larger than a pin's head, but I only succeeded in finding a single case in which these vestiges had disappeared altogether. This was in a pony at Tonsaasen.

In other characters, and more particularly in the length of

* Gudbrandsdal Stud-book (see under Petersen).

the body, in the roundness of the quarters, and in being much "tied-in" at the elbow, the Fjordhest of to-day is frequently similar to the Gudbrandsdal and other horses which belong to the "forest" type.

The Fjordhest has been much intercrossed with the Gudbrandsdal horse, and the great majority of the ponies seen in Christiania and the Norwegian towns, and those usually employed to draw the carriages and stolkerje, are partly bred animals, the fjord characters generally strongly predominating. I have found no positive evidence, however, of fjord horses having been crossed with any other breed than the Gudbrandsdal; but since, as I shall show later, the latter breed has from time to time received infusions of foreign blood, it is probable that the fjord horse has been at least indirectly influenced, but probably to no great extent. The ponies used in the sledge races, which take place in winter at Bergen and Vossevangen, are stated to be pure-bred (according to modern ideas), and only such are eligible.

In 1844 an attempt was made by the Norwegian government to establish a stud of fjord horses at Hjerkin, on the Dovre fjeld, with the object of improving the breed by judicious selection but without having recourse to intercrossing with foreign blood. Horses were advertised for, and it was announced in the advertisement that dun-coloured (borkede) animals would be given the preference. Next brown (brun) horses would be considered; and lastly, yellow (gul) horses with white mane and tail would be accepted. Great difficulty was experienced in obtaining animals considered sufficiently good for the purpose, and in the end the scheme proved a complete failure. The stud was broken up, as was also a branch establishment at Foktuen (Dovre), at the end of 1858. The report on the experiment states:—"It is the usual experience that the Fjordhest does not thrive on coming to the mountains; it is without exception attacked by strangles, and for the first couple of years is unfit for hard work. Subsequently it becomes enduring and strong in proportion to its size, but the general opinion in these parts is that it is in every respect far inferior to the Gudbrandsdal horse."*

The third figure represents an "Udganger" pony or Nordlands-

* Gudbrandsdal Stud-book (Petersen).

hest. This type, which is now said to be extinct, is stated to have been in most points similar to the Fjordhest, from which, according to the reference to it in the preface to the Gudbrandsdal stud-book, it differed chiefly in being smaller and more roughly coated, being subjected to severer conditions of life. Probably the "Udganger" pony was almost purely "Celtic" in its characters.*

The Gudbrandsdal horse, as will be seen from the figure, is very different from the fjord horse. The head is large and heavy, the legs are stout and the joints large, the distance between the nostril and the orbit is relatively appreciably larger than in the Fjordhest, and the lower lip frequently projects beyond the upper, as is sometimes seen in English cart-horses. The quarters are very much rounded. Hock callosities are invariably present so far as I have seen, and are generally well developed. Ergots are also present. There is no suggestion of anything of the nature of a tail-lock or fringe of short hairs on the upper part of the tail. The forehead is not generally flat, as in the Fjordhest, but has two ridges which meet below the forelock, and are sometimes very well marked. The Gudbrandsdal horse is also much bigger than the Fjordhest, and may be as much as sixteen hands high.

The following is a translation of Lindeqvist's description, written in the middle of the last century:—"The Gudbrandsdal horse, by careful breeding and under peculiar local conditions, has developed into the noblest and most valuable representative of the Norwegian horses. It supplies excellent agricultural and artillery horses, and substantial, or even (as things go in Norway) handsome carriage horses." In another place he wrote:—"The Gudbrandsdal horse has such a peculiar stamp that it is usually recognisable anywhere, and amongst a number of horses of different types. The most prominent specimens are about ten

* Professor Ridgeway, who also publishes this figure, says that it represents the last individual of a small extinct breed from the Lofoden Islands (now stuffed in the Bergen Museum). As a matter of fact the "Loftohest" in the Bergen Museum is a dark-coloured individual. Professor Ridgeway regards the animal here figured as a small horse of the heavy type and not a "pony," but I am unable to share this opinion. From inquiries at Messrs Knudsen's of Bergen, who photographed the animal in question, I learn that this was done in the month of April, so that the pony would hardly be in its summer coat, as stated by Mr Ridgeway.

quarters (157 centimetres) high,* are usually of brown or dark-brown colour, and are distinguished by their full, round forms; pointed, shapely, and upright ears; expressive physiognomy; compact bone substance and firm muscles; broad and strong knee and hock joints; sinewy legs, and thick, hard and tough hoofs." The chief defect is the "peculiarly short and unbending neck." "This cannot be considered objectionable in the case of working horses, but for the better class of carriage horses, and especially for riding horses (for all of which purposes the Gudbrandsdal is used), this short and thick neck is an undoubted defect." Lindeqvist regarded the Norfolk horse as representing the ideal which the Gudbrandsdal should emulate, but to which, however, it has never attained.

Koller's description, published in 1886, is very similar.

The Gudbrandsdal horse belongs especially to the Hedemarken and Christiania amts, its breeding ground being the great valley from which it takes its name. Those from the lower parts are sometimes known as Döleheste, and those from the upper as Nordheste. The latter are described in the Gudbrandsdal stud-book, the first volume of which was published in 1902, as being the finer and the most sure-footed. Gudbrandsdal horses are bred also to a greater or less extent throughout all the south-eastern provinces, as well as in the Trondhjem's amt and some other places on the west coast. The attempt to divide Gudbrandsdal horses into two varieties has in recent years been practically ignored, for the large, heavy, heavy-legged Dölehest has gained the victory everywhere over the lighter breed, so that the former at the present day may be regarded as the typical representative of the Gudbrandsdal race.

In former times Gudbrandsdalen was practically one huge stud. In 1729, according to Hiorthøy, there were 157 stallions and 1563 mares. The stallions used to fight for the possession of the mares, whom they also defended from wolves or other enemies. It appears, therefore, that formerly the horses were subjected to rigorous natural and sexual selection. Pontoppidan says: "The Norwegian stallion shows much courage in fighting wolves and

* The height is measured in Norway by tape measure, from over the withers to the hoof.

bears, especially the latter, which he attacks, using his forelegs like a pair of drumsticks, and commonly being the master, which some people at Court doubted, until Statholder Wibe, in King Frederick IV.'s presence, made a trial with one of his carriage horses, which at Fredericksborg at once attacked a bear which was let loose, and left no life in it." The mares, on the other hand, are said to have been frequently killed by wolves and bears.

As already mentioned, the horses of the Gudbrandsdal have from time to time received infusions of foreign blood. About A.D. 1040, nine Icelandic stallions were presented by King Einar.* In the race between Magnus Blinde, on horseback, and Harold Gille, on foot, in 1128, it is recorded that Magnus rode a very fast horse from Gothland. Also the Duke Skule, who fled from the battle of Oslo, when his horse was shot under him, was procured another from Gothland. These are isolated cases of importation. It is not, however, until a much later period that there is evidence of importation on any considerable scale.

We may probably assume that the Danish and German troops, who were stationed in various country districts in the seventeenth century, brought with them Danish or other foreign horses, and some of these may have bred with the native horses. Indeed there is a record that, about 1650, in the district east of the Christiania fjord, the horses were mixed both as to size and colour, on account of crossing with Danish stallions brought by the mounted troops. It is also stated by a contemporary writer that horses were imported by a priest, at great expense, into North Gudbrandsdalen from Denmark, in the latter half of the seventeenth century. There are also a few records in the Gudbrandsdal stud-book of instances of importation in the eighteenth century, and more numerous ones in the last century. Thus it is stated that Spanish stallions were brought to South-East Norway, while an English thoroughbred named "Odin" was brought from London, costing £257, and is said during the first four years to have served over a hundred mares. Since then various others have been imported, but it is unlikely that any of these exercised much influence over the Gudbrandsdal breed as a whole.

* This, and certain of the information which follows, were derived from the Gudbrandsdal Stud-book.

In 1845 a government committee reported that it was almost impossible to find any horses which were beyond doubt of unmixed Norwegian descent. In curious contrast to this conclusion is the rule drawn up in 1872 for government horse shows outside the fjord districts, that only horses of pure Norwegian ancestry would be eligible.

The Gudbrandsdal horse at the present day is usually either black or brown. I was present this year at the great annual horse sale which takes place for a week in August, at Lillehammer, where I had an excellent opportunity of seeing a large number of what are regarded as pure-bred Gudbrandsdal horses, and these were almost invariably either black or brown. Statsconsulent Borchgrevink told me that a pure Gudbrandsdal could not be dun or light coloured, the dark colour being now regarded as one of the essential characteristics of the breed. It is interesting to note, however, that there is every indication that the dark colour has resulted from the introduction of foreign blood, for there are numerous proofs that, in the early part of the eighteenth century, dark-coloured horses were the exception. Thus the Dragoon horses in the Gudbrandsdal in 1711, appear to have nearly all been light in colour. It is also recorded that of those in Hedemarken not more than 10 or 11 per cent. were brown or black. Pontoppidan says that the Gudbrandsdal horses were either yellow with black points, and a black "eel" down the back, or else were brown-grey or mouse-coloured. "Black ones are very seldom seen—scarcely one in fifty." Schytte, writing a little later, says that the best horses in Norway are the Gudbrandsdal, "especially the yellow ones with black legs and an 'eel' down the back."

It is to be noted that when the Gudbrandsdal and fjord horses are intercrossed, the offspring, although shaped much like the pure Gudbrandsdal horses, are very frequently light dun with stripes, but of course it is quite arguable that this character is derived solely from the fjord parent.

Professor Ridgeway has pointed out that in *Beowulf*, which dates from the eighth century, the horses mentioned are dun or light-coloured, while at a later date, from the names given in the appendix to Sijmon's *Edda*, we get indications of the existence

of dark-coloured horses, which, like those mentioned in the Icelandic sagas, Professor Ridgeway regards as affording evidence of the importation of Libyan blood. He considers also that the existence of striped dun ponies points similarly to the conclusion that such an importation had occurred. The first of these conclusions appears to me to be an extremely probable one, but, as we have seen, black horses were very rare until far down into the eighteenth century, so that it is unlikely that the infusion of dark Libyan blood had been at all considerable, and I cannot agree with Mr Ridgeway in the view that the striped dun ponies show any evidence of having had a Libyan origin.

There can be little doubt that the two types of horses which occur in Iceland at the present day are derived respectively from the ancestors of the original fjord horse and from those of the unaltered Gudbrandsdal horse. One of the commonest and most typical colours among existing Icelandic horses is light dun with a dorsal stripe. I have searched the "Landnámabók" or record of the Viking settlements in Iceland,* and although there are numerous references to the importation of horses and other domestic animals, I can only find one to a horse's colour. This is a reference to a stallion which was "apal-grár," which is, I suppose, a shade of dun. But, as the saga of "Burnt Njal" shows, horses of other colours than dun existed in Iceland in the tenth century, and practically all colours are represented there at the present time, though light dun is probably still the most frequent.

Professor Ridgeway, in his recent work, has shown that there is Libyan blood in the ponies of the Hebrides and the north of Ireland, while in a paper published two years ago on the "Horse in Iceland and the Faroes," Mr Nelson Annandale and I have pointed out that a large proportion of the Norse colonists in those islands had been living in the Hebrides or Ireland before they removed to the islands further north, and that it is thus extremely probable that the horses of the Faroes and Iceland are derived partly from the British Isles. So that it is not unlikely that the Icelandic and Faroe ponies have received infusions of Libyan blood through the importation of animals from the Hebrides and Ireland. In

* See Vigfusson and York Powell, *Origines Islandicæ*.

this way the red colour of many of the Faroe ponies may probably be accounted for. But since the "Celtic" ponies of the British Isles are not altogether dissimilar to the fjord horses, it is probable that they themselves have had a Scandinavian origin,* and been subsequently crossed with other horses of Libyan extraction.

In view of these considerations, it seems to me by no means impossible that the primitive small-headed pony of North-West Europe (the horse of the Brighton Elephant Bed) was more closely represented in recent times by the dun-coloured Fjordhest (now probably extinct in its pure form except in Iceland) than by the red or dark-coloured Hebridean and Faroe ponies; and I am disposed to agree with Professor Ridgeway that certain of the characteristics of the existing "Celtic" ponies (whether in the Hebrides, or in the Faroes, or in Iceland), including possibly the absence of hock callosities and ergots (which has been shown to be a Libyan character), may be due in part to an infusion of Libyan blood.†

In conclusion, I wish to thank Professor J. C. Ewart for valuable suggestions and information, as well as to express my indebtedness to Lord Melville, H.B.M. Consul-General at Christiania, Mr Borchgrevink of the Norwegian Agricultural Department, Mr T. Townshend Somerville of Christiania, Mr Gran, jun., of Bergen, Dr Appelov of the Bergen Museum, Mr Johann Fleischer of Vossevangen, and others who rendered me assistance in my investigations in Norway.

* This is also rendered very probable by the fact, mentioned above, that a number of the Norse colonists settled for some time in the British Isles.

† Mr Lydekker, in a recent review of Professor Ridgeway's "Thoroughbred Horse" (*Nature*, December 7th, 1905) expresses a doubt as to whether the "Celtic" and "forest" varieties, as well as *E. przewalskii*, should not be regarded as representing a single northern dun-coloured type, which is to be contrasted with a southern and eastern bay type, including the Barbs and Arabs. I am unable to share in the opinion that the first three varieties form one natural group. Representatives of the "forest" or cart-horse type are not "typically small animals with . . . tails often imperfectly haired at the base," neither is the "Celtic" pony ordinarily large-headed and intractable in temper. (For Mr Lydekker's views concerning the origin of the Barb and Thoroughbred, see *Knowledge*, August 1904.)

REFERENCES TO LITERATURE.

- DASENT, *The Story of Burnt Njal*, Edinburgh, 1861.
- EWART, "The Multiple Origin of Horses and Ponies," *Trans. Highland and Agricultural Soc.*, 1904.
- HAYES, *Points of the Horse*, 3rd edition, London, 1904.
- HIORTHØY, *Physisk og Ekonomisk Beskrivelse over Guldbrandsdalens Provstie i Aggerhuus Stift i Norge, med Kobberne*, Kjøbenhavn, 1785.
- KOLLER, *Handbok för Hästvänner*, Kristiania, 1886.
- LINDEQVIST, *Vor Tids bedste Husdyr-Racer*, Kristiania, 1860.
- *Indberetninger til Departementet for det Indic om haus Virksomhed for Husdyravtens Fremme i Aaret 1858*, Kristiania, 1859.
- MARSHALL AND ANNANDALE, "The Horse in Iceland and the Faroes," *Proc. Camb. Phil. Soc.*, 1903.
- PETERSEN, Introduction to *Stambog over Heste og Gudbrandsdalsk Rase*, vol. i., Kristiania, 1902.
- PONTOPPIDAN, *Det første Forsøg paa Norges naturlige Historie, oplyst med Kaaberstykker*, Kjøbenhavn, 1753.
- RIDGEWAY, *The Origin and Influence of the Thoroughbred Horse*, Cambridge, 1905.
- SANSON, *Traité de Zootechnie*, 4th edition, vol. iii., Paris, 1904.
- SCHYTTE, *Danmarks og Norges naturlige og politiske Forfatning*, Kjøbenhavn, 1777.
- STEJNEGER, *Den Celtiske Pony, Tarpanen og fjordhesten*, Naturen, 1904.
- VIGFUSSON and YORK POWELL, *Origines Islandicæ*, vol. i., bk. 1, "Landnáma-Bóc," Oxford, 1905.

DESCRIPTION OF THE PLATES.

PLATE I.

FIG. 1. "Fjordhest," Bergen, 1905. This animal, which was scarcely more than one-half "Celtic" in its characters, was regarded as having all the points of a pure Fjordhest.

FIG. 2. Gudbrandsdal horse, Lillehammer, 1903.

PLATE II.

FIG. 3. "Udgangerhest," or "Nordlandshest," Bodo, 1895. This pony was probably almost purely Celtic.

FIG. 4. Hebridean pony.

Figs. 1 and 3 have appeared in the Gudbrandsdal Stud-book, vols. i. and ii. Fig. 4 is from a block kindly lent by Professor Ewart.

(Issued separately February 12, 1906.)

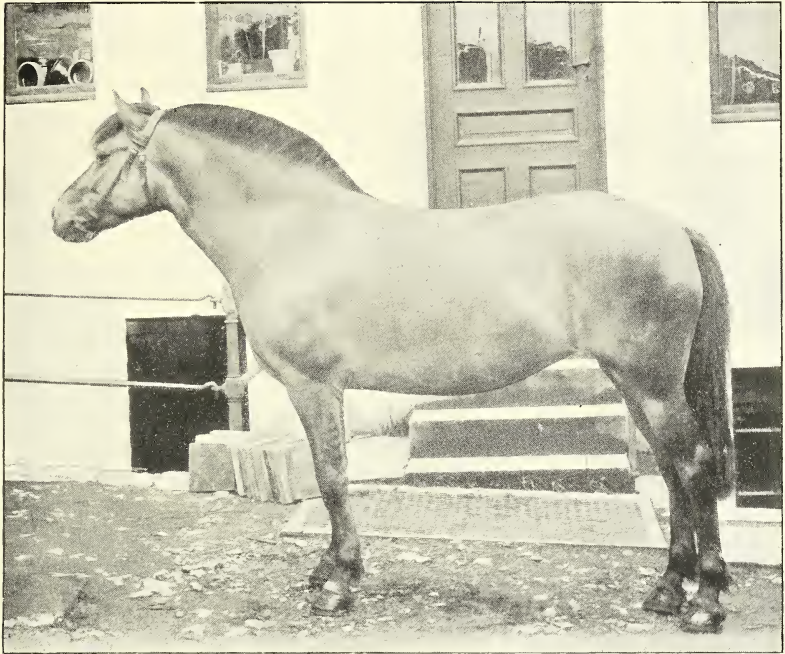

FIG. 1.

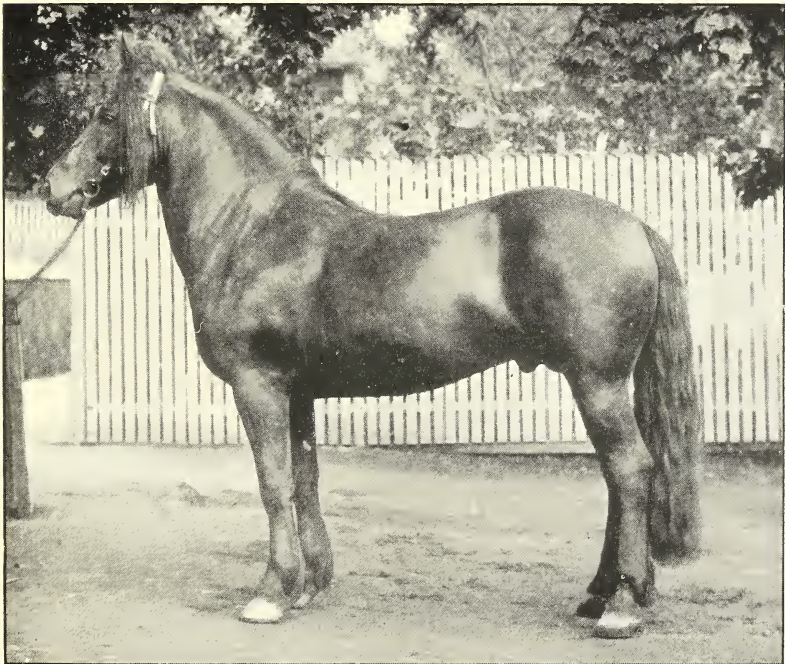

FIG. 2.

MR FRANCIS H. A. MARSHALL.

[Plate I.]



FIG. 3.



FIG. 4.

Notes on the Effect of Electric Oscillations (co-directional and transverse) on the Magnetic Properties of Iron.
By James Russell.

(MS. received December 19, 1905. Read November 20, 1905.*)

In the present communication I propose (1) to give some account of preliminary experiments in which the effects of co-directional and transverse oscillations upon the magnetic properties of iron are directly compared with each other and with the normal curves without oscillations.

Numerous experiments have been made with co-directional oscillations alternately assisting and opposing the field; also with oscillatory currents in iron wires longitudinally magnetised, giving rise to transverse oscillatory effects.

I am not, however, aware that any experiments have previously been made in such a way that the effects of co-directional and transverse oscillations can be directly compared, without introducing conditions so different as those which must obtain when oscillatory currents pass in the magnetic metal experimented with.

I propose (2) to discuss the results thus obtained in the obvious bearing which they appear to have upon a few typical forms of magnetic detectors of electric waves. The supposition is made that the oscillations produced in the closed secondary of a small induction coil are not essentially different in their magnetic effects from the oscillations produced in wires by means of Hertz waves.

Apparatus.

One quality of sheet-iron with large hysteretic constant was used. The sheet was cut into two crosses of the same dimensions. An exploring coil wound diagonally round the central square of one of the crosses was in circuit with a ballistic galvanometer. The four arms of each cross, bent over at right angles to the

* The discussion on magnetic detectors has been somewhat extended since date of communication.

central square, were slipped into four rectangular coils from opposite sides. The arms which thus overlapped were firmly clamped together. Each coil consisted of two independent windings. The inner windings of the four coils were connected in series, and with the secondary terminals of a small induction coil. The outer windings were likewise connected in series, and with suitable resistances and a source of constant E.M.F.

It is evident that connections could be arranged so that a unidirectional current in either winding would produce an induction either co-directional or transverse, relative to the axis of the exploring coil. A rocker in each circuit conveniently effected this alteration.

The constant E.M.F. connected through resistances with the outer windings was used, (1) to demagnetise the iron by reversals decreasing from a maximum, and (2) to produce the field (cyclic or otherwise) and the co-directional induction measured by the exploring coil.

The induction coil in series with the inner windings supplied the oscillatory current which agitated the iron of the central squares, either in a co-directional or transverse direction in the sense indicated. Let this agitation be called either the co-directional or the transverse oscillations, as the case may be (determined by the position of the rocker in circuit), or when this distinction is superfluous, simply the oscillations.

This rotation of the direction in which the oscillations act through an angle of 90° throughout the two central squares involves no change in the ampère turns nor in the measured reluctance of the iron circuits. What it does change is precisely that, the effect of which it is desired to measure.

Field Superposition.

It is now absolutely necessary to discriminate between the order and manner in which oscillations and field are superposed the one upon the other. Two experimental methods were adopted:

- A. Oscillations were superposed upon constant field.
- B. A change of field was superposed upon oscillations permanently acting.

These conditions of field superposition are entirely dissimilar, and the recognition of this fact is of primary importance. It may be observed that if in the former case (A) the field is varied after the superposition of oscillations, the order of superposition passes into those under the B conditions, a change of field being then superposed upon permanently acting oscillations. It is evident that the converse does not hold.

Experimental Methods under A conditions.

First, after demagnetisation of the iron, a fixed maximum field is put on (by increasing reversals, to secure as far as possible symmetry about the zero of induction), and reversed twenty times. The plus change of inductions due to the twenty-first reversal is measured. The co-directional oscillations are now superposed, and the plus induction change measured. Oscillations and field are now put off. Second, the iron is again demagnetised, and the same fixed maximum field put on in the same way as before and reversed twenty times. The plus induction change due to the twenty-first reversal is measured. A single step is now taken to any given point on the hysteresis loop, and the minus change of induction measured. The co-directional oscillations are now superposed and the plus or minus reading taken. Oscillations and field are again put off. This second process is repeated for a sufficient number of points all round the loop. The whole process is repeated for transverse oscillations.

Three curves result from the reduced galvanometer readings taken as above described. These are plotted in figs. 1 and 2, when the maximum cyclic induction values are (without oscillations) $B=780$ and $B=5620$ respectively. The scale of fig. 1 is for both ordinates double that of fig. 2. The ordinates measuring induction are in C.G.S. units; the abscissæ measuring field, in arbitrary units.

Summary of Results under A conditions.

At and near extreme cyclic values the superposition of oscillations produces for low values of field (see fig. 1) a relatively large increase of induction; for higher values of field (see fig. 2), a

relatively small increase of induction. For low values of field the increase is greater for co-directional than for transverse oscillations; for high values of field, this relationship is reversed.

After leaving cyclic extremes there are points when the field is decreasing where co-directional and transverse oscillations respectively produce neither an increase nor a decrease of

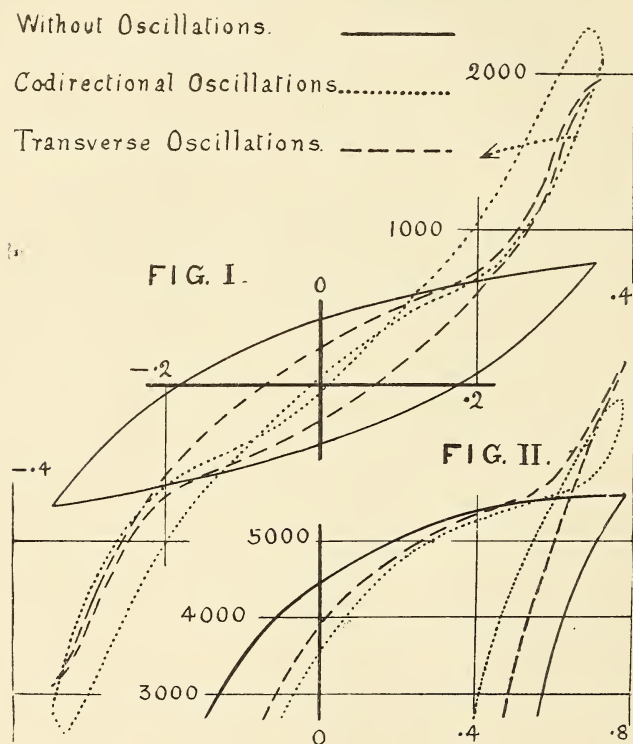

induction. In low fields they are thrust *from* the cyclic extremes, in high fields, *towards* the cyclic extremes.

When these points are passed, oscillations produce a decrease of induction, and this for all values of field is greater for co-directional than for transverse oscillations. This decrease passes into increase in the opposite sense, and the first conditions are reverted to at the other end of the cycle.

In all cases the induction change is greatest when oscillations are superposed on an increasing field. For low fields this occurs

at or near *cyclic extremes*, where the slope of the curves is greatest. But as the cyclic field maximum is increased, the greatest induction change occurs at an *earlier stage* of the increasing field, where in this case also the curves are *steepest*.

To so great an extent is this the case for co-directional oscillations, that the usual order of things is reversed and the *up curve* (increasing field) actually reaches higher induction values than the *down curve* (decreasing field). The curves for the complete cycle thus cross (forming three loops) where co-directional oscillations give rise to an induction the same in value and sign whether they are superposed on the decreasing or increasing field.

It may be worth noting that at some maximum value of field between those given in figs. 1 and 2, these crossing points may coincide with the neutral point when the field is decreasing where superposed co-directional oscillations produce no induction change.

The curves for transverse and co-directional oscillations given in figs. 2 and 3 must not be confounded with the usual hysteresis loops in the sense that the areas they enclose measure the energy loss during one complete cycle. They do not do so.

They measure for any given value of field the instantaneous change of induction which takes place when oscillations—co-directional and transverse—are superposed at any and all stages of the normal hysteresis loop.

Now suppose that after any instantaneous induction change has been measured, the field is made to vary by some small amount—say, by a decrement if the field had previously been decreasing—the induction change which now takes place is entirely different (see dotted arrow). Hysteresis or lag in the usual sense comes into full play, and one naturally passes to the conditions of field superposition where a cyclic field change may be regarded as superposed upon permanently acting oscillations.

Experimental Methods under B conditions.

First. After demagnetisation and twenty reversals of a fixed maximum field, the normal B - H hysteresis loop is determined by Ewing's method of single steps from the fixed maximum to a sufficient number of points all round the loop.

Second. The iron is again demagnetised and subjected to co-directional oscillations, upon which the field at the same fixed maximum value is superposed. After twenty reversals of field, the hysteresis loop is determined as before.

Third. The iron being again demagnetised, the same process is repeated for transverse oscillations and the corresponding measurements made. It is, of course, understood that in cases *second* and *third* the force sustaining the oscillations remains "on" and unaltered until the series of galvanometer readings has been completed.

The above determinations were repeated for many field cycles, the maximum induction values at the extremes of each cycle ranging from a minimum of $B=20$ to $B=12,000$.

Summary of Results under B conditions.

Permeability *—See fig. 3, where the full line, dotted line, and dash line curves have the same signification as in figs. 1 and 2. For low values of field co-directional oscillations increase the permeability relative to the normal (*i.e.* without oscillations) to a greater extent than transverse oscillations.

For higher values of field transverse oscillations, increase the permeability relative to the normal to a greater extent than co-directional oscillations.

The crossing point of these curves occurs when the induction is about 5000 with oscillations.

When the induction does not exceed a few hundreds without oscillations, the corresponding induction with transverse and co-directional oscillations is respectively about three and four times greater. When $B=20$ without oscillations, these ratios become a little less.

Retentivity.—When the field is reduced to zero from a cyclic maximum and the ratio of residual to maximum induction plotted, as in fig. 5, against maximum cyclic induction, the curve with transverse oscillations is higher within wide limits than that obtained with co-directional oscillations. These curves appear to coalesce, or even to cross, in higher fields. The normal retentivity curve lies above both.

* After twenty reversals of field.

It might thus appear that even under the B conditions the effect of oscillations is to reduce residual magnetisation. Such a statement, however, cannot be regarded as correct, because by plotting against maximum induction one of the most important effects of oscillations has been eliminated, viz., that of increased permeability.

In fig. 4 residual magnetisation is plotted against field, and we

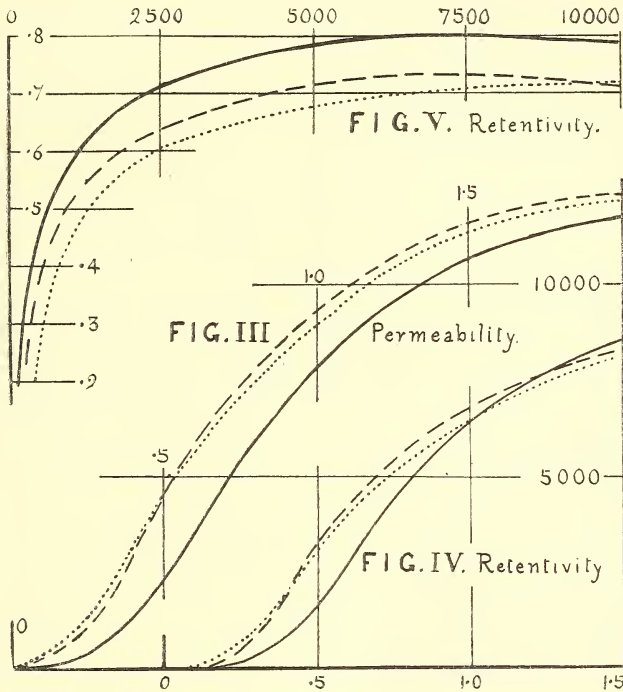

see that it is only at high values of induction—where permeability is, so to speak, naturally eliminated—that the effect of oscillations is to reduce retentivity. For lower fields, and throughout a wide range, oscillations *increase* retentivity. A comparison with fig. 3 shows that the greater the permeability in the three cases, the greater is the residual magnetisation. The residual magnetisation curves with co-directional and transverse oscillations also cross each other—as was found to be the case for permeability,—and greatly exceed in value the normal retentivity curve without

oscillations, with the exception already mentioned, where the induction is great.

Coercive Force.—For low fields of the order of a few hundreds, oscillations likewise increase coercive force, but with slightly higher fields this effect soon disappears, and thereafter oscillations decrease coercive force.

Hysteresis Loss for Constant Induction.—When under normal conditions the maximum cyclic induction is of the order of one to five hundred, co-directional oscillations for constant maximum induction diminish the energy loss in the iron about four times, transverse oscillations about three times. But as the induction is increased this difference gradually lessens, and after B under normal conditions has reached 5000 it is apparent that transverse oscillations diminish the loss in the iron to a greater extent than co-directional oscillations. In all cases for constant induction, oscillations cause a diminution of the energy loss; but when the induction is high (say, $B=12,000$), the diminution, although sufficiently well marked, has become a relatively small effect.

Hysteresis Loss for Constant Field.—When under normal conditions the maximum cyclic induction is of the order of a few hundreds, oscillations for constant maximum fields *increase* the energy loss in the iron about four times relative to the loss when no oscillations are acting. As the induction is increased to some thousands, the energy loss becomes very approximately the same with and without oscillations. When, however, the induction is higher still—say, $B=12,000$ —a sufficiently well-marked but relatively small decrease of hysteresis loss is caused by the oscillations. The energy loss for co-directional and transverse oscillations does not differ greatly relative to each other for constant maximum fields. The greater relative retentivity and the lower permeability at low fields (where the difference is so much greater than under normal conditions), under transverse relative to co-directional oscillations are in harmony with this result. The curves exhibited are not here reproduced. Fig. 6, however, may be referred to, where the full line curve shows the normal hysteresis loop without oscillations, the dotted line curve, the greatly increased hysteresis loop with co-directional oscillations. They do not differ in type from each other. The phenomena of

“lag” is equally well exhibited by both ; but for present purposes it is in my opinion also essential to state *all* the facts in terms of permeability (at cyclic extremes), of retentivity (when $H=0$), and of coercive force (when $B=0$), as has been done above.

Magnetic Detectors of Electric Waves.

The above experimental results have, in addition to their purely theoretical or physical aspect, an especial interest at the present time, in view of the fact that the magnetic properties of iron and steel have been utilised to detect electric waves in space.

Magnetic detectors of the Rutherford type, either in their original forms or as they have been modified for continuous telegraphic work, illustrate what takes place when oscillations are superposed at *one* point of the normal hysteresis loop, viz., that where zero field has just been passed. The reduction of the magnetisation which occurs is sufficiently well understood.

Other forms of detectors in which the adjustment and rates of motion of parts have been experimentally determined, seem to be less perfectly understood. If one may judge from the conflict of opinion which has arisen, and the anomalous results which have been obtained, magnetic detectors seem to have outrun very generally accepted theoretical knowledge.

In view of the experimental results above arrived at, I propose now to discuss three forms of magnetic detectors of electric waves in the following order, viz., Marconi's first form of detector, Marconi's second detector, and the Ewing-Walter detector.

First. In Marconi's first apparatus a fixed core of iron or steel is used, long relatively to its diameter. The poles of a revolving horse-shoe magnet are, during each complete revolution, twice in close proximity to the ends of the core. It is thus continuously carried through a cycle between positive and negative maximum values. Wireless telegraphic signals are received at all stages of this cycle. The instrument is admittedly much less perfect than Marconi's second form, but it is nevertheless interesting to examine its action.

The broken curve of fig. 6 shows the effect of superposing and withdrawing oscillations at twenty-four approximately equi-

distant points in succession during the determination of the hysteresis loop, the "step-by-step" method being in this case the only one available. To secure approximate symmetry about the zero of induction, the maximum cyclic value is first reached by reversals of field increasing from zero, the oscillations being "on."

After twenty reversals the oscillations are put off. The field is now decreased by the first step and the oscillations put on and off. The second step is next taken, followed by oscillations on and off as before. Three galvanometer readings are taken at each

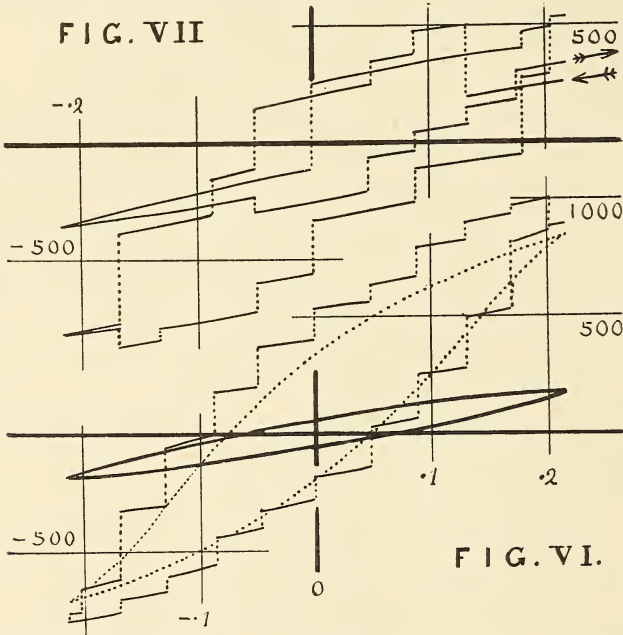

step; the first reading measures the change of induction due to change of field, the second that due to oscillations, and the third any small change if any that may take place when the oscillations are put off. By proceeding in this manner the whole cycle may be completed.

The dotted line curve is the hysteresis loop under the B conditions, *i.e.* when the field cycle is superposed upon permanently-acting oscillations. The full line curve is the normal hysteresis loop (*i.e.* without oscillations) determined by the step-by-step method for the same maximum values of field.

The curves show the results fully. The effects of superposing oscillations, as nearly as possible uniform in intensity and frequency, at approximately equidistant points all round the cycle, are as follows:—first, the area enclosed is enormously increased in comparison with the normal hysteresis loop; second, it is also greater than the hysteresis loop obtained when the oscillations are permanently acting (this is in accordance with what has been stated under “Retentivity”); and third, the amount of instantaneous induction change which occurs upon the superposition of oscillations depends entirely at what particular point of the cyclic field they are superposed.

But the above conditions are not those of practical telegraphic work. If signals are to be received, the waves must be transmitted more or less irregularly.

Fig. 7 shows what takes place when oscillations are superposed and withdrawn somewhat irregularly at various points during two complete cycles. The results are obvious. The induction changes now caused by the superposition of oscillations are determined not only by the particular point at which they are superposed, but by previous irregularities. Thus, if the irregularity be a pause in the signalling, the effect of succeeding signals may either be increased or decreased. If signals are not received when their effect is a maximum, the effect of succeeding signals may be decreased; on the other hand, if they are not received when their effect is a minimum, the effect of succeeding signals may be greatly increased. Note, also, the limitation of the total induction change per cycle or half cycle to which the irregular receipt of wave signals may give rise.

Marconi's first form of magnetic detector appears to owe its sensitiveness to the fact that the instantaneous induction change which takes place when electric waves are superposed at many points of the field cycle is great; but it is equally certain that it owes its imperfections to the fact that the field is varying, signals not being superposed at one definite point of the cycle.

The function of the moving field, therefore, is not to increase the sensitiveness of the iron; it merely renders the receipt of signals possible, by removing the iron from that particular cyclic position at which the immediately preceding signal was received,

and which has been rendered unresponsive to a second wave signal of the same intensity and frequency.

Second.—In Marconi's second instrument, the "varying or moving magnetic field," upon which the invention is based, and by means of which the magnetic material is supposed to become sensitive to high frequency oscillations, is entirely departed from. A continuous band of iron or steel is passed over the poles of two horse-shoe magnets in the following order:—one south pole, one double north pole, and finally one south pole. Let the direction of motion be from left to right. The magnetic circuits of the two horse-shoe magnets are in part completed in the moving band; and if its section be small relative to that of the electromagnets, the magnetic induction in the band will depend largely upon its permeability. The two magnetic circuits, however, are in opposite directions; and it is evident that if change of permeability affected the circuits equally and in the same sense, no E.M.F. would be produced in a coil symmetrically placed between them.

The band as it approaches the double north pole from the left is passing through a field increasing to a maximum; and as it leaves on the right, it is passing through a field decreasing from a maximum. We have, however, seen (figs. 1 and 2) that under these conditions the superposition of oscillations produces in all cases an increase of induction (increased permeability) which is greater with increasing than with decreasing field. In other words, the increase of induction in the band is greater immediately to the left of the double north pole than it is to the right. This differential action is further increased by the fact that the moving band distorts the field in the direction of motion, viz., to the right. Hence the receipt of oscillations will be recorded in the telephone connected with the exploring coil symmetrically placed in reference to the magnets but unsymmetrically placed in reference to field.

It is further evident that once wireless telegraphic communication has been established and is proceeding with reasonable constancy, the increase of induction which takes place in the increasing field (to the left) tends towards a maximum, and renders negligible any further induction change (increase or decrease) taking place in the decreasing field (to the right).

Hence in my opinion Marconi's second instrument detects* the *increase* of induction which occurs when electric space waves are superposed upon field at or near a cyclic extreme, in precisely the same way as Rutherford's original apparatus detected, or rather measured, a *decrease* at another point of the cyclic process.

The function of the moving band appears to be twofold:— first, it supplies the hard iron or steel in a condition of lower permeability, in order that it may be raised to a condition of higher permeability when the signals are received from a distant station; and second, it distorts the field in the direction of motion, the telephone thus tending to respond in a greater degree to signals received when the field is increasing near but not at the cyclic extreme. It has already been pointed out that for low field this is the most sensitive part of the cycle.

Third. The Ewing-Walter form of detector is essentially different from those already discussed. It is based upon Ewing's hysteresis tester, which measures the drag between field and iron when one of these is revolving. The best speed is stated to be from five to eight revolutions per second, while Marconi obtained good results at a speed of only half a revolution per second. The reason for this great difference is obvious. The Marconi instruments detect instantaneous induction change (A conditions), while the Ewing-Walter form integrates (B conditions).

The inventors anticipated that the receipt of electric waves would be detected by a fall in the normal deflection, in accordance with what appears to have been the generally accepted but erroneous view that oscillations in all cases cause a diminution of the energy loss per cycle. A fall in the normal deflection was at first obtained when the oscillations may be supposed to have been co-directional oscillations, and thus to alternately assist and oppose the field. On experiments being continued, however, an increase in the normal deflection resulted, but in this case the oscillations were passed directly through the iron or steel core, thus giving rise to transverse oscillations.

The former result—a decrease of energy loss, due to oscillations—is not in harmony with my experimental results for low fields. A probable explanation may be found in the fact that in my case

* Or even measures, provided the signalling is not proceeding too rapidly.

the magnetic circuit was completed wholly in the iron, and consequently the maximum induction at cyclic extremes depended entirely on the increased permeability due to the oscillations. It is just possible that in the earlier Ewing-Walter instrument, the induction in the iron rings depended upon their geometrical form and very little upon their permeability. If this were the case, the energy dissipated per cycle would be reduced.

The later result, however—an increase of energy loss, due to oscillations—is fully in harmony with my experimental results. Messrs Ewing and Walter state (*Proc. R.S.*, vol. lxxii. p. 120) that the unexpected augmentation of hysteresis (loss) is probably to be ascribed to the oscillatory circular magnetisation increasing the range of longitudinal induction (permeability), and so indirectly increasing the energy loss in the iron or steel.

This explanation, however, is not, taken by itself, altogether adequate. In the first place, it seems to imply that transverse (circular in this case) oscillations facilitate the magnetising process in some unexplained way not possessed by co-directional oscillations. It affords no explanation why the first form of apparatus did not show increased hysteresis loss with co-directional oscillations with low fields. In the second place, induction change due to oscillations (or even to mechanical vibrations) has generally been ascribed to a greater freedom on the part of the molecules to follow a changing field. If the field be increased, the induction will be increased (increased permeability); if the field be decreased, the induction will be decreased (decreased retentivity). Increased range of induction, therefore, due to oscillations, by no means implies, on the usually accepted views, increased energy loss per cycle.

As a matter of fact, however, we have seen that all the more important magnetic properties of hard iron are modified by oscillations. For low fields increased permeability is associated with increased retentivity and also with increased coercive force; for medium field, with increased retentivity but decreased coercive force; while for high fields increased permeability is relatively reduced and is associated both with decreased retentivity and decreased coercive force.

But as these are precisely those factors which determine energy

loss per cycle, it is evident that any apparatus which measures the drag between rotating field and core, or in any other way integrates the B-H cycle with respect to value and sign, will measure increase of energy loss for low fields, and decrease of energy loss for high fields; and this *irrespective* of whether the oscillations are co-directional or transverse. Between these extremes, giving definite and opposite readings, uncertain results, or no results at all, may be anticipated from magnetic detectors of this kind.

I acknowledge my indebtedness to the Royal Society of London for placing at my disposal a Government grant for the purposes of this investigation. The work is being continued.

(*Issued separately* February 8, 1906.)

On a Theorem in Hypercomplex Numbers. By J. H. Maclagan-Wedderburn, Carnegie Research Fellow.

(Read January 8, 1906.)

Scheffers in the *Mathematische Annalen*, vol. xxxix., pp. 364-74, enunciates the following theorem:—If A is an algebra containing the quaternion algebra B as a subalgebra, and if A and B have the same modulus, A can be expressed in the form $BC = A = CB$, where C is a subalgebra of A every element of which is commutative with every element of B: in other words, if i_1, i_2, i_3, i_4 is a basis of B, it is possible to find an algebra C with the basis e_1, e_2, \dots, e_c , such that each of its elements is commutative with every element of B, and such that the elements $e_r i_s$ ($r=1, 2, \dots, c, s=1, \dots, 4$) form a basis of A; and if a is the order of A, then $a=4c$.

The following is a short proof of this theorem. Let the basis of B be as usual $1, i, j, k$ where the laws of combination are the usual laws of quaternions. If x is an element of A, then $x' = x - ixi - jxj - kxk$, $x'' = ix + xi + kxj - jxk$, $x''' = jx - kxi + xj + ixk$, and $x^{iv} = kx + jxi - ixj + xk$ are commutative with every element of B: further, x can be expressed in terms of x, ix'', jx''' , and kx^{iv} , in fact $4x = x' - ix'' - jx''' - kx^{iv}$; hence if C is the algebra of all elements of A which are commutative with every element of B, B and C satisfy the conditions required by the theorem. If y, y_1, y_2, y_3 are any elements of C, $x = y + y_1 i + y_2 j + y_3 k$ can only vanish if $y = y_1 = y_2 = y_3 = 0$, for if $x = 0$, then $4y = x - ixi - jxj - kxk = 0$, and similarly $y_1 = y_2 = y_3 = 0$; hence the order of A is four times the order of C.

In addition to being much shorter than Scheffers' proof, which occupies about ten pages, this proof has the advantage of being rational.

The method used in the above proof may be regarded from two points of view. The first of these will be best understood from the following extension of it.

Let B be the algebra generated by the two elements e_1 and

e_2 where $e_1^n = e_2^n = e$ and $e_1 e_2 = \epsilon e_2 e_1$, e being the modulus of B and ϵ a primitive n th root of unity. If x be any element of an algebra A which contains B and has also e as its modulus,

$y_t = \sum_{r=1}^{n^2} x_r^{-1} x_t x_r$ ($t = 1, 2, \dots, n^2$) are commutative with every element of B, if x_1, x_2, \dots represent $e_1^{\alpha} e_2^{\beta}$ ($\alpha, \beta = 1, 2, \dots, n$); for

$$e_1^r e_2^s y_t = e_1^r e_2^s \sum_{\alpha, \beta=1}^n \epsilon^{-\alpha\beta} e_1^{-\alpha} e_2^{-\beta} x_t x e_1^{\alpha} e_2^{\beta} = \sum_{\alpha, \beta=1}^n \epsilon^{-\alpha\beta + \alpha s} e_1^{r-\alpha} e_2^{s-\beta} x_t x e_1^{\alpha} e_2^{\beta}$$

$$= \sum_{\alpha, \beta=1}^n \epsilon^{-\alpha\beta - \beta r} e_1^{-\alpha} e_2^{-\beta} x_t x e_1^{r+\alpha} e_2^{s+\beta} = y_t e_1^r e_2^s.$$

Now if $x_r^{-1} = e_1^r e_2^s$, then $\sum_{t=1}^{n^2} x_t^{-1} x_r^{-1} x_t = \sum_{\alpha, \beta=1}^n e_2^{-\beta} e_1^{r-\alpha} e_2^s e_1^{\alpha} e_2^{\beta} = \sum_{\alpha, \beta=1}^n \epsilon^{\beta r - \alpha s} e_1^r e_2^s = 0$, unless

r and s are multiples of n , *i.e.* unless $x_r = e$; hence $n^2 x = \sum_r \sum_t x_t^{-1} x_r^{-1} x_t x x_r = \sum_t x_t y_t$. It follows therefore as before

that x is contained in the algebra which is formed by taking the direct product of B and the algebra composed of those elements of A which are commutative with every element of B.

It may be remarked here that the algebra B is, in the complex field, equivalent to the quadrate algebra e_{pq} ($p, q = 1, 2, \dots, n$) where $e_{pq} e_{qr} = e_{pr}$, $e_{pq} e_{rs} = 0$, if $q \neq r$ and $e = e_{11} + e_{22} + \dots + e_{nn}$; in fact, if we set $e_1 = e_{11} + \epsilon e_{22} + \dots + \epsilon^{n-1} e_{nn}$, $e_2 = e_{12} + e_{23} + \dots + e_{n1}$, then $e_1^n = e_2^n = e$ and $e_1 e_2 = \epsilon e_2 e_1$.

The second point of view is perhaps simpler. Let A be any algebra containing a subalgebra B which has the same modulus as A; if A is expressible as the direct product of B and another algebra C, every element x of A can be expressed in the form $x = \sum_r f_r(x) x_r$ where x_1, x_2, \dots, x_b is a basis of B and $f_r(x)$ ($r = 1, 2, \dots, b$) are elements of C and are therefore commutative with x_1, x_2, \dots, x_b . Suppose B is such an algebra that, if $x = \sum \xi_r x_r$ is any element of B, ξ_r ($r = 1, 2, \dots, b$) being scalar co-ordinates, it is possible to express these co-ordinates as rational functions of x and the elements of the basis, say $\xi_r = f_r(x)$: $f_r(x)$ is then necessarily linear in x and we may write $f_r(x) = \sum_{p,q} \xi_{pq} x_p x_q$.

If y is any element of B, then $y f_r(x) = f_r(x) y$, or $\sum_{p,q} \xi_{pq} y x_p x_q =$

$\sum_{pq} \xi_{pq} x_p x x_q y$ for every y and x belonging to B, therefore the matrix represented by $\sum_{p,q} \xi_{pq} (y x_p () x_q - x_p () x_q y)$ is identically zero.

Hence $f_r(x)$ is *formally* commutative with every element of B, and $f_r(x)x \equiv xe = x$ where e is the modulus. If now x is any element of A, $f_r(x)$ is still commutative with every element of B and $x = \sum_r f_r(x)x_r$, since A and B have the same modulus. Hence as before A can be expressed as the product of B and the algebra composed of those elements of A which are commutative with every element of B. If c is the order of this algebra, which as before will be denoted by C, the order of A is equal to bc : for suppose if possible that $y = y_1 x_1 + y_2 x_2 + \dots + y_b x_b = 0$, y_1, y_2, \dots being elements of C; then $f_r(y) = 0$, but $f_r(y) \equiv \sum_{r=1}^b f_r(y_r x_r) = y_r f_r(x_r) = y_r$, therefore $y_r = 0$.

For instance, let B be the quadrate algebra (e_{pq}) described above, then $f_{pq}(x) = \sum_{t=1}^n e_{tp} x e_{qt}$, $e_{rs} f_{pq}(x) = e_{rp} x e_{qs} = f_{pq}(x) e_{rs}$, and $\sum_{p,q=1}^n f_{pq}(x) e_{pq} = \sum_{p,q=1}^n e_{pp} x e_{qq} = x$.

It is interesting to note in this connection that if A is a quadrate algebra of the above type whose order $n^2 = l^2 m^2$, it is expressible as the direct product of two quadrate algebras of orders l^2 and m^2 respectively. This may be shown by setting $\epsilon_{pq} = \sum_{t=1}^m e_{(p-1)m+t}$ ($p, q = 1, 2, \dots, l$) for the algebra B and $\eta_{pq} = \sum_{t=0}^{l-1} e_{tm+p, tm+q}$ ($p, q = 1, 2, \dots, m$) for C. ϵ_{pq} and η_{pq} evidently have the proper laws of combination, and $e_{pm+r, qm+s} = \eta_{rs} \epsilon_{p+1, q+1} = \epsilon_{p+1, q+1} \eta_{rs}$. In general, if $n = n_1 n_2 \dots n_k$, A can be expressed as the direct product of k quadrate algebras A_1, A_2, \dots, A_k of orders $n_1^2, n_2^2, \dots, n_k^2$ respectively. This theorem is the counterpart of one given by Clifford.*

* *American Journal*, vol. i., pp. 350-58.

Library Aids to Mathematical Research.By **Thomas Muir, LL.D.**

(Read December 18, 1905.)

(1) The aids which may fairly be expected from a library towards the prosecution of research, mathematical or other, are of two kinds. First, there is the aid given by furnishing the names of previous workers in the same field, accompanied by the names of the publications in which the results of their labours have been preserved or entombed. Second, there is the help in the opportunity given of consulting the said publications themselves and of borrowing certain of them for lengthened study. In other words, what the scientific investigator wants from libraries is *books* and *books about books*. One of the two is often obtainable without the other, but in that case its value is immensely lessened. To the so-called "ordinary" reader, a library is a labyrinth which probably would give him all he needs if only he had a guide through its intricacies: to the specialist, on the other hand, with his methodic bibliographies and booksellers' lists, it not unseldom presents itself as a lucky-bag in which the blanks are ultimately more in evidence than the prizes. It is the reader of the latter kind that a scientific society naturally wishes to assist, and it is desirable therefore that his difficulties and aspirations be known. All that has been done of recent years for the "ordinary" reader one notices not merely without a grudge, but with admiration: it must never be forgotten, however, that no country can afford to neglect the wants of the working specialist. After all, he it is who is the original source of supply for all readers, and it is therefore *his* output which ought to be of the deepest concern.

My purpose on the present occasion is to show what the situation is in this matter as regards the single subject of *mathematics*. There can be little doubt, however, that other subjects are in as bad a plight, and that the whole question of library aid is worth serious and prompt attention from all scientific men.

(2) First, then, let us see what has been done during the last fifty years to supply mathematicians with *bibliographical* aids. In 1855 Dr Joseph Henry made his appeal to the British Association at Glasgow for the formation of a catalogue of philosophical memoirs referring to mathematics and physics, and the appeal did not fall unheeded. Before anything tangible, however, could result from it, the publication of Poggendorff's *Biographisch-literarisches Handwörterbuch* was begun (1858) in Germany, and partly filled the vacant place. The two volumes of it, alphabetically arranged according to authors' names, were completed in 1863, and dealt with scientific papers published up to 1858.

By the time of the appearance of the first part of "Poggendorff," the seed sown by Henry had germinated, the Royal Society of London having taken it over from the British Association, and having formally resolved to prepare a catalogue of scientific memoirs beginning with the year 1800. The first volumes of this great undertaking, namely, those dealing with the period 1800–1863, were published at the rate of one volume a year, the last appearing in 1872. From the latter date, therefore, there were two books of reference available for the mathematician, the *Handwörterbuch* and the *Catalogue of Scientific Papers*. The fact that they covered in the main the same period was not altogether a drawback, as even within that period they were often mutually supplementary. A more serious objection lay in the fact that neither of them had a subject-index, and that the more up-to-date of the two was almost ten years in arrears when its sixth volume appeared.

About this time a very important fresh venture was made; but, before speaking of it, it may be well to follow out the history of the other two. By 1879 two additional volumes of the *Catalogue of Scientific Papers* had been published dealing with the period 1864–1873, and by 1896 the next decade had been covered by three further volumes: so that at the latter date there were available eleven handsome quarto volumes devoted to cataloguing the scientific literature from 1800 to 1883. For a long time, on the other hand, no addition to the *Handwörterbuch* had been made, and it seemed as if the Royal Society were to be left in possession of the field. Ultimately, however, fresh counsels must

have prevailed with the publishers, for the year which gave birth to the Society's eleventh volume also saw a beginning made with a new volume of "Poggendorff." This was completed in 1898, thirty-five years after the completion of the previous volume, the record being then brought up to the same point as the *Catalogue* had reached two years before. It was now the Royal Society's turn to lag behind, for during 1902-1904 a fourth volume of the *Handwörterbuch* was published, completing the record for the century, whereas all that the Royal Society has since printed is a twelfth volume dealing with the same period as the preceding eleven and supplementing them.*

The fresh venture above referred to was the institution of the *Jahrbuch über die Fortschritte der Mathematik*, the first volume of which was published in 1871. It differed from its predecessors (1) in confining itself to mathematics alone; (2) in being an annual publication devoted to a year's work,—the first volume, for example, dealing with the literature of the year 1868; (3) in being not a mere catalogue of titles, but giving also a short abstract of each paper's contents; (4) in being arranged according to subjects, and having two indexes, the one giving the mere titles arranged alphabetically according to authors' names, and the other giving the same rearranged as in the body of the work. In the first volume the book proper occupied pp. 1-404, the first index (Namenregister) pp. 405-426, and the second (Inhaltsverzeichnis) pp. ix.-xxxiv.

In 1884 a miniature rival to the *Jahrbuch* was started at Stockholm, the *Bibliotheca Mathematica*, giving lists of new publications on mathematics and short bibliographical articles: but after three years it was altered in form and became devoted exclusively to the *history* of mathematics and to the bibliography of mathematics from the *historic* point of view. In April 1900 it assumed a third and more imposing form, still, however, restricting itself to the field of mathematical history. For our present purpose therefore it need not further concern us.

A much more serious competitor took the field in 1893. This

* The Royal Society has not ceased its work, and holds itself pledged to finish what it has undertaken, namely, to catalogue the scientific papers of the nineteenth century.

was the *Revue semestrielle des publications mathématiques*, compiled under the auspices of the Mathematical Society of Amsterdam. Its objects are almost exactly those of the *Jahrbuch*, but its plan is quite different. In the first place, its titles, accompanied by short abstracts, are arranged according to *countries*, and within a country according to *series*; in the second place, since each title has prefixed to it the appropriate symbols indicating its subject according to the classification of the “Congrès international de bibliographie des sciences mathématiques,” it can and does provide a subject-index in comparatively small space; and in the third place, the abstract of a paper is, as a rule, given in the same tongue as the paper itself. Two parts appear in a year, each dealing with the literature of the half year ended three months previously—thus showing a marked promptitude as compared with the *Jahrbuch*, where the corresponding interval is not three months, but three years. In the first volume, embracing the work of half a year, the book proper occupied pp. 1–96, the list of journals pp. 97–100, the subject-index pp. 100–109, and the index of authors’ names pp. 110–114. The cost of the book, it well deserves to be mentioned, is trifling, the subscription price for the yearly couple of volumes being only 8½ francs.

In the end of 1902 still another competitor appeared, namely, volume A of the *International Catalogue of Scientific Literature*, promoted by the Royal Society of London, and designed to be the cosmopolitan continuation in annual instalments of the nineteenth-century *Catalogue of Scientific Papers* above referred to. Its general object is the same as that of the *Jahrbuch* and *Revue*, save that abstracts are not given. A complete volume appears once a year, and contains (1) a list of the previous year’s writings arranged alphabetically according to authors’ names, and hence called “Authors’ Catalogue,” each title having appended to it a number indicating its subject and a number indicating its position on the list; (2) a “Subject Catalogue,” in which the titles, printed anew, are arranged according to the order of their subject-numbers, and under any subject-number according to the alphabetical order of the authors’ names. The scheme of classification of subjects is neither that of the *Jahrbuch* nor that of the *Revue*. In the first volume the “Authors’ Catalogue” occupies pp. 47–111, and the

“Subject Catalogue” pp. 112-194, the last seven pages being taken up with a list of serials and the first 45 pages with the schedule of classification and an index to it, both printed in four languages.

Such, then, is in brief the story of the cataloguing of mathematical writings during the last half century. The net result is seen to be (1) the production of two huge works of reference dealing with what we may call *bygone* literature, that is to say, in the main the literature of the nineteenth century;* (2) the establishment of three annuals dealing with what we may call *current* literature, and aiming, all of them, at giving a methodically arranged list of the whole of each year's literature within a comparatively short time of its appearance. With this in evidence, who shall say that the mathematician is uncared for by bibliographers, cataloguers, and index-makers? The simple truth is, he is overburdened by their labours; for, whereas either of the two former works and any one of the three latter, if complete, would suffice for his wants, he is compelled to use all of them if only as a means of detecting their several errors and omissions.

(3) This being the state of matters as regards “books about books,” our next inquiry naturally is, What is the situation as regards “books” themselves? Have the *librarians* and *library managers* successfully coped with the difficulties on their side? The mathematician who has turned up the *Jahrbuch*, the *Revue*, and the *International A*, and culled from them an array of “references,” proceeds to realise the references at the counter of his library, and what is the result?

To obtain something like a definite answer to this, the following course has been adopted:—First of all, the field of inquiry was narrowed down to practicable dimensions. To have tabulated all the works referred to in these two dictionaries and three current year-books would have been an overwhelming task: if we restrict ourselves to mathematical *serials*, the work becomes quite manageable. That is what has been done; and in order to make

* A third venture might here have been referred to, namely, the *Répertoire bibliographique des sciences mathématiques*, a card catalogue following the system of classification adopted by the *Revue*. Between 1894 and 1905 fifteen hundred cards have been sent out, and the present rate of issue is only one hundred cards per year.

the case still more simple and the argument from it more convincing, only *one* of the three catalogues (*International A*) has been taken advantage of. That is to say, *all* the mathematical serials have not been tabulated, but only those which find a place in the *List of Journals* published in 1903 in connection with the *International Catalogue of Scientific Literature*. Such a list, in view of its relation to the Royal Society of London, and in view of the fact that an international council stands sponsor for it, must be a list free from any grave reproach.

In the next place, the chosen serials having been tabulated, copies of the table were made and submitted directly or indirectly to the librarians of the more important appropriate libraries in Scotland and in London, for the purpose of ascertaining exactly which of the serials each library was at the moment receiving, and what back volumes of these it possessed. The whole of the information thus obtained it is not proposed at present to use; the portion of most value and interest here and now is that concerning Edinburgh and Glasgow.

(4) The test-list of serials is as follows:—

AUSTRIA—

- 25. *Archiv Matematiky a Fysiky*, (¼ jährl.), Praha.
- 290. *Časopis pro Pěstování Math. a Fys.*, (5 H. jährl), Praha.
- 304. *Sborník Jednoty Českých Math. v Praze*, Praha.
- 207. *Monatsheft für Math. u. Phys.*, (zwanglos), Wien.

BELGIUM—

- 8. *Bull. périod.* *soc. belge de géomètres* (bimensuel), Anvers.
- 118. *Mathésis*. Recueil math. (mensuel), Gand.

DENMARK—

- 11. *Nyt Tidsskrift for Matematik*, Kjöbenhavn.

FRANCE—

- 79. *Annales sci. de l'éc. norm. sup.* (mensuel), Paris.
- 231. *Bulletin de math. spéciales* (10 fois par an.), Paris.
- 244. *Bulletin des sci. math.* (mensuel), Paris.
- 322. *L'éducation mathématique*, (bimensuel) Paris.
- 333. *L'enseignement mathématique*, (mensuel), Paris.
- 382. *L'intermédiaire des mathématiciens* (mensuel), Paris.
- 395. *Journal de l'école polytechnique* (annuel), Paris.
- 398. *Journal des géomètres* (bimensuel), Paris.
- 401. *Journal de math. pures et appliquées* (4 fasc. par an.), Paris.
- 557. *Nouvelles annales de math.* (mensuel), Paris.
- 603. *Bull.* *soc. math. de France* (4 num. par an.), Paris.
- 719. *Revue de math. spéciales* (mensuel), Paris.

GERMANY—

76. *Archiv der Mathematik u. Physik* ($\frac{1}{4}$ jährl.), Leipzig.
 167. *Bericht des math. Vereins d. Univ. Berlin* (jährl.), Berlin.
 217. *Bibliotheca mathematica* ($\frac{1}{4}$ jährl.), Leipzig.
 556. *Mittheilungen d. math. Ges. zu Hamburg* (1-2 H. jährl.) Leipzig.
 595. *Journal f. d. reine u. angew. Math.* (8 H. jährl.), Berlin.
 610. *Jahrbuch über die Fortschritte d. Math.* (3 H. jährl.), Berlin.
 625. *Jahresbericht d. deutschen Math.-Vereinigung* (2-4 H. jährl.), Leipzig.
 776. *Mathematische Annalen* ($\frac{1}{4}$ jährl.), Leipzig.
 1088. *Verhandl. d. internat. Math.-Congresses*, Leipzig.
 1210. *Zeitschrift für Mathematik u. Physik* (2 monatl.), Leipzig.
 1211. *Zeitschrift f. math. u. naturw. Unterricht* (8 H. jährl.), Leipzig.
 1310. *Abhandl. zur Geschichte d. math. Wiss.* (zwangios), Leipzig.

HOLLAND—

2. *Nieuw Archief voor Wiskunde*, Amsterdam.
 8. *Wiskundige Opgaven, met de oplossingen . . .*, Amsterdam.
 753. *Revue semestrielle des publ. math.* (2 fasc. par an.), Paris.

HUNGARY—

10. *Mathematikai és Fizikai Lapok*, Budapest.
 11. *Math. és Természettudományi Ertésítő*, Budapest.
 12. *Math. és Természettudományi Közlemények*, Budapest.

ITALY—

30. *Bollettino di bibliog. e storia delle sci. mat.*, Genova-Torino.
 7. *Annali di matematica, pura ed applic.*, Milano.
 85. *Giornale di matematiche*, . . . , Napoli.
 94. *Le Matematiche pure ed applicate*, Città di Castello.
 138. *Rendiconti del circolo matematico*, Palermo.
 143. *Periodico di matematiche*, per . . . , Livorno.
 149. *Il Pitagora*, Palermo.
 157. *Revue de mathématiques*, Torino.
 216. *Supplemento al Periodico . . .*, Livorno.

JAPAN—

38. *Tōkyō Sūgaku Butsurigaku Kwai Kiji*, Tōkyō.

NORWAY—

3. *Archiv for Math. og Naturvidenskab*, Kristiania.

POLAND—

37. *Prace matematyczno-fizyczne* (annual), Warszawa.
 54. *Wiadomosci matematyczne* (once in 2 mos.), Warszawa.

PORTUGAL—

2. *Jornal de sciencias math. e astron.*, Coimbra.
 11. *Jornal de sciencias math., phys. e nat.*, Lisboa.

RUSSIA—

19. *Soobščeniya . . .* (=Rapports . . . soc. math. de Kharkov).
 114. *Math. Sbornik* (=Recueil math.), Moscow.
 177. *Zapiski . . .* (=Mém. . . . soc. nouv.-Russie . . .), Odessa.

SWEDEN—

1. *Acta mathematica*, Stockholm.

UNITED KINGDOM—

94. *Proceedings of the Elinburgh Math. Soc.*, Edinburgh.
111. *Math. reprinted from Educ. Times*, London.
262. *Proceedings of the London Math. Soc.*, London.
316. *Mathematical Gazette*, London.
329. *Messenger of Mathematics*, Cambridge.
380. *Quarterly Journal of Pure and Applied Math.*, London.

UNITED STATES—

16. *American Journal of Mathematics*,, Baltimore.
20. *American Mathematical Monthly*, Springfield, Mo.
23. *Annals of Mathematics, pure and applied*, Cambridge, Mass.
298. *Bulletin of the American Math. Society*, New York, N. Y.
336. *Transactions of the American Math. Soc.*, New York, N. Y.

It is seen that the number included in the list * is 67: if it were perfectly complete the number would be about 80. These 67 are apportioned among the different countries thus:—Austria 4, Belgium 2, Denmark 1, France 12, Germany 12, Holland 3, Hungary 3, Italy 9, Japan 1, Norway 1, Poland 2, Portugal 2, Russia 3, Sweden 1, United Kingdom 6, United States 5. Spain, it will be observed, does not appear: this is not because she publishes no mathematical serials, but probably because she has been slow in forming a “regional bureau” to work with the Council of the *International Catalogue*.

In the second place, all serials like the *Proceedings of the Royal Society of Edinburgh* are excluded, being ruled out by the fact that the contents of such serials are not mainly mathematical. An afterthought, however, makes it doubtful whether the

* The list lays itself open to criticism, but let him throw the first stone who knows the difficulties of organising the machinery necessary to produce not one year-book but the whole seventeen annual volumes of the *International Scientific Catalogue*. For one thing, the director of such an undertaking will find his numerous regional-bureaux at sixes and sevens as to where the line of exclusion is to be drawn, and consequently elementary journals will be inserted in one land and shut out in another. Then, of course, journals have an appreciable death-rate, and no list can be complete and accurate for long: that here used is the first drawn up. In view of what has been already accomplished, alike by the Council and by the Director, the manifest duty of all scientific men is to lend what aid they can towards now perfecting the *Catalogue* in detail.

The number preceding the title of any serial is the consecutive number which distinguishes it in the above-mentioned *List of Journals*.

Nachrichten of the Göttingen Society of Sciences ought not to have been inserted, as the mathematical papers of that society form a large proportion of those published in the Society's mathematico-physical section. The serials of certain Russian physico-mathematical societies, being insufficiently known to me, may have been improperly excluded.

Such matters, however, are of little moment, for the inclusions unjustly made will probably be more than balanced by the similar exclusions, the effect of an exclusion being to strengthen the argument and the effect of an inclusion not necessarily to weaken it.

(5) The returns from the Edinburgh and Glasgow libraries when tabulated appear as follows : *—

* Of those who have assisted me in obtaining details, I desire specially to thank Professor Gibson of Glasgow, and Mr Hardy, the worthy librarian of this Society.

The London libraries which are of importance as regards mathematics are six in number, namely, those of the British Museum, Royal Society, Mathematical Society, University College, South Kensington Science, Patent Office. Some of these possess more serials than any one of the Scottish libraries; but the same general state of affairs prevails. Overlappings repeatedly occur, serials possessed are frequently imperfect, and the full collection of the test-list cannot be furnished forth by all the libraries put together.

The library which possesses representatives of the greatest number of serials is that of the Mathematical Society: unfortunately not more than half a dozen of the sets are complete, and the books are miserably housed. To provide proper accommodation, to complete the sets already represented, and to supply the missing sets, would be a splendid ambition to set before the little band of members resident in London. The serials contained in the British Museum, though somewhat fewer in number, are wonderfully complete and excellently cared for.

Meanwhile it is desirable that a leaflet should be prepared containing a full list of serials, and showing which are obtainable in London, and where. For those which are more elementary, the library of the Mathematical Association might be utilised.

	EDINBURGH.		GLASGOW.	
	University.	Royal Society.	University.	Phil. Society.
AUSTRIA,	25 290 304 207			
BELGIUM,	8 118			
DENMARK,	11			
FRANCE,	79 231 244 232 333 382 395 398 401 557 603 719	(2) iii. (1874), etc. complete complete complete complete complete complete complete complete complete complete	(1) iii. (1866), etc. complete complete complete complete complete complete complete complete complete complete complete	xiv. (1897), etc. complete complete complete complete complete complete complete complete complete complete complete
GERMANY,	76 167 217 556 595 610 625 776 1088 1210 1211 1810	complete complete complete complete complete complete complete complete complete Heft 12, etc. complete complete xi, etc.	complete complete (3) (1900), etc. complete complete complete complete complete complete complete complete complete complete

HOLLAND,	2 8 Fr. 753 complete	xii. (1886), etc. ii. (1883-6), etc. complete		viii. (1900), etc.
HUNGARY,	10 11 12	complete ii, v, vii.-xvi., xviii., etc.		
ITALY,	7 30 85 94 138 143 149 167 216	complete	complete		
JAPAN,	38	complete		xxi. (1899), etc.
NORWAY,	3	complete		
POLAND,	37 54 2		
PORTUGAL,	11 19 114 177		
RUSSIA,	1 94 111 262 316 329 330	complete complete complete complete complete complete	xi. xii, xv., etc. complete complete complete complete complete complete	complete complete complete complete complete complete complete	complete complete complete complete complete complete complete
SWEDEN,	1	complete	complete		
UNITED KINGDOM,	94 111 262 316 329 330	complete complete complete complete complete complete	complete complete complete complete complete complete	complete complete complete complete complete complete complete	complete complete complete complete complete complete complete
UNITED STATES,	16 20 28 298 336	complete complete complete complete	complete complete complete complete complete complete complete	complete complete complete complete complete complete complete	complete complete complete complete complete complete complete

On examining this table, it will be observed that of the 67 serials of our test-list only 34, *just about half*, are to be found in the combined libraries of southern Scotland, that Edinburgh possesses 31 of the 67, and Glasgow 23. In the next place, it appears that 10 possessed by Edinburgh are not to be found in Glasgow, and that 2 possessed by Glasgow are not to be found in Edinburgh: but against this we have to set the fact that 21 which are available in the one city are duplicated in the other.

As regards Edinburgh alone, it has to be noted that 13 serials are duplicated in libraries within a short walk of each other; but that 18 are not duplicated, 11 being possessed by the Royal Society and not by the University, and 7 by the University and not by the Royal Society.

The like facts for Glasgow are even more striking. There the University has 19 serials not found elsewhere in the city, while the Philosophical Society has 4 duplicated by the University, and no others at all.

Some of the countries included in the list our library authorities seem to treat rather hardly, and among these notably Italy and Austria. Of the 9 Italian serials only 1 (the *Annali*) is represented, the unique copy being in the Edinburgh University Library; and of the Austrian 4 there is not one to be found anywhere.

Lastly it has to be noted that in all this summing up the serials have been spoken of as if *perfect*; whereas, unfortunately, the reverse is often the case. At the very least there must be 19 of the examined sets which are more or less defective, and of the 34 different serials represented in the two cities certainly not more than 27 are complete. This, it need hardly be said, is a serious additional depreciation of our treasures.

(6) It is, I hope, quite unnecessary to insist on the unsatisfactoriness of the state of affairs thus brought formally into evidence; and equally unnecessary to say that my purpose is not captious criticism. The authorities of the various libraries referred to are beset with difficulties, of which not the least important arises from the fact that the wants of specialists are constantly increasing, and that even new kinds of specialists are being segregated every year. Further, it would be wrong to forget that not one of the libraries

mentioned is intended to be a specialist's library: even the most rabid mathematical enthusiast could not expect a University library, or the library of a general scientific society, to care for his wants as a mathematical society of like standing might fairly be expected to do.

But while carefully avoiding all hint of blame, one must be equally careful not to hide imperfections that stand in the way of the advancement of mathematical science. As a worker, I therefore crave liberty to express firmly my opinion that under existing circumstances mathematical research can only be pursued in Scotland with difficulty and uncertainty, and that research in mathematical *history* is practically an impossibility.

Further, until a change is brought about the multiplication of bibliographies cannot be looked forward to with much cordiality: the gratitude which they stimulate is marred by discontent arising from their use.

(7) A perfect library arrangement for Edinburgh is not difficult to think of, however hard it may be to bring about, the idea at the basis of it being *co-operation between the libraries* concerned. If the University library, instead of purchasing duplicates, devoted the money at present so spent to the purchase of serials not as yet available in the other libraries, and if the Mathematical Society, purchasing nothing, secured all the more elementary serials by exchange for its own *Proceedings*, the problem would be solved. This, of course, is too much to expect, and to press it would be futile and probably unkind. But is it unreasonable to hope that the libraries referred to will cease to *add* to the number of their duplicates, and that by inaugurating a scheme of co-operation they will gradually find it possible and to their interest to diminish considerably the number they at present possess?

Co-operation of this kind seems so natural that in the extreme case of specialists' serials it might with advantage be extended to the libraries of neighbouring towns. In these days of rapid inter-communication, Edinburgh and Glasgow are almost as if contiguous; and if Edinburgh cannot of itself, and Glasgow cannot of itself, who would object to the two cities uniting in the pursuit of a common good? Certainly not the working mathematician.

There is no need in this case to invoke the aid of the millionaire. Even supposing no money at all were being at present spent on the object, a sum of £100 per annum would purchase and preserve all the serials on the list. If a moneyed benefactor were wanted, it would not be to produce fine bindings and elaborately carved bookcases: it would rather be from fear that in an odd time of indifference or of pinch part of the collection would otherwise have to be discontinued, whereas the whole essence and value of such an undertaking lie in its continuity.

In a final word, be the work done anew as a whole, or done piecemeal out of existing elements, the aim should be to do it soon before we fall further behind, to make it complete and thorough, and to see that it is accessible to all workers who can prove their ability to use it.

(Issued separately February 14, 1906.)

Bathyraco Scotiæ, Poisson abyssal nouveau recueilli par l'Expédition Antarctique Nationale Ecossoise. Note préliminaire, par Louis Dollo, Conservateur au Musée royal d'Histoire naturelle, à Bruxelles. *Présentée par* M. R. H. TRAQUAIR, M.D., F.R.S., V.P.R.S.E.

(Read January 8, 1906.)

I. INTRODUCTION.

L'Expédition Antarctique Nationale Ecossoise, sous le commandement de M. W. S. Bruce, a recueilli une importante collection de Poissons au cours de son exploration de l'Atlantique austral et de la Mer de Weddell (1902-1904).

A la suite de la publication de mon mémoire sur les Poissons de la *Belgica*,* M. Bruce m'ayant fait l'honneur de me prier d'étudier les matériaux ichthyologiques qu'il avait rapportés, je me propose de soumettre à la Société Royale d'Edimbourg, si elle veut bien me le permettre, les résultats de mes recherches, au fur et à mesure de leurs progrès, afin d'assurer à la *Scotia* la priorité de ses découvertes, en attendant que je sois assez avancé pour faire paraître mon travail définitif.

Les *Poissons de la Scotia* comprennent des formes littorales, pélagiques et abyssales.

Les *Poissons littoraux* proviennent de :

- (1) Ile Gough ;
- (2) Iles Falkland ;
- (3) Burdwood Bank ;
- (4) Orcades du Sud.

Les *Poissons pélagiques* et les *Poissons abyssaux* ont été capturés dans :

- (1) L'Océan Atlantique (Zone Subantarctique) ;
- (2) L'Océan Antarctique (Mer de Weddell).

Les Poissons de la Mer de Weddell, des Orcades du Sud et de

* L. Dollo, "Poissons de l'Expédition Antarctique Belge," *Résultats du Voyage du S. Y. Belgica en 1897, 1898, 1899, sous le commandement de A. de Gerlache de Gomery*, Anvers, 1904.

l'île Gough étaient complètement inconnus, et on n'en avait pris qu'un seul sur le Burdwood Bank jusqu'à présent.*

Par conséquent, en restant uniquement, ici, sur le terrain spécial de l'Ichthyologie, on peut dire que l'Expédition Antarctique Nationale Ecossoise fait le plus grand honneur à l'Ecosse, et à M. W. S. Bruce, Chef de l'Expédition, eu égard aux progrès qu'elle a réalisés.

Je m'occuperai, d'abord, des Poissons pélagiques et des Poissons abyssaux,—et je commencerai, aujourd'hui, par les *Nototheniidæ*, si caractéristiques des hautes latitudes australes.

Comme on le sait, cette famille ne présente que des types littoraux ou des types abyssaux.

D'autre part, la collection ichthyologique de la *Scotia* ne comprend qu'un seul *Nototheniidæ abyssal*, et c'est une espèce nouvelle.

Elle appartient au genre *Bathyraco*, découvert par la mémorable Expédition du *Challenger*, qui se rattache aussi à l'Ecosse par tant de liens.

J'appellerai cette espèce nouvelle *Bathyraco Scotiæ*, en souvenir de la *Scotia* et en l'honneur de la Nation écossaise,—me réservant de rendre hommage au Leader de l'Expédition et à ses Collaborateurs lors de la description des autres formes inédites, dans une prochaine communication.

II. LE GENRE BATHYDRACO.

1. En 1878, M. A. Günther, Conservateur honoraire au British Museum, publiait, dans une Note préliminaire, † la diagnose suivante du genre *Bathyraco* :

“Body elongate, subcylindrical; tail tapering; head depressed, with the snout much elongate, spatulate; mouth wide, horizontal, with the lower jaw prominent; eyes very large, lateral, close together. Scales very small, imbedded in the skin. Lateral line wide, continuous. One dorsal fin; ventrals jugular; the lower

* On vient d'en signaler deux autres, tout récemment [E. Lönnberg, “The Fishes of the Swedish South Polar Expedition,” *Wiss. Ergeb. d. schwedisch. Südpolar-Expedition* (1901–1903), Stockholm, 1905, vol. v., fasc. 6, p. 12] (*Note ajoutée pendant l'impression*).

† A. Günther, “Preliminary Notices of Deep-Sea Fishes collected during the Voyage of H.M.S. *Challenger*,” *Annals and Magazine of Natural History*, 1878, vol. ii., p. 18.

pectoral rays branched. Teeth in the jaws in villiform bands; none on the vomer or the palatine bones. Opercles unarmed; ten branchiostegals; the gill-membranes free from the isthmus and but slightly united in front. Air-bladder none."

Et il le plaçait dans la famille des *Trachinidæ*.

2. En 1887, M. Günther reprenait cette diagnose, pour la corriger légèrement et la compléter, dans sa Monographie des Poissons abyssaux du *Challenger*.*

Je me borne à reproduire, ci-dessous, les améliorations et additions :

"Tail tapering and very attenuated behind. Eyes very large, vertical, close together. Lateral line rather wide, continuous. Gills four; pseudobranchiæ none; gill-rakers short."

Et M. Günther continuait à laisser le genre *Bathyraco* parmi les *Trachinidæ*.

3. En 1902, M. G. A. Boulenger, Senior Assistant au British Museum, qui avait déjà incorporé le genre *Bathyraco*, l'année précédente, † dans la famille des *Nototheniidæ*, amendait la dernière diagnose de M. Günther en démontrant l'existence des *Pseudobranchies*.‡

4. Me basant sur les termes de la diagnose de M. Günther : "Scales very small, imbedded in the skin,"—que cet auteur emploie, ailleurs, pour le genre *Anguilla* : § "Small scales imbedded in the skin,"—j'en avais conclu que les écailles de *Bathyraco* devaient être dégénérées au point d'être secondairement cycloïdes (Pseudocycloïdes). ||

Auquel cas le *Nototheniidæ abyssal* de la *Scotia* aurait constitué un genre nouveau.

Mais M. C. Tate Regan, Junior Assistant au British Museum,

* A. Günther, "Report on the Deep-Sea Fishes," *Voyage of H.M.S. Challenger during the years 1873-76*, Zoology, vol. xxii., 1887, p. 47.

† G. A. Boulenger, "Notes on the Classification of Teleostean Fishes. I. On the Trachinidæ and their Allies," *Annals and Magazine of Natural History*, 1901, vol. viii., p. 266.

‡ G. A. Boulenger, "Pisces," *Report on the Collections of Natural History made in the Antarctic Regions during the Voyage of the "Southern Cross,"* Londres, 1902, p. 176.

§ A. Günther, *An Introduction to the Study of Fishes*, Edimbourg, 1880, p. 671.

|| L. Dollo, *Poissons de l'Expédition Antarctique Belge*, etc., p. 140.

qui a bien voulu réexaminer le Type, à ma demande, m'écrit que les *écailles* de *Bathyraco* sont *cténoïdes* :

"I have examined *Bathyraco antarcticus*: the scales are ctenoid, each having a series of small marginal denticles; on the nape and on the abdomen they appear to be cycloid; some of the scales on the side of the body lack the marginal denticulations, but that is evidently due to their having been rubbed off."

5. Enfin, sur mes questions, M. Boulenger, par de nouvelles observations sur le Type, a eu l'obligeance de m'apprendre que, chez *Bathyraco antarcticus* :

- (1) Les *nageoires ventrales* ont une *épine* et *cinq rayons*, et non une *épine* et *six rayons* comme le dit M. Günther; qu'elles mesurent 33 millimètres et que la distance de leur extrémité libre à l'anus est de 20 millimètres;
- (2) La *fente* située *derrière* le *quatrième arc branchial* est *fermée* dans sa *moitié supérieure*;
- (3) Les *branchiospines* sont *beaucoup plus épaisses* et *plus courtes* que dans le *Nototheniidæ abyssal* de la *Scotia*; qu'elles sont *denticulées* et qu'il y en a *16* à la *branche inférieure*.

6. Tenant compte de ce qui précède, et aussi des caractères de l'espèce nouvelle recueillie par l'Expédition Antarctique Nationale Ecossoise (voir plus loin), il y a lieu de modifier et de compléter comme suit la *diagnose du genre Bathyraco* :

"Corps, allongé, subcylindrique; queue, diminuant énormément de hauteur en arrière; tête, déprimée, au museau très allongé et spatuliforme; bouche, large, horizontale, avec mâchoire inférieure proéminente; yeux, très grands, tournés vers le haut et fort rapprochés l'un de l'autre. Ecailles, très petites, cténoïdes. Une seule ligne latérale. Une seule nageoire dorsale; caudale, rhipidicerque; ventrales, jugulaires, avec une épine et cinq rayons; rayons inférieurs des pectorales, branchus. Dents des mâchoires, villiformes; pas de dents sur le vomer, ni sur les palatins. Opercule, inerme; 6 à 10 rayons branchiostèges; membranes branchiostèges, non soudées à l'isthme et seulement réunies légèrement en avant. Pas de vessie natatoire. Quatre branchies; des pseudobranchies; fente en arrière du quatrième arc branchial, fermée dans sa moitié supérieure; branchiospines, courtes, sauf parfois en avant du premier arc branchial. Canaux mucipares, très développés."

III. BATHYDRACO ANTARCTICUS ET BATHYDRACO SCOTIÆ.

Réservant, pour mon travail définitif, la description détaillée, avec figures, du *Bathhydraco Scotiæ*, j'en donnerai, ici, les caractères distinctifs, par comparaison avec ceux du *Bathhydraco antarcticus* :

BATHYDRACO ANTARCTICUS,
Günther, 1878.

1. *Ligne latérale*, continue, suivant le milieu de la hauteur du corps et s'étendant, sans interruption, jusqu'à la base de la nageoire caudale.

2. *Nageoires ventrales*, avec extrémité libre séparée de l'anus par une distance plus grande que $\frac{1}{2}$ de leur longueur.

3. *Canaux mucipares*, larges.

4. *Rayons branchiostèges*, au nombre de 10.

5. *Branchiospines*, en avant du premier arc, courtes et denticulées.

6. *Longueur totale* : 0·26 m. environ.

Type.

British Museum (Londres).

BATHYDRACO SCOTIÆ,
Dollo, 1906.

1. *Ligne latérale*, interrompue, située légèrement au dessus du milieu de la hauteur du corps et s'arrêtant, en avant de l'extrémité postérieure de la nageoire dorsale, à une distance à peu près égale à celle qui sépare cette extrémité de la base de la nageoire caudale.

2. *Nageoires ventrales*, avec extrémité libre séparée de l'anus par une distance plus petite que $\frac{1}{2}$ de leur longueur.

3. *Canaux mucipares*, beaucoup plus accusés et s'ouvrant par de larges ouvertures.

4. *Rayons branchiostèges*, au nombre de 6.

5. *Branchiospines*, en avant du premier arc, longues et sétiformes.

6. *Longueur totale* : 0·14 m. environ.

Type.

Royal Scottish Museum (Edimbourg).

IV. BIONOMIE DES DEUX ESPÈCES DU GENRE BATHYDRACO.

Après avoir considéré les deux espèces du genre *Bathhydraco* au point de vue taxonomique, examinons-les, maintenant, au point de vue bionomique :

BATHYDRACO ANTARCTICUS.

(I.) *Biogéographie.*

Habitat : 60° 52' S. et 80° 20' E.
S.E. de Heard Island.
Océan Indien.
Quadrant Africain.
Station 152.
Challenger.

BATHYDRACO SCOTIÆ.

(I.) *Biogéographie.*

Habitat : 71° 22' S. et 16° 34' W.
Mer de Weddell.
Océan Antarctique.
Quadrant Américain.
Station 417.
Scotia.

(II.) *Ethologie.*

1. *Profondeur.*—1260 fathoms.
2. *Nature du Fond.*—Diatom ooze, and pebbles of granite and sandstone.
3. *Température du Fond.*—32° 9 F.
4. *Mode de Capture.*—Chalut.
5. *Date de Capture.*—11 Février 1874.
6. *Heure de Capture.*—Entre 9 heures du matin et 2 heures et demie de l'après-midi.
7. *Nombre d'Individus capturés.*—Un seul.

(II.) *Ethologie.*

1. *Profondeur.*—1410 fathoms.
2. *Nature du Fond.*—Blue mud and terrigenous deposits.
3. *Température du Fond.*—31° 9 F.
4. *Mode de Capture.*—Chalut.
5. *Date de Capture.*—18 Mars 1904.
6. *Heure de Capture.*—7 heures du matin.
7. *Nombre d'Individus capturés.*—Deux, pris ensemble.

V. CARACTÈRES ADAPTATIFS.

1. *Forme du Corps et de la Nageoire caudale.*—Comme on le sait, il y a lieu de distinguer, chez les Organismes marins, non seulement :

- (1) La Vie Littorale,
- (2) La Vie Pélagique,
- (3) La Vie Abyssale,

mais, dans chacune de celles-ci :

- (1) La Vie Nectique,
- (2) La Vie Planctique,
- (3) La Vie Benthique,*

cette dernière se traduisant, chez les Poissons, † par les catégories typiques suivantes :

- (1) Macruriformes,
- (2) Anguilliformes,
- (3) Dépressiformes,
- (4) Compressiformes asymétriques,

appartenant, respectivement, par un phénomène de Convergence, aux Familles les plus diverses.

Maintenant, outre les Poissons “profondément adaptés” à la Vie Benthique, il faut encore considérer ceux qui ne sont qu’ “en voie d’adaptation” à ce mode de vie.

Or, si on observe que les Poissons adaptés à la Vie Nectique typique (ex. *Thynnus vulgaris*) sont caractérisés par :

* Dans la Zone Pélagique, sur un support, ou au voisinage d’un support ; cas exceptionnel, réalisé, pourtant, dans la Mer des Sargasses, par exemple ; et réalisable, aussi, dans la Région du Kelp, sans parler des Glaces Flottantes.

† L. Dollo, *Poissons de l'Expédition Antarctique Belge*, etc., pp. 106 et 182.

- (1) Un corps fusiforme,
- (2) Une caudale rhipidicerque * puissante et fortement échancrée,

on reconnaîtra qu'un Poisson avec :

- (1) Un corps allongé, subcylindrique,
- (2) Une caudale rhipidicerque moins développée et plus ou moins arrondie,

représente, comme Adaptation, une *tendance à la Vie Benthique*, c'est-à-dire une existence au voisinage du fond.

C'est le cas de *Bathyrdraco*.

Gerlachea, †—genre le plus proche de *Bathyrdraco*, et qui l'accompagnera certainement partout quel que soit le sort futur des *Nototheniidae*,—par son corps moins étiré et par sa caudale plus grande et échancrée,—est moins éloigné de la Vie Nectique typique.

2. *Branchiospines*.—L'étude systématique de l'appareil branchial, au point de vue adaptatif, ne conduira pas à des résultats moins importants que celle de l'évolution de la nageoire caudale. ‡

Bornons-nous à examiner, aujourd'hui, les branchiospines.

M. E. Zander, Assistant à l'Université d'Erlangen, les a classées de la manière ci-après : §

- | | | |
|--|---|--|
| (1) Branchiospines absentes | { | <i>Esox lucius</i> ,
<i>Lucioperca sandra</i> . |
| (2) Branchiospines fonctionnelles en avant et en arrière des arcs branchiaux, mais ne formant que de simples tubercules arrondis | { | <i>Perca fluviatilis</i> ,
<i>Lota vulgaris</i> . |
| (3) Branchiospines fonctionnelles en avant et en arrière des arcs branchiaux, mais nombreuses et fort développées | { | <i>Cyprinus carpio</i> . |
| (4) Branchiospines fonctionnelles en avant seulement des arcs branchiaux, mais très allongées et sétiformes | { | <i>Clupea alosa</i> ,
<i>Coregonus albula</i> . |

* L. Dollo, *Poissons de l'Expédition Antarctique Belge*, etc., p. 97.

† *Ibid.*, p. 24.

‡ L. Dollo, "Sur la Phylogénie des Dipneustes," *Bull. Soc. belg. Géol.*, 1895, vol. ix., p. 96; *Poissons de l'Expédition Antarctique Belge*, etc., p. 235.

§ E. Zander, "Studien über das Kiemenfilter bei Süßwasserfischen," *Zeitschr. f. wiss. Zool.*, 1903, vol. lxxv., p. 249.

La nature adaptative de ces quatre groupes est bien mise en évidence déjà par le fait que la même disposition se rencontre dans des familles éloignées : *Esocidæ* et *Percidæ*, *Percidæ* et *Gadidæ*, *Clupeidæ* et *Salmonidæ* ; et que des dispositions différentes se trouvent dans la même famille : *Percidæ*.

Mais quelle est la signification physiologique de ces diverses branchiospines ?

Pour la découvrir, mettons, comme M. Zander, ces structures en rapport avec le régime des Poissons correspondants.

Nous aurons :

- (1) *Esox lucius* et *Lucioperca sandra*.—Grosses proies en eau claire.*
- (2) *Perca fluviatilis* et *Lota vulgaris*.—Petites proies du fond.†
- (3) *Cyprinus carpio*.—Fouit dans la vase.‡
- (4) *Clupea alosa* et *Coregonus albula*.—Crustacés pélagiques minuscules.§

On en tire :

- (1) *Macrophages*.—Branchiospines inutiles.
- (2) *Microphages*.—Branchiospines pour retenir les particules alimentaires.
- (3) *Limnophages*.—Branchiospines pour protéger les branchies contre la vase.
- (4) *Planctonophages*.—Branchiospines pour capturer les organismes minuscules contenus dans l'eau respiratoire.||

Ceci n'est, évidemment, qu'une esquisse. Mais son développement promet des déductions intéressantes.

Comment les choses se passent-elles, à présent, chez *Bathyraco Scotiæ* ? ¶

* E. Zander, *Kiemenfilter*, etc., p. 252.

† *Ibid.*, p. 252.

‡ *Ibid.*, p. 254.

§ *Ibid.*, p. 255.

|| Nous pouvons distinguer, au moins, trois catégories de *Planctonophages* chez les Vertébrés :

1. *Mammifères*.—Fanons (Cétacés mysticètes).
2. *Ostéoptérygiens*.—Branchiospines très longues (Alose et Polyodon).
3. *Chondroptérygiens*.—Fononcles (Selache et Rhinodon).

Il serait bon de conserver ces termes, déjà créés, pour désigner des structures morphologiquement différentes.

¶ W. Turner, "The Structure of the Comb-like Branchial Appendages and of the Teeth of the Basking Shark (*Selache maxima*)," *Journal of Anatomy and Physiology*, 1879, vol. xiv., p. 273.

En avant du premier arc, les branchiospines sont longues et sétiformes. Entre le premier et le deuxième, le deuxième et le troisième, le troisième et le quatrième, elles sont bien marquées, mais ne forment que de simples tubercules arrondis. En arrière du quatrième, elles sont du même caractère que celles-ci, mais très réduites.

D'où il ressort que *Bathhydraco Scotiæ* n'est, ni macrophage, ni limnophage, ni planctonophage,—mais microphage,—et qu'il doit chercher sa nourriture au voisinage du fond.

Ce qui confirme notre interprétation de la forme du corps et de la queue.

En d'autres termes, *Bathhydraco* nous marque, comme Adaptation, une *Tendance à la Vie Benthique Abyssale*.

Et *Gerlachea*? Ici, les branchiospines sont excessivement courtes, rudimentaires, sur tous les arcs.

Et les dents, au lieu d'être villiformes, comme celles de *Bathhydraco*, sont cardiformes,* très capables de saisir une assez forte proie.

Gerlachea serait donc macrophage, en eau claire. Ce qui concorde avec sa caudale échancrée, indiquant un plus grand éloignement du fond.

Observons que ces conclusions seront susceptibles de contrôle par l'examen du contenu du tube digestif.

Je reviendrai ultérieurement sur ce sujet.

VI. LES NOTOTHENIIDÆ ABYSSAUX.

1. Comme antérieurement,† nous prendrons la ligne de 350 mètres pour *limite supérieure* de la *Zone Abyssale*, puisqu'elle marque la séparation de la Région Aphotique.‡

* C'est à tort que j'ai appelé *villiformes* les dents de *Gerlachea*, quand je n'avais pas de *Bathhydraco* pour faire la comparaison directe ; l'épithète *cardiformes* leur convient mieux. L. Dollo, *Poissons de l'Expédition Antarctique Belge*, etc., p. 24.

† L. Dollo, *Poissons de l'Expédition Antarctique Belge*, etc., p. 64.

‡ A. F. W. Schimper, *Pflanzengeographie auf physiologischer Grundlage*, Iéna, 1898, p. 818. C. Chun, *Aus den Tiefen des Weltmeeres*, Iéna, 1900, p. 507.

Régions de l'Océan.

- | | |
|--|--|
| (1) <i>Euphotique</i> .—0 à 80 m. | } Zone Littorale et
Zone Pélagique.
Zone Abyssale. |
| (2) <i>Dysphotique</i> .—80 à 350 m. | |
| (3) <i>Aphotique</i> .—350 m. et au delà | |

2. Dans ces conditions, les *Nototheniidæ abyssaux* sont actuellement : *

- | | |
|--|-----------------------|
| (1) <i>Bathyraco Scotia</i> , Dollo 2577 mètres. | <i>Scotia</i> . |
| (2) <i>Bathyraco antarcticus</i> , Günther 2303 | „ <i>Challenger</i> . |
| (3) <i>Cryodraco antarcticus</i> , Dollo 450 | „ <i>Belgica</i> . |
| (4) <i>Gerlachea australis</i> , Dollo 450 | „ <i>Belgica</i> . |
| (5) <i>Racovitzia glacialis</i> , Dollo 435 | „ <i>Belgica</i> . |

3. La *Scotia* n'a retrouvé aucun des *Nototheniidæ abyssaux* de la *Belgica*, quoiqu'elle ait opéré à la même latitude et dans la même quadrant : †

- | | |
|---|---------------|
| (1) <i>Bathyraco Scotia</i> , Dollo 71° 22' S. et 16° 34' W. | Q. Américain. |
| (2) <i>Racovitzia glacialis</i> , Dollo 71° 19' S. et 87° 37' W. | Q. Américain. |
| (3) <i>Cryodraco antarcticus</i> , Dollo 71° 18' S. et 88° 02' W. | Q. Américain. |
| (4) <i>Gerlachea australis</i> , Dollo 71° 14' S. et 89° 14' W. | Q. Américain. |
| (5) <i>Bathyraco antarcticus</i> , Günther 60° 52' S. et 80° 20' E. | Q. Africain. |

Ce qui n'est pas trop étonnant, car :

- (1) Les *Nototheniidæ abyssaux* de la *Belgica* ont été capturés sur le Plateau Continental Antarctique. ‡ Tandis que le *Nototheniidæ abyssal* de la *Scotia* provient des *Grandes Profondeurs*.

* L. Dollo, *Poissons de l'Expédition Antarctique Belge*, etc., p. 143.

† *Ibid.*, p. 11.

‡ “La découverte du plateau continental antarctique est des plus intéressante. Le profil que nous avons tracé suivant le 85° de longitude (H. Arctowski) nous montre que c'est l'isobathe de 500 mètres qui marque la bordure du plateau.”—H. Arctowski et A. F. Renard, “Notice préliminaire sur les Sédiments marins recueillis par l'Expédition de la *Belgica*,” *Mém. cour. Acad. roy. Belg.*, 1901, vol. lxi. p. 12.

- (2) Les *Nototheniidæ abyssaux* de la *Belgica* ont été recueillis à l'Ouest de la *Terre de Graham*. Tandis que le *Nototheniidæ abyssal* de la *Scotia* a été pris à l'Est de cette péninsule, avec une différence de longitude de plus de 70°.

Telles sont les considérations que j'avais à présenter, pour aujourd'hui, sur le *Bathyraco Scotiae*.

Si la Société Royale d'Edimbourg y consent, j'espère être en mesure de lui communiquer bientôt les résultats de mes recherches sur d'autres Poissons de l'Expédition Antarctique Nationale Ecossoise.

(Issued separately March 29, 1906.)

**Some Further Results obtained with the Spectro-
heliometer. By Dr J. Halm.**

(MS. received November 15, 1905. Read November 20, 1905.)

(Preliminary Communication.)

In a paper published in vol. xli., part i., of the *Transactions* of this Society, entitled "Spectroscopic Observations of the Rotation of the Sun," I communicated the first results obtained with a spectroscope specially designed for the purpose of measuring the displacements of the solar lines on opposite limbs of the sun occasioned by the motions of the absorbing gases to or from the observer in consequence of the sun's axial rotation. The investigation was originally undertaken with the view of ascertaining whether the peculiar law of surface rotation of the sun, first discovered by Carrington from the motions of solar spots, and afterwards confirmed by Dunér from spectroscopic observations similar to my own, was, or was not, subject to alterations depending on the general state of solar activity. The question proposed is admittedly of supreme importance for solar physics in general. Its solution depends, of course, in the first instance on the delicacy of the spectroscope employed; the efficiency of which must be sufficiently proved before its results can be accepted with confidence. An attempt in this direction will be made in the present communication, in which I propose to discuss the whole bulk of my observations, now extending over fully four years, from a different point of view, which I think will enable us to arrive at definite conclusions with regard to the accuracy of these measurements.

In order to be quite clear, I must describe the method employed in the observations. Without going again into the details of the instrumental arrangements, which are fully explained in the paper referred to, I may briefly say that the two spectra of exactly opposite limbs of the sun are thrown simultaneously into the focus of the viewing telescope, and there appear as indicated

that these differences are quite independent of the absolute positions of the spectra in the field of view; any relative displacement of the one spectrum with regard to the other, which might be due to instrumental deficiencies, is indeed eliminated by the purely differential method employed in the observations. The instrument permits the throwing of the opposite solar points of any desired heliographic latitude upon the slit, and thus enables us to investigate the solar rotation from the equator to the immediate vicinity of the poles. It is also noticed that any shift of the solar lines which is due to the motion of the observer to or from the sun, since it affects both limbs in the same direction, disappears completely from the differences.

While this constitutes the method by which the effect of solar rotation is investigated, another interesting field of investigation is opened by a different treatment of the observations. Suppose, instead of taking the differences $[ab]_R - [ab]_A$ and $[cd]_R - [cd]_A$, we form their arithmetical means, $\frac{1}{2}([ab]_R + [ab]_A)$ and $\frac{1}{2}([cd]_R + [cd]_A)$. Obviously we then eliminate the effect of rotation, and each of these bracket terms represents the distance $[ab]$ or $[cd]$ as it would appear if we made our measurements in the centre of the solar disc. But now these distances are affected to the full extent by any displacement of the solar lines which is due to the motion of the observer in the direction of the radius vector earth-sun. And here we have therefore an exquisite test for the accuracy of the measurements, most simply obtained by investigating how far and with what amount of precision these motions of the observer are portrayed in our observations. I think the following results of my computations cannot but reflect very favourably on the achievements of our instrument, and convey a feeling of confidence in the reliability of the results obtained with regard to the main object of my investigation, the measurement of solar rotation.

Altogether there are three motions of the observer in the line of sight by which the positions of the solar lines can be affected. First, the diurnal rotation of the earth, in consequence of which the lines must be shifted towards the violet in the morning, and towards the red in the evening. Secondly, there is a motion of the earth in the direction of its radius vector, changing with the position of the earth in its orbit, and therefore having an

annual period. It is due to the ellipticity of the earth's orbit, and in consequence of it the earth moves most rapidly from the sun in the beginning of April, and most rapidly towards the sun in the beginning of October. Thirdly, a very small motion is caused by the revolution of the earth round the centre of gravity of the system earth-moon.

The mathematical expressions for these motions (in km. per second) are easily derived. For the diurnal motion we have

$$+ \frac{2a\pi}{86400} \cos \phi' \cos \delta \sin t,$$

where a represents the equatorial radius of the earth in km., ϕ' the geocentric latitude of Edinburgh, and δ, t the declination and hour-angle of the sun, the positive sign denoting an increase in the distance of the observer from the sun.

The annual term is expressed by

$$+ \frac{2\pi A}{T} \frac{e}{\sqrt{1-e^2}} \sin (\odot - \pi) = \frac{2\pi \cdot a}{\sin p \cdot T} \frac{e}{\sqrt{1-e^2}} \sin (\odot - \pi),$$

A being the mean distance of the earth from the sun, T the number of mean time seconds in the year, e the eccentricity of the earth's orbit, \odot the true longitude of the sun and π the longitude of the perihelion, and p the solar parallax ($8'' \cdot 80$).

The small "lunar" term may be sufficiently expressed by

$$+ 0 \cdot 014 \sin (\odot - \lrcorner) \text{ km. per sec.,}$$

\odot and \lrcorner being the longitudes of sun and moon.

Turning to the measurements, I may first state that my computations refer to the arithmetical means of the two distances, viz.—

$$\frac{1}{4} [[ab]_R + [ab]_A + [cd]_R + [cd]_A].$$

In other words, I have formed the means of the micrometer readings, $\frac{1}{4}(a_R + a_A + c_R + c_A)$ for the two telluric lines, and $\frac{1}{4}(b_R + b_A + d_R + d_A)$ for the solar lines, and taken the difference between the two.

The screw value, expressed in wave-lengths, had to be determined on each day. It is based throughout strictly on the distance between the two telluric lines $[bd]$. Possibly the assumed distance between these two lines, $0 \cdot 760$ t.m., is still slightly

wrong, but the error of this quantity is certainly small, and cannot sensibly affect the observed *shifts*.

After the observations had thus been properly reduced, I proceeded in the following way. My object being first to obtain the pure effect of the annual shift, I corrected for the diurnal and lunar displacement, using the above formulæ, and then arranged the observations into groups of 25 to 30 single measurements according to the longitudes of the sun. This first collection of data is shown in Table I.

TABLE I.

☉	Distance in t.m.	Weight.	☉	Distance in t.m.	Weight.
1901			1903		
•			•		
150	0·3904	1	179	0·3801	circles
165	·3913	1	204	·3813	
219	·3901	$\frac{1}{3}$	222	·3807	
1902			1904		
•			•		
341	·3764	1	338	·3609	1
14	·3693	1	17	·3579	1
93	·3794	1	68	·3655	1
161	·3859	1	100	·3729	1
208	·3853	1	176	·3809	1
			189	·3809	1
1903			1905		
•			•		
348	·3621	$\frac{1}{3}$	71	·3649	1
32	·3629	$\frac{2}{3}$	82	·3655	1
64	·3631	1	93	·3671	1
75	·3644	1	115	·3725	circles
147	·3738	$\frac{2}{3}$	201	·3747	

Unfortunately, the low position of the sun, combined with the very unfavourable atmospheric conditions, rendered observations between November and February quite impossible. But in spite of these unavoidable gaps the effect of the annual displacement is very clearly shown in the following graph (fig. 2), which demonstrates the sinoidal character of the annual curves quite plainly. In accordance with the theoretical formulæ, we find a

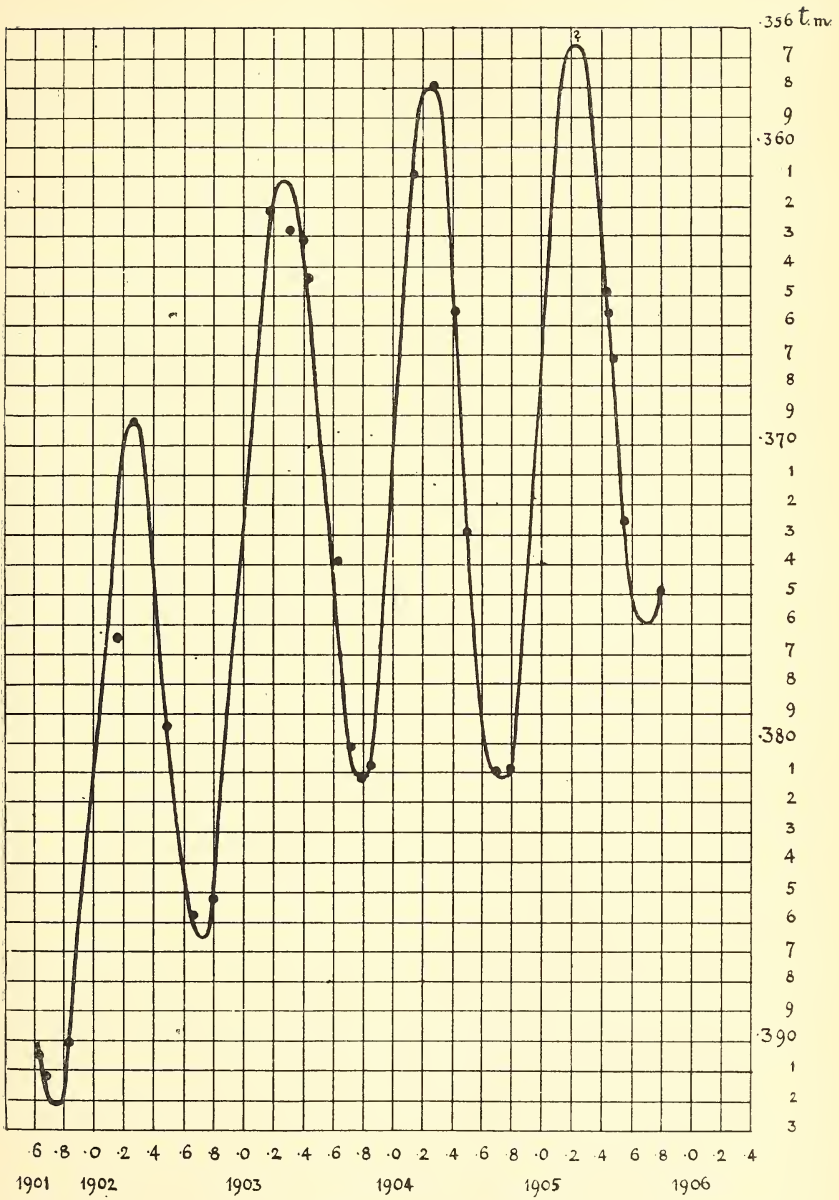

Fig. 2.

maximum shift towards the red in spring, and the maximum displacement towards the blue in autumn. We also conclude from the curves that the amplitude of this annual displacement amounts to about 0·010 t.m., agreeing well with the shift required by theory, viz. 0·0105 t.m. A more minute numerical investigation will, however, be given later on.

In looking at these curves, a most peculiar and, in my opinion, quite enigmatic feature will at once attract attention. One would naturally expect that the annual waves should proceed along a horizontal line. There is certainly no other motion in the line of sight which may account for the remarkable tendency of these curves to assume higher levels as we proceed from 1901 onwards. Nor is there much possibility of systematic errors in the measurements which might produce this progressive shift. No alteration, either in the instrument or in the method of observation, took place during the time from 1901 to 1903, when the shift was most pronounced. If it were due to any such cause, one would expect the change to be abrupt; but in reality it has taken place gradually. I think this fact becomes much more obvious if we study the curve shown in fig. 3, which exhibits the curve of the distances of Table I., after the annual displacement has been eliminated. Instead of the expected grouping of the values along a horizontal straight line, we see a curve which steadily rises from its minimum value in 1901 to an almost stationary position between 1904 and 1905, indicating in its last branch, towards the end of 1905, a tendency to further elevation. I have satisfied myself that this enigmatic change affects chiefly the distances between the solar and telluric lines. If we investigate the distance between the two solar lines during the same interval of time, we find only feeble indications of a successive shortening and widening, the observed values ranging between 0·998 t.m. in 1902 and 0·995 t.m. in 1905. I think that even this much smaller difference is greater than its probable error, but no doubt it is insignificant if compared with the above fluctuation.

I shall not venture upon hypothetical explanations of this singular phenomenon. What I should like to state here is simply the outcome of my observations. But if the shift is confirmed

by further observations, we have doubtless in it one of the most important phenomena of solar spectroscopy, the bearing of which on theoretical and practical questions cannot well be overestimated.

I shall now enter somewhat more closely upon the numerical

Fig. 3.

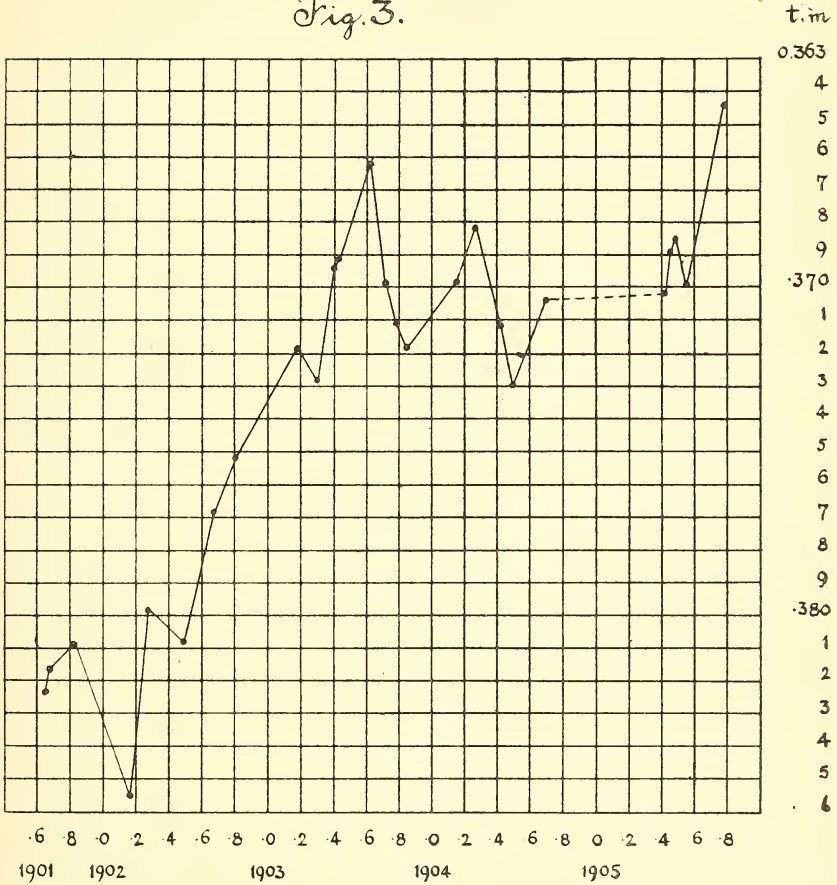

evaluation of the amplitudes and the positions of the turning-points in the annual curves. Since between 1903 and 1905 the shift, of which I have spoken, has certainly been small, we may for the present purpose limit our attention to this period only. I have again arranged the complete material into groups according to the sun's longitude, but now no longer separating the single years. The new values for each group, comprising 30 single

measurements, are shown along with their corresponding longitudes in the following Table II. Here again, of course, the diurnal and lunar shifts have been duly accounted for.

TABLE II.

☉	Distance in t.m.	☉	Distance in t.m.
°		°	
337	0·3611	88	0·3659
0	·3608	93	·3661
8	·3573	95	·3702
24	·3597	103	·3711
48	·3625	120	·3757
61	·3616	151	·3762
65	·3645	170	·3792
70	·3650	176	·3802
73	·3675	183	·3801
77	·3658	197	·3808
81	·3670	201	·3798
83	·3650	214	·3809

If these values are represented by a simple harmonic of the form

$$A + a \sin (\odot - \alpha)$$

and the values of A , a , and α are determined by the method of least squares, we find $A = 0\cdot3700$, $a = -0\cdot01048$, and $\alpha = 281^\circ\cdot4$, or, expressing a in km. per second :

$$a = -0\cdot4986 \pm 0\cdot0162$$

$$\alpha = 281^\circ\cdot4 \pm 1^\circ\cdot9$$

Introducing in our formula

$$\frac{2\pi \cdot a}{\sin p \cdot T} \frac{e}{\sqrt{1 - e^2}} \sin (\odot - \pi)$$

the best-known values of the constants, it assumes the numerical form :

$$0\cdot499 \sin (\odot - 281^\circ\cdot3)$$

Accidentally the agreement is perfect ; the assigned probable errors may, however, give an approximate measure of the accuracy of the values for a and π obtained from the observations.

Let us now investigate how far the measurements are capable of showing the diurnal shift. We correct the original dis-

tances for *annual* and lunar shift, and collect the observations in groups according to the hour-angle of the sun. The diurnal displacement, as the formula shows, depends on the declination of the sun. We may assume, however, that in all the groups the factor $\cos \delta$ is the same, viz. 0.957. Table III. shows the observed distances for different hours of the day (true Edinburgh time).

TABLE III.

Hour.	Distance in t.m.	Hour.	Distance in t.m.
h.		h.	
21.71	0.3727	0.45	0.3694
22.46	.3718	0.65	.3691
22.75	.3727	0.88	.3691
23.02	.3715	1.26	.3676
23.28	.3700	2.18	.3673
23.51	.3712	2.54	.3676
23.67	.3703	2.87	.3667
23.87	.3703	3.24	.3658
0.06	.3700	3.72	.3664
0.26	.3697	4.60	.3652
		5.68	.3649

Representing these values by a formula

$$A + b. \sin t,$$

we find for A and b the values

$$A = 0.3700 \text{ t.m. and } b = -0.00502 \pm 0.00017 \text{ t.m.}$$

$$\text{or in km. per sec. } b = -0.240 \pm 0.008.$$

The true value should be 0.245 km. per sec. Hence we find again an agreement within the limits of the probable error of the observed quantity. The observed annual and diurnal shifts are graphically represented in the figs. 4 and 5. The smooth curves indicate in each case the shifts due to the actual motions.

No doubt a more strictly scientific method, but also a far more troublesome one, would have been to determine the two shifts simultaneously from the measurements. I am confident, however, that the result would have been the same.

The outcome of the preceding calculations seems to be interesting from two points of view. Not only have the observations

established two new cosmic proofs of the validity of Doppler's

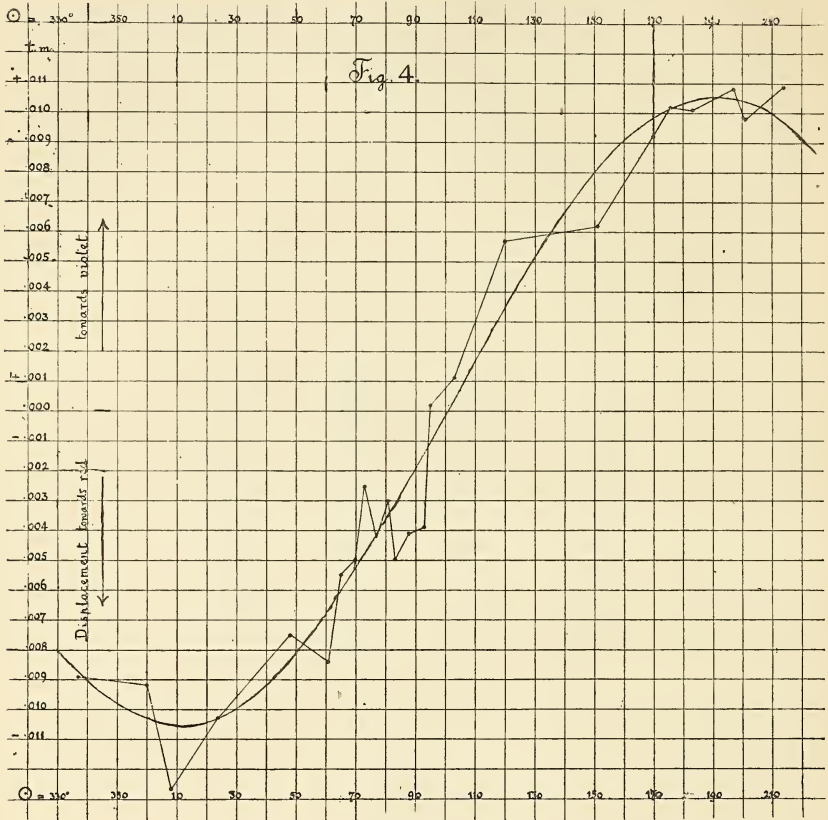

principle, but it seems also clearly shown that the Edinburgh

spectro-heliometer possesses an extraordinarily high degree of accuracy, which promises well for the future measurements of the solar rotation, and also for the eventual final decision on the question as to whether those enigmatic shifts of the solar lines mentioned above have to be assigned to a real cause.

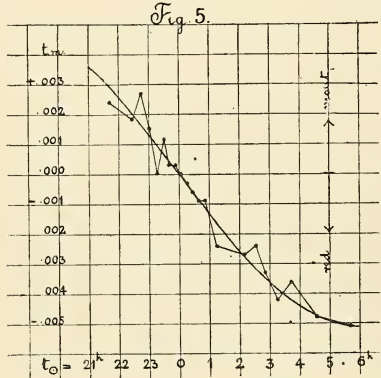

(Issued separately March 29, 1906.)

Preliminary Note regarding an Experimental Investigation into the Effects of Varying Diets upon Growth and Nutrition. By Chalmers Watson, M.D. *From the Physiological Laboratory of the University of Edinburgh.* Presented by Professor E. A. SCHÄFER, F.R.S.

(MS. received December 7, 1905. Read December 18, 1905.)

The object of this research, which is still in progress, is to determine the influence of various diets on the growth and nutrition of animals.

The diets employed have been—(1) uncooked horse flesh, (2) uncooked ox flesh, (3) rice boiled in water, (4) oatmeal porridge made with skim milk, (5) bread soaked in skim milk (the control diet). A known quantity of common salt was added to the rice and porridge foods, and an unlimited amount of water was given to all the animals except those fed on bread and milk. All the foods were supplied *ad libitum*. The chemical composition and heat values of samples of the various foods used were determined by Dr Andrew Hunter, and are given in the following table:—

Dried Foods.	Proteid.	Fat.	Carbohydrate.	Ash.	Physical Heat Values.		Physiological Heat Values calculated.
					Calculated.	Observed.	
Horse flesh	81·62	14·27	1·70	2·41	5506	5640	4772
Ox flesh	49·80	46·48	1·50	2·22	6967	6896	6519
Rice	7·65	1·08	88·76	2·57	4123	4098	4055
Porridge	16·11	8·24	72·15	3·50	4546	4610	4401
Bread and skim milk .	18·50	4·41	73·10	3·94	4341	4305	4176

The animals employed have been tame rats of various ages (in number over 300).

The observations have been as follows:—

(a) On *very young* rats newly weaned, the controls being taken from the same litter (10 litters).

(b) On *young* rats *æt.* 2 to 3 months (14 on each diet).

(c) On *adult* rats (10 on each diet).

(d) On *castrated* female rats * (17).

Throughout the observations the bread and skim-milk diet was employed as the control diet; it appears to be well adapted for the growth and nutrition of rats of all ages (see Charts I., II., III., IV.).

Special attention was directed to the influence of the various diets on the supervision of pregnancy, on the growth and nutrition of the animals in the second generation, and on the recuperative power of animals under a normal diet that had deteriorated in consequence of having been fed for a time, in some cases for more than one generation, on an unphysiological diet.

RESULTS.

Rice.—An exclusive diet of boiled rice arrests the growth of *young* rats. The animals always succumb eventually, although they may live for a few months. *Adults* lose weight rapidly, and die, as a rule, within two months. *Castrated female* rats tolerate the diet well, four out of five being alive and apparently in good health at the end of five months.

Porridge.—This diet retards the growth and is speedily fatal to *very young* rats (see Chart I.); a similar result is observed in the case of *young* rats *æt.* 2 to 3 months. *Adult* rats maintain their weight well for many months on this diet. It may be noted that the composition and heat value of the porridge is essentially the same as that of the bread and skim milk (see Table, p. 87).

Horse Flesh.—In *very young* rats (newly weaned) a diet of horse flesh retards growth and is uniformly fatal within a few months (see Chart I.). *Young* rats *æt.* 2 to 3 months exhibit a mixed result, the majority succumbing within a few months; a minority live, thrive, and become pregnant. The power of lacta-

* I am indebted to Dr F. H. A. Marshall and Mr W. A. Jolly for these animals.

tion appears to be weakened, and the mortality in the progeny is high. *Adult* rats can live on horse flesh and maintain their weight.

Ox Flesh.—An ox-flesh diet is tolerated by *very young* rats

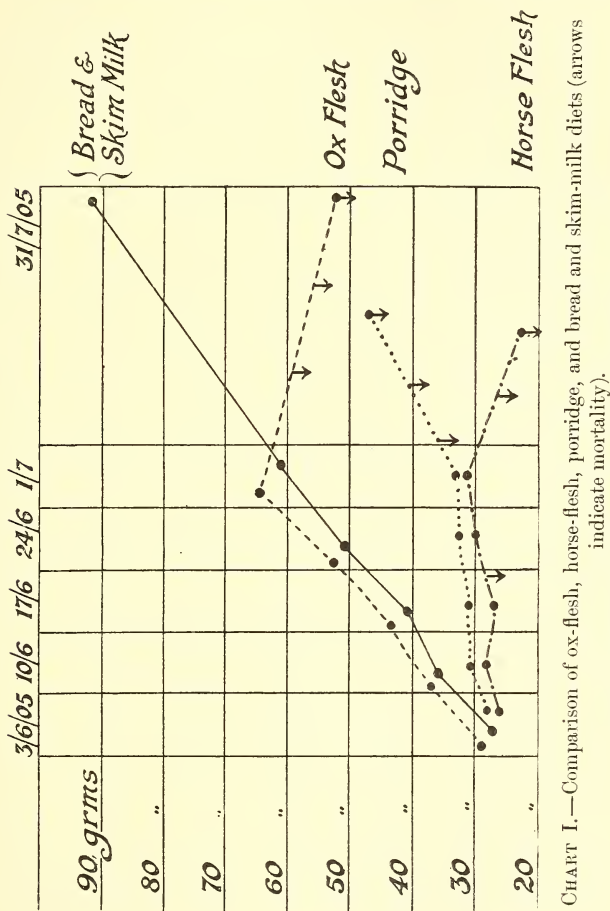

CHART I.—Comparison of ox-flesh, horse-flesh, porridge, and bread and skim-milk diets (arrows indicate mortality).
 Note.—Each curve represents the average of three animals.

better than horse flesh. About one-third of the animals failed to thrive, and succumbed within one or two months; the remainder appeared to thrive, but their gain in weight was appreciably less than in the control, bread, and skim-milk fed subjects. None of these animals became pregnant. In *young* rats *æt.* 2 to 3 months an ox-flesh dietary is conducive to rapid growth and development;

the animals may attain a greater weight than the controls. The animals become pregnant, but, as in the case of horse-flesh fed rats, the mortality of the progeny in early life is high.

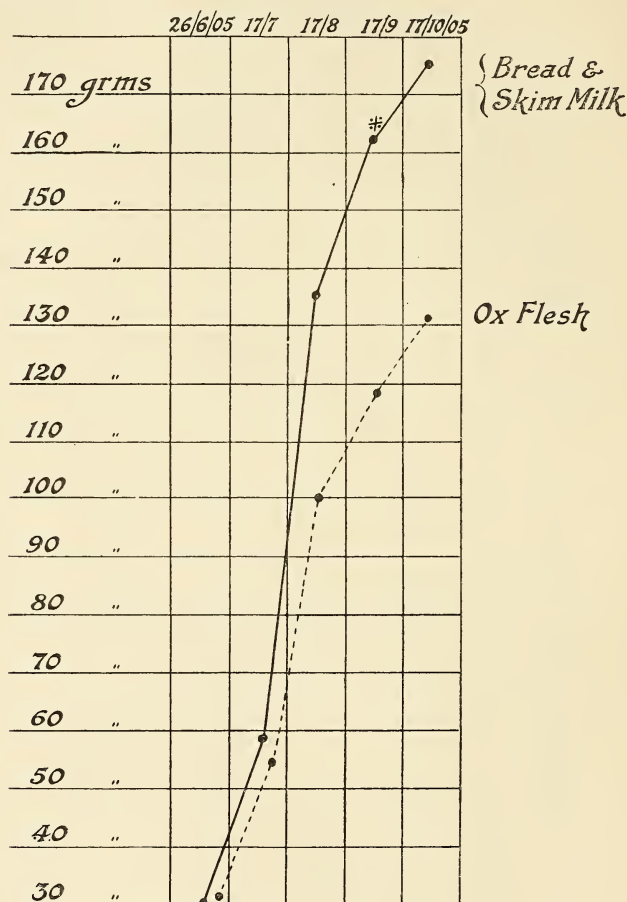

CHART II.—Comparison of ox flesh and bread and skim milk.

The black line=average of 2 fed on bread and milk—1 female which became pregnant.

The dotted line=average of 4 fed on ox flesh—2 females which remained non-pregnant.

Two illustrative charts may be given.

Chart I. shows that the ox-flesh fed animals succumbed within two months. A more usual result with this diet is illustrated in

* On 27/9/05 the female rat gave birth to a litter of eight.

Chart II., in which observation the ox-flesh animals lived and thrived for several months, but gained in weight more slowly and imperfectly than the controls (bread and skim-milk fed); and although kept along with males, the females failed to become pregnant.

INFLUENCE OF A MEAT DIET ON THE SECOND GENERATION.

The following figures illustrate the high mortality in early life of the second generation of meat-fed animals:—

	Litters.	Rats.	No. alive at end of One Month.	Percentage alive at end of One Month.
Meat (ox flesh and horse flesh)	13	93	19	20
Bread and skim milk	14	97	82	84

The effects of a meat diet on pregnancy are further shown by the following history of one rat which had four litters:—

	Date.	Diet.	Number of Young.	Result.
Litter 1.	April 22	Bread and skim milk	9	All lived and thrived.
„ 2.	June 23	Horse flesh	9	All died within two months.
„ 3.	July 30	Horse flesh	6	All died within one month.
„ 4.	Sept. 9	Bread and skim milk	8	All lived and thrived.

OBSERVATIONS ON THE RECUPERATIVE POWERS.

Observations were made on the recuperative power of animals which had been fed on an unphysiological diet for some time during the growing period and then transferred to a normal diet. Chart III. illustrates the recuperative power of three rats placed on a normal diet of bread and skim milk, after they had deteriorated in consequence of having been fed for six weeks on a diet of rice, horse flesh, and porridge respectively.

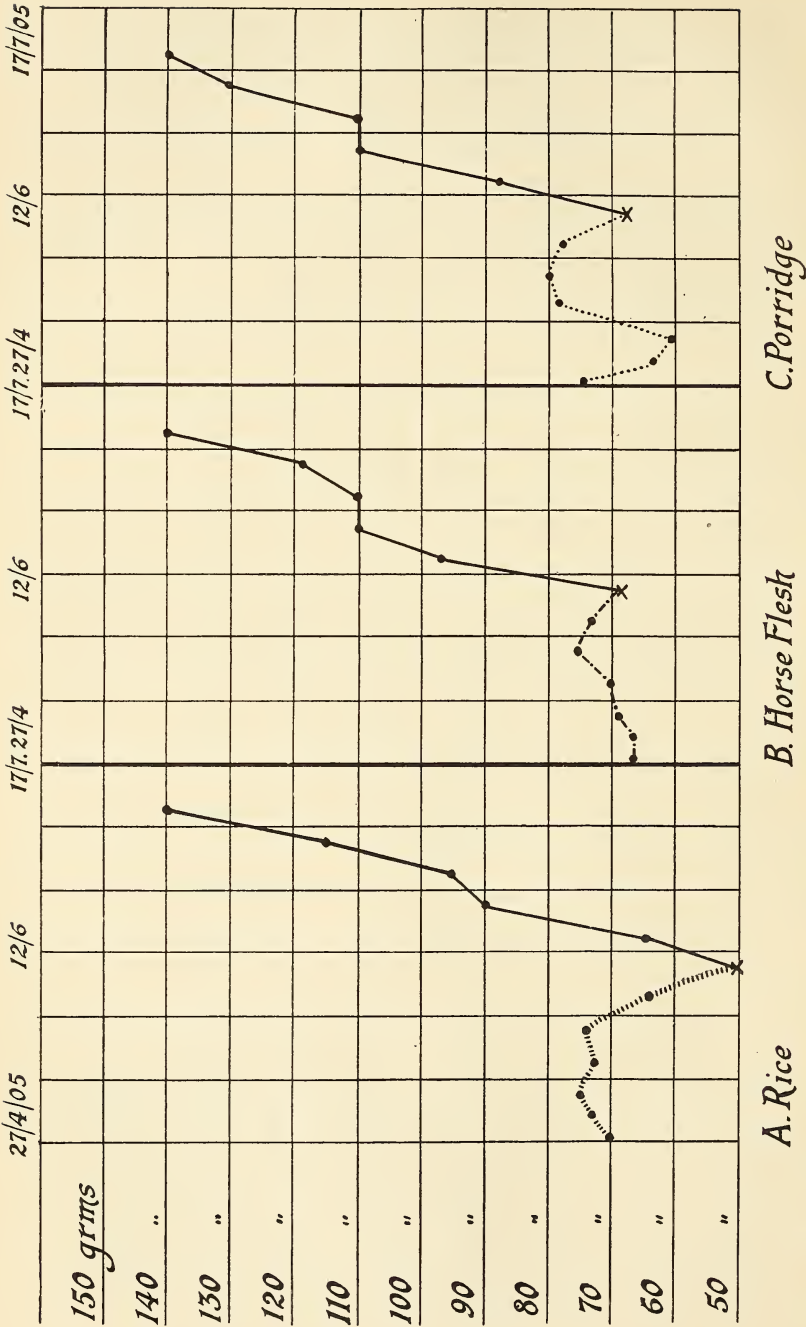

CHART III.—To illustrate the recuperative power of rats under a normal diet (bread and skim milk). Rat A had been fed for six weeks on an exclusive rice diet, B on horse flesh, and C on porridge. The normal diet was begun in all three cases on the same day (June 12). The growth within the following five weeks is striking.

In Chart IV. the recuperative power in the progeny of meat-fed parents is demonstrated. The animals (after weaning) were placed

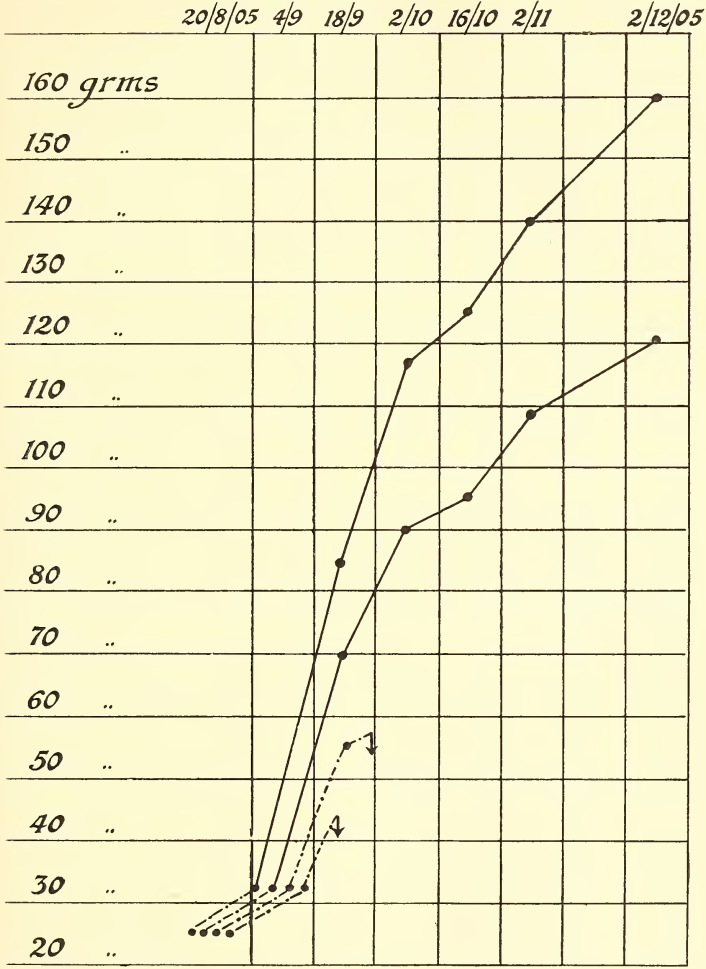

CHART IV. illustrates the recuperative power, under a normal diet (bread and skim milk), in the second generation of horse-flesh fed rats.

The rats (four) were weaned on 20/8/05, and placed on an exclusive horse-flesh diet. On 4/9/05 two were transferred to a bread and skim-milk diet, the meat diet being continued with the remaining two. The latter succumbed within two or three weeks.

on a horse-flesh diet for a period of two weeks, when two were transferred to a bread and skim-milk diet, with the results shown.

SUMMARY.

I. The use of an excessive meat diet in rats induces a deterioration in the health of the animals. This deterioration is shown in (a) an imperfect physical development, (b) a loss of reproductive power, (c) defective lactation, and (d) a high mortality in early life in the second generation of meat-fed subjects.

II. The recuperative powers of these deteriorated animals, on a normal diet, is very striking.

III. In animals deprived of their ovaries, the minimum amount of proteid required is less than in normal females.

(Issued separately February 22, 1906.)

A Contribution to the Study of the Excretion of Allantoïn in Thymus Feeding. By W. M'Lachlan, M.D. (*From the Research Laboratory of the Royal College of Physicians, Edinburgh.*) Communicated by Dr D. NOËL PATON.

(Read January 8, 1906. MS. received January 12, 1906.)

The establishment of the nature of the chemical relationship of the purin bodies, the diureides which form the chief end-product of proteid metabolism in birds and reptiles, with urea, the end-product in mammals, is not the least important of the valuable contribution of E. Fischer to physiological chemistry. The constant presence of diureides in the mammalian urine, and of urea in the urine of birds, shows that no hard-and-fast line exists between the metabolic processes in the two groups, and the fact that in the mammalian fœtus an important end-product of metabolism is a diureide—allantoïn—is a further proof of the close affinity of the tissue changes throughout the vertebrate series. Nor is this allantoïn merely a product of fœtal metabolism, for it has been found in small quantities in the urine of nearly all adult mammals in which it has been tested for. It was found in the urine of adult man by Ziegler and Hermann (1), and in that of cats, dogs, and rabbits, by Meissner (2). Pouchet (3) also found it in the urine of man, and in greater amount in the urine of pregnant women, as well as in diabetes insipidus and convulsive hysteria. Salkowski (4) found it in the urine of the ox to the extent of 0·775 gm. per 1000 c.cm.

I have found it in the urine of a rabbit to the extent of 0·14 per cent., and in the dog, upon a diet of oatmeal and milk, I have found, by the method afterwards to be described, the following amounts :—

	Per cent.
	0·11 gm.
	0·10 „
	0·05 „
	0·06 „
	<hr/>
Average,	0·08 „

Not only is allantoin known to be normally present, but when disturbances in the metabolism are produced by drugs its amount may be increased.

Pohl (5) failed to find allantoin in the tissues of the normal dog, but in hydrazine poisoning he found it in the liver and in traces elsewhere. On a few hours' autolysis of the organs, allantoin appeared chiefly in the intestinal mucous membrane and in the liver.

Hydroxylamine may cause the appearance of allantoin, but it does not appear with arsenic or phosphorus (Pohl) (5).

In dogs diamido sulphate injected in doses of .05 gm. per kilo causes coma and death, with the presence of allantoin in the urine (Borissow) (6). Hydrazine sulphate does not cause the production of allantoin.

In the urine of some animals, *e.g.* the dog, allantoin largely takes the place of uric acid, and the administration of uric acid has been said to lead to the excretion of allantoin, the uric acid being supposed to be oxidised and hydrated with the splitting off of CO_2 —

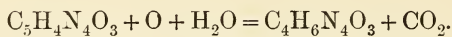

Thus Salkowski (7) demonstrated its presence after feeding uric acid to dogs. When 4 grammes were given on each of two successive days, 1.42 grammes of allantoin were recovered. Mendel and Brown (9) obtained a considerable yield of allantoin after feeding uric acid to cats. Poduschka (8), on the other hand, found that the administration of two grammes of urate of soda caused no increase in the allantoin of a dog's urine. Swain (11) has failed to find a marked transformation of uric acid to allantoin. After the administration of 9 grammes of uric acid, only 1 gramme of allantoin appeared in the urine.

Minkowski (10) showed that when hypoxanthin is given, 77 per cent. appears as allantoin, and that 9 methy-adenin also causes an increase of allantoin. He expresses the view that in the dog the metabolism of the purins still in nucleic acid more readily yields allantoin than the metabolism of the free purins. According to his observation adenin, the purin of the thymus, is not changed to allantoin, and Stadthagen (12) found that guanin, the purin of the pancreas, was not changed.

Mendel and White (13) injected lithium urate in doses of 1 gramme into the veins of dogs, and they record the appearance of allantoïn in the urine. The appearance was not constant, and the amount was small in all cases, being somewhat larger when the injection was made into the portal vein. When it is remembered that mere autolysis of the liver causes the production of allantoïn (Pohl) (5), the significance of these experiments in indicating a production of allantoïn for uric acid is decreased. It might be urged that the allantoïn underwent further change in the organism, but the fact that allantoïn, when injected, is nearly all recovered in the urine, invalidates such an explanation. The origin of allantoïn from uric acid is, therefore, by no means satisfactorily established.

The possible relationship of allantoïn to uric acid and the purin bases tends to connect it with the metabolism of the nucleins, and evidence has been adduced by Mendel, Underhill, and White (14), that in the dog it is formed from this source. By injecting preparations of nucleic acid, prepared from different sources, into the blood vessels, intraperitoneally and subcutaneously in dogs, they caused the appearance of allantoïn in the urine. The symptoms produced by these injections were fairly marked, and the possibility must be borne in mind that the appearance of allantoïn may be ascribed to a toxic action, just as the increased excretion of uric acid, observed by Loewi (15), is, after the subcutaneous injection of sodium nucleate, ascribed by them to a toxic effect.

While the effects of administering the purin bodies, either free or still combined in nucleic acid, upon the production of allantoïn is by no means distinct, the administration of thymus gland substance is always very pronounced. Minkowski and Cohn (10) discovered, independently, that allantoïn may be excreted in the dog as an end-product in the metabolic processes which give rise in man to uric acid after thymus feeding, and an enormous rise in the excretion of allantoïn in the dog under the administration of thymus gland was discovered by Salkowski. This is generally explained as the result of the katabolism of the nucleins contained, but so far this theory has not been tested by actual experiment.

PRESENT INVESTIGATION.

The object of the present investigation is to elucidate the question of the nature of the relationship of the excretion of allantoin to the administration of thymus gland.

A. METHODS.

1. *Methods of Analysis.*

(A) Allantoin Estimation.

The following methods were tried and rejected:—

(a) Loewi's method (16)—a method which depends upon the precipitation of the nitrogenous compounds by means of mercurous nitrate without precipitating allantoin—is unsatisfactory owing to the fact that mercurous nitrate, if too acid, or if impure (containing mercuric nitrate) will also precipitate allantoin.

(b) The second method—that of Moscatelli (17)—consists in the precipitation of allantoin with mercuric nitrate.

The subsequent washing of the precipitate was found to result in considerable loss.

Another cause of loss is the addition of too much ammonia, by which the allantoin nitrogen is set free.

(c) The next method adopted was that of Poduschka (8), of which the following is a description:—

A measured quantity of the urine is precipitated with basic lead acetate, and the excess of lead is removed from a definite volume of the filtrate by concentrated sodium sulphate solution. To a definite volume of the second filtrate 5–10 per cent. silver nitrate solution is added. This is filtered, and 1 per cent. dilute ammonia is added to the filtrate, and the precipitate is washed with 1 per cent. sodium sulphate solution until free from ammonia, and the allantoin is estimated by Kjeldahl's method.

The difficulty with this method is to render the precipitate free from ammonia.

If the precipitate be not free from ammonia, then the nitrogen of the added ammonia would be estimated as allantoin nitrogen. To render the precipitate ammonia-free it must be washed with 1 per cent. sodium sulphate until the alkaline reaction to red litmus

has disappeared. The results with pure allantoin gave only a small fractional return, and with the washing the precipitate was visibly disappearing. The presence of silver allantoin was demonstrated in the filtrate, and hence the method proved unreliable. It would therefore appear that the more one washes the precipitate, the smaller is the result, and the less one washes the precipitate, the nearer it approaches to a correct result, although not free from ammonia.

To overcome this difficulty the following modification of Poduschka's method was devised:—

To 50 c.c. of the urine basic lead acetate was added, and the excess of lead was removed from the filtrate by concentrated sodium sulphate solution.

This was filtered, and to the filtrate was added silver nitrate solution (5-10 per cent.), and again filtered, until no further precipitate formed in the filtrate upon the addition of silver nitrate solution.

Dilute ammonia was then added to the new filtrate, and the allantoin silver was precipitated and filtered.

The precipitate and filter paper were then placed in an Erlenmeyer's flask, with a pinch of oxide of magnesium, as in Mörner and Sjoquist's method, and a little water was added. This was placed over the steam-bath at 60° C. for $\frac{3}{4}$ hour.

By this modification the ammonia was liberated, and only the nitrogen of the allantoin was retained. Even if the allantoin undergoes a decomposition into urea, there is no loss of nitrogen.

The flask and its contents were then left to cool, and the same flask, to avoid loss in transferring the contents to a Kjeldahl's combustion flask, was used for oxidation.

Pure sulphuric acid was then added, and the process continued as Kjeldahl's method, by means of which the nitrogen was estimated and the allantoin equivalent was calculated. Deduction was made for the nitrogen in the filter paper and the sulphuric acid, and the loss in the several stages of filtration was measured and the final filtrate treated as an aliquot portion.

The method of estimation by silver precipitation has been criticised by Salkowski (4) as one of the most difficult of reactions, but as carried out by me it has yielded satisfactory results.

This modification has been tested with Merck's allantoin, which itself was found to be pure by determining the nitrogen by Kjeldahl's method.

When dried in a desiccator, .5 gm. was found to yield .49 gm. The loss during each stage of filtration was calculated, and left .46 gm. to be recovered, as the final filtrate was estimated as an aliquot portion. The actual recovery was .46 gm. or 100 per cent. In another experiment 99.6 per cent. was recovered.

(B) Other Estimations.

The total nitrogen was estimated by Kjeldahl's method.

Methods of Experiment.

For the experiments the animals used were a setter and retriever bitch—each of known weight—and the urine was collected into dilute hydrochloric acid.

B. RESULTS.

The allantoin excretion was first found on a diet of oatmeal and milk, the quantities being 300 gm. oatmeal and 700 c.c. milk. Oatmeal contains .0212 per cent. purin nitrogen, and milk .002 gm. per litre, according to Dr Walker Hall. From this one finds that the diet of oatmeal porridge and milk contains .065 gm. purin nitrogen.

TABLE I.

Allantoin per diem upon oatmeal and milk diet.

1.140	gm.
0.901	„
0.512	„
0.683	„
<hr style="width: 50px; margin: 0 auto;"/>	

Average, 0.809 „ = 0.28 N.

The animals were then fed upon weighed quantities of thymus gland or other substance to be studied. The thymus gland of the ox was procured from the butcher, and the fat determined in a sample. Having estimated the amount of fat, the animal to be experimented upon was fed upon a known weight of thymus gland, deduction being made for the amount of fat.

After raw thymus a marked rise in allantoin excretion was observed.

TABLE II.

Observations.	Allantoin in grammes per diem.	Allantoin Nitrogen in grammes per diem.	Food. <i>Raw Thymus.</i>
1. Setter	5·039	1·786	950 grm.
2. Setter	6·906	2·448	950 grm.
3. Retriever	3·698	1·311	680 grm.

This simply confirms the results of Salkowski.

Are the nucleins and purins of the thymus administered the source of the allantoin excreted? If this were so, simply boiling the thymus given to the animal, since this does not change the nucleins or purins, should not modify the yield of allantoin.

The question was tested in two ways.

1st. By estimating the excretion of allantoin per 100 grm. of raw and per 100 grm. of boiled thymus gland administered.

These results may be tabulated thus:—

TABLE III.

Raw Thymus.

Observations.	Allantoin.		Allantoin per 100 grm. Thymus, less fat.	Food.
	Per cent.	Per diem.		
1. Setter	2·65	5·039	·616	950 grm.
2. Setter	1·151	6·906	·690	950 grm.
3. Retriever bitch	·617	3·704	·708	680 grm.
	Average,	5·2	·671	860 grm.

TABLE III.—continued.

Boiled Thymus.

Observations.	Allantoïn.		Allantoïn per 100 grm. Thymus, less fat.	Food.
	Per cent.	Per diem.		
1. Retriever bitch	·314	1·480	·251	684 grm.
2. „	·431	1·568	·267	680 grm.
3. „	·466	3·032	·325	1080 grm.
4. „	·311	4·977	·498	1160 grm.
	Average,	2·7	·335	901 grm.

The effect of the raw thymus is thus double that of the boiled.

2nd. By studying the proportion of the nitrogen of the urine to the nitrogen in allantoïn after feeding on raw, and after feeding on boiled, thymus gland.

TABLE IV.

Proportion of Total Nitrogen to Allantoïn.

Observations.	Total Nitrogen.		Allantoïn Nitrogen.			Food.
	Per cent.	Per diem.	Per cent.	Per diem.	Per cent. of total Nitrogen.	
1. Setter	2·62	4·984	·94	1·786	*36·4	<i>Raw Thymus.</i> 950 grm.
2. „	2·35	14·159	·408	2·448	17·3	950 grm.
3. „	·946	12·3	·051	·663	5·3	<i>Boiled Thymus.</i> 790 grm.

* The correctness of this figure is further indicated by the fall in the percentage of nitrogen in urea from about 84 to 57.

The percentage of allantoïn nitrogen after thymus feeding in the case of the setter is thus 36·4 per cent., and 17·3 per cent. upon a diet of raw thymus gland, and 5·3 per cent. in the case of boiled thymus gland.

These observations appear to negative the view that the allantoïn found is simply derived from the nucleïns and purïns of the thymus.

To what extent is the increased excretion of allantoïn after boiled thymus due to the free purin bodies?

To test this question, a watery extract of 750 grms. of boiled thymus was prepared and fed to the dog. This, of course, contained the free purins, but not the nucleo-proteids.

The result was the appearance in the urine of 0.365 gm. of allantoïn per 100 gm. thymus—an amount which corresponds closely with that which follows boiled thymus. This tends to show that the free purins are the source of the allantoïn after boiled thymus is given.

The Part played by Nucleins in the Production of Allantoïn.—Since, in feeding with *boiled* thymus, the increased formation of allantoïn appears to be due to the purin bodies, it seemed of interest to investigate how far the formation of allantoïn may be varied by varying the amount of nucleins in the food. For this purpose the proportion of nitrogen in allantoïn to the total nitrogen excreted was investigated on the following diets—oatmeal and milk, liver, raw pancreas, boiled pancreas, and beef.

Food.	Total Nitrogen.		Allantoïn Nitrogen.		Allantoïn Nitrogen, per cent. of total Nitrogen.
	Per cent.	Per day.	Per cent.	Per day.	
1. Thymus raw, 950 gm.	2.62	4.9	.940	1.786	36.4
,, 950 gm.	2.35	14.1	.408	2.448	17.3
2. Thymus boiled, 790 gm.	0.94	12.3	.051	.663	5.3
3. Raw pancreas, 1200 gm.	2.0	5.4	.184	.496	9.1
,, 1000 gm.	3.67	9.1	.520	1.300	14.2
4. Boiled pancreas, 730 gm.	1.7	6.3	.045	.162	2.5
,, 780 gm.	3.8	14.0	.046	.165	1.1
5. Liver, 560 gm.	2.5	8.7	.157	.533	6.1
,, 560 gm.	3.3	8.4	.147	.367	4.3
6. Beef, 200 gm.	4.0	8.1	.093	.186	2.2
7. Oatmeal 300 gm., Milk 700 c.c.,	0.62	6.3	.040	.404	6.4
,, ,,	0.59	5.2	.036	.313	6.0
,, ,	1.3	3.54	.141	.364	10.2

When fed on raw and boiled pancreas, the results were thus:—

Allantoin in grammes per 100 gm. pancreas.

·49	.	.	.	Raw
·24	.	.	.	Raw
·14	.	.	.	Boiled

The effect was slighter, but in the same direction as the thymus.

Salkowski fed a small dog on five successive days upon $1\frac{3}{4}$ kgs. boiled pancreas. In the urine 3·089 gm. allantoin, or 1·074 gm. nitrogen, with 40·7 gm. total nitrogen (2·64 per cent. of the total). Uric acid and purin bases showed no rise. Seven weeks later 2 kgs. pancreas caused only 1·058 gm. allantoin.

It will thus be seen that in the dog, upon a purin-poor diet, about 6 per cent. of the total nitrogen is in the form of allantoin. The proportion remains unaltered when liver is administered, and when moderate amounts of raw pancreas are given, while it may rise temporarily to 14 per cent. when large quantities of raw pancreas are eaten. But, even then, the effect of these diets, rich in nucleins, was to produce at most a slight change in the proportion of allantoin nitrogen to the total nitrogen.

CONCLUSIONS.

These investigations seem to show:—

1. That allantoin is a normal constituent of the urine of the dog on all diets.
2. That the administration of raw thymus causes a great increase in the production of allantoin (·188 gm. allantoin nitrogen per 100 gm. thymus gland, or 36·4 per cent. of total nitrogen).
3. That boiled thymus produces a much less marked effect (·083 gm. allantoin nitrogen per 100 gm. thymus gland, or 5·3 per cent. of total nitrogen), and that therefore the increased formation of allantoin, after feeding with raw thymus, is not simply due to the nucleins and purins contained.
4. That liver and pancreas, although rich in nucleins, cause a rise of only ·08 gm., and ·08 gm. respectively of allantoin

nitrogen, per 100 grm. of organ, or 5.2 and 11.6 per cent. of total nitrogen.

5. The evidence seems to indicate that the administration of raw thymus, and to a less extent of raw pancreas, exercises some specific action on the production of allantoïn.

To Dr Noël Paton, Superintendent of the Research Laboratory of the Royal College of Physicians, I am indebted for much advice and assistance during the progress of the research, and in the preparation of this paper.

The expenses of this research were defrayed from Mr Francis Mason's donation to the Laboratory for the Investigation of the Ductless Glands.

REFERENCES.

1. ZIEGLER und HERMANN, *Archiv f. Gynäkologie*, iii., 1871.
2. MEISSNER, *American Journal of Physiology*, vi.
3. POUCHET, *Contrib. à la conuuis. des mat. extra. de l'urine*, Paris, 1880, xxviii., 37.
4. SALKOWSKI, *Zeitsch. f. phys. Chem.*, Bd. xlii., p. 217, 1904.
5. POHL, *Archiv für experimentelle Pathologie*, xlvi. 367.
6. BORISSOW, *Zeitschrift für physiologische Chemie*, xix., 499.
7. SALKOWSKI, *Berichte der deutschen chemischen Gesellschaft*, 1876, ix. p. 719.
8. PODUSCHKA, *Archiv für experimentelle Pathologie und Pharmakologie*, 1900, p. 65.
9. MENDEL and BROWN, *American Journal of Physiology*, 1900, iii. p. 267.
10. MINKOWSKI, *Centralblatt für innere Medicin*, 1898, No. 19.
11. SWAIN, *American Journal of Physiology*, vol. vi.
12. STADTHAGEN, *Archiv für pathologische Anatomie*, 1887, cix. p. 418.
13. MENDEL and WHITE, *American Journal of Physiology*, 1903, viii.
14. MENDEL, UNDERHILL, and WHITE, *American Journal of Physiology*, 1902, vii. p. 397.
15. LOEWI, *Archiv für experimentelle Pathologie und Pharmakologie*, 1901, xlv. p. 157.
16. LOEWI, *Archiv für experimentelle Pathologie und Pharmakologie*, 1900, xlv. p. 20.
17. MOSCATELLI, *Zeitschrift für physiologische Chemie*, 1889, xiii. p. 203.
18. WALKER HALL, *Purin Bodies*, pp. 46 and 49.

NOTE BY D. NOËL PATON.

Dr M'Lachlan having been compelled to abandon the investigation, I thought it well to determine the influence of feeding with lymphatic glands upon the production of allantoin. The abdominal lymphatics of the ox, freed from fat, were used. When given to the setter used in the previous experiments, they were vomited, and when next given, the dog refused to eat them.

A fox terrier, weighing about 6 kilos, was consequently used.

As I found it difficult to be sure that the ammonia is entirely got rid of from the silver allantoin precipitate by the method employed by Dr M'Lachlan, I adopted the plan of passing a current of air through the Erlenmeyer's flask, kept at 60° C. for several hours, till no change was produced on a piece of wet red litmus paper held in the flask.

The following results were obtained:—

Urine of	Total N. per cent.	Allantoin N. per cent.	Allantoin N. per cent. of total.
24th to 27th, after Pancreas 500 grm. . . .	1.00	{ 0.06 0.06	6
27th to 29th, Fast	1.87	0.038	2
29th to 31st, after 325 grm. Lymph Glands.	0.549	0.059	10

It would thus seem that the administration of lymph glands causes an increase in the allantoin of the urine very little greater than that caused by feeding with pancreas, and that its effect is much smaller than that produced by thymus feeding.

(Issued separately, March 29, 1906.)

On the Formation of certain Lakes in the Highlands. By
 Dr Léon W. Collet, F. Swiss Geol. S., Assistant to
 Sir John Murray, K.C.B., and Dr T. N. Johnston,
 F.R.S.E. With a Note on **Two Rock Basins in the Alps**,
 by Dr Léon W. Collet.

SCOTTISH LAKE SURVEY.

Under the direction of Sir JOHN MURRAY, K.C.B., F.R.S., D.Sc.,
 LL.D., etc., and LAURENCE PULLAR, F.R.S.E.

(Read February 19, 1906.)

When surveying the lochs of the Dee basin in the Highlands, we came across three interesting lochs on the formation of which we propose to deal in this paper.

LOCH MUICK.

Loch Muick (see fig. 1) lies at the head of Glen Muick, at a height of 1310 feet, on the property of His Majesty the King. On both sides of the loch the mountain slopes rise precipitously from the water's edge, and reach a height of 2400 feet on the south-east and from 2326 to 3352 feet on the north-west. The rocks surrounding the lake are granite.

The loch trends in a N.E. and S.W. direction, and is $2\frac{1}{4}$ miles in length, the maximum breadth being $\frac{1}{2}$ mile at the north-eastern end. The maximum depth recorded is 256 feet, and the mean depth calculated from the volume of water is 111.69 feet, approaching the half of the extreme depth. The ratio of maximum depth to the length is 46. That figure shows the importance of this basin, as in Loch Morar, the deepest loch in the British Islands (1017 feet), that ratio is 61, and the Lake of Geneva is 230 times longer than the maximum depth.

Loch Muick is fed by numerous small burns and streams, the largest feeder being the Allt an Dubh-loch coming from the Dubh loch, which lies at the very head of the glen, at a height of about 2100 feet. The Glas Allt flows into the loch on the north-

western shore near the south-western end, forming a big delta which is extending into the loch. The delta is wooded in contrast with the other shores, which are but scantily clothed with vegetation. The Black Burn flows into the loch near the middle of the south-eastern shore, and does not form a delta, for it runs down a steep rocky slope.

We found the deepest part of the loch where the mountain slopes on the opposite sides are steepest and the valley narrowest, this fact being an important one, as will be shown further on. Our soundings (87) show that the basin is of simple conformation, the bottom sloping on all sides towards the deepest part. Indeed the bottom of Loch Muick is a very flat one, as shown by the following figures:—

Feet.	Acres.	Per cent.
0 to 50	170·41	31·06
50 „ 100	95·96	17·49
100 „ 150	68·59	12·51
150 „ 200	90·63	16·52
200 „ 250	113·37	20·67
over 250	9·60	1·75
	548·56	100·00

The contour lines of depth approach each other more closely along the south-eastern shore, showing that the slope is steeper there than along the opposite shore.

The valley or glen in which Loch Muick lies has been occupied in the Great Ice Age by a glacier, as is shown by its U-shaped cross-section. That shape is the most appropriate one for the glacier's movements, according to Penck,* the well-known continental authority in glacial matters.

Loch Muick partakes both of the character of a rock basin and of a barrier basin. The barrier is the latest moraine thrown down by the glacier that once crept along the glen, and it serves still, as at first, to dam back the drainage. A small part of the barrier is above the level of the water, but by far the greater part is sub-

* Dr A. Penck, "Glacial Features on the Surface of the Alps," *Geogr. Teacher*, vol. iii., p. 49, 1905.

merged, as shown on the sketch map by the irregular and stony bottom at the north-eastern extremity of the 50-foot area. We suppose the barrier to be represented by the slope from the north-eastern end of the loch to the 100-foot contour.

Let us now discuss why we consider Loch Muick to be a rock basin.

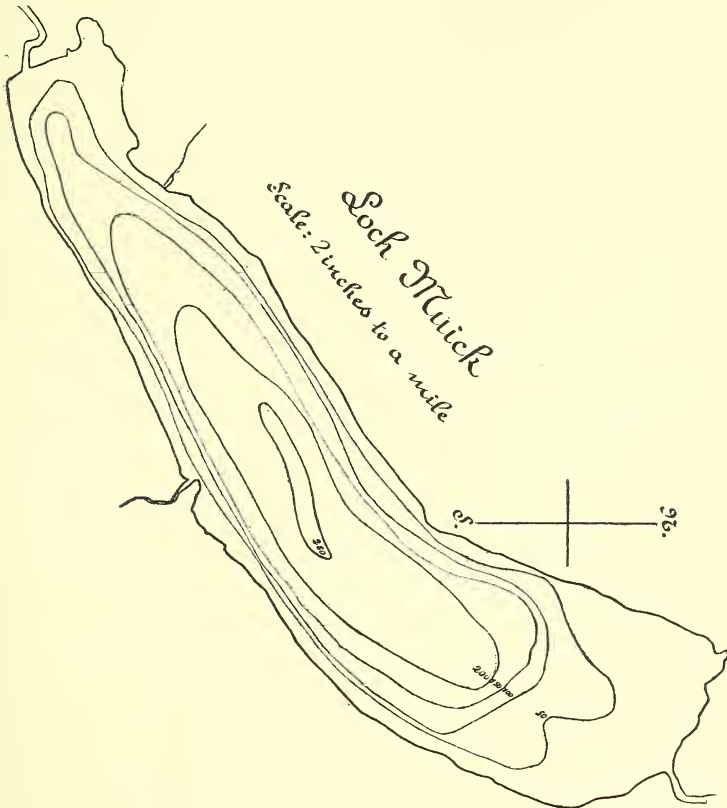

FIG. 1.—LOCH MUICK.

1. If Loch Muick were not a rock basin, the frontal moraine which dams the drainage would be 200 feet high, a figure far too big for a small glacier, for we must not forget that this moraine was the last one deposited by the Muick glacier. The fact that we have never seen moraines 200 feet high, neither in actual glaciers nor at the head of glens, where one meets with moraines,

prevents us from saying that Loch Muick is only a lake dammed up by an old frontal moraine.

2. Penck has shown that a mass of ice coming from a semi-circular head would be pressed into the diameter of the same circle, and in order to maintain a continuous movement, an increase of velocity would be necessary at this place, and this increased velocity must affect the bed of the glacier, until a sufficient depth is attained. Now and then the increase of depth corresponds to the decrease of width in the glaciated valley. On the other hand, a sudden increase of width in a glaciated valley is often connected with a diminution in the depth of the trough. We think that, in the case of Loch Muick, precisely these conditions are present.

3. We pointed out that the submerged south-eastern slope was far steeper than the opposite one. We may find an explanation of this in the fact that the glacier, being forced to change its course at that part, must have exerted a tremendous pressure on the south-eastern slope.

We think we are justified, therefore, in saying that Loch Muick exhibits the characters of a rock basin and of a barrier basin.

LOCH CALLATER.

Loch Callater is a small, narrow loch, lying in Glen Callater, about 5 miles to the south of Braemar, at an elevation of 1625 feet. Its length is 0·84 mile, and the maximum breadth 0·20 mile. The maximum depth recorded is 29 feet. Loch Callater is a true barrier basin, dammed up by a frontal moraine. The burn flowing out of the loch has cut its way through the moraine. At the head of the loch is a large alluvial tract, which evidently at one time formed part of the lake, when the level of the water was higher, and before the burn had cut its way so deeply in the barrier. Indeed the loch is destined to disappear in the future. By and by the alluvial matter will fill up the head of the loch, and simultaneously the burn will cut its way deeper through the barrier, until ultimately the lake will be drained and converted into an alluvial plain, as has been shown by Sir Archibald Geikie and Professor James Geikie.

LOCH BUILG.

Loch Builg (see fig. 2) lies in a short and narrow transverse valley, between Glen Avon and the head of the Gairn valley, at a height of 1586 feet. It is 0·80 mile in length, the maximum breadth being 0·22 mile. The deepest sounding recorded is 86 feet. The loch is the only one observed by the staff of the Lake Survey which is dammed up at both ends by moraine matter. It belongs to the Spey basin, as its normal outflow is at the north

Loch Builg

Scale: 6 inches to a mile.

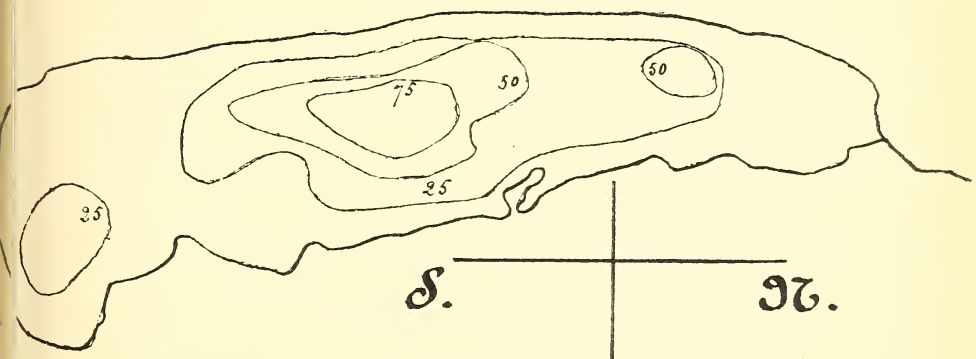

FIG. 2.—LOCH BUILG.

end, but it also contributes to the Dee, as water percolates through the moraine at the south end. As regards the formation of this loch, we believe that at the beginning of the later glaciation a lobe of ice passed northwards from the valley of the Gairn by Loch Builg, towards the Avon, which laid down a frontal moraine at its north end. Mr Hinxman, who mapped the area round Loch Builg, when consulted by Dr Horne, confirmed this view. Now, to what is due the dam at the south end? After its regression, the glacier, increasing considerably, began again to creep down the mountain, now following the direction of the Gairn, laying down lateral moraines, of which one dammed the loch at the south end.

The bottom of Loch Builg is divided into three basins, the more important one being in the middle of the loch. These basins are separated by two ridges, as shown on the sketch map. These shallows might be caused by moraines on the floor of the lake, which seems to us a better explanation than to suppose that these basins are separated by rocky barriers; it is impossible, however, to give a definite opinion on this point. When sounding, we found along the western shore a submerged talus one foot below the water level, about 12 feet broad, with a steep slope falling suddenly to 12 feet. Have we here an ordinary talus at the foot of a slope, or a submerged moraine? It is impossible to say; anyhow, the fact is worthy of record.

NOTE ON **Two Rock Basins in the Alps.** By Dr Léon W. Collet, F. Swiss Geol. S., Assist. to Sir John Murray, K.C.B.

True rock basins are not rare at the head of many small mountain valleys or corries of France and Switzerland. Many flat alluvial plains above gorges in Switzerland, as well as in the Highlands of Scotland, were without doubt at one time glen lakes, as they are called by Sir Archibald Geikie, or true rock basins which have been filled up by the sand and the mud brought into them by their tributary streams.

I propose in this short note to describe two of these interesting rock basins situated at an elevation of about 5500 feet on the mountains called by Swiss geologists "Hautes Alpes Calcaires" (high calcareous Alps).

1. PLAIN OF BARBERINE.*

The plain of Barberine, as shown in fig. 3, is an alluvial one, crossed in its length by a stream; its cross-section is U-shaped. At the lower part of the plain the stream enters a gorge with steep slopes, *i.e.* with a V-shaped cross-section. The plain is an old true rock basin, which has been eroded by the glacier coming from the peaks above (where there are still hanging glaciers), and has

* For the geological map of the region, see L. W. Collet, *Mat. Carte Géol. Suisse*, liv. xix., nouv. série, 1904.

been filled up by detrital matter brought down the slopes by the streams. The plain is surrounded by Trias and Lias limestones. The gorge at the lower end is eroded in the gneiss, and on the slopes we can see beautiful "roches moutonnées." At first the gneiss resisted better the erosive action of the glacier than the limestones, and formed a rock barrier. When the glacier retreated, the stream cut its way through the rock barrier, making a V-shaped gorge. The glacier increasing again considerably, the ice found its way through the gorge scooped out by the stream. The gorge in



FIG. 3.—PLAIN OF BARBERINE.

the gneiss may be due to river erosion during an interglacial period. The lake, now filled up, was due to glacial action in the softer rocks.

2. LAKE OF VOGELLE.

The small lake of Vogelle (see fig. 4) is one of the most beautiful examples of a rock basin I have ever seen. It is a corrie lake eroded by the hanging glacier out of the soft limestone called "Neocomien," or Lower Cretaceous, the rocky barrier at the end of the loch being composed of a hard limestone called "Malm," or Upper Jurassic.

The photographs which accompany the present note speak for themselves, and show that we have here true rock basins.

Conclusions.—I have here dealt with two examples of rock basins or corrie lakes. Now, if small corrie glaciers have been able to erode rock basins, *a fortiori* the tremendous valley glaciers would erode rock basins. In my opinion the erosive action of a glacier is not only due to the pressure of the ice on its bed, but also to the action of the water running over the bed; for the water will fill up the



FIG. 4.—LAKE OF VOGEALLE.

cracks and fissures of the bed, and, in certain seasons when freezing and melting take place, will be a powerful agent of disintegration. It is a fact well known to mountaineers and climbers that the water running underneath the glaciers during the day freezes during the night at the end of the summer and in autumn, cutting off the supply of the streams originating therefrom. That fact is worth noting, because many antiglacialists say that a glacier is a protecting cover on the rocks.

As a heading to chapter xvi. of his book *Ice or Water*, Sir

Henry H. Howorth gives this quotation from Lamplugh : "This is the first glacier I have visited, and I brought away the impression that on the whole it was easier to give explanations of glacial phenomena before I had seen ice!" I am not of the same opinion, and I am sure that we can learn from the study of the present glaciers that there is a lateral action of the glacier against the walls of the surrounding cliffs, an erosive action which is small, I must say, but which cannot be denied. Now, when talking about the tremendous glaciers of the Great Ice Age which in Switzerland reached a thickness of 3000 feet, we are obliged to say that if the present glaciers, which are insignificant in comparison, have an erosive action, *a fortiori* those of the Great Ice Age must have been able to erode rocks.

I have given in this short note facts of observation collected during my climbs in the Alps and during my geological studies in the field. I desire to thank Mr James Chumley for assisting me in preparing this paper for the press.

CHALLENGER OFFICE,
EDINBURGH, *January* 1906.

(*Issued separately April 16, 1906.*)

On the Distribution of the Proper Fractions. By
Duncan M. Y. Sommerville, D.Sc. Communicated by
Professor CHRYSTAL.

(MS. received 15th January 1906. Read March 19, 1906.)

CONTENTS.

Sec.	Page	Sec.	Page
Introduction	116	N.D. is an Even Distribu- tion for Symmetrical Loading	125
1. Normal Distribution	117	7. Division into more than n Classes	125
2. General Theorems on the Normal Distribution	119	8. Division into fewer than n Classes	125
3. Method of writing down N.D.	120	Submultiple Division	126
Tables. N.D. for $\frac{*}{\sqrt{12}}$ and $\frac{*}{\sqrt{13}}$	121	9. Method of writing down any distribution	126
4. Other "even" Distributions	122	Table. Distribution of $\frac{*}{\sqrt{24}}$ into 8 Classes	127
5. Evenest Distributions by the Coalescing of Pairs of Classes	124	10. General Equations for any Distribution	127
6. Equations satisfied by the Weights of the Loaded Denominators	124	11, 12. Effect of omitting the Lower Denominators	128

In statistical work which deals with integral variates, the data frequently appear in the form of ratios, or unreduced proper fractions, *e.g.* sex- and fecundity-ratios; * and to facilitate comparison these are arranged in classes, all the ratios falling within the same class being considered as equivalent. These classes must, as far as possible, contain an equal number of the ratios. Further, in certain fields the different kinds of ratios do not all occur with the same frequency, that is, one denominator will occur more frequently than another, without any reference to the number of fractions having this denominator. In such cases the fractions must be distributed in such a way that, if to each fraction having a particular denominator p there be assigned a multiplier or weight μ_p , in each class the sum of the numbers of

* Cf. Karl Pearson, "On the Inheritance of Fecundity in Thoroughbred Brood-mares," *Phil. Trans. A*, vol. cxcii. pp. 294-296 (1898), where the evenness of various distributions of fecundity-ratios is discussed empirically. For this reference, and also for suggesting the problem, I am indebted to Mr David Heron, M.A., who is at present studying under Professor Pearson.

the various fractions, each loaded with its respective weight, is as nearly as possible the same.

The following paper is an attempt to find the evenest distribution in any case that may arise.

I.

§ 1. Consider all the proper fractions whose denominators do not exceed n . For shortness we shall denote any fraction with denominator p by $*/\overline{p}$, and by $*/\overline{\nabla}n$ the assemblage of all the proper fractions whose denominators do not exceed n .

The whole number of fractions $*/\overline{\nabla}n$, i.e. $\frac{0}{1}, \frac{1}{1}; \frac{0}{2}, \frac{1}{2}, \frac{2}{2}; \dots$ is equal to $2 + 3 + \dots + (n + 1) = \frac{1}{2}n(n + 3)$.

If the fractions $*/\overline{\nabla}n$ are distributed into n classes, $0/n$ to $1/n$, $1/n$ to $2/n$, . . . , $(n - 1)/n$ to n/n , and any fraction which falls between two classes is counted $\frac{1}{2}$ in each of these two classes, each of the others being counted 1 in the class in which it occurs, then in each of the classes there will fall $\frac{1}{2}(n + 1)$ fractions, except in the extremes, which contain $n + \frac{1}{2}$.

Take any class, say that between $\frac{r}{n}$ and $\frac{r+1}{n}$. If $\frac{s}{p}$ is a fraction belonging to this class,

$$\frac{r}{n} \nabla \frac{s}{p} \nabla \frac{r+1}{n},$$

or
$$\frac{ns}{r} \triangleleft p \triangleleft \frac{ns}{r+1}.$$

To each value of s there will correspond a certain number of values of p . Since p cannot be greater than n , it is evident that s cannot be greater than $r + 1$, and if $s = r + 1$, p must = n , giving the fraction $\frac{r+1}{n}$, which is counted $\frac{1}{2}$.

Let $\left[\frac{ns}{r} \right]$ denote the greatest integer less than $\frac{ns}{r}$; if $\frac{ns}{r}$ is an integer, there will be a fraction $\frac{s}{p} = \frac{r}{n}$ which is counted $\frac{1}{2}$: in this case we shall define $\left[\frac{ns}{r} \right] = \frac{ns}{r} - \frac{1}{2}$.

The number of integers lying between $\frac{ns}{r}$ and $\frac{ns}{r+1}$ inclusive is then $\left[\frac{ns}{r} \right] - \left[\frac{ns}{r+1} \right]$.

Giving s the series of values 1, 2, . . . , r , we find that the whole number S of fractions in this class is given by

$$\begin{aligned} S - \frac{1}{2} &= \left[\frac{n}{r} \right] - \left[\frac{n}{r+1} \right] + \left[\frac{2n}{r} \right] - \left[\frac{2n}{r+1} \right] + \dots + \left[\frac{rn}{r} \right] - \left[\frac{rn}{r+1} \right] \\ &= \left[\frac{n}{r} \right] + \left[\frac{2n}{r} \right] + \dots + \left[\frac{rn}{r} \right] - \left\{ \left[\frac{n}{r+1} \right] + \left[\frac{2n}{r+1} \right] + \dots + \left[\frac{rn}{r+1} \right] \right\}. \end{aligned}$$

Suppose first that n is prime to r and to $r+1$; then the remainders on dividing $n, 2n, \dots, rn$ by r are 1, 2, . . . , $r-1, 0$ (though not necessarily in this order), and the sum of these is $\frac{1}{2}r(r-1)$; and as there is one integer in the series, we must subtract $\frac{1}{2}$, hence

$$\begin{aligned} \left[\frac{n}{r} \right] + \left[\frac{2n}{r} \right] + \dots + \left[\frac{rn}{r} \right] &= \frac{n}{r} + \frac{2n}{r} + \dots + \frac{rn}{r} - \frac{\frac{1}{2}r(r-1)}{r} - \frac{1}{2} \\ &= \frac{n}{r} \cdot \frac{1}{2}r(r+1) - \frac{1}{2}r. \end{aligned}$$

In the same way, n being prime to $r+1$, the remainders are 1, 2, . . . , $r-1, r$, and there is no integer in the series, hence

$$\begin{aligned} \left[\frac{n}{r+1} \right] + \left[\frac{2n}{r+1} \right] + \dots + \left[\frac{rn}{r+1} \right] &= \frac{n}{r+1} + \frac{2n}{r+1} + \dots + \frac{rn}{r+1} - \frac{\frac{1}{2}r(r+1)}{r+1} \\ &= \frac{n}{r+1} \cdot \frac{1}{2}r(r+1) - \frac{1}{2}r. \end{aligned}$$

Hence $S - \frac{1}{2} = \frac{1}{2}n(r+1) - \frac{1}{2}nr = \frac{1}{2}n$,

or

$$S = \frac{1}{2}(n+1).$$

Next, suppose that n and r contain a G.C.M. k , so that $n = kn'$, $r = kr'$, and n' is prime to r' ; the remainders, on dividing $n, 2n, \dots, rn$, by r , i.e. $k(n', 2n', \dots, rn')$ by kr' , are

$k(1, 2, \dots, r'-1, 0)$; $k(1, 2, \dots, r'-1, 0)$; . . . (k periods),

the sum of which is $k^2 \cdot \frac{1}{2}r'(r' - 1)$, and there are here k integers, hence

$$\begin{aligned} \left[\frac{n}{r} \right] + \dots + \left[\frac{rn}{r} \right] &= \frac{n}{r} + \dots + \frac{rn}{r} - \frac{\frac{1}{2}k^2r'(r' - 1)}{kr'} - \frac{1}{2}k \\ &= \frac{n}{r} \cdot \frac{1}{2}r(r+1) - \frac{1}{2}kr' = \frac{n}{r} \cdot \frac{1}{2}r(r+1) - \frac{1}{2}r \end{aligned}$$

as before : similarly if n is not prime to $r + 1$.

Hence in each class except the extremes there are $\frac{1}{2}(n + 1)$ fractions, and in the first class there are the n fractions $\frac{0}{1}, \frac{0}{2}, \dots, \frac{0}{n}$ and $\frac{1}{n}$, which is counted $\frac{1}{2}$, *i.e.* altogether $n + \frac{1}{2}$.

We shall refer to this distribution of the fractions $*/\sqrt[n]{n}$ into n classes as the *normal* distribution.

If the series of improper fractions, positive and negative, be joined to the ends of the series of proper fractions, then the fractions $\frac{0}{1}, \frac{0}{2}, \dots; \frac{1}{1}, \frac{2}{2}, \dots$ must each be counted only $\frac{1}{2}$, and the number of fractions in each class without exception is the same, *i.e.* $\frac{1}{2}(n + 1)$.

§ 2. We shall now develop some theorems relating to the way in which the fractions $*/\sqrt{p}$ are distributed throughout the classes.

In any class there can occur, besides the limits, no two fractions $/\sqrt{p}$.*

For $\frac{s}{p} \sim \frac{s'}{p} = \frac{s \sim s'}{p}$, which is greater than $\frac{1}{n}$ unless $p = n$ and $s \sim s' = 1$.

If in any class $/\sqrt{p}$ and $*/\sqrt{n - p}$ both occur, they must both be equal to one of the limits of the class.*

We have
$$\frac{r}{n} \not\asymp \frac{s}{p} \not\asymp \frac{r+1}{n}$$

and
$$\frac{r}{n} \not\asymp \frac{s'}{n-p} \not\asymp \frac{r+1}{n}.$$

Therefore
$$\frac{s}{r} \not\asymp \frac{p}{n} \not\asymp \frac{s}{r+1}, \text{ and } \frac{r-s'}{r} \not\asymp \frac{p}{n} \not\asymp \frac{r+1-s'}{r+1}.$$

Suppose first that $s + s' > r + 1$.

Then
$$\frac{p}{n} \not\leftarrow \frac{s}{r+1} > \frac{r+1-s'}{r+1} \not\leftarrow \frac{p}{n},$$

which is impossible. Therefore $s + s' \not\leftarrow r + 1$, and similarly $s + s' \not\leftarrow r$. Hence $s + s'$ must be equal either to r or to $r + 1$.

If $s + s' = r$,

$$\frac{p}{n} \not\leftarrow \frac{s}{r} = \frac{r-s'}{r} \not\leftarrow \frac{p}{n},$$

$\therefore \frac{p}{n} = \frac{s}{r} = \frac{r-s'}{r}$, and $\frac{s}{p} = \frac{r}{n} = \frac{s'}{n-p}$.

Similarly, if $s + s' = r + 1$, $\frac{s}{p} = \frac{r+1}{n} = \frac{s'}{n-p}$.

It follows from this that *each class must contain either $\frac{*}{p}$ or $\frac{*}{n-p}$, and if any class contains both, each of them occurs counted $\frac{1}{2}$* ; for, leaving out the denominator n , there are $n - 1$ denominators, and only $\frac{1}{2}(n - 1)$ fractions in the class.

§ 3. The classes in which any fraction $\frac{*}{p}$ occurs in the normal distribution can be easily found.

Divide $n, 2n, 3n, \dots$ by p ; let q_1, q_2, q_3, \dots be the quotients, and f_1, f_2, f_3, \dots the remainders.

Then
$$\frac{sn}{p} = q_s + \frac{f_s}{p}.$$

Hence
$$q_s \not\leftarrow \frac{sn}{p} \not\leftarrow q_s + 1,$$

or
$$\frac{q_s}{n} \not\leftarrow \frac{s}{p} \not\leftarrow \frac{q_s + 1}{n}.$$

Therefore the fraction $\frac{s}{p}$ lies in the $(q_s + 1)$ th class. If $f_s = 0$,

$\frac{sn}{p} = q_s$, therefore $\frac{s}{p} = \frac{q_s}{n}$, so that the fraction $\frac{s}{p}$ lies $\frac{1}{2}$ in the

q_s th and $\frac{1}{2}$ in the $(q_s + 1)$ th class.

Also, if $n, 2n, \dots$ be divided by $n - p$, and Q_1, Q_2, \dots are the quotients and F_1, F_2, \dots the remainders, then the

fraction $\frac{s}{n-p}$ will lie in the $(Q_s + 1)$ th class, and the fraction $*/\bar{p}$ will not lie in this class; but if $F_s = 0$, $\frac{s}{n-p}$ lies $\frac{1}{2}$ in the Q_s th and $\frac{1}{2}$ in the $(Q_s + 1)$ th class, and $\frac{s'}{p}$ also lies $\frac{1}{2}$ in each of these classes, where $s' = Q_s - s$.

This gives a simple way of writing down the normal distribution. It is convenient to write the classes horizontally, and the fractions $*/\bar{p}$ in columns under their respective denominators. The numerators s in any column must then occur consecutively from 1 up to p . We note also that the distribution is symmetrical about the middle horizontal line, so that, the upper half having been filled in, the lower half can be written down. In filling in the right-hand half containing the larger denominators it is easiest to determine the *vacancies* by dividing $n, 2n, \dots$ by $n-p$. The other half can then be filled in in a complementary way; or we may proceed *vice versa*, filling in the left-hand side first. The fractions which limit two classes may be distinguished by a bar. Thus the normal distributions for $n = 12$ and for $n = 13$ are represented thus:—

I.

1	2	3	4	5	6	7	8	9	10	11	12
0	0	0	0	0	0	0	0	0	0	0	$\frac{0}{1}$
			$\bar{1}$	1	$\bar{1}$	1	$\bar{1}$	1	1	1	$\frac{1}{2}$
		$\bar{1}$	$\bar{1}$		$\bar{2}$	2	$\bar{2}$	2	2	2	$\frac{2}{3}$
	$\bar{1}$	$\bar{1}$	$\bar{2}$	2	$\bar{2}$	3	$\bar{3}$	3	3	3	$\frac{3}{4}$
					$\bar{3}$	3	$\bar{4}$	4	$\bar{5}$	5	$\frac{5}{6}$
	$\bar{1}$	$\bar{2}$	$\bar{2}$		$\bar{3}$	4	$\bar{4}$	5	$\bar{5}$	6	$\frac{6}{7}$
		$\bar{2}$	$\bar{3}$	3	$\bar{4}$	5	$\bar{6}$	6	7	7	$\frac{7}{8}$
			$\bar{3}$	4	$\bar{5}$	6	$\bar{6}$	7	8	8	$\frac{8}{9}$
					$\bar{5}$	6	7	8	9	9	$\frac{9}{10}$
1	2	3	4	5	6	7	8	9	10	10	$\frac{10}{11}$
						7	8	9	10	11	$\frac{11}{12}$

I. Normal distribution for n even, =12.

Hence the fractions $*/\overline{\mathfrak{A}n}$ are distributed $\frac{1}{2}(n+2)$ in each of the classes except the extremes, which contain $n + \frac{3}{2}$.

If the fractions $\frac{0}{1}, \dots, \frac{1}{1}, \dots$ are counted $\frac{1}{2}$, the extremes contain only $\frac{1}{2}(n+3)$.

(2) Into $n+1$ classes.

Introducing the fractions $*/\overline{n+1}$, the fractions $*/\overline{\mathfrak{A}(n+1)}$ will be distributed $\frac{1}{2}(n+2)$ in each class except the extremes, which contain $n + \frac{3}{2}$. The fractions $*/\overline{n+1}$ are distributed one in each class except the extremes, which contain $\frac{3}{2}$; viz., between $\frac{0}{n+1}$ and $\frac{1}{n+1}$ we have $\frac{0}{n+1}$ and $\left(\frac{1}{n+1}\right)$, and so on. Hence removing these we are left with $\frac{1}{2}n$ in each class except the extremes, which contain n .

If the fractions $\frac{0}{1}, \dots, \frac{1}{1}, \dots$ are counted $\frac{1}{2}$, the extremes contain, like the other classes, $\frac{1}{2}n$.

(3) Into $n+2$ classes.

Introducing the fractions $*/\overline{n+1}$ and $*/\overline{n+2}$, all the fractions $*/\overline{\mathfrak{A}(n+2)}$ are distributed $\frac{1}{2}(n+3)$ in each class except the extremes, which contain $n + \frac{5}{2}$. Now the fractions $*/\overline{n+2}$ are distributed one in each class except the extremes, which contain $\frac{3}{2}$, and the fractions $*/\overline{n+1}$ fall one in each class. Hence removing these we are left with $\frac{1}{2}(n-1)$ in each class except the extremes, which contain n .

If the fractions $\frac{0}{1}, \dots, \frac{1}{1}, \dots$ are counted $\frac{1}{2}$, the extremes contain $\frac{1}{2}n$.

Table II., if we strike out the last and the last two columns respectively, gives us the distributions of $*/\overline{\mathfrak{A}12}$ and $*/\overline{\mathfrak{A}11}$ into 13 classes.

If we distribute the fractions into more than $n+2$, or into fewer than $n-1$ classes, we shall find that the middle class or classes will not have the same number of fractions as the others.

§ 5. In the normal distribution and in the three just considered, when we reckon the fractions at the extremes as 1, the number in the extreme classes is practically double that in the others; but when we count these fractions as $\frac{1}{2}$ the number in all the classes is the same both for the normal distribution and for the distribution into $n + 1$ classes, and for the other two distributions the number in the extremes is $\frac{1}{2}$ more than in the other classes.

On the former convention, we may, if n is even, in the normal distribution make pairs of classes coalesce, starting with the second; then there will be $n + 1$ in each of the $\frac{1}{2}(n - 2)$ compound classes and $n + \frac{1}{2}$ in the extremes.

If n is odd, we may divide into $n + 1$ classes, and then make pairs of classes coalesce; then in each of the $\frac{1}{2}(n - 1)$ compound classes and in each of the extremes there will be n fractions.

These are therefore the evenest distributions on the assumption that all the fractions have equal weights.

II.

§ 6. Let us now give weights to the different denominators, or consider the denominators not as occurring with equal frequency but with relative frequencies denoted by μ_p . We have now to reckon each of the fractions $^*/\sqrt{p}$ not as 1, but as μ_p , and, if it is the limit of a class, as $\frac{1}{2}\mu_p$. Then taking the sum $\sum \epsilon_p \mu_p$, where $\epsilon_p = 1$ or $\frac{1}{2}$, we have to find the distribution which makes this sum approximately the same in each class. It will be easier to proceed in the reverse way and find for any distribution what relations must hold between the coefficients μ_p in order that the sum in each class should be the same. We shall assume in what follows that for the fractions at the extremes $\epsilon = \frac{1}{2}$. (Without this assumption the results require considerable modification for the extremes.)

Let us consider first the normal distribution.

Taking any two classes, we have the equation

$$\sum_1^{n-1} \epsilon_p \mu_p = \sum_1^{n-1} \epsilon'_p \mu_p.$$

[μ_n will not enter into this equation, since $\epsilon_n = \epsilon'_n = 1$.]

This may be written

$$\sum_1^{\frac{1}{2}(n-1) \text{ or } \frac{1}{2}(n-2)} (\epsilon_p \mu_p + \epsilon_{n-p} \mu_{n-p}) = \sum_1^{\text{or } \frac{1}{2}(n-2)} (\epsilon'_p \mu_p + \epsilon'_{n-p} \mu_{n-p}),$$

[If n is even $\mu_{\frac{1}{2}n}$ will not enter, for $\epsilon_{\frac{1}{2}n} = \epsilon'_{\frac{1}{2}n} = \frac{1}{2}$.]

or
$$\sum \{(\epsilon_p - \epsilon'_p) \mu_p + (\epsilon_{n-p} - \epsilon'_{n-p}) \mu_{n-p}\} = 0.$$

Now
$$\begin{aligned} \epsilon_p + \epsilon_{n-p} &= 1 = \epsilon'_p + \epsilon'_{n-p}, & \dots & \dots & (\S 2) \\ \therefore \epsilon_{n-p} - \epsilon'_{n-p} &= -(\epsilon_p - \epsilon'_p), \end{aligned}$$

and the equation becomes

$$\sum_1^{\frac{1}{2}(n-1) \text{ or } \frac{1}{2}(n-2)} (\epsilon_p - \epsilon'_p) (\mu_p - \mu_{n-p}) = 0.$$

Now, by taking the classes in pairs, since the distribution is symmetrical about the middle class or classes, we shall obtain $\frac{1}{2}(n-1)$ or $\frac{1}{2}(n-2)$ distinct equations of this form, according as n is odd or even. But this is the number of the quantities $\mu_p - \mu_{n-p}$, and since the equations are homogeneous and linear in these quantities they can only be satisfied by the quantities $\mu_p - \mu_{n-p}$ all vanishing, *i.e.*

$$\mu_p = \mu_{n-p}$$

for all values of p from 1 to $n-1$.*

Hence *the normal distribution will be an even distribution also in the case where the frequency curve for the denominators is symmetrical.*

§ 7. Suppose now that we divide the fractions $*/\overline{\mathfrak{P}}n$ into more classes than n , say into $n+m$, and consider the possibility of the sums of all the classes being equal; it is the same thing as if we divide the fractions $*/\overline{\mathfrak{P}}(n+m)$ normally and consider $\mu_p = 0$ if $p > n$, and therefore also if $p < m$. Also if $p \overline{\overline{>}} m$, $\mu_p = \mu_{n+m-p}$.

§ 8. Next, suppose the fractions $*/\overline{\mathfrak{P}}n$ to be divided into fewer classes than n , say into m , and let $n = xm + y$, where $y < m$.

* The only alternative is the vanishing of the discriminant of the system of equations. It is easily seen that this disc. is the determinant which corresponds to the left-hand upper quadrant of the normal distribution, omitting the first two rows and the middle and left-hand columns, in such a way that the elements corresponding to fractions occurring in only one class are 1, those corresponding to the limits $\frac{1}{2}$, and the other elements 0. Whether the disc. vanishes or not, the equations are always satisfied by the above values.

Then we can consider the n fractions $*/\bar{1}$ to $*/\bar{n}$ divided into x sets, $*/\bar{1}$ to $*/\bar{m}$, $*/\bar{m+1}$ to $*/\bar{2m}$, . . . , $*/\bar{(m-1)x+1}$ to $*/\bar{mx}$, and a partial set $*/\bar{xm+1}$ to $*/\bar{n}$.

Now if $\frac{s}{p}$ is a fraction lying between $\frac{r}{m}$ and $\frac{r+1}{m}$, so that

$$\frac{pr}{m} \succ s \succ \frac{p(r+1)}{m},$$

then between the same limits there will be $t+1$ fractions $*/\bar{p+tm}$

For let $\frac{s'}{p+tm}$ be such a fraction, then

$$\frac{(p+tm)r}{m} \succ s' \succ \frac{(p+tm)(r+1)}{m}$$

$$\text{or} \quad \frac{pr}{m} \succ s' - tr \succ \frac{p(r+1)}{m} + t.$$

$$\therefore \quad s' = tr + s + t', \quad (t' = 0, 1, 2, \dots, t).$$

But if $p \succ m$ and no fraction $*/\bar{p}$ lies in this class, then

$$s' = tr + \left[\frac{pr}{m} \right] + t', \quad (t' = 1, 2, \dots, t).$$

Hence in the $(t+1)$ th set we have each class exactly the same as the corresponding class in the first set, except for the addition of t fractions of each kind.

It follows that if $y=0$ all the classes will contain the same number of fractions, *i.e.* the fractions $*/\bar{p}$ can be divided evenly into any submultiple of n classes. It follows also that they can be divided evenly into any submultiple of $n+1$ classes, or any submultiple of $n-1$ or $n+2$ classes, though in the two latter cases the number of fractions in the extremes will be $\frac{1}{2}$ more than in the other classes.

§ 9. The distribution into any number of classes $m < n$ is easily effected. First write down the normal distribution for m . Then for the next set from $m+1$ to $2m$ write down in each column p the numbers from 0 up to p consecutively, so that one number corresponds in each class to the number in the corresponding class in the first set, and there is one number in addition. For the third set there must be two additional numbers in each class, and so on. Table III. represents the distribution of the fractions $*/\bar{p}$ into 8 classes.

for $p=1, 2, \dots, \frac{1}{2}(m-1)$ or $\frac{1}{2}(m-2)$, according as m is odd or even. The last term on the right will of course vanish if $(x+1)m-p > n$, *i.e.* $> mx+y$, or if $p < m-y$; and the last term on the left will disappear if $p > y$. Neither will occur if $y=0$; both will always occur if $y=m-1$.

These equations are satisfied if $\mu_p = \mu_{m-p}, \dots, \mu_{p+m} = \mu_{2m-p}, \dots$. If $y=0$ or $m-1$ we have a complete set of pairs, and none of the μ 's vanish, but in other cases certain of the μ 's will vanish. Thus for $y=1$ or $m-2, \mu_n=0$.

Hence the distribution into m classes, m a submultiple of n or $n+1$, will still be even if the frequency curve for the denominators is periodically symmetrical with period m .

§ 11. Let us consider now the effect of omitting certain of the lower denominators. We may for this purpose consider the assemblages $*/\overline{\mathfrak{P}m}$, $*/\overline{\mathfrak{P}(xm-1)}$, $*/\overline{\mathfrak{P}(xm+1)}$, $*/\overline{\mathfrak{P}(xm-2)}$, each distributed into m classes.

The omission of a complete set or any number of complete sets will not affect the distribution.

The omission of one less than a complete set or any number of complete sets will not affect the distribution.

The omission of one more or two less than a complete set or any number of complete sets removes $\frac{1}{2}$ more from the extremes than from the other classes.

The results are indicated by the following table :

	$*/\overline{\mathfrak{P}xm}$ and $*/\overline{\mathfrak{P}(xm-1)}$	$*/\overline{\mathfrak{P}(xm+1)}$ and $*/\overline{\mathfrak{P}(xm-2)}$
Omit $*/\overline{\mathfrak{P}m}$, $*/\overline{\mathfrak{P}(2m)}$, etc.)	} Same in each.	} Extremes $\frac{1}{2}$ more.
,, $*/\overline{\mathfrak{P}(m-1)}$, $*/\overline{\mathfrak{P}(2m-1)}$, etc.)		
Omit $*/\overline{\mathfrak{P}(m+1)}$, $*/\overline{\mathfrak{P}(2m+1)}$, etc.)	} Extremes $\frac{1}{2}$ less.	} Same in each.
,, $*/\overline{\mathfrak{P}(m-2)}$, $*/\overline{\mathfrak{P}(2m-2)}$, etc.)		

These results on submultiple division require considerable modification as regards the extreme classes when the extreme fractions are reckoned 1 and not $\frac{1}{2}$. The number in the extremes is then not even approximately equal to or a multiple of the number in the other classes.

§ 12. One result which we have already obtained may be

restated in this connection. The evenest distribution for the assemblage $\frac{*}{\sqrt{p}}n$ where the lower ratios $\frac{*}{\sqrt{p}}m$ are to be omitted is found by dividing into $n + m + 1$ classes (§ 7). When the extreme fractions are counted $\frac{1}{2}$ there are then $\frac{1}{2}(n - m + 1)$ in each class. If $n + m + 1$ is even, pairs of classes may now be made to coalesce, and now reckoning the extreme fractions as 1 there will be $n - m + 1$ in each class. This result is still true if the frequency curve is symmetrical from $m + 1$ to n .

(Issued separately April 16, 1906.)

On Vibrating Systems which are not subject to the Boltzmann-Maxwell Law. By Dr W. Peddie.

(MS. received February 23, 1906.)

1. It is well known that the Boltzmann-Maxwell Law, which asserts average equi-partition of kinetic energy amongst the various motional freedoms, finite or infinite in number, of suitably conditioned systems, meets with apparently insuperable difficulties in its application to actual gases. Even in the case of gases showing complicated spectra, and therefore possessing numerous vibrational freedoms, the actual values of the ratio of the specific heats never deviate much from values which should, according to the law, be limited to very simple systems. Possible modes of evading this result, such as that supplied by J. J. Thomson's suggestion (*Arch. Néerlandaises*, 1900, Ser. II. t. v.) that individual molecules may not be concerned in radiation, are too problematical to give much relief.

Lord Kelvin (*Baltimore Lectures*, Appendix B) says that Clausius' theorem regarding the specific heats, "taken in connection with Stokes' and Kirchoff's dynamics of spectrum analysis, throws a new light upon what we are now calling a 'practically monatomic gas.' It shows that, unless we admit that the atoms can be set into rotation or vibration by mutual collisions (a most unacceptable hypothesis), each atom must have satellites connected with it (or ether condensed into it or around it) and kept (by the collisions) in motion relatively to it with total energy exceedingly small in comparison with the translational energy of the whole system of atom and satellites."

This asserts actual violation of the Boltzmann-Maxwell condition. Jeans' recent suggestion (*Nature*, vol. lxxi., 1905) that the complete system must include the ether, and that radiation has hitherto prevented attainment, as between matter and ether, of that condition of statistical equilibrium, which the law requires, merely indicates a hypothetical mechanism necessitating Lord Kelvin's conclusion, although it removes the law from direct attack on this side.

2. Rayleigh (*Scientific Papers*, vol. iv., no. 253), in defending Maxwell's argument, desires "some escape from the destructive simplicity of the general conclusion." Kelvin (*Balt. Lect.*, App. B) speaks of the difficulty as one of the two "nineteenth century clouds over the dynamical theory of heat and light," and concludes that the doctrine should be denied. He gives a number of tests tending to show considerable deviations from equi-partition of energy between translational freedoms and also between translational and rotational freedoms. He also points out an, at least, ideal case in which this equi-partition is impossible.

The object of the present communication is to determine cases in which equi-partition of vibrational energy cannot take place.

3. It is convenient to suppose that the motions are limited to one-dimensional space. The simplest case is that of two freedoms expressed, say, by the conditions

$$\begin{aligned}\ddot{\xi}_1 &= -a_1\xi_1 + b_1\xi_2, \\ \ddot{\xi}_2 &= b_2\xi_1 - a_2\xi_2.\end{aligned}$$

These give

$$\begin{aligned}(r+r')\xi_1 &= r'A \sin(nt+a) + rA' \sin(n't+a'), \\ (r+r')\xi_2 &= A \sin(nt+a) - A' \sin(n't+a'),\end{aligned}$$

where $n^2 = a_1 - r'b_2$, $n'^2 = a_1 + r'b_2$, the quantities r and $-r'$ being respectively the positive and negative roots of $b_2\lambda^2 + (a_2 - a_1)\lambda - b_1 = 0$. Hence we obtain

$$2(r+r')^2\{m_1\dot{\xi}_1^2 - m_2\dot{\xi}_2^2\} = n^2(m_1r'^2 - m_2)A^2 + n'^2(m_1r^2 - m_2)A_1'^2$$

where the bracket indicates an average taken over a time which is long relative to the longer of the two periods, and m_1, m_2 , are the masses. If it is possible to determine conditions under which the quantity on the right-hand side of the equation is either always positive or always negative, the Boltzmann-Maxwell distribution of energy is impossible.

Now the third law of motion necessitates the condition $b_1m_1 = b_2m_2$, so that $r^2r'^2 = m_2^2/m_1^2$. Hence it is impossible to have both brackets on the right-hand side always of one sign. Thus, so far as this investigation goes, we can make no assertion as to the observance or non-observance of the Boltzmann-Maxwell Law, except in the case of numerical equality of the two roots, in which case it certainly is observed.

4. It is worthy of note that the impossibility of obtaining a conclusion in the case of two freedoms depends on the observance of the third law of motion. If the third law be not observed in sub-atomic dynamics, there could be bi-periodic atoms exempt from the Boltzmann-Maxwell Law. There is no *a priori* reason why the third law should hold. Steady vibrations could take place until a collision, sufficiently violent to alter the equations of motion, occurred. At that stage, non-observance of the law could give rise to effects analogous to some of those made evident in the phenomena of radioactivity.

5. The next simplest case is that of three freedoms as typified by the equations

$$\begin{aligned} \ddot{\xi}_1 &= a_1\xi_1 + b_1\xi_2 + c_1\xi_3, \\ \ddot{\xi}_2 &= b_2\xi_1 + a_2\xi_2 + d_2\xi_3, \\ \ddot{\xi}_3 &= c_3\xi_1 + d_3\xi_2 + a_3\xi_3. \end{aligned}$$

The third law of motion gives the conditions $b_1m_1 = b_2m_2$, $c_1m_1 = c_3m_3$, $d_2m_2 = d_3m_3$; whence

$$b_1d_2c_3 = c_1b_2d_3. \quad \dots \quad (1)$$

This is Tait's condition (*Scientific Papers*, vol. ii., art. cxx.), for the reality of the roots of the cubic

$$\begin{vmatrix} a_1 - x & b_1 & c_1 \\ b_2 & a_2 - x & d_2 \\ c_3 & d_3 & a_3 - x \end{vmatrix} = 0 \quad \dots \quad (2)$$

regarded as determining the non-rotated lines in homogeneous strain possible in matter. Indeed, the form of the above equations of motion exhibits the analogy between homogeneous three-dimensional strain and the vibrations of a three-period system. The problem of determining non-rotated lines in the one is the problem of determining fundamental periods in the other. Tait's method of reducing the general differentially irrotational strain to a pure strain in the one is the method of reducing the general three-period system to an equal-mass system in the other. This will be farther discussed in § 9.

Tait's limitation of the strain problem to strain possible in matter corresponds to the subjection of the vibrating system to the third law of motion. We can still have the condition $b_1d_2c_3 = c_1b_2d_3$ if we take, for example, $b_1m_1 = b_2m_2$, $c_3m_3 = kc_1m_1$,

$d_3m_3 = kd_2m_2$, $k \neq 1$. This implies denial of the third law of motion with reference to m_3 . More generally, the condition suits with $b_1m_1 = k_1b_2m_2$, $c_3m_3 = k_2c_1m_1$, $d_2m_2 = k_3d_3m_3$, if $k_1k_2k_3 = 1$. This implies denial of the law with reference to two masses at least, and asserts reality of the squares of the periods. Any other condition than $k_1k_2k_3 = 1$ makes two squares of periods imaginary.

6. The solution of the equations of motion, given above, is expressed by

$$\Delta \xi_1 = \begin{vmatrix} A_1 \sin(n_1t + a_1) & \lambda_1 & \mu_1 \\ A_2 \sin(n_2t + a_2) & \lambda_2 & \mu_2 \\ A_3 \sin(n_3t + a_3) & \lambda_3 & \mu_3 \end{vmatrix}, \quad \Delta \xi_2 = - \begin{vmatrix} A_1 \sin(n_1t + a_1) & 1 & \mu_1 \\ A_2 \sin(n_2t + a_2) & 1 & \mu_2 \\ A_3 \sin(n_3t + a_3) & 1 & \mu_3 \end{vmatrix},$$

$$\Delta \xi_3 = \begin{vmatrix} A_1 \sin(n_1t + a_1) & 1 & \lambda_1 \\ A_2 \sin(n_2t + a_2) & 1 & \lambda_2 \\ A_3 \sin(n_3t + a_3) & 1 & \lambda_3 \end{vmatrix}, \quad \Delta = \begin{vmatrix} 1 & \lambda_1 & \mu_1 \\ 1 & \lambda_2 & \mu_2 \\ 1 & \lambda_3 & \mu_3 \end{vmatrix},$$

where $-n_1^2 = a_1 + \lambda_1b_2 + \mu_1c_3$, $-n_2^2 = a_1 + \lambda_2b_2 + \mu_2c_3$, $-n_3^2 = a_1 + \lambda_3b_2 + \mu_3c_3$, and λ_1, μ_1 , etc., satisfy in pairs the equations

$$\left. \begin{aligned} \lambda(a_1 + b_2\lambda + c_3\mu) &= b_1 + a_2\lambda + d_3\mu, \\ \mu(a_1 + b_2\lambda + c_3\mu) &= c_1 + d_2\lambda + a_3\mu, \end{aligned} \right\} \dots \dots (3)$$

If we write the values of ξ_1, ξ_2, ξ_3 in the form

$$\begin{aligned} \xi_1 &= a'_1A_1 \sin(n_1t + a_1) + a'_2A_2 \sin(n_2t + a_2) + a'_3A_3 \sin(n_3t + a_3), \\ \xi_2 &= b'_1A_1 \sin(n_1t + a_1) + b'_2A_2 \sin(n_2t + a_2) + b'_3A_3 \sin(n_3t + a_3), \\ \xi_3 &= c'_1A_1 \sin(n_1t + a_1) + c'_2A_2 \sin(n_2t + a_2) + c'_3A_3 \sin(n_3t + a_3), \end{aligned}$$

we get, on integration over a period which is long relatively to the longest of the three fundamental periods,

$$\begin{aligned} 2\{\xi_1^2\} &= n_1^2a_1'^2A_1^2 + n_2^2a_2'^2A_2^2 + n_3^2a_3'^2A_3^2, \\ 2\{\xi_2^2\} &= n_1^2b_1'^2A_1^2 + n_2^2b_2'^2A_2^2 + n_3^2b_3'^2A_3^2, \\ 2\{\xi_3^2\} &= n_1^2c_1'^2A_1^2 + n_2^2c_2'^2A_2^2 + n_3^2c_3'^2A_3^2, \end{aligned}$$

where the brackets indicate time-averages, as before. Hence we have

$$2\{m_1\xi_1^2 - m_2\xi_2^2\} = (m_1a_1'^2 - m_2b_1'^2)n_1^2A_1^2 + (m_1a_2'^2 - m_2b_2'^2)n_2^2A_2^2 + (m_1a_3'^2 - m_2b_3'^2)n_3^2A_3^2, \dots \dots (4)$$

with two other similar expressions.

7. From equations (3) we find that λ is given by the cubic

$$\begin{aligned} & \lambda^3 [b_2(b_2d_3 - c_3a_2) + (a_3b_2 - c_3d_2)c_3] \\ & + \lambda^2 [b_2(a_1d_3 - b_1c_3) + (a_1 - a_2)(b_2d_3 - c_3a_2) - d_3(a_3b_2 - c_3d_2) + \\ & \qquad \qquad \qquad c_3(a_3(a_1 - a_2) + d_2d_3 - c_1c_3)] \\ & + \lambda [(a_1 - a_2)(a_1d_3 - b_1c_3) - b_1(b_2d_3 - c_3a_2) + c_3(c_1d_3 - a_3b_1) - \\ & \qquad \qquad \qquad d_3(a_3(a_1 - a_2) + d_2d_3 - c_2c_3)] \\ & - [b_1(a_1d_3 - b_1c_3) + d_3(c_1d_3 - a_3b_1)] = 0 \quad . \quad . \quad . \quad (5) \end{aligned}$$

The roots of this equation being regarded as known, the first of equations (3) gives the corresponding values of μ .

The condition (1), for reality of the roots of the cubic (2), gives the single definite relation which subsists amongst the constants, and further limiting relations are imposed through the three equations of type (4). For, if the three quantities in brackets on the right-hand side of one of equations (4) be of like sign, there can never be equi-partitioning of energy between the masses with which that equation deals.

The Boltzmann-Maxwell Law would, if it were applicable to vibrational freedoms obeying the generalised Hooke's Law expressed by the equations of motion given in § 5, constitute a proof of the impossibility of satisfying all the above relations simultaneously.

8. To obtain a definite test, we may choose $\lambda_1 = -1$, $\lambda_2 = 0$, $\lambda_3 = 1$; which give $\mu_1 = [(b_2 - b_1) - (a_1 - a_2)] / (c_3 + d_3)$; $\mu_2 = -b_1/d_3$, $\mu_3 = [(b_2 - b_1) + (a_1 - a_2)] / (d_3 - c_3)$, and also

$$\begin{aligned} a'_1 &= -\mu_2, & a'_2 &= \mu_1 + \mu_3, & a'_3 &= -\mu_2, \\ b'_1 &= \mu_2 - \mu_3, & b'_2 &= \mu_3 - \mu_1, & b'_3 &= \mu_1 - \mu_2, \\ c'_1 &= 1, & c'_2 &= -2, & c'_3 &= 1. \end{aligned}$$

Hence the inequalities are

$$\begin{aligned} \frac{m_1}{m_2} &= \frac{b_2}{b_1} \geq \left(\frac{\mu_2 - \mu_3}{\mu_2} \right)^2 \geq \left(\frac{\mu_3 - \mu_1}{\mu_3 + \mu_1} \right)^2 \geq \left(\frac{\mu_1 - \mu_2}{\mu_2} \right)^2, \\ \frac{m_3}{m_2} &= \frac{d_2}{d_3} \geq (\mu_2 - \mu_3)^2 \geq \left(\frac{\mu_3 - \mu_1}{2} \right)^2 \geq (\mu_1 - \mu_2)^2, \\ \frac{m_3}{m_1} &= \frac{c_1}{c_3} \geq \mu_2^2, \geq \left(\frac{\mu_1 + \mu_3}{2} \right)^2 \geq \mu_2^2. \end{aligned}$$

If we take $\mu_1 + \mu_3 = 2\mu_2$, we get necessarily $\mu_3 - \mu_1 = -2(\mu_2 - \mu_3) = 2(\mu_2 - \mu_1)$, and the inequalities reduce to

$$\frac{b_2}{b_1} \neq \left(\frac{\mu_1 - \mu_2}{\mu_2} \right)^2, \quad \frac{d_2}{d_3} \neq (\mu_1 - \mu_2)^2, \quad \frac{c_1}{c_3} \neq \mu_2^2$$

The values of the λ s being distinct, the values of the μ s are in general distinct. Also the periods, as given by $-n^2 = a_1 + b_2\lambda + c_3\mu$, are in general distinct, and can be made real by suitable choice of a_1 . Reserving a_1 for this purpose, and reserving b_1 to secure the first inequality, the remaining inequalities can be secured by reservation of d_2 and c_1 , which do not enter into the expressions for the μ s. Similarly, distinctness of periods can be provided for by reservation of b_2 and c_3 . The values of d_3 and a_2 are available to give each of μ_2 and μ_1 an infinity of values.

But the reservations leave at disposal an infinity of values of each of a_1 , b_1 , c_1 , b_2 , d_2 , and c_3 . On the other hand, the assumed values of the λ s impose three relations amongst the constants. There is therefore a five-fold infinity of solutions possible, in each of which equi-partitioning of energy between *any* pair of masses is impossible. The values of the λ s being at disposal, there is really an eight-fold infinity possible in the general case of three masses.

This may be regarded as the tri-dimensional case of a single mass under the action of forces which are non-isotropic with reference to the co-ordinates.

If the inequalities become equalities, choice of one λ fixes in general the remaining λ s and the μ s and the values of b_1 , d_2 , c_1 . The fixing of the μ s gives three relations amongst constants, and the cubic for λ gives three more. Thus, in general, there is only a single infinity of cases in which there is complete equi-partition of energy amongst three co-ordinates.

9. The extension to n dimensions of the usual process for finding the necessary relations which subsist amongst the nine constants of a homogeneous tri-dimensional strain, in order that the strain shall be pure, leads to the result that the determinant of the n th order, whose roots determine the directions of non-rotated lines, must be axisymmetrical. The roots are, in this case, necessarily real.

If we now apply the process of "flying" to the medium thus strained, we get a homogeneous, pure, n -dimensional strain, the roots of whose determinant for non-rotated lines are proportional to the squares of the fundamental frequencies of vibration of a system of n equal masses, which are acted upon by linear systems

of forces whose moduli are the n^2 constants which specify the original strain. Therefore that vibrating system has n real positive squares of periods.

To pass to the case of systems of unequal masses, we have to extend to n -dimensional space Tait's process for the determination of non-rotated lines. The equality of action and reaction being postulated, any two constants, each of which is situated at the optical image of the position of the other relatively to the right-handedly downward diagonal of the determinant, bear to each other the inverse ratio of the corresponding masses. It follows at once that Tait's condition (1), § 5, applies to every cubic minor situated on the right-handedly downward diagonal; and that, in every square minor, and its image minor in the diagonal, the product of the right-hand diagonal terms of the one into the left-hand diagonal terms of the other is equal to the product of the left-hand diagonal terms of the one into the right-hand diagonal terms of the other. Thus, in the scheme below, $a_2c_1b_3 = a_3c_2b_1$, $b_4c_2d_3 = b_3c_4d_2$, $d_6e_7f_5g_4 = d_7e_6f_4g_5$.

$$\begin{vmatrix} \cdot & a_2 & a_3 & \cdot & \cdot & \cdot & \cdot \\ b_1 & \cdot & b_3 & b_4 & \cdot & \cdot & \cdot \\ c_1 & c_2 & \cdot & c_4 & \cdot & \cdot & \cdot \\ \cdot & d_2 & d_3 & \cdot & \cdot & d_6 & d_7 \\ \cdot & \cdot & \cdot & \cdot & \cdot & e_6 & e_7 \\ \cdot & \cdot & \cdot & f_4 & f_5 & \cdot & \cdot \\ \cdot & \cdot & \cdot & g_4 & g_5 & \cdot & \cdot \end{vmatrix}$$

We may dispense with the special statement regarding cubic minors. If, for brevity, we use the term "image minors" with reference to any square minor and the minor situated at the image of its position with reference to the right-handedly downward diagonal, and if we use the term "cross-product" with reference to the product of the right-hand diagonal constituents of one minor into the left-hand diagonal constituents of the other, we can make the general statement that—

The roots of an n -ic are real when the two cross-products of each pair of image square minors are equal.

In the case of a diagonal cubic minor, one constant, *e.g.* c_3 in the above scheme, is common to each cross-product, so that we

get Tait's condition. A diagonal square minor, *e.g.* a_1, a_2, b_1, b_2 , is its own image, and the cross-products are identical.

10. The $(n-1)(n-2)/2$ square minors which are not self images give $(n-1)(n-2)/2$ relations amongst the n^2 constants and leave a $(n^2+3n-2)/2$ fold infinity of examples subject to restriction by the inequalities and the conditions that the periods shall be real. The $n-1$ square minors which are their own images give, by the terms not lying on the main diagonal, the $n-1$ ratios of the masses in each example.

If we postulate observance of the Boltzmann-Maxwell condition, and so change the inequalities into equalities, the number of possible infinities of examples is much lessened.

11. In the preceding discussion, no conditions have been postulated for the purpose of ensuring that the centre of inertia of the n masses shall coincide with the origin. We shall see that, except when the periods are all coincident, the centre of inertia cannot lie at the origin. Hence we must presume the existence, at the origin, of a mass which is very large in comparison with the sum of the n masses. In any question regarding the total partitioning of energy in a system so constituted, the motion of this central mass must be considered. But the question of the partitioning of energy amongst the n satellites is not affected by the presence of the central mass.

To see that we cannot dispense with this large mass at the origin if all the periods are not to be identical, we have to consider the various equations of the type

$$\xi_p \Delta = [1, p] A_1 \sin (n_1 t + \alpha_1) + \dots + [n, p] A_n \sin (n_n t + \alpha_n),$$

where

$$\Delta = \begin{vmatrix} 1 & \lambda_1 & \dots & \dots & \nu_1 \\ 1 & \lambda_2 & \dots & \dots & \nu_2 \\ \vdots & \vdots & & & \vdots \\ \vdots & \vdots & & & \vdots \\ 1 & \lambda_n & \dots & \dots & \nu_n \end{vmatrix}$$

and $[r, s]$ is the minor, of order $n-1$, of the r th term in the s th column of Δ . Taking now the centre of inertia condition

$$\sum_1^n m_p \xi_p = 0, \text{ we get the necessary equations}$$

$$\begin{aligned}
 m_1[1,1] + m_2[1,2] + \dots + m_n[1,n] &= 0 \\
 \vdots & \\
 m_1[n,1] + m_2[n,2] + \dots + m_n[n,n] &= 0.
 \end{aligned}$$

Now, since the first column in Δ is composed of units, we have

$$\sum_{r=1}^{r=n} [r,s] = 0 \text{ for all values of } s \text{ greater than unity. Therefore}$$

$$\sum_{r=1}^{r=n} [r,1] = 0; \text{ that is } \Delta = 0.$$

But $\Delta = 0$ is the condition that

$$\begin{aligned}
 n^2 + a_1 + b_2\lambda_1 + c_3\mu_1 + \dots + t_n\tau_1 &= 0, \\
 n^2 + a_1 + b_2\lambda_2 + c_3\mu_2 + \dots + t_n\tau_2 &= 0, \\
 \vdots & \\
 n^2 + a_1 + b_2\lambda_n + c_3\mu_n + \dots + t_n\tau_n &= 0;
 \end{aligned}$$

which means that $n_1^2, n_2^2, \dots, n_n^2$, must have the common value n^2 .

12. As a special example, leading to easily calculable numerical values which might serve for the specification of mechanical models, we may consider the scheme—

1	λ	μ
1	1	2
1	2	1
1	0	3

Using these values in equations (3), together with the conditions for observance of the third law of motion, we get seven of the nine constants given in terms of the remaining two and the mass-ratios. The results are—

$$\begin{aligned}
 a_1 &= a_3 + \frac{c_1 m_1 - m_3}{m_2} d_3, & a_2 &= a_3 + \frac{m_2 - m_3}{m_2} d_3, \\
 b_1 &= -3d_3, & b_2 &= -3\frac{m_1}{m_2} d_3, & c_1 &= -3\frac{m_3}{m_2} d_3, \\
 c_3 &= -3\frac{m_1}{m_2} d_3, & d_2 &= \frac{m_3}{m_2} d_3.
 \end{aligned}$$

Since Δ is zero, the A s in § 6 must be zero; so that, in equations

(4), we must suppose that the divisor Δ is included in each A. The inequalities then reduce to

$$\frac{m_1}{m_2} \geq \frac{1}{9}, \quad \frac{m_3}{m_2} \geq 1;$$

and the common value of $-n_1^2$, $-n_2^2$, $-n_3^2$, is

$$-n^2 = a_3 + \left(\frac{9m_1 - m_3}{m_2} - 9 \right) d_3,$$

and must be negative. A four-fold infinity of examples is possible

The Boltzmann-Maxwell Law holds in the three-fold infinity of cases obtained by changing the inequalities to equalities.

13. Although the case of a self-contained system of n masses vibrating in one-dimensional space; or, say, of a system of k masses, where $n = 3k$, vibrating in three-dimensional space; and not subject to the law of equi-partition, is of great interest, the other case in which a preponderating mass has to be placed effectively at the origin is of even greater interest as embodying Kelvin's view, § 1, that "each atom must have satellites connected with it (or ether condensed into it or around it) and kept (by the collisions) in motion relatively to it with total energy exceedingly small in comparison with the translational energy of the whole system of atom and satellites." When the mass of each satellite is so small that the forces which act on it produce accelerations which are large in comparison with the accelerations to which the central mass is subject, communication of energy to the satellites may have little direct connection with communication of energy to the central mass. And, in any case, there is no necessary observance of equi-partition of energy amongst the satellites, since the effects of collisions appear only in the squared coefficients such as A_1^2 , etc., in equation (4).

The above results apply at once to the case of a luminous gas, provided that we postulate (1) that the time of description of the average free path is long relatively to the longest constituent period and to the time of impact; (2) that the temperature is such that only a small proportion of collisions give rise to disintegration of the molecules or to change of their essential configurations; (3) that the fractional loss of energy by radiation during free intervals is small.

14. The object of the investigation, as stated in § 2, is to determine systems in which equi-partition of energy, of vibrational type, cannot take place. And, as we have just seen, the systems

considered present analogies to the molecular systems of luminous gases. We at least see, therefore, how it may be possible for gaseous systems to be free from subjection to the law of equipartition of energy within their vibratory freedoms.

But it seems also that the possible conclusions reach further. Rayleigh (*Scientific Papers*, vol. iv., no. 253), in verifying Maxwell's conclusions, points out the severely restrictive character of Maxwell's assumption. It implies that the system, between two successive attainments of any given phase, must have passed through all phases consistent with the equation of energy. Maxwell's own words are: "The material points may act on each other at all distances, and according to any law which is consistent with the conservation of energy, and they may also be acted on by any forces external to the system, provided these also are consistent with that law. The only assumption which is necessary for the direct proof is that the system, if left to itself in its actual state of motion, will, sooner or later, pass through every phase which is consistent with the equation of energy.

"Now it is manifest that there are cases in which this does not take place. The motion of a system not acted on by external force satisfies six equations besides the equation of energy, so that the system cannot pass through those phases, which, though they satisfy the equation of energy, do not also satisfy these six equations.

"Again, there may be particular laws of force, as, for instance, that according to which the stress between two particles is proportional to the distance between them, for which the motion repeats itself after a finite time. In such cases a particular value of one variable corresponds to a particular value of each of the other variables, so that phases formed by sets of values of the variables which do not correspond cannot occur, though they may satisfy the seven general equations.

"But, if we suppose that the material particles, or some of them, occasionally encounter a fixed obstacle such as the sides of a vessel containing the particles, then, except for special forms of the surface of this obstacle, each encounter will introduce a disturbance into the motion of the system, so that it will pass from one undisturbed path into another. The two paths must both satisfy the equation of energy, and they must intersect each other in the

phase for which the conditions of encounter with the fixed obstacle are satisfied, but they are not subject to the equations of momentum. It is difficult in a case of such extreme complexity to arrive at a thoroughly satisfactory conclusion, but we may with considerable confidence assert that, except for particular forms of the surface of the fixed obstacle, the system will sooner or later, after a sufficient number of encounters, pass through every phase consistent with the equation of energy."

These remarks of Maxwell seem to apply as conclusively to material systems constituted in the manner postulated in this paper. At least this is so if we presume that, in a collision, individual masses of the system may suffer independent impacts. If that view be correct, Maxwell's assumption is satisfied while his conclusion is departed from. It seems that, before we can arrive at his conclusion, we must at least assume, when periodic motions are concerned, that no phase-cycle is to be continuously completed by any individual member of the system. Thus, in the liquid and isotropic solid states, equi-partition of energy amongst all freedoms may be possible, while in sparse gases it is impossible.

But the statement, that "any law of force which is consistent with the equation of energy" can be postulated, is in general impossible because of the restricting assumption. In general the expression of the law involves relations amongst the momenta and the co-ordinates, which relations prevent the simplification that arises in the Boltzmann-Maxwell treatment, or in Jeans's treatment, and leads to the law of equi-partition. The usual methods will then lead to results such as those obtained above.

As a simple example, which includes Maxwell's example as a special case, we find, in § 5, the relations $(b_2\xi_1 + a_2\xi_2 + d_2\xi_3)d\xi_1 = (a_1\xi_1 + b_1\xi_2 + c_1\xi_3)d\xi_2$, etc. These relations, like the energy condition, subsist despite encounters and collisions. Similar conditions will hold with laws other than the generalised Hooke's law. In this connection an interesting paper by Bryan, published in the volume of the *Arch. Néerlandaises* already referred to, § 1, would have been more fully quoted had I observed it before the preceding sections were written. In 1900, Bryan, by a different process, had indicated the preponderance of conditions for unequal partition

Some Experimental Results in connection with the
Hydrodynamical Theory of Seiches. By Peter
White, M.A., and William Watson.

(MS. received March 15, 1906.)

In a paper read before the Royal Society of Edinburgh, in June 1905, on the Hydrodynamical Theory of Seiches, Professor Chrystal published a number of formulæ from which could be calculated the periods and positions of the nodes of seiches in lakes of various shapes.

The solutions of the most general problems, involving variations of the three dimensions, are there made to rest ultimately upon certain typical cases in which the element of breadth remains constant while the depth is some defined function of the length. In the paper referred to, formulæ are given immediately applicable to lakes of uniform breadth, whose longitudinal sections include concave and convex parabolæ, quartic curves, and rectilinear shapes.

The present paper owes its origin to a suggestion by Professor Chrystal, to find out how closely the values given by these formulæ coincided with the results of actual experiments made with models to represent the typical cases.

The experiments were carried out with water in a rectangular trough whose dimensions were—length, 15·2 cm.; breadth, 10·5 cm.; depth, 12·5 cm. The curves characterising the special forms of the body of water to be experimented with were calculated and transferred to blocks of wood, which were cut and fitted into the trough, being weighted with lead to keep them in position.

The experiments involved the determination of two classes of results—the periods of the different seiches excited and the positions of the nodes of these seiches. The nature of the problem will best be illustrated by reference to the particular case in which the water is in the form of a concave-parabolic curve.

If the end of the trough is carefully raised and then lowered to its original position, the water moves in such a way as if the surface plane slid through a transverse line across the centre. A seiche, or oscillatory motion of the entire body of water, is thus generated. The water rises and falls everywhere except at the central transverse line, which, from analogy with vibrating strings and air-columns in organ-pipes, is called a nodal-line. As in the case of vibrating strings, a node is a position of minimum translational motion but of maximum rotational motion, so in a seiche there is minimum vertical motion but maximum horizontal motion at a node. The liquid particles move backwards and forwards through a comparatively wide range across the central transverse line, in the direction of the seiche motion.

In this present example of a uninodal seiche there is a nodal

Fig. I.

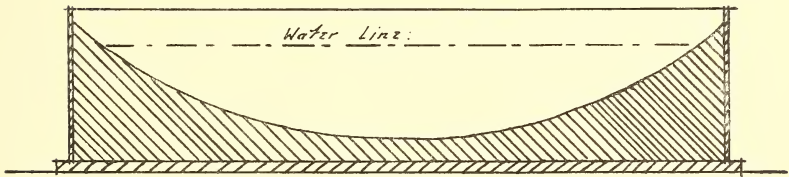

line in the middle of the vessel. The ends are positions of maximum vertical displacement, *i.e.* loops or ventral segments, and it is evident that exactly as in the case of open organ-pipes, the ends of a lake will always be ventral segments. If we compare the oscillating liquid with a stretched string, however, we find the circumstances reversed, since in the latter case the ends are always nodes; and when the fundamental vibration is in existence, the centre is a loop.

Taking advantage of the fact that at a node in a seiche, horizontal motion is a maximum, horizontal motion may be excited at other parts of the water-surface with the object of producing a seiche of a different period. Evidently, in the case referred to above, any such seiche will always have its nodes symmetrically situated about the central transverse axis.

The problem, then, was to determine for any particular curve

the various possible periods of oscillation of the liquid and the positions of the corresponding nodal lines with reference to any fixed line; also to determine for each curve the effect of altering the maximum depth of the liquid.

The first experimental method to be devised was a means to excite the various seiches. Obviously oscillatory motion necessitates regularly-timed impulses. A method of imparting such impulses to the liquid by means of a weighted spiral spring

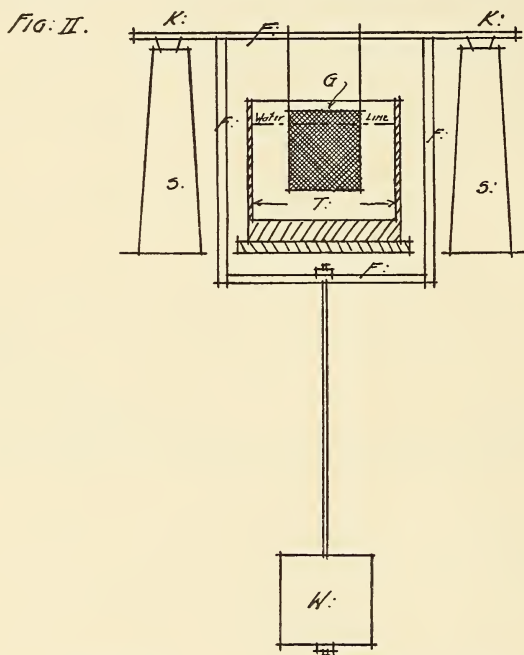

G Wire-gauze.
 KK Knife-edge supports.
 W Weight of pendulum.
 SS Supports of Pendulum.

FFFF Wood frame of pendulum
 supporting wire-gauze.
 T Trough.

is described on p. 612 of the paper by Professor Chrystal referred to above. This is not in all cases practicable. Another method that suggested itself was to make use of a pendulum with a sufficiently heavy bob to give it motive power. To this was attached a frame-work of wire gauze, which, besides being rigid, had the additional advantage of allowing the water to pass freely through it (figs. 2, 3).

If the apparatus be so arranged that the pendulum is of such a length as to swing in the period of any particular seiche while the wire-gauze is situated at a nodal-line corresponding to the seiche in question, the latter is easily set up by causing the pendulum to oscillate.

But while this is a most satisfactory method of supplying motive power to the oscillating system, when the period and the positions of the nodes are known, it is not without drawbacks while these

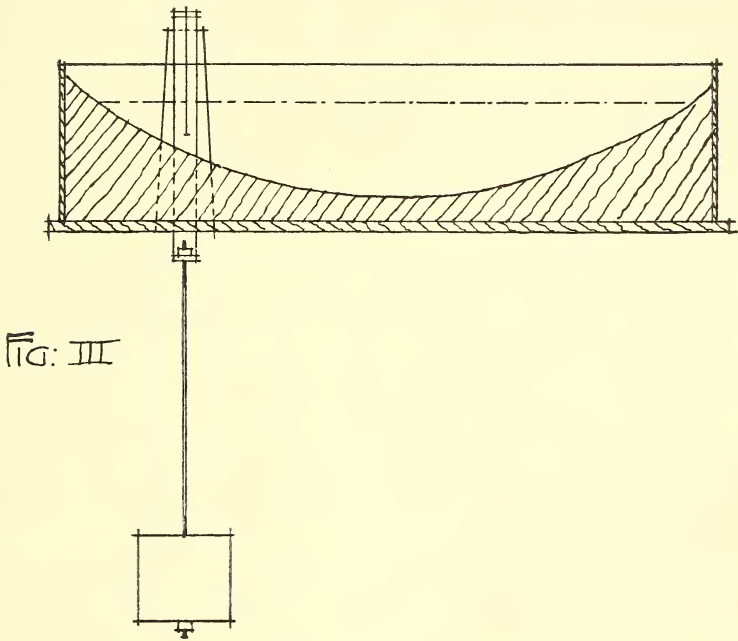

latter are being investigated. For, what may not be altogether without interest, it was found that after the combined systems had been moving in apparent harmony, the water rising and falling synchronously with the pendulum, it was impossible to say whether the period had been the natural period of the seiche or a forced period differing somewhat from it. Occasionally when the pendulum was released from communication with the water, each system would gradually assume a new phase of oscillation, differing between themselves and from the original mutual period.

While the seiche may best be generated by motion transferred to the liquid in the neighbourhood of a node, the natural period can only be satisfactorily determined when the liquid is left to oscillate freely by itself.

The principle of resonance enables us to overcome the difficulty involved in the ignorance of the true periods. If any motion except that approximating closely to a natural period of oscillation be imposed upon the liquid, it will not respond to any extent, and no seiche results. By communicating the motion by hand and regulating the impulses by the responsiveness of the water, the latter could be made to oscillate in some cases in as many as five or seven different periods. After the various seiches had been produced in this manner by repeated trials, varying the timing of the impulses and the position of application of these, the periods of the free oscillations of the water were observed and noted.

The following tables show the relation between the calculated and the experimental results for the particular curves mentioned:—

TABULATED RESULTS.

[*N.B.*—The experimental error-limit in the case of the periods tabulated, involves a correction of ± 0.02 seconds; and in the case of the distance of the nodes from the centre, a correction of ± 2 cm.]

N.B.—The references are to the *Trans. Roy. Soc. Edin.*, vol. xli., part iii. (No. 25).

1. Seiches in a concave symmetric complete parabolic lake [§ 27].

N.B.—All linear measurements are in centimetres; the periods are given in seconds.

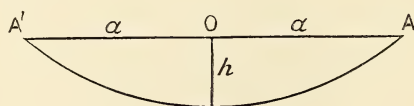

$$h(x) = h \left(1 - \frac{x^2}{a^2} \right)$$

$$[a = 70 \text{ cm.}; h = 10.9 \text{ cm.}]$$

h	T_1		T_2		T_3		T_4		T_5		Position of Binode $\frac{x}{a}$.	
	obs.	calc.	obs.	calc.	obs.	calc.	obs.	calc.	obs.	calc.	obs.	calc.
10.9	2.98	2.99	1.72	1.73	1.24	1.22	.98	.95	.80	.77	.567	.577
9.4	2.98	2.99	1.72	1.73566	.577
6.2	2.98	2.99	1.72	1.73573	.577

2. Seiches in a concave semiparabolic lake [§ 34].

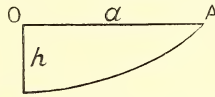

[$a = 70$ cm.; $h = 10.9$ cm.]

h	T_1		T_2		Position of Uninode $\frac{x}{a}$.		Positions of Binodes $\frac{x}{a}$.			
	obs.	calc.	obs.	calc.	obs.	calc.	obs.	calc.	obs.	calc.
10.9	1.73	1.73	.95	.95	.593	.577	.329	.340	.850	.861
9.4	1.72	1.73	.95	.95	.580	.577	.331	.340	.838	.861
6.2	1.74	1.73	.96	.95	.582	.577	.326	.340	.823	.861

3. Seiches in a convex symmetric parabolic lake [§ 37].

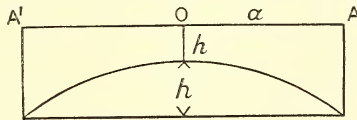

$$h(x) = h \left(1 + \frac{x^2}{a^2} \right)$$

h	a	T_1		T_2		Position of Binode $\frac{x}{a}$.	
		obs.	calc.	obs.	calc.	obs.	calc.
2.5	35.7	2.70	2.72	1.24	1.29	.444	.472
5.4	50	2.58	2.59	1.23	1.23	.457	.472

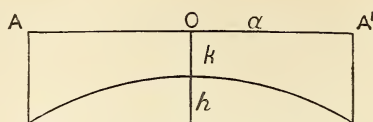

$$[h(x) = k + hx^2/a^2.]$$

k	h	a	T_1		T_2	
			obs.	calc.	obs.	calc.
2.5	2.5	71.5	2.70	2.72	1.24	1.29
5	2.5	71.5	2.06	...	1.00	...
7.5	2.5	71.5	1.6684	...
10	2.5	71.5	1.5076	...

4. Seiches in a complete symmetric rectilinear lake [§ 49].

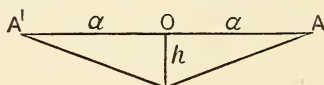

$$h(x) = h\left(1 - \frac{x}{a}\right)$$

$$\left[\frac{h}{a} = 4.02\right]$$

h	T_1		T_2		T_2/T_1		Position of Binode $\frac{x}{a}$.	
	obs.	calc.	obs.	calc.	obs.	calc.	obs.	calc.
8.70	1.99	1.98	1.24	1.24	.622	.627	.560	.605
10.7	2.23	2.19	1.40	1.38	.625	.627	.554	.605
12.9	2.41	2.42	1.51	1.52	.626	.627	.577	.605

5. Seiches in a semi-complete rectilinear lake [§ 51].

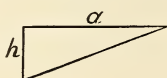

<i>h</i>	T_1		T_2	
	obs.	calc.	obs.	calc.
10.5	1.42	1.43	.78	.78
11	1.50	1.49	.81	.81
11.4	1.52	1.51	.84	.83
11.8	1.55	1.54	.86	.84

6. Seiches in a concave truncated quartic lake [§ 52].

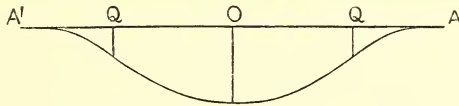

$$[p = q]$$

$$h(x) = h(a^2 - x^2)^2$$

$$[h = \log^{-1} 7.55594. \quad d = 12]$$

<i>d</i>	<i>l</i>	<i>r</i>	T_1		T_2		T_3		T_4		T_5		T_6		T_7	
			obs.	calc.	obs.	calc.	obs.	calc.	obs.	calc.	obs.	calc.	obs.	calc.	obs.	calc.
12	70	8	1.3	1.328	.74	.688	.56	.464
12	84	5.6	1.52	1.62	.88	.85	.67	.57	.54	.43	.48	.34	.44	.29	.39	.25
12	102	3.5	2.02	2.02	1.13	1.102	.80	.748

It will be noticed in the results for the seiches of high nodality of the concave parabola and quartic curve that the divergence between theoretical and observed results increases with the nodality. The rapidity of the oscillations and the corresponding difficulty of observation does not altogether account for this; but it must be remembered that the theoretical investigation presupposes that the square of the ratio of the depth to the wave length is negligible. This was by no means the case in the experiments carried out. In the case of the uninodal seiche of Loch Earn, for example, this quantity is $\frac{1}{4.500}$. In the experiments discussed here its value varied from $\frac{1}{40}$ to $\frac{1}{4}$ for seiches of high nodality.

While the determination of the various periods of oscillation was a comparatively simple matter, that of the exact position of the nodes was very troublesome.

Even when the system is oscillating in as perfect a manner as can be attained by means of the apparatus employed, it would seem that the nodal line does not assume a fixed position, but oscillates through a small range in the direction of the seiche motion. Besides, the slightest variation in the rhythm of the movement causes the apparent position to vary considerably. What requires to be determined is, therefore, the mean of these positions when the oscillations are most perfect. There are two

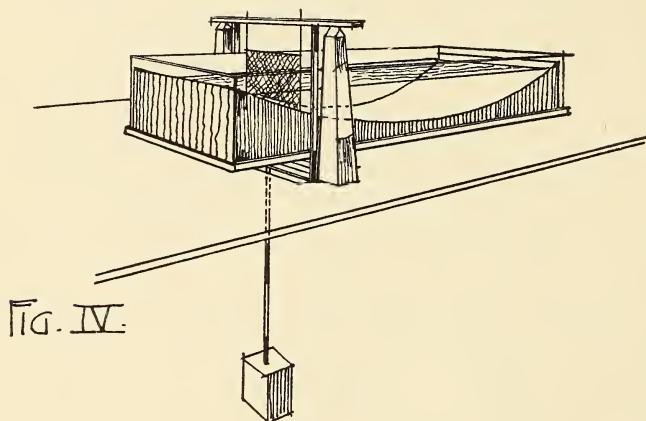

properties of which advantage may be taken in trying to determine the actual position. At a node the horizontal motion is a maximum and the vertical motion a minimum. It at first seemed that the place where the horizontal displacement was greatest would be easily determined; for it seemed a practicable course to measure the range of the oscillating particles at or near the supposed position of the node, and hence find the required maximum position. For this purpose a very thin plate of mica was hung by means of a bifilar suspension in the water, where it swung to and fro with the surrounding liquid. This object was viewed through a small telescope, and the magnitude of the oscillations read on a scale fixed in an appropriate position. After repeated trials, however, it was found that there was a

tolerably large range within which it was impossible to select any particular position as the most preferable. The limits of error thereby involved seemed too large to be satisfactory, and recourse was had to the other method in the hope that better results might be obtained.

At a node the vertical displacement is a minimum, and, under ideal circumstances, would be zero. On one side of the nodal line the liquid falls, while it is rising at the other side; and conversely. The plane of the water in its changing position intersects the plane of the water when at rest along the nodal line. The position of intersection of the initial and moving plane was observed by marking the direction of the former by means of a stretched wire. Limits were noted within which the node appeared to lie, and the mid-point of the average of these limits was taken as representing the nearest approximation to the true position of the node. The limits were necessarily wide, since the angle between the two planes, depending on the amplitude of the seiche, was very small. This part of the experimental results can only furnish limits within which the nodes seemed to lie.

The same difficulty in fixing the precise position of the nodes was experienced by the writers of this paper during observations on Loch Earn under the supervision of Professor Chrystal in the autumn of last year. The method adopted in that case was that of approaching the node from both sides simultaneously, and thus fixing limits within which the node was situated. These observations could only be satisfactorily carried out when the particular seiche motion was not too much masked by the presence of another, a contingency which very rarely arose. Even in the most favourable experimental circumstances it cannot be said that any oscillatory motion is perfectly pure.

The general results of the tabulated observed positions of the nodes show that in comparison with those in a rectangular vessel of uniform depth, the nodes are displaced towards the shallower part of the liquid. Thus in the case of the rectangular vessel of uniform depth, the binodal position is midway between the centre and the end, while in the case of the concave parabola the binodal position is nearer the end than the centre, and in the convex parabola the binodal position is nearer the centre than

the end. In those curves which are symmetrical about the central transverse line, the uninode is obviously not displaced from the centre. Not only does a curve of varying depth have its nodes displaced towards the shallower parts, as specified above, but definite experiments explicitly showed that the tendency of a shallow in the neighbourhood of a node is to displace the node from its normal position in the direction of the shallow.

In the case of the concave parabola, of length 127 cm. and maximum depth 9.4 cm., the binodal line is situated 27 cm. from the end. A rectangular obstacle of dimensions 5 cm. \times 3 cm. \times 2 cm. was submerged. The average distance of the top of the rectangular body from the surface of the water was 2 cm.; the mean distance of the edges from the end of the water was 12 cm. Under these circumstances the position of the node was observed as being 23.5 cm. from the end; *i.e.* the node was displaced 3.5 cms., and towards the shallow caused by the obstacle.

This particular experiment is of interest in connection with observations of the west binode of Loch Earn. This binode was calculated to be in the neighbourhood of the position of greatest depth of the loch, and slightly to the west of it. The calculated binodal position lies between a particularly deep part and a rise in the bottom of the loch. Experimental investigation led to the conclusion that the node was really considerably to the west of the calculated position, thus showing that the deep and the neighbouring shallow had exercised an influence on the position of the node.

Experiments were made with a model of Loch Earn, of which the longitudinal section was that along the line of greatest depth of the loch and in which the depth was increased ten times relatively to the length. While the model, being of uniform breadth, took no account of the varying breadth of the loch, as would be the case in a "normal" curve, the observed periods are nevertheless interesting. These are

Uninodal period	2.8	secs.
Binodal	1.52	„
Trinodal	1.1	„

These give the ratios

$$\frac{T_1}{T_2} = 1.84 \qquad \frac{T_1}{T_3} = 2.55$$

as contrasted with

$$\frac{T_1}{T_2} = 1.79 \qquad \frac{T_1}{T_3} = 2.54$$

for the calculated and

$$\frac{T_1}{T_2} = 1.81 \qquad \frac{T_1}{T_3} = 2.43$$

for the observed periods of the actual loch.

The experiments whose results are tabulated on pages 146-149 are by no means exhaustive, nor was it the aim of the writers to make them so. The purpose in view was rather to furnish sufficient experimental data to supply material for a critical comparison with theoretical calculations.

The respective movements of the water particles at a ventral segment, and at a node of a seiche, may be experimentally demonstrated by means of a float whose motion is magnified by being transmitted to a pointer in a manner best explained by the accompanying illustration. When the float is placed at a ventral segment, the end of the pointer moves through a range of several inches in unison with the oscillating water. When the float is placed at a node the vertical movement of the end of the pointer, if not entirely eliminated, is reduced to a minimum.

If we imagine one seiche superposed on another it will be seen that the motion due to the one can be recorded independently of the motion of the other. For, if a uninodal seiche is in existence along with a binodal seiche, a float on the uninodal line will have no vertical motion from the uninodal seiche, but only from the binodal, and on a binodal line will have vertical motion due to the action of the uninodal seiche alone.

This may be experimentally shown by raising the end of the vessel when the pendulum (fig. 3) is keeping up a binodal seiche, thus superposing on the latter, a uninodal seiche. At the binode and uninode the pointer (fig. 5) moves in the uninodal and binodal periods respectively. In all other positions its motion is a combination of the two motions.

If a vertical transverse barrier be introduced into the liquid near a node, it will prevent the natural movement of the particles there, and thus interfere with the free oscillations of the liquid; but if such a barrier be interposed at a ventral segment, it will not interfere with the motion of the particles which are there moving vertically. In this connection evidently, the uninodal period of each division, in the case of a barrier inserted at the middle of a symmetric parabolic curve, is the binodal period of the complete parabola.

The following observations made during the investigations above detailed, though of a secondary nature as regards the

Fig. V.

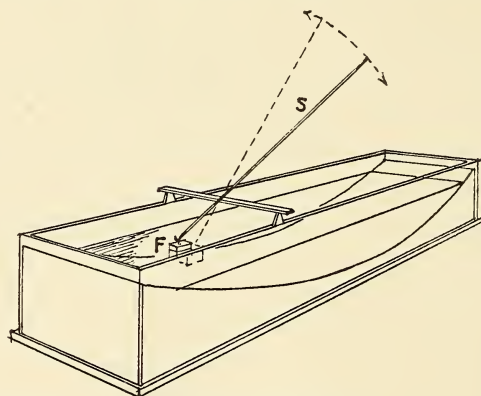

F Float.

S Pointer (straw).

primary object of this paper, are submitted as being perhaps of some intrinsic significance.

(1) In most cases no difficulty was experienced in generating the various seiches beyond that of ascertaining by repeated trials the period of the appropriate impulses. But in the particular case of the convex parabola it was found practically impossible to create the uninodal seiche by any other method than by forcing a vertical motion on a portion of the water, separated from the main body by a partition, on the same principle as the spiral spring mentioned above.

Even by this means it was difficult to get a pure seiche. As a rule the motion would continue apparently regular for two or three oscillations, but would very quickly become somewhat erratic

and lengthen considerably in period. These irregular oscillations gave quite inconsistent results, which were greater than those obtained when the oscillations were regular.

The binodal seiche in the same case presented less difficulty, but could not be increased in amplitude beyond a very limited amount. This latter was also more persistent than the uninodal, which died out very rapidly when left to itself. In the case of the concave parabola and the quartic curve, it was possible to obtain easily even seiches of a high nodality (in the case of the quartic curve as high as the seventh), and these could be forced to a considerable amplitude, showing also a remarkable persistency, particularly as regards the latter curve.

(2) When a vertical barrier was inserted at a ventral segment,

- FIG VI.

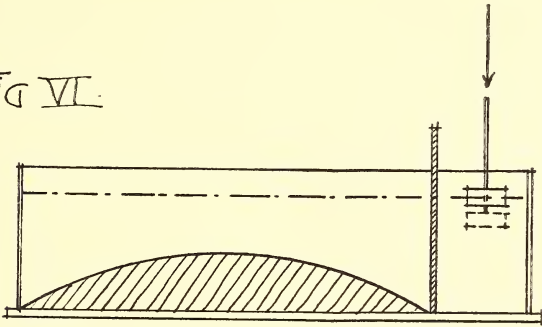

the seiche motion still continued to be transmitted from one portion of the liquid to the other, even when the passage between these two portions was considerably constricted.

(3) Rhythmic movements are generally persistent as contrasted with random displacements which have no periodic connection with the form of the vessel in which they take place. In this connection the movement of the water in a rectangular trough calls for remark. If the end of the vessel be raised and then lowered, a group of high waves or a bore passes along the surface and is reflected from the end, when it returns along its former path. After the motion has somewhat subsided, the movement of the water begins to assume a certain symmetry.

Gradually the smaller waves die out on the slopes of the larger, until two waves are left which move backwards and forwards

along the length of the vessel, passing through each other, and, after being reflected from the ends, crossing again. The position of crossing changes from side to side of the central transverse line, but always approaches nearer to this as a limiting position. When this condition is reached no further change takes place, and a single standing wave with a fixed period (as observations showed) oscillates in the trough with a ventral segment in the middle. This is obviously the binodal seiche.

Sometimes this state of matters comes about without a great diminution of amplitude, but generally the movement dies down considerably before this condition is reached.

(Issued separately June 11, 1906.)

On the Methods of Standardising Suprarenal Preparations. By I. D. Cameron, M.B., D.P.H., Assistant to the Lecturer on Physiology, Edinburgh School of Medicine for Women. (*From the Laboratory of the Royal College of Physicians, Edinburgh.*) Communicated by Dr D. NOËL PATON.

(MS. received March 5, 1906.)

Since a number of preparations of the suprarenal capsules are now extensively used in therapeutics, it seems of some importance to determine the relative value of those most generally used. In the course of a series of experiments on the antagonism between nitrites and suprarenal preparations, and again between these organic extracts and those of the thyroid gland, it became necessary to determine the exact amount of the minimal effective dose. This afforded an opportunity of investigating the methods applicable to the standardisation of these preparations and their relative efficiency.

Since Takamine's * preparation of a pure product of adrenalin, many extracts of the suprarenals have been put on the market.

Meyer † has now established the precise nature of adrenalin and has prepared it synthetically, while Dakin ‡ has, also by synthesis, prepared a body closely allied to it and with a similar physiological action. It has now become possible for manufacturing chemists to prepare a practically pure and uniform product. To test how far uniformity exists in the present preparations, the following were examined :—

Adrenalin (Parke, Davis & Co.).

Suprarenalin (Armour & Co.).

Hemisine (Burroughs, Wellcome & Co.).

Several other commercial preparations were tested, but the results were found to be uncertain even with the administration of very large doses ; in a few cases a fall of blood pressure instead of a rise was given.

* *American Journal of Pharmacy*, 1901, p. 523.

† *Arch. f. Exper. Path.*, xxxv. p. 213.

‡ *Proc. of Roy. Soc.*, Oct. 7, 1905, p. 491.

Various methods of determining the strength of action of the suprarenal preparations have been proposed.

A.—*Chemical.*

Colorimetric methods were suggested by Battelli* and others. The reactions depend on the rose colour given with a weak solution of iodine and on the green tint produced with ferric chloride. The nature of these reactions is little understood, and the possibility of their being given by other substances is great. They do not necessarily afford a reliable test of the physiological activity of the product. I find that, while they afford a means of roughly standardising preparations of greater strength than adrenalin 1 in 40,000, it is impossible to use them in more dilute solutions. An additional difficulty is presented when the solution to be tested is already of a brownish colour. Hence they do not seem to afford a reliable or delicate method for standardising preparations.

B.—*Physiological.*

1. *Perfusion of Vessels of Frog.*—Läwen † perfused the frog's vessels and got a decided constriction with 0.002 mg. of suprarenin in 10 c.cm. (0.2 per million) under a pressure of 20 cm. of water.

2. *Action on Pupil of Frog's Eye.*—Ehrmann, as a preliminary to his investigation as to the fate of adrenalin in the blood, devised a method of standardising the solutions by their effect on the pupil of the frog's eye. To eliminate the sympathetic effect, he used enucleated bulbs. The controls were placed in physiological salt solution. The amount of dilatation of the pupil is expressed as "maximal," "almost maximal," "considerable" and "slight." He showed that 0.00005 mg. in 1 c.cm. (0.05 per million) gave a slight dilatation of the pupil, while further dilutions gave no result.

On repeating these experiments of Ehrmann, similarly satisfactory results were not obtained. There is difficulty in measuring the exact amount of dilatation of the pupil. It is also possible that absorption through a fibrous membrane, especially under artificial conditions, may not be equal and constant. In one experiment, where the solution used was 0.00025 mg. in 0.5 cm. (0.5 per million),

* *Compt. Rend. Soc. de Biolog.*, 1902, p. 571.

† *Arch. f. Experim. Path. u. Pharmacol.*, Bd. li., S. 415.

dilatation of the pupil resulted, but it was followed on long exposure by a marked contraction. Probably any slight injury to the eye during enucleation may interfere with the result.

3. *On Arterial Blood Pressure.*—Ehrmann, who published his results when my investigations were nearly completed, also tested the minimal effect on the blood pressure in cats. He quotes one experiment in which 0.08 mg. (0.02 mg. in 1 c.cm. of which 4 c.cm. were injected) gave a slight increase of blood pressure. The effect was just appreciable when five-eighths of that quantity was used. In these experiments the anæsthetic was ether, and the injections were made into the jugular vein.

Elliott,* in investigating the disappearance of adrenalin from the body, estimated its strength by means of the blood pressure in cats under urethane and with cut vagi. The maximal pressure curves given with increasing doses of adrenalin injected in equal times were found. The intervening values were estimated from these curves. The rise varied with the vein into which the injection was made, being greatest in the external jugular. The blood pressure results were corroborated by the typical eye reactions—widening of the eyelids, dilatation of the pupil, and retraction of the nictitating membrane.

Before the publication of Ehrmann's and Låwen's papers, I had investigated the availability of the perfusion method and of the method of determining the effect on arterial pressure.

In the perfusion experiments, a cannula was tied into the aorta of a pithed frog, and the fluid to be tested was allowed to flow by gravitation from a reservoir. After passing through the vessels of the frog, the fluid escaped through the cut sinus venosus. As the difference in viscosity of the perfused fluids was practically negligible, the effect of each could be determined by the rate of flow from the cut sinus. To avoid the laborious proceeding of counting the drops, a graphic record was taken. The perfused fluid, as it escaped, was allowed to drop on a light aluminium plate, $\frac{3}{4}$ inch square, which was fixed obliquely to the free end of a lever. The movement of the lever caused by the fall of a drop of fluid was transmitted by means of tambours to a second lever, to the

* *Journal of Physiology*, vol. xxxii. p. 447.

end of which a writing style was attached. A record was made on a revolving drum. By this means, and by an electric marker which marked half minutes, the rate of flow was graphically represented.

The solutions were, in all cases, made with Locke's modification of Ringer's solution. It was found necessary to make the solution immediately before use, as the fluid became pink, and rapidly lost its activity.

1. *Perfusion of the Vessels in the Pithed Frog.*—Perfusion of 1 per million gives a very marked constriction, which continues for a considerable time after the adrenalin is withdrawn and Locke's solution is again perfused. Recovery, however, takes place (unless the constricting fluid has been perfused for too long a time), and the normal rate is re-established. Further dilution to 0·5 per million gives a considerable constriction, while there is still a feeble reaction with a solution of ·1 in one million.

The following experiment shows the slight constricting action of 0·1 per million :—

After perfusion for some time.		Solution.
Time.	Drops per minute.	
3·50	24	Locke's solution.
3·53	24	
3·56	24	
3·58		
4·1	20	Adrenalin 0·01 per cent. of 1 in 1000, 0·1 in a million.
4·2	21	
4·3	20	
4·4	20	
4·5	20	
4·8	20	
4·11	20	
4·14	22	
4·16	23	
4·17	22	
4·18	24	Locke's solution.

When this result is compared with Låwen's, a great similarity is seen.

He got marked constriction with ·002 mg. in 10 c.c. suprarenin, *i.e.* with 0·2 per million.

The results on different frogs were somewhat variable, and further, the method of perfusion is tedious and troublesome, especially if the preparation to be tested is used after the action of a preparation of standard strength.

2. *Minimal Effective Dose on Blood Pressure in Rabbits.*—The blood pressure experiments were performed by Dr Noël Paton. Rabbits of fairly uniform size (about 2000 grams) were selected. The carotid artery was connected with a mercury manometer in the usual way, and the injections were made into the jugular vein. Full anaesthesia by ether was maintained till the death of the animal.

Gradually decreasing doses were injected into the jugular vein. The smallest amount which gave a definite and invariable rise of blood pressure was 0·5 c.c. of a 0·125 per cent. solution of adrenalin (Parke, Davis, 1 in 1000)—that is, ·00062 mg. of adrenalin, or ·0003 mg. per kilo. A similar result was given with hemisine and with suprarenalin when used in the same strengths (fig. 1). In the case of the adrenalin and of the suprarenalin, the solution was made from the commercial 1 in 1000 preparation: the hemisine tabloid was first made up to 1 in 1000 with Locke's solution, and was then further diluted as required. This result may be expressed in another way—·00000031 gram per kilogram of body weight causes the minimal rise of blood pressure in rabbits. If the blood of the rabbit is taken as 5 per cent. of its body weight,* then ·006 per million of blood is effective. When we compare this result with that of Ehrmann,† who found that ·00002 gram per kilogram of body weight in a cat gave a rise of pressure which was just appreciable, we find a corroboration of Lesage's‡ statement as to the comparative resistance of the cat to the effect of adrenalin. In an experiment on a cat of two and a half kilogrammes, a rise of blood pressure was given with ·00003 g. in 1 c.c. (·000012 g. per kilo)—that is, just over one-half the amount given by Ehrmann to produce his minimal result. It is interesting to compare this result with Schäfer's§ suggestion, made before

* Douglas, *Journal of Physiology*, vol. xxxiii. p. 493.

† *Loc. cit.*

‡ *Arch. intern. de Pharmac. et de Thérap.*, li. p. 304, and *C. R. Soc. Biol.*, 1904, p. 665.

§ *Text-book of Physiology*, vol. i. p. 957.

the active principle was isolated, that $\cdot 000001$ g. per kilogram of body weight would produce a distinct action of the heart and arteries.

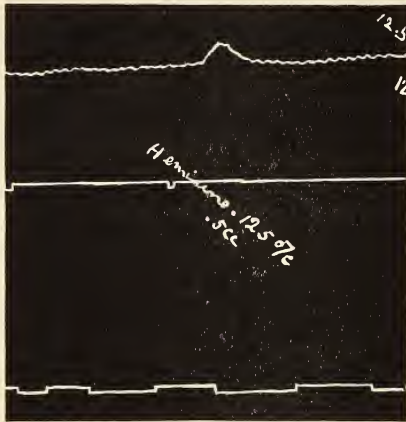

(a)

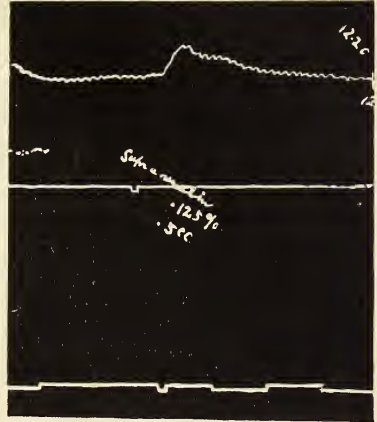

(b)

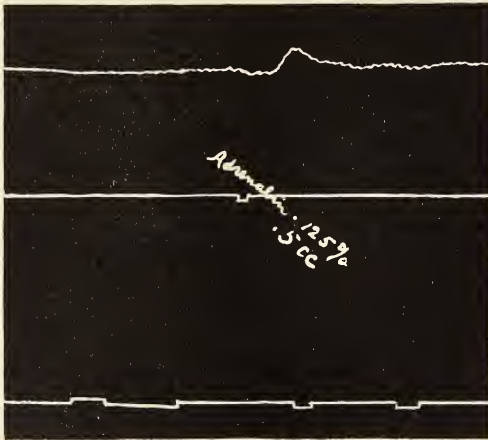

(c)

FIG. 1. To show the effect on the blood pressure of intravenous injection in the rabbit of $\cdot 00031$ mg. per kilo of (a) Hemisine ; (b) Suprarenalin ; and (c) Adrenalin.

The same rise of pressure was given whether the initial pressure was low or high.*

* In all traces time is marked in half-minutes.

A similar curve of increased pressure was given when the same amount of adrenalin was injected towards the end of a fall of pressure from sodium nitrite (fig. 2), and during the slowly rising pressure produced by a weak solution of barium chloride (.5 c.c. of .5 per cent. solution).

This weak solution, then, .0000031 gram per kilo of body weight, produces a distinct effect when the blood pressure is normal, when it is falling gradually, and when it is being increased slowly.

With a reliable adrenalin preparation available to give a standard of comparison, this method affords an excellent and easy means of standardising any preparation. But when this is not available the method is not so satisfactory.

3. *Antagonism to definite Doses of Vaso-dilators.*—On account of the disadvantages of these methods, the plan of standardising against a vaso-dilator of known composition was tried. The marked peripheral vascular dilatation caused by the nitrites suggested their use. It is recognised that all the nitrites cause vascular dilatation, but their effects differ in degree and in duration. The nitrate esters which act as nitrites were not available because of their insolubility. As Atkinson* points out, nitrous acid is too unstable to be used. The amyl base in amyl nitrite has a decided action of its own, and the alcohol required to keep it in solution increases the dilatation. Sodium has not a well-marked pharmacological activity, and so sodium nitrite is a convenient salt to use in order to get a nitrite effect.

Hay † states that nitroglycerin is chemically a nitrate of glyceryl; in an alkaline fluid such as the blood, it is decomposed and a nitrite is liberated. Marshall ‡ does not agree with this view of the action of nitroglycerin. He contends that it probably remains unchanged and is not reduced until it reaches the tissue cells. Wherever the seat of the chemical change may be, there is no doubt that nitroglycerin acts physiologically as a nitrite.

Sodium nitrite was first used in this series of experiments.

* *Journal of Anatomy and Physiology*, vol. xxi. p. 225.

† *Practitioner*, vol. xxx., 1883, p. 422.

‡ *Journal of Physiology*, 1897-98, p. 1.

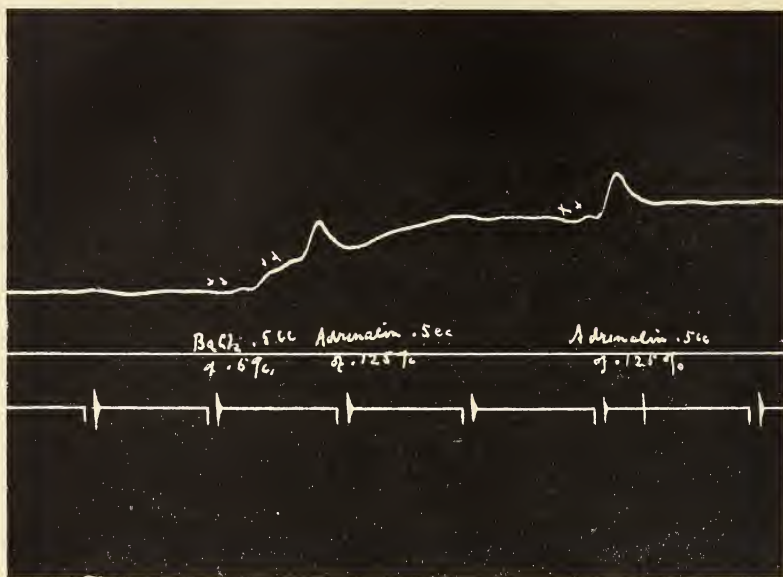

(a)

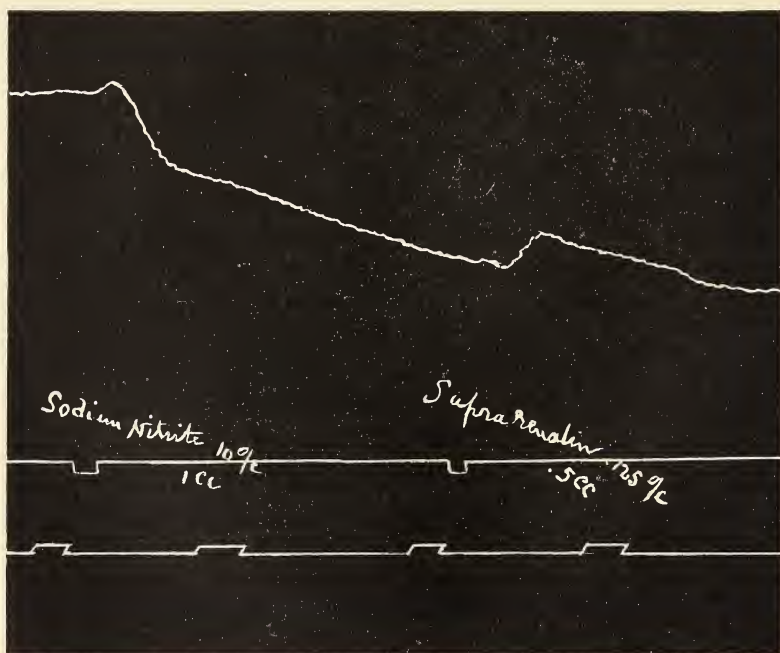

(b)

FIG. 2. To show the effect of a minimal dose of adrenalin on the blood pressure of a rabbit during (a) a rise from injection of barium chloride, and (b) towards the end of a nitrite fall of pressure.

Many commercial preparations of sodium nitrite are very impure and contain considerable quantities of the nitrate. The sodium nitrite of Merck is practically pure. The crystals were kept dry and the solutions were freshly made. When made in this way, the solution of nitrite is practically of uniform strength.

Nitrites have been largely used in perfusion experiments. Atkinson* perfused frogs with solutions of sodium nitrite (containing 99 per cent. of nitrite by the permanganate method), and he got dilatation of the vessels in solutions of from 1 in 100 to 1 in 100,000—the increased flow in the latter case being from 16-18 per cent. A solution of 1 in 200,000 was without effect. He also perfused nitroglycerin, and got an increased flow up to a dilution of 1 in 1,000,000.

Leech † perfused decapitated tortoises with solutions of sodium nitrite and collected the fluid in graduated flasks. After a preliminary contraction, dilatation of the vessel wall resulted with strengths of from 1 in 1000 to 1 in 10,000. This preliminary contraction was not seen on perfusing the kidneys of warm-blooded animals. He also found marked dilatation on perfusion of the lungs of a cat killed by chloroform. Leech calls attention to a certain resemblance between the action of alcohol and that of the nitrites, but he states that the nitrites are more rapid and also more evanescent in their action. Marshall, ‡ in the course of his experiments on the antagonism of digitalis and the nitrites, perfused sheep's kidneys with sheep's blood, and demonstrated that there was not chemical antagonism, but that each drug produced its own effect, which varied with the length of time and the rapidity of action, and also with the strength of the solution.

Both the perfusion method in pithed frogs and blood pressure in rabbits were used as a means of estimating the effect of adrenalin and a nitrite given together.

(a) *Perfusion.*—A solution of adrenalin of the strength of 0.05 per cent. of 1 in 1000 gives a marked constriction when perfused in a pithed frog. Sodium nitrite (Merck) was added

* *Loc. cit.*

† *Brit. Med. Journal*, vol. i., 1893, p. 1305.

‡ *Loc. cit.*

to the solution. Until 6 per cent. of the nitrite was added, the adrenalin constriction was still given. When this strength was reached, no constriction appeared even with continued perfusion, but a slight dilatation was present. When the perfusion of the mixture was stopped and Locke's solution was used, the nitrite effect rapidly passed off, and a prolonged adrenalin effect was given. The nitrite apparently could only antagonise the effect of the adrenalin or delay its action while the two drugs were being perfused through the vessels.

A typical experiment in which antagonism was not established may be given, as it demonstrates the influence of both drugs on the vessels.

After perfusion for 35 minutes.		Solution.
Time.	Drops per minute.	
1·25	20	Locke's. Sod. nitrite, 0·5 per cent.
1·27	20	
1·28		
1·38	46	
1·41	44	
1·43	48	
1·48	44	Locke's. Sod. nitrite, 0·25 per cent. ; adrenalin, 0·05 per cent.
1·50		
1·56	40	
2·0	40	
2·4	28	
2·8	22	
2·25		
2·28		
2·35	6	
2·38	10	

(b) *Blood Pressure.*—The effect of nitrites on the blood pressure has been extensively studied.

Lauder Brunton* investigated the fall of blood pressure caused by the inhalation of amyl nitrite. Atkinson,† in experiments on rabbits with their vagi intact, got a fall of blood pressure and acceleration of the pulse with a dose of $\frac{1}{2}$ grain of sodium nitrite. A similar result was obtained with much smaller doses of nitroglycerin. The pressure fell with 1 in 1500, but with 1 in 50,000

* *Journal of Anatomy and Physiology*, vol. v. p. 92.

† *Loc. cit.*

there was a slight rise. In blood pressure experiments with a mixture of digitalin and nitroglycerin, Marshall * found that, as in his perfusion experiments, each drug gave its own characteristic action, the nitrite fall of pressure, being a less prolonged effect, passed off, and then a digitalin rise was seen. This result was corroborated on the isolated frog's heart.

Leech † has tested the action of barium nitrite on muscle directly. Barium chloride increases the contractile power of muscle and causes contracture. In barium nitrite, the two parts appear to act independently. The barium action is first evident, later the contraction is annulled, and death of the muscle results earlier than with barium chloride.

In the present experiments rabbits were used, and the blood pressure was estimated as described above. Nitroglycerin was here used in order to get a more rapid effect than that given with the sodium nitrite. The preparation used was that of Parke, Davis & Co., made up in $\frac{1}{100}$ grain (0.6 mg.) tablets.

Adrenalin was injected, .5 c.c. of 1.5 per cent. (fig. 3 a), and when the pressure had again returned to normal, the nitrite fall was demonstrated with nitroglycerin $\frac{1}{100}$ grain (0.6 mg.) (fig. 3 b). Then an equal volume of solution which contained both drugs was injected.

When adrenalin 0.5 c.c. of 1.5 per cent. was injected with 1 c.c. containing 0.6 mg. grain of nitroglycerin, the adrenalin rise was almost entirely cut down, and the opposing effect of the nitroglycerin was soon manifested by a very slight fall and then a return of the normal pressure (fig. 3 c). The tracing given closely resembles a minimal adrenalin effect. Each of the drugs is here apparently acting independently, but in opposite directions—the greater rapidity of action of the adrenalin showing itself in the increase of blood pressure before the nitrite acts. If the amount of adrenalin injected be still further diminished (.4 c.c. of 1.5 per cent. being injected) while the same amount of nitroglycerin is used, the effect of the change in proportion is seen (fig. 3 d). Again, the rapid action of adrenalin causes an increase of pressure which is soon abolished by the commencing nitrite action. In this case a sufficient amount of nitrite is given, not only to

* *Loc. cit.*† *Loc. cit.*

prevent the adrenalin rise, but also to cause a definite fall of pressure. This fall is not, however, very marked, as the vascular dilatation is being opposed although not abolished by the adrenalin.

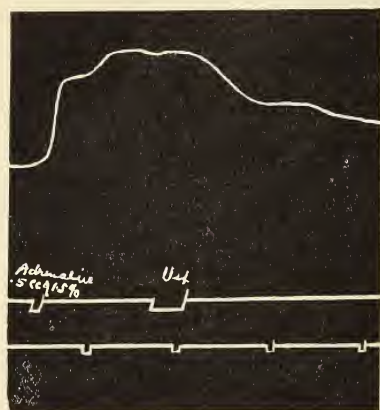

(a)

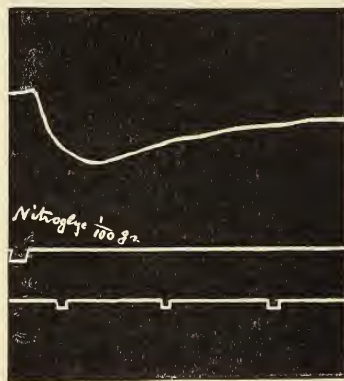

(b)

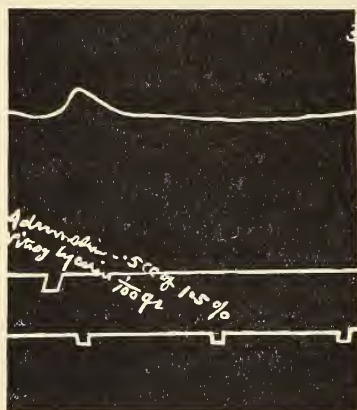

(c)

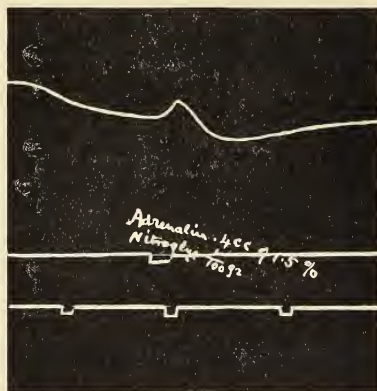

(d)

FIG. 3. To show the neutralising action on the blood pressure of nitroglycerin and adrenalin. (a) Effect of adrenalin 0.0075 mg.; (b) effect of nitroglycerin 0.6 mg.; (c) effect of (a) and (b) combined; (d) effect of adrenalin 0.006 mg. with 0.6 mg. of nitroglycerin.

The best antagonistic action is thus given with .5 c.c. of 1.5 per cent. solution of adrenalin combined with $\frac{1}{100}$ grain of nitroglycerin—0.0075 mg. of adrenalin is antagonised by .6 mg. of nitroglycerin—that is, the nitroglycerin and adrenalin are as 80 to 1.

In an experiment on a cat, the amount of adrenalin which produced a moderate rise of pressure (·03 mg. in 1 c.c.) was combined with $\frac{1}{100}$ grain of nitroglycerin, and a result very similar to that given with the smaller dose in rabbits was given (fig. 4).

The preliminary rise of adrenalin is again inhibited by the action of the nitroglycerin, and the normal pressure level is rapidly reached. It is interesting to note that although the adrenalin must be used in strong solutions in order to effect the blood pressure in the cat, nitroglycerin apparently acts in very much the same way in the cat as it does in the rabbit. This also tends to prove that adrenalin

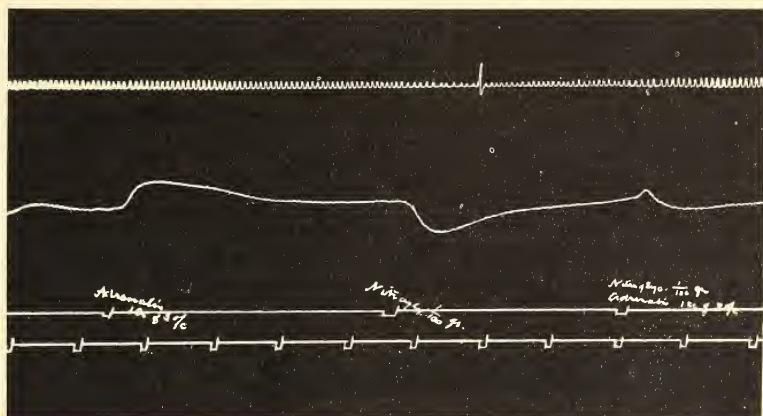

FIG. 4. To show the neutralising effect of nitroglycerin and adrenalin on the blood pressure of the cat, ·03 mg. of adrenalin against 0·6 mg. of nitroglycerin.*

and a nitrite act independently but in opposite directions—in other words, that the antagonism is what might be called dynamic rather than chemical.

Of these two methods employed for the combination of nitrite and adrenalin, that of estimation by the blood pressure is more satisfactory. The action of adrenalin when perfused through the peripheral circulation is of considerable duration, while a return to the normal is more rapid with a nitrite. On long-continued perfusion then, although at first an antagonism is established, the adrenalin effect ultimately appears on discontinuing the perfusion. The power of the cells to react to the stimulus of nitrite is more readily exhausted; then the adrenalin effect is seen.

* Top line is the respirations.

In my hands the method of standardising preparations of adrenalin which has proved most serviceable is that of testing their antagonistic effect to a known dose of nitroglycerin, 0·6 mg. ($\frac{1}{100}$ gr.) of which should require 0·0075 mg. of the adrenalin preparation to antagonise its dilator action.

In one preparation of suprarenal submitted to the Laboratory for examination, the minimal effective dose was 0·5 c.c. of a 1 per cent. solution. The minimal effective dose of adrenalin is 0·00062 mg. for a rabbit of about 2000 grams. Of the solution tested, ·005 c.c. is then equal to ·00062 mg. of adrenalin—that is, 1 c.c. = 0·12 mg.

This result is corroborated when the nitroglycerin method of standardisation is used. The dilator effect of $\frac{1}{100}$ grain nitroglycerin (·6 mg.) is opposed by ·7 c.c. of 10 per cent. The same amount of nitroglycerin is neutralised in effect by ·5 c.c. of 1·5 per cent. of adrenalin (·0075 mg.). Then 1 c.c. of the solution is equal to 0·107 mg.

The solution is therefore rather more than $\frac{1}{10}$ as strong as the adrenalin chloride 1 in 1000 of Parke, Davis & Co.

SUMMARY.

For the standardisation of adrenalin preparations.

(a) The colorimetric method is not reliable with weak or impure solutions.

(b) The effect on the pupil of the frog's eye gives uncertain results.

(c) The determination of the minimum effective dose on the arterioles of the perfused frog is tedious and uncertain; on an average 0·1 per million produces an effect.

(d) The determination of the minimum effective dose in causing a rise on the blood pressure of the atropinised rabbit yields fairly satisfactory results.

(e) Adrenalin, suprarenalin, and hemisine all give a precisely similar result, 0·0003 mg. per kilo of body weight, or 0·006 per million, of the rabbit's blood causing a distinct rise in the blood pressure in the rabbit, and 0·012 mg. per kilo of body weight, or 0·24 per million, of the blood causing a rise in the cat.

(*f*) The most satisfactory method is the determination of the dose just sufficient to antagonise 0.6 mg. ($\frac{1}{100}$ gr.) of nitroglycerin (Parke, Davis & Co.). Of adrenalin, 0.0075 mg. is sufficient.

I wish to express my indebtedness to Dr Noël Paton for much help in the preparation of this paper.

The expenses of this research were defrayed from a grant made to the Laboratory by Mr J. Francis Mason for investigations on the physiology of the ductless glands.

(Issued separately May 21, 1906.)

Neobythites Brucei, Poisson abyssal nouveau recueilli par l'Expédition Antarctique Nationale Ecossaise. Note préliminaire, par Louis Dollo, Conservateur au Musée royal d'Histoire naturelle, à Bruxelles. Présentée par M. R. H. TRAQUAIR, M.D., F.R.S., V.P.R.S.E.

(MS. received March 3, 1906. Read May 7, 1906.)

I. INTRODUCTION.

Le deuxième Poisson abyssal de la *Scotia* dont je désire entretenir la Société Royale d'Edimbourg appartient au genre *Neobythites*, qui fut découvert, en réalité, par le *Challenger*,* en 1875, près du Japon, par 1875 fathoms, bien que le nom n'ait été créé qu'en 1886, sur des matériaux de l'*Albatross*,† comme nous le verrons plus loin.

Et ce deuxième Poisson est encore une espèce nouvelle, à laquelle je donnerai le nom de *Neobythites Brucei*, en l'honneur de M. W. S. Bruce, Leader de l'Expédition Antarctique Nationale Ecossaise, comme un témoignage de reconnaissance pour les services rendus à la Science au cours de son importante Exploration.

Le *Neobythites Brucei* est le premier Poisson de la Famille des *Brotulidæ* capturé à l'intérieur du Cercle Polaire Antarctique, et il y fut pris, non sur le Plateau Continental, mais dans les Grandes Profondeurs, par 2500 fathoms, dans la Mer de Weddell.

C'est, d'ailleurs, une pièce unique, car, outre qu'il n'est représenté que par un seul spécimen, la collection ichthyologique de la *Scotia* ne renferme pas d'autres *Brotulidæ*.

Enfin, aucune autre Expédition Antarctique, parmi celles qui ont recueilli des Poissons à l'intérieur du Cercle Polaire (*Erebus*

* A. Günther, "Report on the Deep-Sea Fishes," *Voyage of H.M.S. Challenger during the years 1873-76*, Zoology, vol. xxii., 1887, p. 100.

† C. H. Townsend, "Dredging and other Records of the United States Fish Commission Steamer *Albatross*, with Bibliography relative to the work of the vessel," *U.S. Comm. Fish and Fisheries: Commissioner's Report*, 1900, Washington, 1901, p. 504.

and *Terror*,* *Belgica*,† *Southern Cross*,‡ *Discovery*,§ *Français*;|| le *Gauss* ¶ et l'*Antarctic* ** n'ont pu traverser ce Cercle), n'en a obtenu de pareilles profondeurs; de toutes ces Expéditions, c'est encore la *Belgica* qui suit la *Scotia* de plus près, avec son *Nematonurus Lecoitei*, pêché à 2800 mètres (1531 fathoms) de profondeur, dans la Mer de Bellingshausen.

Au surplus, les deux Poissons en question,—*Neobythites Brucei* et *Nematonurus Lecoitei*, —proviennent bien du fond même de l'Océan, puisque ce sont des Organismes Abyssaux adaptés à la Vie Benthique, comme en témoigne leur Queue Géphyrocerque,†† acquise indépendamment, par un Phénomène de Convergence (*Neobythites* est un *Brotulidæ*, donc un *Acanthoptérygien*; *Nematonurus* est un *Macruridæ*, donc un *Anacanthinien*).

II. LE GENRE NEOBYTHITES.ⁿ

1. En 1877, M. A. Günther, Conservateur honoraire au British

* J. Richardson, "Fishes," *Zoology of H.M.S. Erebus and Terror, under the command of Captain Sir James Clark Ross, R.N., F.R.S., during the years 1839 to 1843*, Londres, 1844-48, p. 15.

† L. Dollo, "Poissons de l'Expédition Antarctique Belge," *Résultats du Voyage du S. Y. Belgica en 1897, 1898, 1899, sous le commandement de A. de Gerlache de Gomery*, Anvers, 1904, p. 11.

‡ G. A. Boulenger, "Pisces," *Report on the Collections of Natural History made in the Antarctic Regions during the Voyage of the Southern Cross*, Londres, 1902, p. 174.

§ R. F. Scott, *The Voyage of the Discovery*, Londres, 1905, vol. i., p. 120. ". . . It is disappointing to learn that we cannot expect any additions to the deep-sea fauna of the Southern Ocean. The wealth of new material collected by the *Challenger* in its one deep haul in the Antarctic, led to hope that valuable results would be achieved by the powerful deep-sea equipment of the *Discovery*; but apparently it was very little used, owing to the short time spent at sea, and possibly on account of the limited coal supply. One dredging is referred to at the depth of 610 fathoms, another at 100 fathoms, and a third, also in shallow water, off the great ice-barrier."—J. W. Gregory, "The Work of the National Antarctic Expedition," *Nature*, 1906, vol. lxxiii., p. 297.

|| "The fishes, taken in considerable numbers down to depths of 200 feet, represent some fifteen species."—J. Charcot, "The French Antarctic Expedition," *Geographical Journal*, 1905, vol. xxvi., p. 514.

¶ E. von Drygalski, *Zum Kontinent des eisigen Südens*, Berlin, 1904 (carte).

** O. Nordenskjöld, J. G. Andersson, C. A. Larsen, C. Skottsberg, *Antarctic, två år bland sydpolens isar*, Stockholm, 1904 (cartes).

†† L. Dollo, "Sur la Phylogénie des Dipneustes," *Bull. Soc. belg. Géol.*, 1895, vol. ix., p. 90.

Museum, décrit la première espèce de ce genre,* mais il la plaça, à tort, comme il le reconnut plus tard,† dans le genre *Sirembo* de Bleeker.

C'est le plus grand Poisson abyssal ramené par le *Challenger* : il mesure 0.75 m.

2. En 1886, G. B. Goode et M. T. H. Bean, Conservateur honoraire au Musée de Washington, fondèrent le genre *Neobythites* ‡ sur un Poisson capturé par l'*Albatross*, à 111 fathoms de profondeur, dans le Golfe du Mexique.

Ils nommèrent l'espèce *Neobythites Gillii*.

3. En 1887, M. Günther, dans sa Monographie des Poissons abyssaux du *Challenger*,§ lève une *équivoque fâcheuse* :

“This genus has been distinguished by me for some time, but the manuscript name which I proposed for it, *Tetranematopus*, was unfortunately introduced by me into the literature without diagnosis, so that it has to give way to *Neobythites*. I failed to recognise the latter, as it was characterised by single-rayed ventral fins, until Mr. Goode, on inquiry, kindly informed me that the genus to which he had given this name has bifid ventral rays, as, indeed, he had stated in the description of the species.”

Le savant Ichthyologiste reconnaît, d'autre part, quatre espèces de *Neobythites* :

- | | | |
|---|-----------------|---------------------|
| (1) <i>N. grandis</i> , Günther, 1877, | . 1875 fathoms. | <i>Challenger</i> . |
| (2) <i>N. Gillii</i> , Goode et Bean, 1886, | . 111 „ | <i>Albatross</i> . |
| (3) <i>N. macrops</i> , Günther, 1887, | . 310 „ | <i>Challenger</i> . |
| (4) <i>N. ocellatus</i> , Günther, 1887, | . 350 „ | <i>Challenger</i> . |

4. En 1895, paraît la *description détaillée*,|| avec figure, de l'espèce-type, recueillie par l'*Albatross*, du genre *Neobythites*, genre dont les auteurs donnent la diagnose suivante :

* A. Günther, “Preliminary Notes on New Fishes collected in Japan during the Expedition of H.M.S. *Challenger*,” *Annals and Magazine of Natural History*, 1877, vol. xx., p. 437.

† A. Günther, *Deep-Sea Fishes*, etc., p. 100.

‡ G. B. Goode and T. H. Bean, “Descriptions of New Fishes obtained by the United States Fish Commission mainly from deep water off the Atlantic and Gulf Coasts,” *Proc. U.S. Nat. Mus.*, 1885 (1886), vol. viii., p. 600.

§ A. Günther, *Deep-Sea Fishes*, etc., p. 100.

|| G. B. Goode and T. H. Bean, “Oceanic Ichthyology,” *Smithsonian Contributions to Knowledge*, Washington, 1895, vol. xxx., p. 325.

“Brotulids having the body elongate, compressed, covered with small scales, and the head also scaled. Lateral line incomplete, obsolete posteriorly. Eye moderate. Snout moderate, rounded, slightly produced, the lower jaw slightly included. No barbel. Teeth villiform, in narrow bands in jaws and palatines. Vomerine teeth in V-shaped patch. Two weak spines at angle of preoperculum, and a stronger one at the angle of the operculum. Gill-openings wide, the membranes deeply cleft and not attached to the isthmus. Vertical fins united. Ventrals reduced each to a bifid ray. Branchiostegals, 8. Pseudobranchiæ present, but small. Air-bladder present. Type, *Neobythites Gillii*.”

En outre, dans l'*Oceanic Ichthyology*, les Naturalistes américains admettent trois espèces de *Neobythites* pour l'Atlantique :

- (1) *N. Gillii*, Goode et Bean, 1886, . 111 fathoms. *Albatross*.
 (2) *N. marginatus*, Goode et Bean, 1886, 209 „ *Blake*.
 (3) *N. crassus*, Vaillant, 1888, . 4255 mètres. *Talisman*.

5. Avec l'*Investigator* * et les nouvelles campagnes de l'*Albatross*, les espèces de *Neobythites* se multiplient, et, alors, arrive la tendance à la création de sous-genres, ou même de genres nouveaux étroitement alliés.

C'est ainsi que M. S. Garman, Assistant au Muséum de Cambridge (Etats-Unis), définit, † de la manière ci-après, son genre *Holcomycteronus* :

“Closely allied to *Neobythites*, but differing in absence of preopercular spines, in ventrals and in pectorals. The body is compressed, high at the nape, and tapers to slender in the tail. Head massive, deeper than wide, convex on the crown, covered by scales. Snout short, broad, thick, blunt. Mouth large, anterior; intermaxillary forming the upper border. Teeth small, equal, very numerous, in wide villiform bands on jaws, vomer, palatines, basibranchials, and pharyngeals. Nostrils small, lateral,

* A. Alcock, *A Descriptive Catalogue of the Indian Deep-Sea Fishes in the Indian Museum: being a revised Account of the Deep-Sea Fishes collected by the Royal Indian Marine Survey Ship Investigator*, Calcutta, 1899, p. 79.

† S. Garman, “The Fishes (Reports on an Exploration off the West Coasts of Mexico, Central and South America, and off the Galapagos Islands, in charge of Alexander Agassiz, by the U.S. Fish Commission Steamer *Albatross*, during 1891, Lieut.-Commander Z. L. Tanner, U.S.N., commanding),” *Mem. Mus. Comp. Zool. Harvard Coll.*, 1899, vol. xxiv., p. 162.

in front of the eye, with a groove, in which there are sensory papillæ, from the hinder part of the anterior nostril down and forward to the lip. Eyes small, lateral, without an orbital fold. A large, strong, horizontally directed opercular spine; no other spines on the head. Gill openings wide; membranes not united, free from the isthmus. Gills four, a slit behind the fourth; laminæ short; rakers well developed, numerous. Pseudobranchiæ small. Branchiostegal rays eight. An air-bladder. Pectoral fins intermediate in form between those of *Neobythites* and those of *Dicrolene*, some of the lower rays being free for a considerable portion of the length. Ventrals small, a short distance apart, at the humeral symphysis, each composed of two distinct rays. Vertical fins united; dorsal and anal very long; caudal narrow. Scales small, thin. Lateral line rudimentary or absent."

Puis :

"Ventrals small, longer than the snout, less than one diameter of the eye apart, below the humeral symphysis; each fin composed of two rays, separated to their bases, and varying from somewhat inflated and blunt to acuminate or filamentary at the ends."

6. Ce genre nous intéresse particulièrement, car c'est à lui qu'il convient de rapporter le Poisson abyssal de la *Scotia* qui fait l'objet de cette communication.

Seulement, je ne crois pas qu'il y ait lieu d'accorder à *Holcomycteronus* une valeur taxonomique supérieure à celle de sous-genre de *Neobythites*, si tant est qu'il faille aller jusque là.

En effet :

(1) L'absence d'épines préoperculaires se retrouve, notamment, dans trois espèces que M. Garman lui-même laisse dans le genre *Neobythites* (*N. grandis*, *N. steatiticus*, *N. pterotus*);*

(2) Les caractères des ventrales d'*Holcomycteronus* sont reproduits dans une espèce que M. Garman lui-même ne sépare pas du genre *Neobythites* (*N. pterotus*); †

(3) Les rayons plus ou moins isolés, et d'ailleurs non allongés,

* A. Günther, *Deep-Sea Fishes*, etc., p. 100; A. Alcock, *Investigator*, etc., pp. 82 et 83; S. Garman, *Albatross*, etc., p. 391.

† A. Alcock, *Investigator*, etc., p. 83; S. Garman, *Albatross*, etc., p. 391.

des pectorales sont, dès lors, insuffisants pour justifier un genre spécial, d'autant plus que *Neobythites pterotus* a des pectorales entières.*

III. NEOBYTHITES DIGITTATUS ET NEOBYTHITES BRUCEI.

1. Par l'absence d'épines préoperculaires, ainsi que par la nature de ses pectorales et de ses ventrales, le Poisson abyssal de la *Scotia* dont j'ai l'honneur d'entretenir aujourd'hui la Société Royale d'Edimbourg rentre dans le sous-genre *Holcomycteronus*, donc dans le genre *Neobythites*.

2. Et *Neobythites Brucei* se distingue comme suit de *Neobythites digittatus*, la seule espèce du genre pour laquelle il y ait intérêt à établir une comparaison détaillée :

NEOBYTHITES DIGITTATUS, Garman, 1899.

1. *Longueur du corps* (caudale exclue), égale à 5 fois la hauteur maximum (dorsale exclue).
2. *Nageoires pectorales*, avec rayons libres effilés.
3. *Nageoires ventrales*, contenues 4 fois dans la longueur de la tête.
4. *Nageoire caudale*, considérablement plus courte que la région post-orbitaire de la tête.
5. *Branchiospines*, grêles, allongées.
6. *Longueur totale* : 0·36 m. environ.

Type.

Museum of Comparative Zoology,
Cambridge (Etats-Unis).

NEOBYTHITES BRUCEI, Dollo, 1906.

1. *Longueur du corps* (caudale exclue), égale à 6½ fois la hauteur maximum (dorsale exclue).
2. *Nageoires pectorales*, avec rayons libres lancéolés.
3. *Nageoires ventrales*, contenues 2½ fois dans la longueur de la tête.
4. *Nageoire caudale*, égale à la région post-orbitaire de la tête.
5. *Branchiospines*, longues, robustes, émoussées, en avant du premier arc, et formant de simples tubercules arrondis en arrière du premier arc et sur tous les autres.
6. *Longueur totale* : 0·35 m. environ.

Type.

Scottish Oceanographical Laboratory,
Edimbourg (Ecosse).

IV. BIONOMIE DE N. DIGITTATUS ET DE N. BRUCEI.

Comparons, maintenant, nos deux espèces au point de vue bionomique :

* A. Alcock, *Investigator*, etc., p. 78.

NEOBYTHITES DIGITTATUS.

(I.) *Biogéographie.*

Habitat : 2° 34' N. et 82° 29' W. à
25° 29½' N. et 109° 48' W.

G. de Panama à G. de Californie.

Océan Pacifique.

Q. Américain (V. Pacifique) et Q. Pacifique.

Stations 3374 à 3434.

Albatross.

(II.) *Ethologie.*

1. *Profondeur.* — 1201 à 2232 fathoms.

2. *Nature du Fond.* — Brown mud and globigerina ooze.

3. *Température du Fond.* — 35·8° F. à 36·6° F.

4. *Mode de Capture.* — Chalut.

5. *Dates de Capture.* — 3 Mars à 21 Avril 1891.

6. *Heure de Capture.* — Inconnue.

7. *Nombre d'Individus capturés.* — Cinq, pris dans cinq stations différentes.

NEOBYTHITES BRUCEI.

(I.) *Biogéographie.*

Habitat : 67° 33' S. et 36° 35' W.

Mer de Weddell.

Océan Antarctique.

Q. Américain (V. Atlantique).

Station 291.

Scotia.

(II.) *Ethologie.*

1. *Profondeur.* — 2500 fathoms.

2. *Nature du Fond.* — Blue mud and terrigenous deposits.

3. *Température du Fond.* — 31·4° F.

4. *Mode de Capture.* — Chalut.

5. *Date de Capture.* — 7 Mars 1903.

6. *Heure de Capture.* — Entre 8 heures du matin et 8 heures du soir.

7. *Nombre d'Individus capturés.* — Un seul.

V. POSITION SYSTÉMATIQUE.

1. G. B. Goode et M. T. H. Bean placent le genre *Neobythites* parmi les *Brotulidæ*; * M. A. Günther, parmi les *Ophidiidæ*; † M. G. A. Boulenger, Senior Assistant au British Museum, parmi les *Zoarcidæ*. ‡

2. Comme M. Günther distingue une subdivision des *Brotulina* parmi ses *Ophidiidæ*, § son groupement revient, au fond, à celui des auteurs américains; il n'en diffère que par l'appréciation de la notion de famille.

Il n'en est pas de même de la classification de M. Boulenger. Car, en réunissant *Zoarces*, les *Lycodidæ* et les *Brotulidæ*, on enchevêtre deux lignes d'évolution indépendantes; et, en séparant

* G. B. Goode and T. H. Bean, *Oceanic Ichthyology*, etc., p. 315.

† A. Günther, *Deep-Sea Fishes*, etc., p. 100.

‡ G. A. Boulenger, "Teleostei (Systematic Part)," *Cambridge Natural History (Fishes, etc.)*, Londres, 1904, vol. vii., p. 712.

§ A. Günther, *An Introduction to the Study of Fishes*, Edimbourg, 1880, p. 546.

les *Brotulidæ* des *Ophidiidæ*, pour les placer dans les *Zoarcidæ*, on tronçonne une ligne d'évolution homogène, dont les *Ophidiidæ* représentent le point culminant.

3. En effet, la ligne *Brotulidæ-Ophidiidæ* nous fait assister à une *Adaptation* de plus en plus complète à la *Vie Benthique Macruriforme* (cavernicole, littorale, abyssale),—avec *Changement de Fonction* des *Ventrales*, jadis Organes de Locomotion et d'Équilibre, transformées en *Organes tactiles* filamenteux ou lancéolés,—avec *Conservation* d'une *Grande Vessie Natatoire*,—et avec de *Grandes Oüies*.

Par contre, la ligne *Zoarcidæ-Lycodidæ* nous montre une *Adaptation* de plus en plus parfaite à la *Vie Benthique Anguilliforme* (littorale et abyssale),—avec *Atrophie* des *Ventrales*,—avec *Perte* de la *Vessie Natatoire*,—et avec des *Oüies Rétrécies*.

4. Les *Brotulidæ-Ophidiidæ* culminent dans les *Ophidiidæ*,—dont les *Ventrales*, de Jugulaires, sont devenues *Mentonnières*,—c'est-à-dire de véritables *Barbillons*,—*physiologiquement*, non morphologiquement, puisque les *Barbillons* sont essentiellement d'origine cutanée.

C'est l'*Ultime Migration en Avant* des *Membres postérieurs* des *Téléostéens* depuis le *Crétacé*, si curieuse et si inexplicée,*—membres postérieurs qui sont, maintenant, attachés juste derrière la *Symphyse Mandibulaire*!

5. Les *Zoarcidæ-Lycodidæ* culminent dans les *Genres Apodes* de ces derniers (*Gymnelis*, *Maynea*, littoraux; *Melanostigma*, abyssal).

Car l'*Apodie* est une des *Spécialisations corrélatives*,—donc *Principales*,—de la *Vie Benthique Anguilliforme*.

6. Tandis qu'elle n'est qu'une *Spécialisation accidentelle*,—donc *Accessoire*,—de la *Vie Benthique Macruriforme*.

* Comment se fait-il, en effet, que les *Ostéoptérygiens* (*Dipneustes* + *Ganoïdes* + *Téléostéens*), qui, depuis le *Dévonien inférieur* au moins jusqu'au *Crétacé*, avaient pu s'accommoder de *Ventrales abdominales*, dans les *Conditions d'Existence* les plus diverses, ont, plus récemment, acquis des *Ventrales thoraciques*, et même des *Ventrales jugulaires*?

Alors que les *Chondroptérygiens* (*Requins* + *Raies* + *Chimères*) ont tous, même aujourd'hui, et depuis toujours, des *Ventrales abdominales*.

Quant aux *Ventrales mentonnières*, elles se comprennent très bien, du moment que ces organes deviennent *tactiles*: c'est la transformation en *Barbillons*, pour des *Poissons* vivant directement sur le fond.

Ainsi, *Lamprogrammus* et *Hepthocara* sont des *Brotulidæ* typiques,—avec un corps macruriforme, de larges ouïes et une vessie natatoire,—mais des *Brotulidæ apodes*,—parce qu'ils ont pu se passer, cas sporadiques, des Ventrals tactiles ancestrales.*

7. Nous aurions donc :

<i>Ophidiidæ.</i>	<i>Lycodidæ.</i>
<i>Brotulidæ.</i>	<i>Zoarcidæ.</i>
Vie Benthique.	Vie Benthique.
Macruriforme.	Anguilliforme.

Les *Zoarcidæ* comprenant, ici, *Zoarces* et les genres de *Blenniidæ* les plus voisins en voie d'adaptation dans le sens des *Lycodidæ*.

8. L'origine de la *Queue Géphyrocerque* des *Brotulidæ* et des *Ophidiidæ*,—laquelle n'est qu'un résultat de l'Adaptation à la Vie Benthique (Evolution régressive de la Natation, donc de la Caudale),—nous est bien montrée par *Ogilbya*, qui a encore une Caudale Rhipidicerque (Homocerque) distincte, mais arrondie et très réduite.†

Celle de la *Queue Géphyrocerque* des *Zoarcidæ* et des *Lycodidæ*, par un genre tel que *Blenniops*, qui, lui aussi, a encore une Caudale Rhipidicerque (Homocerque) distincte, mais, également, arrondie et très réduite.‡

9. Les considérations qui précèdent demandent à être confirmées par une *Ostéologie approfondie*, basée sur la *Morphologie*.

VI. CARACTÈRES ADAPTATIFS.

Parmi les multiples caractères adaptatifs de *Neobythites*, il y a lieu de relever, notamment :

1. *Corps macruriforme*.—Une des *Adaptations* à la *Vie Benthique* (cavernicole, fluviatile, littorale, abyssale), qui se reproduit dans les Familles les plus diverses (*Macruridæ*, *Brotulidæ*, *Notacanthidæ*, *Halosauridæ*, *Clupeidæ*, etc.)§

* A. Alcock, *Investigator*, etc., p. 78.

† D. S. Jordan and B. W. Evermann, "The Fishes of North and Middle America," *Bull. U.S. Nat. Mus.*, No. 47 (Part IV.), Washington, 1900, pl. ccclv., figs. 872 et 873.

‡ F. Day, *The Fishes of Great Britain and Ireland*, Londres, 1880-1884, vol. i., pl. lx., fig. 3.

§ L. Dollo, *Poissons de l'Expédition Antarctique Belge*, etc., p. 238.

2. *Queue géphyrocerque*. — *Adaptation à la Vie Benthique* (amphibie, cavernicole, fluviatile, littorale, abyssale), qui se retrouve dans tous les cas extrêmes (*Macruriformes, Anquilliformes, Dépressiformes, Compressiformes asymétriques*).*

3. *Rayons lancéolés des Ventrals et des Pectorales*. — Organes tactiles, évidemment.

Mais quelle est la signification de ces rayons *lancéolés*, — qui, lors d'un épanouissement terminal excessif, peuvent devenir *foliacés*, comme dans *Eretmophorus*, † — par rapport aux rayons *filamenteux* ?

Chez *Neobythites*, il s'agit, semble-t-il, d'un *Caractère sexuel secondaire* :

Neobythites pterotus : "Each ventral consists of two rays which are separate from their base ; the inner ray, which is the longer, is about two-fifths the length of the head. In the male both rays have spatulate tips." ‡

4. *Branchiospines*. — Chez *Neobythites Brucei* : En avant du *premier arc*, elles sont longues, robustes, émoussées, au milieu ; rudimentaires, aux deux bouts. Entre le premier et le *deuxième arc*, elles sont courtes, très robustes, claviformes, sortes de tubercules allongés. Entre le deuxième et le *troisième arc*, de même, mais un peu plus faibles. Entre le troisième et le *quatrième arc*, de même toujours, mais encore un peu plus faibles. Derrière le quatrième arc, la fente branchiale est fermée dans sa moitié supérieure ; en arrière du quatrième arc, les branchiospines ne sont plus que de petits tubercules ; et, en avant du *cinquième arc*, des tubercules rudimentaires.

On voit que ces *branchiospines* rappellent celles de *Bathydraco Scotiæ*, et nous induisent à conclure à un *régime microphage*.

Observons, enfin, que, de part et d'autre, nous avons une *dentition villiforme*, et une *Vie Benthique* (*Neobythites Brucei*) ou une *Tendance à la Vie Benthique* (*Bathydraco Scotiæ*). §

* L. Dollo, *Poissons de l'Expédition Antarctique Belge*, etc., pp. 188 et 235.

† H. H. Giglioli, "On a supposed new Genus and Species of Pelagic Gadoid Fishes from the Mediterranean," *Proc. Zool. Soc. London*, 1889, p. 328.

‡ A. Alcock, *Investigator*, etc., p. 83.

§ L. Dollo, "Bathydraco Scotiæ, Poisson abyssal nouveau recueilli par l'Expédition Antarctique Nationale Ecossoise," *Proc. Roy. Soc. Edinburgh*, 1906, vol. xxxi. p. 73.

The Relation between Normal Take-up or Contraction and Degree of Twist in Twisted Threads. By **Thomas Oliver**, B.Sc. (Lond. & Edin.), Carnegie Research Fellow.
Communicated by Dr C. G. KNOTT.

(MS. received February 5, 1906. Read February 5, 1906.)

The "take-up" in twisting threads together is a factor of very great importance in the manufacture of every textile material. The manufacturer who considers this matter so trivial that he makes no allowance for it in his calculations will undoubtedly suffer pecuniary loss. Since many lines of textile work at the present day are cut very keen, the thin fringe of profit which the manufacturer imagines himself to be making may actually have assumed a negative value entirely in consequence of this seeming trifle. The fact that the elementary rule usually employed in the estimation of the size number of a twist takes no account of any contraction which may arise in the process of twisting fosters the idea that this quantity is negligible. I shall only quote one example selected from many which came under my notice during the long period I was engaged in woollen mill work. A cloth made from 36 cut 2-ply hard twisted yarn was calculated to finish at a weight of $10\frac{1}{2}$ ounces per yard, and was specified as such to the merchant. This cloth invariably came into the warehouse $11\frac{1}{2}$ ounces per yard, thus entailing an extra expenditure of 10 per cent. on the cost of the material. The solution of the difficulty simply lay in the fact that no account had been taken of the contraction due to the twisting. The weight per unit length of the 2-ply thread was equal to that of a single thread measuring $16\frac{1}{2}$ cuts per standard weight of $1\frac{1}{2}$ lbs., instead of 18 cuts as estimated.

Twisted threads may be classified under one or other of two general categories, viz.—(1) Normal twists; (2) Abnormal twists.

Under the first heading which I have termed "normal" may

be placed all twists in which the singles are at equal tension, and the contraction may be expected to have some relation to the size of the threads and amount of twist. Under the second heading, which I have termed "abnormal," come all yarns in which a special "take-up" is impressed on the constituent singles according as the manufacturer wishes to obtain special effects. One of the single threads forms the straight core of the folded thread, while the others are made to loop themselves round it by a special device on the twisting frame. In the trade these twists are termed loops, curls, knops, and gimps. Obviously the "take-up" can bear no relation whatever to the dimensions or properties of the threads. This paper has therefore to deal only with the first class of twists.

It may be assumed that single threads are cylinders of uniform density. The term "uniform density," as here applied, must not be interpreted in the usual way. A thread is composed of numerous short fibres of wool, cotton, or other material twisted together. Therefore in the completed thread air-spaces separate the fibres, and it is evident that the density cannot be uniform if infinitesimal areas of the cross section be considered. Suppose there are 80 fibres in the cross section of a thread, and that when the section is divided into 80 equal parts each part contains one fibre. Such is the meaning attached in this case to the term "uniform density." The assumption is sufficiently near the truth for all practical purposes.

If a length l of an untwisted single thread, diameter d , receive n turns of twist, then each fibre traces out a spiral under the influence of torsion, the dimensions of which depend on the distance of the fibre from the central axis of the thread. The average length of Botany fibre is about 2 inches. Supposing the diameter of a thread to be $\frac{1}{100}$ inch, with 10 turns of twist per inch, the average fibre would probably make about 19 turns, if an allowance be made for the contraction in twisting. The coarser fibres are longer, but the threads into which they are formed are thicker and possess less twist per unit length. We may thus take the above condition as typical, and in any case the continuity of a fibre may be assumed for a number of consecutive turns.

The length of fibre which forms one turn will be $\frac{l}{n}$. A fibre on the surface of the thread will trace out a helix whose diameter will be d , while a fibre in the axis of the thread would remain straight. It would be clearly possible to find fibres tracing out all sizes of helix between these limits. It must not be inferred from these statements, however, that some fibres which are central will gain ground on others which are peripheral in their position. The position of a fibre is not fixed in any size of helix throughout its length; it

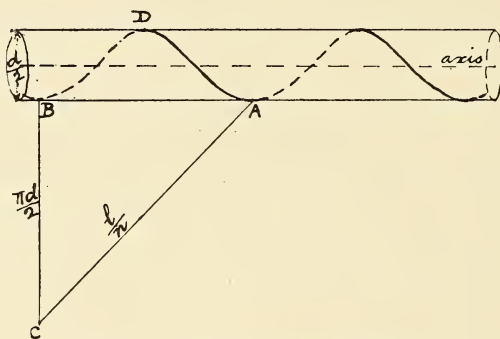

FIG. 1.—Take-up in Single Threads.

may be gradually changing from axis to circumference, and *vice versa*.

Thus the average diameter of helix can be taken as $\frac{d}{2}$.

Let ADB represent one turn of the average spiral or helix in the completed thread,

$$\text{Its length} = \frac{l}{n},$$

AB = the pitch of the twist, or the distance between two consecutive turns,

$$= \sqrt{\frac{l^2}{n^2} - \pi^2 \left(\frac{d}{2}\right)^2}.$$

Since the fibre ADB when uncoiled would form the hypotenuse AC of a right-angled triangle ACB, whose base is the circumference of the helix, *i.e.* $\frac{\pi d}{2}$,

The length of twisted thread producible from length l of untwisted thread

$$\begin{aligned} &= n \sqrt{\frac{l^2}{n^2} - \frac{\pi^2 d^2}{4}} \\ &= l \sqrt{1 - \frac{\pi^2 d^2 n^2}{4l^2}}, \end{aligned}$$

$$\therefore \text{the contraction} = l - l \sqrt{1 - \frac{\pi^2 d^2 n^2}{4l^2}}.$$

Since $\frac{\pi^2 d^2 n^2}{4l^2}$ will, as a rule, not exceed $\frac{1}{10}$ of $4l^2$, we may adopt the usual approximation (that $\sqrt{1-a} = 1 - \frac{1}{2}a$, where a is a small quantity) without affecting the result for practical purposes.

$$\begin{aligned} \therefore \text{the contraction} &= l - l \left(1 - \frac{\pi^2 d^2 n^2}{8l^2}\right) \\ &= \frac{\pi^2 d^2}{8l} n^2. \end{aligned}$$

With the same approximation, the length of twisted thread will be

$$= l \left(1 - \frac{\pi^2 d^2}{8l^2} n^2\right).$$

Let us now consider the case of twisting two single threads together. If two lengths, each = L , receive x turns of twist, and each single be considered to revolve without any motion amongst its constituent fibres, then the pitch of the twist

$$= \sqrt{\frac{L^2}{x^2} - \pi^2 D^2},$$

where D is the diameter of the circle in which the axes of the singles revolve. $D = d$, the diameter of one of the single threads, if they are of the same size. The length of 2-ply thread produced from lengths L of the singles

$$\begin{aligned} &= x \sqrt{\frac{L^2}{x^2} - \pi^2 D^2} \\ &= L \sqrt{1 - \frac{\pi^2 D^2 x^2}{L^2}} \\ &= L \left(1 - \frac{\pi^2 D^2 x^2}{2L^2}\right) \text{ approximately.} \end{aligned}$$

$$\therefore \text{the contraction} = \frac{\pi^2 D^2 x^2}{2L}.$$

The hypothetical condition that there will not be any relative motion amongst the fibres of the single threads will never be realised in practice.

Again, let us consider the twisting of two lengths of untwisted single threads, each = l , and whose diameter = d . Suppose that

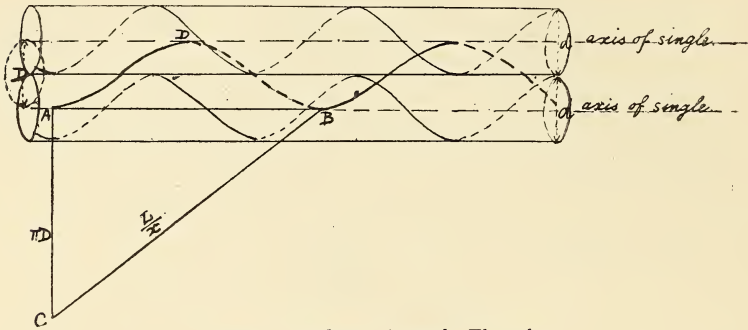

FIG. 2.—Take-up in 2-ply Threads.

they receive n turns of twist each, and that in forming them into a 2-ply thread, they are subjected to a further torsion of x turns.

Then D of the general case = d .

The length of twisted single thread as before

$$= l \sqrt{1 - \frac{\pi^2 d^2}{4l^2} n^2} \quad \text{or} \quad l - \frac{\pi^2 d^2}{8l} n^2 \text{ approx.}$$

$$= L \text{ of the preceding example.}$$

Therefore the length of a strand in one turn of 2-ply thread

$$= \frac{\text{the length of single thread}}{x} = \frac{l}{x} \sqrt{1 - \frac{\pi^2 d^2}{4l^2} n^2}.$$

\therefore the pitch of twist in 2-ply thread

$$= \sqrt{\frac{l^2}{x^2} \left(1 - \frac{\pi^2 d^2}{4l^2} n^2\right) - \pi^2 d^2}.$$

\therefore the length of 2-ply thread = $l \sqrt{1 - \frac{\pi^2 d^2}{4l^2} n^2 - \frac{\pi^2 d^2}{l^2} x^2}$

$$= l \sqrt{1 - \frac{\pi^2 d^2}{l^2} \left(\frac{n^2}{4} + x^2\right)}$$

$$= l - \frac{\pi^2 d^2}{2l} \left(\frac{n^2}{4} + x^2\right) \text{ approx.}$$

\therefore the total contraction = $\frac{\pi^2 d^2}{2l} \left(\frac{n^2}{4} + x^2\right) \text{ approx.}$

We have directly, since the total contraction must be equal to the sum of the contractions due to the consecutive twisting operations of forming the single and double threads,

$$\text{Total contraction} = \frac{\pi^2 d^2}{8l} n^2 + \frac{\pi^2 D^2}{2L} x^2.$$

But as these values will not differ by more than 1 or 2 per cent. in all cases which would arise in practice, we may safely take the first expression.

This analysis takes no account of relative motion of the fibres in each thread. As the second twisting proceeds, the degree of twist



FIG. 3.—Two-ply Thread with Open-band Twist both in Singles and in Double.

in the singles will also vary. The result will be differently affected according as the second twisting is in the same direction as that which the singles possess (shown in fig. 3), or is in the opposite direction (shown in fig. 4).

The former is scarcely ever used in practice, because of the rapid increase in hardness of the thread as the twist increases. Further, the friction between the surfaces of the fibres is not sufficient to prevent the elasticity of the thread from asserting itself in opening out the twist. The excessive degree of twist caused by both operations being in the same direction produces a thread of little use for cloth manufacture.



FIG. 4.—Two-ply Thread with Open-band Twist in the Singles and Cross-band Twist in the Double.

If the fibres have perfect freedom of motion, the total contraction will be equal to that due to $n+x$ turns in the single state plus that due to x turns in the double,

i.e. the total contraction = $\frac{\pi^2 d^2}{2l} \left\{ \frac{(n+x)^2}{4} + x^2 \right\}$

if x be reckoned positive when in the same direction as n , and negative when in the opposite direction. In the latter case the opening out of the twist from the singles at first completely masks

the contraction due to the second twisting. As a result, an elongation is really observed as twisting proceeds. The point of maximum length is, however, soon reached when the rate of contraction due to the second twisting is equal to the rate of elongation due to the opening out of the twist from the singles. After this point the rate of contraction increases.

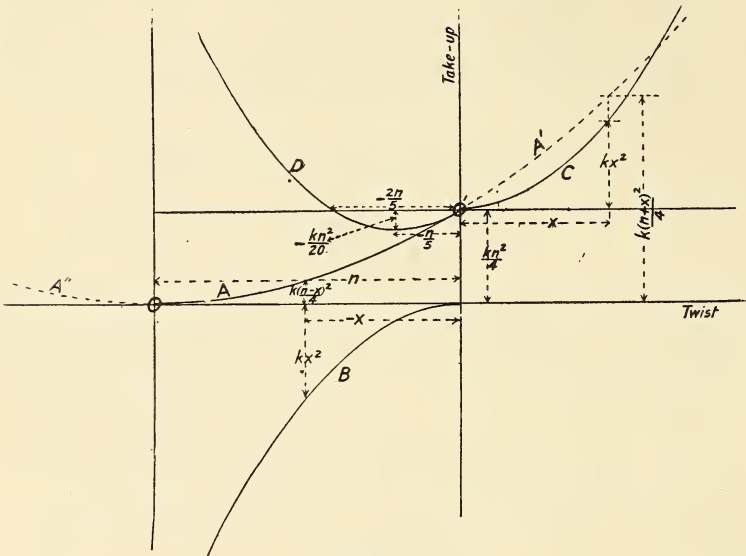

FIG. 5.

- A is the curve of contraction for the singles in the first twisting.
- A' " " " " second direct twisting.
- A'' " " " " " inverse twisting
- after all the single twist is opened out.
- B is the curve of contraction for the 2-ply if no fibre rotation (inverse).
- C " " " " " (direct).
- D " " " " " free " (inverse).

The results are represented graphically in fig. 5. The ordinates represent contraction, and the abscissæ turns of twist.

In the diagram $\frac{\pi^2 d^2}{2l}$ is written as k . The ordinates of any point on curve D is obtained by measuring the vertical distance between curves A and B at the same abscissa, *i.e.* $= k\left(\frac{n-x}{4}\right)^2 + kx^2$.

The practical problem in connection with this subject does not involve the consideration of the length of the untwisted thread l ,

as the singles are always measured in the twisted condition. The "sliver," as the untwisted woollen thread is technically called after it leaves the condenser or last machine in the carding process, is always drawn out about 50 per cent. in length on the mule before any twist is put in. But, in order to understand what is going on in the second twisting, it is necessary to introduce the hypothetical length l in the discussion. To compare the theory with the experimental evidence, the contraction should be referred to the length of the twisted single thread, and only that part of the contraction due to the second twisting need be considered.

The contraction due to the twisting of the singles

$$= \frac{\pi^2 d^2}{2l} \cdot \frac{n^2}{4} = \frac{\pi^2 d^2}{2L} \cdot \frac{n^2}{4} \text{ practically.}$$

∴ the contraction due to the second twisting

$$\begin{aligned} &= \frac{\pi^2 d^2}{2L} \left\{ \frac{(n+x)^2}{4} + x^2 - \frac{n^2}{4} \right\} \\ &= \frac{\pi^2 d^2}{8L} x(5x+2n). \end{aligned}$$

∴ the contraction = 0 when $x = 0$ or when $x = -\frac{2}{5}n$,

∴ is negative ∴ x lies between the limits 0 and $-\frac{2}{5}n$,

∴ is positive ∴ x lies beyond these limits.

By differentiating the above expression, we get the minimum value for the contraction or the maximum value for the length of the 2-ply thread,

$$\begin{aligned} y &= \frac{\pi^2 d^2}{8L} x(5x+2n) \\ \frac{dy}{dx} &= \frac{\pi^2 d^2}{8L} (10x+2n) \end{aligned}$$

if we take $\frac{d^2}{L}$ as a constant, which is not far wrong.

$\frac{dy}{dx}$ will be zero, and y will have a minimum value when

$$10x+2n=0, \text{ i.e. when } x = -\frac{n}{5}.$$

elongation which would result from opening out all the twist from one of the singles separately.

(4) The 2-ply thread is longer than the singles until two-fifths of the number of turns in the singles are put on: when this number is exceeded the 2-ply thread is shorter than the singles. The latter is the important case in nearly all yarns used in cloth manufacture.

(5) When the direction of twist is the same as in the singles, the contraction rapidly increases from the beginning.

The assumption that $\frac{d^2}{L}$ is a constant is further from the truth at the point of maximum length than at any other point, because the diameter decreases throughout with increase of twist, while L is actually longer than at first. It will be useless, however, to attempt to find out by mathematical analysis how much this assumption will affect the results; for there are other disturbing factors in operation of much greater importance. Prominent amongst these are—

(1) When two threads are twisted they lose their cylindrical forms.

As shown in my former paper on “The Diameters of Twisted Threads,” communicated to this Society last year,* the circular cross sections are deformed into ellipses. The effect would make D , the diameter of the circle of axial revolution of the singles, $= 2b$, where b is the semi-minor axis of the elliptical cross section.

(2) In the above analysis the fibres which constitute the thread are considered as arranged parallel to the axis of the thread before twisting. This is only approximately true for worsted yarns, and very far from the truth for woollen yarns. This condition, though probably modifying the amount of the contraction, does not alter the general form of its expression.

(3) In the initial stages of the second twisting, the fibres are free to rotate about the axes of the singles, and the experimental results are practically the same as those deduced from the above analysis. But the movements of the fibres become more restricted as the torsion proceeds, and long before the operation is completed

* *Proc. Roy. Soc. Edin.*, 1905, vol. xxv., part vii.

each single thread revolves as a whole about the axis of the 2-ply thread without any relative motion amongst its fibres.

For a twist composed of three or more singles, the analysis is on similar lines.

When three singles of equal size are formed into a folded thread, the diameter of the circle of axial revolution, D , would be

$$\begin{aligned} &= CD = BC \sec 30^\circ \\ &= \frac{2}{\sqrt{3}}d = 1.055d. \end{aligned}$$

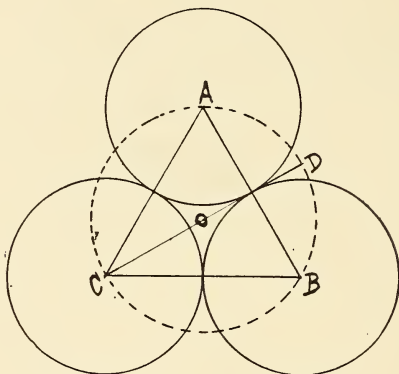

FIG. 7.

The total contraction for folded threads in general has been shown to be

$$= \frac{\pi^2 l^2}{8l} (n+x)^2 + \frac{\pi^2 D^2}{2L} x^2.$$

\therefore the contraction in the formation of the 3-ply thread is (if l is taken = L)

$$\begin{aligned} y &= \frac{\pi^2 d^2}{8L} \left\{ (n+x)^2 - n^2 \right\} + \frac{\pi^2}{2L} \left(\frac{2}{\sqrt{3}} \right)^2 d^2 x^2 \\ &= \frac{\pi^2 d^2}{2L} \left(\frac{2nx + x^2}{4} + \frac{4x^2}{3} \right) \\ &= \frac{\pi^2 d^2}{2L} x \left(\frac{19}{12}x + \frac{n}{2} \right). \end{aligned}$$

This expression is positive when x is positive, and when x is greater numerically than $\frac{6}{19}n$ in the negative direction.

It is equal to zero when $x = 0$, and when $x = -\frac{6}{19}n$.

It is negative between the limits $x = 0$ and $x = -\frac{6}{19}n$.

Differentiating as before, and equating to zero,

$$\frac{dy}{dx} = \frac{\pi^2 d^2}{2L} \left(\frac{19}{6}x + \frac{n}{2} \right)$$

which vanishes when y has a minimum value,

$$\begin{aligned} \text{i.e. when } \frac{19}{6}x + \frac{n}{2} &= 0 \\ \text{,, } x &= -\frac{3}{19}n. \end{aligned}$$

Substituting this value of x in the expression for y gives the minimum value of the take-up or the maximum elongation,

$$\begin{aligned} y_{\min.} &= \frac{\pi^2 d^2}{2L} \left(\frac{3}{76}n^2 - \frac{3}{38}n^2 \right) \\ &= -\frac{\pi^2 d^2}{2L} \cdot \frac{3}{76}n^2, \end{aligned}$$

i.e. $\frac{3}{19}$ of the elongation which would result from opening out all the twist from one of the singles separately.

In general, if $D = pd$

$$y = \frac{\pi^2 d^2}{2L} \left(\frac{2nx + x^2}{4} + p^2 x^2 \right)$$

y is zero when $x = 0$ and when $x = -\frac{2}{4p^2 + 1}n$

y is negative between these limits

y is positive beyond ,, ,,

The maximum elongation = $\frac{\pi^2 d^2}{8L} \cdot \frac{n^2}{4p^2 + 1}$ or $\frac{1}{4p^2 + 1}$ of the elongation which would result from opening out all the twist from the singles separately, and it occurs when

$$\frac{dy}{dx} \text{ or } \frac{\pi^2 d^2}{2L} \left(\frac{n+x}{2} + 2p^2 x \right) = 0.$$

i.e. when $x = -\frac{n}{4p^2 + 1}$.

It may be shown by geometry from diagrams similar to fig. 7 that $p = \sqrt{2}$ or 1.4 or a four-fold thread,

$$= \frac{4}{\sqrt{10} - 2\sqrt{5}} \text{ or } 1.7 \text{ for a five-fold thread,}$$

$$= 2 \text{ for a six- or seven-fold thread.}$$

Since normal folded threads with more strands than three are of little practical importance in cloth manufacture, it is unnecessary to discuss these in detail.

If the origin of the graphs be shifted to the point of maximum elongation whose co-ordinates are

$$-\frac{n}{4p^2+1}, -\frac{k}{4} \cdot \frac{n^2}{4p^2+1}, \text{ where } k = \frac{\pi^2 l^2}{2L}.$$

If X, Y be the co-ordinates of any point on the graph measured from the new origin,

$$x = X - \frac{n}{4p^2+1}$$

$$y = Y - \frac{k}{4} \cdot \frac{n^2}{4p^2+1}.$$

Substituting in the expression for the take-up,

$$y = k \left\{ \frac{nx}{2} + \left(p^2 + \frac{1}{4} \right) x^2 \right\}$$

$$Y - \frac{k}{4} \cdot \frac{n^2}{4p^2+1} = k \left\{ \frac{n}{2} \left(X - \frac{n}{4p^2+1} \right) + \left(p^2 + \frac{1}{4} \right) \left(X - \frac{n}{4p^2+1} \right)^2 \right\}.$$

Reducing $Y = k \left(p^2 + \frac{1}{4} \right) X^2.$

Substituting the values of p in particular cases gives

for 2-ply threads, $Y = \frac{5}{4} kX^2$ or $1.25kX^2$

„ 3-ply „ $Y = \frac{19}{12} kX^2$ or $1.58kX^2$

„ 4-ply „ $Y = \frac{9}{4} kX^2$ or $2.25kX^2$

„ 5-ply „ $Y = \frac{37 - \sqrt{5}}{20 - 4\sqrt{5}} kX^2$ or $3.14kX^2.$

Since working out this theory my attention has been drawn by Professor Barker of Bradford Technical College to a long article in the September 1903 issue of the *L'Industrie Textile*, Paris, entitled “Raccourcissement d'un fil par l'effet de la torsion et conséquences pratiques que l'on peut en déduire” (The contraction of the thread by the effect of twist, and practical results which we can deduce from it), written by Professor Bartolomé Amat, Tarrasa, Spain. He elaborates a theory which is quite at

variance with experimental evidence. I give the opening sentences of his analysis, because it is in these I judge he goes wrong: "Supposons, en effet, un cylindre de diamètre d et longueur L et tâchons de déterminer le raccourcissement de ce fil par l'effet de la torsion.

La ligne ab prendra la position bca' quand L aura reçu un tour de torsion et nous aurons :

$$ab = a'cb = a'b' = L.$$

De même, l'on aura, pour deux tours de torsion,

$$a'b = a''c'b = a''b' = L'.$$

Il s'ensuit que

$$A' = L - L' = L \pm \sqrt{L^2 - \pi^2 d^2}."$$

Translation:—"Let us suppose a cylinder of diameter d and length L , and let us try to determine the contraction of this thread by the effect of twist.

The line ab will take the position bca' when L will have received one turn of twist, and we shall have

$$ab = a'cb = a'b' = L.$$

Similarly, one will have for two turns of twist

$$a'b = a''c'b = a''b' = L'.$$

It follows that

$$A' = L - L' = L \pm \sqrt{L^2 - \pi^2 d^2}."$$

Obviously, the positive sign to the radical gives an inadmissible solution, and, from the same principles as before, Professor Amat easily deduces that the contraction due to n turns of twist

$$A_n = L - \sqrt{L^2 - n\pi^2 d^2},$$

which we may reduce to

$$A_n = \frac{\pi^2 d^2}{2L} n \text{ approximately.}$$

Differentiating this result, we find that

$$\frac{dA_n}{dn} = \frac{\pi^2 d^2}{2L}$$

(if the ratio $\frac{d^2}{L}$ be taken as a constant),

i.e. the rate of increase of contraction relative to increase in the degree of twist is constant. This result at once appears suspicious. Anyone who has made even qualitative experiments would expect that the rate of increase in take-up will become much greater as the twist gets harder.

The error which Professor Amat has dropped into is simply this: he asserts that $a'b = a''c'b$.

Now $a'b$ is merely a geometrical contour of the cylinder which cuts across the fibres (see fig. 9), and is not a material line or

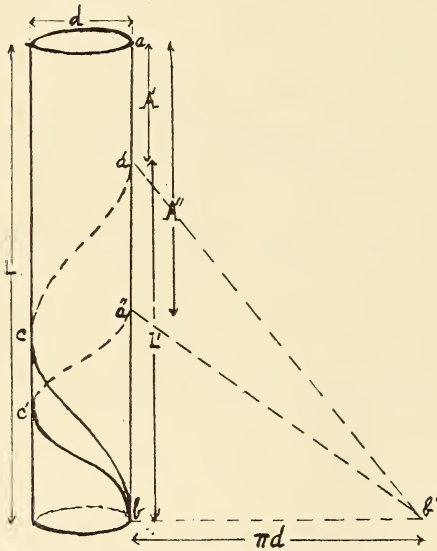

FIG. 8.—Diagram illustrating Professor Amat's Theory.

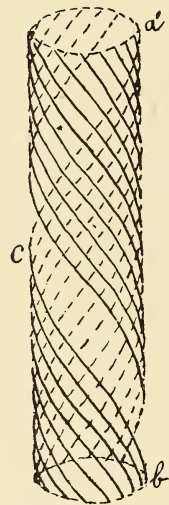

FIG. 9.

fibre itself. The continuity of this line is not preserved as torsion proceeds. Therefore we cannot say that $a'b$ is equal to anything at a subsequent period of the torsion.

It may be asserted, however, that since ab becomes $a'b$ for one turn, that it must be reduced to some shorter length $a''b$ for two turns.

That is true; but if this procedure be adopted, $a''c'b$ will be equal to twice the hypotenuse of a right-angled triangle erected on half of $a''b$, and not equal to the hypotenuse $a''b'$ of a right-angled triangle erected on $a''b$, since $a''c'b$ is two turns of the

spiral, and not one, as shown in fig. 8. Hence the solution becomes identical with the one I have given.

We must now consider the experimental side of this subject. The apparatus shown in fig. 10, which I have used in this investigation, was invented by Mr George R. Smith of Bradford for the purpose of the commercial testing of the strength and stretch of yarns. But as the amount of twist in the yarn under test may also be varied, I have found the apparatus, with only slight modification, admirably suited to my requirements in the present research.

The thread A is stretched between two clamps B and C. C

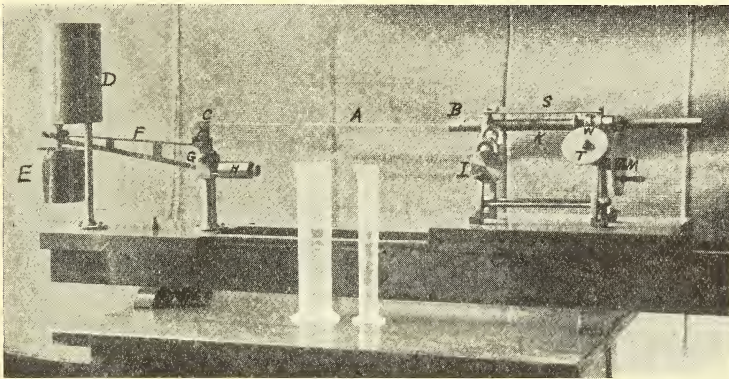

FIG. 10.

forms the end of one arm of a bell-crank lever pivoted at G, whose other arm F carries a can E. Water may be run into E from a reservoir D, and thus the thread may be twisted under any tension. H is an adjustable counterpoise to balance F when can E is empty. The twist in the thread may be varied by turning the wheel M, the turns being indicated on dial T. The thread can be kept throughout the experiment at the same tension by turning wheel I, which communicates motion by a train of wheels to shaft K. K moves the clamp B so that the lever F always remains horizontal. The take-up in the length of the thread may be obtained by taking the difference of the readings on scale S.

I took seven yarns at random—viz., 2/10s* cotton ; 2/12s, 2/16s,

* 2/10s means two threads, each measuring 10 hanks per lb., twisted together.

2/24s, 3/24s crossbred worsted; 2/48s Botany worsted; 2/56 cut woollen—and tested them specially for this paper. If I had selected seven tests from my previous collection, I might have been tempted to select those which agreed best with the theory. The percentage contraction for each turn of twist per inch is shown in the following tables.

TABLE I.—PERCENTAGE CONTRACTION FOR CROSSBRED WORSTED YARNS.

Turns per inch.	2/12s.		2/16s.		2/24s.		3/24s.	
	Open- band.	Cross- band.	Open- band.	Cross- band.	Open- band.	Cross- band.	Open- band.	Cross- band.
1	·40	-·16	·44	-·20	·28	-·12	·20	-·11
2	1·00	-·16	·94	-·24	·66	-·18	·52	-·14
3	1·74	-·08	1·58	-·20	1·16	-·12	1·01	-·10
4	2·70	+·22	2·44	0	1·72	-·01	1·52	+·09
5	3·84	·58	3·32	+·28	2·38	+·14	2·14	·32
6	5·30	1·12	4·28	·60	3·06	·26	2·82	·68
7	6·74	1·76	5·50	1·08	3·82	·54	3·70	1·11
8	8·50	2·56	6·84	1·64	4·72	·86	4·72	1·52
9	10·40	3·42	8·18	2·32	5·70	1·22	5·82	2·12
10	12·50	4·54	9·84	3·04	6·78	1·62	7·01	2·79
11	14·60	5·90	11·62	3·84	7·96	2·10	8·22	3·41
12	...	7·34	13·44	4·92	9·20	2·66	9·53	4·26
13	...	8·98	15·28	6·12	10·56	3·26	10·96	5·14
14	...	11·02	...	7·50	12·04	3·96	12·38	6·16
15	...	13·04	...	8·92	13·40	4·72	...	7·24
16	...	15·16	...	10·52	15·00	5·62	...	8·32
17	12·38	...	6·58	...	9·80
18	14·24	...	7·56	...	11·30
19	8·74	...	12·68
20	10·04
21	11·16

The direction of the twist at the top of each column is that of the folded thread. The twist in the singles is open-band.

The numbers are also plotted on squared paper in fig. 11. The ordinates of the graph for each yarn represent percentage contraction; and the abscissæ, turns of twist.

The forms of the graphs in fig. 11 suggest that if the origin of the diagram be shifted in each case to the point of maximum elongation, the equations to the graphs will probably be of the family $y' = cx'^m$. Let us consider any one of the curves, if its

TABLE II.—PERCENTAGE CONTRACTION FOR MISCELLANEOUS YARNS.

Turns per inch.	2/10s Cotton.		2/48s Botany Worsted.		2/56 cut Saxony Woollen.	
	Open-band.	Cross-band.	Open-band.	Cross-band.	Cross-band.	Open-band.
1	.68	-.60	.16	-.18	.34	-.20
2	1.74	-.84	.44	-.28	.66	-.36
3	2.90	-.94	.71	-.32	1.16	-.38
4	4.52	-.60	1.02	-.32	1.76	-.38
5	6.36	-.14	1.41	-.28	2.32	-.30
6	8.34	+ .42	1.81	-.18	3.04	-.20
7	10.66	1.08	2.22	-.08	3.80	0
8	13.16	1.86	2.74	+ .01	4.64	+ .22
9	15.86	2.54	3.24	.12	5.44	.50
10	18.46	3.68	3.78	.32	6.58	.81
11	...	4.92	4.41	.84	7.64	1.12
12	...	6.26	4.98	1.08	8.88	1.56
13	...	7.76	5.60	1.32	10.26	2.02
14	...	9.36	6.31	1.54	11.78	2.50
15	...	11.36	7.06	1.88	...	3.16
16	...	13.40	7.70	2.20	...	3.72
17	...	15.40	8.56	2.61	...	4.36
18	...	17.76	...	3.04	...	5.10
19	3.44	...	5.90
20	3.92	...	6.78
21	4.44	...	7.72
22	4.94	...	8.82
23	5.48	...	9.94
24	6.04	...	11.22

The twist in the cotton and worsted singles is open-band, and cross-band in the woollen single.

maximum elongation be represented by a , and let this occur when b turns of twist are put on in the inverse direction.

Then $y' = y + a$

$x' = x + b$

or $x - b$ if we consider the inverse direction positive.

If the general equation is

$$y' = cx^m$$

then $y + a = c(x + b)^m$ in the direction of the twist in the singles
 $= c(x - b)^m$,, inverse direction.

To test if this relation is true, we plot on squared paper $\log(y + a)$ as ordinates, and $\log(x + b)$ or $\log(x - b)$ as abscissæ. Fig. 12 shows the results plotted on a sheet of paper squared logarith-

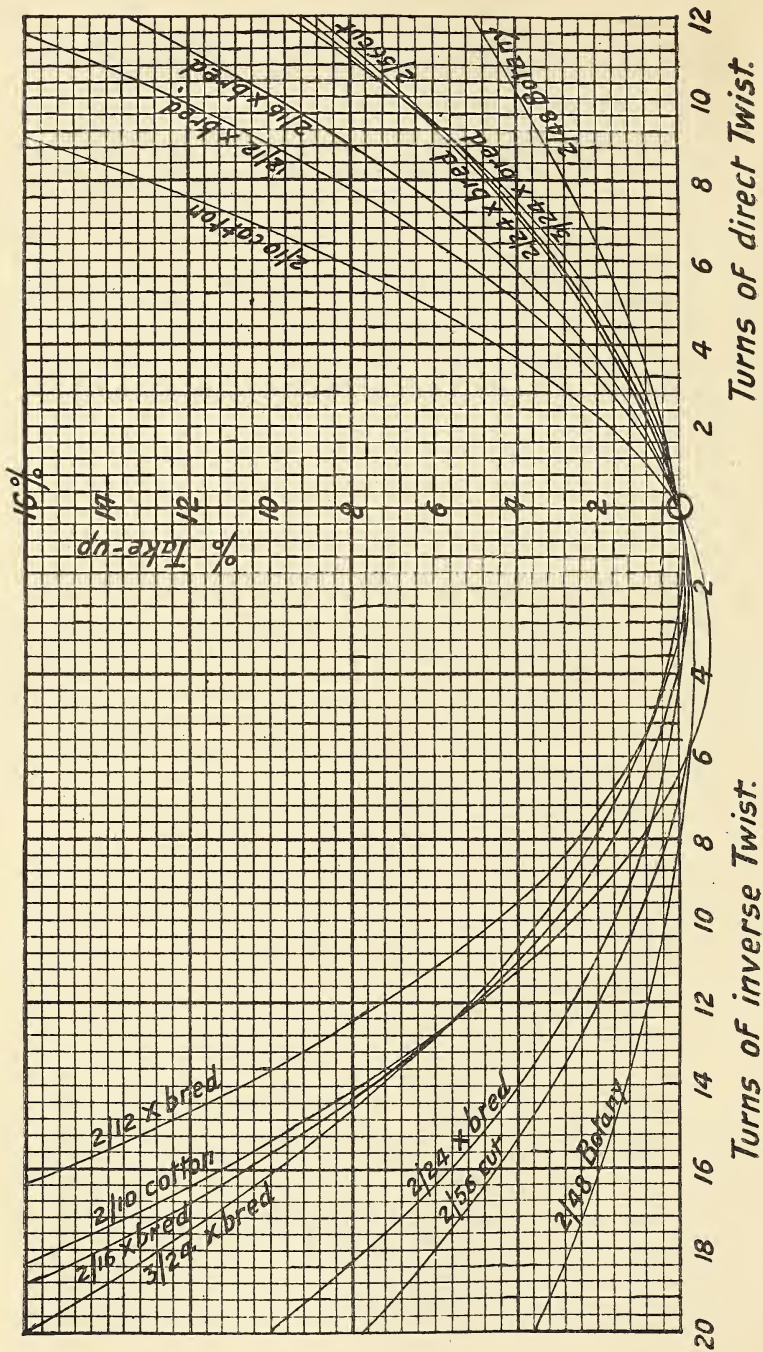

FIG. 11.

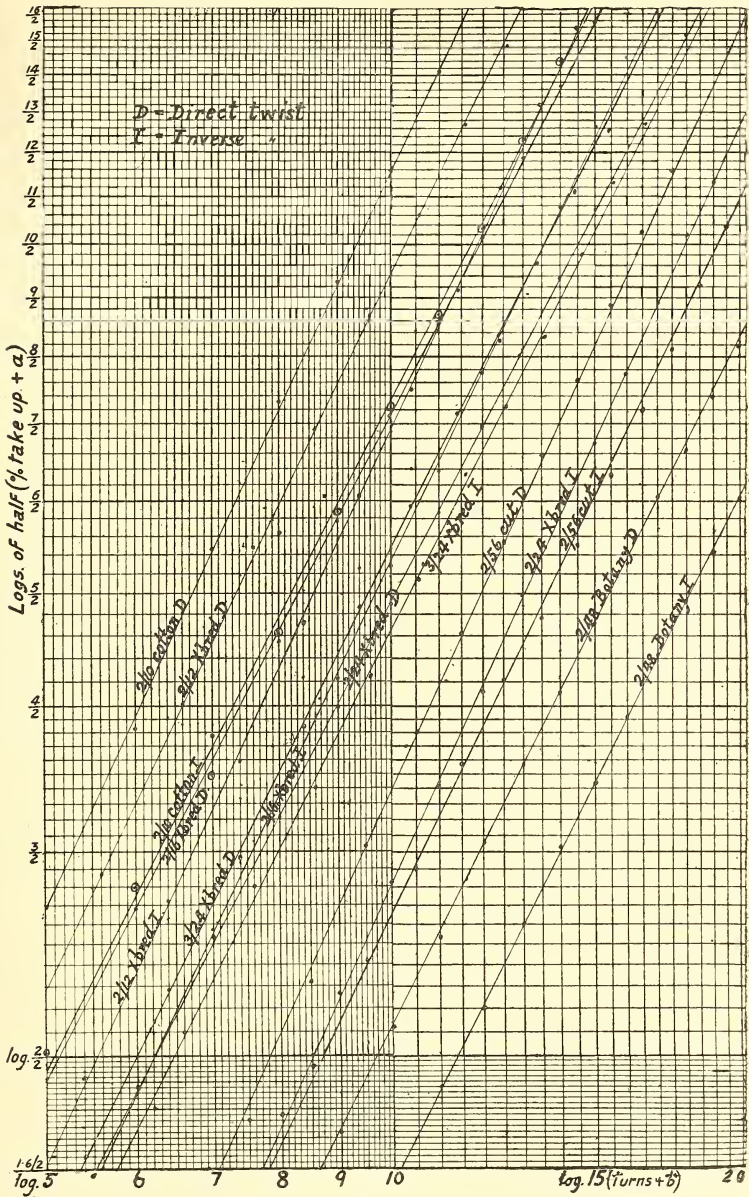

FIG. 12.

mically. In order to suit the scale of the logarithmic paper, the ordinates really represent logarithms of half the percentage contractions.

It is found in every case that a straight line can be drawn evenly amongst the plotted points for each thread, within reasonable limits of experimental error. The assumed law is therefore true, because if

$$\begin{aligned} y + a &= c(x \pm b)^m \\ \log(y + a) &= \log c + m \log(x \pm b) \\ Y &= C + mX, \end{aligned}$$

which is an equation of the first degree, and therefore represents

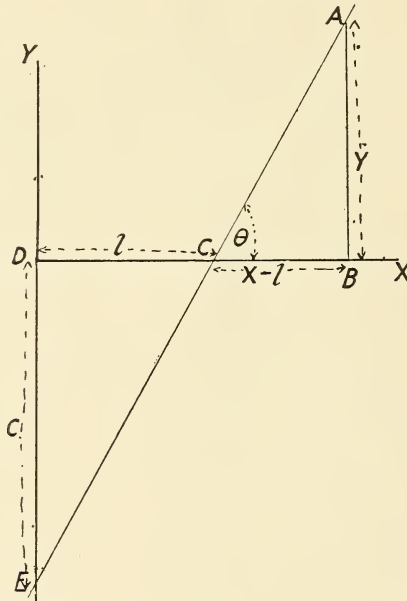

FIG. 13.

a straight line. Also Y and X are the ordinate and abscissæ respectively of any point on the diagram in fig. 12, m is the slope of the line, C is the intercept which the line makes on the axis of Y ,

$$m = \tan \theta = \frac{Y}{X - l} \quad (\text{see fig. 13}).$$

The Y axis is not shown on the diagram, but C may be calculated

by the consideration of the similar triangles ABC, EDC, shown in fig. 13.

$$\frac{C}{l} = \frac{ED}{DC} = \frac{AB}{BC} = \frac{Y}{X-l} = \tan \theta \text{ or } m, \text{ numerically.}$$

Since C is measured downwards from line DX, the sign must be changed.

$$\therefore C \text{ or } \log c = -ml.$$

From which *c* may be found by consulting tables of anti-logarithms. Table III. shows the values of C, *c*, and *m* for all the equations.

TABLE III.

	Direct Twist.			Inverse Twist.		
	C or log <i>c</i> .	$\frac{1}{c}$	<i>m</i>	C or log <i>c</i> .	$\frac{1}{c}$	<i>m</i>
2/10s Cotton	-1.05	11.2	2.09	-1.065	11.6	1.93
2/48s Botany Worsted	-1.63	43.	1.96	-1.79	62.	1.98
2/56s Cut Woolen	-1.62	42.	2.15	-1.61	41.	2.03
2/12s Crossbred Worsted	-1.08	12.	2.06	-1.28	19.	2.08
2/16s " " " "	-1.065	11.6	1.92	-1.325	21.	2.05
2/24s " " " "	-1.21	16.2	1.91	-1.71	51.	2.15
3/24s " " " "	-1.23	17.	1.96	-1.29	19.5	1.96
Average <i>m</i>	2.01	2.02

TABLE IV.

	Average Diameter of Singles.	Turns per Inch in Singles.	$\frac{k \text{ or } \pi^2 l^2}{2L} \cdot L^2$	$k \frac{N^2}{20}$	Max. Elong. from Expts.	$\frac{N}{5}$	No. of Turns at which Max. occurs.
	<i>d</i>	N	p. cent.	p. cent.	p. cent.	<i>a</i>	<i>b</i>
2/10s Cotton016"	7.5	.126	.35	.94	1.5	3.
2/48s Botany0065"	15.	.021	.24	.32	3.	4.
2/56 Cut009"	17.	.041	.58	.40	3.4	3.5
2/12s Crossbred0145"	5.5	.103	.16	.18	1.1	1.6
2/16s " " " "0125"	7.	.078	.19	.24	1.4	2.
2/24s " " " "0101"	9.	.049	.19	.18	1.8	2.2
3/24s " " " "0101"	9.	.049	.15*	.14	1.4†	1.4‡

* ($\frac{3}{76} kN^2$)

† ($\frac{3}{19} N$)

‡ Negative direction.

Let us now compare the analytical and experimental results more closely by plotting on squared paper the figures obtained for one of the yarns, — *e.g.* 2/12s worsted, as shown in fig. 14.

The equation y' or $y + a = \frac{5}{4} k \left(x + \frac{n}{5}\right)^2$ is the relation when the fibres are perfectly free to rotate.

The equation $y = kx^2$ is the relation when the fibres have no relative motion.

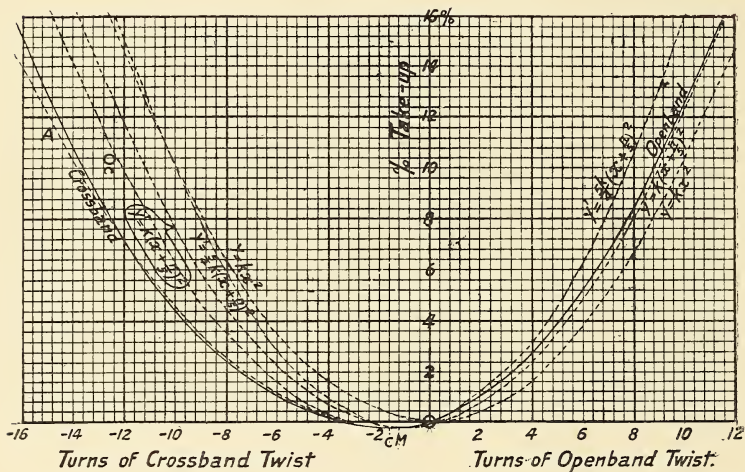

FIG. 14.

Curve O_c is symmetrical with the open-band limb of the yarn curve about a vertical line through C .

M is the point of maximum length for the condition of free fibre rotation.

C is the point of maximum length for the actual yarn.

It will now be instructive to summarise the main conclusions which may be inferred from a study of the analytical and experimental data set forth in the foregoing tables and diagrams.

The following relations have been discovered to hold:

Experimental: (1) $y + a = c(x \pm b)^m$

Analytical:
$$\left\{ \begin{array}{l} (2) \quad y + \frac{kn^2}{20} = \frac{5k}{4} \left(x + \frac{n}{5}\right)^2 \\ \text{or} \quad y = \frac{k}{4}x(5x + 2n) \end{array} \right\} \begin{array}{l} \text{when the fibres have perfect freedom of} \\ \text{rotation about the axes of the singles} \\ \text{during the second twisting.} \end{array}$$

$$(3) \quad y = kx^2 \left\{ \begin{array}{l} \text{when the single threads revolve as elastic solids about} \\ \text{the centre of the 2-ply thread without any relative} \\ \text{motion amongst the fibres.} \end{array} \right.$$

The average value of m taken from Table III. is 2.02, and the extreme limits are 1.91 and 2.15. Therefore the analytical value deduced for m —*i.e.* 2—may be considered as confirmed by experiment also. In the actual yarn, the fibres are neither absolutely free to rotate in the singles, nor absolutely constrained to move as a whole, so that some intermediate condition may be expected to hold good. On examining the open-band side of fig. 14 we find

this is the case. The yarn curve follows the curve $y' = \frac{5}{4}k \left(x + \frac{n}{5}\right)^2$ closely at first, but as torsion proceeds it moves away towards the curve $y = kx^2$, which it never reaches. The fibres, perfectly free for the first one or two turns, gradually become more constrained in their relative movements, though never becoming absolutely so. It will be seen from fig. 14 that the curve of the equation $y' = k \left(x + \frac{n}{5}\right)^2$ approaches closer to the yarn curve as torsion proceeds, and never differs much from the latter at any point.

Considering now the cross-band side of fig. 14, we find that the yarn curve differs widely from either of the curves corresponding to the analytical relations deduced. Much of the discrepancy, however, is due to the fact that (a) the turning-point of the graph of $y = kx^2$ is at O; (b) the turning-point of the graph of $y = \frac{k}{4}x(5x + 2n)$ is at M; (c) the turning-point of the graph of the yarn equation is at C. The differences will be much less if the origins of the hypothetical graphs be transferred to C. Curve A in fig. 14 is the graph of $y = \frac{2}{15}kx(5x - 3n)$, where x is taken positive although measured to the left hand from O. This curve practically coincides with the yarn curve until the twist becomes excessive.

From Table IV. it may be seen that C, the point of maximum elongation, in every case lags behind the point M, where maximum elongation should occur if the fibres were perfectly free to rotate. This fact furnishes us with a clue to the cause of the difference between the actual behaviour of the yarn and the result deduced by analysis. The yarn fibres have acquired a 'set' in one direction during the single twisting, which retards the contraction in the second twisting until a later period.

In concluding this paper, the author has pleasure in acknowledging his indebtedness to the Carnegie Trust for the Universities of Scotland for the financial assistance which has enabled him to prosecute the research.

(Issued separately June 19, 1906.)

A New Form of Harmonic Synthetiser. By J. R. Milne,
B.Sc., Carnegie Research Fellow. (With Plate.)

CONTENTS.

§ 1. <i>General Description</i>	208	<i>True Position of the Pen of an Instrument on the above Principle</i>	216
§ 2. <i>Description of the Mechanism which enables the Period of a Constituent Harmonic to be varied during motion</i>	209	§ 7. <i>Expression for the Greatest Deviation of the Pen</i>	217
§ 3. <i>Description of the Mechanism which enables the Amplitude of a Constituent Harmonic to be varied during motion</i>	210	§ 8. <i>On the Necessity for finding the Deviation of the Pen with Exactness</i>	218
§ 4. <i>Description of the Mechanism connected with the Pen and Paper</i>	214	§ 9. <i>Expression for the Average Deviation of the Pen</i>	227
§ 5. <i>Certain Details of Construc- tion</i>	215	§ 10. <i>Application of the Mathe- matical Results to the Present Instrument</i>	230
§ 6. <i>Mathematical Investigation of the Deviation from its</i>		§ 11. <i>Improvements suggested by the Mathematical Theory</i>	231
		§ 12. <i>Summary of the Paper</i>	232

The author has designed and constructed an instrument for the purpose of drawing the curve which is the summation of a number of simple harmonic curves; and as the apparatus has been found to work very satisfactorily in practice, it seems worth while to publish a description of the machine, especially in view of its numerous applications. Various forms of harmonic synthetiser are already in existence,* but there were two reasons which induced

* The following papers may be consulted:—"Tide Predicting Machine in use at Nat. Ph. Lab.," *Great Trigonometrical Survey of India*, vol. xvi.; also *Proc. of Institution of Civil Engineers*, vol. lxxv. pp. 1-70 (where also is given a description of Lord Kelvin's Harmonic Analyser). "On an Instrument for Compounding Vibrations," Lord Rayleigh, *Phil. Mag.*, p. 127, 1906. T. R. Lyle, "Preliminary Account of a Wave-Tracer and Analyser," *Phil. Mag.*, p. 549, Nov. 1903; and also *ibid.* p. 102, Jan. 1905; and *ibid.* p. 25, Jan. 1906. "A New Harmonic Analyser," A. A. Michelson and S. W. Stratton, *Phil. Mag.*, vol. xlv. p. 85, 1898. W. C. Baker, Note in *Nature*, p. 541, 28th Sept. 1905.

The following references are to Harmonic Analysers:—"An Harmonic Analyser," J. N. Le Conte, *Phys. Rev.*, vol. vii. p. 27, 1898. "On a Simple

the author to add another to their number. In the first place, it was desired to ascertain whether results of a high degree of accuracy could not be obtained from an apparatus of quite inexpensive design; and in the second, to construct a machine in which both the amplitude and periodic time of each of the simple harmonic constituents might be varied at will *while the instrument is in motion*.

§ 1. *General Description.*

The apparatus (see Plate, fig. 1) has a long narrow wooden base, from which spring uprights, carrying the horizontal axes of a succession of wheels arranged in a line, one after the other. The wheels are made of mahogany, with V-shaped grooves turned in their edges, and they are driven from a small electric motor by means of a single, endless leather belt of circular section.

These wheels form the simple harmonic constituents of the machine: and they, or others geared to them, as will be explained later (see the section on change of period, and also that on change of amplitude), have each a pin fixed in the wheel at some distance from the centre, which stands out normally to the wheel, and has mounted on it a freely turning brass pulley with grooved edges.

The base of the instrument is screwed down to a table from which uprights arise to carry a sort of light horizontal frame some three feet above. A length of No. 38 silk-covered copper wire, with one of its ends fixed to this upper frame, is led vertically down and round one of the small eccentric pulleys just mentioned, and then returns up again to the frame (see fig. 7). Passing round a fixed pulley there, it once more descends, and passes round the brass pulley on the pin of another of the simple harmonic wheels, after which it returns back to the bracket; and so on, until all the simple harmonic wheels have been included.

Form of Harmonic Analyser," G. V. Yule, *Phil. Mag.*, vol. xxxix. p. 367, 1895. "Harmonic Analyser," Geo. H. Rowe, *Electrical World and Engineer*, p. 587, 25th March 1905. Three papers by Prof. Sir W. Thomson, *Proc. Roy. Soc.*, pp. 266, 269, 271, 1876. "On an Integrating Machine having a New Kinematic Principle," Prof. James Thomson, *Proc. Roy. Soc.*, vol. xxiv. p. 262, 1876. "On a New Harmonic Analyser," Prof. O. Henrici, *Phil. Mag.*, vol. xxxviii. p. 110, 1894. "Ueber Instrumente zur harmonischen Analyse," O. Henrici, *Catalogue Munich Mathematical Exhibition*, 1892-3.

The free end of the wire is finally led down to a "barograph" pen, which is mounted on a form of Watt's parallel motion that compels it to move in a (sufficiently approximate) vertical straight line (Plate, fig. 2).

In front of this arrangement an upright band of paper is made to slowly pass along in a horizontal direction, and against this the spring carrying the "barograph" pen causes the latter to lightly press. The writing is found to be quite satisfactory, a good line is easily obtained, and there appears to be no appreciable stiction.

§ 2. *Description of the Mechanism which enables the Period of a Constituent Harmonic to be varied during motion* (see Plate, fig. 1).

A simple harmonic element of variable period is constructed as follows. A wooden truncated cone, 6 inches long, 4 inches in diameter at the small end and 6 at the large, has fixed in it a steel rod which serves as axis, and rotates between the pointed ends of two screws fixed in uprights from the general base. A similar cone is arranged with its axis parallel to that of the first, but disposed so that its big end is opposite to the small end of the other. It is well known* that unless the belt employed to connect the two cones be crossed, it will only have the necessary length when in one position on the cones. In the present case the belt is not crossed, but a special tension arrangement is employed (see fig. 1). The belt, a leather one of circular section about $\frac{3}{16}$ of an inch in diameter, encircles the two cones B and C, and also passes round a deeply flanged guide pulley A. A weight hung from the end F of the lever DEF supporting the pulley draws the latter continually upwards, and keeps the belt taut. When in motion the position of the belt on the cones can be changed by sliding the lever D, and therefore the attached pulley, backwards or forwards along the pivot rod E. If then cone B be driven from the electric motor, and cone C carry the small eccentric pulley *p* round which the "summation wire" passes, it is clear that the periodic time of C can be varied at will relative to the rest of the machine by moving A. In practice the arrangement

* Proof may be found in any work on Mechanism, *e.g.* in that by S. Dunkerley, p. 23 (edition 1905).

has been found satisfactory: it allows the use of any period commensurable or incommensurable, and of the alteration of the period during motion. In fig. 2 will be seen a trace of a S.H.M.

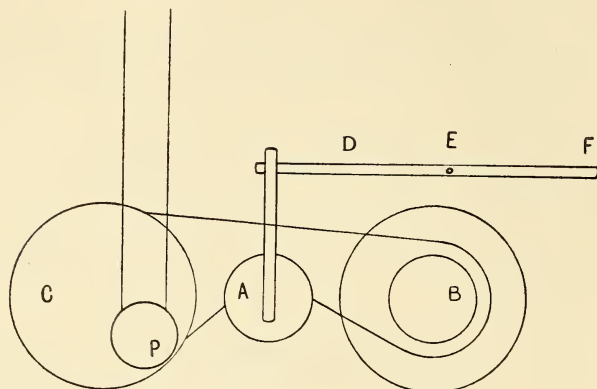

FIG. 1.—It has been found better to slightly alter the arrangement sketched above, and make the guide pulley *A* act on the upper side of the belt. Cf. the later photograph on Plate, fig. 1.

in which the periodic time gradually increases, the lever *D* having been slowly slid along the axis *E* by hand as the machine was running.

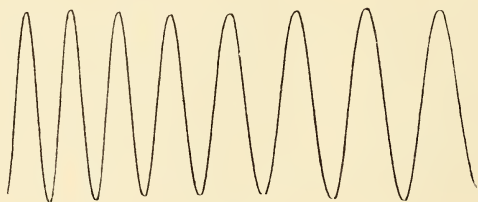

FIG. 2.

§ 3. Description of the Mechanism which enables the Amplitude of a Constituent Harmonic to be varied during motion.

The mechanism used to change the amplitude will be seen in the stereoscopic photograph, Plate, fig. 3.

The further off vertical toothed wheel has rigidly attached to it a grooved wooden wheel round which passes the motor driving-belt. Motion is communicated to the nearer vertical toothed wheel through the intermediary of the "crown" wheel. The

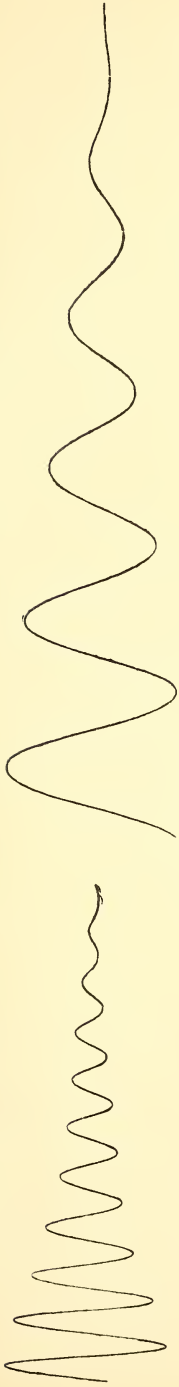

FIG. 4.

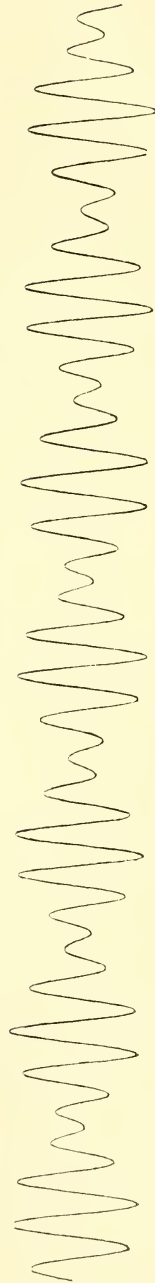
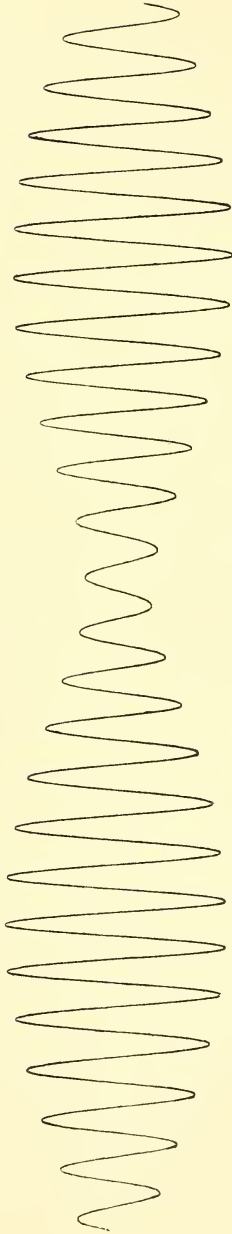

FIG. 5 (continued on p. 213).

axle of this crown wheel can be moved round the common axis of the vertical side wheels and clamped in any required position by means of the set-screw and overhead arch, as shown. Each of the side wheels carries an eccentric pulley, and to these eccentric pulleys the "summation wire" descends. As the side wheels are of equal diameter (3 inches), they must revolve at the same speed; and also the throw of their pulleys is made to be the same ($\frac{1}{2}$ inch). Hence the resultant displacement of the summation wire is that due to two S.H.Ms. of equal period and amplitude. Now the whole point of the device is this, that the relative phase of these S.H.Ms. can be altered at will by moving the axle of the crown wheel. That this is so may easily be seen by supposing one of the side wheels to be fixed, when it is apparent that if the axle of the crown wheel be unclamped and rotated through an angle α , the other side wheel will have to rotate through an angle 2α .*

Mathematically we have then, y being the displacement imparted to the summation wire,

$$y = \frac{1}{2} \cos t + \frac{1}{2} \cos (t + 2\alpha),$$

$$\therefore y = \cos \alpha \cdot \cos (t + \alpha); \quad . \quad . \quad . \quad . \quad (1)$$

that is, we obtain by means of this arrangement a S.H. displacement of the wire, the amplitude of which may be varied from 0 to 1 by turning the crown-wheel axle through an angle of 90° .

In fig. 4 are shown two traces, each of a S.H.M., the amplitude of which was thus altered, the axis of the crown wheel having been slowly moved round by hand as the machine was running.

If the above mechanism is to be used merely for setting the amplitudes *before* the machine is put in motion, it is quite satisfactory; but if the crown-wheel axle be moved *when* the machine is in motion, then in equation (1) α is no longer a constant, but becomes a function of the time; that is (1) no longer strictly represents a S.H.M. of periodic time $2\pi/t$, and indeed in general it would not represent a S.H.M. at all. Of course in practice most likely it would only be wished to change the amplitude slowly, in which case the error would be very small. All error, however, can be removed by means of the following modification of

* The matter is fully discussed in S. Dunkerley's *Mechanism*, p. 97 (edition 1905).

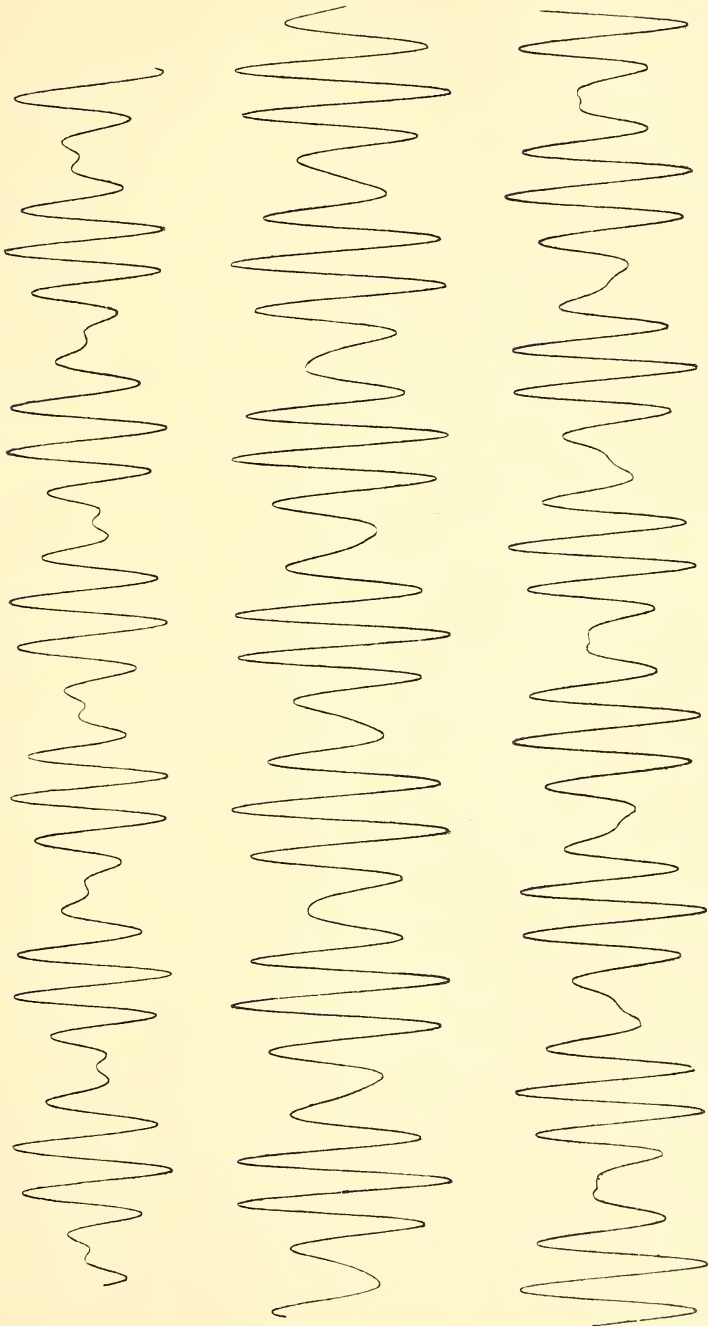

FIG. 5 (continued from p. 211).

passes along some 18 inches to the receiving drum. The latter is caused to turn by means of a weight which is sufficiently heavy to make it wind up the paper and keep it taut as it passes from the one drum to the other, but is too small to interfere at all with the action of the winding drum, which alone controls the rate of motion. The object of having a space of 18 inches between the pen and the receiving drum is simply to allow a considerable number of the waves traced out to be seen simultaneously by the operator. This is always convenient, but it is of course specially so when any progressive change in the wave-form is being studied, or when it is desired to observe the effect produced by gradually altering the period or amplitude of one of the constituent harmonics.

§ 5. *Details of Construction.*

It may be well to mention certain points of detail. The pulleys employed are made of brass, they are carefully turned up, and have a diameter of about an inch. The axle of each pulley is pointed and runs between the hollow ends of two screws, an arrangement which allows good adjustment to be easily made, without shake on the one hand or stiffness on the other, and which also has the useful effect of minimising friction.

There are no slides anywhere throughout the machine: each moving part turns on pivots, even the rectilinearly moving pen, and no doubt to this fact is due the smooth and successful working of the apparatus; which has thus justified the hope that, if properly designed, a simply made instrument of the kind would be quite satisfactory.

It has been found that the use of a leather belt of circular section, engaging in the V-shaped grooves of wooden wheels, which are nowhere less than 4 inches in diameter, has obviated any trouble that might arise from slipping. The plan adopted of having only one main driving belt, with a simple arrangement to keep the tension constant, gives no trouble, and is a great simplification. The small German-made motor employed to drive the apparatus is sent out by the makers furnished with a pulley which is driven from the armature shaft by a worm gear, and the use of this pulley at one stroke gives the necessary reduction to a slow speed.

The whole machine runs without attention, and can safely be left to itself in cases where for any reason a prolonged tracing is required—as for example when the constituent S.H.Ms. have been set to incommensurable periodic times; in which case of course the resulting trace never quite repeats itself, but is always taking new forms. [A machine was constructed by the author in which pendulums were employed to give the S.H.Ms.; but although the machine was satisfactory in many respects, it was abandoned, chiefly because of the fact that the pendulums necessarily ran down, and so rendered the instrument unsuitable for any sort of prolonged work.]

As a further example of work done by the instrument, and to show the interesting character of the composite curves, the traces shown in fig. 5 have been reproduced.

§ 6. *Mathematical Investigation of the Deviation from its True Position of the Pen of an Instrument on the above Principle.*

We now come to discuss the most important consideration in connection with such an instrument as the present—its accuracy. It hardly needs to be pointed out that a principle of construction possessed of great merits from the point of view of simplicity, smoothness of working, and so on, would nevertheless be of little value were the curves produced by the apparatus embodying it liable to appreciable errors of form. After being satisfied by actual trial that any suggested design of synthetiser is satisfactory on the mechanical side, there must always remain the essential question: “In view of the principle adopted, what will be the accuracy of the trace produced?”

Accordingly we must now go on to discuss the pretensions of the present apparatus from this point of view.

It is a nice question whether in such instruments it is more important to minimise the greatest deviation or to minimise the average deviation. If the data of the resultant curve are to be deduced from measurements of it at a number of different places, then it would be desirable to have the average deviation as small as possible; but if some single property of the resultant curve is to be ascertained, *e.g.* the point at which it cuts the time axis,

then the greatest deviation should be minimised, because of the chance that the measurements are being made just at the place where the greatest deviation occurs. Hence in the case of any given instrument it is desirable to know the value both of its greatest deviation and also of its average deviation.

§ 7. *Expression for the Greatest Deviation of the Pen.*

In fig. 6 let S be an eccentric pin fixed in the rotating wheel A and let SRQ be a perfectly flexible wire turning abruptly round an infinitely thin pin R, its end Q being constrained to

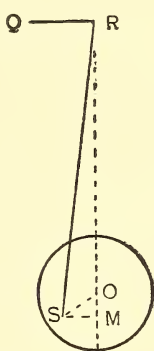

FIG. 6.

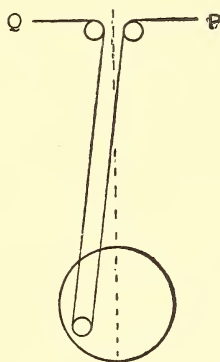

FIG. 7.

For the sake of clearness, in each of the above figures the size of the wheel has been greatly exaggerated relative to the total height. For the same reason, in fig. 7 the three pulleys are shown without flanges.

move in the horizontal line RQ. If Q have a sufficient force applied to it to keep the wire always taut, then as the wheel revolves, Q will describe approximately the S.H.M. which is produced by resolving the circular motion of the pin S in a vertical direction.

Calling ϵ the deviation at any time t (*i.e.* the distance of the actual position of Q from its proper position at any time t), and writing for shortness $RO = l$ and $OS = r$, we have,

$$\epsilon = RS - RM = \sqrt{(l^2 + r^2 - 2lr \cos t)} - l + r \cos t \quad . \quad (3)$$

$$\frac{d\epsilon}{dt} = \frac{lr \sin t}{\sqrt{(l^2 + r^2 - 2lr \cos t)}} - r \sin t ;$$

hence the turning values of ϵ occur when $t=0$ or π , or when $t = \cos^{-1}(r/2l)$. The two former values of t give the minimum values of the deviation; the latter value of t gives the maximum value of the deviation, which on substitution of this value for t is found to be $\epsilon = r^2/(2l)$. In the present machine r is equal to $\frac{1}{2}$ inch, and l to about 30 inches, and so the value of ϵ in the above formula becomes $\frac{1}{240}$ of an inch.

One point remains. If fig. 7, which represents the actual arrangement of one of the harmonic wheels of the latter, be compared with fig. 6, it can be shown without difficulty that the motion of the free end of the wire Q in fig. 7 (P being supposed fixed) will be almost exactly double* the motion of the free end of the wire Q in fig. 6.

On the other hand, however, there must be set against this that, in order to restrict the motion of the pen within the limits imposed by the width of the paper band, it is as a rule necessary to arrange a pulley between the end of the summation wire and the pen, on the principle employed in grandfathers' clocks, so that the pen, like the clock-weight, has a motion only half as great as that of the wire. The net result of the above is that our formula for the deviation remains as before.

§ 8. *On the Necessity for finding the Deviation of the Pen with Exactness.*

At first sight it might seem that a deviation such as the above is wholly negligible, but in reality this is far from being the case. The above deviation is that of only *one* of the S.H. wheels of the instrument; and it must be remembered that the greatest deviation of a trace compounded of n S.H. constituents will be n times the above quantity, for every now and then the deviations of all the different S.H. wheels will fall together with the effect of producing a total deviation in the position of the pen equal to their sum. Of course, as regards the present apparatus, which possesses but

* The diameter of the small pulleys is 1 inch, which is also the distance between the upper pair; and these are both distant about 30 inches from the lower pulley, whose circle of rotation is $\frac{1}{2}$ inch in diameter. Such being the dimensions of the machinery, we are probably led into no appreciable error by having to substitute the above approximate statement for the exact one, which is too complicated to be used.

three S.H. wheels in all, the greatest deviation cannot be more than $\frac{3}{2 \cdot 40}$ of an inch; but the important thing here is not the consideration of a temporary model, but is rather to ascertain whether the mechanical principle employed would be satisfactory in the case of a complete instrument possessing a large number of constituents. As that means a large value for "n," it becomes essential to ascertain the value of the deviation of each S.H. wheel with precision.

Now, in the mathematical reasoning employed above, to obtain an expression for the value of this deviation there may lurk a fundamental fallacy. In order to measure the deviation it is necessary to take some particular S.H.M. as a standard for comparison: and the S.H.M. which we choose for this purpose should be that to which the actual motion is most nearly akin. Unless, therefore, the S.H.M. that was employed in our former discussion can be shown to be the particular one which satisfies this condition, the result arrived at, being deduced from mistaken premises, must be misleading.

In order to investigate this point, let ABCDE in fig. 8 be the curve that would be drawn by the recording arrangement of Plate, fig. 2, were the latter actuated by the harmonic wheel of fig. 6; it being assumed that the wire has been sufficiently lengthened to allow its free end to come down over a pulley at Q, and be attached to the pen, which we arrange vertically underneath. Consideration of fig. 6 will show that AD must be symmetrical about the central line FC; and that it will, except at the points A, C, and E, everywhere lie above the curve AGCHE, which represents the S.H.M. obtained by resolving in a vertical direction the circular motion of the pin S in fig. 6. ϵ in equation (3) gives the difference between the ordinates to the two curves respectively; and this difference we saw will be a maximum at the point $t = \cos^{-1}(r/2l)$; *i.e.* (as may easily be shown) at the point where ABCDE cuts the time axis. Now, were AGCHE to be bodily moved any short distance upwards, keeping it parallel to itself, then the length of its ordinates would all be altered by the same amount; and therefore the maximum discrepancy between the two curves would still occur at $t = \cos^{-1}(r/2l)$; and therefore the value of the maximum discrepancy would be

reduced. That is to say, without any further proof it is clear that AGCHE cannot be that particular S.H. curve to which the actual trace most closely approximates.

Plainly the proper procedure in this problem is first of all to find the particular S.H. curve to which the trace ABCDE most nearly conforms, and then to ascertain the greatest difference between the two curves, which quantity will be the required maximum deviation of the trace.

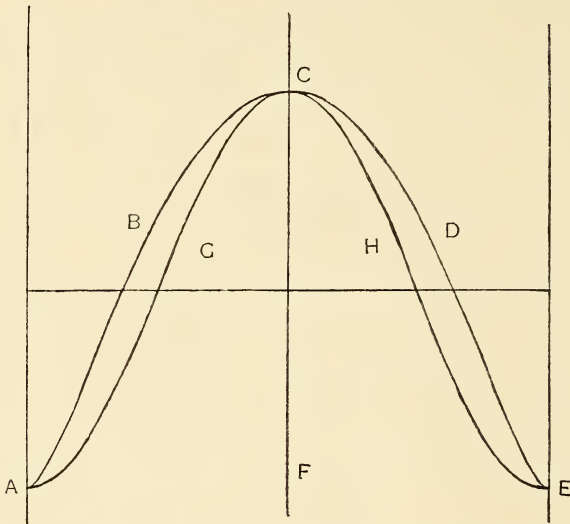

FIG. 8.—To keep the two curves sufficiently apart in the above figure, the deviation of the curve ABCDE has been very greatly magnified by the device of drawing the latter curve as if the length of l in the machine were only 2.5, instead of 30.

The distance between the fixed point R in fig. 6 and the pen which we have supposed to be attached to the free end of the wire led down from Q, if measured up to Q and along QR, is given by the expression

$$m - \sqrt{l^2 + r^2 - 2rl \cos t} \quad . \quad . \quad . \quad (4)$$

where $l = RO$, and $r = OS$ as before, and where m is the total length of the wire from the pen to the point S.

The distance from R, also measured up to Q and along QR, of an imaginary point which moves with any S.H.M. whatever in the same vertical line as the pen, is given by the expression

$$w + p \cos (qt + a) \quad . \quad . \quad . \quad (5).$$

Therefore the distance (or "deviation") at any time t between the actual pen and the imaginary moving point of (5) is given by the equation,

$$\epsilon = p \cos (qt + a) + w - \{m - \sqrt{(l^2 + r^2 - 2rl \cos t)}\} . \quad (6).$$

But the motion of the pen given by (4) has a periodic time 2π , and is, we know, very nearly S.H.; and so the comparison S.H.M. must also have a periodic turn 2π , as otherwise the two would eventually get out of step. Therefore in (5) we may put $q = 1$.

Further, it can be shown that the actual and comparison motions

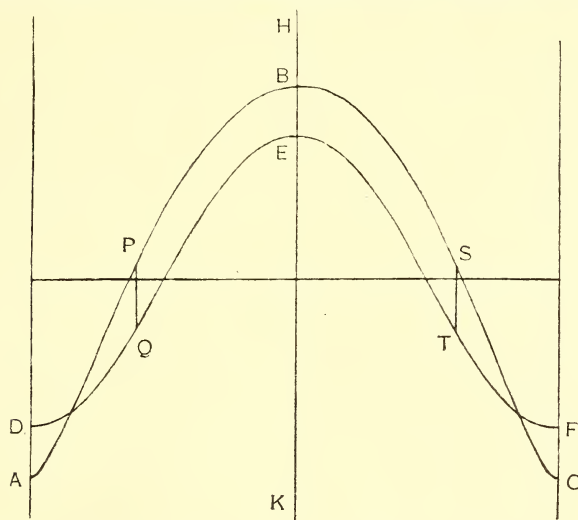

FIG. 9.—In the above figure the curve $APBSC$ is the same as the curve $ABCDE$ in fig. 8, i.e. it has been drawn as if the length of l in the machine were but 2.5 , instead of 30 .

must be cophasal. In fig. 9 let the curve $APBSC$ represent the actual trace of the pen; and let $DQETF$ be a S.H. curve, cophasal and isoperiodic with $APBSC$, but of any amplitude. There will be some point on the time axis for which the difference between the two curves is a maximum PQ . Because of the symmetry of both curves about HK , there must be an equal maximum difference ST between them at an equal distance from HK on the other side. Now suppose the curve $DQETF$ to be shifted bodily a short distance to the right (say); and let it now cut the lines PQ , ST in the points Q' and T' ; then ST' will be

less than ST, but PQ' will be greater than PQ. Therefore the maximum discrepancy that now exists between the curves APBSC and DQETF must be greater than before; for if PQ' be still the maximum discrepancy, it is greater than PQ; and if PQ' be not now the maximum discrepancy, then the latter—whatever it be—is greater than PQ, and hence *a fortiori* greater than PQ. Therefore the maximum discrepancy between the actual motion and an isoperiodic S.H.M. of any amplitude is always least when the two motions are cophasal. As this result holds for any amplitude of the comparison S.H.M., it must hold for that particular one which approaches most nearly to the actual motion. Therefore we may put $\alpha = 0$ in equation (5); which thus finally becomes

$$w + p \cos t;$$

and writing

$$w - m \equiv v \quad . \quad . \quad . \quad . \quad . \quad (7)$$

(6) then becomes

$$\epsilon = p \cos t + v + \sqrt{(l^2 + r^2 - 2rl \cos t)}.$$

In this equation ϵ , the error of motion, is a function of three independent variables, namely t , p , and v .

First of all to deal with the occurrence of t in the above equation. Reference to fig. 6 will show that whatever succession of values ϵ assumes as S in the course of its rotation passes down from its highest to its lowest point, ϵ will again assume in reverse order as S returns up once more to the highest point. That is to say, we need only investigate the values of ϵ , where t ranges from 0 to π (inclusive), all other values of t giving mere repetition in the values of ϵ .

Then again we are only concerned to find the *largest* error of motion committed, and this must occur at the time when

$$\partial\epsilon/\partial t = 0 \quad . \quad . \quad . \quad . \quad . \quad (8)$$

But

$$\frac{\partial\epsilon}{\partial t} = -p \sin t + \frac{rl \sin t}{\sqrt{(l^2 + r^2 - 2rl \cos t)}};$$

hence from (8) either

$$\left. \begin{array}{l} \sin t = 0 \text{ or } \pi, \\ \cos t = \frac{1}{2} \left(\frac{l^2 + r^2}{rl} - \frac{rl}{r^2} \right). \end{array} \right\} \quad . \quad . \quad . \quad . \quad . \quad (9)$$

That is, the largest error of ϵ will occur at the time $t=0$, or $t=\pi$, or $t=\cos^{-1} \frac{1}{2} \left(\frac{l^2+r^2}{rl} - \frac{rl}{p^2} \right)$. If it occur at the time $t=0$, its value will be

$$p+l-r+v=\epsilon_1 \text{ (say)}; \quad . \quad . \quad . \quad (10)$$

if at the time $t=\pi$, its value will be

$$-p+l+r+v=\epsilon_2 \text{ (say)}; \quad . \quad . \quad . \quad (11)$$

and if at the time $t=\cos^{-1} \frac{1}{2} \left(\frac{l^2+r^2}{rl} - \frac{rl}{p^2} \right)$ its value will be,

$$\frac{rl}{2p} + \frac{l^2+r^2}{2rl} p + v = \epsilon_3 \text{ (say)}. \quad . \quad . \quad . \quad (12).$$

Which of these three is greatest depends on the values assigned to p and v ; and our object is of course so to assign the values (*i.e.* determine the comparison S.H.M.) that for the chosen values the greatest of the three functions (10), (11), and (12)—whichever that turns out to be—shall be as small as possible.

Before proceeding to this it should be pointed out that for values of $p < rl/(l+r)$ or $> rl/(l-r)$ the time at which ϵ has the value given by (12), namely, $t = \cos^{-1} \frac{1}{2} \left(\frac{l^2+r^2}{rl} - \frac{rl}{p^2} \right)$, is imaginary; and therefore for such values of p (12), although itself real, has no physical meaning, and is to be ignored.

It will be convenient to regard each of the functions (10), (11), and (12) as being a surface, determined by the two independent variables p and v . Taking then three mutually perpendicular axes for p , v , and ϵ respectively, we have a system of three surfaces, consisting of two planes and an hyperbolic cylinder. Fig. 10 represents the section of these surfaces by the $p-\epsilon$ plane.* If any other section be taken parallel to the $p-\epsilon$ plane, and at a distance $-v$ from it, then, because of the manner in which v enters into the equations, fig. 10 will equally represent this other section,

*The termination of the hyperbolic branch at its points of contact with the two straight lines, *i.e.*, at the points the abscissæ of which are respectively $\frac{rl}{l+r}$ and $\frac{rl}{l-r}$ is simply because, as explained above, (12) is physically meaningless beyond these limits. As negative values of p are also meaningless in the present connection, all that lies on the left of the ϵ axis has been omitted from the figure.

provided the axis of p be moved upwards parallel to itself through a distance $= v$.

The problem may now be restated thus: it is required to find that point in the $p-v$ plane whose ordinate to the most distant of the three surfaces is a minimum.

This, a problem in three dimensions, may be reduced to a problem in two only, by expressing it in the following form, which,

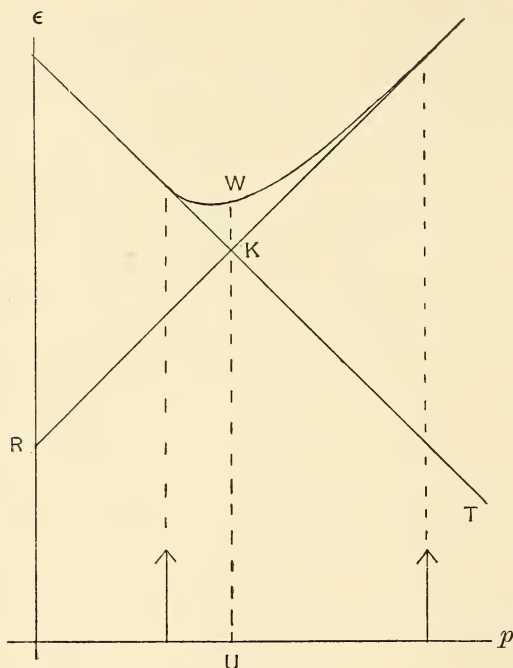

FIG. 10.—In drawing the above figure, l was taken $= 2$ and $r = 1$, for the sake of clearness. Such a combination of values would never of course represent an actual case.

from the foregoing discussion of fig. 10, can easily be seen to be its equivalent: find that position for the p axis of fig. 10, supposed moved parallel to itself, and that value of p , such that the ordinate of the latter to the most distant of the three curves (the hyperbola and the two straight lines) is a minimum.

A little consideration will show that the solution is as follows. Move up the p axis through such a distance that it bisects the shortest vertical line that can be drawn, terminated at one end by

the hyperbola and at the other by the line RK or KT as the case may be : and take for the value of p the abscissa of the ordinate on which the shortest vertical line lies.

It may easily be ascertained by subtracting (10) and (11) respectively from (12) that RKT comes nearer to the hyperbola at its apex K than anywhere else, the distance from the one to the other being measured vertically. Accordingly the p axis must be made to pass through the middle point of KW, and because KW has a length equal to $r^2/(2l)$, as may readily be proved, while the length of UK is l , therefore

$$v = -\left(l + \frac{r^2}{4l}\right) \quad . \quad . \quad . \quad . \quad (13)$$

The abscissa of the point K is r , hence

$$p = r \quad . \quad . \quad . \quad . \quad . \quad (14)$$

When $t=0$, Q (fig. 6) is at its greatest distance from R, and $RQ = m - (l - r)$. Simultaneously the distance from R of the imaginary point given by $(w + r \cos t)$ is $w + r$. Hence, calling δ_0 the distance at the time $t=0$ between Q and the imaginary point, we have,

$$\delta_0 = m - l - w.$$

But from (7) and (13)

$$m - w = l + \frac{r^2}{4l};$$

so

$$\delta_0 = \frac{r^2}{4l}.$$

When $t=\pi$, and Q is at its *least* distance from R, we have similarly,

$$\delta_\pi = \frac{r^2}{4l}.$$

The meaning of the above is, that the time axis of the curve that would be traced out by our imaginary point on the strip of paper passing along at right angles to the line of motion of the point, would be parallel to the time axis of the curve traced out by the pen on that paper; but the time axis of the point would be situated at a distance $r^2/(4l)$ above the time axis of the pen (meaning by the latter a horizontal line drawn along the paper half-way between the highest and lowest positions of the pen).

We have then in this way completely determined the S.H.M. to which the actual motion is most akin ; and we find it to be of the same period and phase (p. 221), and amplitude (equation 14), but situated with its time axis at a distance $r^2/(4l)$ above the time axis of the actual motion. Now this means that if we are to regard the actual curve as an attempt on the part of one of the constituents of the instrument to draw this particular S.H. curve, and are to estimate the deviation of the actual curve accordingly, then when in using the instrument in practice we measure on the paper any ordinate of the trace produced by the pen, it must be done from a line drawn in in the position of the hypothetical time axis of the comparison S.H. curve, and not in the position of the time axis of the actual trace. In the above argument we have been considering only *one* of the constituent harmonics of the instrument ; but the quantity $r^2/(4l)$ has the same value for all the harmonics ; and hence when in practice a number are employed to draw a compound curve, the rule still applies.

The true harmonic motion with which the actual motion is to be compared having been found, we now go on to ascertain the greatest discrepancy between the two, the "deviation" of the actual motion.

This can easily be done by means of fig. 10, for the ordinates to the three curves from any point in that figure give the "turning values" of the deviation function ϵ for the values of p and v corresponding to the point. Now it will be remembered that the values of p and v we have been led to choose correspond to the point U on the p axis when the latter is moved up to bisect WK. Hence the deviation has the same numerical value, $\pm \frac{1}{2}WK = \pm r^2/(4l)$, at each of its three turning values. This then is the value of the maximum deviation ; and it will occur five times in each *complete* revolution, namely, at the times $t = 0$, $t = \cos^{-1} \frac{1}{2} \left(\frac{l^2 + r^2}{rl} - \frac{rl}{p^2} \right)$,* $t = \pi$, $t = \cos^{-1} \frac{1}{2} \left(\frac{l^2 + r^2}{rl} - \frac{rl}{p^2} \right)$,† and $t = 2\pi$. The first three of these times are given by (9), and occur during the down stroke ; the existence of the last two, on the up stroke, is inferred at once from symmetry.

* The angle is to be taken between 0 and π .

† The angle is to be taken between π and 2π .

§ 9. *Expression for the Average Deviation of the Pen.*

By the average deviation of the actual trace we mean the average value of the discrepancy between it and some S.H. curve chosen as a standard for comparison. In fairness this latter curve should, as was pointed out before, be that particular one which is most like the trace ; but the criterion of likeness is not to be the magnitude of the *greatest* difference between the two curves, as in the case discussed above, but the magnitude of the *average* difference. We have first of all then to ascertain the constants of the comparison curve, which—in general at least—will not be identical with the comparison curve determined before ; although the two comparison curves will have this in common, that both must be isoperiodic and cophasal with the actual trace. As regards isoperiodicity, what was said in the former case applies equally now ; as regards cophasality, the proof is simpler than before. It is as follows. Consider any S.H. curve differing in phase from the trace by an amount α , and again by an amount $-\alpha$, in both cases the average error of the trace, measured against this S.H. curve as a standard, would be the same. Here then is a function (the average deviation) which has equal values for values of its argument (the phase difference) that are equal in magnitude but opposite in sign. It follows therefore that when the phase difference is zero, the average deviation must be a maximum or a minimum. In this case obviously it will be a minimum—which proves our theorem. Accordingly, as in the former case, the comparison harmonic must have the form $(w + p \cos t)$; and the difference between it and the trace at any time t will be

$$\epsilon = [w + p \cos t] - [m - \sqrt{(l^2 + r^2 - 2lr \cos t)}],$$

say,

$$\epsilon = p \cos t + v + \sqrt{(a - 2\beta \cos t)}, \quad \dots \dots \dots (15)$$

where

$$v = w - m, \quad a = l^2 + r^2, \quad \text{and} \quad \beta = lr. \quad \dots \dots \dots (16)$$

The value of the average deviation, ϵ' say, will be,

$$\epsilon' = \frac{1}{\pi} \int_0^\pi \epsilon dt, \quad \dots \dots \dots (17)$$

and to complete the determination of the comparison S.H. we

must find the particular values of p and v which minimise ϵ' . As ϵ may change sign between 0 and π , it is necessary to write the above integral

$$\epsilon' = \frac{1}{\pi} \left\{ \int_0^{\cos^{-1}(-m+n)} \epsilon dt - \int_{\cos^{-1}(-m+n)}^{\cos^{-1}(-m-n)} \epsilon dt + \int_{\cos^{-1}(-m-n)}^{\pi} \epsilon dt \right\} \quad (18)$$

where m and n have the following values. Ascertain the points at which ϵ changes sign by putting ϵ equal to zero in equation (15), which leads to

$$p^2 \cos^2 t + 2pv \cos t + v^2 = \alpha - 2\beta \cos t.$$

$$\cos t = -\frac{pv + \beta}{p^2} \pm \frac{\sqrt{(\alpha p^2 + 2\beta vp + \beta^2)}}{p^2};$$

or, say,

$$\cos t = -m \pm n,$$

where,

$$m \equiv \frac{pv + \beta}{p^2}, \text{ and } n \equiv \frac{\sqrt{(\alpha p^2 + 2\beta vp + \beta^2)}}{p^2}. \quad (19)$$

From (18) by partial differentiation, remembering that $\cos^{-1}(-m \pm n)$ when substituted for t in (15) makes ϵ equal to zero, we have—

$$\frac{\partial \epsilon'}{\partial p} = \frac{1}{\pi} \left\{ \int_0^{\cos^{-1}(-m+n)} \cos t dt - \int_{\cos^{-1}(-m+n)}^{\cos^{-1}(-m-n)} \cos t dt + \int_{\cos^{-1}(-m-n)}^{\pi} \cos t dt \right\}$$

$$\frac{\partial \epsilon'}{\partial p} = \frac{2}{\pi} \left\{ \sqrt{[1 - (-m+n)^2]} - \sqrt{[1 - (m+n)^2]} \right\}$$

At a minimum value of ϵ' , $\partial \epsilon' / \partial p$ must be zero. But there are only two ways in which this can occur, either $m=0$, or $n=0$. In the latter case it can be shown that $\partial \epsilon' / \partial v = 1$; hence the only way to minimise ϵ' is to make $m=0$.

With this value of m , by partial differentiation of (18) we have

$$\frac{\partial \epsilon'}{\partial v} = \frac{1}{\pi} \left\{ \int_0^{\cos^{-1} n} 1 dt - \int_{\cos^{-1} n}^{\cos^{-1}(-n)} 1 dt + \int_{\cos^{-1}(-n)}^{\pi} 1 dt \right\}$$

$$\frac{\partial \epsilon'}{\partial v} = \frac{2}{\pi} \left\{ \cos^{-1} n - \cos^{-1}(-n) + \frac{\pi}{2} \right\}$$

Now $0 \nless n \nless \pi$, and therefore when both $\partial \epsilon' / \partial p = 0$ and $\partial \epsilon' / \partial v = 0$, we have

$$m = 0 \quad . \quad . \quad . \quad (20)$$

$$\cos^{-1} n = \frac{\pi}{4} \quad . \quad . \quad . \quad (21)$$

In any actual instrument the dimensions are such that powers of r/l greater than the second may be neglected, hence we have from (20) and (21) with (16) (and 19)

$$p = r \left(1 - \frac{r^2}{4l^2} \right) \quad . \quad . \quad . \quad . \quad (22)$$

and

$$v = -l \left(1 + \frac{r^2}{4l^2} \right) \quad . \quad . \quad . \quad . \quad (23)$$

This completes the determination of the comparison S.H., and, precisely as in the former case, it may be shown that it is a curve having its time axis depressed by a distance $-r^2/(4l)$ below the time axis of the actual curve. The displacement that should accordingly be given to the time axis when drawing in the latter on the paper has already been explained.

The interpretation of equation (22) is this. To make the average error as small as possible, the curve drawn by any one of the wheels of the instrument, the amplitude of the eccentric pin of which, according to the present theory, is r , ought to be regarded as a slightly inaccurate representation of a true S.H. curve, the amplitude of which is not r , but $r \left(1 - \frac{r^2}{4l} \right)$.

The value of the average deviation can now be found by putting the values of p and v into equation (17); or, what comes to the same thing, by putting the values for m and n given by (20) and (21) into equation (18).

There results,

$$\epsilon' = \frac{1}{\pi} \left\{ \int_0^{\frac{\pi}{4}} \epsilon dt + \int_{\frac{3\pi}{4}}^{\frac{\pi}{4}} \epsilon dt + \int_{\frac{3\pi}{4}}^{\pi} \epsilon dt \right\} \quad . \quad . \quad . \quad (24)$$

Now if, as before, powers of r/l greater than the second may be neglected, then it follows from equation (16) that powers of β/a greater than the second may also be neglected; hence from (15)

$$\epsilon = p \cos t + v + \sqrt{a} \left[1 - \frac{\beta}{a} \cos t - \frac{\beta}{2a^2} \cos^2 t \right].$$

Were this expression for ϵ to be substituted in equation (24), and the integration then performed, it would be found that none of the terms would survive the process except the last. Therefore (24) may be written

$$\epsilon' = -\frac{\beta^2}{2\alpha^{3/2} \cdot \pi} \left\{ \int_0^{\frac{\pi}{4}} \cos^2 t \, dt + \int_{\frac{3\pi}{4}}^{\frac{\pi}{4}} \cos^2 t \, dt + \int_{\frac{3\pi}{4}}^{\pi} \cos^2 t \, dt \right\}$$

$$\epsilon' = -\frac{\beta^2}{2\alpha^{3/2} \cdot \pi} = -\frac{1}{2\pi} \frac{r^2}{l} \left(1 - \frac{r^2}{l^2}\right)$$

$$\epsilon' = -\frac{r^2}{6 \cdot 3 \cdot l} \text{ very approximately.}$$

§ 10. *Application of the Mathematical Results to the Present Instrument.*

In the case of the present instrument, where r is equal to $\frac{1}{2}$ inch and l to 30 inches, the greatest deviation is equal to $r^2/(4l)$, equal to $\frac{1}{480}$ of an inch. This result shows the importance of using the true theory in the estimation of the deviation, for it will be recollected that the fallacious theory first advanced (p. 217 *et seq.*) made out the deviation to be $\frac{1}{240}$ of an inch, that is, it just *doubled* it.

As there are three harmonic wheels in the present instrument, the greatest possible deviation of the pen is $\frac{3}{480}$ of an inch; and, moreover, even this amount of deviation will only be present when the deviations of the three harmonic wheels attain their maximum values simultaneously, which in practice will be a rare event. For as a rule the harmonic constituent possessed of a variable amplitude will have its two harmonic wheels set in different phases, and in this case the full error will never be attained; and, again, the two constituents may be set to incommensurable periods, a condition of affairs which has a like effect.

The value of the greatest deviation given above is only true of course if all measurements of the curve produced by the pen be made from the depressed time axis spoken of before, but in practice the simplification occurs, that this axis is quite indistinguishable from the other drawn at the height of the zero of the pen, for the amount of the depression is given by the same formula which gives the maximum deviation, and is therefore only $\frac{1}{480}$ of an inch.

To sum up the points connected with the present instrument, not only does it appear to be satisfactory as regards its mechanical

properties, but the mathematical investigation has shown that the principle employed in its construction gives an accuracy which is more than sufficient for all practical purposes.

§ 11. *Improvements suggested by the Mathematical Theory.*

The mathematical form of the expression for the deviation of the pen (both for the greatest and for the average deviation) indicates a method by which this may be reduced by the following modification of the instrument. It will be observed that r , the distance of the pulley pins from the centre of the harmonic wheels, appears in the formula for the error, raised to the second power. That is to say, the deviation increases as the *square* of the eccentricity of the pins. Suppose that this eccentricity were to be reduced so as to be but $1/n$ of its former value, then the greatest deviation of each harmonic wheel would be $(r/n)^2/(4l)$, and the average deviation $-(r/n)^2/(6.3l)$. Of course the motion of the pen would be reduced to $1/n$ of its former amplitude; but this could be avoided by interposing some multiplying device between the pen and the end of the wire, so that the motion of the pen was multiplied n times over, and made as large as before. Magnifying the motion of the pen magnifies the deviation in the same ratio, hence we should now have

$$\text{(the greatest deviation)} = n \cdot \frac{(r/n)^2}{4l} = \frac{1}{n} \cdot \frac{r^2}{4l},$$

and

$$\text{(the average deviation)} = -n \frac{(r/n)^2}{6.3l} = \frac{1}{n} \cdot \frac{r^2}{6.3l}.$$

But these expressions can be reduced without limit by taking n sufficiently large.

With the present value of r , were a number of additional harmonics to be added to the apparatus, it would be necessary, in order to keep the total deviation sufficiently small, to increase the vertical distance between the fixed and moving pulleys. This of course would be undesirable, because it would make the machine so much less compact, and would, if carried to any extent, destroy that portability which is one of its valuable features. It is here then that the alternative method of reducing the deviation is likely to prove of value. Originally the throw of the eccentric pulleys in the

author's machine was 1 inch, and the distance between them and the fixed pulleys was about 8 feet. After the mathematical theory had been worked out, these dimensions were reduced to their present values ($\frac{1}{2}$ inch and 30 inches respectively), without impairing in any way the mechanical working. How far it may be possible to go in this direction it remains for further experiment to decide, but it certainly does not seem as if the limit had yet been reached.

Another line of improvement is suggested by the following considerations.

In the above discussion the two fixed pulleys in fig. 6 were considered to be at a distance apart equal to their effective diameters, but it is by no means certain that this distance is the best for the purpose, and another might be found, by means of a mathematical discussion or otherwise, for which the deviation of the pen would be much reduced.

The author is continuing to investigate this subject, and hopes before long to be in a position to make a further report. He desires to express his best thanks to Professor MacGregor for the opportunity afforded to him of carrying on the work in the Physical Laboratory of the University of Edinburgh, and also for the loan of apparatus, etc.; and to the Trustees of the Moray Fund for a grant obtained through Professor Chrystal for the construction of the present instrument.

§ 12. *Summary of Paper.*

The apparatus described in this paper is designed for the purpose of drawing the curve which is the summation of a number of simple harmonics, and it is so constructed that both the amplitude and the period of any of its constituent harmonics can be set to all values, commensurable or incommensurable, throughout their range. Further, the amplitude and the period of any of the constituent harmonics can be altered at will *while the machine is in motion.*

The curves drawn by the pen of the instrument, although in theory not truly harmonic, are yet more than sufficiently so in practice, for it is shown that the greatest departure anywhere from the truth cannot be more than $\frac{3}{480}$ of an inch; besides

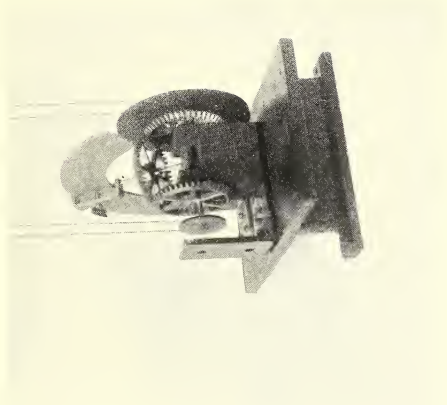
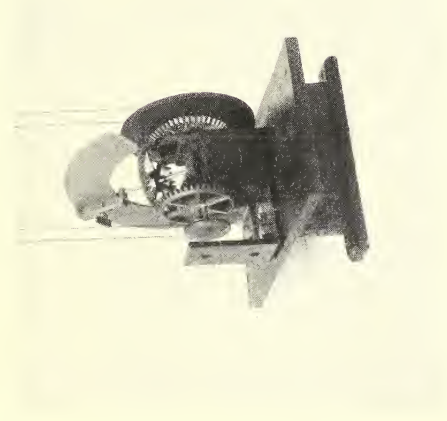

Fig. 3.



MR J. R. MILNE.

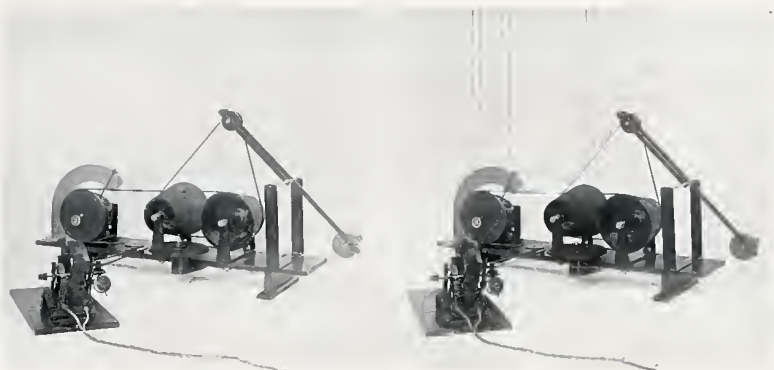

Fig. 1.

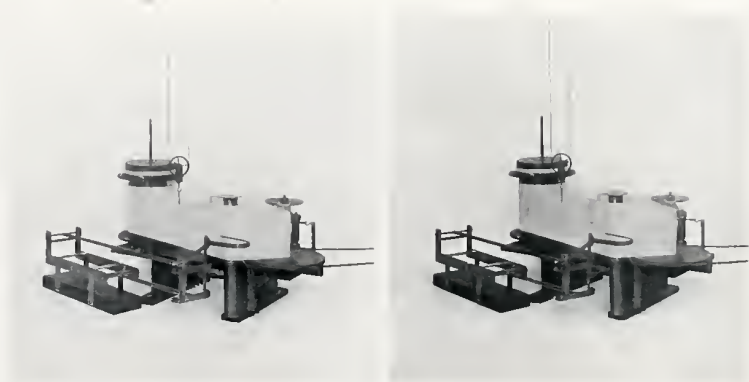

Fig. 2.



Fig. 3.

which the mathematical theory presented in this paper indicates how this deviation could, if necessary, be still further reduced.

The instrument is eminently simple and inexpensive in construction, one of the author's objects being to discover whether an apparatus so designed would give really satisfactory results. The present machine (which, it should be noted, has no *slides* anywhere, but only *pivots*) does its work well; and it has the further advantage of being compact and portable. It is hoped shortly to issue a further paper on this subject.

For some specimens of the traces produced see pages 211 and 213.

(Issued separately July 12, 1906.)

Preliminary Note on the Conductivity of Concentrated Aqueous Solutions of Electrolytes. By Prof. J. Gibson.

(MS. received October 12, 1905. Read November 6, 1905.)

In a paper communicated to the Society in 1897, the author drew attention to increase in electrical conductivity as a characteristic of photo-chemical action, and in a second communication in December of the same year, made the following statement—

“It would appear that the chemical behaviour of the acids just mentioned (HNO_3 , HCl , H_2SO_4) depends in many of their reactions on whether their concentration is above or below that corresponding to their maximum electrolytic conductivity.”*

As a result of prolonged investigation by the author, much experimental evidence tending in this direction has been gained, but the endeavour to arrive at a clear and definite physical meaning has been so far unsuccessful. It is very remarkable that during the last twenty years relatively little progress has been made in our knowledge of concentrated solutions. This is primarily due to the fact that hitherto no simple and general relationship has been discovered between the conductivity and the concentration of concentrated solutions of electrolytes. Oswald's law of dilution holds only for dilute solutions of weak electrolytes, and the formulæ of Rudolphi and of Van T. Hoff are applicable only to dilute solutions of good electrolytes.

Since the publication by Kohlrausch of his classical investigations it has been customary, in stating the relationship between the conductivity and the concentration of solutions of electrolytes, to express the concentration as equivalent concentration, that is, in gram equivalents per unit volume of solution. It has also been customary to express the conductivity as equivalent conductivity, that is, as the ratio of the specific conductivity to the equivalent concentration.

* κ = specific conductivity.

Thus, adopting the recognised symbols :—

κ = specific conductivity in ohm⁻¹ cm.⁻¹

η = concentration in gram equivalents per cc.

$m = 1000 \eta$ or gram equivalents per litre.

$\Lambda = \frac{\kappa}{\eta}$ = equivalent conductivity.

s = specific gravity.

This mode of representation has no doubt one advantage over the older mode in which the specific conductivity (κ) was referred to the percentage composition, for solutions of equal equivalent concentrations contain chemically equivalent quantities which is obviously not the case in solutions of equal percentage composition ; but this advantage is not dependent upon the adoption of the unit of *volume* (litre or cc.), and is equally maintained when the concentration is expressed in gram equivalents per unit *mass*, that is, in gram equivalents per gram or per kilogram.

The adoption of unit volume instead of unit mass was due originally to a certain practical convenience, and proved later on very useful in facilitating the correlation of the laws relating to dilute solutions with the gas laws.

By confining investigation to dilute solutions, very great progress has been made, but it has seemed throughout as if there were a barrier preventing progress in our knowledge of concentrated solutions. The barrier lies in the adoption of the unit of volume instead of the unit of mass. The specific gravity effect which is not negligible in concentrated solution blurs the true relationship.

If the following units be taken—

κ = specific conductivity in ohm⁻¹ cm.⁻¹

γ = concentration in gram equivalents per gram

$\Gamma = 1000 \gamma$

$\Lambda_{\mu} = \frac{\kappa}{\gamma}$ (corresponding to $\lambda = \frac{\kappa}{\eta}$)

the relation between Λ_{μ} and γ approximates very closely over considerable ranges of concentration to

$$\Lambda_{\mu} = a + b\gamma \quad . \quad . \quad . \quad . \quad (1)$$

where a and b are constants.

Thus if we translate the data for good electrolytes given in Table I. of Kohlrausch and Holborn's *Leitvermögen der Electrolyte* into these units, and plot Λ_μ against γ , straight lines are obtained in almost every case.

The range within which this linear relationship holds for good electrolytes, that is, for strong acids, alkalis, and salts, begins at about 0.5 gram molecules per kilogram and extends up to the point of saturation in the case of salts of moderate solubility such as common salt. In the case of several, the very soluble salts, strong acids, and alkalis, the range extends from 0.5 to over 7 gram molecules per kilogram (Γ), or, expressing the concentration in the usual way, from about 0.5 to about 10 normal.

At still higher concentration the relation between γ and K ceases to be linear. In some cases, at any rate, this would appear to be due to false assumptions regarding the nature of the solution. This subject will be discussed in a subsequent paper dealing with the conductivity of the strong acids.

Where equation (1) holds we may write

$$\kappa = a\gamma + b\gamma^2 \quad . \quad . \quad . \quad (2)$$

This is obviously a parabola with a maximum value of κ corresponding to

$$\gamma = -\frac{a}{2b}.$$

For brevity let $-\frac{a}{2b} = \gamma m$.

The maximum value of κ , *i.e.* κm , is therefore

$$a\gamma m + b\gamma m^2 = \frac{a^2}{4b}.$$

We may therefore write equation (1) in the two forms

$$\Lambda_\mu = b(\gamma - 2\gamma m) \quad . \quad . \quad . \quad (3),$$

or

$$\Lambda_\mu = 2\sqrt{b\chi m} + b\gamma \quad . \quad . \quad . \quad (4).$$

The significance of maximum specific conductivity is reserved for discussion in connection with the experimental investigations relating to this part of the subject. Meantime it may be stated that whenever an electrolyte is sufficiently soluble to give a solution of maximum specific conductivity, the maximum falls

within the range of concentration for which the linear relationship holds.

It is important to notice that as $\gamma = \frac{\eta}{s}$ and $\Lambda_{\mu} = \lambda s$, the adoption of unit of mass instead of unit volume does not affect the numerical statement of the relationships which have been established for dilute solutions; for when $s = 1$, as is practically the case in dilute solutions, γ coincides with η and Λ_{μ} with Λ . To prevent confusion, the old units, viz., η , m , Λ will be referred to as volume units; and the new units, γ , Γ , and Λ_{μ} , as mass units.

(*Issued separately August 29, 1906.*)

Recherches sur la Glauconie. Par les Drs Léon W. Collet et Gabriel W. Lee, assistants de Sir John Murray, K.C.B. *Communiqué par Sir JOHN MURRAY.* (Avec 12 planches et 1 carte.)

(MS. received May 28, 1906. Read June 4, 1906.)

I. INTRODUCTION.

Depuis Murray et Renard deux travaux importants sont venus enrichir la bibliographie de la Glauconie : le mémoire de MM. Calderon et Chaves, "Contribuciones al estudio de la Glauconita," et l'œuvre magistrale de M. L. Cayeux, *Etude micrographique des terrains sédimentaires.*

Murray et Renard avaient étudié spécialement la Glauconie actuelle ; MM. Calderon et Chaves basèrent leur synthèse de la Glauconie actuelle sur une analyse de Glauconie des roches sédimentaires ; M. L. Cayeux limita strictement ses belles recherches à la Glauconie des roches sédimentaires et n'attaqua pas le problème de sa genèse.

Après avoir terminé notre étude des "Concrétions phosphatées de l'Agulhas Bank," nous fûmes invités par Sir John Murray à entreprendre une sorte de "mise au point" de la question de la Glauconie. En effet, Gümbel en 1886, puis Murray et Renard en 1891, virent dans la Glauconie un silicate ferri-potassique ; pour MM. Calderon et Chaves la Glauconie, au contraire, est un silicate ferro-potassique. Qui avait raison ? De plus M. L. Cayeux signala des caractères très spéciaux dans la Glauconie de ses roches sédimentaires, caractères qui étaient inconnus dans la Glauconie actuelle, une étude comparative se justifiait donc.

Comment remercier Sir John Murray, qui nous chargea de cette étude que lui seul pouvait nous permettre d'entreprendre, grâce à sa vaste érudition et aux collections qu'il accumule au *Challenger* Office depuis si longtemps. Les nombreuses heures passées en contact avec un tel maître, le créateur de l'Océanographie, seront pour nous un souvenir indélébile.

Nous devons également de sincères remerciements à M. le

Prof. L. Cayeux, de Paris, qui nous communiqua très aimablement des coupes de Glauconie pour les comparer aux nôtres, et qui s'intéressa d'une façon très spéciale à nos recherches.

MM. Arnold Heim, du laboratoire de Géologie de l'Université de Zurich ; Chs. Jacob, du laboratoire de l'Université de Grenoble ; Buxtorf, du Musée de Bâle ; Teall, directeur du H.M. Geological Survey à Londres ; H. B. Woodward, à Londres, ont aimablement répondu à nos demandes d'échantillons, qu'ils reçoivent ici l'expression de notre gratitude.

M. Georges West, du "Lake Survey," a bien voulu se charger des microphotographies, qu'il reçoive ici nos sincères remerciements.

Dans le présent travail, M. le Dr G. W. Lee s'est spécialement occupé de la question purement minéralogique, M. le Dr L. W. Collet de la question géologique. La partie chimique ainsi que les conclusions ont été faites conjointement.

II. GLAUCONIE EN TANT QUE MINÉRAL.

Habitus.—On sait depuis longtemps que la Glauconie se présente sous trois formes différentes : comme *produit de remplissage* de coquilles de foraminifères et comme *grains* prenant part à la formation des sables verts et autres roches sédimentaires glauconieuses. La troisième forme est la Glauconie dite *pigmentaire* qui imprègne la roche, tel un enduit vert dû à la présence d'une multitude de paillettes submicroscopiques. Comme nous le verrons plus tard, ces deux dernières catégories étant dérivées sans aucun doute de la première, nous pouvons les grouper sous le nom de *Glauconie secondaire*.

1. "*Moules glauconitiques.*"—C'est l'étude des "*glauconitic casts*" des naturalistes du *Challenger* qui doit nous donner la clef du problème de la genèse de la Glauconie. L'interprétation de cette forme affectée par la Glauconie sera l'objet d'un chapitre spécial, et nous nous limiterons pour le moment à une courte description des moules mêmes.

Les moules typiques, dont le diamètre est en général inférieur à 1 mm., sont vert foncé, et quelquefois pourvus d'un noyau jaune ou brun. La partie verte a toutes les propriétés de la Glauconie telle que les minéralogistes la comprennent : l'indice

de réfraction, la biréfringence et la structure cryptocristalline, sont les mêmes que chez la Glauconie des grès verts, etc. D'autre part le noyau brun est opaque et amorphe.

Nous attirons l'attention du lecteur sur le fait que jusqu'à présent il n'a point été rencontré de moules à centre vert et périphérie brune, cela bien entendu tant que la coquille du foraminifère est conservée. La présence d'un noyau brun entouré d'une zone de Glauconie parfaite ne peut s'expliquer que par un processus chimique sur lequel nous reviendrons au chapitre traitant de la genèse de la Glauconie.

Glauconie en grains.—La plus grande partie de la Glauconie mentionnée ou étudiée par les géologues appartient à cette catégorie ; elle est le constituant le plus caractéristique des grès verts des assises géologiques et des Sables et Boues Verts des mers actuelles, et il est à peu près hors de doute qu'elle est due au remaniement des moules glauconitiques. Comme ce chapitre n'est qu'une entrée en matière, il est inutile que nous revenions sur la description de ces grains, dont on trouvera la description détaillée, accompagnée de figures, dans les travaux de Murray et Renard, et de M. Cayeux.

Glauconie pigmentaire.—La teinte verte de nombreux échantillons lithologiques sédimentaires et des mers actuelles, tels que concrétions phosphatées, etc., est due à la présence de Glauconie à l'état finement divisé, appelée par M. Cayeux *Glauconie pigmentaire* ; elle est due ou bien à une précipitation chimique, ou bien au dépôt tranquille de Glauconie préexistante amenée par trituration à l'état pulverulant. Dans certains cas elle peut remplir des coquilles de foraminifères, donnant ainsi naissance à des moules dont l'origine est facile à mettre en lumière lorsqu'on peut voir la Glauconie incluse se propager sans interruption dans le ciment englobant les coquilles de foraminifères. Les moules ainsi formés sont, par opposition à ceux cités plus haut, de faux moules, et n'ont pas d'importance au point de vue de la genèse de la Glauconie.

Propriétés physiques.

Poids spécifique.—Selon M. Lacroix, la valeur de la densité de la Glauconie oscille entre les chiffres de 2·2 à 2·3 ; M. Rosenbusch donne le chiffre de 2·30. Pour M. Spurr elle

dépasserait souvent 3, et atteindrait dans un échantillon qu'il cite la valeur 3.634. Nous devons dire que, bien que la Glauconie se montre souvent capricieuse dans ses propriétés, *la densité est une constante physique trop importante pour qu'il soit permis d'admettre une telle variation.* Un minéral dont la densité est 3.6 ne peut être de la Glauconie, même si l'on considérait la Glauconie comme une famille ou groupe de minéraux, et non pas comme une espèce; et même dans les limites de groupes tels que ceux des Amphiboles ou des Pyroxènes, où la nature des bases varie encore plus que ce n'est le cas chez la Glauconie, on ne trouve pas une pareille variation dans la valeur de la densité. Ce minéral est si difficile à séparer du quartz au moyen des liquides lourds, que les chiffres donnés par M. Lacroix et M. Rosenbusch sont sans aucun doute les vrais.

Dureté.—La Glauconie est assez tendre pour être écrasée sous l'ongle; ce peu de cohésion est un argument en faveur de la genèse purement mécanique de la Glauconie pigmentaire (les cas d'épigénie dont nous parlerons plus loin devant être attribués à un dépôt par solution), et explique la forme généralement arrondie des grains.

Structure.—La Glauconie ne se présente que rarement sous forme de cristaux proprement dits; chaque grain ou moule consiste en un agrégat de cristaux lamellaires microscopiques dont le diamètre ne dépasse en moyenne guère 0.003 mm., et dont les axes d'élasticité n'ont pas une orientation commune de sorte que le grain ou moule, quoique d'apparence homogène en lumière ordinaire, offre des plages diversement illuminées entre nicols croisés.

M. le Prof. Cayeux a décrit une variété bien cristallisée de Glauconie, dont il a eu l'amabilité de nous envoyer quelques échantillons aux fins de les comparer à d'autres de la collection de Sir John Murray, et provenant du créacé d'Irlande, de Folkestone et du nummulitique du Sântis en Suisse. Cette variété est fortement polychroïque, ng. vert, np. jaune pâle, et s'éteint à 0°. De toutes les sections étudiées, celle qui était le plus près d'être parallèle à ng.-np. avait une biréfringence voisine de la valeur 0.030, biréfringence notablement plus élevée que celle des particules élémentaires des grains à structure cryptocristalline. Ces cristaux montrent en outre un clivage

plus ou moins parfait, parallèle à l'axe ng. Cette variété est très rare et n'a pas encore été rencontrée en voie de formation dans les mers actuelles, de sorte que nous sommes portés à l'envisager comme étant due à une action métamorphique.

Propriétés optiques.

La *couleur* de la Glauconie pure et non attaquée est verte, vert-olive, et, dans le cas du Gault de Saxonnet en Savoie, d'un beau vert presque bleu. L'intensité de la couleur varie passablement, et semble diminuer avec l'âge du minéral : des échantillons de Glauconie du Cambrien et du Carbonifère d'Angleterre sont vert-d'eau extrêmement pâle, presque incolore ; cela est évidemment dû au métamorphisme, car ici la couleur pâle n'est pas due au mélange mécanique d'une grande quantité d'argile claire, comme cela est le cas pour les moules glauconitiques vert-pâle recueillis par le *Challenger*.

Polychromisme.—Nous avons déjà parlé de cette propriété caractéristique de la variété bien cristallisée ; elle existe aussi chez la Glauconie ordinaire, mais il faut pour l'observer que les particules élémentaires aient une taille suffisamment grande pour que l'on puisse isoler l'une d'elles au moyen du diaphragme oculaire, avec le concours d'un fort grossissement. Nous avons observé que lorsque les particules élémentaires ont un diamètre inférieur à 0.008 mm., elles sont trop enchevêtrées les unes dans les autres pour qu'il soit possible d'observer la moindre trace de polychromisme. Ce dernier est le même que pour la variété bien cristallisée c.à.d. ng. vert, np. jaune pâle. À notre connaissance cette propriété n'avait pas encore été remarquée dans la Glauconie ordinaire des mers actuelles.

Biréfringence.—Même avec les plus forts grossissements il n'est pas possible d'agrandir suffisamment les particules élémentaires pour y observer les figures d'interférence en lumière convergente. On ne peut donc dire avec certitude si les particules qui polarisent le plus haut dans l'échelle de Newton appartiennent à la section principale ng.-np. ou à une section d'orientation quelconque ; cependant comme dans le nombre immense de particules formant les grains ou les moules nous n'en avons jamais rencontrés dont la

biréfringence dépasse le chiffre 0·020, ce chiffre doit être celui de la biréfringence maxima, car il serait inadmissible qu'aucune de ces myriades de particules ne fût parallèle à la section ng-np. La Glauconie ordinaire diffère donc en outre de la Glauconie en grands cristaux par sa biréfringence notablement moins élevée ; cette dernière s'abaisse même d'une manière frappante dans les échantillons du Cambrien et du Carbonifère que nous avons étudiés, tout comme la couleur propre du minéral, la même action métamorphosante qui fait disparaître la couleur abaissant la biréfringence.

Système cristallin.—M. Lacroix considère la Glauconie comme monoclinique, et la place dans le groupe des chlorites ; l'angle des axes varie de 30° à 40°, et peut même s'approcher de 0° ; sauf erreur, ces données ont été étudiées sur la variété en grands cristaux, et nous les avons retrouvées dans les échantillons ayant servi à notre étude : une section de Glauconie du crétacé d'Irlande est presque rigoureusement uniaxe, de signe optique négatif, la figure d'interférence étant de toute netteté, tandis que d'autre part la même variété cristallisée, provenant du Sântis, est franchement biaxe ; mais les sections observées n'étant pas rigoureusement perpendiculaires à la bisectrice aiguë, nous n'avons pu procéder à une mesure d'angle.

Quant à la Glauconie ordinaire on n'a pas les données nécessaires pour établir d'une manière absolue le système cristallin auquel elle appartient, mais il est tout-à-fait légitime de la placer comme l'autre variété, dans le groupe des chlorites, et de la considérer comme monoclinique.

Relations entre la Glauconie et ses diverses manières d'être.

Les sondages entrepris durant ces trente dernières années ont montré que la Glauconie existe le plus souvent sous forme de grains formant un des éléments constituants des boues et sables verts ; les moules sont moins fréquents, et la Glauconie pigmentaire n'est bien observable que dans le cas de dépôts consolidés. Nous avons mené de front l'étude de la Glauconie des terrains sédimentaires et celle des mers actuelles, de façon à avoir une bonne base de comparaison ; nous avons ainsi trouvé que, en règle générale, la différenciation est poussée plus loin dans la Glauconie sédimentaire que dans la moderne.

Différenciation chez les grains glauconitiques modernes.—Une observation digne de remarque est que les grains cimentés montrent une différenciation beaucoup plus avancée que les grains libres des sables et boues, aussi l'ample moisson de concrétions phosphatées recueillie par les bateaux du "Department of Agriculture of the Cape of Good Hope" sur l'Agulhas Bank nous a-t-elle permis de faire de nombreuses observations sur ce sujet, car il ne faut pas oublier que les concrétions phosphatées sont, avec les nodules de manganèse, les principaux dépôts marins trouvés tout formés à l'état *compact*.

Les phénomènes de différenciations observés sont : 1°. Une différence dans l'intensité de la couleur au sein d'un seul et même grain. Les grains de Glauconie de certaines concrétions phosphatées de l'Agulhas Bank ont leur partie médiane d'un vert très pâle, tandis que la partie externe a la couleur vert foncé propre au minéral ; le passage de la teinte claire à la teinte foncée se fait graduellement, sans aucune transition brusque.

En général c'est le contraire qui est le plus fréquent : le centre est plus foncé que la périphérie, avec, comme dans le cas précédent, passage graduel.

Souvent aussi le grain est entouré d'une très mince gaine, visible aux forts grossissements seulement, et que l'examen entre nicols croisés montre être isotrope ; à cette gaine succède quelquefois une nouvelle zone, de couleur verte, plus homogène et moins cryptocristalline que le noyau, et pourvue de clivages radiaux. Entre nicols croisés cette zone se comporte à la façon des sphérolites en donnant le phénomène de la croix noire. Les fibres formant cette couche externe ont un allongement positif, et leur biréfringence est de 0.011 ; en outre, comme la forme de cette couche est quelconque, on ne peut attribuer cette dernière à la pseudomorphose de la calcite de coquilles de foraminifères. Il peut être intéressant de noter que son indice de réfraction est inférieur à celui de la Glauconie du noyau interne.

C'est aussi à un phénomène de différenciation qu'il nous semble devoir attribuer la formation, dans certains grains, de plages dues à la soudure de particules ayant la même orientation ; ces plages cessent d'être cryptocristallines et ont une teinte de

polarisation uniforme, bien que souvent elles aient des extinctions roulantes prouvant que leur homogénéité n'est pas parfaite.

Dans les grains de Glauconie sédimentaire on retrouve tous les exemples de différenciation cités ci-dessus avec en plus la variété bien cristallisée et clivée dont nous avons déjà parlé, et qui n'existe pas chez la Glauconie moderne.

Quant aux moules glauconitiques proprement dits, ils sont presque complètement exempts de ces phénomènes, et les exemples observés peuvent se rapporter à deux cas : l'un dû à une différence dans la cristallisation, l'autre à la présence de minéraux étrangers. Le premier consiste en la présence, dans quelques rares cas seulement, d'un anneau de forme très régulière situé à l'intérieur du moule, et dû à l'arrangement de particules ayant la même biréfringence, de sorte qu'entre nicols croisés on voit au centre du moule un anneau illuminé d'une teinte vive et uniforme. Ce cas a été observé sur des moules d'un sable vert recueilli par le *Challenger* à la station 164, près de Sydney.

Dans le matériel de cette même station nous avons rencontré des moules renfermant des taches foncées et opaques, que leurs contours montrent être dus à la présence de minéraux englobés dans le remplissage glauconitique, et devenus méconnaissables par suite d'une action chimique leur ayant fait subir une sorte de digestion plus ou moins complète (v. Pl. I.). Ce point est intéressant à noter, en ce qu'il indique la présence d'un agent chimique puissant, qui pourrait jouer un rôle dans la genèse des moules glauconitiques.

Ce que nous avons dit dans le chapitre précédent nous amène à parler ici de moules non exclusivement glauconitiques, et que nous pourrions appeler *moules imparfaits*, et qui marquent un acheminement vers la formation des moules glauconitiques.

Les dépouilles de foraminifères déposées sur le fond de la mer sont toutes désignées à être tôt ou tard remplies par la matière minérale tenue en suspension par l'eau, de sorte qu'une coupe microscopique, faite dans un sable vert ou une boue à globigérines prise à une profondeur ne dépassant pas la limite d'environ deux mille mètres, offrira tous les termes de passage entre des moules simplement argileux, et des vrais moules de Glauconie.

Ainsi dans une même préparation on pourra voir que certaines coquilles de foraminifères ne sont qu'en partie remplies par une matière argileuse gris-clair, d'autres sont complètement remplies par cette même matière ; continuant cet examen, toujours dans la même préparation, on verra que certains de ces moules, qui sont ce que Sir John Murray a appelé "*imperfect casts*," sont teintés de brun par l'adjonction d'une certaine quantité de fer, et, la proportion de fer augmentant, on trouvera, comme terme extrême de la série, des moules brun-foncé, complètement opaques. Ces derniers sont facilement attaquables par les acides sulfurique et chlorhydrique, lentement à froid et rapidement à chaud, en laissant un résidu de silice ; donc, si les moules bruns étaient formés d'un mélange mécanique d'argile et de limonite, les acides, attaquant plus rapidement la limonite que l'argile, laisseraient cette dernière sous forme d'un résidu facile à reconnaître. C'est pourquoi il nous semble permis de considérer les moules bruns comme essentiellement formés d'un silicate de fer, tandis que les moules gris sont essentiellement alumineux. Le microscope permet d'aller plus loin encore dans l'étude des différentes phases de l'élaboration d'un moule de Glauconie : le même préparation supposée ci-dessus contient *certaines moules bruns dont la périphérie montre une manifeste transformation en Glauconie, c.à.d. qu'au lieu d'être brune, amorphe et opaque, elle devient verte, cristalline, et translucide en lame mince*. On peut ainsi faire défiler sous l'objectif toute une gamme de moules dont la partie verte l'emporte de plus en plus sur la partie brune, et il est évident que la première est plus récente que la dernière, car il serait absurde d'attribuer le noyau brun de ces moules à un phénomène de décomposition, cette dernière partant toujours de la périphérie.

La transformation se fait très graduellement, et il n'y a pas de transition brusque entre les parties brunes et vertes ; la limite comprise entre ces dernières occupe une surface régulière, de sorte que la métamorphose ne se fait pas irrégulièrement le long de prolongements ou diverticules, sauf dans les cas où la nature de la coquille ou son état de conservation auront permis à l'agent de transformation d'opérer selon une surface irrégulière.

Vu l'importance que nous avons accordée à ce sujet, le lecteur pensera peut-être que les moules glauconitiques forment une part

considérable des dépôts marins ; il n'en est cependant rien, ce qui pourrait être une objection à l'hypothèse que les grains de Glauconie modernes et des assises géologiques ont tous passé par le stade de moules glauconitiques. À cela nous pouvons répondre comme suit : Le processus de la formation de la Glauconie est évidemment très lent, et si le nombre des moules glauconitiques est infini par rapport à celui des grains, le temps qui s'écoule est suffisant pour permettre à un nombre donné de moules de se transformer mécaniquement en grains, en même temps que de nouveaux moules se reforment, et ainsi de suite. Dès lors, cette hypothèse n'a rien que de très admissible, pour peu que l'on songe que si le processus n'agit pas par grands efforts et par grandes masses, il se répartit sans interruption durant des temps infinis.

Nous renvoyons au chapitre traitant de la genèse de la Glauconie les diverses façons possibles d'interpréter le mécanisme selon lequel la silice, le fer, la potasse et l'eau se combinent pour former la Glauconie, et aborderons maintenant l'étude de la troisième manière-d'être de ce minéral, *la Glauconie pigmentaire*.

C'est de nouveau dans les dépôts compacts que l'on trouve de bons exemples de Glauconie pigmentaire, se prêtant à l'étude microscopique des diverses façons dont elle se présente. Il est très probable qu'elle existe aussi au sein des dépôts meubles, mais étant dans ce cas à l'état de boue impalpable noyée dans le reste du sédiment, son manque d'individualité empêcherait que l'on puisse en faire une étude utile.

Ce que M. Cayeux a dit pour la Glauconie pigmentaire des terrains sédimentaires, nous l'avons retrouvé dans celle des concrétions phosphatées de l'Agulhas Bank, et nos dernières recherches nous permettent de compléter ce que nous avons écrit à ce sujet dans notre précédent travail (11).

La Glauconie pigmentaire, qui est toujours mélangée à de la calcite triturée ou à du phosphate de chaux, est ou bien uniformément répandue dans la roche, ou bien plus ou moins individualisée sous forme de taches, ou enfin peut remplir certaines cavités, telles que des loges de foraminifères. Dans le premier cas elle ne fait que communiquer une teinte verte au ciment de la concrétion, et ce dernier est en proportion trop

considérable pour que la Glauconie qui y est diffusée puisse réagir sur la lumière polarisée. Quand elle se présente sous forme de taches le centre est quelquefois suffisamment riche en Glauconie pure pour pouvoir réagir sur la lumière polarisée, de sorte qu'entre nicols croisés on voit des couleurs de polarisation qui diminuent d'intensité du centre à la périphérie, où le ciment l'emporte sur la Glauconie comme dans le premier cas. Nous attirons l'attention sur ce fait qui prouve l'identité de la Glauconie pigmentaire et de la Glauconie ordinaire, bien que la première ne puisse être directement étudiée pour les raisons déjà indiquées.

Si nous répétons ce que nous avons déjà dit à propos de la Glauconie pigmentaire remplissant des coquilles de foraminifères, c'est pour mettre en garde l'observateur, qui pourrait confondre ces faux moules avec les véritables moules glauconitiques. La confusion n'est pas possible si l'on opère entre nicols croisés avec un bon grossissement, car on voit alors les particules de Glauconie noyées dans le ciment, qui est isotrope s'il est argileux ou phosphatique, et montre les teintes de polarisation irisées de la calcite, s'il est dû à la trituration de cette dernière. Enfin, en règle générale, la couleur de ces faux moules n'est pas aussi foncée que celles des véritables, et en plaques minces leur relief n'est pas aussi considérable.

Avant de trancher en faveur de l'une ou de l'autre des hypothèses touchant l'origine de cette manière d'être de la Glauconie, nous voulons parler ici de la *Glauconie épigénique*, avec laquelle elle pourrait avoir certains rapports. Comme la Glauconie épigénique a été étudiée très en détail par M. Cayeux (8) dans certaines roches sédimentaires, il est intéressant de signaler le fait que divers cas d'épigénie de ce minéral se produisent de nos jours au sein des mers.

Ce phénomène affecte 1° des éléments minéraux organisés, tels que la calcite de coquilles de Foraminifères, et 2° des minéraux détritiques, tels que le quartz et les feldspaths. Le centre de la figure Pl. III. est occupé par un moule glauconitique de Globigérine dont la coquille, quoique fraîche et bien conservée, est imprégnée de mouchetages (paraissant noirs sur la photographie) de Glauconie parfaitement typique. La figure Pl. VI. représente un cas plus complexe : la masse générale de la préparation est teintée en vert-

clair par de la Glauconie pigmentaire, tandis que la section de coquille au milieu a sa calcite complètement remplacée par de la Glauconie épigénique vert-foncé. Enfin, la figure Pl. VIII. donne un exemple d'épigénie sur un grain de quartz ; les mouchetages et les barres noires bien visibles sur cette photographie sont dus à la présence de Glauconie ne se distinguant en rien de la Glauconie ordinaire, et ici l'épigénie ressemble absolument à ce que l'on observe dans le cas des roches sédimentaires, bien que chez ces dernières le phénomène se soit souvent produit après la consolidation de la roche, comme l'a montré M. Cayeux.

Maintenant, la Glauconie pigmentaire et la Glauconie épigénique sont-elles dues au dépôt du produit de la trituration de Glauconie préexistante ? Ou bien sont-elles dues à un dépôt de Glauconie tenue en solution par un agent quelconque ? Ou enfin faut-il chercher l'explication dans la métamorphose d'un silicate de fer brun, comme dans le cas des moules bruns se changeant en moules verts ? La première de ces hypothèses ne peut s'appliquer qu'à la Glauconie pigmentaire, car on ne pourrait s'expliquer le remplacement épigénique par l'action mutuelle de deux corps à l'état solide, c.à.d. de Glauconie toute formée d'une part, et d'une coquille ou d'un minéral, selon les cas, d'autre part.

L'intervention d'un dissolvant permet de trouver une explication assez plausible aux phénomènes d'épigénie, mais ne pourrait guère s'expliquer dans le cas de la Glauconie pigmentaire. En effet, dans le premier cas, on comprend assez bien que la Glauconie tenue en solution arrive à s'infiltrer dans les pores les plus intimes d'une coquille ou d'un minéral, et arrive même à les remplacer complètement par pseudomorphose, dans le cas où ce même dissolvant aurait dissous du même coup les minéraux épigénisés, tout en déposant à leur place la Glauconie qu'il tenait en solution. On conçoit que d'autre part l'explication ci-dessus convienne moins bien au cas de la Glauconie pigmentaire, car il semble qu'un précipité doive se déposer en couches homogènes et compactes, et non pas sous forme de paillettes noyées dans un ciment ; en outre les formes bizarres qu'affectent souvent les traînées de Glauconie pigmentaire évoquent à l'esprit la notion d'une matière pulvérulente que de petits remous ou tourbillons forcent à se déposer dans des endroits déterminés.

La troisième hypothèse nous a été suggérée par quelques

observations, dont un exemple est donné par la figure Pl. IX. Le centre de la figure est occupé par la section d'une coquille dont la calcite est complètement remplacée par une matière ferrugineuse brun-foncé. Le remplacement est ici indubitable, mais à l'encontre de ce qui se passe chez les moules bruns et verts, on ne peut dire si la matière brune est postérieure ou antérieure à la Glauconie, cette dernière épigénisant des fragments de coquilles poreuses concurremment avec la matière brune, mais seulement selon une surface plane, ce qui ne permet donc pas de trancher la question (nous avons observé plusieurs exemples de ce phénomène sur des échantillons de nodules phosphatés jaunes de la station 7, Agulhas Bank, par 238 m. de profondeur).

Formation des grains de Glauconie.—Si nous plaçons ici l'étude de cette question, c'est que nous pourrions avoir à recourir à ce qui a été dit dans les chapitres précédents pour arriver aux hypothèses les plus vraisemblables.

C'est un fait bien connu que la Glauconie se présente le plus souvent sous forme de grains arrondis, généralement ovoïdes. Cette forme régulière a toujours intrigué les géologues, et nombreuses sont les hypothèses auxquelles ils ont eu recours pour l'expliquer, ainsi que la taille même des grains, qui dépasse souvent de beaucoup celle qu'auraient les produits du remaniement pur et simple de moules glauconitiques.

Les diverses hypothèses exprimées au sujet de la genèse des grains de Glauconie peuvent *grosso modo* se ramener à deux : une école, avec Murray et Renard en tête, admettent que les grains dérivent des moules, après brisure de la coquille et accroissement subséquent par apport de matière glauconieuse ; l'autre école, représentée surtout par M. Gümbel, attribue aux grains une genèse toute différente et indépendante de la matière organisée. Nous renvoyons pour plus de détails au travail original de M. Gümbel, et nous contenterons de dire ici que si les grains étaient dus au dépôt de Glauconie sur l'enveloppe de bulles gazeuses, avec remplissage subséquent, par intussusception, de la coque ainsi formée, il n'y aurait pas de raisons pour que la Glauconie seule aie une telle attraction pour les bulles de gaz, et dans ce cas il n'y aurait rien d'étonnant à voir maintes espèces minérales, telles que la pyrite, le manganèse, la phillipsite, etc., obéir à la même loi.

Sans apporter une preuve décisive à l'appui de la première manière de voir, nous croyons cependant devoir nous y ranger en modifiant légèrement la manière dont Murray et Renard expliquent le processus. Comme eux, il nous semble qu'il est parfaitement logique d'admettre que les grains dérivent originellement de moules, mais sans toutefois nier qu'il soit possible que le moule continue à croître, pour ainsi dire, en faisant éclater sa coquille et en perdant ainsi sa forme primitive, nous pensons qu'il nous sera permis d'offrir une explication un peu différente, qui nous a été suggérée par le grand rôle que paraissent jouer la Glauconie pigmentaire et la Glauconie épigénique.

En effet, supposons que des moules aient perdu leur coquille et se trouvent placés dans un endroit où l'une des variétés de Glauconie, pigmentaire ou épigénique, soit justement en train de se déposer ou de s'élaborer. Or, puisque cette Glauconie peut souder entre elles des particules de calcite et imprégner les fissures de fragments de quartz, etc., pourquoi ne pourrait-elle souder entre eux des fragments de moules? Cela supposé, le roulement et le frottement avec les autres corps solides déposés au fond de la mer donneront à cet agglomérat la forme arrondie et l'aspect luisant si caractéristiques des grains de Glauconie.

Nous voyons de suite les objections que l'on pourrait faire à cette manière de voir, objections du reste déjà formulées par M. Gümbel (*Ueber die Natur . . . etc.*, p. 435) : l'examen d'une préparation contenant des grains de Glauconie, ne révèle au microscope la présence ni du ciment ni de lignes de suture. Avant d'y répondre nous prions le lecteur de ne pas perdre de vue la plus caractéristique de toutes les propriétés physiques de la Glauconie : c.à.d. que cette dernière est *cryptocristalline*. Cela posé, supposons de nouveau deux ou plusieurs fragments de moules ; chacun de ces fragments est composé d'une multitude de particules *diversément orientées*. Maintenant, le ciment glauconieux qui vient souder les fragments de moules, est lui aussi formé de particules diversément orientées, de sorte que cette espèce d'hétérogénéité dans la structure intime, des fragments comme du ciment, *doit donc masquer toute ligne de suture*.

Associations minérales.—Ce sujet étant important dans l'histoire de la Glauconie, nous comptons en traiter ici, bien que Murray et

Renard d'une part, et M. Cayeux de l'autre, lui aient déjà consacré plusieurs pages.

Les minéraux qui accompagnent la Glauconie dans ses divers gisements peuvent être ou bien détritiques ou bien secondaires, c.à.d. s'être formés *in situ* au fond de la mer.

Des minéraux détritiques le *quartz* est celui qui joue de beaucoup le plus grand rôle ; il va de soit qu'il se rencontre en toutes proportions, et dans le cas des sables verts il est le principal constituant de ce sédiment. Il se présente en grains dont le diamètre varie d'une fraction de centième de mm. à 1 et même 2 mm., avec une moyenne assez constante de 0.3 mm. Ce n'est que rarement qu'ils sont roulés et arrondis ; en général leurs arêtes sont tranchantes ou seulement émoussées. Ils sont le plus souvent libres, et dans le cas de concrétions phosphatées, isolés au milieu du ciment ; nous n'avons observé qu'exceptionnellement des grains de quartz réunis entre eux au moyen d'un ciment siliceux : ils prennent alors en lumière parallèle l'apparence de larges plages qui se résolvent entre nicols croisés en une mosaïque à éléments diversément orientés.

Les autres minéraux détritiques jouent un rôle tout-à-fait subordonné ; le Zircon et la Tourmaline sont pour ainsi dire toujours présents, mais au nombre de quelques grains seulement par coupe. Les Feldspaths, en cristaux plus petits que les grains de quartz, appartiennent, comme nous l'avons fait remarquer dans un travail précédent, aux Plagioclases, et, chose digne de remarque, leur composition ne s'écarte en général guère de celle d'un Labrador plus ou moins basique. Le parfait état de fraîcheur de ces cristaux prouve qu'ils sont remarquablement réfractaires à l'action des agents chimiques de l'eau du fond des mers, ce qui est juste le contraire dans le cas des feldspaths potassiques : ces derniers sembleraient donc avoir été complètement dissous avant d'avoir pu arriver à la zone de sédiments où la Glauconie se forme. En effet, dans toutes les coupes étudiées nous n'avons observés qu'un ou deux cristaux pouvant se rapporter à l'Orthose, et encore ces derniers étaient-ils complètement kaolinisés. Le Mica aussi est fortement décomposé ; il perd toute biréfringence et prend un aspect terreux, et ne se reconnaît qu'à sa forme.

Depuis Murray et Renard les géologues sont à peu près tous d'accord pour admettre que les Feldspaths et les Micas potassiques fournissent, en se décomposant, la potasse nécessaire à la formation de la Glauconie; or, ces minéraux terrigènes ne pouvant être transportés jusqu'à la zone de la "Red Clay," on comprend alors que ces régions abyssales soient pauvres en potasse, et partant dépourvues de Glauconie.

Outre les espèces minérales énumérées plus haut, on en rencontre d'autres telles que Rutile et Hornblende, mais en proportion minime, et variant avec la nature des côtes voisines du gisement glauconieux.

Les matières minérales *secondaires* associées à la Glauconie sont surtout représentées par le Carbonate et le Phosphate de Chaux. Les fragments et particules de Calcite sont toujours dus à la destruction d'organismes calcaires; cela est indubitable dans le cas des gros fragments, où la structure organique est souvent reconnaissable, et quant aux particules, qui sont un des constituants des boues d'une part, et du ciment de certaines concrétions d'autre part, leur origine organique ne peut non plus faire l'objet d'aucun doute. En effet, du Carbonate de Chaux précipité chimiquement par des actions lentes prendrait une forme cristalline régulière, tandis que ces paillettes, examinées aux forts grossissements, montrent des formes irrégulières et déchiquetées.

Sans vouloir revenir ici sur la question du Phosphate de Chaux, nous tenons cependant à appuyer sur ce fait qu'il n'est jamais individualisé sous forme de cristaux; avec ou sans le concours de particules de Calcite, il sert de ciment aux minéraux détritiques et à la Glauconie englobés dans les concrétions phosphatées.

Enfin, nous pouvons placer la Pyrite parmi les minéraux secondaires accompagnant la Glauconie, mais comme elle s'y trouve fréquemment à l'état d'inclusions, nous développerons cette question dans le chapitre suivant.

Inclusions minérales.—Tous les minéraux caractéristiques du sédiment où la Glauconie a été recueillie peuvent se trouver au milieu de grains ou de moules de cette dernière à l'état d'inclusions.

Chez les moules les inclusions sont plutôt rares et naturellement

d'une taille ne dépassant pas le diamètre des orifices qui leur ont donné passage. Au contraire, chez les grains les inclusions de quartz, calcite, etc. peuvent avoir un volume qui dépasse quelquefois le quart de celui du grain même. Nous tenons spécialement à attirer l'attention sur ce fait, qui est un argument en faveur de l'explication que nous avons donnée touchant la formation des grains de Glauconie marine. Si, partant de la notion que cette dernière est engendrée dans les loges des Foraminifères, l'on trouve des inclusions trop volumineuses pour qu'il leur eût été possible de pénétrer dans ces loges, c'est que ces éléments étrangers auront été englobés en même temps que les fragments de moules par le ciment glauconieux que nous faisons intervenir dans le chapitre traitant de la genèse des grains. De telles inclusions sont assez fréquentes, et si l'on envisage leur origine comme nous venons de le faire, cela n'a rien que de très naturel, et prouve que la Glauconie peut fonctionner comme un ciment qui se fusionne sans traces de différenciation avec les éléments qu'il empâte. Ainsi, l'objection élevée par M. Gümbel, c.à.d. que les grains de Glauconie ne montrent rien dans leur structure rappelant un ciment ou des lignes de suture, doit donc tomber.

Comme il est inutile de redonner une description complète des diverses inclusions minérales, cela ayant déjà été fait par Murray et Renard pour la Glauconie marine, et par M. Cayeux pour la Glauconie sédimentaire, nous nous arrêterons seulement à celles que nous considérons comme les plus importantes. On sait que la Pyrite et la Magnétite se rencontrent parfois dans les grains et moules de Glauconie; la première est soit en cristaux bien définis, soit sous forme d'une poussière disséminée dans la Glauconie; dans ce dernier cas il est difficile de la reconnaître au moyen de sa couleur en lumière réfléchie, et pour la distinguer de la Magnétite nous avons utilisé l'inégale action des acides nitrique et chlorhydrique sur ces deux minéraux. Quant à la Magnétite, nous ne l'avons pas observée sous forme de cristaux; tous les exemples que nous en connaissons sont en petits amas informes.

Cette présence de minéraux essentiellement ferrugineux au sein de la Glauconie pourrait faire croire qu'il y a entre eux un rapport

de consanguinité et que l'un procède de l'autre ; toutefois nous pensons qu'il n'en n'est pas ainsi. En effet, quand la pyrite se présente sous forme de cristaux ces derniers ne présentent aucun exemple de corrosion ou digestion, et la Glauconie qui est en contact immédiat avec eux ne diffère en rien du reste de la masse, de sorte que si la Glauconie avait emprunté son fer à la Pyrite, elle devrait être plus foncée, plus biréfringente, etc., au voisinage de cette dernière qu'ailleurs. Le même raisonnement s'applique au cas de la Magnétite.

Une chose frappante est que ces inclusions de Pyrite et de Magnétite sont beaucoup plus fréquentes chez la Glauconie des terrains sédimentaires que chez la Glauconie actuelle, du moins en ce qui concerne les échantillons, très nombreux du reste, que nous avons eus entre les mains. Il nous semble que dans le cas de la Glauconie sédimentaire il faut admettre avec M. Cayeux que cette dernière, même au sein d'une roche consolidée, jouit d'une mobilité considérable qui permet l'introduction de ces minéraux. Pour ce qui est de la Glauconie actuelle on a affaire ou bien à de simples inclusions, ou bien, dans le cas où les cristaux de Pyrite sont bien délimités et ne paraissent pas avoir subi l'action des agents de transport, à une genèse simultanée de la Glauconie et de la Pyrite, ce qui confirmerait les vues de Murray et Renard sur le rôle du soufre dans la production de la Glauconie.

Décomposition de la Glauconie.—C'est un fait bien connu que sous certaines conditions mal connues la Glauconie est instable et se transforme en une matière ochreuse. Le manque de connaissances regardant la nature de l'eau des boues marines fait que l'on ne sait pas quel est l'agent auquel cette décomposition est due ; quant à la Glauconie des roches sédimentaires, dans certaines localités où elle se trouve en grande abondance, elle peut se décomposer sur une vaste échelle. En fait, deux monographies ont été écrites sur des gîtes de minerai de fer devant leur origine à cette cause. La première est celle de M. K. Glynka (17) sur certains gisements de Russie ; la seconde, due à M. Spurr (40), traite des roches ferrifères de la chaîne de Mesabi, Minnesota. Ces deux auteurs sont d'accord pour attribuer aux eaux telluriques l'action décomposante, mais sans spécifier quel est l'agent actif

qu'elles contiennent, bien que d'après une expérience de M. Glynka, de la Glauconie aie perdu, après avoir été plusieurs mois en contact avec de l'eau et de la neige : CaO , K^2O , MgO et Fe^2O^3 , le produit final étant une argile ferrugineuse (la Glauconie de M. Glynka différant beaucoup par sa composition de la Glauconie marine). Dans les cas étudiés par M. Spurr la décomposition va encore plus loin, le produit final étant des couches alternativement formées de silice et de limonite. Il semblerait donc ressortir de cela que la décomposition est surtout due à la perte de cet élément important : la potasse. Une chose qui prouve que les eaux doivent contenir un principe spécial pour opérer cette décomposition, c'est que la Glauconie se comporte à le point de vue d'une façon qui varie avec les localités où elle a été recueillie, cela aussi bien pour la Glauconie marine que pour la Glauconie des terrains sédimentaires. Ainsi la Glauconie analysée par nous et récoltée par le U.S.S. *Tuscarora* par $38^\circ 32'$ de lat. N. et $123^\circ 24'$ de long. W., est d'une fraîcheur parfaite, tandis que dans un échantillon de sable vert identique à tous les points de vue, dragué par $39^\circ 16'$ de lat. N. et $124^\circ 43'$ de long. W., la Glauconie montre de manifestes traces de décomposition, affectant presque tous les grains de l'échantillon.

Nous avons effleuré ce sujet pour être complet, mais, nous tenons à le répéter, on ne pourra en donner une explication satisfaisante que lorsqu'on aura obtenu et analysé l'eau même qui imprègne le sédiment.

III. COMPOSITION CHIMIQUE.

Comme on l'a reconnu depuis longtemps, la Glauconie est un silicate hydraté de fer et de potasse, contenant certaines quantités d'alumine, chaux, magnésie et soude.

De toutes les analyses citées par Gumbel, Dana, Hintze, Lacroix, etc., il n'y en a pas deux qui concordent ; cela provient évidemment du fait que la Glauconie ayant une densité variant de 2.2 à 2.8, il est pour ainsi dire presque impossible d'opérer sur un matériel vraiment pur, surtout exempt de Quartz. Dans le tableau ci-contre nous donnons le résultat de 8 analyses récentes qui sont bien loin de concorder entre-elles ; néanmoins elles valent la peine d'être discutées.

No.	SiO ²	Al ² O ³	Fe ² O ³	FeO	CaO	MgO	K ² O	Na ² O	H ² O	Total.	
1	56·62	12·54	15·63	1·18	1·69	2·49	2·52	0·90	6·84	100·41	} Glauconie des mers actuelles.
2	50·85	8·92	24·40	1·66	1·26	3·13	4·21	0·25	5·55	100·23	
3	51·80	8·67	24·21	1·54	1·27	3·04	3·86	0·25	5·68	100·32	
4	55·17	8·12	21·59	1·95	1·34	2·83	3·36	0·27	5·76	100·39	
5	27·74	13·02	39·93	1·76	1·19	4·62	0·95	0·62	10·85	100·68	
6	46·90	4·06	27·09	3·60	0·20	0·70	6·16	1·28	9·25	99·24	
7	40·00	13·00	16·81	10·17	1·97	1·97	8·21	2·16	6·19	100·48	} Glauconie des roches sédimentaires.
8	52·86	7·08	7·20	19·48	tr.	2·90	2·25	tr.	8·43	100·18	

No. 1-5, Analyses du *Challenger* (34). No. 6, Glauconie de l'Agulhas Bank, Gumbel (20). No. 7, Glauconie d'Antrim, Hoskins (23). No. 8, Glauconie de French Creek, Knerr et Schoenfeld in Dana (13).

Les six premières analyses ont été faites sur de la Glauconie des mers actuelles, les deux dernières sur de la Glauconie de roches sédimentaires.

Le matériel utilisé pour les analyses du *Challenger* était loin d'être pur ou plutôt homogène. Les moules glauconitiques des organismes calcaires sont de différentes couleurs, suivant l'état plus ou moins avancé de la formation de la Glauconie. Murray et Renard (34) ont distingué des moules blancs, gris, jaunes, vert pâle et vert foncé. À notre avis les moules blancs, gris, jaunes, vert pâle doivent être envisagés comme de la Glauconie en voie de formation, les moules vert foncé étant seuls formés par de la Glauconie typique.

Le No. 1 contenait :

- 65 % de moules blancs, gris et quelques jaunes.
- 20 % „ vert pâle.
- 11 % „ vert foncé.
- 14 % de minéraux et organismes siliceux.

Le No. 2 contenait :

- 15 % de moules blancs, gris et jaunes.
- 35 % „ vert pâle.
- 45 % „ vert foncé.
- 5 % de minéraux et organismes siliceux.

Le No. 3 contenait :

- 10 % de moules blancs, gris et jaunes.
- 25 % „ vert pâle.
- 60 % „ vert foncé.
- 5 % de minéraux et organismes siliceux.

Le No. 4 contenait :

- 30 % de moules blancs, gris et jaunes.
- 40 % „ vert pâle.
- 20 % „ vert foncé.
- 10 % de minéraux et organismes siliceux.

Aucune description du matériel du No. 5 n'est donnée, mais il était probablement composé de Glauconie décomposée, comme nous le verrons plus loin.

Les analyses du *Challenger*, spécialement le No. 1, montrent une forte teneur en Silice, sauf le No. 5, où nous avons probablement un cas de décomposition, et où, comme nous le verrons dans le chapitre de la décomposition, la Silice est balancée par une forte augmentation de fer ferrique.

Le fer ferreux dans ces analyses varie de 1·18 à 1·95, tandis que le fer ferrique varie de 15·63 à 39·93. Dans les deux analyses de Glauconie de roches sédimentaires la teneur du fer ferreux augmente considérablement et atteint 19·48 % dans le No. 8, et 10·17 % dans le No. 7, cette dernière analyse ayant été faite sur de la Glauconie triée et vert foncé.

Nous voyons donc une grande différence entre la composition de la Glauconie des mers actuelles et celle des roches sédimentaires.

Ayant eu la bonne fortune de rencontrer parmi les importantes collections du *Challenger* Office le plus pur échantillon de Glauconie actuelle qui ait jamais été trouvé, nous en avons fait une étude microscopique très détaillée, accompagnée d'une analyse quantitative. Ce matériel fut dragué en 1873 par le U.S.S. *Tuscarora* à une profondeur de 317 mètres au point lat. N. 38° 32', long. W. 123° 24'; il se composait de grains vert foncé sans aucune trace de décomposition, et de grains de Quartz qui ont été séparés au moyen d'un puissant électro-aimant.

L'analyse nous a donné les résultats suivants :

SiO ²	=	47·46 %
Fe ² O ³	=	30·83 %
Al ² O ³	=	1·53 %
FeO	=	3·10 %
MgO	=	2·41 %
K ² O	=	7·76 %
H ² O	=	7·00 %
		<hr/>
Total	=	100·09 %

L'analyse qui concorde le mieux avec la nôtre est celle de Gümbel (No. 6) ; la forte teneur en Silice et en Alumine des analyses du *Challenger* s'explique par le fait de la présence de moules blancs et gris dans la substance analysée, ces moules étant en grande partie constitués par de l'argile. La présence de CaO et de Na²O avait déjà été attribuée, avec raison, par plusieurs auteurs à des impuretés, ce que confirme notre analyse qui pourra désormais servir de type. *La Glauconie étant un minéral se formant aujourd'hui sur le fond des mers, ce n'est pas la Glauconie des roches sédimentaires, qui certainement a subi des transformations, qu'il faut étudier pour connaître la genèse de cet intéressant minéral.**

Dans leur intéressant travail, "Contribuciones al Estudio de la Glauconita" (6), MM. Calderon et Chaves donnent une synthèse de la Glauconie qui malheureusement est basée sur les résultats d'une analyse de Pisani, faite à un moment où dans la Glauconie on dosait tout le fer à l'état ferreux ; erreur due, comme l'a fait remarquer Gümbel (20) déjà en 1886, à la couleur verte de ce minéral.

La question de la synthèse de la Glauconie est donc loin d'être résolue, et c'est de la Glauconie actuelle qu'il faudra désormais partir et non de la Glauconie de roches sédimentaires comme l'ont fait MM. Calderon et Chaves. Nous aurons l'occasion de revenir sur cette synthèse dans un chapitre spécial.

IV. FORMATION DE LA GLAUCONIE.

Absence et présence de la Glauconie dans les dépôts marins.—
Avant d'attaquer le problème de la formation de la Glauconie

* Voir aussi Collet et Lee, *Comptes-Rendus Acad. Sciences, Paris*, Avril 1906.

nous voulons essayer de discuter l'absence ou la présence de ce minéral parmi les dépôts marins.

Comme nous l'avons vu précédemment, la Glauconie est généralement présente dans les Boues Bleues, mais ne peut, en aucune façon, en être considérée comme caractéristique.

Grâce à un travail de grande valeur de Murray et Irvine, intitulé "On the Chemical Changes which take place in the Composition of the Sea-water associated with Blue Muds on the Floor of the Ocean" (36), nous pouvons désormais comprendre que la Glauconie se rencontre en petite quantité dans les Boues Bleues.

D'après ces savants les réactions dont les Boues Bleues sont le théâtre sont les suivantes : la matière organique en décomposition réduit les sulfates, en solution dans l'eau de mer, en sulfures, qui sont subséquentement décomposés par l'anhydride carbonique précédemment formé ; ainsi le soufre de l'acide sulfurique présent comme sulfate de chaux ou de magnésie dans l'eau de mer est retiré et fixé dans la Boue à l'état de Sulfure de Fer (FeS), tandis que l'anhydride carbonique prend la place de l'acide sulfurique et une certaine quantité de Bicarbonate de Chaux est formé, proportionnellement au Soufre extrait de l'eau de mer.

Ces réactions, confirmées par des expériences de laboratoire, peuvent se représenter comme suit :

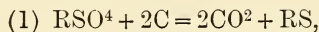

où R est un métal alcalino-terreux.

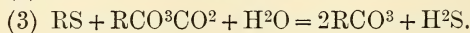
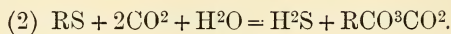

Cet Hydrogène sulfuré rencontrant de l'oxyde ferrique présent dans la couche superficielle de la Boue donnera lieu à la réaction suivante :

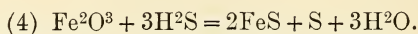

De cette façon une partie du Soufre est fixée dans la Boue comme sulfure de fer. S'il n'y a pas assez de fer dans la Boue pour fixer tout l'Hydrogène sulfuré formé en (3), ce dernier s'échappe dans l'eau de mer, et rencontrant de l'oxygène, s'oxydera pour donner de l'acide sulfurique et de là un sulfate (RSO⁴).

Dans la Mer Noire (33), où nous avons en quelque sorte une exagération des phénomènes se passant dans les Boues Bleues, nous ne trouvons aucune trace de Glauconie, tout le fer étant précipité à l'état de sulfure, l'Hydrogène sulfuré étant en excès sur ce dernier métal.

M. Chaves (9), continuant ses investigations synthétiques au sujet de la Glauconie, décrit dans une note intitulée "Contribuciones à la sintesis de los silicatos ferriferos por via humeda" les produits résultant de l'action durant vingt mois d'un silicate de soude sur du sulfure ferreux préparé artificiellement. Ce savant obtint : 1°, formation de cristaux de sulfate de soude ; 2°, dépôt de grains blancs insolubles dans l'eau, solubles dans l'acide nitrique en laissant un résidu blanc de silice pulvérulente ; la dissolution contenant du fer ; 3°, formation d'un dépôt gris verdâtre, pulvérulent, cristallin sous le microscope, soluble dans l'acide nitrique et offrant les mêmes propriétés que le précédent.

Ces expériences démontrent qu'on peut obtenir un silicate de fer en partant du sulfure et d'un silicate de soude, le sulfure de fer donc n'a pas même besoin d'être oxydé en sulfate pour être combinable à la silice.

Le sulfure de fer des Boues Bleues semble incapable de former du silicate de fer ; la silice en solution ne doit pas manquer, c'est donc l'Hydrogène sulfuré qui doit empêcher toute réaction entre le sulfure de fer et la silice en solution. Des expériences de laboratoire nous ont également montré que l'Hydrogène sulfuré empêche toute réaction entre le sulfate de fer et le silicate de potasse.

Dans les descriptions des dépôts du *Challenger* nous voyons que beaucoup de Boues Bleues contiennent des moules glauconitiques parfaits et d'autres en voie de formation. Dans la description du matériel de la station 167 (p. 87) nous relevons ce qui suit : "This deposit contains a great many Glauconite grains, which are mostly irregular in form, but would appear to have been at one time perfect casts of Foraminifera and other organisms. In some cases the transition can be traced by microscopic examination." Plus loin dans la description du matériel de la station 209 (p. 103) nous lisons : "This seems to be a green mud in process of formation."

Nous ne devons pas oublier qu'il n'y a pas de limite marquée entre les Boues Bleues et les Boues Vertes, et que les unes passent aux autres insensiblement comme du reste cela se produit pour tous les dépôts marins. Nous pourrions donc dire avec beaucoup de certitude *que la formation de la Glauconie dans les Boues Bleues dépend de la quantité de matière organique présente dans le dépôt et par là d'Hydrogène sulfuré.* La matière organique est-elle en faible quantité, le sulfure de fer devient combinable ou transformable en sulfate, et nous avons alors une Boue Verte avec grande quantité de moules glauconitiques et de grains de Glauconie.

La Glauconie est presque absente dans les Vases à Globigérines ; sur 118 échantillons du *Challenger*, 13 seulement contiennent ce minéral en de très faibles proportions, à l'exception des stations 140 et 166, où l'on approche du Continent. Parmi les analyses de Vases à Globigérines du *Challenger* nous en trouvons 5 seulement avec une relativement forte teneur en oxyde ferrique (variant de 6.16 % à 20.93 %) ; ce sont celles du matériel des stations 12, 16, 17, 293, 176, qui contiennent toutes des nodules de manganèse ou de la palagonite, ce qui nous prouve que le fer s'est déposé sous des conditions tout autres que dans le cas des Boues Bleues.

Comme l'ont fait remarquer Murray et Renard, on ne trouve pas de Glauconie dans les Boues Rouges des côtes du Brésil et de la Mer Jaune où la limonite amenée de l'intérieur des terres par l'Amazone, l'Orinoco et le Yang-tsé-Kiang est en quantité considérable. Ce fait de totale absence de Glauconie est très étonnant, car il y a certainement assez de matière organique dans ces Boues pour produire des réductions ; néanmoins nous ne pourrions expliquer d'une façon satisfaisante l'absence de la Glauconie dans ces dépôts *que lorsque nous pourrions étudier l'eau de mer associée aux dépôts marins, étude qui seule pourra nous renseigner sur les réactions chimiques qui ont lieu au fond de la mer.*

Nous saisissons l'occasion de recommander cette étude aux stations marines et aux expéditions futures en recherche de nouveautés ; le problème sera difficile, il faudra inventer de nouveaux appareils, mais les résultats récompenseront les efforts faits.

En résumé, nous pouvons dire que le fait de la présence ou de l'absence de la Glauconie dans les "dépôts terrigènes" est

intimement lié à la faible ou forte présence de matière organique ; cette dernière, comme nous l'avons vu, donnant lieu à d'importantes réactions. Les "dépôts pélagiques" ne contiennent pas de Glauconie parce qu'ils manquent d'un des constituants importants, la potasse.

La Glauconie est donc une caractéristique des dépôts terrigènes en général et des Boues Vertes et Sables Verts en particulier.

Formation de la Glauconie.—Depuis l'explication de la formation de la Glauconie, donnée par Murray et Renard dans le volume des "Deep-Sea Deposits" des Reports du *Challenger* (34), un seul travail traitant de la synthèse de ce minéral est venu enrichir la bibliographie. Il est dû à la plume autorisée de MM. Calderon et Chaves (6) de Madrid, et est intitulé "Contribuciones al Estudio de la Glauconita."

Comme nous l'avons déjà fait remarquer dans un précédent chapitre, ces savants se sont basés sur une analyse de Pisani de Glauconie de Villers sur Mer ; le fer fut dosé entièrement par cet analyste comme *fer ferreux*, comme du reste on le faisait à cette époque où l'on croyait, comme l'a fait remarquer Gumbel, que la couleur verte de la Glauconie impliquait du fer à l'état ferreux.

Basant malheureusement leurs ingénieuses recherches sur cette analyse de Pisani, MM. Calderon et Chaves réussirent à obtenir un silicate ferroso-potassique en faisant réagir du sulfate ferroso-potassique sur du silicate de potasse en présence d'un réducteur. Dans le silicate ainsi obtenu le rapport de l'oxyde ferreux à la silice était de 20·4 à 50·1, ce qui concordait avec l'analyse de Pisani, où ce rapport est de 20·1 à 54·1. Puis partant de l'idée que la Glauconie est un silicate ferroso-potassique nécessitant pour sa conservation l'influence d'un milieu réducteur, ces savants pensent que les agents réducteurs à la faveur desquels la Glauconie s'est formée sont d'une part la matière gélatineuse qui existe en suspension dans l'eau de mer, d'autre part la substance organisée qui existe dans les chambres de foraminifères et d'autres organismes.*

* "Ahora bien ; siendo la Glauconita un silicato de protoxido de origen submarino, necesita indispensablemente para su conservacion la influencia de un medio reductor, que podria ser la substancia sarcodica, mas propicia para seme jante papel que cualquiera otra, enya existencia, ademas, nos serias dificil imaginar. Creemos, por tanto, que la materia gelatinosa qui existe en suspension en las aguas, y sobre todo la substancia organizada misma que

Comme nous l'avons vu dans le chapitre traitant de la "Composition chimique," la Glauconie des mers actuelles doit être envisagée non comme un silicate ferroso-potassique *mais comme un silicate ferrico-potassique*. La belle synthèse de MM. Calderon et Chaves ne nous paraît pas être applicable au cas de la Glauconie des mers actuelles.

Revenons à l'explication donnée par Murray et Renard dans les Reports du *Challenger*: ces auteurs supposent que la matière organique renfermée dans la coquille ainsi que celle que contient la boue transforme l'oxyde de fer en sulfure. Ce sulfure peut être oxydé en hydrate, le soufre étant en même temps mis en liberté serait oxydé en acide sulfurique, que servira à décomposer la fine boue pour former de la silice colloïde. Cette silice pourra alors se combiner avec l'hydrate de fer pour former un silicate.

Une étude très approfondie des différentes espèces de moules recueillis par le *Challenger* nous ont amené à modifier légèrement cette explication fondamentale, en distinguant dans la formation de la Glauconie trois différentes phases :

1. Le premier stade dans la formation de la Glauconie est représenté par les moules gris, composés exclusivement d'argile, c.à.d. de silicate d'alumine.

2. Les diverses nuances de moules bruns représentent divers stades dans le remplacement de l'alumine de l'argile par le peroxyde de fer, comme une analyse faite sur des moules bruns nous l'a montré. En outre, ces moules—et nous attirons l'attention sur ce fait—*ne contiennent pas trace de potasse*. Donc le second stade est représenté par un silicate ferrique provenant d'une élimination progressive d'alumine et de son remplacement par de l'oxyde ferrique. Les moules brun clair contiennent encore de l'alumine, les moules bruns en contiennent très peu.

3. Le troisième stade est celui *de la glauconitisation*, si l'on nous passe ce mot, des moules brun foncé. En effet, nous avons décrit au chapitre des "Propriétés physiques" la marche de ce processus ; il nous reste maintenant à l'expliquer. Les vrais moules glauconitiques sont un silicate ferrico-potassique hydraté, tandis que

elanaba las camaras de los foraminiferos o las cavidades de otros pequenos seres provistos de esqueleto, hau sido, sire duda alguna, los agentes reductores a favor de los cuales se ha consolidado el silicato de protoxido de hierro y potasio."

les moules bruns, comme nous venons de le voir, ne contiennent pas de potasse. *La transformation en Glauconie est par conséquent connexe de l'introduction de la potasse et aussi probablement de l'entrée de l'eau de constitution.*

Tout ce qui vient d'être dit est basé sur des faits d'observation et non sur des vues de l'esprit. Quelles sont les réactions chimiques qui permettent à la potasse de se combiner au silicate ferrique? Nous ne pouvons actuellement que poser la question, car il serait oiseux de fatiguer le lecteur en donnant la liste des essais infructueux faits en vue de transformer des moules bruns en moules verts. Nous devons évidemment tenir compte du facteur *temps*, et peut-être *pression*?

Absence de la Glauconie dans les lacs.—Parmi les différents problèmes qui se présentent dans l'étude des dépôts marins et lacustres, celui de l'absence de la Glauconie dans les boues des lacs n'est pas un des moins intéressants.*

En effet, l'absence de ce minéral ne peut être attribuée ni à une raison bathymétrique, ni à une proportion insuffisante de fer, silice et potasse, ces éléments constitutifs de la Glauconie se trouvant dans l'eau des lacs.

Depuis les belles découvertes de Senft et de Julien, il nous semble que c'est à l'action des acides organiques (créniques, humiques, etc.) que nous devons faire appel.

Julien (25) a montré que des silicates étaient entièrement solubilisés sous forme de sels à radical acide complexe (silico-azo-humate, etc.) dans l'eau douce par l'action des dits acides organiques. Il crut pouvoir appliquer cette notion à la formation de la Glauconie (p. 363, *op. cit.*), mais comme l'ont montré Murray et Irvine (35) (p. 240, note), ces acides organiques une fois au contact avec l'eau de mer sont décomposés et précipités.

C'est à la présence des acides du groupe de l'acide humique, depuis longtemps reconnus dans l'eau des lacs, que l'absence de la Glauconie dans les dépôts lacustres nous semble devoir être attribuée.

Comme l'a montré Julien, dans les lacs le fer est soluble quand il est sous forme de silico-azo-humate ou de crénate *ferreux*. Une

* Cette absence de la glauconie dans les lacs est indiscutable depuis les travaux du *Lake Survey of Scotland*, entrepris sous la direction de Sir John Murray et L. Pullar.

oxydation vient-elle à se produire, le fer est précipité sous forme d'oxyde ferrique ou de limonite, avec production (p. 346, *op. cit.*) d'acide silico-azo-humique soluble et incombinaison avec l'oxyde ferrique précipité.

Le fer en solution dans l'eau, grâce à la présence des acides organiques, ne peut donc se combiner à la silice pour donner un silicate ferrique, étant par oxydation immédiatement précipité à l'état d'oxyde. Les dépôts ochreux du Loch Ness que nous avons eu l'occasion d'étudier nous paraissent devoir être attribués à cette cause.

V. LA GLAUCONIE ET LES CONCRÉTIONS PHOSPHATÉES.

Comme nous l'avons montré dans notre étude des "Concrétions phosphatées de l'Agulhas Bank" (11), la Glauconie est souvent associée aux concrétions phosphatées.

La Glauconie et les concrétions phosphatées se forment actuellement sur le fond des mers, existe-t-il une relation entre ces deux formations au point de vue de leur genèse? Cette question se pose naturellement quand on étudie les dépôts marins, et nous croyons être maintenant en mesure d'y répondre négativement.

Les concrétions phosphatées sont pour ainsi dire l'image du fond dans lequel on les rencontre, ce qui prouve bien leur formation in situ. Ce fond est-il un Sable Vert, comme dans le cas de l'Agulhas Bank, les concrétions phosphatées contiendront de la Glauconie en grande abondance; est-il une Boue à Globigérines formée non loin du continent mais en eau profonde (3475 mètres pour un des échantillons du *Challenger*), la concrétion sera entièrement formée de Globigérines avec minéraux détritiques mais sans Glauconie.

Comme le Dr Lee (11) l'a montré, la Glauconie apparaît dans les concrétions phosphatées sous deux états différents: 1°, à l'état de grains arrondis à contours tranchés qui font partie du nodule au même titre que le Quartz et les autres minéraux, c.à.d. ont été formés avant la formation du nodule; 2°, à l'état de pigment, ce dernier étant manifestement postérieur au dépôt des autres minéraux.

Cette Glauconie pigmentaire doit provenir d'un brassage du dépôt, brassage qui a occasionné la pulvérisation des grains de Glauconie. Ce brassage du fond peut être causé par un courant, c'est à dire qu'il n'est pas nécessaire de faire intervenir une force

très grande, car il ne faut pas oublier que la Glauconie actuelle s'écrase facilement sous l'ongle. La Glauconie ainsi pulvérisée en particules microscopiques peut être tenue en suspension dans l'eau, et les conditions de mouvement venant à s'arrêter elle pourra être précipitée sur le fond ou remplira des fissures de concrétions. Un excellent exemple de ce mode de formation nous est donné dans une des concrétions de l'Agulhas Bank (voir fig. 3 et p. 870, *op. cit.*), où nous voyons une ligne noire de $\frac{1}{2}$ mm. d'épaisseur qui n'est autre qu'un dépôt de Glauconie pigmentaire, comme l'ont prouvé nos dernières recherches.

Le Dr Collet (11) faisait remarquer l'an dernier que la partie brillante et non recouverte d'organismes des concrétions phosphatées devait se trouver dans la vase, tandis que la partie recouverte d'organismes et de couleur grise était exposée dans l'eau. Quelques unes d'entre les grosses concrétions des stations 11 et 12 étaient entièrement recouvertes d'organismes, ce qui prouverait non que ces grosses concrétions aient été changées de place sur le fond de la mer, *mais plutôt un changement dans le niveau du fond, changement qui peut provenir de l'action plus ou moins forte des courants.*

Les concrétions phosphatées de l'Agulhas Bank nous autorisent donc à admettre l'idée d'un brassage du fond ayant occasionné la pulvérisation de la Glauconie en grains.

M. Gosselet, dans son intéressant mémoire sur "La Sédimentation de la Craie" (18), fait remarquer que la couleur verte des bancs durcis et des galets est due à de la Glauconie. "Ce n'est pas, comme on pourrait le croire, un simple placage à la surface du calcaire. La Glauconie pénètre dans la roche jusqu'à une certaine profondeur," écrit ce dernier auteur.

Plus loin ce savant fait remarquer l'analogie de l'enveloppe glauconieuse avec le vernis brun phosphaté des nodules roulés de la craie dure dans la craie phosphatée, et admet que l'un et l'autre ont pris naissance pendant le roulis par les courants.

Il nous paraît exister une certaine relation entre l'enduit glauconitique des bancs durcis de M. Gosselet et la Glauconie pigmentaire de certaines concrétions phosphatées, Glauconie qui, comme nous l'avons démontré, est le résultat d'un brassage ou d'un roulis dû à des courants.

Nous ne voulons pas terminer ce chapitre sans relever cette phrase importante de M. Gosselet dans son mémoire sur les "Observations géologiques faites dans les Exploitations de Phosphate de Chaux" (19): "Or les couches de craie phosphatée sont au milieu de la craie blanche; elles alternent avec les couches de craie blanche, elles passent latéralement à la craie blanche. La conséquence logique est que la craie blanche n'est pas un dépôt de mer profonde. C'est une conclusion importante, si on songe que l'idée de voir dans la craie un dépôt de mer profonde, est un des arguments en faveur de l'instabilité des continents et contre la permanence des océans."

Nos études des concrétions phosphatées et de la Glauconie des mers actuelles nous permettent de confirmer les thèses de M. Cayeux (8) et de M. Gosselet sur la question si discutée de la formation de la Craie.

Des dépôts renfermant des concrétions phosphatées et de la Glauconie ne sont pas des dépôts de mer profonde.

VI. DISTRIBUTION DE LA GLAUCONIE DANS LES MERS ACTUELLES.

En 1856 Bailey, après une étude des échantillons collectés par le Comte Pourtales le long de la côte atlantique de l'Amérique du Nord, fut le premier à faire remarquer que la Glauconie se formait actuellement en plusieurs endroits sur le fond des mers actuelles.

De 1873 à 1876 le *Challenger* trouva de la Glauconie dans les dépôts de mers profondes (deep-sea deposits), et Murray et Renard (34), dans leur célèbre volume des "Reports" du *Challenger*, indiquèrent la répartition de cet intéressant minéral dans les dépôts des mers actuelles.

Nous trouvons en effet la Glauconie dans les Boues Bleues (Blue Muds), les Boues Vertes (Green Muds), les Sables Verts (Green Sands), qui appartiennent à ce que Murray et Renard ont appelé les Dépôts Terrigènes (Terrigenous Deposits) formés dans des eaux profondes en dehors de la ligne de 100 fathoms (183 mètres). La Glauconie fut également rencontrée dans les Boues à Globigérines, mais en faible quantité, car sur 118 échantillons du *Challenger* 13 seulement contenaient de la Glauconie.

(a) *Glauconie dans les Boues Bleues.*

Murray et Renard appelèrent Boue Bleue, un dépôt qu'on rencontre en eau profonde entourant le continent. La couleur bleue est due à la présence de matière organique et de sulfure de fer.

On trouve la *Glauconie* dans les Boues Bleues sous deux aspects différents : à l'état de moules (casts) d'organismes calcaires et à l'état de grains parmi les particules minérales.

La loi suivante peut être formulée : La *Glauconie* est généralement présente dans les Boues Bleues, *mais ne peut en aucune façon en être considérée comme caractéristique*, étant en quantité minime comparativement à celle des Boues Vertes et des Sables Verts.

Il serait trop long d'énumérer ici chaque point où la *Glauconie* a été trouvée dans des Boues Bleues, mais nous dirons néanmoins qu'elle fut rencontrée associée à des concrétions phosphatées dans les draguages du *Challenger* entre les îles Falkland et le Rio de la Plata. Ce minéral fut également trouvé à quatre stations différentes dans des Boues Bleues à proximité des glaces antarctiques (env. 65° S.), et Sir John Murray (32) écrivait en 1894 : "Its presence in the Blue Muds of the far south is therefore most suggestive of an Antarctic Continent."

Parmi les boues collectées par la récente expédition écossaise de la *Scotia* (39), la *Glauconie* est rare et se trouve seulement à l'état de moules de foraminifères.

Dans les échantillons de boues envoyées à Sir John Murray (33) par le Prof. N. Andrusson, collectées dans la Mer Noire par les expéditions russes en 1890 et 1891, *il n'y avait pas trace de Glauconie*.

Nous discuterons plus tard l'importante question de la présence et de l'absence de la *Glauconie* dans certains dépôts.

(b) *La Glauconie dans les Boues Vertes et les Sables Verts.*

La *Glauconie* en grains et en moules d'organismes calcaires est la matière caractéristique des Boues Vertes et des Sables Verts. On rencontre aussi dans ces dépôts une matière amorphe verte, organique car elle devient noire après avoir été chauffée sur la lame de platine et laissant ensuite une cendre colorée en brun par de l'oxyde de fer.

Les Sables Verts diffèrent des Boues Vertes par leur aspect granuleux, dû à une plus petite quantité de matière amorphe; généralement on les rencontre dans des eaux moins profondes que les boues. Le tableau suivant donne une idée de la différence qui existe entre les Boues Bleues, les Boues Vertes et les Sables Verts.

COMPOSITION MOYENNE DES BOUES BLEUES, DES BOUES ET SABLES VERTS.
D'APRÈS MURRAY ET RENARD.

		Boues Bleues.	Boues Vertes.	Sables Verts.	
Carbonate de Chaux.	{ Foraminifères péla- giques	7.52	14.59	21.00	
	{ Espèces vivant sur le fond	1.75	2.94	15.00	
	{ Autres organismes .	3.21	7.99	13.78	49.78
	12.48	25.52	8.00		
Résidu	{ Organismes siliceux .	3.27	13.67	8.00	
	{ Minéraux . . .	22.48	27.11	30.00	
	{ Partie fine (fine wash- ings)	61.77	33.70	12.22	50.22
	87.52	74.48	50.22		
		100.	100.	100.	

Les Boues Vertes et les Sables Verts sont presque toujours développés le long des côtes escarpées et exposées, où aucun grand fleuve n'apporte des matières détritiques dans la mer, à une profondeur n'excédant généralement pas 2000 mètres.

Quand il y a une grande quantité d'hydrate ferrique dans un dépôt, comme le long des côtes du Brésil, ou quand les dépôts sont principalement formés d'éléments détritiques fluviaux, la Glauconie est généralement absente ou très rare.

Depuis l'expédition du *Challenger*, presque toutes les collections de dépôts rapportées par les expéditions ou les bateaux de différents Services ont été examinées au *Challenger* Office, sous la direction de Sir John Murray, par MM. James Chumley et Robert Dykes; il nous paraît utile de dire quelques mots sur la distribution actuelle des Boues Vertes et des Sables Verts, attendu que nous disposons de documents entièrement inédits.

Océan Atlantique Nord.

1873. Le *Challenger* (34) trouva des Boues Vertes et des Sables Verts le long des côtes du Portugal et de l'Espagne du

point lat. $38^{\circ} 31' N.$, long. $9^{\circ} 31' W.$, au point lat. $36^{\circ} 25' N.$, long. $8^{\circ} 12' W.$ Ils proviennent, sauf deux exceptions, de profondeurs inférieures à 1000 fathoms (1830 mètres).

1880. Les mêmes formations furent rencontrées par le U.S. Coast Survey Steamer *Blake* (1) le long de la côte des Etats Unis entre le Cap Hatteras et la latitude $31^{\circ} 48' N.$, à une profondeur variant de 91 à 183 mètres ; c'est à dire sur le bord continental du Gulf Stream sur la ligne de séparation entre les sables siliceux et les fonds calcaires, à l'endroit où le courant était le moins rapide.

Ça et là ces mêmes Sables Verts furent dragués en eau plus profonde sous le courant même. Nous trouvons associés avec ces dépôts des nodules de manganèse et des concrétions phosphatées. Un autre gisement fut trouvé par le *Blake* au point lat. $21^{\circ} 2' N.$, long. $74^{\circ} 44' W.$, devant Cayo de Moa, à une profondeur de 2842 mètres.

1883. Le S.S. *Dacia*, croisant dans l'Atlantique Nord, dragua ces mêmes dépôts au point lat. $31^{\circ} 48' 30'' N.$, long. $10^{\circ} 5' W.$, par 400 mètres.

1886. Le S.S. *Buccaneer* trouva des Sables Verts le long de la côte occidentale de l'Afrique aux points suivants : lat. $6^{\circ} 9' N.$, long. $10^{\circ} 55' W.$, par 82 mètres ; et lat. $5^{\circ} 5' 6'' N.$, long. $4^{\circ} 00' 7'' W.$, par 121 mètres.

Océan Indien.

1887. Comparativement aux autres océans, l'Océan Indien a été étudié beaucoup plus tard, et les premières collections de dépôts furent faites par le Capitaine J. P. Maclear, R.N., à bord de H.M.S. *Flying Fish* (29). Des Boues Vertes et Sables Verts furent collectés aux points suivants :

Prof.	Lat. S.	Long. E.
631 m.	$10^{\circ} 42'$	$124^{\circ} 52'$
1500 m.	$10^{\circ} 33'$	$124^{\circ} 13'$
1027 m.	$11^{\circ} 7'$	$121^{\circ} 52'$
1531 m.	$11^{\circ} 5'$	$121^{\circ} 50'$
2652 m.	$7^{\circ} 3'$	$103^{\circ} 1'$
3512 m.	$7^{\circ} 3'$	$102^{\circ} 1'$

1889. En cette année de nombreuses adjonctions furent faites à nos connaissances des dépôts de cet Océan par les collections rapportées par le Capitaine Pelham Aldrich du H.M.S. *Egeria* (30), et par le Capitaine A. Carpenter du H.M.S. *Investigator*. Les collections de dépôts faites à bord des bateaux posant des câbles le long de la côte orientale d'Afrique ont été également étudiées au *Challenger* Office, et nous pouvons maintenant donner une idée assez juste de la distribution des dépôts à Glauconie dans cet Océan en disant qu'on les rencontre le long de la côte E. d'Afrique, le long des côtes W. et S. d'Australie, à une profondeur généralement inférieure à 1830 mètres (1000 fathoms).

Agulhas Bank.

1873. La Glauconie est très remarquablement représentée dans les dépôts de l'Agulhas Bank, comme cela a été démontré par Murray et Renard.

1875. L'expédition allemande de la *Gazelle* rencontra les mêmes formations sur ce même point.

1898-99. L'expédition récente de la *Valdivia* rapporta de l'Agulhas Bank des Sables Verts et des concrétions phosphatées.

L'an dernier nous avons décrit une importante collection de Concrétions phosphatées provenant de dépôts dragués sur l'Agulhas Bank par les bateaux du "Department of Agriculture of the Cape of Good Hope," prouvant que la Glauconie et les concrétions phosphatées sont également distribuées sur toute l'étendue du banc en dehors de la ligne de 100 fathoms (183 mètres).

Océan Pacifique.

1873. Le Commandant Geo. E. Belknap trouva des Boues Vertes et des Sables Verts tandis qu'il étudiait la côte W. de l'Amérique du Nord à bord du U.S.S. *Tuscarora*. Les collections furent envoyées à Sir John Murray et furent étudiées à nouveau de 1899-1901 au *Challenger* Office. Parmi ces collections nous trouvons 4 échantillons de Boues Vertes et 26 échantillons de Sables Verts provenant de 30 stations différentes du point lat. 44° 54' N., long. 125° 13' W., au point lat. 32° N., long. 118° 26' W., à des profondeurs inférieures à 1830 mètres.

PLATE I.

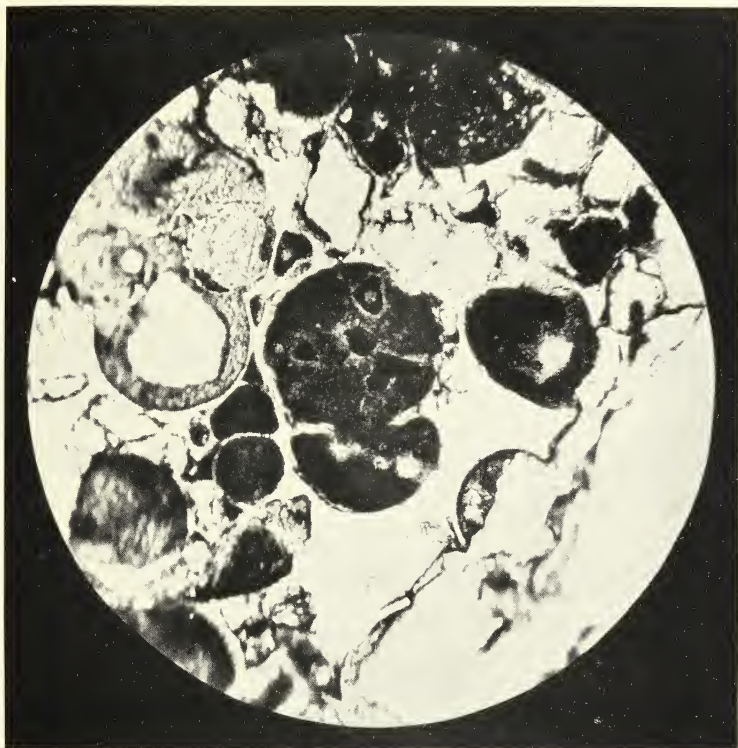

Sable vert recueilli par le *Challenger* à la Station 154 par 750 m. Le centre de la figure est occupé par un moule glauconitique contenant des inclusions opaques.

PLATE II.

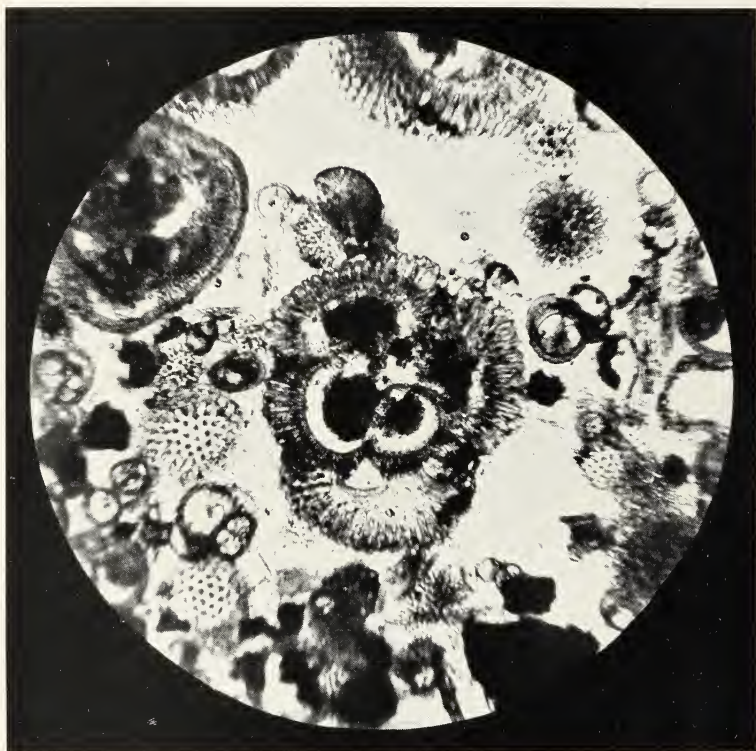

Boue à Globigérines provenant de la Station 176 (*Challenger*). La coquille occupant le centre de la figure est en partie remplie par une matière argileuse brune, et constitue un moule imparfait.

PLATE III.

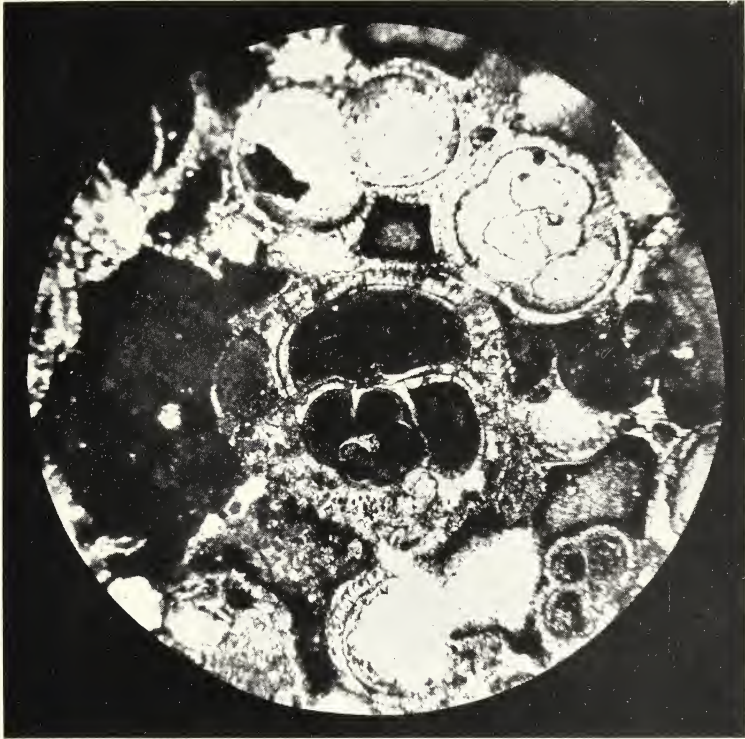

Le moule occupant le centre de la figure est brun foncé, mais ses contours, c.à.d. la partie en contact avec la coquille, montrent un mince liseré de Glauconie. En outre les taches noires qui criblent la calcite de la coquille, sont vertes en lumière naturelle et sont formées de Glauconie typique. (Station 164.)

PLATE IV.

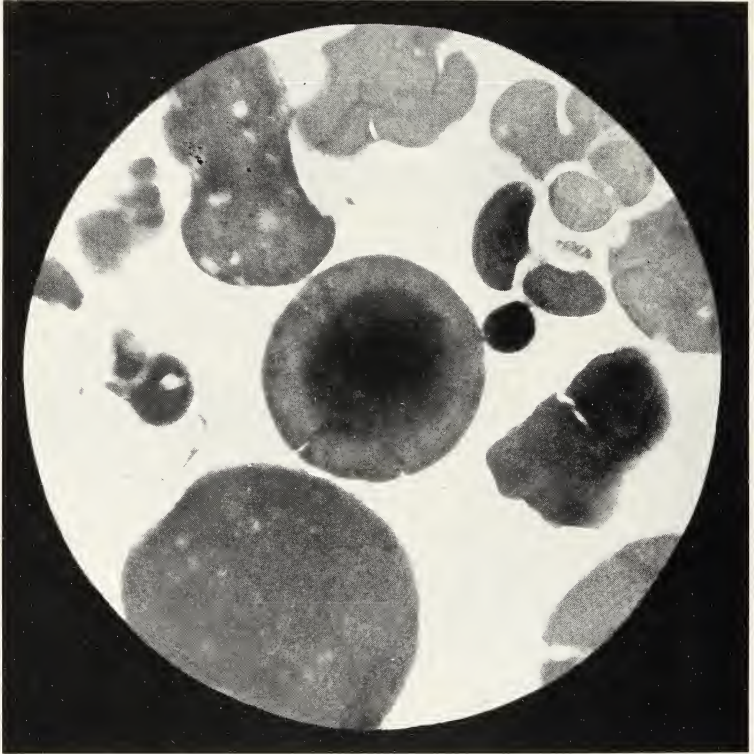

Moules glauconitiques lavés à l'acide. Celui du centre de la figure contient encore un noyau brun de silicate de fer amorphe ; les autres sont parfaits, et certains d'entre eux renferment des inclusions de quartz et autres minéraux (Station 164, *Challenger*.)

PLATE V.



Dans cette coquille (grossissement = 74 diam.) les loges de couleur claire sont glauconitiques, tandis que les autres, brun-foncé, ne montrent pas encore de transformation en Glauconie. Ce moule est contenu dans un nodule phosphaté de l'Agulhas Bank.

PLATE VI.



Nodule phosphaté dont le ciment est teinté en vert-clair par de la Glauconie pigmentaire. La calcite de la coquille au centre de la figure a disparu, remplacée par de la Glauconie épigénique.

PLATE VII.

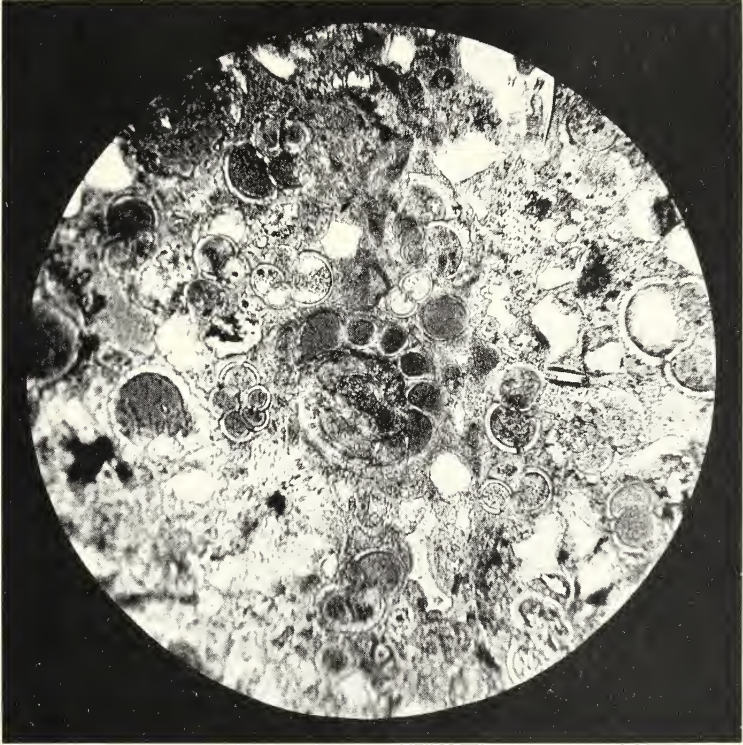

Nodule phosphaté. La ciment est teinté en vert par de la Glauconie pigmentaire et se propage à l'intérieur de coquilles de Foraminifères, constituant ainsi de faux moules.

PLATE VIII.

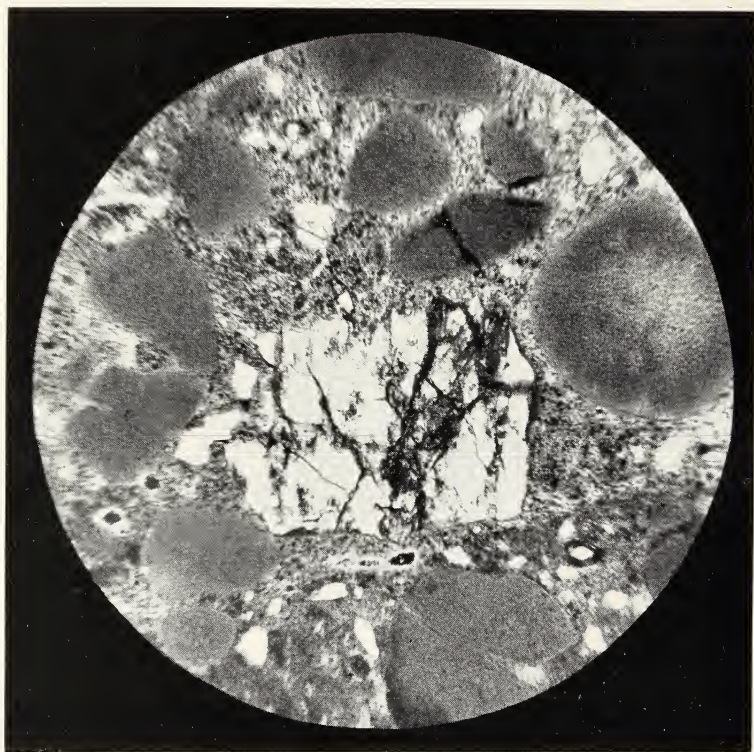

Exemple de Glauconie épigénisant un grain de quartz, au sein d'un nodule phosphaté.

PLATE IX.

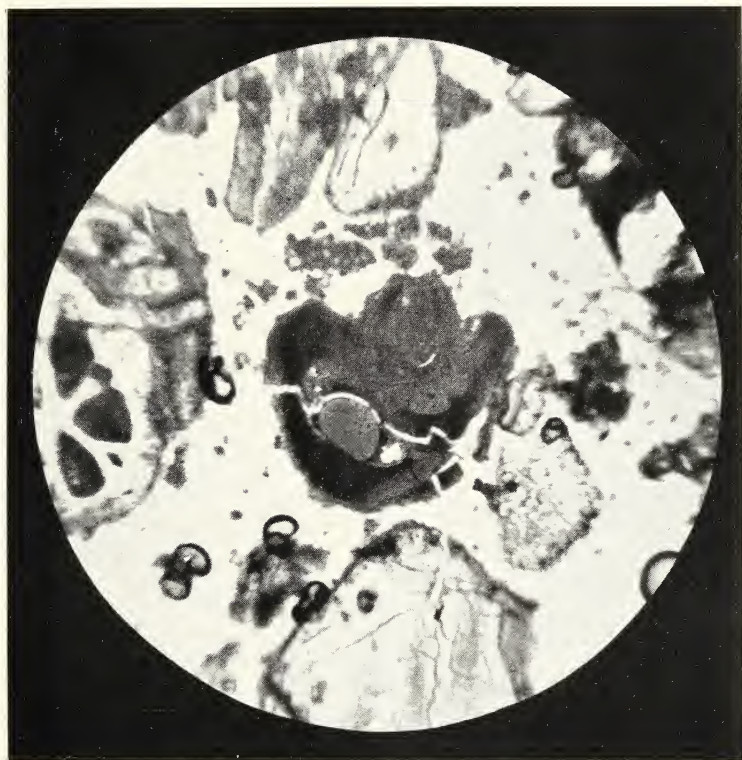

Au centre de la figure, section de coquille dont la calcite est pseudomorphosée par une matière ferrugineuse amorphe.

PLATE X.

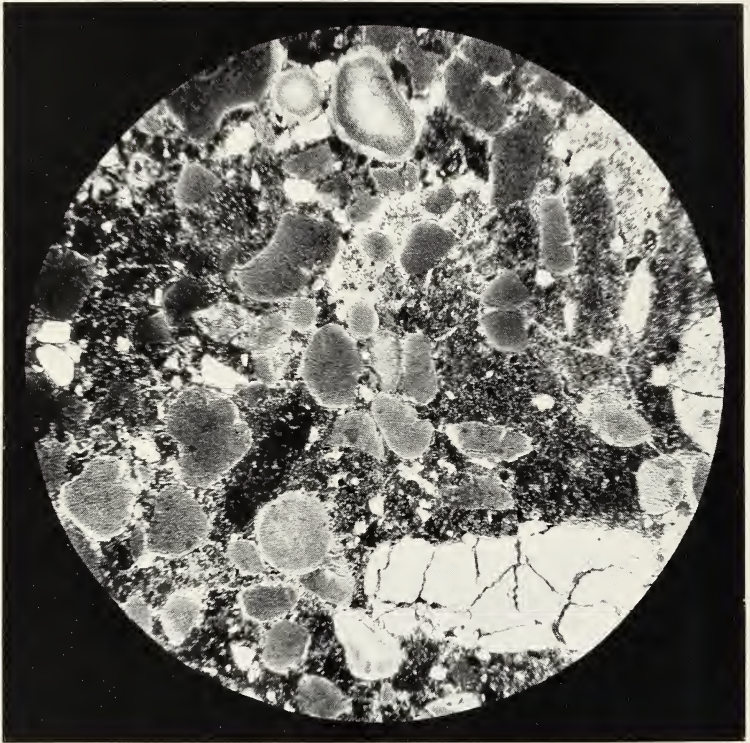

Aspect général des grains de Glaucopine dans un nodule phosphaté.

PLATE XI.



Nodule phosphaté. Grain de Glauconie à centre plus pâle que la masse générale, et entouré d'une zone externe isotrope.

PLATE XII.



Exemple de différenciation chez la Glauconie. La partie interne du grain au centre de la figure est cryptocristalline, tandis que la zone externe est fibro-radiée et a une orientation optique unique. Crétacé d'Antrim (Irlande).

Trois échantillons provenant des stations suivantes sont particulièrement intéressants :

57.	69 - Prof. 774 m.	Lat., 39° 02' N.,	long., 124° 09' W.
"	70 - ,, 232 m.	,, 39° N.,	,, 124° W.
"	72 - ,, 317 m.	,, 38° 32' N.,	,, 123° 24' W.

Ils sont presque totalement composés de grains de Glauconie avec quelques foraminifères et quelques minéraux, spécialement du Quartz. Sans aucun doute ce sont les spécimens les plus purs de Sables Verts qui aient été jamais trouvés, s'ils se trouvent bien à l'état dans lequel ils furent dragués; il se pourrait que les échantillons aient été passés au tamis avant d'avoir été envoyés. Quoiqu'il en soit, ce matériel étant si pur nous en avons fait une étude très détaillée, comme on le verra plus loin.

1874. Le *Challenger* dragua des Sables Verts devant Sydney à 6 stations différentes. Puis il rencontra les mêmes formations entre Cape York et Arrou Island aux points suivants :

Lat. 9° 36' S.,	long. 137° 50' E.
,, 8° 56' S.,	,, 136° 5' E.

De Arrou Island au Japon des Boues Vertes furent collectées à une station dans la mer d'Arafura et à 2 stations aux points suivants :

Lat. 5° 41' S.,	long. 134° 4' 3" E.
,, 5° 26' S.,	,, 133° 19' E.

entre Arrou Island et Banda. De Samboangan à Mauille à 3 stations :

Lat. 12° 43' N.,	long. 122° 9' E.
,, 12° 46' N.,	,, 122° 10' E.
,, 9° 26' N.,	,, 123° 45' E.

les mêmes dépôts furent dragués.

Le long de la côte du Japon, la Glauconie fut trouvée dans les Boues Vertes à 4 stations et pour la dernière fois dans le Pacifique par le *Challenger*, car la Glauconie n'a jamais été trouvée dans les grands fonds au milieu de cet Océan.

1878. Le U.S.S. *Tuscarora* trouva de nouveau la Glauconie à une station lat. 23° 35' N., long. 111° 57' W., par 908 mètres.

1882-83. Le U.S.S. *Enterprise* rencontra ces mêmes dépôts près la Chatham Island dans le Sud.

1889. Lorsque A. Agassiz (2) étudiait la côte W. de l'Amérique du Nord à bord de U.S.S. *Albatross*, il dragua des Boues Vertes avec de nombreux moules de Glauconie au point lat. $31^{\circ} 3' 30''$ N., long. $117^{\circ} 40' 15''$ W., par 1566 mètres. Ce nouveau point situé entre les deux sondages extrêmes sud du *Tuscarora*, semble montrer que les Sables Verts s'étendent sur la côte W. de l'Amérique du Nord de la lat. $44^{\circ} 54'$ à la lat. $23^{\circ} 35'$ N.

1891. Etudiant la côte W. de l'Amérique Centrale, A. Agassiz, toujours à bord de l'*Albatross*, trouva 2 gisements de Sables Verts devant Mariato Point, non loin de la côte aux points suivants : lat. $6^{\circ} 35'$ N., long. $81^{\circ} 44'$ W., par 914 mètres ; et lat. $6^{\circ} 30'$ N., long. $81^{\circ} 44'$ W., par 1280 mètres.

1896. Le H.M.S *Dart* dragua de semblables formations sur la côte E. d'Australie aux points suivants : lat. $23^{\circ} 6' 30''$ S., long. $152^{\circ} 16' 30''$ E., par 145 mètres ; et lat. $23^{\circ} 9' 40''$ S., long. $152^{\circ} 19'$ E., par 165 mètres.

1901. Le S.S. *Britannia* dragua des Boues Vertes à 2 stations au nord de la Nouvelle Zélande : lat. $34^{\circ} 36' 32''$ S., long. $173^{\circ} 35' 37''$ E., par 329 mètres ; et lat. $54^{\circ} 31' 42''$ S., long. $173^{\circ} 34' 30''$ E., par 307 mètres.

1904. Comme les échantillons de Sables Verts collectés en 1891 par A. Agassiz (3) à bord de l'*Albatross* furent perdus, deux draguages furent faits sensiblement aux mêmes points, et les Sables Verts furent retrouvés.

Pour être complet il nous faut citer les localités où le U.S.S. *Nero* (16) trouva des Boues Vertes, tandis qu'il étudiait la route pour la pose d'un câble entre les Etats Unis, les Philippines et le Japon. Plusieurs des déterminations comme Boues Vertes du *Nero* nous paraissent être en désaccord avec la description type donnée par Murray et Renard, et nous semblent devoir être attribuées à des Boues Bleues.

Ces dépôts furent dragués à Dingola Bay (Luzon) à 14 stations différentes à des profondeurs variant de 188 mètres à 4272 mètres? Devant Yokohama, à 21 stations différentes ; toutes, sauf 5, en dessous de 1800 mètres. Ces dernières localités se rapprochent de celles où le *Challenger* en 1874 dragua les mêmes formations.

Méditerranée.

D'après Sir John Murray (31) la Glauconie a été trouvée à de grandes profondeurs dans la Méditerranée à l'état de grains et de moules de foraminifères.

En 1901 S.A.S. le Prince de Monaco, à bord de la *Princesse Alice*, dragua devant la côte du Maroc à la station suivante : lat. 33° 59' 30" N., long. 10° 33' W., par 851 mètres, ce que le Prof. Thoulet appelle : Vase sableuse très calcaire glauconieuse.

Aujourd'hui d'après ce que nous savons nous pouvons dire que la Glauconie est représentée en grande quantité dans ce que Murray et Renard ont appelé les Boues Vertes et les Sables Verts, et dans les localités suivantes : le long des côtes de la Caroline et de la Floride sur les bords des Boues Bleues ; le long des côtes du Portugal et de l'Espagne ; le long des côtes S. et E. d'Afrique ; le long des côtes W., S. et E. d'Australie ; dans quelques mers de l'Archipel Indien ; le long de la côte E. du Japon ; le long de la côte W. de l'Amérique du Nord ; le long de la côte W. de Chatham Island ; en quelques points sur la côte W. d'Afrique.

"CHALLENGER" OFFICE,
EDINBURGH, Mai 1906.

LISTE DES OUVRAGES CONSULTÉS.

(1) AGASSIZ, ALEXANDER, "Three Cruises of the *Blake*," *Bull. Mus. Comp. Zool., Cambridge, U.S.A.*, vol. xiv., 1888.

(2) AGASSIZ, ALEXANDER, "General Sketch of the Expedition of the *Albatross* from February to May 1891," *Bull. Mus. Comp. Zool., Cambridge, U.S.A.*, vol. xxiii., No. 1, 1892.

(3) AGASSIZ, ALEXANDER, "On the Progress of the *Albatross* Expedition to the Eastern Pacific," *Am. Jour. of Scien.*, vol. xix., Feb. 1905.

(4) BAILEY, J., "On the Origin of Greensand and its Formation in the Oceans of the Present Epoch," *Am. Jour. Sc.*, 2^{ième} S., vol. xxii., 1856 ; et *Proc. Boston Soc. of Nat. Hist.*, vol. v., 1856.

(5) BISCHOF, G., *Elements of Chemical and Physical Geology*, vol. iii., 1859.

(6) CALDERON, S., et CHAVES, F., "Contribuciones al Estudio de la Glauconita," *An. Soc. espan. de Hist. Nat.*, vol. xxiii., t. iii., Madrid, 1894.

(7) CAYEUX, L., "Notes sur la Glauconie," *An. Soc. Géol. Nord.* t. xx. p. 380, Lille, 1892.

(8) CAYEUX, L., *Contribution à l'Etude micrographique des Terrains sédimentaires*, Lille, 1897.

(9) CHAVES, F., "Contribuciones a la Sintesis de los Silicatos ferriferos por via humeda," *An. Soc. espan. de Hist. Nat.*, vol. xxiv., Actas, p. 157, Madrid, 1895.

(10) CHAVES, F., "Estudio sobre las pseudomorfosis de proceso químico," *An. Soc. espan. de Hist. Nat.*, t. xxviii., Madrid, 1899.

(11) COLLET, L. W., et LEE, G. W., "Les Concrétions phosphatées de l'Agulhas Bank, avec une note sur la Glauconie qu'elles contiennent," *Proc. Roy. Soc. Edin.*, vol. xxv., part x., 1905.

(12) CORSE and BASKERVILLE, *Am. Ch. J.*, xiv. 627, 1892.

(13) DANA, *The System of Mineralogy*, sixth edition.

(14) DANA, First Appendix of the sixth edition of Dana's *System of Mineralogy*.

(15) DELESSE, *Lithologie des Mers de France et des Mers principales du Globe*, Paris, 1871.

(16) FLINT, J. M., "A Contribution to the Oceanography of the Pacific," *Bull. U.S. National Mus.*, No. 55, Washington, 1905.

(17) GLYNKA, K., *Der Glaukonit, seine Entstehung, sein chemischer Bestand und die Art und Weise seiner Verwitterung*, St Pétersbourg, 1896.

(18) GOSSELET, J., "Observations sur la sédimentation de la Craie," *An. Soc. Géol. Nord.*, t. xxxi., p. 63, Lille, 1902.

(19) GOSSELET, J., "Observations géologiques faites dans les exploitations de phosphate de chaux en 1901," *An. Soc. Géol. Nord.*, t. xxx. p. 208, Lille, 1901.

(20) GÜMBEL, V., "Ueber de Natur und Bildungsweise des Glaukonits," *Sitz. d. Math. Phys. Clas. d. k. Akad. Wiss. München*, 1886.

(21) GÜMBEL, V., "Ueber die Grünerde von Monte Baldo," *Sitz. Ber. A. K. München*, xxvi. 545, 1896.

(22) HEDDLE, "Chapters on the Mineralogy of Scotland," *Trans. Roy. Soc. Edin.*, vol. xxix., part i., 1878-79.

(23) HOSKINS, A. PERCY, "On Glauconite from Antrim," *Geol. Mag.*, July 1895.

(24) IRVING, A., "Organic Matter as a Geological Agent," *Proc. Geol. Assoc.*, vol. xii., 1892.

(25) JULIEN, A., "On the Geological Action of the Humus Acids," *Proc. Amer. Assoc. Adv. of Sc.*, vol. xxviii., 1879.

(26) LACROIX, A., *Minéralogie de la France et de ses colonies*, 1893.

(27) MURRAY, JOHN, "Report on the Specimens of Bottom Deposits," *Bull. Mus. Comp. Zool., Cambridge, U.S.A.*, vol. xii., No. 2, 1885.

(28) MURRAY, JOHN, "On Seas and Estuaries about North Britain," *Phil. Soc. Glasgow*, 1886.

(29) MURRAY, JOHN, "On some Recent Deep-Sea Observations in the Indian Ocean," *Scot. Geog. Mag.*, Nov. 1887.

(30) MURRAY, JOHN, "On Marine Deposits in the Indian, Southern, and Antarctic Oceans," *Scot. Geog. Mag.*, Aug. 1889.

(31) MURRAY, JOHN, "The Maltese Islands, with special reference to their Geological Structure," *Scot. Geog. Mag.*, vol. vi. p. 449, 1890.

(32) MURRAY, JOHN, "The Renewal of an Antarctic Exploration," *Geog. Jour.*, Jan. 1894.

(33) MURRAY, JOHN, "On the Deposits of the Black Sea," *Scot. Geog. Mag.*, Dec. 1900.

(34) MURRAY and RENARD, *Deep-Sea Deposits. Challenger Reports*, 1891.

(35) MURRAY, JOHN, and IRVINE, ROBERT, "On Silica and Siliceous Remains of Organisms in Modern Seas," *Proc. Roy. Soc. Edin.*, vol. xviii., 1891.

(36) MURRAY, JOHN, and IRVINE, ROBERT, "On the Chemical Changes which take place in the Composition of the Sea-water associated with Blue Muds on the Floor of the Ocean," *Trans. Roy. Soc. Edin.*, vol. xxxvii., part ii., 1893.

(37) NATTERER, C., "Chemisch-geologische Tiefsee Forschung," *Geog. Zeit.*, V. Jahrg., Leipzig, 1899.

(38) PEAKE, R. E., and MURRAY, SIR JOHN, "Deep-Sea Sounding Expedition in the North Atlantic during the Summer of 1899," Supp. Paper of the *Geog. Jour.*, 1901.

(39) PIRIE, J. H. HARVEY, "Deep-Sea Deposits of the South Atlantic Ocean and Weddell Sea," *Scot. Geog. Mag.*, vol. xxi., 1905.

(40) SPURR, J. E., "The Iron-bearing Rocks of the Mesabi Range," *Geol. and Nat. Hist. Surv. of Minnesota*, Bull. No. X., Minneapolis, 1894.

(41) TIZARD and MURRAY, JOHN, "Exploration of the Faroe Channel during the Summer of 1880 in H.M.S. hired ship *Knight Errant*," *Proc. Roy. Soc. Edin.*, May 1882.

(42) THOULET, J., *Echantillons d'eaux et de fonds provenant des campagnes de la "Princesse-Alice."* *Camp. Prince Albert I^{er}*, fas. xxii., Monaco, 1902.

(43) ZIRKEL, *Lehrbuch der Petrographie*, 1894.

(*Issued separately August 30, 1906.*)

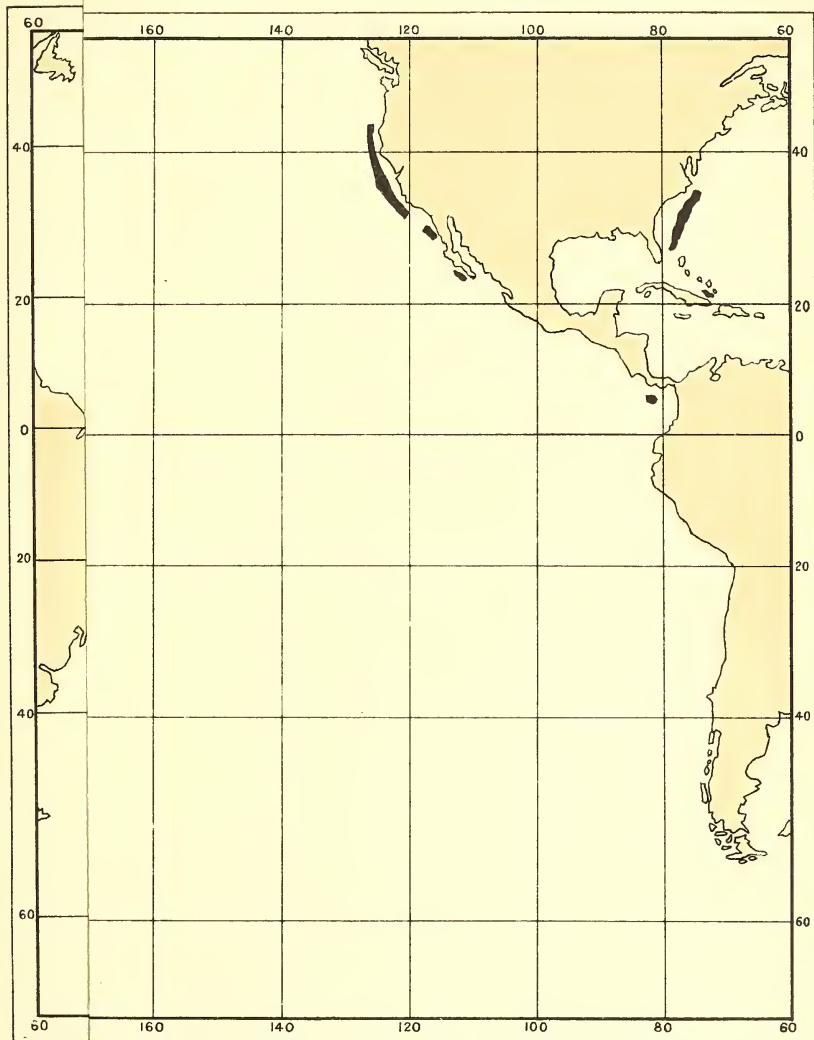

L. W. Collet et G. W. Lee.

DISTRIBUTION DE LA GLAUCONIE.



Boues Vertes et Sables Verts 

L. W. Collet et G. W. Lee

Notes:— 1. On a Human Skeleton, with Prehistoric Objects, found at Great Casterton, Rutland. 2: On a Stone Cist containing a Skeleton and an Urn, found at Largs, Ayrshire. By Dr Robert Munro. With a Report on the Urn, by the Hon. John Abercromby; and on the Skulls, by Professor D. J. Cunningham.

(Read March 19, 1906. MS. received May 18, 1906.)

I. The following is an extract from a letter dated November 18th, 1905, which I received from V. B. Crowther-Beynon, Esq., F.S.A., Hon. Secretary of the Rutland Archæological and Natural History Society:—"I should be most sincerely grateful to you if you could give me the benefit of your opinion on the skull of which I send some photos (fig. 1). I have been comparing it with those illustrated in your 'Fossil Man' chapter in *Prehistoric Problems*, and it seems to me that it is not without interest. I am no craniologist or anatomist, and can bring no scientific knowledge of that kind to bear on the matter."

In replying to Mr Crowther-Beynon's letter, I stated that it would be impossible to form an opinion having any scientific value from photos alone; but that, if he sent the skull to Edinburgh, Dr Cunningham, Professor of Anatomy in the University of Edinburgh, who makes a special study of physical anthropology, would examine the specimen and report on its special characteristics. Along with the skull, my correspondent sent the following graphic and lucid account of the position and circumstances in which the specimen was found, as well as of the objects supposed to have been associated with it:—

"In August 1905, some quarrymen in the employ of Mr Woolston of Stamford at a freestone quarry situated at Great Casterton, on the extreme eastern border of Rutland, struck into a fissure or swallow-hole ('gull' in the local phraseology) in the rock which was filled with clay. In the course of removing the clay a discovery of human bones was made at a depth of about 17 feet 6 inches from the original surface-level. The fissure was

funnel-shaped, narrowing to some 20 inches at the point where the skeleton lay (see Section, fig. 2), and the clay was set hard, a fact which rendered the removal of the bones a matter of difficulty. Unfortunately the find was not reported at once, and consequently there is an absence of any accurate notes either as to the exact disposition of the skeleton in the fissure, or the attendant circumstances generally. It would appear, however, that the body lay on the back, with the limbs in a contracted position above,—the appearance being that of a body which had become



FIG. 1.—Skull and Stone Axe.

jammed, by its fall, in the narrow space of the fissure. Before the bones were all extracted the mass of hardened clay enclosed by the sides of the fissure suddenly fell, some of the men having a narrow escape of being crushed by the downfall. It was in this mass of fallen material that the worked objects described later on were found, and it will be obvious, therefore, that it is difficult to state accurately where and at what level in the fissure the various relics had lain before the fall of the clay, so that we are thus deprived of valuable evidence as to their association with the skeleton.

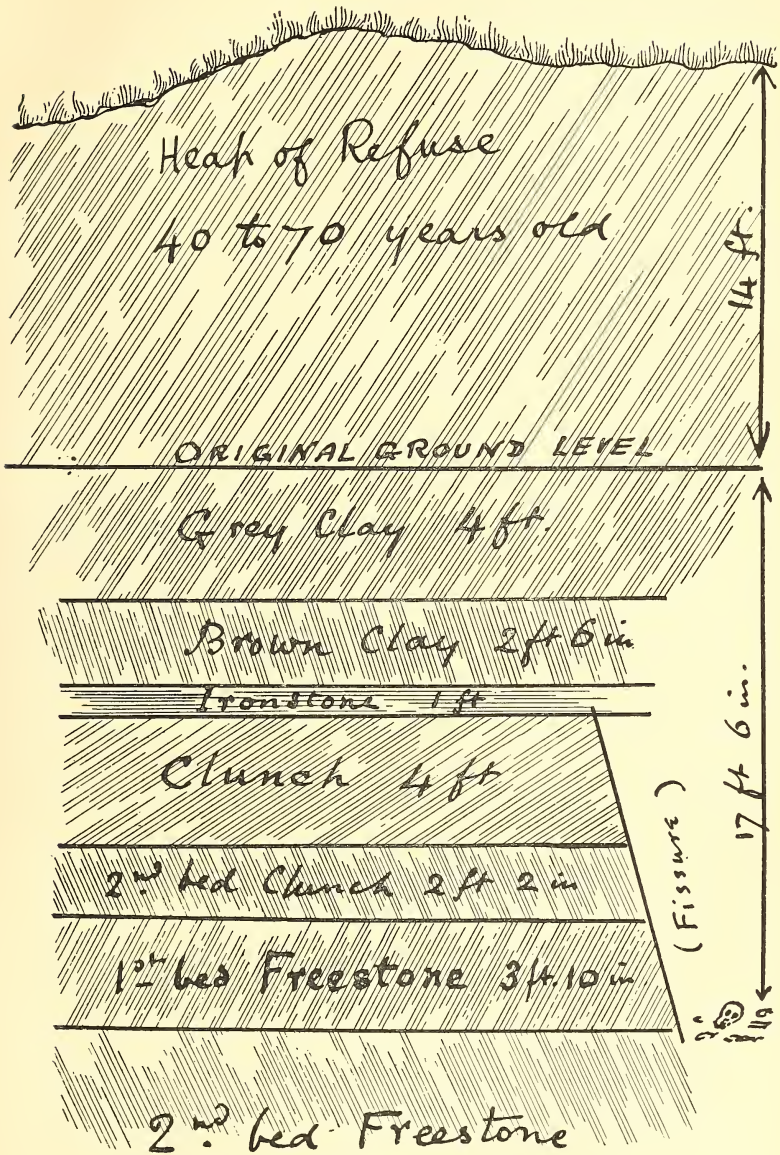

FIG. 2.—Section through fissure.

“ My inquiries made on the spot as soon as I heard of the find, though not till after the removal of all the remains, elicited little information of a definite kind. The men were pretty positive that there were no symptoms of there having been any opening or passage into the fissure except from above.

“ The find consisted of the following antiquarian objects :—

“(1) Human remains consisting of skull and a quantity of bones, but not the complete skeleton. The teeth in the jaws were of a strong type and much worn down with use.

“(2) Polished hornstone celt of late Neolithic type, measuring 4 inches in length, $2\frac{1}{4}$ inches in width at lower end, and $1\frac{1}{4}$ inches at upper end, with a maximum thickness of $\frac{7}{8}$ inch. This is a well-wrought implement, with a finely ground edge and polished all over. It was found in the mass of fallen clay near the rock face, thus showing that it had originally lain low down in the fissure, and consequently at or near the level where the skeleton lay. The clay in the fissure had hardened into a ‘pillar,’ so to speak, and fell outward at full length ; so that the respective distances of the relics from the base of the fallen mass would approximately indicate their original positions in the fissure.

“(3) A stone muller or triturating stone, having one flat surface of an irregular oval shape, measuring about 5 or 6 inches in length and 4 inches in width. Its position in the clay is uncertain.

“(4) Four fragments of pottery, pronounced by Mr Wright, Curator of the Colchester Museum, and Professor Boyd Dawkins, to be mediæval. Their position in the clay is also uncertain.

“(5) Three pieces of sandstone slabs, about $\frac{1}{3}$ inch thick, bearing evidence of having been used as tools, apparently for shaping bone or horn implements. One piece, measuring 3 by 2 inches, has a groove, $\frac{1}{4}$ inch in breadth, running across the shorter diameter, which has the peculiarity of being deep and well-defined at one edge, while towards the other it becomes gradually narrower and shallower. The other two fragments have each a semicircular groove in one of their margins, showing evidence of friction. The position of these objects in the clay is also undetermined.

“(6) Some quantity of decomposed wood, black and soft with age, was found among the fallen clay.”

Having carefully considered the conditions under which the above-described relics were discovered, I do not think we can legitimately associate any of the worked objects with the skeleton. There can be no doubt that the stone axe, the muller, and the grooved rubbing-stones were tools used by people of the Neolithic Age, and, being deposited in the clay at a higher level than the skeleton, we are entitled to assume, *a fortiori*, that the latter also belonged to the Neolithic Age. The skull appears to be similar to those described by Professor Boyd Dawkins from the sepulchral caverns and tumuli of North Wales as belonging to the dark, long-headed Iberians, of whom we shall have something to say later on. (See *Early Man in Britain*, chap. ix.)

II. The Largs skull came into my hands in the following manner:—Happening to be at Largs on the 26th January 1906, I heard various rumours of the discovery of a stone grave, containing a human skeleton, which had been made a few days previously on the estate of Haylee, the property of C. J. C. Douglas, Esq. While pondering over the best way of obtaining precise information on the matter, Mr Douglas and Mr Fryers, architect, called at my house to see if I would accompany them in making an inquiry into the details of the discovery. So we at once started on the business. In the Skelmorlie Mausoleum within the old kirkyard we were shown by Mr Paton a series of red sandstone flags, some seven or eight in number, of which the walls of the cist had been constructed, as well as the covering-stone, broken into many fragments. We then drove to the site of the discovery, and finally to the office of the master of works, where were preserved the remains of the skeleton and a solitary piece of pottery—the rest of the vessel having crumbled into small fragments at the time of its removal from the cist. The cist was uncovered close to the hedge bounding the east side of the Irvine road, while digging a drain from the new cottages now being erected on the ground opposite to May Street, and immediately below the site of a great chambered cairn which, upwards of a century ago, stood near Haylee House, and of which some of the stones of the chamber still remain *in situ*. The cist lay lengthways across the drain, the cover being 2 feet below the surface of the road, but, as was pointed out by one of the workmen, the latter was consider-

ably below the present level of the adjoining field. As already mentioned, the walls of the cist were constructed of red sandstone flags set on edge, sometimes forming a double row, in which case the intervening crevices were said to have been stuffed with clay. The cover, which had to be broken for removal, was a massive block of conglomerate. Both these kinds of rock are common in the district. The dimensions of the cist were $4\frac{1}{2}$ feet long, $2\frac{1}{2}$ feet wide, and 2 feet deep. The body was apparently in a sitting posture, but it, especially the skull, as well as the urn, had been badly damaged by the breaking up of the cover-stone.

The outcome of our consultation over these interesting memorials of the past was to authorise me to procure a report on the portion of the urn from the Hon. John Abercromby, who has made a special study of the ornamentation and chronological range of this class of sepulchral pottery; and to submit the skull to Professor Cunningham, to see if its fragmentary condition would permit of a report being made on its anatomical characteristics.

General Remarks.

From Dr Cunningham's report it will be seen that these two skulls are almost typical specimens of the cranial conformation of two different races who formerly inhabited the British Isles, the one dolichocephalic and the other brachycephalic. As early as 1850, Sir Daniel Wilson maintained, as the result of an investigation of the craniological materials then available, that the earliest British people were characterised by markedly elongated and narrow skulls, to which he gave the name *kumbecephalic*, and that after a time a brachycephalic people appeared on the scene, who, though still practising the simple methods prevalent in the Stone Age, were to some extent acquainted with the use of bronze (*Prehistoric Annals of Scotland*, vol. i. p. 253). Through the researches of Bateman (*Ten Years' Diggings*, etc.), Thurnam and Davis (*Crania Britannica; Mem. Anthropol. Soc.*, vols. i. and iii.), Busk (*Journ. Ethnol. Soc. London*, 2nd S., vol. vi.), Greenwell and Rolleston (*British Barrows*), and others, archæologists have been long conversant with the fact that, as a rule, the crania found in the chambered cairns of Wiltshire, Somerset, Gloucester, and some

adjacent localities were dolichocephalic; but, on the other hand, that both forms were found, almost in equal proportions, in the round barrows and other graves of the Bronze Age. Although Dr Thurnam's aphorism, "Long barrows, long skulls; round barrows, short skulls," is not strictly accurate, it undoubtedly conveys an important ethnological fact, which is thus stated by Professor Rolleston:—"No skull from any long barrow, that is to say, in no skull undoubtedly of the Stone Age, examined by us, has the breadth been found to bear so high a relation as that of 80 : 100 of the length." The more recent discoveries of human remains in the Oban caves (*Proc. Soc. Antiq. Scot.*, vol. xxix. p. 410), and in the chambered cairns of Arran (*ibid.*, vol. xxxvi. p. 74 *et seq.*), also lend support to the same view.

A new and wider significance has been given to the above generalisation by the Hon. John Abercromby in a paper communicated by him to the Anthropological Section of the British Association held at Belfast in 1902, and published in the *Journal of the Anthropological Institute* for the same year (vol. xxxii. p. 373), in which he advocates the hypothesis that the beaker, or, as it was formerly called, "drinking-cup," is the oldest Bronze Age ceramic in Great Britain, and that it was an imported type from Central Europe, by way of the Rhine valley. In the discussion which followed the reading of this paper, Dr T. H. Bryce made the following remarks:—"Not the least interesting feature of Mr Abercromby's valuable paper is the way in which his conclusions conform with the general trend of the evidence derived from the study of skull forms. Wherever the beaker has been found in this country associated with human remains, the skull has been brachycephalic in proportions, and the region from which he derives this ceramic is within the area of the 'Alpine' broad-headed type" (*ibid.*, p. 396). Since then, Dr Bryce (*Proc. Soc. Antiq. Scot.*, vol. xxxix. p. 418) has tabulated the records of some twelve cist-interments which disclose this relationship between beakers and brachycephalic skulls. To these may be added another example from Duns, in Berwickshire (*ibid.*, vol. v. pp. 240, 279), which, together with the Largs specimen, make fourteen in all. It must not, however, be forgotten that beakers are not exclusively confined to short

cists, as they have been found in cairns, barrows, stone circles, etc. Nor had the brachycephalic people in Scotland a monopoly of the short-cist mode of sepulchre, as one of Sir Daniel Wilson's kumbecephalic skulls was found in a short stone cist at Cockenzie, East Lothian (*Prehistoric Annals*, vol. i. p. 238). Nor, indeed, is the association of beaker and brachycephalic skull within a short cist an absolute rule, as a cist at Broomend, Aberdeenshire, contained a beaker and a couple of skeletons, one of which had a skull with a cephalic index of 78 (*ibid.*, vol. vii. p. 113). A few exceptions would not, however, invalidate the general deduction suggested by Mr Abercromby's paper. The culture of the brachycephalic immigrants who surged from the Alpine regions into Western Europe, and ultimately entered Britain by way of the Rhine, would doubtless become more or less affected by that of their predecessors, and *vice versa*. That this has been the case is proved by the finding of skeletons of both races in the round barrows of England and in the Bronze Age burials of Scotland. Thus, Dr Garson describes seven skeletons found in a round barrow in Yorkshire, the cephalic index of which varied from 65·5 to 79·6, or an average of 74·7 (*Journ. Anthropol. Instit.*, vol. xxii. p. 8). Of 17 skulls from Bronze Age interments in Scotland, examined by Sir William Turner, 12 were brachycephalic and 5 dolichocephalic (*Prehistoric Scotland*, p. 455). These statistics conclusively prove that the brachycephalic had found their way to Scotland in considerable numbers, so much so that in some places they appear to have been more numerous than the dolichocephalic,—a result which may perhaps be explained on the supposition that the latter had fled or retired to the higher grounds as the former advanced over the country.

With regard to the ethnology of Ireland, Sir William Wilde expressed the opinion that two races existed simultaneously in that country, viz. a long-headed, dark, Irish stock on the west of the Shannon, and a fair-haired, globular-headed stock on the north-east of that river. But this view has not been corroborated by subsequent researches. So far as I know, the opinion of Professor Huxley, published forty years ago, still holds good. "As the evidence stands at present," writes the Professor, "I am fully disposed to identify the ancient population of Ireland with the

'long-barrow' and 'river-bed' elements of the population of England, and with the long-headed or 'kumbecephalic' inhabitants of Scotland; and to believe that the 'round-barrow' or Belgic element of the Britannic people never colonised Ireland in sufficient numbers to make its presence ethnically felt" (*Prehistoric Remains of Caithness*, p. 127). The fact that the beaker type of sepulchral ceramic has very rarely, if at all, been found in Ireland, may be accounted for on the supposition that the Continental brachycephalic were later in entering that country, or perhaps that they found their way to it by a different route from those who entered Britain by way of the Rhine valley. Anyhow, the rarity of both the beaker and the brachycephalic skull in the prehistoric burials of Ireland is a remarkable coincidence, and supplies fresh evidence in support of the above exposition of Irish ethnology by Professor Huxley.

Without entering on further argumentative details, the following propositions may be accepted as a fair summary of the ethnic elements, so far as these have been determined by modern research, which have helped to mould the physical characters of the highly mixed population now inhabiting the British Isles—but, of course, altogether apart from the influence of the environment, which, as a modifying influence on racial characters, may have been very potent.

(1) Anthropological researches have shown that during the Neolithic Age a long-headed race, of short stature but strong physique (average height 5 feet 5 inches), and who buried their dead in rudely constructed stone chambers, had spread over the whole of Western Europe, from the Mediterranean to the south of Scandinavia. Tacitus informs us that he identified the Silures, a people then occupying South Wales, as Iberians, on account of their swarthy complexion and curled hair (*Agricola*, xi.). The inference that these Silures were the direct descendants of the primitive long-headed people was not unreasonable, more especially as by that time the eastern parts of Britain had been taken possession of by successive waves of Gaulish and Belgic immigrants from the Continent—thus causing the earlier inhabitants to recede more and more westwards. And if this be so, it follows that the long-headed man of the Chambered Cairns of

Britain, Ireland, France, as well as many other parts of the Continent, had a swarthy complexion, with dark hair and eyes, like so many people still inhabiting the more secluded parts of these localities.

(2) The incoming brachycephali were taller than the dolichocephali already in possession of the country, a statement which is proved by actual measurements of skeletons (*average height 5 feet 8 inches*). Although they have been described by many modern writers as "light in hair and complexion" (*British Barrows*, p. 636), there does not appear to be any archæological evidence to support the assertion. The mistake seems to have arisen from inadvertently applying to the Bronze Age brachycephali qualities which were undoubtedly applicable at a later period to the Celts of history. The former buried their dead in short cists and round barrows, and carried with them a knowledge of bronze. While these two early races (the dolichocephali and brachycephali) were living together, apparently in harmony, the custom of disposing of the dead by cremation spread over the land—a custom which was introduced from the Continent, and had its origin probably in the strong religious elements of the time, as it was practised by both.

(3) At a considerably later period, but not many centuries prior to the occupation of Britain by the Romans, there was another Continental wave of immigrants, generally regarded as an offshoot of the "Galli" of classical authors, and probably the Belgæ of Cæsar, who introduced the industrial elements of the civilisation known in this country as "Late Celtic." These newcomers differed radically from the former so-called Celtic invaders in having dolichocephalic heads—a statement which is supported by archæological evidence, as, for example, a skull found in a characteristic late Celtic tumulus at Arras, Yorkshire, was described by Dr Thurnam as having a cephalic index of 73·7. They were a branch of the Celts of history, whose very name at one time was a terror in Europe, and by classical writers they are described as very tall and fierce-looking, with fair hair, blond complexion, and blue eyes.

(4) The next and last of the great racial elements which entered into the ethnic composition of the British people of to-day were

the successive Teutonic invasions from Germany, Denmark, and Scandinavia, all belonging to a tall, blond, dolichocephalic people who existed in Central Europe from time immemorial—possibly the descendants of the Neanderthaloid races of Palæolithic times.

We have made no reference to the Roman occupation as a factor in British ethnology, because the Romans were a mere ruling caste, who, although they introduced new arts, industries, and customs into the country, kept themselves aloof from the natives, and did not, as a rule, intermarry with them. So that when they finally abandoned Britain they left its inhabitants racially unaffected, much as would be the case if the British were now to retire from India. To-day we hunt for remains of military roads, camps, accoutrements of war, and other relics of their civilisation, but of their skeletons we know very little, and of their British offspring nothing at all.

But there is another standpoint from which these skulls have a special interest to the British people of to-day, viz.—What has been the subsequent fate of the primitive races they represent? Can these highly differentiated skull-forms, so strikingly illustrated by the specimens now before us, be still traced among our modern populations? If not, has the assimilation of the two races with one another, and with subsequent immigrants, so equalised their early cranial peculiarities as to be no longer recognisable? From the researches of modern writers on physical anthropology, as stored up in various anthropometric documents, it appears that there is great uniformity in the cephalic index among the present inhabitants of the British Isles. Thus, Dr Beddoe gives, as the result of the measurement of seven groups of Scotchmen in various stations of life, 75·5 as the highest average cephalic index, and 74·2 as the lowest (*Anthropological History of Europe*, p. 104). Mr Ripley, in his *Races of Europe* (p. 304), thus writes:—

“Wherever heads have been measured, whether in the Aran Islands off the west coast of Ireland, the Hebrides and Scottish Highlands, Wales and Cornwall, or the counties about London, the results all agree within a few units. These figures, noted upon the localities where they were taken, are shown upon our little sketch map on page 304. It will be observed at once that the indexes all lie between 77 and 79, with the possible exception

of the middle and western parts of Scotland, where they fell to 76."

Notwithstanding this uniformity of craniological types now prevalent among our populations, it is not a remarkably rare occurrence to meet with a specimen of the dolichocephalic skull which has survived to historical times, with apparently little deviation from its primitive normal characters, such as that from a modern graveyard in Aberdeenshire, referred to by Professor Cunningham (p. 294 *et seq.*). On this point the following remarks by M. de Quatrefages are worth quoting:—

"In passing through the Copenhagen Museum, I was struck by the Neanderthal characters presented by one of the crania in the collection; it proved to be that of Kay Lykke, a Danish gentleman, who played some part in the political affairs of the seventeenth century. M. Godron has published the drawing of the skull of Saint Mansuy, Bishop of Toul, in the fourth century, and this head even exaggerates some of the most striking features of the Neanderthal cranium. The forehead is still more receding, the vault more depressed, and the head so long that the cephalic index is 69·41. Lastly, the skull of Bruce, the Scottish hero, is also a reproduction of the Canstadt type" (*Human Species*, p. 309).

But all this merely proves the strong tendency to survivalism which seems to be peculiar to dolichocephalism. On the other hand, we seem to possess fewer traces of the brachycephalic skulls among our populations of the present day, a fact which is more remarkable inasmuch as the descendants of the "Alpine" broadheads are still the predominating race among the modern populations of France, Belgium, Italy, and Germany. It would seem that brachycephalism was a mere mushroom growth of the Neolithic period, for evidence of it is not, as far as I know, to be found in Palæolithic times. If so, it may be a comparatively unstable factor in the organic evolution of man, and may be paralleled with the fact that a domestic animal when allowed to run wild quickly reverts to the general wild stock and assumes its primitive characteristics. What, then, becomes of the general opinion held by so many of our foremost ethnologists, that these tall, round-headed invaders of our country in the Early Bronze Age were the true Celts of history? If we accept the affirmative of this problem, it would appear as if the brachycephalic skull has become so modified, in the course of some two thousand years, by cross-breeding, etc., as to come within the category of a

well-filled dolichocephalic skull. To this conclusion there is only one alternative, viz. that the race has gradually died out, on the principle of the extinction of the unfittest, having had to give way to the superior vitality of the long-headed race, who were much longer acclimatised to the country.

The cephalic index is, however, only one of the factors which ethnologists make use of in their investigations. Stature, colour of hair and eyes, and even language, especially when fossilised in place-names, supply important evidential materials, not to mention the incidental references of classical authors to the proto-historic inhabitants of Europe. Now, as regards all these physical features, there is a sufficient diversity to be seen among the present inhabitants of this country to suggest a thorough blending of all the racial factors which has to be accounted for in discussing British ethnology. The effect of cross-breeding on the colour of the hair and eyes is difficult to be determined, as the child may sometimes strongly resemble the father and sometimes the mother, or sometimes neither, but may revert, on the principle of atavism, to the type of a more remote ancestor. That, however, a blend in pigmentation ultimately takes place in the course of many generations, and has taken place, is undoubted. Possibly the hazel and grey eyes, now so commonly met with, may be intermediate shades between the dark Iberian and the blue-eyed later Celts, or Galli, or Belgians. It is a remarkable fact that the so-called "Celtic fringe" of to-day—*i.e.* the highland and more inaccessible regions in which the Celtic languages have survived longest—almost coincides with the scattered geographical areas where the dark Iberian people still form the majority of the population. Now, if the language of this dark, long-headed race was not Celtic, we have a striking instance of the instability of language as a racial character. For it would appear as if the descendants of this primitive race, within the historic period, had captured and appropriated the entire heritage of the renowned Celts of Europe as regards language, tradition, and civilisation; while the modern representatives of the latter, so far as concerns Britain, are absolutely lost among, and undistinguishable from, the modern Teutons.

Whatever may be the inherent value of these general remarks,

they bear evidence of the difficulties encountered in the prosecution of anthropological researches, and of the absolute necessity of subjecting every new discovery, whether it be a fragmentary human skeleton or a relic of man's handiwork, to a minute examination at the hands of experts, such as we have had on the present occasion. One of the greatest drawbacks to physical anthropology is the difficulty of associating the facts of craniology with those of the other racial characters on which ethnology is founded. Skeletons do not reveal to us anything of the colour of the hair, eyes, or skin of the individual who owned them; nor of the language they spoke, nor of the religious ceremonies they enacted, nor of the implements, weapons, ornaments, and clothing by means of which they fulfilled their destinies in the organic world. One of the most puzzling problems transmitted to us by classical writers is that they describe two early European races, one short and dark, and the other tall and fair, both of which were dolichocephalic. That brachycephalic immigrants entered France from somewhere to the east at the dawn of the Neolithic period, while the tall dolichocephalic race still lived in the country, there is abundant evidence to show. These latter I am inclined to regard as the descendants of the Palæolithic people of Europe, who had acquired their fair skin, hair, and eyes during their struggles for existence against the severe conditions of life imposed upon them by the Ice Age. But as to the brachycephalic hordes who ultimately pushed their way into Britain, and introduced the Celtic language, which subsequently became the prevailing speech of the British Isles, I am absolutely at a loss to account either for their origin or racial characteristics, beyond the fact that they possessed round-headed and mentally capacious brain-cases.

NOTE ON THE FRAGMENTS OF A BEAKER FROM LARGS.

By the Hon. JOHN ABERCROMBY.

The fragment in question has an extreme length of 20 cm., and a chord of the circumference measures 13·3 cm. When whole, the beaker must have had a maximum diameter of about 17 cm., a height of about 22·9 cm., and it seems to have belonged to type β , *i.e.* ovoid cup with recurved brim. Although such a height

is unusual, it occurs with two beakers of the same type from Court Hill, Dalry, Ayrshire, from Largie, Pottaloch, Argyleshire, and on a beaker of type γ , *i.e.* low-brimmed cup, from Collessie, Fife. The tallest on record is from Somersham, Hunts, and measures as much as 27.4 cm. The clay is fairly well levigated, and contains only a few small stones. Externally the fragment presents a reddish-brown colour. The fracture shows on the outside half of the thickness a reddish-chocolate colour, which becomes darker and blacker towards the inner surface of the vessel. The outside surface is fairly smooth.

As is usual in this class of ceramic, most of the ornament is executed with a narrow instrument, such as a notched slip of bone or wood, leaving small rectangular holes, separated by a narrow septum. But, owing to the shortness of the lines, the horizontal line-chevron fringe bordering each ornamented band is made with a blunt point. The ornament is quite normally disposed in horizontal bands, alternately plain and ornamented. Here we have two of the former and three of the latter. In the central band the principal motive of ornament consists of two parallel line-chevrons, spaced, with their opposite angles united by vertical lines. This motive seems to be a special northern development, as it is found from Ross-shire to Staffordshire, but not further south. The only new motive is the vertical fringe of short horizontal strokes $\equiv \equiv$ which breaks the uniformity and continuity of the belt of ornament of two of the ornamented bands. A similar fringe is found on a beaker of type β from Glan yr Avon, Denbighshire.

So far as I judge, this fragment belonged to a beaker that may be placed about the middle of the Beaker period.

REPORT ON TWO CRANIA SUBMITTED BY DR R. MUNRO FOR
EXAMINATION. By D. J. CUNNINGHAM, M.D., F.R.S.

The specimens which have been placed in my hands by Dr Munro may be respectively designated the Rutland cranium and the Largs cranium, from the districts in which they were found. They belong to two very different types—the Rutland specimen being long, narrow, with prominent brows and sloping forehead, whilst

the Largs cranium is round and lofty, with a straight vertical forehead.

RUTLAND CRANIUM.

The Rutland specimen consists of the calvaria alone, and even that is slightly damaged. The facial and basal parts of the skull are gone, or only represented by a number of small fragments, of which a portion of the lower jaw is alone of any value for reconstruction purposes.

The calvaria, evidently that of a male, possesses certain strongly pronounced characters which give it a striking individuality. These are—(1) a marked projection of the supraorbital part of the frontal bone, due to expansion of the frontal air-sinuses; (2) a constriction of the cranium behind the orbits, leading to considerable narrowing of the forehead at this point; and (3) a strong backward slope of the frontal plate of the frontal bone.

It is a type of skull with which the anatomist is not unfamiliar. A calvaria described many years ago by Sir William Turner, and now in the Anatomical Museum of the Edinburgh University, presents somewhat similar characters. This may be regarded as a comparatively speaking modern specimen, as it was found while digging the foundation of Gordon's Hospital in Aberdeen, an institution which is built on the site of the Blackfriars Monastery.* Another skull obtained from a "Sambaqui" in Santos in Brazil, and described by Nehring, may also be said to show corresponding features.† Amongst the Australians a similar type of cranial contour is likewise sometimes met with.

Such skulls are not infrequently called Neanderthaloid, on account of the forehead and eyebrow regions presenting some resemblance in general contour to the corresponding parts of the famous Neanderthal cranium, but in other respects they stand upon so much higher a plane that such a term is misleading and inappropriate.

* Additional Note on the Neanderthal Skull, by William Turner, M.B., *Quarterly Journal of Science*, 1864, October, p. 758.

† "Menschenreste aus einem Sambaqui von Santos in Brasilien unter Vergleichung der Fossilreste des Pithecanthropus erectus Dubois," by A. Nehring, *Verhandlungen der Berliner anthropologischen Gesellschaft*, November 16, 1895.

Cephalic Index.—The length and breadth measurements of the three skulls referred to above are the following :—

	Maximum Length.	Maximum Breadth.	Cephalic Index.
Rutland specimen	188	138	73·4
Aberdeen ,,	195	150	76·9
Brazil ,,	183	142	77·6

These figures might lead one to place the Rutland skull, which is dolichocephalic, in a different category from the other two specimens. Its low cephalic index in comparison with the higher mesaticephalic indices of the Aberdeen and Brazil skulls is a feature which cannot be ignored. Still, it must be remembered that the maximum antero-posterior diameter of the cranium is composed of two factors of altogether different moment and significance, and in crania with large inflated frontal air-sinuses the cephalic index loses much of its importance as a differential character. When the depth of the frontal air-sinus is omitted from the calculation of the index, the Rutland and Aberdeen skulls enter the brachycephalic list, although they are still differentiated with some sharpness by this character ; unfortunately, in the case of the Brazil specimen, we have not the figures necessary for the calculation of the index.

	Maximum Length of the Brain case.	Maximum Breadth.	Cephalic Index.
Rutland skull	172	138	80·2
Aberdeen ,,	178	150	84·3

Projection of the Supraorbital part of the Frontal Bone.—As is well known,* the projection in this region may be due to expansion

* See Logan Turner, *Accessory Sinuses of the Nose*, Edinburgh, 1901 ; also Zuckerkandl, *Normale und Pathologische Anatomie der Nasenhöhle und ihrer pneumatischen Anhänge*, 1 Bd. 2 Auflage, 1893.

of the frontal air-sinus, or to a large extent to a deposit of bone, as in the case of certain Australian skulls. In both the Rutland and the Aberdeen specimens the supraorbital projection is due to the former cause, and not to any massing of bone in this neighbourhood,—the front wall of the sinus in both cases being not more than 4 mm. thick.

Schwalbe has taught us to examine carefully and critically the contour of the supraciliary region and its relation to the margin of the orbital opening.*

In some cases the supraciliary ridge is fused with the upper part of the orbital rim, and the result is an arcuate continuous projection overhanging the orbital opening. This is the case in the chimpanzee, gorilla, pithecanthropus, and Neanderthal skulls, and in the crania of certain Australian aborigines. In other cases the inner part of the supraciliary ridge is fused with the inner part of the upper portion of the orbital rim, whilst its outer part stands above and apart from the margin of the orbit, being borne upwards, as it were, by the supraorbital nerve, which seems to have some effect in producing this condition. There are many races which show this type of supraciliary projection, and it is not infrequent to meet with it in the modern European skull. Both the Rutland and the Aberdeen skulls fall within this group.

Probably in the European skull it is most usual to find the supraciliary ridge standing quite apart, in its whole length, from the orbital margin. This may be regarded as a third type of supraciliary contour.

The narrowing of the Cranium behind the Orbits.—The minimum frontal diameter of the Rutland skull, determined between the temporal ridges, measures 91 mm. It is a difficult matter to deal with this diameter in such a way as to arrive at a proper conception of its true worth from a comparative point of view, and yet the information gained by the eye is sufficient to show that it is a factor of considerable importance. The absolute measurement as well as the various indices which have been devised may altogether fail to give expression to its proper value and to convey to the mind its right significance.

* "Studien über Pithecanthropus erectus, Dubois," by G. Schwalbe, *Zeitschrift für Morphologie und Anthropologie*, Band i. Heft 1.

In a table given by Schwalbe which deals with 352 skulls, there are no less than 66 specimens with a minimum frontal diameter below 91 mm., and included amongst the latter there are two modern European skulls. The majority of these instances in which this diameter attained so small a dimension occurred in such races as the Veddahs and Australians, in some of which it reached the exceedingly low dimension of 81 mm. From his investigation into this character, Schwalbe comes to the conclusion that it is not always in the lowest races that the lowest postorbital breadth of cranium is found, nor yet is it in the highest races that the diameter attains its maximum.

In the Brazil skull the minimum frontal diameter was even less than in the Rutland specimen. It measured 88 mm. In the Aberdeen skull, on the other hand, in conformity with its larger size, the minimum frontal diameter is 97 mm.

With the view of pushing the comparison still further, outline tracings of the norma verticalis of the Rutland and Aberdeen crania were taken by means of the American periglyph; these were then reduced to a common standard of size by photography and superimposed. The result was very instructive, because it became evident that the contour lines of the two specimens, not only in the postorbital region, but also throughout the entire extent of the tracings, were very similar.

The fronto-parietal index has been employed to express the relative degree of postorbital constriction. In calculating this index the maximum breadth of the skull is taken as 100 and compared with the minimum frontal diameter. The calculation is made in the following manner:—

$$\frac{\text{Minimum frontal diameter} \times 100}{\text{Maximum breadth}}$$

Virchow had considerable faith in this index, and employed it in connection with his study of the cranium of *Pithecanthropus*,* but I am in complete agreement with Schwalbe in the view that it gives no true information regarding the point at issue. The more variable factor, viz. the parietal breadth, is taken as the standard of comparison, and it is not surprising, therefore, that in narrow-

* "Ueber *Pithecanthropus erectus*, Dub.," *Zeitschrift f. Ethnologie*, October 1895, Heft 6.

headed or dolichocephalic races such as the Australians the index should on the average be higher than in the European. This index, therefore, affords no proper conception regarding the degree of postorbital constriction.

Another and a better method is to compare the biorbital diameter (*i.e.* the measurement between the outer margins of the extremities of the two external angular processes of the frontal bone) with the minimum frontal diameter thus:—

$$\frac{\text{Minimum frontal diameter} \times 100}{\text{Biorbital diameter}}$$

FRONTO-PARIETAL AND BIORBITAL INDICES.

	Min. Front. Dia.	Fronto-parietal Index.	Biorbital Index.
Rutland specimen . . .	91	61·5	89·2
Aberdeen ,, . . .	97	64·6	88·2
Brazil ,, . . .	87	61·2	75

This table illustrates what is said in regard to the value of these two indices. The fronto-parietal index would appear to indicate that the degree of postorbital constriction is equal in amount in the Rutland and Brazil specimens, and that both of these are relatively more constricted in this region than the Aberdeen specimen. An ordinary inspection by the eye is sufficient to show that this is not the case, and that the figures of the biorbital index give a much more accurate idea of the degree of cranial narrowing behind the orbits. The most notable feature in the Brazil skull is the narrowing in this region.

In Schwalbe's table xviii. there is no human skull which presents so low a biorbital index as the Brazil specimen. The average biorbital index for the natives of Alsace is 91·8 for the males and 94 for the females, although there are individual cases in which it sinks as low as 82·9, 86·7, and 87·1. In the light of this information, therefore, whilst it is clear that the postorbital constriction in the Rutland skull constitutes a marked feature, we cannot say that its degree is exceptional, even amongst modern European crania.

angles. If the frontal arc were relatively of the same length in all skulls, the point of intersection of the base line would move forwards and backwards as the frontal bone becomes elevated and depressed. This is the principle on which Schwalbe proceeds, but the results of the method are very unreliable. There are two sources of error: (a) as everyone knows, the relative length of the frontal part of the longitudinal arc is a variable quantity in different races, and even in different individuals of the same race; (b) and further, increase in degree of verticality of the frontal

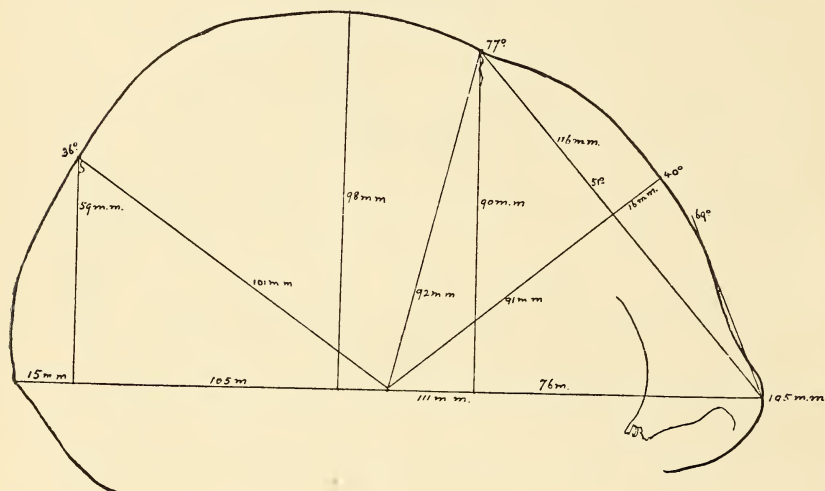

FIG. 2.—Aberdeen Cranium. Tracing of mesial longitudinal arc obtained by the American periglyph. Reduced by one-half.

region does not depend so much on the erection of the whole frontal bone as on an increase on its degree of curvature.

An index of frontal inclination formed on data ascertained by this method may be obtained as follows:—

$$\frac{\text{Part of base line in front of perpendicular from bregma} \times 100}{\text{Length of base line}}$$

(2) A second method consists in drawing a straight line from the most prominent part of the glabella (*i.e.* anterior end of the base line) to the most prominent part of the frontal curve, and measuring the angle formed by it and the base line.

This may be called the *frontal angle*; and whilst it is calculated to give a fair general idea of the slope of the forehead, it must not be forgotten that the varying degree of prominence of the glabella constitutes a disturbing element and introduces a different factor into the result. In skulls such as those under consideration, where the supraorbital projection is great, the general slope of the frontal bone is exaggerated through the pushing forward of the lower end of the frontal line.

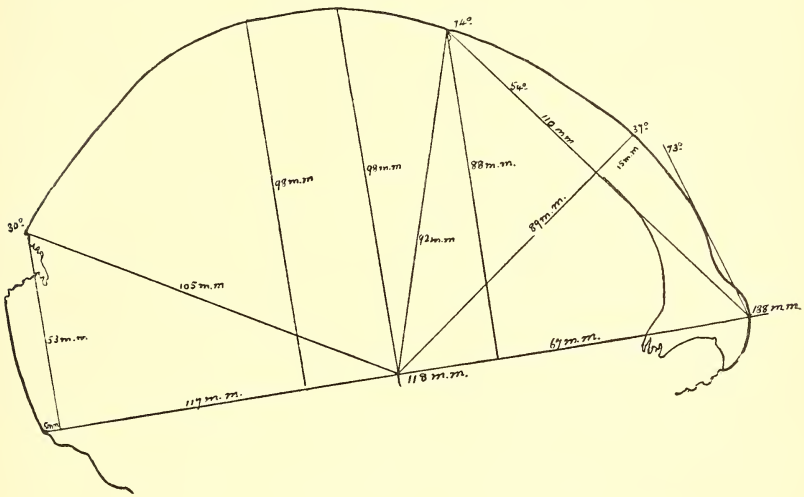

FIG. 3.—Australian Cranium—low type. Tracing of mesial longitudinal arc obtained by American periglyph. Reduced by one-half.

(3) A third method of estimating the slope of the forehead which has been employed by Schwalbe consists in drawing a line from the most prominent part of the glabella to the bregma (bregma line), and measuring the angle which it forms with the base line. This is not a satisfactory plan, because it altogether leaves out of count the degree of forward bulge of the frontal bone, and, as already mentioned, this is quite as important a factor in determining a vertical forehead as the general inclination of the bone.

None of these methods, therefore, are altogether trustworthy, although in all probability the frontal angle gives the best results.

Conjoined with this, however, the degree of frontal curvature should always be determined. This can be done by dropping a perpendicular on the bregma line from the point of maximum frontal curvature, and comparing the length of such a line with the length of the bregma line thus:—

$$\frac{\text{Length of frontal perpendicular} \times 100}{\text{Length of bregma line}}$$

The following table gives the results obtained by the application of these different methods in the case of the three skulls under consideration.

FRONTAL INCLINATION.

	Index showing position of Bregma perpendicular on Base Line.	Frontal Angle.	Angle of Bregma Line.	Index of Frontal Curve.
Rutland specimen .	29·4	73·5°	59°	13
Aberdeen ,, .	38·9	69°	51°	13·7
Brazil ,, .	33·6	70°	54°	12

If we examine the indices which show the position of the bregma perpendicular on the base line, it becomes evident that no just conception can be obtained from them as to the slope of the forehead. Schwalbe gives the average index for the inhabitants of Alsace as 30·5; for the negro as 32·1; and for the Kalmuck as 32·8. In the Rutland skull the index fails to bring out the degree of frontal inclination; in the Aberdeen skull it exaggerates it, seeing that the frontal section of the longitudinal arc is unusually long; whilst in the Brazil skull the index, compared with those furnished by Schwalbe, probably gives a tolerably true idea of the condition.

The frontal angle affords better information on this matter. Amongst living races of men Schwalbe only found one skull with an angle as low as 73°. Had his investigation extended over a wider range, he would probably have found many more with a frontal angle at least as low. For the natives of Alsace he

obtained an average angle of $93\cdot7^\circ$ for the females and of $91\cdot4^\circ$ for the males.

The angle of the bregma line fails altogether to give a true result in the case of the three skulls under consideration. As will be shown later, the frontal slope of the Brazil and Aberdeen skulls are almost identical as regards degree and quality, and yet the bregma angle separates them in this point widely from each other.

The index of the frontal curve brings out satisfactorily the amount of forward bulge of the frontal bone. In the three specimens it is very nearly the same, and must be regarded as being exceptionally low. In a brachycephalic Irish skull I found the index $22\cdot7$, whilst in a dolichocephalic Scotch skull it was $18\cdot6$.

From the various tests applied to the frontal region of the Rutland skull it becomes apparent that the forehead is unusually low and receding, although not in so great a degree as in the Brazil and Aberdeen specimens.

Height of the Calvaria.—The base of the skull being absent, it is necessary to estimate the height of the calvaria by measuring the length of a line drawn from the most distant point of the longitudinal arc to the base line, and in such a direction as to cut the latter at right angles. An index of calvaria height can be estimated thus:—

$$\frac{\text{Calvaria height} \times 100}{\text{Length of base line}}$$

This method gives excellent results, seeing that the measurements from which the index is calculated deals with that part of the cranium which holds the great brain, or that portion of the cranial cavity which is subject to the largest amount of racial and individual change.

INDEX OF CALVARIA HEIGHT.

	Base Line.	Height.	Index.
Rutland skull	180	100	55·5
Aberdeen ,,	195	98	50·3
Brazil, ,,	51·6

These are low indices, but more particularly is this the case in the Aberdeen and Brazil specimens. The Rutland skull stands in this respect midway between these and the modern European skull. According to Schwalbe, the natives of Alsace have a calvaria height index of 59·8; in a dolichocephalic Scottish skull it was 58·1; and in an Australian skull of low type it was 52·1.

When tracings of the longitudinal arcs of the crania in question are reduced to a common length of the base line (*i.e.* diameter between glabella and inion), and superimposed, a very effective

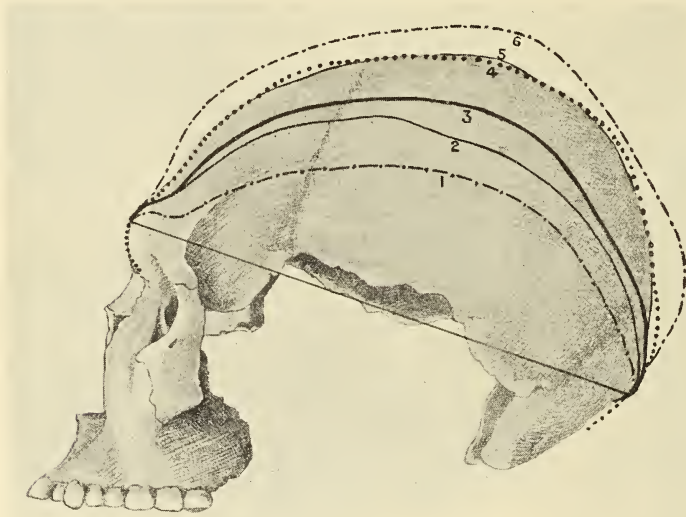

FIG. 4.—Cranial outlines superimposed.

1. Female Gorilla.
2. *Pithecanthropus erectus*, Dubois.
3. Neanderthal (tracing taken from photograph by Schwalbe).
4. Aberdeen Cranium (Sir William Turner).
5. Brazil Cranium (Nehring).
6. Rutland Cranium (Munro).

demonstration of the relative height of each is obtained, and the quality of the curvature in each case becomes evident. In the accompanying figure the numbers 4, 5, and 6 indicate the outlines of the Aberdeen, Brazil, and Rutland crania respectively. The greater height of the Rutland specimen (6), which is also shown in the index, is manifest, whilst the close manner in which the

outlines of the Aberdeen and the Brazil crania follow each other is very remarkable.

In instituting this comparison between the three crania in question, it should be noted that only in one, viz. the Brazil specimen, is the face preserved—and this only partially. Still, enough remains to show that the Brazil skull was distinctly prognathic. It is most unlikely that the Aberdeen skull possessed the same degree of this character; but it should be noted that there is no proof one way or another. In the case of the Rutland specimen it is safe to say that it was not prognathic. A fragment of the front part of the body of the lower jaw of this skull has been preserved, and in this the chief distinguishing features are (1) the vertical sockets for the incisor and canine teeth, and (2) the very pronounced mental prominence—a prominence which extends outwards in a ridge-like manner beyond the incisor portion of the jaw, and which terminates on each side in a marked tubercle.

LARGS SKULL.

The evidence which the Hon. Mr Abercromby has advanced to show that the beaker urn belongs to the most remote period of the Bronze Age has been the means of stimulating an increased degree of interest in the human remains which have been found associated with this form of ceramic.

Dr Bryce* has gathered together the records of twelve such crania, all found within the Scottish area, and each singly within a closed short cist, under conditions similar to those under which the Largs specimen was discovered. These crania exhibit a remarkable uniformity in almost all essential details, and one cannot help concluding that they are derived from a very homogeneous and distinct race. The Largs specimen conforms in a striking manner with this type. A very casual examination is sufficient to show, notwithstanding its damaged condition, that in it we have a combination of definite characters seldom, if indeed ever, encountered in association with each other in modern crania.

* "Notes on a Human Skeleton found in a Cist with a Beaker Urn, and on the Cranial Form associated with that type of Ceramic," *Proc. Soc. Antiq. Scot.*, May 8, 1905. See also *Prehistoric Human Skeletons found at Merthyr Mawr*, Hepburn, Cardiff, 1905.

4

The specimens which were obtained from the Largs short cist consisted of—(1) an imperfect cranium; (2) a portion of the right upper jaw; and (3) the lower jaw,—all clearly belonging to the same individual.

The cranium is that of an adult male. The face (with the exception of the jaw-bones mentioned) and likewise the part of the floor of the cranium around the foramen magnum are absent: fortunately the basion is in position. From the mid-parietal

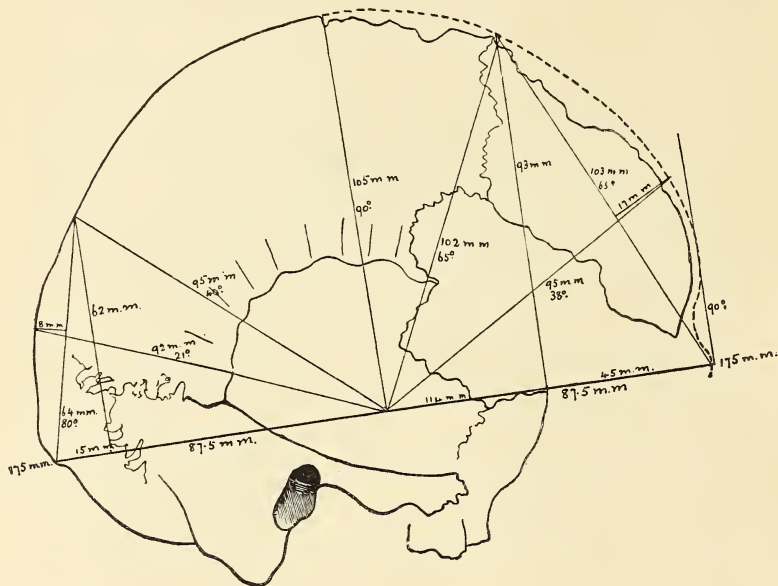

FIG. 5.—Largs Cranium. Tracing of mesial longitudinal arc obtained by the American periglyph. Reduced by one-half.

region forwards the whole of the left lateral, left frontal, and left parietal portions of the wall are gone, but the right part of the roof and of the frontal bone as low as the right supraciliary ridge are present, and thus afford the means of approximately fixing the position of the glabella.

The external occipital protuberance is strongly marked, and coincides with the posterior occipital point when the specimen is held in proper position. Above the inion the posterior wall ascends with a steepness which is remarkable, and the back

of the head in consequence presents a peculiar flattened appearance. The supramastoid crest stands out with an unusual degree of strength, and immediately below there is at the base of the mastoid process and immediately behind the ear-hole a deep depression.

The various measurements which were possible are given in the following table. Two of the series of skulls dealt with by Dr Bryce, both of which have been described by Dr Low, of Aberdeen, are included in the table for purposes of comparison.

	Largs Cranium.	Stoneywood Cranium (Dr Low).	Persley Cranium (Dr Low).
Maximum length	175 (ap.)	169	188
Maximum breadth	148	156	160
<i>Cephalic index</i>	84·6 (ap.)	92·3	85
Height	138 (ap.)	133	146
<i>Height index</i>	78·8 (ap.)	78·7	77·7
<i>Height-breadth index</i>	95·1 (ap.)	85·2	91·2
Frontal angle	90° (ap.)	97° (ap.)	90° (ap.)
Angle of glabello-bregma line	65° (ap.)	62° (ap.)	65° (ap.)
<i>Frontal Curve index</i>	16·5 (ap.)	21·9 (ap.)	20 (ap.)
Length of glabello-inial line } (base line)	175 (ap.)
Maximum height of Calvaria .	105
Index of Calvaria height . .	60 (ap.)

From the above figures it will be noted that the Largs cranium not only presents a high degree of brachycephaly, but also a very high altitudinal index. In the Scottish crania examined by Sir William Turner this index presents an average of 70·9, a small proportion only being hypsicephalic, as is the case with the three crania included in the above table, as well as almost all the other crania which belong to this type (see Bryce's table).

Outline tracings were taken of the longitudinal arc of the photographs of Dr Low's Stoneywood and Persley specimens, which are given by Dr Bryce. These were then enlarged until the base line (glabello-inial line) in each attained a length equal to that of the photograph of the Largs cranium. The three figures thus obtained have been superimposed in the accompanying illustration, with the view of bringing out the similarity of type exhibited in the quality of the cranial arc.

Too much reliance, however, cannot be placed on this figure. It only gives an approximate result, seeing that the glabella and the median frontal outline were absent in the Largs specimen, and that the inion in the photographs of the other two specimens could not be determined with absolute certainty. It may be well to mention that the Persley and Stoneywood crania were not chosen for the purpose of this comparison because, of Dr Bryce's

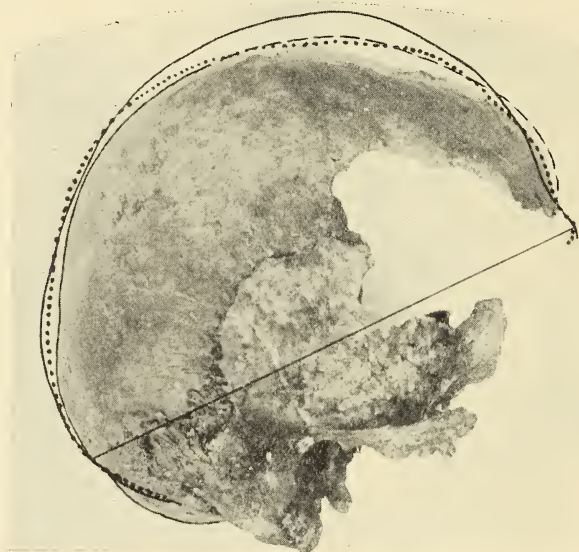

FIG. 6.—Superimposed cranial outlines.

Photograph, Largs specimen (Munro).

Continuous line, Persley cranium (Low).

Dotted outline, Stoneywood cranium (Low).

series, they seemed to present the greatest degree of similarity to the Largs cranium, but because it appeared to me that in these photographs I could determine with the best chance of accuracy the position of the inion.

The fragment of upper jaw belonging to the Largs cranium calls for no special remark. The sockets show that all the molar teeth had been in place; and further, that the incisor teeth had been implanted vertically.

In the case of the lower jaw, the only part absent is the right

ramus. It is quite a commonplace jaw, with nothing to distinguish it from the modern mandible. The three molars of the left side and the first of the right side are present. There is little difference between these teeth in so far as the size of the crowns is concerned, but they are all much worn down, and each presents a more or less flat, even surface at the summit. Both canines and the first premolar on the right side are also present, and considerably ground down on the crowns. The incisors are absent, but the vertical character of the sockets, in conjunction with the corresponding character in the upper jaw, clearly shows that there was no tendency towards prognathism.

The whole lower jaw is somewhat lightly built in comparison with the size of the molar teeth.

(Issued separately August 31, 1906.)

Note on a rare Dolphin (*Delphinus acutus*), recently stranded on the Coast of Sutherland. By Sir William Turner, K.C.B., F.R.S. (With Plate.)

(Read June 4, 1906. MS. received June 29, 1906.)

Through the courtesy of my friend, the Rev. Dr Joass, of Golspie, I received early in April of this year (1906) a specimen of a female dolphin, which had been stranded two days previously on the beach, about half a mile to the east of Dunrobin Castle, where a streamlet enters the sea. The animal, which was carefully secured and packed by a keeper and a gardener of the Duke of Sutherland, reached the Museum in excellent order, with the markings on the skin well seen, and the cuticle not abraded. The short pointed beak, the well-defined yellowish and white band, extending for some distance along the side of the body, and the dimensions of the animal, enabled me, without difficulty, to distinguish the species to be *Delphinus acutus* (Gray), or, as he subsequently called it, *Lagenorhynchus leucopleurus*, the white-sided dolphin.

As this dolphin has seldom been captured on our coasts, I took the opportunity to have it photographed and to write a description of its characters.

The principal measurements were as follows:—

Extreme length along midline of back, . . .	6 ft.
From tip of beak to anterior margin of dorsal fin, . . .	29 in.
" " to anterior border of flipper, . . .	14 "
Length of flipper in straight line, . . .	10 "
" of attached border of flipper, . . .	4 "
" of attached base of dorsal fin, . . .	11 "
Height of dorsal fin,	6·5 "
Width of tail,	15 "
Girth in front of dorsal fin,	35·75 "
Girth at root of tail,	7·5 "
Length of lower jaw,	12·1 "

The head ended in front in a pointed tip, and the lower jaw scarcely projected beyond the upper. One and three-quarter inch



FIG. 1.—Side view of *Delphinus acutus*.

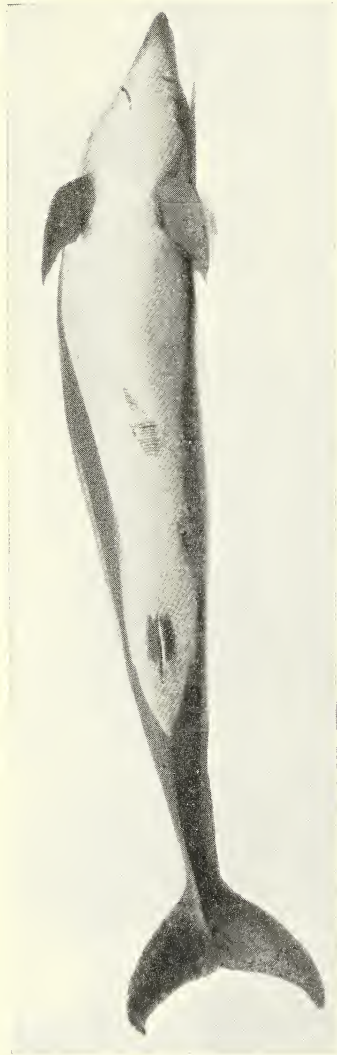

FIG. 2.—Ventral surface of *Delphinus acutus*. The parallel markings near the umbilicus were artificial, and had been made by a sharp instrument.

(These and the other figures are reproduced from Photographs by Mr John Henderson.)

behind the tip a groove was seen, which extended backwards on each side of the beak for 5 inches, and marked off a narrow ledge below and in front of the convexity of the head. From this groove the head, at first somewhat flattened laterally, ascended with a gentle curve to the blow-hole on the top of the head. The lateral flattening of the head contributed to give the pointed form anteriorly. Behind the blow-hole the back was rounded from side to side and the body had the greatest girth. The dorsal fin was sickle-shaped and projected vertically from about the middle of the back. Behind this fin the back was keeled, and preserved this character as far as the tail; the width of the body also gradually diminished and became flattened laterally. The belly was also flattened in the greater part of its extent, but was keeled for a short distance in front of the tail. The caudal fin consisted of two horizontal flattened flanges separated by a mesial notch, and its posterior border was concave. The flipper was flattened on its two surfaces; the anterior border was convex, the posterior a little concave, the tip pointed.

The palpebral fissure was $1\frac{3}{4}$ inch behind the angle of the mouth; the auditory meatus, so minute as to be seen with difficulty, was $1\frac{5}{8}$ inch behind the palpebral fissure. The mouth-slit was $8\frac{1}{2}$ inches long. No hairs were seen on the skin of the beak, or on that covering the symphysis of the mandible. The blow-hole, $1\frac{1}{4}$ inch wide, was 7 inches from each eye, crescentic in shape, with the concavity directed forwards. The dolphin was a female, and the genital fissure was $4\frac{3}{4}$ inches long; on each side a narrow mammary fissure $\frac{3}{4}$ inch long was situated. A small anal orifice was placed $1\frac{1}{2}$ inch behind the genital fissure. The umbilicus was 13 inches in front of the same fissure.

Colour.—The beak was glossy black to the tip and sides of the upper jaw; the dorsum and the sides of the head, the back and upper part of the side of the body, the upper surface of the tail as far as its concave border, the dorsal fin and both surfaces of the flipper were also a rich black. A long light-coloured band, pointed at its anterior end, situated on the side of the body, commenced below the dorsal fin, broadened as it passed backwards, and at about half its length was $2\frac{3}{4}$ inches wide, when it narrowed for some distance and terminated behind, 9 inches in front of the

posterior border of the tail, in a bulbous expansion. In its anterior part the upper half of this band was yellowish-brown and the lower half was white, but posteriorly it was entirely yellowish-brown. The belly was white from near the tip of the lower jaw to 4 inches behind the genital fissure, on each side of which was a longitudinal greyish-black patch. Between the white belly and the band on the side of the body the colour of the skin was greyish-black, and a slender band similarly coloured extended forward from the base of the flipper to the angle of the mouth. The ventral surface of the tail was greyish-white.

Skeleton.—The length of the female, 6 feet, was less than that of a male, 8 feet 3 inches, described by Dr Duguid,* a difference due partly to sex and in part to the ossification in the former being incomplete, as the epiphysial plates were not fused with the bodies of the vertebræ. The Dunrobin specimen, therefore, was not adult, but in the stage of growth which may be called adolescent. The spinal column was $54\frac{3}{4}$ inches long. When examined with the vertebræ undisturbed in their natural position, the vertebral formula was cervical 7, dorsal 15, lumbo-caudal 58, in all 80, which is less than the number 82 said to have been present in some specimens of this species, and materially below the 88 to 92 vertebræ found in *Delphinus albirostris*.

The 1st, 2nd, and 3rd cervicals were fused in their bodies, neural arches, spines and transverse processes into a relatively massive bone. Intervertebral discs were present between the bodies of the other cervicals, which were flattened, and the whole series formed a short, stunted, compressed neck. The dorsals had relatively long spines and articulated with fifteen pairs of ribs. The first five pairs were jointed with the bodies and transverse processes of the corresponding vertebræ; the remaining ten pairs with the free ends of the last ten dorsal vertebræ.

The lumbo-caudals diminished in size before they reached the tail, and the transverse processes ended at the 39th post-costal vertebra; in the tail itself fifteen vertebræ were represented by only the bodies. The tips of the lumbar and dorsal

* *Ann. and Mag. Nat. Hist.*, vol. xiv., 3rd series, p. 133, 1864.

spines and the tips of the transverse processes were partly cartilaginous. The spinal cord ended opposite the 5th post-costal vertebra.

Twenty-five chevron bodies were counted: the 1st began in line with the 20th post-costal vertebra; it and three succeeding chevrons were small, and the two lateral halves were not united mesially to form a ventral spine. The last chevron was associated with the 45th post-costal vertebra; it and the four chevrons immediately anterior, though small, possessed each a stunted ventral spine. The intermediate chevrons were considerably larger and with well-marked ventral spines.

The sternum, $5\frac{1}{2}$ inches long, consisted of three segments, and formed an elongated, flattened bone. The manubrium was the widest; its anterior border was recurved and a pair of cornual processes projected from it; the 2nd piece was about half the width of the manubrium; the 3rd piece was narrower and bifid at its free end. Five pairs of ribs articulated with the sternum and their sternal segments were ossified. From the 6th to the 10th rib the corresponding sternal segment was ossified and the segment belonging to the rib in front was overlapped by the corresponding segment of the rib immediately behind; in the respiratory movements one was permitted to play upon the other. The last five ribs were floating and their free ends were tipped with cartilage. These arrangements, together with the articulations of the last ten pairs with only the transverse processes of the dorsal vertebræ, gave great mobility to the chest walls and permitted the full expansion of the lungs which takes place when the animal dives. The pelvic bones were almost straight and slender, 2.2 inches long; the ends were cartilaginous.

The length of the head in a straight line from the occipital condyls to the tip of the beak was 14.3 inches (375 mm.). The length of the beak from the notch in the maxillary bone to the tip of the premaxillaries was 7.1 inches, being in proportion to the length of the head about 1 to 2. The transverse diameter of the base of the beak between the two maxillary notches was 3.8 inches. The interzygomatic breadth of the skull was 7.6 inches. The malar bone was a long, very slender style. The two pterygoids met in the mesial plane behind the palate, their suture was continuous

with the mid-palatal suture, and their posterior borders formed a continuous transverse edge. The hyoid apparatus consisted of the customary elements. The teeth were conical and pointed, small in size, and the longest projected only 8 mm. beyond the gum; the six most anterior teeth in the upper jaw and the three most anterior teeth in the mandible had not cut the gum. The dental formula was $\frac{36}{37}-\frac{36}{37}$. The mucous membrane covering the hard palate was perfectly smooth. The tongue was free at the tip. The anterior nares were not symmetrical, the right being larger than the left; the mes-ethmoid was prolonged into the medio-



FIG. 3.—Dorsal view of the skull of *Delphinus acutus*.

rostral cartilage. The tympanic bullæ were bilobed; the outer was the larger of the two lobes and smooth. The bulla was 32 mm. long and 19 mm. in greatest breadth. The petrous bone was 31 mm. long and 19 mm. broad.*

Systematic writers on the Cetacea have attached importance in the discrimination of the species of Dolphins to the relation between the length of the skull, measured in a straight line, from the occipital condyl to the tip of the beak, and the length of the beak itself. I have accordingly, for purposes of comparison, taken

* See my paper on the "Sperm Whale," in *Proc. Roy. Soc. Edin.*, vol. xxiv. p. 430, 1903, for measurements and characters of the tympanic and petrous bones in the Cetacea.

these measurements in the skulls of several species of dolphins in the University Museum :—

	Length of Skull.	Length of Beak.	Breadth of base of Beak.
<i>Delphinus acutus</i> , . . .	14·3 inches	7·1 inches	3·8 inches
,, <i>albirostris</i> , . . .	17 "	8·5 "	5·8 "
,, <i>delphis</i> , . . .	17·8 "	11·4 "	3·8 "
,, <i>tursio</i> , . . .	21·5 "	11·25 "	5·9 "

It will be seen that in *D. acutus*, *D. albirostris*, and *D. tursio* the beak was about half the length of the entire skull, but in *D. delphis* the proportion of the beak to the length of the skull was materially greater. Although the skulls of *albirostris* and *delphis* were of almost the same length, the difference in the breadth of the base of the beak was 2 inches; whilst *acutus* and *delphis* had the same breadth of beak, the skull of *acutus* was 3 inches shorter; in *D. tursio* again, though the skull was $4\frac{1}{2}$ inches longer than in *albirostris*, the beak had almost the same breadth at its base. *D. acutus* had not reached its full size, and possibly the proportions may be somewhat altered in the adult.

Skeleton of Flipper.—The *Scapula* was plate-like; the acromion was flattened and strongly projecting; the spine was a slender ridge; the præspinous fossa was a narrow surface in comparison with the post-spinous.

The *Humerus*, 2 inches long, was thick and stunted and the epiphyses were fused with the shaft. The *Radius* was 2·4 inches long and 1·5 inch broad; the distal epiphysis was distinct from the shaft. The *Ulna* was 1·7 inch long and 1·1 inch broad; the distal epiphysis was distinct from the shaft and the olecranon process was moderate in size.

The *Manus* consisted of carpus, metacarpus, and phalanges; it was pentadactylous. The carpalia were arranged in two rows. The proximal row consisted of radiale, intermedium and ulnare, and at the ulnar border a plate of cartilage represented an unossified pisiform. Two bones were readily recognised in the distal row; one articulated with the carpal ends of the

metacarpals of annularis and medius, another with the carpal ends of the metacarpals of medius and index. A third bone was situated distal to the radiale, and close to the radial border of the proximal epiphysis of the metacarpal of the index. The question arose, Could this be the metacarpal of the pollex? but as it was in the same transverse plane as the distal carpalia, and, like the other carpals, showed no sign of an epiphysis, it was presumably a third distal carpal, and represented the carpal element of the pollex.

Each digit had its metacarpal bone. That of the pollex was in the same transverse plane as the shaft of the other metacarpals; it was slender and elongated, with a cartilaginous prolongation at both its proximal and distal ends; there was no sign in the cartilaginous

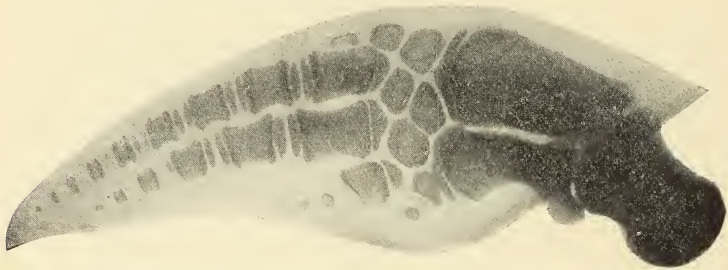

FIG. 4.—Radiograph of the flipper of *D. acutus*, showing the bones and the centres of ossification, reduced to about one-third.

prolongation of an epiphysis or a centre of ossification which could be regarded as even the rudiment of a bony phalanx. The index was the longest of the digits, and they diminished in length from it to the minimus; each of these four had a metacarpal bone, which possessed in the index, medius and annularis a proximal and a distal epiphysis, whilst in the minimus only a proximal epiphysis had a centre of ossification.

The index had eight phalanges, three of which had proximal and distal epiphyses; the fourth had only a proximal, and the terminal four each showed only a small ossific centre without epiphyses. The medius had five phalanges, of which two had proximal and distal epiphyses, and the third had a faint trace of a proximal. The annularis had an ossific centre for each of three phalanges in the right manus but only two in the left. The minimus had a cartilaginous

rod but no centre of ossification in it.* The manus, owing to the animal not being adult, presented an interesting study of the progress of ossification in this species of Dolphin. The following formula represents the osseous elements of the manus:—

	<i>Pol.</i>	<i>Ix</i>	<i>Me</i>	<i>An</i>	<i>Mi</i>
Phal.	?	8	5	3	?
Met.	1	1	1	1	1
	C ₁	C ₂ and C ₃		C ₄ and C ₅ ?	
	radiale	intermedium		ulnare	
	Radius			Ulna	

Owing to the absence of ossific centres the phalangeal formula in the pollex and minimus cannot be stated in this specimen.

The species *Delphinus acutus* was established in 1828 by J. E. Gray, from the examination of a skull from Orkney, now in the Museum at Leyden, which skull he figured in the Zoology of the voyage of the *Erebus* and *Terror*, Plate 12. Other specimens were subsequently obtained from the Faroes and the coasts of Norway (Rasch) and Holland, which have been at various times named *Delphinus eschrichtii* (Schlegel), *Delphinus leucopleurus* (Rasch), *Lagenorhynchus leucopleurus* (Gray), *Lagenorhynchus acutus* (Flower), but their identity with *D. acutus* is now recognised.

In 1835 Robert and Frederick Knox obtained from Orkney a female dolphin, which measured 6 feet $5\frac{1}{4}$ inches.† They named it *Delphinus tursio*, and they prepared the skeleton. The vertebral formula was C 7, D 15, LC 59 = 81. The cranial cavity was opened and the brain removed. Dr J. E. Gray stated (*Catalogue of Whales*, p. 274, 1866) that this specimen was in the Museum of the University of Edinburgh, and he assigned it to the species *Lagenorhynchus leucopleurus*. As the museum referred to by him might have been the Natural History Museum of

* I may refer to my account of the Anatomy of Sowerby's Whale, *Journ. Anat. and Phys.*, Oct. 1885, and to my description of *Balænoptera rostrata*, *Proc. Roy. Soc. Edin.*, Feb. 1892, for a critical examination of the constitution of the manus in the Cetacea.

† Measurements of the skull, skeleton and other characters of this dolphin are given in Knox's *Catalogue of Anatomical Preparations illustrative of the Whale*, Edinburgh, 1838; also in *Proc. Linnean Soc.*, Zoology, 1857, p. 67.

the University, which was transferred to the Government in 1854, and is now incorporated in the Royal Scottish Museum, I have examined, along with Dr Traquair, the Keeper of the Natural History section, the specimens in the collection, but could not identify Knox's specimen. A skeleton marked *Tursiops tursio* is there; it is about 10 feet long, and is stated to have come from the Firth of Forth; its cranium was 20·25 inches long and the beak was 9·75 inches. Obviously the skeleton of *tursio* now in the Museum was not, either as regards dimensions or habitat, that of the dolphin prepared by the brothers Knox.

The Anatomical Museum of the University has long possessed a skull, the skull-cap of which had been taken off and the brain removed; the mandible was absent. Wires were attached to the basis cranii, which showed that it had at one time been articulated to the spine, but the rest of the skeleton was no longer attached to it and could not be found, neither was the skull labelled with a name nor the locality where it had been obtained, so that no mark existed to enable one to identify it. The dimensions of the skull were, length 14·9 inches, length of beak 7·7, breadth of beak 3·9, breadth of skull 8 inches. Its dimensions were slightly greater than in the Dunrobin dolphin, though the ossification in it was also incomplete. Its appearance both in profile and in the dorsal view of the beak was in close correspondence with the Dunrobin specimen. The proportion of beak to skull, the configuration of the maxillæ and premaxillæ, the form of the pterygoids, their relation to the palate, the want of symmetry of the anterior nares, the continuation of the mes-ethmoid into a medio-rostral cartilage, and the shape and size of the bi-lobed tympanic bullæ, closely resembled each other in the two specimens. The teeth in shape and size were identical in both skulls, and twenty-nine were counted on one side projecting through the gum; as the most anterior tooth was a little distance behind the tip of the beak, several were in all likelihood concealed in the dried gum. From its resemblance in size, form, and proportions, I concluded that it also was the skull of a *Delphinus acutus*. From the brain cavity having been opened, and from the evidence of its having at one time belonged to an articulated skeleton, I think that possibly it was that of Knox's Orkney specimen obtained in 1835.

In 1858 a school of dolphins was driven ashore at Scalpa Bay, near Kirkwall, one of which, a male, measured 8 feet 3 inches in length, and along with a specimen 7 feet 2 inches was described by Dr Duguid.* From a drawing of the animal which illustrated Dr Duguid's memoir, it was recognised by Dr Gray as identical with the dolphin to which he was then applying the name *Lagenorhynchus leucopleurus*. Mr Moodie Heddle had in his possession † a drawing of a male dolphin killed at Scalpa in 1858, doubtless one of the school previously described by Dr Duguid, and he further stated that three specimens ran ashore at Melsetten in 1886. That this species frequented the Orkney and Faroe seas, and that it had been occasionally found on the opposite shores of the North Sea, has been satisfactorily established. Evidence of its recognition on the coast of the mainland of Scotland is not, however, so definite, though it should be stated Messrs Harvie-Brown and Buckley have recorded that the Rev. N. Macpherson saw a dolphin lying on the pier at Ardrishaig, Argyleshire, which, from a comparison with the figure in Bell's *British Quadrupeds* he regarded as of this species, but no description or measurements were given.‡ That I am now able to state without doubt that *Delphinus acutus* is an occasional visitor to the coast of the mainland, I owe to the Rev. Dr Joass, whose interest in the natural history and archæology of the northern counties and whose courtesy to his fellow-workers are so greatly appreciated by men of science in Scotland. The skeleton will be added to the series of skeletons of the Cetacea in the Anatomical Museum of the University.

* *Ann. and Mag. Nat. Hist.*, vol. xiv., 3rd series, *op. cit.*

† *Vertebrate Fauna of the Orkney Islands*, by J. A. Harvie-Brown and T. E. Buckley, Edinburgh, 1896.

‡ *A Fauna of Argyle and the Inner Hebrides*, Edinburgh, 1892.

Contributions to the Craniology of the People of the
Empire of India. Part III.: Natives of the Madras
Presidency, Thugs, Veddahs, Tibetans, and Seistanis.
By Sir William Turner, K.C.B.

(Proceedings, June 4, 1906.)

This Memoir is printed *in extenso* in the *Transactions* of the
Society, vol. xlv., part i., 1906.

**Note on the Smolt to Grilse Stage of the Salmon, with
Exhibition of a Marked Fish recaptured. By W. L.
Calderwood.**

(MS. received July 13, 1906. Read July 13, 1906.)

In tracing the various stages of the salmon's growth, precise information has been difficult as to the length of time occupied between the first descent to the sea as a smolt and the first return to the river as a grilse. The difficulty of attaching to so small a fish as a salmon-smolt a suitable mark for subsequent identification has, in the main, been responsible for this lack. The average smolt is $5\frac{1}{2}$ to 6 inches long (14-15 cm.), and weighs from 1 to 2 ounces. In the next stage with which we are familiar the fish may weigh 3 to even 10 lbs. It is clear, therefore, that any mark attached to the smolt must not only be sufficiently small and light for a fish only a few inches long to carry without inconvenience and injury, but must be adaptable to the rapid and great increase of growth which takes place in the sea.

In the past a method of marking has been repeatedly resorted to which, though having the merit of simplicity, is not really reliable; I refer to the method of fin-cutting, especially and commonly the cutting or the removal of the adipose fin. The famous Stormontfield experiments, reported upon by Buist in 1867, and repeated in other localities by other observers since that date, were conducted, so far as the study of migratory movements went, almost exclusively by fin-cutting. These experiments have been chiefly responsible for the belief that the smolt which enters the sea in greatest numbers in the spring, returns to fresh water as a grilse in two or three months, *i.e.* during the immediately succeeding summer. The Duke of Bedford's experiments in Devonshire were conducted by fin-cutting, and are held to show a different conclusion. Only three cases are, I think, on record in which the smolts have been marked by the attachment of a foreign substance, and recapture effected. These cases come from the

Tweed (*Tweed Salmon Reports*, 1868). The marking was done in 1854, 1855, and 1857, and in each case the recapture of the fish as a grilse was fully a year after the date of marking.

In the spring of 1904 I commenced experiments in smolt-marking at the Cunninghaugh Ponds, near Fochabers, the property of the Duke of Richmond and Gordon. The method first used was the attachment of a small silver disc to the operculum by means of a split pin passed through the operculum from beneath; but so many of the marks were torn out, by the yielding of the delicate bones of the gill cover, within a few weeks, that the method was abandoned. I next used, on the Tay, a simple piece of silver wire, which I passed through the skin of the back close to the adipose fin, and formed into a loop by twisting the ends together. The method seemed fairly satisfactory, but the wire used was rather heavy, and interfered somewhat with the balance of the little fishes as they swam away. Next year (1905) the Tay Salmon Fisheries Company, under Mr P. D. Malloch's supervision, took up the marking of smolts, and a wire was employed of lighter weight—so thin that it could be easily cut with scissors. The wire was passed through the dorsal fin close to the anterior border and a short distance above the base of the fin rays, and was formed into a loop or loose ring and the ends snipped off. Mr M'Nicol had charge of the operations, and succeeded in marking 6500 smolts in the spring of 1905. No recaptures were made in 1905.

This summer (1906) a considerable number of those smolts have been recaptured as grilse. In each case the recapture has been made in the Tay estuary, where the marking was originally conducted. The particulars of the first five are as follow:—

1st June 1906,	grilse	weighing	2 lb. 15 oz.
26th	„	„	4 „ 8 „
28th	„	„	4 „ 12 „
3rd July	„	„	3 „ 4 „
4th	„	„	5 „ 8 „

The specimen exhibited is the second on the list, caught on 26th June, and weighing 4 lb. 8 oz. It is a male fish with rudimentary testes, and measures to the fork of the caudal fin 24 inches

(61 cm.); the greatest depth is 4 inches (10·2 cm.), and the depth of the caudal peduncle $1\frac{1}{2}$ inches (3·7 cm.).

These recaptures, then, confirm the belief that the smolt does not return as a grilse the same year as it descends, but rather after a year or fully a year has elapsed. The development shown on the scales of grilse, as well as the capture of the Galway

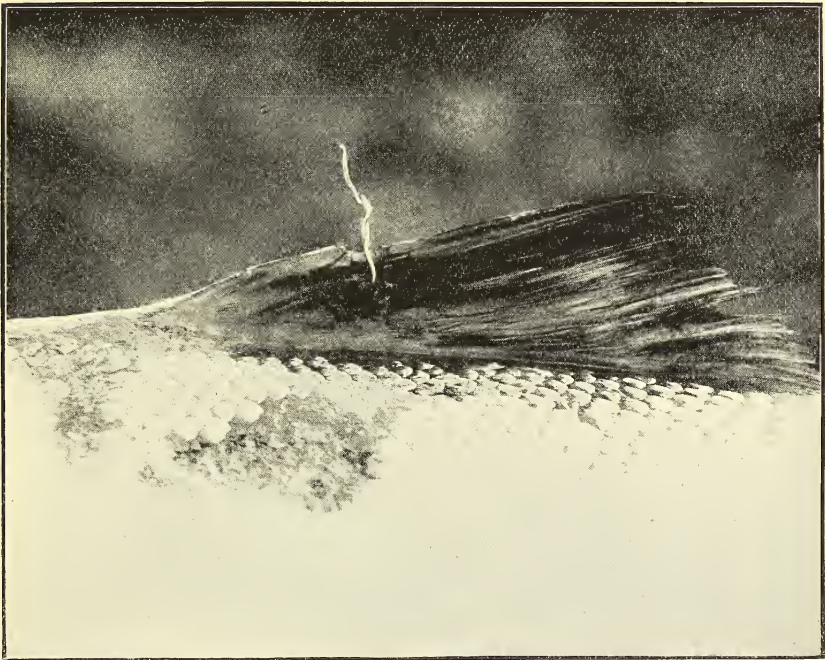

Dorsal fin of grilse, caught 1st June 1906, marked as a smolt in May 1905.
(Photograph by P. D. Malloch, Perth.)

specimen which I exhibited to the Society about a year and a half ago, all give evidence that the first normal return of a smolt to fresh water takes place when the fish, as a grilse, is three to three and a half years old, and after it has been fully a year in the sea. From other observations it seems certain that all grilse do not, however, enter fresh water, but that many fish pass the grilse stage in the sea and return for the first time to fresh water as small spring salmon, four years of age.

With regard to the other wired grilse which have been taken during the fishing season of 1906, I may add that their weights ranged to a maximum of 9 lb., and that when further time has elapsed in which the possible return of those fish may be noted, additional particulars will be published.

(Issued separately October 12, 1906.)

Two Lecture Experiments in illustration of the Theory of Ionization. By Dr W. W. Taylor. *Communicated by Professor CRUM BROWN.*

(MS. received July 2, 1906. Read July 2, 1906.)

The two experiments, which, so far as I am aware, have not hitherto been described, illustrate two of the conclusions drawn from the theory of ionization. The first is that the degree of ionization of a solution of an acid is diminished by addition of a salt of the acid. The experiment differs from many of those employed for the purpose in that it demonstrates the increase in concentration of the un-ionized acid, and not the diminution of activity as an acid, *i.e.* decrease in concentration of H^+ . A solution of egg-albumin is added to a solution of nitric acid which is so dilute that no coagulation of albumin occurs; a saturated solution of potassium nitrate is then added to the mixed solution, and coagulation immediately takes place. The potassium nitrate solution causes no coagulation when the nitric acid is not present.

That un-ionized nitric acid causes the coagulation is shown by the fact that H^+ , K^+ , NO_3^- , and un-ionized potassium nitrate do not do so under the same conditions.

The second experiment illustrates the proposition that, on addition of a weak acid to a solution of a salt of a strong acid, some of the strong acid is displaced by the weak acid. Saturated solution of potassium nitrate, added to an albumin solution, causes no coagulation; a solution of acetic acid likewise causes no coagulation when added to the albumin solution. When the two are added to the albumin, coagulation takes place immediately.

That in this case, also, the precipitation is due to the formation of un-ionized nitric acid is shown by the facts that H^+ , K^+ , NO_3^- , $C_2H_3O_2^-$, and un-ionized potassium nitrate do not cause it. A separate experiment with potassium acetate, the only other substance formed in the reaction, proves that the precipitation is not

caused by it. Un-ionized nitric acid must have been formed to a sufficient extent to coagulate the albumin.

This experiment avoids the complication which ensues when a weak acid acts upon a salt of a strong acid with formation of an insoluble salt of the weak acid, *e.g.* the action of hydrogen sulphide on many metallic chlorides.

CHEMICAL LABORATORY,
UNIVERSITY OF EDINBURGH.

(Issued separately October 12, 1906.)

A Dietary Study of Five Halls of Residence for Students in Edinburgh. By I. D. Cameron, M.B., D.P.H. *Communicated by* D. NÖEL PATON, M.D.

(MS. received June 18, 1906. Read June 18, 1906.)

CONTENTS.

	PAGE		PAGE
I. DIETARY STANDARDS—		(Edinburgh, York, and	
Voit, etc.	327	Dublin)	332
Atwater	328	(c) Japanese studies	334
Chittenden	328	III. PRESENT INVESTIGATION	
Modifications for age, sex,		AND RESULTS	335
etc.	331	IV. COMPARISON WITH OTHER	
II. PREVIOUS DIETARY STUDIES—		STUDIES OF STUDENTS'	
(a) Atwater's American work	331	DIETARIES	346
(b) British investigations		V. SUMMARY OF RESULTS	350

I. DIETARY STANDARDS.

In considering the steps leading up to the present dietary standards, it is necessary first to mention the work of Voit and Pettenkofer. They constructed tables representing "exchange of material"; these were based on the weight of the animal experimented on, and the amount of food taken, considered in relation to the work done and heat developed.

These results may be expressed in three ways :

- (a) As energy, and stated as Calories.
- (b) In terms of the contained nitrogen and carbon.
- (c) In relation to the nutritive materials, as proteids, fats, and carbohydrates.

The method of investigation originated by Voit has been followed by Playfair in England and by Moleschott in Italy. Their results do not differ widely. The general result is that the daily requirement of an average man at moderate work is : proteids, 120 grammes ; fats, 60 grammes ; and carbohydrates, 500 grammes. When expressed as energy, this represents 3130 calories. Given in another form, it is equivalent to 20 grammes of nitrogen and 320 grammes of carbon daily.

Atwater developed this method of investigation. The numerous reports submitted by him to the United States Department of Agriculture give his results along three lines of study :

- (1) With a respiration calorimeter ;
- (2) Chemical analyses of food-stuffs ; and
- (3) Diets of representative classes of the community.

He suggests as a dietary standard : proteids, 125 grammes ; fats, 125 grammes ; and carbohydrates, 450 grammes per man per diem. The noticeable difference from the Voit standard is the increase in fats and the diminution in the amount of carbohydrate. Atwater specially emphasises the fact that no allowance is made for differences in digestibility, and that personal idiosyncrasy is not considered.

Professor Chittenden of Yale has recently carried out an elaborate investigation into the amount of food required in health. These researches are published in book form, *Physiological Economy in Nutrition*. Chittenden's interest in the subject was aroused by the contention of Mr Horace Fletcher that a high standard of health could be maintained on a low proteid intake. Chittenden's criticisms of the former work on this subject are : (1) that the chemical analyses are not accurate, and (2) that the amount of food ordinarily taken is by no means necessarily the amount required.

To eliminate possible fallacies in the work, observations were made over several months with men of different classes and nationalities engaged in different work. The three classes of men studied were : (1) professional men, (2) soldiers, and (3) college athletes.

The quantity of food taken was gradually reduced : not only proteids, but fats and carbohydrates were diminished. The body-weight fell while the change of food was being made, but it soon became stationary. The nitrogen equilibrium was then tested, and a slight plus balance was found. Systematic tests of strength showed an increased vigour, and the subjects of the experiment professed to be in improved health. The amount of proteid taken in these cases was only about one-third the ordinarily accepted standard.

Chittenden concludes his report by pointing out that, if health

can be maintained on one-third the usual proteid allowance, then the additional proteid adds enormously to the wear and tear of the tissues. It is an incubus instead of a help in the bodily economy.

The discussion of the amount of proteid required by young tissues is not touched by Chittenden. It is reasonable to suppose that more proteid is required during growth, as proteid is the "muscle-builder." The power of resistance shown during a long, exhausting disease by tissues nourished for a considerable time on a low proteid intake is also a point of interest. Chittenden's work does not enter on these points, and was not intended to do so.

The influence of this recent work on proteid requirements is seen in the Report of the Departmental Committee on Vagrancy, issued this year. The daily food allowance for casual wards and labour colonies is 70 grammes of proteid, while the total energy value of the diet is 3000 calories. The ration may, however, be supplemented from pocket-money given for industry.

So far, the history of the present dietary standards (expressed as proteids, fats, and carbohydrates) has been considered; and by what methods—at first empirical and later experimental—they have been arrived at. But other standards may be used. The food required may be stated in terms of the contained nitrogen and carbon.

The energy value expressed as heat also serves as an important standard. Lavoisier showed that the final change in the food in the body was a process of oxidation. Frankland decomposed different articles of food, and estimated the amount of heat liberated in the process of disintegration. The unit employed is the Calorie, *i.e.* the amount of heat required to raise 1 kilogramme of water 1 degree Centigrade. In estimating the heat value of proteid, it is necessary to remember that the final product of its metabolism is urea, and allowance must be made for this incomplete oxidation. Rübner* has estimated that 1 gramme of proteid gives on combustion 4·1 Calories; 1 gramme of carbohydrate also gives 4·1; while 1 gramme of fat yields 9·3 Calories. Taking into consideration more accurate chemical analyses and more recent

* *Zeitschr. f. Biol.*, xxi. (1885), p. 337.

knowledge as to the digestibility of different foods, as well as working with an improved calorimeter, Atwater and Bryant * suggest 4.0 as the factor for proteids and carbohydrates, and 8.9 for fats. Rübner's estimate is the one generally used.

The Calorific value cannot be taken as a rigid means of comparison between two dietaries, but it is none the less of great value. In order to perform severe muscular work, a diet of high energy value must be consumed. Since carbohydrates and fats are the main source of energy, at first sight it seems as if an increase in these nutrients would meet the requirements. But most people find that digestive disturbances are set up by a high fat and carbohydrate diet, and the increased amount of food must of necessity be proteid.

A practical application of this point is seen in Dunlop's Report to the Prison Commissioners.† The diet of certain convicts was of an energy value of 3928 Calories, and the waste was great. There was no waste when the diet was reduced to 3517 Calories, but the prisoners lost weight, and complaints were rife. When 74 grammes of bread were added to the ration, the diet was of 3707 Calories. There was no further loss of weight, the complaints ceased, and the waste was inconsiderable.

The dietary standards fixed by different authorities may be tabulated:—

	Proteids, grammes.	Fats, grammes.	Carbo- hydrates, grammes.	Calories.
Voit . . .	118	56	500	3054
Rübner . . .	127	52	509	3091
Playfair . . .	119	51	531	3139
Moleschott . . .	130	40	550	3160
Atwater . . .	125	125	450	3520

It is interesting to compare these with the results of Chittenden's experiments, in which the proteid varied from 44–50 grammes daily, with a Calorific value of 1550–3000 from the entire food.

* *Connecticut Storrs Station Report*, p. 73.

† See also "Food Requirements of Various Labour," *Scottish Medical and Surgical Journal*, 1901.

These standard dietaries are constructed to represent the requirements of an average man doing a moderate amount of muscular work. The amount required varies with the work done, with sex, age, weight, and climate. Personal idiosyncrasy in the matter of food is also a matter of common knowledge. Atwater gives a woman's requirements in food as 0·8 of a man at moderate labour. A boy of 14-16 years of age requires the same amount as a woman; a girl of 14-16 is regarded as requiring 0·7 of a man. A child under 2 years requires 0·3 of a man. Atwater derived these factors from Camerer's* work on energy requirements per unit of work at different ages. König gives practically the same ratio in suggesting 118 grammes of proteid, 56 of fat, and 500 of carbohydrate for a man; and 92 grammes of proteid, 44 fat, and 400 carbohydrate for a woman.

It is important to note that, in these estimates, no allowance is made for differences in the digestibility and absorbability of different kinds of food.

II. PREVIOUS DIETARY STUDIES.

Many studies of the actual diet consumed by different classes have been made both in America and in Europe. Atwater and his co-workers in America have investigated the dietary of different classes in the United States, and they have collected a large number of similar studies. These, of course, do not touch the question of the desirability or necessity for the ingestion of food in such quantities or in these nutritive proportions. Atwater did certainly suggest a standard, as has been already stated. But his dietary results are simply presented as the actual food on which the people live and work. They are taken as fairly representative of different classes of the community, of various social grades, with different customs as regards food. No doubt, the amount of food taken is largely the result of habit; but it must, to some extent, be founded on what experience has taught. Atwater † emphasises the fact that Americans eat more than people of the same social position in Europe. This applies especially to the working classes, and he explains on this ground

* Vierodt's *Daten u. Tabellen*, 1888, p. 7.

† "Foods, Nutritive Value and Cost," *Farmer's Bulletin*, 23.

what he regards as the greater working power of the American. As illustrative of the wide range of difference in the studies collected in America,* a low and a high dietary may be quoted.

A seamstress, whose diet was studied by Playfair, consumed daily 53 grammes of proteid, 33 grammes of fat, and 316 grammes of carbohydrate (energy value, 1820 Calories). A Californian student football team used 270 grammes of proteid, 416 grammes of fat, and 710 grammes of carbohydrate per man per day (energy value, 7885 Calories). It is needless to remark that this huge amount was taken during training. Jaffa, who reports this study, says that "the study seems, on the whole, to warrant the conclusion that the team was overfed."

A number of American middle-class dietaries, including studies of men and women university students, will be referred to later.

The dietary of public institutions has been worked out in a number of cases. Aitchison's *Investigations into the Diet of a Scotch Workhouse* and Smith's *Report of Dietaries of Lunatics and Workhouses* are examples of this kind of work.

A Royal Commission was appointed to inquire into prison dietaries, and their report was presented to the Houses of Parliament in 1878. The diet of soldiers was the subject of a Royal Commission inquiry, and a report on the subject was submitted in 1889. This contains suggestions for the improvement of the quality of the diet, and a comparison with the army dietary in other European countries. The British allowance was shown to be greater than that of the Continental armies. A soldier's daily allowance was then made 113 grammes of proteid, 38 grammes of fat, and 482 grammes of carbohydrate (Calories, 2793). De Chaumont considered this diet deficient, and thought that the allowance ought to be increased, especially in the case of the younger soldiers.

More recent work along the lines of the comparison of the

* *Report to the U.S. Commissioners on Fish and Fisheries*, 1888; and *Nutrition Investigations at the Californian Agricultural Experimental Station*, 1900.

actual food with the standard requirements is found in Dr Craufurd Dunlop's *Report on Dieting of Pauper Lunatics in Scotland* and in his *Report on Prison Dietaries*.

The diet of the working classes in Edinburgh was studied by Drs Noël Paton, Dunlop, and Inglis.* This work was carried out under the auspices of the Town Council of Edinburgh, on the recommendation of the Committee of Public Health. Fifteen families (ninety-five individuals) were studied. These varied from the well-to-do working-class household to those whose total income was less than 20s., and who were not in permanent employment. The average result was a daily amount of 107·7 grammes of proteid, 88·4 grammes of fat, and 479·4 grammes of carbohydrate (Calories, 3224) per man. One old woman subsisted on the meagre allowance of 46·1 grammes of proteid, 33·7 of fat, and 151·3 grammes of carbohydrate (Calories, 1124), expressed per man per day.

Rowntree† carried out an investigation into the social condition of the working classes in York. He discusses the general conditions under which these people live. A special study was made of their food. As a result of his work, he drew up a poverty scale—a table of the minimal amount per week on which “merely physical efficiency” could be maintained. His allowance per man per week for food on this scale is 3s. Of the families studied in York, the daily amount per man was 89 grammes of proteid, 79·9 of fat, and 385·5 of carbohydrate (Calories, 2685).

These York dietaries were compared with Atwater's standard, and 29 per cent. were deficient in proteid, while there was 23 per cent. deficiency in fuel value.

Unfortunately, there is an error in Rowntree's work. The percentage of carbohydrate in flour is entered at 57·1 per cent. instead of 75·1 per cent., and as flour enters largely into the food, the total error is considerable.

Lumsden made an inquiry into the food-supply of the employees of Messrs Guinness in Dublin. His results are published in book

* *A Study of the Diet of the Labouring Classes in Edinburgh*. Otto Schulze & Co.

† *Poverty: A Study of Town Life*. London, 1901.

form.* The average food "as purchased" per man per day in the seventeen families was: 98 grammes of proteid, 89·8 of fat, and 467·7 grammes of carbohydrate. When the coefficient of digestibility of the different foods is allowed for, this represents 85·35 grammes of proteid, 86·2 of fat, and 447·6 of carbohydrates. Lumsden's investigation had the advantage of being carried out for a number of weeks. It is noteworthy that only three of these families had a proteid allowance equal to Atwater's standard. The others were 21·5 per cent. below the requirements. Lumsden says of four families in particular: "All the families are living under the poverty line, and one will rather expect to find a lamentable state of want: however, strange to relate, these families live a happy, contented existence; the children are well kept and particularly healthy-looking."

Numerous Japanese dietaries have also been studied. They have recently been published in English.† Tahara suggested that Japanese, owing to their smaller stature, required less than average Europeans and Americans as their daily allowance. His conclusion was, that the Japanese required 96 grammes of proteid, 20 grammes of fat, and 450 grammes of carbohydrate (Calories, 2380) (*Bullet. Imp. Sanit. Lab. Tokio*, 1887, No. 2). Rübner's factor for energy value is stated to be inapplicable to Japanese food, as it differs from that of Europeans in digestibility. For vegetable proteid, 3·56 was the factor used, and 4·45 for animal proteid. Nearly 400 different dietary studies have been made in Japan. All classes of the community were studied, but no studies of women were made. The period of observation varied from three days to a year.

The general result was that the Japanese were found to be well nourished. They are not vegetarians to anything like the extent that they are supposed to be. Rice is a most important article of diet, but the well-to-do classes take meat and fish to a considerable extent. The vegetarianism is more from economy than from principle, except in the case of strict Buddhists.

* *An Investigation into the Income and Expenditure of Seventeen Brewery Families, and a Study of their Diets*, 1905.

† "A Digest of Japanese Investigations on the Nutrition of Man," by Kintaro Oshima, *Bulletin* 159 of the U.S. Department of Agriculture, 1905.

Cows are scarce in Japan; dairy products are expensive, and can only be obtained by the wealthy classes.

The Japanese eat less than Europeans, but their body-weight is considerably less. The studies of the diet of Japanese students will be considered later.

Studies of the actual food consumption of communities in this country have been confined, so far as I am aware, to these investigations of the dietary of the working classes and of public institutions. There is an impression, which is steadily gaining ground, that the average amount of food consumed by the middle classes, where the factor of cost is not all-important as with labourers, is much greater than even the usual dietary standards.

III. PRESENT INVESTIGATION AND RESULTS.

In order to determine the actual food consumed, a study was made of five residences for students in Edinburgh. Many of these students, especially those studying medicine, have a considerable amount of physical exercise while at work. A number also engage in athletics; but, taken all round, one cannot say that students have what, as purely physical exertion, would be regarded as a moderate day's work. The food requirements of mental work have been studied by Atwater* with great care. A man was confined in a respiration calorimeter. The bodily waste was not found to be increased when the subject of the experiment diligently studied a German scientific book. It has been suggested that, since the nervous system contains 8 per cent. of fatty material, much fat is necessary in mental work.† Leaving the difficulty of digestion of fats out of consideration, the absence of appreciable bodily waste during hard study makes this view untenable. Other popular theories are that fish and phosphorus are direct mental stimulants, but these are not founded on scientific facts. The truth seems to be that easily digested food is best for those engaged in brain-work. The digestion of a heavy meal entails an expenditure of nervous energy, and the blood-supply to the brain is interfered with by the increased supply to the digestive organs.

* U.S. Department of Agriculture, *Bulletin* 44. 1897.

† Referred to by Yeo, in *Food in Health and Disease*.

The method employed in making the present studies was that adopted by Atwater and his colleagues. A detailed account of this is given by Bryant in "Some Results of Dietary Studies in the United States" (reprint from the *Yearbook of the Department of Agriculture* for 1898).

An inventory is made of all the food in the house. Everything is weighed accurately on a tested balance. Each article of food as it is purchased is weighed and added to the inventory. At the end of the study, everything is again weighed. The amount actually used is then calculated. But all the food is not actually consumed. The "refuse" (that is, the inedible part) is allowed for in the chemical analyses, and so in the determination of calorific value. A certain amount of the food is also inevitably wasted. All the "waste" (that is, nutritive material which has not been actually consumed) is also sorted out, and it is carefully weighed and deducted from the food used. In this way the actual consumption during the period of study is arrived at. The cost of the food is also taken into account, and the expenditure on this item per man per diem is calculated. In giving the cost of the "waste," an estimate was obviously all that could be given. A note is also made when anyone is absent from a meal, and the presence of guests is also taken into consideration, in order to make the results as accurate as possible.

The analyses used were chiefly taken from Atwater's "Chemical Composition of American Food-Things" (*Bulletin* 28—revised edition—of the U.S. Department of Agriculture). König's *Chemie der menschlichen Nahrungs und Genussmittel*, Wynter Blyth's *Foods, their Composition and Analysis*, Noble and Firth's *Text-book of Hygiene*, Mitchell's *Flesh Foods*, and Hutchison's *Food and Dietetics* were also consulted. Several analyses made by Dr Craufurd Dunlop in the Laboratory of the Royal College of Physicians, Edinburgh, were also used. In two cases, galantine and haggis, the quantities used were so small that an analysis was not made, but an estimate was made from their composition.

The present studies were conducted for one week—during the month of February in one case, and March in the others. In Studies A, B, C, and D the students in residence were men. All the servants were women, and they were allowed for by

Atwater's estimate—a woman is regarded as eating 0·8 times as much as a man. In Study E the students were women, so each member of the household was calculated on the 0·8 basis.

As the nutritive value of beverages and condiments is small, and their composition varies somewhat, they have not been included in the general results. The amount expended on these two items has been calculated separately. In two of the studies—A and D—the cost of beer is included in the beverages. In the other three studies, beer is not considered.

Five halls of residence were studied, by the kind co-operation of the housekeepers, who undertook the arduous work of keeping accurate accounts of the amounts purchased, and seeing that the waste was collected.

The studies represent collectively the dietary of 1129 men for one day. Allowance in each case was made for absence from meals, and for the presence of guests.

Men	{	Study A = 239·4 men for one day (31 men, 8 women).
		,, B = 198·8 ,, (24 ,, 6 ,,).
		,, C = 316·4 ,, (39 ,, 9 ,,).
		,, D = 207·2 ,, (25 ,, 7 ,,).
Women		,, E = 167·6 ,, (30 women.)
Total		1129·4 ,, (119 men, 60 women).

The figures given in brackets above are those in residence for the week, without allowance for guests and absence. The others are with the allowance made.

(A) *General Statistics of Studies.*

TABLE I.

	Proteid, grammes.	Fat, grammes.	Carbo- hydrate, grammes.	Calories.	Cost in pence.	Men for one day.
Study A .	146·41	160·57	531·33	4303·05	16·7	239·4
,, B .	121·89	106·58	527·55	3663·89	15·5	198·8
,, C .	134·43	137·25	496·79	3864·41	14·3	316·4
,, D .	154·66	146·11	507·50	4073·46	15·8	207·2
,, E .	161·67	139·54	494·92	3989·73	13·6	167·6

This table shows how comparatively closely all these studies

follow the average. Study E is, however, highest in proteid, while B is considerably lower than the others.

Study B is, again, noticeably lowest in fats, but is of high carbohydrate value, and closely approaches the average of energy value.

In Study A, the large amount of fat probably accounts for the slightly higher cost. The high energy value in D results from the large amount of fat associated with proteid and carbohydrates, both of which are over the average in these studies.

The amount of proteid in each one of these diets is in excess of the amount allowed in any dietary standard, the average exceeding the 125 grammes daily of Atwater by 18 grammes, and the 130 grammes of Moleschott by 13 grammes. When, however, this proteid intake is compared with Chittenden's results, it is seen how greatly his requirements are exceeded. If the highest proteid value in his work—soldiers on 55 grammes per man per day—is taken, and compared with the average in the present—143 grammes,—we find the proteid ingested in the latter case is more than twice and a half the amount in the former. The smallest amount of proteid taken exceeds 55 grammes by as much again—the highest proteid is just short of three times 55 grammes.

In Study E, the students were healthy, active, young women. On contrasting this with the other studies, one is struck with the high proteid value of their diet (expressed per man per day). The fat just touches the average, and the carbohydrate falls below it. Although general conclusions cannot be drawn from one study, it is interesting to see that this is in direct opposition to the popular idea that women consume relatively less proteid than men, and more carbohydrate.

(B) *Proportion of Animal and Vegetable Proteid.*

Rübner* considers that in a properly balanced diet the animal should exceed the vegetable proteid. These studies show the proportion that Rübner thought important, and give practically the percentage—60 per cent.—that he considered

* *Zeitschrift f. Biologie*, N.F., Band iii., 1885, p. 374.

desirable. The average shows that 63 per cent. of the total proteid is animal, while 37 per cent. is vegetable. It is noticeable that Study E, with the highest total proteid—161 grammes—has the lowest amount of proteid of vegetable origin. The animal proteid is 70·4 per cent. of the total. In Study B, the animal is more nearly approximated to the vegetable, being 58·4 per cent. of the total proteid.

TABLE II.

Showing amount of animal and vegetable proteid.

	Animal.	Vegetable.	Total.
A	89·39	57·02	146·41
B	71·29	50·60	121·89
C	82·92	51·51	134·43
D	96·34	58·32	154·66
E	113·73	47·94	161·67
Total	453·67	265·39	719·06
Average	90·73	53·07	143·81

This result—the greater amount of animal proteid present—is in contrast to what was found in the Edinburgh labourers' diet. As the result of fifteen investigations, Drs Noël Paton and Dunlop* found that the animal proteid was only 44·9 per cent. of the total proteid.

(C) *Energy Intake.*

If Table I. is again referred to, the high calorific value of the food is noticed. This is due in great measure to the large amount of fat present. In B, the comparatively small amount of fat is compensated for, as regards energy value, by the high carbohydrate. In each one of the studies, however, the energy value is considerably in excess of even Atwater's liberal standard of 3520 Calories.

(D) *Cost of Diet.*

The average cost per man per day is here 15·1 pence (Table III.). In this, the cost of beverages and condiments is not included, as beer is only allowed for in two studies. The relative costs of

* *Op. cit.*

“beverages and condiments” are consequently not comparable, but, omitting stimulants, the average cost would be about 0·7 pence. Of the total expenditure on animal and vegetable food, 66 per cent. is for animal food.

TABLE III.
Cost per man per day, in pence.

	On Animal Food,* pence.	Vegetable Food, pence.	Total, pence.	Beverages and Condi-ments, pence.	Grand Total, pence.
A	11·1	5·6	16·7	1·7*	18·4
B	10·2	5·3	15·5	1·0	16·5
C	9·7	4·6	14·3	0·8	15·1
D	9·6	6·2	15·8	1·7*	17·5
E	9·9	3·7	13·6	0·7	14·3
Total . .	50·5	25·4	75·9		81·8
Average .	10·1	5·0	15·1		16·36

* Includes beer.

In the following table, the amount of animal and vegetable food and the energy value for this expenditure is given :—

TABLE IV.
Animal and vegetable food per man per day.

	Proteid, grammes.	Fat, grammes.	Carbo-hydrate, grammes.	Energy Value, calories.	Cost, pence.
Animal . .	90·73	126·20	38·78	1708·86	10·1
Vegetable .	53·07	11·80	472·83	2270·04	5·0
Total . .	143·80	138·0	511·61	3978·90	15·1

The above table shows again the points already referred to,—the excess of animal over vegetable proteid and the greater amount of money expended on animal food. The average return per penny expended on animal food is 9 grammes of proteid, 12·6 grammes of fat, and 3·8 of carbohydrate, with an energy value of 170 Calories: a penny spent on vegetable food gave 10·6 grammes of proteid, 2·3 grammes of fat, and 94·5 grammes of carbohydrate, with an energy value of 454 Calories.

The following table gives a comparison of present study with Edinburgh labourers' family diet as regards return for one penny.

TABLE V.

	Proteid, grammes.	Fat, grammes.	Carbo- hydrate, grammes.	Calories.
<i>Animal.</i>				
Present study . . .	9	12·6	3·8	170
Labourers . . .	11	19·1	3·4	235
<i>Vegetable.</i>				
Present study . . .	10·6	2·3	94·5	454
Labourers . . .	23·0	4·1	167·9	836

The consumption of food-material in grammes per man per day is shown below.

TABLE VI.

	A.	B.	C.	D.	E.	Average and Total.
Beef, veal, and mutton	181·4	149·17	177·24	233·76	238·82	980·39 (196·07)
Pork, lard, etc.	58·0	25·04	12·25	28·4	22·55	146·24 (29·24)
Poultry and game	38·7	26·47	19·31	18·29	21·69	124·46 (24·89)
Fish, etc. . .	78·6	83·27	101·75	95·90	114·04	473·56 (94·71)
Eggs . . .	62·7	55·0	59·2	41·1	31·83	249·83 (49·96)
Butter . . .	47·9	43·83	58·66	60·91	49·30	260·60 (52·12)
Cheese . . .	36·0	14·66	7·33	6·96	4·74	78·69 (15·73)
Milk . . .	771·0	697·32	752·24	869·22	784·97	3874·75 (774·95)
Total animal .	1241·9	1094·76	1188·24	1354·54	1167·94	6047·38 (1209·47)
Cereals . . .	437·05	374·90	467·05	380·07	451·67	2110·74 (522·14)
Sugars and starches	175·8	232·70	169·95	158·41	159·02	895·98 (179·19)
Vegetables . .	528·8	378·71	364·04	743·49	467·70	2482·74 (496·54)
Fruits . . .	106·9	87·20	21·64	59·50	46·07	321·31 (64·26)
Total vegetable	1248·55	1073·51	1022·68	1341·47	1124·46	5810·67 (1162·13)
Total food . .	2490·45	2168·27	2211·16	2696·01	2292·40	11858·29 (2371·65)

In Tables VII. and VIII. individual articles of food have not been selected for estimation of cost and to calculate the relation to the total diet. In working-class diet, there are certain staple foods, such as potatoes and bread, which bulk largely in the food each day, and so may be compared in different households. In these studies it was thought that a better classification would be made by taking classes of food, *e.g.* cereals and fruits, and this has been done in the two following tables.

TABLE VII.

Cost of various food-materials per man per day.

	A.	B.	C.	D.	E.	Total.	Average.
Beef, etc.	4·0	4·6	3·6	4·2	4·6	21·0	4·2
Pork, etc.	1·1	0·5	0·2	0·5	0·4	2·7	0·5
Poultry, etc.	0·8	0·6	0·6	0·3	0·05	2·35	0·47
Fish	0·6	0·7	0·7	0·6	1·0	3·6	0·7
Eggs	1·3	0·9	1·0	0·6	0·5	4·3	0·8
Butter	1·4	1·1	1·6	1·7	1·4	7·2	1·6
Cheese	0·08	0·04	0·1	0·1	0·1	0·42	0·08
Milk	1·9	1·8	1·9	1·6	1·9	9·1	1·8
Cereals	2·5	2·2	2·4	2·0	1·6	10·7	2·1
Sugars and starches	1·5	1·9	1·1	1·3	0·9	6·7	1·3
Vegetables	1·0	0·6	1·0	2·4	0·8	5·8	1·1
Fruits	0·6	0·6	0·1	0·5	0·4	2·2	0·4

TABLE VIII.

Percentage of total food-material.

	A.	B.	C.	D.	E.
Beef, etc.	7·4	7·3	8·0	8·7	9·6
Pork, etc.	2·5	1·2	0·5	1·1	1·0
Poultry, etc.	1·7	1·3	0·8	0·8	0·9
Fish	3·2	3·8	4·6	3·6	4·9
Eggs	2·6	2·6	2·6	1·6	1·4
Butter	1·9	2·0	2·6	2·2	2·1
Cheese	0·2	0·7	0·3	0·2	0·2
Milk	30·5	31·7	34·2	32·2	33·1
Cereals	17·5	17·2	21·3	14·0	18·6
Sugars, etc.	7·0	10·6	7·7	5·9	6·9
Vegetables	21·2	17·4	16·5	27·5	19·3
Fruits	4·3	4·2	0·9	2·2	2·0
	100·0	100·0	100·0	100·0	100·0

(E) *Total Animal and Vegetable Foods.*

TABLE IX.

	A, grammes.	B, grammes.	C, grammes.	D, grammes.	E, grammes.
Animal . .	1241·9	1094·76	1188·24	1354·54	1167·94
Vegetable .	1248·55	1073·51	1022·68	1341·47	1124·46
Total . .	2490·45	2168·27	2210·92	2696·01	2292·40

In Tables VIII. and IX. it is seen how closely the diets are related in the percentage of the different food-materials taken.

Table IX. shows that the total food ingested varied only from 2168 to 2696 grammes per man per day. There is also great similarity in the relative amount of individual groups of food-stuffs. This is more marked, as one would expect, in the animal food-materials. Cereals, fruits, etc., are more likely to vary with chance circumstances, such as the menu for the particular week of study. This is seen in Table VIII. most markedly with regard to fruits. In Study A, fruit is 4·3 per cent. of total food consumed; while in Study C 0·9 per cent. of fruit is present, with the high cereal figure of 21·3 per cent.

(F) *Waste.*

Tables X. and XI. show that the waste varied very considerably. The proteid waste varied from 3·5 per cent. to 8 per cent. of the proteid purchased. A similar variation is seen in the fat waste—from 5·6 per cent. to 11 per cent. of the total fat. The high proteid and fat waste are found together as they represent the waste in animal food-stuffs—beef and bacon, etc. The percentage of unused carbohydrate is lowest as 0·5 per cent. and highest as 10·2 per cent. In this case, the carbohydrate waste is chiefly in bread and potatoes.

The cost of the waste materials can only be given approximately. The lowest estimate is 0·31 pence per man per day, and the highest is associated with high proteid and fat waste, and is given as 1·2 pence. Stated in another way, the price of waste material varies from 2·4 per cent. to 7 per cent. of the total money expended on food.

This statement of waste cannot be taken as more than an indication of the average amount of food purchased which is not consumed. In the different studies very different food-materials were used, and from a study of only one

TABLE X.
Waste per man per day.

	Proteid, grammes.	Fat, grammes.	Carbo- hydrate, grammes.	Fuel Value (Calories).	Cost (approx- imately), pence.
A.					
Animal . . .	3·31	7·41	0·0	61·46	0·3
Vegetable . . .	3·27	0·18	13·33	69·73	0·01
Total . . .	6·58	7·59	13·33	131·19	0·31
B.					
Animal . . .	4·21	9·07	0·0	101·61	0·76
Vegetable . . .	0·3	0·02	2·01	9·65	0·0
Total . . .	4·51	9·09	2·01	111·26	0·76
C.					
Animal . . .	5·76	11·97	0·02	134·61	0·9
Vegetable . . .	3·33	0·36	21·56	105·39	0·1
Total . . .	9·09	12·33	21·58	240·00	1·0
D.					
Animal . . .	7·48	17·52	0·37	195·11	0·7
Vegetable . . .	5·75	0·72	32·64	164·08	0·5
Total . . .	13·23	18·24	33·01	359·19	1·2
E.					
Animal . . .	3·13	7·3	0·0	80·72	0·3
Vegetable . . .	9·16	1·08	50·68	255·38	0·4
Total . . .	12·29	8·38	50·68	336·10	0·7

week accidental differences are emphasised. Bearing in mind the difference between "refuse" and "waste," as previously defined by Atwater, one sees that increased consumption of certain articles of food tends to increased waste. An example is the increased fat waste associated with a large consumption of ham and bacon, while eggs have practically no waste. Recognising

this, the waste is best expressed as an average. This is found to be 9·14 grammes of proteid, 11·12 grammes of fat, and 26·12 grammes of carbohydrate per man per day. This represents 234·54

TABLE XI.
Waste as percentage of total food purchased.

	Proteid.	Fat.	Carbo- hydrate.	Fuel Value.	Cost.
A.					
Animal . . .	2·1	4·4	0·0	1·6	1·8
Vegetable . .	2·1	2·1	2·4	1·5	0·6
Total . . .	4·2	6·5	2·4	3·1	2·4
B.					
Animal . . .	3·3	7·9	0·0	2·8	4·8
Vegetable . .	0·2	0·0	0·5	0·2	0·0
Total . . .	3·5	7·9	0·5	3·0	4·8
C.					
Animal . . .	4·5	7·9	0·1	3·3	5·8
Vegetable . .	2·3	0·6	4·2	2·5	0·6
Total . . .	6·8	8·5	4·3	5·8	6·4
D.					
Animal . . .	4·6	10·6	0·1	4·7	4·1
Vegetable . .	3·4	0·4	6·0	3·6	2·9
Total . . .	8·0	11·0	6·1	8·3	7·0
E.					
Animal . . .	1·7	4·9	0·0	1·9	2·1
Vegetable . .	5·2	0·7	10·2	5·9	2·9
Total . . .	6·9	5·6	10·2	7·8	5·0

Calories, and costs 0·79 pence. A comparison of the waste of this case with that in American college studies will be given later.

This waste cannot reasonably be compared with that in working-class households with children, as in these cases the younger members of the household are frequently fed on what remains from the meals of their elders, and scraps can naturally be utilised in a way that is impracticable in better-class houses.

IV. COMPARISON OF PRESENT RESULTS WITH OTHER
SIMILAR DIETARY STUDIES.

These results may be compared with the diet of the poorer labouring classes in Britain. The rural diets were compiled from the Board of Trade returns; the urban are the result of the investigations already referred to.

Rural Diets (grammes per man per day).

	England (Eastern Counties).	Scotland (Northern Counties).	Ireland.
Proteids	100	124	98
Fats	76	81	57
Carbohydrates	578	570	586
Calories	3480	3601	3337

Urban Diets.

	Edinburgh (Noël Paton and others).	York (Rowntree).	Dublin (Lumsden).
Proteids	107	89	98
Fats	88	80	90
Carbohydrates	479	386	468
Calories	3228	2685	3107

There is greater interest, however, in a comparison with the dietary of students in other countries. A number of studies have been made in America and in Japan.

Atwater and Bryant* have tabulated the diet of American university boat crews in training, and give as the average of six studies of crews and one individual study of a captain the following figures: proteid, 155 grammes; fat, 177; carbohydrate, 440; Calories, 4085 per man per day.

Other college athletes' results are:—College football team, Connecticut (*Connecticut Storrs Station Report*, 1891): proteid, 181 grammes; fat, 292 grammes; carbohydrate, 577; Calories, 5740, and a Californian college football team ("Nutrition

* *Bulletin* 75, U.S. Department of Agriculture, "Dietary Study of University Boat Crews."

Investigations at the Californian Agricultural Experiment Station," *Bulletin* No. 84, U.S. Department of Agriculture), with 270 grammes of proteid, 416 grammes of fat, and 710 grammes of carbohydrate, representing 7885 Calories.

Comparison with American and Japanese Students' Diets.

	Proteid, grammes.	Fat, grammes.	Carbohydrate, grammes.	Calories.
Average of 16 men's clubs	105	147	465	3705
Average of women's clubs	101	139	414	3402
Average of 2 Japanese men's clubs	98	15	440	3320
Average of Edinburgh studies	143	138	511	3978

These men were "in training," and so the results are not a good means of comparison. Other American college studies, expressed per man per day, are as follows:—

	Proteid, grammes.	Fat, grammes.	Carbo- hydrate, grammes.	Calories.
Average 5 clubs (Tennessee)* Men	103			3820
" 5 " (Conn.)† "	127			3880
" 5 " (Maine)‡ "	159			5440
" 3 " (Missouri)§ "	107			3920
" of 16 men's clubs	105	147	465	3705
Women's club (Lake Erie College)	85	144	401	3330
Women's club (Chicago University)¶	135	128	476	3685
Women's Club (Middletown, Connecticut)**	105	160	330	3270
Women's Club (Fargo, North Dakota)	80	124	450	3325

* "Nutrition Investigations in the University of Tennessee," *Bulletin* No. 53, U.S. Department of Agriculture.

† *Connecticut Storrs Station Report*, 1896.

‡ U.S. Department of Agriculture, *Bulletin* 37.

§ Same, *Bulletin* 31.

|| Same, *Bulletin* 91.

¶ *Review of Reviews*, 1896.

** *Connecticut Storrs Station Report*, 1894.

The Japanese men students' dietary * is also expressed per man per day :—

	Proteid, grammes.	Fat, grammes.	Carbo- hydrate, grammes.	Calories.
Medical students (poor class)	74·4	6·0	479·2	2419
Medical students (good class)	86·0	13·2	333·6	1845
Good-class students (another study)	109·8	17·8	546·3	2796

Several other results are given, but they are not quoted, as waste material is not considered.

The average result for the present studies is: proteid, 143 grammes; fat, 138; carbohydrate, 511; Calories, 3978. With the single exception of the fats, this is higher than the American work, although the high energy value of fat makes the total calorific results closely resemble each other. The disparity between the American and the Edinburgh dietaries is most noticeable in the women's studies. The Edinburgh women students consumed a greater amount of proteid and carbohydrate, and their food had a higher Calorific value.

The Japanese proteid and fat value, especially the latter, are noticeably small, and are both the result of the low animal intake, but it is necessary to remember the small stature of the Japanese.

In connection with this comparison between British and American dietaries, it is noteworthy that Atwater refers to the American of the same social position as being more abundantly fed than the Briton. He believes that the American is more energetic and able, and he attributes this to the more abundant food-supply. His conclusions are hardly borne out by the investigation into the proteid supply of labourers in Edinburgh. These men have as much proteid daily as the labouring class in Philadelphia and New York, although their supply is less than people of the same condition in Chicago.† If we accept Chittenden's view, the additional proteid is an evil instead of an advantage.

* *Op. cit.*

† See *Bulletin* 21 and *Bulletin* 46, U.S. Department of Agriculture.

*Comparison of Percentage Waste of Nutrients with that in
American College Clubs.*

	Proteid, per cent.	Fat, per cent.	Carbo- hydrates, per cent.	Calories.
Women's clubs (3) * . . .	13·8	10·2	6·7	9·1
Men's clubs (14) . . .	16·8	19·2	10·9	14·9
Edinburgh students . . .	5·8	7·9	4·7	5·6

* References previously given.

A comparison of waste cannot be made strictly, as the amount is bound to vary with many circumstances; but so far as it goes it tends to show that the housekeeping in Edinburgh is more economical than in college residences in America.

Of course it is impossible to compare the American and Edinburgh students' results as rigidly representing the same class. Students, even in the same university, are by no means similarly situated as regards the amount of money which can be expended on living generally, and on food in particular. It would be absolutely erroneous to conclude that the average amount spent by students in Edinburgh or in other Scotch university towns in any way approaches the expenditure given in these studies. Dire necessity limits the expenses of many Scotch students. The fairly close correspondence in the studies given is of no little interest. With increased expenditure on food, the nutritive value of food does not necessarily rise. This has already been shown in Table V. The tendency is probably not so much to increase the quantity of food eaten as to get a better quality, and to use more expensive articles of diet. If the question of cost has not to be considered, there can be no possible objection to this. But in the great majority of cases, all over the country, the struggle for existence is so keen that money spent needlessly on food cripples the funds for other requirements. A knowledge of true economy in food is then of the highest importance.

A study of the food-materials used shows that on the whole they were those ordinarily used in middle-class dietaries, and

so it is perhaps not too much to assume that these results may be taken as fairly representative of the diet of this class, giving as they do the food consumed by over a thousand men in one day. The expenditure also approximates to the average middle-class expenditure.

The only accurate account that I could obtain of the expenses of a private well-to-do family has been put at my disposal by a lady who has kept a detailed account of her household for five years. This works out at 11s. 4d. per man per week, but in this no allowance is made for the presence of guests and for special food in time of illness.

Most people, when asked, give 10s. a week as an average middle-class food allowance, and the average in the present study is 9s. 2d. per week. This lower figure may be due partly to co-operation in diet, with the possibility of contract prices; but as the data for comparison are uncertain, it is, unfortunately, impossible to emphasise this important point.

V. SUMMARY OF RESULTS.

1. The diet of five halls of residence was studied. This represents the food of 1129·4 men for one day.

2. The average amount taken per man per day was: proteids, 143 grammes; fats, 138 grammes; carbohydrates, 511 grammes; with a fuel value of 3979 Calories.

3. In all the studies the proteid value is high. The animal proteid is 63 per cent. of the total proteid.

4. The average cost per man per day (exclusive of beverages and condiments) is 15·1 pence. Sixty-six per cent. of this is expended on animal food.

5. The amount of nutritive material per penny is much lower than that given in the study of the diet of Edinburgh labourers' families.

6. The waste varies considerably. The approximate cost of waste was from 2·4 per cent. to 7 per cent. of the total money spent on food.

7. The proteids and carbohydrates are higher than in the American college studies. As the fats are lower, the Calorific

value is about the same. The amount of food taken is greatly in excess of that in Japanese students' dietaries.

8. The waste is only about one-half of that in the American studies of college residences.

9. The expenditure on food of 9s. 2d. per man per week seen in this study is probably about the average spent on a middle-class dietary.

(Issued separately November 9, 1906.)

Further Study of the two Forms of Liquid Sulphur
as Dynamic Isomers. By Alexander Smith and
C. M. Carson.

(MS. received July 13, 1906. Read July 13, 1906.)

(Abstract.)

When sulphur to which after recrystallisation *no air has had access* is melted, or when ammonia is led for a few minutes through ordinary sulphur after it has been melted, the two forms of liquid sulphur (yellow, mobile S_λ , and brown, viscous S_μ) adjust themselves very rapidly to those proportions which are in equilibrium at that temperature to which the liquid may have been raised. The adjustment occupies but a few moments. When specimens thus prepared are then chilled by plunging into water, the reversion of the S_μ to S_λ is equally rapid, and therefore the product is wholly brittle, crystalline, monoclinic sulphur. This behaviour is observed whether the liquid has been heated at, say, 155° , where the amount of S_μ at equilibrium is 7.2 per cent., or at 448° , where the amount is at least 34 per cent.

Sulphur which has been *exposed to the air* since recrystallisation, when melted, reaches a condition of equilibrium with measurable slowness at the lower temperatures. Thus at 155° the proportion of S_μ at the end of an hour is only 6.8 per cent., and not until nearly two hours have elapsed does it reach 7.2 per cent. Leading a few bubbles of sulphur dioxide or of hydrogen chloride through melted sulphur which since recrystallisation has never been exposed to the air confers upon it the same slowness in reaching equilibrium. Specimens of ordinary sulphur, and of sulphur treated with sulphur dioxide, therefore, when chilled do not lose their content of S_μ by reversion. Hence practically the whole amount present at equilibrium at a given temperature may be supercooled and obtained after extraction of the mass eventually as amorphous sulphur.

Thus the proportions at equilibrium at any temperature may most quickly and accurately be measured by leading in ammonia

during the heating, to accelerate the adjustment, and then using sulphur dioxide before chilling, in order to retard the reverse change.

All the gases named above act as simple catalytic agents. Iodine retards the adjustment to equilibrium also, but it likewise acts as a second component in the system and displaces markedly the equilibrium. Two parts of iodine to one hundred of sulphur at 150° increase the S_μ by 7 per cent., and at 448° by 30 per cent.

The two liquid forms of sulphur, S_λ and S_μ , are to be classed as "dynamic isomers." The freezing-point of the former is $119\cdot25^\circ$

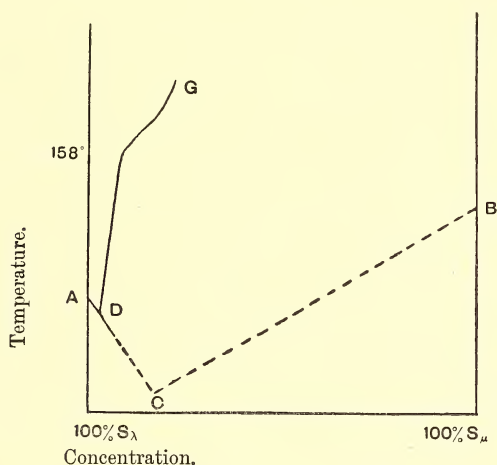

(these *Proceedings*, vol. xxiv. (1902), p. 300); that of the latter is unknown. In presence of ammonia the freezing-point is $114\cdot5^\circ$. This is the temperature at which the two liquid forms of sulphur are in equilibrium with one another and also with solid, monoclinic sulphur. It is the triple point or so-called "natural freezing-point." At this point the proportions of S_λ and S_μ in the liquid are 96·3 and 3·7 per cent. respectively. It has not been possible to observe any freezing-point and simultaneously measure the proportion of S_μ (by chilling; these *Proceedings*, vol. xxiv. (1902), p. 299), below $112\cdot45^\circ$, where the proportion of S_μ was 5·3 per cent. In the figure, which is drawn to scale, these facts are shown diagrammatically. *A* is the freezing-point of S_λ ($119\cdot25^\circ$, $S_\mu = 0$), *D* the natural freezing-point ($114\cdot5^\circ$, $S_\mu = 3\cdot7$ per cent.),

B is the freezing point of S_μ , and its exact location is unknown, and C is the eutectic point (also unknown.)

The curve DG in the diagram is the line showing the proportions of S_λ and S_μ in the liquid at various temperatures, and extends from the natural freezing-point to the boiling-point. Only the lower part is shown. The general form of this curve was determined by measurements at intervals of ten degrees, which were given in a previous paper (these *Proceedings*, vol. xxv. (1905), p. 590, par. 2). The proof that there were two distinct forms of liquid sulphur, given in another paper (these *Proceedings*, vol. xxv. (1905), p. 588), however, suggested the possibility that there might be a transition point at which a sudden change from little to much S_μ took place, with formation of a new phase composed mainly of viscous sulphur. The dilatometric experiments given in the last-mentioned paper showed that this point, if it existed, must be situated at $160\cdot0^\circ$, the point of minimum coefficient of dilatation. In order to ascertain whether any such sudden increase in the proportion of S_μ occurs, a new series of observations in the neighbourhood of 160° has now been made, and the exact form of the curve in this region has been determined. These measurements show that, when equilibrium has been reached, the proportion of S_μ at 155° is 7·7 per cent. and at 165° 15·5 per cent., and that the change in concentration, degree by degree, between these points is continuous. It follows, therefore, that although there are two markedly different forms of liquid sulphur, these forms are miscible in one another to such an extent that no separation into phases occurs when the system is in equilibrium. At all events, the new observations do not afford any evidence that there is a separation. The two phases can be observed only when the system is cooling and is in an unstable condition.

In view of the conclusion just mentioned, there was at least one anomaly which required explanation, namely, the marked absorption of heat and fall in temperature at, or just above, 160° , which are observed when liquid sulphur is heated continuously. The phenomenon is so strongly suggestive of a transition point, accompanied by the formation of a new phase, that it requires separate elucidation. A large number of experiments, of which a few illustrations only are here given, served to clear up the difficulty.

When ordinary liquid sulphur is heated at the rate of about two degrees per minute, the thermal effect asserts itself, with simultaneous sudden access of viscosity, at 167°. The same degree of viscosity is attained with slow heating at 160°, without thermal effect, and when equilibrium is reached at this temperature the proportion of S_μ is 10·7 per cent. Apparently, when the heating is rapid the proportion of S_μ lags behind that required for equilibrium, and the proportion necessary to give the marked viscosity has not accumulated until 167° has been reached. When the same experiment is continued by allowing the specimen of sulphur to solidify and the material is then remelted and heated rapidly once more, the viscosity and thermal effect now supervene at 163°. Evidently the cooling and solidification, although they have destroyed a part of the S_μ , have not destroyed it all. Hence during the second heating the proportion of S_μ is always somewhat larger than during the first heating, and thus the thickening occurs sooner and at a lower temperature. When the sulphur is cooled only to 130° before being heated for the second time, the loss of S_μ is even less, and with rising temperature the mass is still nearer to the equilibrium condition at each temperature. Under these circumstances, therefore, the viscosity begins gradually at 159°, and no noticeable thermal effect whatever is observed.

These inferences were confirmed by measurements of the proportions of S_μ present at various stages of the rapid heating. With sulphur melted at 121° and heated at the rate of two degrees per minute, the following proportions of S_μ were found:—

Temperature	121°	154°	156°	162°	165°	167°
Per cent. S_μ 2° per min.	0·04	5·4	5·7	6·4	7·5	10·3
Per cent. S_μ , equilibrium	3·75	7·5	8·0	13·5	15·5	16·7

At 167° the sample was taken just as the great viscosity was setting in. In the lower line the percentages of S_μ at the same temperatures, when equilibrium has been reached, are given for comparison. It will be seen that with rapid heating the proportion is from 2 to 6 per cent. less.

Finally, the changes in concentration going on *at* 167°, during the process which manifests itself in heat absorption and rapid increase in viscosity, were studied by chilling various samples

at different stages of the thickening, but always at the same temperature (167°). The percentages of S_{μ} found were:—

10.5 11.6 12.9 14.0 15.1

The rapid adjustment of this system, when once 167° has been reached, to a state nearly approaching that required for equilibrium, involving as it does an acceleration of the endo-thermal action $S_{\lambda} \rightarrow S_{\mu}$, thus offers a sufficient explanation of the sudden absorption of heat at this point.

(*Issued separately November 12, 1906.*)

set of equations is not the same as Murphy's, the determinant of the one being conjugate to that of the other.* When the use of determinants is debarred or avoided, this difference is far from unimportant,—a fact which might readily be surmised from the present instance, since Murphy's mode of procedure, though strikingly effective upon his own set, is quite inapplicable to Prony's. It should also be observed that the solution of Murphy's set is not essentially different from the solution of the familiar interpolation-problem *to determine* a_1, a_2, \dots, a_n , *so that* $a_1 + a_2x + a_3x^2 + \dots + a_nx^{n-1}$ *or* y *may have the values* y_1, y_2, \dots, y_n *when* x *has the values* x_1, x_2, \dots, x_n *respectively*,—a problem which had been solved in one way by Newton (1687), in another way by Lagrange (1795), and in a third way to a certain extent by Cauchy (1812).†

BINET (1837).

[Observations sur des théorèmes de Géométrie, énoncées page 160 de ce volume et page 222 du volume précédent. *Journ. (de Liouville) de Math.*, ii. pp. 248–252: or, in abstract, *Nouv. Annales de Math.*, v. pp. 164, 165.]

The main object of this short paper of Binet's was to draw attention to the fact that a theorem regarding homofocal surfaces

* The two sets of equations are

$$a_r^1 x_1 + a_r^2 x_2 + \dots + a_r^n x_n = u_r \quad \left. \begin{array}{l} r=1 \\ r=1 \end{array} \right\} \quad \text{(I)}$$

and

$$a_1^r x_1 + a_2^r x_2 + \dots + a_n^r x_n = u_r \quad \left. \begin{array}{l} r=1 \\ r=1 \end{array} \right\} \quad \text{(J)}$$

The former is substantially the interpolation-problem which goes back to Newton, and which may therefore for distinction's sake be associated with his name: the latter being first found solved by Lagrange (*Recherches sur les suites récurrentes* . . . *Mém. de l'acad. de Berlin*, 1775, pp. 183–272; 1792, pp. 247–299: or *Œuvres complètes*, iv. pp. 149–251; v. pp. 625–641) may be called Lagrange's set, provided we remember that he also gave a solution of the other. The first to deal with both of them in more or less general form by means of determinants was Cauchy (1812): but in saying so a mental reservation must be made in view of Cramer's mode (1750) of continuing Newton's work.

† NEWTON, *Principia*, lib. iii. lemma v.: also *Arithmetica Universalis*, probl. lxi. LAGRANGE, *Journ. de l'éc. polyt.*, ii. cah. 8, 9, pp. 276, 277: or *Œuvres complètes*, vii. pp. 285, 286. CAUCHY, *Journ. de l'éc. polyt.*, x. cah. 17, pp. 73, 74: or *Œuvres complètes*, 2^e sér. i.

which Lamé had just published was originally given by Binet in 1811. He thus has occasion to say that the form under which he had considered the equation of hómofocal surfaces was

$$\frac{a^2}{K - A} + \frac{b^2}{K - B} + \frac{c^2}{K - C} = 1,$$

where a, b, c are the co-ordinates of any point on the surface, A, B, C are positive constants such that $A > B > C$, and K is a quantity which may be of any magnitude greater than C . And as Lamé had obtained expressions for the co-ordinates in terms of three values given to K , Binet intimates that many years before he had not only done the same but had extended the solution to the case of n equations. It is this purely algebraical problem which is of interest to us, and fortunately Binet gives it in full.

Taking the set of equations in the form

$$\frac{a}{K - A} + \frac{b}{K - B} + \frac{c}{K - C} + \dots = 1,$$

$$\frac{a}{K_1 - A} + \frac{b}{K_1 - B} + \frac{c}{K_1 - C} + \dots = 1,$$

$$\frac{a}{K_2 - A} + \frac{b}{K_2 - B} + \frac{c}{K_2 - C} + \dots = 1,$$

.....

he introduces, for temporary purposes, two functions, $F(x), f(x)$, the former being

$$(x - A)(x - B)(x - C) \dots$$

and therefore of the n^{th} degree, and the latter being any integral function of a degree less than n . He then recalls the fact that $f(x) \div F(x)$ can be partitioned into n fractions having $x - A, x - B, x - C, \dots$ for denominators, the result as given by Euler being

$$\frac{f(x)}{F(x)} = \frac{f(A)}{(x - A)f'(A)} + \frac{f(B)}{(x - B)f'(B)} + \frac{f(C)}{(x - C)f'(C)} + \dots$$

Substituting successively K, K_1, K_2, \dots for x in this, a set of equations is obtained from which it is seen that the solution of the set

$$\frac{a}{K - A} + \frac{b}{K - B} + \frac{c}{K - C} + \dots = \frac{f(K)}{F(K)},$$

$$\frac{a}{K_1 - A} + \frac{b}{K_1 - B} + \frac{c}{K_1 - C} + \dots = \frac{f(K_1)}{F(K_1)},$$

$\zeta^{\frac{1}{2}}(a_1, a_2, \dots, a_n) = \zeta^{\frac{1}{2}}(a_1, a_2, \dots, a_m) \cdot \zeta^{\frac{1}{2}}(a_{m+1}, a_{m+2}, \dots, a_n) \cdot \prod_{s=1, 2, \dots, m}^{r=m+1, \dots, n} (a_r - a_s)$
 appears in the form

$$\Pi(a_1, a_2, \dots, a_n) = \Pi(a_1, a_2, \dots, a_m) \cdot \Pi(a_{m+1}, a_{m+2}, \dots, a_n) \cdot M_{1, 2, \dots, m}^r$$

where the mode of denoting the rectangular array of differences cannot be commended.

STURM (1845), TERQUEM (1846).

[Cours d'analyse de l'École Polytechnique. 4to, lithogr., Paris.*]

[Sur la résolution d'une certaine classe d'équations à plusieurs inconnues du premier degré. *Nouv. Annales de Math.*, v. pp. 67-68, 162-165.]

Employing the method of "undetermined multipliers" Sturm here supplies the want left by Prony, namely the solution of

$$a^r_1 x_1 + a^r_2 x_2 + \dots + a^r_n x_n = b^r \quad (r=0, 1, 2, \dots, n-1)$$

The said method may be generally described as making the solution of a set of n equations dependent on the solution of a set of $n-1$ equations, the latter set being related to the former in having its determinant conjugate to a primary minor of the determinant of the other set. Thus the given set being

$$\left. \begin{aligned} a_1 x_1 + a_2 x_2 + a_3 x_3 + a_4 x_4 &= a_5 \\ b_1 x_1 + b_2 x_2 + b_3 x_3 + b_4 x_4 &= b_5 \\ c_1 x_1 + c_2 x_2 + c_3 x_3 + c_4 x_4 &= c_5 \\ d_1 x_1 + d_2 x_2 + d_3 x_3 + d_4 x_4 &= d_5 \end{aligned} \right\}$$

where the suffixes are seen to run twice from 1 to n . Another identity, just as worthy of note, is

$$\zeta^{\frac{1}{2}}(a_1, a_2, \dots, a_n) = \zeta^{\frac{1}{2}}(a_1, a_2, \dots, a_m) \cdot \prod_{s=1, 2, \dots, m-1}^{r=m+1, \dots, n} (a_r - a_s) \cdot \zeta^{\frac{1}{2}}(a_m, a_{m+1}, \dots, a_n).$$

The one is exemplified by the partition

$a_2 - a_1$	$a_3 - a_1$	$a_4 - a_1$	$a_5 - a_1$	$a_6 - a_1$
	$a_3 - a_2$	$a_4 - a_2$	$a_5 - a_2$	$a_6 - a_2$
		$a_4 - a_3$	$a_5 - a_3$	$a_6 - a_3$
			$a_5 - a_4$	$a_6 - a_4$
				$a_6 - a_5$

the other when instead of this the right-to-left dotted line is made to separate the third row of differences from the second. The former is that to which we have drawn attention when dealing with Jacobi's memoir of 1841.

* Not the posthumous book with this title edited by Prouhet and published in 1857.

we conclude therefrom that the equation

$$(a_1 + \lambda b_1 + \mu c_1 + \nu d_1)x_1 + (a_2 + \lambda b_2 + \mu c_2 + \nu d_2)x_2 + \dots = a_5 + \lambda b_5 + \mu c_5 + \nu d_5$$

holds for all values of λ, μ, ν ; and in order to obtain the value of x_1 we have to solve the set

$$\left. \begin{aligned} a_2 + b_2\lambda + c_2\mu + d_2\nu &= 0 \\ a_3 + b_3\lambda + c_3\mu + d_3\nu &= 0 \\ a_4 + b_4\lambda + c_4\mu + d_4\nu &= 0 \end{aligned} \right\},$$

where the determinant of the coefficients of the unknowns is the conjugate of the complementary minor of a_1 in $|a_1 b_2 c_3 d_4|$. With this fact in view, and along with it the nature of the relation of Murphy's set to Prony's, it will be readily seen that both sets appear in Sturm's procedure.

Terquem follows Sturm, and extends his method to the set of n equations

$$\left. \begin{aligned} x_1 + 0.x_2 + x_3 + \dots + x_n &= b_0 \\ a_1 x_1 + 1.x_2 + a_3 x_3 + \dots + a_n x_n &= b_1 \\ a_1^2 x_1 + 2 a_1 x_2 + a_3^2 x_3 + \dots + a_n^2 x_n &= b_2 \\ a_1^3 x_1 + 3 a_1 x_2 + a_3^3 x_3 + \dots + a_n^3 x_n &= b_3 \\ \dots & \end{aligned} \right\}$$

where the coefficients of x_2 are the differential-quotients of the corresponding coefficients of x_1 . The possibility of this solution rests on selecting x_2 as the first unknown to be determined, and on the set being thus reducible to one of the previous type.

CAYLEY (1846, Aug.).

[Note sur les fonctions de M. Sturm. *Journ. (de Liouville) de Math.*, xi. pp. 297-299: *Collected Math. Papers*, i. pp. 306-308.]

The functions referred to, which are really Sylvester's substitutes * for Sturm's functions, are introduced in the form—

* SYLVESTER. On rational derivation from equations of existence, *Philos. Mag.*, xv. (1839), pp. 428-435: *Collected Math. Papers*, i. pp. 40-46.
 STURM. Démonstration d'un théorème d'algèbre de M. Sylvester. *Journ. (de Liouville) de Math.*, vii. (1842), pp. 356-368.

$$\begin{aligned}
 f(x) &= (x - a_1)(x - a_2)(x - a_3) \dots (x - a_n) \\
 f_1(x) &= \sum (x - a_2)(x - a_3)(x - a_4) \dots \\
 f_2(x) &= \sum (a_1 - a_2)^2 (x - a_3)(x - a_4) \dots \\
 f_3(x) &= \sum (a_1 - a_2)^2 (a_2 - a_3)^2 (a_3 - a_4)^2 (x - a_4) \dots \\
 &\dots \dots \dots \\
 f_m(x) &= f(x) \cdot \sum \frac{P^2}{(x - a_1)(x - a_2) \dots (x - a_m)},
 \end{aligned}$$

where P stands for the difference-product of a_1, a_2, \dots, a_m , or for what Sylvester afterwards denoted by $\zeta^{\frac{1}{2}}(a_1, a_2, \dots, a_m)$: and the problem is professedly to express $f_m(x)$ "par les coefficients de $f(x)$," but in reality to express it as a series arranged according to descending powers of x .

This is accomplished by partitioning $P/(x - a_1)(x - a_2) \dots (x - a_m)$ into an aggregate of fractions having $x - a_1, x - a_2, \dots$ for denominators,* namely,

$$\begin{aligned}
 (-)^{m-1} \frac{\zeta^{\frac{1}{2}}(a_1, a_2, \dots, a_m)}{(x - a_1)(x - a_2) \dots (x - a_m)} &= \frac{\zeta^{\frac{1}{2}}(a_2, a_3, \dots, a_m)}{x - a_1} \\
 &- \frac{\zeta^{\frac{1}{2}}(a_1, a_3, \dots, a_m)}{x - a_2} + \dots,
 \end{aligned}$$

so that the coefficient of x^{-r} is seen to be

$$a_1^{r-1} \cdot \zeta^{\frac{1}{2}}(a_2, a_3, \dots, a_m) - a_2^{r-1} \zeta^{\frac{1}{2}}(a_1, a_3, \dots, a_m) + \dots$$

and therefore to be

$$(-)^{m-1} \begin{vmatrix} 1 & a_1 & a_1^2 & \dots & a_1^{m-2} & a_1^{r-1} \\ 1 & a_2 & a_2^2 & \dots & a_2^{m-2} & a_2^{r-1} \\ \dots & \dots & \dots & \dots & \dots & \dots \\ 1 & a_m & a_m^2 & \dots & a_m^{m-2} & a_m^{r-1} \end{vmatrix}.$$

Multiplying both sides by P and performing the requisite summation we find that the coefficient of x^{-r} in $f_m(x) \div f(x)$ is

$$\begin{vmatrix} s_0 & s_1 & \dots & s_{m-2} & s_{r-1} \\ s_1 & s_2 & \dots & s_{m-1} & s_r \\ \dots & \dots & \dots & \dots & \dots \\ s_{m-1} & s_m & \dots & s_{2m-3} & s_{r+m-2} \end{vmatrix}, \text{ or } V_{r-1} \text{ say,}$$

where s_q is the sum of the q^{th} powers of *all* the a 's; in other words, that

* It may be noted in this connection that

$$\zeta^{\frac{1}{2}}(a_1, a_2, \dots, a_n) \div \phi'(a_k) = (-)^{n-k} \zeta^{\frac{1}{2}}(a_1, a_2, \dots, a_{k-1}, a_{k+1}, \dots, a_n)$$

if $\phi(x) = (x - a_1)(x - a_2) \dots (x - a_n)$.

$$f_m(x) \div f(x) = x^{-m} \cdot V_{m-1} + x^{-m-1} \cdot V_m + \dots$$

It only remains now to multiply by $f(x)$ in the form

$$x^n - p_1 x^{n-1} + p_2 x^{n-2} - \dots$$

obtaining

$$f_m(x) = x^{n-m} \cdot V_{m-1} + x^{n-m-1} (V_m - p_1 V_{m-1}) + x^{n-m-2} (V_{m+1} - p_1 V_m + p_2 V_{m-1}) + \dots$$

and then to condense the coefficients,—an easy operation, since all the V 's are identical save in their last columns: for example

$$V_{m+1} - p_1 V_m + p_2 V_{m-1} = \begin{vmatrix} s_0 & s_1 & \dots & s_{m-2} & s_{m+1} - p_1 s_m + p_2 s_{m-1} \\ s_1 & s_2 & \dots & s_{m-1} & s_{m+2} - p_1 s_{m+1} + p_2 s_m \\ \dots & \dots & \dots & \dots & \dots \\ s_{m-1} & s_m & \dots & s_{2m-3} & s_{2m} - p_1 s_{2m-1} + p_2 s_{2m-2} \end{vmatrix}$$

CHELINI (1846).

[Determinazione geometrica in coordinate ellittiche . . . *Raccolta sci. di Palomba*, ii. pp. 109–113, 126–131; see also v. pp. 227–263, 333–374.]

GRUNERT (1847).

[Vollständige independente Auflösung der n Gleichungen der ersten Grades . . . *Archiv d. Math. u. Phys.*, x. pp. 284–302.]

The equations are

$$A_1 + A_2 a_r + A_3 a_r^2 + \dots + A_n a_r^{n-1} = a_r \quad (r = 1, 2, \dots, n)$$

that is to say, are of the type to which Murphy's belong, and with which a problem in interpolation is connected; and the solution, rather tardily reached (p. 301), is

$$(-1)^m A_{n-m} = \frac{K(a_2, a_3, a_4, \dots, a_n)}{(a_1 - a_2)(a_1 - a_3)(a_1 - a_4) \dots (a_1 - a_n)} a_1 + \frac{K(a_1, a_3, a_4, \dots, a_n)}{(a_2 - a_1)(a_2 - a_3)(a_2 - a_4) \dots (a_2 - a_n)} a_2 + \frac{K(a_1, a_2, a_4, \dots, a_n)}{(a_3 - a_1)(a_3 - a_2)(a_3 - a_4) \dots (a_3 - a_n)} a_3 + \dots$$

$$+ \frac{\overset{m}{\text{K}}(a_1, a_2, a_3, \dots, a_{n-1})}{(a_n - a_1)(a_n - a_2)(a_n - a_3) \dots (a_n - a_{n-1})} a_n,$$

where by $\overset{m}{\text{K}}$ is denoted "die m te Klasse der Kombinationen ohne Wiederholungen."

ROSENHAIN (1849).

[Auszug mehrerer Schreiben . . . über die hyperelliptischen Transcendenten. No. IV. *Crelle's Journ.*, xl. pp. 347-360.]

In the course of an investigation regarding the relation between two Abelian integrals Rosenhain is brought up against the determinant

$$\sum \pm \frac{1}{t_1 - a_1} \cdot \frac{1}{t_2 - a_2} \dots \frac{1}{t_{n-1} - a_{n-1}}$$

already dealt with by Cauchy in 1841, and afterwards known as "Cauchy's double alternant." The multiple integrals in question have to suffer transformation of the variables, and as a preliminary it is ascertained that the Jacobian

$$\sum \pm \frac{\partial x_1}{\partial t_1} \cdot \frac{\partial x_2}{\partial t_2} \dots \frac{\partial x_{n-1}}{\partial t_{n-1}} = C \cdot \sum \pm \frac{1}{t_1 - a_1} \cdot \frac{1}{t_2 - a_2} \dots \frac{1}{t_{n-1} - a_{n-1}}$$

and

$$\sum \pm \frac{\partial t_1}{\partial x_1} \cdot \frac{\partial t_2}{\partial x_2} \dots \frac{\partial t_{n-1}}{\partial x_{n-1}} = D \cdot \sum \pm \frac{1}{t_1 - a_1} \cdot \frac{1}{t_2 - a_2} \dots \frac{1}{t_{n-1} - a_{n-1}}$$

where C and D are specified functions of the a 's and t 's. From this by multiplication it follows that

$$\left\{ \sum \pm \frac{1}{t_1 - a_1} \cdot \frac{1}{t_2 - a_2} \dots \frac{1}{t_{n-1} - a_{n-1}} \right\}^2 = \frac{1}{CD},$$

and thence ultimately that

$$\begin{aligned} \sum \pm \frac{1}{t_1 - a_1} \cdot \frac{1}{t_2 - a_2} \dots \frac{1}{t_{n-1} - a_{n-1}} \\ = \frac{(-1)^{\frac{1}{2}n(n-1)} \Pi(a_1 \cdot a_2 \cdot \dots \cdot a_{n-1}) \cdot \Pi(t_1, t_2, \dots, t_{n-1})}{\phi(a_1) \cdot \phi(a_2) \dots \phi(a_{n-1})} \end{aligned}$$

where

$$\phi(\xi) = (\xi - t_1)(\xi - t_2) \dots (\xi - t_{n-1}).$$

There is then added a simple verificatory proof which consists in noting (1) the double alternating character of the function *

$$\phi(a_1) \cdot \phi(a_2) \cdot \dots \cdot \phi(a_{n-1}) \cdot \sum \pm \frac{1}{t_1 - a_1} \cdot \frac{1}{t_2 - a_2} \cdot \dots \cdot \frac{1}{t_{n-1} - a_{n-1}};$$

(2) its degree in any one of the a 's or t 's; (3) the sign of any one of its terms. The exact words are—

“Der Beweis der obigen Formel ergibt sich durch die Betrachtung, dass

$$\phi(a_1) \cdot \phi(a_2) \cdot \dots \cdot \phi(a_{n-1}) \cdot \sum \pm \frac{1}{t_1 - a_1} \cdot \frac{1}{t_2 - a_2} \cdot \dots \cdot \frac{1}{t_{n-1} - a_{n-1}}$$

eine ganze rationale alternirende Function sowohl in Bezug auf die $n - 1$ Grössen t_p als auch in Bezug auf die $n - 1$ Grössen a_m ist. Es übersteigt aber in dieser Function weder eine der Grössen t_p noch eine der Grössen a_m den $(n - 2)$ ten Grad: daher ist sie nicht bloss durch das Product

$$\Pi(a_1, a_2, \dots, a_{n-1}) \cdot \Pi(t_1, t_2, \dots, t_{n-1})$$

theilbar, sondern, abgesehen vom Zeichen, diesem Producte selbst gleich, da ihre einzelnen Terme keine andern Zahlen-coefficienten haben, als ± 1 . Da nun die Determinante positiv sein soll, so musste rechts vom Gleichheitszeichen noch der Factor $(-1)^{\frac{1}{2}n(n-1)}$ hinzugefügt werden.”

MAINARDI (1850).

[Sulla integrazione dell' equazioni differenziali. *Annali di sci. mat. e fis.*, i. pp. 50–89.]

* The product $\phi(a_1) \cdot \phi(a_2) \cdot \dots \cdot \phi(a_{n-1})$ is arrangeable as a square array of binomial factors, being in fact, save as to sign, the product of all the denominators in the double alternant, and is thus seen to be symmetrical with respect both to the a 's and to the t 's. If therefore we multiply each row of the alternant by the product of the denominators of the row, or each column by the product of the denominators of the column, we multiply the alternant by $(-1)^{(n-1)(n-2)} \phi(a_1) \cdot \phi(a_2) \cdot \dots \cdot \phi(a_{n-1})$. The two determinants thus resulting have elements which are the product of $n - 2$ binomial factors, and are equal to

$$(-1)^{\frac{1}{2}(n-1)(n-2)} \Pi(a_1, a_2, \dots, a_{n-1}) \cdot \Pi(t_1, t_2, \dots, t_{n-1}).$$

If, on the other hand, we multiply each element $\frac{1}{a_r - t_s}$ of the alternant by $a_r^{n-1} - t_s^{n-1}$ we obtain the product of the two Π 's as reached by the ordinary multiplication-theorem of determinants.

CAYLEY (1853).

[Note on the transformation of a trigonometrical expression. *Cambridge and Dublin Math. Journ.*, ix. pp. 61, 62: or *Collected Math. Papers*, ii. pp. 45, 46.]

In order to show that the vanishing of the alternating function

$$\begin{vmatrix} 1 & x & (a+x)\sqrt{c+x} \\ 1 & y & (a+y)\sqrt{c+y} \\ 1 & z & (a+z)\sqrt{c+z} \end{vmatrix}$$

implies the vanishing of

$$\tan^{-1} \sqrt{\frac{a-c}{c+x}} + \tan^{-1} \sqrt{\frac{a-c}{c+y}} + \tan^{-1} \sqrt{\frac{a-c}{c+z}}$$

the determinant is proved to contain the factor

$$\sqrt{\frac{a-c}{c+x}} + \sqrt{\frac{a-c}{c+y}} + \sqrt{\frac{a-c}{c+z}} - \sqrt{\frac{a-c}{c+x}} \sqrt{\frac{a-c}{c+y}} \sqrt{\frac{a-c}{c+z}}$$

with the cofactor

$$-\frac{(c+x)^{\frac{3}{2}}(c+y)^{\frac{3}{2}}(c+z)^{\frac{3}{2}}}{(a-c)^2}, \begin{vmatrix} 1 & \sqrt{\frac{a-c}{c+x}} & \frac{a-c}{c+x} \\ 1 & \sqrt{\frac{a-c}{c+y}} & \frac{a-c}{c+y} \\ 1 & \sqrt{\frac{a-c}{c+z}} & \frac{a-c}{c+z} \end{vmatrix}.$$

This is done by writing ξ, η, ζ for $\sqrt{\frac{a-c}{c+x}}, \sqrt{\frac{a-c}{c+y}}, \sqrt{\frac{a-c}{c+z}}$ respectively,* and so changing the given determinant into

* It is simpler still to express the given determinant in terms of alternants having $\sqrt{c+x}, \sqrt{c+y}, \sqrt{c+z}$ for variables. Thus the given determinant

$$\begin{aligned} &= \begin{vmatrix} 1 & x & (c+x+a-c)\sqrt{c+x} \\ 1 & y & (c+y+a-c)\sqrt{c+y} \\ 1 & z & (c+z+a-c)\sqrt{c+z} \end{vmatrix}, \\ &= \begin{vmatrix} 1 & c+x & (c+x)\sqrt{c+x} \\ 1 & c+y & (c+y)\sqrt{c+y} \\ 1 & c+z & (c+z)\sqrt{c+z} \end{vmatrix} + (a-c) \begin{vmatrix} 1 & c+x & \sqrt{c+x} \\ 1 & c+y & \sqrt{c+y} \\ 1 & c+z & \sqrt{c+z} \end{vmatrix}, \\ &= \begin{vmatrix} 1 & \mu^2 & \mu^3 \\ 1 & \nu^2 & \nu^3 \\ 1 & \zeta^2 & \zeta^3 \end{vmatrix} - (a-c) \begin{vmatrix} 1 & \mu & \mu^2 \\ 1 & \nu & \nu^2 \\ 1 & \zeta & \zeta^2 \end{vmatrix} \text{ say,} \\ &= \begin{vmatrix} 1 & \mu & \mu^2 \\ 1 & \nu & \nu^2 \\ 1 & \zeta & \zeta^2 \end{vmatrix} \cdot \{ \mu\nu + \nu\zeta + \zeta\mu - (a-c) \}. \end{aligned}$$

$$\begin{vmatrix} 1 & (a-c)(1+\xi^{-2}) & (a-c)^{\frac{3}{2}}(\xi^{-1}+\xi^{-3}) \\ 1 & (a-c)(1+\eta^{-2}) & (a-c)^{\frac{3}{2}}(\eta^{-1}+\eta^{-3}) \\ 1 & (a-c)(1+\zeta^{-2}) & (a-c)^{\frac{3}{2}}(\zeta^{-1}+\zeta^{-3}) \end{vmatrix},$$

thence into

$$(a-c)^{\frac{3}{2}}\xi^{-3}\eta^{-3}\zeta^{-3} \begin{vmatrix} \xi^3 & \xi^3+\xi & \xi^2+1 \\ \eta^3 & \eta^3+\eta & \eta^2+1 \\ \zeta^3 & \zeta^3+\zeta & \zeta^2+1 \end{vmatrix},$$

and finally into

$$-(a-c)^{\frac{3}{2}}\xi^{-3}\eta^{-3}\zeta^{-3} \begin{vmatrix} 1 & \xi & \xi^2 \\ 1 & \eta & \eta^2 \\ 1 & \zeta & \zeta^2 \end{vmatrix} (\xi+\eta+\zeta-\xi\eta\zeta).$$

BRIOSCHI (1854).

[La teorica dei determinanti, e le sue principali applicazioni, viii + 116 pp., Pavia: French translation by Edouard Combescure, ix + 216 pp., Paris, 1856 : German translation by Schellbach, vii + 102 pp., Berlin, 1856.]

Brioschi devotes the 9th section of his text-book (pp. 73-84) to "determinanti delle radici delle equazioni algebriche," viewing the difference-product and its allies as arising when the roots of the equation

$$x^n + A_{n-1}x^{n-1} + A_{n-2}x^{n-2} + \dots + A_1x + A_0 = 0$$

are substituted for x , and the values of A_{n-1}, A_{n-2}, \dots , are to be determined from the n equations thus resulting. His proof, obtained in this way, that the common denominator of the A 's is resolvable into binominal factors is not of consequence. It is more important to note that, as an alternative, he proceeds "facendo uso di sole proprieta dei determinanti," obtaining in the first place

$$\begin{vmatrix} 1 & 1 & \dots & 1 \\ \alpha_1 & \alpha_2 & \dots & \alpha_n \\ \alpha_1^2 & \alpha_2^2 & \dots & \alpha_n^2 \\ \dots & \dots & \dots & \dots \\ \alpha_1^{n-1} & \alpha_2^{n-1} & \dots & \alpha_n^{n-1} \end{vmatrix} = (-1)^{n-1} \begin{vmatrix} \alpha_1 - \alpha_2 & \alpha_2 - \alpha_3 & \dots & \alpha_{n-1} - \alpha_n \\ \alpha_1^2 - \alpha_2^2 & \alpha_2^2 - \alpha_3^2 & \dots & \alpha_{n-1}^2 - \alpha_n^2 \\ \dots & \dots & \dots & \dots \\ \alpha_1^{n-1} - \alpha_2^{n-1} & \alpha_2^{n-1} - \alpha_3^{n-1} & \dots & \alpha_{n-1}^{n-1} - \alpha_n^{n-1} \end{vmatrix},$$

from which he removes the factors $\alpha_1 - \alpha_2, \alpha_2 - \alpha_3, \dots$; then

repeating the first set of operations he removes the factors $a_1 - a_3$, $a_2 - a_4$, . . . , and so on.

After this an application is made to the solution of a set of linear equations which differs from Prony's set by having z^0, z^1, z^2, \dots in place of z_0, z_1, z_2, \dots , and where therefore, as Cauchy in 1812 had pointed out, the numerators of the unknowns, as well as the common denominator, are resolvable into binominal factors. The determinants in s_0, s_1, s_2, \dots , got by multiplication, are also given. The remaining pages (77-84) contain illustrations.

JOACHIMSTHAL (1854, May).

[Bemerkungen über den Sturm'schen Satz. *Crelle's Journ.*,
xlviii. pp. 386-416.]

In the course of his investigations Joachimsthal evaluates (§5) the determinant

$$\begin{vmatrix} s_0 & s_1 & s_2 & 1 \\ s_1 & s_2 & s_3 & x \\ s_2 & s_3 & s_4 & x^2 \\ s_3 & s_4 & s_5 & x^3 \end{vmatrix}$$

where $s_q = x_1^q + x_2^q + x_3^q$. Using the fact that by reason of the trinomial elements the determinant is partitionable into twenty-seven determinants with monomial elements, he shows next that all of the twenty-seven except six vanish; that the six contain the common factor

$$(x - x_1)(x - x_2)(x - x_3) \cdot (x_3 - x_1)(x_3 - x_2)(x_2 - x_1);$$

that the aggregate of the cofactors is

$$x_3^2 x_2 - x_3^2 x_1 + x_2^2 x_1 - x_2^2 x_3 + x_1^2 x_3 - x_1^2 x_2$$

or

$$(x_3 - x_1)(x_3 - x_2)(x_2 - x_1);$$

and that therefore finally the given determinant is equal to

$$\left\{ (x_3 - x_1)(x_3 - x_2)(x_2 - x_1) \right\}^2 \cdot (x - x_1)(x - x_2)(x - x_3).$$

This is followed by the assertion that if s_q were made to stand for $s_1^q + s_2^q + \dots + s_n^q$ the determinant could be partitioned into n^3

determinants, of which $n(n-1)(n-2)$ would be non-evanescent; and that these could be grouped into sets of six and condensed, the ultimate result being

$$\begin{vmatrix} s_0 & s_1 & s_2 & 1 \\ s_1 & s_2 & s_3 & x \\ s_2 & s_3 & s_4 & x^2 \\ s_3 & s_4 & s_5 & x^3 \end{vmatrix} = \sum \left\{ (x_3 - x_2)(x_3 - x_1)(x_2 - x_1) \right\}^2 (x - x_1)(x - x_2)(x - x_3).$$

A large generalisation is then made, the exact words being "Genau eben so beweist man folgenden allgemeinen Satz: Bezeichnet man die Potenzsumme $x_1^i + x_2^i + \dots + x_n^i$ durch s_i ; ferner das Quadrant des Productes, welches aus den $\frac{1}{2}i(i-1)$ Differenzen der i Grössen x_1, x_2, \dots, x_i gebildet ist, durch $\delta(x_1, x_2, \dots, x_i)$, so ist

$$\begin{vmatrix} s_0 & s_1 & s_2 & \dots & s_{a-1} & 1 \\ s_1 & s_2 & s_3 & \dots & s_a & x \\ s_2 & s_3 & s_4 & \dots & s_{a+1} & x^2 \\ \dots & \dots & \dots & \dots & \dots & \dots \\ s_a & s_{a+1} & s_{a+2} & \dots & s_{2a-1} & x^a \end{vmatrix} = \sum \delta(x_1, x_2, \dots, x_a) \begin{matrix} (x - x_1) \\ (x - x_2) \dots (x - x_a) \end{matrix}$$

wo die rechte Seite eine Summe von $\frac{n(n-1) \dots n-a+1}{1 \cdot 2 \dots a}$ ähnlich gebildeten Gliedern enthält."

The known result obtained from this by equating coefficients of x^a is pointed out: also the extension

$$\begin{vmatrix} S_0 & S_1 & S_2 & \dots & S_{a-1} & 1 \\ S_1 & S_2 & S_3 & \dots & S_a & x \\ S_2 & S_3 & S_4 & \dots & S_{a+1} & x^2 \\ \dots & \dots & \dots & \dots & \dots & \dots \\ S_a & S_{a+1} & S_{a+2} & \dots & S_{2a-1} & x^a \end{vmatrix} = \sum \epsilon_1 \epsilon_2 \dots \epsilon_a \delta(x_1, x_2, \dots, x_a) \begin{matrix} (x - x_1)(x - x_2) \dots (x - x_a), \end{matrix}$$

where $S_i = \epsilon_1 x_1^i + \epsilon_2 x_2^i + \dots + \epsilon_n x_n^i$. It may be noted that the reason for discussing such determinants is that the series of them obtained by giving a the values $n, n-1, n-2, \dots, 2, 1, 0$ is put forward (p. 400) as a substitute for Sturm's series of functions.*

Towards the end of the paper (§ 17, p. 414) the determinant

* In this connection papers by Cayley (1846) and Borchardt (1845) are referred to, but no mention is made of Sylvester's (1839).

$$\begin{vmatrix} (a_1 + b_1)^{-1} & (a_1 + b_2)^{-1} & \dots & (a_1 + b_n)^{-1} \\ (a_2 + b_1)^{-1} & (a_2 + b_2)^{-1} & \dots & (a_2 + b_n)^{-1} \\ \dots & \dots & \dots & \dots \\ (a_n + b_1)^{-1} & (a_n + b_2)^{-1} & \dots & (a_n + b_n)^{-1} \end{vmatrix} \text{ or } \Delta_n \text{ say,}$$

is evaluated. The process consists at the outset in subtracting the first column from each column after the first, removing the factor

$$\frac{(b_1 - b_2)(b_1 - b_3) \dots (b_1 - b_n)}{(a_1 + b_1)(a_2 + b_1) \dots (a_n + b_1)},$$

and writing the cofactor in the form

$$\begin{vmatrix} 1 & (a_1 + b_2)^{-1} & \dots & (a_1 + b_n)^{-1} \\ 1 & (a_2 + b_2)^{-1} & \dots & (a_2 + b_n)^{-1} \\ \dots & \dots & \dots & \dots \\ 1 & (a_n + b_2)^{-1} & \dots & (a_n + b_n)^{-1} \end{vmatrix}.$$

The latter determinant is then transformed by subtracting the first row from each row after the first, when it is found that the factor

$$\frac{(a_1 - a_2)(a_1 - a_3) \dots (a_1 - a_n)}{(a_1 + b_2)(a_1 + b_3) \dots (a_1 + b_n)}$$

can be removed, and that the cofactor is a determinant similar to the original but of the $(n - 1)^{th}$ order, namely, the determinant which is the cofactor of the element in the place (1, 1) of the original. The final result thus obtained agrees with Cauchy's save in having no sign-factor, the latter being only necessary when the b 's are all made negative.

BRIOSCHI (1854, Oct.).

[Intorno ad alcune formole per la risoluzione delle equazioni algebriche. *Annali di sci. e fis.*, v. pp. 416-421.]

All that occurs in this paper in connection with our subject is the statement

$$\left(\frac{\partial \Delta}{\partial x^{n-1}}\right)^2 = \begin{vmatrix} s_0 & s_1 & \dots & s_{n-2} & 1 \\ s_1 & s_2 & \dots & s_{n-1} & x \\ s_2 & s_3 & \dots & s_n & x^2 \\ \dots & \dots & \dots & \dots & \dots \\ s_{n-2} & s_{n-1} & \dots & s_{2n-4} & x^{n-2} \\ 1 & x & \dots & x^{n-2} & 1 \end{vmatrix}$$

where Δ is the determinant-form of the difference-product of x_1, x_2, \dots, x_n . No explanation of the statement is given, nor the mode of arriving at it. All is made clear, however, if we note first that by x on the right hand is meant any x chosen at will from the set x_1, x_2, \dots, x_n : second, that the differential-quotient on the left is intended to stand for the cofactor of the $(n-1)^{\text{th}}$ power of that particular x in Δ , and therefore merely denotes the difference-product of a certain $n-1$ of the x 's. What the statement thus gives us is an alternative form for the square of the difference-product of $n-1$ quantities.

If we use column-by-column multiplication, and put s_r for $\alpha^r + \beta^r + \gamma^r + \delta^r$, we clearly have

$$\begin{aligned} \begin{vmatrix} 4 & s_1 & s_2 & 1 \\ s_1 & s_2 & s_3 & \beta \\ s_2 & s_3 & s_4 & \beta^2 \\ 1 & \beta & \beta^2 & 1 \end{vmatrix} &= \begin{vmatrix} 1 & \alpha & \alpha^2 & . \\ 1 & \beta & \beta^2 & 1 \\ 1 & \gamma & \gamma^2 & . \\ 1 & \delta & \delta^2 & . \end{vmatrix}^2 \\ &= \begin{vmatrix} 1 & \alpha & \alpha^2 \\ 1 & \gamma & \gamma^2 \\ 1 & \delta & \delta^2 \end{vmatrix}^2, \end{aligned}$$

and so the result is established. It will be observed that the chosen letter β which occurs most conspicuously in the new form thus obtained for $\zeta(\alpha, \gamma, \delta)$ is one which the expression is quite independent of. Further, by performing on this new form the operations

$$\text{col}_1 - \text{col}_4, \quad \text{col}_2 - \beta \text{col}_4, \quad \text{col}_3 - \beta^2 \text{col}_4,$$

we return to the more natural form

$$\zeta(\alpha, \gamma, \delta) = \begin{vmatrix} 3 & \alpha + \gamma + \delta & \alpha^2 + \gamma^2 + \delta^2 \\ \alpha + \gamma + \delta & \alpha^2 + \gamma^2 + \delta^2 & \alpha^3 + \gamma^3 + \delta^3 \\ \alpha^2 + \gamma^2 + \delta^2 & \alpha^3 + \gamma^3 + \delta^3 & \alpha^4 + \gamma^4 + \delta^4 \end{vmatrix}.$$

BORCHARDT (1855, March).

[Bestimmung der symmetrischen Verbindungen vermittelt ihrer erzeugenden Funktion. *Monatsber. . . . Akad. d. Wiss. zu Berlin*, 1855, pp. 165-171: *Crelle's Journ.*, liii. pp. 193-198: *Gesammelte Werke*, pp. 97-105.]

The generating function in question is

$$\sum \frac{1}{t-a} \cdot \frac{1}{t_1-a_1} \cdot \dots \cdot \frac{1}{t_n-a_n},$$

or T say, the sign of summation being meant to indicate that of the two series of elements the one is to remain unaltered and the other is to be permitted in every possible way. The development of this function according to descending powers of t, t_1, t_2, \dots, t_n leads to those simplest types of integral symmetric functions of a, a_1, a_2, \dots, a_n which originate by permutation from a single product of integral powers of the said variables. The determination of such functions is thus reduced to the problem of transforming T so as to have no longer occurring therein the single elements a, a_1, a_2, \dots, a_n , but instead those combinatory sums of them which are the coefficients of the powers of z in the development of $(z-a)(z-a_1)(z-a_2) \dots (z-a_n)$ or $f(z)$ say.

Without further preparatory statement the announcement is made that the solution is readily reached when the relation of T to the determinants

$$\sum \pm \frac{1}{t-a} \cdot \frac{1}{t_1-a_1} \dots \frac{1}{t_n-a_n} \quad \text{or } \Delta,$$

$$\sum \pm \frac{1}{(t-a)^2} \cdot \frac{1}{(t_1-a_1)^2} \dots \frac{1}{(t_n-a_n)^2} \quad \text{or } D,$$

is known, namely, the relation

$$D = T \cdot \Delta.$$

In proof of this relation it is pointed out that

$$\{f(t) \cdot f(t_1) \cdot f(t_2) \dots f(t_n)\}^2 \cdot D$$

being an integral alternating function both with respect to the elements t, t_1, t_2, \dots, t_n and with respect to the elements a, a_1, a_2, \dots, a_n is exactly divisible by the two difference-products

$$\Pi(t, t_1, t_2, \dots, t_n), \quad \Pi(a, a_1, a_2, \dots, a_n),$$

and that although we cannot with equal promptness tell the remaining factor, we are able to determine it from knowing a sufficient number of its special values, namely, those values got by putting each t equal to one of the a 's. Since the number of ways in which the $n+1$ a 's can be taken when repetitions are allowed is $(n+1)^{n+1}$, this gives us $(n+1)^{n+1}$ values, of which, however, only two are different, namely, the value $(-1)^{in(n+1)} \cdot f'(a) \cdot f'(a_1) \cdot f'(a_2) \dots f'(a_n)$ obtained in the $n!$ cases where all the a 's used are different, and the value 0 obtained

in every other case. The determination, we are told, can be made by using an extension of Lagrange's interpolation-formula, the outcome of the work being

$$D = T \cdot (-1)^{in(n+1)} \frac{\Pi(t, t_1, t_2, \dots, t_n) \cdot \Pi(\alpha, \alpha_1, \alpha_2, \dots, \alpha_n)}{f(t) \cdot f(t_1) \cdot f(t_2) \dots \dots f(t_n)}$$

which, of course, gives us

$$D = T \cdot \Delta.$$

This relation having been established, Borchardt then proceeds in a line or two to use it for the main purpose of his paper. As the determinant D, he says, arises out of the determinant Δ by performance of successive differentiation with respect to all the variables t, t_1, t_2, \dots, t_n , there is obtained at once an alternative expression for T, namely,

$$T = (-1)^{n+1} \frac{f(t) \cdot f(t_1) \dots f(t_n)}{\Pi(t, t_1, \dots, t_n)} \cdot \frac{\partial}{\partial t} \frac{\partial}{\partial t_1} \dots \frac{\partial}{\partial t_n} \left(\frac{\Pi(t, t_1, \dots, t_n)}{f(t) \cdot f(t_1) \dots f(t_n)} \right)$$

or say rather

$$T = (-1)^{n+1} \frac{\frac{\partial}{\partial t} \cdot \frac{\partial}{\partial t_1} \dots \frac{\partial}{\partial t_n} \Pi(t, t_1, \dots, t_n)}{\frac{\Pi(t, t_1, \dots, t_n)}{f(t) \cdot f(t_1) \dots f(t_n)}};$$

and so the transformation aimed at is accomplished.

PROUHET (1856, March).

[Note sur quelques identités. *Nouv. Annales de Math.*, xv. pp. 86-91.]

In order to generalise certain algebraical identities published by O. Werner in Grunert's *Archiv*, xxii. p. 353, Prouhet first establishes the theorem in alternants foreshadowed by Prony and Cauchy, and readily derivable from Schweins' first multiplication-theorem. His mode of treatment may be concisely stated as follows:—

To say that a, b, c, d, e, f are the roots of

$$x^6 - p_1x^5 + p_2x^4 - p_3x^3 + p_4x^2 - p_5x + p_6 = 0$$

implies that

$$p_1 = \Sigma a, \quad p_2 = \Sigma ab, \quad p_3 = \Sigma abc, \quad \dots;$$

and as it also means that

$$\left. \begin{aligned} a^6 - p_1 a^5 + p_2 a^4 - \dots + p_6 &= 0 \\ b^6 - p_1 b^5 + p_2 b^4 - \dots + p_6 &= 0 \\ \dots & \\ f^6 - p_1 f^5 + p_2 f^4 - \dots + p_6 &= 0 \end{aligned} \right\}$$

from which we have

$$p_1 = \frac{\begin{vmatrix} a_6 & a_4 & a_3 & a_2 & a_1 & 1 \\ b_6 & b_4 & b_3 & b_2 & b_1 & 1 \\ \dots & \dots & \dots & \dots & \dots & \dots \\ f_6 & f_4 & f_3 & f_2 & f_1 & 1 \end{vmatrix}}{\begin{vmatrix} a_5 & a_4 & a_3 & a_2 & a_1 & 1 \\ b_5 & b_4 & b_3 & b_2 & b_1 & 1 \\ \dots & \dots & \dots & \dots & \dots & \dots \\ f_5 & f_4 & f_3 & f_2 & f_1 & 1 \end{vmatrix}},$$

$$p_2 = \frac{\begin{vmatrix} a_5 & a_6 & a_3 & a_2 & a_1 & 1 \\ b_5 & b_6 & b_3 & b_2 & b_1 & 1 \\ \dots & \dots & \dots & \dots & \dots & \dots \\ f_5 & f_6 & f_3 & f_2 & f_1 & 1 \end{vmatrix}}{\begin{vmatrix} a_5 & a_4 & a_3 & a_2 & a_1 & 1 \\ b_5 & b_4 & b_3 & b_2 & b_1 & 1 \\ \dots & \dots & \dots & \dots & \dots & \dots \\ f_5 & f_4 & f_3 & f_2 & f_1 & 1 \end{vmatrix}},$$

.....

it follows that in later notation

$$\begin{aligned} | a^0 b^1 c^2 d^3 e^4 f^6 | \div | a^0 b^1 c^2 d^3 e^4 f^5 | &= \Sigma a, \\ | a^0 b^1 c^2 d^3 e^5 f^6 | \div | a^0 b^1 c^2 d^3 e^4 f^5 | &= \Sigma ab, \\ | a^0 b^1 c^2 d^4 e^5 f^6 | \div | a^0 b^1 c^2 d^3 e^4 f^5 | &= \Sigma abc, \\ \dots & \end{aligned}$$

with similar results when the alternants are of any other order.

SCHEIBNER (1856).

[Ueber die Auflösung eines gewissen Gleichungsystems.
Berichte ... Ges. d. Wiss. zu Leipzig, viii. pp. 65-76.]

JOACHIMSTHAL (1856, Sept.).

[De aequationibus quarti et sexti gradus quae in theoria linearum et superficierum secundi gradus occurrunt.
Crelle's Journ., liii. pp. 149-172.]

The problem of finding the normals drawn from an external point (ξ, η, ζ) to the surface

$$\frac{x^2}{a} + \frac{y^2}{b} + \frac{z^2}{c} = 1$$

being dependent on the solution of the sixth-degree equation

$$\frac{a\xi^2}{(a+u)^2} + \frac{b\eta^2}{(b+u)^2} + \frac{c\zeta^2}{(c+u)^2} = 1$$

the relation between four of the six roots is evidently

$$\begin{vmatrix} \frac{1}{(a+u_1)^2} & \frac{1}{(b+u_1)^2} & \frac{1}{(c+u_1)^2} & 1 \\ \frac{1}{(a+u_2)^2} & \frac{1}{(b+u_2)^2} & \frac{1}{(c+u_2)^2} & 1 \\ \frac{1}{(a+u_3)^2} & \frac{1}{(b+u_3)^2} & \frac{1}{(c+u_3)^2} & 1 \\ \frac{1}{(a+u_4)^2} & \frac{1}{(b+u_4)^2} & \frac{1}{(c+u_4)^2} & 1 \end{vmatrix} = 0.$$

Joachimsthal knowing this, and having obtained by an entirely different process the result

$$\begin{aligned} & \sum \frac{1}{(a+u_1)(b+u_2)(c+u_3)} + \sum \frac{1}{(a+u_1)(b+u_2)(c+u_4)} \\ & + \sum \frac{1}{(a+u_1)(b+u_3)(c+u_4)} + \sum \frac{1}{(a+u_2)(b+u_3)(c+u_4)} = 0 \end{aligned}$$

where the sign of summation refers to permutation of the u 's, is naturally led to inquire into the connection between the two results, and to extend the inquiry to the higher cases of the same kind, including, therefore, the evaluation of the determinant

$$\begin{vmatrix} \frac{1}{(a_1+u_1)^2} & \frac{1}{(a_2+u_1)^2} & \dots & \frac{1}{(a_n+u_1)^2} & 1 \\ \frac{1}{(a_1+u_2)^2} & \frac{1}{(a_2+u_2)^2} & \dots & \frac{1}{(a_n+u_2)^2} & 1 \\ \dots & \dots & \dots & \dots & \dots \\ \frac{1}{(a_1+u_{n+1})^2} & \frac{1}{(a_2+u_{n+1})^2} & \dots & \frac{1}{(a_n+u_{n+1})^2} & 1 \end{vmatrix} \text{ or } J.$$

The investigation of the determinant occupies the fifth and sixth sections (pp. 164-169) of his paper, the third and fourth being devoted to obtaining the other form of the resultant

$$\begin{aligned} & \sum \frac{1}{(a_1+u_1)(a_2+u_2) \dots (a_n+u_n)} + \sum \frac{1}{(a_1+u_1) \dots (a_{n-1}+u_{n-1})(a_n+u_{n+1})} \\ & + \dots + \sum \frac{1}{(a_1+u_2)(a_2+u_3) \dots (a_n+u_{n+1})}, \end{aligned}$$

or, say,

$$[1, 2, \dots, n+1].$$

On multiplying each row of J by the product of all the denominators occurring in the row there is obtained a determinant V whose r^{th} row consists of elements which are expressible as polynomials arranged according to descending powers of u_r , the index of the highest power of u_r being $2n-2$ in all the places except the last where it is $2n$. V, which is equal to

$$J \cdot A_1^2 A_2^2 \dots A_n^2$$

if we put

$$A_s = (a_s + u_1)(a_s + u_2) \dots (a_s + u_{n+1}),$$

can thus be partitioned into $(2n-1)^n(2n+1)$ determinants, each expressible in the form

$$\mathfrak{a} \cdot \begin{vmatrix} u_1^{\alpha_1} & u_1^{\alpha_2} & \dots & u_1^{\alpha_n} & u_1^{\alpha_{n+1}} \\ u_2^{\alpha_1} & u_2^{\alpha_2} & \dots & u_2^{\alpha_n} & u_2^{\alpha_{n+1}} \\ \dots & \dots & \dots & \dots & \dots \\ u_{n+1}^{\alpha_1} & u_{n+1}^{\alpha_2} & \dots & u_{n+1}^{\alpha_n} & u_{n+1}^{\alpha_{n+1}} \end{vmatrix}$$

where \mathfrak{a} is an integral function of the α 's. Further, V in this way is seen to be not of higher order with respect to the u 's than the determinant

$$\begin{vmatrix} u_1^{n-1} & u_1^n & u_1^{n+1} & \dots & u_1^{2n-3} & u_1^{2n-2} & u_1^{2n} \\ u_2^{n-1} & u_2^n & u_2^{n+1} & \dots & u_2^{2n-3} & u_2^{2n-2} & u_2^{2n} \\ \dots & \dots & \dots & \dots & \dots & \dots & \dots \\ u_{n+1}^{n-1} & u_{n+1}^n & u_{n+1}^{n+1} & \dots & u_{n+1}^{2n-3} & u_{n+1}^{2n-2} & u_{n+1}^{2n} \end{vmatrix},$$

that is to say, its order-number cannot exceed $\frac{1}{2}n(3n+1)$; and as it is exactly divisible by the difference-product of the u 's, which is of the order $\frac{1}{2}n(n+1)$, it follows that

$$V = \Delta(u_1, u_2, \dots, u_{n+1}) \cdot V_1$$

where V_1 is a function whose order-number is not greater than n^2 . Noting now that the other form of the resultant, namely $[1, 2, \dots, n+1]$, can by addition be transformed into

$$\frac{U}{A_1 A_2 \dots A_n}$$

where U cannot contain any of the differences of the u 's, and in

The result of the whole change was therefore

$$1 = \xi \cdot \frac{(-1)^n}{\Delta(a_1, a_2, \dots, a_n)},$$

whence it followed that

$$\xi = (-1)^n \Delta(a_1, a_2, \dots, a_n);$$

and so the longed-for result was reached

$$J = (-1)^n \frac{\Delta(a_1, a_2, \dots, a_n) \cdot \Delta(u_1, u_2, \dots, u_{n+1})}{A_1 A_2 \dots A_n} [1, 2, \dots, n+1].$$

Thereupon additional results come with a rush. First we are told that in a similar manner the determinant got from J by changing the second power in the denominator of every element into the first power* is found equal to

$$(-1)^n \frac{\Delta(a_1, a_2, \dots, a_n) \cdot \Delta(u_1, u_2, \dots, u_{n+1})}{A_1 A_2 \dots A_n}.$$

Then "E combinatione aequationum prodit

$$\frac{\det. \left\{ \frac{1}{(a_1+u)^2}, \frac{1}{(a_2+u)^2}, \dots, \frac{1}{(a_n+u)^2}, 1 \right\}}{\det. \left\{ \frac{1}{a_1+u}, \frac{1}{a_2+u}, \dots, \frac{1}{a_n+u}, 1 \right\}} = [1, 2, \dots, n+1].$$

$u = u_1, = u_2, = \dots, = u_{n+1}$

Faciendo $u_{n+1} =$ quantitati infinite magnae, aequatio in relationem a cl. Borchardt inventam transit, scilicet in

$$\frac{\det. \left\{ \frac{1}{(a_1+u)^2}, \frac{1}{(a_2+u)^2}, \dots, \frac{1}{(a_n+u)^2} \right\}}{\det. \left\{ \frac{1}{a_1+u}, \frac{1}{a_2+u}, \dots, \frac{1}{a_n+u} \right\}} = \sum \frac{1}{(a_1+u_1)(a_2+u_2) \dots (a_n+u_n)}.$$

$u = u_1, = u_2, = \dots, = u_n$

BELLAVITIS (1857, June).

[Sposizione elementare della teorica dei determinanti. *Mem. . . . Istituto veneto . . .*, vii. pp. 67-144.]

Bellavitis reaches the subject of the difference-product in § 47 of his exposition, and his proof of the results dealt with in the

* Previous suggestions of such a determinant appear in Binet's paper of 1837 and Joachimsthal's of 1854.

preceding year by Prouhet is his own and interesting. Denoting the equation whose roots are a_1, a_2, \dots, a_n by

$$x^n - p_1x^{n-1} + p_2x^{n-2} - \dots = 0$$

and the difference-product of the roots by Π , he multiplies both sides of the identity

$$(x - a_1)(x - a_2) \dots (x - a_n) = x^n - p_1x^{n-1} + p_2x^{n-2} - \dots$$

by Π ; and as the result on the left-hand side is evidently * the difference-product of $a_1, a_2, \dots, a_n, x_1$ he obtains

$$| a_1^0 a_2^1 \dots a_n^{n-1} x^n | = (x^n - p_1x^{n-1} + \dots) \Pi.$$

It only remains then to equate like powers of x and there results

$$| a_1^0 a_2^1 a_3^2 \dots a_{n-1}^{n-2} a_n^n | = p_1 \Pi,$$

$$| a_1^0 a_2^1 \dots a_{n-2}^{n-3} a_{n-1}^{n-1} a_n^n | = p_2 \Pi,$$

.....

$$| a_1^1 a_2^2 a_3^3 \dots a_{n-1}^{n-1} a_n^n | = p_n \Pi.$$

He points out also that as an alternative to this we may begin with $| a_1^0 a_2^1 a_3^2 \dots a_n^{n-1} x^n |$, express it as a determinant of the next lower order, remove the factors $(x - a_1), (x - a_2), \dots, (x - a_n)$, change the product of these into $x^n - px^{n-1} + \dots$, and then equate coefficients of like powers of x as before.

Multiplying again by Π he has of course

$$| a_1^0 a_2^1 a_3^2 \dots a_n^{n-1} x^n | \cdot \Pi = (x^n - p_1x^{n-1} + \dots) \Pi^2,$$

and by changing Π on the left into

$$\begin{vmatrix} 1 & 1 & 1 & \dots & 1 & 0 \\ a_1 & a_2 & a_3 & \dots & a_n & 0 \\ a_1^2 & a_2^2 & a_3^2 & \dots & a_n^2 & 0 \\ \dots & \dots & \dots & \dots & \dots & \dots \\ a_1^{n-1} & a_2^{n-1} & a_3^{n-1} & \dots & a_n^{n-1} & 0 \\ 0 & 0 & 0 & \dots & 0 & 1 \end{vmatrix}$$

and twice using the multiplication-theorem there is obtained

* See footnote to page 365.

$$\begin{vmatrix} s_0 & s_1 & \dots & s_{n-1} & 1 \\ s_1 & s_2 & \dots & s_n & x \\ \dots & \dots & \dots & \dots & \dots \\ s_{n-1} & s_n & \dots & s_{2n-2} & x^{n-1} \\ s_n & s_{n+1} & \dots & s_{2n-1} & x^n \end{vmatrix} = (x^n - p_1 x^{n-1} + \dots) \begin{vmatrix} s_0 & s_1 & \dots & s_{n-1} \\ s_1 & s_2 & \dots & s_n \\ \dots & \dots & \dots & \dots \\ s_{n-1} & s_n & \dots & s_{2n-2} \end{vmatrix},$$

a result already reached by Joachimsthal, and which by the equatement of like powers of x gives “ i coefficienti p espressi da rapporti di determinanti di n^{esimo} grado.”

BETTI (1857, June).

[Sur les fonctions symétriques des racines des équations. *Crelle's Journ*, liv. pp. 98-100.]

Betti recalls Borchardt's result of the year 1855, namely, that the symmetric function

$$\sum x_1^{\alpha_1} x_2^{\alpha_2} \dots x_n^{\alpha_n}$$

where x_1, x_2, \dots, x_n are the roots of the equation

$$\begin{aligned} 0 &= x^n - p_1 x^{n-1} + p_2 x^{n-2} - \dots, \\ &= f(x) \text{ say,} \end{aligned}$$

is the coefficient of $t_1^{-(\alpha_1+1)} t_2^{-(\alpha_2+1)} \dots t_n^{-(\alpha_n+1)}$ in the development of

$$(-1)^n \frac{f(t_1) \cdot f(t_2) \dots f(t_n)}{\Pi(t_1, t_2, \dots, t_n)} \cdot \frac{\partial}{\partial t_1} \frac{\partial}{\partial t_2} \dots \frac{\partial}{\partial t_n} \left(\frac{\Pi(t_1, t_2, \dots, t_n)}{f(t_1) \cdot f(t_2) \dots f(t_n)} \right)$$

according to descending powers of the t 's. He then gives an observation of his own, namely, that the said symmetric function is likewise the coefficient of $t_1^{-(\alpha_1+1)} t_2^{-(\alpha_2+1)} \dots t_n^{-(\alpha_n+1)}$ in the similar development of

$$\frac{f'(t_1) \cdot f'(t_2) \dots f'(t_n) \cdot \Pi^2(t_1, t_2, \dots, t_n)}{f(t_1) \cdot f(t_2) \dots f(t_n) \cdot \Pi^2(x_1, x_2, \dots, x_n)};$$

and by comparison of the two results draws the conclusion that if Borchardt's generating function be denoted by

$$\theta(t_1, t_2, \dots, t_n),$$

and his own after removal of $\Pi^2(x_1, x_2, \dots, x_n)$ from the denominator be denoted by

$$\phi(t_1, t_2, \dots, t_n)$$

the squared difference-product of the x 's is equal to

$$\frac{\{\phi(t_1, t_2, \dots, t_n)\}}{\{\theta(t_1, t_2, \dots, t_n)\}},$$

$$\frac{t_1^{-(a_1+1)} t_2^{-(a_2+1)} \dots t_n^{-(a_n+1)}}{t_1^{-(a_1+1)} t_2^{-(a_2+1)} \dots t_n^{-(a_n+1)}},$$

where the notation used is sufficiently explained by saying that in accordance with it the coefficient of x^r in the expansion of $F(x)$ is denoted by

$$\{F(x)\}_{x^r}.$$

BALTZER (1857).

[Theorie und Anwendung der Determinanten, vi+129 pp.,
Leipzig: French translation by J. Houel, xii+235 pp.,
Paris, 1861.]

The section (§ 12) dealing with the "Product aller Differenzen von gegebenen Grössen" belongs to the second part of Baltzer's text-book, that is to say, the part concerning "applications." It occupies eleven pages, those devoted strictly to alternants being the first three (pp. 50-53).

At the outset he establishes the determinant form for the difference-product $P(a_1, a_2, \dots, a_n)$: then he gives two determinant-forms for $P(a_1, a_2, \dots, a_n) \cdot P(\beta_1, \beta_2, \dots, \beta_n)$: passes thence to the persymmetric determinants in s_0, s_1, s_2, \dots : and finally gives Cauchy's evaluation of the double alternant $|(a_1 - \beta_1)^{-1} (a_2 - \beta_2)^{-1} \dots (a_n - \beta_n)^{-1}|$. The applications, which come next, concern the solution of Lagrange's set of linear equations, Sylvester's transformation of a binary quantic into canonical form, and the discussion of the equality of two roots of the equation $a_n x^n + a_{n-1} x^{n-1} + \dots + a_0 = 0$, or say $f(x) = 0$, viewed in connection with what he calls the "determinant" of the equation, although Sylvester's use of the word "discriminant" is explained a page or two later.

Under this last head an interesting transformation falls to be noted. Calling the roots of the said equation $\alpha_1, \alpha_2, \dots, \alpha_n$, and taking the determinant which is the square of their difference-product, namely,

$$\begin{vmatrix} s_0 & s_1 & \dots & s_{n-1} \\ s_1 & s_2 & \dots & s_n \\ \dots & \dots & \dots & \dots \\ s_{n-1} & s_n & \dots & s_{2n-2} \end{vmatrix}, \quad \text{or } Z \text{ say,}$$

he substitutes for it a determinant of the $(2n - 2)^{\text{th}}$ order

$$\begin{vmatrix} 1 & 0 & 0 & \dots & 0 & 0 & 0 & \dots & 0 \\ 0 & 1 & 0 & \dots & 0 & 0 & 0 & \dots & 0 \\ 0 & 0 & 1 & \dots & 0 & 0 & 0 & \dots & 0 \\ \dots & \dots & \dots & \dots & \dots & \dots & \dots & \dots & \dots \\ 0 & 0 & 0 & \dots & s_0 & s_1 & s_2 & \dots & s_{n-1} \\ 0 & 0 & 0 & \dots & s_1 & s_2 & s_3 & \dots & s_n \\ \dots & \dots & \dots & \dots & \dots & \dots & \dots & \dots & \dots \\ 0 & s_0 & s_1 & \dots & s_{n-3} & s_{n-2} & s_{n-1} & \dots & s_{2n-4} \\ s_0 & s_1 & s_2 & \dots & s_{n-2} & s_{n-1} & s_n & \dots & s_{2n-3} \\ s_1 & s_2 & s_3 & \dots & s_{n-1} & s_n & s_{n+1} & \dots & s_{2n-2} \end{vmatrix},$$

where the first $n - 2$ rows do not contain an s , and the rows following contain all the s 's in descending order from right to left, beginning with s_{n-1} in the last place of the $(n - 1)^{\text{th}}$ row, with s_n in the last place of the n^{th} row, and so on. He then multiplies every row by a_n , and performs the operations which we may indicate by

$$\begin{aligned} \text{col}_2 &+ \frac{a_{n-1}}{a_n} \text{col}_1, \\ \text{col}_3 &+ \frac{a_{n-1}}{a_n} \text{col}_2 + \frac{a_{n-2}}{a_n} \text{col}_1, \\ \text{col}_4 &+ \frac{a_{n-1}}{a_n} \text{col}_3 + \frac{a_{n-2}}{a_n} \text{col}_2 + \frac{a_{n-3}}{a_n} \text{col}_1, \\ &\dots \end{aligned}$$

thus obtaining

$$Z \cdot a_n^{2n-2} = \begin{vmatrix} a_n & a_{n-1} & a_{n-2} & \dots \\ 0 & a_n & a_{n-1} & \dots \\ 0 & 0 & a_n & \dots \\ \dots & \dots & \dots & \dots \\ 0 & a_n s_0 & a_n s_1 + a_{n-1} s_0 & \dots \\ a_n s_0 & a_n s_1 + a_{n-1} s_0 & a_n s_2 + a_{n-1} s_1 + a_{n-2} s_0 & \dots \\ a_n s_1 & a_n s_2 + a_{n-1} s_1 & a_n s_3 + a_{n-1} s_2 + a_{n-2} s_1 & \dots \end{vmatrix},$$

and by using Newton's relations

$$\begin{aligned} na_n &= a_n s_0, \\ (n-1)a_{n-1} &= a_n s_1 + a_{n-1} s_0, \\ (n-2)a_{n-2} &= a_n s_2 + a_{n-1} s_1 + a_{n-2} s_0, \\ (n-3)a_{n-3} &= a_n s_3 + a_{n-1} s_2 + a_{n-2} s_1 + a_{n-3} s_0, \\ &\dots \end{aligned}$$

the elements of the last n rows of the right-hand determinant, we are told, can be so changed that in each there will occur only one of the a 's and that in the first power. Thereupon the conclusion is formally announced that the determinant with which we started can be expressed as a rational integral function of the $(2n-2)^{\text{th}}$ degree in the quantities

$$\frac{a_0}{a_n}, \frac{a_1}{a_n}, \dots, \frac{a_{n-1}}{a_n},$$

and that the said function becomes homogeneous on multiplication by a_n^{2n-2} . The actual result is not given, but in the second edition (1864) it is stated to be

$$-Z \cdot a_n^{2n-2} = \begin{vmatrix} a_n & a_{n-1} & a_{n-2} & \dots \\ 0 & a_n & a_{n-1} & \dots \\ 0 & 0 & a_n & \dots \\ \dots & \dots & \dots & \dots \\ 0 & na_n & (n-1)a_{n-1} & \dots \\ na_n & (n-1)a_{n-1} & (n-2)a_{n-2} & \dots \\ a_{n-1} & 2a_{n-2} & 3a_{n-3} & \dots \end{vmatrix},$$

“eine Determinante $(2n-2)$ ten Grades, bei welcher die $m-2$ ersten und die $m-1$ folgenden Zeilen in Bezug auf die nicht verschwindenden Elemente übereinstimmen.”

Part of the object which Baltzer had here in view was to establish the relation between two forms of the discriminant of the given equation; namely, that obtained by squaring the determinant-form of the difference-product and that obtained as the eliminant of the equations

$$f'(x) = 0, \quad nf(x) - xf'(x) = 0,$$

or the equations

$$\left. \begin{aligned} \frac{\partial}{\partial x} (a_n x^n + a_{n-1} x^{n-1} y + \dots + a_0 y^n) &= 0 \\ \frac{\partial}{\partial y} (a_n x^n + a_{n-1} x^{n-1} y + \dots + a_0 y^n) &= 0 \end{aligned} \right\}$$

PROUHET (1857, Nov.).

[Questions 410, 411. *Nouv. Annales de Math.*, (1) xvi. pp. 403, 404; xvii. pp. 187-190.]

By reason of the existence of the identity

$$2^{s-1} \cos^s a = \cos sa + s \cos (s-2)a + \frac{1}{2}s(s-1) \cos (s-4)a + \dots$$

it is clear that the determinant

$$\begin{vmatrix} \cos na_0 & \cos (n-1)a_0 & \cos (n-2)a_0 & \dots & \cos 0.a_0 \\ \cos na_1 & \cos (n-1)a_1 & \cos (n-2)a_1 & \dots & \cos 0.a_1 \\ \cos na_2 & \cos (n-1)a_2 & \cos (n-2)a_2 & \dots & \cos 0.a_2 \\ \dots & \dots & \dots & \dots & \dots \\ \cos na_n & \cos (n-1)a_n & \cos (n-2)a_n & \dots & \cos 0.a_n \end{vmatrix}$$

may be transformed into

$$\begin{vmatrix} 2^{n-1} \cos^n a_0 & 2^{n-2} \cos^{n-1} a_0 & 2^{n-3} \cos^{n-2} a_0 & \dots & \cos^0 a_0 \\ 2^{n-1} \cos^n a_1 & 2^{n-2} \cos^{n-1} a_1 & 2^{n-3} \cos^{n-2} a_1 & \dots & \cos^0 a_1 \\ 2^{n-1} \cos^n a_2 & 2^{n-2} \cos^{n-1} a_2 & 2^{n-3} \cos^{n-2} a_2 & \dots & \cos^0 a_2 \\ \dots & \dots & \dots & \dots & \dots \\ 2^{n-1} \cos^n a_n & 2^{n-2} \cos^{n-1} a_n & 2^{n-3} \cos^{n-2} a_n & \dots & \cos^0 a_n \end{vmatrix}$$

by increasing the 1st column by multiples of the 3rd, 5th, 7th, . . . , the 2nd column by multiples of the 4th, 6th, 8th, . . . and so forth. In this way there is deduced the result

$$\Delta_1 = 2^{\frac{1}{2}n(n-1)} \cdot D,$$

where Δ_1 is the first determinant, and D is the determinant got from Δ_1 by changing the multipliers of a_0, a_1, a_2, \dots into indices of powers of $\cos a_0, \cos a_1, \cos a_2, \dots$

Again by using the identity

$$\sin (s+1)a = \sin a \{ 2^s \cos^s a + p \cdot \cos^{s-2} a + q \cdot \cos^{s-4} a + \dots \}$$

on every element of the determinant

$$\begin{vmatrix} \sin (n+1)a_0 & \sin na_0 & \dots & \sin a_0 \\ \sin (n+1)a_1 & \sin na_1 & \dots & \sin a_1 \\ \dots & \dots & \dots & \dots \\ \sin (n+1)a_n & \sin na_n & \dots & \sin a_n \end{vmatrix}, \text{ or } \Delta_2 \text{ say,}$$

it is seen that the factors $\sin a_0, \sin a_1, \dots$ can be removed from the rows in order, and that the determinant so produced is

simplifiable into a multiple of D : so that there is obtained the second result

$$\Delta_2 = 2^{1n(n-1)} \cdot \sin \alpha_0 \sin \alpha_1 \dots \sin \alpha_n \cdot D.$$

The two results are Prouhet's, who set them for proof by others.

SALMON (1859).

[Lessons introductory to the modern higher algebra. xii + 147 pp., Dublin.]

The determinant form of the difference-product and the determinants in s_0, s_1, \dots are given, but merely as illustrative examples of the general subject.

LIUVILLE (1846).*

[Sur une classe d'équations du premier degré. *Journ. (de Liouville) de Math.*, xi. pp. 466-467; or *Nouv. Annales de Math.*, vi. pp. 129-131; or *Archiv d. Math. u. Phys.*, xxii. pp. 226-228.]

The set of equations referred to is that dealt with by Binet in 1837. Chelini and Liouville arrived at a new solution, much simpler than Binet's, and related to that used by Murphy in 1832 in solving other sets of linear equations.

LIST OF AUTHORS

whose writings are herein dealt with.

	PAGE		PAGE
1832. MURPHY	357	1854. BRIOSCHI	370
1837. BINET	358	1854. JOACHIMSTHAL	371
1841. HAEDENKAMP	361	1854. BRIOSCHI	373
1845. BORCHARDT	362	1855. BORCHARDT	374
1845. ROSENHAIN	362	1856. PROUHET	376
1845. STURM	363	1856. SCHEIBNER	377
1846. TERQUEM	363	1856. JOACHIMSTHAL	377
1846. CAYLEY	364	1857. BELLAVITIS	381
1846. CHELINI	366	1857. BETTI	383
1846. LIUVILLE	389	1857. BALTZER	384
1847. GRUNERT	366	1857. BRIOSCHI	387
1849. ROSENHAIN	367	1857. PROUHET	388
1850. MAINARDI	368	1859. SALMON	389
1853. CAYLEY	369		

* This should have been inserted under but not separate from "CHELINI (1846)," the proper joint heading being "CHELINI and LIUVILLE (1846)."

The Theory of Circulants in the Historical Order of Development up to 1860. By Thomas Muir, LL.D.

(MS. received July 9, 1906. Read July 13, 1906.)

So far as mathematical writers have as yet noted, a set of equations of the type

$$\left. \begin{aligned} a_1x_1 + a_2x_2 + \dots + a_nx_n &= u_1, \\ a_nx_1 + a_1x_2 + \dots + a_{n-1}x_n &= u_2, \\ a_{n-1}x_1 + a_nx_2 + \dots + a_{n-2}x_n &= u_3, \\ \dots & \\ a_2x_1 + a_3x_2 + \dots + a_1x_n &= u_n, \end{aligned} \right\}$$

had not made its appearance in mathematical work prior to the year 1846: and it is almost absolutely certain that before that year the *determinant* of such a set had never been considered. It is not at all unlikely, however, that the expression

$$a^3 + b^3 + c^3 - 3abc$$

which is the case of the determinant for n equal to 3 had more than once turned up in other connections, and that its divisibility by $a + b + c$ had been noted: but of this, too, there is no record.

CATALAN (1846).

[Recherches sur les déterminants. *Bull. de l'Acad. roy. . . . de Belgique*, xiii. pp. 534-555.]

As has been already explained, about half of Catalan's paper is occupied with an elementary exposition of known properties of determinants and with the establishment of a fresh theorem of his own, which in his notation might have been written in the form

$$\begin{aligned} \text{dét. } (A_1 + A_2 + \dots + A_n, A_1 - A_2, A_2 - A_3, \dots, A_{n-1} - A_n) \\ = (-1)^{n-1} \cdot n \cdot \text{dét. } (A_1, A_2, \dots, A_n), \end{aligned}$$

and which is to the effect that *If from a determinant Δ of the n^{th} order we form another Δ' , such that the first row of Δ' is the sum*

The procedure, however, is rather perverse, the theorem of § 13 being forced into service. This gives

$$\Delta = (-1)^{n-1} \frac{1}{n} \Delta',$$

where Δ' is the determinant of the system

$$\begin{array}{cccccccc} s & a_1 - a_2 & a_2 - a_3 & \dots & a_{n-1} - a_n & & & \\ s & a_2 - a_3 & a_3 - a_4 & \dots & a_n - a_1 & & & \\ s & a_3 - a_4 & a_4 - a_5 & \dots & a_1 - a_2 & & & \\ \dots & \dots & \dots & \dots & \dots & \dots & \dots & \\ s & a_n - a_1 & a_1 - a_2 & & & a_{n-2} - a_{n-1}, & & \end{array}$$

after which Δ'/s is partitioned into determinants with monomial elements, and certain more or less evident reductions made. The result is "Le déterminant du système proposé s'obtiendra en multipliant $a_1 + a_2 + \dots + a_n$ (i.e. s) par le déterminant du système

$$\begin{array}{cccccccc} a_1 - a_2 & a_2 - a_3 & \dots & a_{n-1} - a_n & & & & \\ a_2 - a_3 & a_3 - a_4 & \dots & a_n - a_1 & & & & \\ \dots & \dots & \dots & \dots & \dots & \dots & \dots & \\ a_{n-1} - a_n & a_n - a_1 & \dots & a_{n-3} - a_{n-2} & & & & \end{array}''$$

a theorem which afterwards came to be written in the form

$$C(a_1, a_2, \dots, a_n) = (a_1 + a_2 + \dots + a_n) \cdot P(a_1 - a_2, \dots, a_{n-1} - a_n, a_n - a_1, \dots, a_{n-3} - a_{n-2})$$

the symbol $P(x, y, z, w, v)$ being used to stand for the "per-symmetric" determinant

$$\begin{vmatrix} x & y & z \\ y & z & w \\ z & w & v \end{vmatrix}.$$

SPOTTISWOODE (1853).

[Elementary theorems relating to determinants. Re-written and much enlarged by the author. *Crelle's Journ.*, li. pp. 209-271, 328-381.]

In the section (§ xi.) which did appear in the first edition, and which bears the title "Miscellaneous instances of determinants,"

the following is given (p. 375), being the fourth of the said instances:—

“Let $1, i_1, i_2, \dots, i_n$ be the $n + 1$ roots of the equation

$$x^{n+1} - 1 = 0,$$

then, whatever be the values of A, A_1, A_2, \dots, A_n

$$\begin{vmatrix} A & A_1 & \dots & A_n \\ A_1 & A_2 & \dots & A_1 \\ \dots & \dots & \dots & \dots \\ A_n & A_1 & \dots & A_{n-1} \end{vmatrix} = (A + A_1 + \dots + A_n)(A + i_1 A_1 + \dots + i_1^n A_n) \dots (A + i_n A_1 + \dots + i_n^n A_n).”$$

No word of proof is added: probably the result was reached by Sylvester’s “dialytic” method of elimination. But however this may be, it should be noted that resolvability into linear factors soon came to be looked on as the fundamental property of the circulant.

It has to be noted that Spottiswoode makes a slip in omitting the sign-factor $(-1)^{\frac{1}{2}n(n-1)}$ from the right-hand member; and that he writes his determinant in such a way as to have it persymmetric with respect to the principal diagonal, whereas Catalan wrote his so as to have it persymmetric with respect to the secondary diagonal. Putting C' for the functional symbol in the former case we have

$$C(a_1, a_2, \dots, a_n) = (-1)^{\frac{1}{2}n(n-1)} \cdot C'(a_1, a_2, \dots, a_n).$$

If therefore Spottiswoode had followed Catalan’s mode of writing, his result would have been strictly accurate.

CREMONA (1856).

[Intorno ad un teorema di Abel. *Annali di sci. mat. e fis.*, vii. pp. 99–105.]

To prove the theorem of Abel referred to in the title, Cremona starts by establishing three lemmas, the first of which is Spottiswoode’s theorem regarding circulants. Taking any n quantities

$$a_0, a_1, a_2, \dots, a_{n-1}$$

and denoting

$$a_0 + a_1 \alpha_r^1 + a_2 \alpha_r^2 + \dots + a_{n-1} \alpha_r^{n-1} \quad \text{by} \quad \theta_r$$

where a_r stands for α^r and a for a primitive root of the equation $x^n - 1 = 0$, he multiplies the determinant

$$\begin{vmatrix} a_0 & a_1 & a_2 & \dots & a_{n-1} \\ a_1 & a_2 & a_3 & \dots & a_0 \\ a_2 & a_3 & a_4 & \dots & a_1 \\ \dots & \dots & \dots & \dots & \dots \\ a_{n-1} & a_0 & a_1 & \dots & a_{n-2} \end{vmatrix}, \text{ or } D \text{ say,}$$

by the determinant

$$\begin{vmatrix} 1 & 1 & 1 & \dots & 1 \\ 1 & a_1 & a_2 & \dots & a_{n-1} \\ 1 & a_1^2 & a_2^2 & \dots & a_{n-1}^2 \\ \dots & \dots & \dots & \dots & \dots \\ 1 & a_1^{n-1} & a_2^{n-1} & \dots & a_{n-1}^{n-1} \end{vmatrix}, \text{ or } \Delta \text{ say,}$$

and obtains a product-determinant from whose columns, he says, the factors $\theta_1, \theta_2, \dots, \theta_n$ may be removed in order, so that their results

$$\begin{aligned} D\Delta &= \theta_1\theta_2 \dots \theta_n \begin{vmatrix} 1 & 1 & 1 & \dots & 1 \\ 1 & a_{n-1} & a_{n-1}^2 & \dots & a_{n-1}^{n-1} \\ 1 & a_{n-2} & a_{n-2}^2 & \dots & a_{n-2}^{n-1} \\ \dots & \dots & \dots & \dots & \dots \\ 1 & a_1 & a_1^2 & \dots & a_1^{n-1} \end{vmatrix} \\ &= \theta_1\theta_2 \dots \theta_n \cdot (-1)^{\frac{1}{2}n(n-1)}\Delta, \end{aligned}$$

and $\therefore D = (-1)^{\frac{1}{2}n(n-1)} \cdot \theta_1\theta_2 \dots \theta_n$.

The proof, which is said to be due to Brioschi, is not improved in neatness by introducing the conception of a primitive root, nor by writing the root 1 in a different form from the other roots.

The second lemma concerns the differential-quotient of D with respect to any variable of which the a 's are functions. Denoting this differential-quotient by D' , and by D_r the determinant got from D by substituting for each element in the r^{th} column the differential-quotient of that element, Cremona of course has at once

$$D' = D_1 + D_2 + \dots + D_n.$$

As, however, D_1 here can be shown by translation of a number of rows and the same number of columns to be equal to any one of the D 's following it, there results

$$D' = nD_1 = nD_2 = \dots$$

The third lemma is to the effect that the quotient of the determinant

$$\begin{vmatrix} m_0 & q_0 & q_1 d & \dots & q_{n-2} d^{n-2} \\ m_1 d & q_1 d & q_2 d^2 & \dots & q_{n-1} d^{n-1} \\ \dots & \dots & \dots & \dots & \dots \\ m_{n-1} d^{n-1} & q_{n-1} d^{n-1} & q_0 & \dots & q_{n-3} d^{n-3} \end{vmatrix}$$

by d is a rational function of d^n . By multiplying the 2nd, 3rd, 4th, . . . columns by $d^n, d^{n-1}, d^{n-2}, \dots$ respectively, and then dividing the corresponding rows by d, d^2, d^3, \dots respectively, there is obtained

$$\begin{vmatrix} m_0 & q_0 d^n & q_1 d^n & \dots & q_{n-2} d^n \\ m_1 & q_1 d^n & q_2 d^n & \dots & q_{n-1} d^n \\ m_2 & q_2 d^n & q_3 d^n & \dots & q_0 \\ \dots & \dots & \dots & \dots & \dots \\ m_{n-1} & q_{n-1} d^n & q_0 & \dots & q_{n-3} \end{vmatrix}$$

where no power of d occurs except the n^{th} . But, if the original determinant be H , the latter is

$$\frac{H \cdot d^n d^{n-1} d^{n-2} \dots d^2}{d d^2 d^3 \dots d^{n-1}} \text{ i.e. } \frac{H}{d} \cdot d^n ;$$

consequently H/d is of the form asserted.

In connection with this last lemma it is curious to find no note taken of the closely related and more attractive fact that

$$C(a_1, a_2 d, a_3 d^2, \dots, a_n d^{n-1})$$

is a rational function of d^n .

BELLAVITIS (1857).

[Sposizione elementare della teoria dei determinanti. *Venezia, Mem. Ist. Veneto*, viii. pp. 67-143.]

Circulants are practically unconsidered by Bellavitis in his exposition, all that appears (§ 85) being two of Laplace's expansions for $C(a, b, c, d)$ obtained by means of Cauchy's "chiavi algebriche," namely,

$$\begin{aligned} & (a^2 - bd)^2 - (b^2 - ac)^2 + (c^2 - bd)^2 - (d^2 - ac)^2 - 2(ab - cd)(ad - bc) \\ \text{and} & \quad (a^2 - c^2)^2 - (b^2 - d^2)^2 - 4(ab - cd)(ad - bc). \end{aligned}$$

PAINVIN (1858), ROBERTS (1859).

[Questions 432, 465. *Nouv. Annales de Math.*, xvii. p. 185 ; xviii. p. 117 ; xix. pp. 151-153, 170-174.]

Here it is special circulants that are set for consideration, namely, by Painvin the circulant whose elements are the first n integers, and by Michael Roberts the circulant whose elements are $a, a+d, a+2d, \dots$, the result in regard to the former circulant being

$$C'(1, 2, \dots, n) = (-1)^{\frac{1}{2}n(n-1)} \cdot \frac{1}{2}n^{n-1}(n+1),$$

and in regard to the latter

$$C'(a, a+d, \dots, a+\overline{n-1} \cdot d) = (-1)^{\frac{1}{2}n(n-1)} \cdot (nd)^{n-1} \cdot \left(a + \frac{n-1}{2}d\right).$$

The first to offer a proof was Cremona, who, after repeating (xix. pp. 151-153) Brioschi's demonstration regarding the resolvability of a circulant, says that in Roberts' case θ_r being

$$\begin{aligned} &\equiv a \frac{1 - a_r^n}{1 - a_r} + d \left\{ a_r \frac{1 - a_r}{(1 - a_r)^2} - \frac{na_r^n}{1 - a_r} \right\}, \\ &= \frac{nd}{a_r - 1} \quad \text{for } r = 1, 2, \dots, n-1 \end{aligned}$$

and $\theta_n = na + \frac{1}{2}n(n-1)d$,

and that consequently

$$\theta_1 \theta_2 \dots \theta_n = \frac{(nd)^{n-1}}{(a_1 - 1)(a_2 - 1) \dots (a_{n-1} - 1)} \{na + \frac{1}{2}n(n-1)d\};$$

whence the desired result readily follows, because the denominator is equal to

$$(-1)^{n-1}(1 - \Sigma a_1 + \Sigma a_1 a_2 - \Sigma a_1 a_2 a_3 + \dots)$$

where $\Sigma a_1 = -1$, $\Sigma a_1 a_2 = 1$, $\Sigma a_1 a_2 a_3 = -1$,

A proof was also given by G. F. Baehr of Groningen (xix. pp. 170-173), who changes

$$C'(a_1, a_2, \dots, a_n) \text{ into } (-1)^{\frac{1}{2}n(n-1)} C(a_n, a_{n-1}, \dots, a_1),$$

performs on the latter determinant the operations

$$\text{col}_1 - \text{col}_2, \text{col}_2 - \text{col}_3, \dots$$

$$\text{row}_1 + \text{row}_2 + \dots + \text{row}_n,$$

$$\text{removal of factors } d^n \text{ and } (-1)^{n-1} \cdot \frac{1}{2}n\{2a + (n-1)d\},$$

leaving as cofactor a determinant of the $(n-1)^{\text{th}}$ order whose diagonal elements are all $1-n$ and non-diagonal elements all 1. On this new determinant he then performs the operations

$$\begin{aligned} & \text{row}_1 + \text{row}_2 + \dots + \text{row}_{n-1}, \\ & \text{row}_2 + \text{row}_1, \text{row}_3 + \text{row}_1, \dots \end{aligned}$$

and so finds its value to be

$$(-1)^{n-1} \cdot n^{n-2}$$

which gives for the circulant with which he started the value

$$(-1)^{\frac{1}{2}n(n-1)} \cdot (nd)^{n-1} \cdot \left(a + \frac{n-1}{2}d \right).$$

BAEHR (1860).

[Solution de la question 432. *Nouv. Annales de Math.*, xix. pp. 170-174.]

After dealing as we have seen with the circulant whose elements are in equidifferent progression Baehr proceeds to the circulant whose elements are in equirational progression, namely

$$C'(a, ar, ar^2, \dots, ar^{n-1}).$$

This he first changes into

$$a^n \cdot C'(1, r, r^2, \dots, r^{n-1})$$

and then into

$$(-1)^{\frac{1}{2}n(n-1)} \cdot a^n \cdot C(r^{n-1}, r^{n-2}, \dots, r, 1).$$

On the determinant thus reached the operations

$$r \text{ row}_1 - \text{row}_2, \quad r \text{ row}_2 - \text{row}_3, \quad \dots$$

are performed, with the result that its value is found to be

$$(-1)^{n-1} \cdot (1-r^n)^{n-1},$$

and thence the value of the original circulant to be

$$(-1)^{\frac{1}{2}n(n-1)} \cdot a^n (r^n - 1)^{n-1}.$$

It is worth noting that instead of the last set of operations we might substitute with advantage the set

$$\text{row}_n - r \text{ row}_{n-1}, \quad \text{row}_{n-1} - r \text{ row}_{n-2}, \quad \dots;$$

also, that Baehr's circulant is a special case of that referred to under Cremona's third lemma.

Initiation of Deep-Sea Waves of Three Classes: (1) from a Single Displacement; (2) from a Group of Equal and Similar Displacements; (3) by a Periodically Varying Surface-Pressure. By Lord Kelvin.

(Read January 22, 1906. MS. received October 15, 1906.)

(1) DISTURBANCE DUE TO AN INITIATIONAL FORM MORE CONVENIENT THAN THAT OF §§ 3-31 OF PREVIOUS PAPERS ON WAVES. §§ 96-113.

§ 96. The investigations of §§ 5-31, including the "front and rear" of infinitely long free processions of waves in deep water, are all founded on initiational disturbances, according to the first of two typical forms described in §§ 3, 4. In this form the initial disturbance is everywhere elevation or everywhere depression, and its amount, at great distances from the origin varies inversely as the square root of the distance ρ , from a horizontal line at a small height h above the water-surface in the middle of the disturbance. In the present paper a new form of type-disturbance is derived indifferently from either the first or the second, of the forms of §§ 3, 4: from the first, by double differentiation with reference to time, t ; from the second, by single differentiation with reference to space, x .

§ 97 (being a repetition of §§ 1, 2, slightly modified with respect to notation). Consider a frictionless incompressible liquid, (called water for brevity,) in a straight canal, infinitely long and infinitely deep, with vertical sides. Let it be disturbed from its level by any change of pressure on the surface, uniform in every line perpendicular to the plane sides, and let it be left to itself under constant air pressure. It is required to find the displacement and velocity of every particle of water at any future time. Our initial condition will be fully specified by a given normal component of velocity, and a given normal component of displacement, at every point of the surface.

Taking O , any point at a distance h above the undisturbed water level, draw $O X$ parallel to the length of the canal, and $O Z$ vertically downwards. Let ξ , ζ be the displacement components,

and $\dot{\xi}$, $\dot{\zeta}$ the velocity components, of any particle of the water whose undisturbed position is (x, z) . We suppose the disturbance infinitesimal; by which we mean that the change of distance between any two particles of water is infinitely small in comparison with their undisturbed distance; and the line joining them experiences changes of direction which are infinitely small in comparison with the radian. Water being assumed incompressible and frictionless, its motion, started primarily from rest by pressure applied to the free surface, is essentially irrotational. Hence we have

$$\xi = \frac{d}{dx} F(x, z, t); \quad \zeta = \frac{d}{dz} F(x, z, t); \quad \dot{\xi} = \frac{d}{dx} \dot{F}; \quad \dot{\zeta} = \frac{d}{dz} \dot{F}. \quad (132):$$

where $F(x, z, t)$, or F as we may write it for brevity when convenient, is a function which may be called the displacement-potential; and $\dot{F}(x, z, t)$ is what is commonly called the velocity-potential. Thus a knowledge of the function F , for all values of x, z, t , completely defines the displacement and the velocity of the fluid. And towards the determination of F we have, in virtue of the incompressibility of the fluid,

$$\frac{d^2 F}{dx^2} + \frac{d^2 F}{dz^2} = 0 \quad . \quad . \quad . \quad . \quad . \quad (133).$$

In virtue of this equation, the well-known primary theory of Gauss and Green shows that, if F is given for every point of the free surface of the water, and is zero at every point infinitely distant from it the value of F is determinate throughout the fluid. The motion being infinitesimal, and the density being taken as unity, an application of fundamental hydrokinetics gives

$$p - \Pi = g(z - h + \zeta) - \frac{d^2 F}{dt^2} = g(z - h) + g \frac{dF}{dz} - \frac{d^2 F}{dt^2}. \quad (134),$$

where g denotes gravity; Π the uniform atmospheric pressure on the free surface; and p the pressure at the point $(x, z + \zeta)$ within the fluid.

§ 98. Suppose now that $F(x, z, t)$ is a function which, besides satisfying (133), satisfies also the equation

$$g \frac{dF}{dz} = \frac{d^2 F}{dt^2} \quad . \quad . \quad . \quad . \quad . \quad (135);$$

we see by (134) that the corresponding fluid motion of which F is the displacement-potential (132), has constant pressure over every surface ($z + \zeta$); that is to say, every surface which was level when the water was undisturbed. Thus our problem of finding any possible infinitesimal irrotational motion of the fluid, in which the free surface is under any constant pressure, is solved by finding solutions of (133) and (135).

§ 99. Now by differentiation we verify that, as found in § 3 above,

$$F = \frac{1}{\sqrt{z + \iota x}} \epsilon^{\frac{-gt^2}{4(z + \iota x)}} \dots \dots \dots (136)$$

satisfies (133) and (135). By changing ι into $-\iota$, and by integrations or differentiations performed on (136), according to the symbol $\frac{d^{i+j+k}}{dt^i dx^j dz^k}$, where i, j, k are any integers positive or negative, we can derive from (136) any number of imaginary solutions. And by addition of these, with constant coefficients, we can find any number of realised solutions. If, as in § 97, we regard any one of the formulas thus obtained as a displacement-potential, then by taking $\frac{d}{dz}$ of it we find ζ , the vertical component displacement, which we shall take as the most convenient expression in each case for the solutions with which we are concerned. Or we may, if we please, take any solution of (135) as representing, not a displacement-potential, but a velocity-potential, or a horizontal component of displacement or velocity, or a vertical component of displacement or velocity.

§ 100. Thus it was that in § 12 we took

$$\left. \begin{aligned} -\zeta &= \{\text{R.S.}\} \frac{\sqrt{2}}{\sqrt{z + \iota x}} \epsilon^{\frac{-gt^2}{4(z + \iota x)}} \\ &= \phi(x, z, t) &= \sqrt{\frac{2}{\rho}} \cos\left(\frac{gt^2 x}{4\rho^2} - \frac{1}{2}\chi\right) \epsilon^{\frac{-gt^2 z}{4\rho^2}} \end{aligned} \right\} (137),$$

where $\rho = \sqrt{(z^2 + x^2)}$, and $\chi = \tan^{-1}(x/z)$,

and in all of §§ 1-31, this notation ϕ and $-\zeta$ was consistently used, with $-\zeta$ to denote, when positive, upward displacement of the water (represented by upward ordinates in the drawings). In the two curves of § 4, fig. 1, that which has its maximum

over O represents (137), for $t=0$. The other curve of fig. 1, with positive and negative ordinates on the two sides of O, represents (137), with $- \{RD\}$ instead of $\{RS\}$. The symbols $\{RS\}$ and $\{RD\}$ were introduced in § 3 above; $\{RS\}$ to denote a realisation by taking half the sum of what is written after it with $\pm \iota$, and $\{RD\}$ to denote a realisation by taking $\frac{1}{2\iota}$ of the formula written after it minus $\frac{1}{2\iota}$ of the same formula with $+\iota$ changed into $-\iota$. A new curve in which the ordinates are numerically equal to $\frac{1}{\sqrt{2}} \frac{d}{dx}$ of the ordinates of the second of the old curves of fig. 1, is now given in the accompanying diagram, fig. 33; and close above it the first of the old curves of fig. 1 is reproduced, with ordinates reduced in the ratio $2\sqrt{2}$ to 1, for the sake of comparison with the new curve. This new curve represents the more convenient initiational form referred to in the title of the present paper.

Its equation, found by taking $t=0$ in (139) or in (144) [most easily from the imaginary form of (139)], is as follows:

$$\psi(x, z, 0) = \frac{1}{2\sqrt{2}} \frac{\sqrt{(\rho+z)}(2z-\rho)}{\rho^3} \dots \quad (138).$$

§ 101. The original derivation of the new particular solution, (which we shall call ψ), from the primary (136), as indicated in § 100, is shown by the following formula:

$$\psi(x, z, t) = \left. \begin{aligned} & \{RD\} \frac{d}{dx} \frac{-1}{\sqrt{(z+\iota x)}} \epsilon^{\frac{-gt^2}{4(z+\iota x)}} \\ & = \frac{1}{2\rho^3} \left\{ \cos\left(\frac{gt^2x}{4\rho^2} - \frac{3}{2}\chi\right) - \frac{1}{2} \frac{gt^2}{\rho} \cos\left(\frac{gt^2x}{4\rho^2} - \frac{5}{2}\chi\right) \right\} \epsilon^{\frac{-gt^2z}{4\rho^2}} \end{aligned} \right\} (139),$$

where $\rho = \sqrt{(z^2 + x^2)}$, and $\chi = \tan^{-1}(x/z)$.

An equivalent formula for the same derivation, which will be found more convenient in §§ 135-157 below, is as follows:

$$\psi(x, z, t) = \{RS\} \frac{1}{g} \frac{d^2}{dt^2} \frac{-1}{\sqrt{(z+\iota x)}} \epsilon^{\frac{-gt^2}{4(z+\iota x)}} = \frac{-1}{g\sqrt{2}} \frac{d^2}{dt^2} \phi(x, z, t) \quad (140).$$

Figure 33

Upper Curve $-\zeta = \frac{1}{2\sqrt{2}} \frac{\sqrt{(\rho+1)}}{\rho}$

Lower Curve $-\zeta = \frac{1}{2\sqrt{2}} \frac{\sqrt{(\rho+1)}(2-\rho)}{\rho^3}$

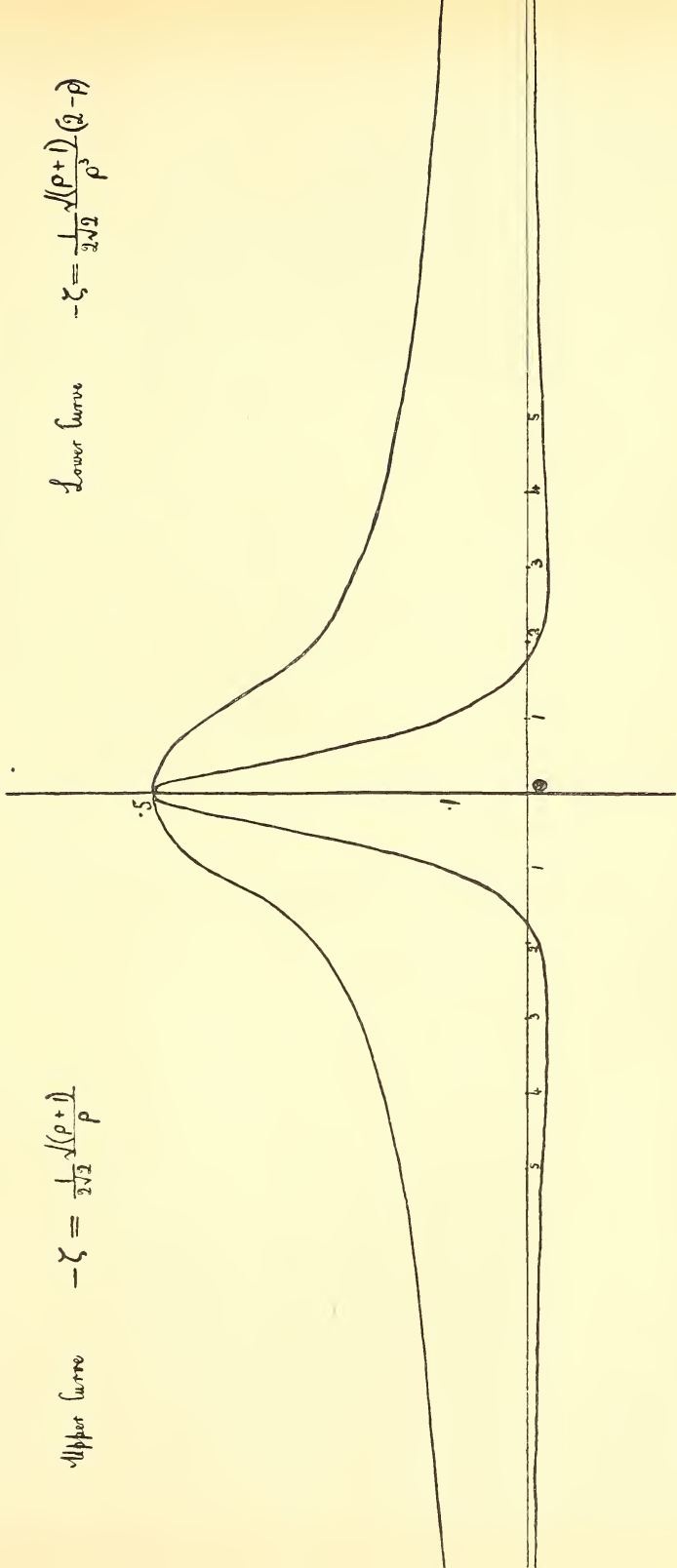
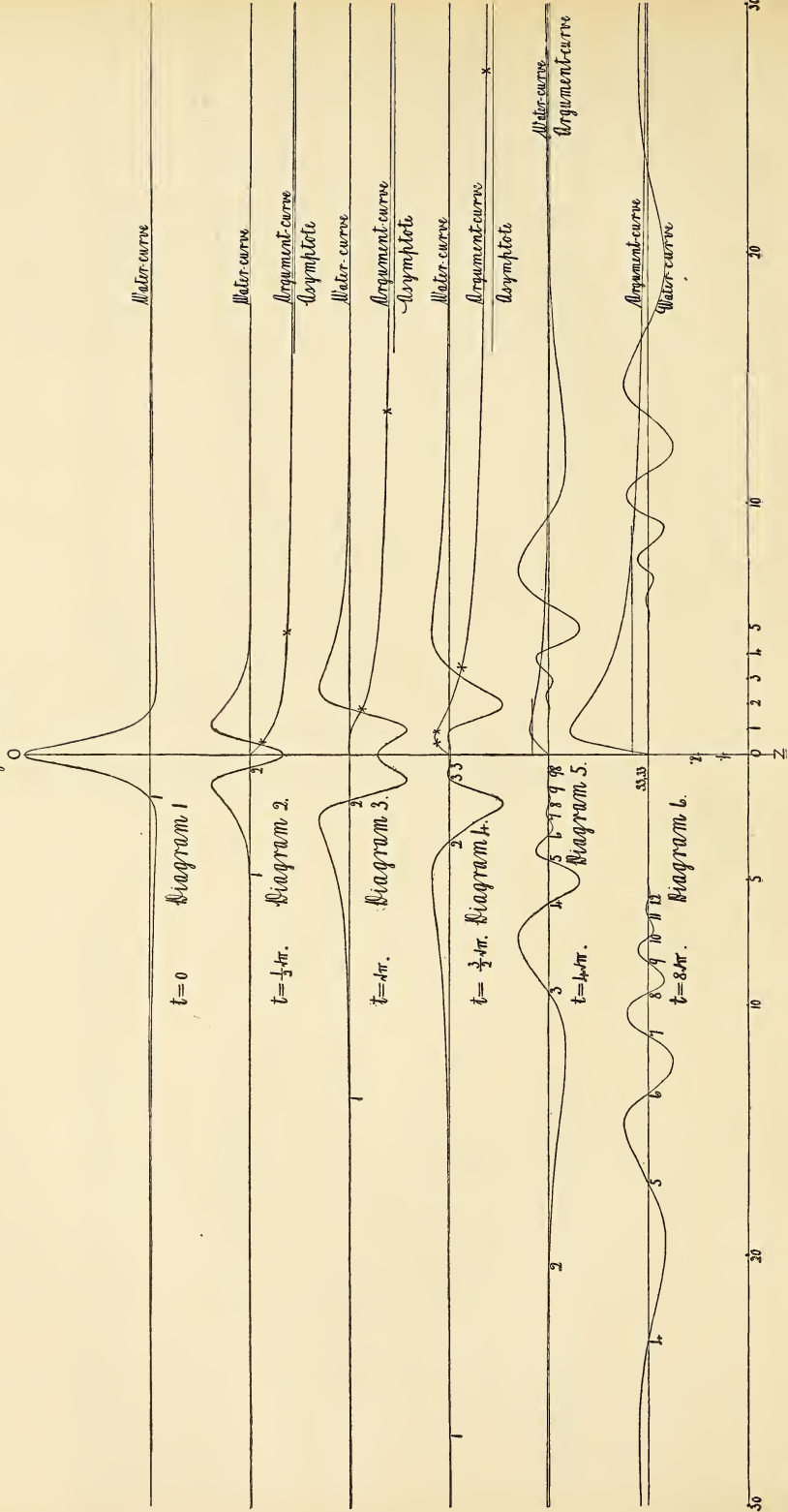

Figure 34



The equivalence of (139) and (140) is easily proved by remarking that by (133) and (135),

$$\frac{dF}{dx} = \iota \frac{dF}{dz} = \frac{\iota}{g} \frac{d^2F}{dt^2} \dots \dots \dots (141),$$

and therefore

$$\{\text{RD}\} \frac{d}{dx} \frac{-1}{\sqrt{(z+\iota x)}} \epsilon^{\frac{-gt^2}{4(z+\iota x)}} = \{\text{RS}\} \frac{1}{g} \frac{d^2}{dt^2} \frac{-1}{\sqrt{(z+\iota x)}} \epsilon^{\frac{-gt^2}{4(z+\iota x)}} \quad (142).$$

§ 102. Look now to fig. 33, and see within how narrow a space, say from $x = -2$ to $x = +2$, in the new curve, the main initial disturbance is confined, while in the old curve it spreads so far and wide that at $x = \pm 20$ it amounts to about .16 of the maximum disturbance in the middle, and according to the law of inverse proportion to square root of distance, which holds for large values of x for the old curve, at $x = 80$ it would still be as much as .1 of the maximum. The comparative narrowness of the initial disturbance represented by the new curve, and the ultimate law of decrease according to $x^{-\frac{3}{2}}$ (instead of $x^{-\frac{1}{2}}$ for the old curve) are great advantages of the new curve in the applications and illustrations of the theory to be given in §§ 135-157 below.

§ 103. Remark also that the total area of the old curve from $-\infty$ to $+\infty$ is infinitely great, while it is zero for the new curve. Remark also that the potential energy of the initial disturbance, being

$$\frac{1}{2}g \int_{-\infty}^{+\infty} dx [\zeta(x, 1, 0)]^2 \dots \dots \dots (143),$$

is infinitely great for the old curve, while for the new it is finite.

§ 104. Equation (139) may be written in the following modified form, which is more convenient for some of our interpretations and graphic constructions :

$$\psi(x, z, t) = - \frac{\sqrt{\{x^2 + (\frac{1}{2}gt^2 - z)^2\}} \epsilon^{\frac{-gt^2z}{4\rho^2}}}{2\rho^{5/2}} \cos \Lambda \quad (144),$$

$$\text{where } \Lambda = \frac{gt^2x}{4\rho^2} - \frac{3}{2}\chi - \tan^{-1} \frac{gt^2 \sin \chi}{gt^2 \cos \chi - 2\rho} \quad (145).$$

§ 105. The main curves, which for brevity we shall call water-curves in the accompanying six diagrams of fig. 34, represent the

surface displacements according to our new solution $\psi(x, z, t)$ for the six values of t respectively, 0 , $\frac{1}{2}\sqrt{\pi}$, $\sqrt{\pi}$, $\frac{3}{2}\sqrt{\pi}$, $4\sqrt{\pi}$, $8\sqrt{\pi}$. The formulas are simplified by taking $g=4$. This is merely equivalent to taking as our unit of length half the space descended in one second of time, by a body falling from rest under the influence of gravity. For simplification in the writing of formulas we take $z=1$ for the undisturbed level of the water-surface. The subsidiary curves, explained in § 107 below, are called argument-curves, as they represent the argument of the cosine in (144).

§ 106. One exceedingly curious and very interesting feature of these curves is the increasing number of values of x for which the displacement is zero as time advances, and the large figures, sixteen and sixty-four, which it reaches at the times, $4\sqrt{\pi}$ and $8\sqrt{\pi}$, of the last two diagrams. These zeros, for any value of t , are given by the equation

$$A = (2i + 1)\pi/2 \dots \dots \dots (146).$$

§ 107. Notwithstanding the highly complicated character of the function represented in (145), the zeros are easily found by tracing an argument-curve, with A as ordinate, and x abscissa (as shown on the x -positive halves of the six diagrams on two different scales chosen merely for illustration, not for measurement), and drawing parallels to the abscissa line at distances from it representing $-\frac{3}{2}\pi$, $-\frac{1}{2}\pi$, $\frac{1}{2}\pi$, $\frac{3}{2}\pi$, $\frac{5}{2}\pi$, etc. A parallel at distance $-\frac{7}{4}\pi$ is an asymptote to each of the argument-curves, and is shown in diagrams 2, 3, 4, on one scale of ordinates. The parallel corresponding to distance $\frac{1}{2}\pi$ is shown in the fifth and sixth diagrams, on the smaller scale of ordinates used in their argument-curves.

§ 108. The first diagram shows zeros at $x = \pm\sqrt{3}$, of which that at $x = -\sqrt{3}$ is marked 1. In the second diagram the argument-curve indicates zeros for the $-\frac{3}{2}\pi$ and $-\frac{1}{2}\pi$ parallels, which are seen distinctly on the water-curve. The zero corresponding to the $-\frac{1}{2}\pi$ parallel was formed at the origin at the time when $\frac{1}{2}gt^2$ was equal to z , that is, when t was $1/\sqrt{2}$, or $\cdot 707$. It is a coincidence of two zeros for x -positive and x -negative.

Diagram No. 3 shows that, shortly before its time, a maximum has come into existence in the argument-curve, which still indicates only two zeros. These are marked by crosses.

Diagram No. 4 shows that, in the interval between its time and the time of No. 3, two zeros of the water-curve for x -positive have come into existence. These and the corresponding zeros for x -negative are seen distinctly on the water-curve; and their indications for x -positive are marked by four crosses on the argument-curve.

Diagram No. 5 shows that, between its time and that of No. 4, twelve fresh zeros have come into existence on each side of OZ, one pair of which is indicated for example on the argument-curve by the parallel $\frac{13}{2}\pi$. Nine only out of all the sixteen zeros on either side are perceptible on the water-curve. The seven imperceptible zeros, on each side, all lie between $x=0$ and $x=\pm 1$.

Diagram No. 6 shows that, between its time and that of No. 5, forty-eight fresh zeros for x -positive have come into existence, one pair of which is indicated by the parallel $\frac{13}{2}\pi$. Fourteen only out of all the sixty-four zeros on each side are perceptible on the water-curve. Thirty-one of the fifty imperceptible zeros on each side lie between $x=0$ and $x=\pm 1$.

§ 109. After the time $1/\sqrt{2}$, the zeros originate in pairs on the two sides of the origin* (x -positive and x -negative): those on the positive side by the two intersections of one of the parallels corresponding to $(2i+1)\pi/2$ with the argument-curve. The maximum of the argument-curve travels slowly in the outward direction towards $x=1$ as time advances to infinity. At times $4\sqrt{\pi}$ and $8\sqrt{\pi}$, of diagrams 5 and 6, it has reached so close to $x=1$ that this point has been regarded as the actual position of the maximum, both for the purpose of drawing the curve, and for the determination of the total number of zeros.

§ 110. Each zero which originates according to an intersection on the outward side of the argument-curve travels outwards with increasing velocity to infinity, as time advances. Each of the others of the pairs of zeros, that is to say, each zero originating according to an intersection on the inward side of the argument-curve, travels very slowly inwards with velocity diminishing to nothing as time advances to infinity. Thus the motion of the

* If we continue the argument-curve to the side of the origin for x -negative, we must include large negative values of i in (146): but for simplicity we have confined the argument-curve to positive values of x .

water in the space between $x = -1$ and $x = +1$ becomes more and more nearly an increasing number of inward travelling waves, with lengths slowly diminishing to zero; and, as we see by the exponential factor in (144), with amplitudes and with slopes also slowly diminishing to zero: as time advances to infinity.

§ 111. The semi-period of one of these quasi standing waves is, as we find from (139), approximately equal to $\frac{2\pi\rho^2}{gtx}$ when the time is so far advanced that $\frac{1}{2}gt^2$ is very great in comparison with ρ . Thus we see that the period is infinite at the origin. This agrees with the history of the whole motion at the origin, which, as we see by putting $x=0$ in (139), with $z=1$ and $g=4$, is expressed by the formula

$$-\zeta = \frac{1}{2}(1 - 2t^2)\epsilon^{-t} \quad \dots \quad (147).$$

The motion of the water in the space between $x = -1$ and $x = +1$ is of a very peculiar and interesting character. Towards a full understanding of it, it may be convenient to study the simplified approximate solution

$$-\zeta \doteq -\frac{t^2}{\rho^{5/2}} \cos\left(\frac{t^2x}{\rho^2} - \frac{5}{2}\tan^{-1}x\right)\epsilon^{-t^2} \quad \dots \quad (148),$$

which the realised part of (139) gives when $\frac{1}{2}gt^2$ is very large in comparison with ρ .

§ 112. The outward travelling zeros on the two sides, beyond the distances ± 1 from the origin, divide the water into consecutive parts, in each of which it is wholly elevated or depressed. These parts we may call half-waves. They travel outwards with ever-increasing length and propagational velocity. Each of the half-waves developed after $t = \sqrt{\pi}$, as it travels outward, increases at first to a maximum elevation or maximum depression, and after that diminishes to zero as time advances to infinity.

§ 113. It is interesting to trace the progress of each of the zeros in the intervals between the times of our six diagrams. This is facilitated by the numbers marked on several of the zeros in the different diagrams. Thus, confining our attention to the left-hand

side of fig. 34, we see in diagram 1 a single zero numbered 1. The future zeros are to be numbered in the order of their coming into existence, 2; 3, 3; 4, 4; . . . ; 10, 10; . . . ; 33, 33; . . all in pairs after zero 2. Thus diagram 2 shows zero 1 considerably advanced leftwards (that is, outwards); and zero 2 beginning its outward progress. Diagram 3 shows zeros 1 and 2 each advanced arther outwards, 1 farther than 2. Diagram 4 shows all the zeros which have come into existence at time $\frac{3}{2}\sqrt{\pi}$. These are zeros 1 and 2, both farther outwards than at time $\sqrt{\pi}$, and a pair, 3, 3, which have come into existence shortly before the time $\frac{3}{2}\sqrt{\pi}$. The outer of these two travels outwards and the inner inwards. Some time later 4, 4 come into existence between 3 and 3: later still 5, 5 come into existence between 4 and 4.

In diagram 5, zero 1 has passed out of range leftwards: but we see distinctly the outward zeros 2, 3, 4, 5, 6, 7, 8, 9, and indications of the inward zeros 9, 8. The whole train of zeros for time $4\sqrt{\pi}$, shown and ideally continued to the middle by numbers, is 1, 2, 3, 4, 5, 6, 7, 8, 9, 9, 8, 7, 6, 5, 4, 3; sixteen in all.

Zero 3 has passed out of the range of diagram 6, but we see in it distinctly the outward zeros 4, 5, 12, and an indication of the pair 33, 33, which has come into existence before the time $8\sqrt{\pi}$. The whole train of zeros for time $8\sqrt{\pi}$, indicated by numbers, is 1, 2, 32, 33, 33, 32, 4, 3; sixty-four in all.

(2) ILLUSTRATIONS OF THE INDEFINITE EXTENSION AND MULTIPLICATION OF A GROUP OF TWO-DIMENSIONAL, DEEP-SEA WAVES INITIALLY FINITE IN NUMBER. §§ 114-117.

§ 114. The water is left at rest and free, after being initially displaced to a configuration of a finite number of sinusoidal mountains and valleys—five mountains and four valleys; in the diagrams placed before the Society. The initial group of waves, shown in diagram 1, of fig. 35, is formed by placing side by side, at distances equal to z (taken as unity), nine of the curves of diagram 1, fig. 34, alternately positive and negative. Diagrams 2 and 3, of fig. 35, are made by corresponding superpositions of

Figure 35.

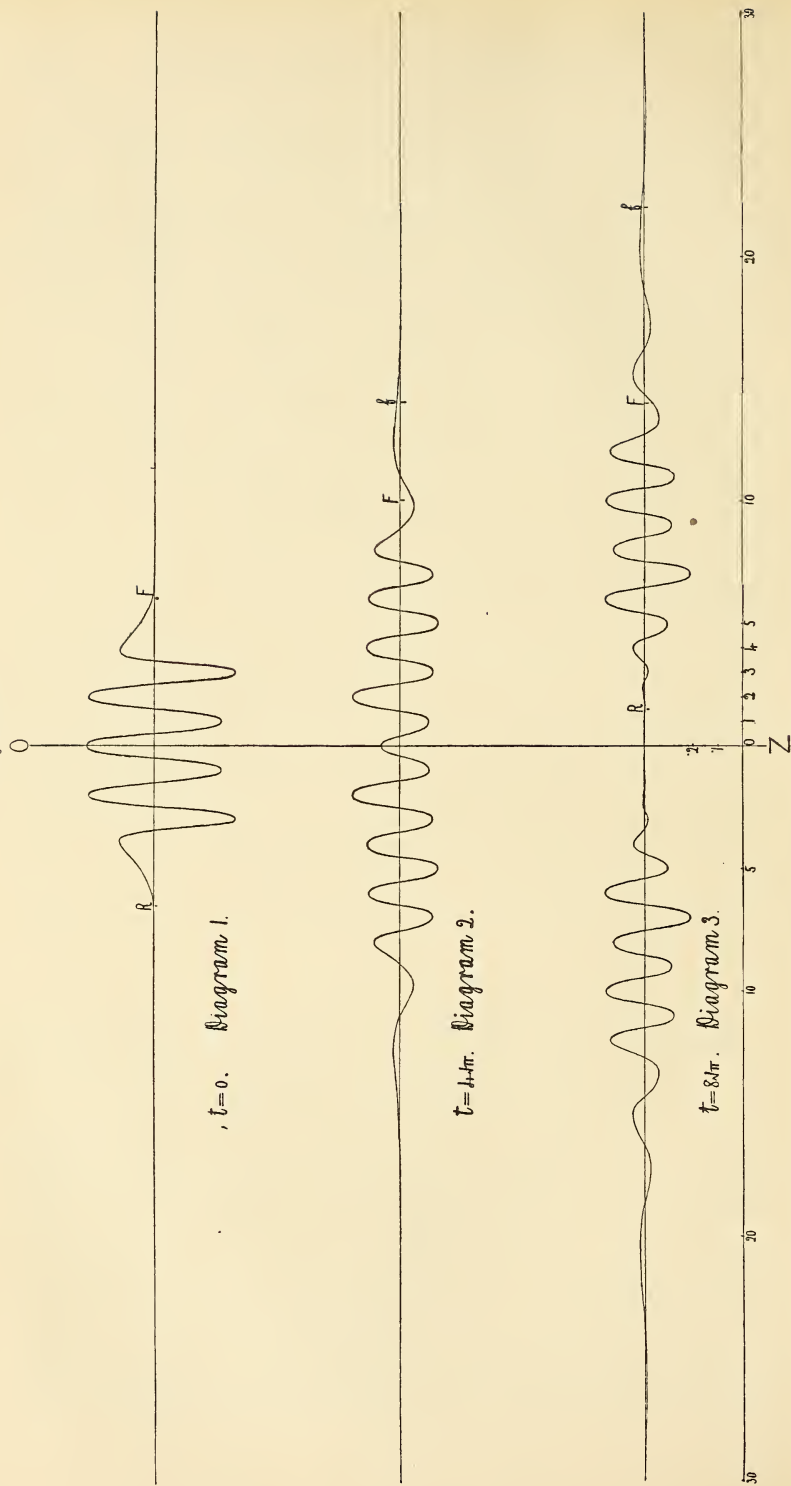

Initial group of five elevations and four depressions emerging as two groups travelling in opposite directions.

the curves of diagrams 5 and 6, of fig. 34. Thus what, according to the known law of deep-sea periodic waves (§ 19 above), would be definitely and precisely the wave-length, if the numbers of crests and hollows were infinitely great, would be 2; and as we are taking $g=4$, the period would be $\sqrt{\pi}$, and the propagational velocity would be $2/\sqrt{\pi}$.

§ 115. Immediately after the water is left free, the disturbance begins analysing itself into two groups of waves, seen travelling in contrary directions from the middle line of the diagram. The perceptible fronts of these two groups extend rightwards and leftwards from the end of the initial single static group, far beyond the "hypothetical fronts," supposed to travel at half the wave-velocity, which (according to the dynamics of Osborne Reynolds and Rayleigh, in their important and interesting consideration of the work required to feed a uniform procession of water-waves) would be the actual fronts *if* the free groups remained uniform. How far this *if* is from being realised is illustrated by the diagrams of fig. 35, which show a great extension outwards in each direction far beyond distances travelled at half the "wave-velocity." While there is this great extension of the fronts outward from the middle, we see that the two groups, after emergence from co-existence in the middle, travel with their rears leaving a widening space between them of water not perceptibly disturbed, but with very minute wavelets in ever-augmenting number following slower and slower in the rear of each group. The extreme perceptible rear travels at a speed closely corresponding to the "half wave-velocity," found by Stokes as exactly the group-velocity of his uniform succession of groups, produced by the interference of two co-existent infinite processions of sinusoidal waves, having slightly different wave-lengths.

§ 116. Our fairly uniform rear velocity is illustrated in diagrams 1 and 3, of fig. 35. In diagram 1, R indicates the perceptible rear of the component group commencing its rightward progress at $t=0$. In diagram 3, R shows the position reached at time $8\sqrt{\pi}$ (eight periods) by an ideal point travelling rightwards from the R of diagram 1 at a speed of half the wave-velocity. This R of diagram 3 corresponds to a fairly well-marked perceptible rear of the rightward travelling group.

Look now to F, F, F , in the three diagrams of fig. 35, and f, f , in diagrams 2 and 3. In diagram 1, F marks a perceptible front for the rightward travelling component group. In diagrams 2 and 3, F, f show ideal points travelling rightwards from it at speeds respectively, the half wave-velocity, and the wave-velocity. We see a manifest wave-disturbance far in advance of F, F ; and very small but still perceptible wave-disturbance in front of f, f . Thus the perceptible front travels at speed actually higher than the wave-velocity, and this perceptible front becomes more and more important relatively to the whole group with the advance of time, as we may judge from fig. 9 of § 20 above.

§ 117. It is interesting to see by these diagrams how nearly the hypothetical group-velocity is found in the rears: while the fronts advance with much greater and with ever-increasing velocity. The more elaborate calculations and graphical constructions of §§ 20–29 above led to corresponding conclusions in respect to the front and rear of a procession, given initially as an infinitely great number of regular sinusoidal waves travelling in one direction. The diagrams, figs. 9 and 10, showed respectively, at twenty-five periods after a sinusoidal commencement, a front extending forward indefinitely, and a perceptible rear lagging scarcely two wave-lengths behind a point, travelling from the initial position of the rear at a speed of half the wave-velocity.

(3) THE INITIATION AND CONTINUED GROWTH OF A TRAIN OF TWO-DIMENSIONAL WAVES DUE TO THE SUDDEN COMMENCEMENT OF A STATIONARY, SINUSOIDALLY VARYING, SURFACE-PRESSURE. §§ 118–158.

§ 118. A forcive consisting of a finite sinusoidally varying pressure is applied, and kept through all time applied, to the surface of the water within a finite practically limited space on each side of the middle line of the disturbance. In the beginning the water was everywhere at rest and its surface horizontal. The problem solved is, to find the elevation or depression of the water at any distance from the mid-line of the working forcive, and at any time after the forcive began to act.

§ 119. As a preliminary (§§ 119-126) let us consider the energy in a uniform procession of sinusoidal waves, in a straight canal, infinitely long and infinitely deep, with vertical sides. If the water is disturbed from rest by any pressure on its upper surface, and afterwards left to itself under constant air pressure, we know by elementary hydrokinetics that its motion will be irrotational throughout the whole volume of the water: and if, at any subsequent time, the surface is brought to rest, suddenly or gradually, all the water at every depth will come to rest at the instant when the whole surface is brought to rest. This, as we know from Green, is true even if the initial disturbance is so violent as to cause part of the water to break away in drops: and it would be true separately for each portion of the water detached from the main volume in the canal, as well as for the water remaining in the canal, if stoppage of surface motion is made for every detached portion before it falls back into the canal.

§ 120. Because the motion of the water is irrotational, we have

$$\xi = \frac{d\dot{F}}{dx}; \quad \zeta = \frac{d\dot{F}}{dz} \quad \dots \quad (149),$$

where \dot{F} denotes the velocity-potential, F having been taken as the displacement-potential (§ 97 above). And by dynamics for infinitesimal motion, as in (64) of § 38 above,

$$p = -\frac{d}{dt}\dot{F}(x, z, t) + g(z - 1 + C) \quad \dots \quad (150).$$

To express the surface condition, let $z = 1$ be the undisturbed level; and let ζ_1 denote the vertical component displacement of a surface particle of the water, taken positive when downwards; and let Π denote constant surface-pressure, and take $\frac{\Pi}{g}$ as the value of the arbitrary constant, C . Thus (150) gives, at the disturbed surface,

$$0 = -\frac{d}{dt}\dot{F}(x, 1 + \zeta_1, t) + g\zeta_1 = -\frac{d}{dt}\dot{F}(x, 1, t) + g\zeta_1 \quad (151).$$

The equality between the second and third members of this formula is due to the disturbance being infinitely small, which makes $\frac{d}{dt}\dot{F}(x, 1 + \zeta_1, t) - \frac{d}{dt}\dot{F}(x, 1, t)$ an infinitely small quantity

of the second order, negligible in comparison with $g\xi_1$, which is an infinitely small quantity of the first order.

§ 121. For a sinusoidal wave-disturbance of wave-length $2\pi/m$, travelling x -wards with velocity v , we have as in (66) above,

$$\dot{F}(x, z, t) = -k\epsilon^{-m(z-1)} \sin m(x-vt) \quad \dots \quad (152).$$

For surface-equation (151) becomes

$$0 = kmv \cos m(x-vt) - g\xi_1 \quad \dots \quad (153).$$

This gives as the equation of the free surface

$$\xi_1 = h \cos m(x-vt) \quad \dots \quad (154),$$

where

$$h = \frac{kmv}{g} \quad \dots \quad (155).$$

Now by (149) and (152) with $z=1$, we find

$$\xi_1 = \frac{k}{v} \cos m(x-vt) \quad \dots \quad (156).$$

Comparison of this with (154) gives

$$v^2 = g/m = \lambda g/2\pi \quad \dots \quad (157).$$

§ 122. Let us now find A (activity), the rate of doing work by the pressure of the water on one side upon the water on the other side of a vertical plane (x). We have

$$A = \int_1^\infty dz p \dot{\xi} = \int_1^\infty dz \dot{\xi} \left[\frac{d\dot{F}}{dt} + g(z-1+C) \right] \quad \dots \quad (158).$$

Eliminating from this $\dot{\xi}$ and \dot{F} by (149) and (152), we find

$$A = -km \cos m(x-vt) \int_1^\infty dz \epsilon^{-m(z-1)} \left[-kmv \epsilon^{-m(z-1)} \cos m(x-vt) + g(z-1+C) \right] \quad (159).$$

Hence, performing the operations $\int_1^\infty dz$, we find

$$A = -km \cos m(x-vt) \left[-\frac{kv}{2} \cos m(x-vt) + g \left(\frac{1}{m^2} + \frac{C}{m} \right) \right] \quad (160).$$

§ 123. Remarking now that $2\pi/mv$ is the periodic time of the wave, and denoting by W the total work per period, done by the water on the negative side of the plane (x) upon the water on the positive side, we have

$$W = \int_0^{2\pi/mv} dt \cdot A = \frac{\pi}{mv} \cdot \frac{1}{2} \cdot k^2 mv = \frac{1}{2} \pi k^2 \quad \dots \quad (161).$$

§ 124. We are going to compare this with the total energy, kinetic and potential, $K + P$, per wave-length. In the first place we shall find separately the kinetic energy, K , and the potential energy, P . We have (the density of the water being taken as unity)

$$K = \frac{1}{2} \int_0^\lambda dx \int_1^\infty dz (\xi^2 + \zeta^2) \quad . . . \quad (162);$$

$$P = \frac{1}{2} g \int_0^\lambda dx \zeta_1^2 \quad . . . \quad (163),$$

where ζ_1 denotes the surface displacement.

By (149) and (152) we find

$$\dot{\xi} = -mk\epsilon^{-m(z-1)} \cos m(x-vt) \quad . . . \quad (164);$$

$$\dot{\zeta} = mk\epsilon^{-m(z-1)} \sin m(x-vt) \quad . . . \quad (165);$$

$$\zeta_1 = \frac{k}{v} \cos m(x-vt) \quad . . . \quad (156) \text{ repeated.}$$

Hence,

$$K = \frac{1}{2} \int_0^\lambda dx \frac{m^2 k^2}{2m} = \frac{1}{4} m k^2 \lambda = \frac{1}{2} \pi k^2 \quad . . . \quad (166);$$

$$P = \frac{1}{2} g \frac{k^2 \lambda}{v^2} = \frac{1}{2} \pi k^2 \quad . . . \quad (167),$$

where v^2 is eliminated by (157).

§ 125. Thus we see that the kinetic energy per wave-length, and the potential energy per wave-length, are each equal to the work done per period by the water on the negative side, upon the water on the positive side, of any vertical plane perpendicular to the length and sides of the canal. Thus we arrive at the remarkable and well-known conclusion that in a regular procession of deep-sea waves, the work done on any vertical plane is only half the total energy per wave-length. This is only half enough to feed a regular procession, advancing to infinity with abruptly ending front, travelling *with the wave-velocity* v . It is exactly enough to feed an ideal procession of regular periodic waves, coming abruptly to nothing at a front travelling *with half the "wave-velocity"* v ; which is Osborne

Reynolds' * important contribution to the ideal doctrine of "group-velocity."

§ 126. The dynamical conclusion of § 125 is very important and interesting in the theory of two-dimensional ship-waves. It shows that the approximately regular periodic train of waves in the rear of a travelling force, investigated in §§ 48-54 and 65-79 above, cannot be as much as half the space travelled by the force, from the commencement of its motion; but that it would be exactly that half-space if some modifying pressure were so applied to the water-surface in the rear as to cause the waves to remain uniformly periodic to the end of the train; without, on the whole, either doing work on them, or taking work from them.

A corresponding statement is applicable to our present subject, as we shall see in §§ 156, 157 below.

§ 127. Go back to § 118; and first, instead of a sinusoidally varying pressure, imagine applied a series of impulsive pressures, each of which superimposes a certain velocity-potential upon that due to all the previous impulses; and let it be required to find the resulting velocity-potential at any time t , after some, or after all, of the impulses. Consider first a single impulse at time $t - q$; that is to say, at a time preceding the time t by an interval q . Let the velocity-potential at time t , due to that single impulse applied at the earlier time $t - q$, be denoted by

$$CV(x, z, q) \dots \dots \dots (168).$$

According to this notation the instantaneously generated velocity-potential is $CV(x, z, 0)$, and the value of this at the bounding surface of the water is $CV(x, 1, 0)$. Hence, by elementary hydrokinetics, if I denotes the impulsive surface-pressure, we have

$$I = -CV(x, 1, 0) \dots \dots \dots (169).$$

§ 128. Considering now successive impulses at times preceding the time t , by amounts q_1, q_2, \dots, q_i ; and denoting by $S(x, z, t)$ the sum of the resulting velocity-potentials at time t , we find

$$S(x, z, t) = C_1V(x, z, q_1) + C_2V(x, z, q_2) + \dots \dots C_iV(x, z, q_i) \quad (170).$$

Supposing now the impulses to be at infinitely short intervals of

* *Nature*, August 1877, and *Brit. Ass. Report*, 1877.

time, we translate the formula (170) into the language of the integral calculus as follows :

$$S(x, z, t) = \int_0^t dq f(t-q)V(x, z, q) \dots (171),$$

where $f(t-q)$ denotes an arbitrary function of $(t-q)$, according to which the surface-pressure, arbitrarily applied at time $(t-q)$, is as follows :

$$\Pi(t-q) = -f(t-q)V(x, 1, 0) \dots (172).$$

Hence the pressure applied to the surface at time t , denoted by $\Pi(x, 1, t)$, is as follows :

$$\Pi(x, 1, t) = -f(t)V(x, 1, 0) \dots (173).$$

§ 129. The solution (170) or (171) gives the velocity-potential throughout the liquid which follows determinately from the dynamical data described in §§ 127, 128. From it, by differentiations with reference to x and z , and integrations with respect to t , we can find the displacement components ξ, ζ of any particle of the liquid whose co-ordinates were x, z when the fluid was given at rest. But we can find them more directly, and with considerably less complication of integral signs, by direct application of the same plan of summing as that used in (170), (171). Thus if, instead of $V(x, z, q)$ in (171), we substitute $\frac{d}{dx}V(x, z, q)$, and again $\frac{d}{dz}V(x, z, q)$, we find $\dot{\xi}$ and $\dot{\zeta}$. And if we take

$$\int_0^t dq \frac{d}{dx}V(x, z, q) \text{ and } \int_0^t dq \frac{d}{dz}V(x, z, q) \dots (174)$$

in place of $V(x, z, q)$ in (171), we find the two components ξ, ζ of the displacement of any particle of the fluid. Confining our attention to vertical displacements, and using (179) below, we thus find

$$\zeta(x, z, t) = \frac{1}{g} \int_0^t dq f(t-q) \frac{d}{dz}V(x, z, q) \dots (175).$$

§ 130. To illustrate the meaning of the notation and analytical expressions in (171), (173), (175), take the simplest possible

example, $f(t - q) = 1$. This makes Π the same for all values of t ; and (173) becomes

$$\Pi = -V(x, 1, 0) \quad . \quad . \quad . \quad . \quad (176);$$

and by integration (175) becomes

$$\zeta(x, z, t) = \frac{1}{g} \left[V(x, z, t) - V(x, z, 0) \right] \quad . \quad . \quad (177).$$

Putting now in this $z = 1$, and using (176), we find

$$\zeta(x, 1, t) = \frac{1}{g} \left[V(x, 1, t) - V(x, 1, 0) \right] = \frac{1}{g} \left[V(x, 1, t) + \Pi \right] \quad . \quad (178).$$

The interpretation of this, as t increases from 0 to ∞ , is that the sudden application and continued maintenance of a pressure $-V(x, 1, 0)$ over the whole fluid surface, initially plane and level, produces a depression, ζ , which gradually increases from 0, at $t = 0$, to its hydrostatic value Π/g , at $t = \infty$. The gradual subsidence of the difference from the static condition, as time advances from 0 to ∞ , is illustrated by the diagrams of fig. 34, for the case in which we choose for $V(x, 1, 0)$ the $\psi(x, 1, 0)$ of §§ 100–104 above.

§ 131. To understand thoroughly the meaning of $V(x, z, q)$ as defined in § 127; remark first that it is the velocity-potential of a possible motion of water, under the influence of gravity, with no surface-pressure, or with merely a pressure uniform over its infinite free surface. This is equivalent to saying that $V(x, z, q)$ fulfils the equations

$$\frac{d^2V}{dx^2} + \frac{d^2V}{dz^2} = 0, \text{ and } g \frac{dV}{dz} = \frac{d^2V}{dq^2} \quad . \quad . \quad . \quad (179).$$

Secondly, remark that at the instant $q = 0$, there is no surface displacement; hence $V(x, z, q)$ is the velocity-potential at time q , due to an instantaneous impulsive pressure, $-V(x, 1, 0)$, applied to the surface of the fluid at rest and in equilibrium, at time $q = 0$. Now, allowing negative values of q , think of a state of motion from which our actual condition of no displacement, and of velocity-potential equal to $V(x, z, 0)$, would be reached and passed through when q passes from negative to positive. It is clear that the

values of $V(x, z, q)$ are equal for equal positive and negative values of q . Hence,

$$\text{when } q=0, \text{ we have } \frac{d}{dq}V(x, z, 0)=0 \quad . \quad . \quad (180).$$

§ 132. Consideration of the $V(x, z, q)$, defined in § 127, which allows $V(x, 1, 0)$ to be any arbitrary function of x , but requires dV/dq to be zero when $q=0$, suggests an allied hydrokinetic problem:—to find W fulfilling (179) with W in place of V ; and, at time $q=0$, having $W=0$ and dW/dq any arbitrary function of x . We assume, as is convenient for our present purpose, that for large values of x

$$V(x, z, 0) \doteq 0, \text{ and } W(x, z, 0) \doteq 0 \quad . \quad . \quad (181).$$

This implies that for all values of x and z , large or small, but for large values of q ,

$$V(x, z, q) \doteq 0, \text{ and } W(x, z, q) \doteq 0 \quad . \quad . \quad (182).$$

§ 133. In the V -problem the initiational condition is:—displacement zero and initiational velocity *virtually given* throughout the fluid as the determinate result of an arbitrarily distributed impulsive pressure on the surface.

In the W -problem the initiational condition is:—the fluid held at rest with its surface kept to any arbitrarily prescribed shape by fluid pressure, and then left free by sudden and permanent annulment of this pressure.

Without going into the question of a complete solution of this (V, W) problem for any arbitrary initiational data, we find a class of thoroughly convenient solutions in a formula originally given in the *Proceedings of the Royal Society of Edinburgh*, January 1887; republished in the *Phil. Mag.*, February 1887; and used in § 3 and § 99 above. We may now write that formula in the following comprehensive realised expression for V or W :—

$$\left. \begin{aligned} \{\text{RS}\} \text{ or } \{\text{RD}\} \frac{d^{i+j+k}}{dt^i dx^j dz^k} \frac{1}{\sqrt{(z+ix)}} e^{\frac{-gt^2}{4(z+ix)}} &= V(x, z, t), \text{ when } i \text{ is even;} \\ &= W(x, z, t), \text{ when } i \text{ is odd.} \end{aligned} \right\} \quad (183).$$

By using (179) we may, instead of (183), take the following as equally comprehensive:—

$$\left. \begin{aligned} \{RS\} \text{ or } \{RD\} \left(A + B \frac{d}{dx} \right) \frac{d^i}{dt^i} \frac{1}{\sqrt{(z + \alpha x)}} e^{\frac{-g t^2}{4(z + \alpha x)}} &= V(x, z, t), \text{ when } i \text{ is even;} \\ &= W(x, z, t), \text{ when } i \text{ is odd.} \end{aligned} \right\} (183').$$

§ 134. Going back to (171) and (175), remark that integration by parts gives

$$\int_0^t dq f(t - q) \frac{d}{dq} V(x, z, t) = f(0)V(x, z, t) - f(t)V(x, z, 0) + \int_0^t dq \dot{f}(t - q)V(x, z, q). \quad (184).$$

This shows that if by quadrature or otherwise we have calculated the velocity-potential $S(x, z, t)$, as given by (171), we can find the vertical component displacement of any particle of the liquid by (175), without farther integration. The formula (184) also shows how by successive integrations by parts we can reduce

$$\int_0^t dq f(t - q) \frac{d^i}{dq^i} V(x, z, q) \quad . \quad . \quad . \quad (185)$$

to the primary integral $S(x, z, t)$, as expressed in (171).

§ 135. Going back now to §§ 128, 127, 118: to make the applied forcive a sinusoidally varying pressure put

$$f(t - q) = \frac{\cos}{\sin} \omega(t - q) \quad . \quad . \quad . \quad (186);$$

which, by (173), makes

$$\Pi(x, 1, t) = - \frac{\cos}{\sin} \omega t V(x, 1, 0) \quad . \quad . \quad . \quad (187).$$

And now let us arrange to fully work out our problem for two cases of surface distribution of pressure, corresponding to the two initiational forms ϕ, ψ , described in §§ 96–113 above. For this purpose take, with the notation of § 101,

$$V(x, z, t) = \phi(x, z, t); \text{ or } V(x, z, t) = \psi(x, z, t) = - \frac{1}{g \sqrt{2}} \frac{d^2}{dt^2} \phi(x, z, t). \quad (188).$$

For brevity we shall call these two cases case ϕ and case ψ . Thus, in these cases (171) and (175), expressing respectively the

velocity-potential at, and the vertical component displacement of, any point of the fluid at any time, become

$$S_{\phi}(x, z, t) = \int_0^t dq \frac{\cos}{\sin} \omega(t-q) \phi(x, z, q);$$

$$S_{\psi}(x, z, t) = \int_0^t dq \frac{\cos}{\sin} \omega(t-q) \psi(x, z, q). \quad (189);$$

$$\xi_{\phi}(x, z, t) = \frac{1}{g} \int_0^t dq \frac{\cos}{\sin} \omega(t-q) \frac{d}{dq} \phi(x, z, q);$$

$$\xi_{\psi}(x, z, t) = \frac{1}{g} \int_0^t dq \frac{\cos}{\sin} \omega(t-q) \frac{d}{dq} \psi(x, z, q). \quad (190).$$

§ 136. The illustrations in figs. 36, 37, 38 are time-curves in which the ordinates have been calculated by continuous quadrature from one or other of the four formulas (189), (190).

§ 137. The curves in fig. 39, being space curves in which the ordinates are vertical component displacements of the water-surface, are therefore pictures of the water-surface (greatly exaggerated in respect to slopes of course), and may be shortly named water-surface curves. Their ordinates have been calculated by an analytical method described in § 151 below. They cannot be calculated continuously for successive values of x by the method of continuous quadratures; if that were the method employed, the value of the ordinate for each value of x would need to be calculated by an independent quadrature $\left(\int_0^t dq\right)$ from 0

to the particular value of t for which the water-surface is represented by the curve. The values of t chosen for fig. 39 are respectively $i\tau$, $(i+1/8)\tau$, $(i+2/8)\tau$, $(i+3/8)\tau$, $(i+4/8)\tau$, where i is any very large integer, and τ denotes $2\pi/\omega$, the period of the varying surface-pressure to which the fluid motion considered is due.

In all our illustrations we have taken $\omega = \sqrt{g}$, which makes $\tau = 2\sqrt{g}$, and, with $g = 4$ as in § 105, makes the wave-length $\lambda = 8$.

§ 138. In figs. 36 and 37, all the curves correspond to $\cos \omega(t-q)$ in the formulas. In fig. 38, all the curves correspond to $\sin \omega(t-q)$ in the formulas.

FIGURE 36.

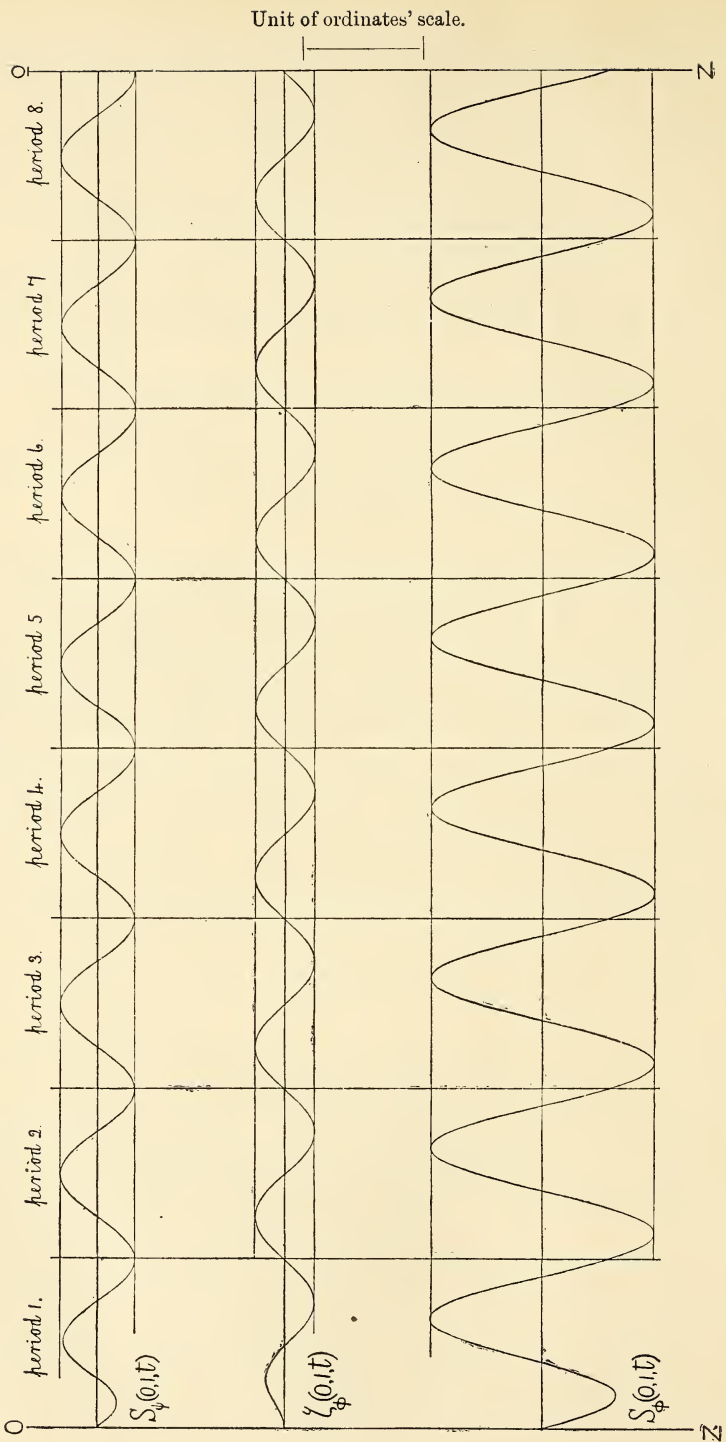

Unit of ordinates' scale.

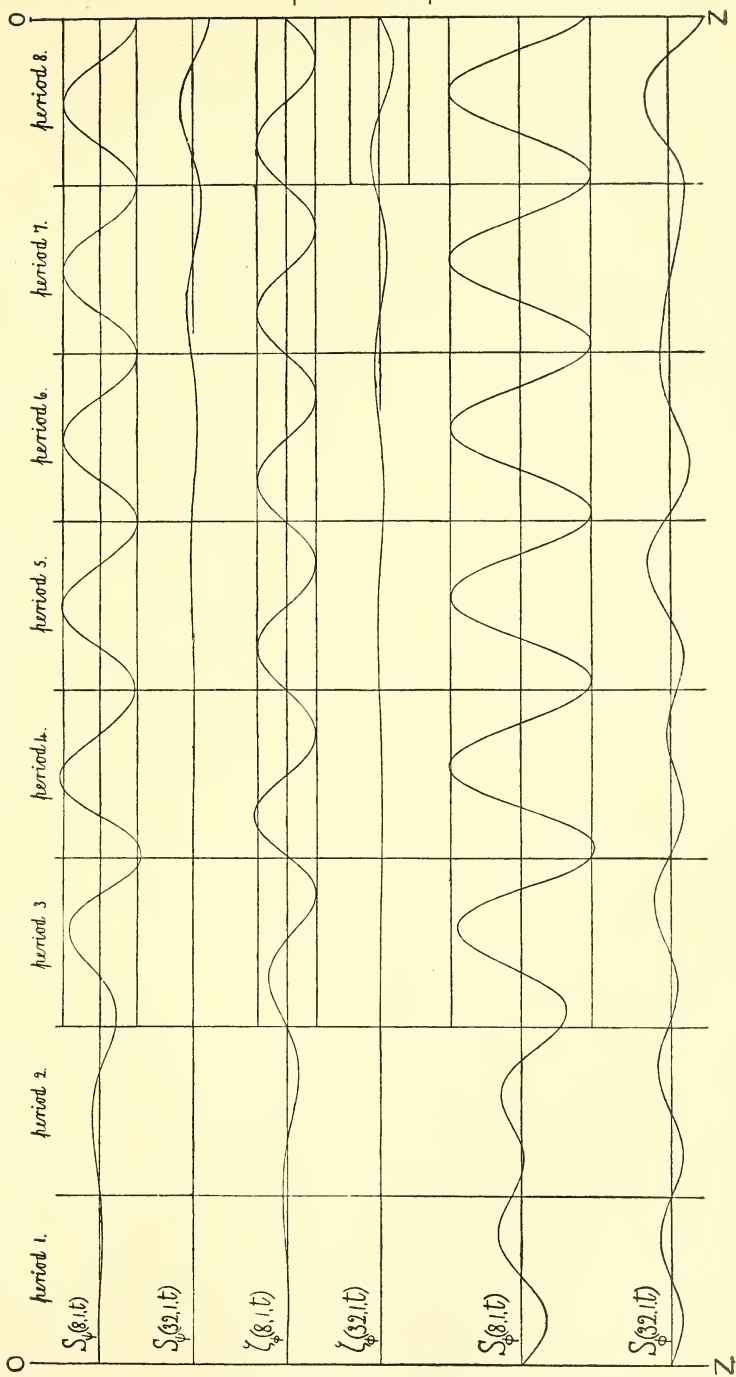

FIGURE 37.

In fig. 39, the inscriptions of times correspond to $\cos \omega(t - q)$ in the formulas. The same curves, with the inscriptions altered to $(i + 2/8)\tau$, $(i + 3/8)\tau$, $(i + 4/8)\tau$, $(i + 5/8)\tau$, $(i + 6/8)\tau$, correspond to $\sin \omega(t - q)$ in the formulas.

§ 139. In fig. 36, representing velocity-potentials and a surface displacement, none of the curves shows any perceptible deviation from sinusoidality except within period 1. Towards the end of period 1 the numbers found by the quadratures show deviations from sinusoidality diminishing to about 1/10 per cent., and imperceptible in the drawings. This proves that sinusoidality is exact within 1/10 per cent. through all time after the end of the first period.

It is interesting to see, in period 1, how nearly the rise from the initial zero follows the same law for $S_\phi(0, 1, t)$ and $S_\psi(0, 1, t)$: notwithstanding the vast difference in the law of initiating surface-pressure, represented by (188), for these two cases. In fig. 36, the initiating surface-pressure commences suddenly at its negative maximum value, $-\sqrt{2}$ for case ϕ , and $-.5$ for case ψ , of which the former is 2.83 times the latter. The semi-amplitudes of the subsequent variations of velocity-potential shown in the first and third curves are .954 for case ϕ and .318 for case ψ , of which the former is 3.00 times the latter.

§ 140. The first, and third, and fifth, curves of fig. 37 show, at a distance of one wave-length from the origin, the complete history of velocity-potential and of surface displacement through all time from the beginning of application of pressure to the surface. The very approximately accurate sinusoidality of each of these three curves through periods 6, 7, 8, shows that the continuation through endless time is in each case sinusoidal.

In remarkable contrast with the initial agreement between $S_\psi(0, 1, t)$ and $S_\phi(0, 1, t)$, to which we alluded in § 139, we find very instructively a remarkable contrast between $S_\psi(8, 1, t)$ and $S_\phi(8, 1, t)$ throughout the whole of the first period. Remembering that in a liquid of unit density the pressure is equal to minus the rate of augmentation of the velocity-potential per unit of time, and remarking that the displacement $\zeta_\phi(0, 1, t)$ is, as is shown in its curve, very nearly zero throughout the first period, and that $\zeta_\psi(0, 1, t)$ is

Unit of ordinates' scale.

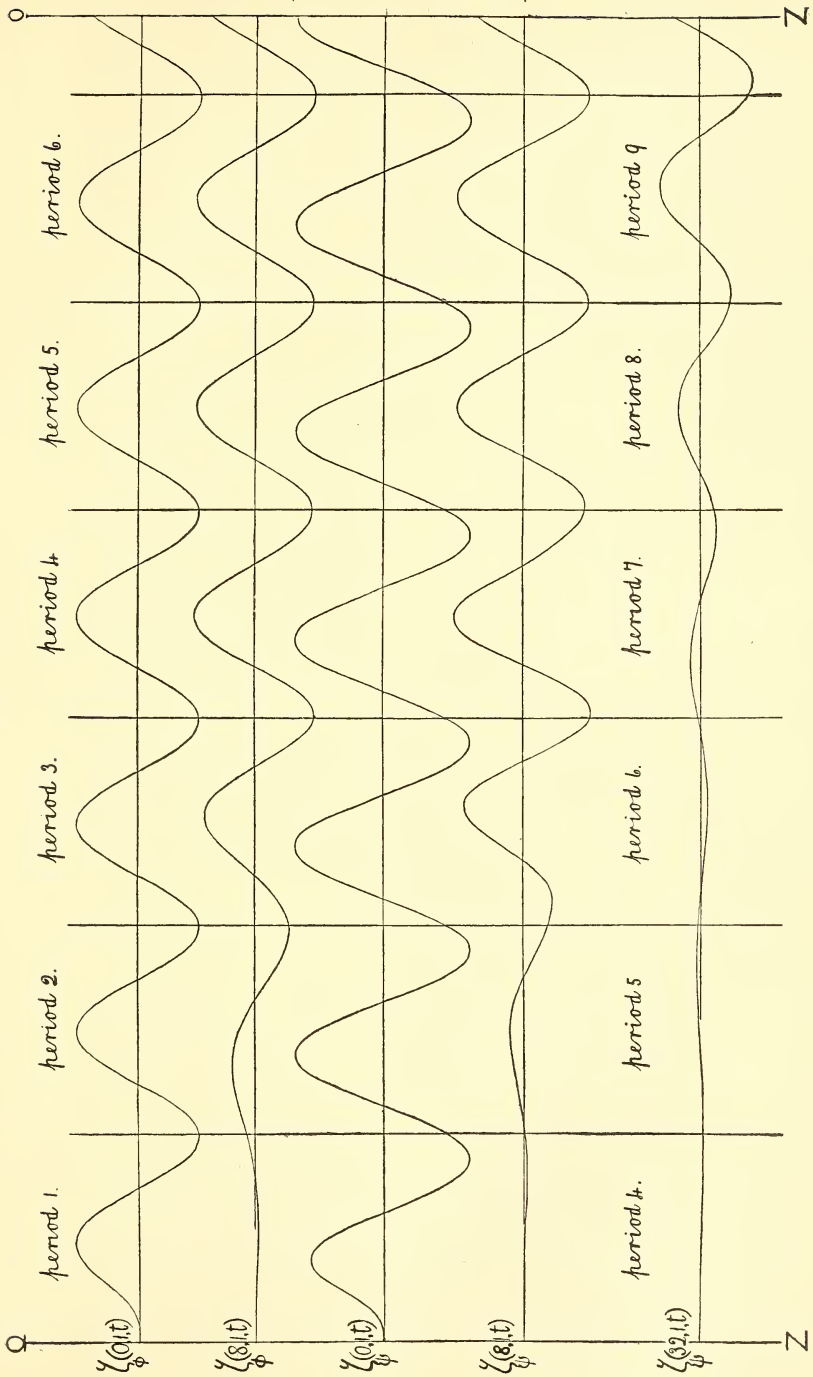
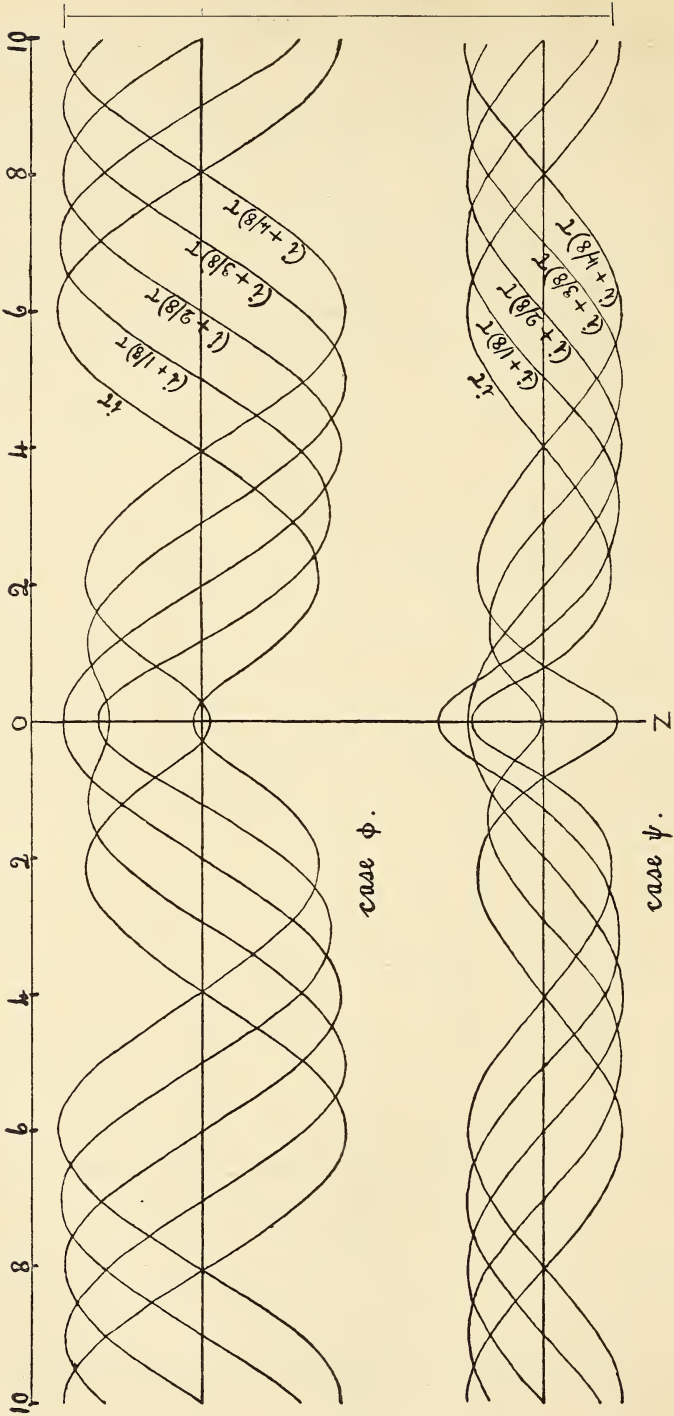

FIGURE 38.

Unit of vertical scale.

FIGURE 39.



certainly still more nearly zero throughout the first period, though we have no curve to represent it, we see that the negatives of the tangents of the slopes in the curves for $S_\psi(8, 1, t)$ and $S_\phi(8, 1, t)$ represent very nearly the values of the applied surface-pressures during the whole of the first period.* Look now to fig. 33; see how near to zero is $\psi(8, 1, 0)$, and how far from zero is $\phi(8, 1, 0)$; and we see dynamically how it is that $S_\psi(8, 1, t)$ is very nearly zero throughout the first period, and $S_\phi(8, 1, t)$ is very far from zero, and is somewhat near to being sinusoidal.

§ 141. We have also a very instructive comparison between $\zeta_\phi(8, 1, t)$ and $S_\phi(8, 1, t)$. In the ϕ case, for values of x as large as 8, or larger, we approach somewhat nearly to the case of a sinusoidally varying uniform surface-pressure over an infinite plane area of water, in which there would be no surface displacement, and the pressure at and below the surface would be at every instant equal to the applied surface-pressure plus the gravitational augmentation of pressure below the surface. Thus we see why it is that, with a great periodic variation of applied surface-pressure, at $x=8$, there is scarcely any rise and fall of the surface level there, until after a period and a half from the beginning of the motion, as shown in the curves for $\zeta_\phi(8, 1, t)$.

§ 142. The second, fourth, and sixth, curves of fig. 37 represent the arrival of three classes of disturbance, $S_\psi, \zeta_\phi, S_\phi$, at $x=32$, four wave-lengths from the origin. If the front of the disturbance travelled at exactly the wave-velocity, the disturbances of the different kinds would all commence suddenly at the end of period 4. In the cases of $S_\psi(32, 1, t)$ and $\zeta_\phi(32, 1, t)$ the diagram shows that they are quite imperceptible at the end of period 4, and begin to be considerable at the end of period 8, which would be the exact time of arrival if there was a definite "group-velocity" equal to half the wave-velocity. The largeness of $S_\phi(32, 1, t)$, approximately uniform throughout the first four periods, is explained in § 141. Its gradual augmentation through periods 5, 6, 7, 8, depends on the wave propagation of disturbances from the origin, as shown for $S_\psi(32, 1, t)$ and $\zeta_\phi(32, 1, t)$ in the second and fourth curves.

* Remember that downward ordinates in all the curves of figs. 36, 37, 38, 39, correspond to positive values of the quantities represented.

§ 143. The $\zeta_\phi(0, 1, t)$ curve of fig. 38 may be compared with the curve of the same designation in fig. 36. They differ because of a quarter period difference in the phase of commencement of the disturbing pressure, which commences suddenly at its maximum for all the curves of fig. 36, and commences at zero for all the curves of fig. 38. If the S_ψ, S_ϕ curves for initiating pressure commencing at zero were drawn, they would differ from the first and third curves of fig. 36 in being at the commencement tangential to the line of abscissas, instead of being inclined to it in the positive direction, as shown in fig. 36. The ζ curves are all initially tangential to the line of abscissas, but the tangency is only of the first order in fig. 36, while it is of the second order in fig. 38.

§ 144. The third and fourth curves * of fig. 38 show the whole history for the points, $x = 0$, and $x = \lambda$, of the surface displacement expressed by the formulas

$$\zeta_\psi(x, 1, t) = \frac{1}{g} \int_0^t dq \sin \omega(t - q) \frac{d}{dq} \psi(x, 1, q) \quad (191),$$

which expresses the surface displacement due to surface-pressure expressed by

$$\Pi(x, 1, t) = -\sin \omega t \psi(x, 1, 0) \quad (192).$$

The fifth curve of fig. 38 shows the history, after period 3, to almost half a period after period 9, of the disturbance at the place $x = 32$. The disturbance has not yet become sinusoidal, but would certainly become almost exactly sinusoidal after a few more periods.

§ 145. In fig. 39, two sets of five curves show, for case ϕ and case ψ , the periodically varying water-surface on each side of the middle, at any long enough time after the beginning of the motion, to give a regular regime of sinusoidal vibration as far as two or three wave-lengths on each side of the middle. The third curve in each case is a curve of sines. The first curve represents the surface at the beginning of a period from $i\tau$ to $(i+1)\tau$. The fifth curve, being the first curve inverted, represents the water-surface at the middle of the period. The other two curves may

* The scale of ordinates of the third, fourth, and fifth curves of fig. 38 is double that of the first and second, indicated on the figure.

be described as components of the first and third, according to the following formula :

$$\zeta(x, 1, t) = P \sin \omega t - Q \cos \omega t \quad . \quad . \quad . \quad (193),$$

where $P = -A \cos 2\pi x/\lambda \quad . \quad . \quad . \quad . \quad . \quad (194),$

and Q is a continuous transcendental function of x , having equal values for $\pm x$, expressed by (195) for positive or negative values of x , exceeding a wave-length.

For x positive, $Q = -A \sin 2\pi x/\lambda$; for x negative, $Q = +A \sin 2\pi x/\lambda$ (195),

where A denotes the semi-amplitude of the vibration, at any time long enough after the beginning, and place far enough from the middle of the disturbance, to have very approximately sinusoidal motion. The determination of the transcendental function Q, and the calculation of A, for both P and Q, will be virtually worked out in § 151 below.

§ 146. We have now an exceedingly interesting and suggestive analysis of the circumstances represented in fig. 39. Consider separately the two motions corresponding to $P \sin \omega t$ alone, and to $-Q \cos \omega t$ alone. The motion $P \sin \omega t$, if at any instant given from $x = -\infty$ to $x = +\infty$, would continue for ever, as an infinite series of standing waves, without any surface-pressure. Hence our application of surface-pressure is only required for the Q-motion : and if this motion be at any instant given from $x = -\infty$ to $x = +\infty$, it will go on for ever, provided the pressure $-\cos \omega t \frac{\phi}{\psi}(x, 1, 0)$ is applied and kept applied to the surface.

§ 147. The plan of § 146 may be generalised as follows:— Displace the water according to the formula (193) with P omitted, and with Q any arbitrary function of x for moderately great positive or negative values of x , gradually changing into the formula (195) for positive and negative values outside any arbitrarily chosen length M O N (M O not necessarily equal to O N). Find mathematically the sinusoidally varying surface-pressure, $F(x) \cos \omega t$, required to cause the motion to continue according to this law. Superimpose, upon the motion thus guided by surface-pressure, the motion $-A \cos 2\pi x/\lambda \sin \omega t$, which needs no surface-pressure. In the motion thus compounded, we have equal

sinusoidal waves travelling outwards in the two directions beyond MN (semi-amplitude A): and, in the space MN , we have a varying water-surface found by superimposing on the motion $P \sin \omega t$ an arbitrary shape of surface, varying sinusoidally according to the formula $-Q \cos \omega t$.

§ 148. A curiously interesting dynamical consideration is now forced upon us. The P -component of motion needs, as we have seen, no surface-pressure. The Q -component of motion is kept correct by the surface-pressure $F(x) \cos \omega t$, which, in a period, does no total of work on the Q -motion; but work must be done to supply energy for the two trains of waves travelling outwards in the two directions. Hence this work is done by the activity of the surface-pressure upon the P -component of the motion.

§ 149. Another curious question is forced upon us. Our solution of §§ 135–145 has given us determinately and unambiguously, in every variety of the cases considered, the motion of every particle of the water throughout the space occupied. The synthetic method of quadratures which we have used could lead to no other motion at any instant due to the applied surface-pressure; but now, in § 147, we have considered a Q -motion alone, kept correct by the applied surface-pressure. Would this motion be unstable? and, if unstable, would it in a sufficiently long time subside into the motion expressed in the determinate solution of §§ 135–145? The answer is Yes and No. At any instant, say at $t=0$, let the whole motion be the Q -component alone of § 148. Let now the surface-pressure, $F(x) \cos \omega t$, be suddenly commenced and continued for ever after. It will, according to §§ 135–145, produce determinately a certain compound motion (P, Q) which will be superimposed upon the motion existing at time $t=0$; and this last-mentioned motion, given with its infinite amount of energy distributed from $x = -\infty$ to $x = +\infty$, and left with no surface-pressure, would clearly never come approximately to quiescence, through any range of distance from 0 on the two sides. Thus we see that, though the Q -motion alone of § 148 is essentially unstable, the condition of the fluid does not subside into the determinate solution of §§ 135–145. It would so subside, if it were given initially only through any finite space however great, on each side of 0. In fact, any given

distribution of disturbance through any finite space however great on each side of 0, left to itself without any application of surface-pressure, becomes dissipated away to infinity on the two sides; and leaves, as illustrated in §§ 96-113, an ever-broadening space on each side of 0, through which the motion becomes smaller and smaller as time advances.

§ 150. It remains only to look into some of the analytical details concerned in the practical working out of our solutions (189), (190). Taking $\cos \omega(t - q)$ in the formulas, and taking case ϕ , we find by (190)

$$S_\phi(x, z, t) = P \cos \omega t + Q \sin \omega t \quad \dots \quad (196);$$

where $P = \int_0^t dq \cos \omega q \phi(x, z, q)$; and $Q = \int_0^t dq \sin \omega q \phi(x, z, q)$ (197).

When P and Q have been thus found by quadratures, for all values of t , and any particular value of x , by integration by parts on the plan of § 134, we readily find, without farther quadratures, or integrations, expressions for the seven other formulas included in (189), (190).

§ 151. Let us first find P and Q for $t = \infty$. Using the exponential form for ϕ , given by (137), we find

$$P = \{RS\} \sqrt{\frac{8m}{g}} \int_0^\infty dq \cos \omega q \epsilon^{-mq^2}; \text{ and } Q = \{RS\} \sqrt{\frac{8m}{g}} \int_0^\infty dq \sin \omega q \epsilon^{-mq^2} \quad (198),$$

where $m = \frac{1}{4} g/(z + \omega x)$.

Hence, according to an evaluation given by Laplace in 1810,* we find, taking $g = 4$,

$$P = \{RS\} \sqrt{\frac{\pi}{2}} \epsilon^{\frac{-\omega^2}{4m}} \quad \dots \quad (199).$$

The definite integral for Q is a transcendent function of ω and m , not expressible finitely in terms of trigonometrical functions or exponentials. By using the series for $\sin \omega q$ in terms of $(\omega q)^{2i+1}$, and evaluating $\int_0^\infty dq q^{2i+1} \epsilon^{-q^2}$ by integrations by parts, we find the following convergent series for the evaluation of Q, for $t = \infty$; and $g = 4$:—

* *Mémoires de l'Institut*, 1810. See Gregory's *Examples*, p. 480.

$$\begin{aligned}
 Q = \{RS\} & \left. \begin{aligned} & \frac{1}{\sqrt{2}} \left[\frac{\omega}{\sqrt{m}} - \frac{1}{2 \cdot 1 \cdot 3} \left(\frac{\omega}{\sqrt{m}} \right)^3 + \frac{1}{2^2 \cdot 1 \cdot 3 \cdot 5} \left(\frac{\omega}{\sqrt{m}} \right)^5 \right. \\ & \qquad \qquad \qquad \left. - \frac{1}{2^3 \cdot 1 \cdot 3 \cdot 5 \cdot 7} \left(\frac{\omega}{\sqrt{m}} \right)^7 + \text{etc.} \right] \\ & = \frac{1}{\sqrt{2}} \left[\omega \sqrt{\rho} \cos \frac{\chi}{2} - \frac{(\omega \sqrt{\rho})^3}{2 \cdot 1 \cdot 3} \cos \frac{3}{2} \chi + \frac{(\omega \sqrt{\rho})^5}{2^2 \cdot 1 \cdot 3 \cdot 5} \cos \frac{5}{2} \chi \right. \\ & \qquad \qquad \qquad \left. - \frac{(\omega \sqrt{\rho})^7}{2^3 \cdot 1 \cdot 3 \cdot 5 \cdot 7} \cos \frac{7}{2} \chi + \text{etc.} \right] \end{aligned} \right\} (200),
 \end{aligned}$$

where, as in §§ 100–113 above, $\rho = \sqrt{(z^2 + x^2)}$, and $\chi = \tan^{-1}(x/z)$.

This series converges for every value of $\omega \sqrt{\rho}$ however great. But for values of $\omega \sqrt{\rho}$ greater than 4, it diverges to large alternately positive and negative terms before it begins to converge. The largest value of $\omega \sqrt{\rho}$ for which we have used it is $\omega \sqrt{\rho} = 5.03$, corresponding to $x = 8$, and requiring, for the accuracy we desire, twenty-one terms of the series. But for this value of $\omega \sqrt{\rho}$ and for all larger values, we have used the ultimately divergent series (208), found in expressing analytically, not merely for $t = \infty$ as in (198), (199), (200), but for all positive values of t great and small, the growth to its final condition when $t = \infty$, of the disturbance produced by our periodically varying application of pressure to the surface of the water initially ($t = 0$) at rest. The curve for $i\tau$ in fig. 39 has been actually calculated by (200) for values of x up to 8, and by the ultimately divergent series for values of x from 5 to 10. The agreement between those of the values which were calculated both by (200) and by the ultimately divergent series (208), was quite satisfactory: so also was the agreement between values of Q found by quadratures for $x = 1$ and $x = 8$, with values found by (200) for $x = 1$ and by (208) for $x = 8$. It is also satisfactory that the values of P found by quadratures, for $x = 1$, and $x = 8$, agreed well with their exact values given by (199), for $t = \infty$.

§ 152. Going back now to the expressions (197) for P and Q , we see that, by an obvious analytical method of treatment, we can reduce them, and therefore (§ 150) all our other formulas, to expressions in terms of a function defined as follows:—

$$E(\sigma) = \int_0^\sigma d\sigma \epsilon^{-\sigma^2} (201),$$

a function well known to mathematicians* through the last hundred and fifty or two hundred years, in the mathematical theory of Astronomical Refraction, and in the theory of Probabilities. I have taken E as an abbreviation of Glaisher's † notation "Erfc," signifying what he calls "Error Function Complement," which he uses in connection with his name "Error Function," defined by

$$\text{Erf}(\sigma) = \int_0^\infty d\sigma \epsilon^{-\sigma^2} = \frac{1}{2} \sqrt{\pi} - \text{Erfc}(\sigma) \quad . \quad . \quad (202).$$

Using the imaginary expression for ϕ in § 137, we find

$$P = \{\text{RS}\} \sqrt{\frac{2m}{g}} \epsilon^{\frac{-\omega^2}{4m}} \int_0^t dq \left[\epsilon^{-(\sqrt{mt} - \iota \frac{\omega}{2\sqrt{m}})^2} + \epsilon^{-(\sqrt{mt} + \iota \frac{\omega}{2\sqrt{m}})^2} \right] \quad (203);$$

$$Q = \{\text{RS}\} \frac{1}{\iota} \sqrt{\frac{2m}{g}} \epsilon^{\frac{-\omega^2}{4m}} \int_0^t dq \left[\epsilon^{-(\sqrt{mt} - \iota \frac{\omega}{2\sqrt{m}})^2} - \epsilon^{-(\sqrt{mt} + \iota \frac{\omega}{2\sqrt{m}})^2} \right] \quad (204),$$

where $m = \frac{1}{4}g/(z + \iota x)$, as in § 151.

Taking advantage now of the notation (201), we reduce these two expressions to the following:—

$$P = \{\text{RS}\} \sqrt{\frac{2}{g}} \epsilon^{\frac{-\omega^2}{4m}} \left[\text{E} \left(\sqrt{mt} - \iota \frac{\omega}{2\sqrt{m}} \right) + \text{E} \left(\sqrt{mt} + \iota \frac{\omega}{2\sqrt{m}} \right) \right] \quad . \quad (205);$$

$$Q = \{\text{RS}\} \frac{1}{\iota} \sqrt{\frac{2}{g}} \epsilon^{\frac{-\omega^2}{4m}} \left[\text{E} \left(\sqrt{mt} - \iota \frac{\omega}{2\sqrt{m}} \right) - \text{E} \left(\sqrt{mt} + \iota \frac{\omega}{2\sqrt{m}} \right) + 2\text{E} \left(\iota \frac{\omega}{2\sqrt{m}} \right) \right] \quad (206).$$

§ 153. Remark first in passing that, when \sqrt{mt} is infinitely great in comparison with $\omega/2\sqrt{m}$, these two expressions agree with the expressions, (198), for P and Q with $t = \alpha$, which we used in connection with the explanation of fig. 39.

§ 154. And now, with a view to finding P and Q for any chosen values of x, z, t , we have the following known series ‡:—

* The beautiful mathematical discovery, $\int_0^\infty d\sigma \epsilon^{-\sigma^2} = \frac{1}{2} \sqrt{\pi}$, seems to have

been made by Euler about 1730.

† *Phil. Mag.*, October 1871.

‡ See Glaisher, "On a Class of Definite Integrals," *Phil. Mag.*, October

1871; and Burgess, "On the Definite Integral $\frac{2}{\sqrt{\pi}} \int_0^t \epsilon^{-t^2} dt$," *Trans. Roy. Soc. Edin.*, 1898.

$$E(\sigma) = \sigma - \frac{\sigma^3}{3} + \frac{1}{1.2} \frac{\sigma^5}{5} - \frac{1}{1.2.3} \frac{\sigma^7}{7} + \dots \dots \dots (207),$$

$$E(\sigma) = \frac{1}{2} \sqrt{\pi} - \frac{e^{-\sigma^2}}{2\sigma} \left[1 - \frac{1}{2\sigma^2} + \frac{1.3}{(2\sigma^2)^2} - \frac{1.3.5}{(2\sigma^2)^3} + \dots \dots \dots \right] (208).$$

The series (207) converges for all values of σ , great or small, real or imaginary : (208) converges in its first i terms, if $2\sigma^2 > 2i - 3$ (modulus understood if σ^2 is imaginary), and after that it diverges, the true value being intermediate between the sum of the convergent terms and this sum with the first term of the divergent series added. The proper rule of procedure to find the result with any desired degree of accuracy, is to first calculate by the ultimately divergent series, and see whether or not it gives the result accurately enough. If it does not, use the convergent series (207), which, by sufficient expenditure of arithmetical labour, will certainly give the result with any degree of accuracy resolved upon.

§ 155. As a guide, not only for numerical calculation, but for judging the character of the desired result without calculation, it is convenient to find the moduluses of the three complex arguments of the function E , in (205), and (206). They are as follows :—

$$\begin{aligned} \text{mod} \left(\sqrt{mt} - \iota \frac{\omega}{2\sqrt{m}} \right) &= \sqrt{\left(\frac{t^2g}{4\rho} + \frac{t\omega x}{\rho} + \frac{\omega^2\rho}{g} \right)} \\ &\doteq t\sqrt{\frac{g}{4x}} + \omega\sqrt{\frac{x}{g}}, \text{ when } x \doteq \infty \dots \dots (209); \end{aligned}$$

$$\begin{aligned} \text{mod} \left(\sqrt{mt} + \iota \frac{\omega}{2\sqrt{m}} \right) &= \sqrt{\left(\frac{t^2g}{4\rho} - \frac{t\omega x}{\rho} + \frac{\omega^2\rho}{g} \right)} \\ &\doteq t\sqrt{\frac{g}{4x}} - \omega\sqrt{\frac{g}{x}}, \text{ when } x \doteq \alpha \dots \dots (210); \end{aligned}$$

$$\text{mod} \left(\iota \frac{\omega}{2\sqrt{m}} \right) = \omega\sqrt{\frac{\rho}{g}} \dots \dots \dots (211).$$

§ 156. The very interesting questions regarding the front of the procession of waves in either direction, of which we have found illustrations in figs. 36, 37, 38, and which we had under consideration in §§ 11–31, 114–117 above, are now answerable in a thoroughly satisfactory mathematical manner, by aid of the formulas (205), (206), (209), (210), (211). When, in the arguments

of E, in (205), and (206), \sqrt{mt} is very great in comparison with $\omega/2\sqrt{m}$, the two added terms in (205) are approximately equal, and (206) is reduced approximately to its last term; and all the solutions (189), (190), become approximately sinusoidal, in respect to t .

This is the case when $t\sqrt{\frac{g}{4x}}$ is very great in comparison with unity, and in comparison with $\omega\sqrt{\frac{x}{g}}$, as we see by looking at the modulus shown in (209), (210), (211). This allows us to neglect ω in the arguments of E in (205), (206), and makes P and Q constant relatively to t .

§ 157. When t is small or large, and x not so small as to give preponderance to the first terms of the modulus (209), (210), we have in (205), (206), (189), (190) a full representation of the whole circumstances of the wave-front, extending from $x = \alpha$ back to the largest value of x that allows preponderance of $t\sqrt{\frac{g}{4x}}$ over $\omega\sqrt{\frac{x}{g}}$, in the modulus, (209), (210). Let, for example,

$$t\sqrt{\frac{g}{4x}} = \omega\sqrt{\frac{x}{g}} \dots \dots \dots (212).$$

This gives

$$x = \frac{gt}{2\omega} = \text{half the wave-velocity} \dots \dots (213).$$

The moving point thus defined is what in my first paper to the Royal Society of Edinburgh (January 1887), "On the Front and Rear of a Free Progression of Waves in Deep Water," I called the "Mid-Front," defined in (45) of that paper, which agrees with our present (213). The following passage was the conclusion of that old paper:—
 "The rear of a wholly free procession of waves may be quite
 "readily studied after the constitution of the front has been fully
 "investigated, by superimposing an annulling surface-pressure upon
 "the originating pressure represented by (12) above [this is a case
 "of (173) of our present paper], after the originating pressure has
 "been continued so long as to produce a procession of any desired
 "number of waves." The instruction thus given with reference to the relation between front and rear has been virtually followed, though with some differences of detail, in §§ 20-24 of my second

Royal Society paper, on the same subject, and under the same title (June 20, 1904). That second paper contained a first instalment of the "calculations and graphic representations" promised in the old first; the present paper contains, in figs. 35, 36, 37, 38, a further instalment of such illustrations.

§ 158. Throughout my work, §§ 96–157, I have had most valuable assistance from Mr George Green, not only in the very long and laborious calculations and drawings, which have been wholly made by him, but also in many interesting and difficult questions which occurred in the fundamental mathematics of the subject.

We hope to apply before long the method of § 128 to calculate, by aid of the formula $\int_0^t dq\psi(x - vq, z, t - q)$, the initiation and continued growth of Canal Ship-waves, due to the sudden commencement and continued application of a moving, steady surface-pressure, $\psi(x, 1, 0)$. We hope also to apply (139) of the present paper to the fulfilment of my old promise (§ 30, June 20, 1904, R.S.E.) to deal with the beautifully varying procession seen circling outwards from the place of a stone thrown into deep water.

(*Issued separately November 17, 1906.*)

“Scotia” Collections. On *Echinorhynchus antarcticus*, n. sp., and its Allies. By John Rennie, D.Sc., University of Aberdeen. Communicated by Wm. S. BRUCE, Esq. (With a Plate.)

(Read March 5, 1906.)

The form described in the present paper was found amongst the contents of the stomach of a Weddell seal (*Leptonychotes weddelli*), taken by the Scottish National Antarctic Expedition in Scotia Bay, South Orkneys. In all about sixty specimens were collected. They occurred unattached amongst material in a semi-fluid condition, so that it is not possible to state definitely whether the seal or some animal upon which it fed is the normal host of this parasite. This question, however, in the case of the Echinorhynchi, appears from the work of de Marval* to be one of minor importance. He has shown that in the Echinorhynchi of birds there is a most marked absence of specialisation of hosts, and quotes from other authors various instances of the same parasite occurring in different vertebrate classes. The worms in the present case showed no indication of having been affected by the digestive juices of the seal. As will appear from the description given below, their structural peculiarities suggest relationships with certain forms known to inhabit aquatic birds.

External Features.

The most striking peculiarity in the structure of this parasite is its external form. This has a marked resemblance to an ordinary pipe with a very short stem and adorned with a somewhat fantastic lid (fig. 1). Three regions are distinguishable—the rostrum and two body-divisions. Of these, the anterior bears spines regularly distributed over its whole surface; the posterior is spiny only in part. The former further differs in shape, being

* *Revue Suisse de Zoologie*, tome 13, fasc. 1, pp. 195-387.

disc-like; the latter is partly bowl-shaped, partly cylindrical. The worms are of small size. The following dimensions of four specimens may be regarded as typical:—

	No.	I.	II.	III.	IV.
Total length of body,		5·25	4·3	3·30	4·3
Diameter of widest part (anterior spiny region),		2·00	2·5	2·05	2·3
Vertical height of anterior region,		1·75	1·6	1·9	2·0
Length of cylindrical tail region,		2·68	2·1	1·2	1·7
Ratio of tail region to total body-length,		·51	·49	·36	·39

Numbers 1 and 2, on subsequent examination, proved males, and 3 and 4 females.

The colour is dead white. The rostrum, which was found fully extended in only a few instances, is very nearly cylindrical, being rather thicker at the base than at the tip. In one specimen its length was found to be 1·14 mm., its width at tip ·13 mm., and at the base ·23 mm. It carries about 28 rows of hooks, of which there are 10 in a row. These hooks differ slightly in form in different regions of the rostrum, but are quite evidently modifications of one type (fig. 2). In the row nearest the tip they are slender, and point more directly outward than those do near the base. Here they are shorter and thicker. Actual measurements are—

Hooks of first row 114 mm. long.

Hooks at base of rostrum 07 mm. long.

The rostrum at its base occupies the centre of a region of peculiar form. Here the anterior part of the body is conical, and from the tip of the cone the rostrum emerges. Around the cone at its base there is a shallow circular depression, the outer border of which rises to form a thickened rim. This rim marks the widest part of the whole worm, and defines the posterior border of the front body-region. The whole of this region—cone, depression, and rim—is covered with minute, slightly recurved spines, regularly arranged in rows. The average measurement of these spines is 0·7 mm. in length. Behind this the body curves backward in a bowl-like manner, beyond which it is bent sharply at a right angle, and continued in a much narrowed tail portion. The free end differs slightly in the two sexes, as will be described. This posterior

body-region bears spines of the same type as those occurring in the anterior part, but upon a restricted area only. The shape of the parasite is such that, when attached by the rostrum to the alimentary canal of the host, one side will be applied along its whole length to the intestinal or stomach-wall. This side, together with a very short portion encircling the tip, constitutes the spiny area; the whole remaining surface of the posterior region is quite naked. Since the object of the spines is primarily to assist in maintaining secure fixation, the significance of their one-sided distribution in an animal of this peculiar shape is apparent. Their occurrence around the tip (genital area) suggests a possible use in copulation.

External Sex Characters.

There is well-marked sexual dimorphism. This is not uncommon in the Acanthocephala. According to de Marval "les Acanthocéphales présentent un dimorphisme sexuel souvent très accentué, et qu'en thèse générale, les femelles sont beaucoup plus grandes que le mâles, voire même quelquefois géantes." The present species exhibits the unusual peculiarity that the males are larger than the females. In support of this interesting fact, which is an exception to what generally obtains amongst animals, it seems worth while to quote the following measurements:—

Length of 12 Males examined.	Length of 32 Females examined.		
	mm.	mm.	mm.
5·25	3·5	3·75	3·5
4·20	4·2	4·0	4·0
5·20	4·0	3·6	4·1
4·20	4·0	3·5	3·0
4·10	3·5	3·6	4·0
5·00	3·5	4·1	4·1
4·00	3·8	3·8	3·2
3·80	3·8	3·4	3·5
4·30	3·5	3·9	
4·75	4·3	3·2	
4·5	3·4	3·75	
4·2	3·8	4·2	

The average length for males examined is 4.46 mm., whilst for females the figure is 3.73 mm. The measurements were taken from the tip of the body to the farther margin of the disc. In the males the posterior region is flattened upon the spine-bearing surface, and slightly keeled along the sides. The tip is usually curved upward; the genital opening is not quite terminal, and there is no marked cleft. In the female the body is expanded around the genital aperture, which is situated at the base of a well-marked cleft. This cleft is upon the lower or naked side of the body.

As regards proportions of the sexes, it was noted that of 60 specimens found, 15 proved males and 45 females.

Body-wall.

There is a well-developed cuticle and sub-cuticle. The latter contains both longitudinal and circular fibrillæ in which the spines are imbedded, and a hypodermis, in which are situated oval-shaped nuclei. The sub-cuticle in the region devoid of spines is thicker than in any other part of the body, and here, for the most part, are to be found the sub-cuticular lacunæ. These consist of a system of very much branched canals, which interlace. They were not observed within the disc-like portion of the anterior region (fig. 4). The hypodermis shows a limiting membrane, against which is placed the musculature of the body-wall, arranged in closely set rows. The cells are *nematoid* in type; in cross section they exhibit a U-shaped contractile portion, and a larger non-contractile part in which the nucleus lies. In most cases a single U-shaped part corresponds to a single cell, but cases were observed, usually occurring in groups, where as many as three or four appeared to possess a common non-contractile part, forming relatively a giant type of circular muscle cell. The longitudinal muscles are fewer, and here the contractile part encloses the non-contractile in a sheath-like manner.

Proboscis Sheath and Nerve Ganglion.

The proboscis or rostral sheath is double; its retractor muscles at their terminations upon the body-wall divide up into a number

of spreading branches, between which run numerous connecting fibrils (fig. 6). The nerve ganglion, which is spindle-shaped, is situated at the base of the sheath.

Egg-spheres and Embryos.

The egg-spheres (Keimzellenballen, "swimming ovaries") are very numerous. Ova of very various sizes were observed, and shelled embryos were present in very large numbers in all the females examined. It seemed useless to measure the ova; for although their size is usually recorded as of value as a specific character, it was difficult to decide whether the ova under observation at a given time were mature. I give, however, the following:—

Diameter of egg-sphere	·114 mm.
Length of unshelled ova (largest noted)	·057 „
Length of fully-coated embryos . . .	·190 „
Width of fully-coated embryos . . .	·04 „

The embryos have a three-layered shell; the outermost layer is thick and fibrillar, the middle one has a constriction at each end marking off a rounded knob-like portion. This layer is very dense. The last layer is comparatively thin. Upon none of the embryos were hooks observed (fig. 8).

Testes.

These are large, and consist of two pairs. The members of a pair are closely apposed to each other, but are easily separated by the dissecting needle, and further, are seen in sections to be quite distinct. They lie antero-posteriorly; the anterior member is pear-shaped, the posterior is more ovoid. Attached to the anterior end of each pair is a soft spongy-looking gland, whose exact nature is undetermined. It has no connection with the cement glands, which lie posteriorly.

Lemmisci.

These consist of a pair of fairly broad bands, in which no canals could be observed.

The present form appears to be new to science, and it has been

named *Echinorhynchus antarcticus*, n. sp. Its distinctive features are, specially, the form of the body and the distribution of spines upon it; the size and shape of its rostrum, and the size, form, and number of its hooks; the characters of the sub-cuticle; the arrangement and distribution of the lacunæ; the relative sizes of the sexes; the size of the shelled embryos, and the number of the

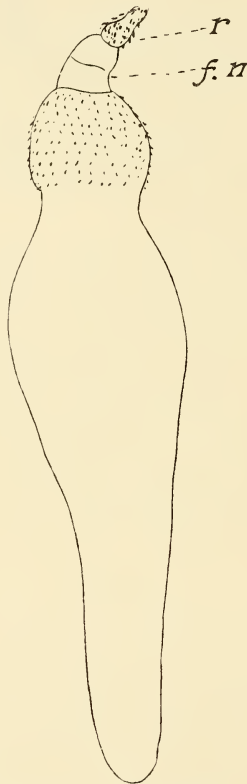

FIG. 1.—*E. striatus*.

testes. Of the foregoing, the form of body and distribution of spines upon it are more especially adaptations, as already suggested, for more secure fixation upon the host; and possibly, in the case of the male, which shows some degree of flattening, in addition the spines upon this flattened area are of service in locomotion. These features are readily understood as modifications (acquired by natural selection) of a symmetrical type with uniformly distributed

	<i>Echinorhynchus striatus</i> , Goetze.	<i>Echinorhynchus hystrix</i> , Bremser.	<i>Echinorhynchus piriformis</i> , Bremser.	<i>Echinorhynchus antarcticus</i> , spec. nov.
Body	Swollen in front and behind, constricted at the middle, armed in front with small spines. 6-15 mm. long.	Swollen in front, with short conical tail. 3.5 to 8 mm. long. Spines around body anteriorly and along one side posteriorly.	Piriform, 2-2.5 mm. long, spiny and swollen in front, behind naked and tapering in a short obtuse tail. Body spines .02 mm. long. Spherical portion of body 9-12 mm. wide and .8 mm. long.	Asymmetrically piriform, 3-5.25 mm. long (not including rostrum) spiny anteriorly and along one side posteriorly. Also circle of spines at tip. Body spines .07 mm. long. Anterior dilated portion of body 2.5-3 mm. wide, conical, with expanded upturned posterior margin.
ROSTRUM	Piriform, swollen at base, or conical or fusiform. 16-18 longitudinal rows of hooks of 12-16 hooks each. Size of hooks at tip .045 mm. near base .036 "	Swollen at base, piriform, with 18 longitudinal rows of 8-10 hooks. Size of hooks at tip .0315 mm. near base .045 " Rostrum .64 mm. long. and .192 " wide at tip, and .336 " at swollen part.	Cylindrical, slightly enlarged at base, with 18 longitudinal rows of 8-9 small hooks. Size of hooks at tip .0315 mm. In middle .045 mm. At base .0315 " long. Rostrum .352 " broad. .144 "	Almost cylindrical, about 28 longitudinal rows of 10 hooks. Size of hooks at tip .114 mm. near base .07 " " Rostrum 1-14 mm. long. .18 " wide.
NECK OR FALSE NECK	False neck, naked, piriform or conical, sometimes fusiform, may be retracted.	False neck, naked, conical, rather long.	Absent.	Absent.
EMBRYOS	Elliptical, elongated, triple-shelled middle layer with constriction at poles. .104 mm. x .026 mm.	Oblong, triple-coated, middle with slight constriction at poles. .0754 mm. x .0364 mm.	?	Fusiform, triple-coated, middle layer thickest with constrictions at poles. .19 mm. x .04 mm., largest shelled embryos. Ova unshelled, .057 mm. long.
SEX CHARACTERS	Females much larger than males.	Females larger than males. Males with two enormous testes.	?	Males larger than females. Males with four testes.
SUB-CUTICULAR CANALS	A number of trunks, abundantly anastomosing with each other.	Large anastomosing canals, clearly visible, especially in the male.	Two longitudinal trunks.	Large anastomosing canals, mostly in naked area of body.
Host	Various aquatic or wading birds,	Various aquatic birds.	<i>Turdus merula</i> .	? Some aquatic animal. Found in Weddell seal.

spines. Different modifications of such a type are not wanting, and an interesting series exists in *E. striatus*, *E. hystrix*, *E. piriformis*, and *E. antarcticus*. The distinctive features of these are

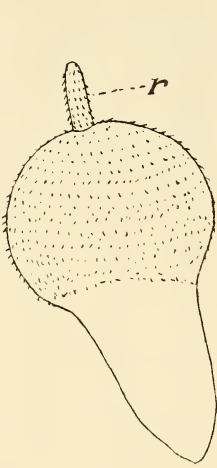

FIG. 2.—*E. piriformis*.

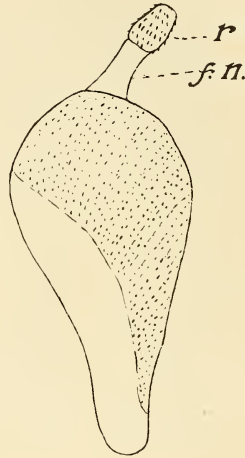

FIG. 3.—*E. hystrix*.

given in the foregoing table, together with the text-figure. The particulars regarding the first three forms are derived from the monograph of de Marval.*

A consideration of the foregoing table and figures shows that

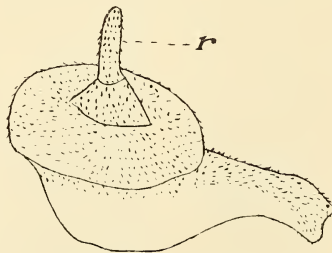

FIG. 4.—*E. antarcticus*.

E. antarcticus differs from each of the other species in more than one particular, and likewise has some points of agreement with each. I shall not recount the full details, but one or two points deserve further comment. While, as regards form, *E. antarcticus*

* *Tom. cit.*, pp. 281, 308, and 318.

is unique, there is a remarkable agreement in the distribution of spines upon it and upon *E. hystrix*. With this species it agrees also in the characters of the sub-cuticular canals. It, however, differs from it in the number and size of rostral hooks, in the absence of the false neck,* in the shape and size of the embryos, and in the number of testes and relative sizes of the sexes. With reference to *E. piriformis*, the shape comes nearest to that of *E. antarcticus*, but the distribution of body-spines is different. They agree in the absence of a neck region, and differ in the nature of the sub-cuticular canals and in the number and rows of rostral hooks. Similar observations apply to *E. striatus*, and all the points are characters of specific significance.

The rostrum in *E. antarcticus* is larger in proportion to size of body than that of the others, and the number of rows of hooks much greater. The size of the shelled embryos also is distinctive. They range from .057 mm. to .19 mm. in length, and even within the same animal considerable variation may be met with. De Marval invariably speaks of the ova ("œufs") as triple-shelled, but his figures are those of embryos in which both ectoderm and endoderm are differentiated, and it is with these that the embryos of *E. antarcticus* are compared in the foregoing table.

EXPLANATION OF TEXT-FIGURES.

r. = rostrum. *f.n.* = false neck.

Figs. 1, 2, and 3 from de Marval.

Figs. 1, 3, and 4 are magnified about 10 times; fig. 2 rather more.

* De Marval thus distinguishes the neck and false neck:—"Nous appelons 'cou' tout organe nettement délimité du corps, soit par un étranglement, soit par une ligne de démarcation bien nette, contenant totalement ou en partie seulement la poche qui vient s'insérer à son bord antérieur. Le cou, non invaginable, supporte à son extrémité le rostre, qui, la plupart, du temps, semble ne former avec lui qu'un seul et même organe. . . . Nous appellerons par contre 'faux cou' toute partie délimitée ou non du corps, nue ou garnie de petits aiguillons, et n'étant somme toute que le corps proprement dit effilé en avant, ou la base du rostre très allongée. Nous parlerons donc, dans la suite, suivant le cas, d'un cou et d'un faux cou, nus ou armés."

EXPLANATION OF PLATE.

B. = Bursa.	END. = Endoderm.
Cut. = Cuticle.	G.AP. = General Aperture.
C.M. = Circular Musculature.	P. = Penis.
ECT. = Ectoderm.	SC. = Sub-cuticle.

- Fig. 1. Female of *Echinorhynchus antarcticus*, n. sp. $\times 10$.
 Fig. 2. Types of rostral hooks in series.
 Fig. 3. (a) Tail of female, showing cleft. $\times 12$.
 (b) Tail of male, with penis and bursa extruded. $\times 12$.
 Fig. 4. Surface view of body-wall as seen from inside, to show ramification of sub-cuticular canals. $\times 12$.
 Fig. 5. Section of body-wall through spiny region. $\times 220$.
 Fig. 6. Retractor muscles of rostral sheath. $\times 220$.
 Fig. 7. Rostrum and portion of disc. $\times 30$.
 Fig. 8. Triple-shelled embryo. $\times 220$.

(Issued separately January 4, 1907.)

RENNIE: ECHINORHYNCHUS ANTARCTICUS. Plate I.

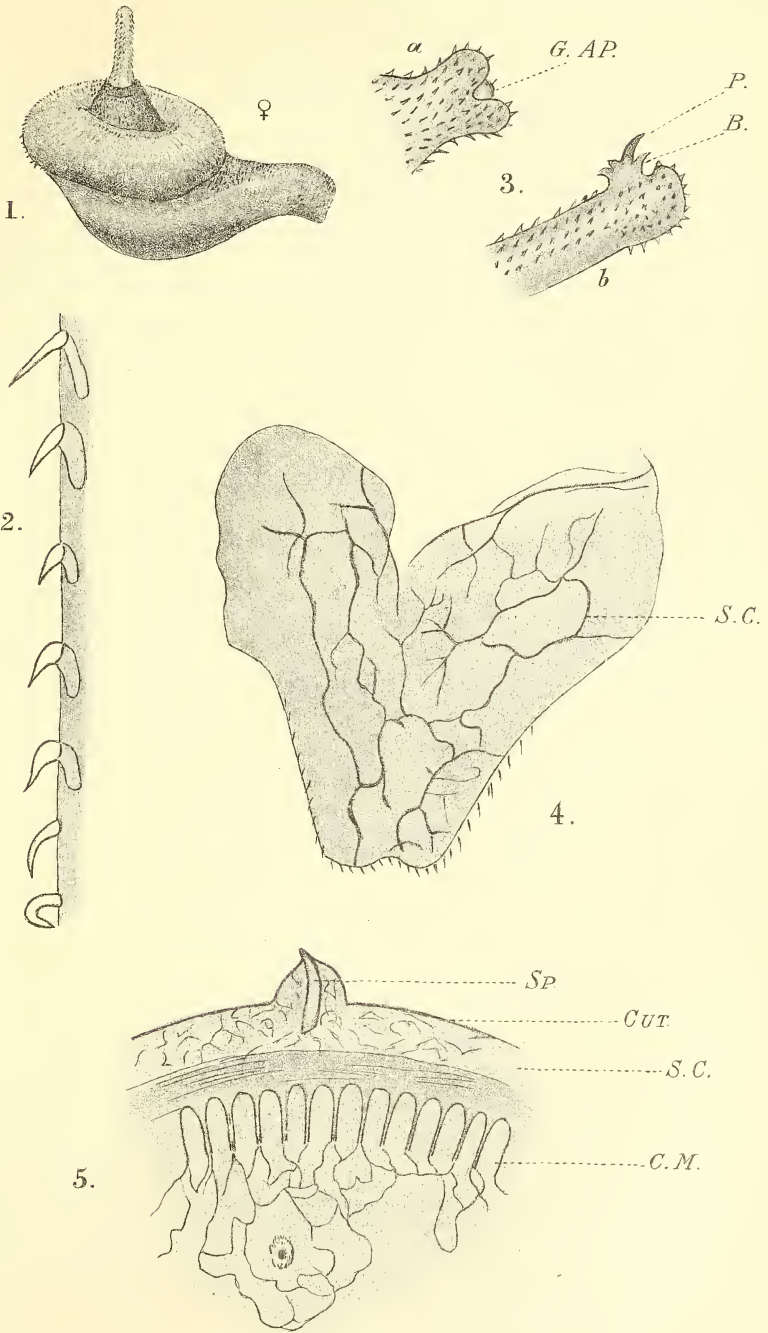

RENNIE: ECHINORHYNCHUS ANTARCTICUS. Plate II.

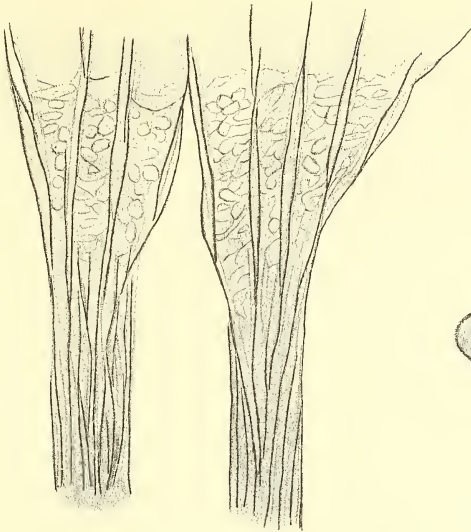

6.

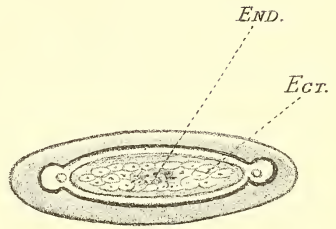

8.

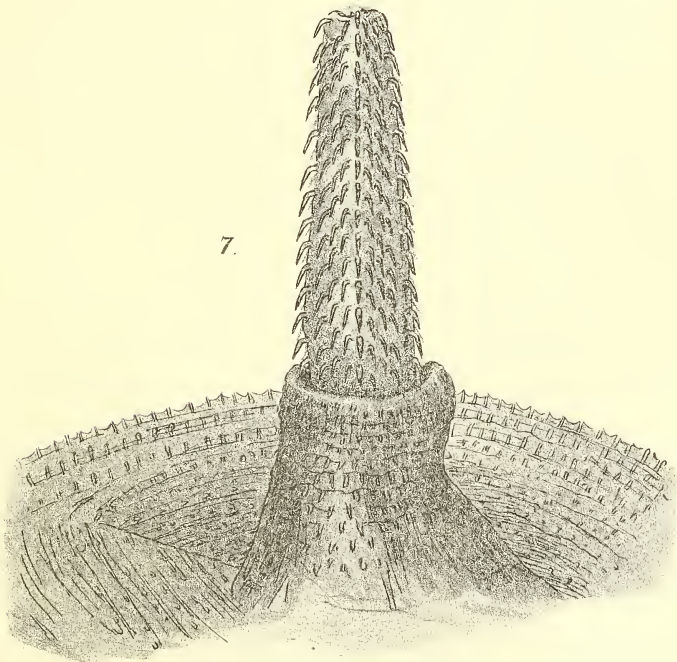

7.

Electrolysis through Precipitation Films. Part I. By
W. S. Millar, M.A., B.Sc., Carnegie Research Scholar, and
Dr W. W. Taylor. *Communicated by* Professor CRUM
BROWN.

(Read July 13, 1906. MS. received October 31, 1906.)

In a paper on the aluminium anode by one of us, in conjunction with Inglis,* it was pointed out that if the suggested theory of the aluminium anode is correct, a precipitation film of aluminium hydroxide should diminish the conductivity of salt solutions to very different extents depending upon the ions present, and that, *e.g.*, the diminution in the case of potassium chloride might be expected to be slight, in the case of potassium bromide somewhat greater, and in the case of potassium sulphate to be very considerable. Preliminary experiments to measure these differences directly were not successful, almost certainly, as was stated at the time, because of the difficulty of freeing the precipitation membrane from the concomitant soluble impurities.

The experiments described in the present paper conclusively prove that the anticipated effect does exist; and, though the quantitative agreement is fairly good, we hope to further improve the method in certain respects and so obtain exact measurements. That diaphragms may affect ions to a different extent was recognised by Hittorf, when he discarded the use of parchment paper or other diaphragms in his classic investigations on the migration ratios of ions. Tammann † found that in some cases osmotic pressure membranes offered considerable resistance to the passage of the ions which form the membrane, but that generally the resistance offered by the membrane was very small. Morse, ‡ in the preparation of osmotic pressure membranes by electrolysis, observed that an efficient film offered a very great resistance to the ions which form the film.

* Taylor and Inglis, *Phil. Mag.*, March 1903.

† Tammann, *Zeit. f. Physikal. Chem.*, vi. p. 237, 1890.

‡ Morse, *Amer. Chem. Journal*, xxix. p. 173, 1903.

APPARATUS AND METHOD.

As it is obviously necessary to have a certain amount of rigidity of support for the precipitation film, the form of apparatus must be adapted to the support selected. In the early experiments various supports were tried, viz., filter paper, hardened filter paper, filter paper impregnated with a solution of hard gelatine, and several kinds of porous earthenware.

For these preliminary experiments a Kohlrausch U cell, with large electrodes and a narrower tube connecting the two limbs, was employed. It was cut into two equal parts, the edges were ground true, and a brass coupling joint was cemented on in such a way that the diaphragm could be mounted, liquid-tight, between two rubber washers. This type of cell was found to be quite satisfactory, and was employed in most of the subsequent experiments.

Filter paper, hardened and unhardened, was found to be quite useless, nor was the gelatinised filter paper much more satisfactory. Incidentally, one or two of the results showing the effect of filter paper and of gelatinised paper on the conductivity of solutions are included later on.

A fairly hard and compact porous earthenware was found to give the most consistent results. It also had the advantage over more open material that the diaphragms could be ground very thin, and were less liable to fracture when mounted between the washers. The same diaphragm was used as often as possible; it was cleaned each time by prolonged boiling with a mixture of potassium chlorate and concentrated nitric acid, with hydrochloric acid, and repeatedly extracted with boiling water. It was then allowed to soak for a long time in the solution which was to be measured.

In a few of the experiments a different type of cell was employed. It was a modification of the Arrhenius type, but the electrodes were much smaller, and the upper one was separated from the other by a wide glass tube, the lower end of which was closed by porous earthenware cemented on water-tight. This form of cell had the disadvantage of not being so easily set up and renewed as the other one; the porous plate was much more troublesome

to clean, owing to the cement; but, on the other hand, the diaphragm was always visible, and there was no metal joint through which leaks or short-circuits might take place. This cell is subsequently referred to as the unsymmetrical cell.

The results obtained in the two very different types of cell were generally in close agreement. Up to the present, the measurements have been made by means of alternating current and telephone only. The principal difficulty in this case appears to be the purification of the film.

When a film is formed by the interaction of two reagents (precipitants), a soluble salt is also formed at the same time, and this is probably enclosed within the film. To remove this enclosed salt by washing is extremely difficult, if not altogether impossible, there being, in addition, the danger of rupturing the film or of washing the colloid film away altogether when the amount of electrolyte is much reduced. The only feasible way of removing the enclosed salt seemed to be by electrolysis with direct current, and experiments in this direction rendered it probable that the salts can be removed in this way, but that, at the same time, the film itself appeared to undergo changes when subjected to this method of purification. Evidence in support of this will be found further on.

Finally, the following procedure was adopted as almost entirely avoiding the difficulties mentioned above. If a comparison is to be made of the effect, say, of a film of aluminium hydroxide on Cl' , Br' , and SO_4'' respectively, in the first instance a fairly strong solution of ammonium chloride is placed in each division of the complete cell, and bridge readings are taken until the resistance is constant. The solution is then removed, and in the one division is placed a solution containing ammonium chloride and aluminium chloride, in the other division a solution containing ammonium chloride and ammonia. The concentration of ammonium chloride on each side is the same as before; the concentrations of the precipitants are equivalent and small in comparison with that of the ammonium chloride. Thus almost the whole of the conductivity is due to the ammonium chloride, and the change of conductivity, owing to decrease of concentration of the precipitants by formation of the film, will be so small as to be negligible.

Measurements were repeatedly made on the ammonium salt solutions, and on the mixed solutions at the beginning and at the end of an experiment, and in every case the above assumptions were verified. Immediately after the cell is set up, bridge readings are taken at small intervals of time. The conductivity first of all increases slightly, which may be a temperature effect, then slowly falls over a long period, and finally becomes practically constant. The maximum is taken as the correct initial value, and the constant end value as the final one. When the final value is reached, the mixed solutions may be replaced by the original solution of ammonium chloride.

The whole of the experiments were made at constant temperature, generally 25° C.

Parallel experiments are then carried out, for bromide, with solutions of ammonium bromide, aluminium bromide, and ammonia; and for sulphate, with ammonium sulphate, aluminium sulphate, and ammonia. In some of the experiments the solutions of the ammonium salts were of equivalent concentration, whilst in others they were of the same specific conductivity; the concentrations of the precipitants were always equivalent.

By this method the only salt produced by the formation of the film is the salt which is under investigation; it is, therefore, unnecessary to attempt to remove it, and all that is required is that equilibrium between the concentration of the salt in the film and in the solution be attained.

RESULTS.

Before giving, in the form of tables, the results of the measurements, we may give in detail some observations which may be of interest.

1. *Effect of filter paper and of gelatin on the conductivity of solutions.*

A. Potassium chloride solution.

- | | | | |
|--|-------------|---|----------------|
| (1) No diaphragm, conductivity | ·00422 mho. | | |
| (2) Hardened filter paper, conductivity | ·00419 | „ | 99·3 per cent. |
| (3) Gelatinised filter paper, conductivity | ·00406 | „ | 96·2 „ |

B. $M/_{12}$ Ammonium sulphate solution.

- (1) No diaphragm, conductivity $\cdot 00971$ mho.
- (2) Filter paper, conductivity $\cdot 00967$,, 99.6 per cent.
- (3) Gelatinised paper, conductivity $\cdot 00954$,, 98.2 ,,

Attempts in the first case to form a serviceable film of aluminium hydroxide, in the latter case of chromic hydroxide, completely failed.

2. *Aluminium hydroxide film. Ammonium sulphate solution.*

The following is the complete record of the measurements made in one experiment, and may be taken as typical of them all.

A. Ammonium sulphate solution, 0.15 mol. per litre.

Time in Minutes.	Bridge reading in mm.	Resistance Box.	Conductivity in mhos.
...	508.5	550	...

Electrolyse for five minutes each way with ten-volt direct current, replace with fresh solution—

...	508.2	550	...
-----	-------	-----	-----

Electrolyse three minutes each way—

...	508.3	450	$\cdot 001879$
-----	-------	-----	----------------

B. $\cdot 15m$ $(NH_4)_2SO_4$ + $\cdot 033m$ $Al_2(SO_4)_3$ in one limb.

$\cdot 15m$ $(NH_4)_2SO_4$ + $\cdot 2m$ NH_3 in other limb.

0	509.5	550	
3	511.5	,,	
6	511.8	,,	
9	512.0	,,	$\cdot 001908$
12	511.7	,,	
15	511.2	,,	
18	510.4	,,	
21	509.0	,,	
24	507.2	,,	
27	505.5	,,	

Time in Minutes.	Bridge reading in mm.	Resistance Box.	Conductivity in mhos.
30	503·4	550	
33	502·0	„	
36	500·7	„	
41	498·4	„	
46	497·2	„	
51	475·0	„	
56	494·0	„	
1080	462·0	550	·001561

Readings were then taken every hour and remained constant within 1 mm. The ten-volt direct current was then passed through the cell for ten minutes, the electrode in the limb containing aluminium sulphate being the anode. The solutions were then thoroughly stirred up.

0	448	600	·001353
3	456	„	
6	458	„	
9	460	„	
15	462	„	
21	466	„	
33	470	„	
48	472	„	
88	473	„	
137	472	„	
185	471	„	
220	471	„	
1250	479	„	·001532

The reason for electrolysing with a direct current and the effects produced by it will be discussed later.

In the tables of results which follow, the first column indicates the cell in which the experiment was made; this is desirable, as the dimensions of the cells employed differed to a considerable extent; * the second column gives the initial conductivity in mhos;

* It should be noted that a cell marked A in one table is not necessarily the same as cell A in another table. The cells frequently broke at the brass joints, and new parts were fitted on.

the third column gives the final conductivity in mhos; and the fourth column is the percentage ratio of the final to the initial conductivity.

Aluminium Hydroxide Films.

1. Ammonium chloride.

$\frac{1}{6}$ mol. NH_4Cl + $\frac{1}{8}$ mol. NH_3 ; $\frac{1}{6}$ mol. NH_4Cl + $\frac{1}{24}$ mol. AlCl_3 .

I.	II.	III.	IV.
A	·001426	·001357	95·2
B	1231	1192	96·8
C	1252	1198	95·8
X	1473	1401	95·3
Y	1122	1078	96·1
Z	1084	1018	93·9
		Mean	<hr/> 95·5

2. Ammonium bromide.

$\frac{1}{6}$ mol. NH_4Br_3 + $\frac{1}{8}$ mol. NH_3 ; $\frac{1}{6}$ mol. NH_4Br + $\frac{1}{24}$ mol. AlBr_3 .

I.	II.	III.	IV.
A	·001423	·001331	93·5
	1455	1338	92·0
	1437	1319	91·7
B	1449	1348	93·0
	1426	1327	93·1
	1466	1324	90·3
	1409	1331	94·5*
X	1176	1097	93·3
Y	1159	1104	95·3*
Z	1192	1144	96·0*
		Mean	<hr/> 92·5

3. Ammonium sulphate.

(a) $\frac{1}{6}$ mol. $(\text{NH}_4)_2\text{SO}_4 + \frac{1}{5}$ mol. NH_3 ; $\frac{1}{6}$ mol. $(\text{NH}_4)_2\text{SO}_4 + \frac{1}{30}$ mol. $\text{Al}_2(\text{SO}_4)_3$.

I.	II.	III.	IV.
A	·001892	·001546	81·7
	1908	1561	81·8
	1976	1565	79·2
B	1805	1449	80·3
	1773	1437	81·1
	1705	1431	83·9
	1805	1448	80·2
		Mean	<u>81·2</u>

(b) $\frac{1}{6}$ mol. $(\text{NH}_4)_2\text{SO}_4 + \frac{1}{10}$ mol. NH_3 ; $\frac{1}{6}$ mol. $(\text{NH}_4)_2\text{SO}_4 + \frac{1}{60}$ mol. $\text{Al}_2(\text{SO}_4)_3$.

I.	II.	III.	IV.
X	·001431	·000980	68·5
Y	1487	1026	69·0
Z	1530	1096	71·6
		Mean	<u>69·7</u>

(c) $\frac{1}{8}$ mol. $(\text{NH}_4)_2\text{SO}_4 + \frac{1}{5}$ mol. NH_3 ; $\frac{1}{8}$ mol. $(\text{NH}_4)_2\text{SO}_4 + \frac{1}{30}$ mol. $\text{Al}_2(\text{SO}_4)_3$.

I.	II.	III.	IV.
A	·000799	·000629	79·7*
B	797	564	70·8
	786	582	74·1
	815	537	65·9
C	691	490	70·9
	697	478	68·6
		Mean	<u>70·1</u>

Chromic Hydroxide Films.

1. Ammonium chloride.

 $\frac{1}{6}$ mol. NH_4Cl + $\frac{1}{4}$ mol. NH_3 ; $\frac{1}{6}$ mol. NH_4Cl + $\frac{1}{12}$ mol. CrCl_3 .

I.	II.	III.	IV.
A	·001811	·001434	79·2
	1774	1417	79·9
	1893	1572	83·0
B	1598	1212	75·9
	1637	1345	82·2
	1644	1452	88·4*
	1677	1412	84·2
C	1611	1378	85·5*
	1624	1400	86·2*
	1573	1378	87·6*
	1566	1378	88·0*
		Mean	<hr/> 80·7

2. Ammonium sulphate.

 $\frac{1}{6}$ mol. $(\text{NH}_4)_2\text{SO}_4$ + $\frac{1}{4}$ mol. NH_3 ; $\frac{1}{6}$ mol. $(\text{NH}_4)_2\text{SO}_4$ + $\frac{1}{24}$ mol. $\text{Cr}_2(\text{SO}_4)_3$.

I.	II.	III.	IV.
B	·000944	·000516	54·7
	1037	500	48·2
	916	414	45·2
	935	454	48·6
	929	308	33·2*
C	897	455	50·7
	921	341	37·0*
	1004	471	46·9
	950	450	47·4
		Mean	<hr/> 48·8

3. Potassium sulphate.

 $\frac{1}{8}$ mol. $K_2SO_4 + \frac{1}{8}$ mol. KOH ; $\frac{1}{8}$ mol. $K_2SO_4 + \frac{1}{48}$ mol. $Cr_2(SO_4)_3$.

I.	II.	III.	IV.
A	·002101	·001041	49·5
	2325	869	37·4*
	1940	1000	51·5
B	2174	1217	56·0
C	1604	845	52·6
	1595	770	48·3
	1721	802	46·6
		Mean	50·8

4. Sodium sulphate.

 $\frac{1}{8}$ mol. $Na_2SO_4 + \frac{1}{8}$ mol. NaOH ; $\frac{1}{8}$ mol. $Na_2SO_4 + \frac{1}{48}$ mol. $Cr_2(SO_4)_3$.

I.	II.	III.	IV.
A	·001700	·000628	36·9
	1738	831	47·6*
	1827	708	38·8
	1857	869	46·8*
B	1906	654	34·3
	1900	667	35·1
	1857	858	46·3*
C	1327	591	44·5*
	1344	524	39·0
	1331	640	48·1*
		Mean	36·8
		(Mean of *, 46·7.)	

Before proceeding to the discussion of these results, we may briefly describe certain isolated experiments which have been made.

A. *Temperature Coefficient.*

The unsymmetrical cell, already referred to, was set up with solutions containing $\frac{1}{6}$ mol. $(NH_4)_2SO_4 + \frac{1}{4}$ mol. NH_3 , and $\frac{1}{6}$ mol. $(NH_4)_2SO_4 + \frac{1}{24}$ mol. $Cr_2(SO_4)_3$.

A very satisfactory film was formed, and the conductivity was determined at various temperatures. The temperature coefficient was calculated from the formula

$$c = \frac{1}{K_{25}} \frac{K_t - K_{25}}{t - 25},$$

in which K_t and K_{25} are the conductivities at temperatures t and 25°C .

The results are as follows:—

Time.	Temperature.	Conductivity in mhos.	C.
12.0 p.m.	25.0° C.	·001523	...
12.30 „	12.0 „	835	·0348
1.0 „	12.3 „	869	338
2.0 „	0.3 „	544	260
3.30 „	16.2 „	1105	312
4.30 „	25.0 „	1782	...
Following morning	25.0 „	1517	...

B. *Effect of a chromic hydroxide film made in sulphate solutions on the other salts.*

In this series of experiments solutions of ammonium chloride, ammonium bromide, and of ammonium sulphate were prepared so as to have the same specific conductivity; the concentrations were .25 mol. NH_4Cl , .25 mol. NH_4Br , and about .17 mol. $(\text{NH}_4)_2\text{SO}_4$. A film of chromic hydroxide was then formed in the unsymmetrical cell exactly as described in the previous experiment.

When the final conductivity had been constant for several days, the mixed solutions were replaced by the .17 mol. $(\text{NH}_4)_2\text{SO}_4$ solution, which was allowed to remain until the readings were constant. This solution was then replaced by a fresh portion of the ammonium sulphate solution, but the readings were found to be the same as before. The ammonium sulphate solution was similarly replaced by the ammonium chloride solution, and the chloride by the ammonium bromide solution; and, in conclusion, the bromide solution was washed out with the ammonium sulphate

solution, and readings were taken with the sulphate. The following results were obtained :—

Date.	Solution.	Conductivity in mhos.	Ratio to Conductivity of NH_4Cl .
July 6	$(\text{NH}_4)_2\text{SO}_4$	·00339	·76
„ 8	NH_4Cl	·00445	1·00
„ 9	NH_4Br	·00410	·92
„ 9	$(\text{NH}_4)_2\text{SO}_4$	·00370	·83

Unfortunately the cement of the tile gave way before the last measurements on the sulphate solution were made. The sulphate solution had only been in the cell for ninety minutes, whereas, in the case of all the other solutions, the cell was left for about twenty-four hours before the final readings were taken. The same series of experiments was also made in one of the U cells. The results were similar in every respect.

The ratios of the specific conductivity of the ammonium solutions of chloride, ammonium bromide, and ammonium sulphate were 1·00 : 1·073 : 1·035 ; with the chromic hydroxide film the ratios were 1·00 : ·92 : ·765.

*C. Effect of a chromic hydroxide film on solutions of sodium ammonium *d*-tartrate, and of sodium ammonium racemate.*

Solutions of sodium ammonium *d*-tartrate and of sodium ammonium racemate were prepared of such a concentration that they had approximately the same specific conductivity as the solutions employed in the experiments described in section B. The exact ratio of the specific conductivity of the tartrate solution to that of the racemate solution was 1·000 : 1·046.

A film of chromic hydroxide was formed with sulphate solutions in one of the U cells, and a series of measurements was taken with the three solutions exactly as in the previous experiments.

With the film, the ratio of the conductivity of the *d*-tartrate solution to that of the racemate solution was 1·000 : 1·040, being the same as without the film.

The conductivities of the two solutions are diminished by the film to about the same extent as is that of the sulphate solution.

DISCUSSION OF RESULTS.

1. A glance at the main tables of results reveals the fact that in many cases the final conductivities in any set for a given cell are generally much more concordant than are the initial values. It might have been better, perhaps, to take as initial value the conductivity of the solutions in the cells without the porous diaphragm.

2. The series of measurements show clearly that the diminution of conductivity of a solution across a precipitation film is dependent on the nature of the ions. Thus, taking the series NH_4Cl , NH_4Br , $(\text{NH}_4)_2\text{SO}_4$, a film of aluminium hydroxide reduces the conductivity of the chloride by only 3 per cent., of the bromide by 7 per cent., and of the sulphate by over 20 per cent. The diminution measured must be the sum of the effects on the cation and the anion, but in these cases, with a common cation, the above values may be taken as an approximate measure of the differences between the anions Cl' , Br' , SO_4'' .

A similar but distinctly smaller effect is found for the cations in the series $(\text{NH}_4)_2\text{SO}_4$, K_2SO_4 , Na_2SO_4 , with a chromic hydroxide film; it is noticeable that K' and NH_4' are affected to about the same extent, whilst Na' stands apart from them, in accordance with other physical and chemical characteristics.

3. A comparison of the results obtained with films of aluminium hydroxide and chromic hydroxide shows that if the ions are arranged in order of increased effect of the film, the order is the same for the two films, but that the amount of diminution is quite different, nor are the ratios the same in the two series. Whether this is due to increased influence of the chromic hydroxide film on the anion or on the cation, there is, at present, no evidence to indicate.

It may be of interest to mention that several attempts were made to form a ferric hydroxide film, but without success. There were indications, in the increased resistance, that a film was being formed, but it did not remain for long, and a gritty precipitate soon made its appearance on one side or the other of the porous plate. Apparently the precipitated ferric hydroxide rapidly disintegrated, probably losing its colloid character.

In some experiments with cupric ferrocyanide also, very little decrease of conductivity was observed either with potassium chloride or potassium sulphate. It may be that this film is permeable with respect to these ions; cupric ferrocyanide might, nevertheless, give large effects with other ions.

4. The tables presented in the paper contain the results of all experiments which were carried out to the end, and it will be noticed that in most cases the values obtained in any one series group themselves around two values, a set of high values and a set of low values, each set being fairly concordant. The high sets are distinguished in the tables by an asterisk, and have not been included in the calculation of the mean value. This peculiarity is particularly noticeable in the chromic hydroxide results; it is not confined to the measurements made in any particular cell, or with one particular solution. The only explanation which seems at all probable is that there is more than one modification of the colloid film; that, as would be expected, they differ in their effect on the conductivity of the solutions, and that on some occasions the one modification, and on others the other modification, is obtained, the precise conditions which determine the formation of the one or the other being so far unrecognised.

This explanation is supported by several observations which have been made; *e.g.*, in the tables for ammonium sulphate with aluminium hydroxide films, it is noticeable that with different concentrations of the ammonium sulphate and of the precipitants, different results are obtained, though each set shows none of the sub-grouping referred to. At the one concentration the one modification may be obtained; at the other concentration the other one. In some cases, also, an apparently final conductivity was obtained, which remained constant for a day or more, and then the conductivity began to decrease very slowly over a period of several days, and attained a much smaller, really constant value. A slow transformation of the film from a less stable to a more stable modification appears to afford the most probable explanation of this behaviour. In this connection it should be mentioned that the solutions of chromic sulphate and of chromic chloride were prepared by reduction of chromic acid

solution in the cold, and consequently contained the violet modifications of these salts.

5. The experiment on the temperature coefficient of the cell containing ammonium sulphate solution and a chromic hydroxide film contains several points of interest. In the first place, the temperature coefficient is much greater than that of the ammonium sulphate solution alone, which, according to Kohlrausch,* is $\cdot 0215$ for $\cdot 7$ equivalent solutions.

Change of temperature must, therefore, in some way alter either the nature of the film or the nature of the process of conduction through the film. That the film is altered by changes of temperature is highly probable from a chemical point of view. The fact that the temperature coefficient is much smaller at the lower temperatures also supports the view that the change is in the film itself.

The slow recovery to the original value for 25° C. is suggestive of the same change. It will be noticed that after the cell had been cooled to 0° C. it was kept at 25° for about sixty minutes, when the conductivity was found to be much higher than its original value at 25° . After the cell had remained at constant temperature of 25° until the following morning, the conductivity fell to exactly the original value.

6. The experiment given *in extenso* in the earlier part of the paper is only one of many observations made of the effect of electrolysis with direct current. When the film had formed by the process of diffusion, and no further diminution of conductivity was observed, a direct current was sent for a few minutes through the cell. The direction of the current was such that the film would be reinforced by the meeting of the metallic ions and the hydroxyl ions. On disconnecting the direct current, and stirring the solutions on each side of the diaphragm by means of the electrodes, one invariably noticed a considerable diminution of conductivity, but that, on allowing the cell to stand for some time, the conductivity very slowly returned to its former value. It is not probable that this is simply due to polarisation, though further experiments are desirable on this point. It may be caused by a heating effect in the film, or by electric endosmosis, the water

* Kohlrausch und Holborn, *Leitvermögen*, p. 151, 1898.

being driven out of the colloid. Whatever the cause of the change, the film slowly returns to its initial condition, as the following examples show.

Aluminium hydroxide films. Ammonium sulphate solution.

No.	No Film.	Film.	After Electro- lysis.	On Recovery.
		Conductivity in mhos.		
1.	·00189	·00160	·00133	·00155
2.	191	156	135	153
3.	198	157	145	157

It is worthy of note that the ratio of the conductivities before and after electrolysis is almost the same as that between the high set of values and the low set of values for ammonium sulphate solutions and aluminium hydroxide films already referred to.

7. In the series of experiments described in B (p. 457) made with the unsymmetrical cell, a film of chromic hydroxide was made in the usual manner with sulphate solutions, *i.e.* with ammonium sulphate and ammonia on the one side, and with ammonium sulphate and chromic sulphate on the other side.

With this film was determined the conductivity of solutions of ammonium chloride, ammonium bromide, and ammonium sulphate, which had been adjusted so that their specific conductivities were the same. When the solutions are arranged according to the loss of conductivity occasioned by the film, the order is as before—Cl', Br', SO", and the ratio of the diminution is approximately the same; there is, however, this curious difference, that the actual conductivities observed are very much smaller. Thus, in the main series of experiments the ratio of the values of ammonium chloride and ammonium sulphate is 1 : ·60, in this experiment the ratio is 1 : ·73; but in the former case the actual drop in conductivity is 19 per cent. for the chloride and 51 per cent. for the sulphate; whilst in this experiment the drop is 75 per cent. for the chloride and 82 per cent. for the sulphate.

That this large difference is due to essential differences in the nature of the films formed from chloride solutions and from sulphate solutions does not appear probable. It may well be that a film formed from sulphate contains ammonium sulphate or chromic sulphate occluded in it, which is not removed to any extent during

the soaking-out process with the other solutions, and that this in some way hinders the transference of other ions across the film.

8. Chemically equivalent solutions of ammonium chloride and of ammonium bromide, if not too concentrated, have the same specific conductivity, but they are affected to different extents by a film of aluminium hydroxide. The experiment just discussed showed that this small difference was distinctly recognisable by means of a chromic hydroxide film prepared from sulphate solutions.

Chemically equivalent solutions of a *d*-tartrate and of the corresponding racemate have also the same specific conductivity, but they also might be affected by the film to different extents. If this were so, the obvious explanation would be that in the racemate solution some of the *d*-ions and *l*-ions were associated to form racemate ions.

As the result of the experiment with sodium ammonium *d*-tartrate and sodium ammonium racemate was that the conductivity of the two solutions was diminished to exactly the same degree, the conclusion seems warranted that in the solution of the racemate there could be no considerable concentration of racemate ions. It might be reasonably expected, however, that *d*-ions and *l*-ions would be differently affected by a film consisting of an optically active substance. Experiments are now in progress in this direction, and if a suitable optically active film can be obtained, it should be possible, by electrolysis in the case of electrolytes, or by diffusion in the case of electrolytes and non-electrolytes, to effect the resolution of racemic compounds or mixtures into their optically active components.

(Issued separately, January 4, 1907.)

Nematodes of the Scottish National Antarctic Expedition, 1902-1904. By Dr v. Linstow, Göttingen.
Communicated by W. S. BRUCE. (With Two Plates.)

(MS. received March 19, 1906. Read May 7, 1906.)

PARASITISCHE NEMATODEN.

Ascaris rectangula n.sp. (fig. 1-3 and 8-15).

Aus *Leptenychores weddelli* Lesson. Ventric. Das Kopfende ist erheblich dünner als das Schwanzende. Die Lippen sind klein, die Dorsallippe ist 0·18 mm. breit und 0·14 mm. lang; aussen an der Vorderseite gerundet, Papillen nach aussen und vorn gerückt, innen mit einem doppelten, rechtwinklig begrenzten Vorsprung, ohne Zahnleisten, Löffelbildung und Zwischenlippen (fig. 1). Cuticula quergeringelt, Nacken-papillen fehlen; Schwanzende abgerundet, beim Weibchen sehr breit. Der Ösophagus ist kurz und schmal und nimmt $\frac{1}{20} - \frac{1}{21}$ der Gesamtlänge ein; in seiner vorderen Hälfte ist er muskulös, in der hinteren drüsig, das Lumen ist aber überall drei-schenkelig; im muskulösen Theil verlaufen 3 Drüsen (fig. 3, a); an der Dorsalseite der Ösophagus verläuft eine breite, blinddarmartige Vörlängerung des Darms nach vorn, die weit nach vorn reicht (fig. 3, b); nicht so lang wie der Ösophagus sondern von $\frac{4}{11}$ der Ösophagus-Länge; die das Lumen auskleidende Membran sowie die äussere Hülle sind dick. Die Muskeln (fig. 3, m) sind dorsal und ventral viel mächtiger entwickelt als lateral; sie sind an vier Stellen, dorsal, ventral und lateral von den 4 Längswülsten unterbrochen; der Dorsal- und Ventralwulst (fig. 3, d u v) sind schwach entwickelt und tragen an ihrer Innerseite einen Nerven (fig. 3, n); die Lateralwülste (fig. 3, l) sind nach innen verbreitert und werden durch eine Scheidewand in eine dorsale und ventrale Hälfte getheilt; an der einen Seite ist die dorsale Hälfte zu einem platten Bande verlängert, das als ligamentum suspensorium, den Ösophagus und Blinddarm stützt (fig. 3, p); auch von dem anderen Lateralwulst gehen solche Ligamente zum Blinddarm hinüber, ausserdem

aber steht mit ihm die unpaare Drüse (fig. 3, *u*) in Verbindung, ein langes, bis in die zweite Körperhälfte reichendes Organ, in dessen Mittelachse ein starkwandiges Gefäss verläuft, das ganz vorn an der Basis der beiden ventrolateralen Lippen mündet.

Das Männchen wird 40 mm. lang und 1·11 mm. breit; das Schwanzende macht $\frac{1}{200}$ der Gesamtlänge aus, jederseits stehen ventral 15 grosse präanale Papillen; sie sind den Seitenlinien nahe gerückt (fig. 2) und reichen bis 0·60 mm. vom Schwanzende nach vorn; die 1.-4. sind mehr nach innen gerückt, die 11. ist gross und doppelt, sie ist von einer bogigen Cuticularverdickung umgeben, auch die 13.-15. werden von einer rundliche Verdickung der Cuticula umrandet, welche die Cloakenmündung vorn begrenzt; in den Seitenlinien ist die Cuticula des Schwanzendes stark verdickt und von senkrecht zur Längsachse stehenden Stäbchen gestützt, welche die Oberfläche nicht erreichen; postanale Papillen fehlen; die stäbchenförmigen Cirren sind 2·9 mm. lang.

Das Weibchen ist 55-60 mm. lang und 1·90 mm. breit; das Schwanzende macht $\frac{1}{141}$ der Gesamtlänge aus; die Vulva mündet vor der Körpermitte und theilt den Körper im Verhältniss von 5:12. Die Eier sind fast kugelförmig und haben eine glatte Schale; sie sind 0·060 mm. lang und 0·055 mm. breit. Die Larven leben in einem Fisch, als common fish berechnet, vermuthlich ein Trematomus oder eine Nothotenia; sie erreichen eine Länge von 39 und eine Breite von 1·30 mm.; das Kopffende trägt den embryonalen Bohrzahn, der Ösophagus nimmt $\frac{1}{11}$, das abgerundete Schwanzende $\frac{1}{120}$ der ganzen Thierlänge ein; der Darm sendet einen an der dorsalen Seite des Ösophagus liegenden Blinddarm nach vorn; Cuticula quergeringelt; Geschlechtsorgane fehlen; dass Ösophagus und Schwanzende relativ länger sind als bei den Geschlechtsform, ist ein Umstand, der bei allen Nematodenlarven beobachtet wird.

Die Magenschleimhaut von *Leptonychotes weddelli* ist mit *Ascaris rectangula* mitunter dicht besetzt; die Nematoden haben sich, zu einer Gruppe vereinigt, mit dem Kopffende in die Schleimhaut geböhrt und die Körper hängen frei in das Darmleimen hinein. Eine solche Gruppe ist in fig. 8 abgebildet, die aus einem bei den S. Orkneys erbeuteten *Leptonychotes weddelli* stammt. Sie wird gebildet von Ascariden von den kleinsten

Larvenformen bis zu geschlechtsreifen Thieren. Bei den Larven assen sich kleinste, kleine, mittelgrosse und grosse unterscheiden.

Die kleinsten Larven waren 3·70 mm. lang und 0·23 mm. breit; der Ösophagus nimmt $\frac{1}{8}$, das conische Schwanzende mit abgerundeter Spitze $\frac{1}{41}$ der Gesamtlänge ein; den Darm setzt sich an der Dorsalseite des Ösophagus nach vorn in einen Blinddarm fort (fig. 12, *b*), der $\frac{1}{3}$ Ösophaguslänge besitzt; der Ösophagus aber ist nach hinten an der Ventralseite des Darms in einen kolbenförmigen Drüsenkörper verlängert, der breiter als der Darm ist und $\frac{2}{3}$ der Ösophaguslänge einnimmt (fig. 12, *ö II*). Die Lippen sind rudimentär, die Dorsallippe ist halbkreisförmig und lässt in Innern 2 rundliche Vorbuchtungen der Pulpa erkennen (fig. 9); ventral steht der embryonale Bohrzahn.

Die kleinen Larven sind etwa 10 mm. und 0·43 mm. breit; der Ösophagus misst $\frac{1}{7}$, der Schwanz $\frac{1}{39}$ der ganzen Thierlänge; der Blinddarm hat $\frac{2}{3}$, der Fortsatz des Ösophagus nach hinten $\frac{1}{31}$ der Ösophagus-Länge. Die Dorsallippe eines Exemplars, das dicht vor der Häutung steht, ist halbkreisförmig und ohne Papillen; der embryonale Bohrzahn ist noch vorhanden, die Länge beträgt 0·056 mm., die Breite 0·10 mm.; im Innern aber sieht man die beiden Vorsprünge der definitiven Lippenform bereits vorgebildet (fig. 10).

Die mittelgrossen Larven haben eine Länge von durchschnittlich 20 mm.; die Breite beträgt 0·55 mm.; der Ösophagus ist $\frac{1}{8}$, der Schwanz $\frac{1}{31}$ der Gesamtlänge gross; der Blinddarm misst $\frac{3}{5}$, der Ösophagusfortsatz nur $\frac{1}{6}$ der Länge des Ösophagus, ist also gegen das frühere Stadium sehr verkürzt. Die Dorsallippe ist 0·072 mm. lang und 0·16 mm. breit und hat eine der definitiven sehr ähnliche Form angenommen (fig. 11).

Die grossen Larven sind 35–40 mm. lang und 1·18 mm. breit; der Ösophagus misst hier $\frac{1}{2}$, der Schwanz $\frac{1}{10}$ der Gesamtlänge; der Blinddarm ist $\frac{1}{3}$ oder $\frac{7}{22}$ der Ösophaguslänge gross; der Ösophagusfortsatz ist geschwunden, der Ösophagus selber aber ist getrennt in einen vorderen muskulösen und einen hinteren drüsigen Abschnitt, deren Längen sich zu einander verhalten wie 2 : 1 (38 : 17) (fig. 13, *ö* und *ö II*).

Zwischen je 2 der hier geschilderten Stadien wird eine Häutung durchgemacht.

Was die Geschlechtsform betrifft, so bleiben die 57-60 mm. langen und 1.18 mm. breiten Weibchen, bei denen man Eier im Uterus findet, mit dem Kopfende in der Magenschleimhaut befestigt, die Männchen aber finden sich frei im Magen.

Der nach hinten verlaufende Ösophagus-Anhang nimmt in seiner relativen Grösse zum Ösophagus beim Wachstum der Larven beständig ab; die relative Länge beträgt bei ganz jungen Larven $\frac{2}{3}$, bei kleinen $\frac{1}{3}\frac{2}{1}$, bei mittelgrossen $\frac{1}{6}$ und bei grossen ist er ganz geschwunden. Die Grenze zwischen muskulösem und drüsigem Ösophagus aber rückt beständig nach vorn und gelangt schliesslich an das hintere Drittel des freien Ösophagus. Der drüsig Abschnitt hat stets ein Lumen. Bei anderen *Ascaris*-Arten bleibt die freie Verlängerung des Ösophagus nach hinten auch im geschlechtsreifen Zustande bestehen; hier hat dieser Anhang aber kein Lumen, sondern wird gebildet von Verlängerungen der im Ösophagus verlaufenden beiden ventralen Drüsen.

In der Larve liegt die innere Auskleidung des Darms an einander (fig. 15, *d*) wie die Schleimhaut der Bronchien einer Foetus-Lunge, die noch nicht geathmet hat; lange, platte Epithelzellen gehen von dieser Auskleidungsmembran bogig nach der Peripherie.

Beim Eintritt des Ösophagus in den Darm umfasst letzterer den ersteren von der dorsalen Seite, dann eine kurze Strecke ringförmig.

Der hintere, drüsig Abschnitt des Ösophagus hat ein dreischenkliges Lumen und wird gebildet von gestreckten, Kerne enthaltenden Drüsensträngen, eine Muskulatur fehlt hier ganz (fig. 14, *ös. II.*).

Die Länge des Ösophagus im Verhältniss zur Gesamtlänge des Nematoden nimmt beständig ab; in den 5 genannten Entwicklungsstadien beträgt sie anfangs $\frac{1}{8}\frac{1}{6}$, dann $\frac{1}{7}\frac{1}{7}$, hierauf $\frac{1}{8}\frac{1}{8}$, bei grossen Larven $\frac{1}{1}\frac{1}{2}$ und im geschlechtsreifen Zustande $\frac{1}{2}\frac{1}{1}$; dasselbe gilt für die relative Länge des Schwanzes, die in den 5 Stadien beträgt $\frac{1}{4}\frac{1}{1}$, $\frac{1}{3}\frac{1}{9}$, $\frac{1}{5}\frac{1}{1}$, $\frac{1}{9}\frac{1}{0}$ und endlich $\frac{1}{1}\frac{1}{7}\frac{1}{2}$ - $\frac{1}{2}\frac{1}{0}\frac{1}{0}$. Der Blinddarm folgt diesem Gesetz nicht; seine Länge im Verhältniss zu der des Ösophagus beträgt in den 5 Entwicklungsphasen $\frac{1}{3}$, $\frac{2}{3}$, $\frac{3}{5}$, $\frac{1}{3}$ und $\frac{4}{1}\frac{1}{1}$; das Lumen des Blinddarms auch im Larvenstadium ist gross und die gestreckten Epithelzellen des Darms sind hier nicht sichtbar (fig. 14, *b*).

Die unpaare Drüse mündet an der Basis der beiden ventro-

lateralen Lippen; in der Larve ist sie im Verlaufe neben dem Ösophagus cylindrisch (fig. 14, *u*); neben dem Darm aber verbreitert sie sich zu einem breiten Bande, das von einem Seitenstrang zum anderen reicht (fig. 15, *u*); hier liegt in ihr ein platter, bandförmiger Kern, an dessen einer Seite das Längsgefäss verläuft. Was ihre Function betrifft, so glaube ich, dass sie eine Flüssigkeit absondert, welche das Gewebe der Mucosa und Submucosa des Magens von *Stenorhynchus* auflösen kann, so dass es in flüssiger Form als Nahrung vom Nematoden aufgesogen werden kann; nur so ist die Ernährung und das Wachstum des mit dem Kopfende in die Magenschleimhaut eingebohrten Helminthen erklärlich; wird eine grössere Menge Flüssigkeit abgesondert, so kann dadurch eine Loslösung aus der Schleimhaut bewirkt werden.

In arctischen Breiten wurden ähnliche Gruppen von Ascariden an der Magenschleimhaut von *Trichechus rosmarus* und *Phoca barbata* gefunden; hier handelte es sich um *Ascaris decipiens* Krabbe (O. v. Linstow, "Die Nematoden," in Römer u. Schaudinn, *Fauna arctica*, Bd. i., Lieferung 1, Jena, 1900, p. 119–124, Tab. VI., fig. 1–20, Tab. VII., fig. 21–27).

Ascaris radiata n.sp. (fig. 4–5).

Aus *Leptenychores weddelli* Lesson. Ventric. 0·79 vom Kopfende stehen seitlich 2 prominente Nackenpapillen. Die Cuticula ist sehr fein quer geringelt; die Lippen sind vorn kreisförmig begrenzt und tragen vorn jederseits einen rundlichen Vorsprung; die Dorsallippe (fig. 4) ist 0·18 mm. lang und ohne die Vorsprünge 0·25 mm. breit; grosse, ohrenförmige Zwischenlippen sind vorhanden, deren mächtige Cuticula radiär gestreift ist; die Papillen stehen im vorderen Drittel und sind weit nach aussen gerückt; Zahnleisten und Löffelbildungen fehlen. Der Ösophagus nimmt $\frac{1}{12}$ der Gesamtlänge ein; er ist dreiseitig mit dreischenkligem Lumen und dorsal verläuft in ihm eine Drüse (fig. 6, *a*); er ist ventral vom Darm zu einem cylindrischen, drüsigen Körper verlängert, der $\frac{13}{17}$ der Ösophaguslänge besitzt. Der Darm sendet dorsal vom Ösophagus einen Blinddarm nach vorn (fig. 6, *b*), der doppelt so breit ist wie der Ösophagus und $\frac{11}{17}$ seiner Länge hat; das grosse, unregelmässige Lumen ist von

einer dicken Membran begrenzt, die radiäre Linien zeigt. Das Schwanzende ist bei beiden Geschlechtern zugespitzt. Von den vier Längswülsten sind der dorsale und ventrale, welche innen einem Nerven als Stütze dienen (fig. 6, *d u v*), schwach entwickelt; der eine Lateralwulst (fig. 6, *l*) ist normal gebildet und im Querschnitt pilzförmig; eine Scheidewand trennt ihn in eine dorsale und ventrale Hälfte; der andere trägt die unpaare Drüse und ist in ein plattes Band umgebildet (fig. 6, *l'*); die unpaare Drüse (fig. 6, *u*) ist oval im Querschnitt; sie ist stark entwickelt und in der Mittelachse verläuft ein starkwandiges Gefäß. Die vier Muskelzüge senden die Marksubstanz nach innen, wo sie zu mächtigen Längszügen verschmilzt, die den Raum innerhalb der Muskeln zwischen Ösophagus, Darm und unpaarer Drüse fast ganz erfüllen und diese Organe in ihrer Lage erhalten, wie ich es in ähnlicher Weise bei *Heterakis distans* Rud. beschrieben habe (fig. 6, *p.*).

Das Männchen erreicht eine Länge von 29 mm. und eine Breite von 0·79 mm.; das Schwanzende ist $\frac{1}{41}$ der Gesamtlänge gross; die Cuticula ist am Schwanzende in den Seitenlinien stark verdickt; ventral stehen jederseits 20 Papillen in einer Reihe, die bis 0·99 vom Schwanzende, das kegelförmig ist, nach vorn reichen; postanale Papillen stehen jederseits 13 in der Anordnung, wie die Abbildung (fig. 5) sie zeigt. Die sehr langen, schmalen Cirren messen 5·13 mm.

Das Weibchen ist 38-41 mm. lang und 1·22-1·26 mm. breit; die Vulva liegt vor der Körpermitte; der durch sie gebildete vordere Körperabschnitt verhält sich zum hinteren wie 7:15; das kegelförmig verjüngte Schwanzende misst $\frac{1}{60}$ der ganzen Thierlänge. Die Eier zeigen beginnende Dotterfurchung und haben eine mit glänzenden Kügelchen besetzte Schale; sie sind 0·078 mm. lang und 0·068 mm. breit.

Ganz junge Exemplare sind 6·72 mm. lang und 0·40 mm. breit; der Ösophagus ist $\frac{1}{17}$, das Schwanzende $\frac{1}{17}$ der Gesamtlänge gross, und Geschlechtsorgane fehlen noch.

Ascaris osculata Rud. (fig. 7).

Aus *Leptenychores weddelli* Lesson.

v. Linstow, *Jahrb. d. Hamburg. wissenschaft. Anstalten*, Bd. ix., 1892, p. 8-9, Tab. III. fig. 11-16.

v. Linstow, *Archiv für microsc. Anat.*, Bd. xliv., Bonn, 1895, p. 528–531, Tab. XXXI. fig. 1–13.

v. Linstow, *Fauna arctica* v. Römer u. Schaudinn, Bd. i., Jena, 1900, p. 124–125, Tab. VII. fig. 28–34.

Die Lippen haben an der Innerseite vorn jederseits einen kegelförmigen Vorsprung; die Zwischenlippen sind gross; das Schwanzende ist zugespitzt; übrigens verweise ich auf meine früheren Beschreibungen. Die Art kommt in arctischen und antarktischen Robben vor, und zwar in *Trichechus rosmarus*, *Cystophora cristata*, *Halichoerus grypus*, *Phoca annulata*, *Phoca pantherina*, *Phoca barbata*, *Phoca vitulina*, *Phoca grœnlandica*, *Monachus albiventer* und *Leptenychotes weddelli*.

Ascaris Diomedea v. Linstow.

Aus *Diomedea* spec., Loof's Albatros, Mundhöhle.

v. Linstow, *The Zoology of the Voyage of H.M.S. Challenger*, vol. xxiii., part lxxi., London, 1888, p. 6, Tab I. fig. 12–13, aus *Diomedea brachyura*.

Junge, geschlechtlich unentwickelten Exemplare, die bis 41 mm. lang und 0.72 mm. breit waren; die Cuticula ist queringelt; die Lippen sind sehr kurz und breit, vorn durch einen Kreisbogen begrenzt, der innere Vorsprung trägt Zahnleisten; das Schwanzende ist abgerundet, seine Länge beträgt $\frac{1}{151}$ der Gesammtlänge, die des Ösophagus $\frac{1}{10}$. Die Exemplare aus *Diomedea brachyura* der *Challenger*-Sammlung waren geschlechtlich unentwickelt, wie die hier vorliegenden, daher ich der vorläufigen Artnamen noch nicht durch einen definitiven ersetzen kann.

Ascaris spec. ?

Aus dem Magen eines nicht bestimmten Thieres (No. 202) *Catarrhactes chrysolophus*.

Es ist nur ein einziges Exemplar vorhanden, so dass eine Artbestimmung nicht möglich ist. Das Thier ist lockenförmig aufgerollt, 51 mm. lang und 1.74 mm. breit; das Schwanzende ist breit abgerundet.

Monorygma dentatum n.sp. (fig. 16).

“From shark's rectum (No. 34); lat. 9° 23' N., long. 25° 31' W.”
Aus dem rectum von einem unbestimmten Hai. Länge 5.37 mm.,

Breite vorn 0·088 mm., hinten 0·176 mm.; am Hinterende verdünnt und abgerundet; von Proglottidenbildung noch keine Spur, nur eine feine Zähnelung ist an den Körperrändern erkennbar in Abständen von 0·0078 mm.; es sind nur junge Exemplare vorhanden, die noch keine Geschlechtsorgane ausgebildet haben. Der Scolex zeigt 4 Sauggruben, die hinten frei vom Körper abstehen und in Zipfel auslaufen; vorn tragen sie einen kleinen Nebensaugnapf. Vom Genus *Monorygma* sind 3 Arten bekannt:

Monorygma perfectum van Beneden, aus *Læmargus borealis*, *Scyllium catulus* und *Scyllium stellare* (van Beneden, *Mém. vers. intest.*, Paris, 1861, p. 125 u. 367, Tab. XVII. fig. 11-14; Zschokke, *Recherches Cestodes*, Genève, 1888, p. 281-294, Tab. VII. fig. 114-120).

Monorygma (= *Trilocularia*) *gracile* Olsson, aus *Acanthias vulgaris* (Monticelli, *Bullet. scientif. de France et Belgique*, t. xxii., Paris, 1890, p. 433, Tab. XXII. fig. 18).

Monorygma Chlamydoselachi Lönnberg, aus *Chlamydoselachus anguineus* (Lönnberg, *Arch. mathem. og naturvidensk*, Bd. xx., Upsala, 1889, p. 1-11, Tab. I.).

Unbeschrieben ist:

Monorygma elegans Monticelli (*Bullet. scientif. de France et Belgique*, t. xxii., Paris, 1890, p. 434).

FREILEBENDE NEMATODEN.

Thoracostoma setosum v. Linstow.

Gedregt aus 9-10 Faden Tiefe, Station 325, Scotia Bay, S. Orkneys.

v. Linstow, *Nemathelminthen des Hamburger Magalhaensischen Sammelreise*, Hamburg, 1896, p. 5-8, Tab. 1. figs. 4-7, *Leptosomatium setosum*.

De Man, *Résultats du voyage du S.Y. Belgica en 1897-1899, Zoologie: Nématodes libres*, Anvers, 1904, p. 25-35, Tab. VI.-X.

Es ist nur ein Exemplar vorhanden von 13 mm. Länge und 0·31 mm. Breite; *de Man* hat eine so ausgezeichnete Beschreibung dieser Art geliefert, dass jede weitere Schilderung überflüssig wäre; das vorliegende Exemplar ist ein junges Weibchen.

ERKLÄRUNG DER ABBILDUNGEN.

ö, Ösophagus; *a*, Drüse; *b*, Blinddarm; *u*, unpaare Drüse; *d*, Dorsal-, *v*, Ventral-, *l*, Lateralwulst; *n*, Nerv; *m*, Muskulatur; *p*, ligamentöse Plasma-Stränge.

Fig. 1–3. *Ascaris rectangula*. 1, Dorsallippe; 2, männliches Schwanzende von der Bauchfläche; 3, Querschnitt durch die Ösophagus-Gegend.

Fig. 4–6. *Ascaris radiata*. 1, Dorsallippe mit Zwischenlippen; 5, männliches Schwanzende von den Bauchfläche; 6, Querschnitt durch die Ösophagus-Gegend.

Fig. 7. *Ascaris osculata*, Dorsallippe mit Zwischenlippen.

Fig. 8–15. *Ascaris rectangula*.

Fig. 8. Gruppe von Exemplaren aller Entwicklungsstadien angeheftet mit dem Kopfe in der Magenschleimhaut von *Leptonychotes weddelli*.

Fig. 9–11. Dorsallippen: 9 von einer sehr kleinen, 10 von einer kleinen, 11 von einer mittelgrossen Larve.

Fig. 12. Vorderende einer sehr kleinen Larve: ö, Ösophagus; ö II., dessen Anhang; *d*, Darm; *k*, Blinddarm.

Fig. 13. Ösophagus und Anfang des Darms einer grossen Larven, Bez. wie in fig. 12.

Fig. 14. Querschnitt durch den hinteren Ösophagusabschnitt von drüsiger Beschaffenheit (ö II.), *b*, durch den Blinddarm; *u*, durch die unpaare Drüse einer grossen Larve.

Fig. 15. Querschnitt durch dieselbe, weiter hinten; *do*, Dorsal-, *v*, Ventral-, *s*, Seitenfeld; *m*, Muskulatur; *d*, Darm; *u*, unpaare Drüse.

Fig. 16. *Monorygma dentatum*.

VON LINSTOW: NEMATODES. Plate I.

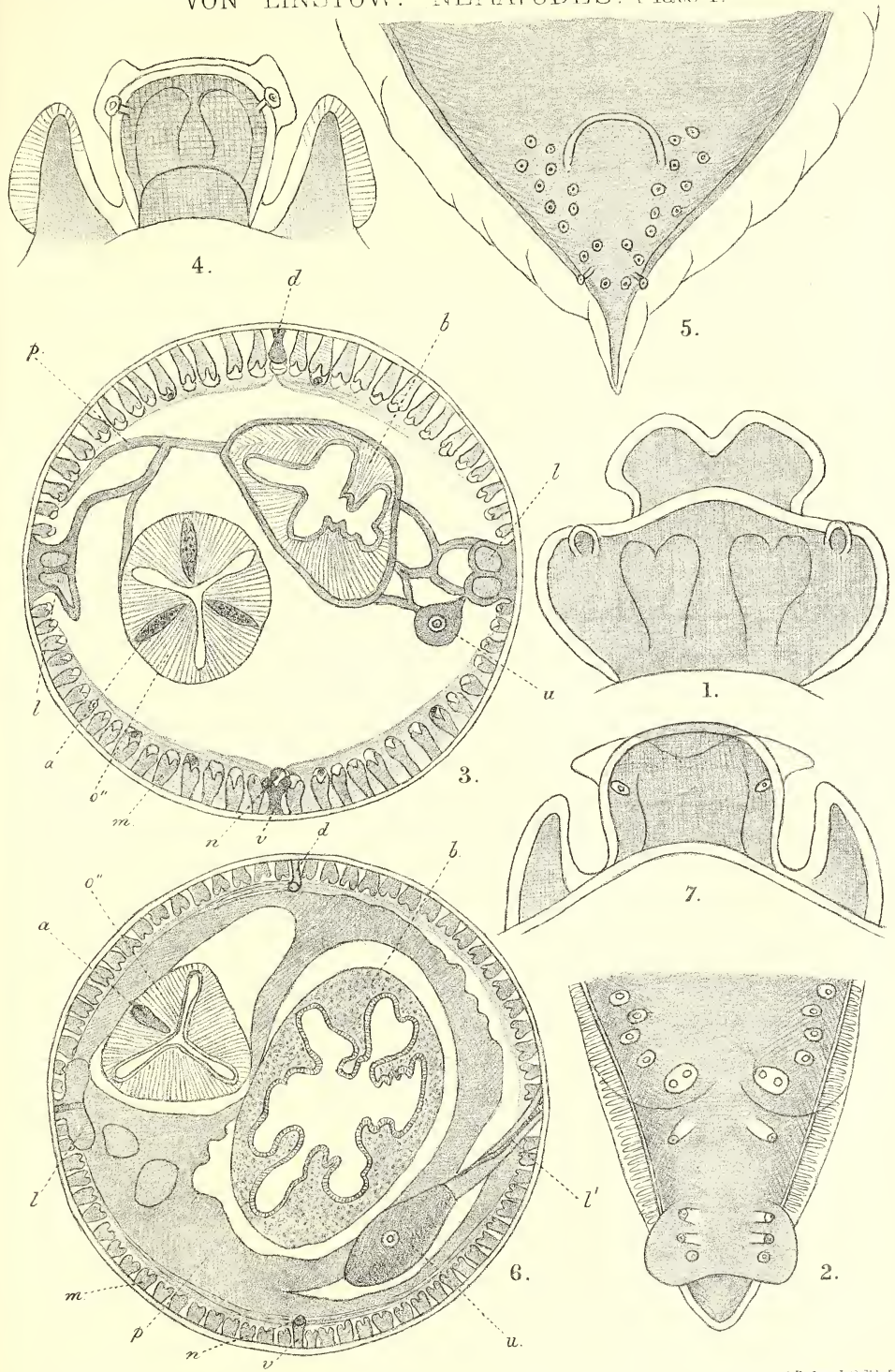

VON LINSTOW: NEMATODES. Plate II.

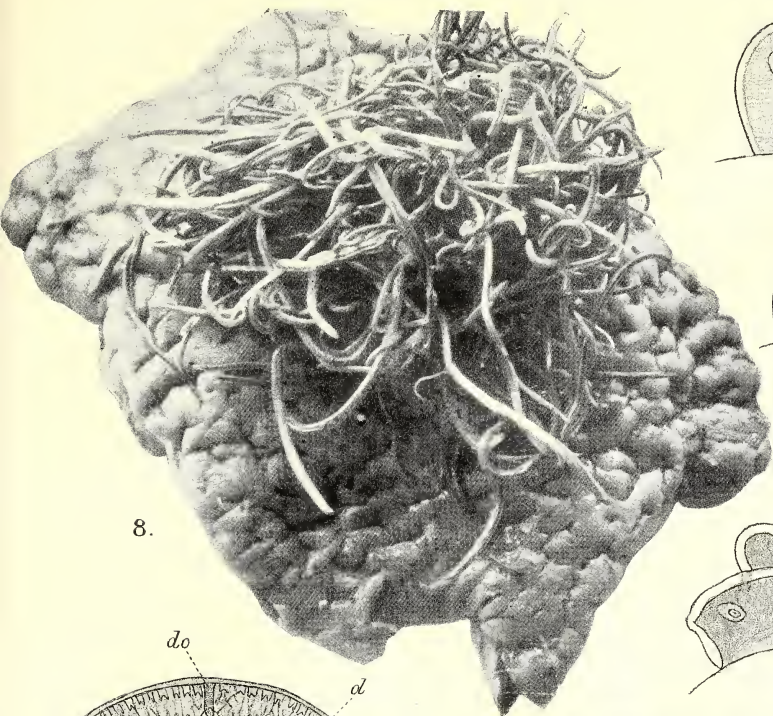

8.

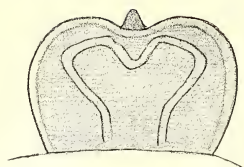

10.

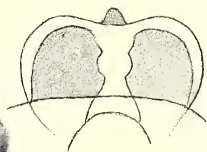

9.

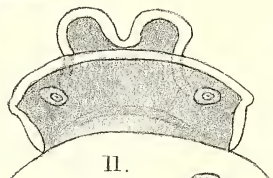

11.

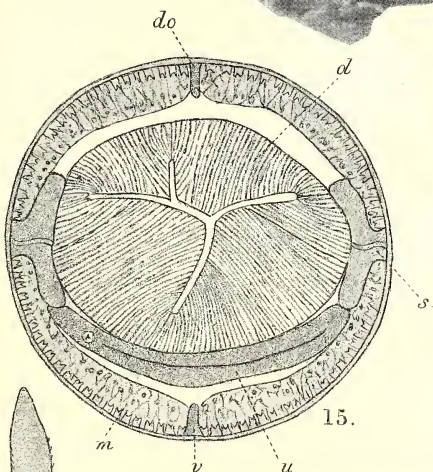

15.

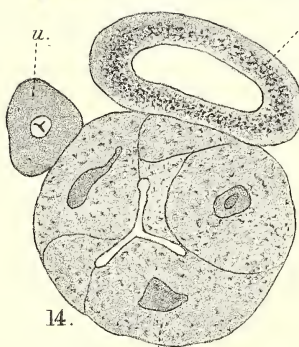

14.

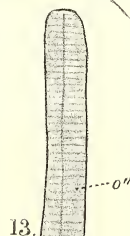

13.

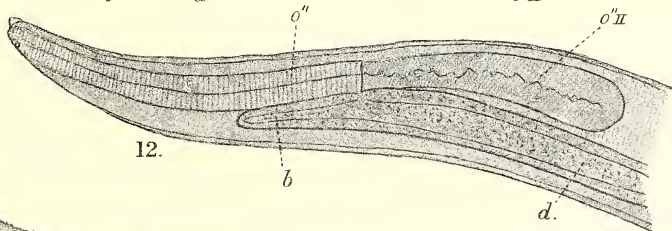

12.

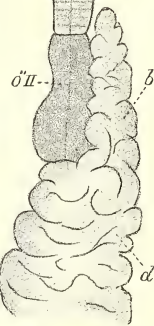

o''II

d

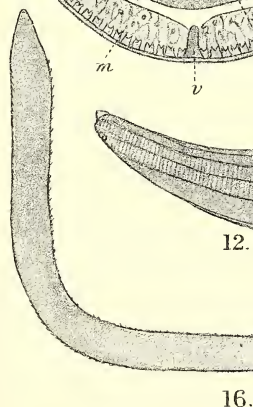

16.

Scottish National Antarctic Expedition. "Scotia" Collections. Collembola from the South Orkney Islands.
By **George H. Carpenter**, B.Sc., M.R.I.A., Professor of Zoology in the Royal College of Science, Dublin. (With Two Plates.) *Communicated by* WILLIAM EVANS, Esq.

(Read March 5, 1906.)

INTRODUCTORY.

Our knowledge of Antarctic Aptera has been growing rapidly during the last few years, a number of species from remote southern regions having been described by Willem (1902) from the countries south of Patagonia explored by the *Belgica*, by Schäffer (1897) from Tierra del Fuego, by Enderlein (1903) from Kerguelen, and a single *Isotoma* by the present writer (1902) from South Victoria Land.* We find in the Antarctic as in the Arctic regions that in our advance towards the most remote and inhospitable lands, where winged insects cease to be represented, the primitive Aptera are still found fairly numerous in species, and often multitudinous in individuals. A careful study of these small frail insects fully repays the naturalist, both on account of the interest of their structure and the light which their distribution throws on geographical problems. For the wingless—primitively wingless, as we believe—condition of these insects, their frail integument, and their concealed mode of life make it highly unlikely that they can cross broad tracts of sea; therefore the presence of identical or closely allied species on widely separated islands or continents may safely be regarded as sure evidence of the antiquity of the insects, and of the former existence of land-connections to explain their present discontinuous range.

Three species of Aptera are represented in the collections from the South Orkneys. All belong to the Collembola, and all are referable to the family Entomobryidæ and to the sub-family Isotominæ, two being members of the cosmopolitan genus *Isotoma*,

* While this paper is passing through the press, Wahlgren's memoir (1906) on the Collembola of the Swedish South Polar Expedition appears.

and the third being referable to Willem's recently described Antarctic genus *Cryptopygus*. The two species of *Isotoma* indicate, as will be seen, affinities of the apterous fauna of the South Orkneys to that of other Antarctic lands eastwards and westwards, as well as to that of the Arctic regions, and even to that of the land whence the *Scotia* sailed.

Two of the species are so abundantly represented that a study of the jaws has been possible. In this research much help has been gathered from the recent careful paper by Folsom (1899) on the mouth-parts of *Orchesella*.

DESCRIPTION OF SPECIES.

Isotoma Brucei, sp. nov. Pl. I. figs. 1-8.

Length 1.75 mm. Feelers as long as head. Six ocelli on each side of head (fig. 2). Ridge surrounding the post-antennal organ elongate and narrow (fig. 2, *p. a. o.*). Feet without tenent hairs, claws slender and untoothed (fig. 5). Spring evidently borne on the fourth abdominal segment, slender and elongate, one-fourth length of insect; manubrium longer than dens; mucro short, with a prominent thick terminal tooth and two strong basal teeth (figs. 1, 6, 7). Colour slaty grey, the pigment somewhat scattered. Hairs on body short, a very few strong bristles on the tail segment.

Locality. — Laurie Island, South Orkneys. Innumerable specimens on the sea-shore on the carcase of a penguin. 9th January 1904.

The discovery of this insect in the Antarctic regions is of very great interest on account of its close relationship to the Arctic and sub-Arctic *I. Beselsii*, Packard.* In the general build of the body and the structure of the spring—particularly the form of the mucro, with its three prominent claw-like teeth—these two species of *Isotoma* stand apart from all other members of the genus. *I. Brucei* is somewhat smaller than *I. Beselsii*, and has the spring, especially the dens, relatively longer and more slender; the mucro relatively longer and narrower and its teeth weaker. These differences are, however, less apparent in young individuals.

* *Isotoma spitzbergensis*, Lubbock. See Carpenter and Evans (1899), Schäffer (1900). The species is recorded by Wahlgren (1906) from Tierra del Fuego.

In the shape of the ridge surrounding its post-antennal organ, *I. Brucei* agrees closely with *I. Beselsii*; but while the latter has the sixteen ocelli which are usually present in species of *Isotoma* the former has only twelve, the two posterior ocelli of the inner row of four, on each side, being absent. The antennal organ consists, as in *I. Beselsii*, of two prominent hemispherical papillæ at the extreme apex of the fourth antennal segment (fig. 2, *a. o.*). The feet in the present species have, as in *I. Beselsii*, untoothed claws and no tenent hairs; the apex of the smaller claw is, however, drawn out in a slender process, which is not so fully developed in the northern species.

The mouth-parts of *Isotoma Brucei* show several interesting peculiarities. The mandibles are remarkably narrow and parallel-sided at the apex (fig. 3), and exhibit two very prominent acuminate processes at the hind dorsal corner of the grinding area (fig. 3, *mo.*). The maxillulæ (fig. 4, *mxl.*) have prominent apices, armed with several stout curved bristles; the spines, arranged in series along the inner edge of the basal region of the maxillula, are elongate and sharp-pointed.

In the structure of the maxilla (fig. 4, *mx.*) *I. Brucei* differs from other species of *Isotoma*, and indeed from members of its family generally, by the slender and elongate form of the "head" (compare the typical semi-globose "head" of *Cryptopygus*, fig. 19). The head in the present species is composed of a strongly chitinised dorsal lobe or "galea" (fig. 4, *ga.*), terminating in three prominent teeth. Ventral to this, and protruding beyond it, is a delicate falcate lamella (fig. 4, *la.*'), fringed with long delicate hairs, while a smaller lamella, also fringed with fine hairs (fig. 4, *la.*"), lies internal to the galea. The palp (fig. 4, *pa.*) carries six prominent bristles, the most distal being inserted on a long acuminate process. The stipes of the maxilla (fig. 4, *sti.*) articulates with the cardo (fig. 4, *car.*), which is itself in connection, as usual, with the supporting "foot" and ligament (fig. 4, *pd. lig.*) of the tongue (fig. 4, *lin.*).

Several at least of these characteristic features of the jaws in *I. Brucei* may also be detected in its northern ally *I. Beselsii*.

The form of the retinaculum in *I. Brucei*, as seen from the side, is shown under high magnification in fig. 8.

Isotoma octo-oculata, Willem, var. *gracilis*, nov. Pl. II. figs 9–12.

Length 1·5 mm. Differs from the type by the short sub-crescentic ridge surrounding the post-antennal organ (fig. 10, *p. a. o.*) and the slender mucro of the spring, with its anterior dorsal tooth pointed and prominent (fig. 12). In this latter character the present variety agrees with that described from Kerguelen by Enderlein (1903).

Localities.—Laurie Island, on cliff and moss 200 feet, one specimen, 18th December 1903; Saddle Island, one young specimen, 4th February 1903.

As only two specimens can be detected in the collection, this is presumably a scarce species in the South Orkneys. The type-form was described by Willem (1902) from insects collected on the shores of Gerlache Strait, between Danco Land and neighbouring islands,* and a sub-species, *Kerguelensis*, has since been described, as mentioned above, by Enderlein. In the form of its mucro our insect agrees with the latter, from which, as well as from the type-form, it may be readily distinguished by the short and relatively broad post-antennal organ. According to Enderlein's figure, however (1903, taf. xxxvi. fig. 66), the organ is broader and shorter in the var. *Kerguelensis* than in the type (Willem, 1902, pl. iv. fig. 11).

Cryptopygus crassus, sp. nov. Pl. II. figs. 13–23.

Length 2 mm. Post-antennal organ elongate, crescentic. Six ocelli on each side of head (fig. 16). Feet with two tenent hairs, not clubbed at the tip, and with untoothed claws (fig. 17). Spring with mucro one-third length of dens, bearing two slight teeth, a terminal and a dorsal (fig. 21). Colour very deep blue-violet, almost black in adult specimens.

Localities.—Saddle Island, innumerable specimens, 4th February 1903; Laurie Island, two specimens in moss on cliff 200 feet, 18th December 1903.

The remarkable genus *Cryptopygus*, showing affinities to *Anurophorus* and to *Isotoma*, was erected by Willem (1902) for a new species of springtail (*C. antarcticus*) found in numbers on the shores

* Recorded also by Wahlgren (1906) from South Shetland, Graham Land and Paulet Island.

of Danco Land and the neighbouring islands.* The present species from the South Orkneys is very closely related to Willem's insect, differing chiefly in having only twelve ocelli (instead of fourteen), and in the comparatively short and stout mucro of its spring. In the adult *C. crassus* the six ocelli on either side are arranged in an anterior triangular group of three and a posterior curved row of three (fig. 16), (the fourth ocellus, nearest to the centre of the head, which is present in *C. antarcticus*, being here absent). In the very young *C. crassus* the six ocelli are more closely grouped (fig. 15). These very young individuals (fig. 13), only .5 mm. in length, have the violet pigment mottled over their bodies, contrasting strongly with their almost black parents. The springs of these young—especially the dentes and mucrones—are shorter and stouter than those of the adults (figs. 21, 22, 23). Among the adults the males may be distinguished from the females (fig. 14) by their more slender form and more elongate feelers (fig. 16). In the male these have the terminal segment half as long again as the third, while in the female there is no appreciable difference in length. The antennal organ consists of a single papilla at the extreme tip of the terminal antennal segment (fig. 16, *a. o.*).†

In the excessive reduction of the hindmost abdominal segment (fig. 14, *abd. vi.*), retracted and almost hidden in a depression of the genital segment (fig. 14, *abd. v.*), *C. crassus* agrees closely with *C. antarcticus* as described and figured by Willem. This character gives the name to the genus.

Examination of the mouth-parts of *C. crassus* (figs. 18-20) shows that they conform to the type usual in the Collembola. The mandible is very slender at the tip, which bends markedly towards the centre of the head (fig. 18, *ap.*) and ventralwards (fig. 20); the apical teeth are feeble and close together. On the outer edge of the mandible, opposite the grinding surface (figs. 18, 20, *mo.*), is a characteristic prominent shoulder (fig. 18, *hu.*), and the conical process (for attachment of a rotatory muscle) on the dorsal aspect of the base of the mandible (fig. 20, *pro.*) is also prominent.

* Recorded by Wahlgren from South Shetland, Graham Land, Paulet Island, and South Georgia.

† *Cryptopygus cinctus*, newly described by Wahlgren (1906) from Tierra del Fuego and East Falkland, has, like *C. crassus*, only twelve ocelli, and no clubbed hairs on the feet. It is, however, variegated in coloration when adult.

The maxillulæ (fig. 19, *mxl.*) are simple in form, with a few minute bristles at the tip or their inner faces; the arm (fig. 19, *br.*) which supports the maxillula is bent and irregularly furcate in shape. It is connected by a ligament (fig. 19, *lig.*) with the outer framework of the maxillula, this being itself continuous with the inner chitinous rod of the maxilla (fig. 19, *rh. int.*), as explained by Folsom (1899) for *Orchesella*.

The maxillæ (fig. 19, *mx.*) are of the typical Collembolan form; the palp, however, is remarkable on account of the production of its tip into a tongue-shaped process bearing four bristles, and the excessive development of the long proximal bristle and its papilla (fig. 19, *pa.*).

DISTRIBUTIONAL NOTES.

As mentioned in the introduction to this paper, the existence of identical or of nearly allied species of *Collembola* on widely separated areas may be regarded as strong evidence for ancient land connections between those areas. Many recent writers on zoological geography have expressed belief in a former extension of the Antarctic continent, wide enough to connect with America, Africa, and Australia. A full discussion of the problem has recently been given in Ortmann's valuable paper (1904, pp. 310-324, with map, pl. xxxix.) on the Tertiary invertebrate fauna of Patagonia, and there can be no doubt that the trend of modern speculation is against the doctrine of the permanence through past ages of the great ocean basins of the present day, as upheld in the classical writings of Darwin and Wallace. Hutton, who many years ago suggested the Antarctic continent as a former means of communication between Australia and Patagonia, and subsequently withdrew the hypothesis in favour of a trans-Pacific continent, has now re-affirmed his former belief (1905), laying special stress on the *Collembola* of South Victoria Land as evidence for the former connection of that remote region with the northern continents.

From the facts established in the present paper, further support for the ancient extension of Antarctica may be readily drawn. The existence of the genus *Cryptopygus* and of the species *Isotoma octo-oculata* on the South Orkneys as well as on Danco

Land, together with the presence of the *Isotoma* on Kerguelen, point to the former existence of extensive land tracts south of the American continent, with connection, either by way of Antarctica or of South Africa, to Kerguelen. It cannot indeed be inferred from the distribution of these springtails that there was at any one period a continuous land surface from Patagonia and Graham Land to Kerguelen. But it can hardly be denied that the insects must have travelled overland, though the land connections may have varied in extent, and become broken at different points during different periods. The bathymetrical work of the *Scotia* Expedition, as set forth by Bruce (1905), demonstrating a continuous bank, less than 2000 fathoms beneath the surface of the South Atlantic, stretching eastwards from the South Orkneys towards South-East Africa, makes the former existence of one such land-tract the more credible. And the geological structure of the South Orkneys leaves no doubt that they must be regarded as strictly "continental" islands. Similarly, the "Kerguelen plateau," as mapped by the explorers of the *Valdivia* (Schott, 1902), renders in the highest degree probable the former union of Kerguelen with Antarctica; and a connection thence to South Africa is not impossible of acceptance.

If, as we believe, these springtails—apparently members of a typically Antarctic fauna—owe their presence on the islands that they now inhabit to a former extension of the Antarctic continent, they must be of a considerable geological age. Ortman (1904) considers that the greatest extension of Antarctica existed in the Cretaceous and Eocene eras. Hutton (1905) argues for the Jurassic as the period of most extensive land in southern regions. We may safely conclude that *Cryptopygus* and *Isotoma octo-oculata* have survived throughout the Tertiary epoch at least, with comparatively little change of structure.

The affinities of *Isotoma Brucei* open up a problem of even greater interest. It is closely allied, as we have seen, to *I. Beselsii*, a springtail which has been found in Spitzbergen, Jan Mayen Island, Scotland (shores of the Firth of Forth), Greenland (Polaris Bay), and Massachusetts. We cannot doubt that this affinity points to a former connection between the Antarctic continent, of which the South Orkneys once formed part, and the

northern continents. The presumption seems that this connection was by way of America, and the distribution of some allied springtails supports this presumption.* The common European *Isotoma palustris*, Müller, occurs both in North and South America; and Schäffer (1897) has described an *Isotoma*—*I. obtusicauda*—from Valparaiso, closely allied to two peculiar northern species, *I. crassicauda*, Tullberg, and *I. littoralis*, Della Torre. These last-mentioned insects come nearer than any other species of *Isotoma* to *I. Brucei* and *I. Beselsii*, agreeing with them in the evident position of the spring on the fourth abdominal segment, but differing in the absence of prominent teeth on the mucrones. We find, therefore, that these groups of springtails, considered until a few years ago characteristically Arctic and sub-Arctic, are represented in the Andean sub-region of South America, in Tierra del Fuego, and in the distant South Orkney Islands.

Must *I. Brucei*, with its northern affinities, be regarded as an older or a newer member of the South Orcadian fauna than the distinctively Antarctic species that share its present home? Northern species, at or beyond the southern limits of the present American continent, must be either comparatively recent immigrants—Pliocene or later—or else carry us back to early Mesozoic times; for the existence of some sea-channel across America, checking migration from north to south, during the Cretaceous and Early Tertiary periods, is generally admitted. Von Jhering, for example, lays stress (1891) on the faunistic distinction between southern and northern South America, and suggests the existence in Secondary and Early Tertiary times of two continents—an “Archiplata” connected with Antarctica, and an “Archicuyana” connected by an Atlantis with West Africa. Now it seems unlikely that *I. Brucei* can be a late Tertiary immigrant into the Antarctic regions. The necessary connection of the South Orkneys with Patagonia can hardly have lasted late enough. And the group to which the species belongs is a primitive group even of this comparatively primitive genus and order. In these insects, as mentioned above, the spring evidently belongs to the fourth abdominal segment, whereas in most species of the genus and

* Which receives unexpected confirmation from Wahlgren’s discovery (1906) of *I. Beselsii* in Tierra del Fuego.

family it is apparently borne on the fifth. Willem (1900) has shown, however, that in reality it always belongs to the fourth. Thus we see that in the group of *I. Brucei* an ancient character has been retained, and the shore-haunting habit of all the species belonging to it is another mark of high antiquity. It seems probable, therefore, that *I. Brucei* is older than the typically Antarctic species; and that, for the land connections over which its ancestors travelled, we must go back to early Secondary times.

It is startling to conclude that these frail insects of the far north and the remote south, now separated by thousands of miles of land and sea and ice, have passed through so great a length of geological time with such slight structural deviation from their common progenitors.

REFERENCES.

1905. W. S. BRUCE, "Bathymetrical Survey of the South Atlantic Ocean and Weddell Sea," *Scot. Geog. Mag.*, August 1905.
1899. G. H. CARPENTER and W. EVANS, "The Collembola and Thysanura of the Edinburgh District," *Proc. R. Phys. Soc. Edin.*, vol. xiv., 1899, pp. 221-266, pls. v.-viii.
1902. G. H. CARPENTER, "*Insecta Aptera*," in *Report on the Collections of Natural History made in the Antarctic Regions during the Voyage of the "Southern Cross,"* pp. 221-3, pl. xlvii., London (British Museum), 1902.
1903. G. ENDERLEIN, "Die Insekten und Arachnoideen der Kerguelen," in *Wissenschaftliche Ergebnisse der deutschen Tiefsee Expedition auf dem Dampfer "Valdivia,"* 1898-9, vol. iii, pp. 199-248, taf. xxi.-xxxvii., Jena, 1903.
1899. J. W. FOLSOM, "The Anatomy and Physiology of the Mouth-parts of the Collembolan, *Orchesella cincta*, Linn.," *Bull. Mus. Comp. Zool. Harvard*, vol. xxxv., 1899, No. 2.
1905. F. W. HUTTON, "Ancient Antarctica," *Nature*, vol. lxxii., 1905, pp. 244-5.
1891. H. VON JHERING, "On the Ancient Relations between New Zealand and South America," *Trans. Proc. N. Zeal. Inst.*, vol. xxiv., 1891, pp. 431-445.
1904. A. ORTMANN, *Reports on the Princeton University Expeditions to Patagonia, 1896-1899*, vol. iv., "Palæontology," Part 2, "Tertiary Invertebrates," pp. 45-332, pls. xi.-xxxix., Princeton, 1904.

1897. C. SCHÄFFER, "Apterygoten," *Hamburger magalhaensische Sammelreise*, Hamburg, 1897.

1900. C. SCHÄFFER, "Die arktischen und subarktischen Collembola," Romer and Schaudinn's *Fauna Arctica*, pp. 237-258, Jena, 1900.

1902. G. SCHOTT, "Oceanographie und maritime Meteorologie," in *Wiss. Ergeb. Exped. "Valdivia"*, Jena, 1902.

1906. E. WAHLGREN, "Antarktische und subantarktische Collembolen gesammelt von der schwedischen Südpolarexpedition," *Wissens. Ergebn. der schwed. Südpolarexpedition*, 1901-3, vol. v., 1906.

1900. V. WILLEM, "Recherches sur les Collemboles et les Thysanoures," *Mém. Cour. Acad. Roy. Sci. Belg.*, vol. lvi., 1900.

1902. V. WILLEM, "Collemboles: Résultats du voyage de S.Y. Belgica en 1897, 1898, 1899, sous le commandement de A. de Gerlache de Gomery," *Rapports scientifiques*, Anvers, 1902.

DESCRIPTION OF PLATES.

PLATE I.

Fig. 1. *Isotoma Brucei*, side view, $\times 40$.

Fig. 2. Do. left side of head, dorsal view, showing ocelli, feeler, antennal organ (*a. o.*), and post-antennal organ (*p. a. o.*), $\times 100$.

Fig. 3. Do. right mandible, ventral view, $\times 200$; *ap.*, apical teeth; *mo.*, grinding surface.

Fig. 4. Do. right maxilla (*mx.*), ventral view, shown in association with the tongue (*lin.*), and the right maxillula (*mxl.*); *ga.*, galea; *la.*', ventral lamella; *la.*"', inner lamella; *sti.*, stipes; *car.*, cardo; *pa.*, palp; *pd.*, foot of tongue; *lig.*, ligament of tongue. The left maxilla and the left half of the tongue are removed to expose the left maxillula (*mxl.*'), and its supporting arm, *br.*, $\times 200$.

Fig. 5. Do. hindmost leg, showing claws, $\times 200$.

Fig. 6. Do. dorsal view of spring, $\times 200$.

Fig. 7. Do. dens and mucro of spring, side view, $\times 250$.

Fig. 8. Do. retinaculum, side view, $\times 600$.

PLATE II.

Fig. 9. *Isotoma octo-oculata*, var. *gracilis*, side view, $\times 40$.

Fig. 10. Do. left corner of head, showing ocelli, post-antennal organ (*p. a. o.*), feeler, and antennal organ (*a. o.*), $\times 100$.

Fig. 11. Do. hindmost foot, with claws, $\times 200$.

Fig. 12. Do. tip of dens with mucro, side view, $\times 300$.

Fig. 13. *Cryptopygus crassus*, young specimen, $\times 40$.

Fig. 14. Do. adult female, side view, $\times 40$.

CARPENTER : ANTARCTIC COLLEMBOLA. Plate I.

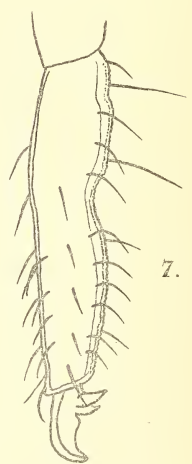
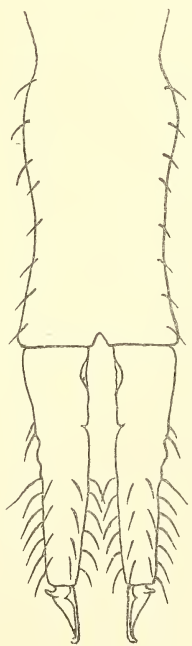
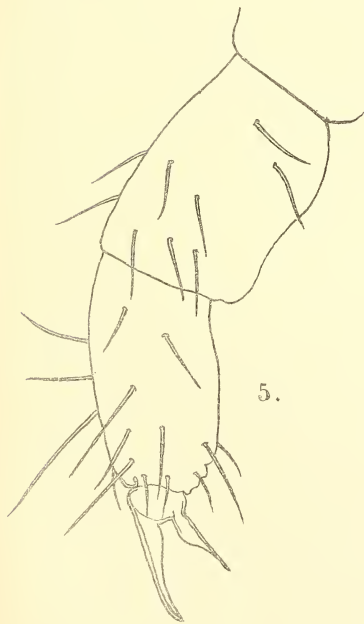
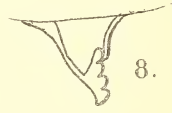
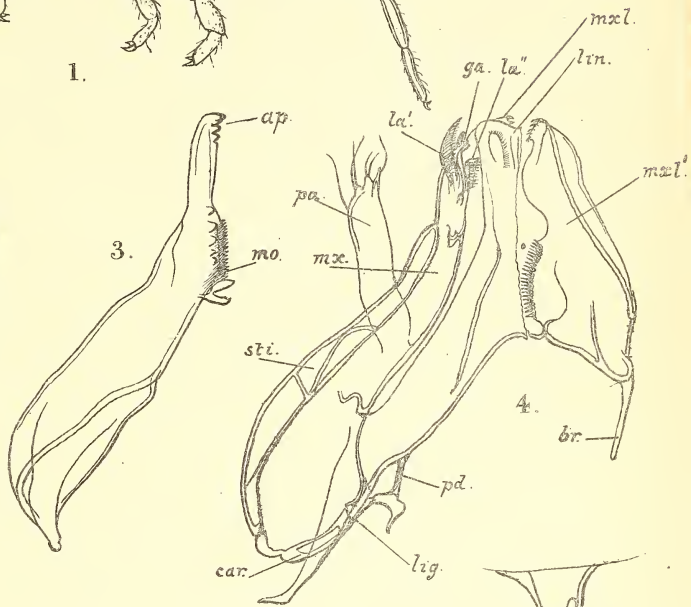
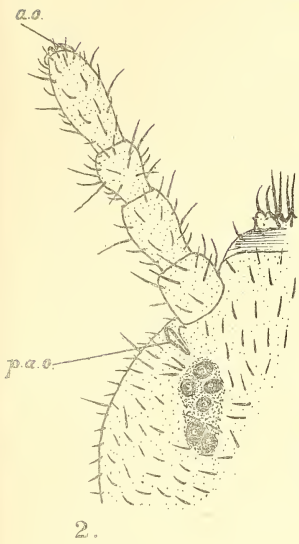
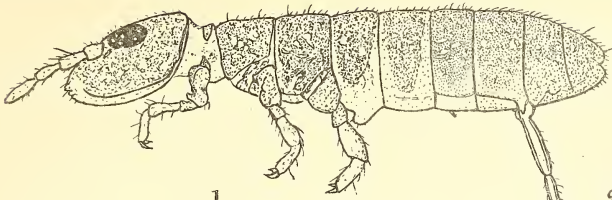

CARPENTER: ANTARCTIC COLLEMBOLA. Plate II.

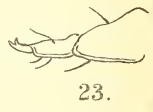
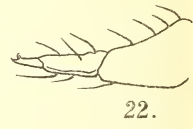
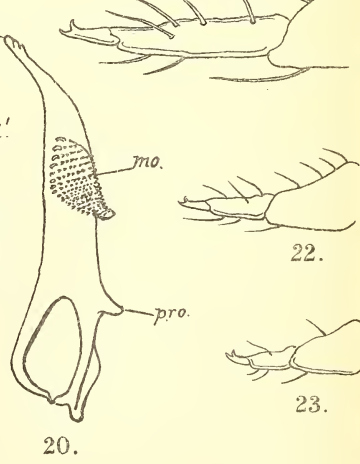
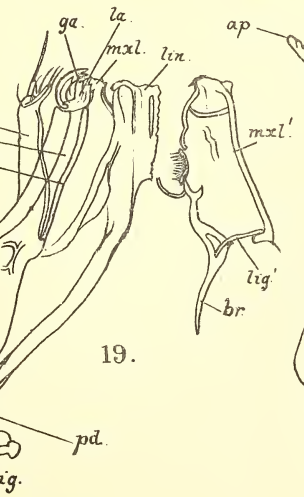
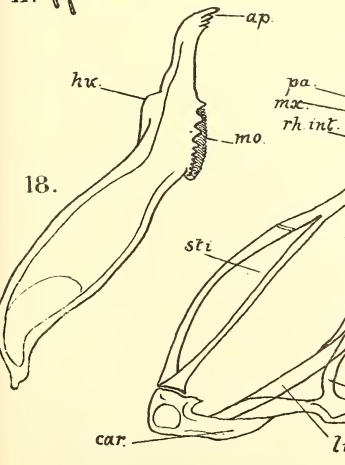
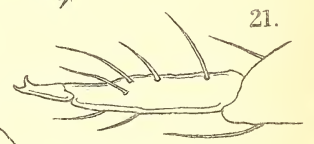
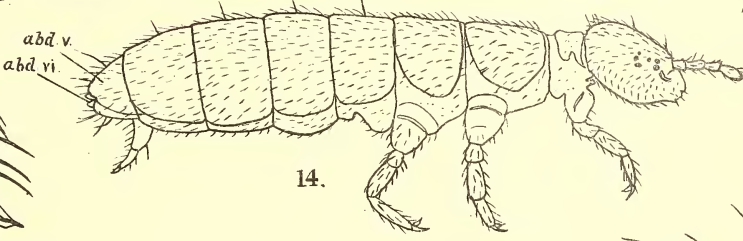
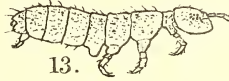
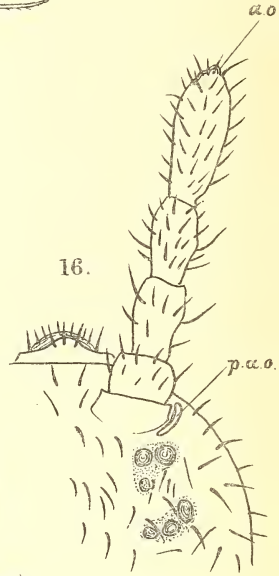
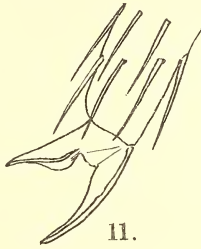
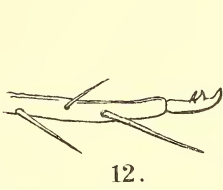
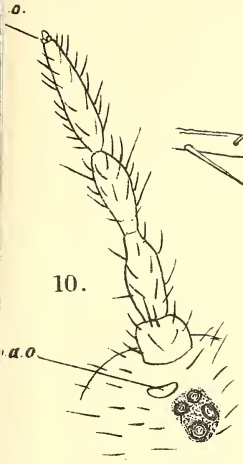
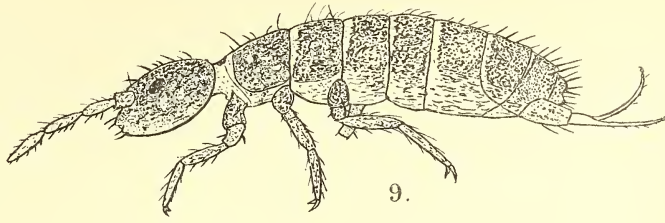

Fig. 15. *Cryptopygus crassus*, ocelli and post-antennal organ of right side of young individual (fig. 13), $\times 150$.

Fig. 16. Do. ocelli, post-antennal organ (*p. a. o.*), feeler, and antennal organ (*a. o.*) of right side. Adult male, $\times 150$.

Fig. 17. Do. hindmost foot, with claws, $\times 200$.

Fig. 18. Do. right mandible, ventral view; *ap.*, apical teeth; *mo.*, grinding surface; *hu.*, external shoulder; $\times 200$.

Fig. 19. Do. right maxilla (*mx.*), maxillula (*mxl.*), and tongue (*lin.*), ventral view; *ga.*, galea; *la.*, lamellæ; *pa.*, palp; *rh. int.*, internal chitinous rod; *sti.*, stipes; *car.*, cardo; *pd.*, foot of tongue; *lig.*, ligament of tongue. The left maxilla and left half of the tongue have been removed to expose the left maxillula (*mxl.*), with its supporting arm (*br.*), and ligament (*lig.*), $\times 200$.

Fig. 20. Do. right mandible, viewed from inner aspect; *ap.*, apical teeth; *mo.*, grinding surface; *pro.*, dorsal process, $\times 200$.

Fig. 21. Do. dens and mucro of spring, adult specimen, side view, $\times 250$.

Fig. 22. Do. spring, half-grown individual, $\times 250$.

Fig. 23. Do. spring, very young individual (fig. 13), $\times 250$.

(Issued separately January 14, 1907.)

Statistical Studies in Immunity: The Theory of an Epidemic. By **John Brownlee, M.D.** (Glas.). *Communicated by* Dr R. M. BUCHANAN.

(Read June 18, 1906.)

The rise and decline of epidemics of infectious diseases have been subjects of interest since the earliest times, but the scientific determination of the laws which govern their course offers even yet a wide and almost unworked field. Not but what a large amount of observation has been made on many of the conditions under which epidemics appear and pass away. Many epidemics are seasonal, and these have been studied; but the lack of any means of determining the course which a given epidemic might have taken in the presence of somewhat different conditions has made the deduction of certain conclusions impossible. Even the laws which regulate solitary outbursts of disease, the special subject of this paper, have been little studied. Explanations offered have varied with the period in history. We find that the pestilence which afflicted Israel for David's sin stayed at the threshing-floor of Araunah the Jebusite; we find in the *Iliad* that with the return of Chryseis "the dread clang of Apollo's silver bow" ceased; later, the great fire of London is commonly believed to have exterminated the plague, while at this moment the hasty cleansing of a town by a terrified sanitary authority is by many thought to be the direct cause of the disappearance of an epidemic; but in all these cases there is a misinterpretation of facts, which is due largely to the absence of any real knowledge of the underlying laws.

The most important contribution to the subject from the point of view of this paper is one by the late Dr Farr, who had that genius which permitted him to perceive a large part of the laws which govern progressions of figures. In 1866, when the cattle plague was making most extensive ravages in this country, and when, from the rate of its progress, there seemed no end to the damage it might do, he wrote a letter in which he showed that, as the rate at which the disease was extending was already lessening, the acme and the decline of the epidemic might soon be expected.

Later, he applied the same method to the case of smallpox in 1871-2, and fitted a curve to the latter portion of the epidemic. His description of his method is not clear, but in a paper by Dr G. H. Evans (*Trans. Epid. Soc.*, 1874-5) it is given in detail. The method practically amounts to assuming that the second difference of the logarithms of successive ordinates of an epidemic curve is a constant, and using a value of this constant, deduced from an early portion of the epidemic, to predict the succeeding portion.

The method in the terminology of finite differences is as follows:—

If $u = \log y$ where y is the ordinate of the epidemic curve, then

$$\Delta^2 u = -c \text{ (a constant by Dr Farr's supposition)}$$

of which the integral is

$$u = -\frac{cx^2}{2} + Ax + B$$

or as $\log y = u$

$$-\frac{cx^2}{2} + Ax + B$$

$$y = e$$

which is the equation to the normal curve of probability.

Dr Farr does not seem to have noticed that the application of his arithmetical law leads to this curve. As a matter of fact, it is a very good approximation to the middle parts of some epidemics, though it does not provide a specially good fit for the whole course of those to which he applied it. In the examples of this method given by Dr Evans nothing more is attempted. The real difficulty in the application consists in finding a good value of the constant from the early portion of the epidemic.

This is all the literature of this subject. My attention was specially drawn to this matter when considering recently some questions of immunity. The interpretation of some of the facts required accurate knowledge of the epidemic processes. I was struck, when I began to examine the course of epidemics, by the close resemblance which many bore to the probability distributions developed by Professor Pearson; and, without any knowledge that Dr Farr had already come indirectly to fit the epidemic curve to that of the normal frequency of error, I applied the methods now in use of fitting probability distributions to statistics.

The result of these calculations has been to show that the curve of the solitary epidemic is singularly constant. It almost uniformly corresponds to that probability distribution which Professor Pearson has termed type IV.,* so that this curve may be chosen for interpolation, as one which gives a very clear representation of the facts. Even when the epidemic becomes symmetrical, it is to the form of type IV., where ν is equal to zero, that the course approximates, and not to the normal probability curve. The precise limitation of an epidemic in point of time does not alter the form referred to, for in this case also the constants generally indicate a curve of type IV., though the latter is unlimited on either side. As the first example of curve fitting to the course of an epidemic wave, miliary fever (Table A, No. 1) † has been chosen. This instance does not afford an example of a curve which gives a good fit, but it is a disease of which the cause and the means of propagation are absolutely unknown, and therefore one which spreads as near as possible in natural conditions. It affects country districts, so that as new townships are invaded at all stages of the epidemic, and as these tend to become more numerous as the disease extends, a supply of susceptible persons is constantly furnished and a criterion given for the approximate estimation of the infectivity of the organism. It is, in addition, an explosive disease, and thus no difficulty arises about the start and close of the outburst. All the factors which make for the investigation of an epidemic type are thus present in this case. The course of an epidemic of this disease is illustrated in diagram I., along with the theoretical interpolation curve as well. As the number of persons exposed increased from the beginning to the end of the epidemic, it is seen that the decline in the number of cases must be due to the loss of infectivity in the germ itself, and not to the lack of individuals who may be supposed open to the contagion. Equally characteristic examples are afforded by the great plagues of London (Table A, Nos. 2 and 3). That of 1665 is specially interesting, as we have many contemporary accounts of the conditions which obtained. Great migrations from the city began as soon as the plague established itself, but the disease had barely begun to abate when the return

* See Note at end of paper.

† Rayer, *Histoire de l'épidémie de Suette Miliare en 1821*, Paris, 1822.

of emigrants began in great numbers. On this Pepys makes anxious remarks in his Diary, and speculates on the occurrence of a recrudescence of the malady, but the infecting power of the organism was exhausted; and though great numbers of susceptible persons came from the country into the zone of infection, even, it is said, occupying the beds of those who had been afflicted, no further extension of the disease ensued. The curve of this epidemic is given in diagram II. The figures on which it is based are taken partly from the London Bills of Mortality* and partly

Diagram I.

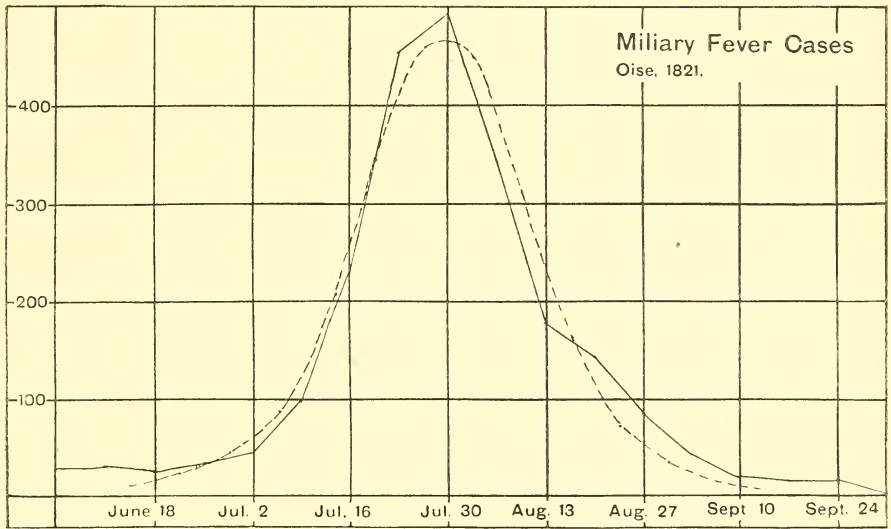

from Pepys' Diary. For comparison, the constants of the curve representing the course of the great outbreak of plague in London in 1563 † are given.

As further examples of the epidemic course, influenza ‡ and cholera (Table A, Nos. 4, 5, 6, and 7) are illustrated (diagrams III., IV., and V.), and the constants given in the table. It is to be noted that the curves are again of the type IV. The epidemics of cholera include that in Exeter in the summer of 1832,§ and

* Quoted also in Creighton's *History of Epidemics in Britain*, vol. ii.

† *Loc. cit.*, vol. i. p. 305.

‡ Reports of Registrar-General for England.

§ *History of Cholera in Exeter in 1832*, Shapter, p. 208.

that in London in the spring of the same year.* The statistics of the summer epidemics in London are difficult to deal with, on account of the manner in which the death certificates have confounded the ordinary summer diarrhoea with the more deadly disease. It is also to be noted that, though the epidemics referred to occurred at different seasons of the year, the form in each disease is much the same, showing that the infecting agent is more

Diagram II.

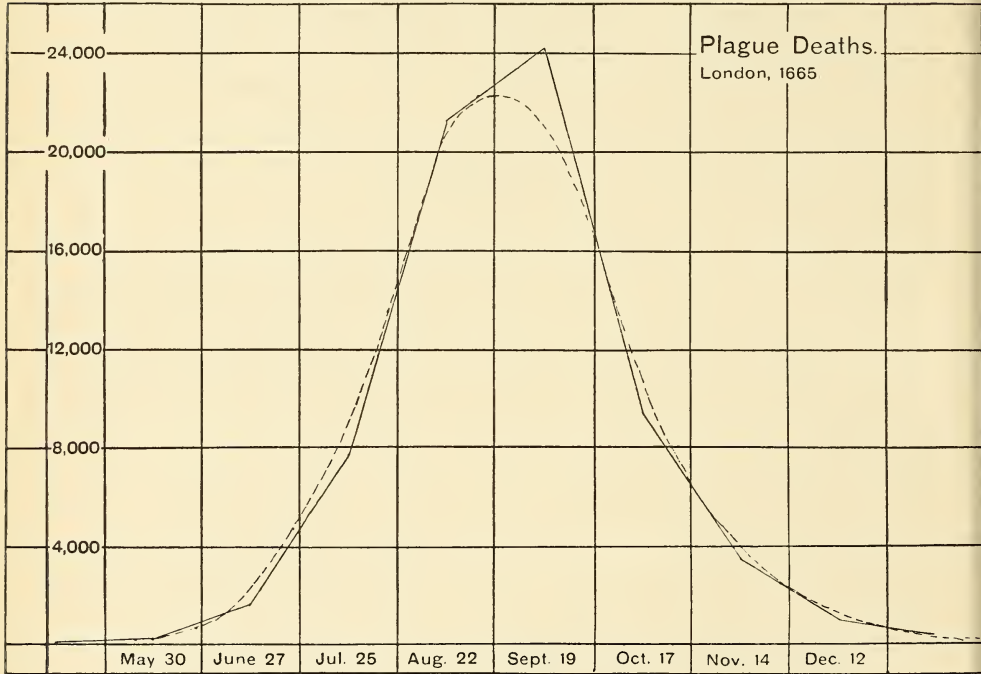

potent in determining the outburst than either season itself or seasonal constitutional differences in the population.

From the large body of figures relating to smallpox, several examples have been chosen. For the last two centuries statistics of numerous epidemics exist where the number of deaths is recorded for each succeeding week or month of the epidemic, and since 1890, when compulsory notification began, the epidemic wave can be traced for both cases and deaths.

* Report of Board of Health upon Epidemic Cholera, 1848-49, plate, p. 26.

Between the conditions which existed in earlier and later times there is some difference. Then smallpox might be entirely absent from a district for long periods of time, or might recur in epidemics every three or four years. These two conditions present differences.

Diagram III.

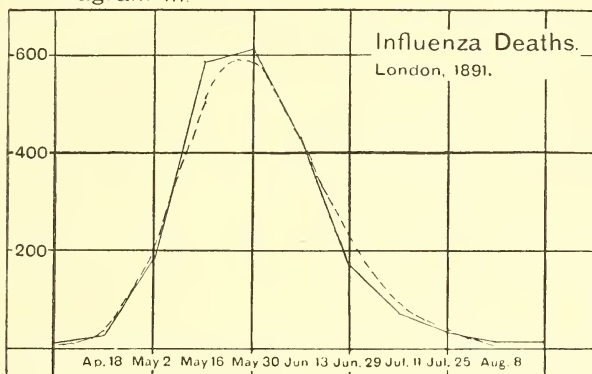

In the former, with half the city open to infection, as in Boston in 1721,* a bad epidemic might burn itself out partly from absence of material. In the latter, those susceptible would be more or less thoroughly mixed with the unsusceptible, and the chance of infec-

Diagram IV

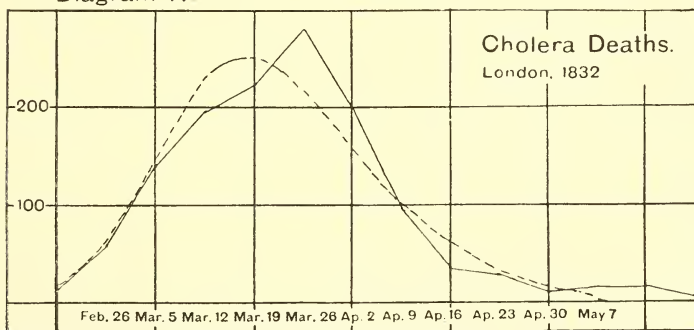

tion reduced so that the organism would have a better opportunity of producing a typical epidemic. The latter approximates more closely to the condition seen at present, where vaccination provides a large insusceptible population. Of the former, the epidemic in Boston, U.S.A., in 1721 (diagram VI., Table A, No. 9), may be

* Creighton's *History of Epidemics*, vol. ii. p. 485.

taken as an example. The population numbered at that time about 10,000, and about half only were protected by a prior attack

Diagram V.

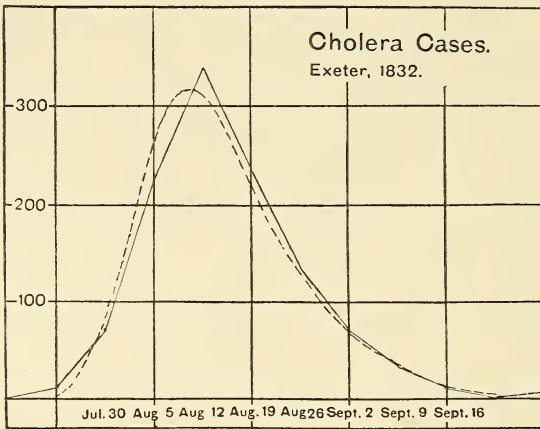

of smallpox; of the remainder, all but 750 persons suffered from the disease. Of the latter, a large proportion were probably susceptible, though the exact conditions which were necessary to

Diagram VI.

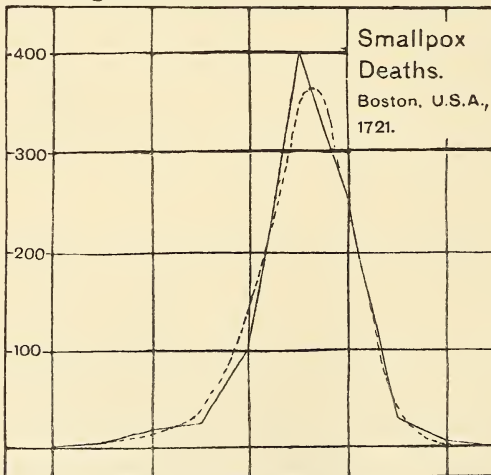

Each abscissal unit is one month.

cause their infection did not occur. In this case the decline of the epidemic was much more rapid than that usually seen,* due

* Compare Diagram XVII.

probably to the comparative exhaustion of susceptible persons. The statistics refer in this instance to the deaths alone. An epidemic occurring in Warrington* in 1743 (diagram VII., Table A, No. 8) is given for comparison. The asymmetry of this is not so great. Although both these epidemics are definitely limited as to beginning and end, the constants are still required by type IV. This great asymmetry was not the rule, however, in places where smallpox was more frequently epidemic, and where, in consequence, a sufficient dilution of the susceptible persons existed to allow the epidemic to run a more natural course, and when even at the end there were still present in the population sufficient persons open

Diagram VII.

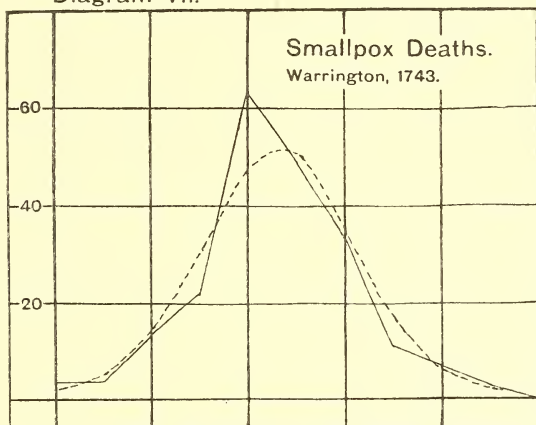

Each abscissal unit is one month.

to infection to permit the decay in the infectivity of the organism to be observed. An epidemic in Glasgow in 1784 † is given to illustrate this (Table A, No. 10).

The epidemics of smallpox in Gloucester ‡ in 1896 and London § in 1902 (Table A, Nos. 11, 12, 13, 14) may be compared with those of last century. At first sight, in epidemics where all the machinery of modern sanitation has been brought to bear, it might be expected that the form of the course would in some way be altered. On examination, however, the course of the London epidemic is

* Report on Epidemic of Smallpox in Warrington in 1892-3, p. 7.

† Watt's *Treatise on the Chincough*, Glasg., 1813, p. 344.

‡ Report of the Royal Commission on Vaccination, —Appendix on Gloucester.

§ Reports of Metropolitan Asylum Boards, 1901-2.

seen to be very much that of presanitary days (diagrams VIII. and VIIIA.). I do not mean to infer that there is no difference in the amount of disease present in a given epidemic, but that a uniform

Diagram VIII.

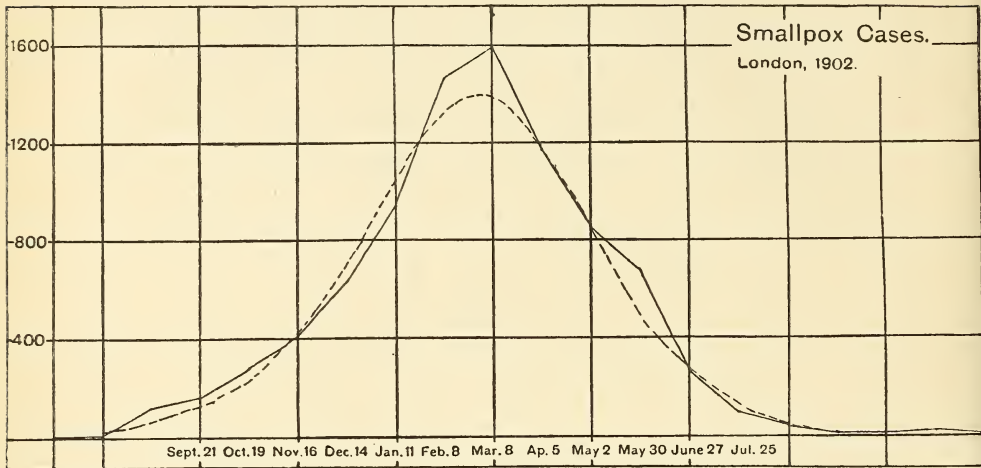
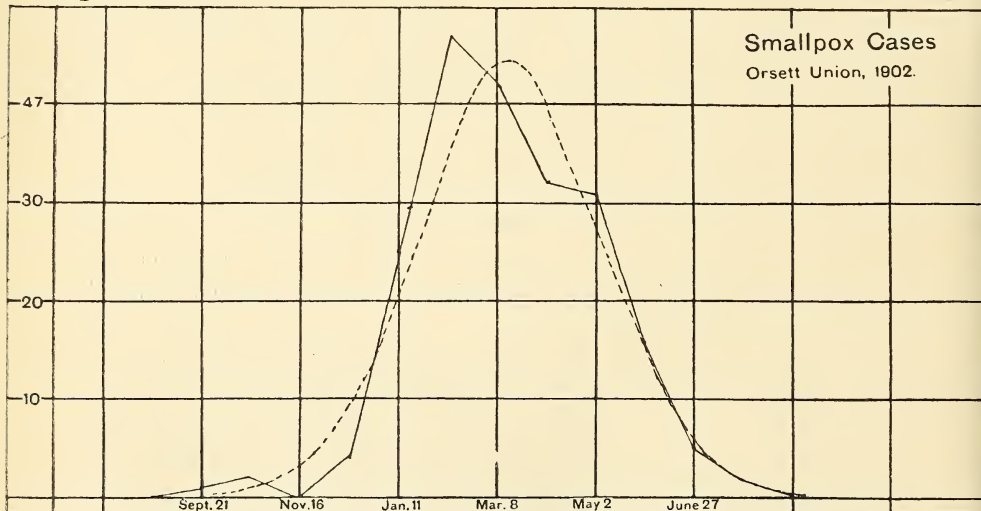

Diagram VIIIA.



force acting towards the limitation of an epidemic produces no perceptible effect on the form of the curve. In the case of Gloucester, the form of the curve has been calculated for the total cases; for the severe cases (diagram IX.); and for the

deaths (diagram X.). The general correspondence shows that the deaths may, in the case of smallpox at least, be taken as giving

Diagram IX.

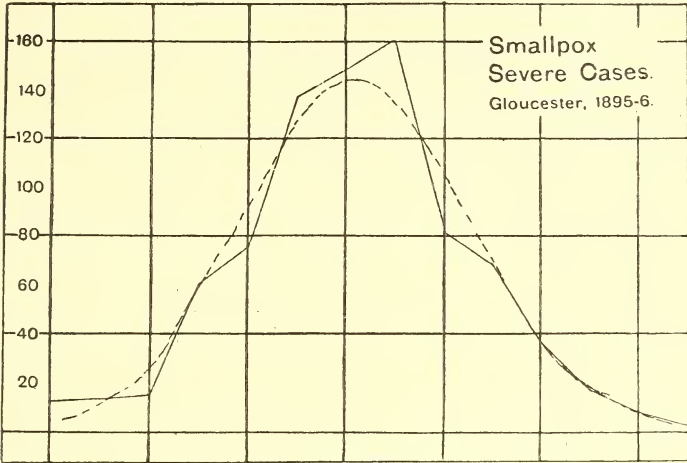

Each abscissal unit equals four weeks.

a fairly accurate representation of the course of the epidemic. With the exception of measles, this exhausts the diseases truly

Diagram X.

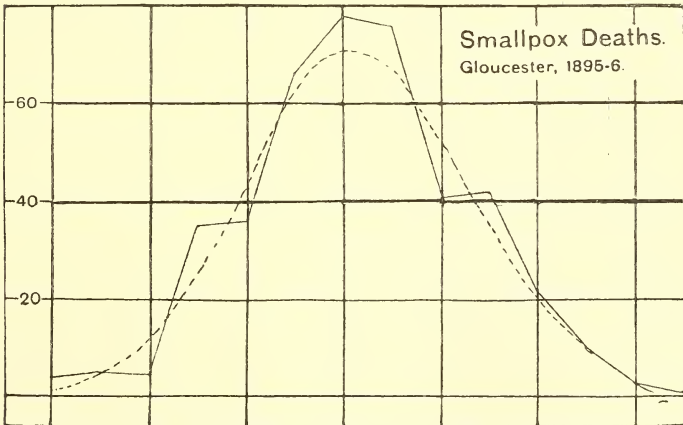

Each abscissal unit equals four weeks.

epidemic in this country. An example of the latter* in Glasgow in 1808 is given in diagram, and is seen to conform to the general

* Watt, *Treatise on the Chincough*, p. 368.

type (diagram XI., Table A, No. 18). The measles epidemic of the present day has exactly the same form.

The theory of endemic disease is more difficult. The degree of endemicity, of course, varies in different instances. Sometimes, when a disease invades a territory, there is a period of some years during which it is never absent. In some such cases we have obviously to deal with two independent epidemics, the tail of the first of which runs into the beginning of the succeeding. More

Diagram XI.

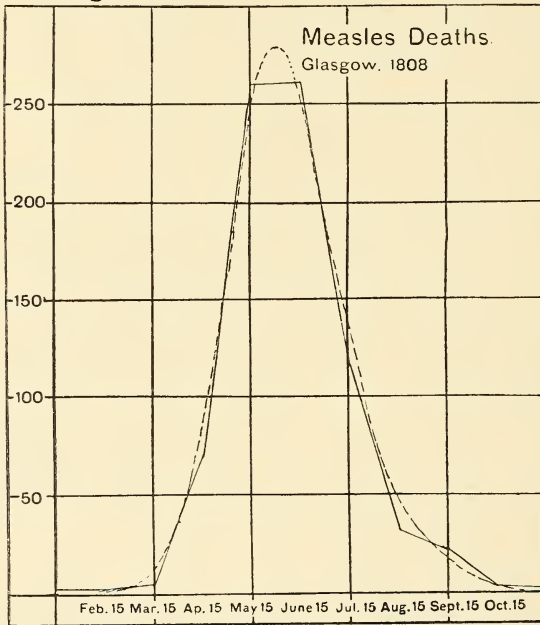

often, however, as with scarlet fever, enteric fever, malaria, etc., there is a minimum below which the amount of disease never falls. One disease, namely, zymotic diarrhœa, partakes of both characters, being truly endemic, occurring year after year at the same season, and yet in characteristic outbursts, so that it may conveniently be considered with first instance. The statistics chiefly refer to deaths, and only in a few instances to cases. The latter are in this disease specially important, as diarrhœa claims its victims mainly at the two extremes of life, and consequently nothing can be inferred *a priori* as to the relationship

of the curves representing the cases and those representing the deaths. The disease shows a marked rise at practically the same period, year after year. During the seasons at which it is nearly absent, the figures giving the weekly number of deaths are almost absolutely constant. Whether these deaths are due to the same form of diarrhœa as that which causes the summer outburst is not clear, but these numbers indicate a distribution which is essentially different from that given by the terminal portions of the probability curves. So that if the epidemic be fitted to such a distribution, some allowance must be made. The most natural assumption is to subtract a number equal to the average number of cases in the inter-epidemic period from the weekly or monthly numbers during the epidemic period.

Zymotic diarrhœa forms the sole example in which an average can be obtained for the course of an epidemic, as the annual outburst lasts only about three months and has a well-defined beginning and end. As a first example the statistics of Glasgow* have been chosen, as they have been for many years less subject to these fashions of death certification which make the returns of the Registrar-General for England difficult of interpretation. The Medical Officer of Health for Glasgow has been in the habit of specially classifying these cases for himself. The result is that, while the figures may not absolutely accurately represent the true number of deaths from zymotic diarrhœa, the statistics are homogeneous. The period chosen concerns the years 1890-1903. The result is represented in the figure (diagram XII., Table A, No. 19), and is seen to be an instance of a really good fitting curve. When tested by Professor Pearson's method, the probability is found to be about $\cdot 35$, which, considering the kind of case, is a good fit. As curves of cases and deaths (diagrams XIII. and XIV., Table A, Nos. 21 and 22), the figures of the Children's Hospital in Manchester † are given. Here, again, as a period of ten years is embraced in the statistics, an average is obtained. In these epidemics a curve very nearly normal in character is given by the cases of the disease, while the corresponding deaths have a dis-

* From the Notebook of the Medical Officer of Health.

† Supplement to the Report of Medical Officer of Local Government Board for 1887 on Diarrhœa and Diphtheria, p. 68.

tribution whose constants are those required by type IV. The fit of both these curves is good. At the beginning and end the divergence of the actual figures from the theoretical distribution is most marked, but it is at these points that the probable error of the statistics is very large. As an equal number was subtracted

Diagram XII.

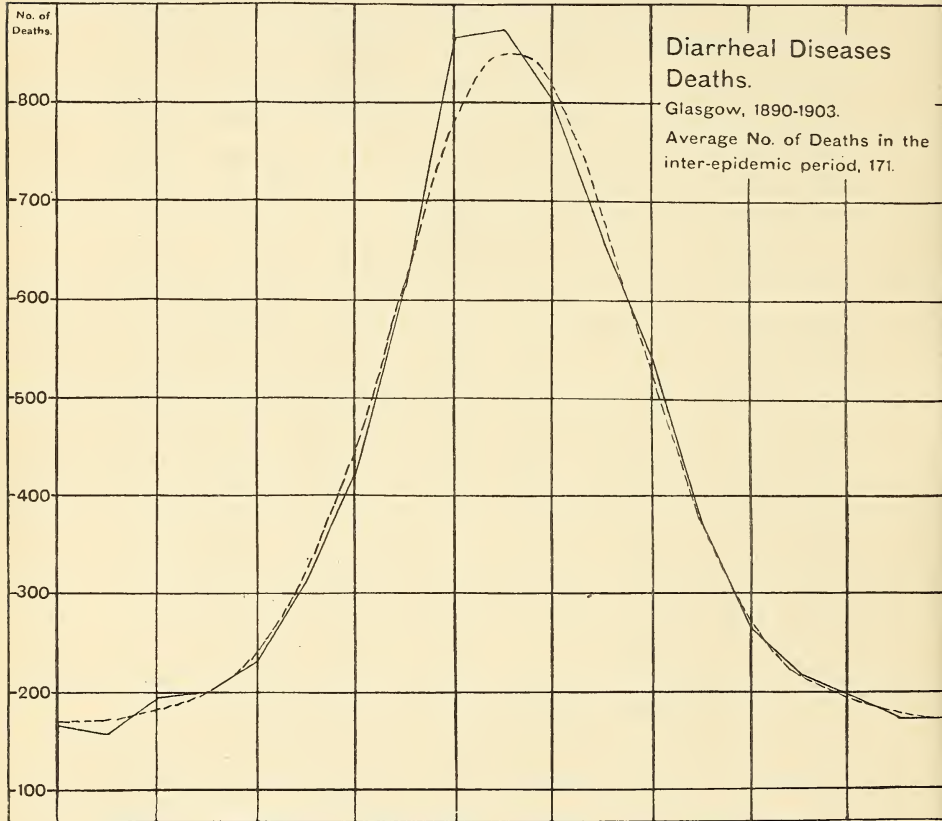

from the whole series, and as at the extremities this number, in place of being only a moderate percentage of the whole cases, becomes equal to many times the residual number of cases, it will be seen that the accuracy of the residual numbers cannot individually be very great. The curve of zymotic diarrhoea deaths, London,* for the years 1853-1903 (diagram XV., Table A, No.

* Report to Registrar-General for England, 1903.

20), is also given. The fit here is not good, but the statistics of London are not nearly so definitely homogeneous. As, however, the divergence of the actual from the theoretical is, though much greater, of the same nature as that observed in the divergence of

Diagram XIII.

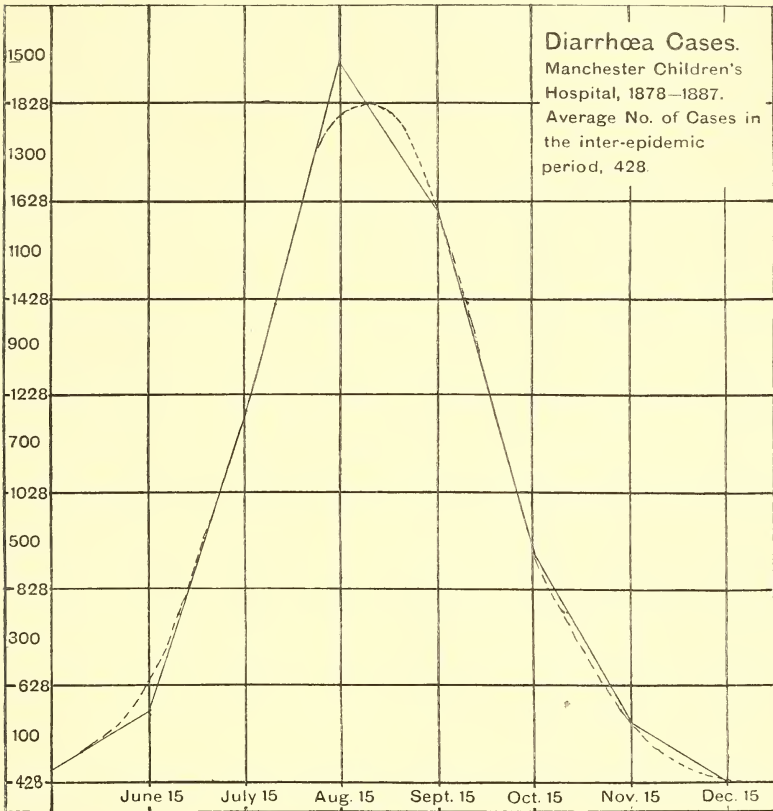

the actual and theoretical curve for Glasgow, it is possible that some other factor affects both.

So far, no exceptions have been noted to the form of epidemic distribution given by type IV. These have occurred in my work only in the case of some small epidemics of which it was difficult to give the beginning or the end, and in the case of outbreaks of endemic diseases where the tail of one epidemic runs into the beginning of another,—cases difficult to treat, as will presently be

shown. One example of this—an outburst of yellow fever* in Demerara—is given (diagram XVI., Table A, 32).

This forms the general survey of an epidemic. The applied curves seem to give a very fair approximation to the facts; but when, as in an epidemic, a disease propagates itself amid a variety of evanescent and manifestly independent influences, it is evident that, whatever the law of its spread, only an approximation can be

Diagram XIV.

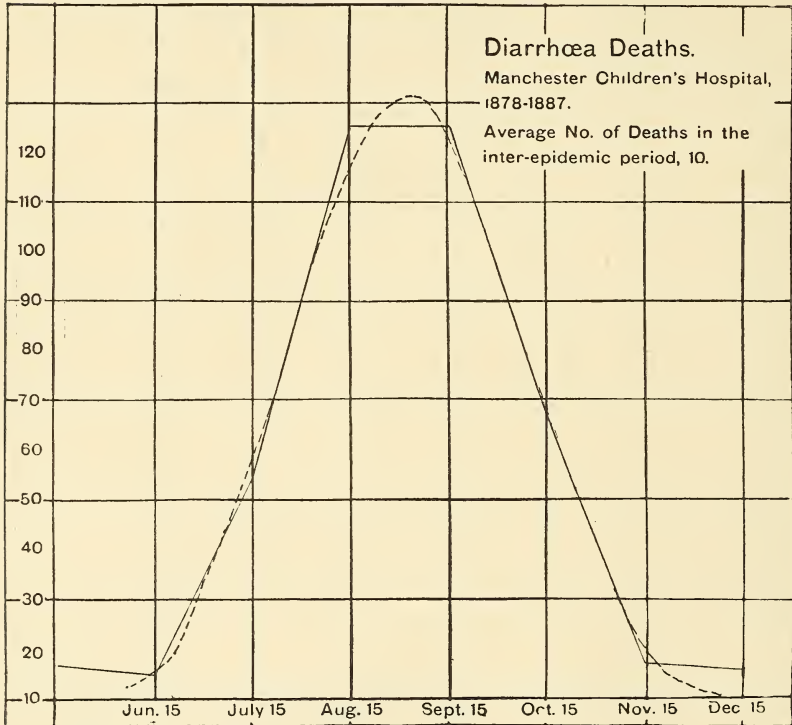

expected in the result. In the first place, there is the weather, exercising an influence which at present there is no means of measuring. Secondly, there is the distribution of the population in the infected districts. In a city, for instance, there are large areas where there is no population, or only a very sparse one, and the disease might initially appear in one of these. Thirdly, there is the nature of the housing or grouping of the people, as is seen in

* Harty, *Yellow Fever in Guiana*, London, 1820.

the case where smallpox invades a school in which there are a great number of unvaccinated children. All these factors and many other minor ones make their influence felt with more or less regularity. These, however, cannot be taken as the complete reasons for the difference noted. It is likely that there is a biological factor in addition. The infecting powers of an organism cannot be expected to obey completely regular laws of growth or

Diagram XV.

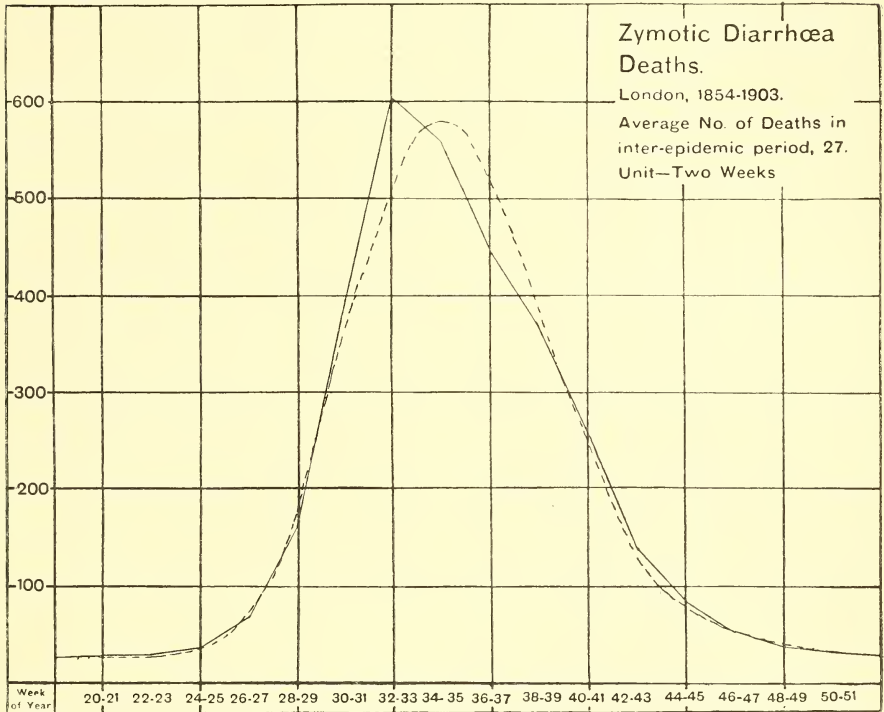

decay. As with children: some have a slow, regular growth; others make little increase in size for some years, then shoot to their full stature in a very short time. While these variations comport themselves so that in the sum the different groups adjust themselves closely to the law of error, yet in individual cases a law can only be expected to give a rough approximation, and the application of a law of averages to an individual instance cannot be expected to give good examples of curve fitting. I intend at some future time, with reference to some special disease, to make an investiga-

tion of the manner in which single epidemics vary from the average. This reason probably accounts for the larger part of the differences seen between the actual and the theoretical distributions. The striking fact is that epidemics in general hold a course whose constants with very great regularity are those of a single member of the large class of frequency distributions. It can hardly be explained on any other hypothesis than that the law which underlies the propagation of infectious diseases is such as in general to

Diagram XVI.

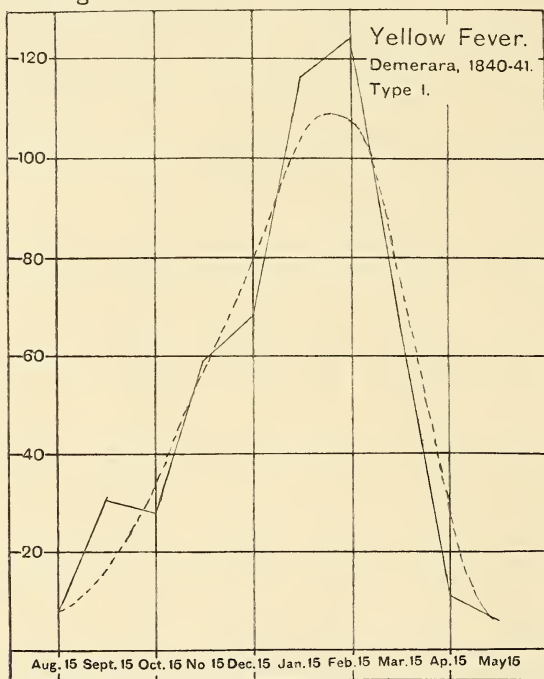

produce such a distribution. The investigation of this is much more easily attempted *a posteriori*. The assumption that the infectivity of an organism is [constant, leads to epidemic forms which have no accordance with the actual facts. If there be given a number of susceptible persons in a community, and if one, say, infect three, the whole body of the susceptible persons will become involved, and the last few remaining finally swept off. Even when allowance is made, on various hypotheses, for the chance of infection being small, because of dilution of the susceptibility

by the insusceptibility, the epidemic is only lengthened, not changed in form, and the course still represents an ascent of constantly increasing slope and a sudden drop to the original level. An example of this is given in the accompanying diagram (diagram XVII.), and it will be seen that the form bears no resemblance to any of the curves shown in the preceding pages.* Another factor is evidently necessary—and this is perhaps to be found in the loss of infecting power on the part of the organism. The rate at which this occurs must be according to some law, and it seems reasonable,

Diagram XVII.

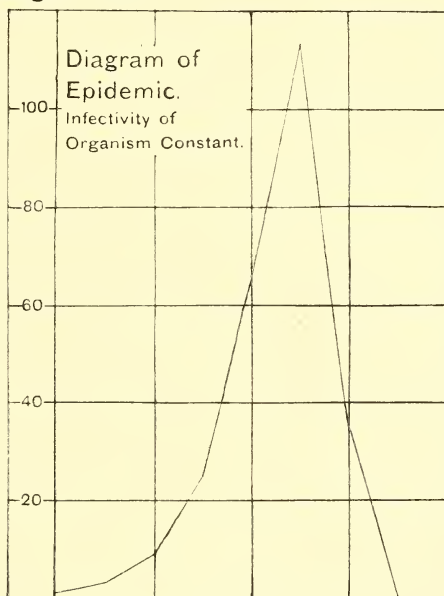

as a hypothesis, to assume that the decline proceeds according to the terms of a geometrical progression. Thus, if at the end of

* This form is sometimes seen when a case of measles develops in a ward in which a number of susceptible children are confined. Although the sufferer be moved at once, yet the infection is present so early in the disease that usually several others succumb. In one actual case, when there were fourteen susceptible children in a ward, the epidemic developed in the following way. First *one* case; at the end of incubation period *three* cases; then a fortnight later *seven*; leaving only three to develop the disease, and these all succumbed in the next fortnight, so that the epidemic came to an end from the cause discussed and took the form of diagram XV. This, however, is under artificial conditions, and bears no resemblance to a natural outburst.

the first period of time the infecting power has declined from unity to q , say, then at the end of a second period of time it will be q^2 , and so on. On this assumption, if a be the number of persons infected originally and ap the number infected by these, then the succeeding terms representing the course of the epidemic will be represented by $a, |ap, |ap^2q., |ap^2q.\{p.q.^2\}, |ap^2q.\{p.q.^2\}\{p.q.^3\}|$, etc., or the general term will be given by

$$a \cdot p^{x-1} \cdot q^{\frac{(x-2)(x-1)}{2}}$$

which transferring to an exponential form

$$(x-1) \log p + \frac{(x-1)(x-2)}{2} \log q$$

is ae .

As q is by hypothesis less than unity, $\log q$ is necessarily negative, and in consequence the slope of the epidemic curve is seen to be that of the normal curve of frequency of error. The normal curve itself, as has been seen, occurs as an epidemic form only very rarely.

This gives an indication how the curve of an epidemic might arise, but it can hardly represent the complete solution. All that can be said is, that in general one of the curves derived by Professor Pearson to represent chance distributions makes a good interpolation formula for the ordinary course of an epidemic. These curves have been found to fit many classes of statistical grouping, and there is nothing in the method by which they are derived at all to preclude their application to this class of phenomena. These curves are the solution of the equation*

$$\frac{1}{y} \frac{dy}{dx} = \frac{-x}{a + bx + cx^2}$$

and the particular one which is found to apply to this case is that where the roots of the quadratic expression in the denominator are imaginary. Its equation is

$$y = \frac{y_0}{\left(1 + \frac{x^2}{a^2}\right)} e^{-\nu \tan^{-1} \frac{x}{a}}$$

But though this curve expresses somewhat closely the facts of the case, yet it does not express the whole truth, as is seen when the

* See Note at end of paper.

diagrams are examined. Without exception, these show near the height of the epidemic a difference, but it is at this point alone that much divergence of the actual statistics from the interpolation formula occurs.

Although it might appear that the application of the preceding to endemic diseases was simple, yet such is not the case. Even when, from the course of an epidemic wave, it might seem easy to form equations of two succeeding epidemics, and combine them so that the sum would accurately represent the course of this epidemic, this is found to be difficult. Thus, on the introduction of a disease like plague, although the rise of the epidemic might be characteristic and the commencement of the decline also lead to the expectation that the outburst would soon approach its close, yet a recrudescence might occur before the first outbreak had finally subsided. In the case of the chief endemic diseases in this country, namely, scarlet and enteric fevers, there is a yet more difficult problem, because at no period of the year are they absent, while in the autumn epidemic outbursts occur with great regularity. Solitary epidemics are not frequent. A number, however, of the latter have been investigated, with the result that they are seen, with one exception, to conform to the same type as has been found in other diseases. For scarlet fever, for instance, the epidemic in Halifax * in 1880-1 gives the usual form (diagram XVIII., Table A, No. 27), while that of Thorshavn, † in the Faröe Islands, invaded in 1873-4 by scarlet fever for the first time for thirty years, is also seen to be of the same type (diagram XIX., Table A, No. 28). The asymmetry is, however, much greater, and the decline of the epidemic so much more gradual as to require a modification of the hypothesis that the infectivity declines according to the terms of a geometrical progression.

It would seem that with scarlet fever a considerable variability may exist in the rate at which infectivity is lost. Two epidemics of enteric fever are also given, one of which, an outbreak due to contamination of the water supply in Coventry ‡ (diagram XX.,

* Report of Medical Officer of Local Government Board, England, 1881, p. 60.

† Nothnagel's *Encyclopædia of Medicine*, art. "Scarlet Fever."

‡ Report of Medical Officer of Local Government Board, 1901-2.

Table A, No. 25), has a similar form to that seen in scarlet fever, while the other, the great epidemic in Maidstone in 1900,* due to the same cause, but followed by large numbers of secondary cases,

Diagram XVIII.

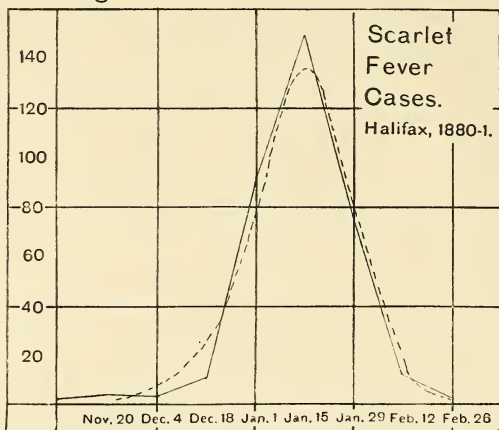

is very asymmetrical, and takes the form of one of the chief exceptions to the conclusions arrived at (diagram XXI., Table A, No. 31). Two milk-spread epidemics of scarlet fever in Wimble-

Diagram XIX.

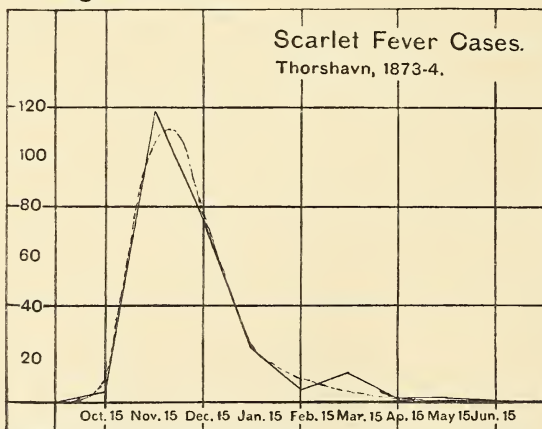

don † and Glasgow ‡ have also been investigated (diagrams XXII. and XXIII., Table A, Nos. 29 and 30). In these it will be seen

* Report of Medical Officer of Local Government Board on Maidstone Epidemic.

† *Ibid.*, 1886.

‡ Special local Report on the Epidemic, by Dr J. B. Russell.

that the loss of infectivity has been specially rapid; and though a large amount of infection has been thrown into the milk, yet when it is observed that the incubation period of scarlet fever is from three to five days, it can be seen that at the time the milk supply was stopped, the organism had in both instances run

Diagram XX.

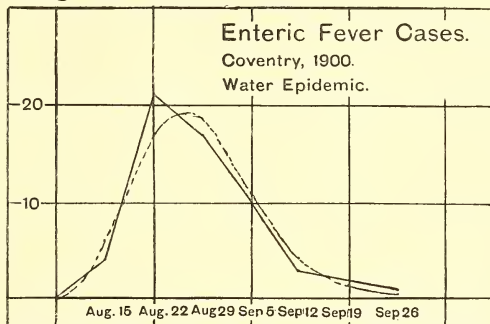

almost the complete cycle of its infectivity. The germ, therefore, of scarlet fever, though it can possibly be introduced into eruptions on the teats of cows, yet cannot evidently long maintain its infectivity if growing in that situation. When a milk supplied from such infected animals has been distributed in a new centre

Diagram XXI.

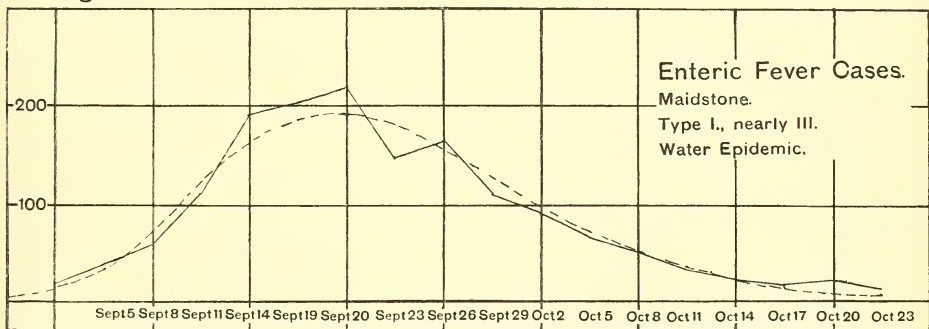

after the outburst of disease has led to its discontinuance in the infected area, though a few cases of fever might occur among the new customers, no outbreak comparable to the original one has been observed. Here a comparison may be made between the milk epidemic at Wimbledon and that previously referred to as occurring naturally at Halifax. Both curves have much the same

constants, though the former has a time unit of two days and the latter of two weeks, the same loss of infectivity taking place for each epidemic in these different periods.

The explanation of endemic prevalence which scarlet fever and enteric fever display may be sought in the fact that two factors are in action, one the true endemic prevalence, and the other the seasonal epidemic prevalence, the former varying according to a

Diagram XXII.

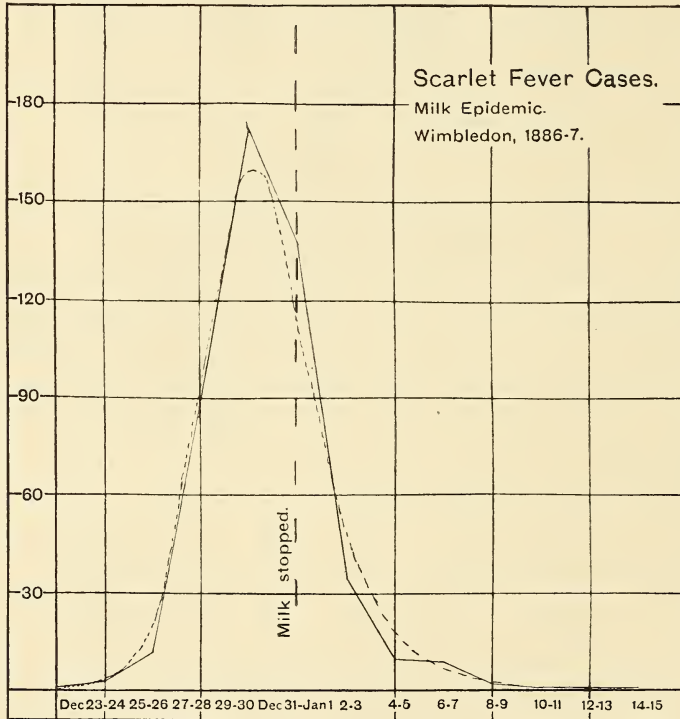

different series of causes from the latter. There may be constantly present a certain amount of infection of a low grade which keeps up the endemic supply, while if the seasonal conditions in the early summer be suitable, some portion of this acquires a high grade of infectivity, and alone produces the true autumnal outburst. Thus a severe autumnal epidemic might readily occur though the endemic prevalence was small, and with the latter at a considerably higher level the presence of unfavourable seasonal conditions might

prevent the development of any autumnal epidemic, both of which conditions are observed to exist. I do not mean to say that the assumption of high-grade infectivity need always occur at the same season of the year—that would not be true; but in the great majority of cases it does take place in the early summer. So far

Diagram XXIII.

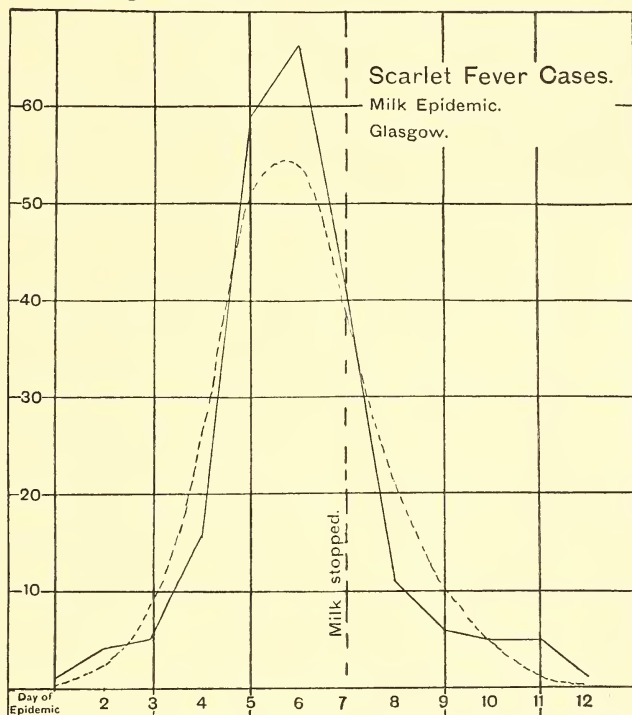

as my investigations go, this seems the only means of explaining the facts.

If this theory is true, certain conclusions are justified. If the number of cases or deaths be given for each week of the year, and if an average of a large number of years be made, the amount of endemic disease should be represented by a straight line, while the epidemic portion should appear on the surface of this in the form which represents the characteristic course of such an outbreak. On the other hand, on the hypothesis that the seasonal maxima and minima are due to different epidemics running into one

another, it would be expected that the average would be easily expressed by an epidemic curve, the base line of which represented the zero prevalence. In actual trial the former gives a much better representation of the facts than the latter, which seemed at first sight the more probable assumption. Two examples are given for comparison: one, the average number of deaths from scarlet fever in London* for the last thirty years; and the other, the average number of cases of enteric fever† for the last thirteen years (diagrams XXIV. and XXV.). It is seen that the fit in both cases is a comparatively good one, and is much better than any I have succeeded in forming on the basis of the second hypothesis.

Before making any special application of the foregoing notes on the regular course of epidemics and the nature of the laws which they obey, one other point requires to be investigated. Is the distribution of an epidemic in space subject to anything like the same kind of law which regulates the distribution of the cases in regard to time? Here an answer seems easy. Given a certain amount of infection in a limited space in the midst of a uniformly distributed population, it seems natural to assume that the chance of any individual coming into the zone of infection will approximate to that given by a normal probability surface of which the maximum corresponds to the area in infection. Further, this assumption being granted, if the persons infected from this source also infect in a corresponding manner, it follows that the derived distribution will also be a normal surface, with, however, a standard deviation of a great amount.

When a disease spreads in a city, however, there are many factors which make the distribution just conjectured a form to which only an approximation can be expected. The population of a city is not equally disposed; the conditions under which people live in different districts are not identical as regards the spread of infection: especially in regard to smallpox, the amount of vaccination performed among the inhabitants of certain parts is much less than in others. Apart from these sources of error, it might be thought, as the process of spread of an epidemic is analogous to

* Reports of the Registrar-General for England.

† Reports of the Medical Officer of Health for County of London.

the drawing of a certain number from a limited quantity, that the

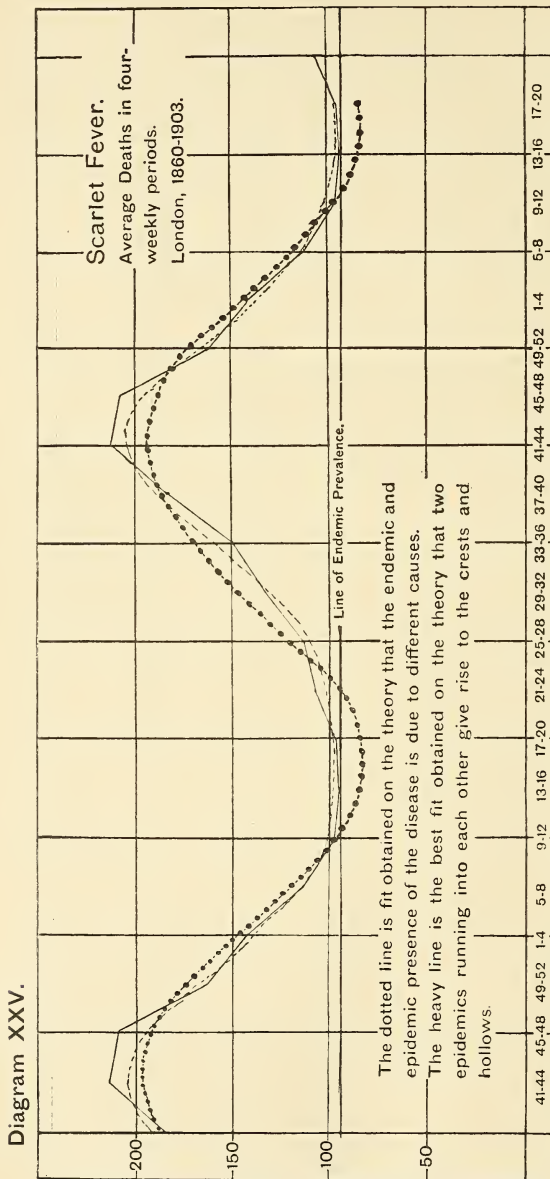

distribution would more nearly resemble that of type IV. than that of the curve of frequency of error. This is found to be the

case in the large epidemic of smallpox in London during 1902. It is unfortunately impossible to consider the whole of this epidemic, as the centre of the outburst was in that part of London adjacent to West Ham. As the cases occurring in the latter are not included in the spot-map of the epidemic issued by the Metropolitan Asylums Board, the complete distribution is not known. If, however, London be divided into squares by a series of lines, of which one set is parallel to the boundary between London and West Ham, the distribution of the cases as these lie to the right and left of the centre of the epidemic may be studied. The summing has been taken along those parallels which are at right angles to the boundary between the two areas.*

The space distribution of the epidemic estimated in this way is seen to be of type IV., and the constants are as given in the annexed table (diagram XXVI., Table B, No. 1). The corresponding distribution of the epidemic of relapsing fever in Glasgow in December 1871 (Table B, No. 4), given for comparison, shows the same form. It does not seem necessary to elaborate evidence on this point, as the general theory is quite obvious, and the instances given sufficiently accord with it.

Two other examples will be referred to later (Table B, Nos. 3 and 4), namely, the north and south and the east and west distributions of the epidemic of smallpox in Liverpool in 1902. The latter of these is again a curve of type IV., which is nearly symmetrical, while the former is exceedingly asymmetrical, due apparently to the fact that the centre of the epidemic was adjacent to the docks, and in consequence the spread thereby so limited on one side as to prevent the development of the usual form. In this case also, however, the criterion $2\beta_2 - 3\beta_1 - 6$ is positive. The

* If the distribution were normal, it is easily seen that the sum taken in this way will also partake of the same distribution.

Thus the equation to a normal distribution is of the form

$$y = ke^{-\frac{x^2}{a^2} - \frac{x}{b}}$$

of which the integral with respect to y is

$$y = ke^{-\frac{x^2}{a^2}} \int_{-a}^y e^{-\frac{y^2}{b^2}} dy$$

the curve of normal frequency.

The same holds with regard to the symmetrical form of type IV.

particular curve belongs to the class of distribution known as type VI.

We are now in a position to make a practical application of the

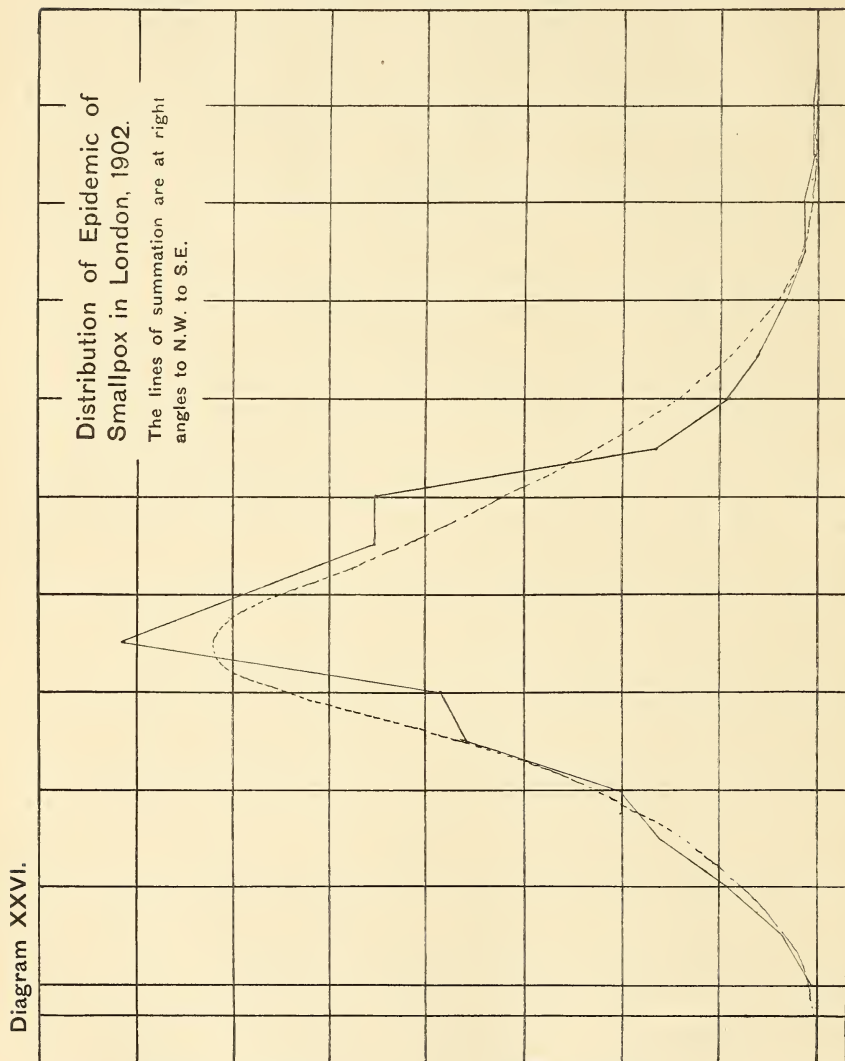

facts regarding epidemics which have been described in the preceding pages. The example which I have chosen is one which has a special interest at the present time, both theoretically and

practically. It concerns the method by which smallpox infection is spread from smallpox hospitals. Many believe that the infection passes aerielly from the infected centre, so that in a district in the immediate vicinity of this, case after case occurs due to this cause. Now, it cannot for an instant be denied that there is often in the neighbourhood of smallpox hospitals an amount of smallpox quite out of proportion to that in the rest of the locality, but that this is necessarily due to aerial infection is a position far from tenable.

In the first place, it has been seen that a small amount of infection placed anywhere in a suitable locality is capable of producing a large epidemic; and though all the cases of the fever be promptly removed from the district, the disease may continue to spread and an epidemic develop with the typical distributions in time and space (*vide* diagrams for London, 1902). It is in relation to this type that the causes of a smallpox epidemic must be investigated.

Secondly, some centres of a town are, for reasons more or less unknown, much more suitable for the spread of an epidemic than others; and though the disease may first start in the part more or less distant from this, yet, as the epidemic proceeds and infection is introduced into this district, the cases there may so increase as to ultimately make this the chief centre of the outbreak. So that it must always be borne in mind that a local outbreak in the neighbourhood of an hospital may be as much an accident of place as a result of the proximity of the hospital.

Lastly, the form of the epidemic wave in time is of importance. If smallpox be introduced into a new district at a late period in the epidemic wave, when the organism has lost its infectivity to a certain extent, then we would, *a priori*, expect that an epidemic of shorter duration would result, unless the new locality prove fitted to temporarily rejuvenate the organism.

The epidemic in Liverpool in 1901-2 is recorded with the greatest care and detail in a report by Dr R. Reece, which was presented to the Local Government Board and published this year. This report is very suitable for the present purpose. Full details as to the dates of the occurrence of the cases, and fortnightly maps showing distribution of these cases in the city, are given. All the

fallacies from the mixing up of epidemics due to essentially different causes can thus be avoided, and the distribution of the disease in the city ascertained for any periods which may be desired. These maps also give the situation of the hospitals, and in addition are divided by parallel lines into transverse squares, and also indicate the quarter-mile zones round the different hospitals.

A careful examination of these maps shows at once that up till 31st January 1902, though there might be a suspicion that there were a few more cases in the neighbourhood of one of the hospitals, yet there was no evidence that the general distribution of the disease in the city was much affected by any but ordinary epidemic influences. The cases for this period were accordingly enumerated in the different areas given by the squares, and the form of the epidemic calculated for both the north-south and east-west distribution of the cases. It was found that the latter was of the expected type, namely, type IV., while the former, being very asymmetrical, comes under type VI. The theoretical maximum of the curves being next calculated, the centre of the epidemic—*i.e.* the locality where, up to this period, the greatest number of cases had occurred—was accurately ascertained; and with this as centre, the distribution of the epidemic in zones around it was ascertained.

It was seen at once that the epidemic, from the point of time at which it started till the 31st of March, groups itself much more naturally around the point which has been found to be the theoretical centre of the epidemic than about the hospital, and that this centre is at a distance of about one mile and a half in a direct line from the area from which infection is supposed to be disseminated. It shows at once the fallacy of calculating the prevalence of the disease in any one district and comparing with the average of the whole town, since, as we see, much the greatest number of the total cases occur in a special area, of which the zone around the hospital forms an important part.

The cases round the Priory Road Hospital, probably spread by the hospital, thus reduce to a very small proportion of the total cases which really have occurred in that zone. That this law of the distribution of the epidemic must be taken into account is easily seen when the distribution of the cases of the disease in

Liverpool is identical with that distribution seen in epidemics where there is no special local predisposing cause (London, 1902).

The incidence of cases in the neighbourhood of the Park Hill Hospital seems, however, in the Liverpool epidemic a more marked example. This case is of very special interest, as a local secondary epidemic occurred in the immediate vicinity of the hospital, beginning in a marked manner six weeks after the acute cases were admitted there. Here two points are again to be noted.

Cases of smallpox had occurred in this area prior to the opening of the hospital; and though these were few in number, there is absolutely nothing in the course of the subsequent epidemic to indicate that they were not the sufficient cause. The course in time is a typical distribution of type IV.,* which has been found to be the general epidemic form. Had special modes of infection played more than a subsidiary part in the development of this wave, there would seem to be a probability that this would not have been the case. There is, therefore, no need to assume special modes of infection. In the second place, the epidemic is so distributed in space as to have its centre three-quarters of a mile from the smallpox hospital; and if this point be joined with the centre of the hospital, it is seen that in the two quadrants which are adjacent to the hospital there are few more cases than in the quadrants which are remote. Here, again, the fallacy of neglecting the real distribution of the cases in space is capable of leading to quite untrustworthy results if the incidences in zones round the hospital are alone considered. So far as can be judged from the map, there is no greater population difference in the distribution of the population in the circle of one-quarter of a mile radius round the theoretical centre of the epidemic, and apparently little in the half-mile zone, while the latter radius includes practically the whole of the cases which strictly belong to this outburst.

Another Local Government Board report has recently been issued regarding the apparent aerial spread of smallpox in the Orsett Union District from the smallpox hospital ships in the adjacent part of the river Thames.

Here, again, when the space and time distributions are examined, there is nothing beyond the fact that the outbreak had its origin

* Table A, No. 16.

in the part of the district nearest to the hospital ships to indicate that the infection was aerial. Any kind of method which would result in the transference of the organism would be sufficient, and all gross methods are, as all who have had experience in working smallpox hospitals know, very difficult to eliminate. The course in time is illustrated in the accompanying diagram, placed for comparison below that of the corresponding epidemic in London (diagrams VIII. and VIIIA.). It will be seen that the period of maximum of the theoretical curves very closely coincides, and that the general course of the two epidemics is too much alike to require the assumption that the Orsett Union outbreak was anything but the development of an ordinary smallpox outbreak (quite possibly due originally to the smallpox ships), resulting from the introduction at a definite time of an organism of a definite infectivity.

CONCLUSIONS.

1. An epidemic is an organic phenomenon, the course of which seems to depend on the acquisition by an organism of a high grade of infectivity at the point where the epidemic starts, this infectivity being lost from that period till the end of the epidemic at a rate approaching to the terms of a geometrical progression.

2. This loss of infectivity, though realised quite clearly by Dr Farr and many other epidemiologists, has not been given the importance which is due to it. For instance, in estimating the conditions of the spread of smallpox from hospitals, it has been assumed that a constant supply of acute cases is necessary, and that, though a good number of convalescent cases are removed into a hospital, there is little risk from these, without examining whether these two factors occurred at different periods of the epidemic, when the infectivity of the organism might be greatly different. Also, in experiments such as the transmission of plague from one animal to another by means of fleas, no regard seems to have been paid to the question as to whether the organism was in a condition to transmit the infection. Attention has only been paid to whether the culture was or was not virulent—a different question altogether. Negative results attained in this manner are clearly worthless.

3. The sudden increase of infectivity in the organism points to the occurrence of some stage in its life-history at present little understood.

4. This increase may happen definitely seasonally, as in scarlet fever and enteric fever, or without apparent reason, as in the case of smallpox, which may continue smouldering in a town for a considerable period, and then suddenly give rise to an epidemic.

5. The whole explanation of the organic course of an epidemic is not to be found in this alone. Other factors, which are not clear, seem to come into play, so as to bring about differences from the form of curve to be expected mathematically on this basis.

6. That the epidemic ends because of the lack of susceptible persons has no evidence in its favour, either from the form of the curve or from the facts: *e.g.*, in the last epidemic of smallpox in London, it can hardly be believed that there were only about 8000 susceptible persons out of a population of more than 5,000,000, and that these were all confined to a small region of London.

7. And lastly, since epidemics of the same disease run pretty much the same course whether they occur in spring, summer, autumn, or winter, it would seem that the condition of the germ has much more to do with the causation of an epidemic than the constitutional peculiarity of the persons affected at the moment.

NOTE ON THE MATHEMATICAL METHOD EMPLOYED IN THIS PAPER.

When any series of measurements are made of any natural object or phenomenon, it is in general seen that these different sizes of this object group themselves in a definite manner. These arrangements have been found by Professor Pearson capable of being represented by a series of curves distinguished as Types I., II., III., IV., V., and VI., which are the solution of the differential equation,

$$\frac{1}{y} \frac{dy}{dx} = - \frac{x}{a + bx + cx^2}$$

The solutions are as follows :—

If $b = c = 0$, then

$$y = y_0 e^{-\frac{x^2}{a^2}}$$

where y_0 is the ordinate at the origin. This is the normal probability curve discovered by Laplace and Gauss.

If the roots of $a + bx + cx^2$ are real,

$$\text{Type I.} \quad y = y_0 \left(1 + \frac{x}{a_1}\right)^{m_1} \left(1 - \frac{x}{a_2}\right)^{m_2} \quad \text{where} \quad \frac{m_1}{m_2} = \frac{a_1}{a_2}$$

If both roots be real and equal,

$$\text{Type II.} \quad y = y_0 \left(1 - \frac{x^2}{a^2}\right)^m$$

If one be infinite, the solution is

$$\text{Type III.} \quad y = y_0 \left(1 + \frac{x}{a}\right)^{\gamma a} e^{-\gamma x}$$

If the roots are imaginary, one solution is

$$\text{Type IV.} \quad y = y_0 \frac{e^{-\nu \tan^{-1} \frac{x}{a}}}{\left(1 + \frac{x^2}{a^2}\right)^m}$$

This last solution is the one which is found to be a good interpolation curve for epidemics.

Types V. and VI. do not concern this paper.

The method of fitting statistics to these curves is thoroughly described in a paper by Professor Pearson in *Biometrika*, vol. i. and vol. ii. part 1, entitled "On the Systematic Fitting of Curves to Observations and Measurements."

The theory by which the curves are derived is fully discussed in the same journal, vol. iv. parts 1 and 2, in a paper written, justifying his methods, by Professor Pearson, entitled "Das Fehlergesetz und seine Verallgemeinerungen durch Fechner und Pearson: A Rejoinder." The subject was originally developed in two papers in the *Philosophical Transactions of the Royal Society*, and is best read in these papers. The references are "Contributions to the Mathematical Theory of Evolution. II. Skew Variation in Homogeneous Material," *Phil. Trans.*, 1895, vol. 186A, page 343; and "X. Supplement to a Memoir on Skew Variations," *Phil. Trans.*, 1901, vol. 197A, page 443.

The symbols used in the paper and table are as follows:— μ_2, μ_3, μ_4 represent the second, third, and fourth moments of the curve round its centre of gravity, and are obtained by multiplying each vertical strip by its corresponding abscissa, squared, cubed, or raised to the fourth power respectively, and dividing by the area of the curve.

For the determination of which curve is to be used in fitting the sign of the quantity $6 + 3\beta_1 - 2\beta_2$ is important, where $\beta_1 = \frac{\mu_3^2}{\mu_2^3}$ and $\beta_2 = \frac{\mu_4}{\mu_2^2}$. For curves of type IV. the sign of this quantity is negative.

The other constant of interest, as indicating the asymmetry of the curve, is d , which is the abscissal distance of the maximal ordinate from that through the centre of gravity.

The value of the other constants will be found in Professor Pearson's papers in the *Philosophical Transactions*

[TABLES.

A.—TABLE OF THE CONSTANTS OF THE THEORETICAL CURVES

TYPE IV.

Disease.	Locality.	Date.	Cases or Deaths.	Unit of Time.	μ_2	μ_3	μ_4	β_1
1. Miliary Fever	Oise . . .	1821	Cases	1 week	7·0285	-4·0867	226·366	·0479
2. Plague	London . .	1665	Deaths	4 weeks	1·7758	1·3117	14·3563	·3072
3. " . . .	" . . .	1563	" . . .	" . . .	6·1454	3·0194	123·7395	·0393
4. Cholera	" . . .	1832	" . . .	1 week	5·2112	9·3849	120·1387	·6223
5. " . . .	Exeter . .	1832	Cases	2 weeks	3·5318	10·1086	98·9950	2·3411
6. Influenza .	London . .	1891	Deaths	" . . .	2·4678	3·08748	27·9962	·6342
7. " . . .	" . . .	1891-2	" . . .	" . . .	2·3093	3·8786	30·5716	1·2217
8. Smallpox .	Warrington .	1743	" . . .	1 month	3·1149	·7893	38·4964	·0206
9. " . . .	Boston . .	1721	" . . .	" . . .	1·3010	-1·2993	8·7323	·7656
	U.S.A.							
10. " . . .	Glasgow . .	1784	" . . .	" . . .	7·8888	2·8044	1·5082	·0161
11. " . . .	Gloucester .	1896	Cases	1 week	21·9069	-5·3486	1640·46	·00272
12. " . . .	" . . .	" . . .	Severe cases	4 weeks	5·7644	·1938	105·39	·00196
13. " . . .	" . . .	" . . .	Deaths	" . . .	5·6492	1·4905	102·115	·01322
14. " . . .	London . .	1902	Cases	" . . .	6·9321	-2·4550	192·8322	·01794
15. " . . .	Orsett Union	" . . .	" . . .	" . . .	3·3240	-·68839	36·5115	·0129
16. " . . .	Liverpool .	1901	" . . .	2 weeks	2·5540	·9005	27·8201	·0487
	(local epidemic)							
17. " . . .	Sheffield .	1887-8	" . . .	4 weeks	7·2097	-·68647	174·6607	·12574
18. Measles .	Glasgow . .	1808	Deaths	1 month	1·7039	1·13235	12·7061	·25920
19. Zymotic Diarrhoea	" . . .	1890-1903	" . . .	2 weeks	6·0870	·21329	115·4617	·00020
20. " . . .	London . .	1854-1903	" . . .	" . . .	4·5056	2·9978	68·2995	·09825
21. " . . .	Manchester .	1878-1887	Cases	1 month	1·4458	·04423	6·2549	·0006
22. " . . .	" . . .	" . . .	Deaths	" . . .	1·62106	-·16702	10·8032	·006
23. " . . .	Islington .	1857-62	Cases ages (1-5)	4 weeks	2·3797	·47904	21·7134	·01703
24. " . . .	" . . .	" . . .	Cases ages (5-)	" . . .	2·10781	-·90887	19·7548	·08724
25. Enteric Fever	Coventry . .	1900	Cases	1 week	1·76744	1·95543	11·71872	·3471
26. " . . .	Rotherham .	1892	" . . .	" . . .	5·27047	5·14338	94·1654	·17811
27. Scarlet Fever	Halifax . .	1880-1	" . . .	2 weeks	1·35199	-1·13994	9·55176	·52582
28. " . . .	Thorshavn .	1873-4	" . . .	1 month	1·83684	3·28100	22·22123	1·7371
29. " . . .	Glasgow . .	" . . .	" . . .	1 day	3·08965	3·18762	43·03616	·34451
30. " . . .	Wimbledon .	" . . .	" . . .	2 days	1·92734	2·60173	26·30963	·94548

TYPE I.

					μ_2	μ_3	μ_4	β_1
31. Enteric Fever	Maidstone .	1900	Cases	3 days	12·0281	26·7769	472·168	·4121
32. Yellow Fever	Demerara . .	1840-1	" . . .	1 month	3·6612	-3·0409	37·5459	·1883
33. Zymotic Diarrhoea	Islington . .	1857-62	Cases under one year	" . . .	1·45193	·57488	4·61391	·10797

B.—TABLE GIVING THE CONSTANTS OF THE THEORETICAL CURVES

					μ_2	μ_3	μ_4	β_1
1. Smallpox .	London . .	N.W. to S.E.	Cases	..	7·4279	7·6882	196·6696	·1442
2. " . . .	Liverpool .	E. & W.	"	4·1247	2·6121	66·1562	·0972
3. " . . .	" . . .	N. & S.	"	1·6609	2·1135	13·0490	·9771
4. Relapsing Fever	Glasgow . .	E. & W.	"	1·5224	·2124	9·7323	·01025

CORRESPONDING TO THE COURSES OF EPIDEMICS.

TYPE IV.

β_2	d	md	r	ν	a		No of Diagram.	Remarks.
4.583	.14798	.6527	6.8217	.9470	5.0493	..	I.	These epidemics are almost identical although the max. of the first was in May and the second in January.
4.5526	.2346	1.2859	8.9635	3.2622	3.5332	..	II.	
4.2209	8.2141	IV.	
4.4240	.71213	6.8129	17.1334	18.931	6.1659	..	V.	
7.9384	.9448	5.5113	9.6667	105.175	.50655	..	V.	
4.5863	.4685	3.7369	13.9478	11.7934	4.4195	..	III.	
5.7329	.5946	4.0726	11.6988	
3.9677	.0824	.4712	9.4378	.8711	5.1049	..	VII.	
5.1578	-.3342	1.3523	10.0932	4.9054	2.7823	..	VI.	
3.5593	.1530	1.2434	14.2556	1.7394	10.1675	
3.4183	-.0905	.8825	17.4959	.8133	18.986	
3.1718	.0479	.9715	38.551	2.5513	14.601	..	IX.	
3.1997	.1181	2.2574	36.2085	5.8743	13.94	..	X.	
4.01274	-.11288	.62727	9.1136	.7625	7.4959	..	VIII.	
3.3046	-.0897	1.17172	24.1147	3.2589	8.6703	..	VIII.A.	
4.2688	
3.35995	.4328	
4.3664	-.2172	1.25287	9.53494	3.55635	3.35904	..	XI.	
3.11622	.01688	.47918	54.7740	1.4512	18.0862	..	XII.	
3.36441	.29294	4.87785	31.3251	..	10.6226	..	XV.	
2.99658	XIII.	
4.1111	-.0318	.1663	8.4564	.405896	3.4727	..	XIV.	
3.8333	.06834	.42576	10.45943	.76214	4.7257	
4.44041	-.12539	.60384	7.6313	1.2489	3.6896	
3.7514	.34452	5.7297	31.26136	3.94458	4.5408	..	XX.	
3.38995	
5.2256	.2482	1.2067	7.7248	3.3742	2.7633	..	XVIII.	
6.5863	.5151	3.5450	11.7664	4.8054	.86803	..	XIX.	
4.5083	.34823	2.01485	9.5718	4.05043	4.76246	..	XXIII.	
7.08272	.32812	1.27706	5.78413	2.68123	2.75496	..	XXII.	

Normal curve.

TYPE I.

β_2	r	m_1	m_2	a_1	a_2	d	
3.2638	15.6768	XXI.
2.7998	10.0166	2.1776	5.8390	3.708	9.942	.6224	XVI.
2.7010	3.33101	1.7606	6.6703	1.7773	6.7345	.5824	..

CORRESPONDING TO THE DISTRIBUTION OF EPIDEMICS IN CITIES.

	r	d	md	ν	a		
3.5645	20.8514	.4269	4.8780	9.1465	11.1204	..	XXVI. Type IV.
3.8885	7.3258	Type IV.
4.7303	Type VI.
4.0435	8.8507	.0440	.2388	.6127	3.451	..	Type IV.

A.—TABLE OF THE CONSTANTS OF THE THEORETICAL CURVES

TYPE IV.

Disease.	Locality.	Date.	Cases or Deaths.	Unit of Time.	μ_2	μ_3	μ_4	β_1
1. Miliary Fever	Oise . . .	1821	Cases	1 week	7·0285	-4·0867	226·366	·0479
2. Plague	London . .	1655	Deaths	4 weeks	1·7758	1·3117	14·3563	·3072
3. " "	" " "	1653	" "	" "	6·1454	3·0194	123·7395	·0393
4. Cholera	" " "	1832	" "	1 week	5·2112	9·3349	120·1387	·6235
5. " "	Exeter . .	1832	Cases	2 weeks	3·5318	10·1086	98·9850	2·3411
6. Influenza	London . .	1891	Deaths	" "	2·4578	3·08748	27·9662	·6342
7. " "	" " "	1891-2	" "	" "	2·3093	3·8786	30·5716	1·2317
8. Smallpox	Warrington .	1743	" "	1 month	3·1149	·7893	38·4964	·0206
9. " "	Boston . .	1721	" "	" "	1·3010	-1·2993	8·7823	·7656
10. " "	U.S.A.	1784	" "	" "	7·8888	2·8044	1·5682	·0151
11. " "	Glasgow . .	1896	Cases	1 week	21·9009	-5·3486	1640·46	·00272
12. " "	Gloucester .	" "	Severe	4 weeks	5·7644	·1938	105·39	·00196
13. " "	" "	" "	cases	" "	5·6492	1·4905	102·115	·01392
14. " "	London . .	1902	Deaths	" "	6·9821	-2·4550	192·8822	·01794
15. " "	Orsett Union	" "	Cases	" "	3·3240	-·68839	35·5115	·0129
16. " "	Liverpool .	1901	" "	2 weeks	2·5540	·9005	27·8201	·0487
	(local epidemic)							
17. " "	Sheffield .	1857-8	" "	4 weeks	7·2097	-·68547	174·5507	·12574
18. Measles	Glasgow . .	1808	Deaths	1 month	1·7039	1·13235	12·7061	·2520
19. Zymotic Diarrhoea	" " "	1890-1903	" "	2 weeks	5·0870	·21329	115·4017	·00020
20. " "	London . .	1854-1903	" "	" "	4·5656	2·9978	68·2995	·09325
21. " "	Manchester .	1878-1887	Cases	1 month	1·4458	·04423	6·2549	·0006
22. " "	" " "	" "	Deaths	" "	1·62105	-·15702	10·8032	·005
23. " "	Islington . .	1857-62	Cases	4 weeks	2·3797	·47904	21·7134	·01703
			ages (1-5)	" "				
24. " "	" " "	" "	Cases	" "	2·10781	-·90387	19·7548	·08724
			ages (5-)	" "				
25. Enteric Fever	Coventry . .	1900	Cases	1 week	1·76744	1·95543	11·71872	·3471
26. " "	Rotherham .	1892	" "	" "	5·27047	5·14338	94·1654	·17811
27. Scarlet Fever	Halifax . .	1880-1	" "	2 weeks	1·35199	-1·13994	9·55176	·52582
28. " "	Thorshavn .	1873-4	" "	1 month	1·83684	3·28100	22·22123	1·7371
29. " "	Glasgow . .	" "	" "	1 day	3·03995	3·18752	43·03516	·34451
30. " "	Wimbledon .	" "	" "	2 days	1·92734	2·60173	26·30963	·94543

TYPE I.

				μ_2	μ_3	μ_4	β_1	
31. Enteric Fever	Maidstone .	1900	Cases	3 days	12·0281	26·7769	472·168	·4121
32. Yellow Fever	Demerara . .	1840-1	" "	1 month	3·6612	-3·0409	37·5459	·1883
33. Zymotic Diarrhoea	Islington . .	1857-62	Cases under one year	" "	1·45193	·57488	4·51391	·10797

B.—TABLE GIVING THE CONSTANTS OF THE THEORETICAL CURVES

				μ_2	μ_3	μ_4	β_1	
1. Smallpox .	London . .	N.W. to S.E.	Cases	..	7·4279	7·6882	190·5696	·1442
2. " "	Liverpool .	E. & W.	" "	" "	4·1247	2·6121	66·1662	·0972
3. " "	" " "	N. & S.	" "	" "	1·6609	2·1135	13·0490	·8771
4. Relapsing Fever	Glasgow . .	E. & W.	" "	" "	1·5224	·2124	9·7323	·01025

CORRESPONDING TO THE COURSES OF EPIDEMICS.

TYPE IV.

β_2	d	md	r	ν	a	No of Diagram.	Remarks.
4·583	·14798	·5527	6·8217	·9470	5·0493	..	I.
4·5526	·2346	1·2859	8·9535	3·2622	3·5332	..	II.
4·2209	8·2141	III.
4·4240	·71213	6·8129	17·1534	18·931	6·1659	..	IV.
7·9384	·9448	5·5113	9·6667	105·175	·50555	..	V.
4·5863	·4685	3·7369	13·0478	11·7934	·44195	..	III.
5·7329	·5946	4·0726	11·6988
3·9677	·0824	·4712	9·4373	·8711	5·1049	..	VII.
5·1578	-·3342	1·3523	10·0932	4·9054	2·7823	..	VI.
3·5598	·1530	1·2434	14·2556	1·7394	10·1675
3·4183	-·0905	·8825	17·4959	·8133	18·986
3·1718	·0479	·9715	38·551	2·5613	14·901	..	IX.
3·1997	·1181	2·2574	36·2085	5·8743	13·94	..	X.
4·01274	-·11288	·62727	9·1136	·7625	7·4959	..	VIII.
3·3046	-·0897	1·17172	24·1147	3·2889	8·6703
4·2588
3·35995	·4328
4·3664	-·2172	1·25237	9·53494	3·56635	3·35904	..	XI.
3·11622	·01688	·47918	54·7740	1·4512	18·0862	..	XII.
3·25441	·29294	4·87785	31·3251	..	10·6226	..	XV.
2·99658	XIII.
4·1111	-·0318	1·063	8·4564	·40586	3·4727	..	XIV.
3·8333	·06834	·42576	10·45943	·76214	4·7257
4·44041	-·12539	·60384	7·6313	1·2489	3·5896
3·7514	·34452	5·7297	31·26136	3·94458	4·5408	..	XX.
3·38995
5·2256	·2482	1·2067	7·7248	3·3742	2·7533	..	XVIII.
5·5863	·5151	3·5450	11·7564	4·8054	·86803	..	XIX.
4·5083	·34823	2·01485	9·5718	4·05043	4·76246	..	XXIII.
7·98372	·3812	1·27706	5·78413	2·68123	2·75496	..	XXII.

These epidemics are almost identical although the max. of the first was in May and the second in January.

Normal curve.

TYPE I.

β_2	r	m_1	m_2	a_1	a_2	d	
3·2638	15·6768	XXI.
2·7998	10·0166	2·1776	5·8390	3·708	9·942	·6294	XVI.
2·7010	3·33101	1·7606	5·6703	1·7773	6·7345	·5824	..

CORRESPONDING TO THE DISTRIBUTION OF EPIDEMICS IN CITIES.

	r	d	md	ν	a		
3·5545	20·8514	·4269	4·8780	9·1465	11·1204	..	XXVI. Type IV.
3·8885	7·3258	Type IV.
4·7303	Type VI.
4·0435	8·8507	·0440	·2388	·6127	3·451	..	Type IV.

On a Simple Way of Obtaining the Half-Shade Field in Polarimeters. By James Robert Milne, B.Sc., Carnegie Research Fellow.

(Read July 16, 1906. MS. received October 5, 1906.)

SUMMARY.

The half-shade effect in polarimeters is usually obtained, either by the well-known method of Laurent, or else by the more recent method of Lippich.* In the former a quartz plate is employed to give the necessary rotation to one-half of the beam of polarised light propagated through the instrument; in the latter, a Nicol prism additional to the polariser serves the same end.

It occurred to the author that the required effect might be obtained very simply by merely interposing a glass plate in the beam of light, so that half the beam traversed it, in an oblique direction. It follows at once, from Fresnel's laws of the intensity of refracted light, that this will produce a slight rotation of the vibration-direction in the traversing half of the beam.

In practice the method is found to give very good results.†

THEORY OF THE METHOD.

Let a parallel beam of plane polarised light proceeding in the direction OZ (fig. 1) meet the glass plate $OQRV$ as shown. Let OP represent the light vibration both in direction and amplitude; and let the angle QOY be the angle of polarisation for glass. On resolving OP along OX and OY , the latter component will be transmitted through the glass with undiminished amplitude, but the former will have its amplitude OS reduced to (say) OS' .

* For a description of the latter, see, for instance, Landolt's "Das optische Drehungsvermögen."

† The author afterwards learned that the same principle of rotation by selective reflection had already been applied to the polarimeter, although in a different manner, by Professor Poynting. See *A Method of Making a Half-Shadow Field in a Polarimeter* by two Inclined Glass Plates, by J. H. Poynting, Sc.D., F.R.S.; *B. A. Report*, p. 662, 1899; also *Catalogue of the Optical Convention*, p. 224, 1905.

On recombining the two components, the new direction of light vibration is OP' , giving an angle of rotation of POP' . The magnitude of this angle depends on the angle of inclination QOY of the plate: and on the direction of the light vibration (defined by the angle POX say). As regards the effect of the first of these, it is

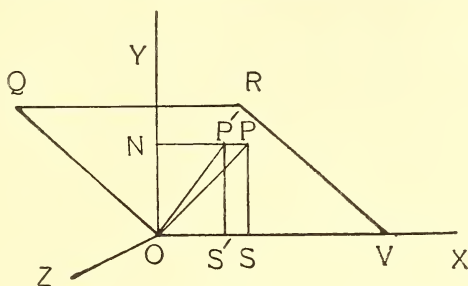

FIG. 1.

clear that if the angle be made less than the angle of polarisation, then the component along OY will suffer loss as well as the component along OX (though, as may easily be shown, always to a less degree), and the angle POP' will be diminished. As regards the effect of the second factor, it appears from the diagram that POP' is a maximum when POX is in the neighbourhood of 45° ,* and that POP' gradually declines to zero as POX proceeds towards either 0° or 90° . To obtain the value of the maximum rotation let

$$QOY = 57^\circ\frac{1}{2}, POX = 45^\circ, \text{ and } OS = 1;$$

then if ρ be the fraction of the light energy polarised in the plane of incidence which is reflected from the front surface of the plate, by Fresnel's formula,

$$\begin{aligned} \rho &= \sin^2(i-r) = \sin^2[57^\circ\frac{1}{2} - (90^\circ - 57^\circ\frac{1}{2})] \\ \rho &= \sin^2 25^\circ = 0.1786. \end{aligned}$$

But the same fraction of the incident light is reflected from the back surface as from the front, hence the amplitude after transmission through both surfaces is given by

$$OS' = 1 - \rho = 0.821.$$

But $[\tan P'OY = OS']$;
therefore $POP' = 45^\circ - 39^\circ\frac{1}{2} = 5^\circ\frac{1}{2}$.

* More exactly $42^\circ.2$.

This rotation is more than is usually required in a polarimeter, but it can be reduced to any desired degree; either by turning the glass plate about the axis OX, so as to decrease the angle Q O Y, or by altering the vibration-direction OP of the light, so as to change the angle P O X.

It will be noticed that this device has the advantage over that of Laurent, that the same plate may be used with *any* colour of light. In illustration of the point, it may be mentioned that the writer is at present using the arrangement described later in a spectro-polarimeter, where it is giving very satisfactory results.

THE METHOD IN PRACTICE.

It is obvious that there are various ways in which this half-shade method might be applied in practice. The author experimented with a number of different schemes, and was led to the conclusions now to be briefly indicated.

In any apparatus of this kind, it is first of all requisite that the two halves of the field shall not be separated by a dark band, but shall be brought perfectly in contact. This condition may be fulfilled by grinding off the top edge of the inclined glass plate so that it makes only a very small angle with the direction of the light rays.

The diagram shows the position of the glass relative to the

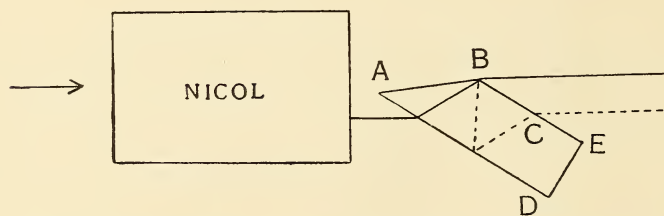

FIG. 2.—The broken line indicates the path of one of the multiple reflections.

polariser. The rays of light fall on the plate at the polarising angle, say $57\frac{1}{2}^\circ$. The upper surface AB is opposite to the middle of the Nicol, and is very slightly inclined downwards from B to A. This ensures that there will be no gap between the edge B and the upper half of the beam. On the other hand, there can be no gap

between the edge B and the lower half of the beam, because the rays which enter A D are, on account of their refraction, more inclined upwards than the surface A B.

The rays which strike the surface A B, whether internally or externally, are reflected by it harmlessly aside out of the way, as may easily be shown.

At C, where the first multiple reflection emerges from the glass, a change of intensity occurs, the two portions of the surface, B C and C E, appearing of different brightness to the eye. This makes it necessary to screen off all the surface beyond C, and to use the portion B C only. The explanation of the change of intensity lies in the fact that beyond C the light emerges elliptically polarised, being a combination of rectilinear vibrations rotated to different extents, due to the direct and to the retransmitted rays respectively.

Now it might be supposed that the necessity for limiting the field could be avoided by using an exceedingly thin plate of glass so that C would sensibly coincide with B. This would mean, however, that the light proceeding from each point of the surface would be polarised in a slightly elliptical manner (which is attested in practice by the fact that it is impossible with any position of the analyser to obtain complete extinction over the rotated half of the field). Now it may be shown from the mathematical theory of the polarimeter, that in such circumstances the sensitiveness of the instrument must be somewhat impaired. It can be shown, however, that the ellipticity is very slight, and in practice the author has found that very good results may be obtained by this method; and that with nothing more elaborate in the way of apparatus than a microscope cover-glass cemented to a piece of cork, fixed slantwise behind the polariser.

For the better plan of the thick plate there is necessary a piece of plain parallel glass, optically unstrained, and having one edge ground off at the proper angle, and subsequently polished. A piece of plate glass can be selected which is sufficiently good to fulfil all requirements. The thickness of the plate is determined by the desired area of the field—it can easily be proved that in fig. 2 the connection between the dimensions of B C and D E is, $BC = \frac{2}{\mu} DE$. The plate is to be securely mounted behind the

polarising Nicol as shown in the figure, and so arranged that the Nicol can be rotated without disturbing the glass (or else *vice versa*). The object of such relative rotation is to provide a means of altering the angle $P O X$ of fig. 1, and therefore the angle $P O P'$ as explained already; and therefore the sensitiveness of the half-shade field. The alternative method of effecting such a change, by altering the angle $Q O Y$, cannot be employed, because it would require the angle $B A D$ of fig. 2 to be capable of alteration; which of course is impossible. With this type of rotator a "triple-field," a form that is preferred by some observers to the more usual double one, can of course be easily arranged by the provision of a second glass plate mounted on the opposite side of the Nicol. The middle part of the beam of light then passes unaffected, while both its side portions are rotated to an equal extent in the same direction.

The author desires to express his best thanks to Professor MacGregor for the opportunity of carrying out the necessary experimental work in the Physical Laboratory of Edinburgh University.

(Issued separately January 14, 1907.)

On an Exception to a Certain Theorem in Optics, with an Application to the Polarimeter. By James Robert Milne, B.Sc., Carnegie Research Fellow.

(Read July 16, 1906. MS. received October 15, 1906.)

[*Abstract.*]

There is a well-known law in geometrical optics, that the "intrinsic luminosity" of the image formed by any lens system whatever is the same as the intrinsic luminosity of the object. An exception, however, which seems not to have been pointed out before, exists in the case of polarised light, based on the fact that by the agency of a double-image prism two light rays polarised in directions mutually perpendicular may be combined into one ray, which carries the total energy of both. In this way an intrinsic luminosity of image can be attained which is twice as great as that of the object.

Now, because the iris opening of the eye is of a fixed size, the

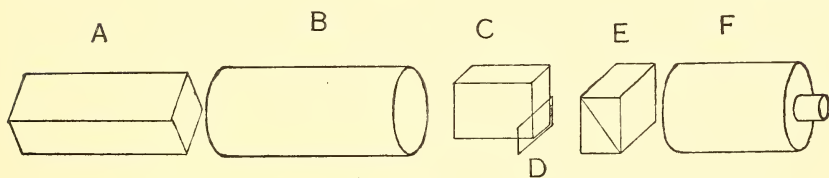

FIG. 3.

only way of increasing the brightness of a retinal image is to increase its intrinsic luminosity; hence it is in connection with images formed in the eye that the above principle has its chief interest.

The application to the case of the polarimeter is shown diagrammatically in fig. 3. A is the polarising Nicol; B the tube for the liquid; C a Nicol half-covering the field as in Lippich's half-shade device (or instead, there may be used the half-shade

device of the preceding paper), and so placed that the division of the field is vertical; D, a quartz plate giving a rotation of 90° to the lower half of the field; E, a double-image prism of such angular strength that the upper and lower halves of the field are superposed in the eye of the observer; and F, the usual telescope, focussed on the dividing edge of C. E acts as analyser for both the upper and lower halves of the field; for their respective plans of polarisation, having been made mutually perpendicular by D, are symmetrically disposed to the two vibration-directions of the double-image prism respectively. Measurements are made by rotating, not E, but A.

The advantage of this arrangement is that it produces a field of view, the illumination of which is twice that of the ordinary field. A much reduced half-shade angle can therefore be employed, from which there results, of course, a corresponding increase in the accuracy of the instrument.

(Issued separately January 14, 1907.)

The Hessians of Certain Invariants of Binary Quantics.

By Thomas Muir, LL.D.

(MS. received August 11, 1906. Read November 5, 1906.)

(1) The cubinvariant J of a binary quartic being

$$ace + 2bcd - ad^2 - b^2e - c^3 \quad \text{or} \quad \begin{vmatrix} a & b & c \\ b & c & d \\ c & d & e \end{vmatrix}$$

its Hessian, $H(J)$, is

$$\begin{vmatrix} . & . & e & -2d & c \\ . & -2e & 2d & 2c & -2b \\ e & 2d & -6c & 2b & a \\ -2d & 2c & 2b & -2a & . \\ c & -2b & a & . & . \end{vmatrix}$$

Performing on this the operations

$$c \cdot \text{col}_3 - e \cdot \text{col}_5, \quad c \cdot \text{col}_4 + 2d \cdot \text{col}_5,$$

and on the result the operations

$$c \cdot \text{row}_3 - e \cdot \text{row}_5, \quad c \cdot \text{row}_4 + 2d \cdot \text{row}_5,$$

we obtain

$$\begin{aligned} c^4 \cdot H(J) &= -8c^2 \begin{vmatrix} -e & cd+be & c^2-2bd \\ cd+be & -3c^2-ace & bc^2+acd \\ c^2-2bd & bc^2+acd & -ac^2 \end{vmatrix}, \\ &= -8c^3 \begin{vmatrix} -ce & cd+be & c^2-2bd \\ cd+be & -3c^2-ae & bc+ad \\ c^2-2bd & bc+ad & -ac \end{vmatrix}. \end{aligned}$$

The three-line determinant here is seen to contain c as a factor, because it manifestly vanishes when c is put equal to 0. A full resolution of it into factors, however, is got by multiplying it by the determinant form of J , an operation which curiously enough leads to the equation

$$\begin{aligned}
J \cdot c \cdot H(J) &= -8 \begin{vmatrix} d(bc - ad) - J & -2d(bd - c^2) & d(cd - be) \\ -2c(bc - ad) & 4c(bd - c^2) - J & -2c(cd - be) \\ b(bc - ad) & -2b(bd - c^2) & b(cd - be) - J \end{vmatrix}, \\
&= -8[-J^3 + J^2\{b(cd - be) + 4c(bd - c^2) + d(bc - ad)\}], \\
&= 8J^2 \begin{vmatrix} a & b & c \\ b & c & d \\ c & d & e \end{vmatrix} - b(cd - be) - 4c(bd - c^2) - d(bc - ad), \\
&= 8J^2 \begin{vmatrix} a & b & c \\ . & c & . \\ c & d & e \end{vmatrix} - 4c(bd - c^2), \\
&= 8J^2 \cdot c \cdot (ae + 3c^2 - 4bd),
\end{aligned}$$

whence we have

$$H(J) = 8JI;$$

so that, in words, our result is—*The Hessian of the cubinvariant of a binary quartic is 8 times the product of the said invariant by the quadrinvariant.*

(2) The next invariant of a similar kind belongs to the binary sextic, its Hessian being a seven-line determinant with quadratic elements. Unfortunately the process just followed does not continue to be useful. Other considerations, however, seem to show that in this case also the invariant is a factor of its own Hessian; and that very probably there exists the theorem that *the Hessian of a persymmetric determinant of $2n - 1$ independent elements contains as a factor the $(n - 2)^{\text{th}}$ power of the said determinant.* As for the cofactor, its nature is unknown; save that when $n = 4$, and when therefore the cofactor is of the 6th degree in the elements of the determinant

$$\begin{vmatrix} a & b & c & d \\ b & c & d & e \\ c & d & e & f \\ d & e & f & g \end{vmatrix},$$

we can easily show that it is neither the sextinvariant of the sextic nor the third power of the quadrinvariant.

(3) Turning now to the binary cubic and to its unique invariant

$$6abcd + 3b^2c^2 - a^2d^2 - 4ac^3 - 4b^3d \quad \text{or} \quad I_{3,4}$$

we see that the Hessian of the latter is

$$144 \begin{vmatrix} -d^2 & cd & bd - 2c^2 & 3bc - 2ad \\ 3cd & c^2 - 4bd & ad + 2bc & 3ac - 6b^2 \\ 3bd - 6c^2 & ad + 2bc & b^2 - 4ac & 3ab \\ 3bc - 2ad & ac - 2b^2 & ab & -a^2 \end{vmatrix} \equiv 144 \odot \text{ say.}$$

Two facts are then recalled from the early days of the algebra of quantics: (1) Cayley's statement (1847) that the said Hessian * contains as a factor the second power of the invariant from which it is derived; (2) Eisenstein's observation (1844) that by substituting

$$\left. \begin{aligned} 3abc - a^2d - 2b^3 \\ 2ac^2 - abd - b^2c \\ acd - 2b^2d + bc^2 \\ ad^2 - 3bcd + 2c^3 \end{aligned} \right\} \text{ for } \begin{cases} a, \\ b, \\ c, \\ d, \end{cases}$$

respectively, $I_{3,4}$ is raised to the third power. These facts have long since been absorbed in larger truths; but it does not appear to have been pointed out that there exists a formal operational connection between the two.

In the case of § 1, the invariant was a determinant of the 3rd order, while its Hessian was of the 5th, and a preliminary transformation was consequently necessary in order to prepare for multiplication. Here both determinants are of the same order at the outset. Multiplying therefore at once \odot by $I_{3,4}$ in its discriminant form

$$\begin{vmatrix} a & 2b & c & . \\ . & a & 2b & c \\ . & b & 2c & d \\ b & 2c & d & . \end{vmatrix}$$

we obtain

$$\begin{vmatrix} \frac{1}{2}\frac{\partial I}{\partial a} & \frac{2}{3}\frac{\partial I}{\partial b} & \frac{5}{6}\frac{\partial I}{\partial c} & \frac{\partial I}{\partial d} \\ -\frac{1}{6}\frac{\partial I}{\partial b} & -\frac{1}{3}\frac{\partial I}{\partial c} & -\frac{1}{2}\frac{\partial I}{\partial d} & . \\ \frac{\partial I}{\partial a} & \frac{5}{6}\frac{\partial I}{\partial b} & \frac{2}{3}\frac{\partial I}{\partial c} & \frac{1}{2}\frac{\partial I}{\partial d} \\ . & -\frac{1}{2}\frac{\partial I}{\partial a} & -\frac{1}{3}\frac{\partial I}{\partial b} & -\frac{1}{6}\frac{\partial I}{\partial c} \end{vmatrix},$$

* Of course not so spoken of by him at that date.

or

$$\frac{(-1)^2}{6^4} \begin{vmatrix} a & 4\beta & 5\gamma & 2\delta \\ \beta & 2\gamma & \delta & . \\ 2a & 5\beta & 4\gamma & \delta \\ . & a & 2\beta & \gamma \end{vmatrix}$$

if we denote the four differential-quotients by $2a$, 6β , 6γ , 2δ respectively. As, however, the operations

$$\text{row}_1 - 2 \text{row}_3, \quad \div 3, \quad \text{row}_3 + 2 \text{row}_1$$

change the last determinant into

$$\begin{vmatrix} -a & -2\beta & -\gamma & . \\ \beta & 2\gamma & \delta & . \\ . & \beta & 2\gamma & \delta \\ . & a & 2\beta & \gamma \end{vmatrix},$$

that is to say, into the result of Eisenstein's substitution, the summary of our operations is

$$\Theta \cdot I_{3,4} = \frac{3}{6^4} (I_{3,4})^3$$

whence we have

$$H(I_{3,4}) = \frac{1}{3} (I_{3,4})^2.$$

(*Issued separately January 16, 1907.*)

The Sum of the r -line Minors of the Square of a Determinant. By Thomas Muir, LL.D.

(MS. received September 3, 1906. Read November 5, 1906.)

(1) If we temporarily denote the product of the r^{th} and s^{th} rows of a determinant Δ by rs , we shall have conveniently

$$\begin{vmatrix} a_1 & a_2 & a_3 & a_4 \\ b_1 & b_2 & b_3 & b_4 \\ c_1 & c_2 & c_3 & c_4 \\ d_1 & d_2 & d_3 & d_4 \end{vmatrix}^2 = \begin{vmatrix} 11 & 12 & 13 & 14 \\ 12 & 22 & 23 & 24 \\ 13 & 23 & 33 & 34 \\ 14 & 24 & 34 & 44 \end{vmatrix}.$$

The sum of the elements of the latter determinant is evidently

$$11 + 22 + 33 + 44 + 2 \cdot (12 + 13 + 14 + 23 + 24 + 34),$$

and therefore may be written in ultra-symbolical form as a square, namely

$$(1 + 2 + 3 + 4)^2,$$

or, with greater and quite sufficient fulness,

$$\{(a_1, a_2, a_3, a_4) + (b_1, b_2, b_3, b_4) + (c_1, c_2, c_3, c_4) + (d_1, d_2, d_3, d_4)\}^2.$$

This being equal to

$$\sum (a_1, a_2, a_3, a_4) \times (a_1, a_2, a_3, a_4) + 2 \sum (a_1, a_2, a_3, a_4) \times (b_1, b_2, b_3, b_4),$$

let us attend to the terms in it which only contain letters with the suffix 1. Of these there are manifestly under the first Σ

$$a_1^2, b_1^2, c_1^2, d_1^2,$$

and under the second Σ

$$2a_1b_1, 2a_1c_1, 2a_1d_1, 2b_1c_1, 2b_1d_1, 2c_1d_1:$$

so that the aggregate is $(a_1 + b_1 + c_1 + d_1)^2$. Similarly the sum of the terms in which the suffix 2 occurs is $(a_2 + b_2 + c_2 + d_2)^2$; and so as to the other suffixes. Further, there are no terms involving a variety of suffixes: consequently we have as the full result

$$(a_1 + b_1 + c_1 + d_1)^2 + (a_2 + b_2 + c_2 + d_2)^2 + (a_3 + b_3 + c_3 + d_3)^2 + (a_4 + b_4 + c_4 + d_4)^2;$$

and the general theorem—*The sum of the elements of the square of a determinant of the nth order is expressible as the sum of n squares, each of which is the square of the sum of the elements of a column of the original determinant.*

(2) It is easily seen what change is necessary when, in squaring, the multiplication is performed in column-by-column fashion. When row-by-column multiplication is used, the result is no longer a sum of squares but is a sum of binary products each of which has for its first factor the sum of the elements of a row, and for its second factor the sum of the elements of a corresponding column. Denoting by R_r the sum of the elements of the r^{th} row, and by C_r the sum of the elements of the r^{th} column, we see therefore that the sum of the elements of Δ^2

$$\begin{aligned} &= C_1^2 + C_2^2 + \dots + C_n^2 \quad \text{when } \Delta^2 = \Delta \times_{rr} \Delta, \\ &= R_1^2 + R_2^2 + \dots + R_n^2 \quad \text{when } \Delta^2 = \Delta \times_{cc} \Delta, \\ &= R_1 C_1 + R_2 C_2 + \dots + R_n C_n \quad \text{when } \Delta^2 = \Delta \times_{rc} \Delta. \end{aligned}$$

(3) Turning now to the 36 two-line minors of Δ^2 we see that they are

$$\begin{aligned} &\left| \begin{array}{cc} 11 & 12 \\ 12 & 22 \end{array} \right|, \left| \begin{array}{cc} 11 & 13 \\ 12 & 23 \end{array} \right|, \left| \begin{array}{cc} 11 & 14 \\ 12 & 24 \end{array} \right|, \left| \begin{array}{cc} 12 & 13 \\ 22 & 23 \end{array} \right|, \dots, \left| \begin{array}{cc} 13 & 14 \\ 23 & 24 \end{array} \right| \\ &\left| \begin{array}{cc} 11 & 12 \\ 13 & 23 \end{array} \right|, \left| \begin{array}{cc} 11 & 13 \\ 13 & 33 \end{array} \right|, \dots, \left| \begin{array}{cc} 13 & 14 \\ 33 & 34 \end{array} \right| \\ &\left| \begin{array}{cc} 11 & 12 \\ 14 & 24 \end{array} \right|, \dots, \left| \begin{array}{cc} 13 & 14 \\ 34 & 44 \end{array} \right| \\ &\dots \\ &\left| \begin{array}{cc} 13 & 23 \\ 14 & 24 \end{array} \right|, \dots, \left| \begin{array}{cc} 33 & 34 \\ 34 & 44 \end{array} \right|, \end{aligned}$$

the array being of course axisymmetric. The first of the 36 is

$$\left| \begin{array}{cccc} a_1 & a_2 & a_3 & a_4 \\ b_1 & b_2 & b_3 & b_4 \end{array} \right| \cdot \left| \begin{array}{cccc} a_1 & a_2 & a_3 & a_4 \\ b_1 & b_2 & b_3 & b_4 \end{array} \right| \quad \text{or} \quad \left| \begin{array}{c} \text{row}_1 \\ \text{row}_2 \end{array} \right|^2 \text{ say :}$$

the second, which occurs twice, is

$$\left| \begin{array}{c} \text{row}_1 \\ \text{row}_2 \end{array} \right| \cdot \left| \begin{array}{c} \text{row}_1 \\ \text{row}_3 \end{array} \right|;$$

and so on. Therefore, just as in the previous case, the sum may be expressed in the very contracted form

$$\left\{ \begin{array}{c} \text{row}_1 \\ \text{row}_2 \end{array} \right| + \left| \begin{array}{c} \text{row}_1 \\ \text{row}_3 \end{array} \right| + \left| \begin{array}{c} \text{row}_1 \\ \text{row}_4 \end{array} \right| + \left| \begin{array}{c} \text{row}_2 \\ \text{row}_3 \end{array} \right| + \left| \begin{array}{c} \text{row}_2 \\ \text{row}_4 \end{array} \right| + \left| \begin{array}{c} \text{row}_3 \\ \text{row}_4 \end{array} \right| \Big\}^2$$

or

$$\sum \left| \begin{array}{c} \text{row}_r \\ \text{row}_s \end{array} \right|^2 + 2 \sum \left| \begin{array}{c} \text{row}_r \\ \text{row}_s \end{array} \right| \cdot \left| \begin{array}{c} \text{row}_{r'} \\ \text{row}_{s'} \end{array} \right|$$

where r, s is any pair of the integers 1, 2, 3, 4, and r', s' any other pair. Falling back, however, on the lengthier form, it is next seen that each of the 36 parts of it is expressible as the sum of six products; for example, the first

$$\left| \begin{array}{cccc} a_1 & a_2 & a_3 & a_4 \\ b_1 & b_2 & b_3 & b_4 \end{array} \right|^2 = |a_1b_2|^2 + |a_1b_3|^2 + |a_1b_4|^2 + |a_2b_3|^2 + |a_2b_4|^2 + |a_3b_4|^2 :$$

so that altogether we have 216 products of pairs of two-line minors of the original determinant. Keeping an eye on those having only the suffixes 1, 2 we find under the first Σ

$$|a_1b_2|^2 + |a_1c_2|^2 + |a_1d_2|^2 + |b_1c_2|^2 + |b_1d_2|^2 + |c_1d_2|^2,$$

and under the second Σ

$$2\{ |a_1b_2| \cdot |a_1c_2| + |a_1b_2| \cdot |a_1d_2| + \dots \},$$

and therefore in all

$$\{ |a_1b_2| + |a_1c_2| + |a_1d_2| + |b_1c_2| + |b_1d_2| + |c_1d_2| \}^2.$$

A similar result is of course got by considering any other pair of suffixes; and, as there are six such pairs, our final result is

$$\{ |a_1b_2| + |a_1c_2| + \dots + |c_1d_2| \}^2 + \{ |a_1b_3| + |a_1c_3| + \dots + |c_1d_3| \}^2 \\ + \{ |a_1b_4| + |a_1c_4| + \dots + |c_1d_4| \}^2 + \{ |a_2b_3| + |a_2c_3| + \dots + |c_2d_3| \}^2 \\ + \{ |a_2b_4| + |a_2c_4| + \dots + |c_2d_4| \}^2 + \{ |a_3b_4| + |a_3c_4| + \dots + |c_3d_4| \}^2.$$

We have thus a theorem exactly analogous to that formulated in § 1 and reached in a perfectly similar way,—a way, too, which is seen to be just as readily applicable in the case of three-line minors, four-line minors, etc. The following generalisation may consequently be viewed as established—*The sum of the r-line minors of Δ^2 is equal to the sum of $\binom{n}{r}$ squares, each of which is the square of the sum of the r-line minors formable from a set of r columns of Δ .*

(4) An especially interesting case is that where $r=n-1$, the theorem then being—*The sum of the primary minors of Δ^2 is equal to the sum of n squares, each of which is the square of the sum of the elements of a column of the adjugate of Δ .* This may be established independently by starting from a known theorem regarding the ‘bordering’ of the product of two determinants (*Messenger of Math.*, xi., year 1882, pp. 161–165). For the third order this theorem is

$$- \begin{vmatrix} \cdot & \alpha_0 & \beta_0 & \gamma_0 \\ \alpha_0 & \times & | \alpha_1 \beta_2 c_3 | \\ b_0 & | \alpha_1 \beta_2 \gamma_3 | \\ c_0 \end{vmatrix} = | \alpha_0 \beta_1 c_2 | \cdot | \alpha_0 \beta_1 \gamma_2 | + | \alpha_0 \beta_1 c_3 | | \alpha_0 \beta_1 \gamma_3 | \\ + | \alpha_0 \beta_2 c_3 | \cdot | \alpha_0 \beta_2 \gamma_3 |,$$

and making an evident specialisation we have

$$- \begin{vmatrix} \cdot & 1 & 1 & 1 \\ 1 & | \alpha_1 \beta_2 c_3 |^2 \\ 1 & | \alpha_1 \beta_2 c_3 |^2 \\ 1 \end{vmatrix} = \begin{vmatrix} 1 & \alpha_1 & \alpha_2 \\ 1 & \beta_1 & \beta_2 \\ 1 & c_1 & c_2 \end{vmatrix}^2 + \begin{vmatrix} 1 & \alpha_1 & \alpha_3 \\ 1 & \beta_1 & \beta_3 \\ 1 & c_1 & c_3 \end{vmatrix}^2 + \begin{vmatrix} 1 & \alpha_2 & \alpha_3 \\ 1 & \beta_2 & \beta_3 \\ 1 & c_2 & c_3 \end{vmatrix}^2.$$

Now the left-hand member here is equal to the sum of the signed primary minors of $| \alpha_1 \beta_2 c_3 |^2$ (*Proc. Roy. Soc. Edin.*, xxiv. pp. 387–392); and the right-hand member is equal to

$$(A_3 + B_3 + C_3)^2 + (A_2 + B_2 + C_2)^2 + (A_1 + B_1 + C_1)^2.$$

That ‘unsigned’ may legitimately be substituted for ‘signed’ is made evident on bordering with 1, -1, 1 instead of 1, 1, 1.

(5) In the theorem of § 3 it is the sum of *all* the r -line minors that we are concerned with: there is, however, an equally important theorem when we confine ourselves to the *coaxial* minors. It is—*The sum of the coaxial r -line minors of Δ^2 is equal to the sum of the squares of all the r -line minors of Δ .*

No formal proof need be given in view of what has come to light in proving the other theorem. Merely as an illustration we may note that when $\Delta = | \alpha_1 \beta_2 c_3 d_4 |$ and $r=2$ we have the sum of the two-line coaxial minors,

$$= \begin{vmatrix} 11 & 12 \\ 12 & 22 \end{vmatrix} + \begin{vmatrix} 11 & 13 \\ 13 & 33 \end{vmatrix} + \begin{vmatrix} 11 & 14 \\ 14 & 44 \end{vmatrix} + \begin{vmatrix} 22 & 23 \\ 23 & 33 \end{vmatrix} + \begin{vmatrix} 22 & 24 \\ 24 & 44 \end{vmatrix} + \begin{vmatrix} 33 & 34 \\ 34 & 44 \end{vmatrix}$$

$$\begin{aligned}
 &= \left| \begin{array}{cccc} a_1 & a_2 & a_3 & a_4 \\ b_1 & b_2 & b_3 & b_4 \end{array} \right|^2 + \left| \begin{array}{cccc} a_1 & a_2 & a_3 & a_4 \\ c_1 & c_2 & c_3 & c_4 \end{array} \right|^2 + \dots \\
 &= \left. \begin{aligned} &|a_1b_2|^2 + |a_1b_3|^2 + |a_1b_4|^2 + |a_2b_3|^2 + |a_2b_4|^2 + |a_3b_4|^2 \\ &+ |a_1c_2|^2 + |a_1c_3|^2 + \dots \\ &+ \dots \\ &+ |c_1d_2|^2 + |c_1d_3|^2 + \dots \end{aligned} \right\}
 \end{aligned}$$

as the theorem specifies.

(6) The theorems of §§ 3, 5 may be further widened by passing from Δ^2 to $\Delta_1\Delta_2$, the results being

The sum of the r-line minors of $\Delta_1\Delta_2$ is equal to the sum of $\binom{n}{r}$ products, each of which has for its first factor the sum of the r-line minors formable from r columns of Δ_1 and for its second the sum of the corresponding minors of Δ_2 .

The sum of the r-line coaxial minors of $\Delta_1\Delta_2$ is the sum of all possible products, having for their first factor an r-line minor of Δ_1 and for their second the corresponding minor of Δ_2 .

Thus if $\Delta_1 \equiv |a_1b_2c_3|$ and $\Delta_2 \equiv |a_1\beta_2\gamma_3|$, the sum of the two-line minors of $\Delta_1\Delta_2$ is

$$\begin{aligned}
 &\{ |a_1b_2| + |a_1c_2| + |b_1c_2| \} \cdot \{ |a_1\beta_2| + |a_1\gamma_2| + |\beta_1\gamma_2| \} \\
 &+ \{ |a_1b_3| + |a_1c_3| + |b_1c_3| \} \cdot \{ |a_1\beta_3| + |a_1\gamma_3| + |\beta_1\gamma_3| \} \\
 &+ \{ |a_2b_3| + |a_2c_3| + |b_2c_3| \} \cdot \{ |a_2\beta_3| + |a_2\gamma_3| + |\beta_2\gamma_3| \};
 \end{aligned}$$

and the sum of the two-line coaxial minors is

$$\begin{aligned}
 &|a_1b_2| \cdot |a_1\beta_2| + |a_1b_3| \cdot |a_1\beta_3| + |a_2b_3| \cdot |a_2\beta_3| \\
 &+ |a_1c_2| \cdot |a_1\gamma_2| + |a_1c_3| \cdot |a_1\gamma_3| + |a_2c_3| \cdot |a_2\gamma_3| \\
 &+ |b_1c_2| \cdot |\beta_1\gamma_2| + |\beta_1c_3| \cdot |\beta_1\gamma_3| + |b_2c_3| \cdot |\beta_2\gamma_3|.
 \end{aligned}$$

(7) The ultra-symbolical expressions used in §§ 1, 3 suggest that a freer use of non-quadrate arrays might be advantageous. We might, for example, use them as elements of a determinant, thereby arriving at such identities as

$$\left| \begin{array}{ccc} (a_1, a_2) & (a_3, a_4) & (a_5, a_6) \\ (b_1, b_2) & (b_3, b_4) & (b_5, b_6) \\ (c_1, c_2) & (c_3, c_4) & (c_5, c_6) \end{array} \right| = |a_1b_3c_5| + |a_2b_4c_6|,$$

$$\begin{vmatrix} b_1 & b_2 & b_3 \\ \beta_1 & \beta_2 & \beta_3 \\ c_1 & c_2 & c_3 \\ \beta_1 & \beta_2 & \beta_3 \end{vmatrix} \begin{vmatrix} b_1 & b_2 & b_3 \\ \gamma_1 & \gamma_2 & \gamma_3 \\ c_1 & c_2 & c_3 \\ \gamma_1 & \gamma_2 & \gamma_3 \end{vmatrix} = \begin{vmatrix} b_1 & b_2 & b_3 \\ c_1 & c_2 & c_3 \end{vmatrix} \cdot \begin{vmatrix} \beta_1 & \beta_2 & \beta_3 \\ \gamma_1 & \gamma_2 & \gamma_3 \end{vmatrix},$$

$$\begin{vmatrix} b_1 & b_2 & b_3 \\ \beta_1 & \beta_2 & \beta_3 \\ c_1 & c_2 & c_3 \\ \beta_1 & \beta_2 & \beta_3 \\ d_1 & d_2 & d_3 \\ \beta_1 & \beta_2 & \beta_3 \end{vmatrix} \begin{vmatrix} b_1 & b_2 & b_3 \\ \gamma_1 & \gamma_2 & \gamma_3 \\ c_1 & c_2 & c_3 \\ \gamma_1 & \gamma_2 & \gamma_3 \\ d_1 & d_2 & d_3 \\ \gamma_1 & \gamma_2 & \gamma_3 \end{vmatrix} \begin{vmatrix} b_1 & b_2 & b_3 \\ \delta_1 & \delta_2 & \delta_3 \\ c_1 & c_2 & c_3 \\ \delta_1 & \delta_2 & \delta_3 \\ d_1 & d_2 & d_3 \\ \delta_1 & \delta_2 & \delta_3 \end{vmatrix} = 0.$$

They might even be used as such alongside of quantitative elements in the same determinant; and there is at least one case of this where the advantage is most striking: indeed it is not too much to say that we are thus enabled to express with fulness and accuracy a famous theorem of Binet's which up till now has remained unformulated. Binet in 1812 (*Journ. de l'Éc. polyt.*, ix., cah. 16, p. 284) says, "On vérifie aisément les formules suivantes

$$\begin{aligned} \Sigma ab' &= \Sigma a \Sigma b - \Sigma ab, \\ \Sigma ab'c'' &= \Sigma a \Sigma b \Sigma c + 2 \Sigma abc - \Sigma a \Sigma bc - \Sigma b \Sigma ac - \Sigma c \Sigma ab, \\ \Sigma ab'c''d''' &= \Sigma a \Sigma b \Sigma c \Sigma d - 6 \Sigma abcd \\ &\quad - \Sigma a \Sigma b \Sigma cd - \Sigma a \Sigma c \Sigma bd - \Sigma a \Sigma d \Sigma bc \\ &\quad - \Sigma b \Sigma c \Sigma ad - \Sigma b \Sigma d \Sigma ac - \Sigma c \Sigma d \Sigma ab \\ &\quad + \Sigma ab \Sigma cd + \Sigma ac \Sigma bd + \Sigma ad \Sigma bc \\ &\quad + 2 \Sigma a \Sigma bcd + 2 \Sigma b \Sigma cda + 2 \Sigma c \Sigma dab + 2 \Sigma d \Sigma abc, \\ \Sigma ab'c''d'''e'''' &= \Sigma a \Sigma b \Sigma c \Sigma d \Sigma e + \dots \dots \dots \end{aligned}$$

The law of formation of the right-hand members was left undivulged: and probably Bellavitis in 1857 was the first to draw attention to the fact that the said members bear a wonderful resemblance to the final expansions of axisymmetric determinants (*Sposizione elementare § 91*); but he only got so far as to say that in order to complete Binet's fourth instance "lo sviluppo del determinante simmetrico" of the fifth order must first be found, and then certain arbitrary changes made therein. With

the use of single-line arrays as elements all difficulty vanishes, the identities then becoming

$$\begin{vmatrix} a_1 + a_2 + \dots + a_n & (a_1, a_2, \dots, a_n) \\ (a_1, a_2, \dots, a_n) & b_1 + b_2 + \dots + b_n \end{vmatrix} = \sum^\dagger |a_1 b_2|^\dagger,$$

$$\begin{vmatrix} a_1 + a_2 + \dots + a_n & (a_1, a_2, \dots, a_n) & (a_1, a_2, \dots, a_n) \\ (b_1, b_2, \dots, b_n) & b_1 + b_2 + \dots + b_n & (b_1, b_2, \dots, b_n) \\ (c_1, c_2, \dots, c_n) & (c_1, c_2, \dots, c_n) & c_1 + c_2 + \dots + c_n \end{vmatrix} = \sum^\dagger |a_1 b_2 c_3|^\dagger,$$

and so on.

(*Issued separately January 16, 1907.*)

OBITUARY NOTICES.

Professor A. W. Williamson. By Professor
A. Crum Brown.

(Read January 8, 1906.)

Alexander William Williamson was born at Wandsworth, May 1st, 1824. He studied chemistry under Gmelin in Heidelberg and under Liebig in Giessen, where he graduated as Ph.D. In 1848 he studied mathematics under Comte in Paris. In 1849 he was appointed Professor of Practical Chemistry in University College, London; and in 1855, in addition, Professor of Chemistry. He was elected Fellow of the Royal Society of London in 1855, and was Foreign Secretary of the Society from 1873 to 1889, and Vice-President in 1889, 1890. He was President of the British Association in 1873. He was elected Hon. Fellow of this Society in 1883. In 1887 he resigned his chair and retired to Haslemere, where he died May 6th, 1904.

Williamson's chemical work was not great in quantity, but was of the very highest importance, and his name will always remain in the history of chemistry in the list of the great leaders.

Berzelius gave H_2O as the formula of water, but the duplicity of the hydrogen in this formula was deduced from physical considerations only, and was not used to explain any chemical phenomena. The chemical unit of hydrogen was to Berzelius and his followers the "equivalent" H_2 and not the atom H , and they wrote hydrochloric acid and ammonia H_2Cl_2 and N_2H_6 , until a special symbol, a barred letter, was invented for the equivalent in the case of each element the equivalent of which consisted of two atoms. It was Williamson who brought to light the chemical meaning of the 2 in H_2O , and showed that these two atoms are not permanently tied together, but are each separately united to the one indivisible atom of oxygen.

By the action of potassium on alcohol one-sixth of the hydrogen

of the alcohol is removed and a compound formed containing potassium in the place of this hydrogen. It occurred to Williamson that if this potassium alcohol were treated with the halogen compound of a hydrocarbon radical the potassium and the halogen would unite, and a new and more complex alcohol be formed containing the hydrocarbon radical in place of the potassium, and therefore in place of the hydrogen which had been removed by the action of the potassium. This idea was the foreshadowing of a very important method of synthesis, but the result showed that it was not applicable in this case. By acting on potassium alcohol with ethyl iodide Williamson obtained indeed potassium iodide, but the other product was not a new alcohol but common ether. He at once saw the explanation of this. He regarded alcohol not as a compound of ether and water, the common view at that time, but as an intermediate substance, not Ae_2O, H_2O , but $AeHO$, in which the ethyl and the hydrogen are independently united to the one atom of oxygen, and he recognised that it is this hydrogen and not hydrogen of the C_2H_5 that is replaced by potassium. "Thus alcohol is $\begin{matrix} C_2H_5O \\ H \end{matrix}$, and the potassium compound is $\begin{matrix} C_2H_5O \\ K \end{matrix}$; and by acting upon this by iodide of ethyl we have

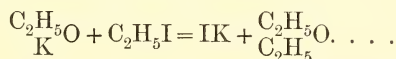

Alcohol is therefore water in which half the hydrogen is replaced by carburetted hydrogen, and ether is water in which both atoms of hydrogen are replaced by carburetted hydrogen, thus :

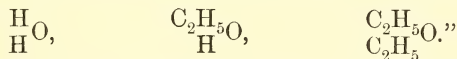

But as the formation of ether in this way could be explained on the supposition that alcohol is a compound of ether and water, and potassium alcohol a compound of ether and oxide of potassium, half of the ether produced being that united with oxide of potassium and the other half coming from the action of the oxide of potassium on the ethyl iodide, Williamson devised and carried out a crucial experiment. By acting on potassium ethylate with methyl iodide and on potassium methylate with ethyl iodide he obtained in both cases the same product, which was not a

mixture of the two ethers but an intermediate ether $\begin{matrix} \text{C}_2\text{H}_5\text{O} \\ \text{CH}_3 \end{matrix}$. In a similar way he prepared the intermediate amyl-methyl and amyl-ethyl ethers. He then goes on to use these principles to explain the ordinary process for preparing ether, giving the sequence of actions now familiar to every student of chemistry, and showing experimentally that three ethers are formed when a mixture of two alcohols is distilled with sulphuric acid.

Williamson's work on etherification was published in a paper read before the Chemical Section of the British Association at its meeting in Edinburgh in 1850 and printed in the *Philosophical Magazine*. It is in this paper that the following striking passage occurs:—"Before quitting the subject of ætherification I would wish to add a few words on an application which naturally enough suggests itself of the fact to which the process is here ascribed. I refer to the transfer of homologous molecules in alternately opposite directions, which, as I have endeavoured to show, is the cause of the continuous action of sulphuric acid in this remarkable process. It may naturally be asked, why do hydrogen and carburetted hydrogen thus continuously change places? It cannot be from any such circumstance as superior affinity of one molecule over another, for one moment sees reversed with a new molecule the transfer effected during the preceding one. Now, in reflecting upon this remarkable fact, it strikes the mind at once that the facility of interchange must be greater the more close the analogy between the molecules exchanged; that if hydrogen and amyl can replace one another in a compound, hydrogen and ethyl, which are more nearly allied in composition and properties, must be able to replace one another more easily in the same compound; and that the facility of interchange of hydrogen and methyl, which are still more similar, will be still greater. But if this be true, must not the exchange of one molecule for another of *identical* properties be the most easily effected of all? Surely it must, if there be any difference at all; and if so, the law of analogy forbids our imagining the fact to be peculiar to hydrogen among substances resembling it in other respects. We are thus forced to admit that, in an aggregate of molecules of any compound, there is an exchange constantly going on between the elements

which are contained in it. For instance, a drop of hydrochloric acid being supposed to be made up of a great number of molecules of the composition ClH , the proposition at which we have just arrived would lead us to believe that each atom of hydrogen does not remain quietly in juxtaposition with the atom of chlorine with which it first united, but, on the contrary, is constantly changing places with other atoms of hydrogen, or, what is the same thing, changing chlorine."

The observed facts of balanced actions of double decomposition led Williamson to this view, and it is interesting to note that the observed facts of electrolysis led Clausius quite independently to a somewhat similar hypothesis about seven years later.

A paper read before the Chemical Society of London, June 1851, contains, besides further details as to the preparation, analysis, and vapour density of the new intermediate ethers, a very important note on the constitution of acetone, and an account of an intermediate ketone, with a very clear statement of the constitution of these bodies and a forecast of the general method of preparing aldehydes afterwards independently discovered by Limpricht and by Piria.

In a paper in the *Chemical Gazette*, 1851, he points out the analogy between ether and the anhydrous monobasic organic acids, then unknown, but soon afterwards discovered by Gerhardt, who obtained them by a process perfectly analogous to that used by Williamson for the preparation of the ethers.

As Williamson had thus, in 1850, established the "water type" on a secure experimental basis, so, in 1854, he extended similar reasoning and demonstration to the case of sulphuric acid, and showed how dibasic acids and their derivatives can be referred to the double type of water.

In a paper communicated to the Royal Society of London he writes:—"An atom of nitric acid, being eminently monobasic, is, as we have already shown, represented in the monobasic type $\frac{\text{H}}{\text{H}}\text{O}$ by the formula $\frac{(\text{NO}_2)}{\text{H}}\text{O}$, in which peroxide of nitrogen (NO_2) replaces one atom of hydrogen. In like manner, hydrate of potash $\left(\frac{\text{H}}{\text{K}}\text{O}\right)$ is obtained by replacing one atom of hydrogen in the type by its equivalent of potassium; and nitrate of potash $\left(\frac{\text{NO}_2\text{O}}{\text{K}}\right)$ by a

simultaneous substitution of *one* atom of hydrogen by peroxide of nitrogen, the *other* by potassium. Sulphuric acid is formed from

two atoms of water $\begin{matrix} \text{H} \\ \text{H} \\ \text{H} \\ \text{H} \end{matrix} \text{O}$; one of hydrogen from each is removed,

and the two replaced by the indivisible radical SO_2 . The series

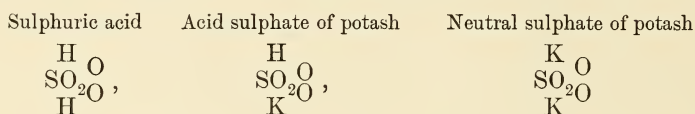

explains itself."

He then describes the action of pentachloride of phosphorus on sulphuric acid:—"Confining my remarks for the present to the case of sulphuric acid, whose decomposition is doubtless typical of that of other bibasic acids, I may state as the result of numerous experiments with the most varied proportions of pentachloride and acid, performed on a scale of considerable magnitude, that the first action of the pentachloride consists in removing one atom of hydrogen and one of oxygen (empirically peroxide of hydrogen) from the acid, putting in an atom of chlorine in their place, and forming the compound $\begin{matrix} \text{H} \\ \text{SO}_2 \text{O} \\ \text{Cl} \end{matrix}$, which is strictly intermediate be-

tween the hydrated acid and the final product SO_2Cl_2 formed by a repetition of the same process of substitution of chlorine for peroxide of hydrogen. The existence and formation of this body, which we may call chloro-hydrated sulphuric acid, furnishes the most direct evidence of the truth of the notion, that the bibasic character of sulphuric acid is owing to the fact of one atom of its radical SO_2 replacing or (to use the customary expression) being equivalent to two atoms of hydrogen. Had this radical been divisible like an equivalent quantity of a monobasic acid, we should have obtained a *mixture*, not a *compound*, of the chloride with the hydrate,—or, at least, the products of decomposition of that mixture."

In another paper in the same volume of the *Proceedings* we find the following:—"According to the results of recent researches in the constitution of salts and the method thence introduced of

explaining chemical reactions, it is equally correct to represent such a reaction as that of hydrochloric acid on hydrate of potash, as consisting in an exchange of hydrogen of the one for potassium of the other, or of chlorine in one for peroxide of hydrogen in the other. In Mr Kay's researches, as described in the following brief outline, this notion has obtained very striking illustrations; for he has obtained a peculiar body in which the chlorine of chloroform is replaced by peroxide of ethyle by the action of chloroform on three atoms of ethylate of sodium, which product may be equally well conceived to be a body in which the hydrogen of three atoms of alcohol is replaced by the tribasic radical of chloroform. According to the older theories of the capacity of saturation of salts, this compound would contain a tribasic modification of formic acid, for it has the same relation to formic ether as a so-called tribasic phosphate has to a monobasic one."

It will be seen from the examples referred to that the leading principle of Williamson's work was the then quite novel idea of the "atomic value" of radicals, which is exactly what we now call their valency, and that his favourite method was the formation of intermediate substances as a guide to a knowledge of the constitution of the bodies between which they lie. This principle and this method led in Williamson's hands to important development and simplification of chemical theory, and they still bear good fruit.

Williamson's influence on the progress of chemistry is not to be measured only by the work done directly by him; every chemist who had the privilege of being his friend knows how much of his clear, intelligent knowledge of chemistry is due to Williamson.

Samuel Pierpont Langley, Secretary to the Smithsonian Institution, Honorary Fellow of the Royal Society of Edinburgh, 1902-6. By **Dr W. Peddie**.

Through the death of Samuel Pierpont Langley this Society has lost one of the most eminent of its distinguished Foreign Members, and Science has lost one of the great leaders who have placed America in the front rank of the nations which concern themselves with the advancement of knowledge. The announcement of his death came as a surprise; for, although he had passed the threescore-and-ten limit, his powers for work were so entirely untouched as to justify the hope that many years of useful labour still lay before him. The work which he actually performed was so colossal, and some of it so recent, that years may necessarily pass before all its results are fully made public.

Born at Roxbury, in Massachusetts, on the 22nd day of August 1834, Langley received his general education at Boston High School. Leaving the school in 1851, he took up the study of civil engineering and architecture, and subsequently practised these professions until he had succeeded in acquiring means which made him independent of routine work. From that time onwards his employments coincided more fully with his mental inclinations.

Astronomy had attracted him powerfully since the days of his childhood; so the years 1864 and 1865 found Langley visiting the chief observatories of Europe, and making acquaintance with its scientific societies, many of which were in subsequent years to bestow upon him their highest honours.

In 1865 he became assistant astronomer at Harvard College Observatory. In 1866 he was appointed assistant professor of mathematics at the United States Naval Academy. In 1867 he became director of the Alleghany Observatory at Pittsburg, a post which, along with the professorship of astronomy and physics at Pennsylvania, he held until, in 1887, he was appointed

Assistant Secretary, and soon afterwards Secretary, to the Smithsonian Institution. This connection continued uninterruptedly until his death on the 27th of February this year. The variety of his successful employments bears eloquent witness to the magnitude of his mental equipment: engineer, architect, mathematician, physicist, astronomer, and administrator by profession, he was also a successful writer, a student of art and of archæology.

The great characteristic of Langley's work is its pioneer nature. Problems of like type to problems already solved had no attraction for him. New problems which presented no special difficulty in their solution were passed by. The problem whose difficulties were such that others had failed to solve it, the problem whose difficulties were such that no other had attempted to attack it—these were the problems which Langley attacked and mastered; and his attack was conducted almost with impatience. He never sat down beforehand to perfect a method of procedure; he began at once on what he believed to be the likeliest lines, and perfected his method as he proceeded.

A subject which had once attracted Langley attracted him always. Questions arising in his earliest work appeared again in work which was uncompleted at the time of his death. All his investigations arose naturally, as all great investigations do, in the course of daily labour. It would serve no useful purpose to enumerate them here. It seems better that a mere indication of their nature and extent should be given, along with a fresh expression of this Society's appreciation thereof.

Between the years 1870 and 1877 Langley's attention was devoted to the question of the structure of the solar disc and the radiation of heat from its various portions. The results were published in a series of papers during that period. It is found that, the more perfect are the atmospheric conditions for observation, the more closely do present-day results agree with Langley's early drawings. The practical aim of all his work is well indicated by a paper, in that series, on the direct effect of sun-spots on terrestrial climates.

Another, and perhaps the most distinctive, branch of his work was that which dealt with the distribution of energy in the solar

spectrum. Finding the thermopile, which at that time was the most delicate instrument available for his object, far too sluggish in its indications, he devised the bolometer, an instrument which, to this day, has no superior, and only one equal, in such work. By its aid he pushed the investigation of the solar spectrum into previously unexplored regions in the infra-red radiations.

A natural extension of that work led to the mapping, by Langley and Very, of the lunar energy spectrum. This was a work of immensely greater difficulty, because of the slight difference between the temperatures of the source and of the surroundings of the instrument, and also because of atmospheric absorption. The results led to the conclusion that the temperature of the moon's surface is not much above 0° C.

A further extension was made to terrestrial sources of radiation, the mapping being pushed more than twice as far into the long wave-length region as had been found possible with solar radiation. In the process, the dispersive power of rock-salt was carefully determined.

In 1892 Langley immensely improved his bolometer by making it an automatic self-registering instrument, and the investigation of solar radiation was pushed as far into the infra-red region as it had been carried with terrestrial sources.

Another distinctively great piece of work was that on the effect of the earth's atmosphere in absorbing solar radiation, and on the determination of the solar constant. The value found for the constant must be regarded as at least a good first approximation.

After he became Director of the Smithsonian Institution, Langley founded the Smithsonian Astro-physical Observatory and arranged its work primarily for the purpose of determining the natural influences having a direct bearing on climate and life. A part of its work, not completed at the time of his death, dealt with the question whether or not the solar radiation was variable to an extent sufficient to affect the earth's climate, and whether or not the effects were predictable. The results already indicate an affirmative answer to the former part of the question.

Another line of work, in which the daring nature of Langley's attack on unsolved problems is well exhibited, is that on the problem of aerial navigation. His papers on *Experiments in*

Aerodynamics and the *Internal Work of the Wind* commanded wide attention. He made successful models of flying machines ; and, although the launching of his actual airship was unattended by success, unimpeachable photographic evidence showed that the failure was not in the vessel but in the launching apparatus.

This Society cannot do other than endorse the strong simple words of the resolution come to by the representatives of the great Institution whose work he so long and so ably controlled—that the scientific world is indebted to Mr Langley for the invention of important apparatus and instruments of precision, for numerous additions to knowledge, more especially for his epoch-making investigations in solar physics, and for his efforts in placing the important subject of aerial navigation upon a scientific basis.

Rev. George Matheson, D.D., LL.D., F.R.S.E.

By Rev. James Lindsay, D.D.

(Read November 5, 1906.)

It is to me a real, though melancholy, satisfaction to utter what Æschylus calls a few "posthumous words in praise of a divinely good man"—ἐπιτύμβιον αἶνον ἐπ' ἀνδρὶ θείῳ.*

Dr George Matheson became a Fellow of this Society in 1890. One of the most valuable features of the Royal Society of Edinburgh is its recognition of literary distinction as well as of Scientific eminence, even though nothing has yet been done to differentiate and develop its literary resources after the manner of the Royal Society of Canada. To this literary side of the Society Dr Matheson belonged. Yet he was not without a keen interest in scientific theories such as those of Tyndall, Spencer, Darwin, and Comte. Indeed, such books as *Can the Old Faith live with the New?* and *The Psalmist and the Scientist* were, at the time of publication, highly useful attempts at some reconciliation of science with religion.

Born at Glasgow in 1842, he became M.A., with philosophical honours, at the University there in 1862, and B.D. in 1866. He held ministerial charges at Innellan and St Bernard's, Edinburgh, in both cases with distinguished success. In 1879 the degree of D.D. was conferred upon him by Edinburgh University, that of Aberdeen bestowing upon him LL.D. at a later period. In 1881 he held the Baird Lectureship; and in 1899 he was appointed to the Gifford Lectureship in Aberdeen, which, however, he declined.

Blind from his youth, Dr Matheson's intellectual interest and Miltonic courage won a supreme conquest. His literary industry was astonishing, his mental energy great and unceasing. He thought rapidly: truth came to him in intuitive flashes. Of volumes he published almost a score, and, in addition, many magazine articles. His work was varied in character and contents—historical, doctrinal, apologetical, exegetical, devotional, and

* *Agamemnon*, 1547.

poetic. So much poetic charm and vital individuality went to the making of his best prose work, that his fame was carried to the ends of the English-speaking world. His genius was *religious*, but it was religious *genius*—the genius of insight and unique performance.

Passing from his work to his personality, one must emphatically say that the man was more than his work, his character greater than his performance. The chief feature of that character was an essential nobility of mind, in which respect Dr Matheson stood far above the level of most distinguished men. He was withal genial and companionable to a high degree. Suddenly, but peacefully, he was, on the 28th of August, withdrawn into the mystic, eternal shadows. Brave in spirit and strenuous in endeavour to the last, his life remains an example and an inspiration.

Meetings of the Royal Society—Session 1905–1906.

THE 123RD SESSION.

Monday, 23rd October 1905.

GENERAL STATUTORY MEETING. Election of Office-Bearers. p. 1.

FIRST ORDINARY MEETING.

Monday, 6th November 1905.

Professor Crum Brown, LL.D., F.R.S., Vice-President,
in the Chair.

The following Communications were read:—

1. Preliminary Note on the Conductivity of Concentrated Aqueous Solutions of Electrolytes. By Professor J. GIBSON. p. 234.
 2. The Tarpan and its relation with Wild and Domestic Horses. By Professor J. C. EWART, F.R.S. (*With Lantern Illustrations.*) p. 7.
 3. The Horse in Norway. By F. H. A. MARSHALL, M.A., D.Sc. (*With Lantern Illustrations.*) p. 22.
 4. Elimination in the case of equality of Fractions whose Numerators and Denominators are linear functions of the Variables. By THOMAS MUIR, LL.D. *Trans.*, vol. 45, p. 1.
-

SECOND ORDINARY MEETING.

Monday, 20th November 1905.

The Hon. Lord M'Laren, LL.D., Vice-President, in the Chair.

The following Communications were read:—

1. Some Further Results obtained with the Spectro-heliometer. By J. HALM, Ph.D. p. 76.
2. Observations on the Normal Temperature of the Monkey and its Diurnal Variation, and on the Effect of Changes in the Daily Routine on this Variation. By SUTHERLAND SIMPSON, M.D., D.Sc., and J. J. GALBRAITH, M.D. Communicated by Professor SCHÄFER, F.R.S. *Trans.*, vol. 45, p. 65.
3. Notes on the Effect of Electric Oscillations (co-directional and transverse) on the Magnetic Properties of Iron. By Mr JAMES RUSSELL. p. 33.

4. Some Electrical Measurements on Metals. By CHARLES E. FAWSITT, D.Sc., Ph.D. Communicated by Professor CRUM BROWN. p. 2.

No other Candidate having been nominated, Dr R. M. FERGUSON was unanimously re-elected the representative of the Society on the Governing Body of George Heriot's Trust.

Mr ROBERT MATHIESON, F.C.S., was balloted for, and declared duly elected a Fellow of the Society.

THIRD ORDINARY MEETING.

Monday, 4th December 1905.

The Rt. Hon. Lord Kelvin, G.C.V.O., etc., President,
in the Chair.

The following Communications were read:—

1. The Development of the Skull and Visceral Arches in Lepidosiren and Protopterus. By W. E. AGAR, B.A. Communicated by Professor J. GRAHAM KERR. *Trans.*, vol. 45, p. 49.

2. Perturbations in Longitude of Neptune by the Hypothetical Planet. By Professor GEORGE FORBES, F.R.S.

3. Exhibition of two Lantern Slides of Zoological Interest. By Professor D. J. CUNNINGHAM, F.R.S.

FOURTH ORDINARY MEETING.

Monday, 18th December 1905.

Dr R. H. Traquair, F.R.S., Vice-President, in the Chair.

The following Communications were read:—

1. Library Aids to Mathematical Research. By THOMAS MUIR, LL.D. p. 51.

2. Preliminary Note regarding an Experimental Investigation into the Effects of Varying Diets upon Growth and Nutrition. By Dr CHALMERS WATSON. Communicated by Professor SCHÄFER, F.R.S. p. 87.

The remaining Papers in the billet were postponed till next ordinary meeting.

Mr WM. SPEIRS BRUCE, Dr THOMAS JAMES JEHU, Dr WM. THOMAS RITCHIE, and ALEXANDER DURIE RUSSELL, B.Sc., were balloted for, and declared duly elected Fellows of the Society.

FIFTH ORDINARY MEETING.

Monday, 8th January 1906.

Professor Crum Brown, LL.D., F.R.S., Vice-President,
in the Chair.

The following Communications were read :—

1. Obituary Notice of Professor Alexander W. Williamson, F.R.S. By Professor CRUM BROWN. p. 540.
2. *Bathydraco Scotiæ*, Poisson abyssal nouveau recueilli par l'Expédition Antarctique National Écossaise. Note préliminaire, par M. LOUIS DOLLO, Conservateur au Musée royal d'Histoire naturelle, à Bruxelles. Présentée par M. le Dr. R. H. TRAQUAIR, F.R.S. p. 65.
3. Influence of Thymus Feeding on Allantoin Excretion. By Dr W. M'LACHLAN. Communicated by Dr NOËL PATON. p. 95.
4. On a Theorem in Hypercomplex Numbers. By J. H. MACLAGAN WEDDERBURN, M.A. p. 48.

SIXTH ORDINARY MEETING.

Monday, 22nd January 1906.

The Hon. Lord M'Laren, LL.D., Vice-President, in the Chair.

The following Communications were read :—

1. On a Form of Initiational Disturbance more convenient than that of §§ 3-31 of previous Papers on Waves. By the Rt. Hon. LORD KELVIN, President. p. 398.
2. Illustrations of the Indefinite Extension and Multiplication of a Group of Two-dimensional Deep-Sea Waves, Initially Finite. By the Same. p. 409.
3. On the Initiation and Continued Growth of a Train of Two-dimensional Waves due to the Sudden Commencement of a Stationary Periodically Varying Force. By the Same. p. 412.

MR JOHN BENNETT CARRUTHERS, MR HENRY O'CONNOR, C.E., MR FRASER STORY, MR GILBERT THOMSON, M.A., C.E., DR DAWSON F. D. TURNER, F.R.C.P.E., DR ROBERT ALEXANDER FLEMING, F.R.C.P.E., the Rev. SAMUEL M. JOHNSTON, B.A., and DR DUNCAN SCOTT MACNAIR, H.M.I.S., were balloted for, and declared duly elected Fellows of the Society.

SEVENTH ORDINARY MEETING.

Monday, 5th February 1906.

Professor Crum Brown, F.R.S., Vice-President, in the Chair.

The following Communications were read :—

1. The Relation between Normal Take-up or Contraction and Degree of Twist in Twisted Threads. By THOMAS OLIVER, B.Sc. Communicated by Dr C. G. KNOTT. p. 182.

2. Some Experimental Results in Connection with the Hydrodynamical Theory of Seiches ; with Experiments. By PETER WHITE, M.A., and Mr W. WATSON. Communicated by Professor CHRYSAL. p. 142.

EIGHTH ORDINARY MEETING.

Monday, 19th February 1906.

Dr R. H. Traquair, F.R.S., Vice-President, in the Chair.

The following Communications were read :—

1. On the Elevation of the Boiling Point of Aqueous Solutions of Electrolytes. By the Rev. S. M. JOHNSTON, B.A. (*With Lantern Illustrations.*) *Trans.*, vol. 45, p. 193.

2. On the Formation of certain Lakes in the Highlands. By Dr LÉON W. COLLET and Dr T. N. JOHNSTON. With a Note on Two Small Rock Basins in the Alps, by Dr COLLET. p. 107.

3. On the Methods of Standardising Suprarenal Preparations. By Dr ISABELLA CAMERON. Communicated by Dr NOËL PATON. p. 157.

Lt.-Col. ARTHUR FREDERICK APPLETON, F.R.C.V.S., Dr THOMAS WM. DEWAR, F.R.C.P., the Rev. ALEXANDER MOFFAT, M.A., B.Sc., Mr HERBERT WATKINS PITCHFORD, F.R.C.V.S., and Dr CALEB WILLIAMS SALEEBY were balloted for, and declared duly elected Fellows of the Society.

NINTH ORDINARY MEETING.

Monday, 5th March 1906.

Professor Crum Brown, F.R.S., Vice-President, in the Chair.

The following Communications were read :—

1. The Igneous Geology of the Bathgate and Linlithgow Hills. Part II.—Petrography. By J. D. FALCONER, M.A., D.Sc. Communicated by Professor GEIKIE, F.R.S. *Trans.*, vol. 45, p. 133.

2. The South Orkney *Collembola* of the Scottish National Antarctic Expedition. By GEORGE H. CARPENTER, B.Sc., M.R.I.A., Professor of Zoology in the Royal College of Science, Dublin. Communicated by Mr WILLIAM EVANS. p. 473.

3. The *Turbellaria* of the Scottish National Antarctic Expedition. By J. F. GEMMILL, M.A., M.D., and R. T. LEIPER, M.B., Ch.B. Communicated by Sir JOHN MURRAY, K.C.B.

4. Scottish National Antarctic Expedition.—On *Echinorhynchus antarcticus*, n. sp., and its Allies. By JOHN RENNIE, D.Sc. Communicated by Mr WILLIAM S. BRUCE. p. 437.

TENTH ORDINARY MEETING.

Monday, 19th March 1906.

The Hon. Lord McLaren, Vice-President, in the Chair.

The following Communications were read:—

1. On the Distribution of the Proper Fractions. By Dr D. M. G. SOMMERVILLE. Communicated by Professor CHRYSTAL. p. 116.

2. Notes:—(1) On a Human Skeleton, with Prehistoric Objects, found at Great Casterton, Rutland; (2) On a Stone Cist containing a Skeleton and an Urn, found at Largs, Ayrshire. By Dr ROBERT MUNRO. With a Report on the Urn by the Hon. JOHN ABERCROMBY, and on the Skulls by Professor D. J. CUNNINGHAM. p. 279.

3. A New Form of Harmonic Synthetiser. By JAS. R. MILNE, B.Sc. p. 207.

Professor FRANK WATSON DYSON, M.A., F.R.S., Mr ALEXANDER TAYLOR INNES, M.A., Mr JOHN PATRICK FAIR BELL, F.Z.S., Dr EDWARD DAVID WILSON GREIG, B.Sc., Dr THOMAS COKE SQUANCE, and Mr JAMES STUART THOMSON, F.L.S., were balloted for, and declared duly elected Fellows of the Society.

ELEVENTH ORDINARY MEETING.

Monday, 7th May 1906.

Dr R. H. Traquair, F.R.S., Vice-President, in the Chair.

The following Communications were read:—

1. On Vibrating Systems which are not subject to the Boltzmann-Maxwell Law. By Dr WM. PEDDIE. p. 130.

2. On the Superposition of Mechanical Vibrations upon Magnetisation,

and Conversely, in Iron, Steel, and Nickel. By Mr JAMES RUSSELL. *Trans.*, vol. 45.

3. *Neobythites Brucei*, Poisson abyssal nouveau recueilli par l'Expédition Antarctique Nationale Ecosaise. Note Préliminaire par M. LOUIS DOLLO, Conservateur au Musée royal d'Histoire naturelle, à Bruxelles. Présentée par M. le Dr. R. H. TRAQUAIR, F.R.S. p. 172.

4. The Nematodes of the Scottish National Antarctic Expedition. By Dr VON LINSTOW. Communicated by Mr W. S. BRUCE. p. 464.

5. A Pfaffian Identity and related Vanishing Aggregates of Determinant Minors. By Dr THOMAS MUIR. *Trans.*, vol. 45, p. 311.

TWELFTH ORDINARY MEETING.

Monday, 21st May 1906.

Held in the Egyptian Hall, 75 Queen Street.

The Hon. Lord McLaren, LL.D., Vice-President, in the Chair.

At the request of the Council, M. TEISSERENC DE BORT gave an Address on "Météorologie de l'Atmosphère Libre."

FIRST SPECIAL MEETING.

Monday, 28th May 1906.

Sir John Murray, K.C.B., Vice-President, in the Chair.

The following Communications were read:—

1. Life in Reservoirs in relation to the Water Supply of Towns. By Mr JAMES MURRAY.

2. The Rotifera of Scottish Lochs. By Mr JAMES MURRAY. *Trans.*, vol. 45, p. 151.

3. Scottish National Antarctic Expedition.—Tardigrada of the South Orkneys. By Mr JAMES MURRAY. *Trans.*, vol. 45, p. 323.

4. The Temperature of the Fresh-water Lochs of Scotland, with special reference to Loch Ness. By E. M. WEDDERBURN, M.A. *Trans.*, vol. 45.

THIRTEENTH ORDINARY MEETING.

Monday, 4th June 1906.

Dr R. H. Traquair, F.R.S., Vice-President, in the Chair.

The following Communications were read :—

1. Recherches sur la Glauconie. Par les Drs LÉON W. COLLET et GABRIEL W. LEE, assistants de Sir John Murray, K.C.B. Communiqué par Sir JOHN MURRAY. p. 238.

2. Note on a rare Dolphin (*Delphinus acutus*) recently stranded on the Coast of Sutherland. By Sir WILLIAM TURNER, K.C.B. p. 310.

3. Contributions to the Craniology of the People of the Empire of India. Part III.—Natives of the Madras Presidency, Thugs, Veddahs, Tibetans, and Seistanis. By Sir WILLIAM TURNER, K.C.B. *Trans.*, vol. 45, p. 261.

4. Interpolation for a Table of Fractions, with a Notice of Synthetic Division and its Use. By Dr JAMES BURGESS, C.I.E.

5. On the Length of the Normal Chord of a Conic. By Professor ANGLIN.

6. The Hydroids of the Scottish National Antarctic Expedition. By JAMES RITCHIE, M.A. Communicated by Mr W. S. BRUCE. *Trans.*, vol. 45.

7. Professor D. J. CUNNINGHAM will exhibit a Photograph by Mr W. E. WARD of the Salmon in the Corrib River, Galway.

FOURTEENTH ORDINARY MEETING.

Monday, 18th June 1906.

Dr Munro, Vice-President, in the Chair.

The following Communications were read :—

1. A Dietary Study of Five Halls of Residence for Students in Edinburgh. By Dr ISABELLA CAMERON. Communicated by Dr D. NOËL PATON. p. 327.

2. On the Theory of Epidemics. By Dr JOHN BROWNLEE. Communicated by R. M. BUCHANAN, M.B. p. 484.

3. The Plant Remains in the Scottish Peat Mosses. Part II.—The Scottish Highlands. By FRANCIS J. LEWIS, F.L.S. Communicated by Professor JAMES GEIKIE. *Trans.*, vol. 45, p. 335.

Mr FRANK A. NEWINGTON, Memb. Inst. C.E., Mr WILLIAM O. VANDENBERGH, Dr DANIEL E. ANDERSON, and Dr DAVID ELLIS were balloted for, and declared duly elected Fellows of the Society.

FIFTEENTH ORDINARY MEETING.

Monday, 2nd July 1906.

Professor Crum Brown, LL.D., Vice-President, in the Chair.

The following Communications were read :—

1. On the Use of Soluble Prussian Blue in investigating the Reducing-power of Animal Tissue. By Dr D. FRASER HARRIS.
 2. The Viscosity of Solutions. Part I. By C. RANKEN, B.Sc., Carnegie Research Scholar, and Dr W. W. TAYLOR. Communicated by Professor CRUM BROWN. *Trans.*, vol. 45.
 3. Two Lecture Experiments in Illustration of the Theory of Ionisation. By Dr W. W. TAYLOR. Communicated by Professor CRUM BROWN. p. 325.
-

SECOND SPECIAL MEETING.

Friday, 13th July 1906.

Dr R. H. Traquair, F.R.S., Vice-President, in the Chair.

The following Communications were read :—

1. Obituary Notice of S. P. Langley, Secretary, Smithsonian Institution. By Dr PEDDIE. p. 546.
 2. The recent Epidemic of Trypanosomiasis in Mauritius: its Cause and Progress. By Dr ALEX. EDINGTON and Dr J. M. COUTTS.
 3. Note on the Smolt to Grilse Stage of the Salmon, with exhibition of a Marked Fish recaptured. By Mr W. L. CALDERWOOD. p. 321.
 4. The Effect of Precipitation Films on the Conductivity of Electrolytes. Part I. By W. S. MILLAR, B.Sc., Carnegie Research Scholar, and Dr W. W. TAYLOR. Communicated by Professor CRUM BROWN. p. 447.
 5. The Theory of Alternants in the Historical Order of Development up to 1860. By Dr THOMAS MUIR. p. 357.
 6. The Theory of Circulants in the Historical Order of Development up to 1860. By Dr THOMAS MUIR. p. 390.
 7. On the Length of a Pair of Tangents to a Conic. By Professor ANGLIN.
 8. Further Study of the Two Forms of Liquid Sulphur as Dynamic Isomers. By Professor ALEXANDER SMITH and Mr C. M. CARSON. p. 352.
-

SIXTEENTH AND LAST ORDINARY MEETING.

Monday, 16th July 1906.

The Hon. Lord M'Laren, LL.D., Vice-President, in the Chair.

The following Communications were read :—

1. Limnographic Apparatus and Measurements on Loch Earn. By Professor CHRYSTAL. *Trans.*, vol. 45, p. 361.
2. Preliminary Limnographic Observations on Loch Earn. By Mr JAMES MURRAY. Communicated by Professor CHRYSTAL. (Apparatus and Lantern Illustrations were shown.) *Trans.*, vol. 45, p. 361.
3. A Note on the Polarimeter. By J. R. MILNE, B.Sc. (An Instrument was shown.) p. 522.
4. Spectroscopic Observations of the Rotation of the Sun. (Further Communication.) By Dr J. HALM.
5. A Monograph on the General Morphology of the Myxinoid Fishes, based on a study of Myxine. Part II.—The Anatomy of the Muscles. By F. J. COLE, B.Sc. Communicated by Dr R. H. TRAQUAIR, F.R.S. *Trans.*, vol. 45.

A B S T R A C T

OF THE

ACCOUNTS OF THE LATE PHILIP ROBERT DALRYMPLE MACLAGAN, ESQ.,

As Treasurer of the Royal Society of Edinburgh.

SESSION 1905-1906.

. ACCOUNT OF THE GENERAL FUND.

CHARGE.

1. Arrears of Contributions at 1st October 1905.....	£160	13	0
2. Contributions for present Session :—			
1. 163 Fellows at £2, 2s. each.....	£342	6	0
135 Fellows at £3, 3s. each	425	5	0
	£767	11	0
2. Fees of Admission and Contributions of sixteen new Resident Fellows at £5, 5s. each.....	84	0	0
3. Fees of Admission of ten new Non- Resident Fellows at £26, 5s. each	262	10	0
	1114	1	0
3. Interest received—			
Interest, less Tax.....	£372	14	2
Annuity from Edinburgh and District Water Trust, less Tax...	49	17	6
	422	11	8
4. Society's Transactions and Proceedings sold ..	111	15	0
5. Annual Grant from Government.....	300	0	0
6. Residue payable to the Society from the Estate of the late Henry Dirck.....	33	12	2
Amount of the Charge.....	£2142	12	10

DISCHARGE.

1. Rent of Society's Apartments for Year, less Tax	£285	0	0	
2. INSURANCE, GAS, ELECTRIC LIGHT, COAL, WATER, ETC. :—				
Insurance.....	£9	19	6	
Gas.....	1	5	4	
Electric Light	2	17	11	
Coal	8	3	0	
Water.....	2	2	0	
Income Tax	15	0	0	
				39 7 9
3. SALARIES :—				
General Secretary	£100	0	0	
Librarian	150	0	0	
Do. Special Allowance	75	0	0	
Assistant Librarian.....	45	0	0	
Doorkeeper.....	12	0	0	
Office Keeper	35	0	0	
Treasurer's Clerk	25	0	0	
				442 0 0
4. EXPENSES OF TRANSACTIONS :—				
Neill & Co., Ltd., Printers	£311	5	7	
M'Farlane & Erskine, Lithographers	38	2	0	
Y. J. Pentland, do.	27	6	0	
Alex. Ritchie & Son, do.	8	5	0	
J. Bartholomew & Co., do.	16	0	0	
Hislop & Day, Engravers.....	21	8	0	
Orrock & Son, Bookbinders.....	74	15	0	
				497 1 7
5. EXPENSES OF PROCEEDINGS :—				
Neill & Co., Ltd., Printers.....	£510	1	8	
Hislop & Day, Engravers.....	31	16	6	
M'Farlane & Erskine, Lithographers	6	10	0	
				548 8 2
6. BOOKS, PERIODICALS, NEWSPAPERS, ETC. :—				
Otto Schulze & Co., Booksellers	£116	15	7	
James Thin, do.	53	12	4	
R. Grant & Son, do.	7	7	6	
Kegan Paul & Co., do.	2	5	4	
Bell & Bradfute, do.	0	15	6	
International Catalogue of Scientific Literature	17	0	0	
Robertson & Scott, News Agents.....	7	11	6	
Egypt Exploration Funds, Subscription	3	3	0	
Ray Society, do.	1	1	0	
Palæontographical Society, do.	1	1	0	
Orrock & Son, Bookbinders.....	28	2	6	
				238 15 3
Carry forward.....	£2050	12	9	

DISCHARGE—*continued.*

Brought forward £2050 12 9

7. OTHER PAYMENTS :—

Neill & Co., Ltd., Printers, General Account.....	£98 2 3	
Williams & Norgate, Publishers	73 14 3	
R. Blair & Son, Confectioners.....	29 13 6	
Orrock & Son, Bookbinders	10 9 6	
Lantern Exhibitions, etc., at Lectures...	13 4 3	
Lindsay, Jamieson & Haldane, Auditors	6 6 0	
National Telephone Co.	7 6 6	
Petty Expenses, Postages, Carriage, etc.	44 11 1	
		283 7 5

8. IRRECOVERABLE ARREARS of Contributions written off.. 2 2 0

9. ARREARS of CONTRIBUTIONS outstanding at 1st October 1906 :—

Present Session.....	£118 13 0	
Previous Sessions	79 16 0	
		198 9 0

Amount of the Discharge £2534 11 2

Amount of the Charge £2142 12 10

Amount of the Discharge..... 2534 11 2Excess of the Discharge £391 18 4FLOATING BALANCE IN FAVOUR OF THE SOCIETY
at 1st October 1905..... £246 3 5Excess of the Discharge as above 391 18 4Floating Balance due by the Society at 1st
October 1906 £145 14 11*Being—*Accounts included in the Discharge, but not paid
until after 1st October 1906 £775 9 3*Less* Balance due by the Union Bank on Current
Account..... £599 3 6,, Dividends included in the Charge
but not paid into Bank until after
1st October 1906..... 30 10 10629 14 4£145 14 11

II. ACCOUNT OF THE KEITH FUND

To 1st October 1906.

CHARGE.

1. BALANCE due by the Union Bank at 1st October 1905		£56 12 10
2. INTEREST RECEIVED :—		
On £896, 19s. 1d. North British Railway Company 3 per cent. Debenture Stock for year to Whitsunday 1906, less Tax	£25 11 4	
On £211, 4s. North British Railway Company 3 per cent. Lien Stock for year to Lammas 1906, less Tax	6 0 4	
		31 11 8
		£88 4 6

DISCHARGE.

Nil.

BALANCE due by the Union Bank at 1st October 1906	85 4 4	
Dividend Warrant, uncashed at do.	3 0 2	
		£88 4 6

III. ACCOUNT OF THE NEILL FUND

To 1st October 1906.

CHARGE.

1. BALANCE due by the Union Bank at 1st October 1905	£30 16 2
2. INTEREST RECEIVED :—	
On £355 London, Chatham and Dover Railway Company 4½ per cent. Arbitration Debenture Stock for year to 30th June 1906, less Tax	15 3 6
	£45 19 8

DISCHARGE.

Nil.

BALANCE due by the Union Bank at 1st October 1906	38 7 11
Dividend Warrant, uncashed at do.	7 11 9
	£45 19 8

IV. ACCOUNT OF THE MAKDOUGALL-BRISBANE
FUND

To 1st October 1906.

CHARGE.

1. BALANCE due by the Union Bank of Scotland at 1st October 1905 :—			
On Deposit Receipt	£135	0	0
On Current Account.....		24	18 4
			<hr/> £159 18 4
2. INTEREST RECEIVED :—			
On £365 Caledonian Railway Company 4 per cent. Consolidated Preference Stock No. 2 for year to 30th June 1906, less Tax			13 17 4
			<hr/> £173 15 8

DISCHARGE.

Nil.

BALANCE due by the Union Bank of Scotland at 1st October 1906 :—			
On Deposit Receipt	£135	0	0
On Current Account		31	17 0
			<hr/> £166 17 0
Dividend Warrant, uncashed at 1st October 1906		6	18 8
			<hr/> £173 15 8

V. ACCOUNT OF THE MAKERSTOUN MAGNETIC
METEOROLOGICAL OBSERVATION FUND

To 1st October 1906.

CHARGE.

SUM on Deposit Receipt with the Union Bank of Scot- land at 1st October 1905	£197 2 5
---	----------

DISCHARGE.

Nil.

Above SUM on Deposit Receipt with the Union Bank of Scotland at 1st October 1906.....	£197 2 5
--	----------

VI. ACCOUNT OF THE GUNNING-VICTORIA JUBILEE
PRIZE FUND

To 1st October 1906.

(Instituted by Dr R. H. GUNNING of Edinburgh and Rio de Janeiro.)

CHARGE.

1. BALANCE due by the Union Bank of Scotland at 1st October 1905	£17 7 10
2. INTEREST received on £1000 North British Railway Company 3 per cent. Consolidated Lien Stock for year to Lammas 1906, less Tax	28 10 0
	<hr/>
	£45 17 10
	<hr/> <hr/>

DISCHARGE.

Nil.

BALANCE due by the Union Bank of Scotland on Current Account at 1st October 1906	£31 12 10
Dividend Warrant, uncashed at do.	14 5 0
	<hr/>
	£45 17 10
	<hr/> <hr/>

STATE OF THE FUNDS BELONGING TO THE
ROYAL SOCIETY OF EDINBURGH

As at 1st October 1906.

1. GENERAL FUND—

1. £2090, 9s. 4d. three per cent. Lien Stock of the North British Railway Company at $89\frac{5}{8}$ per cent., the selling price at 1st October 1906.....	£1873 11 7
2. £8519, 14s. 3d. three per cent. Debenture Stock of do. at $90\frac{1}{2}$ per cent., do.....	7710 6 9
3. £52, 10s. Annuity of the Edinburgh and District Water Trust, equivalent to £875 at $176\frac{1}{2}$ per cent., do.	1544 7 6
4. £1811 four per cent. Debenture Stock of the Caledonian Railway Company at $119\frac{3}{4}$ per cent., do.....	2168 13 5
5. £35 four and a half per cent. Arbitration Debenture Stock of the London, Chatham and Dover Railway Company at 123 per cent., do.	43 1 0
6. Arrears of Contributions as per preceding Abstract of Accounts.....	198 9 0
	£13,538 9 3
<i>Deduct</i> Floating Balance due by the Society as per preceding Abstract of Accounts.....	145 14 11
	AMOUNT..... £13,392 14 4

Exclusive of Library, Museum, Pictures, and Furniture of the Society's Apartments at the Royal Institution.

2. KEITH FUND—

1. £896, 19s. 1d. three per cent. Debenture Stock of the North British Railway Company at $90\frac{1}{2}$ per cent., the selling price at 1st October 1906...	£811 14 10
2. £211, 4s. three per cent. Lien Stock of do. at $89\frac{5}{8}$ per cent., do.	189 5 9
3. Balance due by the Union Bank of Scotland (£85, 4s. 4d.), and uncashed dividend warrant in hand (£3, 0s. 2d.).....	88 4 6
	AMOUNT..... £1089 5 1

STATE OF FUNDS—*continued.*

3. NEILL FUND—

1. £355 four and a half per cent. Arbitration Debenture Stock of the London, Chatham and Dover Railway Company at 123 per cent., the selling price at 1st October 1906	£436	13	0
2. Balance due by the Union Bank of Scotland (£38, 7s. 11d.), and uncashed dividend warrant in hand (£7, 11s. 9d.).....	45	19	8
AMOUNT.....	£482	12	8

4. MAKDOUGALL-BRISBANE FUND—

1. £365 four per cent. Consolidated Preference Stock No. 2 of the Caledonian Railway Company at 113½ per cent., the selling price at 1st October 1906	£414	5	6
2. Sum on Deposit Receipt with the Union Bank of Scotland.	135	0	0
3. Balance due by do. on Current Account (£31, 17s.), and uncashed dividend warrant in hand (£6, 18s. 8d.).....	38	15	8
AMOUNT.....	£588	1	2

5. MAKERSTOUN MAGNETIC METEOROLOGICAL OBSERVATION FUND—

Sum on Deposit Receipt with the Union Bank of Scotland at 1st October 1906	£197	2	5
--	------	---	---

6. GUNNING-VICTORIA JUBILEE PRIZE FUND—Instituted by Dr Gunning of Edinburgh and Rio de Janeiro—

1. £1000 three per cent. Consolidated Lien Stock of the North British Railway Company at 89½ per cent., the selling price at 1st October 1906	£896	5	0
2. Balance due by the Union Bank of Scotland (£31, 12s. 10d.), and uncashed dividend warrant in hand (£14, 5s.)	45	17	10
AMOUNT.....	£942	2	10

EDINBURGH, 15th October 1906.—We have examined the six preceding Accounts of the Treasurer of the Royal Society of Edinburgh for Session 1905–1906, and have found them to be correct. The securities of the various Investments at 1st October 1906, as noted in the above Statement of Funds, have been exhibited to us.

LINDSAY, JAMIESON & HALDANE,
Auditors.

VIDIMUS of ESTIMATED INCOME of THE GENERAL
FUND FOR SESSION 1906-1907.

1. INTEREST:—	
On £8519, 14s. 3d. Railway Debenture Stock at 3 per cent.....	£255 11 10
On £2090, 9s. 4d. Railway Lien Stock at 3 per cent.....	62 14 4
On £1811 Railway Debenture Stock at 4 per cent.	72 8 8
On £35 Railway Debenture Stock at 4½ per cent...	1 11 6
	£392 6 4
2. ANNUITY from the Edinburgh and District Water Trust	52 10 0
	£444 16 4
<i>Deduct</i> Income Tax at 1s. per £.....	22 4 10
	£422 11 6
3. ANNUAL CONTRIBUTIONS:—	
Of 162 Fellows at £2, 2s. each.....	£340 4 0
Of 137 Fellows at £3, 3s. each.....	431 11 0
	771 15 0
4. ANNUAL GRANT from Government.....	300 0 0
5. SALES of Society's Transactions	30 0 0
	TOTAL ESTIMATED INCOME, £1524 6 6

Exclusive of Fees of Admission and Contributions of New Fellows
who may be admitted during the Year.

INDEX.

- Abercromby (The Hon. John). On an Urn found at Largs, 285, 292.
- Allantoin Excretion in Thymus Feeding, by W. M'Lachlan, 95-106.
- Alternants. The Theory of Alternants in the Historical Order of Development up to 1860, by Thomas Muir, 357-389.
- Analysers, Harmonic. See Synthesiser, 207-233.
- Anglin (A. H.). On the Length of the Normal Chord of a Conic (*Title only*), 558.
- On the Length of a Pair of Tangents to a Conic (*Title only*), 559.
- Antarctica, Evidence for Former Extension of, from Distribution of Collembola, by G. H. Carpenter, 473-483.
- Bathyraco Scotice*, Poisson abyssal nouveau, par L. Dollo, 65-75.
- Boltzmann-Maxwell Law, On Vibrating Systems which are not subject to the, by W. Peddie, 130-141.
- Bort (Teisserenc de). *Météorologie de l'Atmosphère Libre (Title only)*, 557.
- Brown (A. Crum). Obituary Notice of Alexander William Williamson, 541.
- Brownlee (John). Statistical Studies in Immunity. The Theory of an Epidemic, 484-521.
- Burgess (James). Interpolation for a Table of Fractions, with a Notice of Synthetic Division and its Use (*Title only*), 558.
- Calderwood (W. L.). Note on the Smolt to Grilse Stage of the Salmon, with Exhibition of a Marked Fish recaptured, 321-324.
- Cameron (I. D.). On the Methods of Standardising Suprarenal Preparations, 157-171.
- A Dietary Study of Five Halls of Residence for Students in Edinburgh, 327-351.
- Carpenter (G. H.). Scottish National Antarctic Expedition. "Scotia" Collections. Collembola from the South Orkney Islands, 473-483.
- Carson (C. M.) and Alexander Smith. Further Study of the Two Forms of Liquid Sulphur as Dynamic Isomers, 352-356.
- Casterton, Human Skull and Prehistoric Relics found at, by Prof. D. J. Cunningham, 279-309.
- Circulants. The Theory of Circulants in the Historical Order of Development up to 1860, by Thomas Muir, 390-398.
- Collembola, New Species of *Isotoma* and *Cryptopygus* from the South Orkneys, by G. H. Carpenter, 473-483.
- Collet (Léon W.) and T. N. Johnston. On the Formation of certain Lakes in the Highlands, 107-115.
- Collet (Léon W.) et Gabriel W. Lee. *Recherches sur la Glauconie*, 238-278.
- Coutts (J. M.). See Edington (Alex.).
- Crowther-Beynon (V. B.). On Prehistoric Relics at Casterton, 279.
- Cunningham (D. J.). On Human Skulls from Casterton and Largs, 293-309.
- Exhibits two Lantern Slides of Zoological Interest, 553.
- Exhibits Photograph, by Mr W. E. Ward, of the Salmon in the Corrib River, Galway, 558.
- Determinants, Minors of Square of, by Thomas Muir, 533-539.
- Dietary Study of Five Halls of Residence for Students in Edinburgh, by I. D. Cameron, 327-351.
- Dollo (Louis). *Bathyraco Scotice*, Poisson abyssal nouveau recueilli par l'Expédition Antarctique Nationale Écossaise, 65-75.
- *Neobythites Brucei*, Poisson abyssal nouveau recueilli par l'Expédition Antarctique Nationale Écossaise. Note préliminaire, 172-181.
- Dolphin (*Delphinus acutus*). Note on a Specimen recently stranded on Coast of Sutherland, by Sir Wm. Turner, 310-319.
- Doppler's Principle. Two new Cosmic Proofs of its Validity

- obtained with the Spectro-heliometer, by J. Halm, 76-86.
- Echinorhynchus antarcticus*, n. sp., and its Allies, by John Rennie, 437-446.
- Edington (Alex.) and J. M. Coutts. The Recent Epidemic of Trypanosomiasis in Mauritius: its Cause and Progress (*Title only*), 559.
- Electric Oscillations and Magnetic Properties of Iron, by James Russell, 33-47.
- Electrolysis through Precipitation Films, by W. S. Millar and W. W. Taylor, 447-463.
- Electrolytes, Preliminary Note on the Conductivity of Concentrated Aqueous Solutions of, by Prof. J. Gibson, 234-237.
- Electromotive Force of Metals, Measurements of the, by Charles E. Fawsitt, 2-6.
- Epidemic, Theory of an, by John Brownlee, 484-521.
- Ewart (J. C.). The Tarpan and its Relationship with Wild and Domestic Horses, 7-21.
- Fawsitt (Charles E.). Some Electrical Measurements on Metals, 2-6.
- Ferguson (Dr R. M.). Elected Society's Representative on George Heriot's Trust, 553.
- Forbes (George). Perturbations in Longitude of Neptune by the Hypothetical Planet (*Title only*), 553.
- Fractions, Proper, On the Distribution of the, by D. M. Y. Somerville, 116-128.
- Gemmill (J. F.) and R. T. Leiper. The *Turbellaria* of the Scottish National Antarctic Expedition (*Title only*), 556.
- Gibson (John). Preliminary Note on the Conductivity of Concentrated Aqueous Solutions of Electrolytes, 234-237.
- Glauconie, Recherches sur la, by Drs Collet et Lee, 233-278.
- Growth, Effects of varying Diets upon, by C. Watson, 87-94.
- Halm (J.). Some Further Results obtained with the Spectro-heliometer, 76-86.
- Spectroscopic Observations of the Rotation of the Sun (*Title only*), 560.
- Harmonic Curves, A New Instrument for drawing the Sum of a number of Simple, by J. R. Milne, 207-233.
- Harris (D. Fraser). On the Use of Soluble Prussian Blue in investigating the Reducing-power of Animal Tissue (*Title only*), 559.
- Hessians of Invariants of Binary Quantics, by Thomas Muir, 529-532.
- Highlands. Formation of Lochs Muick, Builg, and Callater, by L. W. Collet and T. N. Johnston, 107-115.
- Horse. The Tarpan and its Relationship with Wild and Domestic Horses, by J. C. Ewart, 7-21.
- Horse, The, in Norway, by Francis H. A. Marshall, 22-32.
- Human Skeletons at Casterton and Largs, by Dr R. Muuro, 283, 293.
- Hydrodynamical Theory of Seiches, Some Experimental Results in connection with the, by William White and Peter Watson, 142-156.
- Immunity, Statistical Studies in. Theory of an Epidemic, by John Brownlee, 484-521.
- Invariants, Hessians of, by Thomas Muir, 529-532.
- Ionization, Two Lecture Experiments in Illustration of the Theory of, by W. W. Taylor, 325-326.
- Kelvin (Lord). Initiation of Deep-Sea Waves of Three Classes: (1) from a Single Displacement; (2) from a Group of Equal and Similar Displacements; (3) by a Periodically Varying Surface-Pressure, 399-436.
- Lakes, Formation of, in Scottish Highlands and in the Alps, by L. W. Collet and T. N. Johnston, 107-115.
- Langley (S. P.). Obituary Notice of, by Dr Wm. Peddie, 546-549.
- Largs, Bronze Age Burial at, by Prof. D. J. Cunningham, 279-309.
- Lecture Experiments in Illustration of the Theory of Ionization, by W. W. Taylor, 325-326.
- Lee, Gabriel W. See Léon W. Collet.
- Leiper (R. T.). See Gemmill (J. F.).
- Library Aids to Mathematical Research, by Thomas Muir, 51-64.

- Lindsay (Rev. James). Obituary Notice of the Rev. Dr George Matheson, 550-551.
- Linstow (O. von). The Nematodes of the Scottish National Antarctic Expedition, 1902-1904, 464-472.
- M'Lachlan, W. A Contribution to the Study of the Excretion of Allantoin in Thymus Feeding, 95-106.
- Maclagan-Wedderburn, J. H. See Wedderburn, J. H. Maclagan.
- Magnetic Detections of Electric Waves, by James Russell, 33-47.
- Magnetic Properties of Iron and Electric Oscillations, by James Russell, 33-47.
- Marshall (Francis H. A.). The Horse in Norway, 22-32.
- Matheson (the Rev. Dr George). Obituary Notice of, by the Rev. James Lindsay, 550-551.
- Meetings of the Society during Session 1905-1906, 552-560.
- Metals, Electrical Measurements on, by Charles E. Fawsitt, 2-6.
- Millar (W. S.) and W. W. Taylor. Electrolysis through Precipitation Films, 447-463.
- Milne (Jas Robert). A New Form of Harmonic Synthetiser, 207-233.
- On a Simple Way of Obtaining the Half-Shade Field in Polarimeters, 522-526.
- On an Exception to a Certain Theorem in Optics, with an Application to the Polarimeter, 527-528.
- Muir (Thomas). Library Aids to Mathematical Research, 51-64.
- The Theory of Alternants in the Historical Order of Development up to 1860, 357-389.
- The Theory of Circulants in the Historical Order of Development up to 1860, 390-398.
- The Hessians of Certain Invariants of Binary Quantics, 529-532.
- The Sum of the r -line Minors of the Square of a Determinant, 533-539.
- Munro (Robert). On a Human Skeleton found at Casterton, 279, and at Largs, 283,—279, 283.
- On Early British Races, 284-292.
- Murray (James). Life in Reservoirs in Relation to the Water Supply of Towns (*Title only*), 557.
- Nematodes of the Scottish National Antarctic Expedition, 1902-1904, by O. von Linstow, 464-472.
- Neobythites Brucei*, Poisson abyssal nouveau, par L. Dollo, 172-181.
- Nutrition, Effects of varying Diets upon, by C. Watson, 87-94.
- Obituary Notices. Williamson (Alexander William), 540-545.
- Langley (S. P.), 546-549.
- Matheson (Rev. Dr George), 550-551.
- Office-Bearers, Session 1905-1906, 1.
- Oliver (Thomas). The Relation between Normal Take-up or Contraction and Degree of Twist in Twisted Threads, 182-192.
- Optics. On a Simple Way of Obtaining the Half-Shade Field in Polarimeters, by James Robert Milne, 522-526.
- On an Exception to a Certain Theorem in Optics, with an Application to the Polarimeter, 527-528.
- Papers, List of, read during Session 1905-1906, 552-560.
- Peddie (Wm.). On Vibrating Systems which are not subject to the Boltzmann-Maxwell Law, 130-141.
- Obituary Notice of S. P. Langley, 546-549.
- Polarimeter. On a Simple Way of Obtaining the Half-Shade Field in Polarimeters, by James Robert Milne, 522-526.
- On an Exception to a Certain Theorem in Optics, with an Application to the Polarimeter, by James Robert Milne, 527-528.
- Precipitation Films, Electrolysis through, by W. S. Millar and W. W. Taylor, 447-463.
- Races, Early British, by Dr R. Munro, 284-292.
- Rennie (John). On *Echinorhynchus antarcticus*, n. sp., and its Allies, 437-446.
- Russell (James). Notes on the Effect of Electric Oscillations (co-directional and transverse) on the Magnetic Properties of Iron, 33-47.
- Salmon Smolt ascends Rivers as Grilse fully a year after Descent to Sea, by W. L. Calderwood, 321-324.
- Seiches, Some Experimental Results

- in connection with the Hydrodynamical Theory of, by Peter White and William Watson, 142-156.
- Smith (Alexander) and C. M. Carson. Further Study of the Two Forms of Liquid Sulphur as Dynamic Isomers, 352-356.
- Sommerville (D. M. Y.). On the Distribution of the Proper Fractions, 116-128.
- South Orkney Islands, Collembola from, by G. H. Carpenter, 473-483.
- Spectro-heliometer, Some Further Results obtained with the, by J. Halm, 76-86.
- Sulphur, Further Study of the Two Forms of Liquid, as Dynamic Isomers, by Alexander Smith and C. M. Carson, 352-356.
- Sun. Some Further Results obtained with the Spectro-heliometer, by J. Halm, 76-86.
- Suprenal Preparations, On the Methods of Standardising, by I. D. Cameron, 157-171.
- Synthetiser, A New Form of Harmonic, by J. R. Milne, 207-233.
- Take-up or Contraction in Twisted Threads, by Thomas Oliver, 182-192.
- Tarpan and its Relationship with Wild and Domestic Horses, by J. C. Ewart, 7-21.
- Taylor (W. W.). Two Lecture Experiments in Illustration of the Theory of Ionization, 325-326.
- Taylor (W. W.) and W. S. Millar. Electrolysis through Precipitation Films, 447-463.
- Thymus Feeding, Excretion of Allantoin in, by W. M'Lachlan, 95-106.
- Turner (Sir Wm.). Note on a rare Dolphin (*Delphinus acutus*), recently stranded on the Coast of Sutherland, 310-319.
- Contributions to the Craniology of the People of India. Part III. — Natives of the Madras Presidency, Thugs, Veddahs, Tibetans, Seistanis (*Title only*), 320.
- Twisted Threads, Take-up or Contraction in, by Thomas Oliver, 182-192.
- Urn or Beaker of the Bronze Age, by the Hon. J. Abercromby, 292-293.
- Vibrating Systems which are not subject to the Boltzmann-Maxwell Law, by W. Peddie, 130-141.
- Watson (Chalmers). Preliminary Note regarding an Experimental Investigation into the Effects of varying Diets upon Growth and Nutrition, 87-94.
- Watson, William. See White, Peter.
- Waves. Initiation of Deep-Sea Waves of Three Classes: (1) from a Single Displacement; (2) from a Group of Equal and Similar Displacements; (3) from a Periodically Varying Surface-Pressure, by Lord Kelvin, 399-436.
- Wedderburn, J. H. MacLagan. On a New Theorem in Hypercomplex Numbers, 48-50.
- White (Peter) and William Watson. Some Experimental Results in connection with the Hydrodynamical Theory of Seiches, 142-156.
- Williamson (Alexander William). Obituary Notice of, by Professor A. Crum Brown, 540-545.

506-41

PROCEEDINGS

OF THE

ROYAL SOCIETY OF EDINBURGH.

SESSION 1905-6.

No. I.]

VOL. XXVI.

[Pp. 1-64.

CONTENTS.

	PAGE
Office-Bearers, Session 1905-6,	1
Some Electrical Measurements on Metals. By CHARLES E. FAWSITT, D.Sc., Ph.D. (<i>Communicated by Pro- fessor A. CRUM BROWN</i>),	2
<i>(Issued separately February 12, 1906.)</i>	
The Tarpan and its Relationship with Wild and Domestic Horses. By J. C. EWART, M.D., F.R.S. (With Three Plates),	7
<i>(Issued separately February 12, 1906.)</i>	
The Horse in Norway. By FRANCIS H. A. MARSHALL, M.A. (Cantab.), D.Sc. (Edin.). (With Two Plates),	22
<i>(Issued separately February 12, 1906.)</i>	

[Continued on page iv of Cover.

EDINBURGH :

PUBLISHED BY ROBERT GRANT & SON, 107 PRINCES STREET, AND
WILLIAMS & NORGATE, 14 HENRIETTA STREET, COVENT GARDEN, LONDON.

MDCCCXVI.

Price Three Shillings and Sixpence.



REGULATIONS REGARDING THE PUBLICATION OF PAPERS IN THE PROCEEDINGS AND TRANSACTIONS OF THE SOCIETY.

THE Council beg to direct the attention of authors of communications to the Society to the following Regulations, which have been drawn up in order to accelerate the publication of the Proceedings and Transactions, and to utilise as widely and as fairly as possible the funds which the Society devotes to the publication of Scientific and Literary Researches.

1. MANUSCRIPT OF PAPERS.—As soon as any paper has been passed for publication, either in its original or in any altered form, and has been made ready for publication by the author, it is sent to the printer, whether it has been read or not.

The 'copy' should be written on large sheets of paper, on one side only, and the pages should be clearly numbered. The MS. must be easily legible, preferably typewritten, and must be absolutely in its final form for printing; so that corrections in proof shall be as few as possible, and shall not cause overrunning in the lines or pages of the proof. All tables of contents, references to plates or illustrations in the text, etc., must be in their proper places, with the page numbers left blank; and spaces must be indicated for the insertion of illustrations that are to appear in the text.

2. ILLUSTRATIONS.—All illustrations must be drawn in a form immediately suitable for reproduction; and such illustrations as can be reproduced by photographic processes should, so far as possible, be preferred. Drawings to be reproduced as line blocks should be made with Indian ink (deadened with yellow if of bluish tone), preferably on fine white bristol board, free from folds or creases; smooth, clean lines or sharp dots, but no washes or colours should be used. If the drawings are done on a large scale, to be afterwards reduced by photography, any lettering or other legend must be on a corresponding scale.

If an author finds it inconvenient to furnish such drawings, the Society will have the figures re-drawn at his expense; but this will cause delay.

When the illustrations are to form plates, a scheme for the arrangement of the figures (in quarto plates for the Transactions, in octavo for the Proceedings) must be given, and numbering and lettering indicated.

3. PROOFS.—In general, a first proof and a revise of each paper will be sent to the author, whose address should be indicated on the MS. If further proofs are required, owing to corrections or alterations for which the printer is not responsible, the expense of such proofs and corrections will be charged against the author.

All proofs must, if possible, be returned within one week, addressed to *The Secretary, Royal Society, Mound, Edinburgh*, and not to the printer.

To prevent delay, authors residing abroad should appoint some one residing in this country to correct their proofs.

4. ADDITIONS TO A PAPER after it has been finally handed in for publication, if accepted by the Council, will be treated and dated as separate communications, and may, or may not, be printed immediately after the original paper.

5. BRIEF ABSTRACTS OF TRANSACTIONS PAPERS will be published in the Proceedings, provided they are sent along with the original paper.

6. SEPARATE ISSUE OF REPRINTS; AUTHOR'S FREE AND ADDITIONAL COPIES.—As soon as the final revise of a Transactions paper has been returned, or as soon as the sheet in which the last part of a Proceedings paper appears is ready for press, a certain number of separate copies or reprints, in covers bearing the title of the paper and the name of the author, are printed off and placed on sale. The date of such separate publication will be printed on each paper.

The author receives fifty of these reprints free, and may have any reasonable number of additional copies at a fixed scale of prices which will be furnished by the printer, who will charge him with the cost. To prevent disappointment, especially if the paper contains plates, the author should, immediately after receiving his first proof, notify to the printer the number of additional copies required.

7. INDEX SLIPS.—In order to facilitate the compilation of Subject Indices, and to secure that due attention to the important points in a paper shall be given in General Catalogues of Scientific Literature and in Abstracts by Periodicals, every author is requested to return to the Secretary along with his final proof a brief index (on the model given below), of the points in it which he considers new or important. These indices will be edited by the Secretary, and incorporated in Separate Index Slips, to be issued with each part of the Proceedings and Transactions.

MODEL INDEX.

- Schäfer, E. A.—On the Existence within the Liver Cells of Channels which can be directly injected from the Blood-vessels. Proc. Roy. Soc. Edin., vol. , 1902, pp. .
- Cells, Liver,—Intra-cellular Canaliculi in.
E. A. Schäfer. Proc. Roy. Soc. Edin., vol. , 1902, pp. .
- Liver,—Injection within Cells of.
E. A. Schäfer. Proc. Roy. Soc. Edin., vol. , 1902, pp. .

	PAGE
Notes on the Effect of Electric Oscillations (co-directional and transverse) on the Magnetic Properties of Iron. By JAMES RUSSELL,	33
<i>(Issued separately February 8, 1906.)</i>	
On a Theorem in Hypercomplex Numbers. By J. H. MACLAGAN-WEDDERBURN, Carnegie Research Fellow, .	48
<i>(Issued separately February 9, 1906.)</i>	
Library Aids to Mathematical Research. By THOMAS MUIR, LL.D.,	51
<i>(Issued separately February 14, 1906.)</i>	

PROCEEDINGS

OF THE

ROYAL SOCIETY OF EDINBURGH.

SESSION 1905-6.

No. II.]

VOL. XXVI.

[Pp. 65-128.

CONTENTS.

PAGE

Bathyraco Scotiæ, Poisson abyssal nouveau recueilli par l'Expédition Antarctique Nationale Ecossoise. Note préliminaire, par LOUIS DOLLO, Conservateur au Musée royal d'Histoire naturelle, à Bruxelles. (*Présentée par M. R. H. TRAQUAIR, M.D., F.R.S., V.P.R.S.E.*), . . . 65
(*Issued separately March 29, 1906.*)

Some Further Results obtained with the Spectroheliometer.
By Dr J. HALM, 76
(*Issued separately March 29, 1906.*)

Preliminary Note regarding an Experimental Investigation into the Effects of Varying Diets upon Growth and Nutrition. By CHALMERS WATSON, M.D. (*From the Physiological Laboratory of the University of Edinburgh.*) (*Presented by Prof. E. A. SCHÄFER, F.R.S.*), . . . 87
(*Issued separately February 22, 1906.*)

[*Continued on page iv of Cover.*]

EDINBURGH :

PUBLISHED BY ROBERT GRANT & SON, 107 PRINCES STREET, AND
WILLIAMS & NORGATE, 14 HENRIETTA STREET, COVENT GARDEN, LONDON.

MDCCCXVI.

Price Three Shillings.

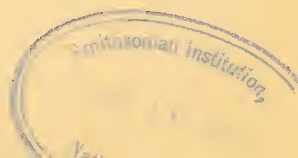

REGULATIONS REGARDING THE PUBLICATION OF PAPERS IN THE PROCEEDINGS AND TRANSACTIONS OF THE SOCIETY.

THE Council beg to direct the attention of authors of communications to the Society to the following Regulations, which have been drawn up in order to accelerate the publication of the Proceedings and Transactions, and to utilise as widely and as fairly as possible the funds which the Society devotes to the publication of Scientific and Literary Researches.

1. MANUSCRIPT OF PAPERS.—As soon as any paper has been passed for publication, either in its original or in any altered form, and has been made ready for publication by the author, it is sent to the printer, whether it has been read or not.

The 'copy' should be written on large sheets of paper, on one side only, and the pages should be clearly numbered. The MS. must be easily legible, preferably typewritten, and must be absolutely in its final form for printing; so that corrections in proof shall be as few as possible, and shall not cause overrunning in the lines or pages of the proof. All tables of contents, references to plates or illustrations in the text, etc., must be in their proper places, with the page numbers left blank; and spaces must be indicated for the insertion of illustrations that are to appear in the text.

2. ILLUSTRATIONS.—All illustrations must be drawn in a form immediately suitable for reproduction; and such illustrations as can be reproduced by photographic processes should, so far as possible, be preferred. Drawings to be reproduced as line blocks should be made with Indian ink (deadened with yellow if of bluish tone), preferably on fine white bristol board, free from folds or creases; smooth, clean lines or sharp dots, but no washes or colours should be used. If the drawings are done on a large scale, to be afterwards reduced by photography, any lettering or other legend must be on a corresponding scale.

If an author finds it inconvenient to furnish such drawings, the Society will have the figures re-drawn at his expense; but this will cause delay.

When the illustrations are to form plates, a scheme for the arrangement of the figures (in quarto plates for the Transactions, in octavo for the Proceedings) must be given, and numbering and lettering indicated.

3. PROOFS.—In general, a first proof and a revise of each paper will be sent to the author, whose address should be indicated on the MS. If further proofs are required, owing to corrections or alterations for which the printer is not responsible, the expense of such proofs and corrections will be charged against the author.

All proofs must, if possible, be returned within one week, addressed to *The Secretary, Royal Society, Mound, Edinburgh*, and not to the printer.

To prevent delay, authors residing abroad should appoint some one residing in this country to correct their proofs.

4. ADDITIONS TO A PAPER after it has been finally handed in for publication, if accepted by the Council, will be treated and dated as separate communications, and may, or may not, be printed immediately after the original paper.

5. BRIEF ABSTRACTS OF TRANSACTIONS PAPERS will be published in the Proceedings, provided they are sent along with the original paper.

6. SEPARATE ISSUE OF REPRINTS; AUTHOR'S FREE AND ADDITIONAL COPIES.—As soon as the final revise of a Transactions paper has been returned, or as soon as the sheet in which the last part of a Proceedings paper appears is ready for press, a certain number of separate copies or reprints, in covers bearing the title of the paper and the name of the author, are printed off and placed on sale. The date of such separate publication will be printed on each paper.

The author receives fifty of these reprints free, and may have any reasonable number of additional copies at a fixed scale of prices which will be furnished by the printer, who will charge him with the cost. To prevent disappointment, especially if the paper contains plates, the author should, immediately after receiving his first proof, notify *to the printer* the number of additional copies required.

7. INDEX SLIPS.—In order to facilitate the compilation of Subject Indices, and to secure that due attention to the important points in a paper shall be given in General Catalogues of Scientific Literature and in Abstracts by Periodicals, every author is requested to return to the Secretary along with his final proof a brief index (on the model given below), of the points in it which he considers new or important. These indices will be edited by the Secretary, and incorporated in Separate Index Slips, to be issued with each part of the Proceedings and Transactions.

MODEL INDEX.

Schäfer, E. A.—On the Existence within the Liver Cells of Channels which can be directly injected from the Blood-vessels. Proc. Roy. Soc. Edin., vol. , 1902, pp. .

Cells, Liver,—Intra-cellular Canaliculi in.

E. A. Schäfer. Proc. Roy. Soc. Edin., vol. , 1902, pp. .

Liver,—Injection within Cells of.

E. A. Schäfer. Proc. Roy. Soc. Edin., vol. , 1902, pp. .

	PAGE
A Contribution to the Study of the Excretion of Allantoin in Thymus Feeding. By W. M'LACHLAN, M.D. (<i>From the Research Laboratory of the Royal College of Physicians, Edinburgh.</i>) (<i>Communicated by Dr D. NOËL PATON</i>),	95
<i>(Issued separately March 29, 1906.)</i>	
On the Formation of certain Lakes in the Highlands. By Dr LÉON W. COLLET, F. Swiss Geol. S., Assistant to Sir John Murray, K.C.B., and Dr T. N. JOHNSTON, F.R.S.E. With a Note on Two Rock Basins in the Alps, by Dr LÉON W. COLLET,	107
<i>(Issued separately April 16, 1906.)</i>	
On the Distribution of the Proper Fractions. By DUNCAN M. Y. SOMMERVILLE, D.Sc. (<i>Communicated by Prof. CHRYSTAL</i>),	116
<i>(Issued separately April 16, 1906.)</i>	

506.41

PROCEEDINGS

OF THE

ROYAL SOCIETY OF EDINBURGH.

SESSION 1905-6.

No. III.]

VOL. XXVI.

[Pp. 129-192.

CONTENTS.

	PAGE
On Vibrating Systems which are not subject to the Boltzmann-Maxwell Law. By Dr W. PEDDIE	130
<i>(Issued separately May 24, 1906.)</i>	
Some Experimental Results in connection with the Hydrodynamical Theory of Seiches. By PETER WHITE, M.A., and WILLIAM WATSON,	142
<i>(Issued separately June 11, 1906.)</i>	
On the Methods of Standardising Suprarenal Preparations. By I. D. CAMERON, M.B., D.P.H., Assistant to the Lecturer on Physiology, Edinburgh School of Medicine for Women. <i>(From the Laboratory of the Royal College of Physicians, Edinburgh.) Communicated by</i> Dr D. NOËL PATON,	157
<i>(Issued separately May 21, 1906.)</i>	

[Continued on page iv of Cover.

EDINBURGH :

PUBLISHED BY ROBERT GRANT & SON, 107 PRINCES STREET, AND WILLIAMS & NORGATE, 14 HENRIETTA STREET, COVENT GARDEN, LONDON.

MDCCCVI.

Price Three Shillings.

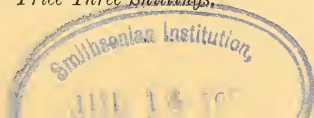

REGULATIONS REGARDING THE PUBLICATION OF PAPERS IN THE PROCEEDINGS AND TRANSACTIONS OF THE SOCIETY.

THE Council beg to direct the attention of authors of communications to the Society to the following Regulations, which have been drawn up in order to accelerate the publication of the Proceedings and Transactions, and to utilise as widely and as fairly as possible the funds which the Society devotes to the publication of Scientific and Literary Researches.

1. MANUSCRIPT OF PAPERS.—As soon as any paper has been passed for publication, either in its original or in any altered form, and has been made ready for publication by the author, it is sent to the printer, whether it has been read or not.

The 'copy' should be written on large sheets of paper, on one side only, and the pages should be clearly numbered. The MS. must be easily legible, preferably typewritten, and must be absolutely in its final form for printing; so that corrections in proof shall be as few as possible, and shall not cause overrunning in the lines or pages of the proof. All tables of contents, references to plates or illustrations in the text, etc., must be in their proper places, with the page numbers left blank; and spaces must be indicated for the insertion of illustrations that are to appear in the text.

2. ILLUSTRATIONS.—All illustrations must be drawn in a form immediately suitable for reproduction; and such illustrations as can be reproduced by photographic processes should, so far as possible, be preferred. Drawings to be reproduced as line blocks should be made with Indian ink (deadened with yellow if of bluish tone), preferably on fine white bristol board, free from folds or creases; smooth, clean lines or sharp dots, but no washes or colours should be used. If the drawings are done on a large scale, to be afterwards reduced by photography, any lettering or other legend must be on a corresponding scale.

If an author finds it inconvenient to furnish such drawings, the Society will have the figures re-drawn at his expense; but this will cause delay.

When the illustrations are to form plates, a scheme for the arrangement of the figures (in quarto plates for the Transactions, in octavo for the Proceedings) must be given, and numbering and lettering indicated.

3. PROOFS.—In general, a first proof and a revise of each paper will be sent to the author, whose address should be indicated on the MS. If further proofs are required, owing to corrections or alterations for which the printer is not responsible, the expense of such proofs and corrections will be charged against the author.

All proofs must, if possible, be returned within one week, addressed to *The Secretary, Royal Society, Mound, Edinburgh*, and not to the printer.

To prevent delay, authors residing abroad should appoint some one residing in this country to correct their proofs.

4. ADDITIONS TO A PAPER after it has been finally handed in for publication, if accepted by the Council, will be treated and dated as separate communications, and may, or may not, be printed immediately after the original paper.

5. BRIEF ABSTRACTS OF TRANSACTIONS PAPERS will be published in the Proceedings, provided they are sent along with the original paper.

6. SEPARATE ISSUE OF REPRINTS; AUTHOR'S FREE AND ADDITIONAL COPIES.—As soon as the final revise of a Transactions paper has been returned, or as soon as the sheet in which the last part of a Proceedings paper appears is ready for press, a certain number of separate copies or reprints, in covers bearing the title of the paper and the name of the author, are printed off and placed on sale. The date of such separate publication will be printed on each paper.

The author receives fifty of these reprints free, and may have any reasonable number of additional copies at a fixed scale of prices which will be furnished by the printer, who will charge him with the cost. To prevent disappointment, especially if the paper contains plates, the author should, immediately after receiving his first proof, notify to the printer the number of additional copies required.

7. INDEX SLIPS.—In order to facilitate the compilation of Subject Indices, and to secure that due attention to the important points in a paper shall be given in General Catalogues of Scientific Literature and in Abstracts by Periodicals, every author is requested to return to the Secretary along with his final proof a brief index (on the model given below), of the points in it which he considers new or important. These indices will be edited by the Secretary, and incorporated in Separate Index Slips, to be issued with each part of the Proceedings and Transactions.

MODEL INDEX.

- Schäfer, E. A.—On the Existence within the Liver Cells of Channels which can be directly injected from the Blood-vessels. Proc. Roy. Soc. Edin., vol. , 1902, pp.
- Cells, Liver,—Intra-cellular Canaliculi in.
E. A. Schäfer. Proc. Roy. Soc. Edin., vol. , 1902, pp.
- Liver,—Injection within Cells of.
E. A. Schäfer. Proc. Roy. Soc. Edin., vol. , 1902, pp.

	PAGE
Neobythites Brucei, Poisson abyssal nouveau recueilli par l'Expédition Antarctique Nationale Ecossoise. Note préliminaire, par LOUIS DOLLO, Conservateur au Musée royal d'Histoire naturelle, à Bruxelles. <i>Présentée par</i> M. R. H. TRAQUAIR, M.D., F.R.S., V.P.R.S.E., .	172

(Issued separately June 14, 1906.)

The Relation between Normal Take-up or Contraction and Degree of Twist in Twisted Threads. By THOMAS OLIVER, B.Sc. (Lond. & Edin.), Carnegie Research Fellow. <i>Communicated by</i> Dr C. G. KNOTT, .	182
--	-----

(Issued separately June 19, 1906.)

506.41

Mus

PROCEEDINGS

OF THE

ROYAL SOCIETY OF EDINBURGH.

SESSION 1905-6.

No. IV.]

VOL. XXVI.

[Pp. 193-320.

CONTENTS.

	PAGE
A New Form of Harmonic Synthetiser. By J. R. MILNE, B.Sc., Carnegie Research Fellow. (With Plate),	207
<i>(Issued separately July 12, 1906.)</i>	
Preliminary Note on the Conductivity of Concentrated Aqueous Solutions of Electrolytes. By Prof. J. GIBSON,	234
<i>(Issued separately August 29, 1906.)</i>	
Recherches sur la Glauconie. Par les Drs LÉON W. COLLET et GABRIEL W. LEE, assistants de Sir John Murray, K.C.B. <i>Communiqué par Sir JOHN MURRAY.</i> (Avec 12 planches et 1 carte),	238
<i>(Issued separately August 30, 1906.)</i>	

[Continued on page iv of Cover.

EDINBURGH :

PUBLISHED BY ROBERT GRANT & SON, 107 PRINCES STREET, AND
WILLIAMS & NORGATE, 14 HENRIETTA STREET, COVENT GARDEN, LONDON.

MDCCCXVI.

Price Seven Shillings.

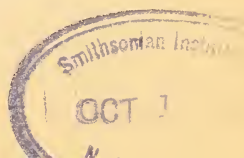

REGULATIONS REGARDING THE PUBLICATION OF PAPERS IN THE PROCEEDINGS AND TRANSACTIONS OF THE SOCIETY.

THE Council beg to direct the attention of authors of communications to the Society to the following Regulations, which have been drawn up in order to accelerate the publication of the Proceedings and Transactions, and to utilise as widely and as fairly as possible the funds which the Society devotes to the publication of Scientific and Literary Researches.

1. MANUSCRIPT OF PAPERS.—As soon as any paper has been passed for publication, either in its original or in any altered form, and has been made ready for publication by the author, it is sent to the printer, whether it has been read or not.

The 'copy' should be written on large sheets of paper, on one side only, and the pages should be clearly numbered. The MS. must be easily legible, preferably typewritten, and must be absolutely in its final form for printing; so that corrections in proof shall be as few as possible, and shall not cause overrunning in the lines or pages of the proof. All tables of contents, references to plates or illustrations in the text, etc., must be in their proper places, with the page numbers left blank; and spaces must be indicated for the insertion of illustrations that are to appear in the text.

2. ILLUSTRATIONS.—All illustrations must be drawn in a form immediately suitable for reproduction; and such illustrations as can be reproduced by photographic processes should, so far as possible, be preferred. Drawings to be reproduced as line blocks should be made with Indian ink (deadened with yellow if of bluish tone), preferably on fine white bristol board, free from folds or creases; smooth, clean lines or sharp dots, but no washes or colours should be used. If the drawings are done on a large scale, to be afterwards reduced by photography, any lettering or other legend must be on a corresponding scale.

If an author finds it inconvenient to furnish such drawings, the Society will have the figures re-drawn at his expense; but this will cause delay.

When the illustrations are to form plates, a scheme for the arrangement of the figures (in quarto plates for the Transactions, in octavo for the Proceedings) must be given, and numbering and lettering indicated.

3. PROOFS.—In general, a first proof and a revise of each paper will be sent to the author, whose address should be indicated on the MS. If further proofs are required, owing to corrections or alterations for which the printer is not responsible, the expense of such proofs and corrections will be charged against the author.

All proofs must, if possible, be returned within one week, addressed to *The Secretary, Royal Society, Mound, Edinburgh*, and not to the printer.

To prevent delay, authors residing abroad should appoint some one residing in this country to correct their proofs.

4. ADDITIONS TO A PAPER after it has been finally handed in for publication, if accepted by the Council, will be treated and dated as separate communications, and may, or may not, be printed immediately after the original paper.

5. BRIEF ABSTRACTS OF TRANSACTIONS PAPERS will be published in the Proceedings, provided they are sent along with the original paper.

6. SEPARATE ISSUE OF REPRINTS; AUTHOR'S FREE AND ADDITIONAL COPIES.—As soon as the final revise of a Transactions paper has been returned, or as soon as the sheet in which the last part of a Proceedings paper appears is ready for press, a certain number of separate copies or reprints, in covers bearing the title of the paper and the name of the author, are printed off and placed on sale. The date of such separate publication will be printed on each paper.

The author receives fifty of these reprints free, and may have any reasonable number of additional copies at a fixed scale of prices which will be furnished by the printer, who will charge him with the cost. To prevent disappointment, especially if the paper contains plates, the author should, immediately after receiving his first proof, notify *to the printer* the number of additional copies required.

7. INDEX SLIPS.—In order to facilitate the compilation of Subject Indices, and to secure that due attention to the important points in a paper shall be given in General Catalogues of Scientific Literature and in Abstracts by Periodicals, every author is requested to return to the Secretary along with his final proof a brief index (on the model given below), of the points in it which he considers new or important. These indices will be edited by the Secretary, and incorporated in Separate Index Slips, to be issued with each part of the Proceedings and Transactions.

MODEL INDEX.

- Schäfer, E. A.—On the Existence within the Liver Cells of Channels which can be directly injected from the Blood-vessels. Proc. Roy. Soc. Edin., vol. , 1902, pp. .
- Cells, Liver,—Intra-cellular Canaliculi in.
E. A. Schäfer. Proc. Roy. Soc. Edin., vol. , 1902, pp. .
- Liver,—Injection within Cells of.
E. A. Schäfer. Proc. Roy. Soc. Edin., vol. , 1902, pp. .

- Notes:—1. On a Human Skeleton, with Prehistoric Objects, found at Great Casterton, Rutland. 2. On a Stone Cist containing a Skeleton and an Urn, found at Largs, Ayrshire. By Dr ROBERT MUNRO. With a Report on the Urn, by the Hon. JOHN ABERCROMBY; and on the Skulls, by Professor D. J. CUNNINGHAM, 279
(Issued separately August 31, 1906.)
- Note on a rare Dolphin (*Delphinus acutus*), recently stranded on the Coast of Sutherland. By Sir WILLIAM TURNER, K.C.B., F.R.S. (With Plate), 310
(Issued separately August 29, 1906.)
- Contributions to the Craniology of the People of the Empire of India. Part III.: Natives of the Madras Presidency, Thugs, Veddahs, Tibetans, and Seistanis. By Sir WILLIAM TURNER, K.C.B., 320
(Title only.)

PROCEEDINGS

OF THE

ROYAL SOCIETY OF EDINBURGH.

SESSION 1905-6.

No. V.]

VOL. XXVI.

[Pp. 321-432.

CONTENTS.

	PAGE
Note on the Smolt to Grilse Stage of the Salmon, with Exhibition of a Marked Fish recaptured. By W. L. CALDERWOOD,	321
<i>(Issued separately October 12, 1906.)</i>	
Two Lecture Experiments in illustration of the Theory of Ionization. By Dr W. W. TAYLOR. <i>Communicated by</i> Professor CRUM BROWN,	325
<i>(Issued separately October 12, 1906.)</i>	
A Dietary Study of Five Halls of Residence for Students in Edinburgh. By I. D. CAMERON, M.B., D.P.H. <i>Communicated by</i> D. NÖEL PATON, M.D.,	327
<i>(Issued separately November 9, 1906.)</i>	

[Continued on page iv of Cover.

EDINBURGH :

PUBLISHED BY ROBERT GRANT & SON, 107 PRINCES STREET, AND
WILLIAMS & NORGATE, 14 HENRIETTA STREET, COVENT GARDEN, LONDON.

MDCCCXVI.

Price Six Shillings.

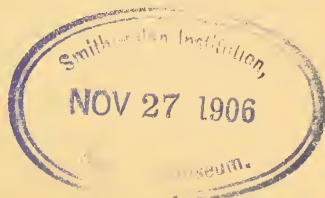

REGULATIONS REGARDING THE PUBLICATION OF PAPERS IN THE PROCEEDINGS AND TRANSACTIONS OF THE SOCIETY.

THE Council beg to direct the attention of authors of communications to the Society to the following Regulations, which have been drawn up in order to accelerate the publication of the Proceedings and Transactions, and to utilise as widely and as fairly as possible the funds which the Society devotes to the publication of Scientific and Literary Researches.

1. MANUSCRIPT OF PAPERS.—As soon as any paper has been passed for publication, either in its original or in any altered form, and has been made ready for publication by the author, it is sent to the printer, whether it has been read or not.

The 'copy' should be written on large sheets of paper, on one side only, and the pages should be clearly numbered. The MS. must be easily legible, preferably typewritten, and must be absolutely in its final form for printing; so that corrections in proof shall be as few as possible, and shall not cause overrunning in the lines or pages of the proof. All tables of contents, references to plates or illustrations in the text, etc., must be in their proper places, with the page numbers left blank; and spaces must be indicated for the insertion of illustrations that are to appear in the text.

2. ILLUSTRATIONS.—All illustrations must be drawn in a form immediately suitable for reproduction; and such illustrations as can be reproduced by photographic processes should, so far as possible, be preferred. Drawings to be reproduced as line blocks should be made with Indian ink (deadened with yellow if of bluish tone), preferably on fine white bristol board, free from folds or creases; smooth, clean lines or sharp dots, but no washes or colours should be used. If the drawings are done on a large scale, to be afterwards reduced by photography, any lettering or other legend must be on a corresponding scale.

If an author finds it inconvenient to furnish such drawings, the Society will have the figures re-drawn at his expense; but this will cause delay.

When the illustrations are to form plates, a scheme for the arrangement of the figures (in quarto plates for the Transactions, in octavo for the Proceedings) must be given, and numbering and lettering indicated.

3. PROOFS.—In general, a first proof and a revise of each paper will be sent to the author, whose address should be indicated on the MS. If further proofs are required, owing to corrections or alterations for which the printer is not responsible, the expense of such proofs and corrections will be charged against the author.

All proofs must, if possible, be returned within one week, addressed to *The Secretary, Royal Society, Mound, Edinburgh*, and not to the printer.

To prevent delay, authors residing abroad should appoint some one residing in this country to correct their proofs.

4. ADDITIONS TO A PAPER after it has been finally handed in for publication, if accepted by the Council, will be treated and dated as separate communications, and may, or may not, be printed immediately after the original paper.

5. BRIEF ABSTRACTS OF TRANSACTIONS PAPERS will be published in the Proceedings, provided they are sent along with the original paper.

6. SEPARATE ISSUE OF REPRINTS; AUTHOR'S FREE AND ADDITIONAL COPIES.—As soon as the final revise of a Transactions paper has been returned, or as soon as the sheet in which the last part of a Proceedings paper appears is ready for press, a certain number of separate copies or reprints, in covers bearing the title of the paper and the name of the author, are printed off and placed on sale. The date of such separate publication will be printed on each paper.

The author receives fifty of these reprints free, and may have any reasonable number of additional copies at a fixed scale of prices which will be furnished by the printer, who will charge him with the cost. To prevent disappointment, especially if the paper contains plates, the author should, immediately after receiving his first proof, notify *to the printer* the number of additional copies required.

7. INDEX SLIPS.—In order to facilitate the compilation of Subject Indices, and to secure that due attention to the important points in a paper shall be given in General Catalogues of Scientific Literature and in Abstracts by Periodicals, every author is requested to return to the Secretary along with his final proof a brief index (on the model given below), of the points in it which he considers new or important. These indices will be edited by the Secretary, and incorporated in Separate Index Slips, to be issued with each part of the Proceedings and Transactions.

MODEL INDEX.

- Schäfer, E. A.—On the Existence within the Liver Cells of Channels which can be directly injected from the Blood-vessels. Proc. Roy. Soc. Edin., vol. , 1902, pp. .
- Cells, Liver,—Intra-cellular Canaliculi in.
E. A. Schäfer. Proc. Roy. Soc. Edin., vol. , 1902, pp. .
- Liver,—Injection within Cells of.
E. A. Schäfer. Proc. Roy. Soc. Edin., vol. , 1902, pp. .

	PAGE
Further Study of the two Forms of Liquid Sulphur as Dynamic Isomers. By ALEXANDER SMITH and C. M. CARSON,	352
<i>(Issued separately November 12, 1906.)</i>	
The Theory of Alternants in the Historical Order of Development up to 1860. By THOMAS MUIR, LL.D.,	357
<i>(Issued separately November 16, 1906.)</i>	
The Theory of Circulants in the Historical Order of Development up to 1860. By THOMAS MUIR, LL.D.,	390
<i>(Issued separately November 16, 1906.)</i>	
Initiation of Deep-Sea Waves of Three Classes: (1) from a Single Displacement; (2) from a Group of Equal and Similar Displacements; (3) by a Periodically Varying Surface Pressure. By LORD KELVIN,	399
<i>(Issued separately November 17, 1906.)</i>	

506.41

PROCEEDINGS

OF THE

ROYAL SOCIETY OF EDINBURGH.

SESSION 1905-6.

No. VI.]

VOL. XXVI.

[Pp. 433-575.

CONTENTS.

	PAGE
"Scotia" Collections. On <i>Echinorhynchus antarcticus</i> , n. sp., and its Allies. By JOHN RENNIE, D.Sc., University of Aberdeen. <i>Communicated by</i> WM. S. BRUCE, Esq. (With a Plate),	437
<i>(Issued separately January 4, 1907.)</i>	
Electrolysis through Precipitation Films. Part I. By W. S. MILLAR, M.A., B.Sc., Carnegie Research Scholar, and Dr W. W. TAYLOR. <i>Communicated by</i> Professor CRUM BROWN,	447
<i>(Issued separately January 4, 1907.)</i>	
Nematodes of the Scottish National Antarctic Expedition, 1902-1904. By Dr v. LINSTOW, Göttingen. <i>Com-</i> <i>municated by</i> W. S. BRUCE. (With Two Plates),	464
<i>(Issued separately January 4, 1907.)</i>	

[Continued on page iv of Cover.

EDINBURGH :

PUBLISHED BY ROBERT GRANT & SON, 107 PRINCES STREET, AND
WILLIAMS & NORGATE, 14 HENRIETTA STREET, COVENT GARDEN, LONDON.

MDCCCXCVII.

Price Six Shillings.

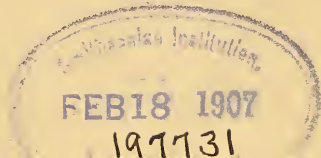

REGULATIONS REGARDING THE PUBLICATION OF PAPERS IN THE PROCEEDINGS AND TRANSACTIONS OF THE SOCIETY.

THE Council beg to direct the attention of authors of communications to the Society to the following Regulations, which have been drawn up in order to accelerate the publication of the Proceedings and Transactions, and to utilise as widely and as fairly as possible the funds which the Society devotes to the publication of Scientific and Literary Researches.

1. MANUSCRIPT OF PAPERS.—As soon as any paper has been passed for publication, either in its original or in any altered form, and has been made ready for publication by the author, it is sent to the printer, whether it has been read or not.

The 'copy' should be written on large sheets of paper, on one side only, and the pages should be clearly numbered. The MS. must be easily legible, preferably typewritten, and must be absolutely in its final form for printing; so that corrections in proof shall be as few as possible, and shall not cause overrunning in the lines or pages of the proof. All tables of contents, references to plates or illustrations in the text, etc., must be in their proper places, with the page numbers left blank; and spaces must be indicated for the insertion of illustrations that are to appear in the text.

2. ILLUSTRATIONS.—All illustrations must be drawn in a form immediately suitable for reproduction; and such illustrations as can be reproduced by photographic processes should, so far as possible, be preferred. Drawings to be reproduced as line blocks should be made with Indian ink (deadened with yellow if of bluish tone), preferably on fine white bristol board, free from folds or creases; smooth, clean lines or sharp dots, but no washes or colours should be used. If the drawings are done on a large scale, to be afterwards reduced by photography, any lettering or other legend must be on a corresponding scale.

If an author finds it inconvenient to furnish such drawings, the Society will have the figures re-drawn at his expense; but this will cause delay.

When the illustrations are to form plates, a scheme for the arrangement of the figures (in quarto plates for the Transactions, in octavo for the Proceedings) must be given, and numbering and lettering indicated.

3. PROOFS.—In general, a first proof and a revise of each paper will be sent to the author, whose address should be indicated on the MS. If further proofs are required, owing to corrections or alterations for which the printer is not responsible, the expense of such proofs and corrections will be charged against the author.

All proofs must, if possible, be returned within one week, addressed to *The Secretary, Royal Society, Mound, Edinburgh*, and not to the printer.

To prevent delay, authors residing abroad should appoint some one residing in this country to correct their proofs.

4. ADDITIONS TO A PAPER after it has been finally handed in for publication, if accepted by the Council, will be treated and dated as separate communications, and may, or may not, be printed immediately after the original paper.

5. BRIEF ABSTRACTS OF TRANSACTIONS PAPERS will be published in the Proceedings, provided they are sent along with the original paper.

6. SEPARATE ISSUE OF REPRINTS; AUTHOR'S FREE AND ADDITIONAL COPIES.—As soon as the final revise of a Transactions paper has been returned, or as soon as the sheet in which the last part of a Proceedings paper appears is ready for press, a certain number of separate copies or reprints, in covers bearing the title of the paper and the name of the author, are printed off and placed on sale. The date of such separate publication will be printed on each paper.

The author receives fifty of these reprints free, and may have any reasonable number of additional copies at a fixed scale of prices which will be furnished by the printer, who will charge him with the cost. To prevent disappointment, especially if the paper contains plates, the author should, immediately after receiving his first proof, notify to the printer the number of additional copies required.

7. INDEX SLIPS.—In order to facilitate the compilation of Subject Indices, and to secure that due attention to the important points in a paper shall be given in General Catalogues of Scientific Literature and in Abstracts by Periodicals, every author is requested to return to the Secretary along with his final proof a brief index (on the model given below), of the points in it which he considers new or important. These indices will be edited by the Secretary, and incorporated in Separate Index Slips, to be issued with each part of the Proceedings and Transactions.

MODEL INDEX.

- Schäfer, E. A.—On the Existence within the Liver Cells of Channels which can be directly injected from the Blood-vessels. Proc. Roy. Soc. Edin., vol. , 1902, pp. .
- Cells, Liver,—Intra-cellular Canaliculi in.
E. A. Schäfer. Proc. Roy. Soc. Edin., vol. , 1902, pp. .
- Liver,—Injection within Cells of.
E. A. Schäfer. Proc. Roy. Soc. Edin., vol. , 1902, pp. .

	PAGE
Scottish National Antarctic Expedition. "Scotia" Collections. Collembola from the South Orkney Islands. By GEORGE H. CARPENTER, B.Sc., M.R.I.A., Professor of Zoology in the Royal College of Science, Dublin. (With Two Plates.) <i>Communicated by</i> WILLIAM EVANS, Esq.,	473
<i>(Issued separately January 14, 1907.)</i>	
Statistical Studies in Immunity: The Theory of an Epidemic. By JOHN BROWNLEE, M.D. Glas. <i>Communicated by</i> Dr R. M. BUCHANAN,	484
<i>(Issued separately January 14, 1907.)</i>	
On a Simple Way of Obtaining the Half-Shade Field in Polarimeters. By JAMES ROBERT MILNE, B.Sc., Carnegie Research Fellow,	522
<i>(Issued separately January 14, 1907.)</i>	
On an Exception to a Certain Theorem in Optics, with an Application to the Polarimeter. By JAMES ROBERT MILNE, B.Sc., Carnegie Research Fellow,	527
<i>(Issued separately January 14, 1907.)</i>	
The Hessians of Certain Invariants of Binary Quantics. By THOMAS MUIR, LL.D.,	529
<i>(Issued separately January 16, 1907.)</i>	
The Sum of the r -line Minors of the Square of a Determinant. By THOMAS MUIR, LL.D.,	533
<i>(Issued separately January 16, 1907.)</i>	

OBITUARY NOTICES,	540
Meetings of the Royal Society—Session 1905–1906,	552
Abstract of Accounts for Session 1905–1906,	561
INDEX,	572

1735 (15)

Piper



SMITHSONIAN INSTITUTION LIBRARIES



3 9088 01303 4731