

SCIENCE
GOSSIP.

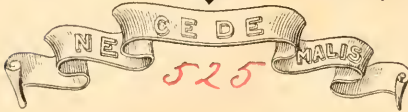
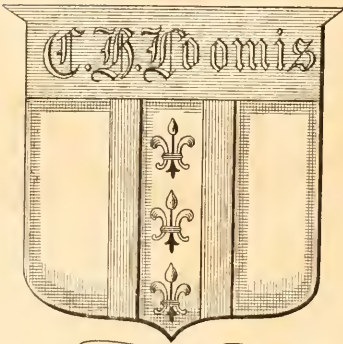

HARDWICKE'S
SCIENCE-GOSSIP:
1877.

WORKS BY THE EDITOR OF "SCIENCE GOSSIP."

HALF-HOURS IN THE GREEN LANES: a Book for a Country Stroll

Illustrated with 300 Woodcuts. Third Edition. Crown 8vo., cloth, 4s.

HALF-HOURS AT THE SEA-SIDE; or, Recreations with Marine Objects.

Illustrated with 150 Woodcuts. Third Edition. Crown 8vo., cloth, 4s.

GEOLOGICAL STORIES: a Series of Autobiographies in Chronological Order.

Third Edition. Illustrated with 175 Woodcuts. Crown 8vo., cloth, 4s.

THE AQUARIUM; its Inhabitants, Structure, and Management. Illustrated

with 239 Woodcuts. Crown 8vo., cloth extra, 6s.

In the Press.

FLOWERS; their Origin, Shapes, Perfumes, and Colours. Illustrated with

Coloured Plates and numerous Woodcuts. Crown 8vo. cloth.

NOTES ON COLLECTING AND PRESERVING NATURAL HISTORY OBJECTS.

Edited by J. E. TAYLOR, F.L.S., F.G.S. CONTENTS: Geological Specimens by the Editor; Bones, by E. F. Elwin; Birds' Eggs, by T. Southwell, F.Z.S.; Butterflies and Moths, by Dr. Knaggs; Beetles, by E. C. Rye, F.Z.S.; Hymenoptera, by J. B. Bridgman; Fresh-water Shells, by Professor Ralph Tate, F.G.S.; Flowering Plants, by James Britten, F.L.S.; Mosses, by Dr. Braithwaite, F.L.S.; Grasses, by Professor Buckman; Fungi, by Worthington G. Smith, F.L.S.; Lichens, by Rev. James Crombie, F.L.S.; Seaweeds, by W. H. Grattan. Illustrated with numerous Woodcuts. Crown 8vo., cloth, 3s. 6d.

HARDWICKE & BOGUE, 192, PICCADILLY.

HARDWICKE'S

Science-Gossip:

AN ILLUSTRATED MEDIUM OF INTERCHANGE AND GOSSIP

FOR STUDENTS AND

LOVERS OF NATURE.

EDITED BY

J. E. TAYLOR, PH.D., F.L.S., F.G.S., F.R.G.S.I., &c.

VOLUME XIII.



LONDON:

HARDWICKE & BOGUE, 192, PICCADILLY.

1877.

WYMAN AND SONS,
ORIENTAL, CLASSICAL, AND GENERAL PRINTERS,
GREAT QUEEN STREET, LONDON, W.C.

10593



PREFACE.

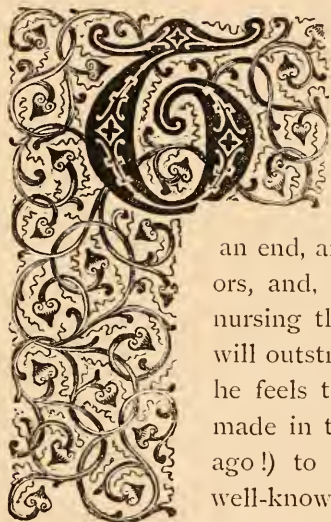

THE practice of writing a few lines by way of Preface to the volume of a magazine gives an Editor the opportunity of drawing more familiarly near to his readers. It feels to him as if he were giving an account of his stewardship. The year is at an end, another volume swells the list of its predecessors, and, even whilst he writes, the Editor is already nursing the scarcely-born infant which he anticipates will outstrip its brethren. It is with some satisfaction he feels that he has been able to retrieve his promise made in the last Preface he wrote (such a short year ago!) to improve SCIENCE-GOSSIP by articles from well-known and able pens.

Each year makes scientific editing a more difficult task. Science is so extending her borders, that brevity in alluding to her discoveries has become an art. The magnificence of the Organic world was never so prominently brought before mankind as in our own time. In writing the history of the intellectual activity of the latter part of the nineteenth century, the future historian (if he be capable for the task) will be obliged to draw attention to the vigorous pursuit of Natural Science, and the sudden leap to a higher platform of Philosophical Speculation which was its natural result.

All this we feel even more than we can express. To chronicle the progress of science in such a way as we have attempted in this volume is not effected without much anxiety to the chronicler.

P R E F A C E .

Our desire is for the Journal to be more effectively entertaining and instructive. Any hints, therefore, which our kind readers may communicate to us to further this end will always be gratefully accepted.

We have to return our thanks for many "words of cheer" received during the past twelve months. To an Editor, anxiously striving to do his best and to raise the character of his magazine, such friendly greetings are like gleams of sunshine!

Our correspondence increases in bulk almost monthly, so that it is impossible we can always reply to queries. But even those who do not receive direct replies will generally find their queries answered in some shape in one or other of the columns of SCIENCE-GOSSIP. If they are not always replied to directly, the fault is not our own.

Lastly, our thanks are due to those of our "Friends in Council" who assist us in naming specimens for querists. Some of the first names in modern science help us in this without fee or reward, although their time must be laboriously taxed. In the name of our readers, as well as for ourselves, we take this opportunity of gratefully acknowledging their kindness.

That SCIENCE-GOSSIP for 1878 will be fully equal to its predecessors, we have every reason to believe, from the generalised "Bill of Fare" which has already been prepared. Perhaps no better proof of the success of our endeavours to make this magazine a popular and yet scientifically accurate one could be adduced than that of its increased circulation during the past year. This is partly due, we are convinced, to the kindness of friends, who seem particularly pleased to introduce their acquaintances to us as subscribers. Of this we have received varied proof of late, and it is a kind of proof dear to the heart of Editor and Publisher alike.

LIST OF ILLUSTRATIONS.



- | | | |
|--|---|---|
| <p>ÆCIDIUM DEPAUPERANS, 124
 Agnostius pisiformis (Tribolite), 14
 Anguilla acutirostris, 7
 Arnotta Plant, 181
 Asaphus caudatus, 12</p> <p>BLYBOROUGH TICK, 104
 Butterflies, Varieties of, in the New Forest, 28</p> <p>CANADIAN PHLOGOPITE, 111
 Carboniferous Limestone, Cutting near Uphill (Bristol and Exeter Railway), showing Lias Fault against, 32
 Carboniferous Polyzoa, 108, 109, 220, 221, 273
 Clematis, Cohesion of Leaflet in, 268
 Colorado Beetle, 202
 Common Seals, 125
 Cowslip, 269
 Coxcomb Prominent Moth, 76
 Crucifers, 128
 Crystals in Damar, 148</p> <p>DAFFODILS, 56
 Delphinium, 248, 249
 Diagram, Boxley Hill, Weald of Kent, 100
 Dudley Locusts, 12</p> <p>EARLY GREY MOTH, 76
 Early Thorn Moth, 76</p> | <p>Emerald Moth, 76
 Encrinites, 132</p> <p>FERNS, VARIETIES OF, 8, 9
 Flame Moth, 77
 Flint Arrow-heads, 86
 Flint Flake, 86
 Fountain in Bell-jar Aquaria, Plan for, 66
 Fossil Fungi, 270, 271
 Fossil Hymenoptera, 84</p> <p>GOATSUCKER, 149
 Grayling Butterfly, Varieties of, 28
 Greenland White Whale, 200
 Grooved Hammer, 86
 Grooved Stone Hammer, 85</p> <p>HEBREW-CHARACTER MOTH, 76
 Herald Moth, 76
 Hoplophora ferruginea, 205</p> <p>KING CRAB, 12, 13</p> <p>LANYON CROMLECH, 85
 Lemings, 105
 Leschenaultia formosa, 204
 Lough Inagh, 180</p> <p>MAIDEN'S BLUSH MOTH, 77
 Moraine in Canon's Platz, Zurich, 84</p> | <p>PARASITE OF SHRIMP, 13
 Pelargonium, 269
 Peregrine Falcon, 52, 53
 Piper nigrum, 131</p> <p>RING OUSEL, 101
 Ringlet Butterfly, 29
 Roman Masonry at Colchester, 85
 Rorqual, the, 244, 245</p> <p>SCALE OF DIURNAL LEPIDOPTERA, 57
 Scale of Gnat, 57
 Seals, 176, 177
 Section of Chalk Pit at Whitlingham, 32
 Section near Chard, showing Chalk, &c., 32
 Section, Geological of, Country between Dartmouth and Plymouth, 169
 Section illustrating Post-Glacial Structure of Thames Valley, 224
 Silver-washed Fritillary, 28
 Slingstone, 86
 Steller's Sea Lion, 81
 Striped Hyena, Head of, 33</p> <p>TORTOISEHELL BUTTERFLY, 28
 Tribolites, 60, 61</p> <p>URCEOLA ELASTICA, 130</p> <p>WALRUS OR MORSE, 4, 5
 White Admiral Butterfly, 28, 29</p> |
|--|---|---|



FOREST PATHOLOGY.

By EDWARD JOHN TILT, M.D.



IT is difficult to get out of a groove, and the habit of looking at mankind as either healthy or diseased sticks fast to me, when riding about the Windsor woods and forests, and I am always on the look-out for patients among the trees. Trees resemble

human creatures: the strongest bear traces of repaired mischief; many give evidence to good conservative surgery, in the shape of well-formed stumps and the healing-over of extensive wounds; but many trees get wounds that cannot be healed by nature, and constitutional diseases that are fatal. Riding the woods reminded me of my first impressions when walking the hospitals as a raw medical student. It then seemed to me that I could understand surgical cases, but it was like looking into a bottle of ink to attempt to understand fevers and constitutional diseases. In the woods I am quite at home with forest surgery, and quite at sea with the constitutional diseases of trees.

I have asked,—what is dry-rot, wet-rot, and touchwood, and what relation they bear to each other, of some who are learned in trees, without getting very satisfactory answers, and I fall back on the learned correspondents of SCIENCE-GOSSIP to enlighten my ignorance. To make clear its extent, I will note a few facts, and the inferences suggested to me by my acquaintance with human pathology.

TOUCHWOOD.—To grow fine timber, young oaks are left to grow sufficiently near each other to check the free access of air to their lower branches. Their scanty foliage and diminished supply of sap stops their growth, they become brittle, lose their moisture, and turn to touchwood. Windsor Forest is thus strewn with the lower branches of oaks planted in 1820. I have picked out great lumps of touchwood from the trunk of a large and still vigorous columnar

beech, the longitudinal half of which had been broken away some years ago. The wood near the bark was quite sound, but the central part of the wood, deprived of sap and exposed to the air, had become touchwood. *Has a fungus anything to do with this process of disintegration, or how is it effected?*

WET-ROT.—During the great wet of last September, and in a very wet hollow of the Forest, I one day found that a well-grown oak, about 400 years old, had snapped across at about three feet from the ground; and the freshness of the foliage, as well as the cleanness of the wound, showed the smash to be very recent. It was a fine case, with bold splinters of sound wood, for the tree was for the most part healthy; but it was easy to see, that as the sound wood approached the point of fracture it was simply wet, then it became soaked with wet. Nearer to the seat of mischief this soddened wood could be easily broken up with the fingers, and showed that a fungus was at work between its rings. In a hollow, where the tree had snapped, could be seen how actively this fungus was doing its work; for I could tear out large masses of a yellowish-white-looking, sweet-smelling, spongy, elastic substance reeking with wet, in which the concentric rings could still be traced, separated by a white soft pith-like fungoid growth. This tree had some years before been seriously damaged near the point of fracture, for there was a dark-coloured flesh-wound, and a hole in this wood was lined by dry-rot, to a very limited extent. I believe that in this case the dry-rot only acted as a wood-perforator to flood with water the central parts of the tree, and I never met with another case in which dry-rot was associated with wet-rot. Mr. Menzies, the highly-accomplished Deputy Surveyor of Her Majesty's Woods and Forests, looks upon wet-rot as a purely local disease, to be cured by scooping out of the tree all its diseased wood, and by preventing the access of water. I showed a bit of the spongy substance just described to a country gentleman, and he told me it would turn to touchwood when dry; but it is now tough and semi-elastic.

What is the ultimate stage of the pathological process I have described? What is the name of this fungus of wet-rot?

DRY-ROT.—In badly-built houses wood gets the dry-rot, or, in other words, damp develops a fungus in dead wood, which soon crumbles it down to the well-known russet powder. As this dry-rot of timber cannot be called a disease, so in living trees the brown wood crumbling into a russet powder is not a disease, but the last stage of a prolonged process of decay. Long before a tree shows the characteristic signs of dry-rot, the wood has been deeply and extensively discoloured; it also loses its tenacity, and thus shows how deeply its mode of nutrition has been perverted. One of the elms in the Long Walk, two hundred years old, was lately cut down, and the whole trunk was of a deep brown colour, with the exception of a few external rings of sound white wood. I should suggest that the discoloration of the wood is no more the disease than the crumbling wood and dust, and that the disease is some impairment of the living force by which the tree started into life, and has been able to grow. The disease calls to its aid a fungoid growth, to damage the texture of the wood and to reduce it to powder. The real cause of the disease is, therefore, some constitutional taint, rendering it as incurable as cancer. In examining that portion of the elm that was broken across, after having been nearly sawn asunder, it was beautiful to see the concentric deep brown rings, separated by the broken ends of a white feathery fluff. If that was a fungus, then it was already set in the changes that accompany the discoloration of the wood. Later on, the reduction of the wood to a red dust is brought about by the fungus of dry-rot; but even if a fungoid growth were progressing from top to the bottom of the tree, as in the elm, I should no more call that internal fungus the disease than I would say a tree was dying of the various fungi that disfigure its beauty and foretell its death. *Is the fungus of dry-rot the same in all trees? Is it the same as the fungus of wet-rot? Is the fungus of dry-rot in a living oak the same as that of an oaken beam?*

Except in the instance related, I have never met with dry-rot and wet-rot in the same tree; neither have I met with dry-rot and touchwood side by side in the same tree: but nothing is so common as to find oaks attacked by dry-rot in their trunk or in some large branch, while their small branches are being turned to touchwood, and strew the ground.

WATERING WINDOW PLANTS WITH COLD TEA.

—It may perhaps interest your correspondents about this subject to learn that, in Germany, I have often noticed that coffee was used for the same purpose, and certainly all the plants so watered were remarkably fine.—*Mally.*

A RAMBLE UP SCAUR.

TO those readers of SCIENCE-GOSSIP who have not had an opportunity of rambling up Scaur Water, a tributary of the river Nith, the following notes may prove interesting.

Starting on a glorious day in July, from the picturesque village of Thornhill, with its grand rows of lime-trees shading the quiet streets, we soon crossed the beautiful stream of Nith, and slowly winding our way through avenues of lordly ash-trees, entered the quiet village of Penfont, situate on the banks of Scaur.

Traversing the public road for about a quarter of a mile, we found ourselves in a well-wooded glade, where the westerly breeze whispered amid the pending boughs of hoary oaks.

The streamlet, through the lapse of ages, has worn a narrow channel through a massive bed of grey-wacke rock, whirling and edding as it rolls along its moorland tide to join the calmer Nith. Pausing here, the visitor is struck with awe while he looks into the seething caldron below, made more gloomy with the fitful shade of pending trees and a multitude of indigenous shrubs which everywhere clothe its banks.

Here the botanist may gather on a solitary spot, and the only locality in the district, the beautiful *Helianthemum vulgare*, and, in the early spring, *Draba verna* in abundance, and on the wet rocks *Cardamine hirsuta*, with its near congener *C. amara*.

Trollius Europæus is equally abundant in the later spring months, and is a sight worth beholding when the golden cups are opened to the sun. Various species of bedstraws are to be gathered, and on the dry banks and rocks one of the commonest of the British species, *Galium saxatile*, displays a profusion of flowers that would make it worthy of a place in the well-cultivated garden. *Asperula odorata* we gathered in the last stage of decay, and nestling amid the stones *Geranium Robertianum* displayed its pink corolla. *G. pratense* and *G. sylvaticum* were abundant in the meadows and woods. *Ranunculus auricomus*, with *Saxafraga granulata*, are to be found in their proper season. Various species of labiate plants were picked up on our way up the glen, one of the rarest being *Stachys betonica*.

The woods were carpeted with a grand profusion of Cow-wheat (*Melampyrum pratense*), and in the spongy nooks *Pedicularis palustris*, though past flowering, was common. Splendid specimens of the Foxglove (*Digitalis purpurea*), three and four feet high, were observed by the roadside.

Emerging from the brushwood, we come upon a small knoll, free from the undergrowth, where *Habentaria viridis* and *H. albida* reigned pre-eminent. *Orchis morio*, *O. mascula*, *O. latifolia*, and *O. maculata* grew in the more moist places, with some few plants of *Listera ovata*. Wandering up a rocky glen,

amid a profusion of wild flowers, with the blackberry overhanging the rocky ledges, we gathered *Athyrium Filix-femina*, *Nephrodium Filix-mas*, *N. dilatatum*, *Asplenium Trichomanes*, *Polypodium vulgare*, *P. Dryopteris*, *P. Phegopteris*,³ and *Hymenophyllum Wilsonii*.

Gaining at last the summit of the hill, we roused the red grouse from his bed of heather; purple tracts of the Ling (*Erica cinerea*) everywhere met the eye, and in the splashy bogs we found the curious *Drosera rotundifolia* in full flower, with many an unwary insect firmly held within its wondrous leaves.

Empetrum nigrum we found but sparsely scattered across the moorland, but abundance of *Triglochin palustre* in full bloom.

Arriving at the head of a small burn, we followed its course till we got entangled in a dense copsewood, where the stream precipitates itself down the face of a cliff about thirty feet in height. Scrambling as best we could, we finally emerged into the open fields at the back of the quaint village of Tynron.

Replenishing the inner man after the fatigues of the day, we next found ourselves on the public road which winds along the base of Auchengibbert and Tynron Doon hills, and then striking into a more open country of wood and brake, of bog and meadow, we left the scenes of our wanderings highly satisfied with our ramble up Scaur.

J. BROWN.

Sunderland.

THE WALRUS OR MORSE.

(*Trichechus Rosmarus*, Linn.).

BY THOS. SOUTHWELL, F.Z.S.

Hon. Sec. Norfolk and Norwich Naturalists' Society.

OF the many strange forms which the Zoological Society of London has been the means of introducing to the stay-at-home naturalists of this country, certainly not the least interesting is that of the Walrus. It is true that in neither of the instances in which the young animal has been brought alive to the Gardens, has it long survived in its new home; but, short though its residence amongst us, the opportunity has been afforded to many of becoming acquainted with the Arctic stranger *in propria persona*, instead of through the distorted medium of the badly-stuffed skins, or the equally bad representations of this interesting animal, which, until recently, we have possessed. The first recorded appearance of the Walrus in this country was, I believe, in 1624, when, according to Hakluyt's "Pilgrimes," a young one was brought to England by Master Thomas Welden, in the *God-speed*, and duly presented at Court. In 1853 the Zoological Society became possessed of a young one, which lived only a few days in their Gardens. On the 1st of November, 1867, another was received, which lived till the 19th of December, when it unfortunately died, notwithstanding the care be-

stowed upon it, both as regards food and accommodation. This last was captured by the whale-ship *Arctic*, on the 28th of August, 1867, in lat. 69° N. and long. 64° W., and brought to Dundee, whence it was conveyed by Mr. Bartlett to the Society's Gardens. The captain of the *Arctic* saw two or three hundred walrus basking upon the ice, and sent out his boats to the attack: amongst the killed was an old female followed by her young one; the latter was taken on board and eventually brought to England.

Although now confined to the icy seas of the Arctic circle, the Walrus was probably not uncommon on our shores in times long past. The skull has been found in the peat near Ely, and Hector Boece, in his "Cronikles of Scotland," mentions it as a regular inhabitant of our shores in the end of the 15th century: in the present century it has occurred several times, although it must be considered as a very rare straggler, sadly out of its latitude. Wallace says that its fossil remains have been found in Europe as far south as France, and in America probably as far south as Virginia, and it was common in the Gulf of St. Lawrence so late as 1770 (Leith Adams). In recent times it has retreated before its great enemy, man, from the northern coasts of Scandinavia to the circumpolar ice of Asia, America, and Europe, sometimes, but rarely, reaching as far south as lat. 60°. Whenever met with, it is the object of ruthless persecution, and is rapidly and surely becoming exterminated; but for its ice-loving habits, which render its present strongholds always difficult, and sometimes impossible, of access, it would doubtless long ere this have become extinct.

The family *Trichechidae*, of which the Walrus (*Trichechus Rosmarus*) is the only member, together with the true (*Phocidae*) and eared seals (*Otariidae*) constitute a sub-order of the Carnivora, which from the form of their swimming-paws have been named the *Pinnipedia*, or fin-footed. The *Trichechus* is placed between the true seals and the eared seals, to both of which families it has affinities: it is carnivorous, feeding on mollusca, fish, and when it can get it, the flesh of whales. Its habits were so well and succinctly described by Captain Cook a hundred years ago, that I cannot do better than quote his own words, the accuracy of which has since been amply confirmed. Whilst in Behring's Straits, in lat. 70° 6' and long. 196° 42', on the 19th of August, 1778, Cook first met with the Walrus: "they lie," he says, "in herds of many hundreds upon the ice, huddling one over the other like swine, and roar or bray very loud; so that in the night, or in foggy weather, they gave us notice of the vicinity of the ice before we could see it. We never found the whole herd asleep, some being always on the watch. These, on the approach of the boat, would wake those next to them, and the alarm being thus gradually communicated, the whole herd would awake presently. But they

were seldom in a hurry to get away till after they have been once fired at, then they would tumble one over the other into the sea in the utmost confusion ; and if we did not at the first discharge kill those we fired at, we generally lost them, though mortally wounded. They do not appear to us to be that dangerous animal some authors have described ; not even when attacked. They are rather more so to appearance than in reality. Vast numbers of them would follow and come close up to the boats, but the flash of a musquet in the pan, or even the bare pointing of one at them, would send them down in an instant. The

The number of walrus killed annually by the Norwegian and Russian hunters is very considerable ; probably nearly an equal number are wounded and lost. As the female produces only a single young one at a birth, which remains with the mother nearly two years, "until its tusks are grown long enough to be used in grubbing up the shell mud at the seabottom," it will readily be imagined that the destruction is greatly in excess of the production, and that they are rapidly decreasing in numbers. About the month of August they repair to the shore, and congregating in vast herds on the beach of some secluded



Fig. 1. The Morse or Walrus (*Trichechus Rosmarus*), from Buckland's "Log-Book of a Fisherman and Zoologist."

female will defend the young one to the very last and at the expense of her own life, whether in the water or upon the ice. Nor will the young one quit the dam, though she be dead ; so that if you kill one you are sure of the other. The dam, when in the water, holds the young one between her fore-fins" (Cook's Last Voyage, vol. ii. p. 458, edition 1784). Since Cook's time the Walrus has learned to fear man, its only enemy except the Polar bear, and is more difficult to approach. When wounded, or its young in danger, it has been known fiercely to attack the boats sent for its capture, striving to overturn them, and piercing their sides with its tusks : many serious accidents have been the result.

bay, lie for weeks together in a semi-torpid condition, without moving or feeding. Should their retreat be discovered whilst in this state, great is the slaughter. Mr. Lamont, in his "Seasons with the Sea Horses," says that in 1852 on a small island off Spitzbergen (one of the Thousand Islands), two small sloops discovered a herd of walrus consisting of three or four thousand, nine hundred of which they succeeded in killing, only a small portion of the produce of which, however, they were able to carry away. The colour of the Walrus is brown, paling with age, and the skin covered with short hairs ; the adult reaches the length of from 10 to 15 feet, or, according to some authorities, even more, and weighs from

two to three thousand pounds. Its rounded head, heavy muzzle, thickly set with stout bristles, small, round blood-shot eyes, and formidable tusks, give to this animal a ferocious appearance which is

walrus will yield from five to six hundred pounds of blubber, the oil from which, however, is not so fine as that of the Seal. The ivory tusks were formerly much used by dentists; at present, I believe, owing



Fig. 2. The "Sea-Horse," or Walrus, from Cook's "Voyage to the Pacific," 1784 ed., vol. ii., page 446.



Fig. 3. *Vacca marina*, Gesner; Addenda, page 369. 1560 (reduced).

foreign to its nature, except when greatly excited or at pairing time, when the old bulls are said to fight with great fierceness and determination. A full-grown

to the introduction of vulcanite, very little is applied to that purpose. Mr. Lamont mentions 24 in. in length and 4 lb. each in weight, as the size of a good

pair of bull's tusks: a pair in the Norwich Museum measure 32 in. in length, and the heavier of the two weighs 9 lb. 9 oz. The immensely elongated canine teeth which form the "tusks," are found in both sexes, but are shorter and more slender in the female than in the male. The skin of the Walrus is valuable for many purposes.

Few animals, so long known to man, have, when figured, been represented so inaccurately as the Walrus: the hind feet are almost invariably depicted extended backwards, like those of the Seal (so also in stuffed specimens), whereas in the living animal they are directed to the front, and serve as supports to the body in progression on the land or ice, in the same manner as the hind limbs of the eared seals. Dr. J. E. Gray, in an article "On the Attitudes and Figures of the Morse," in the Proceedings of the Zoological Society of London for 1853, pp. 112-16, reproduces some of the wonderful prints of this animal from old authors, most of which are purely imaginary: fig. 3, p. 5 is copied from one of these. By far the best portrait known, till quite recently, is one published in Amsterdam in 1613, where an old female and her young one are very accurately depicted: this has been reproduced in Bell's "British Quadrupeds," 2nd edition, p. 269. Fig. 2 is copied from the "Sea Horse," in the foreground of Cook's illustration in "A Voyage to the Pacific," &c., 1784 edit., vol. ii., p. 446. Fig. 1 is copied, by kind permission of Mr. F. Buckland, from his "Log-book of a Fisherman and Zoologist," and represents "Jemmy," the young Walrus, whose brief sojourn in the Zoological Gardens has already been referred to. One of Mr. Wolf's "Zoological Sketches" represents a herd of walruses in almost every conceivable attitude, and of course beautifully drawn and coloured.

It is much to be regretted that the extinction of this harmless and useful animal is merely a matter of time, and that perhaps before many years have passed it may have ceased to exist; the only hope appears to be that when it has become too scarce to render its pursuit remunerative, a remnant may still be left to continue the species around the far-off and unapproachable islands of the Arctic seas.

AQUARIUM NOTES.

"BEN PLANT'S" twenty-years-old Eel, mentioned in SCIENCE-GOSSIP, November, 1876, page 263, seems likely to become of historical interest, like Sir J. G. Dalyell's ancient Sea Anemone, commonly known as "Granny" because of her advanced age. The latter was taken from the sea in 1828, and must therefore be at least forty-eight years old, if, as I doubt not, she is alive and well as when I last had the pleasure of hearing of her. How much older she may be is an unknown problem: there is

not sufficient data to go upon. The conservation of aquatic animals is but of recent date. Mr. Plant raises a question of great interest, "How long may animals be expected to live in aquaria"? That depends on many things. Humanitarian principles are often left out in the dark, and animals are only expected to live as long as they bring in money. If an aquarium is well and humanely managed, and the animals hardy, practically speaking, they may be said to live for ever. Indeed, it has been queried by one authority whether many marine animals ever die of old age, but only from accident, as, for instance, being devoured by an enemy. If the conditions of existence are exactly suited, they seem to flourish indefinitely, as, e.g., in the case of this long-lived Eel and Sir J. G. Dalyell's aged Sea Anemone, with the venerable Pike (*Esox lucius*) in the Fish-house of Regent's Park (Zoological Gardens), who grows so big he can barely turn round in his tank, and with some of my own sea-anemones, that have lived comfortably with me more than a dozen years. I must confess, however, that some established daisies (*Sargatia bellis*) have recently died without apparent cause. Is this from old age? It is very unsatisfactory not to be able to account for death. But it would seem as if the second and third generations of daisies born in the tank flourished better than those imported, and gradually elbowed them out. If so, the vexation remains; for old friends are better than new. The longer an animal lives, the more I prize it; the longer the water is kept, the more valuable it becomes. Most certainly, if "Ben Plant" has kept this sharp-nosed eel (*Anguilla acutirostris*) for twenty years in one house, let him live another twenty. Let him be fed regularly enough to be healthy and happy, but seldom enough to prevent his growing unnecessarily. As aquarium science advances, it becomes a serious question, what is to be done with overgrown specimens? As we cannot all command tanks large enough for our desires, it might be well for small aquaria to supply the large, for their mutual benefit, with home-grown specimens, which, being already acclimatized, might be supposed to fare better than new comers in the struggle for existence. Let "Ben Plant" sacrifice anything to keep his eel happily with his companions. If they are too many, turn them out to make room for his growing dimensions. If, however, the minnows, carp, sticklebacks, and roach are as old as himself, the case becomes complicated. If another tank cannot be provided, I see no way but to turn him back from whence he came, or to make him over to some public institution worthy to receive him,—say at the Crystal Palace, or anywhere under the supervision of so zealous a caretaker as Mr. Lloyd. At some public aquaria animal life is not valued as it should be. Mr. Plant seems the right sort of man to keep aquaria, and I should much like to know whether the water in his tank is as old as his eel? I hope that it is, for the best

aquaria are those where the water *never* is changed, but only circulated or aërated by some means, and purified by growing vegetation. The same water has remained in one of my tanks for fifteen, in another for seventeen years; yet in both it is now absolutely clear and colourless. It would also be interesting to hear of authentic cases of aquarium animals dying of old age, and to elicit opinions whether death can be traced to other causes than neglect, starvation, extremes of heat and cold, accident, casualties, and the like.

Successful aquarium-keeping is no easy thing,

and 3rd, I deprecate the waste and inefficiency accruing from a *periodic change of water*, adopted by some aquarium-keepers. G. S.

A FEW WORDS ABOUT FERNS,—THEIR MANNER OF GROWTH, AND HOW THEY MAY BE RAISED FROM SPORES.

IT is generally known, I believe, that ferns do not blossom like other ordinary wild flowers, but are propagated by spores instead of seeds. The



Fig. 4. Sharp-nosed Eel (*Anguilla acutirostris*).

requiring more patience and perseverance than always falls to the lot of public companies or private individuals. Many and great are the difficulties and disappointments to be encountered. It remains for each to think out these independently, separately, and profit by the experience of others. I am glad to see our editor, Mr. Taylor, has turned his attention to this much-neglected subject, as shown by the announcement of his book on "The Aquarium." I advocate the following leading principles: 1st, the *exclusion of lung-breathers*; 2nd, the system of *unchanged water*, purified by aëration and circulation;

spores are usually borne on the back or under-side of the frond, either in linear forms or irregular clusters. These spores are simple microscopic cells, furnished, like pollen-grains, with a double coat, and differ from seeds in that they germinate from any point, while the latter are restricted in their growth to two,—viz. the radicle and the plumule, which develop about the same time. From the germinating spore first arises a small bud-like process, which, by cell-division, soon produces a leaf-like expansion, termed a prothallium. From the under part of the prothallium filamentous rootlets are given off, and, mixed

with these, what are called Antheridia and Archegonia. The former are scattered promiscuously over the lower surface of the prothallium, but the latter are more restricted in position and fewer in number, being chiefly found in the thicker central parts among the rootlets.



Fig. 5. Frond of Parsley-fern (*Allosorus crispus*).

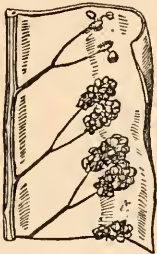

Fig. 6. Portion of fertile frond (magnified).



Fig. 7. Fertile frond of *Osmunda regalis*.

The Antheridia are developed from the lower free surface of one of the cells of the prothallium, and are composed of a single cell, or of two, one being superposed on the other. In the interior of these cells another is afterwards developed, which becomes segmented, and each segment develops into a minute vesicle, containing a spirally-coiled filament called an Antherozoid, or Spermatozoid. When ripe, the top of the antheridial cell drops off, and the vesicles escape, each emitting its antherozoid, which differs in form from those of mosses and liverworts, and has numerous cilia.

The Archegonia are usually produced on the same prothallium as the Antheridia. Their external structure is that of very minute nipples, formed of four collateral tiers of cells, with a passage down the centre; but the mouth of this passage or canal is closed, until the archegonium is ripe, and then it opens. This minute canal terminates, at its end nearest the prothallium, in an embryo-sac. This sac contains the germinal corpuscle, which is fertilized by an antherozoid passing down the canal and coming in contact with it.

It seldom happens that more than one archegonium on a prothallium becomes fertilized, the abortive ones turning brown in the canal and embryo-sac. After fertilization, cell-division ensues in the embryo; and the result is the formation of a bud producing foliage-leaves, which gradually become more and more perfect till the true characteristics of the fern are fully developed.



Fig. 8. *Woodsia Ilvensis*.



Fig. 9. Pinnule of *Woodsia* (magnified).



Fig. 10. Scale-fern (*Ceterach officinarum*).



Fig. 11. Pinnule of *Ceterach* (magnified).

These different stages of growth or development may be observed by means of a microscope. Take a frond with ripe spores and place it on a sheet of white paper, with its front surface uppermost, and leave it there for a day or two. After this the paper will be found covered with a brownish dust: this is composed of the spores. Then take a small piece of porous sandstone; moisten it with water, and place upon it some of these spores. Place the sandstone with the spores upon it in a shallow saucer of water, and cover up the whole with a bell-glass. If kept in a warm place and damp, but not too wet, some of

the prothallia will soon be developed. Now, by keeping these just damp for some time, and then suddenly giving them a larger supply of water, you will induce numerous Antheridia and Archegonia to open themselves; and in an hour or so after this the surfaces of the larger prothallia will be covered with moving antherozoids. If some canals of the Archegonia be now laid open, you may occasionally see these antherozoids in motion.

Peat may be used by itself, but it is apt to get sippy. Or you may sow on silver-sand, or even porous sandstone. Do not attempt to transplant the young ferns till they have acquired their third or fourth fronds, and then move them into pots with care.
W. BREWSTER.

THE HISTORY OF THE GOURDS.

(*Cucurbitacæ*).

THE plants of this genus belong to the natural order of the Cucurbitacæ, and are very nearly allied to the Cucumber. There are several varieties, some of them beautiful in form and colour, others of an immense size. Those which are commonly cultivated in England for food are the Pumpkin (*C. Pepo*), and the Vegetable Marrow (*C. Succada*).

The Gourd tribe was well known to the ancients, and we find them mentioned in several places in the Scriptures. It furnished a model, according to the marginal reading of Knops (1 Kings vi. 18), for some of the carved work in cedar in the temple of Solomon.

The Greeks appear to have been acquainted with several varieties of the Gourd, and they were to be seen at Athens with other products of the spring and summer, in the cold season of the year; for Aristophanes, in his "Seasons," speaking of the glories of that luxurious city, says—

There you shall at mid-winter see
Cucumbers, gourds, grapes, and apples,
And wreaths of fragrant violets,
Covered with dust as if in summer.

* * * * *
There you may see fine pumpkins joined
To the round rape and mighty turnip,
So that a stranger well may fear
To name the season of the year.—ATHENÆUS, b. 9, 14.

Diocles states that the best round gourds are those grown near Magnesia, a town of Asia Minor. Euthydemus, the Athenian, in his book on vegetables, states that the seeds of the long gourd were originally introduced from India. Pliny, in his Natural History, tells us that gourds resemble the Cucumber in their manner of growing, and he classifies them into two primary kinds: the first, which, from the rapidity of its growth, shooting upwards and creeping along the rough surfaces of walls and covering the roofs of houses in a very short time, he calls the "Roof Gourd." This kind, he says, bears a fruit of considerable weight, which is quite immovable by the action of the wind, although the stalks are of a remarkable thinness. This plant is considered by Fée to be *C. longior* of Dodonæus and J. Bauhin, the long gourd and other varieties probably of the calabash gourd—the *C. leucantha* of Duchesnes. The second kind mentioned by Pliny are those which creep upon the ground, most probably the Pumpkin and its varie-

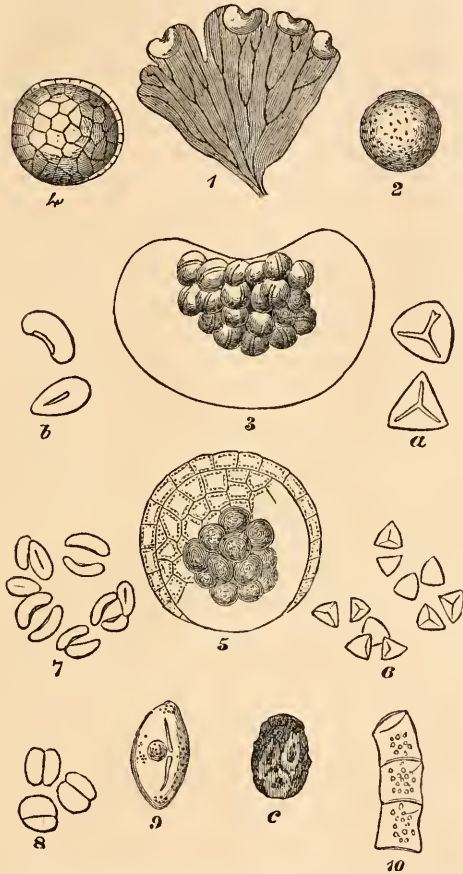

Fig. 12. Development of spores &c., of *Adiantum*, 1 to 6; 7, spore of *Oak-fern*; 8, ditto of *Polystichum lobatum*, &c.

As a plain practical method of raising ferns from their spores take the following.

First, get a piece of turfy peat about three inches square and dip it into boiling water, in order to kill all animal or fungoid life that may be in it. Then break it up, and mix it with some fresh cinders. Place the compost in a saucer, and spread the spores over the surface, leaving them exposed to view on the top of the mould. Cover the whole with a bell-glass to protect it. If after this you keep the soil damp but not wet, and in a warm place, you will find the spores germinate more quickly than if they were kept at a lower temperature.

ties. Gourds were held in higher estimation by the Romans than either melons or cucumbers, as they were employed for more useful purposes than the former fruits. They were considered a light, mild, wholesome food. The young and tender stalks used to be cooked and served up to table as a good dish. The fruit of the roof gourds were considered superior to those which crept on the ground. In Pliny's time large gourds were used as jugs and pitchers in the baths; but long before that time he tells us they had been employed as casks for keeping wine. Nisander tells us that the ancient Greeks used to preserve gourds by the following methods:—Cutting them into moderate-size pieces and stringing them like beads to dry in the air; then smoke them. When wanted for use, each piece was well washed and put into the stewpan with various herbs, such as cabbages, endive, and dried mushrooms. The Romans also preserved gourds and cucumbers, we are told, for some months by putting them into brine. Pliny states that the seeds of the Gourd ought to be steeped in water before sowing, and the proper time for that operation should be between the vernal equinox and summer solstice, about the season of the festival celebrating the anniversary of the foundation of Rome called Purilia. The Roman gardeners used to force gourds to grow into various fantastic shapes by putting them into moulds when quite young; thus we are told that they were made to resemble a dragon, a leg of a man, &c.

Pliny speaks of wild cucumbers and gourds which were possessed of certain medical properties, and gives us a list of eleven remedies for which they were applied. The leaves of the Pumpkin steeped in wine were considered good for the bite of dogs and insects, called *Sep* by the Greeks, perhaps one of the centipede tribe. The seeds were used as a charm to cure the ague.

According to L'Obel, the Pompion or Pumpkin was introduced into this country from the Levant in 1570, and till about 1815 this was the principal plant of the Gourd kind cultivated in the British gardens.

Parkinson mentions, in his "Paradisi" (1629), that in his time only one kind of Pompion was cultivated, but that it would be a waste of time to recite all the forms and colours in which Nature listeth to show herself in this plant. In using it as a culinary vegetable, he tells us that it was customary to take out the inner watery substance with the seeds, and fill up the place with pippins, and having laid on the cover which was cut off from the top to take out the pulp, bake them together; and the poor of the city as well as the country people do eat thereof as a dainty dish.

Gerard, in his "Herbal" (1636), says there be divers sorts of gourds—some wild, others tame for the garden; some bearing fruit like unto a bottle, others longer and bigger at the end, keeping no certain form

or fashion. He tells us that the juice of the Gourd being popped into the ear with oil of roses is good for the pain thereof, proceeding from a hot cause. It is also affirmed that the long gourd or cucumber, being laid in the cradle or bed by the young infant whilst it is asleep and sick of the ague, it shall very quickly be made whole.

According to Miller, pompions were the melons of our early horticulturists, which word was corrupted into millions, a name by which they are still known in some parts of England by the uneducated classes. It was usual in Miller's time, as in the present day, for the English cottagers to plant pumpkins on their manure-heaps in the fields and gardens, letting the shoots train along the grass, without taking much trouble or care of them. In the second volume of the "Transactions of the Horticultural Society," there is a description, with an account of the cultivation and figure of the Gourd called Vegetable Marrow (*Succada*), read in December, 1816, by Mr. J. Sabine. It had not long been then known in this country. The most probable account of its introduction is that the first seeds were brought here in one of our East-Indian ships, and came most likely from Persia, where it is known and called *Cicrader*. Phillips states that the Vegetable Marrow was not seen for sale in our shops or markets before 1819. It is now extensively grown, and the fruit generally used for culinary purposes in every stage of its growth. This plant is considered as a variety of the Pumpkin.

Where the climate is warm enough for them, all the varieties of Gourd are cultivated, and form a very important article of human food; the superabundant shoots are also used for feeding cattle. In America and islands of the West Indies, they are extensively cultivated, and some species grow to an enormous size. The Rev. — Griffiths, in his "Natural History of Barbadoes" (1750), mentions some which, when cleared of their pith, are capable of containing twenty-two gallons; but he adds, however, such are very uncommon. Phillips relates that, in some parts of America, the jugglers or quacks extract the pulp out of the pumpkins, and fill them with stones, with which they make a great noise and pretend to frighten away all complaints of their superstitious patients.

The Squash (*C. Melopepo*) is another kind of gourd, which is a great favourite with the Americans. Gourds were found growing by Captain Cook in the Sandwich Islands of an enormous size. The inhabitants applied them to all manner of domestic purposes; and, in order to fit them better to their respective uses, they had the ingenuity to give them different forms by tying bandages round them during their growth; they also had a method of scorching them with a heated instrument, so as to give them the appearance of being painted in a variety of neat and elegant forms. Specimens of these gourds are to be seen in most museums and

collections of natural history in this and other countries.

The Gourd and its varieties may have sprung from one original species, and, like other plants, have been greatly improved by cultivation. De Candolle, in discussing the history and origin of cultivated plants, refers all the squashes and pumpkins to the Old World, but not to India, because they have no name for them in Sanscrit. Some American botanists believe that the Pumpkin and its varieties are indigenous to that continent, as the Indians declare gourds had been a common food among them long before the Europeans discovered that country; and Champlain, who, in 1604, made a voyage along the coast of what is now the State of Maine, found the inhabitants cultivating citrouilles (gourds) along with maize. Pickering, in his "Races of Men," says that specimens of a small variety of gourd were exhumed from an ancient cemetery in Peru, like those which are still seen in the markets of Lima. M. Naudin, an indefatigable and distinguished botanist, has, during many years, observed and experimented upon all the known forms of gourds, collected from all parts of the globe and cultivated at the Jardin des Plantes. He reduces them to six species, only three of which, with their numerous varieties, are used as esculents (viz., *Cucurbita maxima*, the large yellow gourd; *C. Pepo*, the Pumpkin, which he considers as probably the most variable plant in the world; and *C. moschata*, the Water-melon). An interesting paper on this subject will be found in the *American Journal of Science and Art*, 2nd ser., vol. xxiv., and also in Darwin's "Variation of Animals and Plants under Domestication."

The anther-cells, which contain the pollen of this tribe, present inequalities and curves of a remarkable appearance under the microscope.

The only plant among our English wild flowers that belongs to the Gourd tribe is Bryony (*Bryonia dioica*), which may be seen climbing over our hedges and thickets in the summer, with its whitish flowers with green veins, and red berries in the autumn. This plant abounds with a fetid and acrid juice.

HAMPDEN G. GLASSPOOLE.

OUR COMMON BRITISH FOSSILS, AND WHERE TO FIND THEM.

No. III.

By J. E. TAYLOR, F.L.S., F.G.S., &c.

TO a young and enthusiastic geologist, perhaps there is no class of fossils to which so much interest is attached as the *Trilobites*. They are extremely elegant objects, and are easily identified. Their strict limit to the primary rocks makes them geologically valuable as means of iden-

tifying strata. Even non-geologists remember their glib, half-scientific, half-popular family name, and will occasionally air it as if it were the complete key to paleontology. A good collection of well-arranged trilobites looks better in the cabinet than perhaps any other fossils. There is such a variation from the leading type that one cannot wonder the number of genera should be so great. No two are externally alike, and the deviation is sometimes so extreme that the Trilobites are no longer trilobed.

Trilobites are among the few fossils which possess the associations of folk-lore. Ammonites and encrinure stems, Gryphea and Cycadites, share with them the feeble notice which the curious gave to them in pre-geological days. At that time all fossils were called "petrifications," and all were equally regarded as evidence of the universality of the Noachian Deluge. Perhaps nowhere are Trilobites more abundantly visible than in the Wenlock limestones, near Dudley. The latter have been upheaved to a very high angle, and the surfaces of the hard limestone slabs are so thickly bestrewn with fossils, that it is impossible to place the tip of one's finger without its coming into contact with some of them. These limestones are not even moss-clad, but are constantly clean, from weathering. The fossils are slightly harder in mineral substance, and therefore stand out in relief. They are veritably museums of Upper Silurian fossils, and although hard to extract with the hammer, the student may while away many a summer hour in gloating over these lovely treasures of the ancient deep. Trilobites are there in uncountable thousands, but nearly always in disjointed "heads" and "tails." We cannot wonder, therefore, that they should have attracted the attention of those fond of natural phenomena, although in the days long anterior to scientific explanations of them. As "Dudley Locusts," one genus of Trilobites (*Calymene*) was long known; even the fact of their standing out in relief from the limestone was noticed as very remarkable, for nothing was known in those days of sub-aërial denudation or weathering of rocks. They were named "Trilobites" as long ago as 1771, by Walch, in his "Natural History of Petrifications," on account of the three lobes of joints which usually run along the body. Still their crustacean origin had been guessed at by bold speculators, and even Linneus classed them among the *Entomostraca*.

How utterly at sea the majority of naturalists were as to the true nature of these singular fossils is indicated by some of their generic names. *Agnostus*, *Asaphus*, *Calymene*, &c., the commonest of these, are only Greek words signifying "unknown," or "concealed," &c. Still, since the time of Brongniart they have been universally regarded as crustaceans, and the universal opinion is that they are allied to the *Isopoda*, only that they were legless. Mr. Henry Woodward, F.R.S., who has taken up Mr. Salter's investigations among the Trilobites with great en-

thusiasm, believed he had detected evidences of legs on the under side of some specimens, but others thought these to be the remains of "calcic arches." It may be, however, that the extinct Trilobites really represent a defunct order, and as such we usually find them arranged in systematic works on Zoology. In that case they would come in as "missing links" between the *Iso-poda*, of which the common Wood-louse (*Oniscus*) and the Shrimp-parasite (*Bopyrus*) are familiar types, and the *Merostomata*, of which the well-known "King-crabs" (*Limulus*) are examples. The larval state of the *higher* classes in

it was due to the Trilobites having been "advanced a stage." It will be seen that a species found in the ironstone nodules of Coalbrookdale, called *Belinurus*, more nearly resembles one genus of the Trilobites (*Trinucleus*) than the King-crabs of our own days. Again, the female *Bopyrus* (fig. 20), which parasitically attaches itself to the inner surface of the carapace of the Shrimp, has a rude resemblance to the segmented body of some of the less highly-organized Trilobites. The fact of its being a parasite shows

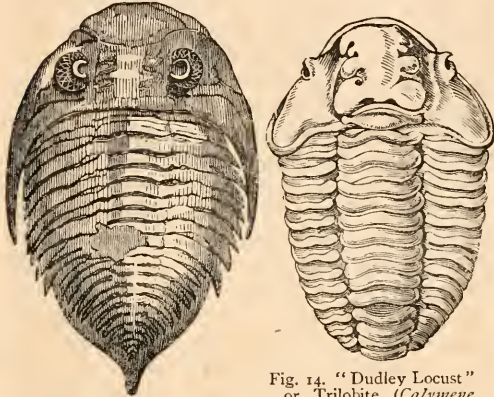

Fig. 13. *Asaphus caudatus*.

Fig. 14. "Dudley Locust" or Trilobite (*Calymene Blumenbachii*).

the same order frequently resembles the adult conditions of the *lower*. In the crustacea a very large number of genera are alike in the youngest state. From its resemblance to the adult condition of one of the lowest of the crustaceans called *Nauplius*, this state is usually called the "*Nauplius* stage." No other group of animals passes through so many metamorphoses before reaching maturity, and each of these is so well marked off from the rest, that it might be regarded as a generic type. Indeed, in many cases, genera have been founded on these distinctions, so that the same animal, at different periods of its life, was regarded not only as a distinct species, but often as belonging to another genus. The young of the common lobster, for instance, passes through at least *six* stages, which are so unlike each other that only careful observation has settled they are not different animals. Even when it has reached the adult condition, a lobster is so unlike what it will be when full-grown, that it might be set down as belonging to another genus. It is as if we knew nothing of the metamorphoses of the Butterfly, and therefore had mistaken the caterpillar and chrysalis for animals belonging to groups widely separated from the winged insect.

The young of the *Limulus*, or King-crab, greatly resembles the adult Trilobites. As the King-crabs succeeded the latter in geological time, it may be that

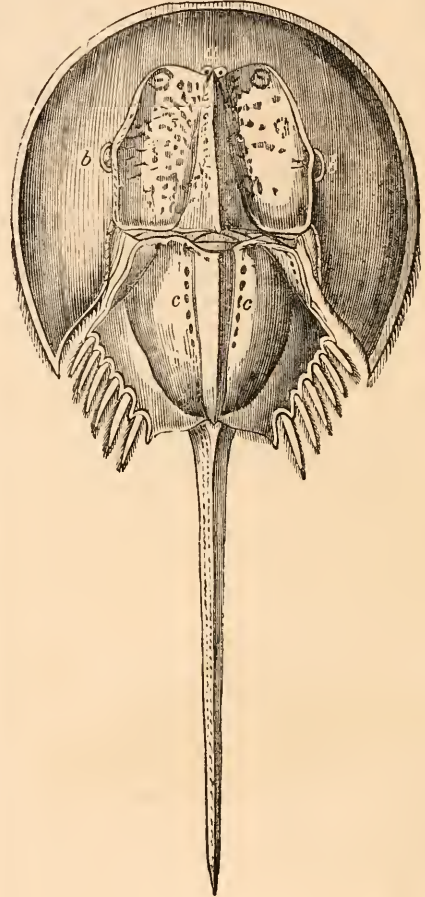

Fig. 15. Under surface of recent King-crab (*Limulus*).

that it must have undergone bodily transformation. The figures will show that the Trilobites find their natural history place between the groups above named. Haeckel, however, places them among the "gill-footed crabs" (*Brachiopoda*), of which the water-fleas are familiar examples. We do not know on what grounds this is done, for no breathing or locomotive organs have as yet certainly been found, although thousands of specimens of all the genera have been carefully examined on their under sides. Again, the *compound eyes* of the Trilobites show that

they were in this respect really very highly organized, and this highly-developed specialization of the sense of sight certainly proves that they ought to be placed much higher among the Crustacea than we find them in Haeckel's "Systematic Survey." In many species of Trilobites the empty eye-sockets can be seen with the naked eye, notably so in *Phacops caudatus*, in which each eye contained four hundred facets. According to Owen, *Asaphus tyrannus* possessed no fewer than six thousand eyes! The number of eyes among the Trilobites varies considerably; some species have none at all.

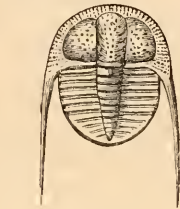
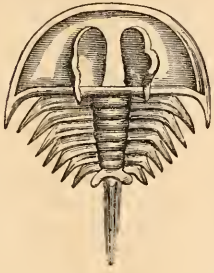

Fig. 16. Fossil King crab, from coal measures of Coalbrookdale (*Belinurus trilobitoides*).

Fig. 17. *Trinucleus finchriatus*, Upper Llandillo beds, Builth.

We have already referred to the fact that the Trilobites are peculiar to the primary rocks. Although they seem to range as high as the Permian, they are chiefly confined to the strata below and including the Carboniferous limestone. No fewer than four hundred species, grouped in fifty genera, have been described

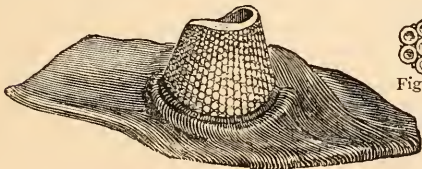

Fig. 18. Compound eye of fossil Trilobite (*Asaphus caudatus*) slightly magnified.
Fig. 19. Ocelli of ditto (magnified).

from these formations, and new forms are still occasionally met with. The greater number of the species are of Silurian age; those of the Devonian rocks are of a well-defined character; and those from the Carboniferous limestone even more distinct still. It would seem as if they reached their maximum of size, as well as of variation, during the Silurian period. The largest is the *Asaphus gigas*, eighteen inches in length, found at Llandillo. On the other hand, they appear to have decreased in size as well as in numbers when we reach the carboniferous rocks. The genus *Phillipsia*, there represented, rarely includes specimens more than three-quarters of an inch in length. It ought to be stated, however, that we

know little about the embryology of the Trilobites. There cannot be a doubt that many of the so-called species, and even genera, are larval stages in the development of the same species. We have referred to the common Lobster as an illustration of the clearly-marked characters appertaining to the various stages in the life-history of the same individual. It must be remembered also that each of these stages is accompanied by as many "moult"; and if we reason from our general experience of the embryology of the Crustacea, we must allow that the Trilobites were

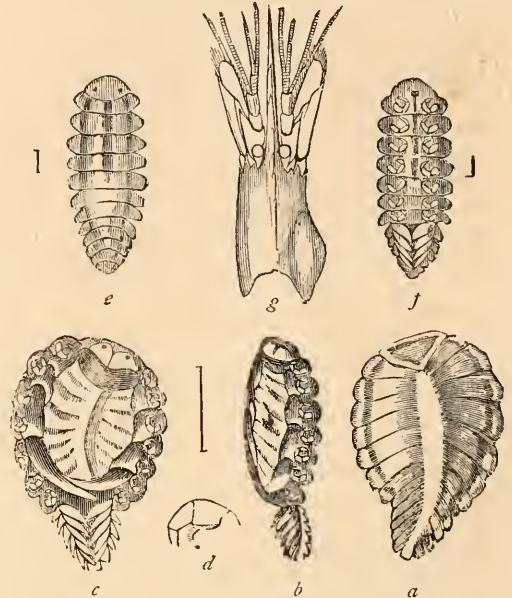

Fig. 20. Parasite of Shrimp (*Bopyrus crangorum*); a, upper side; b, profile; c, under side; d, highly magnified and aborted foot; e, upper side of male *Bopyrus*, much smaller than female; f, lower side of ditto; g, part of carapace of shrimp, swelling out to show presence of parasite underneath.

affected in the same manner. The number of larval stages they passed through depends upon the position they attained as regards organization. We think this was much higher than Haeckel imagines, and therefore that the stages may have been numerous. It is to be expected that individuals would die and be buried in the muddy ooze in each of these intermediate states. Thus found, what more natural than to regard them as different species, and even different genera? Only a fuller knowledge of crustacean embryology will clear away a good deal of the ignorant nomenclature which has gathered about these interesting creatures, and it is hardly to be expected that we shall ever know their accurate life-history. Barrande, who had such splendid opportunities for studying the Trilobites, and who made equally good use of them, satisfied himself, in the case of no fewer than twenty different species of Trilobites, that they passed through larval stages, each unlike the other. In some instances he traced them from when they must only just

have escaped from the egg to the fully-developed and mature state. In the first instance they had no joints to the body, and therefore resembled one of the carapaces of the "Water-fleas"; in the last they possessed ring-covered bodies, movable tails, and compound eyes. This proves that, although in their young states Trilobites resembled the Ostracoda, in their adult life they had proceeded much further; so that Haeckel's classification is thus proved to be incorrect. We ought to add that, parallel with the instance of the development of the Lobster, all the above changes noted by Barrande in the Trilobites, occurred before the animal had attained a tenth part of its full size. In Lyell's "Manual of Geology" the student will find engravings of the *Trinucleus* in three stages, each of which appears specifically distinct from the other. Another skilled observer of the Trilobites was Burmeister, who was strongly of opinion that all of them underwent metamorphoses. This fact ought to be a warning against the careless manufacture of "species." In the case of fossils less care has been taken in this respect than with living animals, and, in many instances, some of those who have christened species were geologists rather than naturalists. The slightest differences have been sufficient to warrant a new specific name, and thus it is more than possible that the various stages in the life-history of one species may be illustrating our manuals as distinct genera and species! Even with regard to *sex* in adult individuals, little or nothing is known; although among nearly all the Crustacea these differ so extremely. Owen remarks that the difference in the head-plate and the terminal spines of the tail in the two so-called species named *Asaphus caudatus* and *Asaphus longicaudatus*, may only be due to difference of sex; the inference, therefore, is that these two species represent the male and female of only one.

The earliest Trilobites (*Agnostus*, &c.) are usually the simplest in structure, so that these animals are not an exception to the general palæontological rule that the simpler always precede the more complex species of the same genus or class. *Agnostus* is usually found in large shoals, something after the manner in which the carapaces of the ancient water-fleas are met with in some of the coal-measure shales. Owen suggests that this disposition of *Agnostus* is "as if it were the larval form of some large trilobite." The young of all Crustacea usually associate together in shoals, and this suggestion might therefore be reasonably taken in consideration with what has already been said on the subject.

The compound eyes of Trilobites are usually thickly placed on raised half-moon-shaped ridges, and the fact that the sockets are so well preserved, speaks plainly of the quiet way in which the fine mud was deposited in which the animals were buried and ultimately fossilized. Dr. Buckland spoke of these ridges as being "like a circular bastion, ranging nearly round three-fourths of a circle, each commanding or much

of the horizon that where the distinct vision of one eye ceased, that of the other began." He also very sagaciously referred to the form of the ridges and their position on the head-shield as "peculiarly adapted to the uses of an animal destined to live at the bottom of the water: to look downwards was as much impossible as it was unnecessary for a creature living at the bottom; but for horizontal vision in every direction the contrivance is complete." We cannot refrain from further quoting a well-known passage



Fig. 21. Simplest kind of Trilobite (*Agnostus pisiformis*).

from the same author, in which a logical inference is drawn from the structure of the eyes of Trilobites. "The results arising from these facts are not confined to animal physiology; they give information also regarding the condition of the ancient sea and the ancient atmosphere, and the relations of both these media to light, at that remote period when the earliest marine animals were furnished with instruments of vision in which the minute optical adaptations were the same that impart the perception of light to crustaceans now living at the bottom of the sea. . . . With regard to the atmosphere, we infer that had it differed materially from its actual condition, it might have so far affected the rays of light that a corresponding difference from the eyes of existing crustaceans would have been found in the organs on which the impressions of such rays were then received. Regarding light itself also, we learn from the resemblance of these most ancient organizations to existing eyes, that the mutual relations of light to the eye, and of the eye to light, were the same at the time when crustaceans endowed with the faculty of vision were first placed at the bottom of the primeval seas, as at the present moment."

That the Trilobites were bottom-feeders and haunters, there can be little doubt. The late Mr. Salter, than whom no geologist was better acquainted with Trilobites, was of opinion that they not only lived there, but fed on the organic mud, something after the manner of earth-worms. The simple structure of their mouths, and the absence of *antennæ* or feelers, indicate such a habit. The inexorable limits of space, however, compel us to postpone a further consideration of this interesting subject to another chapter.

(To be continued.)

COLOUR OF BIRDS.—In addition to the white specimens of birds specified by A. P., I have a hedge-sparrow quite white, except parts of the primary feathers.—J. S. Westley.

MICROSCOPY.

AMPHITETRAS ANTEDILUVIANA.—In the number of SCIENCE-GOSSIP for December, 1867 (vol. iii. p. 271), Mr. F. Kitton contributed a valuable paper on the genus Amphitetras, and amongst others, described this species, together with two varieties of it: β . With sides deeply incurved, and angles much produced; and γ , with five incurved sides. Of the latter (which is figured) Mr. Kitton remarks: "This variety appears to be rare, as I know of only one locality in which it has been found, viz., Hayling Island, Hants, in which it was rare." I have seen no record of the occurrence of this beautiful diatom elsewhere, and therefore have much pleasure in adding a second locality, also in Hampshire, viz., Lymington. Last week I collected material from two places, the shore of the Solent below South Baddesley, exactly opposite Yarmouth; and the bank of the river facing Lymington. The first gathering yielded *Amphi. antediluviana*, var. β , in great abundance, but without the typical form; the second produced var. β in less numbers, sparingly intermixed with var. γ . Should Mr. Kitton care to see a specimen, I shall be happy to send him a slide on receiving a line from him. I would be glad to know whether this beautiful pentagonal form has been found in other counties.—E. D. Marquand, Brockenhurst.

WATERPROOF CEMENT.—I should like to know the formula for a cement impervious to water, and which neither peels off nor cracks. The cement is required for the purpose of spinning rings on *dry* test-slides, so that immersion-lenses may be used without the water running in. The cements used by English mounters and Möller are neither impermeable nor durable. Perhaps I may get the required information through the kindness of some of your readers who have employed such a cement, and *tested* its qualities.—A. S. G.

A WORD ABOUT THE "PYGIDIUM."—That old well-known "test," the pygidium of the flea, is one of the first objects a young microscopist desires to possess, and a very curious apparatus it is. I shall be thankful to any one learned in such matters who will tell me what is supposed to be its use to its proprietor. I cannot find it mentioned in any work on insects in my possession. But the flea is not the only possessor of a pygidium, though it certainly is A I in that line; nor is it always single, or to be looked for in the same position. Generally it is to be found *in pairs* at the extremity of the abdomen; but not always, for in the *Ixodes* of the tiger and Indian bullock we find two on the underside of the abdomen, nearer the upper than the lower end. The *Chrysopa perea* and *vulgaris* have pygidia in the usual locality; and, I believe, several other insects have

the same, but I cannot recall their names. Perhaps the most uncommon pygidia are those of the *Agrion pulchellum*, a very interesting insect in many points. Like all dragon-flies, it is a voracious feeder, and devours all it can catch in the insect line daily. It possesses a powerful set of jaws for breaking up its prey, and gastric teeth, well suited for "grinding the bones to make its bread," like the giant of our nursery days, save that he preferred Englishmen to English insects. The ovipositor has a formidable set of jaws, something like those of the *Sirex*, and its pygidia are large and mammiform, quite at the extremity of the abdomen. Its wings are also worth studying. In short, I know no insect possessing more points of interest, and strongly recommend it to the notice of those who take a pleasure in such things. If asked where it is to be had, I may say that it is not in any list of objects that I have seen. My specimens of *Agrion pulchellum* and *Chrysopa* are by Mr. Enoch, of 30, Russell Road, Seven Sisters' Road, N., who has, I believe, a good supply of both. But, if the want be made known, others possibly may be found able to supply them.—John Bramhall.

THE VIVIPAROUS BLENNY.—This well-known fish, rejoicing in such other popular names as the "Greenbone," "Eel-pout," &c. (*Zoarces viviparus*), retains its ova until they are hatched within the body of the female, and therefore come into the world alive. I obtained several females lately, full of young. Although the female had just died, I cut open the belly, and liberated some hundreds of young. One of the latter, placed under the microscope, and viewed with a quarter-inch objective, showed the circulation of blood in the transparent tail-end of the body for more than five hours afterwards. It is the best object I know of for showing blood-circulation, the shape of the corpuscles being often clearly defined.—J. E. Taylor.

PARASITES ON MIDGE.—Is it generally known that the small midge *Psychoda* is infested with parasites? I have often found this midge with from one to four of what, for a better name, I must term lice, small creatures somewhat resembling cheese-mites, but of a yellow or light cinnamon colour. They cling to the abdomen, ranged closely together, with their heads towards the heart of the midge. On being disturbed, they run away very quickly. I have succeeded in mounting on a slide one good specimen along with the fly. I have also noticed in pressing one of these live midges under a glass cover with a view to mounting, on one occasion one, and on another occasion two, minute worms expelled from its body. Under the microscope their appearance and motion closely resembled thread-worms (*Ascarides*). The vitality of these parasites was very extraordinary. They lived more than a quarter of an hour on a glass slide, kept moist with spirits of turpentine; and under dammar (dissolved in benzole) they con-

tinued to wriggle about for a considerable time, apparently not much inconvenienced by a dose of these ardent spirits.—A. M.

HOW TO RESOLVE TEST DIATOMS WITHOUT ANY SPECIAL APPARATUS.—Turn the instrument at right angles to the sun; close the diaphragm so as to cut off all light below the stage; or, if that cannot be done, place a piece of black paper behind the slide. Bring the light on to the object at the angle which suits it best. This is easily done by moving the microscope to the right or left. If necessary, increase the light by the use of the stage or stand bull's-eye condenser. That is all. A black ring round the covering-glass is an objection when the cover is small, as it interferes with the light. To carry out this plan successfully, only two things are necessary—viz., the sun and an object-glass, capable of resolving the test, just before it. It is not intended to supersede the use of the apparatus, for the sun is far too uncertain an illuminator to be depended upon, and most men work by night; but it may be useful to those who cannot afford to purchase any apparatus—not even an oblique illuminator, the cheapest of all. I must justify this allusion to my *pet child* by stating that I have not, and never have had, any pecuniary interest in its sale. Having been asked questions as to its capabilities, I can only repeat what I have before stated, viz., that by its help I can resolve tests which I never could touch before, though possessing achromatic condensers, spot lens, &c.—John Bramhall, St. John's Vicarage.

DAMMAR.—I have used this as a mounting medium during the last four years, and with the most satisfactory results. The manipulation is very simple, and herein lies its great value to the microscopist. With all due deference to Mr. Williams (p. 254), I do not think that any finishing varnish is required if a thick solution of dammar in benzol is used.—F. Coles.

ZOOLOGY.

TO SECRETARIES OF LONDON NATURAL HISTORY, ETC., CLUBS.—We shall feel obliged by the secretaries of the various Natural History and Microscopical Clubs in and around London communicating to us the titles and addresses of their societies, with a view to publishing a list of them. The date of foundation might be added, as well as the names of presidents and secretaries.

THE DISEASE IN PHEASANTS—"GAPES."—Some years ago I paid considerable attention to the malady called "gapes," in consequence of its destroying a large number of valuable Cochin-China chickens belonging to a friend. To begin with, I found the affection to be most prevalent during a wet,

miserable season; the bird which simulated "gaping" by the opening and shutting its beak, was really gasping for breath, as a very cursory examination made out that the trachea was more or less clogged up with parasitic worms, as Dr. Dickson properly described them, of "a letter Y shape." As I had paid no particular attention to Helminthology, I confess this "Siamese Twin" formation puzzled me extremely, until I had some conversation about it with Prof. Siebold, the eminent naturalist, who had paid great attention to parasitic worms; he put the matter clear, and pronounced my "double-headed worm" to be *Syngnathus*, and to be the male and female in copula, the smaller body to be the male, and the union to be "permanent." I have not Cobbold on parasitic worms to refer to, but I daresay he would enter into detail respecting a pest which has doubtless destroyed more game and valuable poultry than all the other bird-maladies put together. My business was to find a remedy for a disease about which the poultry-fanciers were naturally becoming clamorous, and I hit upon a very simple and very effectual method of cure, which found its way into *The Field*, was received enthusiastically, and was, I believe, the means of saving thousands of valuable lives, for the lives of Cochin-China chickens in that day might well be described as "valuable." There was eventually a delightful simplicity in treating the little feathered patients, and all depending upon the dislike all kinds of worms are known to entertain for "turpentine." A small feather or camel-hair pencil, and a bottle of this said turpentine formed the *Materia Medica*. The operation for the relief of "gapes" was a rapid one, and consisted in dipping the feather or camel-hair pencil in the turpentine, and at the instant the chicken, held in the left hand, gaped, inserting the brush or feather so charged as deep as possible into the trachea, and twirling it round to insure a fair distribution to the worms in possession. The chicken laid on the ground naturally gave a series of kicks and flourishes, and, I may say, invariably coughed up a great mass of the said Y-shaped worms, and then went on his way, I have no doubt rejoicing exceedingly. I believe that this simple proceeding was in all cases effectual where it was adopted before the bird was actually moribund, and I could not find that the malady "gapes" recurred in the same individual. Should it, however, do so, the turpentine treatment might again be employed, as I certainly never saw its use followed by any but the happiest results. As I always read SCIENCE-GOSSIP with pleasure, I am glad to be able to contribute a short paper, which, I trust, will not be found devoid of interest.—John Anthony, M.D., F.R.M.S.

THE ROSY CRIBELLA.—(*Cribella rosea*. Muller.)—When dredging during the past autumn off the entrance to Larne Lough, I was fortunate enough to secure a magnificent specimen of the above rare star-

fish. Forbes, in his work on the British starfishes, records it from only two British localities,—the coast of Ayrshire and the Nymph-Bank, off Waterford. The only other notice I can find of its capture is by Dr. J. R. Kinahan, F.L.S., who dredged several specimens in Dublin Bay (1860). The specimen in my possession measures $8\frac{1}{2}$ inches across, and is of a brilliant orange colour. It was brought up from a depth of 47 fathoms, associated with living *Terebratula*, *Crainia*, and other deep-sea mollusca, &c. The bottom was rocks or stones, upon which our dredge frequently caught, and which, with the strong current that was running, made dredging operations very difficult. It would be interesting to know if the species has been observed in other localities, and under what conditions.—*William Swanston, Belfast.*

THE DOUBLEDAY COLLECTION.—The collection of *Lepidoptera* formed by the late Henry Doubleday was left in charge of trustees, to be placed in a museum in Essex, if a suitable place could be found. The Haggerstone, East, West, and South London Entomological Societies formed a committee of eight for the purpose of obtaining the collection for London entomologists. After communicating with the trustees and the director of the South Kensington Museum, the cabinets were received at the Bethnal Green Branch Museum. The question then arose how it was to be inspected. We petitioned the director again on the subject, and that gentleman very courteously provided a private room for the collection, with an attendant to show it to visitors. Still we had not obtained all we wished for, as the hours for inspection were from 10 a.m. until 5 p.m. I again wrote to the director and asked that arrangements might be made to open it until 9.30 p.m. on Tuesday nights, when the director again met our wishes. I have, therefore, on behalf of the committee, to express our thanks to the director and officials for these extended acts of courtesy.—*D. Pratt, Sec. East London Entomological Society.*

SPIDERS AND THEIR WEBS.—C. L. W. in SCIENCE-GOSSIP, No. 143, pp. 251–254, speaks of some *Epeira* spiders being in the habit of laying up a store of food in the egg cocoon “for the sustenance of the young spiders from the time they leave the egg till they leave the cocoon”; the evidence in support of this is the presence of “shells of the larvæ of the house-fly,” in “one of the cocoons,” together with young spiders just ready to leave it. I would suggest that the “shells” observed were the empty pupæ cases of a parasitic fly who had laid its eggs within the cocoon, probably soon after it was made; the larvæ of the fly had then fed upon as many of the spider’s eggs as they needed, and so passed through their transformations, leaving the empty pupæ cases behind, with the unconsumed remainder of the spider’s eggs. No case, so far as I am aware, is on record in which such a habit as that

supposed to be proved by these empty cases in a spider’s cocoon has been authenticated. The destruction of spiders’ eggs within the cocoon by the larvæ of parasitic insects is well known; and if this be the true explanation of C. L. W.’s case (as I believe it to be), the only notable point in it is, that the parasites should have left any of the spider’s eggs untouched.—*O. P. Cambridge, Bloxworth.*

NEW KIND OF PORCUPINE.—At a recent meeting of the Zoological Society, Dr. A. Gunther, F.R.S., read a report on some of the recent additions to the collection of mammalia in the British Museum, amongst the more remarkable of which was a new form of porcupine, from Borneo, proposed to be called *Trichys lipura*; and a new marmoset, obtained by Mr. T. K. Salmon, near Medellin, U.S. of Columbia, to which the name *Hapale leucopus* was given.

AN INTRA-OVAL EGG.—In the Museum of the College of Surgeons are six specimens of so-called double eggs, *i.e.*, eggs contained in the interior of larger ones. My friend Mr. C. J. Lambe-Eames has submitted to me a case of a similar kind, but, if I may venture to say so, of even greater interest than any of the older specimens. Subjoined is the history of this particular egg:—On September 26 a game bantam hen of rather large size, which had only been a short time in Mr. Eames’s possession, and had shown the peculiarity of never laying except when separated from the male bird, laid an egg normal in colouring, but of rather abnormal size. When that egg was broken, Mr. Eames’s attention was drawn to the fact that a smaller egg was floating in the albumen near the small end. The outer egg was of the ordinary white colour, the inner one of a darker hue, resembling those laid by the Cochin or Bramah breed. It has been since called to mind that that particular hen has not unfrequently laid coloured eggs of the normal size. Since producing the intra-oval egg the hen has laid about two more, and then ceased laying entirely. The last egg was laid about the end of September. In Chance’s curious book on Bodily Deformities, at page 69, is a record of a similar case in respect to a swan’s egg; and in his appendix, Lecture ii., another of a hen’s egg in many particulars strikingly similar to the case we are bringing forward. The swan’s egg is said by Chance to be in the Museum of the College of Surgeons, but a careful search there has failed to find it. From the drawing in Chance’s book it is evident that our specimen differs from both of those recorded there, as it does from all in the College Museum, in the very great difference between the sizes of the inner and outer egg. I bring this case forward with a desire for enlightenment, and with the hope that some reasonable explanation of this remarkable phenomenon may be forthcoming from some of the readers of SCIENCE-GOSSIP.—*Edward B. Aveling, D. Sc., Lond.*

BOTANY.

THE FLORA OF MARION ISLAND.—At a recent meeting of the Linnean Society, Mr. H. N. Moseley, who was one of the naturalists on board the *Chalenger*, read a paper on the above subject. He stated that Marion Island possesses considerable interest, from its isolation and being within the Antarctic drift. It is about 1,000 miles from the African continent, 450 from the Crozets, 1,200 from the desolate Kerguelen Island, above 2,000 from Tristan d'Acunha, and 4,500 from the Falklands, to which, nevertheless, its flora appears related. It is of volcanic origin and snowclad. The rocks at half-tide are covered with *Darvilea utilis*, above high tide *Tillea moschata* is found in abundance, and beyond the beach a swampy, peaty soil covers the rocks, where there is a thick growth of herbage. This is principally composed of species of *Acana*, *Azorella*, and *Festuca*, the first of these three being the most abundant plant on the island, though the latter grass is by no means scarce. The cabbage-like plant *Pringlea antiscorbutica* is less profuse than at Kerguelen's Land. Some of the ranunculus group are met with at water pools near the sea. Four kinds of ferns were obtained, *Lomaria Alpina* being the most numerous. Lichens are scarce, but mosses in plenty form yellow patches, which stand out conspicuously midst the green vegetation, which rises to an altitude of probably 2,000 feet. From the occurrence of *Pringlea* on Marion Island, the Crozets, and Kerguelen Island, and the existence of fossil tree-trunks on the two latter, Mr. Moseley thinks there was an ancient land connection between them.

A NEW VIEW OF THE ABSORPTION OF ORGANIC MATTER BY PLANTS.—Prof. Calderon contests the ordinary view that the nitrogen of the tissues of plants is derived entirely from the nitrates and ammoniacal salts absorbed through the roots. He adopts the theory that the source is the nitrogenous organic matter which is always floating in the air. The nutrition of plants he divides into three classes: *necrophagous*, the absorption of dead organic matter in various stages of decomposition; *plasmophagous*, the assimilation of living organic matter without elimination, or distinction of any kind between useful and useless substances, such as the nutrition of parasites; and *biophagous*, the absorption of living organisms, such as that known in the case of the sundews and other insectivorous plants. A further illustration of the latter kind of nutrition is, according to Prof. Calderon, furnished by all plants provided with viscid hairs or a glutinous excretion, the object of which is the detention and destruction of small insects. To prove the importance of the nitrogenous substances floating in the air to the life of plants, he deprived air of all organic matter in the mode de-

scribed by Prof. Tyndall, and subjected lichens to the access only of this filtered air and of distilled water, when he found that all their physiological functions were suddenly suspended.

"MUSHROOMS AND TOADSTOOLS."—Nobody has now the right to complain of being unable to distinguish between poisonous and edible fungi. Here is a book written by one of our best fungologists, with two large folded plates, one containing lithographed figures of the chief poisonous, and the other of the principal edible fungi, altogether of sixty species, for the sum of one shilling! It is published by Hardwicke & Bogue, 192, Piccadilly.

ANOTHER INSECTIVOROUS PLANT.—Allow me to call the attention of your readers to a remarkable insectivorous plant which has recently been brought to my notice by my nephew, F. Brittain, of Sheffield. It is met with over a large portion of the American continent, but the specimen I refer to was found in France. The plant is named *Apocynum androsacmifolium*. Its especial peculiarity is that the insects are caught by the petals, which close upon the insect and retain it a close prisoner, in the manner of the Venus' Flytrap (*Dionea muscipula*). I have not had an opportunity of examining the physiology of the plant, and cannot say at present if the action be produced by glands or hairs, or any other agency. The dried specimen I have has but one leaf and three flowers. Every flower has a fly in its deadly embrace. In two instances the wings project outwards; in one only a leg is seen. In the three cases the entire body of the insect is quite covered by the petals. I showed my specimen to Prof. Williamson, of Owens College, lately, but he could not give me any information, as the plant was new to him. I have referred to Darwin's interesting work on "Insectivorous Plants," but I don't see in that book any notice of the plant I have referred to. Probably this plant may be known to some of your American readers; if so, I hope they will enlighten us as to its habits and natural history. The flowers of the dead specimen are of a dull yellow colour, but I am inclined to think that they are of a reddish colour when living.—*Thos. Brittain.*

ERICA VAGANS.—A friend of mine, who attended the recent meeting of the British Association at Glasgow, brought me, on his return, a specimen of this beautiful Cornish heath, which he found growing, apparently quite wild, on the hill-sides, about half a mile from the inn at Stronachlachter, near the head of Loch Katrine. My friend says that he could see no signs of its having been planted there, or of its having escaped from cultivation. It was growing amongst patches of *Calluna*, *Erica tetralix*, and *Polypodium phegopteris*, and to all appearance was just as indigenous as these. Your botanical readers, however, will know that Cornwall is the only recog-

nized station for this heath, and its existence so far north is at least curious. Perhaps some of our northern botanists can inform me whether it has been previously noticed in the locality I have named, and whether there is any evidence of its having been introduced there.—*J. W. Oliver, Birmingham.*

PROPOSED AMATEUR BOTANISTS' EXCHANGE CLUB.—Most amateur collecting botanists have long felt the need of an exchange club, where they could without expense send all their spare duplicates at the end of each season, with the certainty of having a large return parcel of dried and correctly-labelled specimens from other parts of the British Islands, which can seldom be secured without this medium. Again, most botanists would be glad to secure a few good critical species of the *Rubi*, or Roses, and be thankful to see the pile of grasses and sedges on their herbaria shelves increasing with reliable specimens every year. It is proposed at once to establish an Exchange Club to further this object, to be composed of botanists from all parts of the United Kingdom, who will contribute a few specimens every year: no membership fee required, each member paying the carriage of his own parcels. Surely one hundred can be found willing to give in their names, who are connected with our large naturalist field clubs, and to these it will prove a boon long desired. Botanists wishing to join are requested to send in their names, not later than the end of January, 1877, to the Editor of SCIENCE-GOSSIP, when rules, best method of drying, labelling, and packing specimens, with other useful information, will be forwarded to each applicant. The last edition of the "London Catalogue," published by Hardwicke & Bogue, 192, Piccadilly, will be used by the members, both in labelling and marked for desiderata. To save expense, it is proposed to publish the Yearly Report in SCIENCE-GOSSIP.

GEOLOGY.

OBSERVATIONS ON THE GEOLOGY OF EAST ANGLIA, ETC.—This is the title of an important paper recently read before the Geological Society of London by S. V. Wood, jun., F.G.S., and F. W. Harmer, F.G.S., &c. The subjects discussed in this paper were threefold, viz.,—1. The unfossiliferous sands of the Red Crag; 2. The unconformity between the Lower and Middle Glacial deposits; 3. The mode in which the Upper and Middle Glacial were accumulated. The views of the authors under the first head were similar to and confirmatory of those advanced in the previous paper by Mr. Whitaker; but they pointed out that the Red Crag, which these sands, in an altered form, represent, could not belong to the Chillesford division of that formation, by reason of the casts of shells which had been preserved not com-

prising any of the more characteristic Chillesford species, and of their including among them forms confined to the older portions of the Red Crag. They also pointed out that the Chillesford Clay had been removed over all the area occupied by these sands by denudation prior to the deposition of the Middle Glacial, which rests upon these sands wherever they occur. The removal of the Chillesford Clay, the authors consider, was due in part, if not in all, to the great denudation between the Lower and Middle Glacial, which gave rise to the unconformity discussed under the second head. This unconformity they illustrate by lines of section traversing most of the river valleys of Central and East Norfolk and Suffolk. These show that such valleys were excavated after the deposit of the contorted drift, and out of that formation and the beds underlying it. They also show that the Middle and Upper Glacial have been bedded into these valleys, as well as spread (the middle only partially, but the upper more uniformly) over the high grounds formed of contorted drift out of which they were excavated, and thus generally concealing that deposit, which manifests itself only in the form of occasional protrusions through these later formations, but which they consider constitutes, though thus concealed, the main mass of the two counties. The authors also describe a glacial bed as occurring at various localities in the bottom of some of these valleys, and which in one case they have traced under the Middle Glacial. This they regard as having been formed in the interval between the denudation of the valleys and their subsequent submergence beneath the Middle Glacial sea; and inasmuch as such valley-bed invariably rests on the chalk in a highly glaciated condition, they attribute its formation more probably than otherwise to the action of glaciers occupying the valleys during an interglacial interval of dry land. They also suggest that if this was so, it is probable that the forest and mammaliferous bed of Kessingland, instead of being coëval with the preglacial one of the Cromer coast, may belong to this interglacial interval—that is to say, to the earliest part of it, before the glaciers accumulated in the valleys, and when the climate was more temperate, any similar deposits in these interglacial valleys having been for the most part subsequently ploughed out by the action of the glaciers. In discussing the subject under the third head the authors point out the many perplexing features which are connected with the position and distribution of the Middle Glacial formation; and while they admit that as to one or two of these the theory which they offer affords no explanation, they suggest that the theory of this formation's origin which best meets the case is as follows, viz.,—As the country became re-submerged, and as the valley glaciers retreated before the advancing sea, the land-ice of the mountain districts of North Britain accumulated and descended into the low grounds, so that by the time East Anglia

had become resubmerged to the extent of between 300 and 400 feet, one branch of this ice had reached the borders of the counties of Norfolk, Suffolk, Essex, Herts, and Bedford, ploughing out and destroying any Lower Glacial beds that had been deposited over the intervening counties upon which it rested, and over which we ought otherwise, having regard to the depth of the earlier submergence under which they were accumulated, to find them, but do not. The Middle Glacial formation, consisting of sand and gravel, they attribute principally to the action of currents washing out and distributing the morainic material, which was extruded on the sea-bottom by this land-ice; that ice itself by keeping out the sea over all the country on which it rested, which was then below the sea-level, preventing the deposit of the Middle Glacial in those parts. The termination of this current action was accompanied by increased submergence, and by a gradual retreat of the land-ice northwards to the mountain districts, until Britain was left in the condition of a snow-capped archipelago, from which eventually the snow disappeared and the land emerged. To the moraine extruded from the base of this ice and into deep water they refer the origin of the Upper Glacial Clay, the moraine material remaining partly in the position in which the ice left it, and partly lifted by the bergs which became detached from the ice. Such part of it as was lifted was dropped over the sea-bottom at no great distance from its point of extrusion, and in that way the marine shells occurring in a seam of sand in the midst of this clay at Dimlington and Bridlington on the Yorkshire coast became imbedded, the mollusca which had established themselves on the surface of this moraine material having been thus smothered under a lifted mass of the same, which was dropped from a berg. The authors point out that precisely in the same way in which the Middle Glacial is found stretching out southwards and eastwards beyond the Upper Glacial Clay in Suffolk and in Herts, and is succeeded by such clay both vertically and horizontally, so does the earlier formed part of the Upper Glacial Clay, or that with chalk *débris*, stretch southwards beyond the latter formed part, or that destitute of such *débris*, and is succeeded by it, both vertically and horizontally. This, they consider, shows that the Middle and Upper Glacial deposits, which constitute an unbroken succession, were due to the gradually receding position of the land-ice during their accumulation, the sequence being terminated with the Moel Tryfaen and Macclesfield gravels, which were accumulated during the disconnection and gradual disappearance of the ice, and while the land still continued deeply submerged.

THE SIVATHERIUM IN SPAIN.—At a late meeting of the Geological Society of London, Prof. Calderon read a paper on "The Fossil Vertebrates of Spain," in which he stated that remains of the *Sivatherium*

and *Ilyenarctos* had been found in that country. The President (Prof. Duncan) remarked that the presence of these animals, if confirmed, would be particularly interesting as showing a great western extension of the Miocene fauna peculiar to the Sivalik hills, in India.

THE SIBERIAN MAMMOTHS AND HAIRY RHINOCERI.—The long woolly hair with which these extinct animals were clothed has been deemed a plain proof of their special adaptation to an extremely cold climate. Some years ago the teeth of a Mammoth were subjected to close scrutiny, and some dark vegetable matter found in the hollows was microscopically examined, and found to belong to coniferous vegetation, such as is to be found in the extreme North, the inference being that the Mammoth most probably fed on the young shoots of fir-trees. Very recently M. Schmalhausen has made a communication to the St. Petersburg Academy, on the constituents of a mass of dark-brown matter extracted from hollows in the teeth of a rhinoceros in the Irkutski Museum. That this was truly the remains of fodder of the animal seemed clear from the appearance and the macerated character of the vegetable substance, of which only the woody and cuticular parts showed a more or less distinct structure. The greater portion of the piece consisted of leaf-remains, with here and there a fragment of stem. For the most part the stem and leaf-fragments were those of monocotyledonous plants, probably of Graminæ; there were also, in less quantity, leaf-fragments of dicotyledonous plants. Besides leaf-shreds of Coniferæ, there were woody pieces which indicated the existence of *Picea* (*Obovata?*), *Abies* (*Sibirica?*), *Larix* (*Sibirica?*), *Gnetaceæ*, *Betulaceæ*, and *Salicinæ*. It seems unquestionable that these remains must be referred to northern plants and to such as are still partly found in the arctic or sub-arctic regions.

GEOLOGICAL MAP OF SCOTLAND.—We have received a new geological map of Scotland, by Professor A. Geikie, F.R.S., the Director of the Geological Survey of Scotland. It is unquestionably the best which has yet been issued. The specific colours for the various formations and outcrops are well-chosen and distinct, so as to catch the eye at once. The dip of the strata is marked, as well as the places where they are contorted. Signs and tokens for anticlinal and synclinal axes, and for faults, point out clearly to the student where these phenomena most abound. The colours and symbols chosen for the igneous rocks are excellent. The topography of the map is by Mr. T. B. Johnston, F.R.G.S. The map is published by Messrs. W. & A. K. Johnston, Edinburgh.

CARROT.—The wild carrot may always be known by the red flowers in the middle.—E. T. Scott.

NOTES AND QUERIES.

LOCUSTS AT CHEDDAR, SOMERSET.—Your correspondent's (H. W. Livett) account of the locust found at Wells, reminds me that while staying at Cheddar last year (1875), I was told that the year before a large number of locusts visited that village; and the villager who was my informant said that they created great havoc among the vegetable produce of his garden. His description exactly tallied with the appearance of *Pachytylus migratorius*, a specimen of which is in my possession, and was sent to me from Egypt by a relation.—*Charles Williams, Redland.*

FERTILIZATION OF FLOWERS.—A little work on bees which I read some time ago, states that bees collect pollen only on flowers of the same species, in order not to mix the pollen of different flowers together, and I have several times observed this statement as perfectly true during the time when resedas, roses, and geraniums adorned a bed close to a bee-hive. The same bee or humble-bee which had been on a reseda would only visit resedas, another only geraniums, &c. I quite agree with A. B., Kelso, that this seems to point out a certain law of nature which favours the more perfect fertilization of flowers.—*Blanche.*

FEEDING CUCKOOS.—In the volume of SCIENCE-GOSSIP for 1874, I sent an account of a young cuckoo, but I never saw anything in its way of feeding different from usual. We used to feed it two or three times a-day, from the time almost of its birth till we lost it; and the parent hen bird used to come and feed it within two or three yards of us. The cuckoo had a large mouth, and opened it wide to be fed, but certainly never put out its tongue to have the food placed upon-it. The parent bird always put its beak in its mouth like any other bird; and the way in which it got on its back to feed it when the cuckoo was sitting on the top of a post was very amusing. The male bird would sometimes feed it, but it always struck us as being somewhat afraid of it.—*E. T. Scott.*

DEATH'S-HEAD MOTH.—As none of your readers answered this question in SCIENCE-GOSSIP for October, allow me to state that something of the same kind occurred to me. Finding the caterpillar under a potato-plant on the earth, I put it in a box containing some cotton-wool which I had in my pocket. On coming home I put the box down on the hall-table, where it was left till next morning, when I wanted to place the caterpillar in a larger box; but, to my surprise, I found it had used some of the cotton-wool to make a kind of cocoon, glued firmly together, through which I could see the caterpillar lying stiff and motionless. After three more days the skin was thrown off and the reddish-brown chrysalis appeared in the cocoon. I suppose the caterpillar used the cotton-wool because it could not bury itself in the earth when the change of nature took place.—*Little Lambie, Cannes.*

HEDGE-HOGS AND THEIR FOOD.—I think I can add some information to the article by Mr. Charles W. Whistler, in the August number of SCIENCE-GOSSIP on the Hedge-hog. Asking a friend if he could tell me anything about this animal, he related to me the following story:—A farmer here having an order for some apples, ordered his men to pick them, put them together in a heap, cover them with some straw, and leave them to be packed the next morning. Coming the next day to pack them, they found but few, and could not find the thief. About a week

after they were stopping a ditch which divided two fields. The men found a heap of straw; removing the straw they found a quantity of apples, and further on found quite as many potatoes; besides this they caught several hedge-hogs. These were supposed to be the thieves, for they were seen afterwards rolling themselves over, and the apples stuck on their skin.—*J. W. Mee.*

SKELETONIZING OF STARFISH.—Being once desirous of obtaining the skeletons of some of these creatures, I adopted the plan usual with vertebrates, viz., simple maceration in water; and both those I thus treated came out well, one of them being still in my possession. The water should not be changed too often, and the skeleton should be removed when the flesh is sufficiently rotten to be washed away by the current of water from a tap.—*David A. King.*

SPARROW-HAWK AND CROW.—Whilst shooting one day in September last I saw a crow chasing a hawk. The hawk settled once, but on rising was again pursued by the crow; they finally disappeared over a brow. My companion told me this was of common occurrence.—*David A. King.*

SEEDS DIGESTING.—W. G. P., in his paper on the Mistletoe, rather seems to uphold the idea that seeds swallowed whole will digest. I thought it was perfectly well known that this is not the case, but that uncooked and unbroken seeds always pass unaltered.—*E. T. Scott.*

AN UNIDENTIFIED BIRD.—A short time since I purchased of a young Arab a little bird of the finch family, but which I had never before seen nor read a description of. I am convinced that it is no native of these parts of Syria, nor yet a regular passing visitant. The bird is about 4½ inches long, of a warm cinnamon-brown, with black head and neck, and some black about the vent. The bill is similar in shape to that of a bullfinch, and of a light leaden-blue colour; the tail is rather short in proportion to the body. This bird tries to sing, but does not produce any sound until near the close of his effort, when an attentive listener may hear a few very sweet notes, resembling those of a canary-bird. Can any one inform me what this bird's name is, and where a description of him may be found; also, whether there is any reasonable hope that his voice may yet "come out"?—*W. T. Van Dyck, Beyrout, Syria.*

VOLVOX GLOBATOR.—I endeavoured last season to renew my acquaintance with the above, but entirely without success, as I have not been able to obtain one single specimen. I do not think that the absence of the Volvox from the different ponds which I have explored in the neighbourhoods of Finchley, Hampstead, Hornsey, &c., can be attributed to the voracity of Rotifera, unless the latter have been exceptionally prolific this summer under the influence of the extraordinarily hot weather. I am more inclined to think it is owing to the increase of building operations, whereby the virgin ponds become either disturbed or impregnated with alkaline and other matter, that we experience difficulty in finding the favourites we could so easily procure a few years ago. I have indeed had to give up whole days recently "out of town" in the endeavour to obtain a few objects worthy of investigation. As regards the caddis worms (of which I have collected some extraordinary specimens this year), I think they are not injurious, to any great extent, except to the plants to which they attach themselves; and as their microscopic value is of itself microscopic, I would suggest the advisability of dispensing with their presence in

any aquarium kept solely for the purpose of rearing or preserving either Rotifera or any similar small but edible objects. In answer to your correspondent's inquiry, I would observe, that the *Volvox globator* is to be obtained in certain places long after the "fort-night in June" to which he refers; but as he does not intimate the locality whence he writes, it is impossible to form an opinion about the freak of nature which he alleges has taken place for the last few years. It would afford me great pleasure to learn where I can again readily come across the *Volvox* in the vicinity of London, as it is a tedious task to have to search for this interesting stranger in new and unknown neighbourhoods. Ponds with sandy or gravel bottoms are, I believe, the best in which to search for our now scarce friend; and when found he should be placed in a light-green-coloured bottle and exposed to the light (not the sun), when his graceful evolutions can be easily observed without even the aid of the microscope. I need scarcely remind your readers that the *Volvox globator* forms one of the prettiest animated objects that can be exhibited at a soirée, and is specially attractive to the ladies.—*G. E. Ladbury.*

"SCIENCE-GOSSIP SECTION MACHINE."—Permit me to add my testimony to that of Greenwood Pim (whose paper in this month's GOSSIP on Section-cutting is most interesting), as to the excellency of the SCIENCE-GOSSIP Section Machine. All who use it will, I feel sure, agree that for cheapness and neatness of working it cannot be equalled. Until one of these section machines was given me by a relation, I never could procure really good specimens fit to mount and show; but now I find no difficulty at all. Let me advise all readers of SCIENCE-GOSSIP who may be in want of an instrument of this kind to give the one which bears the name of one of the most popular of our present scientific journals a fair trial, before laying out money on a more expensive, and, perhaps, not so effective an instrument.—*Charles Williams Redland.*

GOLDEN PHEASANT AND BANTAM.—A short time ago a gentleman living in the neighbourhood of St. John's Wood bought a golden pheasant, and thinking it would be rather lonely, he gave it a bantam hen as a companion. The birds bred, and in the course of time the hen hatched five chickens (three cocks and two hens). When the chicks were about eight months old he gave me a pair, which I have had about two months. For about three weeks after I got them they uttered the same peculiar cry as the pheasant, but now the cock has left that off, and crows very much the same as a bantam. The feathers of the cock are very similar to those of the golden-laced bantam, except those on the back and shoulders, which are of a brick-red colour. There is no peculiarity in the plumage of the hen, but the head is rather more like that of a pheasant than that of a domestic fowl. Is it a common occurrence for the golden pheasant to breed with the domestic fowl? If any of your readers can give me any information on the subject I shall be much obliged.—*G. W. Landels.*

CUCKOO'S EGGS.—May I venture, without giving offence to any one, to express a hope that such of the readers of SCIENCE-GOSSIP as are interested in the cuckoo-egg controversy, but have not given much attention to it, will accept the true version of that theory, as it is admirably expressed by Mr. Southwell in your November number, page 260; for really the rubbish that has been written about that question, and the ridiculous dress in which a very beautiful theory has been vested by some, who were com-

pletely at sea as to the real question at issue, has made more than one ornithologist shy of expressing his views on the matter, lest he too should be misrepresented, and opinions attributed to him the very reverse of those he entertained. As Mr. Southwell has referred to my translation of Dr. Baldamus' paper, which was printed in the *Zoologist* in April, 1868, I feel bound to thank him for his timely rescue of the learned doctor from the mud with which he has been too liberally bespattered by some. And as Mr. Southwell very fairly acknowledges that his own opinion is not in favour of the theory above-mentioned, I hail a true exposition of that theory from him, as from an unprejudiced and competent authority. While, on the other hand, I should not be honest if I did not as openly acknowledge that the more I have studied Dr. Baldamus' view, the more convinced I am that it contains the nucleus of a great truth; though I do not think we have yet reached the whole of it; nor can we speak otherwise than very reservedly and cautiously on a question which has not yet been settled, and about which our best ornithologists are not yet by any means agreed.—*Alfred Charles Smith, Yatesbury Rectory, Calne, Wilts.*

COLOUR OF EGGS.—In reply to the inquiry of "A. P.," in the November number of SCIENCE-GOSSIP, page 259, for information in regard to the species of birds which have been ascertained occasionally to assume white or parti-coloured plumage, I beg to refer him to a list of fifty-seven species which I published in the *Zoologist*, in 1853, pages 3,969–3,980, at the conclusion of a paper "On the General Colour and the Occasional Variations in the Plumage of Birds"; but I would add that a great many additions might now be made to that list from subsequent observation. In short, so numerous are such instances, and in so great a variety of species, that I have come to the conclusion that in all probability *no species* of bird is altogether exempt from a liability to this accident, or defect, as I think it should be called, however peculiar and sometimes beautiful such white or mottled specimens may be, inasmuch as constitutional, or hereditary, or other weakness, appears to be the general cause of the absence of the pigment or colouring matter which forms the normal hue of more healthy members of the species. Therefore I would deprecate the preservation of such abnormal and unnatural specimens as I would of any other deformities.—*Alfred Charles Smith, Yatesbury Rectory, Calne, Wilts.*

RARE BIRDS.—Does it not seem a pity that every rare bird that visits us should be shot? Last November a fine specimen of the bittern was shot at Sutton Coldfield. A hoopoe was also shot about five miles from Birmingham. Is it not rather rare for the hoopoe to be taken so far north?—*G. T. B.*

AN ANCIENT CAT.—At Gundagai, New South Wales, there is in existence a cat which is said to have attained the extraordinary age of 100 years. It was brought from England in the *Golden Grove* one of the three storeships that accompanied the first fleet of convict ships, which cast anchor in Botany Bay on the 20th of January, 1788. This vessel may be characterized as the Noah's Ark of Australia. She conveyed thither—one bull, four cows, and one calf; one stallion, three inares, and three colts; one ram, eleven sheep, and eight lambs; one billy-goat, four nanny-goats, and three kids; one boar, five sows, and a litter of fourteen young pigs; nine different sorts of dogs; and seven cats, including that of Gundagai, which is supposed to be the sole survivor of the magic number of seventy-seven quadrupeds

brought by the *Golden Grove*. The cat passed into the possession of a pensioner of the Imperial Government, who settled in Gundagai in 1839, and who was drowned in the local deluge of June, 1852.

THE CUCKOO.—Too much has already been said about the cuckoo, but having many opportunities of observing its habits I cannot resist adding to it. I have seen a good many nests with cuckoos' eggs in them, and all were the same size and colour, but all were in the nests of the meadow pipit or the skylarks. I never saw a cuckoo's egg in any other nest. The cuckoo does not suck nor destroy the eggs that hers are deposited with, but I have known several instances of the cuckoo extracting one egg in place of that she had left, and on one occasion I was an eyewitness of the fact. Having got the nest of a meadow pipit one night about eight o'clock and while examining the three eggs (only three had been laid at that time) my attention was directed to the cuckoo circling round me, and thinking it had something to do with the nest I concealed myself, and had the satisfaction of seeing the cuckoo alight at it. I waited about ten minutes, but my curiosity was greater than my patience, I therefore scared her away, and found nothing but the three eggs as before. But concealing myself again the cuckoo returned, and giving her no disturbance this time I was surprised when she left to find one of the pipit's eggs gone, and the cuckoo's substituted in its place. Now if the cuckoo carried her egg in her bill to the nest she would have nothing to do but place it there and leave it, but this was not the case, the pipit's nest was much disfigured with the transaction, and the pipit screamed loudly all the time. I have seen the cuckoo destroy young birds by throwing them out of the nest, and tearing them with her bill; but what could be her reason I could not conceive, unless it was to make them lay again and have a chance of disposing of her egg. I saw two young cuckoos in the nest this year, one I took home and fed it on gooseberry caterpillars, but all the caterpillars I could get were soon exhausted, it had such a wonderful appetite. I then gave it the flesh of small birds, which it took with great relish, and though it was quite tame and healthy, it was discontented with confinement, and after keeping it a few weeks I gave it its liberty.—*W. Sim.*

THE CUCKOO.—Once more I intrude a few observations, and I would direct attention to that *questio vexata*, the Cuckoo. Probably no member of the vertebrate kingdom has provoked more discussion than this bird. The recent numbers of the SCIENCE-GOSSIP have furnished the lovers of nature with many interesting details relating to this truly wonderful bird; old authorities have been searched; old theories brought out in a new form; and some of the most ingenious of SCIENCE-GOSSIP contributors have ventured to launch forth original remarks founded upon facts or surmises. One of your contributors in the last number quotes a remarkable passage from Bishop Stanley's "History of Birds," which, if wholly reliable, tends to intensify the mystery in which the habits of this bird are involved. Bishop Stanley, I may mention, also relates an instance in which a young cuckoo was adopted by a young thrush, and the *protégé*, with the base spirit of ingratitude, took one of the thrush's eyes out, because it could not resist the temptation of swallowing a fine plump worm, which the cuckoo had expected to receive. The sporting naturalist Vaillant, after having shot several golden cuckoos (*Cuculus auratus*) with eggs of their species in their gullets, came to the conclusion "that the female

cuckoo deposits her egg in the nest of another bird, conveying it thither in her beak." The persistent mobbing of the cuckoo by smaller birds, which one sometimes sees, is due, either to its accipitrine-like contour, or to a knowledge of its habits and propensities. A bird which was a source of error to the older naturalists, from Aristotle to Pliny, has still many points in its biography which are controversial. If we admit that it possesses the power of discerning the different colours, when it places its eggs in the nest of a bird whose eggs correspond to its own; or, that it has some regard to number when it cautiously and with great foresight, places its egg in a nest where the laying is not completed, so as to secure the incubation of its egg; also, when it breaks one of the eggs in the nest, after introducing its own, so as to make the number the same as before; or that it possesses prudence, when it only puts one egg in each nest, thus providing effectually for the welfare of its offspring, the foster-parents not being able to meet a greater demand upon their resources—by subscribing unconditionally to all these facts, we must admit that the cuckoo has perfect reasoning powers, and, consequently, real intelligence. In short, this bird is a great example of the endless variety of ways and means which nature adopts for the perpetuity of species; every preparation is made, and all possible contingencies provided for.—*F. L. C. Richardson.*

ALBINISM IN BIRDS.—In addition to the list "A. P." gives of the birds that have been found white or ivory-coloured, I may mention the following:—Kestrel (*Falco Tinnunculus*); green woodpecker (*Picus viridis*); redwing (*Turdus iliacus*); fieldfare (*Turdus pilaris*); curlew (*Numenius arguta*); landrail (*Gallinula crex*); snipe (*Scolopax gallinago*); wood-pigeon (*Columba palumbus*); missel-thrush (*Turdus viscivorus*); wren (*Sylvia trochilus*); house-martin (*Hirundo urbana*); crow (*Corvus corone*); partridge (*Perdix cinerea*); pheasant (*Phasianus colchicus*), and woodlark (*Alauda arborea*). Two or three of the above I have in my possession, and the others have been proved from various reliable sources.—*C. D. Wolstenholme.*

THE WRYNECK.—I once kept a young wryneck for some time, and always fed it on house-flies. It did not generally eat the legs and wings, but preferred the fleshy parts of the insects. It ate very voraciously. I may add that it was anything but shy, and would eat from any one's hand.—*A. H.*

WOOLLEN MOTHS.—I am much pleased to see that the subject of destroying woollen moths has given rise to so much discussion in SCIENCE-GOSSIP. I agree with Mr. J. S. Wesley to a certain extent, but I must say I think the most effectual way of destroying the larva that is in the woollen material is to tie them in a bundle, and bake the material for a short time, thereby destroying all life eggs, &c., then well brush, and place them in the drawer if you like.—*William Bean.*

COMMUNICATIONS RECEIVED UP TO 8TH ULT. FROM:—G. H. K.—T. S.—W. B.—G. S.—A. R. G.—E. S. L.—R. M. M.—W. E. G.—F. S.—A. E.—T. S. W.—S. C. A.—Dr. H. P.—L. H. H.—W. G. P.—A. M.—F. J. G.—D. A.—O. P. C.—J. B.—J. W. M.—J. W. S.—F. C.—R. M. C.—Mrs. G.—J. J. M.—W. T. V. D.—Dr. G.—R. G.—J. W. G.—W. G. P.—C. W.—F. C.—H. A.—E. T. S.—M.—B.—A. C. S.—T. B.—W. L. S.—H. F. W.—E. D. M.—Dr. J. A.—H. N. R.—W. S.—A. S. G.—W. B.—D. B.—J. E.—C. D.—F. C.—W. S.—J. P.—J. B. Jun.—J. W.—V. M. A.—G. P.—C. A. G.—A. M.—T. D. R.—A. J. R. S.—W. H.—W.—Dr. J. H.—T. C. M.—L. P.—C. W. S.—H. L.—T. H. P.—Dr. P. Q. K.—J. W. O.—T. C. R. G.—A. P.—J. L.—S. C. M.—H. M., &c., &c.

NOTICES TO CORRESPONDENTS.

TO SUBSCRIBERS.—The compilation of the classified index of the last twelve volumes of SCIENCE-GOSSIP has proved a more difficult and painstaking task than we at first imagined. It is now in a forward state of preparation, and we crave a little grace from our numerous correspondents, who have already applied for it.

TO CORRESPONDENTS AND EXCHANGERS.—As we now publish SCIENCE-GOSSIP at least a week earlier than heretofore, we cannot possibly insert in the following number any communications which reach us later than the 8th of the previous month.

A SUBSCRIBER.—You will find Jardine's "Naturalist's Library" one of the best systematic works on Natural History yet published, and all the more advantageous to the student in that he can obtain any work bearing on his own particular study.

S. C. ADAMS.—Obtain Prof. Harvey's three volumes of "Phycologia Britannica." This has excellent coloured plates, and gives the geographical distribution and varieties of the chief species of sea-weed. Mr. W. H. Grattann's excellent and cheap little book on British Sea-weeds will also help you. These plants have a very extensive geographical distribution, as all lowly-organized forms usually have.

F. J. GREENFIELD.—It is no uncommon thing for flowers to change colour when plucked. Many do so after pollination; those of the hawthorn, to wit, whose petals usually assume a pinkish tinge when fading. The cause is due to a chemical change in the colouring matter of the cells of the petals.

S. C. M.—The pods are those of *Iris fatidissima*, with the capsules open, showing the bright red seeds within.

JOHN ROPER.—The fossils are: 1. *Ammonites latus*; and 2. a coral (*Trochocyathus*).

MISS R. R.—Dr. Lankester's "Half-hours with the Microscope," especially the new edition, which is considerably enlarged, would answer your purpose fully.

T. O. (Sale).—The plants are: 1. *Drosera rotundifolia*; 2. *Pinguicula vulgaris*; 3. *Habenaria viridis*; and 4. *Narthecium ossifragum*.

J. BATTERSBY.—Prof. Nicholson's "Advanced Text-Book of Zoology," price 6s., published by Blackwood & Sons, is the best you could get.

R. GREENWOOD.—The mineral was iron, not copper, pyrites (iron sulphate). It may be told from copper by its superior hardness. A knife will scratch copper pyrites, but will not touch iron pyrites.

J. J. (Burton).—Get Cooke's "Microscopic Fungi," published by Hardwicke & Bogue, 192, Piccadilly.

R. M. CHRISTY.—We are sorry to say that, owing to the loose way in which it had been packed, your slug came to us amid a mass of hardened silvery slime, representing a fossil sticking-needle. Next time send one inclosed in oil-silk, to protect it from the air.

J. J. M.—The "jelly" was a species of *Nostoc*, showing the bead-like connection of cells.

E. GROVE.—The depreddators are either mole-crickets or the large species of ear-wig.

A. R. C.—The only book we know is Page's "Handbook of Geology and Physical Geography," published by Blackwood & Sons.

MISS T.—Mrs. Lankester's "British Wild Flowers worth Notice" has coloured plates of the commoner species, and it is the cheapest we know of.

W. THOMPSON.—You will find all the monstrosities relating to the different parts and organs of plants fully treated of in Dr. Master's "Vegetable Teratology," published by the Ray Society, at, we believe, one guinea.

ACOLYTE.—Consult Bailey's "Characteristic British Fossils," for the Primary rocks; and Prof. Nicholson's "Manual of Palæontology" for the rest.

THOS. PALMER.—Your shells are: 1. *Nasoa reticulata*; 2. *Dentalium entale*; 3. *Cyprea Europæa*; and 4. *Tellina Baltica*.

W. HAMBROUGH.—The leaves of the water-cress sent us are not unusually found in the state you observed, especially when the growth of the plant has been unusually rapid.

EXCHANGES.

PLANTS from United States of America and Canada, to exchange for British plants; English and other European Ferns particularly desired. Only well-preserved specimens wanted and given in the exchange.—Lyman H. Hoysrad, Pine Plains, Dutchess Co., New York, U.S.A.

FIRST 6 vols. of SCIENCE-GOSSIP, bound in two, for micro slides, &c., &c.—J. S. Harrison, 48, Lowgate, Hull.

A FEW specimens of *Synapta* and *Chirodota violacea*, or other good micro material wanted in exchange for well-mounted objects, &c.—W. L. S., 6, Dagnall Park Terrace, Selhurst, S.E.

FOR Seeds of *Collomia* (spiral fibres), send stamped and directed envelope to F. Coles, 248, King's-road, Chelsea, S.W.

WANTED, rubbing of Monumental Brasses, for Seaweeds, Ferns, or bound volumes of SCIENCE-GOSSIP.—F. Stanley, 6, Clifton Gardens, Margate.

WANTS to exchange *Linnaea stagnalis*, *Unio tumidus*, *Unio pictorum*, *Anodonta cygnea*, *Anatina*, or *Helix arbusculorum*, or any other common or rare shells from Yorkshire, for any other as good from any county in England.—J. Whitenham, Cross-lane Marsh, Huddersfield.

"BERKLEY'S Cryptogamic Botany," quite new, uncut, cost one guinea, offered in exchange for Gosse's "Anemones," "Devonshire Coast," "Tenby," "Marine Zoology," or other good work on Natural History, or a Kerner Eye-piece, or large Bullseye Condenser, or other microscopic apparatus.—C. A. Grimes, 8, Crafford-street, Dover.

FOR specimens of *Plumaria cristata*, *Laomedia geniculata*, and *Lepralia hyalina*, send stamped envelope or object of interest to T. Combridge, 5, Norfolk-street, Brighton.

Nos. 24, 34, 40, 58, 67, 81, 100, 125, 133, 136, 146, 235, 276, 273, 282, 287, 305, 273, &c., 7th Edition London Cat., for other flowers, plants, or mosses. Lists to W. E. Green, 24, Triangle, Bristol.

IGNEOUS ROCKS wanted in quantity from known localities; liberal exchange in Shells, Fossils, Crustacea, Minerals, or Microscopic Objects.—Thomas D. Russell, 48, Essex-street, London, W.C.

SLIDE of Fossil Fibrous Wood (from Shropshire clay, ironstone), in exchange for other good slide or material. *Unmounted Marine Algae wanted*.—J. P., 63, Legh-street, Warrington.

PORTION of wing of Morpho, showing scales *in situ*, Opaque Slide, Fijian Tapa Cloth, balsam mounted for polariscope, in exchange for first-class Slides.—J. W. S., 7, Charlemont-terrace, Cork.

FIVE hundred Slabs of Polished Madreporas; will exchange for Gault Fossils, Silurian Corals and Fossils, one good polished-slab for each Gault, or good Specimen of Trilobite; will exchange also for good Foreign Shells. Some few British Shells also required.—A. J. R. Sclater, 9, Bank-street, Teignmouth, Devonshire.

Artemisia campestris (Linn.) or *Orbanche caryophyllacea* (Sm.), for Nos. 23, 101, 106, 156, 535, 536, 544, 545, 546, 679, 851, 913, 959, 971, 1,020, 1,089, 1,121, 1,133, 1,220, 1,247, 1,279, 1,312, 1,329, 1,343, 1,484, 1,618, 1,622, 1,624, 1,632, 7th ed. "Lon. Cat."—A. B., 107, High-street, Croydon.

I SHOULD be glad to hear of some one with whom to exchange a few British Land and Fresh-water Shells.—Robt. M. Christy, 20, Bootham, York.

HALF-an-ounce of Upper Peruvian Guano, containing an abundance of *Aulacodiscus scaber*, with a number of other good forms, *A. Combesi*, &c., &c., in exchange for the same of Monterey Stone or Earth. Also a number of duplicate Diatom Slides in exchange.—Address, Mr. Powell, 327, Camden-rd., N.

MICRO Material, consisting of Sections, Zoophytes, Leaves, &c., in exchange for other objects.—H. Livesey, 6, Upper Phillimore-gardens, Kensington, London, W.

VOL. I. of Cassell's "Popular Natural History," unbound, for Pupæ (living) of Atropos, &c.—C. Swatman, Mr. Feldwick's, London-road, Sevenoaks.

In exchange for other mounted Natural History Objects: Proboscis of Blow-fly, *Amphipleura pellucida*, *Navicula rhomboides*, *Pleurosigma angulatum*, *Pleurosigma fasciola*, *Podura* Scales.—Address, T. C. Maggs, Yeovil.

FOSFILLS, from Somerset and Dorset Oolite, for Silurian from Dudley and Ludlow.—J. Purdue Ridgeway, Plympton, Devon. *Linnaea glabra*, *Ancyclus fluviatilis* (var. *albida*), *A. lacustris*, *Zonites radiatulus*, *nitidus*, and *excavatus*, *Helix fusca*, *Helix cæparata* (var. *alba*), *C. rugosa* (var. *dubia*), &c., offered for good British Marine or Foreign Shells; or would exchange for British Land and Fresh-water Shells with collectors in other countries.—Lister Pearce, Hebble-terrace, Bradford-road, Huddersfield, Yorks.

BOOKS, &c., RECEIVED.

"The Geology of England and Wales." By H. B. Woodward, F.G.S. London: Longmans & Co.

"Cross and Self-fertilization of Plants." By C. Darwin, F.R.S. London: John Murray.

"The Smoker's Guide." London: Hardwicke & Bogue.

"Transactions of the Literary and Philosophical Society of Liverpool." Vol. xxx.

"The Yorkshire Naturalist." December.

"The American Naturalist." November.

"Botanische Zeitung." November.

"Les Mondes." November.

"Land and Water." December.

"Monthly Microscopical Journal." December.

"British Journal of Photography."



THE MISTLETOE: ITS GROWTH, AGE, AND THE USAGES CONNECTED WITH IT.

By EDWIN LEES, F.L.S., F.G.S.



THE elaborate paper on the History of the Mistletoe that appeared in SCIENCE - GOSSIP for December last is not quite exhaustive, and requires supplementing with a few further remarks. The author of the article rather strangely says that the oldest

specimen of mistletoe that he has heard of was no more than fifteen years old. Surely he must be a young observer, or his own experience would have extended far beyond this. Nearly forty years ago I mentioned, in the Cheltenham "Looker-on," and afterwards in my "Botanical Looker-out in England and Wales," that there was an oak growing on the Ridgway in Eastnor Park, Herefordshire, with a mass of mistletoe upon it; and this tree, with the mistletoe upon it—perhaps a little diminished by the attacks of curious explorers—still exists, and if the oak is allowed to stand, will continue to grow there, I have no doubt, for many years to come. Indeed, as far as my observation goes, the Mistletoe very rarely dies upon the tree that sustains it, though detrimental to the well-being of the tree, and so justly called the "baleful mistletoe" by Shakspeare.

Having myself long ago gone into the history of the Mistletoe, I have come to the conclusion that the domestic use of it in England at Christmas time is to be traced to the northern nations, who dedicated it to Freya, the Scandinavian Venus; and a great deal of what has been stated about the Druids is mythical. At all events, the Romans upset the Druidical superstitions, and it is hardly probable that, during their sway in Britain for about four hundred years, the Mistletoe would be permitted to be held in any honour. But the northern nations had always regarded it in a superstitious light, and their inroad and settlement in our island re-introduced the

use of the plant for irreverent or mirthful rites connected with sexual intercourse; and thus it ought never to appear in sacerdotal ornamentation. The Druids no doubt honoured the Mistletoe religiously, "with a sense of mystery and awe"; but in the present day it is only regarded mirthfully, and in connection with loving or sportive influences. The plant therefore, I do not think has been with us derived from Druidical lore, and it is curious enough that in Wales, where Druidic influence was longest felt, the Mistletoe is almost unknown, and little regarded or sought after by the Welsh-speaking people.

The Druids, it is asserted by various authors, gathered the Mistletoe at the commencement of the new year, but the Druidical new year did not correspond with our Christmas time, but began in March, for Toland, in his "History of the Druids," says that the Druidical New Year's day was the 10th of March, "which was the day of seeking, cutting, and consecrating the wonder-working all-heal." According to Pliny, the virtue of the Mistletoe was to resist all poisons, and make fruitful any that used it. This latter idea seems to connect it with its present appropriation as a hall or kitchen guest, and unfits it for sacred uses, though why it should be thought conducive to fertility does not clearly appear, unless its numerous white berries were considered indicative. Peter Roberts, however, in his "Popular Cambrian Antiquities," has remarked, that "the blossoms fall off within a few days of the summer solstice, and the berries within a few days of the winter solstice. This, then, rather than any medical virtues of the herb itself, which are at least dubious, was probably the true cause of its estimation." The same Welsh author says the British Druids called the plant *Grodd*, meaning *the Herb*, by way of pre-eminence, but that it was commonly called *Uchel-Wydd*, or the high-growing herb, by the Celtic population.

It was only the *Mistletoe of the Oak* that was esteemed medicinally, and an observant friend of mine has assured me that he knew an old oak that was

entirely stripped of its mistletoe by country people, who considered it a remedy against fits. This may account in some degree for the rarity of the Mistletoe upon the Oak, or its loss from any tree where it was once known to grow. Ray, indeed, mentions our plant as a specific in epilepsy, as well as useful in apoplexy and giddiness, and some years ago Sir John Colbatch published a "Dissertation concerning the Mistletoe, a most wonderful specifick Remedy for the Cure of convulsive Distempers." This seems to have been the last serious effort made in behalf of the medical virtues of this mystic plant, but it failed to keep it within the pale of the "Materia Medica"; for, as Sir James Smith rather sarcastically intimates in his "English Flora,"—"a plant of *viscum* gathered from an oak is preferred by those who *rely on virtues*, which, perhaps, never existed in any mistletoe whatever."

The Mistletoe abounds far too much in the apple orchards of Worcestershire and Herefordshire, but passes over pear-trees, and long observation has only given me two or three instances where pear-trees had mistletoe upon them. The apple was known to the Druids, and it has been suggested that the wily priests furtively transplanted their mystic plant from apple-trees, where it was sure to grow, to oaks, where otherwise it would be unlikely to be found. This is rendered not improbable by what Davies says in his "Celtic Researches," that the apple-tree was considered by the Druids *the next sacred tree to the oak*, and that orchards of it were planted by them in the vicinity of their groves of oak. This was certainly an astute plan for keeping up the growth of the Mistletoe.

With regard to the propagation of the plant by birds, I have no faith in the nasty Latin adage as to its spreading from their deposited ordure. Black-birds, thrushes, and fieldfares are fond of the mistletoe-berries, and when their bills get sticky from eating them, they wipe their mandibles on the branches of trees where they rest, and from the seeds there left enveloped in slime young plants take their rise. I have thus observed mistletoe bushes extending in long lines across country where tall hawthorns rise from hedges bounding the pastures; for, next to apple-trees, mistletoe is most plentiful upon the Hawthorn. But rather curiously, in modern times, the parasite has shown a predilection for the black Italian poplar, which has been much planted of late years; and wherever in the midland counties this poplar has been planted, the Mistletoe is sure to appear upon the trees in a short time. The Lime is also very often obliged to support the plant, which disfigures its symmetry, raising huge knots upon its branches; and I have observed limes that must have nourished protuberant bushes for thirty years or more. The Maple, the Ash, and the Willow have frequently mistletoe bushes upon them; but, common as the Elm is, that tree almost entirely escapes an intrusion; and, in-

deed, I never but once saw mistletoe upon an Elm. On the Oak it is very uncommon in the present day, and where apparent it is on trees of no very great age, whatever their descent may be.

My friend Professor Buckman, who has written economically upon orchards in his useful book on "Farm Cultivation," asserts that while the Mistletoe is hurtful to the tree in hastening its decay, yet in apple-trees it has the effect of pressing on their maturity and fruit-bearing earlier than would be the case without the parasite, which urges a quicker growth upon its foster-parent. The tenant of an orchard would thus be benefited for a few years, though premature decay would be the result.

Authors may differ as to the etymology of Mistletoe, but it appears to me that our common English name has no very recondate origin. *Mistion* is an obsolete old English word, used, however, as late as in the writings of *Boyle*; and this is defined in Dr. Johnson's original folio edition of his Dictionary as "*the state of being mingled.*" Now this is truly the condition of our plant, which is intermingled with the foliage of other trees, and mixes up their juices with its own; and is indeed in rural places still simply called the *Mistle*. If to this we add the old English *tod* or *toe*, signifying *bush*, we have at once the derivation, meaning the *mingled bush*, mixed up and growing among foliage dissimilar to its own. Still, in winter its stiff and leathery evergreen leaves and dense bushy aspect give it a visible position on its own account; and thus the epithet of "*frigore viscum*" given it by *Virgil*, is peculiarly applicable. It is certainly remarkable that the hanging up of mistletoe in houses for mirthful purposes and emblematical of Christmas should so long endure that the Midland towns have their markets filled with it as Christmas approaches, and loads of it find a ready sale in the North of England, where the plant is a rarity, if found at all.

SPORT IN THE NEW FOREST.

THE interesting paper which appeared in the last volume, on the "Lepidoptera of the New Forest," has induced me to think that a short account of a visit there last summer might not prove unacceptable to some of the readers of SCIENCE-GOSSIP.

Although the list of entomological captures be but meagre, yet this does not at all represent the amount of enjoyment to be derived from a holiday in this locality, even by the most enthusiastic collector of insects; and although his collection may be in no way enriched, yet delight in the beauty of the woods should keep him from disappointment. The character of the scenery of the New Forest is almost unique among English woodlands, and its vast extent and the size of its timber render it quite so. In

the solitude of its deep oak woods, unaltered in many places since the time of its planter, the various orders of creation dwell and increase undisturbed by the hand of man as in perhaps no other place in England. And this the entomologist finds to be specially the case with his chosen objects of study, as the numbers of nets by day and lights by night which are to be seen in its precincts abundantly testify.

To us dwellers in a northern county the New Forest is always a "land of promise." The southern entomologist may only care for its great rarities and peculiarly local species; but to those who inhabit a locality where *Rhamni* is rarest of the rare; where the whole groups of "Fritillaries," "Hairstreaks," and "Skippers" are utterly unknown; where even *Ægeria* and *Hyperanthus* are not to be missed,—where, in short, about seventeen species of the sixty-five to seventy species of British Diurni only are obtainable, the very commonest species of the Forest are worth having, while its great rarities are prizes more to be vaguely hoped for than definitely expected.

Thus we set out to visit the New Forest, bent quite as much on enriching our minds and eyes with the fairest sylvan scenery of England, as our cabinets with choice entomological captures.

It was a drizzling rain when we alighted from the train at Lyndhurst Road Station, and the long, straight road to the town looked anything but inviting. However, with knapsack on back and folding-net in pocket, we sallied forth. The dreary heaths and stunted fir plantations near the station do not certainly impress one with the idea of the glorious richness and fertility of the South of England; but as one gets further on the trees get thicker and more stately. After about a mile the rain ceased, and the sun shone forth with transient gleam. Hardly had it done so when a splendid *Paphia* rose from the fern, and sailed off on easy wing; then the nets came out; the hurried run forward, dexterous turn of the arm, and quick drop, were the work of an instant, and none but an entomologist could appreciate the delight with which the captive struggling within the gauze was regarded. Hardly had he been effectually boxed when a *Sibylla* was started, and then a *Sylvanus*, and both run down, and then a *T. Quercus*, all new insects to us, although by many to be regarded with contempt. Then the brightness passed away, and with it all the butterflies. So we continued on our way till we arrived at Lyndhurst, with its long yellow street, its curious church perched on a small hill, and its large and comfortable "Crown." Lyndhurst, however, we quickly discovered, was a much nicer place to look at than to stay in; in fact, the population seemed far too large for the houses, and we should advise any one who contemplated a visit to that wood-encircled town to make sure beforehand of a comfortable lodging. Although it may be quite true that to the ordinary Britisher, the greater part of whose life is passed in an artificial and monotonous

way, it is really enjoyable for a season to throw off all conventionalities, and take the varying chances of travel with all the zest of novelty, yet excess destroys the charm in this even more quickly than in most other things. However, our choice of accommodation being limited—in fact, restricted to the only empty apartments in the village, or to return by the way we came—we accepted the former, and determined to live as much as possible out of doors, in which we were fortunately pretty successful.

The next day rose in unclouded splendour; so we soon equipped ourselves with nets and boxes, and took the road to the woods of Denny, which are considered as some of the best in the Forest for insects. On the way, by the side of the oak plantations, a few *Sibylla* were captured, as also *Paphia*, and a few other things; then came a bare and bleak heath, where *Semle* and *Ægeria* were abundant; but both moor and insects seemed as old friends; so we continued, and after crossing a marshy hollow, came up into a splendid piece of rank vegetation under the shadow of the mighty oaks of Denny. Then the real sport began. *Adippe* was numerous, *Paphia* more so; but *Sibylla* was nearly past, and all the specimens we obtained were rubbed, and quite unfit for the cabinet. Great tall thistles and other flowers grew in uncultured profusion in this place, and on their petals sat these great butterflies, "opening and shutting splendid wings." Skippers buzzed backwards and forwards; in fact, the place was alive with insect life of every kind. One was quite bewildered, fairly brought to a standstill by *embarras de riches*; the killing-box would not act quickly enough, and nets had an unaccountable propensity to catch in brambles; but this sport, though exciting, was tiring—up and down hill, net in hand, hat gone, coat-tails flying behind, with tin boxes clinking in the pockets thereof, and at the same time attacked and bitten by the hateful forest fly. After a short time at this we were glad enough to sit down *sub tegmine fagi*, and pin out our captures, and then up and at them again. Proceeding a little further, a grand *Polychloros* was netted, and just after a beautiful female *Argiolus*, and then a male of the same species—*Quercus*, *Rhamni*, and *Sinapis*—added to the slain, while *L. quadra* and *Trapezina* rewarded our beating among the oaks; and the same operation in the heather doomed *Myrtilli* and a few others to the ammonia-box and setting-board. The old entomologist would have smiled at the rapture which greeted the boxing of a good specimen of these to him common things; but profusion or the contrary are only relative qualities, and the position might just be reversed in the case of *Opina* or *Zonaria*. For *Iris* we hoped in vain, although we were told that several had been taken that year. Among our *Paphia* were many of the dark variety of female; but none were of very first-rate quality, as they had been on the wing too long; in fact, we discovered that the early part of July,

instead of the end, would have been the better time to visit the Forest; but as it was we had got quite as many as we could easily set, and returned home hot and tired, but well contented with our day's sport. In the evening we tried sugar; but the clear coldness



Fig. 22. The Grayling (*Satyrus Semcle*). Upper Side of Male.



Fig. 23. Under Side of Male Grayling.



Fig. 24. Upper Side of Female Grayling.



Fig. 25. Under Side of Female Grayling.

of the night, and the undimmed brightness of the moon, prevented our having any more aristocratic visitors than one undaunted *Pronuba*, which seemed to glare at us with mocking eye. So we departed, our hopes of *Promissa* and *Sponsa* seriously shaken.

The next day we devoted more to seeing the Forest than to entomology, and took the road to Boldrewood. Here the Forest is appreciable in all its grandeur; the great thick oak woods crown the eminences, and mighty beeches stand out in solitary majesty into the sea of fern which swells in long undulations deep into the hidden recesses of the Forest. The beeches of Mark Ash are perhaps some of the finest trees in the Forest; their tall,



Fig. 26. Silver-washed Fritillary (*Argynnis Paphia*). Upper Side of Male.



Fig. 27. Large Tortoiseshell Butterfly (*Vanessa polychloros*).



Fig. 28. White Admiral (*Limenitis Silylla*). Upper Side.

smooth stems rise up straight and branchless, like pillars in a cathedral aisle, while the light coming dim and green through the far-off roof of leaves gives that sense of solemn beauty which is so impressive in these silent depths of the woods. Where the sun gleams through in an open glade, the bramble-bushes are absolutely swarming with *Paphia*, *Sibylla*, *Rhamnii*, and *Ægeria*; and in such places we secured a few more *Argiolus* and *Valczina*, and other

things we wanted. After passing through Boldwood Hall Park we emerged on a dreary moor, which description of land seems to divide the Forest equally with the actual trees. From Stoney Cross, the other side this heath, the view is most extensive, stretching far away in every direction over long sweeps of forest and moorland; in fact, this is the finest view of the Forest as a whole in the district. Nor should the visitor to this spot forget to turn aside to the stone of Rufus, placed on the spot where tradition says the Nemesis overtook the Red King for the sins of his



Fig. 29. White Admiral. Under Side.



Fig. 30. The Ringlet (*Epinephele hyperanthus*). Upper Side.

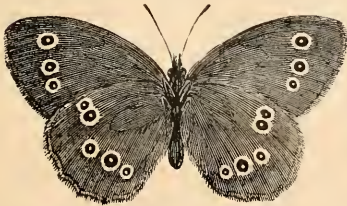

Fig. 31. The Ringlet (*Epinephele hyperanthus*). Lower Side.

father, and now enclosed in an iron case bearing appropriate inscriptions on each side.

The way back to Lyndhurst led through Minstead; but it being late in the afternoon, no more sport could be expected. Sugar that night was little better than before; three *Pyramida* and a few other common *Noctua* completed the list, and the last hope of the red underwings vanished away. Alas! the golden days of sugaring for the *Catocalide*, as Mr. Anderson describes, seem to have departed for ever. Indeed, sugar seemed quite to fail us for the whole time we were out. The next day being very wet, finished our campaign, and we left the Forest with as much regret as our lodgings with delight, and

betook ourselves to a fresh locality, only envious of those who lived near enough to the New Forest to be able to make its glades a frequent resort. For those who would really study the entomology of this forest a short stay is nearly useless, as different species come out at different periods all the year round, and of course any systematic beating or sweeping for larvæ is impossible in a hurried holiday. Yet he must be sadly lacking in perception of the manifold riches of Nature, whether artist, entomologist, ornithologist, botanist, or antiquary, who cannot find some new objects of study or acquisition even in the shortest stay in this vastest and grandest of the forests of England. W. E. S.

AN EARLY SUMMER RAMBLE ON THE EAST COAST OF KENT IN 1876.

BY DR. E. DE CRESPIGNY.

THE aspect of the deserted quays and promenades of a gay place of resort in early summer reminds one of the dreary desolation of a banqueting-hall on the morning following a revel. The "high jinks" for which the watering-places of Thanet are so renowned "in the season" are not as yet. Boatmen idle about the doors of the hotels which face the little harbour; shopkeepers eye you as you pass with sullen listless looks, and there is hardly a lodging-house but is garnished with a notice in the windows that the apartments are to let. Not a soul upon the sands but the shrimper trudging homewards "his weary way." There is, however, no lack of life out at sea in the offing; steamers, with or without a sailing craft in tow, pass up and down the Channel between "the Goodwins" and the shore in scores, to and from all parts of the world south of the Downs; but the naturalist, of whatever department of his subject a student, is nowhere and at no time at a loss for amusement, and a botanist visiting this part of the Kentish coast, even in June, may count upon adding many an uncommon plant to his herbarium.

The coast of Thanet fronting the Straits is remarkable for its perpendicular chalk cliffs, which do not, except at one or two points, exceed two hundred feet in altitude. They extend from near Margate to a little below Ramsgate. On these cliffs grow, *Beta maritima*, *Cheiranthus Cheiri*, *Centhranthus ruber*, *Diploxaxis tenuifolia*, *Parietaria diffusa*, *Statice spathulata* (not in flower). The country above is open and level, consisting of chalky corn-fields, almost treeless. The few small copses *en évidence* are carefully walled or fenced in: hedges there are none. Of constant occurrence, both in the cultivated fields and by the roadsides, is *Lepidium Draba*, so abundant as to form a characteristic production: it is known to the country people as "Thomson's weed," and looked upon by the farmers as a great pest, spreading everywhere with much rapidity. *Scandix pecten-Veneris* and

Veronica Buxbaumii were common, and along the margins of the cliffs, *Poterium Sanguisorba*, both *Reseda*, *Sclerochloa rigida*, and *Smyrniolum Olusatrum*.

At Pegwell Bay, two miles below Ramsgate, the chalk cliffs disappear, and a low-lying, somewhat marshy-looking country succeeds, which extends inland and is watered by the Stour. In the distance towards Deal the country is again hilly. Along the bay runs a road *vis à* Sandwich to this port. Left of it is a narrow stretch of sand and gravel and grassy flats, overflowed by the sea at times; right of the road are marshy well-drained pastures, upon which feed countless herds of cattle and sheep innumerable. The undermentioned plants grow here, in addition to others of ordinary occurrence. Cliffs about Pegwell:—*Ficneium vulgare*, *Smyrniolum Olusatrum*. By the shore:—*Artemisia maritima*, *Armeria maritima* (flowers in bud), *Aira flexuosa*, *Beta maritima*, *Carex arenaria*, *C. divisa*, *Cochlearia officinalis*, *Eryngium maritimum* (not in flower), *Medicago minima*, *Phleum arenarium*, *Psamma arenaria* (not in flower), *Plantago maritima*, *Trifolium scabrum*, *Triglochin maritimum*. Ditches in the marshes:—*Apium graveolens*, *Hydrocharis morsus-rane* (not in flower), *Menyanthes trifoliata*, *Phragmites communis* (not in flower).

At Sandwich, near the Custom-house, grows *Polygonum mouspellensis*, but it was too early in the season to look for this with any prospect of success.

Ramsgate is much exposed to the north-east winds, from which there is little protection; Dover, on the contrary, although on the same line of coast, lies snugly sheltered from rude Boreas by chalk cliffs rising to treble the height of those about Ramsgate.*

The town lies at the foot of these cliffs and in a gorge extending westwards. A pebbly beach and perpendicular cliffs washed by the sea at high water, with here and there a small sandy bay, characterize the coast: inland are chalky downs, hill and dale, well cultivated for the most part, and varied in many places by patches of wood. On the cliffs and downs:—*Anthyllis vulneraria*, *Arabis hirsuta* (by Biggles's Tower), *Arvens pubescens*, *Brassica oleracea*, *Beta maritima*, *Cheiranthus Cheiri*, *Cistus Helianthemum*, *Carex glauca*, *Chlora perfoliata*, *Crithmum maritimum* (not in flower), *Crambe maritima* (below Abbot's Cliff), *Carlina vulgaris*, *Diplotaxis tenuifolia*, *Euphorbia Cyparissius* (slope near Biggles's Tower), *Glaucium corniculatum* (shore below Abbot's Cliff), *Hippocrepis comosa*, *Hippophae rhamnoides* (below Abbot's Cliff), *Iris fetidissima* (below Abbot's Cliff), *Kalera cristata*, *Ophrys aranifera* (Abbot's Cliff and elsewhere,—frequent), *Orobancha major* (below Abbot's Cliff), *Orchis*

ustulata (slope north of the Castle), *Rubia peregrina* (below Abbot's Cliff,—not in flower), *Silene nutans* (abundant; and other common plants of the chalk formation), *Echium*, *Linum catharticum*, &c. By the steam above river, *Mentha sylvestris*.

Towards Folkestone, at the base of the cliffs, is some wild broken ground: here *Cynoglossum officinale*, *Lithospermum officinale*, *Hippophae rhamnoides*, *Mentha rotundifolia* (by a pond), &c. Fields and waysides about:—*Bunium flexuosum* (near Hougham), *Scandix pecten-Veneris*, *Lepidium Draba* (scarce), *Lithospermum arvense*, *Papaver Argemone* (pasture St. Radigund's Abbey), *Carex præcox*. Copses in that direction:—*Asperula odorata*, *Habenaria bifolia*, *Iris fetidissima*, *Listera ovata*, *Lanium galobadolon*, *Milium effusum*, *Neottia nidus-avis*, *Orchis militaris*, var. *fusca* (plentiful), *Orchis mascula*, *maculata*, *Sedum Telephum* (not in flower). Hedges in the lanes, &c.:—*Nephrودیun Filix-mas*, *Scelopendrium vulgare*, *Aspidium aculeatum*. St. Margaret's Bay:—*Brassica oleracea*, *Arabis hirsuta*, *Crithmum maritimum* (not in flower), *Glaucium corniculatum*, *Ophrys aranifera* (cliffs about), *Silene nutans*.

Within a mile or so of Folkestone the high chalk hills by the sea-coast bend to the right, and are continued westwards. The low cliffs about the town here are composed of blue clay: their elevation does not exceed two hundred feet. On and above these, *Armeria maritima* (in profusion), *Carex arenaria* (occasionally), *Psamma arenaria* (foot of the cliffs), *Sinapis nigra*.

About Faversham the country is somewhat flat, and a salt-water creek comes up to the town, where, in addition to plants common to similar localities, we observed *Allium oleraceum*, *Armeria maritima*, *Obione portulacoides*, *Peucedanum officinale* (plentiful, flowers budding), *Trifolium maritimum*. Ditches in the flats by the creek:—*Hippuris vulgaris*, *Sclerochloa procumbens*, &c.*

A GOSSIP ABOUT NEW BOOKS.

IT is only within the last twenty years that it has been found possible to construct a philosophy of natural history. The views of Mr. Darwin and his school have undoubtedly laid the foundations, and its practical use is seen in the suggestive way in which new lines of research are being opened out. The natural sciences are in such a state that almost every month fresh light is thrown on old relationships by

* *Spartina stricta* grows about the mouth of the creek, but some distance from the town. The archaeologist will find, both at Dover and in the neighbourhood, several interesting architectural remains in a good state of preservation; no part of the country is more prolific in this respect. The church tower of St. Mary the Virgin, Saxon; the church of St. Margaret, one of the finest specimens of the early Norman style extant; those at Barfreston and Patricbourne, well worth a visit, both of them, for their singular and beautiful porches; with many others; to say nothing of Canterbury Cathedral, a medley of ancient styles in itself. On an old wall near St. Martin's Church, grows *Festuca pseudo-myrtus*.

* Life enough here, in season or out of season; what with the coming and going of steamers, the marching and counter-marching of troops, the military bands, the bustle and salutes attendant on the arrival and departure of august personages, there is always something or other going on; but "high jinks" there are none; the place is, as a worthy tradesman of our acquaintance informed us, "so awful respectable."

some thoughtful paper; or new methods of viewing structures hitherto not understood, or misunderstood, are developed. Biology is fast becoming a demonstrable science, to which all others are auxiliary.

The new book by Mr. Charles Darwin ("Cross and Self-Fertilization of Plants." London: John Murray) will be hailed with welcome by all true naturalists, whether they assent to his developmental views or not. The relationships between the colour, shapes, and perfumes of flowers, and the visits of insects, have delighted modern botanists with the clear light they have thrown on structures that before were regarded as more or less arbitrary. Sir John Lubbock's little book has put all amateur botanists in possession of the outlines of the facts, and now Mr. Darwin's new book stamps the theory with all the emphasis of varied proof. The present work has a value not even second to that encyclopædia of Darwinism, "The Variation of Animals and Plants under Domestication." It literally bristles with personal experiments, and the reader finds himself arriving at certain inevitable conclusions long before the author himself draws them. Moreover, the conclusions have a practical bearing, alike to the horticulturist and the breeder of stock, which such individuals would do well to accept. We have regarded the brilliant speculations as to the direct connection between colour, perfume, and often *shape* in flowers, and the cross-fertilization induced by insect visitations, as one of the most notable scientific promulgations of the last five or six years. But here we find that Mr. Darwin has been quietly experimenting upon the theory for *eleven years*, with a view to proving it! And the present book gives a detailed account of every experiment, both in self- and cross-fertilization of well-known British and exotic plants. We hardly know which most to wonder at—the patient and never-tiring industry, the minute accuracy and conscientious truthfulness of the experiments, or the important and brilliant conclusions which are to be drawn from them! No fewer than 1,101 crossed plants and 1,076 self-fertilized plants have been experimented upon by Mr. Darwin. These belong to fifty-seven species, selected from fifty-two genera and thirty great natural families. The conclusion drawn is that an extraordinary advantage in height, weight, and fertility is derived by plants from crossing, and that in every instance this gives them an advantage over self-fertilized flowers. It is very certain that these experiments have considerably enlarged our certain knowledge of the *raison d'être* of the chief attractions of flowers; and at the same time, by showing how almost every winged insect is actively engaged in the all-important work of floral crossing, we are led to see more clearly than ever the intimate union between, and the absolute necessity for the existence of, widely-separated groups of organic objects.

"The Geology of England and Wales," by H. B.

Woodward, F.G.S. (London: Longmans & Co.), has obtained deserved and noticeable commendation from the leading scientific journals. A more carefully compiled work does not exist in our language. The student feels instinctively that Mr. Woodward is a *field* geologist, and is narrating the conclusions to which he and his confrères have arrived. Our geological literature owes a large debt of gratitude to the officers of the Geological Survey of Great Britain. They are to the front in every department of the "stony science," and their work is nearly always marked by a conscientious care that other writers would do well to imitate. Mr. Woodward is well known as an active member of this useful corps, and one who has done good work by his contributions to special geological literature. The present book is more geological and stratigraphical than palæontological; and indeed, to a large extent, it takes the place in modern times that the work, bearing the same title, by Messrs. Conybeare and Phillips, did to the geologists of fifty years ago. The maps and sections are most excellent; indeed, the woodcuts of the latter call for special commendation on account of their marvellous truthfulness. We are enabled, by the kindness of the publishers, to lay several of them before our readers, who will at once see how well woodcuts can represent actual geological features. The author commences with the Laurentian formation, and gradually works on to the latest of the Tertiary series, describing the chief sections, the characteristic fossils of the beds, the physical features produced by the various rocks, and the writings and opinions of local and other geologists who have made them their special study. In this way every British formation is exhaustively described, whilst the magnitude of the work forbids both tautology and obscurity of expression. So clearly is even every subdivision of each geological formation described, that the work is a chart, as well as a manual. The concluding chapters on "Denudation and Scenery" are well and clearly written, and there is a copious glossary of geological and other terms. There is a reproduced article on "Darwinism," which perhaps Mr. Woodward would have done well to have left out, as, although it is ably written, it seems to us out of place with the general character of the work. With this hardly-to-be-mentioned exception, we have nothing but words of the highest commendation to say of a book which we feel certain will take an important place in all geological libraries.

Unquestionably there are few men who either have better opportunities or can contribute more accurate information concerning the habits of wild creatures than sportsmen. Unfortunately for science, such gentlemen usually treat us, when they do write books, to nothing beyond enthusiastic descriptions of hairbreadth escapes and adventures, or of successful "dodges" in overcoming their prey. In "The Large and Small Game of Bengal and the North-

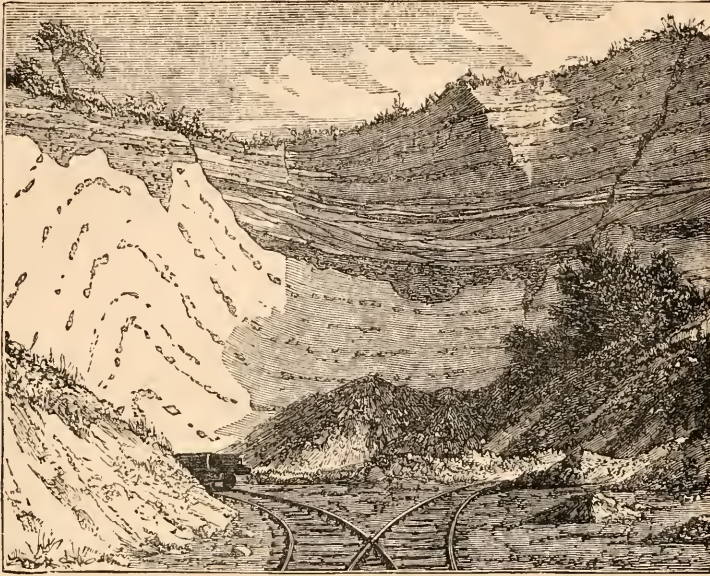

Fig. 32. Section of Chalk-pit at Whittingham, near Norwich, showing Chalk overlaid with Crag and Lower Drift. (From Woodward's "Geology of England and Wales.")

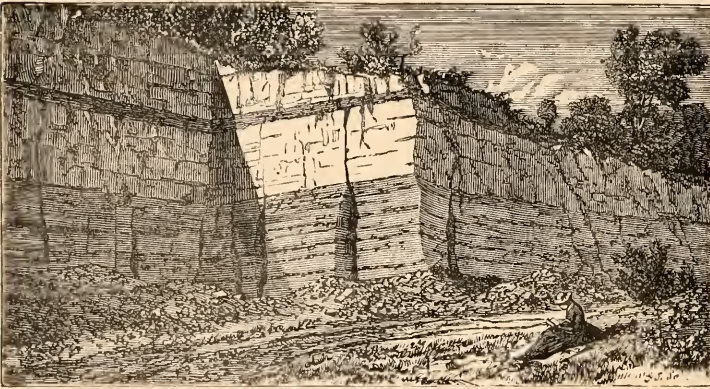

Fig. 33. Section at Snowdown, Chard, showing Upper Greensand, Lower Chalk, and Chloritic Marl.

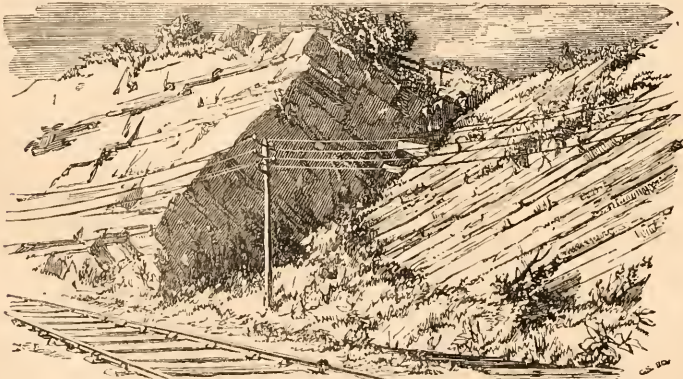

Fig. 34. Cutting near Uphill (Bristol and Exeter Railway), showing the Lias faulted against Carboniferous Limestone.

Western Provinces of India" (London: H. S. King & Co.), Captain Baldwin, F.Z.S., shows how it is possible to combine the ardour of the sportsman with that of a naturalist. This book is written in that fresh and lively style which usually marks works of the class. The author was long quartered in one of the best game districts of the Bengal Presidency, such as the Central Provinces, Oude, Assam, and Central India, where both large and small game are abundant; and, as he kept accurate notes of his experience and observations, and now gives them in the work before us, our readers will understand that it is really a most valuable contribution to the literature of natural history. The author also tells us that on five different occasions he made extensive sporting expeditions into the interior of the Himalayas, and twice visited parts of the most unfrequented and least-known quarters of that little-known range of mountains. On one occasion he made his way along the snow passes into Thibet. The reader gets the benefit of this varied geographical, sporting, and zoological experience in a narrative which most happily combines all three. We have no doubt whatever that the author's hope that some young hunter about to start for the East will find some useful hints from his experiences, will be abundantly realized. The chapters on "Tigers" and "Tiger-hunting" are, as we

might expect, the longest and fullest of any; but Captain Baldwin was a noted Nimrod, and here narrates to us all that it is possible to say on this subject. Among other animals whose habits he observed minutely in his sporting adventures, are the panther, the leopard, the snow leopard, the red lynx, the cheetah, Indian black bear, Himalayan black bear, hyæna, Indian wolf, wild dog, wild buffalo, Indian elephant, rhinoceros, wild boar, and the numerous kinds of Indian deer and antelopes. The game birds of the regions visited by the author are more numerous than in any other part of the world,—the pheasants and partridges notably so. Captain Baldwin devotes many chapters to the most interesting of these birds, including the pea-fowl, jungle-fowl, spur-fowl, the various species of pheasants and partridges, the quails, sand-grouse, bustards, plovers, cranes, woodcock, wild geese and ducks; &c. Each species is prefaced with a technical zoological description; there is quite as much science as sport in the subject-matter of every chapter, and the text sparkles with many a well-told anecdote and tale of adventure. The sketches are by the author, and are for the most part both artistic and vigorous, as will be seen by the example here adduced. It is impossible for the



Fig. 35. Head of Striped Hyena.

naturalist not to derive both pleasure and profit from Captain Baldwin's ably-written work.

Already two books based on the "Challenger" Expedition have been given to the public, and yet the authoritative description of the results from the pen of the chief of the scientific staff has not appeared. We have received "Log Letters from the Challenger," by Lord G. Campbell (London: Macmillan & Co.). It does not profess to be a scientific description of the work of the voyage, but is merely an historical account of the famous cruise.

As such the book is welcome, for there can be little doubt that Sir Wyville Thomson will find quite sufficient on his hands in the shape of scientific discovery to leave this to other writers. That the present volume is intended as a sort of pendant to Prof. Thomson's eagerly-expected book, is evident from its being published by the same firm. The only chapter of a scientific nature in Lord George Campbell's book is the last, in which we have some notes chiefly on the various kinds of oceanic ooze. This is illustrated by a coloured map, showing the distribution of the areas, from Mr. Murray's paper read before the Royal Society. But the author comes of too scientific a stock not to take a deep interest in the actual work of the voyage, and so we find frequent references to it in the vigorously and even picturesquely written, but professedly unscientific account of the cruise.

SCIENCE IN THE PROVINCES.

NO fact better illustrates the spread of natural science than the increase in the number of societies founded for the purpose of mutually studying the various branches of natural history. A great deal of real good work is thus effected; and although the larger number of every society consists of members who are not active field naturalists, yet those who are thus receive a sympathy and encouragement they would not have obtained a quarter of a century ago. The natural history features of each neighbourhood thus get a better chance of being worked for the benefit of science generally, whilst the "ornamental members" at least come into contact with genial natures, flowery meadows, craggy rocks, purling streams, and sunny blue skies, during the ordinary summer rambles. The facilities for publication of memoirs enable each society to issue its "Transactions," and in most of these we find excellent papers, some of which would ornament the annual volumes of the Metropolitan learned societies. The North Staffordshire Naturalists' Field Club have recently issued a handsome volume to their members, containing addresses and papers, delivered or read during the last three or four years. This plan is better than that of publishing a thin, paper-covered annual *brochure*, whose insignificance causes it soon to be lost. Among the papers in the above volume we have one by a well-known anthropologist, Dr. J. B. Davies, F.R.S. (illustrated), "On the Interments of Primitive Man." Mr. John Ward contributes a short paper "On the Fossil Trees in a Hanley Marl-pit," and a more important and lengthy communication (illustrated), "On the Organic Remains of the Coal-measures of North Staffordshire." No man is better able to speak on this subject than Mr. Ward, whose knowledge of carboniferous fishes is well known among palæontologists. Mr. Molyneux has

an essay on "The Trentham Gravel-beds," which are of Triassic age; and Mr. J. D. Sainter one on "The Geology of Mow Cop, Congleton Edge, and the surrounding District." The veteran naturalist, Mr. R. Garner, F.L.S., has some humorous and suggestive "Lines on a Fossil Tree," as well as other papers. In Zoology the Rev. Thomas W. Daltry, F.L.S., besides contributing the "Introduction" to the volume, has a valuable paper "On the Macro-Lepidoptera taken and observed in North Wales by Members of the Club"; and in Botany, Mr. W. S. Brough has written a thoughtful essay on "The Literature of Botany." Besides the above, we have papers on local Archaeology and general questions related to science. The Bedfordshire Natural History Society and Field Club have issued their first volume of "Transactions." This society originated through a discussion as to whether *Acorus calamus* was indigenous to Britain. It was shown by several local naturalists to be abundant on the banks of the Ouse near Bedford, and this incident led those concerned in the inquiry to form themselves into a club. Several well-known names hail from the Bedfordshire district, and we are glad to see them in this volume. Thus, Mr. James Wyatt, F.G.S., has two papers, one on the "Geology of Sandy," and another on "Land and Freshwater Shells found in Bedford Gravels." Mr. W. Hillhouse, F.L.S., has "A Contribution towards a New Flora of Bedfordshire," and an essay on "The Botanical Divisions" of the same county. Mr. T. Gwyn Elger, F.R.A.S., contributes a very capital paper "On the Scope and Objects of Natural History Societies." Besides the above, we have a paper, by Mr. W. B. Graham, "On the Geology of Sharnbrook," and others by Dr. Prior, Captain De Vismes, Dr. Adams, Mr. Blower, &c. We heartily congratulate the Bedfordshire society on the interesting character of their first volume. The Cardiff Naturalists' Field Club is one of the most successful in point of numbers of any in the kingdom. The indefatigable honorary secretaries have managed to interest most of the educated people of the neighbourhood in the club, and we are therefore not surprised to find so many summer excursions are arranged for. In the winter months the society introduces to the members some of the leading scientific men of the day as lecturers in the several departments of science in which they are known workers. A good deal of general useful work is thus effected. In the "Proceedings" of the club recently issued, we find a capitally-written account of the excursions. The abstracts of numerous papers are well done, the most important being those by Mr. Waldron, "On Roman Mining in the Mendip Hills" (illustrated); by Mr. R. Drane, "On Four British Birds,"—a capital sketch of the Green Woodpecker, Cuckoo, Kingfisher, and Quail. Mr. Cruttwell contributes an essay on "The Age of Reptiles," and Dr. Taylor a most readable

one on "Animals living before Man." Mr. J. W. Lukis, the well-known antiquary, was then President of the club, and his lecture on "Some of the Primitive Customs of Man" is exceedingly instructive, and refers as much as possible to local illustrations. "Man and his Habitations" is the title of a paper by Mr. James Milward. The various Meteorological "Reports," by Mr. Franklen G. Evans, are scientifically valuable. The "Proceedings of the Liverpool Field Naturalists' Club for 1875-6" opens with a most valuable address by the President, the Rev. H. H. Higgins, "On the Names of Plants," and gives us brief but graphic *résumés* of field excursions, &c. "The Proceedings of the Belfast Naturalists' Field Club" for the same year is also before us, and, as usual, contains some excellent papers on "Vegetable Parasites on the Human Body," by Dr. J. M. Scott; "The Beginnings of Life," by W. J. Browne, M.A.; "Practical Hints to Collectors of Lepidoptera," by Rev. J. Bristow, M.A.; and a capital account of dredging operations in Belfast Bay and the adjacent waters. At Norwich we find a useful and social "Science-Gossip Club," which meets fortnightly in the winter for the reading and discussion of papers. A Report of Proceedings from June, 1875, to June, 1876, has just been published by the Committee, and in it we find some good abstracts of papers by Messrs. Squirrell, John Parker, S. C. Sothorn, M. Knights, T. E. Gunn, J. B. Bridgeman, John Gunn, F.G.S., T. G. Bayfield, F. Kitton, and others. The ground taken up is perhaps broader than it is deep, but there can only be one opinion as to the value of associations like these.

A CHAPTER ON THE DUCKWEEDS

(*Lemnaceæ*).

BY J. T. RICHES.

DURING the later summer months, there may be seen upon the surface of almost every stagnant pool of water, minute, more or less spherical plants, floating on the surface, and by close examination we find them to consist of a small leaf (frond) budding out from the margin, and one or more slender roots proceeding from the under part of the frond; and it is extraordinary good fortune if we chance to find them producing flowers, as one may ask old or young botanists whether they ever saw them in flower, and by far the greater number never have. We need not say what these tiny floating organisms are, as everybody knows a "duckweed" when he sees it; but everybody does not, in a scientific sense, know what a duckweed really is,—its structure and peculiarities. And there are many young students of nature who can distinguish accurately the different species of duckweeds, yet could not, if we

asked them, give their structural characteristics. It is to such readers of SCIENCE-GOSSIP that we think a short account of them will be acceptable.

Of course, like all other known organized beings, the Duckweeds are classified and form a distinct family, viz. *Lemnaceæ*, the genus *Lemna*, of which there are four species found in Britain, being the type of the natural order. Thus we will briefly enumerate the general characteristics of the natural order *Lemnaceæ*. Plants consisting of solitary or clustered green fronds, cellular, or with rudimentary tracheæ developed, rootless, or with one or more simple slender roots proceeding from the under parts of the frond, usually tipped by a membranous sheath; propagated by budding from marginal clefts in the frond, and by autumnal hibernating bulbils; very rarely by seed. Flowers most minute, 1-3, contained in a spathe or without a spathe; floral row absent. Stamens 1 or 2; anther 2-celled, dehiscent crosswise; pollen round, muricate or not; ovary 1-celled; ovules varying from 1 to 7, orthotropous, anatropous, or semi-anatropous. Fruit bottle-shaped, not splitting, or splitting transversely. Seeds 1 or more, with fleshy albumen, or without albumen.

The Duckweeds are the smallest known flowering plants: they are more or less in all climates, but more especially in temperate regions. They are rarer in the tropics, as the great heat dries up the swamps, and the violent rains greatly agitate the water. They are closely allied to the Aroids by the genus *Pistia*, which approaches them in the form of inflorescence, and the seed-structure of the genus *Grantia* closely corresponds with that of *Pistia*, and the ovule of *Lemna trisulca* is very similar to the ovule of *Orontium*. Some scientists give *Arum maculatum* the honour of being the progenitor of the Duckweeds; but let that be as it may, their affinity with the Aroids cannot be doubted. Lindley united them with the *Pistias* and established the natural order *Pistiaceæ*; but undoubtedly, as classified by other botanists, the *Pistias* form a good section of the Aroids, rather than a distinct family.

The principal genera composing the family are, *Lemna*, *Telmatophace*, *Spirodela*, *Wolffia*, and *Grantia*. It would appear that Linneus established the genus *Lemna*, and included under that category the four species known in Britain. But later on Schleiden established two other genera; viz. *Telmatophace*, in which he placed *L. gibba* of Linneus, and *Spirodela*, in which *L. polyrhiza* of Linneus was placed. Since then, however, the two latter genera have been made subordinate to the genus *Lemna*, which is certainly desirable, as the characters upon which they are founded are insufficient for generic rank.

Perhaps it will be well to glance at the characters of *Lemna* proper; also those of *Telmatophace* and *Spirodela* of Schleiden.

1. *Lemna* proper.—Root single; ovule solitary, semi-anatropous; seed horizontal, with a copious

supply of albumen,—including *L. minor*, Linn., and *L. trisulca*, Linn.

2. *Telmatophace* (Schleiden).—Root single; ovules varying from 2 to 7, anatropous; seeds erect, with a scanty supply of albumen, or none,—including *L. gibba*, Linn.

3. *Spirodela* (Schleiden).—Roots numerous; ovules 2, erect, anatropous,—including *L. polyrhiza*, Linn.

It will be easily seen that the above characters may all be included in one genus, making the two latter genera only sub-genera, as Dr. Hooker has already done.

The characters as he gives them are, "Fronds with one or more simple roots. Flowers in marginal clefts of the fronds. Stamens 1-2. Anthers 2-celled; pollen muricate. Ovules 1 to 7." And we think the four British species may be easily disposed of in that way. Those four species we will now briefly describe.

1. *L. minor*, L. (fig. 36).—Frond $\frac{1}{8}$ - $\frac{1}{4}$ inch, obovate or oblong, slightly convex below, green above, paler beneath. Young frond sessile upon the old, soon disconnected. Spathe unequally 2-lipped. Stamens 2. Style moderately long. Distribution almost ubiquitous.

2. *L. trisulca*, L. (fig. 39).—Frond $\frac{1}{4}$ - $\frac{1}{3}$ inch, varying in shape, usually obovate-lanceolate; tip serrate, or very often entire, proliferous on one or both sides; young fronds hastate, placed crosswise to the old. Distrib. Europe, Siberia.

3. *L. (Telmatophace, Schleiden, fig. 37) gibba*, L.—Frond $\frac{1}{4}$ - $\frac{1}{2}$ inch, obovate, or nearly round, opaque, pale green, large air-cells beneath; young fronds sessile. Stamens 2. Fruit bursting crosswise. Distrib. throughout Europe, Siberia, North Africa, America.

4. *L. (Spirodela, Schleiden, fig. 40) polyrhiza*, L.—Frond $\frac{1}{4}$ - $\frac{1}{3}$ inch, broadly obovate, sometimes nearly round, dark green above, purple beneath; tracheæ copious. Spathe 2-lipped. Stamens 2. According to Dr. Hooker, the flower of this species is unknown in Britain. Distrib. throughout Europe, Siberia, North America, &c.

Besides the genus *Lemna* we have another genus represented in Britain,—viz. *Wolffia*; the characters of which are—"Fronds very minute, rootless, proliferous. Flowers bursting through the upper surface of the frond, without a spathe. Anther sessile, 1-celled. Ovary globose; style short; ovule 1, erect, orthotropous. Fruit indehiscent. Seed with scanty fleshy albumen.

There is only one species of *Wolffia* known in Britain, viz. *W. arrhiza*, L., which is the smallest known flowering plant; the frond being only about $\frac{1}{20}$ inch long, and $\frac{1}{10}$ inch broad, loosely cellular beneath. This is found in ponds in Essex, Middlesex, Hants, Surrey, &c. Fig. 38 represents the inflorescence of *Wolffia*; fig. 41 represents a section of another plant belonging to *Lemnaceæ* not known in Britain, distinguished from *Wolffia* by the presence of a root, a

filamentous stamen, and seed with a copious supply of albumen.

Having then taken such a glance at the Duckweeds, we might reasonably ask, "What is their place in the

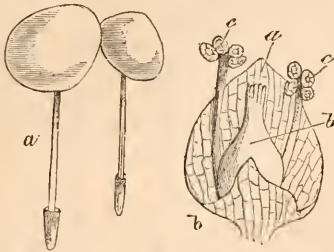

Fig. 36. *Lemna minor*, L.: a, entire plant; b, inflorescence; a', spathe; b', pistil; c c, stamens (mag.).

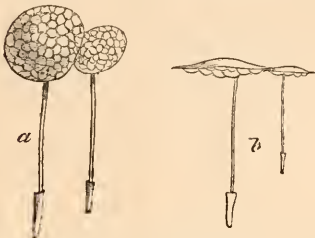

Fig. 37. *L. gibba*, L.: a, plant seen from above; b, side view.

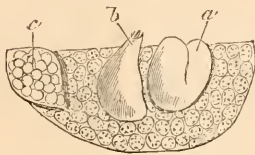

Fig. 38. *Wolffia*: a, anther; b, pistil; c, young shoot.



Fig. 39. *L. trisulca*, L. (mag.).

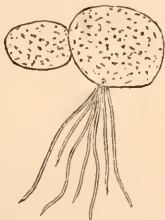

Fig. 40. *L. polyrhiza*, L. (mag.).

economy of Nature?" Several reasons have, and might be, assigned for their existence, but no doubt the most feasible one is, as has already been suggested,

to protect from the solar light those inferior organisms of the animal kingdom which inhabit swamps, and at the same time serve them for food. Whether

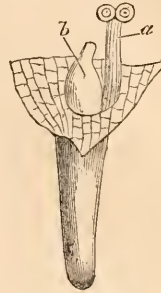

Fig. 41. *Grantia microscopica*: section showing the filamentous stamen, a, and pistil, b.

the latter is true or not, the function of protection seems reasonable: for this end, vegetative reproduction would certainly be the best, being much quicker than reproduction by sexual union.

MICROSCOPY.

VOLVOX GLOBATOR.—In the spring of last year I found many of these beautiful organisms with very little trouble, and am looking forward to the coming season when I may once again see them. My hunting-ground was confined to two small ponds by the side of the road that leads from Higham Station [S. E. R.] to the village of Shorne, near Gad's Hill, and thence along the old Dover highway towards the other part of Shorne and Gravesend. Now these ponds were certainly not "clear pools on open commons," the habitat usually assigned, nor were they, however, polluted by man's refuse of any kind. In the dippings I brought home, besides the Volvocineæ, I found many of the small crustaceans (and these are sad devourers of their vegetal companions); but no Rotifer. In another specimen of water from the canal by the side of the railway, I found numbers of rotifers (chiefly *Brachiornis amphiceros*) together with some Volvoces. The date of this excursion was neither the fortnight in June, spoken of by your correspondents, but quite new to me, nor after, but was made during the first week in May. Thus the active stage may be found at least from May till July, and of course resting-spores can be found (though with greater difficulty) during the rest of the year. At the time stated I met with many active and developing volvoces, but far more abundant were the nearly allied *Pandorina*. These, with their cask-shaped colony, their thirty-two gonidia arranged in five parallel transverse bands, the whole revolving on their long axis whilst they move in its direction, are, I think, even more beautiful than their less symmetrical, though spherical brethren. In a pleasant garden-pond in Sussex, I found, last

autumn, a few resting-spores of the *Volvocineæ*, but to which species they belonged I believe it impossible to decide, save by watching their development. I have never seen the orange-coloured resting-spores—the results of conjugation—which were described by the recently deceased Ehrenberg as distinct forms under the names *V. aureus* and *V. stellatus*. Each has a thick double envelope and bright orange-coloured central mass, the latter being covered with spines. I found I could demonstrate the cilia by oblique illumination almost as well as by iodine staining. I should be very glad to learn from some of your correspondents how best to preserve *Volvocineæ*. “A thing of beauty is a joy for ever,” but the joy in my case is confined to sweet memory. Calcic chloride and glycerine very much alter the gonidia, though the temporary action of these reagents renders evident (or forms *de novo*?) the double lines connecting the gonidia. Though the multiple nature of Volvox has been clearly proved, yet a correlation—a sympathy—of even the proximate cause of which we are entirely ignorant—a sympathy whose analogue we see in all Nature—is observable in the identity of the direction in which the pairs of cilia on the gonidia move, no less than in the carrying out of the principle of the division of labour, by which some of the gonidia take on the sexual function, some producing spermatozoa, others germ-cells, whilst the rest undergo no change, but continue the nutritive process.—*David A. King*.

FORMS OF HELIOPELTA.—In looking over some unprepared diatomaceous earth (Nottingham deposit) I found a complete double frustule of *Heliopelta*, which I singled out and proceeded to clean under a microscope on a glass slide by itself. After a little manipulation with a very small camel-hair brush, wetted, I succeeded in splitting the frustule in the middle, and saw with surprise what I had not remarked previously, that the five sides had a different number of rays and septa. One had four rays (Maltese cross) called in the Micrographic Dictionary *H. Lecurwenhoekii*, and the other with five rays and septa. Have any of your readers come across a similar abnormal (?) form? In the Micro. Dict. I see there is a query about the frustule being single. The form I found was undoubtedly a double frustule. I find that authorities differ as regards the names of the various *Heliopelta*; some say that *H. Metii* has four rays and septa, whereas the Micro. Dict. terms it *H. Lecurwenhoekii*. Which is correct?—*G. M. Gorvan*.

FLUID CAVITIES IN CRYSTALS.—At a recent meeting of the Chemical Society, Prof. W. N. Hartley made a communication entitled “A Further Study of Fluid Cavities,” in which he described the results of his examination of a large number of topaz and of rock sections, mostly granites and porphyries. The fluid contained in the cavities was almost invariably water, but it was very remarkable that the cavities

often took the form of the crystals in which they were contained, and nearly always arranged themselves symmetrically with regard to the faces of the crystal.

DIATOMS, &c.—I have some beautiful gatherings of Diatomaceæ *in situ*, on marine algæ, &c., and shall be happy to correspond with persons interested in their study. I find a very good way for preserving them is, to dry the algæ on the slide, and, when ready for balsam, to drop on some pure benzole first, which will remove the endochrome from the valves, and replace the air they contain. This discoloured benzole can be soaked out by blotting-paper, and the balsam laid on as usual. I find the best medium is balsam diluted with benzole, which can be applied without heat, as air-bubbles give very little annoyance with this medium. Walter White, of Litcham, sells tubes of “damar” which can be used in the same way with very satisfactory results; and in many cases there is nothing gives such satisfaction, and certainly I know nothing so easily worked, and have algæ, now in it for four years, as perfect and beautiful as the first day. There is not the least change, and their natural colour is as bright and lovely as when in their native element. I also find “damar” a capital medium for mounting scale-mosses, &c.—*T. McGann, Burren, Ireland*.

HOW TO FILTER WATER TO OBTAIN MINUTE ORGANISMS.—Dr. A. Meade Edwards writes as follows to the *American Journal of Microscopy*:—“I can tell you of two good ways of accomplishing the above object; both of which have their applications under special circumstances, and both of which I have used for several years with great satisfaction. First, a modification of the conical muslin bag. Have a conical muslin bag, but leave the point open, and place therein a one-ounce wide-mouthed phial, which fasten by means of string tied around its neck, or, better still, with a rubber ring. Now pour your water into it to any extent. The water will run through the meshes of the muslin, and the minute organisms will gradually collect in the phial below. When you have enough, remove the phial, turn the bag inside out and wash it thoroughly in clear water, replace the phial by another, and you are ready for another haul. Such a bag having a stick tied across its mouth, and a large cork fixed to the phial, can be towed after a boat or ship, and the ‘wonders of the deep’ gathered in any quantity. My second device I have commonly made use of in examining potable water; and I have the sediments so collected from several of our large cities. Anon it is my intention to publish something with regard to what I have therein. Take a large glass jar of a half to one gallon capacity—a large beaker or ‘specie jar’ will do, or even a pitcher may be used on a pinch; fill it with the water we wish to ‘concentrate’ at night, and let it stand. Next morning carefully pour off all the water except about a pint. Fill up again, and let it stand until

night; pour off again, and go on so for at least a week. At the end of that time we shall generally find we have a pint of pretty thick sediment without the admixture of any fibres that might come from a muslin strainer."

ZOOLOGY.

MARINE AQUARIA.—I always read with great interest the occasional contributions of your correspondent "G. S." on the management of Marine Aquaria; but there is one point which she strongly insists upon, respecting which I cannot entirely agree with her; I allude to change of water. That a system of frequent and entire renewal of water is bad, I will freely admit, causing as it does sudden changes of temperature and density, which will often prove fatal to delicate animals. But an occasional partial renewal—say, to the extent of one-fourth or fifth of the bulk of water, if carefully and judiciously made—I have found, in an experience of nearly twenty years' successful aquarium-keeping, to be productive of the best results. I have for years been in the habit of drawing off a portion of the contents of my aquaria—say, once in three or four months, and replacing with fresh sea-water previously allowed to stand for twenty-four hours to settle, and I see no reason to be dissatisfied with the practice. On the contrary, I always find that for some days afterwards the anemones open better, and the fish and crustacea are more lively and vigorous. That this should be so seems to be consistent with reason and the laws of nature. The animals we keep in aquaria are mostly of shore-haunting species, and are accustomed in a state of nature to the regular ebb and flow of the tide twice in something over twenty-four hours. This source of health and nutriment they are entirely deprived of in confinement; hence the deterioration which most of them gradually show in even well-managed aquaria. It is indeed often a matter of wonder to me that, considering the immense change of the conditions of life which aquarium animals experience in the transfer from the sea to our tanks, we are able to keep them in as good health as we do. Anything like a periodic tidal flow is, of course, impracticable in any but large public aquaria, and in small private tanks the trouble incurred is generally an obstacle to a frequent exchange even from a reserve stock of water, however beneficial this might be. It therefore seems to me a pity, for the sake of a hard-and-fast rule, to debar our captives from the evident enjoyment and increased vigour imparted by an occasional supply of water fresh from their native sea.—*Edward Horsnail, Dover.*

EMBRYOLOGY OF FISH.—Dr. Gunther, the well-known ichthyologist, has recently discovered that the young of the Sword-fishes and Chætodons differ in structure very much from the adults. In the young of Chætodon the front of the body is shielded with

large bony plates. In those of the Sword-fish the scapular arch is prolonged into a horn at the lower part, and the ventral fins are absent. No "sword" is possessed by them, but the jaws are long, and are both armed with teeth. As the Sword-fish grows, the upper jaw gradually alters, and the "sword" is formed.

"THE POPULAR SCIENCE REVIEW."—The January number of this favourite review commences under new editorship, Mr. W. S. Dallas, F.L.S., having replaced Dr. H. Lawson in the editorial chair. The present number is a capital one, and includes papers by the Rev. W. S. Symonds, entitled, "Among the Volcanoes and Glaciers of Auvergne"; another by Professor F. W. Rudler, F.G.S., which will be largely read, inasmuch as it exposes one of the "dodges" practised at some watering-places, on "Agates and Agate-working"; an article (we presume by the Editor) on "Echinoderms"; a paper by Mr. E. G. Ravenstein on "The Arctic Expedition," &c. The articles are well and abundantly illustrated; and besides them we have the usual monthly summary of progress in the various sciences, physical and natural, as well as cleverly-written and telling reviews of new books.

BATHYBIUS.—It will be remembered that the researches of the naturalists on board the *Challenger* threw great doubt on the reality of *Bathybius* as an organism. Dr. Bessels, of the *Polaris* Expedition, however, states that he discovered in Smith's Sound a form exactly like *Bathybius*, only a simpler structure (?), to which he has given the name of *Protobathybius*.

CRIBELLA ROSEA, Muller.—In a publication of Cork Cuvierian Society, entitled "Contributions towards a Fauna and Flora of the County of Cork, read at the Meeting of the British Association held at Cork in the Year 1843," Youghal is given as a station for *C. rosca*. In 1868 I gathered specimens of this echinoderm at Church Bay, outside Cork Harbour, at the low tide-mark, among the rock-pools, along with *Uraster glacialis*, Linn.; *U. violacea*, Mull., and *Palinipes membranaceus*, Retz. In the following year I saw several specimens lying on the shore after a storm near the Old Head of Kinsale.—*H. J. Ryder.*

THE INSECTS OF THE ARCTIC EXPEDITION.—Mr. McLachlan has remarked, in the *Entomologist's Monthly Magazine*, on Captain Fielden's collection of the insects of the Arctic expedition. The greater number of the insects were collected near Discovery Bay in 81° 42' N. latitude; some of the *Lepidoptera* are even from 82° 45'. The most interesting fact is the occurrence of five or six species of butterflies within a few hundred miles of the North Pole, especially when taken into consideration with the fact that Iceland and the large islands of the Spitzbergen group,

although in lower latitudes, have apparently no butterflies. In *Lepidoptera* Mr. M'Lachlan observed four examples (2 ♂, 2 ♀) of the genus *Colais*, possibly two species (? *Boothii* and *Hecla*). Apparently three species of *Argynnis* or *Melitæa* (or both). A *Chrysophanus* apparently identical with *phleas*. In the *Noctuide*, only one individual—an *Acronycta*. In the *Geometride*, one *Amphidasis* or *Biston*, and several Cheimatobioid forms with apterous females. Of the *Crambites*, one *Phycis*, perhaps our *fusca*. The *Hymenoptera* are represented by a *Bombus*, and one of the *Ichnumonide* of considerable size. In the *Diptera* there is one large fly, probably belonging to the *Tachinida*, and perhaps parasitic on the larvæ of some of the *Lepidoptera*. One specie of *Tipulidæ*; and a considerable number of *Culicidæ*, and of what looks like a *Simulium*, which, however, do not appear to have annoyed the members of the expedition in these high latitudes. Mr. M'Lachlan saw no *Coleoptera*, *Hemiptera*, nor *Neuroptera*; but the bird-lice are naturally well represented.

BOTANY.

FERTILIZATION OF FLOWERS.—The fact of bees visiting the same species referred to by your correspondent "Blanche," was, as Mr. Darwin points out in his recent work ("Cross- and Self-fertilization," &c., p. 415), observed by Aristotle, and Mr. Darwin himself adds that "bees are good botanists, for they know that varieties may differ widely in the colour of their flowers and yet belong to the same species." Mr. Darwin and another great authority, Dr. Hermann Müller, arrived at almost exactly the same conclusion with respect to the reason of this, viz., that the insects, by learning "how to stand in the best position on the flower, and how far and in what direction to insert their proboscis, are thus enabled to work quicker." (Darwin, *op. cit.*, p. 419, Müller, "Bienen Zeitung," July, 1876, p. 182, abstracted in "Nature," December 28th, 1876, p. 178.) I have myself observed, however, several interesting exceptions to the rule, bees flying to several distinct species of similarly-coloured flowers, others only settling on one species, but turning aside occasionally at the sight of a somewhat similar one; and one bee visiting a great variety of flowers of all hues and kinds indiscriminately, whilst other bees of the same species confined their attention to one species of flower.—*G. S. Boulger.*

CELTIC NAMES FOR THE MISTLETOE.—Welsh has several names for the Mistletoe:—*Uchelfar*, high branch (*uchel* and *bar*); *uchelfa*, high-placed (*uchel* and *ma*); *uchellawr*, high-placed (*uchel* and *llawr*, a floor). This last name occurs in the old Welsh laws in a passage quoted by Pughe in his Dictionary, "a branch of mistletoe sixty pence in its value."

Uchelwydd, the high shrub (*uchel* and *gwydd*, a tree or shrub); *awyrbrén*, the air-tree (*awyr*, air, and *brén*, a tree); *gwynglys*, perhaps compounded of *gwyng*, a dress, and *llys*, a hall; *gwyng* only means a stream or bias. *Hoenllys*, the joy of the hall (*hoen*, gladness, and *llys*). *Holliach*, all-healing (*holl*, all, and *iach*, healthy). This last is the name in the Irish branch of Celtic, as the Erse, *uile-iceadh* (from *uile*, all), and the Gaelic *uill'-ioc* (from *uile*, all, and *ioc*, cure). The Breton name is *huelvar*, compounded of *huel*, high, and *bar*, a branch. The French *gui* has no connection with the Welsh *gwydd*; Littré and Brachet both follow Diez in deriving it from *viscus* (compare Ital. *visco*, *vischio*; Spanish, *visco*, Neoprovençal, *visc*). *Gu* may represent *γ* in French; thus *vagina* becomes *gaine*. I do not remember any place in old Welsh poetry which refers to the Mistletoe; it is not alluded to in Taliessin's curious "Battle of the Trees." The lines from Taliessin's "Chair," which your correspondent quotes from Davies, have probably no reference to the Mistletoe. The Rev. D. Silvan Evans translates "the tree of pure gold" as "wood the purifier," i.e., *brén purawr* for *brén puraur*. (See Skene's "Four Ancient Books of Wales," vol. i. p. 535; ii. 153.) I may perhaps mention that, in addition to the allusion in Virgil, there is also a fragment of Sophocles's "Meleagar," where he speaks of "mistletoe-bearing oaks."—*E. B. Cowell, Cambridge.*

FIELD NOTES ON BRITISH BOTANY.—*Hypericum pulchrum*.—This species, which is not uncommon in sunny spots, is easily recognized from all our St. John's Worts by its scarlet pollen, slender cylindrical stems, and sessile cordate leaves. In aestivation (when in bud) it may be at once known by the buds being tipped with deep red. In some sheltered nooks, where it appears a little earlier in flower, the petals are found to be a bright orange-colour. *Hypericum Anglicum*.—Is this species really distinct from *Hypericum Androsænum*? The only difference in most specimens is that the styles are much longer than the stamens. *Hypericum perforatum*.—Have any of our readers observed the petals of this pretty way-side flower deeply notched at the sides? Sometimes they appear as if some child had been playfully cutting out a small piece with a pair of scissors. *Geranium Robertianum*.—The cottagers on Delamere Forest call this "Rubwort" and "Redweed." The commonly-received English name of Robert may have been a corruption of this perhaps older name of "Rubwort." *Papaver Rhæas*.—The petals are a rich crimson, not, as is often described, scarlet. When merely in flower, and before the development of the capsule, it may be known from all its nearly allied sister species by this character alone. *Geranium columbinum*.—This ought certainly to be named the Dove's-foot Cranesbill, if the specific name is followed. It has *blue pollen*. Not having closely

examined all the other species, I may, perhaps, not be quite correct when I state it ought to be at once known or recognized by the blue pollen-grains. *Geranium lucidum*.—When I saw this plant growing in large masses in the Vale of Llangollen I thought it the most handsome of the whole genus. The shining, often pink, leaves and stems are very conspicuous. When once seen, it can never again be mistaken for any other cranesbill. Lime-trees (*Tiliacæ*).—Most botanists agree in finding three species of lime in the British islands—*Tilia parvifolia*, *T. grandifolia*, and *T. Europæa*. Probably there is much confusion respecting them, but from my limited observations I do not believe any of them are indigenous, excepting only *T. parvifolia*. Dr. Bromfield looked upon *T. Europæa* as a native tree. I never met with it anywhere, except where I knew or was informed it was planted, generally as an ornamental tree. Formerly, by being misled with others, I simply regarded or looked upon them as natives; but during the past three years I have closely studied, and with a constantly growing conviction that *T. parvifolia* is truly indigenous, the others are alien and introduced. *Iberis amara*.—I find if the Candytuft is grown in rich soil the flowers become double by the sepals being transformed into petals, though they are not like the ordinary petals, having a green vein down the centre of each sepal. Cruciferous plants are usually a dread to young botanists, but the *Iberis* is at a glance detected by the lower petals being at least twice as long as the upper ones. *Cochlearia grenlandica*.—I always find the petals of this plant with a purplish tint. However, I do not think this ought to be sufficient to make it into a distinct species. In cultivation I cannot tell the difference betwixt *C. danica* and this plant.—*R.*

VOLVOX GLOBATOR.—There seems to be a prevalent idea that this beautiful object is only to be found during the summer months, and that at the approach of winter it dies out in its ordinary form, to be produced from resting-spores in the following spring. In opposition to this, I may state that during last winter I could always obtain an abundant supply from a pond in the open part of the forest near Walthamstow, on several occasions having broken a considerable thickness of ice and taken them from beneath; the ice in one instance being sufficiently thick to support a number of skaters.—*W. H. Gilbert.*

THE BOX.—Syme says of the Box: "Very rare. Kent, Surrey, Bucks, and Gloucester are the only counties of which there is any possibility of its being a genuine native." Growing on dry, chalky hills, may not the chalk downs of Sussex be included? In some places, as at Lavington, it would almost seem to be indigenous, and flourishes luxuriantly. Can any reader tell of other Sussex habitats in which it occurs in abundance? Mrs. Lankester has also the follow-

ing statement: "The largest box-hedge is at Petworth (Sussex). It is supposed to be more than two centuries old, and is more than 12 feet at the bottom, 15 feet high, and 40 yards long." I should be very glad of the authority for this and for a precise description of its locality at Petworth.—*F. H. Arnold.*

DISCOLORATION OF COOKED MEAT.—The carmine spots and surfaces on the meat mentioned by your correspondent "B." were no doubt due to the thallophyte mentioned in Rev. M. J. Berkeley's "Introduction to Cryptogamic Botany" (p. 264), and in the "Micrographic Dictionary" (second edition, *sub voce* "Blood on Bread") as *Monas* or *Palmeella prodigiosa*, *Cryptococcus glutinis*, or a form of *Penicillium glaucum* or *Oidium*.—*G. S. Boulger.*

GEOLOGY.

A NEW FOSSIL CRUSTACEAN.—At a recent meeting of the Geological Society, Mr. R. Etheridge, jun., F.G.S., read a paper entitled, "On the Remains of a large Crustacean, probably indicative of a new species of *Eurypterus*, or allied genus (*Eurypterus? Stevensoni*) from the Lower Carboniferous series (Cement-stone group) of Berwickshire." The fragmentary crustacean remains described were referred by the author to a large species of *Eurypterus*. They are from a rather lower horizon in the Lower Carboniferous than that from which *Eurypterus Scouleri*, Hibbert, was obtained. The animal was probably twice the size of *E. Scouleri*. The remains consist of large scale-like markings and marginal spines which once covered the surface and bordered the head and the hinder edges of the body-segments of a gigantic crustacean, agreeing in general characters with the same parts in *E. Scouleri*, but differing in points of detail. For the species, supposing it to be distinct, the author proposed the name of *E. Stevensoni*. In the discussion which followed the paper, Mr. H. Woodward remarked that the remains of *Eurypteri* from the Carboniferous rocks are so distinct from the Upper Silurian *Eurypteri* of America, Shropshire, Lanarkshire, and Russia, as probably to entitle them to be placed in a distinct genus; and, indeed, at some future day, when more remains are obtained, they may perhaps have to be arranged among the Arachnida, along with many curious fragments which have been called *Arthropleura*, discovered in the Radstock coalfield, in the Saarbrück coal-basin, and in the Manchester coalfield. *Eurypterus Scouleri* occurs at Kirton with *Sphenopteris Hibberti*, in a remarkable siliceous deposit, probably thrown down by an old thermal spring in the Carboniferous period.

A NEW TERTIARY MAMMAL.—Prof. Marsh has described another early Tertiary Mammal from the Rocky Mountain deposits. It was of carnivorous

habits, and about the size of a large wolf. In general characters it resembles the *Hyaenodon*, but had only four incisor teeth, and seven lower molars, on each side. The top of the skull is marked by a very large sagittal crest. Prof. Marsh has called it *Dromocyon vorax*.

PROCEEDINGS OF THE GEOLOGISTS' ASSOCIATION.—We have received No. 9 of the fourth volume of this work, giving papers on the "Geology of Lewisham," by H. J. Johnson Laris, F.G.S.; "On the British Palaeozoic Arcadae," by J. Logan Lobley, F.G.S.; on "The Bagshot Sands of the Isle of Sheppey," by Major F. Duncan, F.G.S.; and one on "The Mill-Hill Cutting, Sheppey," by W. H. Shrubsole. There are, also, four well-written descriptions of excursions made by the members of the association to various places of geological note.

"THE INTRUSIVE CHARACTER OF THE WHIN SILL OF NORTHUMBERLAND."—This was the subject of an important paper recently read before the Geological Society by W. Topley, F.G.S., and G. A. Lebour, F.G.S. The authors stated that the Carboniferous Limestone series of the North of England contains a bed (or beds) of basalt, known as the "Whin Sill," regarding the nature of which opinion has long been divided. Some writers regard it as truly interbedded and contemporaneous; others look upon it as intrusive, and as having been forced laterally between the planes of bedding. The latter opinion is that held by the authors, who stated that through South and Mid-Northumberland there can be no doubt as to the intrusive character of the Whin Sill. This conclusion can be established by the line of outcrop of the trap, and also by the evidence of individual sections. A review of the literature on the subject was given by the authors, showing that the opinions of geologists are very much divided as to the nature of the Whin Sill. But amongst the practical miners of the North of England there are very few who will admit any doubt that the Whin lies evenly, and at one constant horizon, amongst the strata. Clear cases to the contrary are looked upon as merely local variations, possibly due to successive eruptions of submarine lava. The Whin Sill serves them as a definite line, and the limestone next above it is always called the "Tyne Bottom Limestone." The question is thus of considerable economic importance. It is also of interest in reference to the volcanic history of Britain and to classification. Prof. Phillips took the Whin Sill as the base of the Yoredale Series; the Great Limestone he regarded as its top. But the work of the Geological Survey has shown that the Whin Sill lies at different horizons in different places; sometimes it even lies above the Great Limestone itself. In other words, *the Whin Sill, which is supposed to mark the base of the Yoredale Series, sometimes lies above the limestone which forms the top of that series.* With the disappearance of the supposed

base-line of the Yoredales goes also any good reason for drawing a line here at all. The so-called "Tyne Bottom Limestone" cannot be traced definitely through Northumberland, and the beds above and below this horizon have the same general character. The authors traced the Whin Sill through Northumberland, as far north as Dunstanborough Castle, showing the varying positions at which it occurs in the Limestone series, and noting points of interest in some of the sections. The Whin shifts its position amongst the strata to the extent of 1,000 feet or more. It frequently comes up in bosses through the bedded rocks, and bakes the beds above it quite as much as those below, especially when those beds consist of shale. As to the age of the Whin Sill, nothing definite can be said. It is frequently thrown by faults and lodes. There is no certain case of its being unaffected by faults which throw the neighbouring rocks, although there are a few doubtful cases which seem to point in this direction. As the Whin Sill does not approach the Permian area of Durham, the fact that some of the faults there are believed to be pre-Permian cannot be applied as a test of age in this case. In other districts in Britain in which intrusive basaltic sheets occur amongst the Carboniferous rocks, there is good reason to believe that in most cases they are pre-Permian, or at least pre-Triassic. Whether or not this be the case with the Whin Sill cannot be determined. No light is thrown on this question by the composition of the rock. Mr. Allport has shown that it resembles, in all essential characters, the basalts of other Carboniferous districts, some of which are possibly contemporaneous, some certainly intrusive.

NOTES AND QUERIES.

ANTS AND ANT-EATERS.—Having read the following account in a book about ants and ant-eaters, I thought it would interest the readers of SCIENCE-GOSSIP. A traveller in South America says:—"We rode over hills used as pasture-ground, which were literally dotted with the upright and fallen columns that had been erected by the *termites* or white ants. These curious edifices, and their still more curious architects, have always had a great attraction for the naturalist. The hillocks are conical in their shape, but not with a broad base and tapering point as those built by the termites of Africa. Exposure to the sun has rendered them exceedingly hard, and doubtless many that are seen in the uplands of St. Paulo and Minas-Geraes are more than a century old; for houses whose walls have been built from the same earth are still in existence which were built by early settlers in the seventeenth century. Sometimes the termites' dwelling is overturned by the slaves, the hollow scooped out and made wider, and it is then used as a bake-oven to parch Indian corn. In my ride over Soldade I saw a number of very large vultures, who during the rain had taken refuge in the houses that had been vacated by the white ant. These insects do not, however, always dwell in columnar edifices of three and six feet high. I have seen in some portions of Brazil

the ground ploughed up to the extent of 100 feet in circumference by one nest of white ants. Again, they will climb trees, carrying building materials with them, and erecting a small archway (resembling what carpenters call an inch bead) over them for protection against their sworn enemy the black and brown ant, and on the loftiest branches they will construct their nest. My introduction to the cupim, or white ant, was in the house of our former consul, ex-Governor Kent. A box of books sent out by the American Tract Society was placed in a lower room, and the next morning it was announced to me that the cupim had entered my property. I hastened to the room, and, turning over the box, beheld a little black hole at the bottom, and white, gelatinous-looking ants pouring out as though very much disturbed in their occupation. I opened the box, and found that a colony of cupim had eaten through the pine-wood, and then had pierced through 'Baxter's Call,' 'Doddridge's Rise and Progress,' until they had reached the place where Bunyan's Pilgrim lay, when they were rudely deranged in their literary pursuits. On another occasion, I saw a Brussels carpet, under which cupim had insinuated themselves, and had eaten out nearly all the canvas before the proprietor made the sad discovery. The writer, at Campinas, witnessed the depredations of the white ants in the *taipa** houses. They insinuate themselves into the mud walls, and destroy the entire side of a house by perforations. Anon, they commence working in the soil, and extend their operations beneath the foundations of houses, and undermine them. The people dig large pits in various places, with the intent of exterminating tribes of ants which have been discovered on their march of destruction. Mr. Southy states, on the authority of Manoel Felix, that some of these insects at one time devoured the cloth of the altar in the convent of St. Antonio, at Maranham, and also brought up into the church pieces of shrouds from the graves beneath its floor; whereupon the friars prosecuted them according to due form of ecclesiastical law. What the sentence was in this case we are unable to learn. The white and other ants have, however, enemies far more tangible than bulls of excommunication in the *Myrmecophaga*, or the great ant-eater, the *Tamandua*, and the little ant-eater, of which the last two have a prehensile tail. The great ant-eater is a most curious animal, but well adapted to the purposes for which it was designed by the Creator. Its short legs and long claws (the latter doubled up when in motion) do not hinder it from running at a good pace; and when the Indians wish to catch it, they make a pattering noise upon the leaves as if the rain were falling; upon which the *Myrmecophaga* cocks his huge bushy tail over his body, and, standing perfectly still, soon falls a prey. In the northern part of Minas-Geraes, a naturalist once came suddenly upon the great ant-eater, and, knowing the harmless nature of its mouth, seized it by the long snout, by which he tried to hold it, when it immediately rose upon its hind legs, and clasping him around the middle with its powerful forepaws, would not release its hold till a pistol-ball was lodged in its breast. When the great ant-eater sleeps, it lies on one side, rolls itself up so that its snout rests on its breast, places all its feet together, and covers itself with its bushy tail. In this way it may be easily taken for a heap of hay. The Indians of the Upper Amazon positively assert that the great ant-eater sometimes kills the jaguar by tightly embracing the latter, and thrusting its enormous claws into the

jaguar's sides. The aborigines also declare that these animals are all females, and believe that the male is the 'curupira' or demon of the forest. The peculiar organization of this animal has probably led to this error.—*J. W. Mee.*

OUR AMERICAN COUSIN THE ROBIN (*Turdus migratorius*).—The Englishman when he settles in either Upper or Lower Canada, hearing his neighbours speaking about the robin, is apt to imagine that none other but the far-famed Robin Redbreast of nursery folk-lore is referred to: he could not, however, make a greater mistake, and sooner or later, with much sorrow, he learns a far different bird is called Robin by the backwoodsman than he knew in his English home. Now for the reason: doubtless the Pilgrim Fathers, when they went over the Atlantic in the *Mayflower*, to form a settlement where they could worship God with a freedom denied to them in their native land, were short of one thing. A great number of objects would crowd around their everyday life of bustle and activity, to remind them of home, because in many points similar; but when winter came on, with its snow and frost, to some extent compelling them to a forced idleness for a time, they would then think more of homely associations, especially in walking abroad they would, methinks, long to see the homely familiar birds, so welcome in the far-off Fatherland. They would not have to search far before finding the robin, a bird, too, so like in general appearance the "*redbreast*," that it could not be long without a name, and was at once hailed as the robin; but mark, dear reader, it was not called, after all, Robin Redbreast. As before stated, in many points it is similar to our *Redbreast*, but it is much larger, being about the size of the starling; it has a chocolate-coloured dress, tinged with bright red over the breast. Its song does not resemble our robin in the slightest, being much louder and more flute-like; in one point, as our brothers in the New World are very loud in its praises, it is not pugnacious. We have been honoured by having a little red-breasted companion every winter for several years as a constant visitor at our homely cottage in Cheshire, but we do not thank him, for he will have no rival near: every sparrow dreads his approach, and as all the family take a pleasure in attending to the wants of a very large flock of feathered friends in severe weather, we often feel grieved when witnessing a contest betwixt the robin and some other little bird. This is not the case with the American robin—he becomes very familiar and tame, and is friendly with all the neighbouring songsters. Miss Cooper in her book, so full of interesting country scenes and observations, often mentions the appearance of the friendly robin; in fact, this alone adds a thorough charm to the volume. A few years since a communication was read before the Boston Naturalists' Society, by Prof. Tredwell, giving the results of many carefully conducted experiments and observations, to show how many worms or other insects were destroyed by the robin alone. He stated that on one day, the fourteenth day after birth, it ate sixty-eight earthworms, or 41 per cent. more than its own weight. The length of these worms if laid end to end would be about 14 feet, or ten times the length of the intestines. Do we not owe much to the labours of our feathered tribes, and does not Providence induce us to protect, or rather cherish, such birds as the homely red-breast, by throwing them a few crumbs during wintry weather, thus preserving life, to keep up the balance in nature?—*Apis.*

FRIENDLY SPIDERS.—"Spiders are unamiable, quarrelsome, spiteful creatures, even to their own kin,"

* Clay house.

—such is the character these Arachnids bear, though I do not believe they always deserve it. Upon the window of an out-house, last summer, I noticed there were spread the webs of several spiders, two being in close contiguity. A fly bounced into one of these two webs, and his size gave the occupant trouble. Hearing the buzzing (or feeling the vibration of the threads, for it has been conjectured by several naturalists that spiders are deaf), the spider in the adjacent web entered and gave his aid, and the two spiders sucked the juices of the fly very amicably. I have seen, however, as I must confess, under other circumstances, when one spider has approached another's prey, that the owner has either fled or "rushed to the charge" and fought, or frightened away the intruder.—*J. R. S. C.*

EARLY HISTORY OF THE DOMESTIC CAT.—It is certainly a singular circumstance that an animal so noticeable where it occurs as is the domestic cat is not named in the Bible, nor even indirectly referred to. And yet the Jews, one would suppose, kept cats at an early period of their separate existence as a nation; at their exodus from Egypt the people must have known well an animal to which their oppressors were partial, living and dead. Some have conjectured, however, that their Egyptian memories of the cat led the Jews to regard this quadruped with superstitious dislike. A recent correspondent of the *Academy* maintains that the ancient Greeks had cats, though the contrary has been formerly argued, and it would appear by his references that the habits of the cat were observed with some accuracy, if it be the animal intended by the Greek word he quotes, as the satirist compares women to cats. And if we asked the old Greeks why they are like the feline race, the uncomplimentary response would be, that the resemblance lies in the quality of caprice, and in a fondness for wandering abroad.—*J. R. S. C.*

VOLVOX GLOBATOR.—As far as my experience goes, I should say that the end of summer is decidedly the best time for obtaining this beautiful organism. I have frequently sought it in May and June, both here and round Canterbury—the latter a neighbourhood, I believe, singularly favoured by many of the less common forms of pond life, but always without success. The finest gathering I ever had was obtained quite late in September, from a very small pond in a gravel-pit near Brabourne, in this county. The pond was only 6 or 7 feet across, and was perfectly green with *Volvox*; so that the contents of an ordinary stage cell would show forty or fifty specimens. This was in 1870, the September of which year was remarkably fine and warm; but early in October cold autumnal rains set in, when the *Volvox* suddenly and entirely disappeared. I visited the same pond in August, 1871, but though the weather was hot, and the conditions apparently unchanged, could find none. Not having been in the neighbourhood since, I cannot speak respecting subsequent years; but, like many other forms of microscopic life, I have no doubt that its appearance in any given locality is somewhat intermittent.—*Edward Horsnaile, Dover.*

THE CUCKOO, AND WHY SHE DOES NOT BUILD A NEST.—The Danish legend is that every village girl when she first hears the cuckoo note in early spring kisses her hand, and asks the following question, "Cuckoo, dear cuckoo, when shall I marry?" Whilst the old women cry out, "Cuckoo, when shall I be released from this world's cares?" The

bird, in reply, cries "cuckoo" for every year that is to elapse before their desires will be granted, and in so doing all her time is occupied. The season for building a nest goes by, and at last, in despair, she lays her egg in another bird's nursery, generally in that of the hedge-sparrow.—*Helen E. Watney.*

CUCKOO'S EGGS (p. 23).—Whether the Cuckoo is possessed of the remarkable instinct attributed to it by some writers (as to the selection of a nest where the eggs correspond in colour with its own) is more than I can say; but I know that two cuckoos' eggs found by me in the nests of water-wagtails (*M. Yarrowellii*) almost exactly corresponded with those of the rightful owner of the nest, and that an egg of the same singular and interesting bird taken from the nest of the little Tree-pipit (*A. arborvus*) bore a striking resemblance to those of that bird. The eggs found in the wagtails' nests were thinly speckled, while the one taken from the pipit's was very thickly streaked. Each of these varieties agreed in the most perfect manner with those previously deposited by the real owner, the only difference noticeable being the superior size of the intruded egg. The men who work in stone-pits inform me that the Cuckoo may be often seen flapping about the heaps of stones in its search for the nests of the dishwashers (wagtails), and from the position of these nests I know perfectly well that the Cuckoo must use either its bill or its claws in conveying its eggs into them.—*W. H. Warner, Standlake, Oxon.*

THE MISTLETOE.—Some short time ago several letters appeared in *SCIENCE-GOSSIP* respecting the trees on which the Mistletoe has been found. One of your correspondents mentioned the Pear. May I ask, whether your correspondent actually saw this instance, or whether the statement was made on the authority of others? I am induced to ask this question because I have never heard the Pear mentioned, though it is one of the first trees, after the Apple, on which we might expect to find it. And some years ago a relation of mine was present at a large rent-dinner in Herefordshire, in the midst of the apple and pear-growing district, and he asked the farmers whether any of them had ever seen the Mistletoe on the Pear. Only one of them thought he had once seen it, but he would not speak positively. A Herefordshire friend once showed me an interesting collection of photographs of all the oak-trees on which the Mistletoe was there known to be growing. There were, I think, about nine or ten of them, and I was told that another had been found since those photographs were taken. I was told, by a good authority, that a fair-sized plant of Mistletoe was once found in that part of Herefordshire upon a wild rose, but I did not see it. It is very curious to see how long the young shoots of the mistletoe-seeds will exist with no other nourishment than that of their own juice. If a berry be made to stick against a pane of glass in an ordinary window, it will soon throw out two arm-like shoots, which will turn inwards towards the dark, and not towards the light. They will last for several months, but will not increase after a certain growth.—*H. M. M.*

THE MISTLETOE.—In reading the interesting account of the traditional uses and virtues of the Mistletoe, by "W. G. P.," in a late *SCIENCE-GOSSIP*, I see no mention made of the reason why we can take the well-known liberty with the fair sex beneath its shade; can any of your correspondents explain this curious superstition?—*W. T. E.*

MISTLETOE.—I can inform "W. G. P.," that in Germany this plant is known by different names, *Mistel*, however, being the most common. *Ginster*; *Kinster*; *Kenster*; the first of these names is also given to a plant the flower of which is used for dyeing purposes. *Heilige Kreuzholz*; the German of *Lignum Sanctæ Crucis*. *Mahrensacken*; the same as the Dutch, *Marentakken*. *Afholder*, or *Asterbaum*; *af* and *after* from the old *afar*, *aftr*, not genuine, false; *holder*, elder; *baum*, tree.—*H. Macco*.

HARVEST BUGS.—The best remedy that I know of for the bites or stings of harvest bugs is "Liquor Ammoniac Fortissimus" (spirit of ammonia) which should be applied to the exact spot by means of a camel's-hair brush, and will be found to give immediate relief.—*Frank Johns, Winton*.

HARVEST BUGS.—Your correspondent, G. H. Piper, complains of the pain caused by the bite or sting of the harvest bug; it is almost impossible to altogether stop their intrusion, but if "toilet vinegar" be applied to the wound, it will speedily allay all irritation. It can be bought of almost any chemist.—*H. F. Wyatt*.

HARVEST BUGS.—In reply to G. H. Piper respecting harvest bugs, I remember in the month of September passing through a field of barley when out shooting about three years ago, and unfortunately some of these unpleasant little insects found me out. They will not trouble you very long, and the best antidote to allay irritation is eau-de-Cologne.—*William Bean*.

BREEDING OF HAWFINCH.—In the number of SCIENCE-GOSSIP for November, I see that "R." discredits the statement of the hawfinch having bred in this country. I have in Kent found in the breeding season as many as six nests in as many days, and in one season more than twenty nests were known in the neighbourhood. I have seen the bird, not only in winter but in summer, in almost every place I looked for it, especially at Oxford, and near Henley. It is very shy, which accounts for "R.'s" not having often seen it. But it is by no means a rare bird.—*H. N. R.*

HAWFINCH.—R. says, "I believe it must have been a mistake to record it as having bred in this country." If he looks at Yarrell, vol. i., p. 559, 3rd edition, he will find an account too long for insertion here of its nidification in Epping Forest, from the pen of no less an authority than the late Henry Doubleday. Amongst other things, he says, "I can safely assert that they are permanent residents." Further on, Yarrell says, "in a letter from Mr. H. D., the situations of five nests are thus noticed," and other authorities are adduced. What says Professor Newton? I have not yet seen his new edition of Yarrell, as far as the Hawfinch.—*J. S. Westley*.

BEEES AND FLOWERS.—I have noticed that the Honey-bee does not visit the Monk's-hood, although the Humble-bee takes plentiful supplies from it. Near the Monk's-hood grew a plant of the "Red-hot Poker" (*Tritonia*), which the Honey-bee made the most of. From this flower you can shake showers of nectar, so that it must be a first-class bee-plant for bees. I suppose the Humble-bee could not get into the long narrow bells of this flower. The Humble-bee patronized the *Fuchsia* up to September, then seemed to hand over all claims on it to its active little cousin.—*T. McGann*.

COLOURS OF SHADOWS.—When getting dusk yesterday (Dec. 21) I lighted my study-gas early, and noticed, what I have often done before, that the shadows of the plants in the window thrown on the white blind were distinctly blue; the shadow of my hand or figure was the same. The subject has been mentioned in SCIENCE-GOSSIP with regard to table-lamps, but not with regard to gas. What is the cause of the shadow being blue, as all blue disappears the moment daylight is gone?—*H. O. Sterland*.

SPARROWHAWK AND CROW (p. 21).—I can assure Mr. King that it is a common sight in the country to see crows (rooks, I suppose, are meant) chasing hawks. I once saw a couple of beautiful little hawks most shamefully maltreated by a flock of rooks, which, after a time, divided into two parties, one of which continued to buffet the weaker-winged hawk, while the other followed in chase of its more vigorous companion, which, however, contrived to make good his escape.—*W. H. Warner*.

DEATH'S-HEAD HAWK-MOTH (p. 21).—My experience in rearing the "Death's-head" has always led me to believe that the caterpillar, under any circumstances, does not build a cocoon; why then should the one spoken of by your correspondent evince so decided an inclination for doing so? I have reared many different kinds of caterpillars, and always found that the earth-burrowers when unprovided with mould made no attempt to construct a cocoon, but changed into the chrysalis without further ado.—*W. H. Warner, Standlake, Oxon*.

ORCHIDS IN SURREY.—Can any one tell me the best hunting-ground for Orchids in Surrey, not much farther south than Box-hill, where the greatest number of species are likely to be met with, time being limited?—*J. R. N., Kingston*.

APOCYNUM ANDROSÆMIFOLIUM.—The following is a copy from a work by Mr. Maxwell T. Masters.—"The Fly-trap of North America is cultivated as an object of curiosity in that country. The S scales in the throat of the corolla secrete a sweet liquid, which attracts insects to settle on them. The scales are endowed with a peculiar irritability, the cause of which has not been accurately determined, but which causes them to bend inward toward the centre of the flower when touched, and to retain the unlucky insects as prisoners. Numbers of dead insects may be seen in the several flowers of this plant. The movement of the scales probably serves to scatter the pollen on the stigma. They are widely distributed on the temperate parts of both hemispheres, and as flowers in cultivation." The English representative is *Vinca minor*.—*Periwinkle*.—*Thomas Hobden*.

BLEACHING FERNS, &c.—I shall feel much obliged for any information on the preparation of ferns and mosses for mounting as fire-screens, window-blinds, &c. &c. I have dried and pressed them in such a way as to be very fit for herbarium purposes, but on exposure they become brown and unsightly after a while. I am told the best way is to bleach them and then dye in aniline colours, and shall be glad to hear how the bleaching is best done inexpensively. Perhaps some kind reader could tell me how they are mounted with butterflies, &c., between sheets of glass for window-blinds, panelling.—*T. McGann*.

NORTHERN HOLY-GRASS.—I think Mrs. Edwards and myself only differ as to terms. I can understand a flower being called "hermaphrodite" which has both stamens and pistil, but not the stamens and

pistil being so termed, as they are by Mrs. Edwards. I consider that the term "hermaphrodite" might well be confined to those plants which are normally self-fertilized—*i.e.* both morphologically and physiologically bi-sexual. All "synacmic" plants are not so. Plants which have stamens and pistil in one flower, but are not self-fertilized, should be called "monoclinous." "Perfect" is a technical term, and does not mean finished or complete. As applied to a flower, it means having all its essential organs present, not necessarily at the same time; or it may be used of a single organ in opposition to "aborted." "Matured," with reference to the stamen, means on the point of discharging its pollen; with reference to the pistil, it means that the stigmatic surface is viscid with its secretion, and in a condition adapted for the growth of pollen-tubes. As I said in my last letter, *Hierochloë borealis*, though monoclinous, or morphologically hermaphrodite, is not physiologically hermaphrodite, not being synacmic, but protogynous.—*G. S. Boulger.*

CAPTURE OF "DISPAR."—On asking just lately a young entomological friend what captures he had made in the present year, he informed me that when near Belfast, in the middle of August, he had taken *Dispar* in a garden. Unfortunately, he had mislaid the box in which he brought it home; but, from his description, I can have no doubt that the insect he took was *Dispar*. I thought the capture was worthy of mention.—*Windsor Hambrough.*

THE STUDY OF AMERICAN ANTIQUITIES.—I beg to inform those of your readers who are interested in this subject that the Second International Congress of Americanists will be held at Luxembourg on September 10-13 in the present year, when it is hoped that many English will attend. I shall be happy to supply tickets or any further information.—*A Delegate for England.*

LOCUSTS (p. 21).—I am inclined to think that the Locust (properly so called, and not *C. viridissimus*) does really occasionally occur in the British isles. I am told that a specimen of the insect was captured in this parish (Standlake, Oxon) a few years ago, kept for a long time under a glass, fed on green stuff, and finally taken to an experienced naturalist and collector living in the vicinity, who was fully persuaded of its identity.—*W. H. Warner.*

SNOWDROPS.—The very evidence adduced by J. L. Vincent in favour of the snowdrop being indigenous (its "flourishing in the greatest profusion on the sandy banks of the rivers in Mid-Devon"), is to my mind direct evidence against its being indigenous. I, too, know many such instances. The sandy sides of rivers, especially beneath the level of floods, are its usual habitat, but these instances are always below towns, villages, or gardens. I have never found them above. There is, to my mind, no more suspicious locality for a doubtful plant than the sides of a river. One often finds undoubted garden-flowers in such places.—*J. S. Wesley.*

SEEDS DIGESTING (p. 21).—Mr. E. T. Scott is perfectly correct in his assertion: witness the neighbourhood of ivy-bushes frequented by blackbirds; there any one may have ocular demonstration that seeds swallowed whole are not digestible.—*W. H. Warner.*

PRONUNCIATION OF NAMES.—I cannot but think that Gleichenia, Sellignea, and Lachenalia, on being coined as Latin derivatives of barbarous words, must

acquire a Latin pronunciation, just as the Hebrew words borrowed by the Greek. They are therefore equivalent to Glikenia, Sellignea, and Lakenalia. So *Fuchsia* should not be pronounced either *Fewshia*, as now, or *Fooksia* like the German name whence it is derived, but, as "ch" is equivalent to "s" in Latin (*e.g.*, "chinensis" and "sinensis"), *Foossia*.—*G. S. Boulger.*

CAUSE OF COLORATION.—Though no doubt we can as yet be said to have little, if any, definite knowledge of the cause of colour in birds, butterflies, or flowers, your correspondent "H. B.'s" opinion, that all flowers grown in a cellar would be white, is at variance with the result of most past experiments, though these are certainly not altogether satisfactory. White Persian lilac is produced at Paris by growing the coloured species in the dark; but it is, as yet, an article of faith, that, whilst chlorophyll, the green colouring-matter of leaves, is dependent on light for its colour, other colours are independent of that agency.—*G. S. Boulger.*

EARLY PRIMROSES.—February, I believe, is usually considered to be the earliest month in which we find the Primrose (*Primula vulgaris*) in bloom. Some of the readers of this paper will, no doubt, be surprised to hear that the woods about Little Baddow are already (Jan. 1st) becoming gay with these ordinarily spring flowers. This early flowering is probably owing to the unusually warm, damp weather there has been for this time of year. I have looked in vain for any recorded instances for such early flowering; any readers, therefore, who know of more instances of this unusual flowering, would, by recording them in this paper, confer a favour on those who take interest in noticing the peculiarities of plants.—*C. W. H., Chelmsford.*

DENSITY OF SEA-WATER.—Your correspondent Ch. Fred. White, in giving his kind advice to J. F. James and others (p. 280, last vol.), seems to have overlooked that with all thermometers, registration below zero is the inverse of what it is above zero, so that of the two, 3° 67' C. and 2° 55' C., the former above zero, or (+), would indicate the warmer temperature, but below zero, or (—), it indicates the colder. Now, as it is a known fact that all water, fresh or salt, when agitated, requires a lower temperature to freeze than when perfectly still, and as, according to quotation the contrary is stated, it follows that J. F. James is fully justified to make his remark. Probably there is a misprint or slip of the pen, which it would be well to see corrected.—*H. Macco.*

THE GLASTONBURY THORN.—The enclosed specimen of the Glastonbury thorn has just been sent me from Somersetshire; it has been out for more than a fortnight. It seems to bear a resemblance to the common hawthorn, by possessing the same strong smell. In case the readers of SCIENCE-GOSSIP be interested in the subject, I take the liberty to send the following, copied from Miss Pratt's "Flowering Plants":—"Culpepper mentions a thorn, which grew at Romney Marsh, and another near Nantwich, in Cheshire, where it flowered both at May and Christmas; though, he says, that if the weather was frosty it did not flower for the second time until January, or till the hard weather was over."—*H. J. T.*

VOLVOX GLOBATOR.—I found the *Volvox globator* from early in April to the 29th November last year, and was exhibiting the same a few days since. I did not try the earlier months of the year.—*George Pearce.*

TEUCRIUM CHAMÆDRYS.—The following extract from Green's "Universal Herbal," &c. &c. (1820), may interest SCIENCE GOSSIP. After describing the plant and its medicinal uses, the writer tells us that it is a "native of many parts of Europe, the islands of the Archipelago, and Palestine, near Jerusalem. In England it is scarcely indigenous, being chiefly found on the ruins of old buildings."—*F. S.*

PARASITES ON CYCLOPS.—On some specimens of the common Cyclops, I have often observed some parasites consisting of a head with cilia like Vorticella, but wanting the spiral stalk. Can any one tell me what they are?—*A. H.*

WATER-VOLE.—R. speaks of the rat, the water-rat and the water-vole. The water-rat is the water-vole. See Bell's "Quadrupeds," p. 316, 2nd edition.—*J. S. Wesley.*

THE PLAGUE OF FLIES.—We are much annoyed each summer by flies, in two rooms of our house. They swarm every warm sunny day on the windows and ceiling; killing and driving out of the windows seem to have no effect, as they reappear the next day as strong as ever. We think they must hide themselves in the woodwork, which is varnished, not painted, as the rest of the house. Can you, or any of your correspondents, tell us of any way of getting rid of these plagues?—*E. C. M.*

LOCAL PLANT NAMES.—*Iris fetidissima*, called by the country people "glading" root, corrupted from "Gladwin" root, cure for dropsy and scarletina. A curious little incident occurred in this neighbourhood regarding the local name of *Hypericum calycinum*. A lady driving through a demesne saw a quantity of this plant growing, and asked the gate-keeper what it was, and for answer was told that it was called "The Rose of Sharon, or the Lily of the Valley." The common "peony" is known in these parts as the "piano rose." *Scrophularia nodosa* is known by the name of "rose-noble," which at first strikes one as a very strange name for a plant with such an insignificant flower. The name may have originated in its being a cure for the *rose*, which the country people call a *rash*, and the term *noble* may have come from its being a cure for the "king's evil."—*Rev. T. A. Brennan, Cloghan, co. Tyrone.*

GOLD-FISH.—An olive carp has been in our aquarium for three years and a-half. At the beginning of that time it was about 1½ inch in length, and is now an inch longer. During the last six months it has gradually changed to a bright golden colour, with the exception of the fins, which retain the original dark hue. Is this change usual?—*E. S., Leeds.*

THE COMMON NETTLE.—I have seen in books of travels that when the rook is met with in wild and unpopulated districts it is a sign of a human habitation being at hand. But only lately have I heard that the nettle is also a sign of the late presence or actual presence of man. A friend of mine was one day driving on a coach through one of the Scotch deer-forests. Several times during the drive the whip pointed to a bed of nettles, and said there had been a house there, though long before his time. On being asked how he found out, he said that the nettles only appeared where the hand of man has turned up the ground, and in the greatest profusion about the house-door. He also said that when a hut is made in a place quite free from them, they appear in a few months. This is another case of the sudden appearance of plants which cannot be accounted for by

Mr. Edwin Lees's hypothesis, the deer-forests having no trees in them.—*Ducarp Ackone.*

ÆSTINOMUS ÆDILIS.—It may be interesting to some of your correspondents to hear that I found about ten days ago, in the town of St. Peter's Port, Guernsey, a perfect specimen of the extraordinary beetle, popularly known by the name of Timberman (*Æstinomus ædilis*). I believe it is not common to find this insect so far south.—*Adela M. Collinson.*

LOCAL NAMES OF BIRDS.—Mr. J. G. Henderson is no doubt aware that the Northumbrians as a rule cannot pronounce the "r," and hence yorlin with them will sound very like yowlin, yowley, or yoalin. It is merely a corruption of the same word. Hogg, the Ettrick Shepherd, who had a good knowledge of the local names of the fauna and flora of Scotland, introduces it in that beautiful lyric, "Kilmeny in the Queen's Wake,"—

"It was only to hear the Yorlin sing,
And pu' the cress-flower round the spring,
The scarlet hypp and the hindberry,
And the nut that hang frae the hazel-tree."
Dipton Burn.

THE VENOMOUS SPIDER OF NEW ZEALAND.—Mr. J. M. Meek, of Waiwera, sends the following narrative of the effects of the bite of the kapito, or native spider:—"It was on the morning of the 24th ult., at three o'clock, my son (a man of thirty-one years of age) was awakened from his sleep by the bite of one of those poisonous insects, and came into our bedroom about an hour afterwards, and exclaimed to his mother and myself, 'I am bitten by one of those spiders that the natives have so often spoken to me about, and am full of pain. See, here it is, in the bottom of the eandlestick.' I looked at the insect, whose body was about the size of an ordinary pea, and in colour nearly approaching to black. His mother, on looking at his back, saw the puncture the spider had made, and immediately commenced sucking the wound. I proceeded to the hotel, and obtained the services of Dr. Mohmber, when, on my return with him to my house, my son was suffering the most exerceiating pain in the groin, the virus apparently working its way in that direction. After an application of ammonia by the doctor, the pain shifted from the groin and worked its way up the spine, affecting the arms and chest during the remainder of the day and lasting till the following morning, my son moaning with pain the whole time. On Tuesday the pain became intense, the virus working its way into his legs, causing the veins to swell very much. We applied turnip poultice to the wound, and when taken off a quantity of black fluid came from the sore. During the afternoon the pain in the legs and big toes still continued. Dr. Mohmber prescribed a liniment, which after rubbing well into the legs, caused a black, inky-coloured fluid to emit itself through the pores of the skin in large drops, from which time my son began to improve, and has continued improving ever since, but suffers much from weakness. From the time he was bitten on the Monday till the Friday following he lost exactly 12 lb. in flesh. I forgot to state that, when he was first bitten, I gave him small doses of brandy at intervals during the first two days, which seemed to have the effect of greatly relieving the pain. I am informed by Te Hemera, native chief here, and also by other natives, that many fatal cases among their ranks have taken place by the bite of the katipo; they also believe the sufferer is sure to die if they cannot find the spider; but, on the contrary, if they find it and burn it in the fire, the patient gets well in three days. If they cannot find the insect, they set fire to the house

and burn building, effects, and everything else. In this case, the spider was found, and Dr. Mohnbeer has it preserved in spirits in his surgery. I write this to caution persons to look well to their bedclothes before retiring to rest, as I have witnessed persons suffering from the bite of snakes and other reptiles in Australia, but never saw any one in such agony as my son during the time the poison was taking effect."

BIRDS.—Could any of the readers of SCIENCE-GOSSIP oblige me with a list of the birds to be found round the coast of Kent?—*Henry Lamb, Maidstone.*

HABITS OF HERONS (No. 144, p. 283).—Mr. Arnold asks if heronries are ever built in other trees than oak or fir. The nests in Lord Portman's park (Bryanstone), I may tell him, are in *Elm* trees.—*W. R. Tate.*

HERONS.—I can inform F. H. Arnold that herons do sometimes have their nests in a rookery; one had its nest two years in succession in the Fyvie rookery, no other heron's nest being known of within six miles. The rookery and herony at Hatton, near Turiff, were at one time connected: the trees are now cut down, they are separated a little; the herons' nests at that place are mostly in spruce-trees of a great height.—*W. Sim.*

HERONS.—In answer to a question asked by F. H. Arnold in the December number of SCIENCE-GOSSIP as to whether herons build only in fir and oak woods, I wish to state that there is a wood near here composed principally of beech, no oak nor fir, and in which there are two heronries. There are also rookeries in the same wood, but at some little distance from the heronries.—*The Needler, Strangford, Co. Down.*

HERONRIES.—In answer to F. H. Arnold's queries respecting the habits of herons, I may state that there is a large herony in North Germany, not very far from the town of Bremen, at a place called Stülhe, where the nests are built exclusively on fine beeches. The birds find their food in the marshes on the western banks of the Weser, about twelve miles distant from the colony.—*V. M. Oelsson.*

TENNYSON AND HIS "SEA-BLUE BIRD OF MARCH."—I think I can set "J. R. S. C.'s" mind at rest on this vexed question. My father, the late Mr. B. B. Woodward, who was a great lover of nature, was at first much puzzled concerning this passage, which he knew must refer to the Kingfisher; but what connection existed between it and March he was unable to discover, until he asked Mr. Tennyson himself. Mr. Tennyson informed him that the Kingfisher was the bird intended, and that it abounded in the Fenland during the month of March. *In Memoriam* was written while he was staying in that district.—*E. B. Woodward, British Museum.*

ANTHROPOID APE IN SOUTH AMERICA.—It is curious that the idea of the existence of an anthropoid ape in the dense tropical forests of South America is so firmly held by the natives, who are, like most savages, acute and exact observers. Warned by our experience in Africa, where the Gorilla existed unknown (except a casual mention in the Latin classics) to very recent times, and by the fact that the forests of Brazil are comparatively unexplored, we ought, I think, to hesitate before pronouncing decidedly against the idea. Legends of the existence of such an ape exist in Brazil, and I fancy that

Captain Burton alludes to the subject in his work upon the "Highlands of Brazil." At any rate, Captain Masters, in his work entitled "At Home with the Patagonians," says (p. 120) that he was told that the Chilotes aver that an animal called the Tranco or Trauco inhabits the western forests of the Cordillera (of Chili). An intelligent Chilean officer—Gallego—also informed him "that there was no doubt of its existence, and described it as possessing the form of a wild man, covered with a fell of coarse, shaggy hair. This animal is said to descend from the impenetrable forests, and attack the cattle." Humboldt also mentions the traditional existence of this monstrous ape, and it has been suggested that it is a legend of the former existence of the fossil ape, whose remains are found in South America. Reading Barrington Brown's "Canoe and Camp Life in British Guiana," I find the following information about a similar monster in Guiana: "The first night after leaving Peaimah, we heard a long, loud, and most melancholy whistle, proceeding from the direction of the depths of the forest, at which some of the men exclaimed, in an awed tone of voice, 'the Didi.' The 'Didi' is said by the Indians to be a short, thick-set, and powerful wild man, whose body is covered with hair, and who lives in the forest. A belief in the existence of this fabulous creature is universal over the whole of British, Venezuelan, and Brazilian Guiana. On the Demerara rivers, some years after this, I met a half-bred woodcutter, who related an encounter that he had with two Didi—a male and a female—in which he successfully resisted their attacks with his axe. In the fray, he stated that he was a good deal scratched, &c." All this evidence seems singularly circumstantial, and travellers might with good results follow up their inquiries on the spot. When we learn that the recent inundations in Spain stranded on the fields unexpected denizens of the river Guadalquivir—whose occupants ought by this time to be pretty well known,—what *lusus nature* may we not expect to find in the fastnesses of tropical America?—*Francis A. Allen.*

QUERY ABOUT MARIGOLD.—In the first act of the "Two Noble Kinsmen" these lines occur:—

Oxlips in their cradles growing,
Mary-golds on death-beds blowing,
Larkes-heeles trymme.

The Mary-gold is evidently the March marigold, which is contemporary with the Primrose, first-born child of *Ver*. Was it ever especially used to strew a corpse? Can any of your correspondents tell me whether the wild columbine (*Aquilegia vulgaris*), also a spring flower, is called lark's-heel in any part of the country? The *Delphinium consolida* (field larkspur) is somewhat later, and seldom found at the same time as the Primrose.—*J. P., Maidenhead.*

ABUNDANCE OF CONVULVULUS ARVENSIS.—The dry, hot summer which so seriously diminished the number of our wild flowers in many districts, especially where the soil is chalk or limestone, and the land is intersected by few streamlets, served to stimulate the growth of a few species. Amongst these, I particularly noticed, in fields about North Kent, the great profusion of *C. arvensis*, which so bespangled, in some cases, the rows of potatoes, that the pinkish white bells appeared to be the most conspicuous object on the surface. And yet, on examination, I could not assert that the "weed," as the agriculturist would naturally style it, interfered at all with the rightful growth of our valued esculent.—*J. R. S. C.*

NOTICES TO CORRESPONDENTS.

TO SUBSCRIBERS.—The compilation of the Classified Index of the last twelve volumes of SCIENCE-GOSSIP has proved a more difficult and painstaking task than we at first imagined. It is now in a forward state of preparation, and we crave a little grace from our numerous correspondents, who have already applied for it.

TO CORRESPONDENTS AND EXCHANGERS.—As we now publish SCIENCE-GOSSIP at least a week earlier than heretofore, we cannot possibly insert in the following number any communications which reach us later than the 8th of the previous month.

A. W. S.—Many thanks for your valuable suggestion. The point you note had not occurred to us before; but it shall be attended to henceforth.

F. C. S.—We believe the "SCIENCE-GOSSIP Section-Machine" can be obtained from Mr. Walter White, Litcham, Norfolk.

H. J. RYDER.—The price of the "London Catalogue" (which may be had at 192, Piccadilly) is sixpence.

I. R. R.—The "pink stone" is a fragment of calcite (crystallized carbonate of lime), coloured with a small quantity of iron oxide.

T. MERRYFIELD.—One of the best trees to grow in towns is undoubtedly the Oriental Plane. We are surprised that it is not more cultivated, under such conditions, than it is; for it would grow, we believe, even in our manufacturing towns. If that man is a public benefactor who makes "two blades of grass to grow where only one grew before," what shall we say of him who makes a tree to grow where *none* grew before?

S. E. M.—Your plants are: 1, the Viper's Bugloss (*Echium vulgare*); 2, the Nodding Marigold (*Bidens cernua*); and 3, the celery-leaved Buttercup (*Ranunculus sceleratus*).

ROBERT TETLOW (Leeds).—Get Woodward's "Geology of England and Wales," published by Longmans & Co., at, we believe, 14s.

W. BRADLEY.—The objects you mention as imbedded in orange and apple peel are doubtless the pupa-cases of *Ceratites citriperta*.

T. B.—The "mineral" you enclosed is a fragment of carboniferous limestone, and the fossils imbedded are corals (*Lithostrotion sociale*), one of the commonest and most characteristic of the carboniferous beds.

H. M. MAPLESON.—Accept our thanks for your kindly courtesy.

J. B. JOHNSON.—If your correspondent will send the mosses you refer to, we will do our best to have them named, if they are in a fit state to be authoritatively identified.

C. H. S.—For dressing skins see Swainson's treatise on Taxidermy.

TO CORRESPONDENTS.—Our best thanks are due to numerous correspondents for hints and suggestions all intended for the improvement of our magazine. As far as possible, we shall avail ourselves of them.

R. MIDDLETON.—We are sorry to say the specimen of a longicorn beetle was much too imperfect to identify. Send us a perfect specimen. We cannot undertake to give names of any imperfect specimens of natural history objects, and unfortunately we are usually treated to these, on account of people not likely to send their best objects.

S. E. H.—Your coloured drawing of a fungus is evidently that of *Agaricus lactuarius*.

H. E. FORREST.—You had better get "Half-Hours at the Seaside," price 4s., where you will find all your queries answered much more fully than we have space for, as they are only very elementary questions. No. 3 is a frond of a red seaweed (*Deliseeria*), and the "little cells" you speak of are those of a Polyzoan called *Membranipora*.

A. K. LAST.—We have never heard it authoritatively stated who was the author of "Vestiges of Creation." It was generally laid to the door of the late George Combe. For the second query consult Bell's "British Quadrupeds."

W. J. V., JUNIOR.—SCIENCE-GOSSIP is generally published on the 25th of the month. Your most expeditious way to get it would be to have it sent directly from the publishers.

EXCHANGES.

WANTED, for scientific research, small quantities of pollen (named, but unmounted) of any plants.—G. S. Boulger, Cressingham, Reading, Berks.

WANTED, clean short specimens of Shore Birds (Gulls, Plovers, Sandpipers, &c.). British and foreign birds' eggs, and other objects of natural history, given in exchange.—Send list of desiderata and particulars to C. Dixon, 60, Albert-road, Heeley, near Sheffield.

WANTED, back volumes of SCIENCE-GOSSIP. Microscope slides given in exchange.—W. A. Hyslop, 22, Palmerston-place, Edinburgh.

ANY one interested in good diatomaceous material, fossil, recent, and *in situ*, &c., or in Marine Algae for microscopic work, or Herbarium, Sertularians, Holothuridea, Echinidea, Crustacea, Foraminifera, &c. &c., all unmounted, are requested to send stamped address.—T. McGann, Burren, Ireland.

GEMLARIA CUCULATA.—Having a few slides of this rare zoophyte mounted in *damar*, I shall be glad to exchange one of same for other good slide.—J. Smith, Leigh-street, Warrington.

WANTED to exchange two dozen miscellaneous Micro Slides for others. Send list to W. D. Bray, Lurgan, Ireland.

HEAD of *Bombix Perityx*. Send a stamped directed envelope to W. H. Gomm, Somerton, Somerset.

Nos. 146, 45, 107, 124, 366, 618, 875, 906, 991, 1,036, 7th Edition London Catalogue, for other plants. Lists to H. R. Moiser, F.G.S., 2, South View, Heworth, York.

WANTED, to borrow or purchase, Astruc's "Histoire Naturelle de Languedoc," "Flora of Shetland," Edmonstone's "Glossary of Shetland Words."—W. G. Piper, Lark Plain, Norwich.

FOR specimens of Boracic acid, Lycopodium, Salicine, and Tobacco seed, send stamped envelope to F. Coles, 248, King's-road, Chelsea, S.W.

FOR Sections of Palm Nut, Polar, and Cotton-seed, showing oleo-resin cells, send other good unmounted objects to R. H. Philip, 28, Prospect-street, Hull.

FOR well-mounted stained Section of Kidney, or Diatom Gallionella in balsam, send well-mounted object of interest to W. H. Gilburt, 41, Clarence-road, Coborn-road, Bow, London.

A GRASSHOPPER WARBLER'S nest in exchange for good Sea-birds' Eggs.—A. W. Martin, Evesham.

IRISH and Scotch Algae, a good series of each, wanted in exchange for North and South Devon and Cornish Sea-weeds, or of Australian and American growth.—Address, H. G., 15, Mulgrave-street, Plymouth.

FOR specimens of *Anguinaria spatula* and *Flustra foliacea*, send stamped envelope or object of interest to J. W., 7, Farm-road, Hove, Brighton.

WANTED, Exotic or European specimens of Lepidoptera, in exchange for several good British species.—J. T. Willis, Adwick-le-Street, Doncaster.

MARINE Algae with Diatoms *in situ*, well mounted, in exchange for other good slides.—W. Nash, 11, London-road, Reading.

POLLEN of Hollyhock, Mallow Stamens, &c., for other well-mounted slides.—J. C. H., 13, Great Cheetham-street, Manchester.

S. & E. AFRICAN SHELLS offered for Foreign Land and Marine, or the rarer British Marine.—Address, J. S. G., 2, Lower Belmont-terrace, Portswood, Southampton.

BOOKS, &c., RECEIVED.

"Log-Letters from the *Challenger*." By Lord G. Campbell. London: Macmillan & Co.

"Large and Small Game of Bengal." By Capt. Baldwin. London: H. S. King & Co.

"Transactions of the North Staffordshire Field Naturalists' Society."

"Transactions of the Bedfordshire Nat. Hist. Soc."

"Les Mondes." January.

"The Field." January.

"Land and Water." January.

"Popular Science Review." January.

"Monthly Microscopical Journal." January.

"Ben Brierley's Journal." January.

"The Lancel." January.

"Potter's American Monthly." December.

"American Naturalist." December.

"Botanische Zeitung." December.

"Monthly Journal of Education." January.

"Journal of Applied Science." January.

&c. &c. &c.

COMMUNICATIONS RECEIVED UP TO 10TH ULT. FROM:—
F. K. T. S.—H. O. S.—T. McG.—J. W.—Dr. E. de C.—
G. M. G.—H. G.—F. S.—W. H. G.—W. H.—I. T.—
E. D. M.—Prof. C.—E. B.—C. H.—E. W.—F. H. A.—
C. W. H.—H. S.—W. D. B.—J. R. S.—A. A. P.—W. L. N.—
J. T. W.—W. H. W.—W. H. G.—T. H.—J. B.—H. R. M.—
H. J. R.—H. G. P.—C. D.—F. H. A.—H. E. W.—J. F. R.—
D. A. K.—C. W. H.—H. M.—L. R. R.—W. H. L.—
C. J. D.—J. C.—F. A. A.—H. R. S.—F. L. C. R.—M. F.—
H. W. T.—Prof. B.—S. B.—W. A. H.—J. R. N.—J. C. H.—
H. M. M.—W. J. B.—E. H.—W. B. G.—J. H. B.—F. C. S.—
A. H. M.—J. M.—W. L. W.—W. E. T.—E.—H. F. W.—
B. B. W.—S. M.—F. C.—W. H. W.—W. W. H.—W. C.—
J. W. O.—R. M.—N. M. G. W.—J. L.—J. W. G.—T. J. R.—
J. W.—T. J. W.—T. W. W. R. T.—W. N. C.—H. L.—
Dr. V.—C. D.—E. L.—R. G., &c. &c.



AN ANGLO-SAXON HERBAL.

BY F. KITTON, HON. F.R.M.S.



TWENTY years ago the Master of the Rolls suggested the desirability of publishing the texts of various valuable MSS., the property of the Government; and that every effort should be made to obtain as perfect a text as possible.

Various MSS. were collated, and the deficiencies of one MS. were made good by another. Among the numerous volumes published, probably the most interesting to the readers of SCIENCE-GOSSIP would be the following: "Leechdoms, Wordcunning, and Starcraft of Early England," and from which we now propose to give some specimens.

The learned editor (Rev. O. Cockayne, M.A., Cantab.) gives the probable date of the MS. of the Herbarium as not earlier than A.D. 1000, nor later than A.D. 1066; of the writer or compiler nothing is known: it must have been a most expensive work, as it has coloured illustrations of the plants described therein.

The author (or more correctly, the translator, the Herbal being a translation from the Herbarium of Apuleius) does not appear to have adopted any arrangement, not even an alphabetical one, neither does he invariably give the Anglo-Saxon equivalent for the Latin name.

The plant whose properties he first describes is *Betonica officinalis*. "The wort that one names betonicam is produced in meadows and on clean downlands, and in shady places; it is good for man's soul and for his body; it shields him against monstrous nocturnal visitors, and against horrible visions and dreams." The medical qualities of this plant seem to have been numerous and diverse; it would cure broken heads, sore eyes and ears, prevent drunkenness (that is, if a man were so minded), weariness from riding or walking, snake-bites, and the

bite of a mad dog. The various methods of preparation occupy five royal Svo. pages.

Plantago major, Waybread, properly Waybread.—This herb had, or was imagined to have, numerous virtues, but it did not equal the preceding in the number of ailments it could cure; its various preparations were good for fevers, wounds, snake-bites, stomach disorders, for corpulency ("if a man would that his womb [belly] dwindle"), and foot-addle (fotadle—gout).

The herb *Quinquefolium*, that is, five-leaf, *Potentilla reptans*.—This plant was good for ten disorders; the most important was the cure of cancer ("blind a cancer"); it was to be seethed in wine mixed with pig's grease, and worked into a plaster and laid on the wound, which would soon heal.

Verbenica, or Ashthroat.—"This wort, which is named by some verbenaca, and by another name, ashthroat, is produced everywhere, on smooth lands and on wet ones." The roots of this herb wreathed about the swere (neck), were highly beneficial in ulcers and glandular swellings ("kernels"); for calculus, the roots were to be boiled in hot wine.

Hyoxyamus niger, Henne belle, sometimes belene (now Henbane).—According to the Glossary, this name was given to it on account of its bell-shaped capsules: it was also called Henne-wol (*wol* meaning poison).

Polygonum Bistorta, Nædre-wyrt (Adderwort). *Acorus Calamus*, Bee-wort.—"That bees may not fly away, take this plant and hang it in the hive, and they will stay."

Alchemilla vulgaris, Lionfoot.

Ranunculus sceleratus, Cluf-thunge (Cloufing), *cluf* = clove, *thunge* = poison, in allusion to the form and poisonous qualities of the root. This plant is described as growing in damp and watery places. "Whatsoever man eat of this wort fasting leaves his life laughing."

Artemisia vulgaris, *A. dracunculus*, *A. pontica*.—The Herbal recognizes the three forms, but they are all classed under the English name of Mugwort

(Midge-wort). *Orchis*? &c. Raven's-leek.—It is said to grow on high downs and in "hard places, and also in meadows, in cultivated lands, and sandy ones."

Erythraea pulchella, Field-wort. *Cyclamen hederæ-folium*, Slite = Sowbread. *Polygonum aviculare*, Unfortrædde (Untrodden to pieces*), Knot-grass. *Aristolochia clematitis*? Smear-wort. Some doubt exists as to what plant is meant by Smear-wort; the Saxon name literally means Butter-wort. The compiler of the Herbal says it is *Aristolochia*. "This wort, that some call *Aristolochiam*, and others name *Smerowyrt*, grows on down lands and solid places."

Nasturtium officinale, Crose, Watercress.—"This plant is not sown, but is produced of itself in springs and brooks." This is an interesting fact, as evidence of spontaneous generation amongst the higher order of plants.

Colchicum autumnale, Great-wort.—The roots of this plant mixed with oil cure pimples on a woman's face.

Convallaria majalis, Glove-wort, Lily of the valley.—According to the Herbal, it was also called *Apolinaris*, and was said to have been first found by Apollo, who gave it to Æsculapius, the leech, whence he set on it the name. Its healing properties seem to be confined to curing sore hands. Apollo's discovery does not appear to have much medical value.

Anthemis nobilis, May. *Teucrium chamaedrys*, Hart-clover (Heort-clæfre). *Dipsacus sylvestris*, Wolf's-comb, valuable as a diuretic. *Ajuga chamaepitys*, Henep, Hemp. *Ranunculus ficaria*, Raven's-foot. *Sambucus ebulus*, Lithé-wort (according to Bosworth this plant is *Celandine*).

Lactuca Scariola, Wood Lettuce (Wudu lectric).—It is said when the earn (eagle) will fly up so that he may see more clearly, he will touch his eyes with the juice and by that means obtain the greatest brightness.

Agrimonia eupatoria, Garclive (Garclife).—The derivation of the name is somewhat obscure: *gar* evidently means a spear, a javelin; *clife* is cliff; the Glossary suggests that the last syllable is derived from *klifian* (to tower).

Asfodelus ramosus, Woodroffe (Wudu rofe). *Rumex acetosa*, Wood dock (Wudu docce, Surdocke, Sourdock). *Chlora perfoliata*, Earthgall (Curmel). *Erythraea Centaurium*, Feferfuge (Fever fue). *Malva sylvestris*, Hocleaf. *Cynoglossum officinale*, Hundes tunge (Hound's tongue). *Panicum crusgalli*, Atterlothe (Atter, poison, venom; *lothe*, evil). *Marrubium vulgare*, Horehound, Harehune (Hare's honey). *Sparanium simplex*, Foxesfoot. *Sempervivum tectorum*, Houseleek, Singrene, Evergreen. *Achillea tomentosa*, Solwherf, Sigelwearfa (*Sigel*, the sun, and *hwearfan*, to turn).—"This wort is produced everywhere in cultivated places; it hath with it some wonderful divine qualities, that is, that its blossoms turn

themselves according to the course of the sun, so that the blossoms when the sun is setting close themselves, and again when he upgoeth they open and spread themselves."

Papaver somniferum, Poppy, Popig. *Campanula Trachelium*, Hals-wort (Throat-wort), so named from its supposed curative properties for throat diseases. *Ceterach officinalis*, Brune wyrt, Brown wort. *Ruscus aculeatus*, Cneowholen, Knee holly, Butcher's broom. Bosworth translates *holen-rush*. Knee-rush would seem a more appropriate name than knee-holly. *Symphytum officinale*, yalluc, Comfrey. *Trifolium arvense*, Haran hyge, Hare's-foot. The derivation of this name is obscure; *Haran* is evidently hare, but *hyge* is not foot. The Glossary connects *hyge* with the modern English verb to *hie* (higan). The MS. text has "genim thas wyrte the man leporis pes and otherum naman haran hige" (take this plant, which by some is called *leporis pes* and by another name hare's-foot). If the compiler of the Herbal had not so positively translated *leporis pes* into *haran hige*, we should rather have referred *hige* to *hag* or *hys*, hay. *Trifolium pratense*, Clæfr, Clover. *Verbascum thapsus*, Felt-wort (Mullein). A twig of this plant borne by any one was a charm against frights or hurts from any wild beast or any evil coming near. *Scenocio vulgaris*, Grunde swelge, Groundsel (? Ground swallower). *Rosmarinus officinalis*, Bothen, Rosemary. *Polypodium vulgare*, Efor fearne, Ever-fern.

Antirrhinum orontium, Hound's head. *Rubus fruticosus*, Bremel, Bramble. *Achillea millefolium*, Gearwe, Yarrow. This plant seems to have been in high repute as a medicine; no less than sixteen preparations of it are given for as many different diseases. *Mentha Pulegium*, Dwarf Dwosle, Pennyroyal. "This plant is named *pulegium*, and by another name, dwarf dwosle, hath many leechdoms, though many men know them not. This plant is of two kinds (genders), *wer* (man) and *wife* (woman); the *wer* hath white blossoms and the *wife* hath red or brown; either is beneficial and wonder-like, and they have in them wondrous virtue" (fourteen leechdoms are given). *Saxifraga granulata*, Sundcorn. *Artemisia absinthium*, Waremoth, Wormwood. *Atropa mandragora*, Mandrake. "This plant, which is named *Mandragoram*, is great and illustrious of aspect, and it is beneficial. Thou shalt take it in this manner: when thou comest to it, then thou understandest it by this that it shineth at night like a lamp. When first thou seest its head, then inscribe thou it instantly with iron, lest it fly from thee. Its virtue is so mickle and famous that evils immediately flee from an unclean man when he cometh to it; but thou shalt not touch it with iron, but delve about it with an ivory staff, and when thou seest its hands and its feet, then tie thou it up; then take the other end and tie it to a dog's neck, so that the hound be hungry; next, cast meat before him, so that he may not reach it, except he jerk up the wort with him."

* Not to be trodden out or killed.

Veratrum album, Tunsing wyrt (Tungilsing wyrt), from *Tungil*, a star, and *wyrt*, a plant.

Some of the remedies given in the Herbal are ludicrous and harmless, but many of them are disgusting and dangerous, and I should think it probable that the practitioner of the period must have killed more than the diseases he tried to cure. As a specimen of the first-named, I quote the following recipe:—"Against a woman's chatter, taste at night, fasting, a root of radish; that day the chatter cannot harm thee."

One of the cures for cancer was compounded of no less than forty-two plants made into a salve with tar.

In many cases certain magical rites accompanied the preparation of the medicine, and in others a certain number of Paternosters. The following remedy for lunacy has the merit of simplicity. "In case a man be a lunatic" (*monath seec*, monthly sick, in allusion to the paroxysms supposed to occur when the moon was at the full), "take skin of a mereswine [porpoise], make into a whip, swinge the man therewith; soon he will be well. Amen."

THE PEREGRINE FALCON

(*Falco peregrinus*).

THE Falcon now under notice is the perfection of its kind, when carefully and properly trained. The Gyr is indeed a larger and stronger bird, and was used for the very best sport; but it is extremely difficult to procure, great expense and trouble have to be incurred to obtain it. It has a very obstinate temper, and requires a great amount of training, while, on the other hand, the Peregrine can be procured in our own island, is more docile and tractable, and does not require such severe training as the Gyr. For these few reasons, it was much more liked, and much more used by falconers.

There was a time when the Peregrine might be found abundantly on the British isles; but, alas! that time has passed; and now, instead of being held in high repute, and tended with jealousy and care, this noble bird is classed with the rest of the "winged vermin," which profusely deck the gable-end of the keeper's house.

In days gone by, the Peregrine was used a great deal in the chase. Falconry in those days was considered a fit pastime for persons of high rank and position in life; but nowadays it is little used. The falcons were distributed according to the rank of the person; thus the Gyr and the Peregrine were for kings and princes, while the other falcons were distributed according to their relative strength, courage, and power of wing, to persons of different degrees of rank. Even the peasant had a falcon allotted to him—the Kestrel (*Falco Tinnunculus*). In falconry the male is called the "Jiercel, and the female *the* Falcon." As in other falcons, there is

great disparity of size between the two sexes; the female being from two to three inches longer than the male; she is heavier in proportion to her size; and she is likewise possessed of more courage.

The Peregrine is a bird possessed of first-rate powers of flight. The final rush, (that is flight, or rush direct on to its prey) is perhaps not so swift as that of the Gyr; but in straightforward flight it is thought by many to fly even swifter than the Gyr. The rate at which the Peregrine flies is exceedingly great, one hundred and fifty miles an hour being computed as *full speed*. The long pointed wings, together with the ample tail of the Peregrine (which enables it to hover, although not to such a degree of perfection as the Kestrel), make escape almost a matter of impossibility, as it can turn with such ease and quickness. The finest flights, which bring out the Peregrine's extraordinary power of wing, are those with woodcocks (*Scolopax rusticola*) and curlews (*Numenius arquata*)—not on account of their excellent flight, but because of their numerous turnings and twistings. Those flights showing the dauntless courage and spirit of the Peregrine, are with the Heron (*Ardea cinerea*). Both the birds being high and graceful fliers, some good sport is seen; and it is only by strategy and great exertion that the Heron is at last brought down a victim. Both strive to fly highest, for whilst below its victim, the Falcon has little or no power; although one has been known to strike from below. When the Peregrine does get overhead, the Heron, as a last resource, throws back his neck and protrudes his bayonet-like bill in the face of his enemy; and in that position awaits its dread onslaught. If the Falcon be rash, and make a dash at its intended victim, it will assuredly be transfixion on the spear-like bill. This seldom occurs, for a good falcon would not do this, but, awaiting its opportunity, would strike the wary Heron on the wing, and if it be successful in disabling its foe, whilst descending to the earth, it would follow close behind, and on the Heron reaching the ground, soon put an end to its existence.

The Peregrine seldom or never strikes with his beak when in pursuit of his prey; always with his formidable feet. So powerful is the force with which the Peregrine strikes, that it has been known to cleave birds open, to sever their heads from their bodies, and even to cut a snipe in two. The Peregrine has been known also to pursue and capture a bird while having another partially eaten in the grasp of one of its claws. The Peregrine spends a great portion of its time on some high cliff by the seashore. It is a sight worth seeing, to behold a Peregrine on one leg on some crag which overhangs the sea, and notice how it launches itself into the air, and, after marking out a victim from a flock of seafowl disporting themselves, dashing in among them, and amidst loud screams of terror bearing off some unlucky guillemot or tern (*Sterna arctica*).

Numerous are the stories that we hear of this bird's dauntless spirit—of its following hunters on the moors, and carrying off the game from under “their very nose” ; of its flying away with the hunted hare, and thus putting the dogs off the scent ; and many others, far too numerous to mention.

Swift as the Peregrine flies, it is seldom it comes

circle, and again awaits its chance. When once the Peregrine has compelled its prey to take cover, it does not wait patiently like the Goshawk (*Falco palumbarius*), but immediately abandons it and goes in search of another victim. In Falconry the Falcon (female) was flown at very large game ; that is, at birds often much larger than itself, and endowed



Fig. 42. Peregrine Falcon (*Falco peregrinus*), on the look-out.

to harm through it ; for if in its flights any obstacle arise—a fence, a huge rock, or some natural rising on the earth's surface—it is cleared as if with a bound. In the final rush at its victim, should it miss its aim (an occurrence which rarely happens), instead of dashing itself against the earth (as one not used to seeing this magnificent bird in his wild nature would be led to expect), it rises in a beautiful

with great strength ; such as herons and ducks, and sometimes even at geese.

The food of the Peregrine consists of the various kinds of aquatic birds, together with grouse, partridges, rabbits, hares, &c. Small birds are consumed entirely, the feathers and bones being afterwards ejected in the form of pellets. Birds about the size of a partridge are carried off to some quiet nook,

and there disposed of at leisure ; but, on the contrary, if the bird or victim be too large and weighty to be carried off, it is eaten on the spot on which it happens to be killed.

All birds alike are dreaded by this depredator. It is even more feared than man ; and should one appear in sight when a flock of ducks or other aquatic birds are enjoying themselves on the surface of some lake, instead of instantly taking flight, as they certainly would if the intruder were a man, they all disappear as if by magic, instinctively knowing that if they take to flight some of them are sure to fall victims. As the Falcon cannot procure them while they are on the water, it tries to compel

The Peregrine is not found in Australia ; but there is a species very similar, which Gould says is quite distinct from it. It is called the Black-cheeked Falcon (*Falco melanogenys*). This is quite as bold as our Peregrine, carrying off and attacking birds twice its own size, and it is said to be quite a favourite with the aborigines. In the United States and the whole of North America there is a bird very similar to the Peregrine ; so much so that many naturalists say they are but local varieties. This is the far-famed Duck Hawk (*Falco Anatum*) of the Prince of Canino, who is one of the few who say this American hawk and its European representative are distinct. I think so too, for the following reasons. The American bird

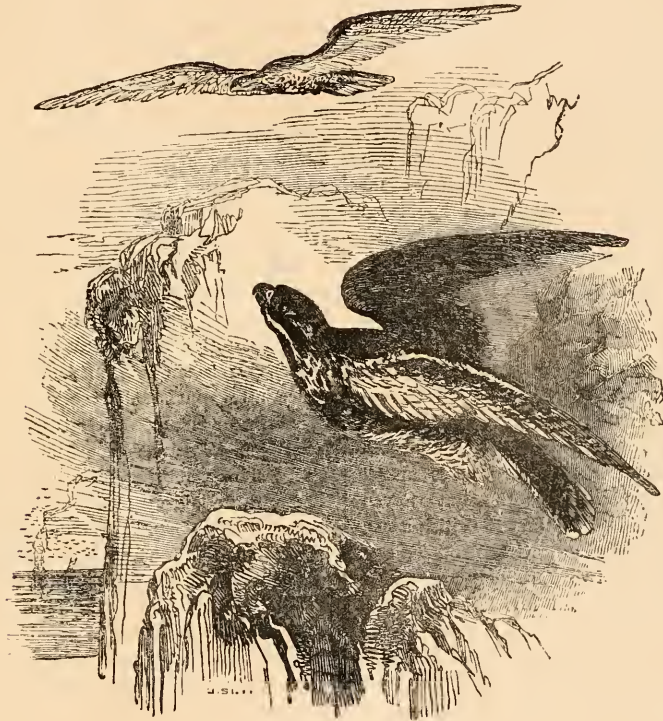

Fig. 43. Peregrine Falcon on the Wing.

them to take to their wings, by performing gyrations immediately over their heads, whenever they appear above water ; thus gaining the desired result of so terrifying them that at last some of them take flight, when of course the Falcon follows in hot pursuit. Sometimes, however, the ducks, instead of diving and seeking safety on the water, all rise in a compact body, and endeavour to procure safety by unity ; but the Peregrine is not to be balked so easily, and soon dashes at some outsider or straggler, and carries it off in triumph. Birds pursued by the Peregrine will often allow themselves to be taken by man rather than fall in the clutches of their pursuer ; so great is their terror of this courageous bird.

is an inch or two the longest, besides being larger in proportion. Again, Wilson says "that it permits the duck to fall previous to securing it. The circumstance of the hawk's *never* carrying off the duck on striking it, has given rise to the belief of that service being performed by means of the breast, which vulgar opinion has armed with a projecting bone, adapted to the purpose." He says the hawk *never* carries off the duck. Now its European ally, the Peregrine, is known often to carry off birds equally heavy as a duck, if not heavier. He says : "In the breeding season the Duck Hawk retires to the recesses of the gloomy cedar swamps, on the tall trees of which it constructs its nest, and rears its young secure from all molestation."

The Peregrine never frequents swamps of any description—always rocky ground. In Thompson's "Natural History of Ireland," vol. i. p. 35, we find the following:—"On two occasions I had opportunities of remarking this falcon (Peregrine) in haunts similar to those which, according to Wilson, it frequents in America." These, however, are not mentioned as a general habit, but rather as exceptional cases. Mr. Mudie says "the Peregrine seldom nestles in low countries and never in marshy ones." Again, Wilson says it constructs its nest on tall trees. The Peregrine has never been known to construct its nest on a tree of any sort,—always on the rocks.

Besides, the natural disposition of the Peregrine leads it to frequent the rocky parts of the seashore or inland lakes, rather than the swampy parts of a country. Not having skins of the two birds at hand, I am not able to point out the difference which I feel quite sure exists, for Mr. Thompson says "that the American birds are larger than the European and of a darker shade of colour." I think, however, I have pointed out the chief differences between the two birds. How a great naturalist like Wilson could have pronounced birds with habits and haunts so strikingly at variance with each other to be the same, I cannot say; but such it is. Be it as it may, the Duck Hawk is not very abundant in the United States, because Mr. Wilson experienced great difficulty in procuring a specimen.

The Peregrine, however, is not the largest of the Falconidæ; the Gyr (including Iceland and Greenland Falcon) being only superior to it in size and perhaps in spirit, but certainly not in the ease and gracefulness of its flight. The Peregrine is also a much more numerous species than the Gyr. Seven species of falcons are to be found in the British isles; viz. the Gyr (*Falco islandicus*), Greenland Falcon (*Falco candicans*)—(these two were long confounded as one and the same bird, until Mr. Hancock took the matter in hand, ably proving, by the aid of numerous specimens of both species, the distinction. Rev. J. O. Morris, in his "British Birds," says he "cannot see it," and puts them both under one name—the Gyr),—Peregrine (*Falco peregrinus*), Hobby (*Falco subbuteo*), Red-legged Falcon (*Falco rustipes*), Merlin (*Falco aesalon*), and the Kestrel (*Falco tinnunculus*).

The Peregrine, like numerous other birds of prey, appears to be less abundant than it really is; yet in no place is it any way numerous. Over the British isles it is generally diffused, and is found in favourable situations either on the coast or in the interior; but chiefly the former. It has been said that every rocky headland around our coast contains a pair of "Blue Hawks." This will show that it is not rare; but if the persecution against all species of falcons or hawks goes on at the rate it has done, we shall have reason in the course of a few years time to regret the absence of the Peregrine from our

coast scenery. The Peregrine is most abundant in Scotland, particularly on its northern and western shores. In Ireland, Mr. Thompson says, "it inhabits suitable localities throughout the island, both marine and inland." In our country—England—it is least numerous; Flamborough Head, on the coast of Yorkshire, is said to breed at least one pair every year; so does the Needles in the Isle of Wight; the Isle of Man; and in a few other situations round the English coast it is known to bring up its young.

The chief attraction which lures the Peregrine to the seacoast is the numerous sea-fowl there to be found. According to different authors, it is found inhabiting the whole of Europe and many parts of the adjoining continents of Asia and Africa.

The Peregrine is rather an early breeder, commencing operations about the end of March or beginning of April. The nest, or eyrie, as it is termed, is placed on those rocks, either on the coast or more inland, which are most precipitous and inaccessible. It spends a deal of time near its nest, occasionally taking a long flight. The nest is a slovenly structure, with very little or no beauty about it, except in its adaption to the wildness of the surrounding scenery. It is built of sticks intermixed with sea-weed and other such-like coarse materials. It is lined with sea-weed or a little hair, or perhaps the nest is entirely without lining of any description. Sometimes the Peregrine takes possession of the nest of the Raven (*Corvus corax*). It is situated on some portion of the precipice jutting out into the sea, or perhaps in a crevice. Wherever it is placed, it is used by the birds for a succession of years. Sometimes no nest at all is made, the eggs being deposited on the bare rock. The eggs are laid very early in spring and are from two to four in number; two and three being the general number; and when there are more, one is smaller than the remainder; probably one of them is added, though four young birds have been taken from one nest, all being of equal size. This was an exception to the general rule. The eggs are of an extremely beautiful and elegant colour. The ground-colour (often not perceptible on account of the predominance of the markings with which the egg is profusely marbled) is of a light reddish-brown, with blotches, streaks, and dots of a still darker shade, elegantly distributed over the surface of the egg. The older the parent bird, the darker, richer, more abundant will be the colouring matter on the egg. Indeed this rule applies to all species of the Falconidæ. It is no easy matter to procure either the young or the eggs of this falcon, on account of the situation chosen, and one has need of a strong nerve, a cool head, and a steady arm before he can essay an attempt. The way in which they are generally taken is by a man being lowered from the summit of the rocks by means of a rope; sometimes, however, the nest is so situated that an expert climber would have no difficulty in procuring them without the aid of ropes.

An account of an eyrie situated on the Isle of Man will perhaps interest the reader :—This eyrie has been situated on the Isle of Man for many years. It is placed on the west side of the island, on the very highest part, the cliffs here rising from the water to a perpendicular height of nearly 400 ft. ; this renders the taking of the nest rather difficult. The eggs or young ones were eagerly sought for year after year by a gentleman or his gamekeeper, who resided on the mainland. If the eggs were taken, they were generally placed under a hen to be hatched. This did not drive away the falcons, and they continued to use the same nest every successive year, although it was repeatedly robbed. When small game was scarce, the Peregrine used to commit great havoc among the rabbits with which the island is overstocked. This rather pleased the keeper than otherwise, as the rabbits are only a nuisance and in the way ; but on the falcon (not content with rabbit) beginning to make too frequent visits to the poultry-yard, one of them was shot. This was in the year 1874. The other, after a day or two spent in hovering round the isle, as if loath to leave its old home, at last quitted the place, and was not seen again until the spring of last year (1876), when either this or another falcon was observed surveying the old place of nidification, looking if it had been disturbed, or perhaps looking if there were a more suitable spot to situate its nest. After a few days spent in this way, and not seeming to fix on any particular position, it disappeared, and had not been seen again in June, 1876. The Peregrine goes by the name of "Falcon Hawk" in the Isle of Man. It is a much-liked bird by all who reside there, and its familiar form, together with its courageous nature, makes its loss seem more apparent ; but of course it was allowed to stay as long as it kept within bounds.

There is (or was a few years since) an eyrie of "Falcon Hawks" at Barra Head, which is much easier of access than the last-mentioned. I am told by the keeper that he captured one when it had but recently learnt to use its wings. It had wandered in a dense fog, and flown down into the court. It was a noble bird, and so much did the keeper appreciate its courageous spirit that he shot sea-birds for it, and with these fed it for over a fortnight. Thinking then that the falcon would best like its liberty, he gave it its freedom. The eyrie on this isle is situated on the south-west side, among some high cliffs ; but as it is placed very near their summit, and as the land rises gradually to the cliffs, it is a very difficult matter to get at it. They were seldom or never molested, but allowed to bring up their broods in peace, and have bred there for a great many years.

The Peregrine is as elegant in both colour and figure as he is in flight. The head and back part of the neck, and a patch below the eye, are of a deep blue-black ; the back and upper half of the wings a darkish blue or slate-colour, while the other half of

the wings is brown. The long ample tail is of a deep dark blue, crossed or barred by still darker bands, getting lighter towards the rump. The breast is of a very light yellowish-brown, and the belly of a darker yellowish-brown. The strong legs, large feet and toes are of a bright, rich yellow, and the claws are black. The base of the bill is yellow, but the beak itself is a blue-black, getting deeper towards the point. The tooth is very prominent in the upper part of the bill. Altogether the Peregrine is a very compact bird, and well fitted for its occupation. The length of the female is from 17 to 18 inches, while the male is only from 14½ to 15½ inches, or about the length of a large female sparrow-hawk.

T. W. DEALY.

DAFFODILS.

"Daffodils
That come before the swallow dares, and take
The wind of March with beauty."

I VENTURE to send a few notes, which for the last two or nearly three years I have made upon this most beautiful of spring flowering bulbous plants. The genus *Narcissus* forms a distinct, and very natural group belonging to the order *Amaryllidaceae*.

The common Daffodil (*Narcissus Pseudo-narcissus*) is distinguished by having the cylindrical cup, longer than the funnel-shaped tube ; the filaments are adnate (or lie) along the lower part of the tube, and the style subulate (*i.e.* not broader than thick, compared to an awl), and three-furrowed. It is characterized by a *perianth*, or floral envelope of six segments, within which is a more or less campanulate or bell-shaped corona, or crown. There are six stamens, which, in the common wild Daffodil, are in one set, and spring from the base of the *corolla-tube* ; in most of the other species the stamens are divided into two sets, and in some cases they are adherent to the *corolla-tube* nearly its entire length, but invariably become free at its mouth, and never adhere to the mouth of the crown, as in other species of this order.

I had a boxful of these elegant flowers sent me last March, and, being invalidated at the time, I carefully watched the development of the flowers as they stood by me in water.

At first, the six stamens, with their long anthers, entirely covered the pistil with its crown-like stigma ; but as the latter ripened, it protruded far beyond, and out of the way of the stamens ; therefore I conclude, that in its wild state it is not fertilized by the pollen of its own individual stamens, but from that of other flowers, carried by bees and other insects, which, I presume, are for the most part the fertilizers of this lovely flower. I would here remark that the

ovary is inferior or adherent to the perianth-tube, three-celled. Fruit a capsule, with several seeds, opening in three valves.

Though the *Daffodil* (*N. Pseudo-narcissus*) is a rare plant in Scotland and Ireland, and in many parts of England, it is by no means uncommon in Staffordshire, being found in Eaves Lane, Stoke Meadows, Bagnall, Baddeley Edge, Stanley Hill, Chorlton, Madeley, Lichfield, &c. At Skeet, a village near

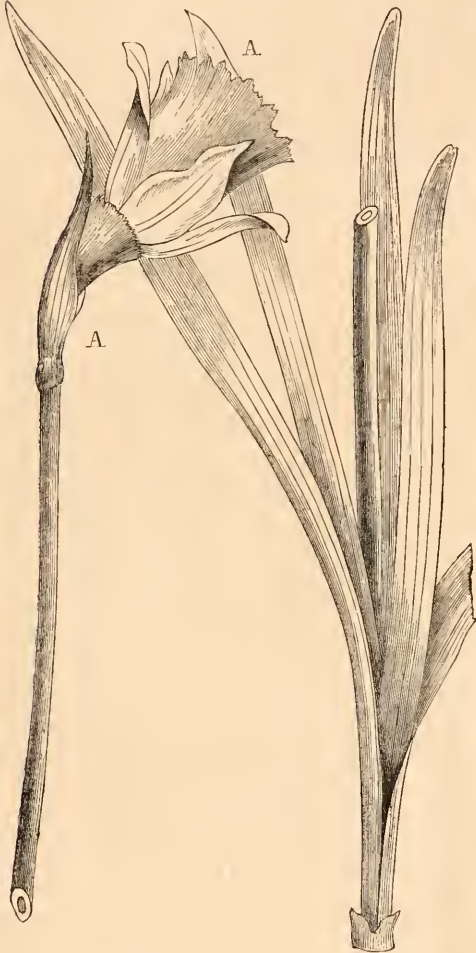

Fig. 44.—A. Daffodil (*Narcissus Pseudo-narcissus*).

Newcastle, the seat of the Rev. W. Sneyde, there is a field called the Daffodil Meadow. It grows also at Trentham, the seat of the Duke of Sutherland. It was in 1873 when, for the first time, I saw the wild Daffodil growing in a rich, lovely part of Staffordshire, near Sandon, the seat of the Earl of Harrowby. The meadows were full of them, looking like a cloth of gold. I cannot find words better to describe the

impression they made upon my mind when I first saw them than those of Wordsworth:—

“I wander'd lonely as a cloud
That floats on high o'er vales and hills,
When all at once I saw a crowd,
A host of golden Daffodils
Beside the stream, beneath the trees,
Fluttering and dancing to the breeze
Continuous as the stars that shine
And twinkle on the Milky Way,
They stretch'd a never-ending line,
Across the margin of a bay,
Ten thousand saw I at a glance,
Tossing their heads in sprightly dance.”

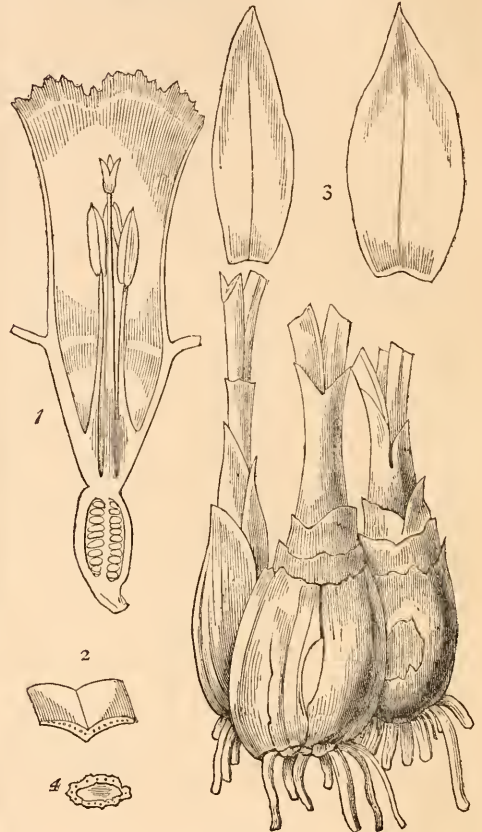

Fig. 45. Floral Parts, &c., of Daffodil.

1. Section of flower. 2. Section of leaf.
3. Leaves of Perianth. 4. Section of *flower-scape*.

It is in moist woods and thickets, as well as in rich meadow-land, we must chiefly look for the Daffodils; though in the orchard belonging to the Hall where I was visiting, they very thickly skirted the margin of a pool; indeed, all growing in this locality were finer and more abundant along the banks of a brook or stream forming one of the tributaries of the Trent.

The popular names Daffodil, Daffodilly, and Daffa-down-dilly, are in all probability corruptions of the word *Asphodel* or *Asphodelus*. The old name Lent Lilies had reference to the time when most of the *Narcissus* family flower, while the name Chalice Flowers had reference to the obconical form of the

corona, which nearly resembles in shape the cup or chalice used for holding the sacramental wine. In 1874 I again visited the lovely spot above referred to, in time to see the pretty village church decorated for Easter-day with this poetic flower, in unison with the Primrose, Rose, and wild Ivy, and very artistic the effect was.

According to some authors, the generic name is derived from the classical story of the youth Narcissus, as related by Ovid and other ancient authors; while Pliny and others derive the generic name from the Greek word *narce*, on account of the narcotic perfume. This is so great that the smell in a close room is said to often cause faintness and headache.

The perianth is of a paler yellow than the corollatube or cup, which is an outgrowth of the perianth.

In Hertfordshire and other counties, an old custom still exists of gathering these flowers, and placing them on sticks, and these bouquets are carried by children into towns while singing the old ditty, "Daffa-down-dilly is coming to town." They term this custom "going a daffying."

Few flowers except the Lily and Rose, have received more fanciful tributes from poets of all ages than this. Herrick's is perhaps the most touching:—

"Fair Daffodils! we weep to see
You haste away so soon:
As yet the early rising sun
Has not attain'd his noon.
Stay, stay,
Until the hastening day
Has run."

Virgil and numerous others have also alluded to these beautiful flowers.

E. EDWARDS.

ERRORS OF INTERPRETATION; WITH
ESPECIAL REFERENCE TO THE EX-
AMINATION OF SCALES OF INSECTS.

BY JABEZ HOGG,

Surgeon to the Royal Westminster Ophthalmic Hospital, Hon.
Member of the Belgian Microscopical Society, &c.

(Read before the Belgian Microscopical Society, Sept. 29, 1876.)

SCALES of insects and other minute objects, when viewed under high-power lenses, and by certain methods of illumination—as by rays of light transmitted in an oblique direction—assume appearances that become sources of error in the interpretation of structure. Even those experienced in the use of the microscope may for a time remain under some misconception with regard to details of objects, or the differentiation of constituent tissue. It has for many years past been my aim, both by teaching and writing, to put beginners on their guard on matters of so much importance.* Nothing in my opinion has more tended towards the promotion and perpetuation of errors in microscopy than the promulgation of in-

flated notions on the value and importance of "amplifiers" and "aplanatic searchers" as accessories to the microscope. Indeed, it is contended that the "aplanatic searcher" is an absolute necessity for obtaining increase of magnification, and enabling the observer to compare the *known with the unknown*; that by its aid we "improve the penetration, amplify magnifying power, intensify definition, and raise the objective somewhat further from its dangerous proximity to the delicate covering glass, indispensable to the observation of objects under very high powers."*

A gentleman of some experience in the use of this instrument, and who has apparently thoroughly imbibed the erroneous views of the author of the "aplanatic searcher," believes that to such an accessory we must look for increase in magnification. He writes: "From the great improvements in object-

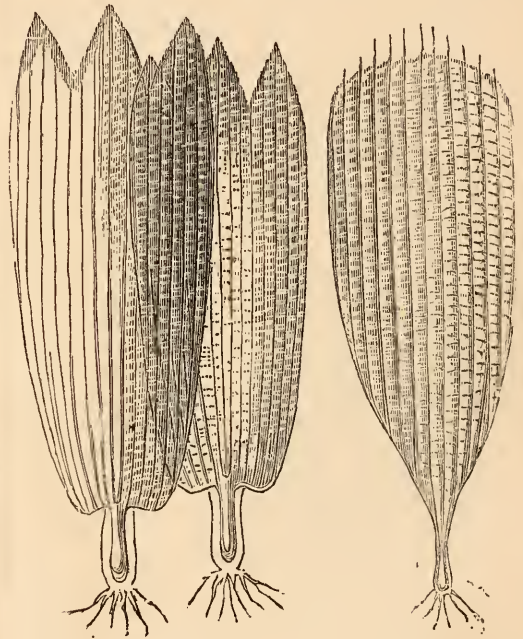

Fig. 46. Scale of Gnat. Fig. 47. Scale of Diurnal Lepidoptera, showing "beading."

glasses made within the last few years, it would be reasonable to infer that opticians have reached the limit of perfection in that direction, and that future progress in the power of the microscope must depend mainly upon the eye-piece or intermediate arrangement of lenses between the eye-piece and object-glass.† He thereupon proceeds to construct an "amplifier" by means of which "the microscope can be increased four or eight-fold without apparent loss of definition." A close examination of "amplifier?"

* See the several editions of my book, "On the Microscope," from 1854 to 1870, pp. 63 *et seq.*

* Dr. Pigott. *The Monthly Microscopical Journal*, vol. iv. p. 62, and vol. v. p. 120.

† The Rev. J. H. Wythe, M.D. *The Cincinnati Medical News*, May, 1876, p. 237.

and "aplanatic searcher" will convince the impartial observer that in principle and in construction they are opposed to geometrical and practical optics, and break down on being put to experimental proof.

Not many years since similar attempts were made to interpose an "amplifier" between the object and field-glass of the telescope; but it led to no practical results. Barlow's lens, an elegant optical toy, is not known to have been the means of making any discovery in the hands of the astronomer; on the contrary, it was, soon after its introduction, discarded because it produced spectral images. That any mere amplifying apparatus should have been seriously proposed for obtaining "transcendental definition" and increasing the power of observers with the microscope, is very surprising. It is asserted by the inventor of the "aplanatic searcher" that in principle the instrument involves the correction of the residuary chromatic and spherical aberrations in the image-pencil after it leaves the objective, and is in course of projection to the conjugate focus. This, it will be observed, is equivalent to asserting that every lens made is, to some extent, imperfectly constructed; and this I suppose no practical optician will dispute. But if this reasoning be followed out to its logical conclusion, we are brought to the strange and almost inconceivable proposition that an objective constructed as nearly as possible on the most rigid geometrical formulæ, but with a residuum of uncorrected aberrations, all its errors are made to vanish by means of the "aplanatic searcher." This contravening accessory to the microscope has been conscientiously employed by a number of practical men; among others, a former President of the Royal Microscopical Society of London. He writes of it, "Even the name of the instrument, a 'searcher,' seems to imply that its application is wholly empirical; even in his own hands it has been observed that while the desired appearance is sometimes speedily produced, at other times a considerable amount of manipulation has seemed to be required for that purpose. Under these circumstances it appears that the controversy that has existed as to the beaded appearance of podura scales must still be considered an open question. Reviewing this, however, under the dictates of common sense, when observing the familiar podura 'notes of admiration,' well defined and free from colour, I cannot resist the inference that in the objective all aberrations are nicely balanced, and the object truly represented in the visual image; on the contrary, when the same object is viewed as rows of ill-defined beads loaded with colours, it is difficult to avoid suspecting that the appearance is a spectral illusion, resulting from some unexplained diffraction or interference; and this suspicion can hardly be dispelled by anything short of rigid mathematical demonstration."*

* Charles Brook, F.R.S. President's Address. *Monthly Microscopical Journal*, February, 1874, p. 94.

Admitting then, that the "aplanatic searcher" does "amplify magnifying power," it is mere amplification, that can be obtained by various well-known eye-pieces, tried, but not even generally accepted, by microscopists. That any piece of accessory apparatus of the kind, "searcher" or "amplifier," should be vaunted as "an improvement," or as a valuable means of "increasing the resolving or defining power" of the instrument, at this advanced age of its history, is to me quite remarkable. That the makers of such accessory appliances have never ventured to exhibit them in public, is also very significant; it is reasonable to suppose that, had they possessed any merit, they would have been the first to bring them prominently into notice, and advocate their employment with a zeal quite equal to that of their inventors. This, however, has not been done; and without entering deeply into the optical principles involved in the construction of the "aplanatic searcher"—and which would involve a fruitless discussion on empirical optics,—it will occur to every practical mind, that, supposing such an accessory to effect some amount of correction—and the *onus* of proof or demonstration rests with its inventor,—it can be unmistakably shown that residuary aberrations should be removed by a more rigid adherence to mathematical formulæ in the construction of the objective, which would involve far less expenditure of optical means, and loss of light, than by any extraneous arrangement of lenses in the body of the microscope.

In what way "aplanatic searchers and amplifiers" tend to increase errors of interpretation rather than the elucidation of structure, is intelligibly explained in Dr. Woodward's valuable communication to the *Monthly Microscopical Journal*, "On the Structure of the Gnat's Body-scale."* "By varying the illumination from a strictly central to a gradually increased oblique condition, all the more familiar phenomena of diffraction can be produced, even to the beaded structure." Microscopists are well acquainted with the fact (and it is almost unnecessary to recall it to the minds of the members of a learned society), that if we interpose minute diaphragms between a strong source of light and an objective, the phenomena of diffraction will be produced. Such objects as gnats' body-scales, podura scales, or the frustules of diatomaceæ, may be regarded as so many minute forms of diaphragms, not necessarily diaphragms in the common acceptation of the term, that is, apertures cut out of an opaque material; but in them we have tissue or substance more or less transparent and refractive in combination, in the highest degree complex, and producing the phenomena of diffraction in almost infinite variety and complexity. The admirable photographs of the gnat's body-scale, made by Dr. Woodward, conclusively prove this, and as effec-

* *Monthly Microscopical Journal*, vol. xv. p. 253.

tually demolish the "beaded structure" theory; or, as Dr. Arrhenius pertinently puts it, "strike at the root of a vast number of descriptions of *quasi*-beaded tissue, said to have been seen in many objects when examined under high power lenses."*

By a simple contrivance, the arrangement of a few thin glass rods placed at right angles to each other, and made to revolve in contrary directions, the late Mr. Hennah demonstrated how easily illusory appearances can be produced and photographically depicted. As the light is made to strike the rods in a more or less oblique direction, a variety of very curious spectral phenomena will appear. These can be considerably varied and rendered more deceptive, as the foci of objects placed behind the rods are made to fall within or upon their front surfaces.† I have repeatedly amused myself by producing "beaded" and other phantoms with a series of rods so arranged. I have also by using a very oblique pencil of light, observed "beads" in many of the scales of Lepidoptera. The drawing fig. 46 was made whilst I was engaged on the paper published in the *Monthly Microscopical Journal*, 1872, "On Gnats' Scales"; fig. 47, a large scale from the wing of one of the diurnal Lepidoptera, was drawn at the same time; both of which convey some idea of "rows of beads," and have since been proved by Dr. Woodward to be illusory or spectral. A thorough investigation of all the circumstances and facts at our command in connection with this question can only lead to one conclusion—that nothing new has either been made out or discovered with regard to the structure of podura or gnats' scales by the aid of the "aplanatic searcher," or "amplifier"; and further, that rows of red, green, and blue "*quasi*-beads," when seen in them, are solely due to diffraction phenomena and increase of chromatic aberration, produced by the introduction of a series of lenses into the body of the microscope. Moreover, the charm of novelty cannot be claimed for these beaded appearances; they were described and figured in the third volume of the "Transactions of the Microscopical Society of London," 1848, by Mr. Warren De la Rue, who described cross *striae* on the scales of *Amathusia Horsfieldii* with "beaded lines or protuberances." When these were focussed at their summits, they appeared as "brown dots."‡ When these scales were exhibited, they were pronounced by competent observers to be "the overlying pigment-cells" between the two layers of membrane. The interference of "overlying pigment" in a corrugated tissue might be expected to produce a delusive appearance, and it scarcely admits of a doubt that the generally received description of the structure of the podura-scale is the

more correct one. The bead-like swellings or dots observed in these scales, and in those of many of the Lepidoptera, are simply aggregations of minute particles retained between layers of membrane thrown into wavy longitudinal folds, again crossed by ribs or *striae*. These, when slightly out of focus, appear as varicose dots or beads.* This is fully confirmed by careful focussing; when first the upper series of varicose ribs come into view, then, by slightly depressing the objective a lower set is seen, the upper set almost disappearing. By another slight movement of the fine adjustment, the true ribs are lost sight of, and the "exclamation dots" come into view, or the object assumes a variety of colours. This train of phenomena is frequently reversed, in consequence of the relative differences between the upper and lower series of *striae*. In the darker-coloured scales or scales slightly charred and broken, the *striae* and pigment are best defined.

The footstalk of the scales of the larger Lepidoptera is sometimes seen filled with colouring matter, of an albuminoid or fatty nature. Scales examined before the insect is dead, or whilst it is under the influence of chloroform, and still attached to the wing, are seen to terminate, not as a simple *stalk*, but as a series of diverging *rootlets*, as represented in the accompanying drawing. I infer, then, that all scales and wings are nourished in a somewhat similar manner as hairs and the epidermal coverings of animals. The colouring matter of the scales heightens the iridescent effects, and aids in imparting beauty and variety to the gossamer wings of the insect tribe. Besides the charm of colour, the scales of Lepidoptera are exceedingly variable in form; being oval, oblong, cordate, curvate, filiform, or capillary; with free ends, rounded, truncate, toothed, &c. These, and other peculiarities, have a certain value for the entomologist in the study of the laws of evolution, variation, and distribution of species, while to the microscopist, all modifications tending towards persistency materially assist in the differentiation of the fauna. In the Lepidoptera especially, changes in form and colour eventuate in that interesting phenomenon, now known as "protective mimicry." I have no hope of presenting an exhaustive examination of these interesting objects, and must content myself on the present occasion with a few brief remarks on a few of the more curious forms of scales, and which, I trust, will induce other workers with more time at command to follow up the subject. Among the diurnal Lepidoptera the scales of the genus *Papilio* terminate in a double footstalk, and somewhat resemble an ancient weapon, a "bipennis." On the anterior wing of *Papilio Polydamus*, two curious scales are found; one leaf-shaped, and very pointed, the other not

* *Monthly Microscopical Journal*, vol. xv. p. 256.

† *Monthly Microscopical Journal*, vol. v. p. 195.

‡ Warren De la Rue, F. R. S. &c. "On the Markings on the Scales of *Amathusia Horsfieldii*," *Microsc. Soc. Trans.*, December, 1848.

* See Dr. Woodward, "On the Structure of the Podura Scale," *M. M. J.*, vol. v. p. 158; also, Dr. Maddox, "On the Structure of the Scales of some of the Lepidoptera," *M. M. J.*, vol. v. p. 247.

unlike a footprint in sand. *P. Agamemnon* exhibits a singular variety: the footstalk is to one side of a filiform scale, scarcely distinguishable, except under a high power, from hairs. These are toothed at their upper extremity. Another scale, almost peculiar to the species, is diamond-shaped. It bears a close resemblance to the ace of diamonds. The scales on the under wing of *Parnassus Apollo* are for the most part leaf-shaped, but more obtuse than those of *Papilio Polydamus*; whilst certain scales of *Parnassus Phœbus* very nearly resemble those of *P. Apollo*. They occupy different positions,—a diversity between two closely-allied species worth noting, and of service in the determination of specific identity.

From the pretty little genus *Thais*, one of the Mediterranean fauna, is obtained an elegant scale, in form resembling a single flower of the Lily of the Valley, and may, in future, be distinguished as the "Lily-scale." *F. Cassandra* furnishes, besides the "Lily-scale," another of an irregular shape, three-pointed, elongate, and not unlike an ancient partisan or halberd. *Anthocaris Eupompi* (Orange-tip), of Sierra Leone, furnishes us with a white scale, irregular in form, and with a double footstalk: its orange scales have triple footstalks, and are remarkably attractive objects under a medium power. Seen in clusters on the wing, they form a brilliant prismatic band of a golden hue. The scales of *Pieris Daphnice*, although leaf-shaped, are widely cleft; while those of *P. Belia* afford typical examples of the "battledore scale." The scales of *P. Pyrrha* differ in the two sexes, and are diversified in form and other characters. Triangular scales, confined to the anterior portion of the wings, are found in all the *Callidryas*, and among the genus *Colias* the lily-shaped scale prevails. A somewhat remarkable scale is found on the wing of the female *Colias Edusa* (it is something like a *phial-bottle*), and in an Indian species an arrow-headed scale. A wing scale of *Idea Hestia* bears a striking resemblance to a fragment of sea-weed (*Fucus*). It is triangular in form, and deeply serrated, while scales taken from other portions of the wing are very nearly square. Among the beautiful species *Argynnida*, a very few scales presenting variety are found. One bears a resemblance to a palm-branch, and for this reason may be designated the "palm-branch scale."

From these cursory observations it will be seen that the scales of Lepidoptera present attractive variations, which furnish evidence of that beauty of design that generally pervades the works of Nature.

OUR COMMON BRITISH FOSSILS, AND WHERE TO FIND THEM.

No. IV.

By J. E. TAYLOR, F.G.S., &c.

MY readers will have seen from the illustrations accompanying the last article on this subject, the strong external resemblances between the earliest King-crabs, such as the *Belinurus*, and one genus of Silurian Trilobites (*Trinucleus*). The chief apparent difference is in the ends of their bodies, that of the King-crab being prolonged into the dart shape which gives to it its generic name, whilst in the *Trinucleus* it is round. But we have only to glance at figures of various kinds of Trilobites to see that they vary among themselves in this respect. Thus in *Asaphus caudatus* (fig. 13), one of the commonest of Lower Silurian Trilobites, we have the pygidium, or tail, drawn out into a point.

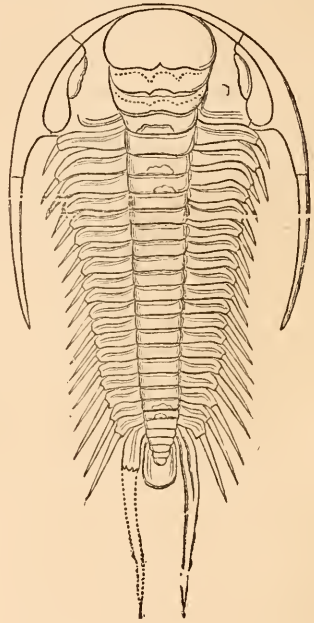

Fig. 48. *Paradoxides Davidis*.

Undoubtedly the *Trinucleus* (fig. 17) is one of the prettiest of Trilobites. It has a look which suggests the mysterious Egyptian figures of ancient courtiers! The head or cephalic shield is much developed, and on each side is prolonged into two spines half as long again as the body. Like the *Agnostus* and several others, the *Trinucleus* had no eyes. In this respect we find the various genera of Trilobites differing very much from each other. Some have a very large number, as *Asaphus tyrannus*; and thence we find them decreasing until they are absent altogether. All the genera of the order *Trinucleida*, however, are not eyeless; and this illustrates the uncertainty with

THE DOMESTIC CAT (p. 43).—The cat is mentioned in Baruch, ch. vi. (the Epistle of Jeremy). In ver. 21, the prophet, describing the helplessness of the idols in the heathen temples at Babylon, says:—"Upon their bodies and heads sit bats, swallows, and birds, and the cats also."—*W. R. Tate, Blandford.*

which the power of vision seems to have been distributed among these ancient crustaceans. Doubtless, this variation was the result of special conditions of existence, eyes being always possessed when they were required. Thus the living male *Bopyrus*, or shrimp-parasite (fig. 20), has rudimentary eyes, whilst

Undoubtedly many of the fossil Trilobites we meet with in any of the above rocks, are *moult*s,—that is, portions of the carapace thrown off after the manner of the shells of lobsters and crabs. This moulting process appears to have peeled off the external hard shell in two or three pieces. Thus, the head-piece or

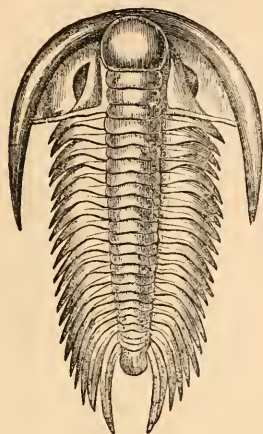

Fig. 49. *Paradoxides Tessini*.

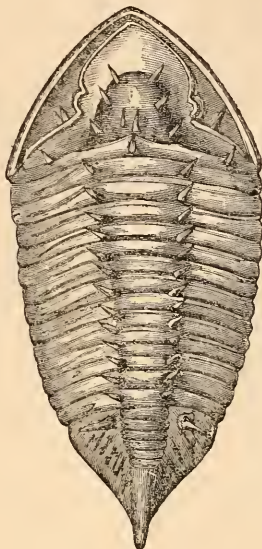

Fig. 51. *Homalanotus*.

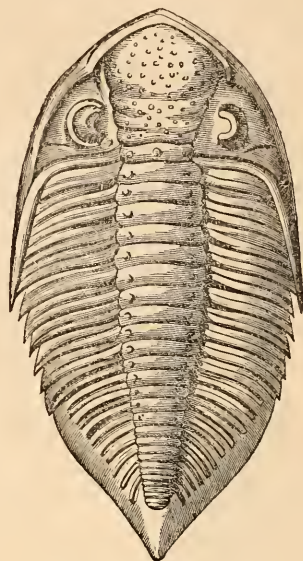

Fig. 52. *Phacops caudatus*.

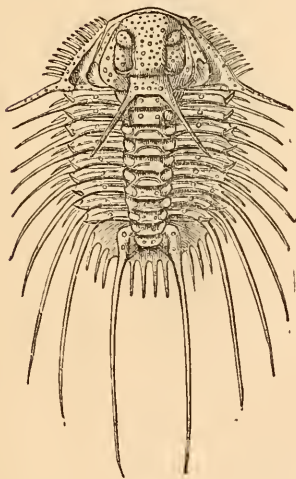

Fig. 50. *Acidaspis Dufrenoyi*.

the female has none; but this is entirely due to the very different habits of life of the two sexes. *Trinucleus* is abundant in the Caradoc shales of Shropshire.

From the Cambrian to the Carboniferous formations we find certain Trilobites peculiar to the various geological systems. Thus, *Paradoxides* and *Agnostus* are peculiarly Cambrian; *Trinucleus* and *Asaphus* are almost exclusively Lower Silurian; *Phacops* and *Calymene* are markedly Upper Silurian; *Brontes* and *Harpes* are among characteristic Devonian fossils; whilst *Phillipsia* and *Griffithsides* are genera of small Trilobites—the last of their race—which are peculiar to the Carboniferous limestones.

cephalic shield, is usually found alone; the thorax, or ringed part, is also abundantly found separate; whilst the pygidium, or tail, is frequently met with apart

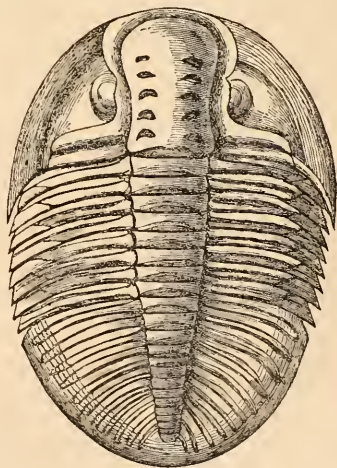

Fig. 53. *Ogygia Buchii*.

from the others, although it is usually adhering to the thoracic part. Of course, animals which have died and been buried in the mud are found with all the above parts adhering to each other. The carapace or shell differed in its character in various species. In

some it appears to have been very thin, in others harder. As a rule, it was chitinous, after the manner of the *elytra* of beetles, although there can be no doubt this was often strengthened by the presence of limy matter. In the carboniferous Trilobites (*Phillipsia*, &c.) the carapace seems to have contained more limy matter in its composition than other species. In this genus we always find the moultings in the two parts of body and tail, and head. In the *Calymenes* (fig. 14) the thoracic or ringed part is frequently found by itself, and not seldom the rings are detached, as if the whole mechanism of the coat-of-mail-like armour had become loosened and got scattered about. Undoubtedly the chemical composition of the carapace differed accordingly as the habits of the Trilobites varied.

The Cambrian Trilobites, as a rule, differ from their

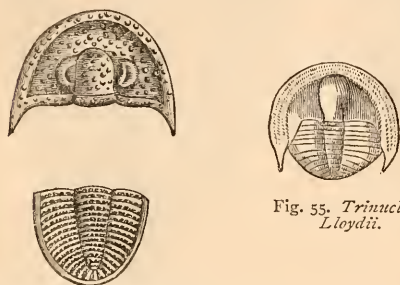

Fig. 54. Head-shield and Caudal shield of *Phillipsia*.

Silurian descendants and representatives in having a larger number of rings or segments to the thoracic (or middle) part of the body. The tail part (caudal shield) is, however, less developed than in the Silurian species. The side-lobes of some genera, *Paradoxides* and *Acidaspis*, are fringed, and, in the case of the latter, further adorned with spines. Some of these may have been sexual distinctions, although we are now forced to regard them as specific. Dean Buckland and many other naturalists have regarded an isopod crustacean abundant in the seas around Tierra del Fuego and the Straits of Magellan, as being nearly allied to this group of Trilobites. This crustacean is called *Serolis*. Its cephalic shield has compound sessile eyes, arranged in half-moon-shaped lobes exactly like those of some Trilobites. The segments or joints of the thoracic portion of the body are fringed, as in *Paradoxides*, and there is a movable caudal or tail shield, as in *Phacops caudatus*, an abundant Silurian Trilobite. Only the antennae and mouth-organs differentiate them. But these are very thin and weak, and after death may soon be detached, as various geologists believe was the case with some Trilobites. The legs are fitted for crawling about, but, as is frequent in animals living in sea-water, they are also weak and thin. The *Serolis* is a slow crawler and swimmer, and is usually found on seaweed. Some geologists have imagined that a few

Trilobites had genetic relations with the common *Apus* of our ditches and ponds. Sufficient has been said, however, to show how large a middle space the numerous family of Trilobites occupy. At the one extreme they nearly touch the King-crabs, and at the other the aborted shrimp-parasites, as in the case of *Agnostus*. Perhaps the living *Serolis* better represents the average forms of Trilobites than anything else.

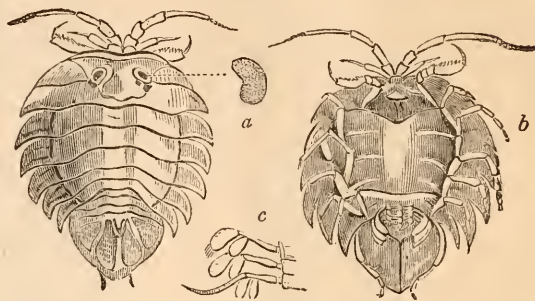

Fig. 56. *Serolis Fabricii*. Fig. 57. Under side of *Serolis Fabricii*.
a. Eyes. b. Feet. c. Organs of Mouth.



Fig. 58. *Apus productus*.

The Cambrian strata have recently been made to extend upwards as high as the "May Hill" group, so as to include rocks formerly classed as Lower Silurian. They are well represented in many parts of Great Britain, notably in North Wales and the Lake districts. Trilobites of various genera may be met with in many localities which are usually visited by tourists for the sake of the scenery alone. It is one of the privileges of the geologist, that his calling takes him to some of the wildest, grandest, or most beau-

tiful scenes in nature. Although, in not a few instances, rich fossiliferous strata occur in unlovely places, amid densely-populated neighbourhoods, as at the Wren's Nest, near Dudley; yet as a rule fossils are most abundant where the rocks crop out along mountain or hill sides or sea-cliffs. In searching for them he startles the grouse or the moor-fowl, finds many a lovely mountain plant solitarily blooming, and inhales fresh air which seems to him like draughts of old wine! Scenes of unsurpassed loveliness are thus revealed to him, in the grandeur of rock-masses, or the panoramic stretch of the valleys below and beyond. What wonder if men who have had to toil the year round for the bread which perisheth, in dingy offices or amid the noise and bustle of machinery, should so value the week or two of summer holiday, which enables them to devote themselves to those geological pursuits which have all the charm and excitement of hunting without any of its cruelty! For, if the geologist wish to change the area of his labours from the mountain-side to the sea-side, he can do so at leisure, without interfering with his success in fossil-hunting. Some of the very best sections are those to be seen in our sea-cliffs—some of the richest fossiliferous districts are where the student may be taking in a fresh stock of health whilst he is following his bent, and have silently impressed on his memory scenes of beauty which will last as long as his own individuality! Perhaps it is this direct contact with Nature in all her varied moods which makes such enthusiasts of geologists. Not even botanists are more devoted to their hobby; and it is undoubtedly this enthusiasm which makes geological investigation not to depend upon companionship for success.

The recent absorption of most, if not all, the Lower Silurian rocks into the Cambrian system has, of course, largely added to the number of localities where fossils are to be obtained. The Menevian beds near St. David's, in South Wales, are exceedingly rich in Trilobites; among which *Paradoxides Davidis*, the largest of its order, is abundant. This species sometimes attains a length of two feet, and is, therefore, strongly contrastable in this respect with the little *Agnostus* (fig. 21) and the *Phillipsia* (fig. 54). The South Welsh valleys are little explored, although the geological student might do so to his double advantage, for they are equally rich in scenery and in fossils. Monmouthshire presents an area of country where we have, perhaps, a more varied geological outcrop than anywhere else in Great Britain. Near Newport a patch of Silurian strata abounds in several species of Trilobites, notably *Asaphus* and *Ogygia* (figs. 13 and 53).

Maentrog and Port Madoc have long been celebrated for their rich yields of Trilobites. The student may obtain them, in many places, from the slates which build up the walls by the roadside, whilst in the quarries there are usually bands or seams especially full of them. Few localities are better worth

a visit, for we are here within the charming circle of Snowdonia. The lower Lingula flags are well developed at Maentrog, and one Trilobite is so abundant in them that it was proposed to call them "*Olenus*" beds. Two species of the obscure little *Agnostus* are associated with it, along with various other fossils. At no great distance up the higher parts of the valley is Festiniog. A diminutive railway, with cars of the same proportion as the narrow diameter of its "permanent way," runs up one side of the valley to Festiniog, and the geological student can take advantage of it in his rambles, and thus pass over the outcrop of beds rich in Trilobites. Another locality for Cambrian Trilobites is the neighbourhood of Dolgelly, a district whose magnificent scenery of wild mountain and umbrageous valley is annually drawing to it a larger number of tourists and visitors. Here *Conocoryphe*, *Agnostus*, &c. may be found in certain places in tolerable abundance. The student might advantageously work his way to Dolgelly by Tremadoc, at which place he will find abundant employment for his hammer. At the village of Penmorfa the slates are often crowded with remains of Trilobites. Garth Hill is also a capital collecting-ground. In many places the Llandeilo flags are so full of Trilobites that Sir Roderick Murchison gave them the name of "Trilobite Schists." Perhaps the neighbourhood of Builth is the best place for obtaining them. Several species of *Ogygia* occur, associated with numerous other fossils.

The Cambrian and Silurian rocks of the Lake district are not so abundant in Trilobites as those of North Wales and Shropshire, although we have found them in the rich fossiliferous shales of Applethwaite Common, and on the Lancashire side of Windermere,—chiefly *Asaphus*. *Calymene*, *Homalototus*, and others occur in the Dafton shales, of Upper Llandeilo age. In the Coniston limestone, also, we have *Illenus*, *Cheirurus*, *Agnostus*, &c., all of them well-marked genera of Trilobites.

In the Silurian proper (the upper Silurian of geologists only a few years ago), we find Trilobites reaching their maximum of existence, both in genera, species, and individuals; and we have tolerably certain evidence that after this epoch they began to decline until they became extinct. In the loveliest parts of North Wales, as at Conway, the Devil's Bridge (near Pentre Voelas), Craig Hir, and at Mynydd Fronfrys, about four miles from Llangollen, among the mountains, we find abundance of fossils, and among them are various species of *Phacops*, *Calymene*, &c. The pretty village of Woolhope, near Hereford, is another charming collecting-ground, rich in Upper Silurian fossils; and here we find *Illenus*, *Homalototus*, *Phacops*, &c. Trilobites are also abundant in the Wenlock shales forming part of the Malvern Hills. Of the Dudley limestone and its treasury of these peculiar ancient forms of life, we have already spoken. The neighbourhood of Ludlow

has also long been known as a rich storehouse of Trilobites of various species and genera.

In the Devonian beds it is only here and there we can meet with Trilobites in any abundance. One of the best localities we know of is Newton Abbot, in Devonshire, where the limestone contains numerous Trilobites. The Pilton beds yield certain species of *Phacops* in plenty. The Trilobites are most abundant in the Middle Devonian strata of England, owing to the probable fresh-water conditions under which most of the other beds were deposited. The carboniferous limestone, both of England and Ireland, is frequently rich in Trilobites of the genera *Phillipsia* and *Griffithsides*, named after two distinguished geologists. At Castleton, in the Peak of Derbyshire, along the outcrop of the strata forming Tre-cliff, is a band especially crowded with *Phillipsia*; and in the curious gorge to the immediate south of the cavern called "Cave Dale" (undoubtedly an ancient cavern with the roof worn off), we may find this Trilobite associated with a wonderfully abundant collection of other fossils. At Salt Hill, Clitheroe, in Lancashire, the shales which part the limestone bands are seen crowded with the evidently moulted remains of *Phillipsia*.

The large number of species, even of British Trilobites, obtained from the various strata above mentioned, are grouped into certain families. We have first the *Agnostida*, characterized by their small size, by the head and tail being covered with two nearly equal shields, and the possession of not more than two body-rings. This family was *eyeless*. The *Olenidae* or *Paradoxidae* had long bodies, with numerous free segments. The caudal or tail shield was small; the side lobes were prolonged into curved spines. A large number of the more ancient genera of Trilobites belong to this family. The *Asaphida* were tolerably large oval Trilobites, with smooth carapaces, and possessed about eight body-rings. *Illanus* and *Ogygia* are included in this group. The *Trinucleidae* had a large head-shield, ending in two long spines, one on each side. The body-rings were five or six in number. The *Cheiruridae* included seven distinct genera, which had a geological range from the Cambrian to the Devonian strata. The facial sutures of the head-shield ended on the outer margin. The number of rings or segments was eleven, and these were free at their ends. The *Talymenidae* had carapaces roughened over with granules or tubercles, and the number of body-rings was usually thirteen. In *Homalonotus*, one of the two genera composing this family, the body-rings are not so distinctly trilobed as usual. *Phacopidae* was a family of Trilobites with large faceted eyes. The number of body-rings is eleven. The *Lichada* had small head-shields, and a tail or pygidium with a broad limb. It contains only the genus *Lichas*. The *Proctida* includes the carboniferous genera *Phillipsia* and *Griffithsides*. Their number of body-rings was

usually nine. The carapace of *Phillipsia* is generally roughened with granules. *Acidaspidæ* had a very ornamental carapace, with eight to ten body-rings, and the segments of the side lobes (pleuræ) directed backwards. The tail had also two or three segments, furnished with prominent spines. The *Bronteida* had a large expanded tail or pygidium. The *Harpeida* were noted for the horseshoe-shaped head-shield, whose angles were greatly prolonged. The body was numerously jointed, usually with twenty-six segments. Only one genus, *Harpes*, belongs to it. Lastly, we have the *Cyphaspidæ*, whose head-shield was also prolonged into spines, and the carapace marked by spiny or pitted surface ornamentations. The number of body-rings varied in the different genera from ten to twenty-two. These are among the less common of the Trilobites. It will give us much pleasure to hear from any correspondents respecting habitats where any genus of species of Trilobite is to be plentifully found.

METROPOLITAN NATURAL HISTORY AND MICROSCOPICAL CLUBS.

THE following is a list of some of the clubs in London devoted to natural history pursuits, &c. :—

Medical Microscopical Society (founded December, 1872).—This society meets at the Century Club, 6, Pall-mall-place, W., on the third Friday of each month from October to May inclusive, at 8 p.m. There is no entrance-fee, and the subscription is 10s. per annum. The members are qualified members of the medical profession and students of medicine or comparative histology whose qualifications are acceptable to the society. The objects of the society are the discussion of questions in normal and pathological histology, medico-legal and medico-chemical microscopy, mechanical and optical arrangements requisite for the proper examination of specimens, the preparation of the same, &c.; the formation of a cabinet of preparations for the use of members, and the exchange of specimens and material. The officers for 1877 are—*President*, H. Power, F.R.C.S., &c.; *Hon. Secretaries*, J. W. Groves, C. H. Golding-Bird.

South London Entomological Society (established 1872).—Meets at the Assembly-rooms, 104, Westminster-bridge-road, S.W. (side entrance). *President*, 1877, Mr. J. Platt Barrett, Radnor-street, Peckham. The society has been formed to promote entomological science in South London. Meetings of the members are held every alternate Thursday, from 8 to 10 p.m., in the above Assembly-rooms, when papers are read, exhibitions of specimens made, and discussions take place. A library is being formed as rapidly as funds will permit, all surplus money being devoted to the purchase of books. The society's room is easy of access from all parts of

London, and the committee cordially invite the co-operation of *all* entomologists, especially those who are willing to further the objects of the society by reading papers and exhibiting their captures. Since its formation the society has rapidly increased in numbers, a large portion of the members being experienced collectors. Subscription, 6s. per annum, with an entrance-fee of 1s. *Hon. Secretaries*—Mr. G. C. Champion, Mr. W. C. Chaney.

Greenhithe Naturalists' Society (founded 1872).—*President*, Rev. J. M. Gatrill; *Secretary*, S. Martin.

East London Natural History and Microscopical Society (founded 1871). *President*, J. M. Knight, Esq.—Meetings held fortnightly on first and third Thursdays in each month, at the Board School, High-street, Bromley. Gentlemen desirous of joining the society can obtain further information from the *Hon. Secretary*, Mr. Harry Smart, 8, The Paragon, Hackney, E.

Tower-hill Microscopical Club (established July, 1872).—Its meetings are held on the second Tuesday in each month, with excursions on Saturdays in the summer months. The Soirée held in February. *President*, Mr. James B. Crosfield; *Hon. Secretary*, Mr. R. Sedgwick.

The Charterhouse Science and Art Society (founded October, 1875).—It has for its object the reading and publication of papers connected with the numerous subjects embraced by science and art, and the collection of objects for a museum which has been established in the school. *President*, Rev. G. S. Davies, M.A.; *Secretary*, S. D. Titmas, B.Sc., F.C.S.

Greenwich Microscopical and Natural History Society. *President*, Prior Purvis, M.D., London; *Hon. Secretary*, Geo. Dannatt.—Meets on the first and third Thursdays in each month. Annual subscription, 10s. Each member supplied gratis with a monthly copy of HARDWICKE'S SCIENCE-GOSSIP, and entitled to two tickets to the Annual Soirée. The last Soirée was held in the Lecture Hall, Greenwich, on February 14th.

[We shall be glad to hear further from the honorary secretaries of other London societies, inasmuch as we hold it to be of importance that the existence of such clubs should be widely known.]

MICROSCOPY.

SECURING COVER-GLASSES.—Your correspondent "A.S.G.," in the January number of SCIENCE-GOSSIP, asks for some plan of securing the cover-glass over dry objects, so that the water used with immersion-lenses will not run in and spoil his tests. Perhaps a plan I have for years adopted may meet his wishes, and therefore, I ask you to find room for this small communication. The method I advocate consists in filling in the angle between the edges of

the covering-glass and the slide with a compound of wax and Canada balsam, which can be easily done by melting this mixture, and dipping a heated piece of wire into it, and then running it round the edge of the cover, and so sealing it up that any cement put on afterwards cannot run in: the wax composition sets directly it touches the cold slide. This plan may also be adopted in mounting any opaque object in a deep cell, allowing the removal of the cover should a dewiness at any time become apparent on its inner surface; it is also a useful thing sometimes to employ this composition for the rapid construction of temporary troughs for the examination of microscopic life, and I hope the knowledge of this may meet the want of "A. S. G.," as well as the many microscopic readers of your journal.—*T. Charters White*.

HELIOPELTA METII.—The separation of the frustule into two valves, with the number of rays differing, is not unusual. I have often found this to be the case, not only in this genus (if it be really distinct), but in *Actinoptychus* the valves themselves often separate into dissimilar plates (and which I designate secondary plates, and called by Schmidt in his Atlas, regeneration-valves); this secondary plate in *Heliopelta* and *Actinoptychus* is usually marked with fine decussating punctate, appearing under a low power like watered silk, or *moiré antique*. The only exception to this, so far as I am aware, is in *A. undulatus*. The secondary plate in this species is faintly but coarsely punctate, the punctæ connected with each other by fine lines; the surface is scarcely undulate, and not divided into compartments like the primary plates. Frustules of *Aulacodisca* also frequently have valves in which the nodules differ in number. I have separated frustules of *A. margaritaceus*, one of the valves having only four, whilst the other had six; and some double frustules have had different numbers on all four valves; this is, however, not peculiar to that species. I have detected it in the following:—*A. Kittoni*, *A. Kittoni*, var. *Africanus*, *A. Oreganus*, and *A. pulcher*. The same thing occurs in *Eupodiscus Argus* and *E. Rogersii*. As entire frustules do not mount well, excepting in front view, the following hint for separating the valves may be useful. Push the specimen away from the other diatoms, and let it dry (taking care, however, that it does not skip away, which it is very apt to do if the valve is uppermost: I always keep the trestle upon it until it is perfectly dry); then transfer it to a drop of water on a clean slide. The expansion of the air inside frequently splits the frustules; if it does not, heat it quickly over the lamp, and success is almost certain. Before the drop dries up, add another, and examine: manipulation with the breath will thoroughly detach them, and also separate the primary and secondary plates.—*F. Kitton*.

CRYSTAL PRISMS OF ALLIUM PORRUM.—The

tissues of *Allium Porrum* (the Leek) abound in crystal prisms. To obtain them with ease, take a small portion from the bulbous part of a boiled leek, and press out on a slide with a little water; examine with a $\frac{1}{4}$ -inch, and myriads of the crystals will be met with. The crystals being very minute, nothing lower than a $\frac{1}{4}$ -inch will be of much use. To mount the crystal prisms use glycerine jelly or damar. Any reader interested at the present time in plant crystals should refer to Professor Gulliver's admirable paper on "Raphides, Sphæraphides, and Crystal Prisms" (SCIENCE-GOSSIP, 1873, p. 97).—*Charles F. W. T. Williams, Redland.*

VARNISHING CELLS.—I often see complaints from some of your correspondents about varnishes running in and spoiling their objects. May I be allowed to suggest a plan which I have tried myself, and which I find answers very well? It is true it can only be applied to a certain class of objects; but where it can be applied, I think it will be of some use—at least to those who, like myself, do a good deal of mounting. The cell (for it is only where a cell is required, and one made with varnish) should be held over a spirit-lamp till the varnish becomes quite sticky; the object should then be placed in it, and the cover gently pressed down till it is hermetically sealed. In an hour or two it will be dry enough to place on the turntable, when, if it is properly done, there will be no fear of the varnish running in. The cell should not be more than two or three days old, as it gets too dry to *soften*, otherwise it will crack when dry.—*E. W., Lewisham.*

THE PYGIDIUM.—Allow me to correct an error. I stated in my paper on the *Pygidium* (p. 15), that I had found a pair on the *Ixodes* of the tiger and Indian bullock. Further examination with a higher power convinces me that these are not *Pygidia* but *spiracles*.—*John Bramhall.*

"HOW TO CHOOSE A MICROSCOPE." By a Demonstrator (London: Hardwicke & Bogue).—We feel personally obliged to the author of this *brochure* for its publication. We are constantly being asked to recommend the "best microscope," and the "best maker." We hardly need say how invidious this task is, and our only answer usually is *silence*. Now, any designing purchaser may learn all about the microscope and its adjuncts. In this pamphlet all the separate parts of a good microscope are explained so clearly that it is impossible to mistake them; and if it were possible, that would be rendered difficult by the eighty illustrations, simple but vigorous, which assist the text. The writer is evidently a man of experience, and knows exactly how to anticipate a student's difficulties and wants. All intending to buy a microscope should first purchase this pamphlet, and those who have one will here learn how they can add to it.

ZOOLOGY.

A FOUNTAIN WITH BELL-JAR AQUARIA.—All who have read our Editor's "Aquarium" must, I am sure, have found much in it that was new to them, and nothing but what was useful. Amongst other practical suggestions, the advantage of a circulation of the contained water is insisted on. Leaving out the cry of trouble—a cry unworthy of consideration—a great difficulty at first presented itself in arranging for circulation in the inverted bell-jar form of Aquarium. What was desired was a waste-pipe that would work automatically, always keeping the water-line constant; for a siphon, when it had reduced an excess of height, would empty itself and would not, unless sucked, work on a fresh accession of water. A hole through the bottom of the aquarium gave the chance of leakage, was difficult to make, and weak-

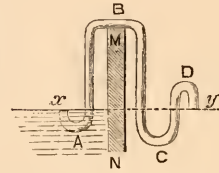

Fig. 59. Simple Hydrostatic Arrangement for Aquarium.

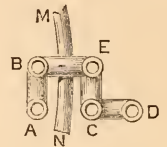

Fig. 60. Horizontal Section of Ditto.

ened the vessel. I was therefore led to devise the following simple hydrostatic arrangement. A glass tube bent in an ordinary gas-flame, after the manner known to all who have dabbled in chemistry, was made to form four curves, as represented. The curves A and C are made in planes, at right angles to those of B and D, which are parallel, so that a horizontal section through *xy*, which represents the water-line, would show the sections of five pipes, A, B, C, D, and E, while MN is in each case the side of the aquarium. The ends of the tube at *x* and *y* must be cut off with a file on the same horizontal line, which must be at the distance from M, the brim of the bell-jar, at which it is desired to have the water-line. Thus, with the aid of the little apparatus described in the "Aquarium" a fountain can, by the means just described, be adapted to an inverted bell-jar, and the tube-apparatus, when once filled, can be removed without emptying itself.—*D. A. K.*

VANESSA ANTIOPA (female) I caught at Cromer November 15th, 1876. This butterfly is in splendid condition.—*A. Savin.*

A NEW SPECIES OF ECHIDNA.—The unexplored area of New Guinea promises to yield many new and perhaps strange species to naturalists. Announcement has been made of a new species of monotrematous mammal which has been called *Tachyglossus Bruinii*. Only two species of this animal, formerly called *Echidna*, and which is nearly related to the *Ornithorhynchus*, had previously been known. The

chief difference in the new species is the greater length of the snout. The entire animal seems to be much greater in size than its Australian brethren.

VARIETIES OF MEDUSÆ.—At a recent meeting of the Linnean Society, Mr. G. J. Romanes read a paper on varieties and monstrous forms of *Medusæ*. He said that among the naked-eyed group of jelly-fishes, with their lowly organization and tendency to budding, monstrosities are comparatively rare. In the cases he had met with, especially in *Aurelia aurita*, the deviations from the normal type always occurred in a multiplication, or abortion, or suppression of entire segments. This affects the segments of the disc in a symmetrical manner, whilst the ovaries and manubrium, to a certain extent, may not be implicated.

ENTOMOLOGICAL NOTES.—July 12th to 31st, at Pegwell Bay, I took *Galathea*, *Alexis*, *Argiolus*, *Polychloros*, *Atalanta*, *Javira*, *Linea*, and *Sylvanus*, very abundant. *L. Quercus* and Satin-moths common. July 15th, took a new specimen of *C. Hyale*, but, although I frequented same locality till end of month, saw no more. Took *Edusa* within 2½ miles of Marble Arch. August 10th, in Warm-lane, Cricklewood, took a ♀ *Edusa*. August 23rd, in field at back of Rockhall-terrace, Cricklewood, took ♂ *Edusa*. Saw another, but unable to catch it. September 6th, saw ♂ *Edusa* in Regent's-park, but unable to catch it, as without net. On February 4th, 1877—unusually warm—captured two 7-spot lady-birds in St. John's Wood-road, N.W. Warm-lane, Cricklewood, is a very fair collecting-ground. Query? What is the proper generic name of *Cardamines*? Mr. Morris says *Mancipium*; Mr. Coleman, *Erichloe*, and Mr. Stainton, *Anthocares*.

THE CLASSIFIED INDEX TO SCIENCE-GOSSIP.—We apologize for the unexpected delay in the publication of the classified index to the twelve volumes of SCIENCE-GOSSIP. The work has been of a more laborious kind than we imagined. We hope, however, it will be issued with the present number, or, at all events, only a few days afterwards.

“THE USES OF ANIMALS TO MAN.”—We are glad to see a reprint of the course of Lectures delivered at the South Kensington Museum, under this heading, by the late Dr. Edwin Lankester, F.R.S. No writer was better able to treat this comprehensive subject than he. The subjects are practical in their importance, and are treated in an unusually suggestive manner. They include “Silk,” “Wool,” “Leather,” “Bone,” “Soap,” “Waste,” “Sponges and Corals,” “Shell-fish,” “Insects,” “Furs,” “Feathers, Horns, and Hair,” and “Animal Perfumes.”

NEW SPECIES OF DEEP-SEA ASCIDIANS.—Mr. H. N. Mosely, naturalist on board the *Challenger* during her three years' cruise, has given an account of two new and remarkable species of deep-sea Ascidi-ans.

One of them, named *Hybithius calycodes*, was brought up from the North Pacific from a depth of 2,900 fathoms. It is stalked and cup-shaped, and is believed to be allied to *Boltenia*. It differs from that genus, however, in possessing a series of cartilaginous plates, symmetrically developed in the soft test. The second species is called *Octacnemus bythius*: this was brought up from a depth of 1,070 fathoms. It is star-shaped, with eight rays. The gill-sac is nearly absent in it, and the usual gill network entirely so. Muscular prolongations of the tunic run into the curious conical protuberances of the test. The nucleus is contracted and small, like that of *Salpa*. This singular species is believed to be without living allies.

SWARM OF LOCUSTS.—It appears that a swarm of locusts passed over Yorkshire last autumn. At a recent meeting of the Entomological Society of London, Mr. McLachlan exhibited some of the locusts, on behalf of Mr. W. D. Roebuck, of Leeds. Mr. McLachlan is of opinion that the species visiting us is not *Pachytylus migratorius*, but *P. cinerascens*, which is supposed to breed in the north of Europe.

LARGE SPECIMEN OF UNIO.—On March 7, 1876, near Repton, Derbyshire, I took a specimen of *Unio tumidus*, 4¾ in. in breadth, 2¾ in. in length, and weighing 4½ ounces. Jeffreys (“British Conchology,” vol. i. p. 34) says, in his article on this shell, “The Rev. A. M. Norman has recorded, in the ‘Zoologist’ for 1857, having taken specimens at Fleckney and Wistow, in Leicestershire, of the extraordinary (*sic*) dimensions of nearly 4½ in. in breadth, and more than 2 in. in length, the weight being over 3 ounces.” It would be interesting to many conchologists besides myself, to know whether any specimens of equal or larger dimensions and weight have ever been taken.—*W. W. Fowler, Repton.*

BOTANY.

“FERTILIZATION OF ORCHIDS,” by Charles Darwin, F.R.S.—We have received a copy of the second edition of this, one of the most striking of all Darwin's works. It was the first to call attention to the various contrivances by which Orchids, both native and exotic, are fertilized by insects; and how the seemingly strange and fantastic shapes and structural parts of these singular plants could only be understood from this point of view. A good deal more has been learned concerning Orchids since Mr. Darwin first drew attention to them, and in this second edition we find all the new discoveries included. We are glad of a reprint of this valuable book, which it has been impossible to purchase for two or three years back, owing to its being out of print.

“THE SYMMETRY OF FLOWERS.” By John Gibbs (Chelmsford: John Dutton, Tindal-street).—

The perusal of this charming little *brochure*, published at fourpence, has given us much pleasure. It sets forth the typical structure of symmetrical and unsymmetrical flowers in a manner that is as clear as it is deeply interesting. The author is an operative botanist, one of those men who follow science for its own sake, and not for its emoluments. Those of our readers who obtain a copy will, we are sure, thank us for recommending it.

OROBANCHE MINOR.—Vegetable phenomena are now things of everyday life. One cannot, with the present knowledge of things, but discover peculiarities in every living organism. It is generally looked for, and generally asked, What is the peculiarity of anything in question? A peculiar phenomenon came under my notice a short time since; viz., several plants of *Orobanche minor* showed themselves happily growing with some geraniums in pots, also with some Bouvardias, and no doubt robbing them of a great portion of food. These plants of *Orobanche* were taken up and placed in other pots, since which time one of them has grown about eight inches. The question arises, How has this growth been sustained? Does *Orobanche* draw up moisture from the soil by its own roots? Have the hairs (which are copious enough) upon the stem and every part, which are always bedewed with moisture, anything to do with the absorption of food? It would be well to have these questions answered. Perhaps the readers of SCIENCE-GOSSIP can throw some light upon the matter.—*J. T. Riches.*

THE SCIENCE-GOSSIP BOTANICAL EXCHANGE CLUB.—The following are the proposed Regulations of the above newly-formed Club. 1. The object of the S.-G. Exchange Club is to facilitate the exchange of dried specimens of British plants. Any lover of botany can become a member, on promising to send a parcel of dried plants, carriage-paid, not later than 7th October, to Messrs. Hardwicke & Bogue, Office of SCIENCE-GOSSIP, 192, Piccadilly, London. 2. Specimens sent for distribution must be carefully dried; must not exceed in size half a sheet of demy (16 in. by 10 in.), and must illustrate the species they represent as completely as possible. Grasses and sedges should on no account be dried without roots. 3. Each specimen must have a label bearing the number and name of the species, as given in the last edition of the "London Catalogue"; also the locality and county where, and the date when, the specimen was collected, and the collector's name. To guide those who have not been accustomed to distribute specimens, we give an example:—

No. 233: GERANIUM ROTUNDFOLIUM, Linn.
Loc.: NEAR CONWAY.
County: CARNARVONSHIRE.
Date: 7th June, 1877.
Collector: JOHN P. JONES.

The label should be attached to the specimen. 4. Each parcel must be accompanied by a list of the plants the member wishes to be sent in his return parcel. This list is to be made by drawing a short line in red ink before their names in the London Catalogue. The name of the member and address should be written on the outer cover of the Catalogue. *Note.*—The London Catalogue can be procured from Hardwicke & Bogue, 192, Piccadilly, London, W., post free, 7d.—Manuscript lists will not be received. 5. From ten to fifty specimens of any rare plant may be sent for distribution, though no common species need be preserved. By looking over the Catalogue any one may be guided as to what example would be acceptable, but none with a greater census than forty should be dried for the Exchange Club. Our friends need scarcely be reminded that neatly-dried and carefully-selected examples of any species are at all times valuable. Members sending the most valuable parcels will have their return parcels selected before those who send inferior ones. 6. Anything that the collector may deem noteworthy must not be written on the label, but on a separate paper: these will afterwards be *published* in the yearly Report. 7. The specimens sent out in the return parcels will afterwards be of great value, from the fact, that each example will pass under the eyes of one of our best British botanists, so as to make each label thoroughly trustworthy. In the case of critical species, or sub-species, all doubtful examples will be placed before a competent authority. 8. About eighty botanists have already signified their wishes to join the Club. May we ask each one of these to secure another name, and to promise the coming season to work with a will? Upon this zealous effort depends our success: let it not be localizing in its tendency, but a national club.

APOCYNUM ANDROSÆMIFOLIUM.—Mr. T. Britain, who communicated the fact of this plant probably being "carnivorous," has forwarded to us the following copy of a letter from Mr. Charles Darwin on the subject:—"I am much obliged to you for calling my attention to the very curious case of the Apocynum. I am quite unable to understand the meaning of this trap-like arrangement. I do not believe that it is of any benefit to the plant, and certainly it is none to the unfortunate insects. I have at present a plant in my hothouse, and if it flower I shall attempt to solve the problem. I may mention that a well-known naturalist in Brazil, Fritz Müller, has been hitherto baffled by trying to understand this plant."

WATER-GLASS.—Can any reader of SCIENCE-GOSSIP give me directions for mounting micro-objects in water-glass? It is mentioned in the Micro-graphic Dictionary, but no directions are given for using it, and it is said to spoil after a time. Is this so?—*A. H. S.*

GEOLOGY.

THE GIGANTIC LAND-TORTOISES FROM THE OSSIFEROUS CAVERNS OF MALTA.—This was the subject of a paper lately read before the Geological Society by Prof. Leith Adams. The author described three extinct species of tortoises from the Maltese rock-cavities, one of which was of gigantic proportions, and equalled in size any of the living or extinct land Chelonians from the Indian or Pacific islands. The characteristic peculiarity in the two larger species is a greater robustness of the long bones as compared with the denizens of the Mascarene and Galapagos islands with which he had been enabled to contrast them. The largest, on that account, he had named *T. robusta*; it rivalled the gigantic *Testudo ephippium* (Günther) in size, showing affinities to it in a few minor characters. A smaller species, *T. Sprattii*, and a small *Lutremys*, not distinguishable, as far as the few remains extend, from the recent *L. europæa*, besides many fragments of shields of tortoises of various dimensions, had been obtained. These Chelonians were found in conjunction with the remains of the dwarf elephants and other members of the remarkable fauna, collected by Admiral Spratt and the author in the ossiferous rock-cavities of Zebbug, Mnaidra, Benghisa, &c. The paper contained a list of the animal remains hitherto recorded from the Maltese fissure-caverns, including three species of dwarf elephants, two species of hippopotamus, two gigantic species of myoxus, a gigantic swan, and other animal remains.

“THE STONE AGE IN NEW JERSEY.”—This is the title of a lengthy paper in the last Smithsonian Report, by Dr. C. C. Abbott, an old and welcome contributor to our columns. It is numerously illustrated, and the author makes out a clear history of the ancient people who were driven forth or exterminated by the original “Red Indians.” From the evidence here carefully accumulated and logically worked out, Dr. Abbott shows how, in New Jersey alone, there is abundant proof of the high antiquity of the human race.

“THE ROYAL SCHOOL OF MINES MAGAZINE.”—Parts 1 and 2 of a new magazine, published by Wyman & Sons, have made their appearance during January and February. It is conducted by students of the School of Mines, and present and past students furnish the well-written and various literature which fills its pages. There are some capital geological articles by Messrs. F. Drew, C. L. Morgan, and others, and other contributions of a high-class character. We congratulate the students on having made a most creditable literary *début*.

THE GEOLOGY OF WALTON-ON-THE-NAZE AND HARWICH.—The Geological Survey of Great Britain have just issued a short memoir, by W. Whitaker, F.G.S., on this district. It is a most interesting

neighbourhood for its complicated geology, but Mr. Whitaker has worked out the details with his usual clearness. The details of well-sections and lists of fossils are most valuable.

HOW TO STRENGTHEN FRAGILE FOSSILS.—Some Tertiary fossils are remarkable for being not only wonderfully perfect *in the rock*, but unfortunately for being also terribly fragile out of it. By soaking such tender specimens in a little dilute silicate of potash and then warming them gently, they are toughened almost instantaneously and can be handled with impunity.—*L. A. G.*

PALÆOSPALAX MAGNUS.—On the 16th of January, 1877, I found, at the Runton Freshwater deposit along the Norfolk coast, a perfect lower jaw of the above extinct species of mole.—*A. Savin, Cromer.*

NOTES AND QUERIES.

EARLY-FLOWERING IVY.—Passing along a stretch of brick wall thickly invested with ivy, on the 15th of September, I was awakened to the fact, through hearing a sonorous hum overhead, that the green blossom, so pleasing to a host of insects, was yielding its store of honey earlier than usual. This must be ascribed to the intense heat of August, which had hastened the development by two or three weeks. This may be agreeable enough to many of the Hymenoptera, which were put upon “short commons” in consequence of the scarcity of wild-flowers through the lack of rain. But, on the other hand, there are various moths to which the ivy-bloom furnishes food, and in a season like the present it does not follow that their emergence from the pupa state will be sooner, to correspond with the flowering of the ivy; for the growth of spring and summer caterpillars is affected, not only by the temperature, but by the condition of the food-plants.—*J. R. S. C.*

TEA-LEAVES AS A MANURE.—The value of tea-leaves as a manure for window plants is undeniable. I first became aware of this from the circumstance of a lady friend being unusually successful with several species of *lilium* grown in a window. On inquiry she told me that they were mulched frequently with tea-leaves. Acting on the hint, I have found the same material excellent in the case of *cyclamens*.—*Rus in Urbe.*

MICA IN THE ARCTIC REGIONS.—Now that so much interest is evinced in everything relating to the Arctic regions, it may not be uninteresting to recall to the minds of your *geological* readers an incident of one of the old Arctic expeditions, which has, within the last few months, received corroboration from our enterprising Yankee brethren. Those who recollect the quaint records of Frobisher's courageous expeditions in search of a passage to Cathay round north-west America may remember that in his first voyage in 1576, one of the seamen happened to pick up a stone as a memorial of his voyage, and that when his wife “cremated” it as a useless trifle, “it glistered with a bright marquetet of gold,” whereupon the gold-finders of London became much excited; and the thrifty Queen Elizabeth advanced part of the money for a second expedition in 1577. On some of the islands near Frobisher's Strait or Cumberland Land

(opposite Labrador) 200 tons of the supposed gold ore were discovered and put on board; but on the return the cargo proved a sadly disappointing one. From the accompanying extract, the Americans appear to have rediscovered this "mine," which proves to be of *mica*, and not of *gold*, as poor Frobisher and the London gold-finners imagined; so that Frobisher's discovery is at last turned to practical account. The brilliant appearance of mica might well deceive the somewhat credulous Jack Tars of the sixteenth century, who took the Esquimaux for "porpoises" or "strange fish" when they first saw them in their "kajaks" (or canoes), and let one old woman go (to her great delight no doubt) as a "devil or witch"; but how the Cockney gold-finners came to mistake mica for gold is indeed a *crux*, and shows the necessity for a little "technical education" in these matters.—*Francis A. Allen.*

BLACK AND WHITE CROWS (?).—I fancy the bird seen by your correspondent, F. M. C. Whittaker, and described by him as a black and white crow, is a stray specimen of the Nutcracker Crow, a bird of rare appearance in the country, and which answers the description given, as to plumage; though the description of its habits, as given in Wood's Natural History, hardly agrees with those given by your correspondent. The following is the description of the bird as given by the authority referred to:—"The Nutcracker Crow, whose true position in the scale of creation has so long bewildered naturalists, is about the size of a jackdaw, but its form is more slender, and the tail is longer. It is seldom found in this country, but is very common in more northern districts. In its habits it displays a singular mixture of the Woodpecker and the Nuthatch, and exhibits so few of the well-known habits of the Crows, that observers might well be perplexed where to place it. It is now supposed to be a connecting link between the Crows and the Woodpeckers. It runs about the branches of trees, using its tail for a support, and pecks away the bark, in order to reach the insects beneath. It also pecks open the fir cones, in search of the hidden seed, and breaks nuts by repeated strokes of its bill like the Nuthatch. It is usually seen in flocks, but is not so wary as the Crows." From the above it will be seen that the habits of the Nutcracker Crow are very dissimilar to those of the bird seen; but from the engraving of the bird, given in the above work, I fancy they are identical, the Nutcracker being speckled something after the manner of a starling.—*Jos. Laing.*

THE NEW INSECTIVOROUS PLANT (*see* January SCIENCE-GOSSIP, page 18).—Your correspondent Mr. Brittain will find a good figure and description of *Apocynum androsaemifolium*, and the mode suggested by which the flower retains the insect entrapped, in the 8th vol. of Curtis's *Botanical Magazine*, plate 280, published November, 1791.—*F. B., Staines.*

CROCUSES CHANGING COLOUR IN THE SHADE.—The influence of light, heat, and soil on the colouring of all plants being very great, I have no doubt but that these three causes combined worked the change of hue A. E. Worcester describes as having taken place in his crocuses. Every vegetable that grows in the shade is pale, but the more plants are exposed to the light the greater the amount of brilliant colouring they acquire. Colour, say sap green, in plants is said to arise from their nitrogen, red from their oxygen, and blue from their hydrogen character; therefore some chemical combinations must, I conclude, take place between the fluids or gases of plants (I do not know the correct term) and the colouring proper-

ties of light. There are three rays (colours) in a beam of light,—red, blue, and yellow, and according to the ray or rays reflected by the flower, so will be its colour. Parts of the colours or rays in a beam of light get absorbed in the body or flower on which the beam falls, and parts get thrown back; reflected, they enter the eye of the gazer, and fix the colour of the flower. The power certain plants have of absorbing light depends on their chemical constitution; so when a flower changes hue, its constitution has undergone a chemical change, and this change may be effected by soil.—*H. E. Watney.*

"VESTIGES OF THE NATURAL HISTORY OF CREATION."—Respecting the unknown authorship of the above work, mentioned in your "Notices to Correspondents," the following passage may not be uninteresting to your readers, which appears in the "History of Booksellers," showing that the late Robert Chambers, of Edinburgh (whose earliest essays, published in his *Journal*, had been upon geology; and to this branch of science, it is said, he became more and more addicted, if not the author, must at least have taken a very prominent part in its production:—"It was known that the proof-sheets passed the hands of Mr. Robert Chambers; and on no better authority than this, not only did the public believe the story, but the 'Vestiges' was entered in the Catalogue of the British Museum under his name. A writer in the *Critic* boldly stated, 'on eminent authority,' that George Combe was the author; and though this was contradicted, and though the authorship is still a mystery, it would appear that Combe had, at all events, something to do with the work. In 1848 Robert Chambers was selected to be Lord Provost of Edinburgh; he was requested to deny the authorship, but his refusal to plead, and his consequent retirement, were probably due to his contempt for people who could make the authorship of a book a barrier to civic honours." Taking the above statements as correct, I think we may infer that either Combe or Chambers was the author, though it will not allow us to fix with certainty on either.—*H. G.*

[The recently published "Life of Robert Chambers," by his brother, has, we believe, no mention of the authorship of this work.—*ED. S. G.*]

EARLY PRIMROSES AND OTHER FLOWERS.—In reply to C. W. H. Chelmsford's observations, I write to say that, at the date he gives (the 1st of January), primroses were out in full bloom all around Hockley, and that tufts of buds had been daily expanding in the hedge of this garden for some time previously. I gathered, on the shortest day in the year, quite a pretty nosegay, composed of primroses, violets, monthly roses, periwinkles, and the exquisitely perfumed flowers of the *Chimonanthus fragrans*. The Blackthorn has been in bloom, in a rather sheltered hedge near the village, for the last three weeks; and an oxlip, one solitary specimen, has likewise put in a claim for our admiration. Snowdrops and crocuses have also come out.—*Helen E. Watney, Berry-grove, Liss, Hants.*

EARLY PRIMROSES.—It may interest some of the readers of SCIENCE-GOSSIP that common primroses were in full flower in Beaumaris, N. Wales, fully six weeks ago, and other plants are equally forward.—*J. S. Riches.*

EARLY PRIMROSES, &c. (p. 45).—In the neighbourhood of Watford primroses have been in flower here and there nearly all through the winter, and from the middle of January the Hawthorn has been in

bloom. At Ware, the Winter Aconite has been in flower since the 2nd of January, and a cowslip was out on the 14th; while the Thrush has been in full song since the 18th of December.—*J. H., Watford.*

EARLY PRIMROSES.—“C. W. H.” will see in SCIENCE-GOSSIP, vol. vi. p. 45, that primroses were gathered in the woods near Hurstpierpoint on Christmas eve, 1869. I have had primroses in flower on a railway bank adjoining my garden since the first week in January, and a friend has had them blooming since November in her garden. Last year mine were in flower from the end of October until the end of April.—*Alicia Bogue, Surbiton.*

STRANGE DEATH OF FOWLS.—Last autumn I noticed that some of my chickens were troubled with over-distended crops, and were not relieved by being made to fast for several hours. A day or two after this symptom first showed itself, the fowls were generally seized with that peculiar spasmodic upward contraction of the crop, such as most birds get after eating plentifully without drinking. This was again followed by a partial paralysis of the legs, owing to which the birds became unable to walk naturally, lifting the feet very high and throwing them far forward, altogether presenting a very awkward appearance; at this stage the bird would grow mopy and ruffled in appearance, yet generally ate voraciously all through the illness, the distention of the crop increasing daily, and the breath growing somewhat offensive after the paralysis showed itself; and death followed in all but two cases (a strong young cockerel and a fine good-sized hen) within three or four days. On making a post-mortem examination, I found all the indications of death by starvation, with this exception—that the crop and gizzard and the duct connecting them were as full of grain and other food as they could be, but all the intestines almost absolutely empty and much emaciated. On opening the crop, I could find nothing to explain all this; but in the gizzard I discovered in one case about twelve, and in another forty shot, of various sizes. The mystery was solved, a clear case of lead poisoning. The fowls had evidently mistaken shot, carelessly spilt in places to which they had access, for some sort of grain, and swallowed it accordingly. All who died with these symptoms (eight or ten in number) I examined, and always with the same result. Three or four I dosed with olive-oil, and among them were the two that recovered,—whether from that, or their own hardy constitution is more than I can say; all that died were young birds, hatched last spring; of all the old fowls, only the hen above mentioned seems to have suffered. Have any of the readers of SCIENCE-GOSSIP ever had such an experience? and if so, have they found any good remedy? I would be much obliged for information on this subject.—*W. T. Van Dyck.*

THE SISKIN OR ABERDAVINE.—This bird used to make its appearance in the vicinity of Beyrout, and through a large region of Lebanon, in the early part of the winter, and stayed till spring, being more plentiful every other year; but now, for the three or four past years, only a very occasional straggler has been seen; and whereas they used to be sold at the rate of two for a penny in the streets, it is now very difficult to find one at all, and then it cannot be procured for less than a couple of shillings or thereabouts. Has this been the case in other than these localities?—*W. T. Van Dyck, Beyrout, Syria.*

SPARROW-HAWK AND CROW.—I owe “J. W. D.” many thanks for pointing out the gross blunder in my note concerning the “Sparrow-hawk and Crow” in the October number. The sparrow-hawk, in the act

of clinging to the church spire, with outspread wings, appeared at first sight to be a large one. I was not undecieved on the point until it flew away from the place, followed by the crow. In writing the note to our paper, describing what I had seen, I gave my first impression as to its size, when I first mentioned that quality, which was a wrong one. The passage, “I found the cause of the commotion to be a large sparrow-hawk,” &c., should read, “I found the cause of the commotion to be a sparrow-hawk,” &c. I have seen it several times since I wrote, and am assured of its unusual smallness. I will also correct a typographical error in the same note. The word “stacks” in the passage, “as he was walking through a field just cleared of stacks of corn,” should read “stooks.” On August 26, while out shooting, my brother killed a sparrow-hawk. Round the bird’s left leg was knotted a piece of string. It must have been on for some time, the string having grown very dark with exposure. My brother did not notice when it was on the wing, that it was impeded by its unpleasant appendage.—*A.P.*

THE HERON.—One of the great advantages of SCIENCE-GOSSIP is, that it elicits correspondence from all parts of the world. I cannot forbear thanking those who have favoured me with facts as to the habits of the Heron. One point only I should like to know supplementarily. Is the Heron a bird of good flavour? In mediæval times it was so considered; but the prevalent idea is that it is far otherwise. Will any one who has recently tasted a heron kindly give me his opinion?—*F. H. Arnold.*

THE BONTREE.—This tree grows in great abundance in a wood on the northern slope of Walsbury Beacon, which is not far from the Devil’s Dyke, Sussex. It has the appearance of having been planted there a long time ago; but young trees are growing up in all directions. Many of them are from eight to twelve feet in height. When I saw them, March 13, 1875, they were flowering profusely.—*W. B. G.*

GEOLOGY, &c., OF LYONS.—I should be glad to receive any information on the Geology, Botany, and Natural History of Lyons, and of the departments of Rhône, Ain, and Isère, or the names of any French books on the subject.—Letters to be addressed to *R. N., 40, Rue des Missionnaires, Lyon, France.*

VOLVOX GLOBATOR (p. 21).—If this is dying out in the immediate neighbourhood of London, it may still be found at no great distance. On the 1st of July it was collected in abundance in the small pools adjoining the Elstree Reservoir, by members of the Quekett Microscopical Club and the Watford Natural History Society, who also found it in pools on Bricket Wood Common, near Watford, on the 3rd of June.—*J. H., Watford.*

BOOKS, &c., RECEIVED.

- “Fertilization of Orchids.” By Chas. Darwin, F.R.S. Second Edition. London: John Murray.
 - “Across Africa.” By Commander Cameron, R.N. London: Daldy & Isbister, 2 vols.
 - “Half-hours with English Antiquities.” By Llewellyn Jewitt. London: Hardwicke & Bogue.
 - “Text-book of Botany.” By Otto W. Thome, translated by A. W. Bennett, M.A., F.L.S. London: Longmans, Green, & Co.
 - “Life of a Scotch Naturalist.” By S. Smiles. London: John Murray.
 - “Monthly Microscopical Journal.” February.
 - “Land and Water.” February.
 - “Yorkshire Naturalist.” February.
 - “Botanische Zeitung.”
 - “Les Mondes.”
 - “Royal School of Mines Magazine.”
- &c. &c. &c.

NOTICES TO CORRESPONDENTS.

TO SUBSCRIBERS.—The compilation of the Classified Index of the last twelve volumes of SCIENCE-GOSSIP has proved a more difficult and painstaking task than we at first imagined. It is now in a forward state of preparation, and we crave a little grace from our numerous correspondents, who have already applied for it.

TO CORRESPONDENTS AND EXCHANGERS.—As we now publish SCIENCE-GOSSIP at least a week earlier than heretofore, we cannot possibly insert in the following number any communications which reach us later than the 8th of the previous month.

M. M.—The "Exchanges" in our last page are mainly confined to Natural History subjects.

W. E. T.—We refer you to "The Aquarium: its Inhabitants, Structure, and Management," just published at 6s., by Hardwicke & Bogue, 192, Piccadilly, for fuller answers to all your aquarium questions than we have space to give. The book is copiously illustrated, and you need not have any difficulty in successfully carrying out your object.

R. W.—Many thanks for your suggestions.

I. CRAWFORD.—Swainson's "Taxidermy" was published by Longmans, at, we believe, 6s. Grattann's "Seaweeds" was published at the Bazaar Office, London, at 2s. or 2s. 6d.

J. W. G.—The specimen sent is *Gorgonia flabellum*.

T. LISLE.—Get Wood's "Insects at Home" (Longmans), the new and, we believe, cheaper edition.

E. H.—Our correction is the right one.

DR. D.—We should advise ringing the slide with asphalt.

R. N. V.—The calculations based on the observations made during the late "Transit of Venus" Expedition have not yet been published.

W. G. P.—The only work we know is Stainton's "Tineina of Southern Europe," 16s. (Van Voorst); Rye's "British Beetles," 10s. 6d. (Reeves).

W. SAUNDERS.—Get Greene's "Insect Hunter's Companion," and Merrin's "Lepidopterist's Calendar,"—both of them cheap books.

C. V. GREEN.—We omitted to say that the specimens of fungi were in a state of deliquescence when they reached us, and utterly unidentifiable.

W. H. LEGGE.—We believe your egg is a lighter specimen than usual of the Blackcap Warbler—not the Garden Warbler.

J. H. P. (North Shields).—We should imagine the "Micrographic Dictionary," published in half-rown parts by Van Voorst, would be the kind of book you require.

W. J. Vandenbergh.—We are afraid your fossil from the Suffolk Coprolite pits has been over-estimated in value. Fragments of deers' antlers are often met with. You had best send it to us for further remark.

H. J. MCG.—Your specimen is the Winter Aconite (*Eranthis hyemalis*), not a truly indigenous plant.

A. W. ROSLING.—You had better send us a specimen. They appear to be eggs of some kind, but we cannot undertake to name them from your drawing.

TO VARIOUS QUERISTS.—We are not aware by whom, or at what price, the volume of the North Staffordshire Field Naturalists' Club (noticed in our last number) is published. You had better inquire of the President, Mr. John Ward, F.G.S., Longton, Stoke-on-Trent.

EXCHANGES.

A LARGE selection of Macro-Lepidoptera in exchange for Pupæ of almost any species.—W. K. Mann, 14, Wellington-terrace, Clifton, Bristol.

OFFERED, Van Beneden's "Animal Parasites" (5s.); Scrivenor's "Greek Testament" (4s. 6d.); Keble's "Christian Year" (3s. 6d.)—all new. Wanted, a good flora, Lubbock's "Wild Flowers and Insects," or other books.—A. R. R., 12, Great College-street, Brighton.

PHOTO Magic Lantern Slides of Diatoms, Parasites, &c., in exchange for other lantern slides; comic or coloured preferred. Also, lot of other photo slides, for exchange or otherwise.—For particulars, address Wm. Tylar, 165, Well-street, Birmingham.

WELL-BLOWN Eggs of Kestrel, Red-backed Shrike, Spotted Flycatcher, Wren, Lapwing, Partridge, Pheasant, Moorhen, and a few others, to exchange for other eggs, side-blown, one hole. Sea-birds particularly wanted.—T. E. Doeg, Evesham.

WANTED, a few perfect Specimens of the Colorado Potato Beetle, in exchange for micro slides, or sections of wood, Foraminifera, &c.—Address, A. H. Searle, 20, Essex-villas, Kensington, London, W.

For exchange or otherwise, an "Amateur" Printing-press type, &c. Also a Binocular Microscope, with apparatus.—Address, E. J. Dickson, Canonbury, Falkland.

LAST four vols. of *Journal of Horticulture*, unbound, and last vol. *Popular Science Review*, unbound, for back vols. SCIENCE-GOSSIP, unbound, Wood's "Natural History of Man," unbound, or other good literature.—A. Lockyer, George-lane, Woodford, Essex.

For a packet of Diatomaceæ, collected last summer from Jersey, send a stamped directed envelope to W. H. Gomm, Somerset, Somerset.

PRITCHARD'S "Infusoria, Living and Fossil," coloured plates, 1841 edition, for good German or French $\frac{1}{2}$ objective, or other microscopic apparatus.—T. Brown, 7, Spencer-street, E.C.

For slides of Pennsylvania Freshwater Diatoms, and Richmond, Va., or New Jersey fossil ditto, send other good slides to E. Penneck, 805, Franklin-street, Philadelphia, U.S.A.

SEVERAL objects to exchange for other slides, or gathering of *Volvox globator* or *Plumatella repens*.—E. Howell, Gasworks, Yeovil.

FOUR dozen well-mounted slides will be given for the first nineteen numbers of the *Transactions of the Quekett Club*.—B., 69, St. Giles-street, Norwich.

FOSILS from Cambridgeshire Coprolites in exchange for others.—A. Floyd, 5, James-street, Cambridge.

WANTED, Wood's "Tourist's Flora" and Gosse's "Marine Zoology." Microscopic slides given in exchange.—Rev. J. J. Muir, Waterloo, Liverpool.

GOOD Diatomaceous Material or Marine Soundings wanted in exchange for good slides.—W. Nash, 11, London-road, Reading.

For specimen of *Puccinea Buxei* and *Peridermium columnare*, send stamped address envelope, to H. Munro, Lyme Regis, Dorset. Any named micro fungi acceptable.

WANTED, past Nos. of *Quarterly Journal of Microscopical Science*, and *Monthly Microscopical Journal*.—T. E. Blomfield, Launton Rectory, Bicester, Oxon.

A FRENCH botanist, M. Gautier, Narbonne, France, wishes to correspond with some one who will send him English plants in exchange for Mediterranean ditto.

TRANSPARENT Coal Sections (E. Spines and others) for good diatomaceous material, recent and fossil.—M. Fowler, 20, Burn-row, Slamannan, N.B.

AMERICAN Land and Freshwater Shells offered in exchange for other foreign or the rarer British species. Send list. Extensive exchanges desired with Continental and Colonial collectors.—Edward Collier, 7, Dale-street, Manchester.

WANTED during the season, Eggs of the larger kinds of Silkworm Moths, especially Regalis. Will exchange British Lepidoptera.—J. T. Willis, Adwick-le-street, Doncaster.

Nos. 386, 389, 390, 558, 865, 1,526, 1,527, 1,537 offered in exchange for others, London Catalogue, 7th edition.—W. J. Hannan, 6, Tatton-street, Ashton-under-Lyne.

WANTED Eggs of North American Game-birds,—Falconidæ or Anatidæ. Can offer British Birds' eggs.—N. B. correspondence invited. All letters answered. T. W. Dealy, 142, Clarence-street, Sheffield.

Utricularia vulgaris, *U. minor*, *U. intermedia*, *U. neglecta*, *Drosera anglica*, *D. longifolia*, in exchange for Microfungi, lichens, or other microscopic objects.—T. Brittain, 8, York-street, Manchester.

COMMUNICATIONS RECEIVED UP TO 9TH ULT. FROM:—
E. T.—W. H. W.—J. H. R.—P. B. M.—J. H. P.—F. B.—
E. F. R.—R. R.—S.—T. W. D.—J. H. N.—N. F. H.—
J. W. S.—D. J.—D. J. P.—A. B. M.—J. F. R.—W. A. L.—
W. J.—V. G.—C. D.—A. H. W.—M. H. A.—H. S.—
G. H. G.—C. J. T. R.—J. S. G.—M. K.—F. S.—W. W. F.—
R. B.—T. S.—J. M. M.—J. J. M.—H. E. W.—C. F. C.—
N. P.—E. P.—W. H. W.—W. H.—F. W. M.—D. D.—
W. T.—V. D.—E. H.—J. P. S.—M. L.—T. F. W.—F. E. H.—
H. T.—I. H. K.—W. K. B.—J. F. R.—T. B. W.—
Dr. G. D. B.—F. A. A.—G. S.—A. S.—R. N.—H. E. W.—
W. H. G.—H. G.—E. C.—M. F.—F. H. A.—W. B. G.—
W. S. B.—J. C. W.—Prof. G. S. E.—F. L.—W. P. B.—
H. P. S.—R. A. B.—T. J. S.—F. B. M.—L. S.—
J. B. S. M. I.—J. W. P.—L. T.—H. G.—H. P. M.—J. T. R.—
—W. W. F.—J. G. M.—J. E.—G. M. D.—T. W. D.—A. J. R.—
—H. T.—W. G. T.—D. A. K.—L. A. G.—J. T. W.—R. T.—
—R. T. G.—F. C.—F. T. M.—Dr. P. Q. K.—Dr. C. C. A.—
A. F.—C. W. C.—E. H.—M. M.—A. F.—A. J.—W. R. C.—
—E. C.—W. E. T.—J. F. G.—W. M.—R. W.—W. G. P.—
—H. W. T.—I. C.—W. L. W. E.—E. W. W.—E. W.—H. G.—
—J. W. G.—W. B. G.—W. K. M.—W. L. S.—D.—W. T.—
—H. E. W.—E. R. B.—T. L.—T. W.—G. C.—W. W.—T. W. T.—
—T. E. D.—W. H. I.—A. D. M.—A. B.—H. B.—W. I. H.—
—A. H. S.—P. W. B.—C. F. W.—T. W.—C. F. W.—
R. M. C.—H. P. S.—Dr. D.—T. F.—A. L.—T. P.—A. M.—
G. L. B.—A. C. C.—R. N. Y.—F. E.—V. B.—F. A.—
—T. W. D.—H. J. Mc G.—A. W. R.—G. D.—H. H.—C. W. B.—
—H. I. T.—J. A. P., &c. &c.



QUARTZ: ITS VARIETIES AND MODES OF FORMATION.

BY THE REV. J. MAGENS MELLO, M.A., F.G.S.



QUARTZ is in its many forms probably the most abundant, as well as one of the most beautiful, of all the various minerals which enter into the formation of the earth's rocky surface. To describe it and its principal varieties, and

to give a short sketch of the modes of its occurrence and of its formation, will be the object of these papers. Among the elements known to chemistry is one named Silicon, sometimes called Silicium; the oxide of this substance, which is never found in a free state in nature, constitutes Silica, the chemical name for Quartz and all its varieties. Its pure crystallized form is familiar to us as the colourless and transparent Rock Crystal.

Rock Crystal.—As Rock Crystal, the typical form of quartz is a hexagonal prism terminated at each end by a rhombohedron, when broken it will be seen to have a conchoidal or splintery fracture. Rock Crystal is very widely distributed, being found in rocks of all ages. The most beautiful and perfect specimens are usually obtained from large cavities or geodes in the older igneous rocks, and also from veins in these and other rocks. The size and colour of quartz crystals vary greatly; some are so small as to be microscopical, whilst others are of very considerable bulk. In the museum of Berne may be seen specimens of both the clear rock crystal and also of black or smoky quartz upwards of a foot in length; there are also some very large ones in the British Museum. Quartz crystals are often found presenting almost every shade of colour,—yellow, brown, black, red, blue, violet, and green. Various names have been given to these coloured varieties. The violet, blue, and some of the yellow, and even of the white crystals, which, when fractured, are seen to have a peculiar undulated structure, which Sir D.

Brewster pointed out, have been classed together as Amethysts, a name often popularly restricted to the violet crystals, which owe their beautiful tint to the presence of oxide of manganese. Violet amethysts are not uncommon in the geodes occurring in volcanic rocks in many localities; but the finest are obtained from Siberia, Persia, India, and Ceylon; whilst Brazil yields white and yellow amethysts. The yellow and brown crystals known as Cairngorms are varieties of rock crystal or of crystallized quartz, if we restrict the term rock crystal to the clear colourless specimens. The darker brown and black crystals, as well as those designated as Cairngorms, may be grouped under the common name of Smoky Quartz. The dark green quartz is called Prase, and is coloured by amphibole; there is also a lighter green species known as Chrysoprase, tinted, it is said, by oxide of nickel; whilst oxide of iron probably gives colour to the numerous red varieties. The common milk-white quartz, which is the ordinary quartz of veins and of quartz rock, will be found, on microscopical examination, to be really transparent quartz, but so full of minute cavities as to cause it to assume its milky opacity.

Quartz Rock.—Quartz Rock, or massive quartz, is often found in mountainous masses, hundreds of feet in thickness. Many of the quartz schists and micaceous schists consist chiefly of quartz irregularly split up by thin leaflets of mica.

Sandstone.—Sandstone rocks, often consisting of little besides more or less rolled grains of quartz, will have been derived from the breaking up, under various denuding agencies, of rocks in which quartz has been the prevailing mineral.

Quartz Veins.—Veins of quartz have already been mentioned. These are very frequent in the old slate and schist rocks, sometimes forming broad and irregular bands; at others, mere threads traversing the other materials. Such veins will often present open spaces in which the quartz will be found regularly crystallized.

Flint, Chert, Hornstone.—Flint and Chert are

forms of quartz usually occurring as concretions in limestone rocks; sometimes, however, as bands of considerable thickness. The black colour so common to the flints of the chalk formation and to the chert nodules and bands in the mountain limestone is due to the presence of carbon. Hornstone is merely a variety of chert.

Chalcedony, Agate.—Chalcedony has been described as a mixture of crystalline and amorphous quartz; its tendency is to assume a botryoidal or stalactitic form; and its numerous variations of colour and modes of occurrence have led to the adoption of different distinguishing names. Carnelians and sardes are only colour distinctions of chalcedony; and the immense family of agates, including the onyx and sardonyx, is more or less composed of chalcedony, disposed in layers, regular or irregular, and combined with other forms of quartz, such as amethyst, jasper, &c. This latter name is applied to an aluminous variety of quartz: it is opaque, and has a less crystalline appearance than ordinary quartz. It is very varied in colour: some beautiful red, brown, and green-banded stones are obtained in Siberia, in Egypt, and elsewhere. Bloodstone is considered to be a mixture of chalcedony and jasper, coloured by metallic oxides.

Opal.—One of the most beautiful forms of quartz is Opal, which is nothing more than amorphous silica combined with water, which has filtered out from the rocks, usually igneous ones, and is found in cavities and fissures in those rocks. Bohemia, Hungary, Auvergne, and Queensland yield opals, some of them of great beauty and value.

Having thus briefly pointed out the principal varieties of quartz, and the modes of their occurrence, we will next turn to the history of their formation. We shall find that quartz may have been formed by more than one process in the grand laboratory of Nature.

According to Cotta, there are two modifications of chemical composition in quartz, which are distinguished by their different degrees of solubility. "The one is insoluble in water and in every acid except hydrofluoric, and the other is soluble in water at high temperatures, especially in the presence of other acids and alkalis." The insoluble variety of quartz may, it is said, in process of time become "converted into the soluble by the contact-influence of infiltrated moisture." It may, however, be noted that ordinary quartz, if fused with carbonate of soda, becomes soluble in water, and from this solution gelatinous silica is precipitated by hydric chloride. Years ago it was noted that silica when combined with an alkali is soluble in water, and that thus the decomposition of felspar might in some instances be a source of silica in solution. The residue of decomposed felspar, when it has been examined, has been found to contain only a portion of the silica due to it, the remainder having been dissolved. In a similar

manner mica is another mineral which may be a source of supply for pure silica. A fact of some importance in studying the mode of the formation of quartz is that, unlike felspar and other minerals, which in crystallizing pass at once from the fluid to the solid state, quartz passes through an intermediate viscous, or colloid condition before it assumes the crystalline form. It is, comparatively speaking, only very recently that we have had any practical acquaintance with this colloidal form of silica. The late Mr. T. Graham, by his most valuable experiments in dialysis, succeeded in obtaining pure silica dissolved in water, which rapidly assumed a gelatinous condition.

The three principal agencies that have taken part in the formation of quartz are heat, water, and organic life. When we examine, by the aid of the microscope, certain forms of quartz, such for instance as the crystals occurring in some of the quartz porphyries, and occasionally in the pitchstones, as well as much of the quartz of granite rocks, we find that they contain minute cavities which inclose very frequently tiny crystals of other minerals; in the quartz of granite these are very often found to be alkaline chlorides, or sometimes the cavities are filled up with glassy mineral matter; as, for instance, in the quartz of some of the Icelandic trachytes. Other cavities are found, especially in the granitic quartz, filled with gas, or sometimes with water, or liquid carbonic acid. In these latter cavities small bubbles will be found which are movable; the smaller ones, indeed, appear to be endowed with a kind of perpetual motion of their own. The quartz in these rocks must have crystallized at a very high temperature,—indeed, where glass cavities occur, from a state of true igneous fusion. Mr. Sorby has shown, in a recent paper,* that the solvent power of liquid water at the temperature of about 412 deg. C. is very great: its action on glass has been such as to produce quartz crystals from it.

There seems to be clear proof that the quartz of the granite rocks which contains partially filled fluid cavities, and cavities inclosing crystals of common salt, &c., has been formed in a partially melted mass of rock, and began to crystallize when that mass was exposed to the solvent action of liquid water, at a temperature not far below 400 deg. C., but yet not sufficiently high to expand the water into steam. Mr. Sorby concludes that "by far the larger part of the quartz in granitic rocks was set free and crystallized through the action of liquid water, at a temperature of a dull red heat, just visible in the dark. The exact temperature may, however, have varied considerably, since if the pressure were not sufficiently great, the water might remain in the form of steam until the rock had cooled somewhat more." It has been noticed as somewhat remarkable that the quartz in granite should have been usually the last mineral

* *Mineral Magazine*, No. 2, 1876.

to crystallize, although it is that one which is the most difficult to fuse, and which would therefore naturally be expected to have been solidified before the felspar and the mica. But it has been shown that when quartz is in combination with other mineral substances, it is often as readily fusible as they are; and thus what must be called accidental circumstances may have led, in the case of the rocks in question, to its being crystallized after the felspar, which we so generally find to have modified the form of the quartz; this latter appearing as a glassy paste inclosing the accompanying minerals, instead of having a definite form of its own. It has also been observed that the felspar in solidifying would liberate a sufficient quantity of heat to enable the quartz to retain its viscous state (Durocher); just as, on the other hand, in the quartz porphyries we see an instance of the analogous effect of the crystallizing quartz upon the felspar. It is asked how the enormous masses of quartz which form some of the schistose rocks can have been produced? We must appeal to metamorphism. The contact of highly-heated eruptive matter might thus alter a quartz or sandstone into an almost pure quartz rock. Heat and pressure combined are mighty agents, which might also effect a similar change during the course of long ages.

That water at a high temperature can hold quartz in solution is well illustrated by the deposits of silicious sinter, thrown down by thermal springs, as, for instance, the Geysers of Iceland, and by others in Kamtschatka and in New Zealand: this silica often encrusts mosses and other substances in the same way that we may see calc-tuff forming petrifications in other localities. The delicate feathery crystallizations of silicious sinter are extremely beautiful.

The quartz of veins appears generally to have been deposited from aqueous solution, and will be seen, as has been already remarked, to contain innumerable cavities inclosing water. Occasionally these watery cavities are of large size, and may be observed without any instrumental aid.

(To be continued.)

THE ENTOMOLOGY OF EPPING FOREST.

EPPING FOREST, being a large tract of beautiful woodland, affords ample scope for pleasure and recreation to the lover of nature; no matter whether a collector of fungi, a botanist, an ornithologist, or entomologist, or naturalist in any shape or form: here is situated, as if for the special benefit of the inhabitants of this great metropolis, a beautiful recreation-ground, in which each can carry on the particular branch of Natural History in which he takes the greatest delight.

To the entomologist, Epping Forest seems to have

a special charm, the glades in the neighbourhood of Servardstone and High Beech being both full of good sport and sylvan beauty. Let us commence our rambles in the old forest in the month of April. The scene of our sport shall be Chincford, and that embarrassing little insect *Pictaria* the chief object of it. It is just getting dark, and as much as we can do to keep our feet out of the little rivulets or brooks which are continually coming in our way; but, lighting our lanterns, which are a great boon for other than entomological purposes, we proceed to examine the blossoms of the Sloe. We are fortunate enough to obtain a few of this local insect, whilst flying about are Geometers, *Badiata*, *Suffumata*, and *Illunaria*, and on sallows in the neighbourhood, Noctuas, *Cruda*, *Gothica*, *Instabilis*, *Rubricosa*, and *Lithorhiza*. In the month of May, when every hedge is showing itself off to its best, and when the air is teeming with insect life, we may with great pleasure take another ramble in the same locality. At Fairmeads Plain, High Beech, we shall be delighted to see flying here and there over the bracken that pretty little fritillary, *A. Euphrosync*, and later on in the month, *Selene*, the small pearl-bordered fritillary, but not so plentifully as her twin sister. In meadows adjoining, and on the outskirts, we may count on getting *Cardamines*, *Argiolus*, *Tages*, and most of the common butterflies out this month; and we may also come across the half-noctuas *Mi* and *Glyphica*, together with those pretty Geometers *Jacobaea* and *Maculata*, and flying about in the sunshine two of the Hooktips, *Hamula* and *Falcula*. On a bright day in this month we shall not return home with empty boxes, and shall have had quite enough to do to set our captures.

The beginning of June is the best time for larva-beating. In the first week we may expect to obtain by beating the Oak the larva of *Thecla Quercus*, and shall by this means be able to procure a far more beautiful and perfect series for our cabinets than by the most careful selection from those obtained on the wing. On blackthorn, *Ceruleocephala* (very plentiful), *B. Cratægi*, and *Quercus*, together with *Thecla Betule*, will reward the perseverance of the collector. In the evening, we may get by dusk, in the neighbourhood of Walthamstow, Geometers, *Petraria*, *Obliquaria*, perhaps *Papilionaria*, and *Russata*; and among the Cuspidates, *Spinula* and *Camelina*; whilst on sugar *Batis* and *Berava* are beginning to appear, together with *Trilinea*, *Psi*, *Plecta*, and hibernated specimens of *Libatrix*. By beating the bushes in the daytime, *Temerata*, the Clouded Silver, will reward our exertions, and not unlikely *Punctaria*, *Atomaria*, and *Prunaria* will come across our path.

July brings many fresh moths and butterflies with us. In the neighbourhood of oak-trees we shall see *Thecla Quercus*, giving us a glimpse now and then of his rich purple colours; but we shall not obtain many

without a long-handled net (say about fifteen feet). Flitting about over the blackberry bushes, and often settling on the blossoms, is *Hyperanthus*, and scudding here and there over the long grass in the glades, basking in the sunshine, are the two common skip-pers *Linea* and *Sylvanus* in great profusion. At High Beech, on the rushes, we shall be pleased to take in plenty that local little butterfly *L. Ægon*, and among the furze-bushes close by *Geometra Palumbaria*, and on the heath we shall perhaps meet *Porphyrea*. Sometimes we may be honoured with a

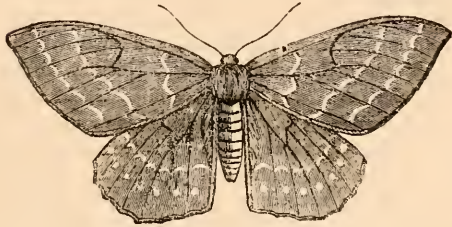

Fig. 61. The Large Emerald Moth (*Geometra papilionaria*).



Fig. 62. Hebrew-Character Moth (*Teneocampa gothica*).



Fig. 63. The Coxcomb Prominent (*Notodontella camelina*).

visit from *A. Adippe*, or perhaps see the chaste underside of *A. Paphia*, flapping his wings whilst settled on the flowers of a neighbouring bramble; but they are neither very plentiful. At dusk we may expect *Rubiginata*, *Syringaria*, and perhaps *Porcellus*, whilst on sugar, *Fimbria*, *Fanthina*, *Puta*, *Oo*, and *Pinastri*, together with many commoner noctuas, occur.

We must now pass on to August, the harvest month, not only to the farmer, but also to the entomologist. On a bright sunny day in this month we may expect *G. Rhamni* in nice condition, on the outskirts and in glades *Thec. Betula* is beginning to make his appearance. Sugaring is now in its prime; on a favourable evening the trees are literally swarming with such insects as *Nictitans*, *Trapezina*, *Pyramidea*, *Typica*, *Maura*, and *Nupta*, with an occasional sprinkling of *Affinis*, *Diffinis*, *Libatrix*, and more rarely *X. Aurago*. Towards the latter end of the month *Xanthographa* and *C. nigrum* begin to make their

appearance, and in the beginning of September *Lunosa*, *Pistacina*, and *Suffusa* are to be met with on sugar. By visiting the neighbourhood of Wanstead, we shall find on the broom the larva of *Pisi* in plenty, and by beating in the same locality, or at dusk, we shall get *Spartiatea*. Later on in the month



Fig. 64. The Herald Moth (*Gonoptera libatrix*).



Fig. 65. Early Thorn Moth (*Selenia illunaria*).



Fig. 66. Early Grey Moth (*Nylocampa lithorhiza*).

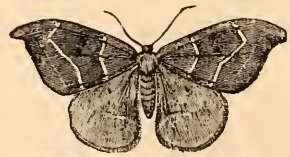

Fig. 67. The Oak Hook-tip Moth (*Platypteryx hamula*).
(Female and Male.)

Oxyacanthæ and *Satellitia* will give us most work at sugar, and almost immediately October commences *Vaccinii* and *Spadicea* will join them. *O. macilentæ* and *Lota* are also to be taken, together with *Exoleta*: these last may also be taken feasting on blossoms of the Ivy.

The part of the year most suited to entomology is over, and we must now be thinking of arranging our captures and looking forward to as pleasant and prosperous a season's sport as we have just enjoyed.

Many are the recollections of past pleasure when we think where this rarity was caught, or the lovely scenes with which this or the other capture is con-



Fig. 68. Maiden's Blush Moth (*Ephyra punctaria*).



Fig. 69. The Flame (*Anticlea rubidata*).

nected; so that often the thought of pleasure gone by is brought back to our memory, and we can really enjoy the pleasure over again. A. J. R.

THE ECONOMICAL PRODUCTS OF PLANTS.

By J. T. RICHES.

THE *Bikh* or *Bish* Poison of *Nepal*.—This most virulent poison is the produce of one or more species of *Aconitum*, which is a very important genus of *Ranunculaceæ*, and characterized by coloured sepals, the upper one being large and helmet-shaped, from which has originated the name of "Monkshood," commonly applied to the plants belonging to the genus. It is well known that *A. ferox*, Wallich, which is thought by some botanists to be a variety of *A. Napellus*, is the principal species from which the poison is obtained, although other species may also yield it. It is obtained from the leaves and roots of the plant. The plant is a native of *Nepal*. The root-stock is perennial, sending up an annual herbaceous stem, with acuminate-lobed leaves, purple flowers, with a semicircular helmet. The poison is used to a great extent in Northern Hindostan for poisoning the arrows used for tiger-shooting. The effect very rapidly reveals itself, for we have read of a tiger shot from a bow in *Assam* being found dead only sixty yards from the spot.

Aconite Root.—This drug is the produce of *Aconitum Napellus*, Linn.; a plant very commonly grown in gardens, and which was originally thought to be indigenous to *Britain*, but that is now open to doubt. It is found wild in the South of *Europe*, and the greater portion of the bulk used in this country is imported from *Germany*. Some, however, is cultivated in this country. The stem is about three feet in height, with dark green glossy leaves deeply pal-

mately divided. Flowers arranged in erect clusters, of a dull purple colour. The roots are clustered and tapering, dark brown externally and white internally. The taste of the fresh root is bitter, but after a while a numbness and tingling of the lips and tongue is experienced. The acrid narcotic principle of the root is due to the presence of an alkaloid known as "Acotine," which is a white amorphous solid substance, extremely virulent; so much so that one-fiftieth part of a grain would kill a cock-robin. The alkaloid is prepared from the roots, and is used, as well as a tincture of the root occasionally, with success externally for the removal of neuralgic and rheumatic pains. And it need scarcely be said, that the greatest caution is necessary in using it. This root has often produced fatal results by being mistaken for horseradish root: probably this has been brought about by taking up the root after the flowers and leaves have died away, as it would be impossible for such a terrible blunder to occur when the plant is in a state of leaf and flower, owing to the great dissimilarity of the two plants in that particular. The root of the *Horseradish* may be distinguished from the *Aconite* by being much larger, of a dirty yellow colour externally, and having rings at the top of the root, indicating the place of fallen leaves. It is advisable that all young students should have in their *Materia Medica*, or *Herbaria*, specimens of each mounted side by side, when the distinction will be obvious enough. Figures of the plant may be seen in Wood's "Med. Bot.," plate VI.; Lindley's "Med. Bot.," p. 151.

Sweet Sop, Sour Sop, Custard-apple, and Chermoyer.—These are the names applied to four very important and largely cultivated tropical fruits, furnished by different species of the genus *Anona*, a genus of trees and shrubs, natives of *South America* and the *West Indies*. The flowers of the genus are somewhat remarkable (although not an uncommon exception) in having several ovaries placed on a receptacle slightly united at their bases, which, before the fruit matures, are completely united into a many-celled fruit. The *Sweet Sop* is the produce of *Anona squamosa*, Linn., a native of the *Malay Archipelago*, as other genera of the family are, but is cultivated in the *East* and *West Indies*. The fruit is ovate, scaly, with a thick rind inclosing luscious pulp, concerning which, however, tastes greatly differ. The *Creoles* greatly fancy it, but the delicate palate of a *European* requires time before the taste is appreciated. The fruit produced in the *Malay Islands* is much superior in flavour to any other. The *Sour Sop* is the produce of *Anona muricata*, Linn., a native of the *West Indies*. The fruit of this species is very large, often weighing two pounds. It is greenish and covered with prickles, with a moderately thick rind inclosing a white pulp of a very agreeable sub-acid flavour. The *Custard-apple*, or *Bullock's-heart*, is produced by *A. reticulata*, Linn., a native of the *West Indies*, cultivated

as well in the East Indies. The fruit is very large, but the pulp is not so much relished as any of the other kinds. The Cherimoyer of Peru is produced by *A. Cherimolia*. The fruit is somewhat heart-shaped, and scaly externally; much esteemed by the natives—nay, thought by the Creoles to be superior to any other fruit in the world, but not so by Europeans, although we have heard Europeans greatly admiring the fruit, and have brought home seeds as relics of remembrance. Specimens preserved in spirit may be seen at the Kew Museum.

Cocculus indicus.—This term is applied to the fruit of *Anamirta Cocculus*, a plant belonging to the family *Menispermacea*, most of which are climbers. The name applied to this drug would lead to the conclusion that it was obtained from the genus *Cocculus*. It must, however, be borne in mind, that such is not the case. It was formerly included in that genus, but has since been separated and established as a distinct genus; the characters, in fact, admit of such a rank.

The characters of the genus *Cocculus* are thus: flowers unisexual, the male flowers with six sepals, six petals, and three stamens; the female flowers with three ovaries placed on a short stalk. The genus *Anamirta* has unisexual, diœcious flowers, with six sepals but no petals. The male flowers have numerous stamens united into one bundle (monadelphous); the female flowers with three ovaries attached to a thick receptacle.

The plant is a native of the East Indies, growing especially in Malabar and the Eastern Archipelago, from whence the supply of this country is obtained. It is a climbing plant with a light-coloured bark. Leaves cordate, smooth, light green, paler beneath; flowers pendulous; fruit slightly ovate, somewhat larger than a full-sized pea, dark brown externally, wrinkled, containing a yellowish, oily, kidney-shaped seed. The quality of this substance is extremely acrid, poisonous, and intoxicating; its legal uses are not very important, while no doubt the illegal uses to which it is applied are otherwise. An ointment, which was formerly more used than at the present time, is obtained from it. It is also used for taking fish. But the amount annually imported far exceeds what is required for legal purposes. Where does the superfluous portion find a home? It is said that the extract is very largely used for the adulteration of porter; and of course the result of such adulteration is to produce giddiness and intoxication; and it is to such wholesale system of adulteration that the many ills which are often heaped upon "malt liquor" may be attributed. The poisonous nature of this drug is due to the presence of a chemical substance known as "picrotoxin." This plant is figured in Wallich's "Asiat. Res.," vol. xiii. Pl. 15, 16; or, what is more desirable, the plant itself may be seen growing in more than one place in the Royal Gardens, Kew.

THE MICROSCOPE IN GEOLOGY.

THE annual address of the President of the Royal Microscopical Society (H. C. Sorby, F.R.S., &c.) for the present year, will, I fear, scarcely meet with the unqualified approval of the "Microscopist." It contains no hints about "pretty objects," &c.; but, for those who look upon the microscope as an invaluable instrument of research, it will be read with much interest. Unlike the usual addresses, it does not contain a *résumé* of the work done with the microscope during the past year. It might be fairly called a lecture on the microscopical structure of rocks, as the following outline of its contents will show:—The application of the Microscope to Geology; Structure of Stratified Rocks; Preparation and mounting of the objects; Object-glasses used. On the Microscopical Characters of Sands and Clays:—Origin of the Material, viz.: Quartz, Mica, Hornblende and Schorl, Felspars, Pumice, Iron oxides, Sorting the material. Practical application of above described: General Principles; Identification of the constituent materials; Application of similar principles to the sections of Rocks; Application of the above to special cases, viz.:—Millstone-grit of South Yorkshire; Sand of Egyptian Desert; Sand derived from Schists, Clays, &c.; Volcanic Ash-beds in British Strata. Conclusion.

The author, after alluding to the labours of "our late distinguished Honorary Fellow, Dr. Ehrenberg," in the study of the organic constituents of rocks remarks that very little has been done in the application of the microscope to the investigation of the nature and origin of loose and unconsolidated sands and clays. . . . Seeing that this great subject had hitherto been so much neglected, and is yet the very foundation of our knowledge of the history of those rocks which constitute a large portion of the accessible framework of our globe, it appears desirable in my address this evening to treat this subject in a systematic manner.

The study of the microscopical structure of stratified rocks is very naturally divisible into two very distinct questions, viz., the nature and origin of the materials deposited, and the changes which have occurred since deposition, but on the present occasion I must almost entirely confine myself to the former.

When the stratified rocks are sufficiently hard to allow of their sections to be made, many facts may be better seen in slices cut perpendicular to the stratification, than by attempting to disintegrate the rock and examine the detached particles. If the particles are held together by calcic or ferrous oxide, or by any of the oxides of lime, they may be set free by the action of cold dilute hydrochloric acid, or by a stronger hot solution, or if not reducible by these means a small stiff brush may be used; but violent mechanical separation by crushing must be avoided. When the particles are separated they should be

attached to the slide by a weak solution of gum, and when dry, mounted in Canada balsam.

In order to detect the minute fluid and glass cavities, an amplification of about 600 linear is desirable. Mr. Sorby states that the Messrs. Beck constructed for him a low angle $\frac{1}{3}$ (75° angle of aperture), which performed admirably.

“In studying loose and unconsolidated sands and clays, little or nothing can be learned respecting the structural arrangement of the particles. Our attention must be almost entirely confined to their mineral nature, external form, and internal structure.

“The examination of a comparatively recent deposit may be extended into comparatively remote epochs, and in a similar manner the study of the ultimate constituents of the very oldest stratified rocks might enable us to form some opinion respecting the nature of still earlier rocks, of which no other record remains. This appears to me to be a question of so much interest, and its solution so dependent on microscopical investigations, that I venture to bring it before you in some detail, even although the conclusions have a more direct bearing on geology than on those branches of science which usually claim the attention of this Society.”

F. KITTON.

EARED SEALS.

BY THOMAS SOUTHWELL, F.Z.S.

Hon. Secretary of the Norfolk and Norwich
Naturalists' Society.

WIDELY distributed on the lonely shores and islands of both hemispheres of the globe, are found certain animals known as Sea Lions and Sea Bears: they belong to the order Pinnipedæ, and are closely related to the true seals (Phocidæ), and Walrus (*Trichechus*); from both of which they are distinguished by the possession of an external ear; hence the family to which they belong is appropriately named *Otariidæ*. Unlike the true seals, which seem to have the head set upon the body, almost without a neck, the eared seals possess a long and remarkably flexible neck and body; and their limbs are so modified as to admit of being used in progression on dry land, with the body raised from the ground. Instead of the short stiff hair of the true seal, they are covered with a coat of coarse hair, longer in some parts of the body than in others, and at the base of which, in some species, is found a thick soft coat of under fur, which, when properly dressed, forms the beautiful “seal-skin” so much prized by the fair sex when made into jackets, &c. These are called Fur Seals or Sea Bears. Those in which the under fur is not present are called Hair Seals or Sea Lions. Mr. J. W. Clark, of Cambridge, in an excellent paper on the “Sea Lions,” delivered at the Zoological Society’s Gardens on April 22, 1875 (forming one of the “Davis Lectures”), and published in the *Contemporary Review* for December, 1875 (to which I am much indebted for

what follows), remarks, that he strongly suspects it will turn out, when the subject has been thoroughly investigated, that all the Otariæ have under fur *at some period of their lives*. Dr. Gray, in his catalogue of the “Seals and Whales in the British Museum,” has divided the family into numerous genera and species, in some cases upon very slight grounds. Mr. Clark, however, is of opinion that in the present state of our knowledge it would be better to retain the original genus, *Otaria*, as founded by Péron in 1816, under which he includes all the species which have been made out with certainty, and which he considers do not exceed nine or ten in number, remarking, however, that as we become better acquainted with the family the number will probably be increased.

Various species of Eared seals are found widely scattered over the seas of the world: commencing in the north, with the Prybilov Islands, in Behring’s Sea, the Aleutian Islands, they extend southward to California and the Galapagos Islands; round Cape Horn and the adjacent islands to the river Plate; the Cape of Good Hope, the far-off shores of Kerguelen’s Land, and the coasts of Australia and New Zealand. The range of some species is very extended; that of others more or less restricted. Space will not allow of my noticing each member of this interesting family, but I will select two individuals, which will fairly illustrate the habits and appearance of the whole.

The best known of the fur seals is the Northern Sea Bear, *Otaria ursina*, which, although almost entirely confined to the islands of the Prybilov group in Behring’s Sea, is there at the proper season of the year found in great numbers. The male, which reaches its full size at the age of six years, measures about nine feet in length, and is dark brown or nearly black in colour, with a grayish tinge about the head, neck, and anterior parts; the ears in both sexes are pointed and slanting backward. The female arrives at maturity at the age of four years, and does not reach above half the size of the male; her colour is silver-gray, becoming darker with age. The young are black at first, which changes to silvery-gray; the under fur is very silky and of a reddish-brown colour. A single young one is produced at a birth, which takes place about the middle of July. In addition to the value of the skin, each fur seal yields a gallon and a half of oil, and the flesh is said to be very good eating. Of the general appearance of the animal the accompanying drawing (fig. 70) will convey a more correct idea than would a long description.

The limbs are encased in a coating of tough bare skin, which extends beyond the ends of the toes of the hind flipper, the toes themselves being nearly equal in length, and the three middle ones armed with claws. The fore flipper has the thumb the longest, and the other digits decreasing rapidly in length give it a very fin-like appearance contrasted with the square margin of the hinder extremity: there are no claws present on the fore flippers. The

eyes are large, glistening, and very expressive. The great haunt of this species during the breeding season is the small group of islands in Behring's Sea, discovered by Prybilov in 1786 and named after him. Upon the discovery of the islands the Russians at once established a fur company there, and, says Mr. Clark, "slaughtered annually, for thirty years, from 80,000 to 90,000 animals, *without regard to sex or system*. About 1817 it was observed that they had diminished in number. Still no change took place. But in 1836 only a tithe of the former number appeared, and then the system was adopted which is practically the same as that enforced at the present day by the government of the United States, to whom the islands now belong" (*Contemporary Review*, vol. xxvii. p. 36). In Scammon's "Marine Animals

middle of July the "rookeries" are full. At this time it has been estimated that on the Island of St. Paul's, with a beach extending for eight miles in length and 129 feet in depth, over three millions of breeding fur seals with their cubs are to be found, and on the smaller Island of St. George are 163,420 more; add to which the yearlings and males under six years of age, estimated at two millions more, and the astounding total of five or six millions of fur seals are found to congregate upon these small islands.

Upon the arrival of the females or "mothers," the duties of the "bachelors" commence: following the females, they compel them to land, when, immediately, down comes the nearest old male, who, with much clucking and many bows, contrives to get between the lady and the water: "then his manner



Fig. 70. Northern Fur Seal (*Otaria ursina*),—after Scammon.

of the North-western Coast of North America" is a long and interesting account of the breeding habits of this species, from which the following is condensed.

By the middle of April the first old males make their appearance at the breeding-places in the Prybilov Islands, and after landing and reconnoitring depart, to return, however, in a few days with the first party of males of all ages; then follow fresh animals daily till all the males of various ages have arrived. The old patriarchs, called "married seals," immediately land and take up their stations in the "rookery," often, it is said, returning to the same spot year after year, each reserving for himself a space equal to about a square rod for the accommodation of the ten or fifteen wives he is expecting shortly to arrive. The young males are compelled to stay in the water, and are called "Bachelors." About 15th June the females begin to appear, and by the

changes, and with a harsh growl he drives her to a place in his harem," alas! only to be seized by the nearest male above, as soon as her lord is otherwise occupied; the new lord in his turn being subjected to the same robbery till the males farthest from the sea have secured their complement of females. The poor "mother" often gets roughly used in thus passing from mouth to mouth (for she is lifted about like a kitten); and, should a fight for her possession occur, is not unfrequently pulled in two. When all the places are filled up tranquillity prevails, the old males keeping order, each in his own harem, and driving off all intruders. The young are born two or three days after all is quiet, and carefully tended by their mothers. By the middle of August the young are all born and the females again pregnant; the old males then resign their charge to the younger males and go off to sea to break the long fast which has

continued during the whole of their stay upon the land. The pups do not take readily to the water at first, but soon learn to love the element in which so much of their future life is to be spent. By the 1st of October the seals begin to leave the islands, the males going last and keeping to themselves.

The seals engaged in breeding are on no account allowed to be disturbed, all those which are killed belonging to the "bachelor" class, and of these only about 100,000 are killed annually, those of two or three years of age being selected. The bachelor seals, as before observed, are not allowed to occupy the "rookeries," but take up their station on the slopes above; they can thus be surrounded and driven

suitable age are allowed to escape and return to the shore; those destined to be killed are driven to the killing-place, some six or seven miles distant (out of sight and smell of the rookeries), by easy stages of rather over a mile a day; here they are allowed to rest and cool themselves, as, if too much heated, the fur is loosened. When required for killing, from 70 to 100 are separated from the flock, driven together, and those selected quickly dispatched by a blow on the nose; the rejected ones are allowed to go to the nearest water, and quickly return to their old haunts. This goes on till the whole flock is disposed of. The skins, after being removed, are salted in bins, and afterwards packed, the flesh sides inward—with a



Fig. 71. Steller's Sea-lion (*Otaria Stelleri*),—after Scammon.

away without alarming the breeding seals. The killing commences in June, but the best months are September and October, although more care has to be exercised then, as at that time a large number of females are mixed with the young males, from which it is difficult to distinguish them (not a single female is allowed to be killed), whereas, earlier in the season, males alone occupy the slopes, and it is only necessary to select those of the proper age. When it is determined to make a drive, a party of men approach quietly and creep between the seals and the shore, when, starting up with a shout at a given signal, they commence driving the seals inland. As they proceed, as many as possible of those of an un-

little fresh salt between them—for shipment. On arrival in this country the skins are properly dressed and the long hairs removed by paring down the flesh side of the skin till the roots of the hairs, which are deeper seated than those of the fur, are cut through; all the coarse hair is then brushed off and the beautiful under fur alone is left; this is at first of a reddish-brown colour, arranged in little curls, which in the subsequent process of dyeing lose their crispness, and the skin, which in the rough was sufficiently unattractive, is now converted into the beautiful silky fur so well known as "seal skin."

By the wise regulations of the American Government an annual rent of 50,000 dollars and a tax on

each skin taken, are realized from the Alaska Commercial Company, to whom the islands are leased, and the breeding herd still maintained undiminished; so that a permanent source of industry and profit is established, which, should nothing unforeseen occur, may continue for an indefinite period. What a lesson to the Governments interested in the northern seal fishery, both in prudence and humanity!

In the South Seas, the fur seals, being unprotected, have been nearly exterminated, slaughtered without regard to sex or age, and their skins so carelessly cured that in one instance 100,000 rotted on the voyage home, and had to be dug out of the ship's hold! Well might a correspondent of Mr. Clark's exclaim, "I should as soon expect to meet a sea-lion on London Bridge as on any one of the islands in Bass's Strait!"

I will now turn briefly to the other section of the Eared seals, the Sea-lions.

Steller, the naturalist to Behring's second expedition in the year 1741, discovered a sea-lion, to which he gave the name of *Leo marinus*, and first described, in a paper published after the death of its author, in the "Transactions of the St. Petersburg Academy for 1751." This species, *Otaria Stelleri* (*Eumetopias Stelleri* of Gray), inhabits Behring's Straits, and the coasts and islands of the North Pacific, its range extending westward to Kamschatka and the islands of the Ochotsk Sea, and southward along the west coast of North America to California and the Galapagos Islands. The adult male varies much in colour from dull grey to black or reddish-brown; the head and neck are much elongated, the upper lip furnished with strong flexible whiskers of a whitish colour; the eyes full and expressive, especially when excited; ears cylindrical, tapering, short, and lying nearly in a line with the body. The female is of a light brown colour. The total length of the full-grown male is about twelve feet, that of the female a little over six feet. Many of my readers have doubtless seen the pair of Steller's sea-lions now living in the Brighton Aquarium; to those who have not, the accompanying figure (fig. 71) will convey an idea of their general appearance. For an interesting account of the habits of this species in confinement and an excellent figure, I beg to refer the reader to an article by Mr. Lee in *Land and Water* for February 5th, 1876.

Although not yielding the beautiful fur of commerce, almost every part of this useful animal seems to be of value to the natives of the coasts on which it is found: the skin forms excellent leather for boats and tents, the flesh is used for winter food; from the lining of the throat the legs of their boots are made, and the soles from the skin of their flippers; a large quantity of oil is extracted from their blubber; even their stomachs, intestines, and sinews, have their uses, and the whiskers are sent to China, there to be used as ornaments by the Celestials. In its habits this species greatly resembles the preceding. Scammon says that, like the fur seal, it congregates in

great numbers at the breeding time, which takes place on the Californian coast from May to August, and upon the shores of Alaska from June to October; but in disposition it is much less shy, frequenting "not only remote and secluded places, but also thickly-inhabited coasts; entering inland bays and rivers; at times disporting itself among the shipping, and quite frequently making some detached rock or reef, contiguous to the busy shore, a permanent abode, where it seems to enjoy its approximate union with civilization." Not far from the city of San Francisco, on an island called the "Seal Rocks," a colony of these animals, wisely protected by the authorities, exists. There in happy security they disport themselves (watched by the inhabitants, who frequent an hotel erected near the spot and called "Ocean House"), sometimes basking in the sun, at others sporting in the waters, into which they plunge from rocks at least twenty feet high, with a mighty splash amid showers of spray, their gambols enlivened by a running accompaniment of incessant barking. At their "rookeries" or breeding-places, the polygamous males are not so fiercely jealous as the fur seals, but, unlike the latter, there appears to be very little attachment between the parent and its offspring, and still less between the lord and his numerous wives. Their food consists of fish, mollusks, and sea-birds, and in the capture of the latter great ingenuity is displayed. During the time they frequent the "rookeries," however astonishing it may appear, little or no food is taken by the males, and not much more by the females. The mode adopted for their capture is similar to that pursued in the case of the fur seal as already described. After the breeding season they disperse in all directions; and in proof of the migratory habits of this species it is recorded, on the authority of Professor Davidson, of the U.S. Coast survey, that a large male sea-lion, killed in June, 1870, on the coast of California, at Point Arenas, in lat. 30°, bore in its body a spear-head such as is used by the natives of Alaska. On the coasts of Siberia and Kamschatka, the sea-lions ascend the rivers to feed upon the salmon, and are taken by the natives in stake nets or captured upon the ice in spring. In the southern regions Scammon says sea-lions escape capture by the feeble Fuegians, but the Patagonians kill them for their skins, which are also inflated by the natives of Chili and Peru and used as boats. In conclusion he remarks that in the far north and south, where they are hunted by the natives solely for domestic consumption, they do not materially diminish in number, but that on the shores of California "they will soon be exterminated by the deadly shot of the rifle, or driven away to less accessible haunts."

The larger Southern sea-lion, *Otaria jubata*, now living in the Zoological Society's Gardens, was brought from the Falkland Islands, where it was captured in 1867; the smaller one, *O. pusilla*, is from the Cape of Good Hope, where it was taken in 1871.

A GOSSIP ABOUT NEW BOOKS.

THE Christmas publishing season was marked by an issue of several scientific and other works from the press, which cannot fail to have great influence. Chief among these may be mentioned Commander Cameron's "Across Africa" (London: Daldy, Isbister, & Co.). The story of African travel and adventure has lost none of its charm by often telling. Cameron was among us last autumn at the Geographical Society, the British Association, and elsewhere, in plain but pithy language narrating his eventful journey. Now we have the full and complete story, in two handsome volumes, crowded with illustrations of scenery, natives, natural history objects, &c. So full of fresh matter is the book that there is little or no room left for those sporting adventures which, we may be sure, were indulged in. The time occupied in this journey across Equatorial Africa was nearly three years and a half. In many places Commander Cameron's was the first European face which had been seen. The entire route was crowded with most interesting and important incidents, so that we can well believe the author when he tells us how his book would have swollen to an unwieldy size had he included his party's adventures and sports. As a work of African travel it stands higher in literary execution than any other. Much as we have heard of African Equatorial exploration in recent years, conducted by German and English travellers, we do not think any writer has kept more to the point in narrating it than Cameron. We say this in no invidious spirit; we have reason to be proud of that glowing spirit of adventure which has impelled all alike to peril their lives for the sake of adding to our knowledge of unknown and important countries. But, in spite of the studied plainness with which Commander Cameron has kept to the strict particulars of his route, the physical characters of the scenery, and the manners and customs of the various countries through which he passed, this rather enhances the charm of his narrative than otherwise. We feel we are listening to a man who has something to tell us that nobody else can narrate. Then, again, no other African writer has so thoroughly exposed the iniquitous traffic in slaves which goes on in Equatorial Africa, nor traced it so thoroughly to its source. If the knowledge of an evil is the first step towards its cure, then we have to thank Commander Cameron for taking that step. Let us hope that the uplifted voice of the civilized world will denounce the curse more vehemently than ever, and yet more peremptorily demand its immediate suppression! In conclusion, we can only refer our readers themselves to this quietly thoughtful and impressive book, and they will rise from its not unexciting perusal, as we have done, all the more prepared to honour the gallant author who bore so patiently evils which other travellers have immediately and cruelly resented, with the

noble spirit of an enlightened and a Christian man.

"The Life of a Scotch Naturalist," by Samuel Smiles (London: John Murray), has created a greater sensation than any other book of its kind. It is a noble record of a brave and noble life. With Thomas Edward, the subject of it, we have from time to time had similar epistolary intercourse to that which we abundantly enjoy with many others of his stamp. It was to ourselves that he appealed in the case of the "auld been," figured on page 369 of this work; and it was in the "Answers to Correspondents" of our pages that it was finally named from the photograph Thomas Edward sent us. Two good results have already issued from the publication of this remarkable book—one, that Thomas Edward has been placed by Her Majesty on the Civil List, and so rendered independent for the rest of his life, and free to follow his delightful pursuits after the "auld beasties"; and the other, that his life has been the means of widely interesting educated people in the studies of operative naturalists, and in natural history generally. For, useful though Edward's life has been, we feel like the English king when he heard of the results of Chevy Chase,—we know there are "five hundred men" as good as he! And in making this remark we are not detracting from the position which Thomas Edward has so nobly attained. We have in our mind's eye the men who compose the botanical and natural history societies in Lancashire, Yorkshire, and elsewhere—operatives in mills or workers in coal-mines—men whose only education, perhaps, was obtained in a Sunday-school, but whose acquaintance with plants and insects and birds and fossils would surprise any one whose life has been spent in the schools! We are constantly in correspondence with such men, of some of whom Mr. James Cash has so well written in his "Where there's a Will there's a Way." Such men as these are one of the glories of modern England, and it is delightful to feel that the educated classes are being stirred in their favour, so as to give them that recognition their services so richly deserve. To return to Mr. Smiles's book: when we say that for style it is not excelled by any of his other books, those who have read the latter will know how attractive it is. The illustrations, which are by Mr. George Reid, are a labour of love, and all of them are artistic in the highest degree. The frontispiece is the full-page etching of the rugged and powerfully-lined head of Thomas Edward himself. In conclusion, we thank Mr. Smiles for this book: it is emphatically a good one, and its influence for good will not end when it is placed on the shelf.

"The Primeval World of Switzerland," by Professor Heer (London: Longmans, Green, & Co.), is a welcome contribution to our geological literature. Swiss tourists who desire to do more than gaze in wonder at the Alps, will here find the difficult stratigraphy of that wonderful region clearly worked out.

The various localities where fossils are to be found in the various formations—from the Carboniferous series to the Miocene, are all noted; and, as many of them lie within the usual range of the tourist, this book will be all the more welcome to him of geological tastes. The details of the Miocene beds are given at great length, as we should have expected beforehand, seeing that they attain a greater development in

Switzerland than anywhere else, and are there crowded with fossil plants, flower-bearing and cryptogamous, in hundreds of species, as well as with the remains of insects which were associated with this magnificent flora. To Professor Heer is due the great merit of working out the details of these Miocene fossil plants, and of showing how they were related to genera and species now growing elsewhere,



Fig. 72. Moraine in the Canon's Platz in the City of Zurich. (From Heer's "Switzerland.")

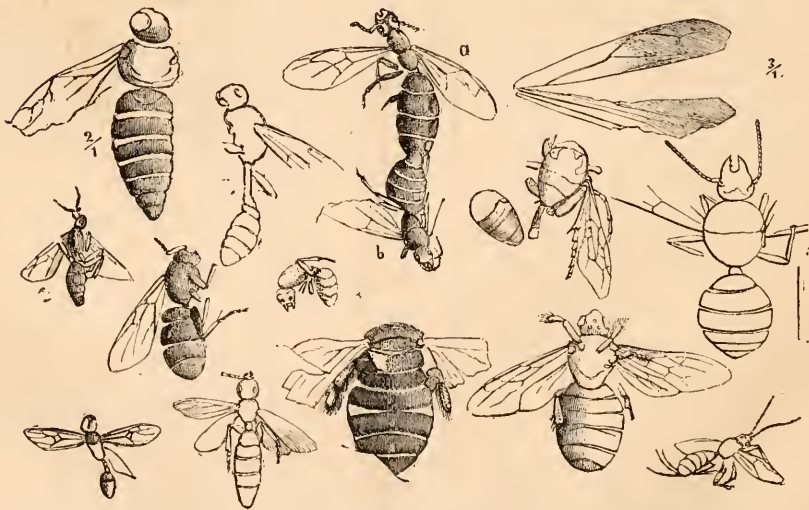

Fig. 73. Various Genera of Fossil Hymenoptera, from the Miocene strata of Moudon. (From Heer's "Primeval Switzerland.")

but widely distant, geographically speaking. Professor Heer has spent the best part of his life, and won numerous scientific laurels, in deciphering this great stone book of Miocene Switzerland. Hitherto, the only way the geological student could get at Professor Heer's results was either second-hand, through the pages of "manuals," or by unearthing them from scientific journals and memoirs. Now we have the full and complete results set before us by the author himself, and we are thankful for them.

has grown into a completeness it did not possess before. Intending students and actual workers in this department of research will therefore welcome Mr. Llewellyn Jewitt's "Half-hours with English Antiquities" (London: Hardwicke & Bogue). No other writer was more fit to undertake the somewhat difficult task of making these things plain as Mr. Jewitt has done. The work is richly illustrated by vigorous and artistic woodcuts, some of which we are enabled to reproduce here for the benefit of our

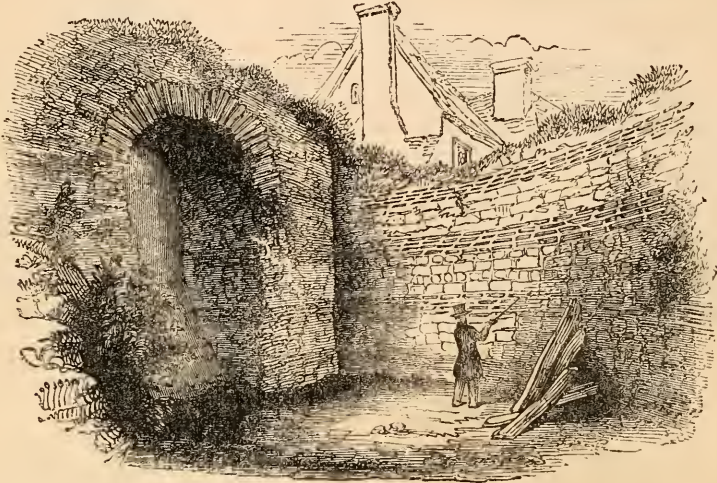

Fig. 74. Roman Masonry at Colchester. (From Jewitt's "Half-hours with English Antiquities.")

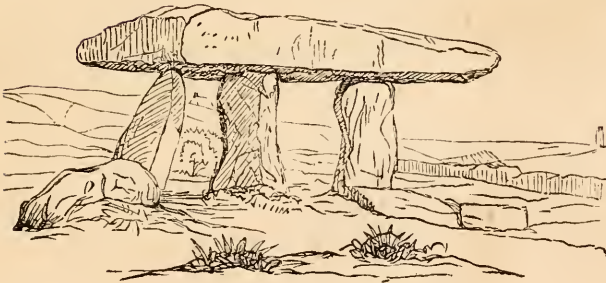

Fig. 75. The Lanyon Cromlech.

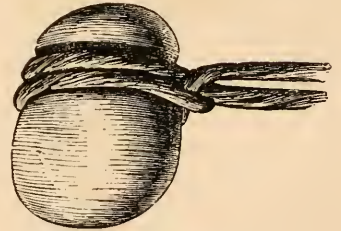

Fig. 76. Grooved Stone-hammer, with twisted Withes for holding.

The work is in two volumes, abundantly illustrated with capital woodcuts, of which we are enabled, by the kindness of the editor, to reproduce several. Numerous full-page lithograph illustrations are also introduced, giving us "ideal landscapes," &c., of the various geological epochs. A coloured geological map adds to the completeness of this work for practical purposes. We should say that the present is an English translation, edited by Mr. James Heywood, F.R.S., who has in every way done his part well, and presented to English geologists the best book on Swiss geology we have yet received.

Within the last few years the study of archæology

readers. The arrangement and style of the book are alike excellent. The former includes chapters on "Barrows," "Stone Circles, Cromlechs, &c.," "Flint and Stone Implements," "Celts and other early Instruments of Bronze," "Roman Roads, Tessellated Pavements, Altars, Temples, Inscriptions, &c.," "Ancient Pottery," "Arms and Armour," "Sepulchral Brasses, &c.," "Coins," "Church Bells," "Stained Glass, Tapestry," &c., "Personal Ornaments," &c. From this list the reader will see how important an introduction is the above work to the study of archæology.

"Text-books" of science are among the notable

features of modern literature, and they indicate the course of thought, perhaps, more strikingly than any other works. We have now to welcome Professor Thomé's "Structural and Physiological Botany,"

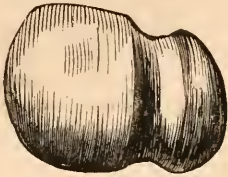

Fig. 77. Grooved Hammer.



Fig. 78. Sling-stone.



Fig. 79. Common type of Flint Flake.

translated and edited by Mr. A. W. Bennett, B.Sc., F.L.S., &c. (London: Longmans, Green, & Co.). The work is embellished by 600 woodcuts, all of which materially assist the botanical student. This is the recognized text-book of botany in the German technical schools, and its appearance in an English garb is therefore required. No better or more trustworthy editor and translator could have been selected

than Mr. Bennett, who himself takes high rank among our most distinguished botanists. The ar-



Fig. 80. Barbed Flint Arrow-head from Derbyshire.

rangement is both clear and exhaustive, and the price (6s.) will, we hope, bring this most useful book within the range of every intending student.

MICROSCOPY.

HOW TO FILTER WATER TO OBTAIN MINUTE ORGANISMS.—Upon this subject there are some observations of Dr. A. Meade-Edwards in your February impression, and as it appears that a second contribution may not be wholly unacceptable to the readers of SCIENCE-GOSSIP, I beg to inclose a sketch of a little piece of apparatus designed by me for the same purpose some three years since, and then introduced at one of the meetings of our Margate Microscopical Society, to which I am honorary librarian, and which has been found both portable and useful at the pond-side. Indeed, by its use, one may in half an hour collect all the living organisms contained in a butt of water, and carry home in his breast-pocket a myriad of the larger and smaller fry which abound in pond-life. The entire apparatus costs only a couple of shillings, and was made for me by a local tinman, and neatly finished off with a coat of red sealing-wax varnish. A is one of the three-inch jam-covers patented by Mr. Jennings, and consisting of a disc of tin with an indiarubber ring (B) beneath, by which an instant and air-tight joint is effected with a glass tumbler or wide-mouthed bottle. C is a small funnel with a double wire rim, and over the mouth of which a piece of coarse muslin—simply as a strainer, to arrest duckweed, bits of stick, &c.—may be kept stretched by a small indiarubber ring, which will lie between the two wire rings forming the rim; and D is a similar tin funnel, across the mouth

of which a piece of *fine* muslin is stretched, and confined in a similar way. Arriving at the pond-side, or at the seashore, or while the net is down in towing, the collector snaps the band B around the mouth of a glass tumbler, a jam-pot, beaker, or wide-mouthed bottle, and proceeds at once to ladle water in at C, which, finding its way into the containing

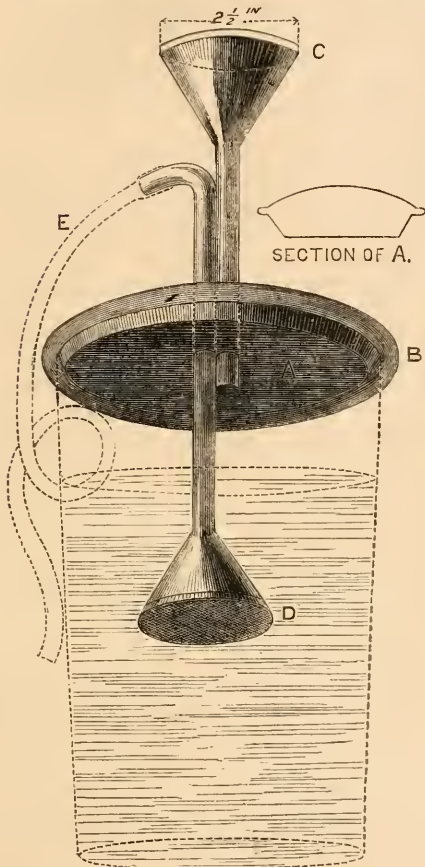

Fig. 81. Pond-side Filter.

vessel, rises through the finer muslin at D, and flows off by the indiarubber tube E, the siphon-like character of the arrangement materially assisting the operation, while Desmids, Volvoes, Daphnia, Rotifers, Floscularia, &c., are all retained in the three or four ounces of fluid which the jam-pot or tumbler may contain. Jennings' patent covers may be obtained at the price of a few pence at either of the indiarubber-shops in Ludgate-hill, or at Abbott Anderson's, in Queen Victoria-street.—*W. Lane Scar, Margate.*

NEW METHOD OF ILLUMINATION. — Being in New Orleans some three weeks ago, and having some curiosity to see the silver microscope made and exhibited at the Royal Microscopical Society by Smith & Beck about two years ago, I called on the owner, Dr. A. W. Smyth, and was very much pleased with

the construction and working of the instrument, but particularly with the effects produced by a mode of illumination which was claimed by him as original and exceedingly simple. It was produced by a disc of ordinary cover-glass ground on *both* sides, and used in the same place and in the same manner as the ordinary black-ground stop below the condenser, the marginal rays of light passing unobstructedly around the outer edge of the ground cover-glass, producing a different and far more pleasing effect than that produced by the ground glass extending over the whole aperture of the condenser, and entirely different to that produced by a ground glass cap over the top of the condenser. I am sure your readers will be pleased with this simple mode of illumination on nearly all objects usually viewed on black ground, as well as those objects viewed by direct light.—*J. A. Perry.*

BRAMHALL'S HORIZONTAL SUPER OR SUB-STAGE REFLECTOR.—Mr. Bramhall's recommendation of this, backed by the authority of Mr. F. Kitton, induced me to order it. Some delay occurring in its receipt, probably owing to accidental circumstances, I resolved to make a temporary substitute, and, with this view only, disregarding the precise instructions given in SCIENCE-GOSSIP (p. 136, 1876), chose materials that came most readily to hand and promised least trouble to adopt. A small toy mirror-plate, a cardboard back and millboard front of the same size, the latter punched centrally with a $\frac{7}{8}$ -in. aperture; two pieces of gummed covering-paper, that for the upper side being similarly perforated; in a few minutes, I provided an accessory which enabled me to see the transverse markings on *A. pellucida* under $\frac{1}{12}$ immersion with eye-piece and 3-in. draw-tube. The conditions of stand, stage, and light being all unfavourable, and purposely accepted to severely test asserted fitness to supply students and others with a substitute for costly appliances which will always be used by those who can afford such luxuries. This result and others, obtained with a low angle 5th (blue glass being interposed between condenser and the slide lying upon it), surprised me; the latter were very beautiful, and not less wonderful, as I think, the fine lines of *S. gemma* being distinctly visible, and those on more difficult valves dimly so. A stereoscopic image of *P. angulatum* and *balticum* gave a better idea of their shape and character than I had ever before got. Mr. Kitton's praise would seem, as might be expected, to be well deserved, and probably both my mechanical execution and manipulation are open to improvement by longer acquaintance with this inexpensive condenser.—*M. O. H.*

MOUNTING IN DAMAR.—I am very glad to see that, at last, the use of damar as a mounting medium is so warmly advocated, especially in the extremely convenient form mentioned—namely, in a tube: nothing could be cleaner, nothing more expeditious,

as it is always ready for use. Towards the end of his article, I see that Mr. Williams justly laments the time that damar takes to properly fix and dry; indeed, I have often asked myself the question, "Does it ever get thoroughly dry?" I having found slides quite loose, and the damar sticky, three weeks after mounting. A few weeks since, however, I discovered a process by which an object can be mounted in damar, finished with "black japan" or other varnish, labelled and put in its place in the microscopical cabinet in less than half an hour. The apparatus required consists of a small copper plate, fixed at a convenient height on iron feet; a spirit-lamp; a few needles; and some bullets: conical pistol-bullets are the best. The way I mount is as follows: Having fixed my metal table a sufficient height above the flame of the spirit-lamp (say about two inches), I place my slide on the copper plate, with the object put in the right position for mounting, and the glass cover on top; this I let warm for about two or three minutes; then (having previously warmed the tube of damar, which has the effect of making it much more fluid) I drop a small quantity on the slide, in such a manner that the edge of the medium shall come in slight contact with the glass cover: capillary attraction causes the damar (which is now very liquid) to gradually flow under the cover; if air-bubbles appear around the object, they must be removed by slight pressure and the aid of a heated needle. If the object is not flat, and raises the cover, a bullet placed on the top will keep it down. The above operation ought to take from ten to twelve minutes. Having proceeded thus far, I remove the spirit-lamp from under my table, and let the slide gradually cool. When cold, the damar is quite *hard*, and the cover *firmly* cemented. I now (with an old pocket-knife) remove the superfluous damar, wash the slide with a camel-hair brush dipped in turpentine, and then again with the same sort of brush, only using soap and water. Having thoroughly wiped dry the slide, I finish with a ring of "black japan varnish," although I believe asphalt will do quite as well, and finally I label and put away in my cabinet; the whole having been completed in less than half an hour. Of course, "practice alone makes perfect," and the microscopist must expect some few failures to commence with. The failures most likely would occur from one of the following causes: Too *great* heat, thereby making the damar boil under the cover, which would have the effect of destroying the object, —the only remedy would be to at once remove or lower the flame of the lamp. Too *little* heat, the result of which would be that the damar would not harden when cold. And air-bubbles: these are only got rid of by watching and carefully pressing the cover; and if that will not remove them, by very gently lifting the cover so as not to disturb the object, and introducing a drop more damar from the tube, which will no doubt prove effectual. Of the two

former causes of failure experience alone can properly set right, so as to enable the operator to judge the exact time to keep the slide heated: this any one can easily do after half a dozen attempts. I should be glad if Mr. Williams, or some other gentleman, would (if they have not already done so) try this mode of mounting, and let me know the result. I feel positive that most of our amateur microscopists would use damar as a mounting medium, especially with the afore-mentioned process, if they only knew how easy it was to work, and what capital results were obtainable.—*E. B. L. Brayley.*

CLEANING DIATOMS WITH GLYCERINE.—The *American Naturalist* for February gives an account of a process for cleaning diatoms with glycerine, discovered by Mr. James Neil. It states that this is an easy and effective way of separating the valves from the foreign matter with which they are usually mixed. Mr. Neil filled a two-ounce graduated measuring-glass three-quarters full of glycerine and water mixed in equal parts. The diatoms, after being heated with acid and thoroughly washed, are then shaken up in some pure water, and poured gently over the diluted glycerine. If carefully done the water and diatoms do not at first sink into the glycerine, but gradually the diatoms sink through the water and into the glycerine, preceding the light flocculent matter held in the water. In a few minutes a pipe introduced closed through the water and into the glycerine will bring up remarkably clean diatoms, which must afterwards be freed from glycerine by repeated washing and decanting.

THE MICROSCOPICAL SOCIETY OF BATH.—We have received a copy of the annual address given to the members of this Society by the President, Mr. J. W. Morris, F.L.S., on February 6th. It is a capital discourse on most of the prominent and important topics with which microscopists have to deal, and we think the Society have done right to publish it.

"ERRORS OF INTERPRETATION," &c.—By an error the figures illustrating Dr. Jabez Hogg's paper on the above subject, in last month's number, were transposed. Fig. 46 represents the "Scales of Diurnal Lepidoptera," magnified 250 diameters; Fig. 47, the "Scale of a Gnat," magnified 650 diameters.

THE QUEKETT MICROSCOPICAL CLUB.—The thirty-third number of the journal of this well-known club has just been published. It contains papers on a new Anti-vibration Turn-tray, by Mr. W. K. Bridgman; on a new Universal Reflecting Illuminator, by the same microscopist; and a capital paper by Mr. H. Crouch, on Microscopy in the United States. In addition to the above are papers by Messrs. T. C. White, W. H. Gilbert, G. F. George, &c.

ZOOLOGY.

PERSONAL OBSERVATIONS IN NATURAL HISTORY.—A neatly-bound little pamphlet has been issued, written by Mr. Thomas Kingsford, of Canterbury, and entitled "Reminiscences of Animals, Birds, Fishes, and Meteorology." It is a series of personal jottings on natural phenomena, and indicates the author to be a man fond of nature and possessed of large powers of observation.

LIFE.—A most thoughtful and suggestive paper on "Life," appears in the *Medico-Chirurgical Journal* for January, from the pen of that well-known naturalist, Mr. R. Garner, F.L.S., of Stoke-on-Trent. The subject is treated alike from the evolutionistic and specialistic point of view, the author boldly and eclectically accepting whatever views appear to him most explanatory of facts. He argues in favour of teleology, and against the idea that life is the result of organisation.

DANAIS ARCHIPPUS.—A specimen of this North American butterfly, taken near Hassock's Gate, Sussex, was exhibited at a recent meeting of the Entomological Society, by Mr. F. Bond. This makes the third specimen of this species which has been captured in England.

BATHYBIUS.—Notwithstanding that Professor Huxley and other naturalists have given up, from discoveries made by the "Challenger," the idea of there being such a primitive animal substance as *Bathybius*, Dr. Bessels, of the "Polaris" expedition, states that he discovered in Smith's Sound a substance much like it, only even simpler in its structure. He proposes to call it *Protobathybius*.

PROVINCIAL MUSEUMS.—We noticed, in the last Report of the East Kent Natural History Society, some remarks as to the usual contents of many local museums, which remind us of the discourse on this subject given a few years ago by Professor Gulliver. The report shows how money is often squandered in such institutions which might be advantageously applied in making them worthy of their name. Many museums are nothing better than old curiosity shops, whose contents convey no lesson to the minds of people. Thus the study of natural history is retarded rather than advanced. Local museums should be adapted to the best mental culture, and their contents ought to explain the general principles of nature. Systematic sets of specimens to explain the general natural history of the district ought to be especially exhibited, and all useless objects should be weeded out.

THE INTELLIGENCE OF ANTS.—The researches of Sir John Lubbock do not lead him to think so highly of the intelligence of ants. In another of his remarkable observational papers, lately read before the Linnean Society, he states that they had not sense

enough to drop from a height of only three-tenths of an inch from the ground, but went a long way round, owing to their want of power of calculating distance. It appears, however, that in other respects they are intelligent enough. Thus, they soon recognize their friends, even after a year's separation. Slavery in certain genera is a regular institution. The Amazon ants (*Polyergus rufescens*) absolutely require a slave to clean, dress, and feed them! Repeated experiments prove that they will rather die than help themselves.

THE WATFORD NATURAL HISTORY SOCIETY.—The sixth part of the first volume of the Transactions of this flourishing Society has just appeared. It contains papers on the "Herefordshire Bourne," by Mr. John Evans, F.R.S., the President; on the "Herefordshire Bench-marks," by Mr. John Hopkinson, F.G.S., Hon. Sec., and an important one on the "Polarisation of Light" (illustrated), by Mr. James U. Harford.

PUBLIC AQUARIA.—Mr. John T. Carrington has been appointed "Resident Naturalist" to the Royal Aquarium Society, Westminster, in place of Mr. W. Saville Kent. Mr. Carrington has for the last year been studying aquarium management with Mr. W. Alford Lloyd, at the Crystal Palace Aquarium. Mr. C. P. Ogilvie, formerly a pupil of Dr. J. E. Taylor, F.L.S., and who studied aquarium management under Mr. W. S. Kent, at Westminster, has been appointed Curator to the Great Yarmouth Aquarium.

MARINE AQUARIUM.—My experience of the above may be interesting to some of your readers. Last July, when at Westgate, I collected half a dozen common Mes., and brought them to town with me, likewise two gallons of sea-water and some small stones with ulva and callithamnion growing attached. I had a spare bell-glass, and, wanting something better, I fitted this up, intending it to be *pro tem.*, covering half the outside of the glass with light green paper and copal varnish. Everything flourished so well that, after a month, I determined to leave things as they were. The anemones seemed at home, some small mussels, limpets, winkles, and acorn barnacles made their appearance, and also four small nereis; and these always appear when the anemones are fed. The food that I have found to suit them best is oyster cut into small slips; the only care I have bestowed upon it is to remove the rejecta of the animals and to add a little filtered fresh water when the hydrometer has indicated the necessity. Two months ago I added six sagartia. These have flourished equally well, and, a fortnight since, I discovered a colony of over twenty young ones and sagartia attached to the glass near the bottom. In addition, I may say that the coats the anemones occasionally cast off, and small pieces of ulva I have sometimes removed,

have furnished me with many beautiful objects for the microscope, and have afforded many pleasant evenings to myself and friends. — *G. L. F., Camberwell.*

BOTANY.

CRYSTAL PRISMS IN ALLIUM PORRUM. — Mr. F. W. T. Williams has given a very useful note on this point (SCIENCE-GOSSIP, No. 147), to which may be added that these crystals are very beautiful in the bulb-scales of many other species of *Allium*, as may be easily seen in the Shallot, &c., always to be had at Covent-garden. — *Q. F.*

INSECT-TRAPPING PLANTS. — Besides *Apocynum androsaemifolium*, mentioned by Mr. T. Britain in the March number of SCIENCE-GOSSIP as a carnivorous species, there are other plants of different orders which entrap insects, and this by means and for an end which would appear to be obscure. Thus, at a late meeting, at Canterbury, of the East Kent Natural History Society, Major Hall read an interesting paper, to which Professor Gulliver contributed an historical introduction, showing that the flowers of *Physianthus albens* catch and kill such large insects as humble-bees and noctua-gamma moths, a fact which, so far as is known, cannot be beneficial to the plant. — *Q. F.*

CORNELIAN CHERRY (*Cornus mascula*). — The Brighton town gardener has asked for the name of a shrub, 10 or 15 ft. high, in the Pavilion Gardens, very old, evidently planted when the Palace grounds were originally laid out eighty or ninety years ago. It is the *Cornus mascula*, a native of Austria, but little cultivated, I believe, in England. From the beginning of February it has been (and is still) in full flower, very conspicuous, presenting as it does one mass of yellow. I have seen it in fruit in shrubberies in Switzerland, and tasted the cornelian-coloured berries: they have an acid taste, and are eaten by children and made into sweetmeats and tarts. I think it might be a pleasing addition to our shrubberies, as the flowers appear before those of any shrubs. — *T. B. W., Brighton.*

TEUCRIUM CHAMÆDRYS (from Teucer, son of Scamander, and father-in-law of Dardanus, king of Troy). — The Germanders and their allies form a most extensive genus of herbs and shrubs, comprising nearly a hundred species, widely dispersed throughout the world, but abounding chiefly in the northern temperate and sub-tropical regions of the eastern hemisphere. Several species of *Teucrium* were formerly reputed to possess medicinal virtues, and found a place in the *Materia Medica*; but they are now discarded by all except rustic practitioners. There are only three British species. *T. Chamædris* was once much employed in medicine, and entered as an

ingredient into the celebrated Portland powder. It was at one time employed in gout and rheumatism, and also as a febrifuge. *T. Scordium* was once highly esteemed as an antidote for poisons, and as an antiseptic and anthelmintic. *T. Scordonia*, wood germander or sage. The smell and taste of this plant resemble very much the hop. In Jersey it is sometimes used as a substitute for hops in beer, and by some persons the bitter given by the germander is preferred to that of the hop. *T. Marum*, or catthyme. This was formerly included in the "London Pharmacopœia," and employed in the preparation of compound powder asarabacea. It has been recommended as a stimulant and aromatic in various diseases. Cats are very fond of it, and destroy it when they get near it. — *Dipton Burn.*

LADY SMITH. — A link between the periods which, in the history of botany at least, we may call the old times and the new, has been severed by the death of Lady Smith, wife of Sir James Edward Smith, the celebrated botanist, and first President of the Linnean Society. Her ladyship, who died at Lowestoft, on the 3rd of February, lived to the ripe age of 104.

GEOLOGY.

REMAINS OF THE MAMMOTH AND OTHER MAMMALS FROM NORTHERN SPAIN. — Prof. A. Leith Adams recently read a paper on this subject before the Geological Society. The author said that the remains were obtained by MM. O'Reilly and Sullivan in a cavern discovered at about 12 metres from the surface, in the valley of Udias, near Sautander, by a boring made through limestone in search of calamine. They were found close to a mound of soil which had fallen down a funnel at one end of the cavity, and more or less buried in a bed of calamine which covered the floor. The cavern was evidently an enlarged joint or rock-fissure, into which the entire carcasses, or else the living animals, had been precipitated from time to time. The author had identified among these remains numerous portions, including teeth of *Elephas primigenius*, which is important as furnishing the first instance of the occurrence of that animal in Spain. He also recorded *Bos primigenius* and *Cervus claphus* (?), and stated that MM. O'Reilly and Sullivan mention a long curved tooth which he thought might be a canine of hippopotamus.

GEOLOGICAL HONOURS. — At the annual meeting of the Geological Society of London, the Wollaston gold-medal was presented to Mr. Robert Mallet, F.R.S., for his researches in the phenomena of earthquakes; the Murchison medal was presented to the Rev. W. B. Clarke, for his investigation of the geology of New South Wales; the Lyell medal was given to Dr. Hector for his services in working the

geology and paleontology of New Zealand; and the Bigsby medal was presented to Professor Marsh, of the United States, for his labours in American geology. The proceeds of the Wollaston fund were awarded to Mr. R. Etheridge, jun.; those of the Murchison fund to the Rev. J. F. Blake; and of the Lyell fund to Mr. William Pengelly. In each case the honour has been well and worthily won.

GEOLOGY OF THE PLANET MARS.—In the *Geological Magazine* for March there appears a paper by Mr. Edward Carpenter, M.A., on "Evidences afforded by the Planet Mars on the subject of Glacial Periods." He holds that the present condition of *Mars* is in favour of the view held by Mr. Murphy and others as to the cause of the earth's last glacial period. The same journal has another excellent paper on "A Permian fauna, associated with a carboniferous flora, in the uppermost portion of the coal formation of Bohemia."

GEOLOGY OF HEREFORDSHIRE.—We have received a copy of a paper reprinted from the Transactions of the Watford Natural History Society, by Mr. W. Whitaker, F.G.S., of the Geological Survey, giving a very complete list of works on the geology of Herefordshire. Mr. Whitaker is well known for his knowledge of geological literature, and his services seem to be at the command of nearly all our provincial societies.

THE CAUSE OF ACTIVITY IN EARTHQUAKES AND VOLCANOES, by Mr. R. A. Peacock, C.E., F.G.S.—A thoughtful pamphlet on the above subject has just been published by G. E. & F. N. Spon, in which it is argued that *steam* is their active cause, whilst heat, produced by the crushing of rocks (Mr. Mallet's theory), is not.

NOTES AND QUERIES.

EARLY PRIMROSES.—For the last four years we have resided at a small village in Hampshire, about twelve miles from Winchester, and each year we have found primroses in flower out of doors before Christmas. The place where they bloom first is on ground where a copse has stood, which was cut down the previous year. Snowdrops growing in the woods were also in flower the first week in January this year.—*A. J. V., West Meon.*

WATER-TORTOISES, AND WHAT THEY EAT.—Some time since, wishing to procure two water-tortoises for a friend, I applied to a person in the neighbouring city, of whom I had frequently bought gold and other fish for my aquaria, to know if he could supply them. His answer was, "Oh, no! I do not keep them. I did so once; but they always died after I had them a few months." I asked, "How did you feed them?" He replied, "I did not feed them at all; I did not think they required feeding." Lest any of your readers should entertain the same opinion, I venture, in the interest of the poor animals, to give you my experience during two years. In the early spring of 1875 I purchased, in

Covent Garden Market, two water-tortoises; the carapace of one measured $3\frac{1}{2}$ inches in length, that of the other $2\frac{1}{2}$ inches. (At the present time they measure 4 inches and 3 inches respectively.) Never having kept them before, I scarcely knew what food to give them; but, upon trying them with earth-worms, and finding they ate them with avidity, I supplied them through the summer with worms, occasionally varied with slugs, woodlice, and blue-bottle flies; of the latter they seemed to be remarkably fond. During their hibernation last winter, they rarely ate anything; scarcely ever coming above water; in the spring of 1876, soon after coming to their appetite, and still thin and poor from their long fast. One morning, on going into the conservatory in which their tank is placed, I discovered a sparrow, which had got in through an open window, and in its efforts to escape had fallen into the tank upon a piece of rock, in the centre of which the two tortoises were basking in the sun. Before I had time to take the sparrow out of the water, the larger tortoise had slipped from off the rock, caught it by one of its legs, and held it so, until it was drowned. I now left it for two hours, and upon my return found nothing visible of the bird but its cleanly picked bones and its wing-feathers,—all else had been devoured. After this I could not tempt them to eat, not even with their favourite food, a meat-fly, for nearly a week. I now thought I would try them with another kind of food, and gave them a gold-fish about 5 inches in length, that had jumped out of an aquarium in the night, and so died. This they ate eagerly, and left nothing but the head and backbone. A week or ten days after this I dropped from a trap upon their rock a live mouse: this the larger tortoise no sooner discovered than he gave chase, mounting the rock, and the mouse taking to the water, here soon became nearly exhausted, and soon clung to the rock. The tortoise now warily approached him, made a grab at his head, and held him under water until he was dead. He now, after tearing off the head, turned the skin of the mouse inside out, being unable to tear it, and in two or three hours ate the whole except the skin and bones. During the course of the present summer they have eaten in addition five other mice. The consequences are that they are in capital condition, and the brightness of their colouring is such that they are not like the same creatures I bought two years ago.—*George N. Harris, Clifton, Bristol.*

PEREGRINE FALCON.—Mr. J. W. Dealy, in his article on the "Peregrine Falcon" (*SCIENCE-GOSSIP*, p. 53), speaks of the so-called *Falco anatum* as identical with *F. peregrinus*; he also gives the reasons on which he bases his opinion. I have just been looking through the splendid series of peregrines from all parts of the world in the Norwich Museum, and although the American race differs slightly from those of Europe and Asia, I confess that were the labels removed I should be utterly unable to distinguish one from the other. Mr. Gould certainly includes *F. anatum* amongst the birds closely allied to *F. peregrinus*, and which, "although closely resembling each other, possess distinctive characteristics, and have rightly [he thinks] been regarded as so many different species"; but most modern ornithologists, including Dresser, Newton, and Gurney, think otherwise, and regard the "Duck Hawk" as a local race of *F. peregrinus*. As to Mr. Dealy's reasons for his faith, I do not think size is to be depended upon. In a series from American and European localities, birds could, I believe, be found which would not differ perceptibly from each other. Wilson says that the Duck-Hawk never carries off its prey, but permits

the duck to fall previous to securing it. It is curious that Mr. Gould's plate of the European peregrine, in his "Birds of Great Britain," represents the bird striking down a duck precisely as the American peregrine is said to do by Wilson. Mr. Dealy says the Duck-Hawk constructs its nest upon trees in the cedar swamps, and that the true peregrine never frequents swamps of any description, and has never been known to construct its nest on a tree of any sort—always on the rocks. I do not think this is strictly correct. Professor Newton, in "Ootheca Wolleyana," pp. 102-3, gives repeated extracts from Mr. Wolley's note-book of eggs of the peregrine taken from nests found on the ground, amongst the bear-moss, in a marsh: this was in Lapland. Mr. Dresser says ("Birds of Europe") that in the flat wooded parts of North Germany, "it appears, as a rule, to nest in trees." In Livonia, Von Middendorff states that it nests on the moors in the moss, "never otherwise than on the ground." Mr. Dresser obtained eggs of the peregrine in Northern Finland, "which were placed on a large tussock in the middle of a great morass." It also occasionally breeds in church towers, and has been known to do so in the steeple of Corton Church, Suffolk, not many miles from where I am now writing. Under these circumstances I think Mr. Dealy can hardly be said to have made out a good case in favour of *Falco anatum*. Wilson was, as Mr. Dealy says, a truly great naturalist, and could at once appreciate the powerful influence circumstances and surroundings would have upon the habits and mode of feeding of a species so widespread over the globe as the Peregrine Falcon, even, it might be, to the production of a darker shade of plumage, or a slightly superior size.—*T. Southwell, Norwich.*

THE HERON.—In answer to F. H. Arnold's query as to whether the Heron is a good bird to eat, he may be glad to know that I, on my uncle's persuasion, tried one about three years ago; and in spite of the protestations of the cook, who declared that it was carrion, found it very good eating, both roast and hashed: its flavour is something like hare. I am afraid he will find it, however, no easy matter to get his friends to taste it, as there seems to exist in England a strong prejudice against the use of herons as food.—*J. G. P. Vereker.*

THE COMMON NETTLE (p. 46).—Mr. Augustus Mongredien, in his work on "Trees and Shrubs for English Plantations" (Murray, 1870), has a chapter on "Man's Influence on Vegetation," in which he gives a list of plants which follow human cultivation, and mentions the nettle as follows:—" *Urtica dioica* (the common nettle), whose presence almost infallibly indicates that not far off a house or shed exists, or has existed."—*W. R. Tate, Blandford.*

FERTILIZATION OF CRUCIFERS.—At a recent meeting of the West Sussex Natural History Society, when the Crucifers were under discussion, a question was put—Why are two of the stamens shorter than the other four? What advantage does this give for insect fertilization? In Sir J. Lubbock's work this order is stated as "not offering so many special specific adaptations [for this purpose] as other groups." Is this so? Any observations on this point will be acceptable.—*F. H. Arnold.*

FERTILIZATION OF MOSSES.—Will you or some of your numerous readers kindly answer in your journal the two questions that arise from the following quotation from "Footnotes from the Page of Nature," page 32:—"There is one remarkable species [of

mosses], the male plants of which exist only in Europe, so far as can be ascertained, and the female only in America, and yet they propagate themselves with as much facility as though they grew side by side in the same crevice of rock." The two questions are: (1) What is the name of this species? (2) How do they propagate themselves? A short answer, or a reference to books containing the information, will be very acceptable; but, since books are suspected things here, a direct answer will be more serviceable.—*James Key, St. Petersburg.*

APOCYNUM ANDROSÆMIFOLIUM.—The fact that this plant is insectivorous is not new, as it is mentioned in Kirby and Spence (4th edit., i. 289), where, indeed, this plant heads the list of "Vegetable Muscipæ."—*Albert C. Coxhead.*

DESTRUCTION OF RARE BIRDS.—I was glad to read "G. T. B.'s" protest, in the January number of SCIENCE-GOSSIP, respecting the destruction of rare birds. I frequently see recorded in a Cornish newspaper the name of some so-called naturalist who has shot a rare bird visitor. Last week a Northern Diver was killed near Penzance. Would not the fact that such visitors had been seen and were unmolested be much more satisfactory to all true lovers of nature than that their skins were handed to a taxidermist for stuffing?—*H. Budge.*

TEUCRIUM CHAMÆDRYS.—In the autumn of 1875 I gathered *Teucrium Chamædrys* on the walls of Winchelsea Castle, where it grew in some abundance. The locality is a very solitary one, far from gardens or houses. The fact of a plant being found on ruins, or old walls, does not appear to me, as it does seem to one of your correspondents, to be any reason for thinking it not to be indigenous, any more than the grass, chickweed, or ivy that is sure to be growing in every crevice, is to be supposed doubtful also!—*H. E. Wilkinson, Anerley, S.E.*

EARLY FLOWERING PLANTS.—It may interest your readers to know that to-day (Feb. 7th) I found the following plants in bloom near Hughenden Park, the seat of Lord Beaconsfield: *Lamium purpurcum*, *Veronica Buxbaumii*, *Geum urbanum*, *Potentilla fragraria*, *Mercurialis perennis*, *Stellaria media*, and flower-buds of the Bramble; also hazel catkins in abundance, barren and fertile "palm." The wild honeysuckle and elder are also in leaf, and the beechwoods seem almost ready to follow their example.—*E. K. B.*

ORCHIDS NEAR BOXHILL.—Your correspondent, J. R. N., Kingston, inquires for a good locality, near Boxhill, where many species of orchids may be found. During residence at Guildford, I used to visit Compton chalk-pit, a wild spot on the left slope along the Hog's Back (one mile from Guildford Station). On one occasion, in various stages of flowering, I gathered the following species: Early purple, Ladies' Tresses, Musk, Bee, Fly, Pyramidalis.—*T. H. Stock.*

THE COLOURS OF SHADOWS.—The answer to H. O. Sterland's inquiry is simple. A shadow is only a space from which light is cut off by an opaque body. If the light is entirely intercepted, the space becomes invisible; but in practice all so-called shadows receive some light by reflection from surrounding objects. The apparent colour of the shadow (on a white ground) in such cases is always complementary to that of the light; this illusion being simply the well-known effect of contrast. Thus

in ordinary daylight the shadows are grey. If the light contains any tinge of yellow, inclining to orange, the shadow will contain a tinge of blue in the same proportion. Since the yellowish light of gas contains comparatively few blue rays, of course all purely blue colours nearly disappear when the gas is lit: but that is the very reason why the shadows have a blue tinge, and that is the only way in which the blue tinge could arise. Two simple experiments will illustrate this. At the time of sunset in autumn, when the clouds are all aflame with rosy light, it will be found that the shadow of a pencil or finger, on white paper, is so decidedly green, that it is hard to believe the appearance is illusory. Again, if the green Venetian blinds be nearly closed on a bright day, so that all the light which enters is reflected from their surfaces, and is therefore green, the shadow will be found to have an equally strong rosy tinge.—*W. B. G.*

COLOURS OF SHADOWS.—The blue colour of the shadow thrown by gas during daylight, may, I think, be observed with all ordinary artificial light, but at the same moment the shadow of the same object, or of adjacent ones, thrown by the daylight will be seen to be yellow-brown. The cause I take to be that the artificial light is yellow, and that in the shadow thrown by it, where the yellow light is absent and the daylight only seen, the object illuminated by daylight alone looks blue by contrast, whereas in the other shadow, where the daylight is more or less absent and the yellow light alone seen, it looks yellow-brown by contrast or complementary colour.—*Albert D. Michael.*

CYCLAS CORNEA.—Is this creature wholly or partially carnivorous? Having had reasons for an answer to the above question, I made a limited search, but did not succeed in finding the required information. A few days since, a living frog was brought to me with a full-sized specimen of this shell-fish attached to one of its toes, having been found upon a bank by the side of a canal. Upon examination the frog appeared to be suffering very much from its intruder; its eyes very red, and it moved its leg backwards and forwards evidently trying to get rid of cyclas. After allowing the shell to remain for two days, I removed it and sent the frog on its way rejoicing, a small hole having been made where the shell was fastened. It is certain that the shell became attached in the water, and probably when the frog was quietly reposing on the mud, as these animals bury themselves in the mud, at all events during the day. Was the cyclas hungry? If the attachment was made to satiate its appetite, was it not a daring attempt? I should be glad to know if any of the readers of SCIENCE-GOSSIP ever witnessed such, and whether *Cyclas cornea* is really carnivorous.—*J. T. Riches.*

THE PLAGUE OF FLIES.—The common fly (*Musca domestica*, &c.) has a strong dislike for the musk-plant (*Mimulus moscatius*). If "E. C. M." has boxes of this plant before the windows of the rooms affected, the nuisance may be abated.—*David A. King.*

PARASITES ON CYCLOPS.—The vorticella-like parasites "A. H." mentions as occurring on cyclops are probably epistyles. Of these, there are many species, most of them branched, which Vorticella in its adult stage never is. Some species—e.g., *E. vegetis* and *E. grandis*—are not branched, and almost always occur on the minute crustaceans. The animal might be podophrya, a suctorial infusorian, having

a short stalk and head, covered with single, radiating, cilia-like suckers.—*David A. King.*

WILD STRAWBERRIES IN JANUARY.—I think the following fact is worth recording. Whilst out for a walk with a friend last week (the third week in January) on the borders of Wales, I gathered some wild strawberries, about half the size of peas. They were green and in a healthy state, and the plants on which they were growing were covered with flowers and flower-buds.—*H. G., Oswestry.*

VOLVOX GLOBATOR in great profusion was found by me in a pond near this town on 25th December, 1875. Myriads of specimens were to be found there throughout the following January, and then they disappeared altogether. I have searched the pond many times since, particularly in December last, and in the present month of January, without finding a single specimen. Owing to the heavy rain which has fallen so continuously for several weeks past, the water has been highly coloured with red marl, a condition which may have been unfavourable to the development of Volvox again this winter.—*T. J. Scatler.*

HAWFINCHES.—With regard to the Hawfinch breeding in this country: they are very common in this part of Hertfordshire, but not much noticed on account of their shyness. I have several times reared the unfledged young ones, and repeatedly have had the nests and eggs of the Hawfinch brought to me.—*F. L.*

INSECTS AND PLANTS.—Allow me to call the attention of your readers to pp. 167-170, Letter IX, in the seventh edition of Kirby and Spence's "Entomology," 1856. There occurs the following: "Some plants are gifted with the faculty of catching flies. These vegetable muscipæ which have been enumerated by Dr. Barton, of Philadelphia (*Philos. Mag.*, xxxix. 107), may be divided into three classes: First, those that entrap insects by the irritability of their stamens, as *Apocynum androsaemifolium*, *Asclepias syriaca* and *curassavica*, *Nerium Oleander*, and a grass, *Leersia lenticularis*. The second class entrap them by viscosity; . . . and the third by their leaves, whether from irritability, as in *Dionæa*, *Drosera*, &c., or from forming hollow vessels containing water, into which the flies are enticed either by their carrion-like odour, or the sweet fluid which many of them secrete near the faux, as in *Sarracenia*, *Nepenthes*, *Aquarium*, *Cephalotus*, &c. In this class may be placed the common *Dipsacus* (Teazle), the connate leaves of which form a basin, in which many insects are drowned. To these a fourth class might be added of those plants whose flowers smell like carrion (*Stapelia*). Dr. Barton doubts whether the flowers can derive any nutriment from the insects, and he does not think the leaves of *Dionæa*, &c. can need any stimulus." An experiment of "Mr. Knight's, nurseryman, in King's Road, London," is then quoted, who "laid fine filaments of raw beef" on the leaf of *Dionæa*, which "was much more luxuriant than others not so treated." . . . "However problematical the agency of insects as to their nutriment, there can be no doubt that many species perform an important function with regard to the impregnation of plants, which, without their aid, would, in some cases, never take place at all." The *Barberry*, *Iris*, *Asclepiadæ* and *Orchidæ*, *Aristolochiæ*, and *Fig* are then referred to. Sprengel's then despised "Eudektes Geheimniß" being quoted. "Sprengel asserts that, apparently to prevent hybrid mixtures, insects will, during a whole day, confine their visits to that species on which they

first fixed in the morning; and the same observation was long since made with respect to bees by our countryman Dobbs" (*Phil. Trans.*, xlv. 536).—*G. S. Boulger.*

HERONS AND ROOKS. — Your correspondent "T. H. Arnold, LL.B.," in your Notes and Queries for December, 1876, asks for information as to the habits of herons, and more particularly if it is the case that herons and rooks seldom build in company. In the fine old woods of Dallam Tower, near Milnthorpe, Westmoreland, in peaceable neighbourhood, there is a herony and a rookery. The situation is not far removed from Morecombe Bay, an excellent feeding-ground for the birds. I well remember, many years ago, hearing, at the Kendal Literary Institution, a charmingly written allegory, read by the late Mr. Pearson, of Borderside, Winstler, on the fierce struggle which took place between the black-coats and the long-necked gentlemen, and the ultimate destruction of nests and young by the partisans of each genus, until first a truce, and at length peaceful relations, were established between the rival colonies. Your correspondent, by writing to Thomas Gough, Esq., of Sandside, Amside, Westmoreland, will be able to obtain all the information which he seeks on this subject.—*John Harker, M.D., &c.*

STRENGTH OF THE STAG-BEETLE.—I had a specimen of the Stag-beetle that lifted nearly three pounds in weight. A boy brought me one a short time since, in a glass tumbler, and I placed it in a strong card box, four inches square, so as to examine it next day. Before going to bed that night, I placed the box, with the beetle in it, on a glass case, and placed a large polished outside slab of madrepore on the box containing the beetle. In the morning the slab I found turned over, and the cover off the box, and the beetle walking about the floor. Can any readers of SCIENCE-GOSSIP inform me if they have noticed any similar instance of strength in the Stag-beetle (*Lucanus cervus*)?—*A. J. R. Selater, Teignmouth.*

CAUSE OF COLORATION.—Mr. A. R. Wallace, of London, having recently delivered two lectures at the Literary and Philosophical Society, Newcastle-on-Tyne, on "Colours of Animals and Plants," and being a well-known authority on these subjects, I think that a few notes taken at one of these lectures would not only be interesting to "H. B.," p. 281, but also to the readers of SCIENCE-GOSSIP in general. I shall merely give a few of those which have reference to the questions raised by "H. B." He said it had long been supposed, and was still held by some very high authorities, that heat and light had some direct influence in producing colour; but many facts were opposed to this idea. Tropical plants and animals, although many were excessively brilliant, were not perhaps more brilliant, on the average, than those of temperate climates; and there were some striking examples of tropical countries, in which the brilliant colours usually present in tropical countries were entirely wanting. Again, we saw a wonderful difference between different classes of animals; and whereas birds and insects display immense minuteness and variety of colour, mammalia, on the other hand, are rarely if ever brilliant. Again, the birds of the tropics are only very partially brilliant. It is probable there are more perfectly plain, dull-coloured birds in the tropics than there are brilliant-coloured; and those groups of birds which in our country are most prevalent, and which are characterized by the ordinary dull colours, where they extend to the tropics, are generally equally dull. On the other

hand, there are some groups which exhibit their greatest, or an equal brilliancy of beauty, in the temperate zone. Some of the most magnificent birds in the world inhabit the temperate regions of China and the Himalayas; and there are a few in the arctic regions, such as the arctic duck and divers, which are even more brilliant than those of the temperate or tropical zone. With insects and flowers the same thing prevails. In a great many cases colour has no relation whatever to light. This was very well seen in the general colour of fishes, the colours of the upper sides of which were almost invariably black, while the lower was white; whereas if the effect were produced by light, the reverse would be the case. Again, the gorgeous colours of the greater part of the brilliant butterflies and birds have no relation whatever to the general circumstances which surround them; and in the arctic regions, though the prevailing colour is white, yet we find the raven as black as with us. Colour answered the purpose of concealment, and the animals which had not had this protection had been killed off by their enemies. The colour of the blacks is too extensive a subject to enter upon.—*Dipton Burn.*

SPAWN OF NEWTS, &c.—Pardon me if I again revive the discussion concerning the spawn, &c., of newts, which occupied so much of your space some time ago. But several of your correspondents appear to be incredulous of my statement (*vide* SCIENCE-GOSSIP, Dec. 1, 1875) that the mother newt does not *always* wrap up her eggs separately in the leaves of some water-plant. In order to set the matter at rest, on the 14th April last I procured a quantity of newt spawn from the same pond as that mentioned before. The spawn *was not wrapped up*, nor even covered, but there was mixed up with it a small quantity of a green slimy matter which is often seen floating on stagnant water. That the spawn was that of the newt was evident from the fact that each egg was separate, and not connected into a mass like that of the frog, or in strings like that of the toad. The tadpoles began to hatch out on the same day. I put two of them under my microscope, when I could easily see the blood circulating in the branchiæ or gills. I noticed that it moved much faster in the smaller than in the larger specimen, and, what is very remarkable, the water in contact with the gills was moving rapidly along, closely following their outline. Can any of your readers tell me by what means it was propelled? By the 24th April the branchiate gills had entirely disappeared. By the 1st of June the front legs were just appearing, but I was unfortunately unable to follow up their development, for there was a sudden mortality amongst them, and they all died in a very short time. There can be no doubt, however, that they were newt tadpoles, as the *front* legs were then apparent. I think that the reason the newts in this pond do not wrap up their eggs is, that none of the water-plants in it have leaves fit for the purpose, being all of a more or less filiform or threadlike shape.—*H. E. Forrest.*

SINGULAR STAR-FISH.—I have a specimen of a six-armed brittle star, probably *Ophiothela mirabilis*, which was found entangled in a dried gorgonia from the Pacific Ocean. I should like to learn from some of your readers how common it is to find six arms amongst normally five-armed ophiurans and star-fishes.

THE GLASTONBURY THORN.—A note on this subject appears in p. 45. May I ask the favour of your finding room for two more paragraphs on this

interesting topic? "Luscus," who dates from Bristol, writing to the *Standard* "says: It may interest some of your readers to hear that the Glastonbury Thorn—a tree of which is in my parish—is blossoming this Christmas. The blossom is small and of a white colour. I enclose a spray from a branch before me, which is fairly covered with blossom. The tree on which it grew is in an orchard, and is as large as a good-sized apple-tree, and must be of very great age. The legend of Joseph of Arimathea planting his staff in the ground is well known, and generally disbelieved, but the thorn can be traced back to a very early period at Glastonbury, and was probably brought over by some early monk (perhaps in Saxon times) whose conscience did not revolt at a pious fraud. *Pitman's Weekly News* says that a piece of the original Glastonbury Thorn is growing in the garden of a cottage between Hewish and Woolmington. For several years past, the tree—or, rather, a small bush—has been visited at midnight on Old Christmas Eve by people who vow that the bush actually blossomed while they were watching it, and became bare again shortly afterwards. On Friday night, the number of 'pilgrims' to this shrine was at least 200—from Crewkerne, Misterton, and other places—and those who came to scoff remained—if not 'to pray' at least to be convinced of the wonderful phenomenon. They say that at half-past eleven not a sign of a flower could be seen, but that at midnight every twig of one side of the bush was covered with delicately-tinted May light blossoms." This last paragraph appeared in a Crewkerne paper, and was copied, among others, by a Yeovil paper having a circulation of some 25,000 copies in Somerset and the neighbouring counties. Strange to say, however, it has not been contradicted nor even queried so far as I have been able to ascertain. The natives seem quite capable of "swallowing" the above and a great deal more about "the holy thorn." This notice in a scientific journal may be the means of causing some of your curious readers to endeavour to throw a little light on this superstition or phenomenon—whichever they may decide it to be.—*W. Macmillan, Castle Cary.*

THE SUN.—While in the fields last autumn with my little boy, he called my attention to what he called little black balls rising out of the sun. On looking at the sun, I fancied I could witness similar phenomena. Will some one kindly account for this?—*Pater.*

NORTH WINDS.—A friend of mine asks me a question I am unable to answer, and therefore pass it on to your readers. How is it that the row of plants facing the north suffer less severely from the cold than those facing the south?—*Pater.*

THE DOMESTIC CAT.—I am glad that the question of the introduction of the domestic cat into Europe is exciting attention, for there are several conflicting data to reconcile with the facts of history on the matter. Professor Mahaffey, in his "Old Greek Life," claims the Cat among the household animals of the ancient Greeks, while the Rev. William Houghton (a contributor to Smith's "Dictionary of the Bible"), in a paper on the domestic animals of the Assyrians, in "Trans. Soc. Bib. Archaeology," vol. v. p. 1, maintains that the Cat was entirely unknown to the ancients—Assyrian, Greek, or Roman, and that its use and "cultus" were confined solely to Egypt. On the other hand, there is the indisputable evidence that when Herodotus, in "Euterpe," describes the reverence paid by the Egyptians to their cats, he does so in terms which imply that the crea-

ture was well known to his readers; and with this agrees also his theory of that reverence as arising from the goddess Artemis having taken refuge in Egypt in the form of a cat during the temporary overthrow of the Olympic deities by the Gigantomachia. Further also, in the ancient (?) mock heroic poem of the Batrachomomachia, at one time attributed to Homer, and more probably written in the later Greek period, as it is quite in the style of Lucian, there are no less than three distinct references to the Cat: the hero of the poem, the Prince Psycepxax, was one whom "cats pursued in vain." His elder brother "perished by the ravening cat, as near my door the Prince unheeded sat." And the chief of the army of the mice, when they attack their rivals the frogs, wears a cuirass "faced with the trophy of a cat they flayed." Heroic mice indeed! Still, despite all these citations, it is also certain that the ancients used a species of "Mustela," or Ailurus, or ferret, as a destroyer of household mice; and the early Christian bishop, Timothy Ailurus, was so named from his thin, eager, weasel face and piercing eyes. The discussion in the *Academy* unfortunately dropped, and I was at the time too seriously ill to take it up (indeed, I now write without my books and quite from memory), still I trust that some more of your readers may find time and inclination next month to pursue this interesting subject further.—*W. R. Cooper, F.R.A.S.*

EXCHANGES (continued.)

DUPLICATES.—Fine-bred specimens of the large American Silk-moth (*Bombyx Cecropia*) in exchange for birds' eggs, side-blown. Accepted offers answered in three days.—John Thorpe, Spring-gardens, Middleton, Manchester.

Isthmia invernalis, a pure gathering, in exchange for Monterey or Bermuda Diatomaceous Earths.—R. Rattray, 30, Balfour-street, Dundee.

GLOBERGERINA Ooze, mid-Atlantic, and fossil Polyzoa, carboniferous, for good slides.—N., 18, Elgin-road, St. Peter's Park, London.

VERY GOOD MICRO. Slides to exchange for British birds' eggs—any except the very common.—Send list to Micro, care of Mr. C. Gray, 11, Crooked-lane, London, E.C.

BOOKS, &c., RECEIVED.

"Vis-Inertiae, and Recent Explorations." By W. L. Jordan. London: Hardwicke & Bogue.

"Land and Water." March.

"American Naturalist." February.

"Canadian Entomologist." February.

"Les Mondes." February.

"Botanische Zeitung." February.

"Monthly Microscopical Journal." March.

"Ber. Briery's Journal." March.

"Boston Journal of Chemistry." February.

&c. &c. &c.

COMMUNICATIONS RECEIVED UP TO 6TH ULT. FROM:—
T. B. W.—T. S.—J. F. R.—G. D.—J. A. P.—H. I. T.—
A. W. R.—T. J. W.—E. V. B.—F. Q.—F. C.—W. B.—
Prof. G.—W. L. S.—W. L. W.—E. H. W. T.—W. G. P.—
W. M.—E. C.—W. R. C.—A. F.—W. R. T.—A. J. R.—
A. C. C.—W. W. I.—J. F. G.—W. E. T.—G. C.—E. R. B.—
T. W. T.—H. B.—A. D. M.—W. B. G.—C. F. W.—P. W. B.—
F. T. M.—R. M. C.—A. M.—A. J. A.—G. D.—S. H.—
A. B.—S. A. [S.—J. W. S.—G. W. C.—G. L. B.—G. M. D.—
—C. I., jun.—J. T. W.—T. B. A.—W. J. B.—W. Y.—
—C. F. W. T. W.—I. H. K.—Col. H.—J. H. I. A.—J.—
H. A. A.—H. R. M.—J. T. R.—W. P.—T. W.—E. E.—
E. J. L.—A. H. A.—A. J. A.—C. B.—W. L. N.—R. H. M.—
J. C.—J. H. A.—A. H.—D. B.—A. B.—J. W.—T. H. B.—
S. J. W. S.—T. C. R.—W. T. E.—J. T.—M. F.—E. L.—S. S.—
—M. H. R.—B. B.—S. H.—F. J. A.—C. G.—E. H.—G. W.—
—G. N.—H. H. C.—T. B.—E. B.—A. G.—R. R.—D. B.—
Dr. C.—J. J. M.—W. G. N.—F. W. P.—M. M.—C. W. S.—
E. R. F.—A. W.—J. W.—G. K.—A. C.—E. L.—W. B.—
W. H. G.—F. H. D.—A. S.—A. H. W.—G. C.—W. E. T.—
H. E. F.—H. C.—T. W.—F. M. H.—E. L.—M. L. W.—
H. J.—C.—D.—R. V. T.—M. W.—G. B.—J. C.—E. H.—
J. W.—T. P.—W. E. L.—H. P.—C. J. W., &c. &c.

NOTICES TO CORRESPONDENTS.

TO CORRESPONDENTS AND EXCHANGERS.—As we now publish SCIENCE-GOSSIP at least a week earlier than heretofore, we cannot possibly insert in the following number any communications which reach us later than the 8th of the previous month.

C. DRINKWATER.—The piece of coal you sent has white veins of calcite (carbonate of lime) running through it.

ARTHUR.—There is no truth whatever as to limetrees behaving as you say is reported.

H. D.—For popular information about earwigs, see Wood's "Insects at Home," or "Episodes of Insect Life."

PAULINE.—The virgin ferns undoubtedly went through the artheridial and archeogonial stages. Those borne as shoots on the fronds, as in the cases you name, do not pass through these stages.

W. J. BEUMONT.—The *Dytiscus marginalis* leave the water in August and fly about, so that it is not singular to find a specimen under the circumstances you name.

C. F. W. T. WILLIAMS.—The slides arrived safely. Many thanks for them.

T. BOYLE.—Your fern is a young specimen of the Northern Hard Fern (*Blechnum boreale*).

T. SMITH, JUN.—Your insect is not a beetle, but one of the homoptera. It usually lives in fresh-water ponds, but leaves the water for the air at certain seasons of the year. Its name is *Nepa cinerea*.

E. V. B.—Get Nicholson's "Elementary Text-Book of Zoology," published by Blackwoods, at, we believe, 2s.

F. F.—Many thanks for your good wishes.

A. F.—The name of your moth is *Plusia, v. aureum* (female); commoner in Ireland than in England.

F. QUARTERMAN.—The specimen sent was that of one of our commonest British sponges, called *Chalina oculata*.

A. CROALL (Stirling).—Address M. Gautier himself, at Narbonne, France.

T. W.—Your zoophyte appears to be *Sertularia rugosa*, but it is anything but a good specimen to identify.

J. A.—The seed of which you sent a sketch, found in wool, goes by the name of "The Devil's Horns." Botanists know it by the name of *Martinia Montevidiensis*.

G. M. DOR.—The act of spinning, indulged in by certain snails and slugs is well known. See an article by Mr. G. Sherriff Tye, in SCIENCE-GOSSIP for 1874, page 49, on "Molluscan threads."

To members of "Science-Gossip" Naturalists' Clubs, &c.—Will a member of above clubs oblige me with regulations and hints for forming a "Science-Gossip" club?—John J. Morgan, Tredegar.

MISS SPARKES.—The moss from the Arctic regions is *Distichum capillaceum*.

G. A. HOLT.—Your mosses are:—1. *Grimmia pulvinata*; 2 and 5. *Ceriododon purpureus*; 3. *Orthotrichum anomalum*; 4. *Tortula subulata*.

R. R. T.—Your specimens are:—1 and 3. *Physcomitrium pyriforme*; 2. *Rhacomitrium heterostichum*; 4. *Orthotrichum cupulatum*; 5. *Grimmia apocarpa*, var. *rivularis*; 6 and 7. *Orthotrichum affine*.

J. PERCIVAL.—Your moss is probably *Bryum pendulum*.

R. G.—The following are the names of your mosses:—1. *Rhacomitrium lanuginosum*; 2. *Dicranum fuscescens*; 3. *D. scoparium*; 4 and 5. *Hypnum trisetrum*; 6. *H. cuspidatum*; 7. *H. splendens*; 8. *Bartramia fontana*; 9. *Hypnum loreum*; 10, is a flowering plant, probably a *Sagina*; 11. *Tortula tortuosa*; 12. *Bartramia pomiformis*.—R. R. B.

H. A. (Cannes).—The names of the two species you enclose are: No. 1 with a dark-looking hood over the long spike of real flowers, is a Cuckoo-pint, *Arum Arisarum*, L. No. 2, with the light pink-lipped corolla, is a Hen-bit, or *Galopsis angustifolia*.

J. H. G. (Gravesend).—We have never noticed the *Gelsemium* as a garden or cultivated species; so we should judge it is a *Jasminum* you have observed.—J. F. R.

G. C. D. (Northampton).—Thanks for specimen of *Linaria spuria*; it is a true "peloria," at least several flowers are thus transformed. The *Rhynchospora* is what we have always regarded as the typical form; all our herbarium specimens are similar. The grass is *Glyceria aquatica*, *Linaria minor*—yes. Ergotized example is very interesting. A short paper upon this with drawing will probably appear soon in our pages.

EXCHANGES.

WANTED, the rarer British or any Foreign Algæ, Mosses, &c. for others.—A. Croall, the Smith Institute, Stirling, Scotland.

OFFERED, 1st Vol. of "Cassell's Book of Birds," including Parrots, Passeres, and Ravens (7s. 6d.), and Ramsay's Mineralogy (3s.), both nearly new, for a book on British Birds.—D., 78, Claverton-street, London, S.W.

WANTED, Fleas and Parasites from Bats, also Ixodes (Ticks) from foreign animals; good slides or books in exchange.—H. E. Freeman, 48, Woodstock-road, N.

WANTED, to exchange with American, Continental, and Colonial Collectors, British Land and Fresh-water Shells, for foreign ones, either land, fresh-water, or marine. Also the first seven vols. of SCIENCE-GOSSIP to purchase. State lowest price in cash.—Address, H. Crowther, Philosophical Hall, Leeds.

WANTED, a few specimens illustrative of deep-sea formations, mounted or otherwise; also of marine zoology; a variety of similar objects for exchange.—Edwd. Lovett, Holly Mount, Croydon.

WELL-MOUNTED Slides of Tous les Mois Starch, Hair of Esquimaux Dog, and others, to exchange.—Edwd. Howell, Yeovil.

WANTED, the Three first Volumes of SCIENCE-GOSSIP, for years 1865, '66, and '67. Also those for years 1872, '73, and '74.—Dr. Cunynghame, 6, Walker-street, Edinburgh.

I AM desirous of having Australian Eggs. I can offer British and also a few North American eggs. The commonest species accepted, if neatly blown; mine are side-blown. Australian correspondence invited. All letters answered.—T. W. Dealy, 142, Clarence-street, Sheffield.

FINE duplicates, early this month, of *Gothica cruda*, &c. Wanted, in exchange, old edition "Merrin's Calendar," or back numbers SCIENCE-GOSSIP.—J. T. Willis, Adwick-le-street, Doncaster.

WANTED, in exchange for eighty distinct and well-dried specimens of exotic Ferns, including species of the genera *Hymenophyllum*, *Trichomanes*, *Deparia*, *Gleichenia*, &c., all correctly named.—British Shells (rarer kinds), several specimens of each species, or British Fossils; the former preferred, especially the Helices.—A. B., 12, Ellesmere-road, Victoria-park, London, E.

WANTED, the Back Volumes of SCIENCE-GOSSIP. Other books given in exchange; a list will be sent.—W. T. E., 1, The Prairie, Lowestoft.

BRITISH and foreign Butterflies wanted in exchange for Trap-door Spider's Nest, and the Adult Spiders of *Nemesis meridionalis* and *Nemesis Eleanora*.—Address, Miss Maulere, 15, Queen-street, Mayfair, London, W.

WILL give specimens of Himalayan Ferns, about thirty kinds, to any one who will name them correctly for me.—J. A., 2, Oriental-place, Brighton.

JOURNAL of the Chemical Society for the past year offered for other books.—W. A. Law, 11A, Abington-street, Northampton.

NOS. 551, 873, 162, and 1652 Lon. Cat. 7th ed., and Plants from Goza (unnamed). Wanted: Nos. 873l, 874, 874l, 875, 876, and others.—Tom Watson, 54, Bank-parade, Burnley.

FOR *Trollius Europæus*, *Anemone apennina*, *Myosurus minimus*, *Ranunculus confusus*, *R. ficaria*, with bulbils and fruit,—*Daphne laureola*. Send stamp and address to W. G. Piper, 70, London-street, Norwich.

ANCHORS and plates of Synapta in arranged form, in exchange for good Slides. Send list.—W. Nash, 11, London-road, Reading.

WANTED, Two examples, dried, of *Festuca sylvatica*. State Sussex plant desired in exchange.—F. H. Arnold, LL.B., Fishbourne, Chichester.

Cellularia avicularis, showing bird's-head processes. I have a few Slides of the above, and should be pleased to exchange one of same for other good slide.—J. Wooller, 7, Farm-road, Hove, Brighton.

BERKTON'S Dynamometer, with Lens (for measuring the power of any Telescope, and gauging glass covers of any thickness) offered for six good slides.—T. H. Baffham, Clarendon-road, Walthamstow.

WANTED to exchange, Shells from *Limax lewis*, *Testacella Maugei*, or *Vertigo edentula*, *Vertigo pygmaea*, *Limnaea peregra* (white shells, which are rare), for either *Testacella halottidea*, *Limax gagates*, *Geomalacus maculosus*, or *Vertigo Moulinsiana*, *V. alpestris*, *V. substriata*, *V. pusilla*, *V. angustior*; no other sorts will do.—J. Whitenham, Cross-lane Marsh, Huddersfield.

WANTED, *Helix lapicida*, var. *albida*. In exchange offered *Unio tumidus*, var. *ovalis*, and other rare species.—Address, Miss F. M. Hele, Fairlight, Elmgrove-road, Cotham, Bristol.

FIGUIER'S "Vegetable World," cost 7s. 6d., nearly new; would like to exchange for a work on Entomology. Offers requested.—Henry Jones, Hawley, Farnborough Station.

VOL. I. of Cassell's "Popular Natural History," unbound, for Pups (living) of Machaon.—C. Swatman, Mr. Feldwick's, London-road, Sevenoaks, Kent.

FOSILS from the Chalk and Gault, and British Shells, offered for foreign shells.—Address, M. M., Post-office, Faversham.

FOR Mounted Palates of *Ancylus fuvialis* send other well-mounted slide; named diatoms preferred, or good materials.—M. Fowler, 20, Burn-row, Slamannan, N.B.

BUTTERFLIES and Moths from Madagascar, Opals and other precious stones, and Exotic Shells to exchange for good microscopic slides.—G., 18, Elgin-road, Harrow-road, London, W.

DUMERIL'S "Sciences Naturelles," 2 vols., for good microslides.—F. W. Phillips, Maidenhead-street, Hertford.

IN Mr. T. Brittain's exchange of last month the word "Wanted" should have appeared before "Utricularia, &c."



QUARTZ: ITS VARIETIES AND MODES OF FORMATION.

No. II.

BY THE REV. J. MAGENS MELLO, M.A., F.G.S.



AMONGST the most varied and beautiful forms of quartz which have had a purely aqueous origin, are all the varieties of crystalline and amorphous silica, which frequently coat the interiors of geodes and other hollow spaces in the igneous rocks, and which consist chiefly of an intermingling of chalcedony and jasper, and are conveniently grouped under the general name of Agates. Pure rock crystal, amethyst, cairngorm, and other valuable crystallized forms of quartz, are often found in connection with the same rocks, or in others of a more purely metamorphic character. All these varieties of quartz are secondary formations, deposited from watery solutions. The exact mode in which agates have originated is a question full of interest, and not easy in every case to answer. A wonderful history of mineral growth is written in the folded leaves, if one may so denote the bands of a single agate. A very large number of agates consist of more or less concentric layers of chalcedony of various colours (the colours depending on the presence of metallic oxides), together with jasper, rock crystal, amethyst, &c., in many cases.

Chalcedony is sometimes described as a uniform condition of silica, and though apparently amorphous, when it is microscopically examined, it generally, if not always, exhibits a minute and definite radiated crystalline structure. It frequently forms stalactites, and many of the most exquisite of the banded agates are sections cut from stalactitic formations. Jasper may be looked upon as chalcedony, which, as it consolidated, caught up a certain amount of alumina, or sometimes of lime or oxide of iron. Professor Ruskin, who has paid some attention to this subject,

has observed* that "jasper will collect itself pisolitically out of an amorphous mass into a concretion round central points, but does not actively terminate its external surface by spherical curves; while chalcedony will energetically so terminate itself externally, but will, in ordinary cases, only develop its pisolitic structure subordinately, by forming parallel bands round any rough surface it has to cover, without collecting into spheres, unless provoked to do so by the introduction of a foreign substance, or encouraged to do so by accidentally favourable conditions of repose."

According to the same observer, some agates appear to be of the nature of concretions formed from within, round a nucleus; these would consist of chalcedony or jasper in the inner portions, and have distinctly crystallized exteriors. There is another class of agates composed of external bands of chalcedony or jasper, stalactitically deposited in a cavity which may either have a hollow centre, or one filled up with crystals of quartz. There appear, however, to be intermediate varieties in which concretionary or stalactitic formations have been combined with, or interrupted by, other modes of growth.

Some of the most curious and beautiful agates are those containing dendritic crystallizations; in these we see, in the more or less transparent chalcedony, which in these agates is not banded, wonderful mossy or confervoid-like growths, often very closely resembling vegetable forms. The valuable stones from Mocha contain ferruginous brown or black inclusions, whilst some of the dendritic agates from India are filled with a bright green network of what appear to be filaments of *confervæ*. These dendritic forms in the moss agates are mostly the oxides of iron or manganese; or in the green Indian pebbles, delessite or chlorite. The question of their origin is a difficult one. In some agates the dendrites may have resulted from a segregation of the

* *Geological Magazine*, vols. iv. and v.

oxides of the metals from the colloid or partially crystallized silica; in other cases they may be the effect of subsequent infiltrations; or again, the quartz may have been consolidated around previously existing crystallizations. With regard to infiltration by these oxides, it is well known that even the most compact-looking chalcedony is permeable, as it is possible by steeping it in solutions of the aniline or other dyes to impart the most brilliant tints to agates, the dye undoubtedly gaining access to the interior of the specimen through the interspaces of its minutely crystalline structure.

In a large group of agates, of which beautiful specimens come from India, an appearance of banded formation is seen, which, upon microscopic examination, resolves itself into an infinite number of red or brown spots, regularly arranged in bands or concentric groups: these spots appear to be segregations of oxide of iron. I have not seen a specimen of this species of agate cut sufficiently thin to show whether the arrangement of these minute spots is dependent upon a banded structure in the chalcedony itself, or whether it is independent and the result of molecular force which has determined the arrangement in question. It may here be noticed that a vast number of the Indian agates come from the neighbourhood of the Gulf of Cambay. Near Turkeysar there are agate conglomerates intercalated between beds of laterite which belong to the Eocene period. These conglomerates we may suppose to have been derived from the denudation of the earlier igneous rocks which abound in the same district. Uruguay, in South America, also produces a large number of remarkably fine banded agates. Sometimes well-formed quartz crystals will be found inclosing other substances, which, in some instances, have been caught up by the crystals in the course of their formation, or have crystallized, perhaps, almost simultaneously with the quartz. In other cases the quartz is proved to have crystallized over other previously-formed crystals; thus schorl is occasionally seen partially inclosed in quartz crystals and partially free, the ends of the crystals of schorl projecting through the quartz. Titanite, asbestos, and other minerals are not unfrequently found in minute acicular forms in quartz. The quartz in the igneous rocks may frequently be seen to inclose crystals of felspar or titanite, or portions of the matrix which must have been previously solidified.

Opal, as has already been pointed out, is a product of aqueous origin found in the fissures and amygdaloid cavities of igneous rocks. Its wondrous play of colours has given rise to much discussion by Brewster, Des Cloiseaux, and other writers. Some have attributed it to the presence of numerous cavities of varying size, which cause a kind of iridescent refraction. Des Cloiseaux was inclined to suppose that organic matter might be inclosed in small quantities in its cavities. The most reasonable sup-

position, however, appears to me to be that of Reusch,—that light reflected or transmitted from numberless flaws in the mineral gives rise to the phenomena in question through a process of double refraction.

We may now turn to the consideration of forms of quartz which have a more or less organic origin. At the head of these may be placed such undoubtedly organic aggregations of silica as the Tripoli and semi-opal of Bohemia, which consist almost entirely of fossil diatomaceæ. Some beds of rock also in the island of Barbadoes are found to be composed of little else than polycystinæ and spiculæ of sponges. Much of the flint so characteristic of the chalk rocks, as well as the chert of the greensand and of the mountain limestone, appears to have been derived from the precipitation, by organic substances, of silica held in solution by the waters of the ocean; at any rate, much of it seems to have been thus deposited; flinty nodules are often found to consist of fossilized sponges, the silicious skeletons of which may have attracted to themselves the silica dissolved in the surrounding water. Spiculæ of sponges, diatomaceæ, foraminifera, shells, corals, and other organisms are abundant in the flint, and also in much of the chert. Recent observations by MM. Guignet and Teller have shown that the water of the Bay of Rio-de Janeiro contains large quantities of both silica and alumina in solution, the amount in the case of silica being as much as 9.5 grains per cubic meter.

Wood will sometimes be found to be pseudomorphosed into silica, the woody structure being replaced atom by atom, so that the minutest vessels are perfectly preserved. Various species of palm from the East Indies are frequently found fossilized in this manner, and sections of them make very beautiful objects for the microscope. Large fragments of a partially silicified wood, named *Endogenites erosa*, may often be found in the neighbourhood of Hastings, derived from the Wealden formation.

The curious so-called mineral Beekite is really coral or shelly matter which has been replaced by silica. Researches into the behaviour of the colloid form of silica, already spoken of, have shown how in many instances large deposits of silica, such as the flinty bands of the cretaceous formation, may have originated. Mr. Church's experiments, made some years since, proved that the minutest particle of carbonate of lime was sufficient to transform the pure aqueous solution of silica into the solid state in the course of a few minutes; and he was able, by the infiltration of silica in solution, to replace almost entirely the carbonate of lime in recent coral by silica, producing by this means what may be looked upon as a kind of artificial Beekite. Thus in the slower, perhaps, but mighty chemistry of nature, marvellous re-actions may have taken place, giving rise to some of the multitudinous forms in which silica presents itself to the mineralogical student.

OUR FIRST SPRING RAMBLE.

ONE Friday afternoon my friend, Dr. Morton, having freed himself from his professional duties with a view to a botanical tour, we started at two p.m. upon a long country drive, which proved to both of us one of the most enjoyable excursions we have made for a long time. The morning had been heavy and threatening, but soon after twelve o'clock the sky became perfectly clear, the sun shone out with the splendour of summer, and a light and refreshing breeze played over us, toning down the fierceness of the solar rays.

In about ten minutes' time we found ourselves obliquely descending the steep face or escarpment of the first parallel (to use a military phrase) of the great chalk range which forms the beautiful chain of hills known as the North Downs. These hills here dip gently to the N.E., the chalk passing beneath the Medway; for some distance on each side of which it is covered with alluvial sand, in many places rich in coprolites. At the distance of about a mile and a half S.W. of the Medway, the long incline of chalk, with an immense tract of fine grass-land reserved by Government for military purposes, known as the "Lines," is abruptly terminated by the escarpment, AB of fig. 82. These "Lines," lying as they do equally between the three towns, New Brompton, Old Brompton, and Chatham, and being for the most part open to the public, are simply invaluable as a *lung* to the large population of these towns.

The lines of "dip" and "strike" of these cretaceous deposits are well shown by the beautiful sections laid bare in the numerous chalk-quarries found along the slope, the alternate layers of chalk and flint revealing in an unmistakable manner the direction of each. Many beautiful fossils are to be found in these pits, and a visit to them well repays the geological student for his trouble. The long slope of the next ridge is furrowed by many transverse valleys opening into the great longitudinal valley B (fig. 82), which runs for miles to the south-east, gradually shallowing out so that the two ridges ultimately become more or less merged into one. Some of the effects of aqueous denudation during the upheaval of the great anticlinal chalk ridge from the bosom of the deep, and the subsequent denuding of the central part, afterwards occupied by the estuary of a mighty river, are well shown by these transverse furrows and by the scooping out of the escarpment immediately opposite the terminations of these hollows by the waters which rushed through them. Standing on our ridge near the Windmill, upon the spot where one of the forts for the defence of Chatham is to be erected, and looking over the country to the south-west, noting as one must the termination of these valleys opposite the denuded face of the chalk and the splendid bay-like inward sweep of the ridge at these points, even the most ungeological of men could scarcely fail to see in it the

direct agency of water. In fact, I know of no place better fitted for a "lay sermon" than this. Fig. 83 shows the termination of two of these transverse valleys, and the modification thereby of the contour of the ridge opposite.

This cliff, facing as it does the south-west, is in summer a perfect flower-garden, furnishing to the eye botanical a feast that can be surpassed in few places. A notion of its richness and beauty may be gathered from a bare enumeration of a few only of the flowers that adorn its banks. *L. corniculatus*, *A. vulneraria*, *Hippocrepis comosa*, *O. sativa*, *L. pratensis*, *Helianthemum vulgare*, numerous Compositæ, several species of Bed-straw, *D. carota* and other Umbelliferæ in abundance; showy common mallow, wild mignonette, ver-bena, the showy *Echium vulgare*, the ragworts, *Alyssum maritimum*, numerous labiates,—among them *Origanum vulgare*, thyme, three species of Chenopodium, *N. cataria*, *N. gluchoma*, &c. In the hedge we find *Euonymus*, *V. lantana*, *P. aria*, with magnificent silver-lined leaves, privet, black-thorn, white-thorn, *cum multis aliis*. At the present, however, we have but a small promise of these in the budding leaves, the enlarging corymb of *V. lantana*, and in the appearance of *V. odorata*, *V. canina*, *S. holostea*, and the pretty blossoms of the black-thorn.

Passing along the valley we came, near Bradhurst, to a small wood, a favourite hunting-ground of ours, where we found the showy flowers of *Anemone nemorosa*, *R. ficaria*, *Cardamine pratensis*, and *P. fragariastrium* gaily intermingled, forming a most pleasing picture. Among these were scattered tufts of *L. campestris*, while mosses of various kinds clothed the earth as with a carpet of many-tinted green. After a few turns amid its thickets, feasting our eyes upon its beauties and securing for the future some of its treasures, we drove on through Lidsing to Boxley-hill.

Here again meets the eye of the wanderer a scene that is rarely surpassed for beauty and variety. Immediately before us lies the abrupt descent of the chalk escarpment, a counterpart of the one already alluded to, but on a grander scale, and, unlike that, clad from base to summit with thousands of trees of various species. Prominent among them are the giant gloomy-headed yew, the beautiful beech, the graceful elm, the pretty evergreen oak, its massive gnarled brother, the English oak, and the elegant birch. Among its humbler denizens we find *V. opulus*, *V. lantana*, the hornbeam, the hazel, various willows, buckthorn, *Atropa belladonna*, and the curious juniper. Stretching away for miles before us, studded with magnificent elms and other forest trees, and dotted over with town and hamlet, rises the Weald of Kent, forming a picture that surpasses description, and thus justifies by its beauty and fertility the boast that "Kent is the garden of England."

Arrived here, we descended on foot the steep lane that leads to the lower land of Boxley village, making

frequent detours right and left into the wood which borders the road on either side. The anemone, pilewort, dog-violet, and primrose everywhere met our eyes, covering, as with a carpet, the openings between the trees, and slyly peeping out from beneath every tuft and bush. About halfway down the hill we visited a piece of rough ground formed by old chalk-pits and their *débris*. Here among the bushes we found *Helleborus fetidus* in great abundance, hanging out its great handsome panicle of drooping green, red-margined flowers. Here we were also delighted to find in considerable abundance the pretty Spurge-laurel (*Daphne laureola*) in full bloom. The flowers

porosity enabling it to drink in all that falls upon its surface. This dearth of water is one of the charms wanting to render the lovely, undulating, wooded chalk district perfect in its beauty. To the botanist it is a source of annoyance, or rather regret, as it deprives him of a large section of the common flora; viz., all the freshwater-loving plants. Directly we leave the ridge, however, we meet with numerous streams like that at Boxley, issuing in plenty from below the chalk.

Here we had a refreshing drink, and an equally refreshing rest, after which we turned our attention to our favourite pursuit. The wall bordering the

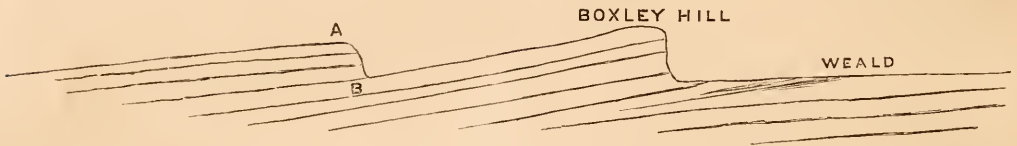

Fig. 32. Escarpments of the Chalk.

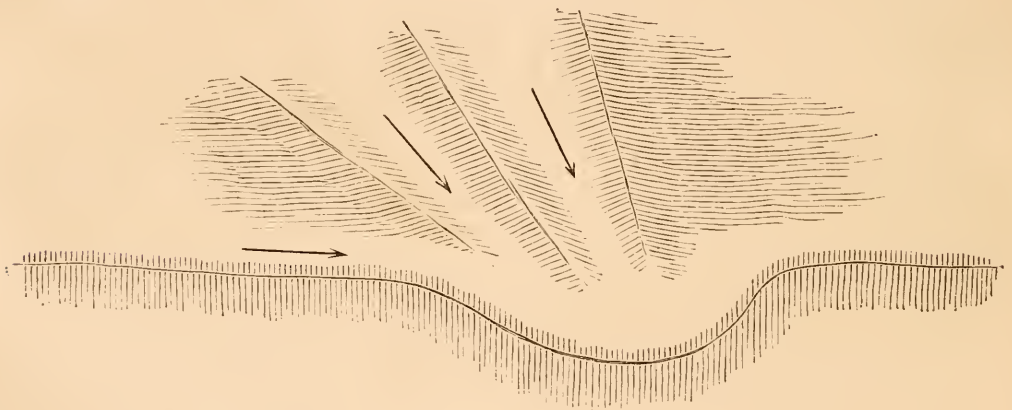

Fig. 33. Diagram showing the Termination of Two Transverse Valleys, and Modification of Opposite Ridges.

are very like those of *D. meserium*, but green. They are strongly fragrant, emitting a sweet, more or less primrose-like scent. This, though deemed agreeable by us, was thought to have a sickly-sweet odour by others to whom we showed it. Bentham speaks of it as "scentless"; but how he could arrive at that conclusion we are at a loss to understand. Surely he never visited Boxley woods in March, or he would not have fallen into so strange an error. In the same place we were struck with the gay appearance presented by the rich orange-yellow seeds of the *Iris fetidus*, which remained clinging to the opened and partially-decayed seed-vessels of last autumn. On leaving the chalk at the foot of the hill, we meet with a splendid stream of the coolest and most sparkling of waters, reminding one forcibly of the beautiful streams seen so frequently in Derbyshire. On the chalk one never meets with streams of water, its

stream was resplendent with flowers of the golden saxifrage (*C. oppositifolium*), and the beautiful green fronds of the liverwort. The grassy banks and the lower lands perfectly blazed with the golden-yellow of the pilewort. On the wall we found, just bursting into bloom, the singular little *Saxifraga tridactylites*, *Linaria cymbalaria*, and the stone-cress (*Arabis petraea*). In many of the lanes *Tussilago farfara* was very plentiful.

We now drove on past Pennenden Heath, which was *en fête*, a kind of fair being held there on Good Friday. The scene was gay in the extreme, contrast no doubt adding something to the effect, as we had spent the greater part of the afternoon in the woods. Tents bedecked with flags everywhere dotted the heath; swings, boats, roundabouts, the cocoa-nut-capped sticks of Aunt Sally, and other similar sport-producing apparatus, were thickly crowded together. Numbers

of young men, who, though *en dimanchés*, showed by their heavy, slouching gait they were tillers of the soil, proudly paraded the heath, while others spent their hard-earned coppers in short rides upon unfortunate *skeleton* horses and ponies brought from Maidstone and surrounding districts. Perhaps this was the only part of the scene that produced pain in the beholder. To see those poor half-starved brutes mercilessly belaboured with sticks in the vain effort to make them move their weak, stiffened limbs at an impossible speed, was really painful, and greatly marred the pleasing effect of the scene, which in every other respect seemed one of light, thoughtless happiness. The "Society for the Prevention of Cruelty to Animals" might have done good service here, and would do well to have an agent present at all such gatherings.

From here we drove to Grove Green, the boyhood haunts of my friend, in whom it stirred up many sweet remembrances of the past, and who was thus led to give me many reminiscences of those happy days of yore that made one mentally sigh—

I would I were a careless boy.

Returning through country lanes bordered with wood and high banks, *à la* Devonshire, we finally struck the high road from Maidstone to Chatham. It was now dusk, but our route up the long, steep "Blue Bell Hill," along which we thought it right to walk to ease the horse, was lightened by the incessant singing of the thrush and blackbird, and the occasional calls of other birds preparatory to their final settling down for the night.

We arrived home about 8.30, bearing our spoils for further examination, and a rich harvest of sweet recollections for future years.

J. HEPPWORTH.

THE RING OUSEL.

(*Turdus torquatus*.)

THIS bold and handsome Thrush is somewhat thinly distributed over our islands, becoming more frequent as we advance northwards. It is common in France, Germany, and other parts of Europe. Unlike the Fieldfare and Redwing, which visit us in the winter, the Ring Ousel is a summer visitant, arriving on our shores in April.

It inhabits the wildest parts of our moors and commons, among the secluded glens and large boulders of rocks over which flow swift mountain-torrents. Soon after their arrival the Ring Ousels commence building their nests, which are generally placed on or near the ground, on some bank, especially one which is near to water. They are somewhat common on the moors near Sheffield, and in the Peak of Derbyshire: hence one of their local names, "Moor Blackbird." It has for the last three years bred, to my knowledge, on the banks of a large

piece of water near Sheffield. The nest, something like the Blackbird's in shape and materials, is composed of coarse grass, cemented with mud, and lined with fine grass and roots. The eggs, five in number, one inch and a quarter long, by seven-eighths broad, are of a bluish-green ground-colour, spotted and blotched with brown. They bear a striking resemblance to those of the Blackbird. When their nest is approached, they fly round in circles, uttering loud

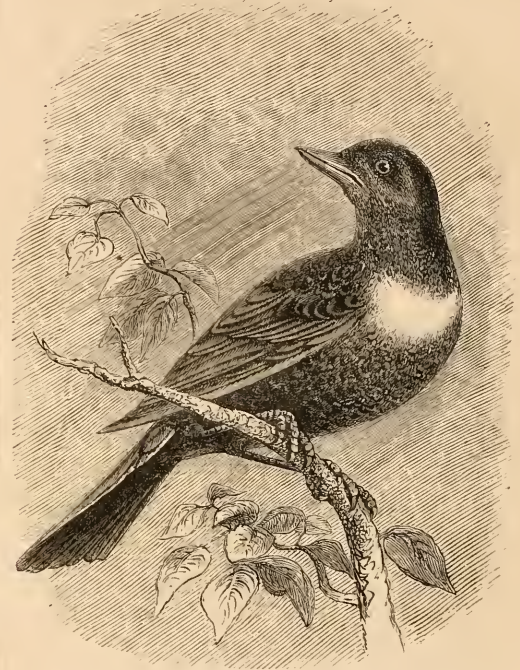

Fig. 84. The Ring Ousel (*Turdus torquatus*).

cries, and will feign lameness, fluttering along the ground with drooping wings, and try every artifice to lead the intruder from their coveted treasure. I have known them fly into my face, and I have even struck them with a fishing-rod, but still they have darted at me, and turned away with the rapidity of an arrow, and have followed me, keeping up their incessant cries, until I have gone some distance from the place where their nest was concealed.

The food of the Ring Ousel is composed of snails, insects, and berries; it is also very partial to fruit, to gain which, it makes great depredations in the garden and orchard, for which penalty it sometimes suffers death by the hand of the indignant gardener.

The length of the male Ring Ousel is from ten to twelve inches; beak yellow, tipped with black; head, neck, back, wing-coverts, upper tail-coverts, wings, and tail, all one colour, which is brownish black, each feather of body bordered with blackish grey; throat, belly, and under tail-coverts, same as upper parts. Across the chest is a band of pure

white; legs and claws brownish black. The female is not so deep coloured; also the band of white across the chest is not so broad and pure as in the male.—*Charles Dixon.*

THE HISTORY OF OUR SALAD HERBS.

THE use of salads is of the greatest antiquity, for we find mention of the Lettuce, Endive, Radishes, &c., in most of the books of ancient authors who wrote upon plants. In the "Mishna," a Hebrew book containing the traditions and explanations of Scripture, we find that the bitter herbs commanded to be eaten at the Paschal feast of the Jews, was a salad consisting of wild lettuce, endive, the young green tops of horseradish, a species of nettle and coriander, all of which, in their uncultivated and unbleached state, are of an intense bitter.

The ancient Epicureans of Athens and Rome took great pains to have their salad herbs of the first-rate quality; even poets sang their praises.

Ovid, in his tale of "Philemon and Bauris," says:

A garden salad was the third supply
Of endive, radishes, and succory.

In England there is no doubt at a very early period the old monks and the ecclesiastical orders had the gardens of their monasteries, which were scattered over the kingdom, well stocked with salad herbs and other simples, both for the table and medicinal use. Oil for salads is mentioned in one of the Paston letters written in 1466 ("Paston's Lett.," i. p. 228).

Our ancestors used a great many more herbs and roots, which are never put in the salad-bowl at the present day. Gerard's list of garden growths, and simples good for salads, comprised more than thirty. John Evelyn, in "Acetaria, a Discourse on Sallets," published in 1699, enumerates over seventy. He praises the milky or dappled thistle, either as a salad or baked in pies; it was at that period sold in our herb-markets for a supposed virtue, in consequence of its name, *Carduus Marie* (Our Lady's Milk-thistle), which caused it to be esteemed a proper diet for nurses; but of all his dainties which we, in the present age, would be the least willing to partake, are the small young acorns which we find in the stock-doves' craws, and which he declares are delicious fare, as well as those incomparable salads of young herbs taken out of the maws of partridges at a certain season of the year, which give them a preparation far exceeding the art of cookery. They were certainly valiant eaters in those days, and one who admired such salads might have sat down with a relish to a Northern Indian's feast. Nettles and twigs of rosemary, with pickled gherkins, we are told, were also a favourite salad with our forefathers.

Although many herbs might be, and are, used on the Continent as material for salad, I must confine

myself in these articles to those which are in common use among us. The first of these is the genus containing the Lettuce, Endive, and Succory, all belonging to the order *Compositæ*.

The Lettuce (*Lactuca sativa*) is mentioned by Hippocrates and Dioscorides, both as an aliment and medicine. We also learn from an anecdote related by Herodotus, that lettuces were served in their natural state at the royal tables of the Persian kings at least 550 years before the Christian era. Cambyses, son of Cyrus the Great, had his brother Smerdis killed from mere suspicion, and, contrary to the laws, married his sister: this princess being at the table with Cambyses, she stripped a lettuce of part of its leaves, when the king observing that the plant was not so beautiful as when it had all its leaves, "It is the same with our family," replied the princess, "since you have cut off a precious shoot." This indiscreet allusion cost her her life.

Pliny tells us that the Greeks cultivated a variety of lettuce which grew to a great height, and that they bestowed, like his own countrymen, great care in the cultivation of them. It is stated that Aristoxenes, a philosopher by profession and epicure by taste, grew a variety of these plants in his garden that were the envy of his neighbours. He used to sprinkle them at night with a sweet-smelling wine, and when asked the means he employed to get lettuce of such delicate perfume and exquisite taste, replied that the earth prepared them expressly for him (Athen., i. 12).

Theophrastus in his "History of Plants," mentions that the Lettuce was a favourite plant of the beautiful Adonis; and that on his death Venus threw herself upon a bed of lettuces to lull her grief and repress her desires; thus showing that the narcotic and sedative virtues of this plant were well known to the ancients. The celebrated physician Galen, who lived A.D. 150, mentions that in his old age he found no remedy against wakefulness with which he was troubled so effectual as eating lettuces of an evening. Many persons, he says, boil this tender herb in water, before it produces stalks, "as I myself now do since my teeth begin to fail me." Suetonius, the biographer of Augustus Cæsar, informs us that this emperor was cured of a dangerous disease by the use of lettuces, recommended by Antonius Musa, his first physician. After that the Romans began to devise means of growing them at all seasons of the year, and even preserving them, for they were used in pottage as well as in salads. They were anciently eaten at the conclusion of supper; but in the time of Domitian they changed this order, and served them with the first entries at their feasts. We do not know exactly at what period the Lettuce was introduced into England, but Turner, 1538, mentions it as not being a rare or recently-cultivated plant, but being one with which the public had long been familiar. In the Privy Purse Expenses of Henry VIII., in 1530, we find that the gardener at York-place received

a reward for bringing "lettuce and cherries to Hampton Court." In 1597 old Gerard gives us an account of divers sorts of lactuse or lettuce that were then cultivated in England. He says: "Lectuces maketh a pleasant sallade, being eaten rawe with vinegar, oil, and a little salt; but if it be boiled, it is sooner digested and nourisheth more." He adds: "It served in these daies and in these countries at the beginning of supper, and eaten first before any other meat; but notwithstanding, it may now and then be eaten at both these times to the health of bodie; for being taken before meate it doth many times stir up appetite, and, eaten after supper, it keepeth away drunkenness which cometh by wine; and that it is by reason that it staieth the vapors from rising up into the head." He also says: "Lectuce cooleth a hot stomake called heartburning, &c. &c."

The native country of the Lettuce is not known, but the genus is spread over Southern Europe and Central Asia. In England we are no doubt indebted for some of its varieties to the Greek islands. The Cos Lettuce, as its name indicates, is a native of the island of Cos, and was most probably brought from thence into this country. About the year 1771 this plant was first introduced into the modern pharmacopeia by the celebrated physician Collin, of Vienna, who recommended the inspissated juice in the treatment of dropsy. The Lettuce was largely cultivated at one time at Brechin, in Forfar, and its juice collected nearly in the same way as opium for medical purposes; and as far back as 1799 there was an article published in the "Transactions of the American Philosophical Society" (vol. iv. p. 387), on the comparative effects of opium extracted from the White Poppy and that from the cultivated Lettuce.

Our poet Pope notices the narcotic property of this plant in one of his poems, for he says—

If you wish to be at rest,
Lettuce and cowslip wine *probatum est*.

The *Extractum Lactuce*, as it is called, is not prepared from the garden lettuce (*L. sativa*), but from the strong-scented lettuce (*L. virosa*), which abounds with a milky and narcotic juice, and is sometimes to be found growing wild on banks and waysides in England, especially in a chalky soil.

Phillips tells us that the Latins gave this plant the name of *Lactuca* from *Lac*, on account of the milky juice with which it abounds. The French, for the same reason, call it *Lactue*; the English name, *Lettuce*, is a corruption of either the Latin or the French word, and in all probability originated from the former, as several of our old authors spell it *Lectuce*.

ENDIVE (*Cichorium Endivia*.)

The *Cichorium* mentioned by Theophrastus in use among the ancients is supposed to be a kind of wild

endive, and a species, if not the same, as our Succory (*C. intybus*). Pliny informs us that this plant was eaten both as a potherb and a salad by the Romans. It also possesses, he tells us, medicinal properties; the juice mixed with rose-oil and vinegar was used to allay pains in the head, and when mixed with wine it was thought good for complaints of the liver. It is one of those plants with which the magicians, in credulous ages, used to endeavour to impose on their easily-seduced believers. They affirmed that if persons anointed their bodies all over with the juice of this herb mixed with oil it would make them appear, not only so amiable that they would win the goodwill and favour of all men, but that they would easily obtain whatever they set their hearts upon.—(See Phillips's "Hist. of Veg.")

The common garden Endive now in use appears to have been first cultivated in England in the reign of Edward VI., 1548, and is said to be a native of China and Japan.

Gerard gives us an account of the manner by which this plant was preserved for winter use in the days of Queen Elizabeth:—"Endive being sown in July, it remaineth till winter, at which time it is taken up by the rootes, and laide in the sunne or aire for the space of two houres; then the leaues be tough, and easily endure to be wrapped upon an heape, and buried in the earth with the rootes upwards, where no earth can get within it, which if it did would cause rottenness; the which so couered may be taken up at times convenient, and used as sallades all the winter, as in London and other places is to be seene, and then it is called white endive."

Succory, Chicory (*Cichorium intybus*) is mentioned by Gerard under the name of *Hedynois* in his Catalogues. He says, "These wild herbes are boiled in pottage or broths for sicke and feeble persons that haue hot, weake, and feeble stomacks, to strengthen the same. Thess plants growe wilde in sundry places in Englande upon wilde and untilled barren grounds, especially in chalkie and stonie places." Miller and other English authors on horticulture do not notice this plant as an article for the garden, and it is very little cultivated with us in the present day as a salad herb, though it is in much repute on the Continent, especially in France and Italy. Both in France and England, Succory has been occasionally cultivated as food for cattle; the roots, when well grown, have the appearance of large white carrots, and sometimes produce a crop from three to five tons per acre. The root, when dried and ground, has long been employed both for mixing with, and as a substitute for, coffee.

HAMPDEN G. GLASSPOOLE.

HOW TO PRESERVE STAR-FISH.—A very good way to prepare a star-fish for the cabinet is as follows:—Take the star-fish, and wash it thoroughly in fresh water; then pin it to a board, and leave it to dry in the sunshine till ready.—*G. H. Rayner.*

THE BLYBOROUGH TICK.

(Argas Fischerii.)

THIS interesting and curious arachnid was found in considerable numbers during the removal of the old roof from the village church at Blyborough, near Kirton-in-Lindsey, Lincolnshire; it forms a very beautiful object for the lower powers of the microscope. When living, the vermicular movements in the cœca, which occupy nearly the whole of its body, can be very distinctly seen. The cœca are well shown in the diagram. Mr. Ball's drawing (fig. 85) is taken from a mounted mature specimen, and shows eggs in its interior; but the anus, which is situated very nearly in the centre of the abdomen, is not shown, nor are the spiracles (which are two in number, and situated between the third and fourth legs on either side) to be seen. Like its near relation, *Argas reflexus*, which was found in Canterbury Cathedral, it is very tenacious of life; I have some at this present time which appear to be as lively as ever, and have been about five months in a glass-topped box, with nothing but two small pieces of wood for them to crawl upon; I cannot see that they have altered in appearance during the whole of that time. They differ greatly from *Argas reflexus* in colour, shape, size, and deportment; thus, *Argas reflexus* is slate-coloured, oval, three-tenths of an inch long, by nearly one-fifth broad, whilst *Argas Fischerii* is of a beautiful red-brown colour, nearly circular, and the finest specimens do not reach one-fifth of an inch in their largest diameter; as to their deportment, if you touch *Argas reflexus* it immediately simulates death, and so remains long enough to tire out your patience, whereas *Argas Fischerii* waits a few seconds, and then hurries off, with a gliding motion, at a tolerably rapid pace. Mr. Fullagar's drawing, which was taken from a living, medium-sized specimen, gives a very good idea of the creature, but would be much improved by the addition of a little colour. I think it not unlikely that this creature will be found tolerably common if well looked for in likely situations, for I have heard of two cases where creatures, supposed to be bugs, have been noticed when old church roofs have been taken down. Their life history has not by any means been satisfactorily made out. I have not seen a male, nor have I heard of the male of *Argas reflexus* yet having been seen. The structure of the mouth, resembling *Ixodes*, seems to point out their parasitic nature; but I have not yet heard of their being found on their host, at least in this country, although *Argas reflexus* is said to be parasitic on the pigeon, and *Argas Fischerii* may be parasitic on the bat; but if so, how is it that no one has yet found them on these creatures? I have carefully examined bats from this very church, but have not succeeded in finding the Argas on them. On February 16th I saw an Argas changing its skin; the process was rather more than half completed when I first observed

it; the skin parted at the edges, either half being turned backwards. On viewing the Argas as an opaque object, I could see the tracheæ, like whitish threads, branching from two centres, over the position of the spiracles; the contractions and dilatations

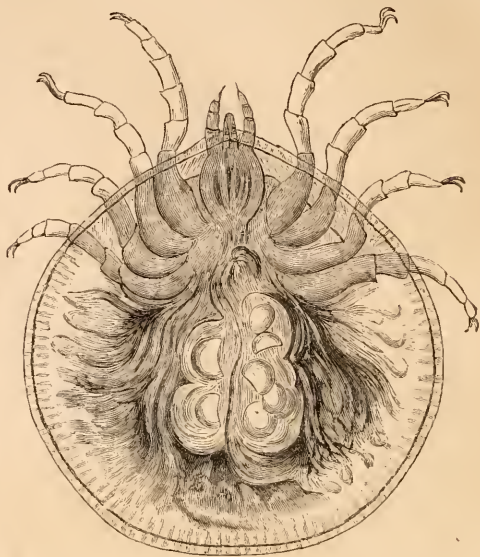

Fig. 85. The Blyborough Tick (*Argas Fischerii*), from a mounted adult specimen, showing eggs in interior.



Fig. 86. Mouth Organs of ditto.

Fig. 87. Foot of ditto.

in the cœca were at the same time being carried on with tolerable activity. One specimen which I dissected contained several ova, and in each of them the embryo was easily seen in a considerably advanced state of development.

I must refer those interested to my paper published in the "Journal of the Quekett Microscopical Club," No. 33, February, 1877, for some further remarks on this subject.

C. F. GEORGE, M.R.C.S.

"HERB-PARIS, or *Herb Truclove*. *Paris* is incorrectly spelt with a capital P. The name is from the Latin *Herba-paris*, the best of a pair, of a betrothed couple, in reference to its four leaves being set upon the stalk like a true-love knot."—*Dr. Prior*.

THE MIGRATION OF THE LEMMING.

IN the *Popular Science Review* for April (an unusually good number), we find a suggestive article, by Mr. W. D. Crotch, M.A., F.L.S., on "The Norwegian Lemming and its Migrations," in which the author indulges in a bold and striking theory as to the origin of these migrations. He thinks they point to a lost page in the history of the world. It is certainly most singular that instinct should seem to be so much at fault as it is with these little animals. Instinct is usually *preservative*, but in the Lemmings it is highly *destructive*, for Mr. Crotch tells us that every member of the vast swarms which periodically devastate Norway perishes voluntarily, or at least instinctively, in the ocean.

After describing the zoological characters and general habits of the Lemming, Mr. Crotch shows

a rug, merely because its ancestors found it necessary thus to hollow out a couch in the long grass."

Mr. Crotch goes on to seek for the "lost continent" towards which the migratory instincts of the Lemmings still turn:—"Is it probable that land could have existed where now the broad Atlantic rolls? All tradition says so: old Egyptian records speak of Atlantis, as Strabo and others have told us. The Sahara itself is the sand of an ancient sea, and the shells which are found upon its surface prove that no longer ago than the Miocene period, a sea rolled over what is now a desert. The voyage of the *Challenger* has proved the existence of three long ridges in the Atlantic Ocean, one extending for more than three thousand miles; and lateral spurs may, by connecting these ridges, account for the marvellous similarity of the fauna of all the Atlantic islands. Moreover, I do not suppose the Lemmings ever went so far south,



Fig. 88. Group of Lemmings (*Myodes lemmus*).

that mere lack of food is not the cause of their migrations. He thinks that it results from a former long-continued habit, which was of benefit to them in geological days, but destructive now that physical geological changes have submerged the ancient goal of the migrations. He illustrates the present habit of the Lemmings by those of the swallows, which leave us every year for Africa, and says, "If the continent of Africa were to become submerged, would not many generations of swallows still follow their inherited migratory instincts, and seek the land of their ancestors through the new waste of waters?" It seems to the author quite as probable that the impetus of migration towards such a "lost continent should be retained, a that a dog should turn round before lying down on

though they are found as fossils in England; but it is a remarkable fact that whilst the soundings off Norway are comparatively shallow for many miles, we find a narrow but deep channel near Iceland, which probably has prevented the Lemming from becoming indigenous there, although an American species was found in Greenland during the late Arctic expedition. If, as is probable, the Gulf Stream formerly followed this deep channel, its beneficent influence would only extend a few miles from the coast, which would also have reached to a great distance beyond the present shores of Norway, and thus the Lemmings would have acquired the habit of travelling westward in search of better climate and more abundant food; and as, little by little, the ocean encroached on the land, the same

advantages would still be attained. And thus, too, we find an explanation of the fate which befalls the adventurous wanderers; for no lake deters them, and they frequently cross the fiords in safety. No doubt, therefore, they commit themselves to the Atlantic in the belief that it is as passable as the lakes and fiords they have already crossed, and that beyond its waves lies a land, which they are never destined to reach."

THE BIRDS OF NEW GUINEA.

BY GEORGE BENNETT, M.D., F.L.S., F.Z.S., &c.

AN unexplored and fertile country like New Guinea cannot fail to excite the attention of the naturalist, whether his speciality may be ornithology, botany, ethnology, or any other branch of natural history. The discoveries already made, the numerous rare birds, insects, reptiles, &c., collected and already described, have excited the deepest interest among zoologists, and have aroused the enthusiastic collector to still further perseverance in adding to our stores more of the rich fauna which New Guinea possesses; for New Guinea and the adjacent islands are well known to teem with varied and beautiful forms of life in a luxuriant region, for the most part of tropical vegetation.

In the geographical distribution of birds, New Guinea may be very correctly placed in the same region as Australia, and may also include New Britain, New Ireland, and the Duke of York group of islands. Dr. Sclater considers that, while "Borneo, Java, and Sumatra are inseparably allied to the South Asiatic fauna, Amboyna, Timor, Gilolo, and New Guinea, with some of the other eastern islands, are properly appertinent to the same primary zoological region as Australia. The Straits of Macassar are perhaps the determining line separating these two regions, the island of Lombok (which lies due south of them) being (as Mr. Wallace's investigations have shown) in some respects debatable ground between them. New Guinea agrees with Australia in the absence of two families, the Woodpeckers (*Picidae*) and the Pheasants (*Phasianidae*), both of which are very fully developed in the region of Indian zoology. Signor D'Alberty obtained in New Guinea a remarkable form of rapacious bird, a New Guinea Harpy, which has been described and published very recently by Salvadori (in the *Annali del Mus. Civ. di St. Nat. di Genova*, vol. vii. 1875). It forms a new genus allied to the South American Harpy (*Thrasetus harpyia*), and he has named it *Harpyopsis Nova Guinea*.

New Guinea and the adjacent islands are well known to be the home of the more splendid forms of the Birds of Paradise; for the *Paradisida*, or Birds of Paradise, form one of the most remarkable families of birds, unsurpassed alike both for the beauty and singularity of their plumage. The various

species of true Paradise Birds having ornamental plumes developed from different parts of the body, are almost wholly confined to New Guinea and the adjacent Papuan islands, one species only being found in the Moluccas, and three in Australia. Wallace observes that of the "eighteen species which deserve a place among the Birds of Paradise, eleven are known to inhabit the great island of New Guinea, eight of which are entirely confined to it and the hardly separated island of Salwatty." But since Wallace wrote in 1869, many other species have been discovered; as *Drepanornis Albertisi*, *Epimachus Elliottii*, and *Diphilloides Gulielmi III.*, *Paradisca Raggiana*.

The naturalists, Lesson, Wallace, Meyer, D'Alberty, Beccari, and others, have done much to develop the zoology of New Guinea and the adjacent islands. Many Australian forms of birds, &c., are met with in New Guinea, and others, again, are peculiar to New Guinea, that is, they have not been found elsewhere; many, again, are common to both Australia and New Guinea; others occur in other of the eastern islands as well as New Guinea, and some are birds of a wide distribution. This extends even to New Britain, New Ireland, and the Duke of York group of islands, as I observed when looking over a collection of birds, &c., made at those islands by a Wesleyan missionary, the Rev. George Brown. With respect to Duke of York Island, Mr. Brown says that it is not one island, but forms a group of twelve islands; seven of these are inhabited, the population of which he supposes amounts to between 4,000 and 5,000.

New Guinea, as far as we at present know, is very deficient in mammals, compared with Australia. In the ornithology of New Guinea, some of the most interesting to notice will be the group of true Paradise Birds, with their waving golden trains, and rich crimson plumes, clothed all over the head, back, breast, and shoulders, in colours of deep metallic green, rich yellow, bright crimson, deep purple shading gradually into delicate mauve, silver, and, indeed, a combination of most exquisitely rich and beautiful colours, gradually blending into the most delicate hues conceivable, forming a dazzling beauty of plumage not to be surpassed.

Indeed, a very strong feature of the Papuan ornithology is the large proportion which the handsome and bright-coloured birds bear to the more obscure species, compared with birds of other countries where brilliancy of plumage was always supposed to be in the ascendancy. In New Guinea we notice the richness and specialization of the parrots, pigeons, and kingfishers, the beautiful paradise birds, and some remarkable species of flycatchers. But the Birds of Paradise present the most wonderful developments of plumage, and the most gorgeous varieties of colour to be found among Passerine birds; so I will commence with the Great Bird of Paradise, or Footless

Bird of Paradise, which perpetuates the memory of a fable respecting these birds (*Paradisæ apoda* of Linneus). It is the largest species known, and is said to be confined to the Aru Islands, and, according to Wallace, is not found in any parts of New Guinea visited by the Malay and Bugis traders, nor in any of the other islands where Birds of Paradise are obtained; but this is by no means conclusive evidence, for it is only in certain localities that the natives prepare skins, and in other places the same birds may be abundant without ever becoming known. It is, therefore, quite possible that this species may inhabit the great southern mass of New Guinea, from which Aru has been separated, while its near ally (*P. Papuana*) is confined to the North-western peninsula."

In a recent letter from my friend L. M. D'Albertis, dated from Katau, September, 1876, he says: "The presence of the Great Bird of Paradise (*P. apoda*) in the centre of New Guinea, but at the same time in almost the same latitude as Aru Island, is of the greatest importance after what Lesson has asserted, and which has been denied by Wallace. I have got specimens in every stage of plumage, and of both sexes, and I have no doubt it is *P. apoda* and not *P. Papuana*. It is, nevertheless, much smaller than all the specimens I have seen in the British Museum and in the collections of M. Beccari and Mr. Cockrell, and if with this distinction, when compared, any other difference may be perceptible, then it will probably prove a new species. For the present, I believe it to be the *Paradisæ apoda*; I have two beautiful male birds in full plumage."

It was in 1834 that I had an opportunity of observing the habits of a living bird of this species in captivity in the aviary of Mr. Beale, at Macao, in China, and an account of whose habits I then published in my "Wanderings in New South Wales, Sumatra, and China." It was a fine male bird arrayed in full and splendid plumage, and had been in captivity for nine years. The elegant bird had a light, playful, and graceful action, with an arch and impudent look as he throws the head on one side to glance at visitors, uttering his cawing notes. The sounds produced by this bird are very peculiar; and that which seems to be a note of congratulation, and uttered when a visitor approaches, and when he appears delighted at being admired, resembles somewhat the cawing of a raven, but changes to a varied scale in musical gradations, *He, hi, ho, haw*, repeated rapidly and frequently, as lively and playfully he hops round and along his perches, descending to the second, or lower perch, to be admired, and congratulate the stranger who has made a visit to inspect him; he frequently raises his voice, and sends forth notes of such power as to be heard at a long distance: these notes are *Whock, whock, whock, whock*, uttered in a loud, barking tone, the last being given in a low note as a conclusion.

One of the best opportunities of seeing this splendid bird in all its beauty of action and a display of its rich and delicate plumage, is early in the morning, when he makes his toilet; for many mornings I watched this charming bird. After his ablutions the beautiful subalar plumes were thrown out and cleaned by being passed gently through the bill; the short, chocolate-coloured wings are then widely extended and kept in a steady movement, as if preparing for flight, at the same time the long plumes are thrown up over the back, spreading out in a graceful and elegant manner; and this elevation and depression of the rich golden plumes are continued for some time in quick succession, the bird uttering at the time its cawing notes. After the toilet is complete it approaches close to the bars of its cage to receive donations of living grasshoppers, which it usually receives at this time. When a grasshopper is given to him in an entire state, he places the insect on the perch, keeps it firmly fixed by the claws, and with great rapidity divests it of the legs, wings, &c., and then devours it; but usually the servant who attends to the aviary prepares the insects ready for him, when he devours them with great rapidity. The Wumbi, or Lesser Bird of Paradise (*P. Papuana*), is a smaller bird than the former, and has a comparative wide range, being a common species on the mainland of New Guinea, as well as on the islands of Mysol, Salwatty, Jobie, Biak, and Sook. It is very probable, says Wallace, that it ranges over the whole of the mainland of New Guinea. The opinion of Mr. Wallace has been disproved by M. D'Albertis, who found in the central and south-eastern part of New Guinea the closely-allied species *P. Raggiana*, supplanting the *P. Papuana* of the west. The Red, or Ruby Bird of Paradise (*Paradisæ rubra*) is obtained at Waigiou, and as an instance of limited range, is confined to that locality, a small island off the north-west extremity of New Guinea, where, according to Wallace, it replaces the allied species found in the other islands. D'Albertis, however, discovered a new species in Orangerie Bay in 1873, allied to *Paradisæ rubra*. At first sight it resembled *P. rubra*, but on a close examination and comparison it was evidently distinct. It was sent to England to Dr. P. L. Sclater, by whom it was described, and at Mr. D'Albertis' request named after his friend the Marquis Raggi, *Paradisæ Raggiana*. The original specimen was not in good condition, but he has since obtained at the Fly River and other southern parts of New Guinea specimens, male and female, in every stage of plumage, from the young bird to the adult, and among them some males in full and gorgeous plumage. During his recent expedition to the Fly River, in 1876, he writes to me that he has obtained but few specimens of *P. Raggiana* of both sexes; but in 1875 he found thirty-six specimens, six in full plumage. A most beautiful little paradise bird is found in great numbers widely spread over New

Guinea, and seen climbing about the vines in the forests—it is the King Bird of Paradise (*Ciccinnurus regius*), the “Burong Rajah,” King-bird of the Malays. This exquisite little creature frequents the smaller trees in the thickest part of the forest, feeding on various fruits; it is very active, both on its wings and feet. D’Albertis in his recent expedition up the Fly River obtained the Twelve-wired Bird of Paradise (*Seleucidés alba*). This beautiful and singular bird appears at first sight to be velvety black, but by holding the bird in various lights, it is found that every part of it glows with the most exquisite metallic tints—rich bronze, intense violet, and on the edges of the breast-feathers brilliant green colour. An immense tuft of dense plumes of a fine orange-buff colour springs from each side of the body; and six of these on each side terminate in a black curled shaft, which form a perfectly unique adornment to this lovely bird, and from these raches or shafts it has been named the Twelve-wired Paradise Bird. Wallace says “it is found in the island of Salwatty, and in the north-western parts of New Guinea, where it frequents flowering trees, especially sago-palms and pandani, sucking the flowers, round and beneath which its unusually large and powerful feet enable it to cling. Its motions are very rapid.”

(To be continued.)

CHAPTERS ON CARBONIFEROUS POLYZOA.

BY G. R. VINE.

THE Polyzoa of the Carboniferous epoch have been only partially described. There is no monograph as yet, and probably some time will elapse before one is called for. Material for the work is fastly accumulating, and every now and again some few additional species are noticed in works devoted to popular geology. The few species that are fully described are in books too often inaccessible to the general reader, or isolated in periodicals not always on the shelves or tables of our free libraries and reading-rooms. Then, again, the proper identification of species, and the synonyms of various authors, prove too often a stumbling-block in the way of new beginners. If, by the publication of a few papers in SCIENCE-GOSSIP I can help others to follow up a most delightful study, I shall be more than amply repaid for the many difficulties I have had to encounter.

When De la Beche, in 1832, published the second edition of his “Geological Manual,” he gave as a list of then known Carboniferous Polyzoa two species only, *Cellepora Uvii*, *Retepora elongata*, and two doubtful species, under the genera *Millepora (foliacea)* and *Retepora*, but stated that “Polypifers were very numerous in the British Isles, but that the genera were undetermined.”

In the “Geology of Yorkshire,” by Professor Phillips, there is a plate of figures, with descriptions of about sixteen species of Polyzoa from the carboniferous limestone of Ireland and Yorkshire. Under the generic term *Retepora* he describes and figures the species *membranacea*, *flabellata*, *flustriformis*, *pluma*, *undulata*, *polyporata*, *irregularis*, *temnisfila*, *laxa*, and *nodulosa*; four species of *Millepora*—*rhombifera*, *interporosa*, *spicularis*, *oculata*; and one doubtful species, which he gives as *Flustra parallela*.



Fig. 89. *Fenestella membranacea* (magnified).

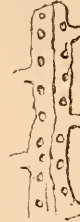

Fig. 90. Fragments of *Fenestella* (magnified).



Fig. 91. Another fragment of ditto.

In the “Student’s Manual of Geology,” by J. Beete Jukes (ed. 1857), the list of Carboniferous Polyzoa is increased to twenty-two species and fourteen genera: *Ceriopora distans* and *rhombifera* (this is the *Millepora* of Phillips); *Diastropora megastoma* (M^cCoy); *Fenestella (Retepora* of Phillips); *Glaucanome (Retepora pluma* of Phillips); *Hemistrypa Hibernica*; *Ichthyorachis Newenhami*; *Orbiculites antiquus*; *Polypora fastuosa*, *laxa*, *polyporata*; *Phlopora pluma (Retepora flustriformis* of Phillips); *Pustulopora oculata* and *spicularis*; *Retepora undata*; *Sulcoretopora parallela*; *Vincularia dichotoma* (the *Flustra* (?) of Phillips).



Fig. 92. Larger fragment of *Fenestella*.



Fig. 93. *Vincularia megastoma*.

In King’s Catalogue, and in M^cCoy’s “Carboniferous Fossils,” there are several species of Polyzoa figured and described; but as these works are at present inaccessible to me, I cannot give details of the genera and species. The particular part of vol. xxx. of the “Quarterly Journal of the Geological Society” is also inaccessible; but in it Drs. Young, of Glasgow, figure and describe a new genus, *Actinostoma fenestralium*, and also a new species, *Glaucanome stellipora*. There is also a paper,

by the same authors, in the "Annals of Natural History," vol. xiii., on a new genus of Carboniferous Polyzoa, in which the authors examine the generic value and affinities of the genus *Cerriopora* with special reference to the Carboniferous *Millepora gracilis* (*Cerriopora gracilis* of Morris). This species they conclude to be entitled to separation from *Cerriopora*, however this genus may be ultimately defined. They therefore propose the name *Rhabdomeson gracilis* for this form.*



Fig. 94. *Polypora tuberculata*.



Fig. 95. Portion of ditto, magnified.

There are a few more papers in the "Geological Magazine" and the "Proceedings of the Geologists' Association," and this is nearly all of the English literature that I am aware of in which descriptions and figures of Carboniferous Polyzoa are given. Lists may be found in Armstrong's "Carboniferous Fossils of the West of Scotland," in the "Memoirs of the Geological Survey," especially in the explanation of sheet 23 (Scotland), and also in Morris's "Catalogue of British Fossils."



Fig. 96. *Retepora Trentonensis*, nat. size.



Fig. 97. Ditto, magnified.

As all, or nearly all, of the genera and species of the Carboniferous Polyzoa are become extinct, it will be necessary to give the generic characters in a connected form; reserving the specific differences for another paper, with a few illustrations of the more common species, together with their range in space, more especially in the British carboniferous strata.

FENESTELLA, Miller. — Cup-shaped, conical, formed of thin carinated (keeled) radiating ribs, connected by transverse, non-poriferous bars; two rows of prominent pores on the external carinated

face of each interstice. In his introduction to his genus *Retepora* (*Fenestella*), Phillips says the openings in the network are called "fenestrules"; the spaces between the ends of these, "dissepiments"; those between the lines of fenestrules, "interstices."



Fig. 98. *Fenestella undulata* (magnified).



Fig. 99. *Glaucanome plumula*.



Fig. 100. Outline of ditto.



Fig. 101. *Fenestella* (Devonian Species), nat. size.

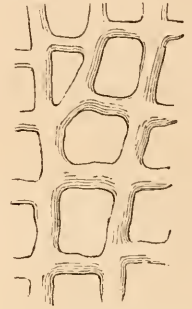

Fig. 102. Ditto (magnified); non-poriferous side only.

RETEPORA, Lamarck. — The cœcœcium, or face, fan-shaped; in place of transverse "dissepiments," the branches of the cœcœcium unite with one another in such a manner as to form ovate interspaces of "fenestrules." The outer surface of the cœcœcium is non-celluliferous, and minutely striated. The inner surface bears several rows of small cells.

PTILOPORA. — A feather-like arrangement. A central stem giving off lateral branches, which are connected by dissepiments, leaving oval fenestrules; external face of the interstices carinate, and bearing two rows of pores. Fig. in Page's "Introductory Text-book," p. 81.

GLAUCANOME, Goldfuss, restricted by Lonsdale. — Stem elongate, oval, laterally branched, bearing longitudinally-disposed cellules, but which are not united by transverse dissepiments; reverse striated. In another description of the genus it is stated "that both stems and branches have two rows of cells on one face, which is usually carinated between them; in some species a row of small cells on the keel." This genus is the *Acanthoclada* of King.

ARCHIMEDIPORA. — Two figures of this genus are given in Dana's "Manual of Geology," as common in the United States. The cœcœcium is wound round in an oblique column, or spiral, on a central

* See also paper on Hairmyre's Polyzoa in the "Edinburgh Geological Transactions," 1874.

axis, similar in many respects to an Archimedian screw. There is a figure also in Page's "Introductory Text-book to Geology," p. 81.

CERIOPORA, Goldfuss.—Polypidom tuberosa, composed of numerous concentric layers; pores round, unequally placed (the Millepora of Phillips).

POLYPORA, M^cCoy.—Expanding, interstices round, branching, from 3 to 5 rows of pores, the margins of which are never raised; interstices connected by thin transverse, non-poriferous dissepiments. Corallum a delicate reticulated calcareous expansion.

VERTICILLOPORA, De Franc.—Polypidom branched, cylindrical, composed of aggregated polygonal tubes, divided by transverse septa; axis hollow or filled. A peculiar genus, which may be probably modified in course of time. There are two species described and figured by M^cCoy: one *abnormis*, Lonsdale, the other *dubia*, M^cCoy.

VINCULARIA, De Franc.—This is a beautiful and delicate genus, several species of which Eichwald has figured and described in his "Palæontology of Russia." The only generic description that I have is this: "without lateral branches, and having more than two rows of pores."

CARINELLA.—This is a new genus of Carboniferous Polyzoa. "The characters, which are particularly constant and well-marked, assign to it a position between *Fenestella* and *Polypora*. Polyzoarium composed of angular, irregularly-disposed anastomosing branches, strongly carinate on both aspects, but celluliferous only on one, apparently arising from a common root. No regular dissepiments; the branches bifurcate and reunite with one another to form hexagonal, pentagonal, or polygonal fenestrules, often of most irregular form."*

HEMITRYPA, Phillips.—A stony cup-shaped network, keeled and poriferous as in *Fenestella*, covered with an external (imperforate?) sheath.

ICHTHYORACHIS, M^cCoy.—A straight central stem, having on each side a row of short simple branches or pinnae, all in the same plane; obverse rounded, without keel, each bearing several rows of small prominent oval pores, arranged in quincunx; reverse rounded, smooth, or finely striated.

SYNOCLADIA, King.—Corallum cup-shaped, with a small central root-like base, reticulated, composed of rounded, narrow, often branched interstices, bearing on the inner face from 3 to 5 alternating longitudinal rows of prominent edged pores; separated by narrow keels, studded with small, irregular vesicles, alternating with the cell-pores; dissepiment thin, forming short spur-shaped pinnae, extending upwards from the sides and meeting those from the adjoining interstices at an angle directly upwards, bearing two alternate rows of cell-pores.

Much of the above information is culled from various sources; from books, as I said before, too often out

of the reach of the ordinary reader; and from communications by letter from friends and well-wishers. My thanks are especially given to the Rev. W. Howchin, of Haltwhistle, and to Professor Duncan, for the kind assistance they have given me in my researches among the Carboniferous Polyzoa. I shall still be thankful for all the information I can obtain from the various sources of rocks or books which can help to throw light on a most important branch of Palæontological history; and, though writing especially in the interest of working men, who, like myself, can only give to the studies the moments of relaxation between the hours of labour, I hope this *résumé* will be profitable to others of more leisure and greater opportunities for study.

Attercliffe, Sheffield.

(To be continued.)

CANADIAN PHLOGOPITE.

THIS mineral, a variety of mica found in Canada, has the property of so diffracting light that if a small flame be viewed through a thin film of it held close to the eye, a well-defined six or twelve-rayed star is seen surrounding the luminous centre. On rotating the film the rays revolve also.

Having lately, through the kindness of my friend Professor Rudler, obtained a specimen, I thought that a short account of the constitution and mode of action of this peculiar mineral might, perhaps, be of interest to your readers.

When a thin film is examined under the inch-power of the microscope, it is seen to be thickly studded with minute crystals; some short and comparatively broad, others long and very slender. These are arranged at no definite interval from one another, and are seemingly placed at all angles one with another. But, on careful inspection and comparison, aided by the quarter-inch power, it is seen that the vast majority of the crystals have their long sides pointing (in the twelve-rayed specimen) in six directions only. These lines of direction make equal angles with one another, so that if produced so as to intersect, a twelve-rayed star would be formed. The confused appearance of the crystals is shown in fig. 103, drawn with the camera lucida.

If the direction of the crystals in Fig. 103 be traced out, it will be found that (with two exceptions only) they unite to form a twelve-rayed star, with equal angles between the rays. This is shown also in fig. 104, taken at random from another part of the same specimen. Here the crystals are less crowded together, and it may be seen that it needs only one differently-inclined crystal to complete the twelve rays. Of course in so minute a part it is not strange that one direction should be missing; all around may be found plenty of crystals pointing in this before-unrepresented direction. The variety of Phlogopite

* "Mem. of Geo. Survey, Scotland." Explan. of Sheet 23.

that produces the six-rayed star has its crystals disposed mainly in three directions.

Very often a six-rayed specimen will give six other intermediate and less brilliant rays. These secondary rays are seen to be produced by more minute or less frequent crystals, arranged at intermediate angles with those crystals that form the primary and brighter star. Occasionally a piece will show two or four more rays, making the star look unsymmetrical. Careful inspection will then show other sets of crystals at a different angle.

The crystals vary in shape, sometimes being short, flat, and tabular, but are usually very narrow, being about from six to ten times longer than their width.

They have often a faint, pinky-blue colour, though the majority are colourless; occasionally a yellowish crystal may be seen.

The larger crystals show polarization pretty well. Numerous minute "Newton's rings" are formed by the excessively thin laminæ, of which even the thinnest film that one can prepare is composed. These are best seen when the film is mounted in Canada balsam. Prolonged soaking of pieces in ether, and, after-immersion in turpentine, successive exhaustions by the air-pump, failed to exhaust the air entirely from between these exceedingly minute laminæ. It occurred to me that a film might, perhaps, give some effects with polarized objects if used above or below the eyepiece of the microscope; but I failed to find that it gave any at all. Its action on light can be well imitated by blacking a plain microscopic slide over the flame of a lamp, and then with a camel-hair brush scratching fine lines along the slide. When a light is looked at through this, a ray of light is seen crossing the flame at right angles to the lines scratched. Now, on cross-hatching these with lines at right angles, and again looking at the light, a luminous cross is observed. Then, if lines at angles of eighteen degrees with the former lines be made (not an easy task), a twelve-rayed star may be seen, on viewing a light through the glass.

This effect may be, however, far more easily and brilliantly produced by spreading a little viscid oil on a large microscopic cover-glass. The striæ in this case are made by wiping off the mass of the oil by a single straight rub, using a coarse, napless cloth. This will give, as in the case of the partly-blackened glass, a brilliant ray at right angles to the striæ. By single careful rubs two other sets of lines may be made on the same side of the glass, producing a six-rayed star. Now, the other side of the glass is to be treated similarly, taking care not to smear the first side, and making the rubs at alternate angles to the last set. Thus, by very careful manipulation, a twelve-rayed star may be produced. A glass slide does not succeed so well as a thin cover-glass, its thickness preventing the striæ on opposite sides of the glass focussing in the eye at the same time.

A familiar instance of the same phenomenon must have been observed by most people.

Coming along the streets on a rainy evening (no rarity of late), if you are under a silk umbrella and chance to twirl it round as you approach a street lamp, you may have noticed a luminous ray extending vertically down the middle of a gore. As a rib

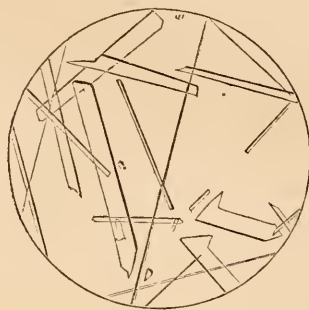

Fig. 103. Slide of Canadian Phlogopite, showing confused appearance of Crystals $\times 250$ diam.

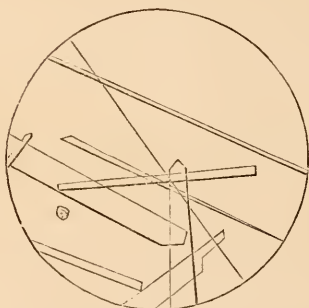

Fig. 104. Another Slide of ditto, showing tendency to rayed condition $\times 250$ diam.

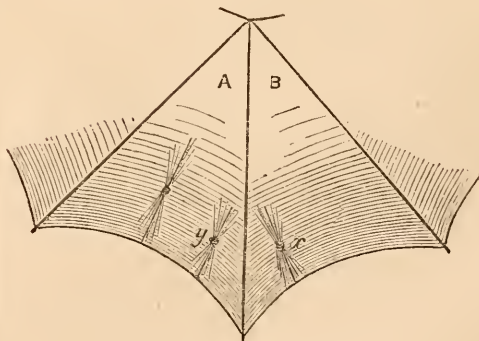

Fig. 105. Diagram illustrating radiating "gores" of an umbrella.

approaches toward the light, the ray is inclined, say, from light to left; on the rib passing the light, and the edge of the next gore coming in front of the lamp,

the inclination of the ray is changed, it leaning now from left to right. When the umbrella is rotated at a moderate pace, the two edges of each gore, aided by the persistence of vision, produce a sort of St. Andrew's Cross. The inclination of the rays is seen to be produced by the tightly-stretched and curved threads that run from rib to rib. In fig. 105 two gores are roughly shown here, while the light is seen through the centre of gore A; where the minute portions of the threads are horizontally arranged, the ray is necessarily vertical. When the light is seen through the silk at *y*, the threads there being inclined from the horizontal, the ray produced is likewise inclined from the vertical. The threads in gore B, at the part *x*, having an inclination opposite to those at *y*, the luminous ray has, therefore, a similarly opposite inclination to that formed previously.

On advancing close to a lamp, and pointing the ferule of the umbrella exactly towards the light, a star is seen, one ray of which extends down each gore of the umbrella; so that the star has as many rays as there are gores. This star revolves as the umbrella is rotated. A fainter set of luminous lines at right angles to each ray of the star may be observed, these being formed by the threads that run in the direction of the length of the umbrella. They do not form so bright a line, because they are not quite parallel, and are further apart from one another than the cross threads.

These instances, I think, may serve to show that it is not necessary to conceive that the crystals of Phlogopite exert, because of their crystalline nature, any refractive influence, thus causing the phenomenon described. It naturally occurs to one to explain similarly the rays seen proceeding from points of light when these are looked at with half-closed eyes. But, on examining the rays thus formed, they are seen to form either a confused, many-pointed star, or more usually a long line of light stretching above and below the flame; that is, in a direction parallel with the intervening eyelashes (the supposed cause of the phenomenon), instead of at right angles to them, as one would have expected from the previous examples. So that we are obliged to seek some other explanation in this case. The true explanation was pointed out by Mr. Arnulph Mallock in the August number of *Nature*. These effects are produced by small, prism-like tear-films, situated at the upper and lower angles formed by the eyelid and the eye, the effects being due to refraction in this case. When two Phlogopite films are rotated one behind the other, both stars are distinctly seen, the rays of one alternately coinciding and falling between those of the other.

I forward you a mounted slide of each variety of Phlogopite. I have a few other specimens, should any of your readers care to exchange.

A. W. STOKES.

Laboratory, Guy's Hospital.

MICROSCOPY.

FALSE LIGHT EXCLUDER.—The *American Naturalist* states that Mr. E. Gundlach mounts his new two-inch lenses with a brass tube five-eighths of an inch long, projecting below the front surface of the objective, and having a perforated diaphragm at its lower end. This cuts off much of the stray light that would otherwise enter, and still leaves one inch and an eighth of working focus.

SYDENHAM AND FOREST HILL NATURAL HISTORY AND MICROSCOPICAL CLUB (founded 1871).—The objects of this club are the reading of papers and exhibition of specimens in all branches of Natural History and Microscopy. It meets on the first Thursday in each month at the Foresters' Hall; Forest Hill, at 8 p.m.: first excursion during the summer months on Saturday afternoon. Annual subscription, 5s. President, Mr. Edward Simpson; Hon. Sec., Mr. E. L. C. P. Hardy.

VORTICELLÆ.—In a bottle I have had standing by me for some time I found some fungoid growths at the bottom, to which were attached several vorticellæ; they were very minute, and had long, thin, and very slender footstalks; but the peculiarity about them was, that one and all of them were living singly, and not in colonies, as I have seen in others. Is this characteristic of a distinct species? One individual had the power of bringing the head down, by bending the footstalk at an exceedingly sharp angle midway between the point of attachment and the bottom of the bell; this it did several times, and always bent it at the same place. Can any of your readers tell me what species of vorticellæ this is?—*P. B.*

PARASITES ON CYCLOPS.—Several specimens of the Cyclops, which I have at present, are quite crowded with the bell-shaped parasite "A. H." writes about in the February number of *SCIENCE-GOSSIP*. I counted on one poor unfortunate upwards of eighty individuals, and not one part of his body, except the antennæ, was free of them; even the eye-spot had two upon it. They are very long in the body, comparatively speaking, and have no spiral stalk, but otherwise are similar to vorticellæ.—*P. B.*

MOUNTING IN DAMAR.—Having read Mr. E. B. L. Brayley's article on the above subject, I should like to be permitted to ask one or two questions. 1st. How air-bubbles are to be prevented from forming within an object when placed upon a hot slide without any medium? It seems to me that the heat soon fills the object with air, unless it is kept moist with turps or benzole: and secondly, does not the Japan varnish ever run into the damar when there is no other varnish between? I have been accustomed to use damar with heat as Mr. Brayley does, with this exception, viz., that I first heat the

damar on the slide, and then, while hot, put the object in, and put the cover on; thereby avoiding air-bubbles within the object; and those outside, if there happen to be any, generally disappear if the slide is gradually cooled. I should be much obliged if any one would recommend a tough varnish which will not run into damar nor crack under any ordinary circumstances: I only know of shellac, and that cracks so easily.—*J. A. Le M. H.*

IDENTITY OF THE RED BLOOD-CORPUSCLES IN DIFFERENT RACES OF MEN.—Dr. J. G. Richardson, of Philadelphia, has been experimenting on different races of mankind, specimens of which attended the Philadelphian International Exhibition. As might have been expected, these show little difference, the slightly smaller averages of the Italian, Swedish, and Norwegian specimens being too small for a decisive indication of natural difference.

ZOOLOGY.

FISHES OF THE ARCTIC EXPEDITION.—Dr. Gunther has read a paper on the fishes collected during the above expedition by Captain Fielding. Among them, he said, were some of great interest, notably a new species of Charr, to which the name of *Salmo arcturus* has been given. This new species was discovered in the freshwater lakes of Grinnell Land, and it is stated to be the most northern freshwater fish known to exist.

“ZOOLOGICAL CLASSIFICATION.”—It is with much pleasure that we heartily recommend a “Handy-book of Reference on Zoological Classification,” by F. P. Pascoe, F.L.S. (London: Van Voorst.) Such a book has long been wanted, and we believe that Mr. Pascoe has done his work well. In it the student will find all the new views as to classification fully and succinctly expounded. It also contains tables of the sub-kingdoms, classes, orders, &c., as well as of their characters, and lists of the families and principal genera.

RECENTLY EXTINCT LIZARDS.—At a late meeting of the Linnean Society, Dr. Gunther gave a description of two large extinct lizards which formerly inhabited the Mascarene Islands. To one the name of *Didosaurus Mauritanicus* has been given. It was related to both the Glass-snakes and the Scinks, but differed from both. The second lizard, found at Rodriguez, was allied to the Geckos, and yet distinct from them. This has been named *G. Neotomii*.

STRUCTURE OF THE RED BLOOD-CORPUSCLE.—Mr. Hammond, of Milton Chapel, lately gave a demonstration of the nucleus in the red blood-corpuscles of the Trout, while they were circulating within the living blood-vessels of this fish. This he showed to the meeting of the Natural History Society at Canter-

bury, April 5th. The fact, if confirmed, will go far to prove that the nucleus really exists in the living corpuscle, contrary to the conclusion of Professor Savory and other eminent physiologists, who assert that, until after death, when the nucleus is formed by a sort of coagulation, the whole red corpuscle is homogeneous. But Professor Gulliver, in his Tables of the Blood-discs of Vertebrates, published in the *Proceedings of the Zoological Society*, June 15, 1875, while confirming Savory's observations on the blood of frogs and newts, has long since maintained the view now given by Mr. Hammond on the blood of fishes. The question, which is one that may be well prosecuted at this season, would afford instructive employment for the microscope.

METROPOLITAN SOCIETIES.—The West Kent Natural History, Microscopical, and Photographical Society meets in the Hall of the Mission School, Blackheath. The President is Mr. J. Jenner Weir, F.L.S., &c., and the hon. secs., Messrs. C. Sharpe and B. Guest.

BIRD-PRESERVING.—We have received a copy of the shilling edition of “The British Bird-Preserver,” by Samuel Wood, published by F. Warne & Co. We can sincerely recommend it to those of our young readers who are going in for taxidermy.

LAMPYRIS NOCTILUCA.—While walking over Hayes Common on the evening of April 3rd I discovered a specimen of the glow-worm (*Lampyrus noctiluca*). Is not it unusual to find this little creature at this part of the year?—*Geo. Clinch, West Wickham, Kent.*

EOLIS PUSTULATA.—I was fortunate, about a fortnight ago, to capture an *Eolis pustulata*, which is still living. Jeffrey's “Conchology,” which gives Alden's description, states only two individuals of this species having been found. It is therefore very rare. It was found on a stone at low water-mark.—*Thos. Bowes, Sunderland.*

GENERAL INDEX TO SCIENCE-GOSSIP.—For the benefit of those who have procured this part, we beg to say that the volumes are counted as follows:—Vol. I.=1865, II.=1866, III.=1867, IV.=1868, V.=1869, VI.=1870, VII.=1871, VIII.=1872, IX.=1873, X.=1874, XI.=1875, XII.=1876.

TWO-HORNED RHINOCEROS.—At a recent meeting of the Zoological Society of London, Mr. Sclater called the attention of the meeting to an article in the *Oriental Sporting Magazine* for May, 1876, by which it appeared that a two-horned rhinoceros had been killed in February, 1876, at a place some 20 miles south of Comillah, in Tipperah. Mr. Sclater stated that this was the third recorded occurrence of a two-horned rhinoceros north of the Bay of Bengal.

EARLY APPEARANCE OF CETONIA AURATA.—On the 30th of March I saw a fine specimen of this

insect crawling along the road just outside what used to be Coombe Wood. Stephens gives its time of appearance as May to August, and I have never previously observed it earlier than the third week in April.—*J. W. Slater.*

TESTACELLUS HALIOTIDEUS.—I have in my possession a specimen of this remarkable slug, and thinking that a description of it might interest your readers, I send the following notes. Its chief peculiarity consists in the shell, which is on the hinder part of its back, and not, as in most other slugs, on the head. The length of the shell is about one-third of an inch. From the upper end of the shell two deep furrows traverse the sides of the creature, and terminate at the head. It is of a dingy yellow, deepening here and there into brown. The habits of this slug are curious. It is carnivorous, principally feeding upon worms, of which it is able to swallow specimens longer than itself. It lives most of its time under ground, and is therefore difficult to observe. I have arranged mine so that I can at any time remove the top of his subterranean abode and watch him. He has lived thus for a month, and is in very good condition.—*S.*

WATER-CURRENTS ON GILLS OF THE NEWT.—In the April number of *SCIENCE-GOSSIP* Mr. H. E. Forrest asks how the current of water is propelled rapidly along the surface of the gills. The water is carried by the action of vibratile cilia, as may be seen with a good quarter-inch objective, especially when the cilia begin to relax their extreme activity. The process is respiratory, the organ of which is the gill, by which the free oxygen of the water is taken up according to the wants of the economy. And hence the necessity of a constantly rapid current of the water over the gills.—*Q. F.*

METAMORPHOSES OF AMPHIBIANS.—Much interest has lately been caused among philosophical zoologists, by certain experiments relating to the metamorphoses of some amphibians. Hitherto it has been regarded as absolutely necessary that this group should be characterized by the intervention of a distinct intermediate stage between the egg and the adult; although several exceptions occurred, notably that of the Black Salamanders. Dr. Peters has recently made a communication to the Berlin Academy of Sciences, giving an outline of various cases in which no metamorphosis takes place, but where a young frog is developed *directly* from the egg, without any intervention of the "tadpole" stage. The paper was based upon the researches of various zoologists, chiefly on those of Dr. Bello, who has observed a tree-frog, found at Porto Rico, which lays its eggs far from any water, in which the young breathed air as soon as they were hatched. This frog is *Hylodes Martincensis*. Dr. Gundlach has succeeded in artificially hatching out some of the eggs of this frog, which were sent to him. In doing so he was enabled to

watch the entire process in the egg-stage, and he sent Dr. Peters specimens in various stages of development, who discovered that much of the process of what we call in the amphibians "metamorphoses," in this instance occurred within the egg. The tail was gradually reduced before hatching, and had almost disappeared a few hours after birth. The only other instances previously known of absence of metamorphoses (except the Black Salamander), is in the genus *Pipa*, in which the eggs are hatched in the pits or hollows which cover the back of the mother. In addition to the above a German lady has, perhaps, given to the scientific world, by dint of patience and perseverance, the most remarkable facts. Fräulein Chauvin has succeeded in forcing Axolotls to pass into the other so-called generic form known as *Amblyostoma*. Some years ago several axolotls did this of their own accord, in one of the Parisian aquaria, and much surprised the world by the act. But no other instance has been given, we believe, and Miss Chauvin's is certainly the first where the *Amblyostoma* stage has been scientifically brought about by a sudden change of environment. Her plan consisted in gradually accustoming the axolotls to a *terrestrial* existence. A good many died during the process; but eventually the experiment proved successful, and is scientifically valuable as showing how even new generic types may have been developed through the changed physical geographical conditions produced by the myriads of geological operations which we know have taken place during our planet's past history.

SINGULAR STAR-FISH.—In reply to the paragraph headed "Singular Star-fish," in page 94 of this year's *SCIENCE-GOSSIP*, I beg to inform the writer that in a miscellaneous gathering lately made by a friend in the Bay of Naples I have found numerous small *Ophiurida*, all of which have six arms.—*Major L.*

BOTANY.

THE FERTILIZATION OF MOSSES.—The moss inquired about by Mr. Key is a species of the immense genus *Fissidens*, named *F. grandifrons*, Bridel, found throughout the Pyrenees, and in the South of France, Baden, and Algeria; and no doubt, if plants of both sexes were cultivated together, fecundation would take place. With respect to propagation, it must be borne in mind that the moss-spore does not develop into a new individual, but produces on germination a branched confervoid protonema, from certain cells of which young plants are produced. We need not, then, be surprised to find that certain cells of the old plants are capable of development into new individuals, for which in some cases special provision is made, as in the production of gemmæ or propagula in *Tetraphis pellucida*, *Aulacomnium*, and others,

where they form clusters terminating the stem, or in *Orthotrichum Lyellii* and *Phyllanthum*, where they are produced on the leaves. But this is not all; for in various *Grinnia* and *Tortula* tubercles are developed on the roots, which produce protonema and new plants; and some are truly viviparous, for some species of *Campylopus* and *Leucobryum* throw out young plants among the radicular tomentum which besets the stem, which fall off and continue the species; and it has been observed in the common *Funaria hygrometrica* that from the basal cells of a cast-off leaf protonema has been thrown out which has produced a new colony of plants.—*R. Braithwaite*.

NOTE ON THE NETTLE.—With respect to the Nettle (*Urtica dioica*), the sudden appearance and dispersion of which a correspondent of SCIENCE-GOSSIP has remarked upon as my not having accounted for, it is certainly true that this pestilent stinging plant does follow any human settlement or resting-place in a manner that is surprising; but this in a different way to the sudden appearance of plants where woods have been felled. The Nettle appears to follow the footsteps of man, or rather more probably of the animals that are in his train. Nobody would willingly disseminate the Nettle, and it seems difficult to suppose how men themselves could bear the seeds about them. But the animals attendant upon or kept by man unquestionably do. Sheep especially, as I have frequently noticed, are harbingers of the Nettle, and they may carry its seeds about in their fleeces. Indeed, as to the instance of the beds of nettle observed in some of the present deer-forests of Scotland, as mentioned by "Daccort Ackone," it will be found that these deer-forests, so called, were formerly sheep-walks, and that the sheep were really instrumental in bringing the seeds of the Nettle. Only last year I noticed in a pasture near Worcester, which I have been cognisant of for many years, the introduction of nettles by sheep. Till lately it had been only used for the produce of hay, and though horses were fed on the aftermath, no sheep were introduced. But now, sheep having been turned in the next year, I observed numerous tufts of nettles scattered over the field. So I have noticed in the Malvern Hills, where sheep alone are depastured, that nettles are rampant, not only on their sides, but on the very summit of the Herefordshire Beacon. In fact, wherever sheep are placed the Nettle soon appears, not on fresh turned-up ground, but in the midst of the pasture itself. Very probably, also, dogs may carry the Nettle about, which does not so much attach itself to man's actual residence, as spots where he has had only a temporary lodgment, or been occasionally, and then left the ground to neglect. But there it remains with singular tenacity, pointing out where, at some time or other, a wandering human footstep or some domestic animal has been. It is rather curious, therefore, that

no botanist should have suspected that the Nettle is a plant that has been furtively introduced into Britain, and though now become a "denizen," has had a foreign origin as much as any agrarian of our corn-fields. Its inroad may have been at a very early time, brought, perhaps, with the very first wanderers that set foot on our island; but I do not believe that they found it already established. It is certainly a sticker, like the American water-weed, which has become a curse in our streams and canals; and the Nettle can never be got rid of from its perennial roots, though sharp frosts cut it down to the ground. Its dissemination by animals is clearly shown by its abounding in rural churchyards, where sheep are often placed to graze; and it is in pastures rather than in gardens where it becomes so pestiferous, and grows so tall. In some sequestered spots I have found it growing nearly six feet in height, and forming a dense thicket difficult to get through. I never saw the Nettle in such abundance as within the area of Norton Camp, Shropshire, an eminence about 800 feet high, which it entirely occupied, excluding every other plant. Here, no doubt, sheep had some time previously been depastured, though no blade was left for them until the Nettle was displaced.—*Edwin Lees, F.L.S., Worcester*.

SCIENCE-GOSSIP BOTANICAL EXCHANGE CLUB.

—We are glad to be able to inform our numerous botanical friends that there are several enthusiastic members who are working most heartily to make this club a success. We hear of fair collections having already been made; the Easter holidays witnessed many presses and drying-boards again brought into use. We trust this success may be maintained with vigour all the year.

NOTES ON FERNS.—I send you a fern from my Warden case as I plucked it last summer, but I am sorry that I do not remember where I obtained it originally. Its peculiarity is the existence of dark-green fleshy buds or galls, springing apparently from the rachis of the pinnules on the under side. Can you determine—first, what the fern is? and secondly, what is the nature of the bodies in question?—*R. G.*

SEEDS.—On two occasions certain seeds, of which I inclose specimens, have been sent to me as taken from or around blackbirds' and thrushes' nests. I cannot think of any plant to which they belong unless it be the Arum or Wake-Robin. They are covered with husks, and I presume have passed through the bodies of the young birds. But are not these fledged before the scarlet berries of the Arum are ripe? Being very acrid, are they not strange food for young birds? The Blackbird in the district where the seeds were found is not seen in the immediate environs of the towns, neither is the Wake-Robin.—*R. G.*

FERTILIZATION OF THE FLOWERS OF BROOM.—The mechanism by which the flower of Broom is fertilized through the visit of the bee is very admir-

able, and has been described by Mr. Darwin; but of this no more. Last year I noticed that a great number of the flowers remained closed and unfertilized, and upon examination I found that all such flowers contained each a little lively grub, spinning a web, which fastened the lower petals together; and by the spinning of the same thread it was also able to suspend itself when thrown down. It appeared to feed on the stamens, and turned to a little moth—I think a species of *Depressaria*.—*R. G.*

RESEARCHES IN THE STRUCTURE OF THE COMMON TEASEL.—At a meeting of the Royal Society, a paper by Mr. Francis Darwin has been read, of which the following is a summary:—Certain observations have been made on the protrusion of protoplasmic filaments from leaf-glands on the Teasel, and the only theory which Mr. Darwin thinks capable of accounting for all the facts is that these glands were, in the ancestors of the *Dipsacæ*, mere resin-excreting organs; that the protoplasm which comes forth was originally a necessary concomitant of the secreted matters, but that from coming into contact with nitrogenous fluids it became gradually adapted to retain its vitality, and to take on itself an absorptive function. This power, he thinks, was further developed in relation to the decaying fluid accumulating within the connate leaves of the Teasel.

AN ELECTRIC PLANT.—A plant possessing natural electrical powers is said to have been discovered in Nicaragua, and a short description of it is given in a Belgian horticultural journal. It is a species of *Phytolacca*, and has been christened *P. electrica*, in consequence of its curious properties, which are so strong as to cause a sensible shock, as from a galvanic battery, to the hands of any person attempting to gather a branch. I should be glad if any correspondent can give more information about the plant.—*D. Douglas*.

GEOLOGY.

A NEW AREA OF UPPER CAMBRIAN ROCKS IN SOUTH SHROPSHIRE, WITH THE DESCRIPTION OF A NEW FAUNA.—This was the title of an important paper lately read before the Geological Society by Mr. C. Callaway, M.A., F.G.S. The purpose of the author was to prove that certain olive, micaceous, thin-bedded shales exposed at Shineton, near Cressage, and covering an area of eight miles in length by two in the greatest breadth, which had been mapped as Caradoc in the survey, were of Tremadoc age. They were seen clearly to underlie the Hoar Edge Grit, the lowest beds in the district, with Caradoc fossils; and no rock distinctly underlying the shales could be detected. The evidence for their age was chiefly palæontological. With the exception of *Asaphus Hoarfayi*, a Tremadoc form, the species are

new. Genera such as *Olenus*, *Conocoryphe*, *Obolella*, and *Lingulella* suggested a very low horizon, but two asaphoid forms (though not typical *Asaphi*) pointed in an opposite direction. Corroborative evidence was found in a correlation of the shales at Shineton with the *Dictyonema*-shales at Pedwardine and Malvern. It was shown from lithological characters and from fossils, that the shales at the three localities were of the same age; and as the beds at Pedwardine and Malvern were, on their own testimony, admitted to be of *Lingula*-flag or Tremadoc age, the Shineton shales were inferred to be on the same horizon, the Asaphids leading the author to adopt the younger of the two formations. He was of opinion that the Black Shales of Malvern (Dolgelly beds) were not represented in the Shineton area. He announced the discovery of the Hollybush Sandstone, forming a continuous band between the Shineton Shales and the Wrekin axis, recognized by the occurrence of *Katorgina cingulata*, and probably separated from the shales by a fault. This also afforded corroborative evidence of the identity of the *Dictyonema*-shales with the shales at Shineton.

ORIGIN OF THE FLORA OF SOUTHERN FRANCE.—M. Martins has read a paper before the Paris Academy of Sciences, on the Palæontological Origin of the trees, shrubs, and bushes indigenous to the South of France, and which are most sensitive to cold during extreme winters. He considers them to be the *survivors* of the flora which covered the same area during the mid-Tertiary period. They are, he thinks, exotic as to *time*, just as other plants are to *space*.

THE LATE DR. BOWERBANK.—Many naturalists at home and abroad will be sorry to hear of the death of this veteran zoologist and palæontologist. He was best known for his researches in the *Spongiæ*, especially as regards their geological relations. He was also one of the founders of the Palæontological Society, in which he took great interest. He died at the ripe age of eighty years.

RADIOLARIANS FROM THE CARBONIFEROUS LIMESTONE.—A discovery of some importance has been announced to the Chester Natural History by Mr. J. D. Siddall. This is the finding of *Radiolaria* in various localities in the carboniferous limestone, as in the Halkin, and also in the Mineva limestones. Two polished blocks beautifully showed the Radiolarians *in situ*. Mr. Siddall has thus thrown back our knowledge of the distribution of the *Radiolaria*, in time, to the Palæozoic period.

UPPER DEVONIAN FOSSILS AT TORBAY.—In the *Geological Magazine*, Mr. J. E. Lee, F.G.S., has called attention to the occurrence of Upper Devonian fossils in the shales of Torbay, similar to fossils from Budesheim, in the Eifel. These fossiliferous shales occur at Saltem Core, and have yielded several species of *Goniatites* and other fossils, believed to be identical

with those from Budesheim, and recognized there as of Upper Devonian age.

FACTS FOR DARWIN.—During the recent two days' excursion of the Geologists' Association into the Crag district of Suffolk, under the direction of Mr. W. Whitaker, F.G.S., of the Geological Survey, Dr. J. E. Taylor, F.G.S., and Edward Charlesworth, F.G.S., the latter gentleman, who is well acquainted with the paleontology of the Crag deposits, in the course of a short address to the members, showed that the Red Whelk (*Fusus antiquus*) and the Dog-whelk (*Purpura lapillus*) lived together in the Red Crag seas as they do now in our own. But, whereas a child could tell the difference between these two genera of shells now, in the Crag period these two forms were so alike that he often found it difficult to discriminate between them. The same thing occurred with the *Trochi*. It was the easiest thing in the world for a conchologist to tell the difference between the existing British species; but it was often a very difficult task to determine the Crag forms, owing to the way in which the species of *Trochi* seemed there to run into each other. Mr. Charlesworth expressed it as his opinion that these were strong facts for Darwin.

THE LIAS OF FENNY COMPTON, WARWICKSHIRE.—We have received a very able paper on the above subject, by Mr. Thomas Beesley, F.G.S. It was originally read at the annual meeting of the Warwickshire Naturalists and Archæologists' Field Club, held in the Warwick Museum last February.

THE INSECT FAUNA OF THE TERTIARY PERIOD.—One of the most interesting and exhaustive papers on this most suggestive topic has just been read before the Brighton and Sussex Natural History Society, by Mr. Herbert Goss, F.L.S. The paper is fully reported, in five columns of small printed matter, in the *Sussex Daily News* of March 9th. We can only express our admiration of the ability and fulness of Mr. Goss's paper, and express a hope that it will be given in full to the scientific world.

NOTES AND QUERIES.

MICROSCOPICAL.—In looking over the back volumes of SCIENCE-GOSSIP, I recently came upon the expression "a microscopic gentleman," used seriously to designate a gentleman devoted to the microscope or microscopy. I have noticed a similar use of the word in other places, and I should like to suggest the propriety of confining the word *microscopic* to the sense of requiring the microscope for observation, and the word *microscopical* to the sense of pertaining to the microscope or microscopy.

HOW FOREIGN PLANTS ARE INTRODUCED.—I have just entered a cloth manufacturing business, and, of course, we use a large quantity of raw wool, from our colonies chiefly, but sometimes German. I have found various kinds of beetles in the wool, and

though not very good specimens, they are interesting on account of the peculiar manner of importation: we recently found a most curious one, gold and green, with a long proboscis just like a rhinoceros. If I have the good fortune to find another, as I daresay I shall, you shall have it; but wool-sorters are doing sixty bales of Buenos Ayres, and that is where I found it. We get most curious things in the wool: frogs, crushed quite flat, with their bones showing to perfection; leaves, seed-vessels, and seeds, some of which we have grown. One especially, called the "Devil's Horns" by the natives, we sent to Dr. Hooker, of Kew, and he said the name of it was *Martinia Montevidensis*; but had never been grown in England before. It is covered with short, sharp, and strong prickles, and it will sometimes kill the sheep when it gets into the wool. The last two things on the "Australian" are seed-vessels, or rather seeds, which grow easily, and are very abundant in our mill-yard, where the seeds get often thrown to, but I have never seen one in bloom. Bird of Paradise feathers, ticks, nutmegs, and even knives and money, are among the curiosities which we find. Two snakes I have obtained I cannot quite determine. No. 1: Back dark, with black markings, and a V on its head; belly slate-colour. No. 2: Back dark green, shading into light green towards the belly, which is dark slate, and green patches; yellow mark round the back of head, followed by black. It has dark spots on its back. Which is best for preserving—gin, or spirits of wine?—E. E. Evans.

MERMAID'S PURSES.—Most people who pay their annual visit to the sea-side must have noticed in their rambles certain curious-looking objects of a brownish-black colour and horny consistence, shaped somewhat like a stretcher, or a pillow-case, with four handles, called provincially, "Mermaid's Purses," "Skate Barrows," &c., and known to naturalists as "Skate's Eggs." Their average length is about four inches, but one in my possession measures seven, and not unfrequently they are invested with a miniature forest of algae and zoophytes. Now, I have a great desire to know the approximate number of eggs dropped by any one skate during the spawning season. I have searched through "Yarrell" and other "eminent authorities" without success: the "purses" are described and figured, but no allusion is made (so far as I can see) to the numerical proportion between these and the eggs of other fishes. We are gravely informed that in the roe of a single "cod," nine millions of eggs have been counted (calculated would be the more correct term); other fish are, I presume, equally prolific; the herring, for instance. Now an ordinary-sized herring's roe might be placed inside one of these "purses," yet the skate is not uncommon, and there are some dozen species. The Dog-fish, again, is plentiful enough (there are some seven or eight species, exclusive of the two sharks), as any fisherman can tell you, as they injure his nets and devour his "catch"; they produce the same kind of egg slightly modified, being somewhat narrower, of a lighter colour, and with an elongated tendril at each of the four corners, by which they become attached to sea-weeds or other fixed bodies. Now, it does appear to me rather singular that such pains should be taken to ascertain the millions of eggs contained in a cod's roe, or the still more startling announcement that a cubic inch of the Polierschiefer or polishing-slate of Bilin contains forty-one thousand millions of the silicious shells of *Galionella*, and yet that we should be ignorant of the approximate number of "cases" or "purses," varying from three or four to

seven inches in length, contained in the common skate (*Raia batis*, Montagu). I may have jumped to a conclusion, and the *Raia* may have been ascertained with mathematical accuracy by some ichthyologist for aught I know to the contrary; but having made diligent search, and being ignorant of the fact, I seek information. I trust that some of your numerous correspondents may be able to throw some light upon the subject.—*N. P.*

THE COMMON THREE-SPINED STICKLEBACK (*Gasterosteus semiarmatus*).—I procured a three-spined stickleback from a Hampstead pond in September last, together with five others who since died. I have always noticed that sticklebacks do not live long unless they have plenty of room afforded them; or at least a large amount of oxygen. In the short time I have had this stickleback he has become tame enough to take his food freely from my fingers; he even invariably nibbles the latter in mistake for food. A tench and British carp are also kept in the vessel with him; the former does not seem to mind his presence, although he sometimes annoys the carp; but this, however, seldom happens. The tench generally gives chase if the stickleback comes too close, and when such is the case, the colours of the latter glow, and the sharp spines are protruded to their utmost, but they have never proceeded to extremities. The stickleback seems to feel the want of oxygen sooner than the larger fish; as, should the air of the room in which he is kept become close, he is sure to be seen gasping at the surface of the water. Blood-worms seem to be his favourite food. I have known him take three or more of them one directly after another, and then be ready for more in a few minutes; but where he manages to stow them is beyond my comprehension. He used to be very fond of biting at the toes of some newts that were kept with him, mistaking them I suppose for worms, much to the discomfort of the poor newts, who were almost afraid to move their feet, and if they ventured to do so, the stickleback was sure to notice the movement and dart towards them, and, staring at them with all his spines extended, watching for their next movement. The changing of colour when frightened seems to be pretty generally the case with most fish; the stickleback, when he is suddenly touched or otherwise startled, turns from his usual colour to that of a very light brown, and does not recover his silvery hue entirely until a few minutes afterwards. If the British carp is frightened, all the black colour of his back vanishes and leaves a red-brown tint in its place. The stickleback cannot be recommended as a suitable fish for the aquarium on account of its pugnacity, but it can be kept in a separate vessel, and will well repay the trouble by its amusing vagaries and pleasant familiarity. I have followed the plan recommended in Mr. Shirley Hibberd's book on the aquarium, and have placed a piece of board across a window on which are placed a dozen or so glass jars; these I have stocked with beetles, larvæ, water-spiders, and other inhabitants of our ponds and streams. I find this plan aids me greatly in watching the movements and habits of aquatic insects, and the latter being divided in the separate jars prevents their destroying one another, which they are sure to do if confined in single vessels altogether.—*Frank Roxbotham.*

AQUARIUM v. AQUAVIVARIUM.—A year or two ago there was some stir made with reference to an appellation which has now become a very familiar one. "Aquarium," so it was urged, speaking correctly, can mean nothing more than a receptacle for water, large or small, as may be, and conveys no notion as to its living contents. The word "Aqua-

vivarium" was accordingly introduced, and struggled into a certain amount of popularity, but of late the old term seems to have re-established itself. Its brevity gives convenience, no doubt, still I think it may be alleged that nowadays it is too loosely used, and such places as the Brighton, or the Crystal Palace "Aquarium" appear to want some other name than that first given to the glass globe or tank we place in a drawing-room or conservatory.—*J. R. S. C.*

QUERY ABOUT A FLOWER.—What flower does Shelley mean,—described as below in his poem "The Question"?—

"And that tall flower that wets
Its mother's face with heaven-collected tears,
When the low wind, its playmate's voice, it hears."

A. H.

PRONUNCIATION OF NAMES.—Is there any book, or books, from which a self-teaching student might learn the correct pronunciation of scientific proper names? I have "Alcock's Botanical Names for English Readers," but this covers only the field of British botany. Is there a similar work, with a more comprehensive range? Does the "New" pronunciation of Latin affect scientific names? If you would kindly answer the above, you would confer a great favour on an isolated countryman.—*D. J.*

FRESHWATER TORTOISE.—In reply to "H. F., Jun.'s" inquiry, I write to say that freshwater tortoise will live out of doors in the south of England. I had one for some years in a small pond in my lawn, when I resided in Hampshire; and land tortoises that have escaped from confinement have been found again, after a lapse of over twenty years, in the grounds surrounding the house they left.—*Helen E. Watney.*

LEPIDOPTERA, &C., OF THE BLACK FOREST.—I should be much obliged if you or any of your numerous correspondents would give me a list of the Lepidoptera and Land and Freshwater Mollusca to be found in the neighbourhood of the "Black Forest"; also the Mollusca of North Wales.—*H. J. Taylor.*

PECULIAR HABIT OF STARLINGS.—That starlings are accustomed in the evening to leave the place where they have spent the day, and repair in a body to roost in some rather distant wood, is a familiar fact. In the summers of 1867 and 1868 I noticed every evening a large flock of these birds rendezvous on a large tree in Pye Nest Park, near Halifax, and take wing in a south-easterly direction, down the valley of the Calder. When they had proceeded say three or four hundred yards, a small number of birds, perhaps thirty, fell out, wheeled round, returned to Pye Nest Park, and there dispersed themselves among the trees. This singular procedure was repeated night after night, and the number of starlings who thus returned was always approximately the same.—*J. W. Statur.*

EGGS OF YAMA-MAI.—Can any of your correspondents tell me where I may obtain eggs of the *Yama-Mai* silkworm? Some years ago I purchased a small quantity of Dr. Wallace, of Colchester, but afterwards received a circular stating that he had ceased rearing the silkworm and had given his stock to some one else, whose name I have lost.—*George M. Doe.*

SINGULAR FACT ABOUT THE DOGWOOD.—The mildness of the past three or four months has been the cause of somewhat extraordinary behaviour on the part of the Dogwood (*Cornus sanguinea*) in this neighbourhood. In November the plant was en-

tirely denuded of leaves, yet blossoms were produced in abundance at the extremities of the branches. The same phenomenon took place during December, and up to the present time flowers are being produced, showing that though the leaves have fallen, there is still circulation of sap. Why did the leaves fall if the sap was still in sufficiently active circulation to produce perfect flowers?—*J. H. A. Jenner.*

TEA-LEAVES AS MANURE.—These leaves abound in spheraphides, which are calcareous crystals; and so, independently of the decaying vegetable matter, might be reasonably expected to prove very valuable for mulching plants in pots. At a late scientific meeting, Prof. Gulliver gave demonstrations of the spheraphides in tea-leaves; and of these and several other allied crystals, which are so abundant in British trees, as to lead to the conclusion that the constant clearing of the dead leaves away from the roots, is one cause of the decay of trees in shallow soils, as in Hyde Park. In short, depriving the plants of the rotting or rotten leaves is simply withholding an important part of the food of trees which have no other manure given to them.—*Q. F.*

“VESTIGES OF THE NATURAL HISTORY OF CREATION.”—Mr. Robert Chambers or his friends may not have chosen to acknowledge his connection as author with this book. That he was the author I was long since confidently told by the late Mrs. Edmondston, of Balta Sound, Shetland, whose husband was long the respected physician in that district, and a regular correspondent of Thomas Bewick. Mrs. Edmondston was a literary lady of distinguished talents, mother of the promising young naturalist—too early lost to science—who first discovered *Arenaria Norvegica* in Britain; and her husband was an able and zealous ornithologist, still represented by descendants or connections of the same taste in the Shetland Isles.—*Q. F.*

DAFFODILS.—The instructive paper by E. Edwards, while giving us some agreeable poetical associations, has omitted Milton's, who, in his “Comus” has,

“Pansies, pinks, and gaudy daffodils”;

and in his “Lycidas” makes it a mourning flower—

“Bid amaranthus all her beauty shed,
And daffodillies fill their cup with tears,
To strew the laureat grave where Lycid lies.”

It is remarkable that this great poet spells daffodils with an *a* instead of an *o* in the second syllable. But my chief reason for noting this plant is to mention that it is an excellent one in which to examine true raphides, of which figures are given in Professor Gulliver's papers in SCIENCE-GOSSIP, May, 1873. It is necessary to warn the reader against the still common error in the “Micrographic Dictionary” and most recent botanical books, of confounding raphides with other and very different microscopic plant-crystals.—*Q. F.*

VENTRICULITES?—Not long since a friend of mine found an enormous sponge (?) embedded in a block of the upper chalk at Whitecliff Bay. The fossil was well preserved and very perfect; it measured fully 20 in. in diameter, and the whole was converted into red iron pyrites. It resembled a huge circular fan spread out on the rock. The fossil was the most perfect one of its kind I have ever seen. The outer foliation, the skin, and even the perfect roots were beautifully preserved. Could any of your readers inform me if this is of common occurrence, and if fossil sponges often attain these gigantic dimensions?—*G. W. C.*

MILDNESS OF THE SEASON.—Some of the readers of SCIENCE-GOSSIP may be interested by the following facts, in reference to the unusual mildness of the former part of the present season. During the latter part of January I was staying in the east of Somersetshire, near to Frome, and between January 20th and 27th, I observed the following wild flowers in full bloom:—Creeping Buttercup, Shepherd's-purse, Whitlow-grass (*Draba verna*), Thyme-leaved Sandwort (*A. serpyllifolia*), Herb-Robert Geranium, Furze, Wild Strawberry, Daisy, Dandelion, White and Purple Deadnettle, Primrose, Procrumbent Veronica (*V. agrestis*), Spurge Laurel (*Daphne laureola*), Snowdrop, Hazel. I also saw on February 3rd and 4th, near Oxford, *Senecio squalidus* and Lesser Periwinkle (in abundance). It will give some idea of the remarkable earliness of the plants if I give the mean date and earliest appearance of each flower, as taken at Rugby, since the year 1867. Creeping Buttercup, mean date, May 15, earliest appearance, May 9, 1874; Shepherd's-purse has been seen on January 1; Whitlow-grass, mean February 19, earliest February 1, 1869; Thyme-leaved Sandwort, mean June 7, earliest May 24, 1867; Herb-Robert Geranium, mean May 6, earliest April 23, 1872; Furze has been seen on January 1; Strawberry, mean April 12, earliest April 4, 1872; Daisy and Dandelion have been seen on January 1; White Deadnettle, mean February 9, earliest January 20, 1869; Purple Deadnettle, has been seen on January 1; Primrose, mean March 6, earliest February 17, 1872; Procrumbent Veronica has been seen on January 1; Spurge Laurel, mean February 28, earliest February 3, 1875; Snowdrop, mean February 13, earliest February 2, 1868; Hazel, mean February 15, earliest January 23, 1875; *Senecio squalidus*, not found at Rugby; Lesser Periwinkle, mean April 12, earliest March 23, 1869. The only one of these flowers about whose identity I am not certain, is Thyme-leaved Sandwort. I dare say other botanists have noticed the early appearance of plants, and could add many more to my list. I may add that the leaves of *Arum maculatum* are springing up everywhere in abundance; usually, I believe, they do not appear till much later in the year.—*H. W. Trott.*

OCCURRENCE OF RABIES IN WILD CANINE ANIMALS.—The lamentable case of a gentleman worried by three dogs left in his charge by a friend, has called forth, in a morning paper, a leader in the “dog-fancying” interest. The writer maintains that canine madness is unknown, or nearly so, in polar and in tropical regions, and is caused by the confinement to which dogs are subject in civilized countries. Now I have always understood that rabies is exceedingly common among jackals in India, and far from rare among wolves on the Continent. Perhaps some of the correspondents of SCIENCE-GOSSIP may be in possession of facts bearing on this subject.—*J. W. Slater.*

COMMUNICATIONS RECEIVED UP TO 7TH ULT. FROM:—
T. S.—Prof. G.—Dr. C. C. A.—H. G. G.—D. E. S. C.—H. P.—
A. S.—T. P.—W. E. T.—G. K.—A. H. W.—E. L.—
M. L. W.—W. B.—T. W. S.—F. J. A.—T. C. R.—J. T. R.—
G. W. R.—T. B.—W. H.—A. W.—W. J. S. S.—T. W.—
J. S. W.—Dr. G. B.—T. H. B.—G. H. R.—M. S. Mc. D.—
W. E. G.—W. J.—A. W. S.—J. H.—S. E. L.—G. G.—D. D.—
W. M. P.—J. E. S.—G. H.—R.—A. B.—J. H. S.—
R. H. N.—B. C. D.—F. L. P.—C. R.—J. P. P.—H. S.—
J. G.—A. M.—J. D.—J. A. L.—M. H.—G. O. H.—Dr. R.—
E. S.—J. F. G.—W. V.—J. C.—E. F. M.—J. F. P.—G. B.—
G. C.—W. G. P.—H. G.—J. W. S.—V. G.—J. W.—D. J.—
C. D.—H. E. B.—J. C.—Dr. P. O. K.—T. C.—G. C. D.—
C. A. O.—H. F. P.—R. M. C.—T. H. H.—A. H. S.—W. T.—
A. L. S.—A. S.—C. A. O.—G. R. Y.—J. M. W.—H. M.—
R. H.—J. B.—J. P.—E. H.—H. N., &c. &c.

NOTICES TO CORRESPONDENTS.

TO CORRESPONDENTS AND EXCHANGERS.—As we now publish SCIENCE-GOSSIP at least a week earlier than heretofore, we cannot possibly insert in the following number any communications which reach us later than the 8th of the previous month.

J. GREGORY.—The specimens you enclosed are those of silicified and partially opalized wood. Thin sections would show microscopic structure.

A. MILNE (Carnforth).—You had better state definitely what you have to exchange, in the manner of our last page. Send the specimen up, and we will see if it can be named.

C. FLETCHER.—The specimen sent is a fragment of micaceous granite. The glittering, silvery-looking crystals imbedded in it are those of mica.

W. H.—We cannot undertake to name *Australian* zoophytes. We are not aware of any general work which has been published on them.

"QUERIST."—No. 1 is *Abyssum calycinum*; No. 2, *Veronica Buxbaumii*.

W. M. P.—Many thanks for the sample of Diatomaceous earth from Inverness-shire.

A. B. desires to know the name, price, and publisher of any book on Scottish entomology.

S. C. L. is desirous of knowing if there is a flora of Cumberland and Westmoreland, or of the North-western counties of England published. If so, by whom and at what price. Perhaps some of our friends will reply.

J. L. MITCHELL.—All queries to be answered and specimens to be named, should be addressed to the Editor of SCIENCE-GOSSIP, 192, Piccadilly, London.

GWALIA.—For information as to how to keep sea-anemones, salt-water, &c., consult "The Aquarium," by J. E. Taylor, published by Hardwicke & Bogue, 192, Piccadilly, London. The best fossiliferous locality, nearest to Caermarthen, is Llandovery, where you get abundance of Silurian fossils.

ERRATUM.—In our notice of the Watford Natural History Society's Transactions, for *Hertfordshire* read *Hertfordshire*.

C. A. O.—No. 9 of your list of objects sent is a marine sponge, but too small and imperfect to determine which. It appears to be a *Grantia*. The rest of your objects will be named in due course.

DR. W. J. D.—One of the slides has mounted the Water Scorpion (*Nepa cinerea*). Many thanks for the other slides. The one queried will be answered duly.

W. E. GREEN.—1. *Ptycomitrium polyphyllum*; 2. *Rhacomitrium lanuginosum*; 3. *Hypnum Schreberi*; 4. *Ditrichum flexicaule*; 5. *Bryum pallens*.

J. C. D.—1 and 3. *Mnium hornum*; 2. *Hypnum Swartzii*; 4. *Mnium cuspidatum*.

A. SOMMERVILLE.—1. *Hypnum serpens*; 2. *H. praelongum*; 3. *Tortula ruralis*; Berkeley's "Handbook of British Mosses," and Leighton's "British Lichens."—R. E.

EXCHANGES.

SEND three well-mounted Microscopic Slides for a sample tube of splendid pure, unmix'd gathering of Diatoms (Gomphonema), enough for thirty slides.—John L. Mitchell, 39, Gilmore-place, Edinburgh.

WANTED, all or part of the back numbers of SCIENCE-GOSSIP, bound or unbound. State lowest price.—John L. Mitchell, 39, Gilmore-place, Edinburgh.

BRITISH Land, Freshwater, and Marine Shells to exchange for others.—W., The Hawthorns, Hawthorn-road, Bootle, Liverpool.

WANTED to loan, Watson's "Topographical Botany." All expenses paid.—G. C. Druce, Northampton.

EXCHANGE, a few specimens of *Gagea lutea* for other plants.—G. C. Druce, Northampton.

FOR Hair of Sea Mouse (unmounted) send object of interest to T. Combridge, 5, Norfolk-street, Brighton.

SAMPLES of a new Diatomaceous deposit, from Inverness-shire, exchanged for other deposits, or gatherings of good Diatoms or Polycystinae.—W. M. Paterson, Westfield-terrace, Loftus-in-Cleveland.

Characium minimum, *C. laminata*, *Planorbis glaber*, *Zonites purus*, *Z. crystallinus*, and *Lepidoptera*, offered for fine perfect *L. avicularius*, *H. pulchella*, *B. perversa*, *B. acutus*, *Paludina vivipara*, or good marine species.—F. H. Hedworth, Dunston, Gateshead.

DUMÉRIE'S "Sciences Naturelles," 2 vols. for good Microslides.—F. W. Phillips, Maidenhead-street, Hertford.

WANTED, Nos. 9, 65, 90, 119, 130, and others, for 131, 165, 260, 575, 285*b*, 873*b*, and many rare plants. Lists exchanged.—C. A. O., 76, Trafalgar-road, Old Kent-road, London.

WANTED, good shells of *Ameletta lineata*, *H. lamellata*, *H. rotundata*, var. *alba*, *Zonites excavatus*, var. *vitrea*, or other good shells, for *Vertigo Moulinsiana*, *V. alpestris*, *V. pusilla*, or *V. angustior*.—J. Whitwham, Cross-lane Marsh, Huddersfield.

WANTED, *Anacharis alinastrum* and *Valisneria spiralis*, or other plants for aquariums, for Silkworms' Eggs.—D. Jones, 97, Percy-street, Caermarthen.

SLIDES of post-pliocene Foraminifera, &c., in balsam, also "Journal of Horticulture" for 1876, for Coal Fossils or polished Sections of Corals, &c.—J. Carpenter, Cheshunt, Herts.

CARBONIFEROUS Microzoon, a recent Foraminifer, mounted, and named in species, for unmounted Fossil Polyzoa and Foraminifera, or recent foraminiferous material or fossil earths.—G. R. V., Hill-top, Attercliffe, Sheffield.

FOR *Bupleurum rotundifolium*, *Silene conica*, *Censio squalidus*, *Anchusa sempervirens*, or *Franckenia lewisii*, &c., send stamp and address to W. G. Piper, care of Sutton & Co., Bankplain, Norwich.

WANTED to exchange, some E. Indian Lepidoptera for British local species.—W. S. R., 36, Euston-square, W.C.

HAVE about one hundred cases suitable for micro slides and for herbarium specimens: will exchange for Photo Apparatus, or otherwise. Any one wanting any can have particulars per post.—W. Tylar, 165, Well-street, Hockley, Birmingham.

BRITISH Coleoptera, S. E. coast, well set, for Books.—R. H., 66, Carlton-square, Mile-end, E.

BRANCHED Hairs from Mullein, Crystals of Strychnine, and other objects to exchange.—Edward Howell, Yeovil.

ANEROID Barometer, Duplex Thermometer, self-registering, silent Metronome, and Drum Clock with alarm and horizontal movement, in exchange for Microscope, or Rhumcorf coil, of same value.—J. Liddy, 6, Harman-street, Kingsland, N.

WANTED, Moore and Brady's "Middle and Upper Lias of South-west of England" (Somersetshire Nat. Hist. Soc. Proc. 1865-66). Fossils or cash offered.—Address, E. W., 21, West Bar-street, Banbury.

WANTED, Eggs of Birds of India. Can offer British and a few North American eggs. Hindostanee correspondence invited. Send full lists of duplicates to T. W. Dealy, 142, Clarence-street, Sheffield.

WANTED, good Silurian Trilobites, in exchange for European, American, Australian, Canadian, Brazilian, Indian, Chinese, Hawaiian postage-stamps, also from Natal, Jamaica, Trinidad, and Barbadoes. Only a limited number of the latter six.—Address, M. L., 88, High-street, Bridlington, Yorkshire.

WANTED to exchange, British Land and Freshwater Mollusca for other British and Foreign Shells. Land shells preferred.—Harry Nelson, 65, Freehold-street, Leeds.

A TWELVE-INCH Plate Electrical Machine, with discharges, &c., complete in case, for Microscopical Apparatus.—Apply to A. C. Rogers, 132, High-street, Southampton.

GOOD Microscopic Slides offered in exchange for Scientific Books or Instruments, or unmounted material.—R. H. Phillips, 28, Prospect-street, Hull.

EXCHANGE, a few North-American Bird-skins, three Red Squirrels, and one Flying Squirrel. *Desiderata*: Eggs of British Sea-birds.—Mr. John Dearden, Bishop's-buildings, Oldham-road, Ashton-under-Lyne.

WANTED to exchange, Ohio *Unionide*, *Helicidae*, other Land and Freshwater Shells, for British Land, Freshwater, &c., Shells.—J. P. Patterson, Washington, C. H. Fayette & Co., Ohio, U.S.

WANTED, a Raven's Skin in good condition for mounting; good exchange in other British Birds' Skins.—C. H. Robinson, Lynnfield House, West Hartlepool.

FOR Membrane of Bat send a stamped directed envelope to W. H. Gomm, Somerton, Somerset.

WANTED, Moore's "British Ferns and their Allies": offered in exchange, Stark's "British Mosses," quite new, coloured plates.—Address, F. L. Poulton, 6, Southfield-road, Cotham, Bristol.

Nos. 40 and 1283, seventh edition London Catalogue, for other flowering plants or mosses.—J. S. Wesley, Wetherby, Yorkshire.

WELL-MOUNTED slides of Spicules of Corsican *Holothuria* and *Pedicularia* of *Uvaster glacialis*, for *Pleurosigma fasciola*, or other *Pleurosigmata* dry, or Eggs of Lepidoptera for mounting.—T. H. Buffham, Clarendon-road, Walthamstow.

BOOKS, &c., RECEIVED.

"The Complete Peerage, Baronetage, Knightage, and House of Commons for 1877." London: Hardwicke & Bogue.

"Vis-Inertia, and Recent Explorations." By W. L. Jordan. F.R.G.S. London: Hardwicke & Bogue.

"The British Bird-Preserver." By Samuel Wood. London: F. Warne & Co.

"The Argonaut." April.

"Monthly Microscopical Journal." April.

"Popular Science Review." April.

"Potter's American Monthly." March.

"American Naturalist." March.

"Yorkshire Naturalist." April.

"Land and Water."

"Journal of Applied Science."

"Canadian Entomologist." March.

&c. &c. &c.



THE BIRDS OF NEW GUINEA.

No. II.

By GEORGE BENNETT, M.D., F.L.S., F.Z.S., &c.



BIRD very little known—except very recently only from imperfect specimens—is the Superb Bird of Paradise (*Lophorina atra*). It was found by Mr. D'Albertis in the north of New Guinea, about thirty miles from the coast,

at an elevation of 3,600 feet above the level of the sea, near Mount Arfak, and feeds upon various kinds of fruits. D'Albertis says,—“It flies from branch to branch in the forests, uttering a cry of ‘Nied, Nied,’ and from this peculiar note is named by the natives ‘Niedda.’” The Six-feathered Bird of Paradise (*Parotia sexpennis*) has also been until recently only known from mutilated specimens. It is one hundred years since the bird was first figured by Montbeillard, and until about three or four years ago nothing was known of this beautiful species, but a few specimens, roughly prepared by the natives, which existed in some of the great collections of Europe. Even its exact *habitat* was unknown; but the correctness of the supposition that it came from New Guinea has been verified by D'Albertis, who found it in a similar locality to the *Lophorina atra*, about thirty miles from the coast, at an elevation of 3,600 feet above the level of the sea, near Mount Arfak. Of this bird, D'Albertis says,—“I have never found the adult male in company with females or young birds, but always in the thickest parts of the forests. The female and young male birds I have generally found in a much lower zone. This bird is very noisy, uttering a note like ‘Gnaad, Gnaad.’ It feeds upon various kinds of fruit, more especially on a species of fig which is very plentiful in the mountain-ranges; at other times I have observed it feeding on a small kind of nutmeg. The

bird is named *Corana* by the natives. To clean its rich plumage this bird is accustomed, when the ground is dry, to scrape (similar to a gallinaceous bird) around places clear of all grass and leaves, and to roll over and over again in the dust produced by the clearing, at the same time crying out, extending and contracting its plumage, elevating the brilliant silvery crest on the upper part of its head, and also the six remarkable plumes from which it derives the specific name of *Sexpennis*.” I have, by the kindness of Mr. D'Albertis, now before me a beautiful and perfect pair of these birds, male and female, and observe that the plumage of the male glows in certain lights with bronze and deep purple, with the brilliant tints of the emerald and topaz; over the forehead there is a large patch of feathers of silvery hue, and from each side of the head spring the six feathers from which the specific name of the bird is derived. These are slender wires, about six inches long, with a small oval web at the extremity.

We now come to a long-billed Paradise Bird, belonging to the Epimachina section of the group, and forming both a new genus and a new species. It is named by Dr. Sclater *Drepanornis Albertisi*, after its discoverer. This remarkable new form of Paradise Bird was one of the most interesting discoveries made by Mr. D'Albertis during his exploration in the island of New Guinea. He shot it at Mount Arfak, and subsequently Dr. Meyer had one brought to him from the same locality. D'Albertis's account of the bird is as follows:—“It is very rare, and many of the natives did not know it, but others called it ‘Quarna.’ The peculiarity of this bird consists in the formation of the bill and head, and in the softness of the plumage. At first it does not appear to have the beauty peculiar to other birds of this class; but when observed more closely, and in a strong light, the plumage is seen to be rich and brilliant.”

A very marked New Guinea form discovered on the continent of Australia, and placed by naturalists

with the Paradise birds (*Paradiside*), is an elegant "Crow Shrike," adorned with plumage of a green and purplish-black colour : it is the *Manucodia Keraudreni*, and a question arises whether it migrates. This bird has a peculiar formation of the trachea, the convolutions being very large and numerous for the size of the bird, and are lodged between the pectoral muscles and the skin. Dr. Sclater informs me that this peculiarity in the trachea has been already described by Lesson, and I find a very accurate description of it has been published very recently by Pavesi of Genoa. This bird is found about the same localities as the Rifle-birds (*Epinachus magnifica*, et *Victoria*) : they frequent the dense forests, and are usually seen high up in the trees : the note uttered by these birds is a deep guttural, loud and prolonged. Their movements are active and graceful ; when approached, they evince more curiosity than fear, looking down at the slightest noise, and appearing to be more desirous of obtaining a full view of the intruder than regarding their own safety. They are almost universally seen in pairs. In "Elliott's Monograph of the Birds of Paradise," I find he mentions the *Manucodia Keraudreni* as inhabiting the continent of Australia, and other species of the same genus which are only found in New Guinea, still I do not see how they can be classed with the Paradise Birds, being so deficient in all the rich and splendid plumage of that class of birds, as well as differing in their anatomical structure. Yet if we refuse to admit this bird among the Birds of Paradise, Australia still possesses three species ; one in common with New Guinea, viz. *Epinachus magnificus*, and two exclusively to Australia, *Ptiloris Alberti* of New South Wales and Queensland, and *Ptiloris Victoria*, which is found on a limited area in Queensland.

The zoologist, when exploring the dense forests of New Guinea, contemplates with admiration the magnificent and gigantic fig-trees, the wild nutmeg (*Myristica*), the Canary-nut (*Canarium*), the noble palms, the Candle-nut (*Aleurites*), and other lofty trees, clothed in luxuriant foliage. At some places the vegetation was found more dense, and entangled by numerous vines, and the strong-growing climbing palm (*Calamus Australis*), mingled with numerous ferns, orchids, and a variety of flowering plants. The abundance of fruit-bearing trees attracted a number of frugivorous and other birds, most of whom were arrayed in the most gorgeous plumage conceivable. Among them the fruit-eating pigeons (*Carpophaga*) were plentiful, and on the tops of the loftiest trees, the magnificent new Red Bird of Paradise (*Paradisia Raggiana*) may be seen displaying its rich and elegant plumage under the bright sunshine, or endeavouring by the display to excite the attention of the unadorned female, being apparently aware that his elevated position left him out of the reach of the arrows of the natives or the gun of the naturalist. In some of the localities, where the trees are lofty but not too

much overgrown by vines, the large and noblest crowned pigeons (*Goura coronata* and *G. Albertisi*), the size of a turkey, are often seen walking majestically about, seeking for the fruits and seeds upon which they subsist. The last (*Goura Albertisi*) was found by Mr. D'Albertis on the south end of New Guinea, opposite Yule Island. By a rivulet in some secluded nook, the splendid and rare Kingfisher, the *Halcyon nigrocienea*, and another, the *Ceyx solitaria*, are heard uttering their very pleasing notes. Another of the Kingfishers is seen in the midst of the forest, the elegant racquet-tailed Kingfisher (*Tanysiptera daa*), whose plumage of vivid blue and white, and coral-red bill, combined with the long spatulate tail, renders this bird one of the most interesting of the family : it may occasionally be seen darting down upon a beetle, or some other insect. But still more attractive for its rich beauty is the small, but not less brilliant, King Bird of Paradise (*Cicinnurus regius*), who may be seen climbing over the vines, displaying the bright tints of its splendid rich and varied colours to the bright rays of a tropical sun, as it occasionally penetrates the dense foliage of the trees. Where the jungle is not very dense, a small bamboo grows, and is a place of resort for the mound-building birds, as the *Megapodius* and *Talegalla*, the place being suitable both for obtaining their food and for the construction of their nests. The Great Black or Palm Cockatoos were also attracted by the fruit of several species of Canary-trees (*Canarium*) as well as by the soft cabbage of the palm-trees on which they feed. The note of this bird is very peculiar, being a prolonged, loud, and shrill but mournful whistle. I saw a fine living specimen of this bird in the Zoological Gardens at Amsterdam in 1860. The Red-necked Hornbills (*Buceros ruficollis*) were also seen : their flight is very peculiar, being slow and steady, with the puffing noise of a locomotive engine. At night the attention of the naturalist is directed to the myriads of fire-flies flitting about in all directions, the variety of the strange noises, and probably still stranger animals, still further banish sleep ; while at dawn of day his attention is again attracted by the piercing cries of dense flocks of lorries (*Lorius*), honey-eating parrots (*Trichoglossus*), passing overhead, the latter darting with the rapidity of an arrow. Then he hears the loud cries of "Whock, whock, whock," emanating from the unmusical, harsh, and far from celestial voice of the true Birds of Paradise (*Paradiside*), and this is followed by the shrill but mournful whistle of the Great Palm Cockatoo (*Microglossum aterrimum*), followed by the drum-like sound of the Cassowary, and numerous other birds. The novelty of the situation was most interesting, and the traveller would feel difficulty in expressing the intense delight and irresistible fascination he experienced at the wildness and beauty of the scene. The number of birds seen in certain localities in New Guinea is very great. D'Albertis says,—“In the month of

December, from our anchorage at Attack Island, we saw large flocks of the Straw throated Ibis (*Ibis strickipennis*) flying at a great elevation in the north-west and south-west directions." At Yule Island, parrots (*Eclectus poliolorus*) start early in the morning in a westerly direction, and return to the east in the evening: he observed this also at Sorong Island, north-west of New Guinea, near the Salavati. At Kiwai Island, on the Fly River, early in the morning, and a little before sunset, he observed thousands of a black and white pigeon (*Carpophaga spilloroa*), and they were also seen at Yule Island, going from the east to the west to their roosting-places; and in the morning would be seen returning from the west to the east. He considered this pigeon to be almost as plentiful in this part of the world as the Passenger Pigeon (*Columba migratorius*) in North America.

The collections made will not only determine the birds or mammals confined solely to New Guinea and the more adjacent islands, but enable us to judge of the geographical distribution of species; and, after an examination of its fauna, it may be decided whether New Guinea may be placed in the Australian region, which would appear to be more correct than dividing it into East and West. D'Albertis says, "The most beautiful and characteristic species of the north-west are also found far east of New Guinea, and are dispersed from one end to the other; for instance, the Paradise Oriole (*Sericulus aureus*), the King Bird of Paradise (*Cicinnurus regius*), the Superb Bird of Paradise (*Lophorina atra*), and others, are all common from the north-west to the most south-eastern part of New Guinea, at the same time that there are many genera belonging to Australia; as *Podiceps*, *Porporio*, *Lobivanellus*, *Manucodia*, *Plotus*, *Mycleria*, &c.

THE HISTORY OF OUR SALAD HERBS.

PART II.

THE next plants or herbs which are largely used in composing a salad with the foregoing ones, are the Radish, Mustard, and Cresses, all belonging to the natural order of the *Cruciferae*. The Radish (*Raphanus sativus*) is mentioned by the writers of antiquity, and the size to which they said these roots attained must make the enormous Beet-roots and Turnips which are exhibited in the present day at our agricultural shows very diminutive in comparison, for in the Babylonian "Talmud" (which book contains some very singular and doubtful records) it is stated that the land of Judæa produced such large radishes that a fox hollowed out one of these enormous roots, and made it his residence for a time: after vacating this new kind of lair, it was put into a scale, and found to weigh nearly 100 lb. (?) The Radish was highly esteemed by the ancient Greeks, for we read that in the oblations of vegetables offered

to Apollo in his temple at Delphos, these plants were presented in beaten gold, whereas beet was in silver, and turnips in lead. Moschian, one of their chief physicians, thought so highly of this root, that he compiled one whole book on the Radish alone. The Greeks appear to have known three varieties, one of which was wild, and the other two cultivated. The Radish was largely cultivated in Egypt in the days of the Pharaohs for the abundance of oil produced from the seed; and as this root did not pay so much tribute as corn, it was more profitable to the cultivator. Pliny states that the Radishes of Egypt were better and sweeter than any in the world, because they were watered with brackish water, and are bedewed and sprinkled with nitre; and adds that salt was considered necessary for the growth of these roots. This author gives us an account of the Radishes known in Rome in his time. "We have," says he, "one kind from Mont Algidea, about fifteen miles from this city, where the climate is cool, and the soil produces fine radishes, the roots of which are so transparent that one may see through them." Another variety he describes that produces a root like a turnip or rape, which is tender and sweet, and is able to endure the frost and winter weather. The largest kind came from Germany; and some of the roots he mentions as weighing 40 lb., which size was gained by stripping off the leaves.

The ancients used to boil their radishes, but the Roman physicians recommended them to be eaten raw, of a morning, with salt, before taking other food. They also had a method of preserving them by covering them with a paste composed of honey, vinegar, and salt, and thus have them for winter use; but at all times they were considered injurious to the teeth, nevertheless they gave a beautiful polish to ivory. The seeds, parched and mixed with honey, were given to cure short breathing; indeed, this plant was believed by the ancients to possess wonderful medicinal properties. It was considered an antidote against poison, particularly in cases where persons had partaken of poisonous mushrooms; and it is stated that if a man rub his hands well with either the juice of the root or the seeds he can handle scorpions safely, and that if a radish be laid on one of these reptiles it will cause its death. Varro, one of the celebrated Latin writers on plants, tells us that at the end of three years the seed of this vegetable produced very good cabbages, which must have been rather vexatious at times to honest gardeners, who might have preferred radishes, as some author remarks.

Our poet Thomson has described the patriots of the city of the mistress of the world, sitting at their frugal supper,—

"Under an oak's domestic shade
Enjoy'd spare feast—a radish and an egg."

The Radish has long been in cultivation in this country. Bullein, who wrote in 1562, says, "Of radish rootes there be no small store growing

about the famous City of London; they be more plentiful than profitable, and more noysome than nourishing to manne's nature." It appears that they were used thirty years before this date at the table of Henry VIII. Gerard informs us that he cultivated three varieties of radishes in the reign of Elizabeth.

He tells us, that "the root stamped with honey and the powder of sheep heart dried causeth the hair to grow in a short space." He also states that when boiled in broth a decoction of this plant was thought good for an old dry cough by "making thin the thick flegm which sticketh in the chest."

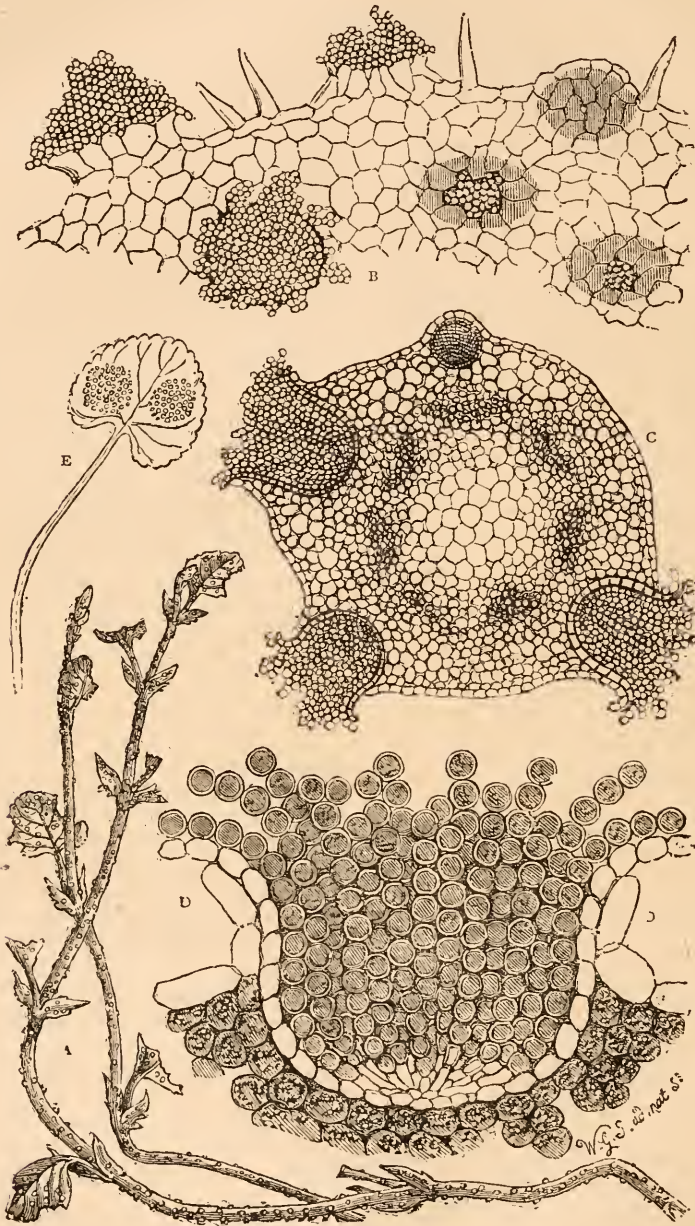

Fig. 106. *Aecidium depauperans*.

- A, Runners of *Viola cornuta alba*, showing habit of the *Aecidium* (nat. size); B, Fragment of bract, showing cells of leaf and *Aecidium* in different stages of growth, $\times 40$ diam.; C, Transverse section through runner, showing the fungi bursting through the epidermis, \times diam.; D D, Section through an *Aecidium* cup, showing chains of spores and transparent cells of peridium (outer coat), $\times 160$ diam.; E, *Viola* leaf attacked by *Aecidium Virole*, Schum. (nat. size), showing difference in habit.

Thomas Cogan, M.D., of Manchester, a medical writer, who died 1607, thought radishes unwholesome, but states that they were largely eaten by his countrymen as a sauce with roast mutton. Trajus states that he had seen radishes that weighed 40 lb., and Matthiöle assures us that he had met with some weighing 100 lb. each; these, I should think, must have been roots of some other vegetables, as we never meet with such enormous radishes in the present day. There is a specimen of one in the Museum at Kew, which weighs 11 ounces, and is 17 inches in length, and 6 inches in circumference. Some authors state that our garden radish originally came from China, where Miller states it is a native; but Mr. Benthams suggests that it may be a cultivated race of one of the wild species that are found growing on the coast of the Mediterranean.

one a correct idea as to its contrast with the general *Æcidium* found on violets. It is a singular circumstance that in a thin bed of *Viola cornuta* extending several yards in length, both the yellow, purple, and white varieties grew together, but only the white one had the *Æcidium* on it; and very singular, too, that the fungus does such damage to the leaves and stems it infests as to dwarf the plant and not give it strength to mature its leaves. The lower leaves seem to be the first affected, although the top ones are the first to be decomposed. Another peculiarity about it is that the cluster cups (*acidia*) do not congregate together in patches: they are solitary, and perhaps by this means the rootlets (*mycelia*) do their destructive work more effectually, and in less time. The following are the characteristics of this species:—*Æcidium depauperans* (Vize): spots none, peridia

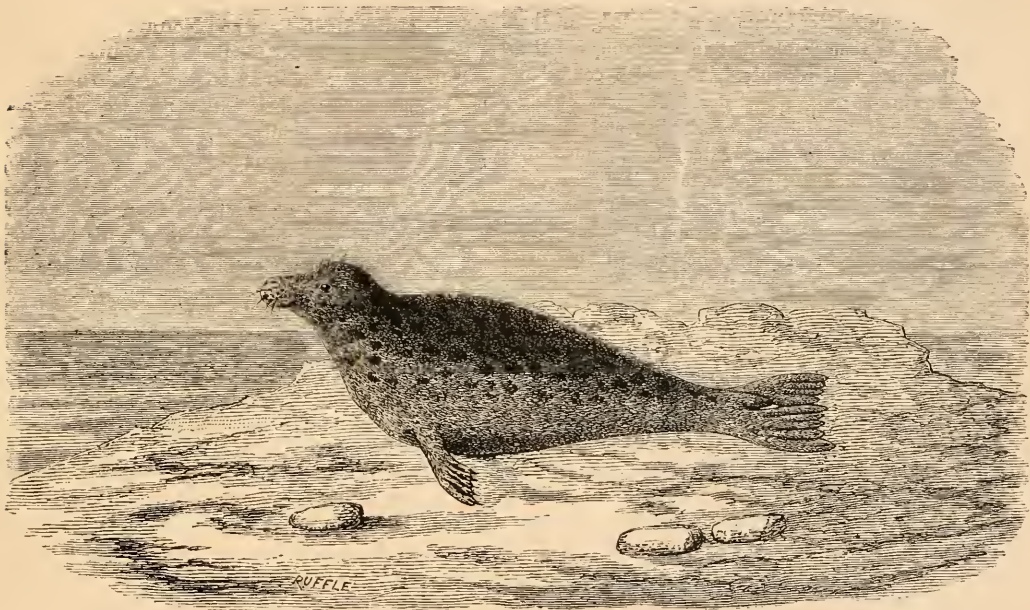

Fig. 107. Common Seal (*Phoca vitulina*).

The outer rind of the root of the radish gives a blue tint to water, but becomes red on pouring acids on it; from this circumstance it was much used by chemists in former days as a substitute for the litmus paper now in use.

The Latin name of this plant, *Raphanus*, is derived from the Greek *ra*, quickly, and *phainomai*, to appear, on account of its rapid germination. The English name is derived from *Radix*, a root.

H. G. GLASSPOOLE.

NEW VIOLET FUNGUS.

A CORRESPONDENT in the *Gardener's Chronicle* says:—The accompanying figure (fig. 106) of *Æcidium depauperans* will give to any

scattered, at first round, becoming elongated, but when elongated parallel with the length of the *Viola* stem. Spores yellow. Locality, Nantcribba Hall, Forden.

ON THE SEALS AND WHALES OF THE BRITISH SEAS.

BY THOMAS SOUTHWELL, F.Z.S.,
Hon. Secretary to the Norfolk and Norwich
Naturalists' Society.

TO the inhabitants of an island home, the terrestrial Fauna of which must of necessity be very restricted and well known, the study of the marine animals frequenting its seas and coasts cannot fail to be possessed of a peculiar charm. The un-

certainty and rareness of their occurrence, their exceptional forms, the mystery which shrouds their origin, heightened by the romance which, like a halo, surrounds the seas and high latitudes forming their chief homes, must always render them objects of the greatest interest. I purpose attempting to give in the following papers such an account of our Marine Mammalia as will, I trust, assist the uninitiated to identify those specimens which may chance to come under their notice, and if at the same time I succeed in inducing others to take up the study of this most interesting class of animals, I am sure it will be to their benefit and advantage.

The two great groups of Marine Mammals known as *Pinnipedia* and *Cetacea*, although widely separated from each other zoologically, naturally present themselves to us side by side as inhabiting the same regions; the facilities for studying the one are also equally favourable for obtaining a knowledge of the other. It is remarkable that in few groups of the animal world, until recently, has so much confusion existed as in the seals and whales. This has, of late years, through the labours of English and Continental naturalists, to some extent been remedied, although very much still remains to be done, and the excellent and carefully-executed portion of the second edition of Bell's "British Quadrupeds" devoted to these groups has brought together the widely-scattered results attained by scientific labourers, and presented them in a sound but popular form. Adopting the arrangement and nomenclature used by Bell in his second edition, I purpose to give a short account of the seals and whales inhabiting or occurring in the seas, or on the shores, surrounding the British Islands, with remarks on their habits and distribution.

The *Pinnipedia* (fin-footed) forms a well-marked sub-order of the Carnivora, and may be divided into three distinct families—the *Phocidæ*, or true Seals; the *Trichechidæ*, represented by one species only, the Walrus; and the *Otariidæ*, or Eared Seals. The *Phocidæ* are found both in the Northern and Southern hemispheres, most plentifully in the cold regions, but extending into the temperate seas; in the Northern hemisphere they are found as far south as 40° N. latitude; two species, however, are said to be subtropical. The true seals may readily be distinguished by the absence of external ears and the position of the posterior limbs, which are not adapted for progression on land, but admirably suited for propelling the animal through the element in which it obtains its sustenance. These limbs are directed backwards, and compressed laterally, the soles of the flippers being turned inwards, and are only free from the ankle-joints. Like the whole group, they are carnivorous. Five species are believed to have occurred on our shores. The family of *Trichechidæ* is limited to one genus, and that consisting of only one species, the Walrus or Morse, which is essentially Arctic in

its habitat, and on our coasts can only be regarded as a very rare and accidental straggler; in this animal there is no external ear, and its limbs are adapted for raising the body from the ground, thus enabling it to progress by their means upon dry land. The third family, *Otariidæ*, consists of several genera and species (according to Grey), none of which find a place in our fauna; they are distinguished from both *Phocidæ* and *Trichechus* by the presence of external ear-conchs, and from the former by the structure of their limbs, which are free and adapted for progression upon land, where at a certain season they take up their abode for a considerable period, whereas the Walrus visits the shore only occasionally,—generally towards the end of summer,—and the true seals pass much of their time basking on the shore or ice, but never leave the immediate vicinity of the water.*

The Eared Seals inhabit the lonely shores and islands of the South Seas and North Pacific Ocean, where they are hunted for their skins, the beautiful "seal-skin" of commerce, so much prized for its lustre and softness, being the produce of some members of this family. Of this family I have already given some account (see SCIENCE-GOSSIP, April, 1877, p. 79).

The true seals, as has already been said, spend most of their time in the water, but visit the shore or ice to bask in the sun or bring forth their young; this takes place early in the summer, and it is seldom that more than one is produced at a birth. Some species enter the water almost immediately after birth, but others are two or three weeks before they leave the ice, quitting it at first very unwillingly, but soon becoming expert at swimming and diving. The power of the seal to remain beneath the water for lengthened periods Dr. Wallace† believes to be acquired rather than structural. Their food consists of crustacea and fish, with an occasional sea-bird. Some species are migratory in their habits. In disposition they are timid and gentle, and capable of attachment, when in confinement, to those who feed and attend them. The Bladder-nose Seal, however, appears to be an exception to this rule; it is said to be fierce and vindictive, rather courting than fleeing from danger, and altogether a formidable opponent. Their great affection for their young is made use of by the sealers for their destruction. When the sea is covered with ice, the seals, by their constant visits to the surface to breathe, always returning to the same spot, keep open spaces which are termed "blow-holes"; as they cannot remain beneath the water longer than from five to fifteen minutes, these holes are prevented from freezing over, and here the hunter

* Professor Bell also points out that the fore-feet are hardly used by the true seals as means of propulsion in the water, whereas in the eared seals they form the chief organs used for that purpose, and in the walrus all four limbs are employed.

† Dr. Robert Brown on the "Seals of Greenland." Reprinted, with additions, in the "Manual and Instructions for the Arctic Expedition, 1875," from the *Proc. Zool. Soc.*, 1868, pp. 405–440.

and polar bear patiently await their visits and frequently effect their capture.

Although not found in sufficient numbers round our own coast to be of any commercial value, in the Northern Seas, where they congregate in vast numbers at the breeding season, the seal-fishery is of great importance as a branch of industry, and finds employment for a large number of vessels and men, both from this country and from the ports of Northern Europe. In the Greenland sea-fishery the Norwegian whalers had in 1874 sixteen steamers and nineteen sailing-ships, with an aggregate tonnage of 9,000 tons, manned by 1,600 sailors, and in the three years ending 1874 they killed 142,500 young seals and 128,000 old ones, notwithstanding which the balance-sheet of the three years showed only a small profit on the steamers and a large loss on the sailing-vessels. (*Land and Water*, August 26th, 1875.) In a newspaper report (*Daily News*, April 15th, 1874) eleven British ships, there named, are said to have returned in 1874 with cargoes varying from 9 to 95 tons of oil, amounting in all to 528 tons, which, at the estimate of 100 seals to the ton of oil, would show the vast number of 52,800 seals to have fallen to the British ships alone in that season, exclusive of those wounded and lost, or otherwise destroyed. Dr. Wallace * estimates the annual produce of the Greenland seal-fishery alone at the sum of £116,000; the bulk of the seals taken are the Harp-seal (*Phoca groenlandica*). To show the wasteful manner in which this trade is at present prosecuted, I will quote from a letter written by an old and experienced sealer, Captain David Gray, of the steamship *Eclipse*. He says that five ships in 1873 shot among the old seals for four days until the pack was utterly ruined. "I suppose," he continues, "about 10,000 old seals had been taken. Add 20 per cent. for seals mortally wounded and lost, gives an aggregate of 12,000 old ones; add 12,000 young ones which died of starvation [their parents being killed before the young ones were of any value or able to shift for themselves], gives 24,000 . . . The whole of the young brood was destroyed, and had these seals been left alone for eight or ten days, I am quite within the mark when I say that, instead of only taking 300 tons of oil out of them, 1,500 could as easily have been got, and that without touching an old one."† So great are the cruelties perpetrated by the crews of the sealers, that even the men themselves, hardened as they are, sicken at the work, and cry shame that the law does not put a stop to them. Let anybody who cares to know what fearful cruelties man is capable of perpetrating for gain, read Captain Gray's letter. The remedy for this waste of life (of course its cruelties can only be modified) is perfectly simple. Let the ships, says Captain Gray, be kept from sailing before

the 25th March, about a month later than they now start, and by the time they reach the fishery and find the seals the young ones will be sufficiently grown to be worth killing, and the frightful waste of life which now occurs from the destruction of the old seals before their young are able to shift for themselves, resulting in the death from starvation of the whole brood, will be put a stop to. An attempt was made last season by the countries interested in the seal fishery to regulate the departure of the vessels; but for some reason the necessary treaties were not completed.* It is to be hoped that legislation on the subject will be delayed no longer, or the time will have passed for restrictions to be of benefit. "Supposing the sealing prosecuted with the same vigour as at present," says Dr. Brown, "I have little hesitation in stating that before thirty years shall have passed away, the seal-fishery, as a source of commercial revenue, will have come to a close, and the progeny of the immense number of seals now swimming about in Greenland waters will number but comparatively few."†

The Walrus is rapidly and even more surely becoming exterminated than the seal; it has become extinct from station after station, and but for its ice-loving habits, which render its present strongholds always difficult and sometimes impossible of access, it would now probably, like Steller's Rhytina, have to be spoken of in the past tense.

The Common Scal, *par excellence*, of the British waters is *Phoca vitulina*, Linn. (fig. 107). It is found in more or less abundance on unfrequented shores and sands from the Orkney and Shetland Islands, where it most abounds, to Cornwall, often ascending estuaries and rivers for a considerable distance, but never quitting the immediate vicinity of the water. It is found, according to Bell, on both sides the North Atlantic, and is common in Spitzbergen, Greenland, and Davis Straits; also Northern Russia, Scandinavia, Holland, and France, and is said to occur occasionally in the Mediterranean. It figures largely in the returns of the Danish and Greenland fishery. The number killed annually of this species and *P. hispida* is estimated by Dr. Brown at about 70,000. On our own shores it is not so frequent as formerly; but still, in suitable situations, is by no means rare.

* Since the above was written another season has been allowed to pass, and no steps have been taken to regulate this cruel and wasteful trade; the sealing crews are probably at this moment engaged in their bloody work of extermination. Would that some of the well-meant but misdirected energy which has been brought to bear against so-called vivisection could be employed to urge upon all the powers interested a speedy and thorough reform in a trade which, conducted as at present, is a disgrace to all nations and people concerned in it.

† Brown, "Seals of Greenland." Dr. Brown's prediction is already virtually fulfilled, for, as this paper is passing through the press, I read in the *Daily News* of April 10th an account of the success of Dundee vessels engaged in the Newfoundland seal-fishery. 30,000 seals are said to have been captured by two vessels. The paragraph ends thus: "Previously all Dundee vessels were employed at the Greenland seal-fishing, but Captain Adams has for some years been of opinion that *that ground is practically used up*, and hence his visit to Newfoundland." The italics are not in the original.

* Dr. Brown's "Seals of Greenland," "Arctic Manual," p. 67.

† *Land and Water*, May 9th, 1874.

In the great estuary between the Norfolk and Lincolnshire coasts, called the "Wash," this species frequents the sand-banks left dry at low water, and I doubt not many young ones are produced there annually. At birth, which takes place about the month of June, the young one is covered with a coat of white woolly hair, which is shed at birth or shortly after, and the young one takes to the water when only a few hours old. Mr. Bartlett gives an account of the birth of a young one (at the time believed to be *P. hispida*) in the Zoological Gardens,* and states that it completely divested itself of its coat of fur and hair in a few minutes, and was swimming and diving about within three hours of its birth; its mother turned on her side to let it suck, and its voice was a low, soft "ba." The first coat is not shed so quickly in some species, nor do they all take to the water at so early an age; as, for example, *P. granlandica*, which is two or three weeks before it leaves the ice. The total length of the adult is about 4 feet, and its coat is generally of a yellowish colour, thickly spotted with black on the back and upper parts, but less distinctly so on the sides. The under parts are a bright silvery hue; there is, however, considerable variety in colour and in the distinctness of the spots. This species is readily domesticated, and displays great intelligence, and even affection for those who feed and tend it. Almost everybody must have been struck with the docility displayed by the seals which are occasionally exhibited as "talking fish." At the Zoological Gardens and Brighton Aquarium they are a never-failing source of attraction, and their graceful movements in their confined homes cannot fail to excite admiration. Swimming silently and swiftly along, the animal threads with the greatest accuracy the intricacies of its narrow pond, assuming every possible attitude, and turning over and over in its course, as much at ease when swimming on its back as in its usual position. When, tired with this exercise, it comes to the edge of its pond and raises itself out of the water, its rounded head, and bright, full black eyes have something almost human in their expression, and the fabled "mermaid" seems a reality; but when once it leaves the water, it is clearly seen that it is no longer in the element in which it is destined to live and move, for its motions are laboured and awkward in the extreme. It throws itself along, first on one side and then on the other, just as a man tightly sown in a sack would do, but, notwithstanding its clumsiness, contrives to make considerable progress.

This species may be distinguished by the arrangement of its molar teeth, which are placed obliquely along either side of the jaw, not in a line with each other. It has been said that this is only a characteristic of youth, and that the peculiar arrangement disappears "before the skull attains its maximum

size." In the second edition of Bell's "Quadrupeds," however, the author expresses his belief that "it will be found a characteristic of all ages, although certainly more marked in the young than in very old animals." Dr. Brown says that the Greenland Seal (*P. granlandica*) in its second coat has often been mistaken for this species, but that the former may readily be distinguished by having the second toe of the fore-flipper the longest. The hair next the skin is short and woolly, but externally harsh and shining, admirably adapted for repelling the water in which the animal passes so much of its time; the whiskers with which the upper lip is furnished, are thick, flattened hairs, laterally compressed, presenting diamond-shaped inequalities. The food of this species consists of fish and crustacea.

(To be continued.)

FERTILIZATION OF CRUCIFERS.

IT is very easy to ride a hobby too far, and, perhaps, in assuming every modification of the flower to have some reference to insect fertilization, we run the risk of doing so. The quotation made by



Fig. 108. Diagram of *Cleome droserifolia*.

Mr. F. H. Arnold from Sir John Lubbock is undoubtedly correct. There are hardly any specific special adaptations in the flowers of Crucifereæ. But then morphologically and otherwise the Crucifereæ are a "very natural order," as is evidenced, for instance, by their wholesome, antiscorbutic properties so general amongst them. The relative length of the stamens seems a purely morphological matter, applicable on Eichler's binary hypothesis. Eichler (Ueber den Blütenbau der Fumariaceen, Cruciferen, und einiger Capparideen, in Flora 1865-1869), derives the flowers from a primitive type, resembling *Cleome droserifolia* and some species of *Lepidium*, *Senebiera*, and *Capsella*, represented in fig. 108. This typical flower consists of two lower median sepals, two upper lateral sepals, four diagonal petals

* *Proc. Zool. Soc.*, 1868, p. 402.

in one whorl, two lower lateral stamens, two upper median stamens, two lateral carpels. Deviations from this type occur from the replacement of each of

Cleomeæ of the allied order Capparidaceæ, the stamens are indefinite in number, a condition indicated in the genus *Crambe*, in which each of the four inner stamens puts out a lateral sterile branch.

G. S. BOULGER.



Fig. 109. Diagram of the *Cruciferae*.

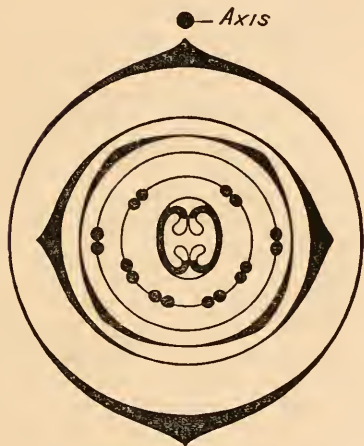

Fig. 110. Diagram of *Polanisia graveolens*.



Fig. 111. Stamen of *Streptanthus*.

the upper (inner) median stamens by two or more, through "collateral chorisis"; in the *Cruciferae* usually by two, in the *Cleomeæ* sometimes by more (figs. 109 and 110). This "chorisis" is a branching at an early stage of development, and is rendered probable by the genera *Atelantha* and *Streptanthus*, in the first of which the median stamens are only split, each half-filament bearing a half-anther, whilst in the latter the forked filament bears two entire anthers (fig. 111). In the *Crucifer Megacarpa polyandra*, and in many members of the section

THE ECONOMICAL PRODUCTS OF PLANTS.

No. II.

By J. T. RICHES.

CAOUTCHOUC.—This important produce is obtained from many different plants, belonging to totally different natural orders. However, for the present we shall only notice four of the principal plants, distinguished for their superiority in the qualitative and quantitative production of this valuable article of commerce.



Fig. 112. *Hevea (Siphonia) Brasiliensis* (reduced). a, flower.

The plants are:—*Hevea (Siphonia) Brasiliensis*, Mull., Arg., and *Castilloa elastica*, Cerv., natives of the western hemisphere; and *Ficus elastica*, Rox., and *Urceola elastica*, Rox., natives of the eastern hemisphere.

Commencing with those natives of the western hemisphere, *H. Brasiliensis* is a native of Guiana, the Amazon and Rio Negro districts of Brazil. The tree has a straight trunk, about sixty feet in height. Leaves on long footstalks, ternate; leaflets elliptical,

entire, smooth. Flowers monoecious, racemose, at the ends of the branches.

This tree produces the best "Pará rubber," the most esteemed. To obtain the juice incisions are made in the bark, from which the juice very quickly and readily flows. It is collected in earthen vessels, and poured upon clay-moulds, often in the form of bottles. After one layer is poured upon the mould it is subjected to the dense smoke produced by burning palm-nuts (*Attalea excelsa* and *Cocos coronata* nuts) until it is sufficiently blackened and hardened, when a fresh layer is poured on and treated in the same way, until it assumes the black, homogeneous mass known to us as "indiarubber." The clay is removed by washing, leaving the rubber pure.

The bulk of Caoutchouc imported to this country produced by this plant is from Pará; but that imported from the Upper Amazon and Rio Negro is usually obtained from other species (*H. lutea* and *H. brevifolia*).



Fig. 113. *Urucola elastica* (reduced). a, flower—(magnified).

The other plant belonging to the western hemisphere is *Castilloa elastica*, a native of Central America. It is a large tree, growing to the height of from 150 to 200 feet, with a cylindrical, hispid stem; unbranched until near the top, giving the tree the appearance of a gigantic umbrella. Leaves alternate, ovate, acuminate, crenate-serrate, hispid, accompanied with large amplexicaul, ovate, acuminate, seven-ribbed, hispid, stipules.

The trees in Panama grow by the side of rills and rivulets, and in the rainy season the stems are five or six feet under water. They delight in a swampy situation. Those grown in this country, it is said, succeed best when standing in water.

A good tree yields seventy pounds of rubber in a

season; it is, however, somewhat inferior to that produced by *Hevea*, but such a deficiency is more than made up by the greater quantity it yields.

The Indian Government has undertaken the task of introducing these two plants to India for the purpose of cultivating them, and there is a fair prospect of the enterprise proving very successful.

The plant most known as belonging to the eastern hemisphere is *Ficus elastica*, Rox., native of the East Indies, growing to the size of a moderate-sized tree. Stem, cylindrical; leaves, alternate, ovate, acuminate, glabrous, coriaceous, with a prominent mid-rib. Fruit not edible.

This plant is a universal favourite for ornamentation. It is largely cultivated for the production of Caoutchouc; but the produce is not so much esteemed as that imported from the western hemisphere.

Urucola elastica, Rox. (fig. 113) is a native of Borneo, Sumatra, and other islands of the Indian Archipelago.

It is a large, climbing shrub, or small tree. Leaves, ovate-oblong, opposite, roughish; flowers, cymose, terminal, of a greenish colour; fruit double; each portion about the size of an orange, containing numerous reniform seeds in a copious pulp, which is much relished by the natives and British residents.

The juice is collected from incisions made in the bark, and forms one of the kinds of Caoutchouc known as "Juitawan"; but owing to want of care in preparation it is very inferior in quality to the South American, the juice being simply coagulated by mixing with salt water, instead of gradually being inspissated in layers.

PEPPER (*Piperaceæ*).—This agreeable and valuable condiment is the produce of a plant originally a native of India and the Indian Islands, but now cultivated in those places; also Western Africa and the West Indies, from which places the supplies of this country are derived.

The plant (*Piper nigrum*, Linn.) is a climber. Stem in a wild state reaching to twenty feet in height, but under cultivation

only allowed to grow from eight to twelve feet, dichotomously branched; leaves broadly ovate, alternate, acuminate, five to seven-nerved, connected by lesser transverse veins, dark green colour above, pale, glaucous green beneath; flower, spikes opposite the leaves, three to six inches long, slender, pendulous, uni- or bi-sexual; fruit, distinctly round, about the size of a pea, red when ripe.

The plants are placed at the base of trees as rough as can be found, to facilitate the climbing nature of the plant. In three years fruit is gathered from them until they are eight years old, when they decline. The Black Pepper of shops is produced by gathering the fruit before it is quite ripe and drying it in the sun, when it loses its red colour, and becomes

shrivelled and black, and is known as "peppercorns." The white pepper is produced by allowing the fruit to ripen, and removing the pulp by maceration, or, as has been done in this country, removing the dry, black skins of the black pepper by mechanical agency.

It has been ascertained that pepper contains a peculiar neutral principle called "piperine," an acrid resin, a volatile oil, gum, starch, malic, and tartaric acids, &c. That known in commerce as "ground pepper" is usually adulterated with flour, sago, &c., which may easily be detected with the microscope.

that in the fifth century Attila demanded, among other things, three thousand pounds of pepper in ransom for the city of Rome.

The following description of the plant was given by Sir John Mandeville, who travelled in the fourteenth century, which applies now, with some exceptions. He writes:—"The Peper groweth in manner as doth a wyld vine, that is planted fast by the trees of the woodee for to susteynen it by, as doth the vyne, and the fruyt thereof hangethe in manere as reysinges; and the tree is so thikke charged that it semethe that it wolde breke; and when it is ripe it is all gréne, as it were ivy berries; and then men kytten hem as men doe the vynes; and then they putten it upon an owven, and there it waxeth blak and crisp."



Fig. 114. *Piper nigrum* (reduced).

Piperine, when perfectly pure, is in colourless crystals, neutral, and not alkaline. Pelletier says that when quite pure it is tasteless; Dr. Christison, however, states that the very whitest crystals he ever found were very acrid. The resin is very acrid and pungent; and it is thought by some that the properties of pepper depend chiefly upon the resin.

Its uses as a universal condiment are too well known to need further remark. It is used to a small extent in medicine.

The uses of pepper were known from the earliest times of which we have any record. It is frequently mentioned by ancient Roman writers, and it is related

—remains of creatures which actually lived millions of years ago, in other seas than any now existing, and that he has collected them with his own hand. The first flush of geological investigation surrounds these common palæontological objects with a halo of interest, which is not eclipsed even by fuller and more accurate knowledge of them. They are the pegs on which sunny holiday rambles have been hung,—rambles which, even after the lapse of years, cannot be remembered without their recalling the perfume of the heather, the hum of insects, the glint of sunshine on distant streams, and the shadows cast by cumulous clouds on the brown slopes of sunlit hills!

OUR COMMON BRITISH FOSSILS, AND WHERE TO FIND THEM.

No. V.

By J. E. TAYLOR, F.L.S.,
F.G.S. &C.

PERHAPS there are no fossils with which the delighted young geologist so soon becomes acquainted as those called *Encrinites*. Especially is this the case if his attention has first been called to rocks of the Palæozoic period. The limestones of the Silurian, Devonian, and Carboniferous epochs are often crowded with the varied remains of the fossils which half-popularly and half-scientifically come under the denominational name of *Encrinites*. It is true, the student frequently has hazy, and even erroneous, notions as to what they really are. But that is then a secondary consideration. The most important to him is that they are *fossils*

These Encrinites are often spoken of as *Zoophytes*,—a term which, although still in use among naturalists, is a bad one, inasmuch as it conveys the idea that the creatures thus named partake of an intermediate nature between animals and plants. At any rate, this



Fig. 116. Individual of *Pentacrinus* expanded (magnified).



Fig. 115. Larval stage of *Comatula* (*Pentacrinus Europæus*), nat. size, adhering to a Sea-fir.

beginners in palæontology, we regard it as a duty first of all to *disabuse* the mind of errors, previously to placing before it legitimately-deduced facts. We may say at the

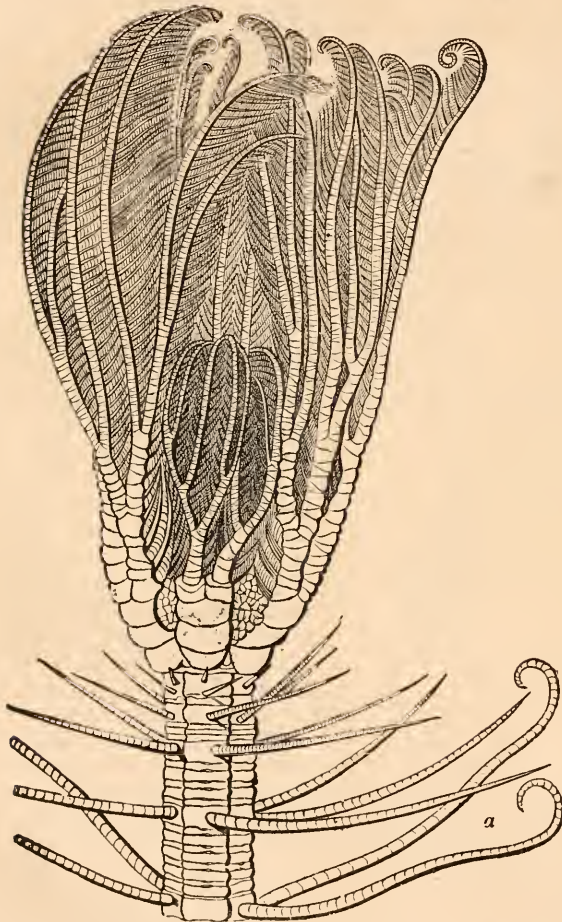

Fig. 117. Living West Indian Encrinite (*Pentacrinus Caput-Meduse*).



Fig. 118. Triassic Encrinite (*Encrinurus moniliformis*).

is the popular signification attached to the word *zoophyte* by the unscientific public. Encrinites have been loosely grouped among Zoophytes, and so have been regarded with the same degree of haziness. As these papers are intended solely for the use of first

outset, therefore, that none of the Encrinite family have any or the slightest relationship with plants of any kind. They are most nearly related with common marine animals, belonging to a group having a

world-wide distribution,—the star-fishes and sea-urchins.

At first sight it seems strange to associate the stemmed and jointed Encrinites with animals having

renders it difficult for the young geological student to understand that they are not *Zoophytes*, or “plant-animals.” Then, again, the manner in which the feathered arms fold up against the body, represented

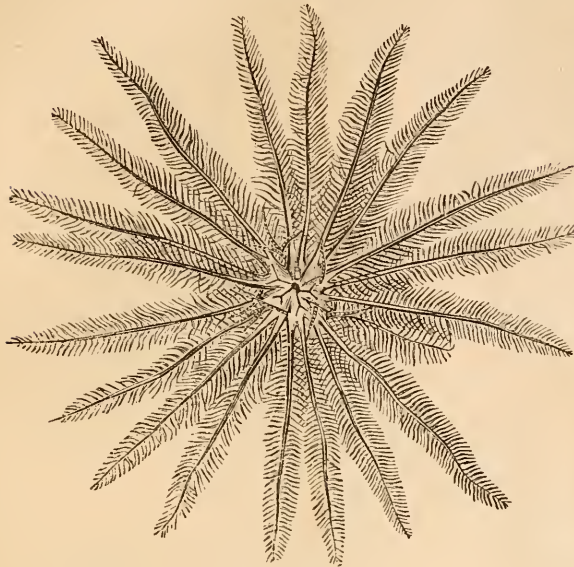

Fig. 119. Australian Feather-star (*Comatula adonæ*), $\frac{3}{4}$ nat. size.

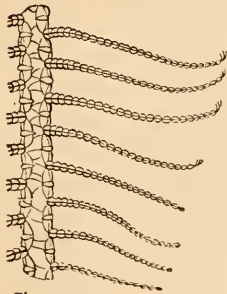

Fig. 120.

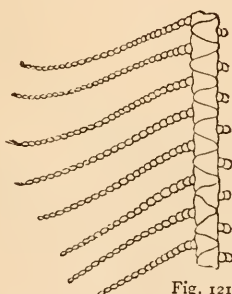

Fig. 121.

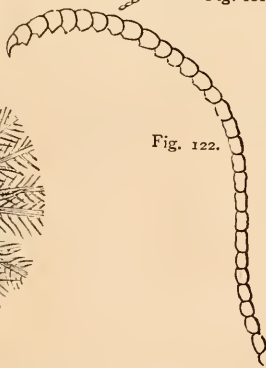

Fig. 122.

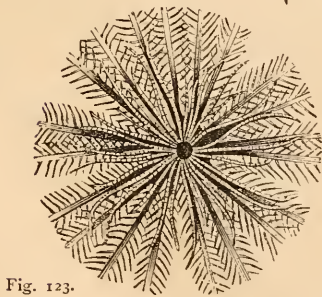

Fig. 123.

Figs. 120 and 121. Magnified portions of arms of *Comatula*, showing joints or ossicles.

Fig. 122. One of the rays of the *Comatula* (magnified), showing terminal hook.

Fig. 123. *Comatula* (reduced).



Fig. 125. Body of ditto, showing proboscis-like anus on summit, and articulating places of the arms.

Fig. 124. Nave Encrinite (*Actinocrinus triacontydaetylus*).

the power of locomotion. Perhaps it is the fact that Encrinites were all fastened to one spot by means of a jointed stem (just as a flower is by its stalk), which

in illustrations of them, just as the petals of a tulip are folded up; and the flower-like aspect resulting from this mode of rest; the names attached to *parts*

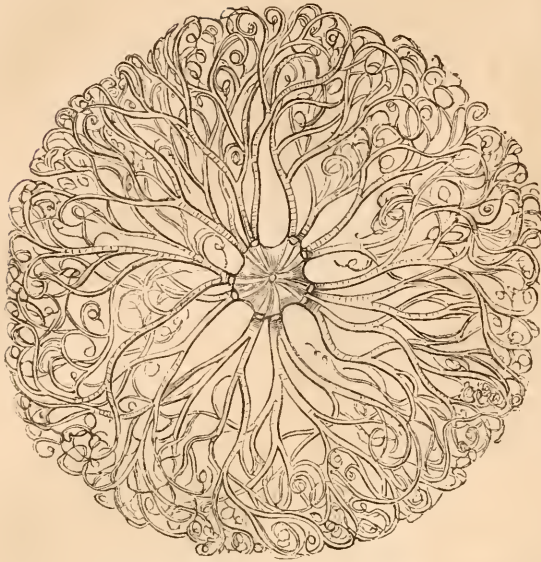

Fig. 126. Feather-star (*Euryale costosa*)

of Encrinetes, such as "stem," "calyx," &c., —all these are apt to still further magnify the error with which the beginner starts, of somehow imagining that the Encrinetes have certain relations to plants which other marine animals do not possess.

This is entirely wrong : an elephant or a lion is not more distinctively an animal than any

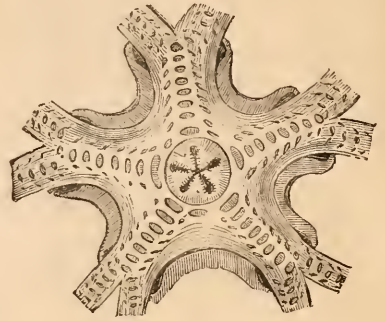

Fig. 128. Body, or centre, of *Euryale costosa* (back view).

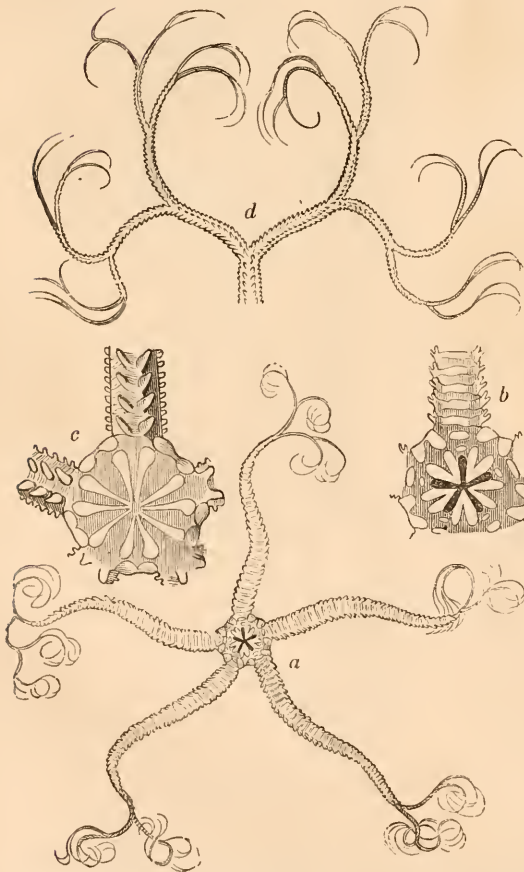

Fig. 127. *Euryale palmifera*, showing at *b*, disk and part of arm (front view); *c*, ditto (back view); *d*, extremities of arms.

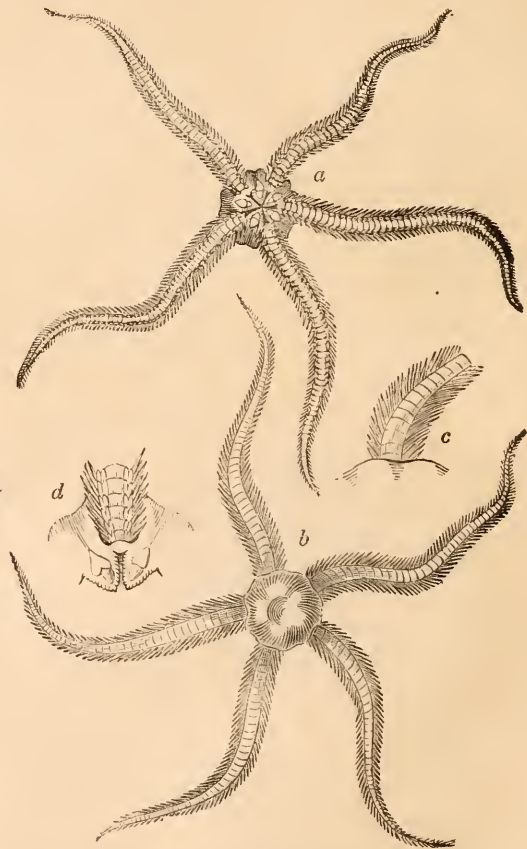

Fig. 129. Common Brittle-star (*Ophiura granulata*), showing affinities with *Euryale palmifera*. *a*, front view; *b*, back view; *c* and *d*, magnified portions of arms.

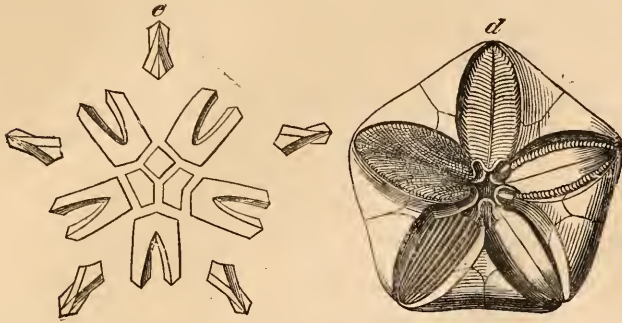

Fig. 130. *c*. Detailed plates which compose test of *Pentremites*; *d*, Upper surface of *Pentremites*, showing ambulacral furrows.



Fig. 131. *Pentacrinus briareus*. *a*, common Liassic Encrinure; *b*, upper surface of body.

species of Encrinure is, no matter what shape the latter may assume. But the history of Encrinures has been involved in a good deal of obscurity, from which it is now emerging. This was partly due to the fact that, a few years ago, few or no real Encrinures were known to be in existence; and none had been thoroughly dissected. The dredging expeditions of Carpenter, Wyville Thomson, and others, brought to light several species. One called *Rhizocrinus lofo-tensis*, found living in the deeper parts of the sea,

between the extreme north of Scotland and Iceland, is known to belong perhaps to the same genus as that found fossil in our chalk strata, and called *Bourgetocrinus*. Now this recently-discovered genus of living Crinoids has been well examined, and much light has consequently been thrown upon the structures of fossil Encrinures of all ages.

Cuvier, and many naturalists after him, including even Agassiz, grouped the Encrinures among that hodge-podge of marine objects still called *Radiata*. This term is about as expressive of any real facts or mutual relationships as the names of the orders and classes of plants under the Linnean system of botany are to the plants themselves. The order *Radiata* is a kind of zoological "lumber-room," into which all kinds of little or not understood creatures were thrust, if they only had radiating organs around the mouth; or even if the body itself was of a stellar or radiated shape, as in the case of the star-fishes. The *Radiata* is no longer used by modern naturalists, and most of the animals, living and extinct, formerly grouped under that name, have been assigned to distinctive and clearly-understood groups.

Thus, all the spiny-skinned animals (*Echinodermata*) are now included in the sub-kingdom *Annuloida*, or "ring-like" animals. All are internally related, although their external shapes may be different, by the possession of a peculiar apparatus called the "water-vascular system." In the Sea-urchins and common Star-fishes this highly-developed hydraulic machinery is immediately applied to locomotive purposes; and these creatures are thereby enabled to move about over the sea-floor. In the Crinoids, the water-vascular system is perhaps employed for respiratory purposes. But, even in the shapes of the *Echinodermata*,

varied though they be, we can pass almost imperceptibly from one type to another. Thus, we might begin with living Encrinures, such as the *Rhizocrinus* of northern seas, the rare and beautiful *Pentacrinus Caput-Meduse* of West Indian seas, nearly related to the abundant species (*P. briareus*) found in the Lias, and the little *Pentacrinus Europæus*, occasionally dredged up in quiet spots off the southern coasts of Ireland. The latter has a jointed stem, and is usually attached to Sertularians. It is now

known to be but the larval stage of the common Feather-star (*Comatula rosea*), which may be dredged up in immense quantities in the quieter parts of our sea-beds, but particularly so in the Irish Sea, and from the bottom of the salt-water lochs which indent the western coasts of Scotland. The *Comatula* is

nearly related to another of our native free-moving echinoderms, the *Euryale*, a genus which has a very large geographical distribution. One living species of *Euryale*, called *palmyra* (fig. 127), is evidently nearly related to the common Brittle-stars (*Ophiuride*), which are distinguished by not possessing a water-vascular system, and in being covered with rows of limy plates. The commonest of our British species is *Ophiura granulata* (fig. 129). Thus, we may pass from true living Crinoids, stalked and jointed, to others which are Crinoids only during the earlier part of their lives. Thence to free-crawling *Comatulas* and *Euryales*, and through the latter to the Brittle-stars. This remarkable relationship is still further indicated by the external limy plates which cover or otherwise enter into the structure of Crinoid, Feather-star, *Euryale*, and Brittle-star alike. A similar blending of the external shapes of allied forms may be seen in another large group of *Echinodermata*—the Star-fishes and Sea-urchins. Thus, beginning with *Asterias* (noted for the body and arms being covered with limy plates), we pass on to the Cushion-stars, where the arms seem to have been so stretched along their sides that they have eventually grown together. Thence we pass by such forms as *Scutella* and *Spatangus*, until we come to the true and abundant Sea-urchins (*Echinus*), so that the wide space between the Encrinites and the Sea-urchins is bridged over by a large number of intermediate generic forms. Still more remarkable is the fact illustrated by Haeckel and others, that the young of all the Echinoderms are so alike that it is most difficult to tell one from another. All commence life as free-swimming, worm-like larvæ.

The relationship between the Crinoids (or Encrinites) and the other leading members of *Echinodermata* is undoubtedly bound still more nearly together by the intercalence of several extinct groups. Thus the two extinct orders, *Cystidea* and *Blastoidea*, were in some degree intermediate between Encrinites and Sea-urchins in a manner that we have no examples of now living. The Tortoise-Encrinites of the chalk (*Marsupites*), and the *Saccosoma* of the Oolite (most probably allied to the Feather-stars) are deeply interesting, inasmuch as they are stalkless fossil Encrinites.

We may regard the body and arms of an Encrinite, of any species, as a kind of star-fish attached to a jointed stalk. The base of the Encrinite's body is called the "pelvis." Hence the mouth is uppermost, surrounded by the feathered arms—a position just the reverse of that which would be assumed by a star-fish, for the latter in crawling over the sea

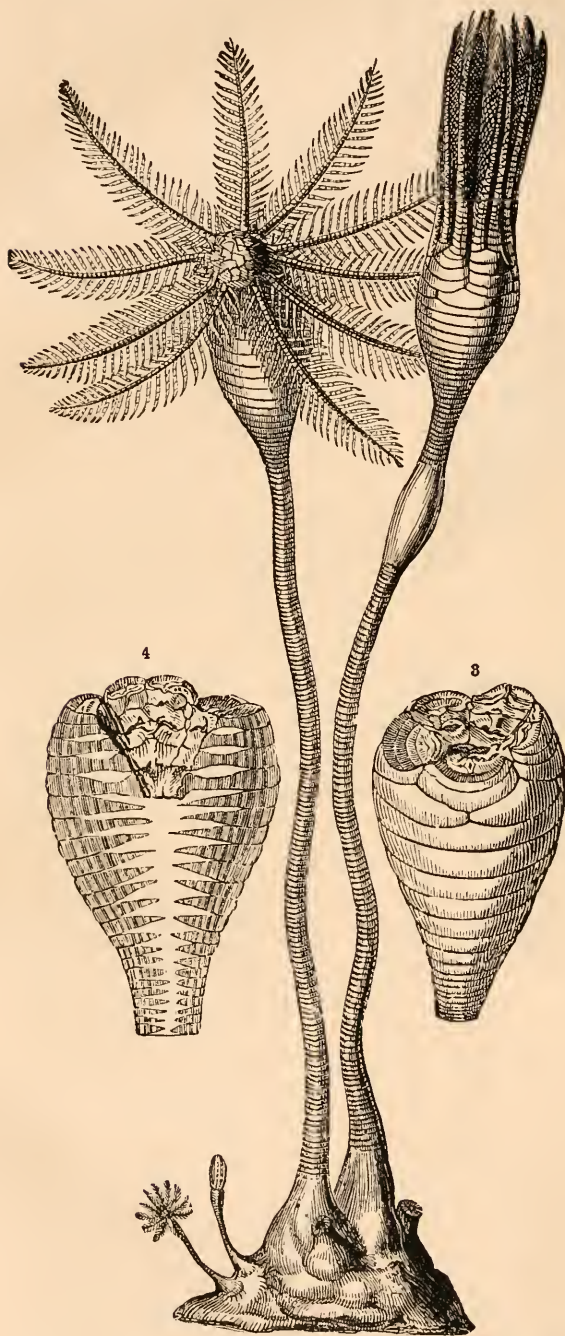

Fig. 132. Pear Encrinite (*Aptocrinites rotundus*), from the Oolite formation; 3, Body, or pelvis; 4, Vertical Section of ditto, showing stomach.

floor would have the mouth downwards. Both mouth and anus are usually present on the upper surface of the body of a Crinoid, the anus often terminating a nipple-shaped protuberance. In the most ancient Crinoids there seems to have been a difference from the structure seen in their *living* representatives. If we carefully examine the arms of recent Crinoids we see that they are *furrowed* on the upper surface. Both the arms and the pinnæ which give to them such a feathered appearance are formed of an immense number of limy joints. (In the extinct *Pentacrinus briareus*, found so abundantly in the Lias near Whitby, it is estimated that no fewer than one hundred and fifty thousand joints are employed in the construction of the five pinnated arms of one individual!) All are alike grooved on their upper surface, and thus we have channels or gutters running over every part of the upper surface of each arm. All is covered by a membrane or skin, which not only keeps the ossicles together, but is itself covered with thousands of minute cilia. The latter are movable, and are, as most of our readers are aware, a kind of motive machinery much in use among all kinds of the lower forms of aquatic life. The consequence of the general action of these vibratile cilia over the entire upper surface of the arms of the Encrinites is that currents of water bearing food are constantly being deflected down the bases of the five arms. The main grooves of these are continued over the *surface* of the body of the Encrinite, and all converge toward the mouth, which is thus supplied with fresh food and fresh water.

In the Palæozoic Crinoids the arms are grooved above, but the grooves terminate at their bases, and do not continue over the surface of the body, as above described. Instead of this they open into tunnels or channels, which are excavated, so to speak, in the under-surface of the limy plates, and thus reach the mouth of the Encrinite *beneath* the plates, instead of from above. The arms of Encrinites are not hollow, as is sometimes supposed, but formed of solid joints or *ossicles*, as they are scientifically called. The joints of the stem, on the contrary, have a cavity running down their middle, of various shapes, sometimes round, and frequently petal-shaped into five radiating arms. This continued hollow was formerly believed to be a continuation of the alimentary canal, but the notion is incorrect. The joints of the stems of all species of Encrinites are either grooved or toothed along their margins. In this way they were firmly interlocked, and yet were so capable of free movement that there is no doubt the whole Encrinital structure was swayed about by the tides and currents as freely as any of our larger rooted sea-weeds. From what we have said as to the pinnated arms of Crinoids, it will be seen that the old notion of their being so many nets in which to catch organic waifs and strays, is a good way from the truth. In comparison with the size of the entire structure, the

stomach is wonderfully small, and enclosed in the large and densely-plated body. Some of the carboniferous Encrinites must have had stems of enormous length, judging from the strength and diameter of the joints. In the Yoredale shales of the valleys running from Hebden Bridge to Halifax, in Yorkshire, we have disinterred and exposed connected stems of Encrinites ten feet in length, the ossicles of which were not a fourth part the diameter of those to be abundantly met with in the Carboniferous limestones of Derbyshire.

In our next article we propose describing the chief generic types, and the localities where they most abound in the fossil state.

(To be continued.)

MICROSCOPY.

MICROSPECTROSCOPES.—The proposition I should like to make through the medium of your journal is one which I at least, though apparently alone, would most willingly be always glad to do something for. I would speak to those who have a microspectroscope. Is it not in many cases purchased to be put into one's case that people shall say "What a perfect set of instruments!" or are its revelations too abstruse? Surely this cannot be, for those things which have the character of being abstruse seem to be most sought after. The fact is, that its use is not even realized as an addition to our microscopes. I have been a student at it now for over three years, and my experience tells me that we owe to Mr. H. C. Sorby a great deal, and should show forth those feelings of gratitude by forming in some way a community of combined workers who could compare measurements and so perhaps bring forth some good fruit. I would therefore propose that some of your readers who have worked at this instrument should develop (through your journal) this research more generally. An exchange, or rather a post-box, to contain tubes, might be kept in circulation, and worked on the same rules as one we all know of, which sends slides for the microscope. As to the supposed difficulty of measurement, that is overcome: the correct one is, of course, wave-lengths, and any measurements expressed should be always quoted by that standard, by which alone it appears possible to establish formulæ.—*Thos. Palmer.*

MICROSCOPICAL SOCIETIES.—The Quekett Microscopical Society held their annual *soirée* in University College on April 13th. The tables were as usual crowded with microscopes, and most of the new microscopical and mechanical appliances to these instruments were to be seen in working order. The list of objects exhibited was both large and various. The *soirée* was a complete success in every way, and it is gratifying to find the efforts of the committee and secretary so highly appreciated. The Medical Micro-

scopical Society held their annual meeting in their new rooms, 6, Pall-Mall-place, W., in January, under the presidency of Dr. Payne. The secretary's report showed that twelve papers on important subjects had been read during the year, of which four were illustrative of new forms of instruments applied to medical histology. The number of members of this society in December last was 129. Dr. Payne delivered an address on the above occasion, chiefly on the study of histology, and in the course of his remarks he reviewed the scope and bearing of most of the important papers which had been read.

THE FRESH-WATER SPONGE.—At a recent meeting of the East Kent Natural History Society, Mr. Fullagar (who has been successful in getting it to live and grow in confinement) again exhibited the fresh-water sponge (*Spongia fluviatilis*), illustrated by diagrams, showing (since the last meeting, December 6th) the production by growth of the pellucid, semi-transparent, gelatinoid substance termed sarcode, which had extended to some distance on the glass cell in which it was placed; in the new sarcode the pores through which the current of water enters the sponge were observable, forming the in-current, bearing with it the nutriment on which the sponge feeds. In the newly-formed sarcode was to be seen a number of new spicules; they were pointed at each end, and their middle or centre was bulged out, from which the growth extended to both terminal points; the mature spicules are a little bent or curved, and pointed at both ends, but not bulged out in the middle. Some good specimens of the mature spicules have been cleaned and mounted by Mr. Hammond. They are composed of the pure silix, as transparent as glass. The peculiar spicules of the ovaria were beautifully shown under the microscope. In a specimen Mr. Fullagar had successfully mounted in damar, by first drying the ovaria and then in a drop of damar with a thin glass cover gently pressed down, the granular contents of the ovaria were pressed out, and the beautiful stellated form of the spicule was seen standing out in form of so many miniature palm-trees: the real form of them is stellated at the two ends, connected together by a shaft, similar to two wheels on an axle. This form of spicule in the ovaria performs the double office of tension and defence.

ON CLEANING MICROSCOPIC SLIDES.—For removing Canada balsam from spoilt or useless slides, turpentine is, I believe, in general use. If the slides be immersed for about two minutes in strong sulphuric acid, heated to about 100° Fahr., the balsam will be decomposed into a filmy substance, easily got rid of by washing with cold water. If the acid is cold, the time will be somewhat longer. Circles of asphalt and rubber, the deposit of carbon from a lamp, which is sometimes very difficult to remove by other means, turpentine from beakers, bottles, &c., may be done in the same manner.—*W. M. Paterson.*

MOUNTING IN DAMAR.—As the writer of the article on damar, which has given rise to several remarks and suggestions as to using that fluid aright (see "Damar as a Mounting Medium," S. G. 1876, p. 254), I should like just to mention that Mr. E. B. L. Brayley has very kindly sent me two or three specimens of slides mounted in the manner described by him in the April number. I have thoroughly examined and tested these slides, and must say that, as far as I can judge, they are of a very superior character; for not only are the slides free from air, but the damar is *thoroughly* hard. I have not had time to try Mr. Brayley's method myself yet, as requested by that gentleman, but I feel sure that when I do so my opinion will be the same as above. Correspondents complain of there being no varnishes sufficiently tough to use with this medium; but is this not more the fault of the mounting and moistness of the damar than of the varnish? If this is not the case, how is it that, though I have never used any but asphalt varnish, I find all my slides perfectly dry and clean, without the slightest appearance of varnish having run in? To say that I have never had such a mishap happen to my slides would be simply stating what is untrue; but then, when the varnish has run in, it has either been from the fact that the damar was not sufficiently dry, or the varnish too liquid. As for air-bubbles, I never find any trouble with them; and I think that, did others but follow my plan (see my paper, p. 254, 1876), they also would have less reason to complain. Doubtless the *thorough* hardening of the damar, as achieved by Mr. Brayley, will do more for making damar a popular mounting medium than anything one could write or say in connection with its other valuable qualities.—*Charles F. W. T. Williams, Redland.*

ZOOLOGY.

PROVINCIAL SOCIETIES.—We have received the reports of meetings of various provincial natural history societies, all of which indicate the spread of the spirit of scientific inquiry. The "Botany of Northamptonshire" has been the subject of an able and exhaustive paper by a well-known correspondent to our columns, Mr. G. C. Druce. The report of the Chichester and West Sussex Natural History and Microscopical Society has just been issued for 1876-7, and shows that thirteen papers have been read during the year on various geological, botanical, and zoological subjects; in addition to two very successful summer excursions, and one annual exhibition held during two days in September. The East Kent Natural History is strong in well-known names, and we think it is a pity its Transactions are not published in a fuller manner. Mr. James Fullagar has been exhibiting and making additional discoveries in the

economy of the fresh-water sponge. The monthly meetings of this society are marked by a spirit of thorough and earnest scientific inquiry. The "Society of Inquiry," which holds its meetings in the Museum at Thornhill, Dumfriesshire, is not so ambitious in its aims. It is a quiet but commendable band, chiefly of "Inquirers" into natural science, who are pursuing their studies under the direction of Dr. Grierson, Dr. Sharp, and other naturalists, and we wish them every success. The Goole Natural History have several energetic members, notable among whom is Dr. Franklin Parsons, a well-known botanist and naturalist, whose thoughtful and well-written paper recently read before the Goole Society, on the "Coverings of Animals," we hope before long to publish. The Staffordshire Field Naturalists' Club have already commenced their well-attended summer excursions. These cannot fail to make such societies popular and attractive; and we commend them, if only sufficient care is taken to preserve, instead of destroying, the rarer animals and plants which may form the chief scientific attractions of such outings.

METROPOLITAN SOCIETIES.—The West London Scientific Association and Field Club hold their meetings at the rooms, Horbury Schools, Nottinghill Gate. The president is the Rev. Professor Henslow, M.A., F.L.S.; and the hon. secretary, Mr. Henry Walker, F.G.S. Three excursions, on Saturday and Tuesday afternoons, have already been held up to the end of May, to different places of geological and botanical interest; and three lectures and papers on geology and zoology have been given by Dr. Foulerton, Mr. F. P. Pascoe, F.L.S., and Miss C. Donagan.—The West London Entomological Society (established 1868), president, Mr. E. G. Meek. Meetings are held every Friday evening, between 8.30 and 11 p.m., in the club-room of the St. Mark's Institute, George-street, Oxford-street, W. (near Grosvenor-square). The object of the society is for the promotion and investigation of entomological science by reading of papers and members exhibiting their captures. The library contains many valuable works on Lepidoptera, Coleoptera, and Botany, which are lent to the members; and the library is increased as fast as the funds will permit. During the past three years the society has held three exhibitions, which have been very largely attended. The number of members on the books is 93. The subscription is 4s. 4d. per annum, with an entrance-fee of 1s. All information and rules can be obtained from E. W. Timms, secretary, at the address of the society.

THE BOROUGH OF HACKNEY MICROSCOPICAL AND NATURAL HISTORY SOCIETY.—This society was established March 20th, 1877. There are now about fifty members. The Meetings are held the first and third Tuesday of every month, at 194, Mare-street,

Hackney; Mr. C. Wilmott, hon. secretary. The Society invite the support of all microscopical students and lovers of nature.

BIRDS' EGGS.—We are glad to see that the Woolhope Club has abolished its practice of giving a reward for the best collection of Birds' Eggs. We should like to see every natural history society in the kingdom following the example, and thus declining to keep company with nest-robbers. Indeed, we hold that it is the duty of all our natural history societies to do all they can to carry out the Wild Birds Protection Act as far as possible, and by their influence thus to make a very poor and discreditable piece of legislation as thoroughly effective for preservative purposes as it can be. We should like to hear what our ornithological readers have to say on this important subject.

THE FOLK LORE OF NATURAL HISTORY.—We have received a copy of a lecture on this extensive subject, given before the Warrington Literary and Philosophical Society, by an old correspondent of SCIENCE-GOSSIP, Mr. Robert Holland, a naturalist well capable of dealing with this suggestive and interesting question.

"THE SUN-BIRDS."—Capt. Shelley, F.Z.S., has completed his Monograph of the *Cinnyrida*, or family of Sun-Birds, and it is now being issued in one-guinea parts. The plates, of which there are ten in each part, are magnificently got up. We have never before seen the metallic tints or shades of colour so well represented, and those who are acquainted with the Sun-Birds know how important it is that any coloured delineation of them shall express it.

THE CENTRINE SHARK.—Mr. Thomas Cornish gives an account in the *Zoologist* of a specimen of the Centrine Shark (*Squalus centrina*) taken in twenty-six fathoms of water near the Wolf Lighthouse, off the Cornish coast. This, he believes, is the first specimen taken in English seas. It is not uncommon in the Mediterranean, but has not before been noted as occurring farther north than Lisbon.

COLOURED BUTTERFLIES AND COLOURED FLOWERS.—Mr. A. S. Packard, jun., calls attention in the *American Naturalist* to some interesting observations of his own. He noticed in a field where a low white Aster and a common Golden-rod (*Solidago*) were abundant, twelve European Cabbage butterflies (*Pieris rapa*) fly directly to the less conspicuous but white Aster, and that they invariably passed by the yellow flowers of the Golden-rod. On the following day they visited some of the Golden-rods, but evidently had a partiality for the white Asters. On the other hand, the yellow sulphur butterfly (*Colias philodocce*) visited the flowers of the Golden-rod much oftener than those of the white Asters.

AQUARIA.—We understand that Mr. W. A. Lloyd is collecting material for a work on Aquaria he is engaged upon, in which he will narrate his varied experiences. Such a work, from Mr. Lloyd's hands, cannot fail to be a valuable contribution to practical zoology.

BOTANY.

CORNUS MASCULUS (CORNELIAN CHERRY).—In SCIENCE-GOSSIP for the month of April, page 90, I drew attention to this shrub, growing in the Pavilion Garden at Brighton, which was in full flower at the beginning of February. The flowers were all perfect; but as there is now (April 28th) no appearance of the young fruit, and I cannot learn that the shrub has ever been known to bear any, I wrote to Mr. Baker, of Kew Gardens, to know if the shrub bore fruit there, and if he could account for the failure of it at Brighton. In answer, he says "*Cornus mas.* fruits sometimes near London, but I do not think the fruit is common in England." It would seem, therefore, that the climate of England, with some few exceptional localities, is too severe at *so early a season* to allow the flowers to fertilize. In France and Switzerland it fruits, I believe, freely. I have met with it in fruit at Lausanne, in Switzerland.—*T. B. W., Brighton.*

CORNUS MASCULUS.—Your correspondent, "T. B. W.," describes this valuable but much-neglected old plant "to the life," in one of your recent issues. We have here at Valentines, an old seat of Archbishop Tillotson's, several aged trees of the same. It might aptly have been named *nudiflora*, as the mass of yellow blossoms come long before any sign of foliage, and afford a pleasing floral feature quite devoid of accompaniment at a very early season. I have seen them in bloom, "full out," late in February. The cornelian cherry it bears in Britain is very small and acrid, and such as few children, I think, would care to eat. If my memory is to be depended upon, the wood is superior for gunpowder manufacture; whilst the cherry abroad, in its native home or habitat, is as large as the fruit of the olive. If this be so, what a gorgeous fruiting plant! especially when we note the contrast between the small leaves and fruits of such colour and proportions. The fruit is more or less flat-sided. The old trees have bloomed indifferently this season. *Cornus*, from wood as hard as horn. Some species are highly valued in America for their tonic properties.—*W. Earley.*

DEATH OF CELEBRATED BOTANISTS.—Such of the botanical readers of SCIENCE-GOSSIP as have been in the habit of pursuing their vocation at Genoa will be sorry to hear of the recent death of Mr. De Notaris, who was so many years Professor of Botany at that University, and subsequently, on the changes in Italy, transferred to the University of Rome, where

he was also Professor. All who were fortunate enough, as I was, to make his acquaintance, will bear testimony to his courtesy and readiness to render all the assistance in his power. He was a great authority on cryptogamy as well as botany in general. His most extensive production was his "*Bryologia Italiana*," a folio volume of 781 pages.—Another botanist (an Englishman), I regret to say, died a short time back, Mr. Giles Munby, of York, who for a great many years was residing in Algeria, and contributed largely to the flora of that country, of which he published a catalogue, taking as his foundation the *Flora Atlantica* of Defontaine, to which he added many hundred plants. He will also be remembered as having brought conspicuously before the world the "Manna of the Desert" (*Lecanora esculenta*), which is so abundant in the desert beyond the Atlas mountains in Algiers, and fed the French army for three days. (See SCIENCE-GOSSIP, viii. 60, 186; xi. 146.) I had the pleasure of his acquaintance in the province of Oran for four seasons, when he gave me great assistance in collecting and forming a herbarium of the extensive and interesting flora of that country.—*Thomas Birch Wolfe.*

RARE PLANTS.—Mr. Thomas Rogers, the hon. sec. of the Manchester Botanists' Association, sends us a copy of a paper recently read by him before the above society, entitled, "A Botanical Excursion to the Grampian Mountains." It is a well-written and agreeable account of the peculiar and attractive flora of this region. The paper is published by Mr. James Nield, Oldham.

GLAUCIUM LUTEUM.—With reference to the article in January's number, entitled "An Early Summer Tour in Kent," the term *corniculatum*, as applied therein to *Glauclium luteum*, is an obsolete one, and more a synonym of the garden species, I am told, than of the common seaside sort.—*E. de C.*

VEGETABLE PARTHENOGENESIS.—The following looks very much like the phenomenon known among zoologists as *Parthenogenesis*. In an Alpine dioecious flowering plant, *Antennaria Alpina*, a native of the high Alps and the Arctic regions, the *male* plant is extremely scarce. Professor Kerner has never seen the male plant, and he relates how, in 1874, he cultivated the female plant with very great care in the Botanical Gardens at Innsbruck, excluding all possibility of foreign impregnation either by this or any allied species. Notwithstanding this, the plants produced a number of seeds. These were sown the following spring, and six out of ten germinated, two only reaching maturity, but showing no signs of hybridisation.

SEXUAL MODIFICATIONS OF THE GLUMES OF GRASSES.—M. Fournier gives the following as the result of his examination of Mexican grasses. Among those with sexes separated, if the sexes are borne on

different plants, the female flowers differ very little, if at all, as regards the situation or form of the floral envelopes. But when the plant is monœcious, the glumes of the two sexes are widely different. These differences are most marked in certain genera of *Chloridæ*, normally diœcious, and accidentally monœcious. The grass named *Buchlœ dactyloides* is a curious example in point. Besides this is now placed *Opiza stolonifera*, of which Presle had only seen the female plant. Although the flowers of these plants differ very widely, their male plants resemble each other so much that they have been grouped in the same genus. *Castiostega humilis* is the male form of *Buchlœ*, and *Castiostega anomala* the male form of *Opiza*.

INSECTS AND FLOWERS.—In a lecture recently delivered by Sir John Lubbock on "Certain Relations between Insects and Plants," Sir John shows the probable use to plants of hairs, &c., on stems and flower-stalks. Although flowers tempt flying insects, it is not to the advantage of flowers that *ants*, which are decidedly nectar-loving insects, shall rob the floral nectaries of their contents. Ants could not produce crossing by crawling over flowers; and Sir John Lubbock suggests that hairs covering flower-stalks are usually bent with the points downwards, and act as a *chevaux de frise*, hindering ants and other useless insects from crawling up. Thorns and prickles are equally protective against snails and slugs. When the flower-stalks are smooth, the flower-head is often covered with teeth or hairs, as in the cornflower (*Centaurea cyanus*). When *Polygonium amphibium* grows on land, the stems are covered with hairs, which secrete sticky matter to deter crawling insects from reaching the honey-laden flowers. But when the same plant grows in water the stem is smooth, inasmuch as there is no fear of creeping insects in the water.

YEW-POISONING.—We often hear of cases of cattle dying from partaking of the leaves of the Yew. M. Maviné has found a poisonous alkaloid in the leaves and seeds of the common Yew (*Taxus baccata*), which is named *Taxine*. It is nitrogenous, and evolves ammonia when heated with freshly-ignited soda-lime. *Taxine* is present in larger quantities in the leaves of the Yew than in the seeds.

THE ALKALOIDS OF THE GREATER CELANDINE (*Chelidonium majus*). From chemical experiments which have been made on this plant by E. Masing the following results have been arrived at: There is a diminution in the total amount of alkaloids before flowering, and a marked increase a few days afterwards. The young plant gathered in autumn shows a regular increase of alkaloids. The weather is an important matter in the contents of alkaloids. In rainy weather the consumption is greater than the production, whilst in sunny weather consumption and production are nearly in equilibrium. These changes are more noticeable in the root than in the leaf. A

good soil influences the formation of alkaloids; and plants grown in gardens were found to have double the amount of alkaloids found in wild plants.

GEOLOGY.

HOW TO CLEAN FOSSIL POLYZOA, ETC.—All collectors of carboniferous polyzoa have frequent occasion to notice that in the case of large handsome specimens of *Fenestellæ* and allied forms the polypiferous face is unfortunately seldom that which is exposed. This circumstance of course considerably lessens the value of the fossils, and those among the readers of SCIENCE-GOSSIP who are inclined to follow Mr. Vine's excellent example, and become collectors of the palæozoic "sea-mats" and "bottle-brushes" will be glad to know how the evil in question may be remedied. Mr. John Young, F.G.S., of the Hunterian Museum, Glasgow University, has very successfully solved the difficulty by applying the slabs bearing the polyzoa on to plates of asphalt heated to a proper degree of softness. The original shale is then removed, and the *fenestellæ* are found, polypiferous face uppermost, adhering to the hardened asphalt in a perfectly natural manner. This may appear to some a rather risky process of dealing with tender fossils, but an examination of the very beautiful results which Mr. Young has obtained by this means, and which form one of the many attractions of the fine carboniferous series under his care, will set such fears at rest. I may add that I have tried the method myself with invariable success.—G. A. Z.

THE METROPOLITAN WELL BORINGS.—Some misunderstanding has taken place in the public newspapers as to the views of geologists respecting the Metropolitan under-ground water supplies. At Messrs. Meux's brewery, Tottenham Court Road, the base of the gault has been penetrated, and a depth of one thousand and fifty-nine feet from the surface reached. From minute examinations of the lowest cores, there are reasons for believing the *lower* greensand has been reached. If this should prove to be the case, the water-supply of London will be practically inexhaustible. Twenty-seven years ago Prof. Prestwich published a work on the "Water-bearing Strata in and around London," wherein he stated (although no boring about London had then been carried more than three hundred feet into the chalk), that the chalk would be penetrated at a depth of 650 feet. Subsequent borings proved this prophecy to be correct in several instances. Later on, Mr. Godwin-Austen showed the probability of an ancient ridge of primary rocks stretching under the upper cretaceous system, along the line of the Thames valley; and the deep boring at Kentish Town, and another at Harwich, also proved Mr. Godwin-Austen to be correct. Prof. Judd thinks that although this old ridge of primary rocks must limit the area of the available

water-bearing *lower* greensand beneath London, there can be little doubt that an enormous supply will be obtained from the latter source.

NOTES AND QUERIES.

PEREGRINE FALCON.—In my remarks on Mr. Dealy's paper on the Peregrine Falcon (SCIENCE-GOSSIP, p. 91), I find I have been guilty of a very strange slip of the pen. I must ask your readers to be good enough to substitute for "identical with," at lines 3 and 4, the words "distinct from." They will doubtless have perceived the error.—*T. Southwell.*

THE PEREGRINE.—Perhaps Mr. T. Southwell will not mind my pointing out a few errors in his remarks on my article on the Peregrine. He says that in this said article (p. 53) I speak of the so-called *Falco anatum* as identical with *F. peregrinus*; saying at the same time that I give reasons to support this opinion. I believe, however, if Mr. Southwell would again look over the paragraph wherein this is contained, he would see that, far from saying they are *identical*, I tried to prove that they are *distinct*. Again, although I said that *F. peregrinus* often carries off birds as heavy as a duck, I did not imply that it always carried off the birds—as one would be led to think, where Mr. Southwell remarks: "Curious, that in Gould's 'Birds of Great Britain,' the Peregrine is represented in the act of striking down the duck." Of course the Peregrine does sometimes strike down its prey, and let it fall previously to securing it. I never said it did not; indeed, this is implied in what I said. But Wilson says that *F. anatum* *always* strikes down its prey. Mr. Gurney's opinion as to the fact that *F. anatum* and *F. peregrinus* are merely local varieties, is undoubtedly high; still the proofs that Mr. Southwell has put before me are not sufficient to convince me of this. Does Mr. Southwell mean (when he says that in a series from American and European localities there could, he believes, be found birds which would not differ perceptibly from each other), that if we were to take an adult American specimen and an adult European, they would look alike; that there would be no difference—no perceptible difference; or does he mean to compare *immature* specimens, when it *might* be possible to find them to all appearance alike? Again, as to Mr. Southwell's quotations of the Peregrine breeding in a morass, in trees, and on the moors, I believe I am right in saying that they are merely the deviations from the general rule of breeding, which now and then occur in most birds. This, however, cannot be said of *F. anatum*, as North America is not without its mountainous rocky situations,—situations such as the European representative delights in; yet this *F. anatum* passes by all these seemingly suitable localities, and places its nest on a *tree* in a gloomy cedar-swamp to bring up its young. This I could fancy, even in a Peregrine, were there no precipitous places in America; but this is not so. Many different opinions have been given *pro* and *con*, the separation of these two birds; and among them, as Mr. Southwell says, are those of Dresser, Newton, and Gurney, who say that they are merely local varieties, and not two distinct species. Presumptuous as it may appear for me to differ from ornithologists of such high repute, I cannot help it. The proofs which Mr. Southwell has given are not such as to make me waver from this opinion.—*T. W. Dealy, Sheffield.*

PEREGRINE FALCON.—In my article on the Peregrine, p. 51, the second line from the bottom of first column, for "Jiercel" read "Tiercel." In the thirty-ninth line on the second column of same page, for "whilst descending" read "now fast descending." In the first paragraph on page 55, instead of "Isle of Man," substitute "Isle of May" (off Crail, in the Firth of Forth). A few additional notes on the eyrie at Barra Head will, perhaps, not be out of place here. The account I gave on p. 55 was procured mainly from a former keeper of the lighthouse there. In a letter from the present keeper, dated January 16th, 1877, he says that these birds have of late years nested in places inaccessible. He says he has been now, at the request of English gentlemen, for the last seven or eight years on the look-out for the eggs of the Peregrine and Raven (*Corvus corax*), but has been unable to procure either, on account of the fact aforementioned. They still continue unmolested and nestle in one place year after year.—*T. W. Dealy, Sheffield.*

MIGRATION OF BIRDS.—On Monday, April 2nd, I heard and saw the ring ousel (*T. torquatus*) at Castleton, Derbyshire, where, amid the rocky valleys of that place, it delights to rear its young. On April 4th (Wednesday) I heard several willow-wrens (*S. trochilus*) uttering their call-notes, but no signs of any song at present. On April 6th I again saw the ring ousel upon the moors: the white ring across the throat made it very conspicuous. It was singing, but the song was very monotonous. I did not observe any females. I also saw another willow-wren fly from a tuft of heather: it was very lively. It would be very instructing and interesting for naturalists to insert in this paper a few notes upon this subject, and it would also tend to clear up many doubts which encircle the annual movements of some of the feathered tribes.—*Charles Dixon.*

SUDDEN RE-APPEARANCE OF PLANTS.—I have often heard my aunt say that all the earth from the gravel-pits at Oundle, Northamptonshire, became of a blood-red colour owing to the poppies which covered them wherever the waste was cast, and that British remains were found in the beds, which would imply great age. I thought I had by me some seed of a tall white poppy (*P. somniferum*, I believe), which I gathered amongst some turnips in the parish of Chelboro, Dorset. A small wood in a hollow at the foot of Castle Hill—so called from a building once upon it—had been cleared of timber, and as nearly as possible brought to the level of the field by shifting the soil. This part of the field was covered with these poppies, but I saw none in the other part, nor do I remember ever to have seen it wild or cultivated in that neighbourhood before. What I have heard of the forests here fully bears out your paper; but I have not had time to prove it by experience. Captain Main says that the boundary line between the States and Canada through the primeval forest which he cut was in a year or two so blocked with gooseberries and raspberries as to be hardly recognizable. I presume he means the pink-flowered one, called salmon berry, which is common here, and larger and stronger than the ordinary one.—*C. R. Bashett, Victoria, British Columbia.*

PRIMROSES.—Two specimens of double-headed primrose have been found here this spring; both heads are enclosed in one calyx, with separate stamens and pistil, and are united by the tubes of the corollas. Does this often occur in primroses?—*The Needles, Strangford, Downpatrick.*

TADPOLES.—I shall be much obliged to any one who will tell me the best way of keeping and feeding tadpoles.—*The Needles, Strangford, Downpatrick.*

MISTLETOE ON LIME-TREE.—It may interest readers of this journal to know that in the grounds of Clare College, Cambridge, there is a lime-tree (*Tilia Europæa*) bearing a large bunch of mistletoe in a flourishing state of growth. It seemed such an extraordinary occurrence that when I first saw it I could hardly believe that the bunch was really mistletoe; a further examination, however, convinced me (though I could not climb to observe it closely) that it was nothing else, the characteristic habit of the plant, and the dichotomous branching of the stems and leaves being very conspicuous.—*Frank J. Allen, St. John's College, Cambridge.*

THE SUN.—"Pater" asks an explanation of the phenomenon witnessed after looking at the sun—viz., the appearance before the eye of "small black balls." These are no doubt attributable to the fact that the intense light of the sun so fatigues the nerves of the part of the eye upon which it falls that the feeble diffused light of the sky is unable for a time to stimulate them to action; and we have thus a small round temporary blind spot of the size of that part of the eye affected by the sun. As the parts of the eye all round are sensible to light, this looks like a "small black ball," or rather, circular disc. If there be more than one such disc, they are doubtless caused by the slight involuntary movements of the eye while looking at the sun, and the consequent formation of several such blind spots. Other very interesting cognate effects are produced by gazing steadily at highly illuminated coloured bodies. On removing the eye and fixing it upon a white surface, it will be found strongly tinged by the complementary colour to the one previously looked at. This is due to the fatiguing of the nerves that respond to waves producing this colour, while those not so affected respond freely to the stimulus of waves of light, giving rise to other colours; hence we get a tint complementary to the original. "Pater" should read Helmholtz "On the Recent Progress of the Theory of Vision," one of his "Popular Lectures on Scientific Subjects," where he would find much highly-interesting and curious information on this subject.—*John Hepworth, New Brompton.*

SPARROW-HAWK AND CROW.—The propensity of crows to chase the sparrow-hawk, referred to at pages 21 and 44, is so well known in Germany as to be utilized for sporting purposes. A common mode of shooting crows there is as follows: A hut in the shape of an Indian's wigwam, capable of holding several persons, with holes in the sides about a foot square, is erected in the field. Outside this hut is a perch; near the perch, opposite the hole in the side of the hut, is a naked or dead tree. When the sportsmen want to shoot crows, they chain a sparrow-hawk, kept for the purpose, on to the perch and ensconce themselves in the hut. Immediately, crows arrive in numbers for the sole purpose of flying and pecking at the helpless hawk and bullying it generally. They settle on the dead tree to rest from their labours and recruit for a renewed attack, and are then a capital mark for the inmates of the hut. My single experience in one of these "crow huts," as they are called, enables me to answer a question as to the Hoopoe at page 22, unless indeed that question refers to England only. While in the hut, a bird settled on the tree which I did not at the moment recognize. On applying to the gamekeeper with us

in the hut, he said "It is a hoopoe, shoot it by all means: they are troublesome birds and do great damage to the crops." I acted accordingly. This was in North Prussia, not far from Stettin, considerably further north than Birmingham, and in a much colder climate. It was in the early spring.—*T. C. R.*

DESTRUCTION OF RARE ANIMALS.—Mr. H. Budge, who makes some judicious remarks on this subject (*SCIENCE-GOSSIP*, April, 1877), will be glad to learn that the evil has long since been reprobated by the East Kent Natural History Society. The committee, in their last report, state that, "instead of favouring the destruction of rare animals and plants, by offering premiums for the best collections, like the rewards of our forefathers for wolves' heads, it would be better to encourage the diligence of young persons by inducing them to study the nature and economy of common plants and animals." The committee add that, for this purpose, there are such plants as our familiar willows and sedges, of which the specific characters are still obscure; and that raphides and other plant-crystals, and the intimate structure of the glands, hairs, and other appendages, which have been often illustrated in *SCIENCE-GOSSIP*, would afford ample ground for the exercise of observation and proof of knowledge. And as to animals, the structure and general economy of numberless common species, of different classes and orders, would include far more useful and interesting results than the extirpation of the precious species of our native flora or fauna.—*E. R.*

NAMES OF ANIMALS.—The rabbit-catchers here call the male ferret a *Hob*, the female a *Jill*. Both are old names for male and female bipeds, not respectable; in fact, sometimes worse than not respectable—unearthly. We have Hob's-hurst-hole, the cavern of the fiend's grove—even to this day avoided by the superstitious as haunted; and so with regard to the word "Jill."—*R. G., Stoke-on-Trent.*

FRUIT CULTURE.—If apples or pears are raised from seed, and the suckers of such seedlings planted and taken care of, will the fruit of such suckers be identical with the fruit of the seedlings from which the suckers were originally obtained or not? Again, if the suckers of those suckers were taken care of, would the fruit so obtained be the same with the suckers of the first generation?—*Baats.*

SUSSEX OAKS.—The history of ancient trees is of great interest; can any correspondent furnish me with such, as to any Sussex Oak antecedent to the 17th century?—*F. H. Arnold, LL.B.*

BOOKS, &c., RECEIVED.

- "Smithsonian Report for 1875."
- "Somerville's Physical Sciences." 10th edition. Edited by A. B. Buckley. London: John Murray.
- "Somerville's Physical Geography." 7th edition. London: John Murray.
- "The Winds and their Story of the World." By W. L. Jordan. London: Hardwicke & Bogue.
- "Mesmerism, Spiritualism, &c." By Dr. Carpenter. London: Longmans & Co.
- "Elementary Text Book of Physics." By Professor Everett. London: Blackie & Sons.
- "Monthly Microscopical Journal." May.
- "Journal of Forestry," No. 1.
- "Journal of Applied Sciences."
- "Land and Water."
- "Chambers's Journal."
- "Canadian Entomologist."
- "American Naturalist."
- "American Journal of Microscopy"
- "Potter's American Journal."
- &c. &c. &c.

NOTICES TO CORRESPONDENTS.

J. A. C.—Some mistake may have occurred, for your note of April 20th contained no specimen of any kind, flower or otherwise. We believe that the paper you refer to was read at the West of London Club.

"A READER."—Please send us your name and address, and we will send you the name and address of such a person as you require.

A. D. M.—"The Transformation of Insects," by Professor Duncan, gives numerous illustrations of the structural parts of insects.

F. W. B. N.—Election into the Linnean Society is by payment of an entrance fee of six guineas, and an annual subscription of three pounds. A candidate must have his admission paper signed by three Fellows, who will testify to his fitness from "a personal knowledge of his work and writings," &c. Admission to the Royal Society is by an entrance fee of ten guineas. Only fifteen are elected every year, and are chosen on account of the scientific work they have done. Peers of the realm are F.R.S. without election.

P. E. C.—For full details about aquarium keeping, marine and fresh-water, stocking aquaria, balance of animal and vegetable life in ditto, consult Taylor's "Aquarium: its Inhabitants, Structure, and Management." Published at 192, Piccadilly, Price 6s.

REV. W. H. P.—We see no reason why the plants you refer to should not be eligible as exchange.

C. J. A. CRAWLEY.—The umbelliferous flower enclosed is that of the Wild Chervil (*Cherophyllylus Sylvestris*). No. 2 is more important, for the "succulent plant" is the Toothwort (*Lathraea squamaria*), which is found parasitically growing on roots of alder, &c. We cannot pronounce on the *Helix* until we see some specimens.

BERVILL.—The "Mineral" Magazine referred to was an abbreviation for the "Mineralogical" Magazine.

G. H. RAYNER.—The name of the commonest living species of coral known as "Madrepore" is *Madrepora plantaginea*; the word "Madrepore," however, is very loosely used, and often includes several genera of living corals, besides fossil ones.

F. W. S.—The fungus on the nettle leaves sent is that called the "Cluster-cup" (*Aecidium urticae*).

H. J. M'GILL.—Your specimens are as follows:—No. 1. Flowers of the White Beam tree (*Pyrus aria*). 2. Three-fingered Saxifrage (*Saxifraga tridactylites*). 3. Field Veronica (*V. agrastis*). 4. Small Sand Rocket (*Brassica viminea*). And 5. Stem and leaves of the Woodruff (*Asperula odorata*).

C. L. LAMPLUGH.—There is no separate work that we are aware of on the Sponges of the Yorkshire Coast. Get Gosse's "Manual of Marine Zoology," which will answer your purpose. (2) A new edition of Professor Phillip's "Geology of Yorkshire" contains all that you require as to the coast sections. It is published by Taylor and Francis at one guinea. (3) Pretty much the same kind of the commoner fossil sponges will be found in the Yorkshire chalk as in the chalk elsewhere in England. (4) Your specimens from the Boulder clay are, No. 1, *Tellina balthica*, and No. 2, a fragment of *Panopea*. You cannot do better than make a collection of such marine shells from the Boulder cliffs. Collectors of them are much in request.

T. RICHARDSON.—The case of the "Cockroaches" you mention is not one of *albimix* at all; for all these insects, when they first emerge from the pupæ state, are nearly white. In a few days they assume their natural colour.

ISAAC CRAWFORD.—Get the shilling work published by Warne & Co., and written by Samuel Wood, called "The British Bird Preserver."

F. QUARTERMAN.—The fossils you inquire about are as follows:—*Astræa erissolamellata*, Tertiary (a coral); *Cyclocyathus Pittoni*, Gault (a coral); *Alveolaria semi-ovata*, Lower greensand (a Polyzoon); *Nullopia*, Lower greensand (a calcareous sea-weed, like existing species of ditto, and *Corallina officinalis*); *Tragos*, Lower greensand (a sponge); *Verticillipora anastomosis* (a Polyzoon?); *Nebulipora pulchella*, Wenlock formation (a sponge?).

ROB.—The "American Naturalist" is published by B. O. Houghton & Co., Boston. "The American Journal of Microscopy" is published at Box 4875, New York City. Get Proctor's "Half-Hours with the Telescope," price 2s. 6d.; and Proctor's "Plain and Easy Guide to the Constellations," illustrated with 12 star maps, price 5s. Published at 192, Piccadilly. The "Astronomical Register" is published monthly.

EXCHANGES.

CASSELL'S "Natural History," "Book of Birds," and many other works on Natural History, &c., in exchange for Bottell's or Catman's Monumental Brasses, or for Rubbings.—F. Stanley, 6, Clifton Gardens, Margate.

COLORADO Potato Beetles given in exchange for good Slides.—Address E. Penneck, 805, Franklin-street, Philadelphia, U.S.A.

FOR Geological Slides (Transparent) send good Injections to M. Fowler, 20, Burn-row, Slamannan, N.B.

A FEW rare British and Foreign Birds' Eggs for others not in collection. Also a few Skins for Eggs.—J. T. T. Reed, Ryhope, Sunderland.

WANTED, a number of Snakes' and Blindworms', or other Lizards' Eggs or Young, for Embryological purposes. State price or what required in exchange, to T. W. Bridge, New Museum, Cambridge.

GOOD Microscopical Material (Chirodota or Holothurians preferred) wanted in exchange for well-mounted objects.—W. L. S., 6, Dognall Park-terrace, Selhurst, S.E.

A FEW Slides of "Synapta," with Anchors and Plates, and Crystals of Zeolite for Polariscopo, to exchange for other interesting Slides.—William A. Firth, Whiterock, Belfast.

FOR a Primrose leaf with cluster cups send a stamped directed envelope to J. Turner, Davenport, Stockport.

AM open to receive offers of uncommon Birds' Eggs, side blown, in return for Lepidoptera in fine condition, also a few Birds' Eggs.—R. Kay, 2, Spring-street, Bury.

MICROSCOPIC Objectives in exchange for any of the Palæontographical Society's Monographs prior to 1873.—Address, T. C. Maggs, Yeovil.

WILL exchange Sponges from the Yorkshire Chalk, Plana, Convoluta, &c., for good fossils from Tertiary or Palæozoic Strata.—G. W. L., Londesborough House, Bridlington Quay.

Nos. 40 and 1283, seventh edition London Catalogue, for other flowering plants or mosses.—J. S. Wesley, Wetherby, Yorkshire.

FOR exchange, Vols. for 1866 and 1867, one bound in blue cloth, the other half-calf, both in nice fresh condition. *Desiderata*: "Humphrey's Coin Collectors' Manual," 2 vols. (Bohn's series).—Address, H. Allingham, Ballyshannon, Ireland.

PUPÆ of *Monacha* offered for pupæ of *Villica*, *Plantaginis*, *Fulginosæ*, or *Lanestræ*.—H. Miller, Junior, Ipswich.

FOR exchange, *Fritillaria meleagris* (with white variety), *Leucotox astrivum*, *Anemone pulsatilla*, and *Saxifraga granulata*. Send list of plants for exchange to E. W. Andrews, University School, Hastings.

Hematodites equi vel asini, mounted or unmounted; also *Trichodectes Scalaris*, unmounted, in exchange for good Slides. Send list to H. Barker, The Grove, Kirton-in-Lindsey, Lindsey.

WANTED, in exchange for other books, or to purchase, Wilson's "Bryologia Britannica," with coloured engravings of Mosses, a second-hand copy in good condition.—Address, Miss Sparkes, St. John's, Bridgnorth.

SEVERAL Sets of 6 or 12 Slides of *Carboniferous* Microzoa (Foraminifera, Polyzoon, and Radiata) to exchange for Vegetable preparations, Palates, Entomological, or Diatom Slides.—G. K. Vine, Attercliffe, Sheffield.

WANTED, "Davis's Welsh Botany." Exchange in Dried Plants or cash.—H. S. Fisher, 1, Gladstone Road, Liverpool.

A NOSE Plate to hold 3 Objectives, by Wheeler. Cost £1. 15s. Wanted, good 1-Inch Object Glass or Slides. Also Hoggan Microscope, and Gosse, "Evenings with Microscope." New.—Address, T. 24, St. Patrick's-hill, Cork.

WANTED, a few fresh specimens of the following mollusks:—*Neritina fluviatilis*, *Valvata piscinalis*, *Limæa auricularia*, *Ancylus oblongus*, *Vitrina pellucida*, *Zonites nitidulus*, *Zua lubrica*, *Achatina acicula*, *Carychium minimum*, *Succinea*. Microscopic objects, &c., or Cash offered.—W. White, Litcham, Norfolk.

"BRITISH Nests and Eggs." Morris, 3 vols. For *Aculeate Hymenoptera*, or *Coleoptera*.—C. H. Goodman, Leanness Heath, Kent.

UNMOUNTED duplicates of *Aecidium ari* on *Arum maculatum*, in exchange for other good, named species.—Charles J. Watkins, King's Mill House, Painswick, Gloucestershire.

Grimmia Dominiana and other mosses, in exchange for Mosses or Plants.—Robert Kenton, Threeburnfoot, Lauder, N.B.

Zonites radiatulus, var., *Viridescens alba*, *Helix lamellata*, *Helix pygmea*, *Vertigo minutissima*, *Cochlicopa tridens*, var. *crystallina*, &c., offered for the rarest *Vertigos* or *Geomalacæ maculosus* (living). Silence, a negative.—Lister Peace, Crosland Moor Bottom, Huddersfield, Yorks.

COMMUNICATIONS RECEIVED UP TO 7TH ULT. FROM:—T. S.—F. K.—Dr. C.—Dr. H. F. P.—Prof. E.—P. B. W.—G. C.—E. E.—W. W.—F. W. S.—H. J. McG.—F. S.—E. B. L. B.—J. O.—T. O. J.—H. M.—J. S. W.—F. H. A.—J. B.—E. P.—C. F. C.—J. N. B.—A. D. H.—W. E.—J. G.—F. H.—T. C.—D.—G. B.—T. P.—C. M. V.—S. H.—G. O. H.—C. C. H.—Dr. P.—Dr. V.—J. W.—C. R. B.—W. L. S.—E. P.—H. E. W.—C. F. W. T.—W. J. H.—J. A. C.—H. G. G.—J. T. T. R.—C. J. A. C.—T. W. B.—W. H.—P. F. C.—W. A. C.—W. M. P.—M. F.—H. E. W.—T. C. M.—R. F. S.—R. D.—A. D. M.—N. P.—J. A. L.—E. W. A.—I. C.—R. K.—W. A. F.—J. T.—T. W. D.—F. W. E. N.—A. W. S.—J. F.—G. W. L.—H. P. M.—H. A.—E. B. L. B.—H. B.—T. L. C. R.—C. W.—N. M. E.—W. M.—L. P.—C. J. W.—E. R. T.—R. B.—J. A. S.—G. R.—H. S. F.—H. L.—C. H. J.—E. F. M.—F. C.—W. St. H.—W. W.—J. V. D.—G. S.—J. A. F.—R. R.—T. E. D.—&c. &c. &c.



ON CLEANING DIATOMACEÆ.

By FRED. KITTON, F.R.M.S.



IN spite of the instructions for the above purpose which have appeared from time to time in this and similar works, I am constantly asked to describe my *modus operandi*. I do not claim any originality or special merit for the following methods, and

I can only say I generally succeed in making good preparations; and it is probable that those who are accustomed to prepare slides of Diatomaceæ will learn nothing from these directions, or may have better methods of their own. I am writing for those who have just taken up the study of these organisms, and are anxious to prepare their own slides. Below is a list of apparatus and chemicals required, which, it will be seen, is neither numerous nor costly.

APPARATUS.

A spirit-lamp (or, where gas can be obtained, a Bunsen burner).

Test-tubes of various sizes and diameters. (It is better to use a small tube if the material to be operated upon is minute in quantity.)

Two pint precipitating glasses, with lips.

Three porcelain saucers, holding one, two, and three ounces.

Florence flasks are extremely useful when operating on large quantities of material (from one-half to two ounces.

Litmus-paper.

CHEMICALS.

Hydrochloric acid.

Nitric acid.

Sulphuric acid.

Caustic potash, or soda.

CHEMICALS—continued.

Bicarbonate of soda.

Liquor ammoniæ (strongest).

Chlorate of potash.

Methylated spirit of wine.

Pure spirit.

Distilled water.

Diatomaceous material may be divided into three classes, each of which will require a different mode of treatment. The first kind, and that which offers the least difficulty to the preparer, are the "pure gatherings,"—that is, those free from extraneous matter. If the forms in it are to be mounted with the valves and frustules not separated, it should be gently heated, so as to kill the diatoms and cause them to subside; when this has taken place, pour off the water and replace it with methylated spirit, in which they can be kept till wanted: this will dissolve out the endochrome, or colouring matter, and not separate the valves. When the frustules are very stout and not easily broken up, a solution of hydrochloric acid may be used (about five parts of water to one of acid): this will, in the course of a week, destroy the endochrome. If the diatoms are stipitate or parasitic on other algae, and it is desirable to mount them *in situ*, the water in which they are growing must be poured off and replaced by spirit, every trace of which must be washed away before mounting. The slide (or cover, if the specimen is mounted upon it) should now be made sufficiently hot to slightly char the stipes. When the valvular aspect only is required, the gathering must be boiled in nitric acid for about ten minutes, and after the diatoms have subsided (four or five hours are usually sufficient), the supernatant acid should be poured off and the test-tube about one-third filled with distilled water, repeating the process until every trace of acid is eliminated. (I must caution the operator against allowing the fumes of the acid to come in contact with the stock

of distilled water; and in order to avoid this, the water should be poured into a clean test-tube, or, preferably, into an ordinary graduated glass measure. I would also remark that it is more economical to use small quantities of water at different times than a larger quantity at once, although, of course, it takes somewhat longer to get rid of the acid.) When the water no longer shows any trace of acid, pour off and replace it with liquor ammoniæ,* cork up the test-tube and allow the diatoms to remain in it for from half an hour to nine or ten hours: the time will, of course, depend on the delicacy of the forms. Although ammonia is not so injurious as soda or potash, it will in time destroy the diatoms; it is, therefore, better to pour off a little too soon than too late. When the ammonia is decanted, fill the tube with water and shake well, and if it is desirable to separate the clean diatoms into densities, it should now be done. Pour into another tube all that have not reached the bottom of the tube in five minutes. (If the gathering contains very large and stout forms, from one to two minutes will be long enough.) Ten minutes may be allowed for the next density, and should there be any very minute diatoms, at least an hour should be allowed for their subsidence. The water last poured off will contain the connecting zones and flocculent matter (the latter is sometimes held in suspension for several days). We have now three or four test-tubes, each containing diatoms of different sizes, and also ammonia: this must be got rid of before mounting. If the material is valuable, it is best to begin with the heaviest density. Fill the tube about one-third full, shake it, allow the same time as before for subsidence, then decant into the next density; continuing the process with the other densities.

Unfortunately, diatomaceous gatherings generally contain the débris of various algæ, mosses, leaves, microzoa, &c. In collections made from fresh-water sources the process just described is usually sufficient to eliminate the extraneous substances, particularly if the gathering is strained through a piece of muslin, previously macerating it in hydrochloric acid and water; but those from marine habitats, such as dredgings, stomachs of ascidians, salpæ, noctiluçæ, or mollusca, require sulphuric acid for the entire destruction of the organic matter.

I have generally found the following process successful. If the material contains much animal matter, it is best to give it a preliminary boil in a solution of bicarbonate of soda (half an ounce to two ounces of water), and filtering through a piece of fine net: add more water and allow the solid matter to subside; boil the residuum in nitric acid, wash away the acid, and, after pouring off the water as closely as possible, add sulphuric acid (this must be done with care:

if added too rapidly, steam will be suddenly generated and a portion of the contents of the tube scattered about), and boil until the organic matter is carbonized. If this exists in any quantity, the material will become black; small pieces of chlorate of potash must now be dropped into the tube, allowing the effervescence to subside before using a second piece. This must be continued until the contents become white, or decarbonized. The whole should now be slowly poured into warm distilled water and washed as previously described. If the residuum, when free from acid, should contain any crystals of sulphate of potash, a further boil in nitric acid will dissolve them.

In guanos Ehrenberg discovered many rare and beautiful forms of diatomaceæ, which he described in a communication to the Berlin Academy in 1844. Unfortunately, in guanos, the amount of organic matter is very large, and offers considerable difficulty to the tyro; and most of the recent samples it is almost impossible to make sufficiently clean to allow of mounting anything but picked specimens. One of the earliest discovered guanos was that on the island of Ichaboe, on the west coast of Africa (26° 19' S. lat., 14° 15' E. long.); and if any of the original samples are still in existence, they would well repay the trouble of cleaning. This guano speedily became of little value to the diatomist, and is, I believe, now entirely worked out.* The guano from the Chincha Islands and Arica, commercially known as Peruvian guano,† was also very good, and not very difficult to clean. I adopt the following plan for that purpose (I usually operate on about two oz.). I wash away all the soluble matter by boiling in hot water (a Florence flask is very convenient for this purpose). A small piece of carbonate of soda in each boiling will be found advantageous. The insoluble residuum may now be treated with nitric acid: this must be added in small quantities, as considerable effervescence ensues, and, if poured on too quickly, considerable waste of acid and material will occur. The sulphuric acid process must be used after the nitric acid has been got rid of: when there is much lime in the guano, as, for example, that from Algoa Bay, a boil in hydrochloric, before using nitric acid, is desirable.

The fossil deposits may be divided into two kinds: those which are of comparatively recent date, to which class belong the subpeat deposits, of which so many kinds are found in America, and the marine deposits, such as those occurring in Virginia, California, Oregon, Barbadoes, and many other localities. Most of these require what the late Professor Bailey called "heroic treatment." A preliminary boil in nitric acid, to eliminate the lime, is generally necessary. Sometimes this is sufficient to break up the

* Genuine samples of this guano were found to contain from 1.08 to 2 per cent. of siliceous matter (sand and diatoms).

† Peruvian guano contained from 1 to 1.46 of siliceous matter, principally diatoms

* A small quantity is usually sufficient: enough to cover the diatom about half an inch will do.

material, but usually a caustic alkali is necessary to effect it: this requires great care in using, as silica is soluble in potash or soda. I usually add the caustic to the water and deposit whilst boiling: in the course of a few seconds the material begins to break up. The contents of the test-tube should now be poured into a precipitating glass three parts filled with water (ordinary water will do); after subsidence, the water must be poured off, and the deposit returned to the test-tube (which should be three parts filled with water), and then vigorously shaken. If, as is frequently the case, some of the material still remain unbroken, a further boil in caustic will be necessary.

The sub-peat deposits generally yield to a weak solution of bicarbonate of soda: they should afterwards be boiled in nitric acid.

The final treatment with liquor ammonia should never be omitted: those who have never before tried it will be astonished at the freedom from flocculent matter, and the brilliancy of the diatoms.

In concluding these instructions, I must urge all those who wish to make good slides to use the purest distilled water obtainable, and to make sure that no traces of the acids or alkalies used in cleaning have been retained. I must also caution the learner against a plan proposed in some books on the preparation of microscopic objects, viz., burning the vegetable and animal matter away by heating on a platinum spoon. This is utter destruction to the diatoms.

In a future number I hope to describe my plan of selecting and mounting.

THE UNDERGROUND GEOLOGY OF LONDON.

THE ultimate conclusions based upon the results of the deep boring at Messrs. Meux's brewery, Tottenham Court-road, have been singularly confirmative of geological predictions. We referred to these in our last number, and pointed out, what were for a few days believed to be differences of opinion, although we were strongly inclined to believe that Mr. Godwin-Austin's general theory would ultimately prove true: such has been proved to be the case. Many years ago the above eminent geologist pointed out that the rocks which came up in Somersetshire on the west, and formed hilly ground there, and which, beyond the south-eastern side of England, on the Continent, formed the high ground of the Ardennes, must strike across England in the vicinity of London. Thereabouts this chain of hills must be let down, and over the tops of the hills other deposits of later date must have accumulated and masked them. Messrs. Meux's hope in going on with their deep boring, was to find the Lower Greensand formation, where they would secure plenty of good water. At first, after the London clay and upper chalk had been passed through,

it was thought that this formation had been struck upon. Such an event would have been good news for the metropolis. Instead of this, however, it now turns out that the bed, which it was thought might be one of the Greensand strata, is only the old, weathered, superficial upper surfaces of a deposit, geologically speaking, much older. After the borer had passed through a few feet of this, it suddenly entered green and purple-coloured slates, having an appearance which geologists are in the habit of associating with the Primary rocks. It will be remembered that Mr. Godwin-Austin held that the old ridge of rocks lying at no great depth underneath London would be found to be of Primary or Palæozoic age, and possibly belonging to the Carboniferous formation. A well-boring, carried on some years after this theory was propounded, at Kentish Town, actually struck on the old ridge, although the cores brought up were not scientifically satisfactory in determining the geological age of the rocks thus reached. Afterwards, in a deep well-boring at Harwich, underneath the chalk, similar old rocks were pierced at a depth of a little over 1,100 feet, and here the Lower Carboniferous rocks were reached, as was evident from one characteristic Lower Carboniferous fossil brought up in the lowest cores of rock.

These two facts, so strangely confirmatory of a bold geological theory, have caused geologists to be on the look-out for deep-well or other borings in and about London. They had no small influence in bringing about the sub-Wealden explorations in Sussex. The green and purple slates brought up a few days ago from beneath Tottenham Court-road, were found to be highly inclined, at an angle of about 30 degrees dip. Unfortunately the boring tool which brought up a specimen of these highly-inclined slates, had to be turned round many times before it came to the surface. Hence we are completely in the dark as to the *direction* of the dip. If this could be ascertained, it would be no difficult task to calculate how far we should have to go, on the south and north of this subterranean mountain axis, before we should bore for coal with any possibility of success. The purplish green slates found underneath Tottenham Court-road are said strongly to resemble the rocks found at the bottom of the deep well-boring at Kentish Town. The cores containing these slates were confided to Mr. Robert Etheridge, F.R.S., palæontologist to the Geological Survey, who immediately discovered, from the nature of the fossils imbedded in them, that they were of Devonian, or Old Red Sandstone age; and they are said to be almost identical with the rocks of the Eifel. The most characteristic fossils found in the cores were *Spirifera disjuncta* (formerly called *Spirifera Verneulli*, a characteristic Devonian fossil on the Continent), and *Rhynchonella cuboides*.

We here obtain a glance at the vastness of the physical changes which must have taken place underneath us. These Devonian rocks were formed along

the floor of an ancient sea, and were afterwards upheaved and converted into a mountain-chain, whose rocks lay inclined at a steep angle. This mountain-chain was subsequently lowered until seas covered its highest summits, and deposited beds of chalk, London clay, &c., which ultimately buried them up to the depth of more than a thousand feet.

J. E. TAYLOR.

APPEARANCE OF CRYSTAL FORMS IN MOUNTING MEDIUM.

THOSE microscopic readers of SCIENCE-GOSSIP who read my paper on "Damar as a Mounting Medium," in the November number of last year, will remember the high terms in which I spoke of it as a substitute for balsam. As I have found from several kind letters and slides received, that many others are of my opinion, I wish now to call attention to a most

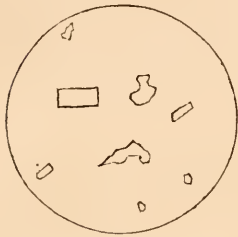

Fig. 133. First Appearance of Small Crystals in Damar.



Fig. 134. Second Appearance of ditto.

remarkable and aggravating appearance that has come under my notice within the last few weeks. Let me remark at the commencement, that though what I am going to describe is (as all who read this will, I feel sure, agree) annoying to me personally, still no brother microscopist with whom I am acquainted has experienced anything of a like nature. As you will see by reference to the paper mentioned above, I have used damar in mounting for some considerable time, and you will also see the method I adopt in mounting with it. Some four weeks ago I mounted a slide of a spiracle of a Privet Hawk-moth larva for a friend, who remarked, on receiving it, that there was a peculiar, scratchy appearance seemingly between the slide and thin cover. On looking myself, I remarked that it was a scratch on the glass, and so the matter ended for the time. About a fortnight since, however, I was examining a slide of Sphæraphides which I had mounted a few days before, when I was surprised to observe the same appearance of scratchiness that was noticed by my friend in the spiracle slide, except that, whereas in that only two or three scratches were visible, here they were fast covering the slide, and obliterating almost, in many cases, the Sphæraphides. I at once saw that these forms were no marks on the glass, but decidedly some chemical property either of the object or of the

fluid. As I had been mounting other slides at the time, I at once examined them, when I found, to my annoyance, all showed signs of the crystal forms; one slide in particular, the mandibles of a house spider, which I had mounted for a friend rather successfully, I was vexed to find almost surrounded by the crystal form, some large, some small; and since then they have quite covered part of the object. Had the crystals made their appearance in animal preparations only, I should have thought that the

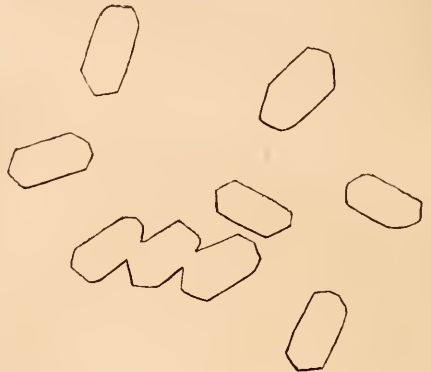

Fig. 135. Crystals in Damar, seen under higher power.



Fig. 136. Another set of ditto.

liquor potassæ or turpentine with which they were prepared had had somewhat to do with it; but vegetable and animal preparations shared the same fate; so I at once came to the conclusion that the damar must be the cause.

The tube of damar that I am now using has been employed in the mounting of many slides, and all, with the exception of those mounted within the last two or three weeks, are as clear and good as any one could wish. The peculiar thing is, then, what is the cause of the damar only recently producing these crystals? In order that I might be certain that the

crystals appeared from the damar, I on Friday (February 23rd) dropped some damar on a slide, and put a thin cover over. On examining, I found some particles of an amber colour floating about (see fig. 133). On Saturday the slide appeared fairly clear; but on Sunday morning an inch objective revealed the crystals in their early form (see fig. 134): the circle is only drawn to show the positions of the crystals within the thin glass. Figs. 135 and 136 show various forms of the crystals, both great and small, taken from a slide of antenna of Field Beetle: this slide, together with one of Sphæraphides, I shall forward with this to the Editor for his inspection.

THE GOATSUCKER.

(Caprimulgus Europæus.)

JUST about this time of the year, any one taking a country walk on some fine evening towards dusk, in our southern counties, must notice that most remarkable of our migrants, the Goatsucker. Even if the bird itself has been overlooked in the shadows around, the curious jarring note characteristic of the species cannot fail to have been heard, seeming, perhaps, to come from close at hand, and then becoming more distant, while the bird is within a stone's throw from where the listener stands.



Fig. 137. Goatsucker (*Caprimulgus Europæus*).

When the polariscope is applied, the most beautiful colours emanate from the crystals.

My object in writing this paper is not only to lay before my readers an aggravating case of a mysterious appearance, but more especially to (if possible) have three questions solved by some kind correspondent or correspondents.

Firstly, Is this a new appearance, and am I a solitary victim so far? Secondly, What in damar is likely to produce *such* results? Thirdly and lastly, Why have not the dozens of other slides which I have mounted from the same tube developed the same remarkable and annoying appearance?

Ralland.

CHARLES F. W. T. WILLIAMS.

The Goatsucker reaches us about the middle of May, and leaves us at the end of August or beginning of September, its stay being determined by the disappearance of the insects on which it feeds. On its first arrival it at once attacks the swarms of cockchafers, large or small, as they congregate round the tree tops in the evening, following them in their descent to the meadows towards dusk. Failing the cockchafers, the Goatsucker pursues an allied species, the fernchafer, which makes its appearance in beds of fern in June. Moths—especially the large swallow-tailed moth—and bees form a large proportion of the food of the Goatsucker, together with dor-beetles and flies from the low damp meadows, and around the cattle.

The structure and habits of the Goatsucker seem to constitute it a link between the Swallows and the Hawks, while its night-flying propensities give it a claim to relationship with the Owls. Its flight is essentially hawk-like, and exceedingly rapid and graceful, though as perfectly silent as that of an owl; and indeed, on examining the wing, we find a similar margin to the outer feathers of serrated fibres, to that possessed by the Owls. In common, too, with them, the eyes are large and bright, and surrounded by a well-marked radiation of feathers. In its general characteristics, however, the Goatsucker resembles its near relations, the Swallows. The mouth is remarkably wide, the opening extending behind the eye. The beak is small, but the great peculiarity consists of an array of long bristles growing from above and below, from the margins of the mouth, and so disposed as to prevent the escape of the insect when once captured—an obviously necessary arrangement when we consider the powerful insects on which the bird feeds. The feet, like those of other insectivorous birds, are small and weak: on the middle toe, however, is a peculiar comb-like structure, formed by dilation and serration of the hard covering of the bone. What purpose this comb serves is not known, but it has been conjectured that it may be of use in capturing and retaining large moths, &c., while on the wing. The only way in which the plumage of the Goatsucker can be described is by comparing it to the undermarking of the wings of some of the Vanessidæ among butterflies. It is a most intricate combination of black-greys and sepia. This colouring renders the bird perfectly undistinguishable while in shade, and probably preserves it from notice in the daytime, as it generally hides among the long fern in woods, where its colouring would blend with that of the dead leaves and wood scattered around.

The Goatsucker breeds with us, laying its two eggs on the ground, without forming a nest of any description. These eggs are about the size of a dove's, marked with grey and brown on a white ground. I have noticed that these two eggs are never, as far as I know, alike in marking, one being boldly dappled with colour and leaving broad spaces unmarked, and the other closely marked with small spots in such a way as to leave little of the ground showing. Can any one say whether this is always so?

Another point on which I should like information is whether the Goatsucker ever "jars" whilst on the wing, while it is settled on the ground, or lengthwise on a rail. I have seen it in the act of so doing, but have never been able to determine if it does so during flight. The names of the Goatsucker are numerous, all referring to its habits. The commonest are Fernowl, Nightjar, Evesjar, and Night-hawk.

The range of the family of the *Caprimulgida* is very extensive, as they belong to the old and the new

world. That of our one English representative is limited to the southern and south-eastern counties, seldom extending far inland.

CHAS. W. WHISTLER.

AN IRISH BOTANIST'S HOLIDAY TOUR.

HAVING made up my mind to snatch a few days from business and enjoy a brief holiday, I fixed on the second week of May last for that purpose, and decided on devoting it to what seems to me the pleasantest of all mundane pursuits—botanizing. The season thus selected was not, of course, the very best time in which to collect a large number of plants, nevertheless I reckoned on finding as many representatives of the spring flora of the West of Ireland as I could conveniently manage to dry on my return.

My route to the West was by way of Dublin, and, on nearing that city, I was gratified by seeing on the railway-banks an abundance of *Primula veris*, a plant that does not grow wild in the county of Antrim, and is extremely scarce in the neighbouring counties of Down and Derry. This species seems to prefer a limestone soil: it abounds not only about Dublin, but all along the Midland Railway line to Galway, and I observed it by the road north-west of that city until near Outerard. In many places it seems more abundant, even, than the Primrose, but does not enter Connemara. In fact, I noted that the Cowslip disappeared as soon as we left the limestone and entered on a country carved out of the metamorphic rocks.

On reaching Dublin I at once made tracks, as the Yankees say, for the Royal Canal, in hope of meeting with *Equisetum Wilsoni* before night would set in. In this I was successful, and found the desired horsetail growing in dense tufts in the shallow water at the edge of the canal. Twilight was, however, coming on, and not getting satisfactory specimens, I decided on visiting the canal again in daylight, when returning from Galway. While referring to this species I may be allowed to anticipate, and just mention that, eight days later, I came up from Galway by the night mail for the purpose just stated. The Midland line runs for a great distance parallel with the canal, and on arriving at Maynooth, fifteen miles west of Dublin, I left the train, and set out on foot, following the course of the tow-path. *Equisetum Wilsoni* is even more abundant than the record in "Cybele Hibernica" leads one to expect. I found it in quantity not only east of Clonsilla, as stated in the "Cybele," but also close to Maynooth, and at many points between that station and Clonsilla. It grows in large dark-green masses, much more densely tufted than either *E. palustre* or *E. limosum*, fringing the canal as they do, but readily distinguished, even at a distance, by its darker colour. *E. Wilsoni*

comes very near to *E. trachyodon*: the latter grows in a more scattered way, on wet rocks, never, as far as I have seen, in water, as is the case with its ally.

Connemara is quite easy of access to the tourist; a few hours bring one from Dublin to Galway, and vans leave the latter city twice each day for Clifden, in the heart of the mountains. I took the day-car, and, barring the dust, enjoyed a delightful drive of forty miles, the greater part of which lay over wild, uninhabited moors and beside picturesque mountain-lochs, veritable rock-basins. This region has been so often described that it would be useless to enlarge on it; suffice it to say that it seems the very paradise of the naturalist. Here Nature holds undisputed sway over mountains and lakes that have not been profaned by the improving hand of man; one can label specimens obtained in such a locality without being haunted by any doubt that they may be only "casuals" or "introduced."

Having, on the evening of my arrival, perambulated the boundaries of Clifden, a clean and respectable village for such an out-of-the-way region, I set out next morning to visit Urrisbeg, and fill my vasculum with specimens of the beautiful heath *Erica Mediterranea*. I made an early start, and soon leaving the road, struck out across the moor, or, as they call it here, the mountain. This seems to be in Ireland the usual term for a heath; and I found that I was not understood when I spoke of Urrisbeg as the mountain, but that it was necessary to distinguish it as the hill, and to call the low-lying boggy flat behind it, with its numberless lakelets, the mountain. Urrisbeg, though dignified in books as a mountain, is not entitled to that distinction, being only a hill of 987 feet, that overlooks Roundstone Bay, and dominates the pretty little village of that name. It is one of those hills that, by reason of their isolation, appear much larger than they really are. In the seven or eight hours that I spent there I ascended and descended it many times, and on all sides, poking into nearly every nook, and scaling nearly every crag to be met with. I was, however, disappointed with regard to its botanical riches: as far as the early spring is concerned, it is scarcely worth a visit. *Orchis Morio* was rather plentiful in places, but the plants small. I found also leaves of *Vaccinium vitis-idaea*. *Glyphomitrium Daviesii*, a rather rare moss, occurs on rocks near the summit, but not in such plenty as we find in Antrim. *Erica Mediterranea* was not to be found anywhere, and, after careful search, I could not help feeling considerable doubt as to whether a single scrap of it now remains on the hill. I had consulted all the notices of this heath that I could find, and certainly the impression received from reading these was that the plant grows plentifully on Urrisbeg. That, doubtless, has been the case; but it is certain that it is now nearly, if not altogether, extirpated in that station. Having stayed on the hill until sunset, and then got entangled in a

labyrinth of little lakelets, out of which there seemed to be no outlet. I was delayed until near midnight before reaching the hotel at Clifden. Here I found the people all gone to bed, save the "boots," and I had to retire supperless, a regimen that possibly was healthful, but scarcely agreeable under the circumstances.

Next day I started to visit the Twelve Pins, and took advantage of the van as far as Ballynahineh, from whence I commenced the ascent of Ben Lettery. The Twelve Pins form a magnificent group of mountains, and the climbing is excellent. Bare rocks, as hard and as reliable as a street pavement, give a firm footing; and in scaling the steepest cliffs, one feels that he may trust his life on the smallest surface whereon he can get foothold. During the day, I ascended three of the principal tops, and had I not been occupied with plant-hunting, I could have done the whole dozen before night. A fine stream comes down the west face of Ben Lettery, and has cut a deep gorge, in which plants attain unusual luxuriance. Here, in a sheltered, sunny nook I found one specimen of *Daboecia polifolia* already (May 10) in flower. I also found *Sphagnum rubellum* growing on rocks by the stream, and in abundant fructification thus early: this moss is plentiful in the North of Ireland, but I have never seen it fruiting there. The greatest charm of this mountain is, however, the London Pride (*Saxifraga umbrosa*), which grows in the greatest profusion from the base up, close to the very summit: the form that occurs is the variety *punctata*, and it is especially luxuriant on the banks of the stream, becoming dwarfed on the dry, unsheltered cliffs above. On the summit I found *Armeria maritima*, a dwarf form, and not in flower; *Cochlearia alpina* also occurs, growing on the cairn at the very summit of Lettery. The cryptogamic flora of these mountains seems to be good. I have luxuriant specimens of *Hymenophyllum Wilsoni* in my herbarium, from gorges cut in the cliffs: some of my fronds measure five inches in length. *Hypnum flagellare* occurs in profusion on wet rocks by the stream, but barren; *Entosthodon Templetonii* also occurs, but not plentifully; *Hypnum undulatum* grows magnificently, but immature at that date; *Campylopus atrovirens* was abundant, but not in fruit. I am not familiar with the *Hepatica*, but one fine species that I met with abundantly could not fail to attract attention—namely, *Physiotium cochleariforme*. *Sentniera adunca* was also in great quantity. At the base of the mountain were great plants of the Royal Fern just commencing to throw up their fronds. Here also I met with *Carduus nutans* in flower, but not full-grown.

On the next day I set out on my return, and on the way enjoyed the excitement of a breakdown that threatened to keep us longer in the mountains than we had bargained for. Late in the afternoon I arrived in Galway, and arranged with a Claddagh

fisherman to take me across the bay next morning to Ballyvaughan, in the famous Burren of Clare, which yields more rare plants than can be found in the same area anywhere else in Ireland. Ballyvaughan is the headquarters of the botanist who would do the Burren, and the very comfortable hotel there is kept by a gentleman who is one of the "ould stock" of co. Clare, and who understands the use of the *vasculum*, and takes an interest in directing the visitor to spots where he is likely to meet with rarities to fill it. The rocks here are of carboniferous limestone, and not only very singular, but especially adapted for the growth of many of the species that abound in this region. The limestone is split up by numerous fissures, varying from a few inches to two or three feet in width. These fissures are not filled up to the surface with soil, and plants that cannot endure the full blaze of the sun find needful shade between the vertical walls. The Scaly Hart's-tongue grows in these clefts with a luxuriance beyond anything that I had anticipated, and in enormous profusion. On the afternoon of my arrival I visited Blackhead, on the southern shore of Galway Bay, a singularly terraced hill of 650 feet. On the rocks here *Dryas octopetala* grows in immense quantity; the large cream-coloured flowers are very fine, resembling closely those of *Rosa spinosissima*. The Bear-berry (*A. uva-ursi*) grows here also, and was just in flower at this time. On my second and last day in the Burren I passed again over Blackhead, and proceeded a good distance to the south of it. I found *Helianthemum canum*—three small specimens only; its bright yellow flowers are hard to distinguish from those of *P. tormentilla* as one passes along. After a long and patient search I came upon *Adiantum Capillus-Veneris*, and brought away a few of the roots, the fronds being not yet up. I was almost ashamed of taking the plants, as the Maiden-hair is rapidly becoming more rare. My scruples were, however, allayed on my return to Ballyvaughan. Here I met with a collector, or rather an extirpator, who had come over to gather rare ferns for the English market. Armed with a sledge-hammer, and assisted by a native with a donkey-cart, the coast was scoured and ferns were being lifted by the hundred. The few select specimens which the botanist takes away can have little effect on the life of the species; but such wholesale uprooting for commercial purposes as I witnessed must, in a brief period, doom to extinction any plant which has the misfortune to become fashionable. Why do not fern-cultivators endeavour to raise their plants from spores, instead of banishing the ancient denizens of the country from their native rocks? *Geutiana verna* deserves a passing notice before concluding this narrative: the short pastures and the hillsides were everywhere spangled with the brilliant blue flowers of this lovely plant: on this side of Galway Bay it is one of the commonest species met with.

S. A. STEWART, *Belfast.*

CHAPTERS ON CARBONIFEROUS POLYZOA.

NO. II.

BY G. R. VINE.

IN writing these Papers it will, I hope, be understood that they are to be taken in a popular, rather than in a strictly scientific sense. In the present state of our knowledge of these fossil Polyzoa, we can do no more than classify provisionally. Before long the whole class will have to undergo complete revision. Even now, with the material already in the hands of specialists, it is a great difficulty to completely identify species, either by the figures or the written descriptions of Phillips or M^cCoy. In my first paper I felt that the whole weight of responsibility would have rested upon me had I committed myself to original figures or descriptions. I therefore gave figures from Phillips and Nicholson as the most accessible to me at the time. Since then I have received the kindly

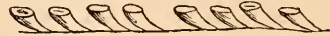

Fig. 138. Cells of *Fenestella*, in section.

'*Fenestella tenuifila* (Phillips).



Fig. 139. Non-poriferous side, slightly rubbed down, to show base of cells.

Fig. 140. Poriferous side. Nat. size $\frac{1}{8}$ of an inch.

advice of Mr. John Young, of the Hunterian Museum, Glasgow, also two papers by him on Carboniferous Polyzoa; and rather than alter what I had previously written, I give this introductory paragraph as a guard, both to myself and to the readers of this journal, that specific distinctions can only be at present provisional. A vast field of inquiry is open for intending students, and if I can influence some few of the many microscopists to turn their attention to this much neglected branch of study, these articles will not have been written in vain.

At the base of that division of the animal kingdom termed MOLLUSCA, the *Polyzoa* are now, by universal consent, most judiciously placed. They thus enjoy with the *Tunicata* a subdivision which is called the MOLLUSCOIDA. "The class of *Polyzoa* is composed of small animals, which always grow together upon a common stock, in the same manner as the compound Polypes, with which they were formerly arranged. Each animal resides in a separate cell, within which it can usually retract itself entirely. The cells are sometimes soft and flexible, sometimes horny, and some-

times calcareous: they frequently stand upon short footstalks rising from a tubular stock, which creeps over the surface of stones and aquatic plants, in the same way as the horny stems of many of the hydroid polypes. In other cases the cells are sessile, forming a crust upon submarine objects, whilst in others the colony is attached only by its base, with the opposite extremity floating freely in the water. In these the stock is more or less branched, and often leaf-like. . . . The cells are generally partially free; but in some of the stony species they form a calcareous mass, presenting some resemblance to true Corals, from which, however, they may always be distinguished by the absence of the calcareous partitions which the latter invariably exhibit.**

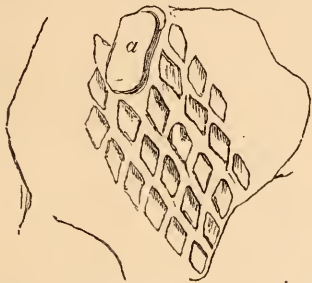

Fig. 141. Cell-structure of *Retepora*, from Coralline Crag, Suffolk. a. fenestrule. Nat. size $\frac{1}{8}$ of inch.

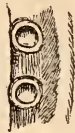

Fig. 142. Two cells of *Fenestella formosa*, highly magnified.

TRIFUGINÆ or TUBULIPORIDÆ group. These are again subdivided into families.

A.—The CELLULINA.

FAMILY I.—CELLARIOIDÆ, of which the genera *Electra*, *Electrina*, *Caberea*, *Reteplectrina* have no known fossil species; *Cauda*, *Cellaria*, *Tubucellaria*, with fossil representatives.

FAMILY II.—ESCHAROIDEA: *Lanceopora*, *Terebriopora*, no fossil species; *Vincularia*, *Eschara*, *Lunulites*, *Retepora*, *Cellepora*, *Vincularina*, *Porina*, *Escharifora*, *Discoporella*, *Steginopora*. Some of the genera in this list have fossil species ranging from the Palæozoic rocks to the present seas, or to the cretaceous formation.

FAMILY III.—FLUSTRINOIDA: *Siphonella*, *Flustrella*, *Flustrina*, all with fossil representatives.

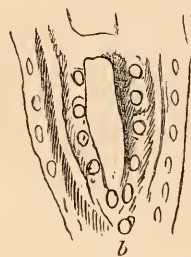

Fig. 143. *F. formosa* (Hurst, Yorkshire), showing fenestrule at bifurcation. Nat. size $\frac{1}{2}$ of inch.



Fig. 144. *Fenestella undulata* (Phillips). Nat. size $\frac{1}{2}$ of inch. Poriferous face, imperfectly rubbed, showing both the inner chamber and also the mouth of cell undulating the margin.

The *Tunicata* have no known fossil representatives, on account, probably, of the absence of those hard parts which were most likely to be preserved; but the Polyzoa have fossil representatives, ranging from the lower Silurian rocks up to the Post-Tertiary, and family connections connecting the living Polyzoa of to-day with families which long ages ago had become extinct.

The ordinary divisions of this important class have reference chiefly to living genera, or to genera which can be traced backward in time, connecting the living with the fossil species. To follow the subject still further backward, it is necessary that we should take in the whole class and allow the old to piece in with the new, and thus form a connected group, whether that group, or portions only of that group, may be designated either fossil or recent. It will be well, therefore, to confine our attention to one arrangement of the Palæontological record, rather than to many; and the student who desires to enlarge his knowledge of the past may very appropriately study the affinities of those genera named in the list which belong to the living Polyzoa of our present seas.

M. Pictet, in his Palæontology, divides the Polyzoa into two groups. One (A) called the CELLULINA or ESCHARIDÆ group; the other (B) called the CEN-

B.—The CENTRIFUGINÆ. (The Cyclostomata of Busk).

FAMILY I.—RADICELLÆ: *Crisea*, *Unicrisia*.

FAMILY II.—OPERCULINÆ: *Nodelea*, and the extinct genera *Melicertites* and *Elea*.

FAMILY III.—TUBULIPORIDÆ: *Fasciculipora*, *Fron dipora*, *Berenicea*, *Idmonea*, *Tubulipora*, *Stomatopora*, *Hornera*, and the extinct genera *Theonoea*, *Fascipora*, *Spiropora* (*Cricopora*), *Diastopora*, *Cavea*, *Ceriopora*, *Heteropora*. To these M. Pictet appends the following extinct genera: *Fenestella*, *Synocladia*, *Glaucanome*, *Ptilodactia*, *Seriatopora*, and *Oldhamia*. Below these, Professor Huxley is of opinion, the family of *Graptolites* ought to be placed.*

In dealing with the Carboniferous Polyzoa, the only genera I shall have to illustrate and describe in the above list are those printed in *italics*. The list will be useful to the scientific student, and those who wish to follow up the study will do well to refer to Mr. Busk's arrangement as given in his "Crag Polyzoa" and museum catalogues.

FENESTELLA.—This genus, as restricted by Lonsdale from Miller's MSS., so far as is yet known

* Jukes's "Manual of Geology," pp. 367-8. I have not mentioned the sub-genera, extinct and living, as given by Jukes.

* W. S. Dallas, F.L.S. "Invertebrated Animals."

began in the Lower Silurian, having but one representative; in the Upper Silurian, six; in the Devonian, five; in the Carboniferous formation, twenty-two, and in the Permian, one. This was previous to the labours of Professor Nicholson on the Palæozoic Palæontology of North America. Since then he has described several species new to the fauna of the Silurian and Devonian era, swelling the list of described species to nearly forty in number—a sufficient evidence that this was the most prevailing genus of the Palæozoic seas. The signification of the term is, a “little window,” and if the reader will bear this interpretation in mind, he will soon get over the difficulty of specific differences. Let us, then, suppose a common window-frame, *minus* the glass. The vertical bars will represent the “interstices,” the horizontal bars the “dissepiments,” and the open spaces where the glass should be, “fenestrules.” The whole expansion is called a *Polyzoary*. Professor Nicholson, in describing species of *Fenestella*, calls the vertical bars “branches,” and wherever the branches separate, like the prongs of a fork, “bifurcations.”

The *Polyzoary* of the *Fenestella* is a calcareous and cellular structure, forming a conical or fan-shape expansion of radiating branches. The external surface of the branches is rounded and covered by a minutely porous layer. The middle portion of the interstices is occupied by a keel (*carina*) separating two rows of mouths or short tubular cells. The non-celluliferous side is formed internally of a layer of vertical hair-like tubes.* Many of the species of *Fenestella* encrusting rocky masses of the Silurian or the Devonian seas are known only by the non-poriferous side, as also many species of the carboniferous limestone. Whenever the celluliferous side is shown, the cell-mouths are either round or slightly oval. In section, the cells may be said to have an outer and an inner chamber, but are really the continuous cell in an oblique line. In the longitudinal section, prepared for microscopic examination, the keel is a thin wall with a sinuous outline, which occupies the whole length of the branch, separating the two rows of pores which run along the border-lines of the fenestrules. Every cell is independent of the other, and the living animal, which at one time occupied the cell, was as distinct in its habitation as are the cyclostomatous *Polyzoa* of the present time. The dissepiments are, apparently, continuations of the border-line of the fenestrules, forming a part of the *canaliculum* only, and are entirely destitute of pores. The exact form of the cell is not peculiar to *Fenestella*, but there is a generic difference in the manner of development of the cell along the whole length of the branches which separate the species of this genera from *Retepora*, although there may be a resemblance in the facial configuration. My experience leads me to believe that true *Retepora* are far from common in

the carboniferous limestone; and to study the affinities of the genera I have had to have recourse to sections of species from the Coralline crag of Suffolk. In *Retepora* the cells are in oblique lines, and the fenestrules, on account of their irregularity, are probably accidental in part, whilst in *Fenestella* the shape of the fenestrule has often been taken as the groundwork of specific distinction. The development of *Fenestella*, as also the development of *Polyzoa* generally, was from the base outwards by means of bifurcations of the branches. In one particular species (*F. formosa*), at every bifurcation of the branch, a cell, larger than the ordinary cells, McCoy says,* is formed in each angle.† In the specimen that I am now describing, from Hurst, in Yorkshire, this angular cell is formed within the immediate angle of bifurcation, having a small tubercle where the branches join. A narrow keeled dissepiment unites the interstices, and above this two cells, the walls of which come close together without any intercellular space, form the real base of the newly-developed fenestrule; above this, four circular cells are formed on each side of the interstices of the fenestrule, about half the cell's diameter apart. This regularity is, in many cases, unerring; but the animals were not always regular in their continuous operation, for at one bifurcation in the same specimen no fenestrule is formed, and the slightly alternate cells are developed in one plane, the interstices of the non-poriferous side being likewise double. I notice another peculiarity in this species, but in another specimen. The first-formed fenestrule above the root is destitute of cells, and the fenestrule above this is destitute of cells on the interstices fully a third of the distance upwards, and the uninterrupted branches are covered with closely-set striae, bending in a spiral round the branch.

Another species of *Fenestella* found at Hurst, in Yorkshire, will answer to the description given of *F. bicellulata*, a new species of *Fenestella* found in fragments only in the Calderwood limestones of Western Scotland. The specimen measures a quarter of an inch by three-sixteenths. The celluliferous, as well as the non-celluliferous aspect, is distinctly visible. In the limits of this space I can count 41 fenestrules, besides several halves. The enlargement of this species is by bifurcations, and the fenestrules on the non-poriferous side are very much like the Devonian species figured in SCIENCE-GOSSIP for May (fig. 101), but considerably smaller, and the branches rounded. The *Polyzoarium* is flattened and expanding. The interstices are straight, carinated (keeled), occasionally bifurcating, and the whole carina is ornamented by prominent pores. There is no regularity in the arrangement of these pores; occasionally one pore is placed at the end of each

* “Carboniferous Fossils.”

† In several specimens that I have in my cabinet the cell of the angle is the same size as the other cells.

* See McCoy's “Carb. Fossils.”

dissepiment and one between, but only occasionally. The dissepiments are thin and sub-opposite. The fenestrules are nearly square, and the margins are slightly indented by the cells. The cells are in alternating rows on the margins of the fenestrules, one placed in each angle formed by the junction of the interstices and dissepiments, and one between; sometimes the cells of the angle are on the dissepiments. A cell *not larger than ordinary cells* is placed on the keel, as well as in the angle of bifurcation. In this description I have adopted all that I could adopt from Mr. Robert Etheridge's description from one of the Appendices of the "Geo. Survey, Scotland" (Sheet 23).

Nearly all the species figured and described by Phillips, in his "Geology of Yorkshire," under the generic term *Retepora*, are now considered to be true *Fenestella*. In *F. membranacea** the interstices are straight, equidistant, with elongated fenestrules, and pores a little oblong, with *thick* dissepiments. In *F. flabellata* the dissepiments are *thin*, and the pores small but prominent. In *F. tenuifila* the dissepiments and interstices are thin, the fenestrules rectangular with small pores with prominent edges. In *F. undulata* the interstices are also thin, fenestrules large and irregular, with large prominent pores. The species figured from Nicholson's † sketch is nearly allied to *F. laxa*, which Phillips describes, from the Carboniferous and Devonian rocks of Great Britain—a proof of the wide geographical range of allied species. The differences in the fenestrules of *F. laxa* are, however, from two to four times larger than those of *F. magnifica*. In the species termed *F. nodulosa* the branching is very peculiar; the fenestrules are comparatively close together, and the pores—generally three in number—undulate the margin, with small pores in the interstices. The interstices of *F. poly-porata* are thick, the fenestrules large and irregular, with numerous small rounded pores. In the Geological Survey of Scotland, several new species are described in the explanatory memoir of sheet 23, but the specimens discovered and described are in a very fragmentary condition. Two of these—*F. bicellulata*, already described, and *F. tuberculo-carinata*—may, says the author, with the discovery of better material, probably rank as distinct species; the fragments are, however, well marked, and distinct from others. In his catalogue of carboniferous fossils, M^cCoy figures ten more species, as found in the British carboniferous rocks. They are *F. carinata*, *crassa*, *ejuncida*, *hemispherica*, *Morrisii*, *multiporata*, *oculata*, *plebeia*, *quadradeimalis*, and *varicososa*. In the Carboniferous Limestone formation of Nova Scotia, *Fenestella plebeia* (M^cCoy) was recognized by Mr. J. Kirkby as common to the Permian and Carboniferous formations of England. Amongst a series of Indian carboniferous

fossils discovered by Dr. A. Fleming, of Edinburgh, and described by Professor de Koninck,* there were three Polyzoa provisionally classed with *Fenestella* and *Retepora*. The first of these, *F. megastoma* (De Kon), has a faint resemblance to *F. crassa* of M^cCoy. "It is composed of rays which are sub-parallel with each other, and the visible surface is garnished with very small longitudinal striæ, similar to those which ornament one of the surfaces of some other species." The non-poriferous side only of this species is known; and, judging from this, the species differs from *F. crassa* by the much more shortened shape of its fenestrules and the distance of its principal branches. There is another *Fenestella* among the Indian fossils which De Koninck names *F. Sykesii*, the figure of which has some resemblance to an Irish specimen in my own cabinet. The Indian "Polyzoa is fan-shaped, irregularly plaited, composed of a number of rays soldered one to the other, the direction of which is indicated solely by the feeble thickening, and especially by the series of small circular openings which border them. The arrangement of the openings demonstrates sufficiently that the rays bifurcated once, or several times, during the development of the polyzoarium, and that this bifurcation is the principal cause of its rapid enlargement. The openings are almost all the same size, and are little more than half a millimetre in diameter. One may generally count seven in the breadth of a centimetre. There is no trace of pores and striæ on the surface of the specimen, although it is perfectly well preserved."† The same description will suit the Irish species from Athlone, with this exception: the polyzoary is much more delicate than the Indian species, and the openings (fenestrules?) count about twelve to the one-eighth of an inch, both ways, and the shape of the openings is hexagonal instead of circular.

One remarkable genus of recent Polyzoa approaches the *Fenestella*, not so much by the development of the cell as by the fenestrate appearance of the polyzoarium. The genus was established by Kirchenpaur, and called *Retihornera*. "The zoarium is foliaceous, composed of sub-parallel branches connected by transverse tubules, so as to form an expanded frond with quadrangular fenestræ." M^cGillivray's species, discovered among the Australian Polyzoa, is placed by Busk among this genus, with the remark that "Herr Kirchenpaur's genus *Retihornera* would, from his descriptions, appear to include some Escharidan or cheilostomatous forms approaching *Retepora*; but amongst them, his *R. dentata* and *plicata* appear without doubt to be cyclostomatous; and I have therefore ventured to appropriate his expressive appellation for the fenestrate forms of *hornera*, not regarding it, however, as impossible that the fossil genus *Fenestella* may have a prior claim after all."‡

* Fig. 89, SCIENCE-GOSSIP, May.

† SCIENCE-GOSSIP, May, p. 109. Figs. 101 and 102. *F. magnifica*, Nicholson.

* *Quarterly Journal of Geo. Soc.*, vol. xix., 1862.

† De Koninck, *ibid.*

‡ Busk's "Mus. Catalogue," Part III., page 20.

I have the fragments of several undescribed species of *Fenestella*, but enough has been said in a popular article to indicate the riches of the Carboniferous formation; and I now desire that local investigators in and around Richmond and Hurst, in Yorkshire, will search for species of *Fenestella*, *Glauconome*, *Cerriopora*, and *Vincularia*, as the riches of this deposit are equalled only by that of Hairmyre, in Scotland.

Attercliffe, Sheffield.

(To be continued.)

sometimes seen in the Hebrides, and believed by the natives to be a distinct species: this was rendered probable by their not associating with the common seals, and not being so wild in their nature. It is thought probable that this small seal may have been *P. hispida*. I have more than once heard of small dark-coloured seals having been seen on the Norfolk and Lincolnshire coast, or exhibited in the towns, which it is quite possible also may have belonged to this species. That it inhabited the coast of Scotland in the past, there is evidence in the abundance of the

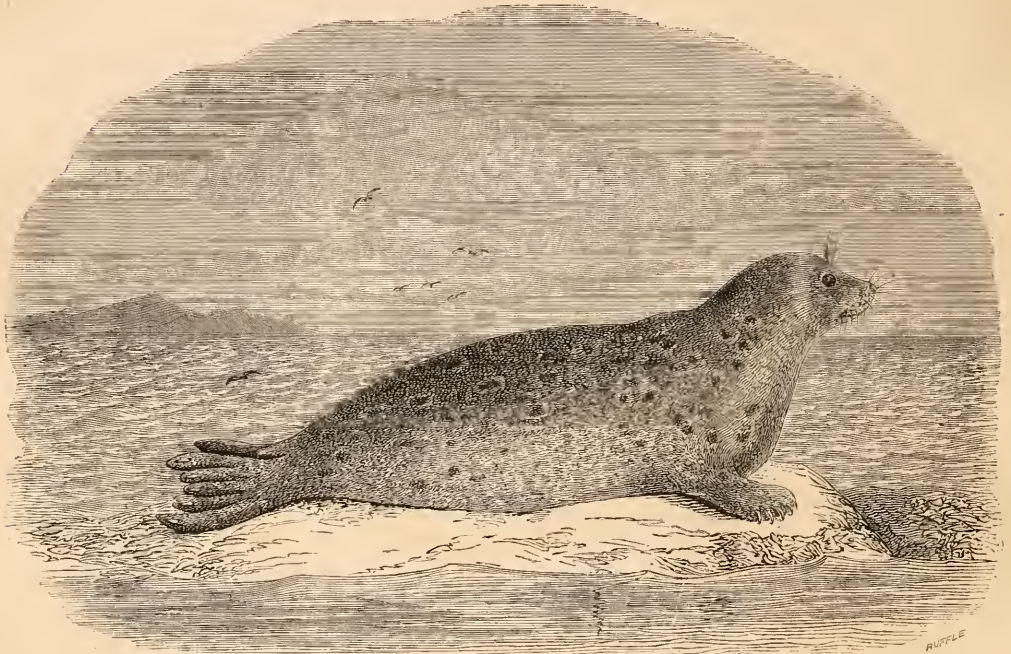

Fig. 145. Ringed or Marbled Seal (*Phoca hispida*, Schreber).

ON THE SEALS AND WHALES OF THE BRITISH SEAS.

No. II.

BY THOMAS SOUTHWELL, F.Z.S.,

Hon. Secretary to the Norfolk and Norwich Naturalists' Society.

THE only recorded instance of the occurrence of the RINGED SEAL, *Phoca hispida*, Schreber (fig. 145), on the British coast, is that of an individual captured on the Norfolk coast in June, 1846, and purchased by Mr. J. H. Gurney, in the flesh, in the Norwich fish-market, the skull of which is now in the museum of that city. Although no other instance of its occurrence is on record, it seems not improbable that it may occasionally be met with, and pass unrecognized. In the first volume of the "Magazine of Zoology and Botany," Mr. Wilson, in a paper on the Scottish seals, speaks of a small seal which was

remains of this species found in the glacial clays of that country, as identified by Professor Turner.* At present its home is the high latitudes of the Arctic seas, especially parallels 76 and 77 deg. North. In Davis's Straits it is found all the year round, particularly up the ice-fjords, and many are killed in South Greenland. Mr. Alston informs me, on the authority of Captain Fielden, the naturalist to the expedition, that this was the only species found by the late Arctic expedition north of Cape Union, 82° 15' N. lat. The small seal found in the inland fresh-waters of Lake Baikal is believed to be a variety of this species, differing only in its darker colour; it is also said by Wheelwright ("Scandinavian Fauna"), on what authority I know not, to have been taken in the Channel off the French coast. Dr. Brown, in his paper on the "Greenland Seals" ("Proc. Zool. Soc.," June, 1868),

* *Journal of Anatomy and Physiology*, 1870, p. 260.

gives an interesting account of this species, which, like the preceding, is littoral in its habits, seldom frequenting the open sea, but found generally in the neighbourhood of the coast ice, in retired situations. They are known by the whalers as the "Floe rat," and their food consists of various species of crustacea and small fishes. This is the smallest of the Northern seals, and of very little commercial value: its flesh, however is eaten, and its skin forms the chief material of clothing in Greenland.

In appearance, this species is very like the common seal; but it is darker in colour, more particularly on the back, and the spots in the adult are surrounded

is copied from Karl Thorin's "Grundlinier Zoologiens Studium," p. 53 (Stockholm, 1868).

The claims of the GREENLAND SEAL, *Phoca grœnlandica* (Fab.), to a place in the British Fauna, although long considered highly probable, were not perfectly conclusive until, in January, 1868, they were satisfactorily established by the production of the animal itself. A seal, recorded as belonging to this species, was killed on the above date near the viaduct on the Lancaster and Ulverstone Railway, and is now preserved in the Kendal Museum. Professor Turner ("Journal of Anatomy and Physiology," vol. ix. p. 163) says that he has himself examined this specimen, and



Fig. 146. Greenland Seal (*Phoca grœnlandica*, Fab.), Adult and Immature.

by oval-shaped whitish rings; the young ones are lighter in colour. The old male is said to emit a most disgusting smell: hence one of its specific names, "fœtida." The molar teeth are arranged in a straight line along the jaws, and not obliquely, as in the common species. As this seal is very likely to pass unnoticed, should it occur on our coast, it will be well to bear in mind that the arrangement of the molars will at once distinguish it from *P. vitulina*, the only species with which it is likely to be confounded. Professor Flower has given a minute description of the skull of the Norfolk specimen in the "Proc. Zool. Soc." for 1871, pp. 506-12. The figure of this species

found the dentition exactly to agree with that of the skulls of the Greenland seals with which he compared it. The individual in question, a male, measured six feet from the tip of the nose to the "point of the hind toes," and the colour indicated the age to be about three years. Previously to this, the claims of this species to a place in our list rested principally upon the skulls of two seals killed in the Severn, and exhibited by Dr. Reilly at the meeting of the British Association at Bristol in 1836. These skulls were at first referred by Professor Nilsson to *P. hispida*, but afterwards, both by that gentleman and Professor Bell, determined to belong to *P. grœnlandica*.

Doubts having been thrown on the accuracy of this decision, Professor Bell, in the second edition of his "British Quadrupeds," p. 253, again states his belief that he was correct in assigning the skulls to the young of this species. These skulls are unfortunately lost. Several supposed cases of the occurrence of this species are recorded, but in no instance were they supported by the production of the animal itself. Dr. Saxby ("Zool.," 1864) says that this species is not rare in bad weather in the Voc of Baltasound, Shetland; and Mr. H. Evans, of Darnley Abbey, Derbyshire, in the year 1856, shot what he believes to have been a Greenland Seal near Roundstone, county Galway,—“Unfortunately, the animal sank and was lost; but Mr. Evans, who is well acquainted with the common and grey species, is perfectly certain that it was quite different from either” (Bell, 2 edit., p. 254). Perhaps the best-authenticated case of the supposed occurrence of this species on our shores is given by Mr. H. D. Graham in Part I., vol. i. of the "Proceedings of the Nat. Hist. Society of Glasgow," p. 53 (Feb. 24, 1863). Three large white seals were seen by Mr. Graham in Loch Tabert, Jura, Western Isles, lying on some shelving rocks, about 300 or 400 yards from the shore. They were watched through an excellent deer-stalking telescope for three hours, and Mr. Graham states that the characteristic markings of the Harp Seal could be distinctly seen. He also believes that, in three authentic instances, captures of *white* seals, of extraordinary size, had been made, and states some particulars of the habits and appearance of these animals, as communicated to him by the islanders—to whom they appear to have been well known,—which render it highly probable that they belonged to this species. Although essentially an Arctic species, this animal has a very wide geographical range, which, added to its migratory habits, renders it not at all improbable that individuals occasionally wander to our shores. It is a native of the Arctic Ocean, and ranges from the N.E. coast of America to the Kara Sea (where it was found by the Swedish Arctic Expedition in 1875), changing its quarters according to season.* It is this species which constitutes the chief object of pursuit in the northern seal fishery, and the season chosen for the attack is when they visit the ice for the purpose of producing their young ones. Dr. Brown says, "They take to the ice, to bring forth their young, generally between the middle of March and the middle of April, according to the state of the season, &c., the most common time being about the end of March. At this time they can be seen literally covering the frozen waste, with the aid of a telescope, from the 'crow's-nest,' at the main royal mast-head, and have on such occasions been calculated to number upwards

of half a million of males and females."* The young, when born, are pure white, which changes to a yellow tint. At about 14 days old they begin to take to the water, and at the age of a month are capable of taking care of themselves: they then assume a spotted coat, which changes gradually to the adult markings, which are perfected in about three years. The adult male is about five feet long, the body generally of a tawny grey, varying to nearly white, marked with a conspicuous band of dark brown or black spots running into each other, which, commencing on the upper part of the back between the shoulders and curving downwards, is continued along the sides, disappearing before it reaches the hind flippers. The under parts are a dingy white, and the muzzle nearly black. The female, according to Dr. Brown, rarely reaches five feet in length, and is a dull white or yellowish straw-colour, tawny on the back, and with similar markings to the male, but somewhat lighter. Some are bluish or dark grey on the back, with "oval markings of a dark colour apparently impressed on a yellowish or reddish-brown ground": these, Dr. Brown believes to be young females. The adult Greenland Seal is readily recognized, but it varies so greatly in its different stages, and individuals differ so much from each other, that the most reliable characters are to be found in the dentition and the structure of the skull, which should in all cases be preserved, as affording the most ready and reliable means of determining the species of doubtful individuals. As has been before said, the second toe of the fore flipper is the longest in this species.

HOW TO CLEAN FOSSIL POLYZOA.

IN the June number your correspondent "G. A. L.," in a note, "How to clean Fossil Polyzoa," has called the attention of your readers to a method I have adopted for exposing the poriferous face of fronds of polyzoa that may be adhering by that face to the stone. Perhaps you will allow me space to explain the *modus operandi* to your readers more fully than he has done? In the first place, I may state, that it is only those specimens of polyzoa imbedded in shales that yield readily to the disintegrating influence of the weather, which can be treated successfully by the asphalt process. Very little can be done by this method with specimens imbedded in hard calcareous shales or limestones. After selecting the specimens of polyzoa that are to be operated upon, it is best to let them be well dried at a fire, or in the sun's rays for a few days, to get quit of the moisture, before applying the layer of melted asphalt to the surface of the fronds, as I find, by so doing, the asphalt adheres more firmly than when the specimens are damp. I also heat the specimens for a short time

* *Ph. groenlandica* was the only seal met with by the Austrian Arctic Expedition, in the *Tegethoff* in August, 1873, the ship then drifting in the ice in lat. 79° 31', long. 61° 43'. Subsequently, both this species and *Ph. barbata* were met with about North lat. 81°.

* "Seals of Greenland." Reprinted in "Manual and Instructions for the Arctic Expedition, 1875," p. 47.

at the fire before applying the asphalt, so as to make it bite the fronds of the polyzoa more keenly. Never let gum or any other mucilage touch the fronds that are to be treated by the asphalt process, as these interfere with the adherence very much. The asphalt I use is the common sort, free from sand, employed in the construction of pavements for our streets. When a specimen of polyzoa is wished to be operated upon, let it be heated as above directed, then lay it down flat, and with a piece of iron heated nearly to redness (the kitchen poker does very well), melt a layer of the asphalt over the surface of the frond, spreading it evenly with the iron. Let there be a bit of tough brown paper ready beside you to cover the surface of the asphalt, and while it is still hot, press the paper down over the surface evenly with the fingers. The layer of tough paper strengthens the asphalt very much, and afterwards, when the specimen is finished, the paper adheres more firmly to the tablet on which it is mounted than when the asphalt is used alone. When I lift large fronds of polyzoa from the shale, I use, first a layer of the asphalt; next, a layer of paper; then a second layer of asphalt and paper. This method forms a firm thin cake, which, in large specimens, is less liable to break across. The next operation, after fixing the asphalt to the fronds of the polyzoa, is to place the specimens in water, and let them lie until the shale softens. The length of time this requires varies according to the nature of the shale. In some cases the polyzoa parts from the shale in a few minutes, in others it may take as long as an hour or two, or even a day; but the process may be hastened by placing the specimens in a saucer filled with water, and as the shale is softened keep picking it away with a thin sharp knife until you see the fronds of the polyzoa appearing; then with a worn nail- or tooth-brush mash the surfaces of the specimens until you consider you have got them quite clean, and the cell-pores well exposed. If the fronds of the polyzoa have been well fixed to the asphalt, you may use the greatest freedom in the mashing of the specimens without fear of their removal by the brush. My collection contains a large series of beautiful specimens that I have treated according to the above method, and I find no difficulty in lifting the largest fronds of *Fenestella* and other fenestrate genera of polyzoa that are preserved in our shales, so as to show their poriferous face. Lately I have managed to show by the same process the poriferous face of some of the feathery fronds of the more delicate branching *Glauconome* with perfect success. The last thing I have to note regarding this process is, that the surplus asphalt and paper can easily be neatly cut away from around the fronds by using a pair of sharp scissors. For cleaning small specimens of polyzoa that are intended for microscopic examination, I use the following method. After having picked the specimens out from amongst the weathered limestone shales, where they often have a thin layer of clay adhering

to them, I take a glass slide and cover it with a layer of thin gum. I then, with the forceps, lift all the fragments of polyzoa that I wish to clean, and place them on the slide with the poriferous face uppermost, afterwards allowing the slide to dry slowly for a day or two. When the gum is quite hard, place the slide in a saucer of water, and brush the specimens gently and quickly with a nail- or tooth-brush. The gum will hold the fragments of polyzoa firmly and safely in position, quite long enough before dissolving, so as to allow of the specimens being well cleaned. When this is done, allow the slide to lie in the water until all the specimens are melted off from the surface: they can afterwards be collected with a soft hair-pencil, and dried on blotting-paper, when they are then quite ready for mounting. By this method, the appearance of the polyzoa is very much improved, and the cell-pores much more satisfactorily examined.

JOHN YOUNG.

Hunterian Museum, University of Glasgow.

MICROSCOPY.

THE QUEKETT MICROSCOPICAL CLUB.—We have received No. 32 of the Journal of this energetic and popular society, published by Hardwicke & Bogue, 192, Piccadilly. It contains well-illustrated papers, by W. K. Bridgman, on the "Principles of Illumination in connection with Polarization"; by Prof. H. L. Smith, "On a New Method of Mounting Microscopic Objects"; by Dr. Francis E. Hoggan, "On a New Process of Histological Staining"; and by James Fullagar, on "*Tubicolaria Najas*." In addition to the above, we have also the Annual Address of the President, Dr. John Mathews.

MOUNTING IN DAMAR.—I am glad to see by the SCIENCE-GOSSIP for May, that some one as well as myself has used heat in the process of mounting in damar, and I hope with as satisfactory results as I have obtained. I observe in "J. A. Le M. H.'s" article on the subject that he asks two questions which I trust I can answer to his satisfaction. 1st. "How air-bubbles are to be prevented from forming within an object when upon a hot slide without any medium?" When air is heated it is rarefied; therefore there would be less air between the slide and the glass cover, when SLIGHTLY heated than when quite cold. The only reason I have for heating it first is, that it facilitates the damar running in by capillary attraction, which, as it ran in, would drive out what air there was. Of course I do not heat the object long enough to dry up the turpentine or benzole in which it had previously been soaked. The only time I have any trouble with air-bubbles is when, by accident, I heat the medium to boiling pitch; which I now avoid by the following slight alteration of my process. Instead of having the flame of the spirit-lamp about two inches below

the metal plate, I place it from five to six inches below; and instead of heating the slide from ten to fifteen minutes, I heat it for about an hour. The result is precisely the same by either process; the only advantage of the longer being, that it does not require so close watching, as the heat is not so fierce, the damar does not boil, and therefore no air-bubbles form; besides which, one can work at something else whilst the slide is being heated. I have tried Mr. Williams's mode of DROPPING the damar on the object previous to placing the glass cover on it, with good result; a few bubbles accumulating occasionally, which, however, the heat has expelled. The way to ascertain when it has been heated long enough, is to dip the point of a pin into any superfluous damar that may have collected round the edge of the cover: if it forms a HARD globule—not in the SLIGHTEST degree sticky—on the point, when cold, you can remove the lamp and finish off. The second question is, "Does not Japan varnish ever run into the damar when there is no other varnish between?" Ever since I have used Japan, which has been for a considerable time, only once I have found it run in; and that was because I had not heated the damar enough for it to get hard. I find it very TOUGH and trustworthy, and prefer it to asphalt, being easier to work with. Of course, if made very liquid with turps, it would have a tendency to run in, as turps dissolves damar; but not otherwise; at least, I don't think so. If "J. A. Le M. H." will send me his address, I shall be most happy to send him a slide so finished.—E. B. L. Brayley, Bristol.

SPONTANEOUS GENERATION.—Professor Tyndall, in a paper read at a recent meeting of the Royal Society, showed that repeated heatings for a short time destroy the living germs from which infectious growths proceed, much more effectually than any continuous heating for a long time, even though that time should be much longer than all the shorter periods added together. His view is that living germs exist in all stages of growth, in some of which they are hard and insensible to heat, in others plastic and instantaneously destroyed by heat, and he thinks that by repeating the heating process very often, the heat catches the different germs in all their stages, while if one heating takes place, even though it last for many hours, some of the germs may live through it, owing to their not having reached the age of development in which they are destroyed by heat. Another way of destroying the vitality of these germs is to deprive them completely of air by the use of the Sprengel pump, after five or six hours' exposure to which they will be rendered permanently barren. Dr. Bastian may find that this discovery of Professor Tyndall's accounts for some of the seeming successes which he has achieved in producing life out of tubes previously raised to a very high temperature, and sustained at that temperature for many hours.

CEMENT.—Some of your correspondents have been asking for a good cement. I can strongly recommend the white cement sold by Mr. White, of Litcham, Norwich. If put on as a thin layer first, and this allowed to dry, there is no fear of running in, even with quite soft balsam or damar; in fact, I have been in the habit of putting the white ring round at once. The white cement dries very rapidly, and especially if the turn-table is twisted quickly for a few minutes. If there seems to be any danger of running in, I put some shellac and castor oil cement round first.—Fred. Ahn, M.D.

DRY MOUNTING.—I would like to draw the attention of those readers who are in want of a good method for mounting objects dry, with asphalt cells, to a method I found out some time ago, and which I have since used with complete success. The methods to be found in text-books, at present, are briefly as follows:—1. Make a ring, dry it, warm over a lamp until slightly soft, and having placed the object in position, adjust the cover. 2. The former method is sometimes varied by making two rings; the second after the first has dried. 3. Narrow rings of paper are introduced between the ring and cover, and a few other modifications of these processes. The whole of the foregoing methods are liable to the objection that the medium employed for making the cell, asphalt and rubber, or whatever else it may be, runs in by capillary attraction, and either spoils the object or renders the slide unsightly. Of the above-mentioned methods, I decidedly prefer the first one, but I could not depend on it six times out of ten, and have many a time spoiled both slide and temper. Most microscopists seem to have battled against the material "running in," a propensity which I have, to some degree, taken advantage of. Take a slide, and with the turn-table make two narrow concentric rings of asphalt-and-rubber varnish, the inner one-half, and the outer seven-eighths of an inch in diameter, and fill up the space between the two with varnish, so as to make a thin cell of varnish, with an interior a half-inch in diameter. Dry the slide in an oven, slightly warmed, and when quite dry, make a narrow ring of varnish on the extreme outer edge of the cell, and having placed the object in position, or, according to circumstances, before the first ring was made, adjust a cover, pressing it down slightly. The varnish is generally only flattened out, and only occasionally spreads to the edge of the cell encircling the object. The reason for its not "running in," is simply because very little capillary attraction is offered to the film of varnish by the dry cell and cover, compared with the capillary attraction offered to varnish by two plain surfaces of glass, as is the case when the old methods are employed. When the cover has become fixed, the slide should be finished by making a ring on the cover, corresponding with the cell beneath. My experience

with this method relates to diatoms and chemical salts, and I have succeeded so well that I have not yet spoiled a single slide—and I have mounted many—even including those used in performing the test experiments. In mounting chemical salts, care must be taken that the level of the ring is above that of the object.—*W. M. Paterson, Loftus.*

ZOOLOGY.

ELEMENTARY ZOOLOGY.—Messrs. W. & R. Chambers have just issued a capital little manual of "Elementary Zoology," written by Dr. Andrew Wilson. This little book certainly meets a want long felt by intending students, in giving outlines of the comparative anatomy and physiology of the leading types of animals, as well as of their morphology. The manual is profusely illustrated, and is furnished with a good list of questions turning upon the subjects taught. It cannot fail to be useful in schools.

SCIENCE IN THE PROVINCES.—We have received the third part of the second volume of the "Transactions of the Norfolk and Norwich Naturalists' Society," just presented to the members. As is well known, this society is one of the most vigorous in the prosecution of local natural history in Great Britain. The present part contains a short but comprehensive and remarkably clear address by the President, Mr. T. G. Bayfield. It contains papers on "The Diatomaceæ of Norfolk," by Mr. Fred. Kitton; on the "Naturalization of the Edible Frog in Norfolk," by Professor Newton; on "Aculeate Hymenoptera," by Mr. J. B. Bridgman; "Ornithological Notes," by Mr. H. Stevenson; on "The Polish Swan," by the hon. sec., Mr. T. Southwell; and a paper by Mr. Randall Johnson, giving an approximate list of the extinct mammalia of Norfolk.

VITALITY OF GASTEROPODA.—Most naturalists are acquainted with the instance, cited by Dr. S. P. Woodward, of extraordinary vitality in a *Helix desertorum*, which was found alive after having been fixed on a board four years all but eighteen days. Mr. Stearns states, in the *American Naturalist*, that he kept in a box, from March, 1873, to June, 1875, nine individuals of *Bulimus pallidior* (Sow.), received from Lower California, and at the end of that time they were all still alive. A little later, they all died but one. A *Helix Vatchii*, of Cerro Island, lived about six years (1859–1865) without food. Mr. Stearns calls attention to the fact that the three species of *Helix* and *Bulimus* known for this extraordinary vitality, belong to arid regions almost without rain. The vegetation is thus very limited, and the animals are compelled to make prolonged fasts.

SPAWN OF NEWT.—The question as to the manner in which the Newt deposits its spawn has been the

source of continued discussion among correspondents of SCIENCE-GOSSIP. I think all differences of opinion may be terminated by the following notes, taken from observing the habits of about a dozen fine specimens of the Crested Newt (*Triton cristatus*). (The largest newt measured eight inches long.) I observed the newts laid their eggs and hid them in the four following ways:—(1) Amongst the moss on a rock projecting out of the water: the eggs were inclosed in a transparent gelatinous bag: about six or eight eggs were usually the contents of one of these envelopes. (2) Singly amongst the same moss as No. 1. (3) In small clusters on the under side of, and rolled up in, the oval leaves of a water-plant. (4) Singly, and rolled up in a similar way to No. 3. It may be noticed that, in the first two ways, the eggs were not rolled up, as is the supposed manner in which all newts conceal their eggs.—*G. W. C.*

"EDUSA" AND "HYALE."—I think it worthy of note that on Monday last, 4th inst., while walking in Hampton Court Palace-gardens, a fine *Edusa* flew past me, and scarcely had I gone twelve steps further when a *Hyale* also did the same. What is the meaning of this very early appearance of these two insects?—*Windsor Hambrough.*

METROPOLITAN ENTOMOLOGY.—Having last year made Warm-lane, Cricklewood, my collecting-ground, I have this year tried another locality, viz., a lane on the west side of Bishops-wood, Highgate. On June 1, 1877, being then on the look-out for *Cardamines*, I captured *G. Rhamni*, and saw a specimen of *C. Edusa*, which, after a desperate run of 200 yards, I missed. On June 4th, 1877, I again frequented the lane, and this time I was fortunate enough to capture a female hibernated specimen of *C. Edusa*. Again this morning (June 7th), I captured a remarkably fresh specimen of *C. Edusa* (male), and chased another half over the Vale of Health, Hampstead. I can find no record of such captures in any work on Entomology.—*R. T. Gibbons.*

BOTANY.

FLOWERS IN NEW ZEALAND.—The wild flowers of New Zealand are neither numerous nor generally very beautiful. In the early spring festoons of *Clematis indivisa* hang on the shrubs in the skirts of the great forests, and warn the native gardener to prepare for the duties of the coming year. Then *Sophora grandiflora*, a shrub-tree, and almost the only one that sheds its leaves in winter, puts forth its clusters of large papilionaceous blossoms, reminding the colonist, by their yellow colour, of the wild daffodil of the early British spring. *Dysoxylum spectabile*, a tree whose leaves resemble those of the Lilac, its timber Pencil Cedar, and its fruit the Chestnut, now also hangs out its sprays of white bell-flowers from

shoots proceeding from the bark of mature limbs, and not from the terminal branches. As the spring advances, *Aristotelea racemosa*, a shrub bearing a strong resemblance to the American blossoming currant, is in bloom in the forest clearings. Towards Christmas the woods are in their glory; then the grand *Rata Metrosideros robusta* is suffused with a rosy blush, by reason of its multitudinous crimson myrtle blooms peeping out among its green leaves all over its great crown; the curious flowers of *Astelia* hang delicately out between the stout grassy leaves of epiphytes, perched high up on the branches of the great trees; then both white and crimson myrtle blooms hang from creepers running like the shrouds of a vessel up the trunks of the giants of the forest; then sweet-scented dendrobiums hang pendent from many a stem, mingling their yellowish blossoms with silky and transparent fronds of *Trichomanes* and *Hymenophyllum*; then the native Screw-pine, bound like ivy with a network of rootlets to some supporting stem, expands in the midst of its sedge-like leaves its curious spadices and its white sugary spathaceous bracts, sought after by natives and schoolboys as a delicacy; then, too, *Wenmannia racemosa* is gay with a profusion of racemes, of white veronica-like blossoms; then on the edges of precipices *Rhabdothamnus Solandri* displays its orange-coloured bells, and *Knighlia excelsa*, a tree whose timber presents a curious interwoven appearance, bears its honeysuckle blossoms. On the mountains, at this season, *Ranunculus nivicola*, a robust buttercup, reminds the mountain shepherd of his native fields; and on the volcanic peaks, just beneath the snow-line, may now be found, in full bloom, dwarf veronicas, *Senecio elegnifolia*, *Claytonia*, *Forstera*, *Gaultheria*, *Selmesia*, *Ozothamnus*, and other interesting plants. On the sea cliffs to the north, *Metrosideros tomentosa* puts forth its really splendid cymes of crimson myrtle blooms, and a beautiful crimson veronica, with a large dark green glossy leaf, may be found in the same locality. There is a great dearth of herbaceous flowering plants here: the Buttercup, a white linum, Ouresia, a feeble violet, and daisy, with a small pale mesembryanthemum, being nearly all that we possess. Strangers, however, from almost every clime are stealing in upon and amidst the native plants. The Purple Foxglove of Britain, and the white species from the Canaries, now grow by the sides of the forest roads; while thistles, hawkweeds, daisies, and buttercups are everywhere. In our gardens *Agave Americana* is quite at home; variegated and other yuccas send up pillars of tulip-shaped blossoms; camellias, six or seven feet high, bear profusion of delicate blooms, and rhododendrons open their great cups, shedding rich fragrance around. Near to the sea geraniums and pelargoniums blossom all the winter. Indeed, a bouquet may be gathered in North New Zealand any day in the year, both in the forests and in the gardens—*B. Wells*, *Taranaki*, *New Zealand*.

FLORA OF CUMBERLAND AND WESTMORELAND.

—I beg to inform your correspondent "S. C. L." in SCIENCE-GOSSIP for May, that there is no published completed "Flora" of either Cumberland or Westmoreland. One was projected for these two counties about three or four years ago by a society in Kendal, but to the regret of many it was never completed. There are lists of plants in several local guidebooks, but often imperfect and untrustworthy. Dr. Trimmen, in "Journal of Botany" for June, 1874, enumerates a great variety of these lists, contributions, remarks, and such-like. He says the list in Mrs. Lynn Linton's book is the best. From a manuscript "Flora of Cumberland" which I possess, from a London catalogue, marked to show Cumberland flowers, by Mr. H. C. Watson, from lists contributed by botanical friends, and other sources, I conclude that a Flora of Cumberland should comprise at least 875 flowering plants. We have great diversity of elevation and soil, from the top of Scawfell Pike, 3,210 feet, to the level of the sea. And the sandy sea-banks, the morasses, the debris covering the red sandstones, the coal-measures, the mountain limestone, and the different clay-slates—not to speak of the plutonic rocks—form a suitable habitat for many classes of plants. Cumberland can boast of having produced one plant which, as regards England, is unique,—*Lychnis alpina*, and also that still greater rarity, *Alchemilla conjuncta*; concerning which Dr. Syme doubts whether it has ever been found truly wild in Britain or not.—*R. W.*

ANEMONE CLUSTER-CUP.—I lately found near Windermere the Anemone Cluster-cup (*Acidium leucospermum*) on the petals and along the stalk of the flower. This, I think, is a most unusual case, for amongst many thousands of specimens I have found, I never before met with such a circumstance.—*Thos. Brittain*.

TERATOLOGY AMONG THE CRUCIFERÆ.—Among plants that bear flowers in racemes or spikes, I know of none in which the characters of indefinite inflorescence appear more constant than in the Cruciferæ, of which I have been so confident as to think it as likely that water would run up hill as that any cruciferous plant would produce a flower on the top of a branching stalk. This year, however, I am sorely tempted to cast away my confidence in the fidelity of any plants to such a law. For I have in my garden a stock raised from seed sown in 1875, which has flowered for the first time in the present spring, and is covered with purple blossoms. On one of its branches there are three flowers, one at its extremity and the other two at its sides. The flower at the extremity was the first to open, the lateral flowers afterwards. This abnormally terminal flower is evidently double, in the sense of being formed of two united, so that it might be thought that they were only lateral flowers coherent; but in that case I

cannot understand this uppermost flower expanding before those below it, as if it were really terminal. For a flower-stalk of a perennial stock to bear two flowers instead of one does not seem very unusual, but for the same stalk to have lateral flowers below, which do not expand until after those at the top, seems to me so unprecedented that, if I am mistaken in considering it remarkable, I would rather expose my ignorance to your readers than lose an opportunity of having it removed by reading of any similar phenomenon, if such has been observed.--*John Gibbs, Essex and Chelmsford Museum.*

CLAYTONIA PERFOLIATA.—This plant is well established on the border of Epping Forest, near Walthamstow. From its position by the side of a ditch and outside a fence, it is probably an outcast. It is now (June 2) blooming and shedding its beautiful black seeds freely along a strip of ground some twenty yards in length, where it is successfully struggling for life with chickweed, dock, and other common plants. From its succulence it dries slowly, but when mounted makes a nice addition to the herbarium.—*J. T. Powell.*

GEOLOGY.

THE WINDS, &c.—Mr. William Leighton Jordan, F.R.G.S., has written a well got-up *brochure* which cannot fail to interest all geologists and others concerned in the study of physical geography. It is entitled "The Winds, and their Story of the World," and is published by Hardwicke & Bogue, 192, Piccadilly.

THE BONE-CAVES OF CRESSWELL CRAGS.—The Rev. J. M. Mello, F.G.S., has read another paper on this subject before the Geological Society. The author gave an account of the continued exploration of these caves, and of the completion of the examination of the Robin Hood Cave. Five deposits could be distinguished in the Robin Hood Cave. Variations both in thickness and in character occur in different parts of the cave. The surface-soil yielded traces of Romano-British occupation, such as enamelled bronze fibule, fragments of pottery, &c. The most important discoveries were made in the cave-earth, and chief among these was a fragment of bone, having on it a well-executed outline of the head and neck of a horse, the first recorded discovery of any such work of art in this country. The cave-earth also yielded a canine of *Machairodus latidens*, hitherto obtained in England only in Kent's Hole. Numerous remains of the Pleistocene mammalia already recorded were found, together with a great number of implements of quartzite and flints, and two of clay ironstone. The quartzite implements were most abundant in the lowest bed. In the other cave examined, the Church Hole, which consists principally

of a long fissure in the south side of the crags opposite Robin Hood's Cave, the succession of beds was nearly the same as in the latter. In the surface-soil near its mouth a fine bronze brooch was found. Some of the implements met with in the cave-earth were of great interest, and several of them were of bone. Bones of rhinoceros were found in great abundance; and those of the Mammoth, Horse, &c., were also plentiful. As the result of the exploration of these caverns, the author said it is evident that during the Pleistocene period Derbyshire and the adjoining counties were inhabited by a very numerous and diversified fauna, the vast forests and pastures, which extended far to the east and south, offering a congenial home to the Mammoth, the Woolly Rhinoceros, the Hippopotamus, the Irish Elk, the Reindeer, the Bison, and the Horse; whilst among them the Hyæna, the Glutton, the Bear, the Lion, the Wolf, the Fox, and the great sabre-toothed *Machairodus* roamed in search of prey; and that with these and other animals man lived and waged a more or less precarious struggle, amidst the vicissitudes of a varying climate, sheltering himself in the numerous caves of the district, which were already the haunts of the Hyæna and its companions. After Mr. Mello had concluded, Professor W. Boyd Dawkins followed with a paper on the "Mammal Fauna" of the same cave. In this paper the author gave an account of the remains found in the caves explored by the Rev. J. M. Mello. He stated that the recent explorations had proved that the Robin Hood Cave was inhabited by hyænas, not only during the deposition of the cave-earth and breccia, but also during that of the red-sand clay underlying it, which had also furnished traces of the existence of man. An immense number of specimens were collected in this cavern, including bones of the following animals:—*Machairodus latidens*, Cave Lion, Wild Cat, Leopard, Spotted Hyæna*, Fox*, Wolf, Bear, Reindeer*, Irish Elk*, Bison*, Horse*, Woolly Rhinoceros*, Mammoth*, and Hare*; those marked with an * occurring in the red sand and clay as well as in the cave-earth, although much more sparingly. The traces of man consisted of more than 1,000 implements; and, as before, those made of quartzite were generally found in the lower strata. The most important indication of human handiwork was the outline of the head and fore quarters of a horse, engraved upon a fragment of the rib of some animal. Among the animal remains the most interesting discovery was that of a canine of *Machairodus latidens*; it consisted of the sabre-shaped crown only, which appeared to have been purposely broken away from the root. The superficial layer of earth in the cave contained remains belonging to the historic and prehistoric ages, including a Romano-British enamelled bronze brooch, of the same pattern as one found in the Victoria Cave; fragments of pottery, human bones and teeth, and bones of both wild and domestic

animals. The distribution of the remains found in the Church Hole Cave agreed generally with that above described: traces of human occupation and remains of the Hyæna occurred both in the cave-earth and in the red sand and clay. The bones found indicated the following animals:—Lion, Polecat, Hyæna, Fox, Wolf, Bear, Reindeer, Irish Elk, Bison, Horse, Woolly Rhinoceros, Mammoth, and Hare—all common to both the cave-deposits, except the Lion, which was found only in the cave-earth, and the Polecat, of which a single jaw occurred in the red sand. The latter contained a larger proportion of the remains than in the Robin Hood Cave, but, as in the latter, the quartzite implements were more abundant in the lower strata of the deposits. Among the articles of human workmanship was a perfect and well-shaped bone needle. The superficial soil of the Church Hole Cave also contained articles of the historic and prehistoric age, including a bronze fibula, fragments of pottery (one mediæval), and bones of man and animals. From the presence of these objects in the surface-soil the author inferred that the caves of Cresswell Crags, like those of Yorkshire and elsewhere, were used as 'places of refuge by the British during the conquest of the country by the English. After noticing the conditions of the fossil bones found in the caves, the author proceeded to remark upon the general results of the explorations with regard to their Pleistocene fauna, and concluded that there is no evidence from these or other caves in this country to prove that their faunas are either pre- or interglacial, and that we have no proof of the existence of pre- or interglacial man in Britain.

NOTES AND QUERIES.

DENSITY OF SEA-WATER.—In the February number of SCIENCE-GOSSIP, H. Macco says, "It is a known fact that all water, fresh or salt, when agitated, requires a lower temperature to freeze than when perfectly still." But is he quite sure of this? The following statement occurs in the article "Ice," in "Chambers's Encyclopædia":—"Water in ordinary cases freezes at the degree of heat marked 32 deg. on Fahrenheit's thermometer, and 0 deg. on Centigrade and Réaumur's, but if it is kept perfectly still, it may be cooled to nearly 22 deg. Fahr. below freezing and still remain liquid. The least shake, however, or the throwing in a solid body, makes a portion of it freeze instantly, and its temperature rises immediately to 32 deg." As this is just the reverse of what Mr. Macco says, it would be interesting to know which is right.—*D. Douglas.*

PRONUNCIATION OF NAMES.—Mr. G. S. Boulger says that he thinks that the "ch" in *Lachenalia*, *Gleichenia*, &c., should be hard, i.e. like k. There is a genus of plants named *Richardsonia*, after Mr. Richardson. Is this then to be pronounced Rikardsonia? If it is not, and the English sound of the "ch" is to be retained in this word, why should not the soft sound of the French "ch" be used in *Lachenalia*,—a genus named after M. de la Chenal?—*E. C.*

ALBINISM IN BIRDS.—I send you the following, hoping it may be of some interest to your readers. Feb. 24. When walking near the edge of the receding floods in this place (Weston, near Bridgwater), I saw a number of starlings, and amongst them a white one. I saw it fly from the ground several times with the others. I was only about sixty yards distant when I first noticed it, so had a good view.—*E. J. King.*

VITALITY IN SEEDS.—The mines of Laurium, which gave rise recently to such lively diplomatic discussion, are generally known to be largely encumbered with scoræ, proceeding from the working of the ancient Greeks, but still containing enough of silon to repay extraction by the improved modern methods. Professor Hendrich relates, that under these scoræ for at least 1500 years, has slept the seed of a poppy of the genus *Glauicum*. After the refuse had been removed to the furnace, from the whole space which they had covered have sprung up and flowered the pretty yellow corollas of this flower, which was unknown to modern science, but described by Pliny and Dioscorides. This flower has disappeared for fifteen to twenty centuries, and its reproduction at this interval is a fact parallel to the fertility of the famous "mummy wheat."—*London Medical Record.*

LINING BUTTERFLY-BOXES.—Some years ago I used some linoleum as a lining for butterfly-boxes, and experience has shown me how good a material it is for this purpose. Cork and oil entering into its composition render it both tenacious of the pin and insect-proof. I lined my box with brown linoleum in March, 1873, and now every specimen is intact, no mites having ever appeared since. The insects show up well on the dark ground, and, as I said before, the pin holds better than in anything I have ever tried. The only objection I have to it, is the increase of weight in travelling. Of course those who object to the colour could cover it with paper.—*A. Hamilton.*

IVY.—The Ivy is always described as having the leaves of the climbing stems angular and lobed, while those of the flowering stems are ovate or lanceolate and entire. I have just gathered a variety from the trunk of a large elm in which the leaves of the flowering stems are *not* entire. On each side of the acuminate point is a sharp lobe pointing forwards, the base of the leaf being sometimes a little rounded, sometimes cuneate. In this variety the leaves of the climbing stems are very deeply divided, very dark in colour, and with whitish veins. On another elm, about twenty yards distant, grew the more common variety with leaves of a paler green, the lobes shorter, broader, and blunter, and those of the flowering branches all entire. I do not remember any British plant in which the leaves vary so much in the same species, and even on the same individual, as the Ivy, unless it be the Hawthorn; but in this case the lobed leaf of the flowering branch is not accidental but quite characteristic. It was so striking that it attracted my attention at once as I walked along by the hedgerow, although the flowering branches were some feet above me, and I had to climb to get one. There are two very small entire leaves just below the umbel of fruit; every other leaf on the branch is lobed. This form may possibly be the origin of the garden variety *digitata*. The tendency to division of the leaf is evidently stronger in this than in the common form, so that its force is not quite exhausted even in the flowering branches.—*F. T. Mott, Leicester.*

THE UN-COMMON NETTLE.—There grows in the Australian bush a nettle-tree which attains the size of

the largest trees seen in England. It has a large round furry leaf; is, as all other Australian trees are, evergreen, but it makes no timber, the trunk being simply a tube filled with pith, and one stroke of the axe will fell a young tree about a foot through. The tree is well known, very common, and carefully guarded against; but if by accident one does happen to touch a leaf, it is an occurrence one does not easily forget. Surveying a line one day through the dense scrub, I happened inadvertently to brush against a young tree, and the leaves just touched the back of my hand. The pain caused was extreme, and extended immediately right up the arm, with a sensation as if the arm were paralyzed, and it was quite useless; and a swelling, the size of an egg, appeared within five minutes exactly under my arm. These symptoms lasted some hours, then a smart tingling was left; but this remained for six weeks, and it was considerably increased by wetting the part with cold water.—*Brisbane.*

PEREGRINE FALCON.—I am not surprised, seeing the initial blunder which I made, that Mr. Dealy does not quite understand the purport of my observations as to the specific value of the so-called *Falco anatum*. If you will kindly allow me a little more of your space, I will briefly reconsider Mr. Dealy's grounds for his conclusions. That gentleman says: "The American bird is an inch or two the longest . . . of a darker shade of colour"; also, "not having skins of the two birds at hand, I am not able to point out the difference which I feel sure exists." I wish I could have the pleasure of showing Mr. Dealy the splendid series of 46 mounted specimens of *Falco peregrinus* which I have to-day examined, and from which I selected five adult males from widely distant localities; viz. Port Kennedy, Greenland, England, Ceylon, and Formosa. I think he would agree with me that it would be impossible, the localities being withheld, to distinguish the North American species from the others, so exactly similar are they in all respects. The same applies to five adult females; one from the Saskatchewan River, Hudson's Bay, New York, England, and Egypt. I hope Mr. Dealy will give me credit for being too old a bird myself to find my comparison on immature specimens; it is between adult birds from the purposely selected far-distant localities, that I can find "no perceptible difference"; that is to say, none greater than there exists between undoubted individuals of any other species. With regard to the habits of the so-called *F. anatum*, Mr. Dealy says, quoting from Wilson, that it "never" carries off the duck on striking it, but permits it to fall previous to securing it. Wilson makes rather a strong assertion when he uses the word "never," as, judging from the difficulty he experienced in procuring a specimen, he probably had no very extensive acquaintance with the bird. Be this as it may, the Duck-hawk has not the habit all to itself, for the Peregrine often does the same; and I repeat, it is a curious circumstance that the Peregrine in Gould's plate should be represented as striking down the bird in precisely what is stated to be the Duck-hawk fashion; showing that the habit is not confined to the latter species, and therefore is of no value as a distinctive character. Mr. Dealy says "the Peregrine never frequents swamps of any description—always rocky ground," and that it "has never been known to construct its nest on a tree of any sort—always on the rocks," whereas the Duck-hawk breeds in swamps on tall trees. In my previous note I gave numerous instances of the European *F. peregrinus* habitually nesting on the ground in swamps in Lapland, Northern Finland, and Livonia. I also gave instances

of its nesting in trees in North Germany "as a rule," and even in a church steeple. The Duck-hawk, therefore, cannot be said to have the exclusive monopoly of trees; consequently, as this habit also is shared by the European race, it cannot be said to be distinctive, unless indeed the North German Falcon be *F. anatum*. Seeing, therefore, that the so-called *F. anatum* differs so little (if at all) in appearance from *F. peregrinus*, and does not appear to have a single habit which is not in a more or less degree shared by the latter species, I for one am content to accept the decision of modern ornithologists, and regard the two races as identical in species.—*T. Southwell.*

ORNITHOLOGICAL ERRORS.—It makes me feel uneasy for the welfare of Ornithology when I see that one author remarks that our Wagtails jerk their tails to arouse the clouds of insects which infest their haunts (by the way, does the sprightly Magpie, or the little Redstart, both veritable tail-jerking birds, perform these motions for the same object?); or that the Robin decorates his nest with a plentiful lining of feathers, and that the feathers from the base of the Rook's bill are rubbed off by frequent collision with the earth; and when I see an ornithologist arguing over the specific distinction of a bird which he has never seen. As to the latter circumstance, I very much doubt if his (Mr. Dealy's) present opinions would have come before the public if he had had access to the recent works on ornithology. He has based his opinions entirely on the writings of authors whose facilities of observation were extremely limited. I hope that, since those volumes were circulated, ornithology has risen to a science which brings her students to nature for knowledge. I hope Mr. Dealy will see these remarks, and kindly give me his opinion on the matter. I hope to prove to him how much better it is to describe birds which we have observed in their native wilds, than to attempt to describe the habits of a bird from the writings of others.—*Charles Dixon, Healey, near Sheffield.*

QUERY ABOUT A FLOWER.—I think the flower referred to by Shelley is the Crown Imperial (*Fritillaria imperialis*). Its nectaries are filled with large drops of liquid, which, from the pendulous habit of the corolla, are scattered either on the earth or leaves when the plant is agitated by the wind.—*G. S.*

QUERY AS TO A FLOWER.—"A. H.," in the May number of SCIENCE-GOSSIP, asks what flower Shelley refers to in lines which are quoted. May it not be the *Arum* that is meant? I have observed a copious exudation of a watery fluid from the tendril-like extremity of the blossom of this plant. I refer to the cultivated variety. Perhaps the wild ones exhibit the same peculiarity, but I have not noticed it.—*W. J. Horn.*

EXUDATION FROM SYCAMORES.—I have frequently noticed, under lime-trees and sycamores especially, that flagstones overshadowed by them have been quite covered with drops of some apparently gummy exudation—I presume from the leaves. I have sometimes thought it might be caused by aphides, but have failed to see any when I have looked. It appears to be more noticeable after some duration of hot weather. Perhaps some correspondent may be able to explain this.—*W. J. Horn.*

ENDIVE.—In connection with the reading of Mr. Glasspoole's interesting paper on "The History of our Salad Herbs," a very interesting remark of

Horace's, in his "Odes," may be new to some of your readers. I allude to the lines,

"Me pascunt olive,
Me cichorea levesque malvæ."

HORACE, l. xxxi. 15, 16.

The word cichorea here may be translated in the name of three herbs; for cichorium, which = κίχῶριον, is either chicory, succory, or endive. It is therefore of some interest to find, in an ode written about B.C. 28, such favourable mention made by the poet to these herbs from a nourishing and supporting ("pascunt") point of view.—*Charles F. W. T. Williams, Relland.*

THE WILD TULIP.—This plant (*Tulipa sylvestris*) is growing in our parish, in the corner of a meadow, a quarter of a mile from any house or road. As it is rare, perhaps you would like to mention it in SCIENCE-GOSSIP. I enclose a specimen, so that you may see it is genuine.—*J. Onions, Dymock, Gloucestershire.*

ALBINO BIRDS.—Seeing in previous numbers of your useful work a list of Birds, White or Cream Colour, I have seen most of those already named, and can vouch for the accuracy of the following:—The Crow (*Corvus corone*). This bird was quite white; its feathers of a much finer texture than other crows I have had. I thought the bird was diseased, as it was very poor.—The Sand Martin (*Hirundo riparia*). This bird is a splendid specimen, beautifully white, and in the possession of a friend of mine.—*G.B.*

BAT (*Vespertilio pipistrellus*).—This specimen was obtained by a keeper from some eaves of a barn on a gentleman's estate in this neighbourhood. Its body was as white as down, and the texture of the wings was beautiful, their transparency giving them a beautiful blush appearance. I could not secure this species, as it was intended for the gentleman himself.—*G.B.*

HAW-FINCH (*Fringilla coccythraustes*).—Seeing many different opinions on this bird's breeding in this neighbourhood, I have heard from good authority, worthy of belief, that they have found its nest in the neighbourhood, as I have specimens brought in different times of the year.—*G.B.*

PRESERVING CRUSTACEANS.—Could any of your obliging correspondents inform me of the best way of preserving crustaceans (crabs, lobsters, &c.), echini, and such-like things, dry for the cabinet?—*A Constant Reader.*

BLISTER-BEETLE.—Can any one inform me whether the Blister-beetle (*Cantharis vesicatoria*) has been found in this country?—*G. O. Howell.*

AQUARIUM-KEEPING.—Can any SCIENCE-GOSSIP contributors give me some information as to aquarium-keeping? I have a bell glass about 8 in. across, in which I have deposited 3 sticklebacks, 3 large planorbis snails, 2 caddis-worms, and 1 common stagnalis. I have filled the bottom with mould and planted therein 2 water-plants. Now I believe I ought to have the weeds so arranged that they may give out sufficient oxygen for the sticklebacks and other animals, but at present it does not seem to do so; secondly, the sticklebacks will not allow one snail to appear from under its shell: directly the snails attempt to move about, the little fish come up and make the most vigorous endeavours to get a bite out of them, so I am fairly puzzled, and I should like to know how to feed them, and in what way to stop such very barbarous proceedings. Do sticklebacks eat snails? I should be glad to know of any hints which

your readers can throw out about this matter. How many animals could I keep in such a space?—*P. E. C., Trin. Coll., Cambridge.*

MANAGEMENT OF SMALL AQUARIA.—Can any reader of SCIENCE-GOSSIP give me information as to the management of small bell-shaped aquaria? My sticklebacks attacked and killed all the water-snails I kept confined with them. Is this always the case, and is there a preventive? Also, has any one successfully reared caddis-worms into their final stage?—*P. E. C.*

CHANGING AQUARIUM WATER.—In reply to your correspondent "A. S." (Jan. No.) about changing the water in aquaria, I would say that when I commenced keeping one, about 23 years ago, the beginner was instructed to periodically change the water, besides keeping it pure by means of aëration, filtration, &c.; and I well remember that, to the inexperienced it seemed to require it, for at that time the list of life given as suitable for aquaria was: of Plants, *Vallisneria spiralis*, *Anacharis alsinastrum*, *Callitriche autumnalis*, *Nuphar lutea*, *Potamogeton crispus*, and many others; of Mollusks, univalves, *Planorbis corneus* and *carinatus*, *Paludina vivipara*, *Lymnaea stagnalis*, &c.; bivalves, *Anodon cygneus*, *Unio pictorum* and *tumidus*; besides reptiles and fishes. With a small selection from these, what with decaying vegetation, death of mollusks, especially bivalves, and other causes, the water, in a month, seemed anything but pure. But experience and observation taught what to keep and what to reject; so that periodical changing of the water was no longer necessary. The plants were reduced to *Vallisneria spiralis*, *Stratiotes aloides*, and Frog-bit, the latter only on account of its beautifully-formed leaves and the nice cool shade it gives to the water in summer (for it is a rapidly-decaying plant); the mollusks to *Planorbis corneus*, and the fresh-water limpet; reptiles were rejected; for though I have had them live twelve months, they are bad feeders in confinement, droop, get very thin, and soon become objectionable objects in aquaria. I think that with a dozen good plants of *Vallisneria*, one or two *Stratiotes*, and some frog-bit, an aquarium containing ten gallons of water placed at a window looking west or north-west, where the light will fall mostly at the top, sixteen fish can be kept in good condition for many years without either filtration, aëration, or change of water. The longest time the water in my tank remained was two years, and then it was only changed on account of being removed to other premises; still it was as clean and pure as when first put in. But under all circumstances, water pure or foul, changed or unchanged, the eel has lived; and though for his age he must be considered small, he is to-day apparently as cheerful and vigorous as if his twenty years had been spent in the waters of the Severn. Of the other fish I cannot speak so well; they will die from some unknown cause. Carp, sticklebacks, and minnows, I find live longest—some for one or two years; but dace, roach, perch, ruffe, &c., soon become unhealthy, sluggish, blind, and then die.—*Ben Plant.*

POTATO BEETLE.—Caution.—Too much care cannot be taken to prevent that dreaded pest, the Potato Beetle (the *Colorado*) from becoming an inhabitant of this country. Six were carefully packed in a pill-box and sent to me from Canada, and one was alive when I received them and for a week afterwards. I want some paste eels, and offer one or two of the beetles in exchange.—*A. Nicholson, Fareham.*

VESTIGES OF THE NATURAL HISTORY OF CREATION.—The author of this work must have been born a geologist and phrenologist, and have had an intimate knowledge of both these sciences. Of the latter science it is well known that Mr. George Combe was the head of the phrenological school during a great portion of his life, but I am not aware that he had any knowledge of geology, and I am tolerably well acquainted with his writings. The greatest portion of them is devoted to mental and moral philosophy. But with Mr. Robert Chambers the case is quite different. He possessed an intimate knowledge of both these subjects. He was a member for many years, and I believe one of the original members, of the Phrenological Society of Edinburgh, and of course on intimate terms with Mr. George Combe. That the subject of development or evolution treated of in the "Vestiges" was a subject often discussed by the two we may naturally suppose; and it is quite possible that Mr. Combe might not only be aware of the authorship, but even assist by his advice in the composition of that great work, but that it was written solely by Mr. Robert Chambers I do not entertain the slightest doubt. Mr. Robert Cox, brother-in-law of Mr. Combe, wrote a review of the "Vestiges" shortly after its publication, and from passages which occur there I am tolerably well satisfied that Mr. Combe was not the author. But what I ground my opinion principally on is the following. Not very long ago I was informed by a well-known author of several scientific works, and who is now a professor in one of our colleges, that he knew for a fact that Mr. Robert Chambers was the author of the "Vestiges." This may be said to be only assertion, but I know that this gentleman, from the position he held during the publication of the "Vestiges" in 1844, had a better means than any other man, except those to whom the author might have divulged the secret, of obtaining the necessary information for making this assertion. I may here conclude these fragmentary observations by expressing my surprise that the doctrine of evolution should be solely placed to the credit of Mr. Darwin, when we have here a work on the same subject written several years before the publication of Mr. Darwin's works, in which the aim of the author was to show "that the simplest and most primitive type under a law to which that of like production is subordinate, gives birth to the type above it, and this again produces the next higher, and so on to the very highest,"—a work of great originality, and which by the grandeur of the conceptions and the occasional bursts of eloquence produces the effect of a great historical poem.—*Dipton Burn.*

THE GRAVE OF THE REV. GILBERT WHITE.—Being a great admirer of Gilbert White's history, I had long desired to visit Selborne, so I accordingly drove over from here three weeks ago, accompanied by two young friends, to see the old naturalist's grave. We duly admired the noted yew-tree in the churchyard and read the inscription on the tablet in the edifice, and then began to seek for the grave. Failing to find it, I spoke to one of the workmen, who came and pointed out a heap of rubbish, broken bricks, mortar, pieces of slate, &c. "It lies somewhat about there," he said. Clearing away some of the *debris*, a headstone became visible, and on it the simple letters, "G. W." "Two gents came and cleaned that ere stone last year," added our guide. I was pained to witness such want of respect shown to the memory of one whose writings have made "Selborne" a wide-world name; but imagine my disgust later in the day, when speaking to an inhabitant of the village, who had informed me, with a vast

amount of local pride, that "a great number of strangers, some of them carriage people, came to see the village in the summer," he said, in reply to my remark of "Yes, Gilbert White has made it famous. What a pity it is to so neglect his grave." "I don't know him—never saw it," and looked utterly puzzled. "Gilbert White" was evidently to him an unknown name.—*Helen E. Watney.*

THE "ICE AGE."—In the last number of the *Popular Science Review* I read with much interest an article on the "Evidences of the Ice Age," by Mr. H. Woodward, F.R.S., &c. It possessed additional interest for me in the fact that I was engaged in reading Mr. Geikie's "Great Ice Age" at the time when the above-mentioned number of the *Popular Science Review* reached me. It would be simply presumption on my part to question, on my own sole authority, any statements put forth by Mr. Woodward, but, in comparing his statements with Mr. Geikie's, I was quite at a loss to account for the following discrepancy. Mr. Woodward says, at the bottom of page 113, *Popular Science Review*, April, 1877—"When the earth, from these two causes combined, became subject to a slight variation in its two hemispheres, which would give to one $7\frac{1}{2}$ days more of the sun's presence in one tropic than the other now enjoys, then Mr. Croll concludes the ice on the more favoured pole would melt . . . &c.; and this cause alternating, would give rise to . . . glacial epochs . . ." &c. &c. Does Mr. Woodward mean by the word "now," the glacial epoch, or A.D. 1877? If the latter, it is, I suppose, correct to say that the earth is $7\frac{1}{2}$ days longer in aphelion than in perihelion; but the point and drift of the passage seem to be gone. If, on the other hand, he means the glacial period, surely the interequinoctial difference ought to be represented as more than that it is now. Mr. Geikie, at least ("Great Ice Age," p. 139), estimates the difference as 36 days.—*W. D.*

PARASITES OF PLANTS.—Can you, or any of your readers, recommend a good descriptive work on the parasites of plants?—*J. M. W.*

BOOKS, &c., RECEIVED.

- "Report of the United States Department of Agriculture, 1872."
 "Zoology." By Dr. Andrew Wilson. London and Edinburgh: W. & R. Chambers.
 "Annual Report of West London Scientific Association."
 "Annual Report of Norfolk and Norwich Naturalists' Society."
 "Monthly Microscopical Journal." June.
 "Land and Water."
 "Les Mondes."
 "American Naturalist." May.
 "American Journal of Microscopy." May.
 "Canadian Entomologist." May.
 &c. &c. &c.

COMMUNICATIONS RECEIVED UP TO 12TH ULT. FROM:—
 T. S.—J. B.—A. S.—E. C.—C. W. W.—Captain H.—C. C.—
 G. S. T.—H. L.—E. V.—E. S.—E. A. C. W.—V. M. G.—
 R. J. M.—Dr. A. H. N.—D. D.—J. E. P.—E. C. D.—J. F.—
 H. H. C.—R. L.—T. E. B.—J. G.—J. M. W.—D.—
 E. W.—G. W. L.—W. J. V.—T. W.—F. B.—B. W. H.—
 H. W. P.—B. W.—F. F.—B. J. S.—F. H. A.—A. B.—
 G. F. B.—W. T.—J. R.—W. B.—R. W.—H. H. C.—F. K.—
 J. R. S. C.—M. H.—E. T. M.—Dr. C. C. A.—B. B.—G. N.—
 E. E.—R. D.—G. R.—J. P.—W. E.—J. A. S.—W. H. W.—
 T. V. D.—W. W.—T. S.—T. W. S.—T. R. C. G.—H. S.—
 A. W.—G. O. H.—J. F. R.—Dr. P. Q. K.—T. J. W.—
 C. W. B.—B. P.—C.—J. M. M.—F. S.—H. M.—W. T.—
 M. F.—W. S.—Fun.—W. M. P.—P. E. C.—H. A.—J. L.—
 S. E. A. W.—J. B. P.—E. S.—G. H. R.—C. J. S. W.—Dr. C.—
 J. S. H.—F. W. F.—J. W. M.—J. T.—J. M.—H. S.—
 W. R.—T.—G. N.—T. H. M.—W. H. G.—J. T. R.—G. W. C.—
 J. Y.—E. M.—A. N.—J. T. P.—R. H. B.—R. T. G.—
 W. H.—M. S.—C. D.—W. K. M.—J. H.—A. R. C.—M. O. H.—
 H. J. S.—&c. &c. &c.

NOTICES TO CORRESPONDENTS.

TO CORRESPONDENTS AND EXCHANGERS.—As we now publish SCIENCE-GOSSIP at least a week earlier than heretofore, we cannot possibly insert in the following number any communications which reach us later than the 8th of the previous month.

E. W. A.—The worm whose name you request is that familiarly known as the "Hair-worm" (*Gordius aquaticus*). It is the one which schoolboys religiously believe is developed by putting a horse-hair in shallow running water exposed to the sun! The "Hair-worm" passes the first stage of its life within the bodies of some insects.

H. W. HITCHCOCK (Hadleigh).—The "Grub" sent us is the larva of the common Stag Beetle (*Lucanus cervus*), abundant in your part of the country.

A SUBSCRIBER.—The fern you sent, with young ones growing on the ends of the older fronds, is in the not unusual condition called *proliferous*. The young one may be taken off, when ready, and, if properly potted, will develop into another plant. Your *proliferous* plant is *abnormally* in the condition which, in the Strawberry is *normal*—as when the latter puts forth its stolons and buds.

W. STATHAM.—Get Cooke's "Manual of Botanical Terms" (London: Hardwicke & Bogue). It is just the kind of book you want.

CONSTANT READER.—The shrub you enclosed was *Garrya elliptica*.

A. L. S. (Camden-street).—The portion of flower you sent was a *Bougainvillea*.

V. G. (Waltham-cross).—Could you send us a more perfect specimen of the shrubby plant? The primrose which you believe to be the Japanese P. is one with much less pretension, *Primula denticulata*.

INQUIRER.—Your specimen, judging from the rough outline sketch sent us, is *Kotifera vulgaris*.

T. V. D.—You can obtain anything you require for an aquarium, marine or freshwater, from Mr. King, Sea-horse House, Portland-road, London.

J. M. M.—No charge is made for the insertion of "Exchanges," unless they extend over three printed lines.

G. W. LANDELS.—We imagine you must be mistaken in the number of legs of the parasite on the Tortoise. Otherwise your description makes it answer to a species of *Ixodes*.

W. J. V.—The only book we know of relative to Felixstowe (except the "Suffolk Traveller" and other county works) is an old-fashioned and incorrect local guide-book.

R. HAMILTON.—The white variety of the Hyacinth you enclosed is undoubtedly a natural variety, and not a garden sport. White specimens of the common Hyacinth are not uncommon in some localities.

R. J. MANNING.—No specimen of a plant was enclosed in your letter of May 20th.

FRED AHN.—We should be glad to receive an article from you on the subject you mention.

F. S.—Get Johnston's "British Zoophytes" from some natural history bookseller in London.

D. P. and ALPHA.—You will find McNicol's "Dictionary of Natural History Terms" answer your purpose, as it gives the correct pronunciation of each name, and the Latin and Greek words from which the names are derived. It was published, we believe, by Lovell Reeve & Co.

ERRATUM.—In the article on "Economic Products of Plants" last month, the names of the first two illustrations were transposed. No. 112 is *Urceola*, and 113 *Herva*.

J. T. POWELL.—The popular character of SCIENCE-GOSSIP does not admit of mere lists of plants or insects being published, unless they illustrate some general principle.

M. O. H.—Sir John Lubbock's work on the *Physanura* was published in the Linnean Society's Transactions, in 1862, 1867, and 1869. We are not aware that a new edition of Pritchard's "Infusoria" is in hand. It has been talked of for some time, and is much wanted.

H. SCADDING.—Accept our best thanks for the capital slides you sent.

H. J. SAVORY, JUN.—The insects enclosed in small bottle are a species of Long Horn-moth (*Adela de Georalla*).

"RANUNCULUS."—You did not give us any name to answer your query by. From the remains of the plant you sent us packed in moss, we think it is *Anemone ranunculoides*.

EXCHANGES.

Æcidium allii (on Garlic) and others, offered for *Æcidium solanella*, or *Æ. dracontii*; *Æ. valerianacearum*; *Æ. asperifolii*; *Æ. orobi*; *Æ. serophulariaris*; *Æ. pedicularis*.—Thos. Brittain, 52, Park-street, Green Hays, Manchester.

WANTED, transparent sections of Petrified Wood from known localities. Foraminifera, &c., given in exchange.—Geo. Clinch, West Wickham, Kent.

SEVERAL good Slides of foreign diatomaceæ for good Injections.—T. Brown, 7, Spencer-street, E.C.

WILL exchange Coprolite Fossils for others.—J. F., Mission House, Alcester, Warwick.

FOR one dozen *Sphærium corneum* (living), send small box and postage, or any local Land or Freshwater Shells.—Mrs. S., Brentford End.

BRITISH plants, named, but not mounted, offered. Wanted Johnston's "British Zoophytes."—G., 15, Thornhill-road, N.

WANTED, SCIENCE-GOSSIP for years 1872 and 1873.—Apply, Dr. Cunynghame, 6, Walker-street, Edinburgh.

DUPLICATES.—Larvæ of *Liparis dispar*. Desiderata.—many common or local species.—Robert Laddiman, Upper Hellesdon, Norwich.

WANTED, good section of Agate or other mineral for polariscope. Two good Slides for polariscope given in exchange.—Wm. Sargent, jun., Caverswall, Stoke-on-Trent.

PURE of *Filipendula*, *Fuliginosa*, and *Bucephala*, for others.—John Rae, Hanover-street, Aberdeen.

DOUBLE Nose-piece for microscope by Swift, offered for Freshwater Algae and Zoophytes, living, or Shells.—F. E., Vine-street, York.

WILL exchange *Fritillaria Meleagris*, No. 1327, 7th edition London Catalogue, for other good Plants.—F. Crosbie, The Chestnuts, Barnet.

STUDENT'S Polariscope, a good $\frac{1}{2}$ -in. or good $\frac{1}{4}$ -in., for good 1-in. Object Glasses: two required; Swift's or Crouch's preferred.—J. S. Harrison, 48, Lowgate, Hull.

SEEDS of *Pseudonia imperialis*. I have a few of the above, which I shall be happy to distribute, on receipt of stamped envelope.—G., 15, Thornhill-road, N.

EEL Scales, Seaweeds, &c., mounted in balsam, sent for other mounted Micro. Objects of interest.—Address, H. Stiby, Yeovil, Somerset.

FOR exchange a few Slides, Gorgonia spicules, Elytron of Diamond Beetle, and Sulphate of Cadmium Crystals.—Alex. Milne, Silverdale, Carnforth.

WANTED, a dried specimen of each, *Geranium columbinum* and *G. pusillum* for Herbarium. Will send examples of *Fritillaria Meleagris* (with the white variety), fresh collected this season.—G. Garrett, Harland House, Wherstead-road, Ipswich.

MICROSCOPIC Slides of Insects, whole and dissected, Marine Algae, Tongues of Mollusks, &c., to exchange.—T. H. Moorhead, Dalkey, Dublin.

Carex ericetorum, Poll. (Suffolk) for either, 23, 106, 511, 536, 544, 545, 546, 730, 851, 913, 933, 971, 997, 1115, 1279, 1286, 1329, 1410, 1552, 1553, 1622, or 1624, 7th Edition London Catalogue.—A. B., 107, High-street, Croydon.

"SURVEYS of Nature," 2 vols., by Fitzinger; Weld's "Pathological Histology"; 2 Saws of Saw-fish, and a few Micro. Photos for album, for books or anything useful.—W. Tylar, 165, Well-street, Hockley, Birmingham.

YOUNG of *Hippocampus* (Sea-horse), well-mounted, polarize beautifully. Send a first-class Slide, anatomical preferred.—E. Eaton, 48, Currie's-lane, Ipswich.

SEND specimens of named Shells, Minerals, or Natural Objects, for fac-simile Warrant for beheading Charles I.; unmounted Micro. Material for Minerals, Fossils, &c.—W. Tylar, 165, Well-street, Birmingham.

WANTED, pure Gatherings of any of the *Neuro-sigmata*, for good Slides; also living specimens of *Cyclostoma elegans*, *Littorinide*, *Paludina*, and *Valvata*.—M. Fowler, 20, Burn-row, Slamman, N. B.

EGGS for exchange, side-blown, Golden Plover, Ring Plover, Snipe, Grouse, Oyster-catcher, Dipper, Dunlin, Redshank, Tern, Wood Wren, Sparrow-hawk, and others.—J. Lancaster, 24, Prince's-street, Carlisle.

WANTED, Professor Newton's "Suggestions for forming Collections of Birds' Eggs." Will exchange a few British Birds' Eggs, or give reasonable price.—Address, H. H. Collinge, Stanley-park, Letherland, near Liverpool.

I WILL give a liberal exchange in North American Land and Freshwater Shells to any one who will send me some good specimens of Scotch Anodons (*Unio* not required).—G. Sheriff Tye, 62, Villa-road, Handsworth, near Birmingham.

EGGS of Red Grouse, Redshank, Ringed Plover, and Lesser Tern, for other good eggs; a good exchange would be given for an egg of the Chough.—J. B. Pilley, 2, High Town, Hereford.

MARINE Objects for dissection or mounting for the microscope, for Gosse's "Marine Zoology" or "Sea Anemones," or part exchange in cash.—X. Y., 48, Leonard-street, Finsbury, London, E.C.

1st and 2nd vols. of the "Naturalist" (first edition), and 1st and 2nd vols. "Entomologist," for Foreign Shells or British Birds' Eggs.—R. H. B., 13, Dairy-grove, Wavertree-road Liverpool.

BRITISH Birds' Eggs required; can offer good Lepidoptera and other Natural History Specimens.—W. K. Mann, Welling-ton-terrace, Clifton, Bristol.



A SKETCH OF THE GEOLOGY OF PLYMOUTH AND THE NEIGHBOURHOOD.

BY HORACE B. WOODWARD, F.G.S.

Of the Geological Survey of England and Wales.



THE country around Plymouth possesses very many features of geological interest, affording a good school for the beginner, and furnishing plenty of problems for the most advanced student. Representatives of the three great divisions of the

stratified rocks can be observed within easy distance by road and rail; and many exposures of both igneous and metamorphic rocks can be reached with equal readiness. The formation of the scenery is a subject which opens up a number of interesting questions, and leads us, when we come to study the records of

Devonian strata to be concealed by the shales and grits of the Culm-measures.* Turning eastwards, we find outliers of the red sandstones, breccias, and conglomerates of the Triassic period, which beyond Torquay form part of the great belt of red rocks which stretches across England to the mouth of the Tees.

Again, in the neighbourhood of Newton Abbot are traces of the Upper Greensand; and in the Bovey valley beneath, occur the well-known clays and lignites classed as Miocene. Extensive beds of gravel are locally met with; the coast-line is fringed here and there with relics of raised sea-beaches and submarine forests; and the caverns, formed in the Devonian limestone, have yielded the bones of mammalia, many of them belonging to extinct forms, associated with the ancient implements of man.

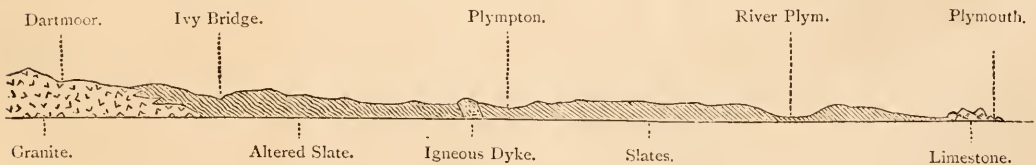

Fig. 147. Section from Dartmoor to Plymouth (after Sedgwick and Murchison).

the caverns, into close connection with the early history and antiquity of man. Speaking generally, the rocky structure of Plymouth and its neighbourhood is composed of limestones, slates, and sandstones, which belong to the Devonian period. The rugged highlands of Dartmoor are formed of granite; while numerous igneous rocks, contemporaneous and intrusive, jut out here and there amongst the old slates and limestones.

Westwards, near Mevagissey, we find traces of Upper Cambrian (or Lower Silurian) rocks; and if we turn to the north and north-east, we find the

But while the relative ages of the rocks have, on the whole, been well established, yet the geology of Devonshire presents, perhaps, more problems in regard to the classification of its strata than any other English county. Some of the hardest geological battles have been fought over the Devonian rocks; and whether they entirely correspond in age with the Old Red Sandstone, or belong partly to this formation and partly to the Lower Carboniferous

* The term Culm is a local name for anthracite, and the beds in which it occurs are classed with the coal-measures and millstone grit.

group, is still a much-vexed question.* The age and exact equivalents of the several subdivisions of the Triassic rocks have not been established; and the Greensand hills of Haldon are outlying fragments of the Blackdown beds, the subject of great discussion. Confining ourselves as much as possible to facts, we may take a section from Dartmoor to Plymouth, as drawn by Sedgwick and Murchison, which gives the general structure of that line of country.†

The granite, which forms the highest ground, is a pale grey, or white, porphyritic rock, containing large crystals of felspar; and it has been thrust up amid the Palæozoic rocks, and even intruded as veins amongst the slates, so as to produce great metamorphism in its immediate vicinity. It has burst through both Devonian rocks and Culm-measures,—a very significant fact, and one which sufficiently explodes the early notion that granite is always the oldest rock. Thus the granite of Dartmoor is more recent than the Culm-measures, but whether these rocks represent the whole of the Coal-measures, or merely the lower part, is a question that has yet to be settled. We have the means, however, of marking off the age of the granite in another direction. Large boulders of this rock are occasionally met with in the Triassic rocks near Teignmouth. Hence it must have been formed in an earlier period, and may very likely be, as has been suggested, of Permian age.

In our section, the granite abuts against the metamorphosed Devonian slates; these assume their natural character of bluish-grey and claret-coloured slates further south. In them are occasionally found various igneous rocks, most of which, according to Mr. Worth, are contemporaneous with them. They pass beneath the limestone of Plymouth, which rests conformably upon them.

The Devonian limestone, which is so conspicuously developed at Plymouth and in the cliffs that face the Sound, is a bluish-grey crystalline rock, sometimes stained red, and veined with calc-spar. In its general aspect, and in the scenery it produces, it reminds us forcibly of the mountain limestone; but when we come to study the organic remains, it will be found that, especially in its coral fauna, the forms of life were different. From the southern portions of Plymouth this limestone stretches some two or three miles eastward of Oreston, and it is again developed in the neighbourhood of Yealmpton. A study of the geological maps of this district, and of that around Torquay, would seem to indicate that the limestone occurred in great lenticular masses. But although in places the limestone becomes more or less shaly, and has been considered to pass

almost directly into this type of rock, yet a careful study of portions of the limestone district near Newton Abbot convinced me that its frequently abrupt termination was more often due to faults than to any disappearance of the limestone in its passage into slates.

In that district we find a well-marked succession (in descending order) of—(3) Limestone, (2) Slates, and (1) Red Sandstones, very like Old Red Sandstone; and the same divisions have been very carefully mapped out in the country around Totnes by Mr. Champernowne.

Now, in their section drawn from Plymouth to Bolt Head, Sedgwick and Murchison represented a series of contorted red sandstones as abutting against the limestone of Mount Batten, Plymouth, and their diagram would make them appear to rest upon it. They state that this sandy division, “in many parts, is exactly like the Old Red Sandstone.” It is quite possible that the southern margin of the Plymouth limestone may be a faulted one, as suggested to me by Mr. Champernowne; or the structure may be that of an inverted anticlinal, as supposed by Jukes. The red sandstones may therefore be on the same horizon as those which occur at the base of the slaty rocks before mentioned, and which are very well exposed in a quarry at Cockington, near Torquay.

The red sandstones of Staddon are overlaid by greenish-grey and sometimes “glossy” slates, which occasionally yield slates useful for roofing purposes, and these are stated to occur in planes parallel to the bedding.

In the promontory of Bolt Head and Salcombe, the beds have been highly altered into micaceous and slightly chloritic slates. No direct clue to the agent which produced this change can be seen; but Jukes was of opinion that a boss of granite may be approaching the surface in this region, and perhaps reaches it under the sea in adjacent parts of the Channel.*

Although fossils are not common in the slaty series, specimens of *Spirifer*, *Orthis*, *Leptæna*, and *Trilobites* may sometimes be procured.

In the Plymouth limestone, and in that developed around Torquay and Newton Abbot, many beautiful fossils have been obtained. But it is generally necessary for the specimens to be polished before their structure can be well seen, and the visitor may frequently be disappointed in his search among the quarries. He must, however, look out for the weathered surfaces of the rock, and as the fossils are better capable of withstanding the wear and tear of atmospheric agencies than their matrix, they may not unfrequently be found standing out in bold relief.

Wherever the limestone is developed, quarries abound, for the stone is extensively dug for building and paving purposes, for road-mending, to be burnt for lime, or to be polished for purely ornamental uses.

* This question has recently been reviewed by Mr. R. N. Worth in an article on the Geology of Plymouth,—*Trans. Plymouth Inst.*, vol. v. p. 450.

† *Trans. Geol. Soc.*, 2nd Ser., vol. v. Plate LI.

* “Notes on parts of South Devon and Cornwall,” 1868.

Much of Plymouth itself is paved with this stone, and hence it is said that the town is paved with marble, the beauty of which may well be perceived on a rainy day, when the moistened stone best exhibits its structure.

Some of the choicest varieties of marble are dug in the vicinity of Ipplepen, Newton Abbot, and St. Mary Church. In this district, as well as at Plymouth, the beds are sometimes specially distinguished by the character of their organic remains.

Thus the "Feather Stone" contains the coral *Favosites polymorpha*; some varieties contain *Cyathophyllum caspitosum*, *Heliolites porosa*, *Astraea pentagona*, &c., while the "Buck's Horn Marble" is formed of *Stromatopora*. Other varieties again are noted for their colour or the peculiar veins of spar which run through them, one of which is termed "Thunder and Lightning."

The disturbances to which the Devonian beds and culm-measures have been subjected are worthy of much attention. In some quarries it is impossible to make sure of the dip of the limestone, it being affected with a rude cleavage, and cut up by parallel joints. In the grand cliffs of Torquay the contortions may be seen to advantage, and Mr. Champemowne has drawn attention to an inverted anticlinal, which, apart from physical structure, is also marked by a bed at the base of the limestone which contains *Calceola sandalina*.*

At Hope's Nose, a quarry in the limestone shows beds apparently horizontal resting on the upturned edges of similar limestone, and this feature has been produced by a fault which runs along the face of the quarry with a hade dipping away from it. In the culm-measures the contortions and faults are equally numerous, so that it must be the labour of many years and many lives ere the entire structure of Devon is worked out in detail.

Most of these disturbances were produced prior to the accumulation of the Triassic rocks, and the beds themselves must have been largely denuded before the earliest sediments which mark this period were deposited.

The red sandstones, conglomerates, and breccias of the Triassic period, which form the picturesque cliffs at Dawlish and Teignmouth, occur in outliers at Slapton, and at Thurleston on the shores of Bigbury Bay. At this last-named locality a natural arch, formed of these rocks, stands out on the foreshore.

No organic remains belonging to this period have been found in the district, but pebbles of the Devonian limestone washed out of the rocks are frequently picked up on the beach at Teignmouth and Dawlish, and are sometimes polished for brooches.

Resting indifferently on any of the older rocks are found the outliers of Upper Greensand which form the Haldon Hills, and perhaps the crest of Milber Down. †

These are composed chiefly of sand of many colours, green, red, and brown, with a few included sandy and cherty concretions; but there is no such development of this upper cherty part of the series as we meet further east at Chard and Lyme Regis. The hills are, however, capped by accumulations of flint and chert gravel, the relics of the chalk and of the upper part of the Greensand which formerly extended over the district. In the Greensand are found species of *Ammonites*, *Trigonia*, *Exogyra*, &c.

In the valley of the Teign, between Bovey Tracey and Newton Abbot, are certain clays and lignites which contain plant-remains pronounced by Dr. Heer to be Miocenc. The details of the lignite-beds in which these fossils are chiefly found, have been most carefully worked out by Mr. Pengelly, and they are well shown in a large pit near Bovey Tracey. Some of the beds have been used as fuel during the past 150 years, but the burning of the Bovey coal is almost discontinued now.

The clay beds, which are worked very largely in the parish of Kingsteignton, are about 40 feet in thickness, and are most probably older than the lignites. Sandy beds are met with beneath them, and the entire series must attain a thickness of about 300 feet. The clays are largely used in the manufacture of pottery, &c.

The formation itself, when looked at in a large way, seems to have been deposited in a lake, the slopes surrounding which were covered with a luxuriant vegetation, comprising Wellingtonia, Cinnamons, Evergreen Oak and Fig, Vines, Rotang-palm, numerous Ferns and Water-lilies. Much of the sedimentary deposit was due to the destruction of the granite hills, the felspars giving rise to the clay, and the quartz yielding material for the coarse sands.*

Far more recent deposits of gravel fringe this Bovey basin, and extend up the hills on to Haldon. To what exact period they belong is uncertain, but it is probable that their formation may have taken place during some of the changes which affected the country during the Glacial period. Considerable portions of them have been reassorted in modern times by the river, and constitute parts of the "head" beneath which the Bovey clays are worked.

In the higher portions of the Dart valley are very coarse boulder-gravels containing large masses of quartz, quartzite, granite, and other rocks, which the present stream would seem incapable of shaping or transporting. †

Mention should also be made of the China-clay worked at Lee Moor, about five miles from Plympton, which deposit, like the Bovey clays, owes its origin to the destruction of the felspar in the granite.

Among the most interesting of the geological phenomena offered for our study, are the caverns and

* *Trans. Devon Assoc.* for 1874.

† See *Quart. Journ. Geol. Soc.*, vol. xxxii. p. 230.

* Pengelly and Heer, *Phil. Trans.*, vol. clii.

† See paper by W. A. E. Ussher, *Trans. Devon Assoc.* for 1876.

fissures in the Devonian limestone of Plymouth and Torquay, which have yielded so many bones of mammalia, and not a few of the implements fashioned by man.

Plymouth can boast of possessing the first bone-cave that was systematically explored in this country. So early as 1816 Mr. Whidbey, an engineer, discovered bones and teeth in a loamy deposit which he met with in fissures of the limestone at Oreston, and one of these belonged to the *Rhinoceros megarhinus*. Among other remains found there are the Cave Bear, Cave Lion, Grizzly Bear, Hyæna, Horse, Bison, &c. Remains of Rhinoceros and Hyæna were twenty years later (1835-6) discovered by Mr. Bellamy and Col. Mudge in a cavernous fissure of the limestone at Yealmpton.*

By far the most important researches have been carried on more recently at Brixham and Torquay. The cave at Brixham was first discovered in 1858, and it was entirely explored by a scientific committee appointed for the purpose. Of this committee Dr. Falconer and Mr. Prestwich were leading members, and the latter has prepared an ample report. Upon Mr. Pengelly, however, who was enabled to undertake active personal superintendence, the chief work devolved, and he has also furnished us with an interesting account of the cave. Amongst the remains obtained are the Mammoth, Tichorine Rhinoceros, Reindeer, Cave Lion, Cave Hyæna, Cave Bear, Brown Bear, Grizzly Bear, &c.; and associated with them were implements fashioned by man.

Kent's Cavern, near Torquay, which is so well known to all visitors to that charming neighbourhood, and has been known "from time immemorial," was first found to contain bones in 1824, and later on was actively explored by the Rev. J. MacEnery.

In 1864 the investigations were carried on by the British Association under the unflinching superintendence of Mr. Pengelly; and to him we owe the chief part of our knowledge of the history of this cave. All the species obtained in the Brixham cave have been found at Kent's Hole, and in addition, the *Machairodus latidens*, Wolf, Glutton, Badger, Irish Elk, &c. In this cave of Kent's Hole the oldest deposit consists of a breccia with remains of Bear only, and flint implements. Above it, and separated by a bed of crystalline stalagmite, comes the cave-earth with remains of Hyæna, &c., and more flint implements. This deposit is covered with a granular stalagmite, and with more recent deposits.

Mr. Pengelly has pointed out that the implements found in the breccia are very dissimilar to those found in the cave-earth above, the former being much ruder than the latter, which are very elaborate, and were associated with bone implements and ornaments. He considered that the cave was tenanted by two

distinct races of men, between which was evidence of a long lapse of time: both races of men were coeval with extinct animals, but they nevertheless represented two distinct civilizations. Mr. Pengelly thought it possible that the earliest race may have witnessed the separation of England from the Continent, and its formation as an island.

We must not linger any more over the caverns, but proceed to notice other subjects deserving of attention.

Submarine forests have been observed in Torbay, in the Salcombe Estuary, and more recently in Bigbury Bay.

These are much obscured by the recent accumulations of marine sand or shingle. Mr. Pengelly mentions that by a great and almost sudden removal of sand at Blackpool, near Dartmouth, a submerged forest was there disclosed in 1802, and not again exposed until about fifty years subsequently.

An excellent example of a raised sea-beach was first described by Mr. Godwin-Austen at Hope's Nose, near Torquay. The lowest part was 31 feet above the usual high-water line. Another raised beach is met with on the Thatcher Stone, an islet of Devonian limestone, near Torquay.

On the Hoe at Plymouth, and at Boveysand, certain deposits of clay and sand have been described by Mr. C. Spence Bate and Mr. R. N. Worth. They are regarded by Mr. Worth as old fluviatile accumulations, formed either when the river ran at a higher level, or when the land was lower. In the latter case they may constitute a raised river-bed. Traces of a genuine raised sea-beach have also been noticed on the Hoe at an elevation of 30 feet above high-water mark.

Glancing briefly at the character of the changes that the rocks around Plymouth teach, we find that the oldest are those of Verman Bay and Mevagissey, rocks which were originally spread out as soft sands in later Cambrian times, or, as some would say, in the Lower Silurian period.

Portions of these rocks, now altered into quartzites, may have formed part of the coast-line in the Devonian period, between which, long ages past, when rocks elsewhere developed, the Upper Silurian, and perhaps the Lower Old Red Sandstone, were deposited. In all probability they formed part of a mass connected with what is now the French coast as late as Triassic times, for the "popples" of the Budleigh Salterton pebble-bed are many of them quartzites of similar character, and contain similar fossils.*

The Devonian strata, commencing with sandy sediments, which may be the only true representatives of the Old Red Sandstone, in condition as well as in time, perhaps originally commenced as lacustrine deposits, which were succeeded, on depression of

* Prof. W. Boyd Dawkins, "Cave Hunting," pp. 13, 317. See also Pengelly, *Geologist*, vol. ii. p. 434; *Trans. Devon Assoc.*, vol. iv. p. 81.

* See paper by Salter, *Geol. Mag.*, vol. i. p. 5.

the area, by the marine muddy sediments now hardened into the slates or "killas," so largely developed over South Devon and Cornwall. Volcanic agency was rife then, and some ash-showers and lava-flows are interbedded with the slates. Succeeding this period the eruptive force was subdued, manifesting itself only in the slow subsidences of the area. Extensive growths of coral now took place, as represented by the limestone. Again, the waters became muddy, the conditions altered, and we pass into the Culm-measure shales, sandstones, and grits, with here and there beds of anthracite, or culm, and occasional bands of limestone.

Succeeding this period, great volcanic activity was manifested. The granitic bosses, of which Dartmoor is one, were intruded amongst the rocks, both Devonian and Culm-measures, which have since been extensively denuded from above them, while Elvan dykes and other veins of igneous matter were thrust out here and there amid the slates and limestones.

Portions of some large lake then occupied the area in which the Triassic rocks, so Prof. Ramsay tells us, were deposited. The area may have been continuously upheaved in this tract, which was certainly not the case in others. It is, however, scarcely probable that any of the Liassic or Oolitic sediments were spread over the area.

Not until we come to the Cretaceous period do we again find evidence of extensive deposition or evidence of submergence. Then the sandy sediments of the Greensand were formed along the eastern margin of Dartmoor; but how far they extended to the south and to the south-west is uncertain. The chalk must, it is considered, have spread over the whole of Devon, for it required a deep sea for its formation. It is quite possible, however, that Dartmoor remained as an islet above water, and this would have yielded the pea-like grains of quartz which are found in the lowest beds of chalk in Devonshire and Dorsetshire.

Enormous denudation must have taken place since this period, in Tertiary times, of which the gravels and superficial soils are but feeble relics. The Miocene deposit of Bovey Tracey tends to show that much must have been denuded in Eocene times; but this period, small as it may seem in comparison with other geological epochs, must itself have been of great duration.

In more recent times—Pliocene, Glacial, and Post-Glacial—the area can scarcely have remained unaffected by the changes, of which elsewhere in the British isles, we have such conspicuous records. Forty years ago, Mr. Godwin-Austen hinted that the meagre list of shells from the raised beaches pointed to the period having been "one less favourable to the development of marine life, owing, perhaps, to a lower temperature." And he added that the broken-up or detrital edges of the slate rocks, a feature frequently to be observed, might have been

produced by agencies in a period having a lower temperature and attended by the action of deeper searching cold.*

But the connected history of these later deposits, of raised beaches, submarine forests, and caverns, recording as they do many of the ups and downs of modern geological change, remains yet to be told.

The scenery itself is the general result of the changes that have affected the area throughout all the geological periods. The consolidation of the strata after deposition, their induration and elevation, their disturbance and dislocation, produced the ground-work upon which at various times the agents of destruction have operated.

The features of the coast-line, and the features inland, are the results of marine and subaërial denudation acting on rocks of unequal hardness, and the direction of which forces has been modified more or less by the disturbances which have affected the rocks. Bays and promontories are formed, like hill and dale, by the alternation of hard and soft rocks, the latter having been more easily worn away than the former. The granite of Dartmoor has been upheaved to its present elevation, but the tors and other fantastic forms which it assumes are the results of subaërial denudation. The igneous dykes which often form little conical hills, owe their present features to the fact that they are better capable of withstanding denudation than the surrounding slates, and none, not even Brent Tor, so Mr. Kutley informs me, have any immediate relation in outline to the old volcanic features of which they are the relics. Were we, however, to enter into any further discussion of this subject, to attempt to trace out the origin of the valleys of the Tamar, or of our "English Rhine," the Dart, we should have to dwell upon more of the local details of structure than the space allotted to this sketch would permit.

BOTANICAL NOTES IN THE NEIGHBOURHOOD OF CADER IDRIS.

FEW districts present so charming a diversity of rock, wood, and water, of grand mural precipices and craggy heights, of rich undulating woods, of dark solemn lakes, leaping streams, and far-reaching estuary, as the picturesque country about the quaint Welsh town of Dôlgelly, anciently written Dôlgellau. Weeks might be spent in exploring the fine streams that come tumbling down between the mountains, in ascending the many rocky heights, or in reaching the shores of the lakes; some beautiful exceedingly, some grandly rocky, others the picture of calm but stern solitude.

In June of 1876 I spent four days at Dôlgelly with a scientific friend, and subsequently re-visited that

* *Trans. Geol. Soc.*, 2nd Ser., vol. viii. pp. 437, 442; see also Mackintosh, *Quart. Journ. Geol. Soc.*, vol. xxiii. p. 326.

town a few weeks afterwards, mainly to rest and enjoy the scenery, so that scientific work of any kind was a secondary object; nevertheless we recorded a few plants during some most enjoyable and long rambles, some notes of which may be acceptable to readers of SCIENCE-GOSSIP.

Starting off one morning for Abermaw (by corruption changed to Barmouth), we found upon an old wall just outside the town *Hypericum montanum*, dwarfed by position, one of the less common St. John's worts; and not long afterwards came across *Hypericum humifusum*, a smaller and less rigid species; while growing upon the first old wall, and nearly everywhere on walls and rocks, was a profuse quantity of *Cotyledon Umbilicus* (some racemes being of gigantic proportions), and of *Sedum anglicum*, with its matted and pretty flowers of white and pink, growing in the driest of places: this latter a plant, by the way, that seems to dislike the less pure air of more inland counties. At about one mile from the town, on left of the road, field near the private road to Dôlwluch-cogryd, I found in flower on my second visit some fine examples of *Epilobium tetragonum*, so attractive with its long flower-stems, very profuse in this instance, of a deep and rich rose-colour, constituting a very showy wild flower. Presently at Llanelltyd Bridge we were arrested by sheets of colour bespreading the tidal meadows, where the Sea Pink, *Armeria maritima*, flourished in great masses, nearly aeres in extent, imparting a more rich and beautiful aspect to a spot peculiarly charming in picturesque features; where Cader Idris assumes a grand outline, and the Mawddach river comes down between far folds of purple mountains. Here also, in damp spots, are great clumps of *Iris Pseudacorus*, which drew the eye by their masses of gold, in certain spots, between which flat habitats the tide here and there insinuates itself, running up the river and its arms as far as the bridge, when higher than usual. Passing on, we diverged from the road several times, striking some distance up the hillsides, or staying to explore some of the side streams leaping down sonorously among the woods. Carpeting the ground of these woods in some places *Allium Ampeloprasum* had gained mastery over other plants, really pretty in its delicate white flowers, but assailing the nose fearfully; while in a few spots the yellow Cow-wheat, *Melampyrum pratense*, reigned supreme, partly in flower,—a plant one sometimes may travel a long way to see a single specimen, but when found generally very abundant at that spot: when dried, its dusky name explains itself. Among the soft ancient turf, in green open spots bordering hillside rocks, the golden hue of small *Potentilla* was blended with various shades of blue from *Polygala vulgaris*, the latter here and there also of a pure white; while at foot of some rocks in one spot we found one of the rarer *Ranunculi*, probably *lingua*, not far removed from a group of

remarkably fine *Scrophularia nodosa*, with some leaves of a strikingly rich bronzy colour, the latter not yet in flower. Here and there on our way to Abermaw, we found *Silene inflata*, *Euphrasia officinalis* (very frequent), *Chelidonium majus* (scarce), *Brassica campestris*, *Hypericum quadrangulum*, and *Epilobium montanum*; and upon rocks at Abermaw some very richly-blue specimens of *Scabiosa succisa*, as we determined, but far deeper in colour than usual, possibly from the sea air.

Upon crossing the long railway bridge and returning upon the opposite side of the estuary, we had small time for botany, as evening began to settle upon the mountains, but observed that wherever the turf had been cut from off the peat-beds, abundance of the pretty Cotton-sedge, *Eriophorum polystachyon*, had sprung up after a year or so had passed, its graceful glumes waving in the breeze and tempting the hand by their whiteness; the seeds evidently enduring long burial in the peat. Some good and probably rare kinds of sedges and grasses prevailed in peaty drains near the railway, but for these time failed us. As we sped along in the deepening twilight we could desery some large masses of the grand white Waterlily, *Nymphaea alba*, coating the surface of a little lonely tarn, nestling under the woods, near Garth Anghared.

I will now recount some plants noted during three or four rambles upon Cader Idris, including two ascents of that grand wall of rock, one by way of the Foxes' path, returning down the pony track—greatly enjoyed with my friend before-mentioned, a most delightful companion at once humorous and scientific; one by way of Geu Graig, when alone I took the five principal peaks of the mountain and walked nearly from end to end; also including Mynydd Gader, that long ridge of rocks that is really part of Cader, though by a wild upland moor stands somewhat apart, as you discover when upon it. First I would observe that upon this moor, in rock-bound cups of peaty water, I found large masses of that rare plant *Lobelia Dortmanni*, then only beginning to flower, just showing a lilac bloom here and there, but mostly the plant submerged, growing in water of a certain depth, and there monopolizing nearly all space on the rocky bottom of the *tarnlets*, to coin a word. Sighted about the same locality, in less thoroughly watery habitats, but in wet peat, the beautifully-divided leaves of *Pedicularis palustris* showed themselves, a plant memorable for strong upright growth, fern-shaped leaf, and for its large crimson-purple flowers, all quickly dying away into a black mass early in autumn. Here also, and at several spots, on high mossy and wet spaces, all about the lower ridges of Cader, I found great plenty of *Pinguicula vulgaris*, associated with those other and more remarkable flesh-consuming plants *Drosera rotundifolia* and *intermedia*, whereon numerous flies were caught, some struggling still in the toils of the

viscid glands of the exquisitely sensitive tentacles. Three grey-coated artists left their studies of cloud on the upper rocks, to cluster over my specimens, one morning as I returned. I noticed thereabouts various Orchids sending up their strange flowers into the brilliant sunshine; as *Orchis mascula* and *maculata*, *Haabenaria bifolia*, with the green flowers of *Listera ovata*, and *Epipactis latifolia*; some of these only then in flower, and many dwarfed by position. Upon Mynydd Gader grows *Cystopteris fragilis* in abundance in crevices of rocks, a pretty little fern that mostly prefers pure air; associated with *Asplenium Trichomanes* and *Adiantum-nigrum*. I would here remark that the very rare fern *Asplenium septentrionale* is to be found under the precipices of Cader: its exact position botanists will mostly keep silent, for I have heard of baskets, full of this choice fern, being sent off to Cambridge! Wholesale slaughter!

About Llyn Gafri, or Goat Lake, my friend and I found *Erica tetralix* profuse, the prevailing heath, but of course not then in flower; also great clumps of that giant of mosses, *Polytrichum commune*, with its spore-cases fringed with richly-brown hair. We observed, as I have done on several other mountains, that at an elevation of about 2,000 feet above the sea, the Club-mosses show themselves in great force; thus about Llyn y Gader, and elsewhere at a like altitude, we found fine clumps of *Lycopodium clavatum*, *alpinum*, and *Selago*, all plants attractive by their comparative rarity and beautiful mode of growth; the latter peculiarly interesting from its viviparous buds, which fall from the ends of the stems and form fresh plants. Some grand *Lichens* were seen on the extraordinary rocks cast about in wildest chaos ("put round the lake by previous tourists," my friend suggested), and on dead sticks of the peat, which I at least had neither time nor knowledge to determine. Beside the somewhat steep and stony Foxes' path we found a few large tufts of the Parsley Fern, *Allosorus crispus*, partial only to a few spots on this mountain, but which I discovered in plenty subsequently upon the very summit of Cyfrwy, the second in altitude of the peaks of Cader Idris.

Not far from the summit of the mountain we found one specimen of *Saxifraga nivalis*, and subsequently, in the spring of water on the edge of rocks directly above Llyn Aran, I saw a large growth of *Saxifraga oppositifolia*, mingled with moss; and among the fine grass of the crest I gathered a true *Viola lutea*, or yellow Heartsease, found once before high on Radnor Forest. Among the rare kinds of ferns growing in favoured spots on the slopes I would mention *Lastrea Oreopteris* and *Polypodium Phegopteris*; not to omit one other rare plant, found in quantity in one or two peaty cups of water on the rocky moorland above Dôlgelly, namely, *Menyanthes trifoliata*, with its lovely white flowers so exquisitely fringed.

One morning, with three merry companions, I stayed an hour or more at Llyn Gwerman, rowing about among the waterlilies, white and yellow, *Nymphaea alba* and *Nuphar lutea*, flowering in rich profusion round the shores, two ladies of the party vastly enjoying the fun. Presently three of us struck off across the mountains to Llyn Creigenen, a grand and lonely lake, in a spot remarkably wild, and set in crag and moorland, beneath the face of Cader Idris, a pool that in dry weather becomes divided, but in wet times has two outlets, one at each end—an unusual condition. On the shores of this lake it was that we found the finest *Drosera*, with many insects caught in their tentacles; also near there, in boggy ground, quite a large and beautiful mass of the Bog Pimpernel, *Anagallis tenella*, with its delicate pink flowers clustered into a showy expanse.

Rambling one day over the high land to the northeast of Cader Idris, near the little hamlet of Brithdir, growing in an old pasture, we came upon *Trollius europæus*, looking very effective, with its double golden flowers; and during the same walk found *Linaria Cymbalaria*, growing where we could not doubt it was truly wild. The woods above Pont Newydd were most charming in luxuriance of the more common wild flowers of the woods, a fine contrast to the rich brown of young oak-leaves. But space presses. I would, however, allude to an old wall on the way between the ancient village of Llanfachreth and Nannau Park, clothed with moss, lichen, and various plants, but peculiarly rich in ferns, of which these at least were there in plenty: *Polypodium vulgare* and *Phegopteris*, *Asplenium Trichomanes*, *Adiantum nigrum* and *Ruta muraria*, *Scolopendrium vulgare*, *Blechnum spicant*, *Polystichum angulare*, *Lastrea Oreopteris*, *Filix-mas* and *dilatata*, *Athyrium filix-femina*, and *Pteris aquilina*. These, and possibly one or two more kinds, were growing upon, or directly at the base of, this rich old wall—verily, "a sweet and lovely wall."

I will merely add, regarding the ferns of the district, that I once found a plant of the *Ceterach officinarum* growing on Llanelltyd bridge; that abundance of the pretty Oak-fern, *Polypodium Dryopteris*, may be found among the disintegrated rocks below the Precipice Walk, well known to tourists of this part; and that the noble *Osmunda regalis* has for untold ages had a fitting home in moist depressions of the wild and lofty mountain-range extending from near Dôlgelly to beyond Harlech.

Stourbridge.

HORACE PEARCE, F.L.S.

THE COLORADO BEETLE.—The Lords in Council have issued natural history descriptions and coloured drawings of this much-dreaded insect, with a view to familiarizing all those whom it may concern with its habits and appearance. We may observe that we published a lengthy article on this beetle (illustrated) in SCIENCE-GOSSIP for January, 1874.

THE SEALS AND WHALES OF THE
BRITISH SEAS.

No. III.

By THOMAS SOUTHWELL, F.Z.S., &c.

THE HOODED OR BLADDER-NOSED SEAL, *Cystophora cristata* (Erxleben), fig. 149, has occurred at least twice upon our shores. In June, 1847, a young one was killed in the Orwell, and is now in the Ipswich Museum, and in 1872 a second young one was killed in Scotland near St. Andrews. Others are believed to have been obtained in the Orkneys, and a seal supposed to be of this species was seen off

temperate waters of Europe and America. It is polygamous and migratory in its habits: during the rutting season it is very pugnacious, and Dr. Brown says great battles take place between the males, and their roaring is said to be so loud that it can be heard for miles off. The young, which are born in April, are pure white at first, which changes to grey, and gradually becomes darker till it assumes the adult colour and markings, which it appears to do about the fourth year; the colour then is "dark chestnut or black, with a greater or less number of round or oval markings of a still deeper hue." The adult is furnished with a curious bladder-like appendage, com-

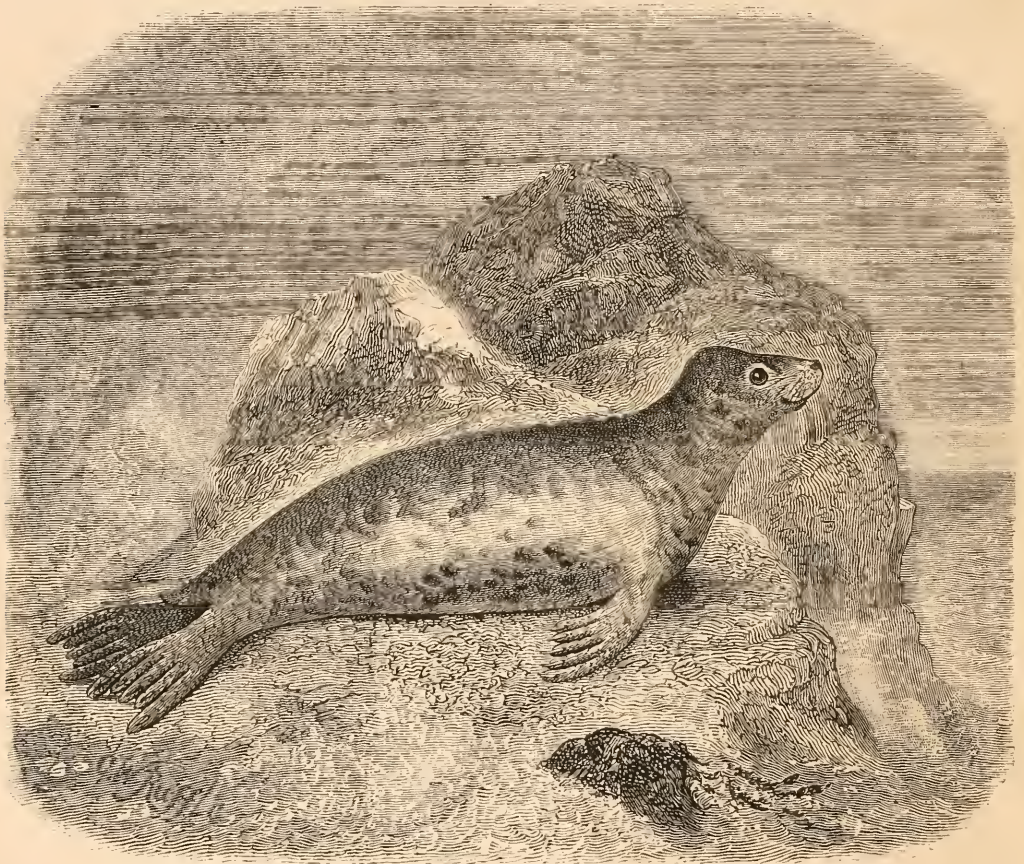

Fig. 148. Grey Seal (*Halichoerus gryphus*, Fab.).

the Irish coast near Westport. "In Hollingshed's 'Chronicles,' in the year 1577, 'sundry fishes of monstrous shape, with cowls on their heads like monks, and in the rest resembling the body of a man,' are said to have occurred in the Firth of Forth" (Bell's "Brit. Quads."), the appearance of which was of course followed by pestilence and famine. Throughout the Polar seas this species is widely distributed, being found in the Greenland seas, Iceland, and Spitzbergen, also occasionally in the

mening at the nostrils, with which it is connected, and continued upwards to the forehead: this when inflated presents a very remarkable appearance; when the animal is at rest it remains flaccid, but when irritated or excited it is blown up to its full extent. It is generally supposed that the "bladder" is found only in the male, but Dr. Brown does not think there is any just ground for this belief. The Bladder-nose Seal is fierce in its nature and dangerous to attack; although not actually taking the initiative, it is always

ready for battle, and will avail itself of any advantage by turning upon and following its opponent. The air-bladder, which is placed in the spot usually most vulnerable, renders it difficult to kill, as it forms a protection from the clubs of the sealers. This is one of the largest of the Northern seals, varying, according to different authorities, from 7 to 10 or even 12 feet in length.

One other species of true seal, the GREY SEAL, *Halicharus gryphus* (Fab.), claims a place in the British Fauna. Dr. Brown says the Grey Seal "has no doubt been frequently confounded with other

Ireland, however, appear to be its chief places of resort on our shores; it has also been known to breed on the Fern Islands. According to Bell, it inhabits the "temperate northern seas rather than the Polar waters," and is found in the North Sea, Baltic, Iceland, Scandinavia, Denmark, and North Germany. Dr. Brown met with a specimen a little south of Discoe Island, but can only speak of its claims to a place in the Greenland Fauna as strongly probable. Bell gives some interesting information with regard to the habits of this species as observed in various British stations, and calls attention to the remarkable



Fig. 149. Hooded Seal (*Cystophora cristata*, Erxleben).

species, particularly *Ph. barbata* and *P. granlandica*." Such has undoubtedly been the case, and a specimen in the British Museum, long regarded as *Ph. barbata*, has been referred to this species. There is, I believe, no sufficient evidence that *Ph. barbata* has ever occurred on the British coast; but so imperfect even now is our acquaintance with the seals which frequent our shores, that it may even yet be found.

The Grey Seal has been found on various parts of the coast, from Shetland to the Isle of Wight; the Shetland Isles, the Hebrides, and the west coast of

fact, that whereas in this country it produces its young in the months of October and November, on the Continent this is always said to take place in February; he suggests, to account for this singular discrepancy, that in our milder climate pairing takes place much earlier than in Scandinavia. The young, which are born white, are suckled for about a fortnight; the first coat is shed before they take to the water, which is not for some weeks after birth. The colour varies with age, sex, and season, so much, that it is not of great service in their identification, their large size

being the best external guide. The general colour of the adult is greyish, tinged with yellow, and spotted and blotched with darker grey; the under parts lighter. The length of the adult varies from 7 to 10 feet. By the form of its skull and teeth it is readily distinguished, as well as by the great size of the animal. In the skull the brain-case is small, the nasal opening very large, and the grinders conical, only the two hinder pair in the upper, and the last pair in the lower jaw, double-rooted, the rest simple. Professor Bell, in his history of "British Quadrupeds," gives excellent figures of the skulls of the various British seals, which will be found most useful in determining the species of any doubtful individuals; other carefully executed figures will be found in Dr. Gray's "Catalogue of the Seals and Whales in the British Museum," as well as the generic and specific characters in both authors.

The family *Trichechidae*, restricted to a single genus and species, *Trichechus rosmaris* of Linnæus, the MORSE or WALRUS, is the only remaining representative of the *Pinnepedia* found on our shores; the third family, *Otariidae*, not being represented in our Fauna. Although it has occurred in several instances, here the Walrus can only be regarded as a rare and accidental straggler, far from its native habitat, the icy seas of the Arctic regions, from which it rarely strays. Wallace ("Geo. Dist. of Ani.," vol. ii. p. 203) gives as its true home the shores of Asia, between 80° and 160° E., or on the N. shores of America, from 100° to 150° W., but occasionally reaching as far south as lat. 60°. In the Kara Sea, the German Arctic expedition in the *Prøven* found it abundant, but the object of "exterminating pursuit" on the part of the Norwegians. In the better-known regions of the Arctic Seas it has gradually become exterminated by the hands of man; from the northern coasts of Scandinavia it has receded to the coasts of Greenland and Spitzbergen, which now form its stronghold for a time; but the fate which awaits it cannot long be deferred. Its fossil remains, Wallace says, have been found in Europe as far south as France, and in America probably as far as Virginia: a skull in the Cambridge Anatomical Museum was found in the peat near Ely. Recently it has been met with on our shores, according to Bell, on the coast of Harris in 1817; in the Orkneys in 1825; one was seen in Hoy Sound, but not captured; and in 1841 one was killed near Harris. Dr. Brown also states that two were seen, one in Orkney and the other in Shetland, in 1857. More than one successful attempt has been made to bring the Walrus alive to this country; but although they show considerable docility, and readily recognize the voice and person of their keeper, in no instance have they long survived in confinement.

In a paper in SCIENCE-GOSSIP for January, 1877, I have given a more particular account of the habits of the Walrus, with illustrations.

(To be continued.)

ANOTHER SKETCH IN THE WEST OF IRELAND.

(Hiar, or West, Galway.)

By G. H. KINAHAN, M.R.I.A., &c.

THE county of Galway has been called by a recently deceased popular novelist, "the land of Nimrod, Ramrod, and Fishingrod." This seems to be rather a happy thought, its champaign country being famed for the Foxhunters it has produced, its mountains being the abode of the Kirkenafree (*anglicè*, Heather-hen or Grouse), while its lakes teem with Salmon and Trout. The sight in summer from the West bridge in Galway will never be forgotten by those who have seen it, the bottom of the river being literally paved with salmon.

Before the advent of the English under de Burgo, the major portion of the co. Galway belonged to the powerful sept of the O'Fflaherties, or some of their dependents, their territory being known as Hiar (pronounced Yar) Connaught. This extended from the Shannon on the east to the Atlantic on the west. Afterwards the O'Connors, with the aid of their English allies under de Burgo, drove the O'Fflaherties west of lochs Corrib and Mask; the name of the territory retreating with them. Hiar-Connaught of the present day, the subject of this sketch, is bounded on the east by these lakes, west by the Atlantic, south by Galway Bay, and north by the fiord of Killary Harbour and the Formnamore mountains. It comprises the barony of Moycullen, Connemara, and the Joyce country. Moycullen, or Magh-Ullin, *the field of Ullin*, was so called from Ullin having slain the famous navigator Mananan-mac-Sir (Mananan, *the son of the Sea*), in a battle in the district. This place was marked by a long standing stone: according to Wilde, the stone is now lying prostrate in a furze field in the townland of Leagaun (*anglicè*, standing stone), not far from the old road between Oughterard and Galway, and about six miles distant from the latter place. Connemara, or Coumhaicnemara, that is, Sea-Counacney, was called after Coumac or Coumhaicne, to distinguish it from two other territories also called after him, namely Conmacny-rein, in the cos. Longford and Leitrim, and Conmacny-dunmore, in the N.E. of the co. Galway. This name was changed to Ballynahinch (*town of the Island*), after the O'Fflaherties' castle in Loch Ballynahinch, but of late years the old name has been much in use. Joyce country, so called from a Welsh family of Jjoyce or Shoyc who settled in the district of Partry, west of Loch Mask, under the O'Fflaherties, about the middle of the thirteenth century.

Hiar-Connaught is most interesting to the antiquarian, botanist, and geologist, especially to the latter, as in it the solution of many geological problems is manifest. Here we can study the different phases of the Drift, also what ice can do to rocks; the

formation of "rock-basins," and the connections between valleys, fissures, and breaks. Vast areas are bare, or nearly bare, tracts of rock, in which the solution of many of these different problems is mapped out by Nature's hand. The relation between many of the different kinds of rocks is also exemplified; as the gradations from the sedimentary rocks through the metamorphic into the granites; as also the gradations from the latter rocks into the Plutonic. These subjects, however, we hope to treat of in future sketches, and in this will give an epitome of the Physical features of the area.

To the east of the district, margining lochs Corrib and Mask, is low limestone ground, while in general the rest of the area is composed of groups of hills intersected and divided from one another by narrow low-seated valleys; to this, however, there is an exception, namely, the champaign country between Roundstone and Clifden.

To the south-east of the area are the low irregular Moycullen Hills, rising from the carboniferous limestone flat, margining Loch Corrib; while to the north, and separated from them by the Oughterard Valley, are other hills in the same barony; and still farther north, on the other side of Maum Bay, the north-west arm of Loch Corrib, are the Joyce country hills. The latter at one time formed one extensive slightly undulating table-land. To the right hand, but now isolated from the rest, is Benlevy or Gable Mountain, so called from its likeness to the gable of a cabin; while in the background is the massive table-land of Formnamore, the only true highland in the country. This is separated from the hills in the foreground by the deep valleys in which are situated Derry and Kilbride bays, arms from Loch Mask, and the valley of the picturesque Loch-na-foeey. The massive form of Formnamore is seen from Ailledubh, at the west end of Loch-na-foeey. The Maum valley, extending northward from the end of Maum Bay to Leenaun, on Killary Bay, is a narrow deep low-seated valley, nowhere more than 130 feet above the sea-level, and rising on each side abruptly to form hills having peaks of considerable altitude. Maum, a connecting gap between two valleys, is a common term in this part of Ireland. *Maam* or *Mām* (pronounced *Mawm*) is the hollow formed by the palm of the hand when the fingers are raised up. This Maum is the gap, *par excellence*, having been the great leading thoroughfare in ancient times from the central plain of Ireland into the wild country to the west. There are also others, such as Maumturk, *the pass of the wild boar*; Maumbwe, *the yellow pass*; Maumean, *the pass of the birds*; Maumeen, *little pass*; Maumnagee, *windy pass*; and numerous others.

To the south of Maum is the isolated sugar-loaf hill called Lackavrea. This, although low compared with many other hills in the country, is considered by many of the natives as the highest. This mistake,

however, is allowable, if the hill is seen towering above you while rowing up the narrow fiord-like—Maum Bay. The name of this hill, which means *tangled flags*, is most expressive, the hill being composed of quartzite, metamorphosed flagstones, that perfectly deceive the observer, as, from appearance, the rocks seem capable of being spit up, while in reality they are a compact intractable mass. West of the Maum Valley is the abrupt rugged Maumturk range, called after the deep pass through it; while to the north are the Leenaun hills, separated from the range just mentioned by the pass called Glenisky (*the watery glet*); to the south it is separated from the Coreogmore hills by Maumean (*the pass of the birds*). Through the latter all the woodcock and duck when migrating are said to pass. This may have been the case once, but nowadays they do not seem to frequent it much. It is also remarkable for a Tober and Labba, both called after St. Patrick, who is said, when, weary and tired in his peregrination through Ireland, he at nightfall reached this place, to have prayed for water and a resting-place, which were immediately given him; but in the morning, when he saw the desolate country before him, he said, "I bless you to the west, but never a foot I will put among you," when, turning on his heel, he went back again. We can scarcely credit that such a good man would make such a rash speech; we therefore hope it has been put into his mouth by his enemies.

Here it may be mentioned that all the quartzite hills in the country, with only one or two exceptions, have peaked summits, while in general none of the other kind of rocks form peaks. Bounding Maumturk range on the west and south-west is the valley of Lough Inagh. This to the south is split into two by the isolated hill called Lissoughter (*upper fort*), so called from an ancient encampment on its south-west slope; Caher-eighter (now called Caher), or the *lower fort*, being situated farther south in the valley. To the west of the valley of Lough Inagh are the well-known twelve pins or stacks, called in Irish Ben-na-Beola.

To the north of Ben-na-Beola is the picturesque wooded valley and lake of Kylemore, much improved and beautified by the owner; while farther north are the massive hills of the Benchoona group, bounded on the north by Killary Bay.

The hills that have been mentioned, excepting the South Moycullen hills, all lie to the north of the low wide valley that stretches from Oughterard, on Loch Corrib, westward to Clifden, on the Atlantic; to the south of this line, and west of the South Moycullen hills, the character of the country is slightly undulating, dotted over with lakes and lakelets (lochs and lochauns); but from it rise four isolated hills. Towards the east is the massive hill called Shannavarra; to the south, margining Kilkievan Bay, is the long smooth hill called Slieve Moirdaun; while farther S. E. are the hill-islands forming the Archipelago

that bounds the north-west portion of Galway Bay. To the N. and N.W. of the latter are a few isolated abrupt hills, the most marked being the broken but peaked hill of Cashel, rising out of the plain to the north of Bertrabve Bay; while to the southward is Errisbeg, the rugged hills on the west of Roundstone Bay. The name of this bay is interesting, as the Irish name of the place was Carrig-na-roan, or *the rock of the seals*, from a rock near the entrance of the bay formerly much frequented by these animals; the Carrig has been translated, but *roan* has been corrupted into *round*—hence the present name.

of them being fiords; that of Streamstown, to the north of Clifden, being four or five miles long, and on an average four hundred yards wide, while Killary Harbour, the mearing between the cos. Galway and Mayo, is over nine miles long and in general not a quarter of a mile wide. The latter is most striking, being for its entire length margined by abrupt hills of greater or less altitude. The sketch gives some idea of it; but as it was taken from high ground near the east end, in the vicinity of Leenaun, in places the adjoining hills do not appear to be as high as they really are.

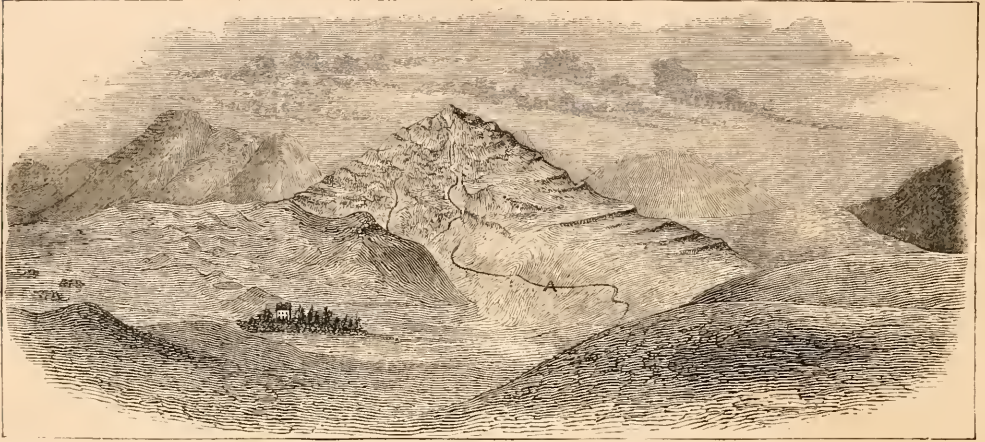

Fig. 150. Panoramic view of Lough Inagh, with Ben-na-Beola on the west, and the Maum-turk range to the east.—A, road.

West and north of the Errisbeg hills is the champaign country previously mentioned. This, viewed from any of the southern peaks of Ben-na-Beola, has a most peculiar aspect, studded as it is with innumerable lochs and lochauns, which, in connection with the archipelego to the south-east, makes it nearly impossible to detect where the sea ends and the mainland begins. This place can scarcely be described: it must be seen to have any conception of it. We have previously drawn attention to the floors of the valleys being so low; but it ought to be mentioned, that if Hiar-Connaught was lowered 10 feet, the major portion would be under water, and if 150, all the mountain-groups mentioned would be disconnected islands. Besides the lakes mentioned, there are others in all the principal valleys, except that of Maum.

As yet no mention has been made of the bays that indent both the south and the east coast. Those to the south are more or less irregular, but have a tendency to run nearly north and south. These north and south bays, however, are connected with others that cross them more or less obliquely; thus giving the sheets of water irregular outlines. On the west coast the bays run nearly east and west, two

THE ECONOMICAL PRODUCTS OF PLANTS.

No. III.

By J. T. RICHES.

OPIUM.—The well-known and most important drug is the inspissated juice of a plant known as *Papaver somniferum*, Linn.

The plant is supposed to have been originally a native of the Levant; it grows, however, very readily in this country, but there is no doubt it has been introduced at some early period. It grows about two feet high, usually with a smooth stem; leaves oblong, clasping the stem, glaucous, smooth; flowers light violet with purple centre; capsule smooth. It is cultivated in this country for the sake of its capsules, which are known as "poppy-heads," a decoction of which with chamomile flowers is often used for the relief of toothache and similar pains; an extract is also obtained from them. There is an abundance of oil contained in the seeds, which is expressed and used as an article of food, often mixed, it is said, with olive oil. In Greece and other places the seeds themselves form an article of food. The seeds of one variety are imported to this country, and

sold under the name of "Maw-seed," for feeding cage-birds.

The most important use, however, of this plant is the production of opium, for which purpose it is very largely cultivated in India, China, Asia Minor, Persia, Egypt, &c. There are two varieties more especially known in cultivation—one with violet or white flowers and black seeds; the other, with white flowers and seeds. The latter is the variety cultivated in India, where we may easily judge it forms an important article of trade by the "opium-pipes" kindly allowed for

(where such exists), and placed into large troughs or vats, when it is kneaded into a homogeneous mass by native workmen; it is then examined by native examiners, and the true quality is ascertained, and freedom from adulteration is insured. When the drug has arrived at that state, it is ready for exportation.

It is moulded into spherical masses, from 4 to 5 inches in diameter, and invested with dried petals fastened together with inferior opium, packed in cases, and exported in very large quantities to China,



Fig. 151. Arnotto Plant *Bixa orellana*.

exhibition by the Prince of Wales, presented to him during his recent visit to India.

The way in which opium is obtained in India is similar to, if not wholly the same, as that in other countries. When the plants are in flower, the petals are taken off and preserved for the investment of the opium balls. The capsules, when but imperfectly ripe, are lanced from top to bottom by small instruments known as "nushturs,"—an operation which is only performed on favourable occasions, usually about three o'clock in the afternoon. The milky juice quickly exudes from the incisions, hardens upon exposure to the atmosphere, and is collected in small iron "scoops." After repeated incisions are made, and the juice collected until the supply is exhausted, the drug is carried into the Government factory

where the practice of "opium-smoking" is carried on to an alarming extent, about which we have all heard. Its effects, of course, are most injurious to the persons habitually practising that habit. A small amount also finds its way to this country; but the chief supply of this country is obtained from Turkey and Egypt, and is the most esteemed: it is usually in the form of irregular lumps, varying from four ounces to two pounds, and covered with dock seeds. It is worthy of remark that the workmen employed in opium-factories, although exposed for several hours in a day to opium fumes, do not materially suffer therefrom: occasionally they are troubled with a drowsy sensation at the latter part of the day.

The chemical nature of opium is very complex; its

medicinal properties, however, are due to the presence of the alkaloid morphia.

It is one of the most valuable of all drugs, and is used with advantage in an immense number of conditions,—to relieve pain, allay spasm, produce sleep, prevent restlessness, promote perspiration, &c.

ARNOTTO.—This, to some extent, important colouring agent, is obtained from the seeds of *Bixa orellana*, Linn., originally a native of tropical America, by the side of rivulets and streams, but now cultivated throughout the tropics. It is a small tree, with a stem from 12 to 15 feet in height. Leaves cordate-peltate, tapering at the apex, smooth, on long petioles. Flowers in terminal panicles, pale pink; stamens numerous. Fruit bristly, two-valved, many-seeded. Seeds angular, covered with an orange-red waxy pulp. The pulp surrounding the seeds is the important part in an economical point of view. It has the smell of violets, and is bitter and astringent. A refreshing decoction is prepared from it, which is considered febrifugal, and is also used in cases of hæmorrhage, gravel, diarrhœa. The aromatic bitter seeds and root are reputed stomachics. So much for its "reputed" medicinal properties.

To obtain the arnotto, the seeds are steeped in water, and allowed to ferment; it then forms a valuable red dye, which by evaporation becomes a solid paste. This is made into cakes or rolls, known as arnotto or annotto. It is largely used by silk-dyers and varnish-makers, also for colouring cheese, butter, chocolate, &c. It was formerly considered an antidote to the poison of *Jatropha Manihot*. The Caribbeans formerly tattooed themselves with it to prevent mosquito-bites.

A MICROSCOPICAL SLIDE-BOX.

THE old cloth-covered microscopic slide-boxes, that we all know so well, have to this day some advantages possessed by no others. They take a large number in a small space, and, with a dozen or two slides, go easily into the pocket. They are unequalled for carrying about, but possess, as stationary boxes, this serious drawback, that each slide rests upon one edge, giving the object a great tendency to slip.

The newer tray-boxes are a great improvement upon these, in that all the slides lie flat. But it is very awkward when you happen to want a particular slide, and do not remember exactly in which tray you put it, to have to pull out a number of trays before you come upon the one containing the slide you want. Cabinets are well enough for home use; but are not portable, and labour somewhat under the same disadvantage as the tray-boxes.

There is great need of a box in which each slide may lie flat, and be kept in its place whatever temporarily may be the position of the box, one into which

the name of every slide may be seen at once, and any slide be taken out without disturbing any other.

Such a box, I think, is shown in the accompanying drawings. Fig. 152 gives a general perspective view, and fig. 153 shows a section of the same.

It consists of a box opening in front and at the top, like the tray-slide box; but here the trays, or rather shelves, are fixed, and have no front ledge. Each shelf projects a little beyond the one above, and is divided along its length by thin slips of wood into spaces, each just wide enough to take one slide. The

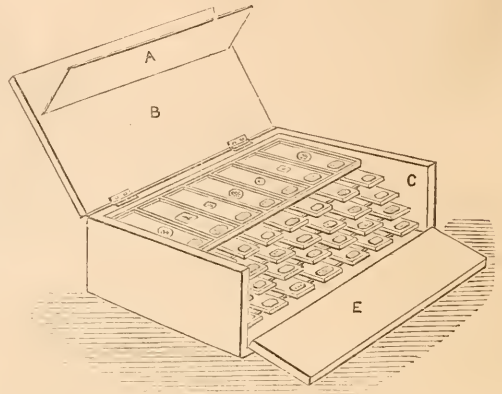

Fig. 152. Perspective view of Microscopical Slide-box.

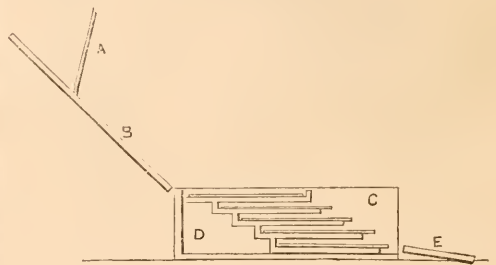

Fig. 153. Section of Microscopical Slide-box.

piece marked A in both drawings is a piece of card-board, or wood, loosely jointed to the lid, B. This, when the box is open, lies flat upon the lid, B; though it is drawn in the illustrations projecting, in order better to show its position. When the lid B, and the front, E, are closed, the piece A falls down, so that its lower edge rests in the angle formed by the bottom of the box and its front, E. It therefore lies fixed against the front edges of all the slides; so that if the box be placed on its end or upside down, the slides cannot shift, and will be found each in its place when the box is righted and opened. The slides project in front $\frac{1}{4}$ inch beyond the shelves, so that with the finger and the thumb, applied either laterally or vertically, any slide may be instantly removed. By making the shelves project $\frac{1}{2}$ inch, the labels on every

slide are visible at once. The top slides rest on a tray with a front ledge, and are prevented from shifting by this ledge and the lid when the box is carried about. All the shelves can be made of cardboard, as they have little or no weight to bear, and are each well supported by the partitions of the one below. This construction lightens the weight of the box considerably. If the shelves and sides be covered with white enamelled paper, they will be less likely to get dirty, besides giving a pleasing effect.

A box holding 35 slides, as in the illustration, would be 9 in. long by 5 in. broad and 2 in. deep.

The only spaces lost are those marked C and D in fig. 153. In a small box these could not well be utilized; but in a larger box I have made, these are also filled with slides; so that all the slides, 180 in number, can be seen at once.

I am indebted for the drawings to the kindness of my friend Mr. G. C. Maile.

Doubtless the idea is capable of improvement: whether it has previously occurred to any one else, I do not know, but I think the box has some advantages over other boxes now in use.

I have shown the box to Mr. Stanley, the optician, Railway-approach, London-bridge, who approves of the design, and expresses his intention of forthwith making some of this pattern. Should any of your readers not care to make them for themselves, he would doubtless be able to supply them.

A. W. STOKES.

Laboratory, Guy's Hospital.

MICROSCOPY.

MOUNTING IN DAMAR.—Having had a similar experience in mounting in damar to that related by Mr. Williams at p. 148 of the July number, I will shortly relate it. I had mounted some scales of Eleagnus in damar obtained from Mr. White, of Litcham, and shortly after the slides had been put aside to dry, I found in all of them crystals like those in fig. 136, which had the property of polarizing beautifully. Mr. White could not explain the circumstance, but gave me another bottle of damar, which has not hitherto deposited any crystals. Whether damar contains any ingredient of a saline character, or whether the solvent added to liquefy it was not free from such impurity I cannot say.—*G. D. B., Ealing.*

WHITE COPAL AS A MOUNTING MEDIUM.—I have seen much correspondence respecting the merits of damar as a mounting medium, but have found great difficulty in drying. This has caused me to look around for something which would possess the advantages of damar without the great disadvantage of its not drying. This I think I have found in the best white copal. I should be glad if any of your correspondents would try it and report thereon.—*T. B.*

“HISTOLOGY OF THE ISLAND OF REIL.”—Thoughtful microscopists will be delighted with an article in the last number of the *Monthly Microscopical Journal*, by Dr. H. C. Major, Medical Director of the West Riding Asylum, on the above subject. It is a careful histological inquiry into the structural peculiarity of the central lobe of the brain, called the *insula* or “Island of Reil.” It is that part of the brain which appears earliest both in the human foetus and in the higher apes. With the exception of the *Makis*, no indication of its presence has been observed in other animals. There are good grounds for believing that this part of the brain is connected in an especial manner with the exercise of the faculty of language.

ZOOLOGY.

THE BRITISH ASSOCIATION.—In the matter of excursions, the Plymouth meeting of the British Association, commencing August 15th, under the presidency of Professor Allen Thomson, will be notably attractive. There are very few localities in the kingdom in and around which there is so much to interest; and the object of the Excursion Arrangement Committee has been to cater for all tastes, and to give the widest range of choice. Plymouth itself is a very pleasant town, with its wide streets, delightful suburbs, magnificent Guildhall, and its famous promenade, the Hoe, which overlooks the waters of the broad Sound, with the Breakwater and the Eddystone, and the lovely domain on Mount Edgcumbe on its western shores. At the sister-town of Devonport are the Government dockyards and arsenals, which are open to inspection, while scores of ships of war, of all kinds and sizes, stud the Hamoaze—the estuary of the noble river Tamar,—across the upper reach of which Brunel threw the famous Albert Bridge. As is usual, two days are allotted to excursions. Saturday, the 18th of August, and Thursday the 23rd, are those selected; and the local executive have endeavoured to arrange the shorter excursions for the Saturday, to meet the case of those members who may be engaged in the sections which will sit on that day, so far as is possible. One of the chief of the Saturday excursions will be by steamer to the Breakwater and the Eddystone, and on the return round Hamoaze, passing the various Government establishments. The Breakwater is a mile in length, and two miles from the Hoe. The Eddystone, Smeaton's great work, is built on a reef thirteen miles from Plymouth, and has now defied the waves and the winds for over a century. It is possible that while in Hamoaze a visit may be paid to some of the ships there. One of the most interesting features of the excursion to Plymouth and Devonport at the time of the Exeter meeting was a visit paid to the *Cambridge* gunnery ship, to witness what may be called the electric gun drill and torpedo

experiments. Another excursion on the Saturday will be by rail to Liskeard, passing over the Royal Albert Bridge, and along the banks of the winding Lynher; and from Liskeard to the mines on the Caradon Hills,—a bleak range of barren moorland, but abounding in the picturesque, and stored with hidden wealth. Arrangements have been made to visit the well-known South Caradon copper-mine, and the productive tin-mine of Phoenix, not far distant. Here the mining operations, which are the special industry of the county, may be seen to the fullest advantage. To the mineralogist, too, this district should have much interest. South Caradon yields many forms of copper ore—chalcocite, chalcopyrite, and cuprite, with chesylite and malachite; and Phoenix, besides its cassiterite, has produced the rare chalcociderite, andrewsite, and the lovely turquoise, henwoodite. It is intended also to visit the Cheese-wing, the most grotesque pile of granite rocks in the county. Hard by are large granite quarries; and in the vicinity are the stone arches known as the Huslers, the Trevelly Cromlech, and other antiquities. It is understood that the good people of Liskeard will in some way entertain their visitors. The third excursion of the Saturday will be to the great China-clay works at Lee Moor, on the borders of Dartmoor, and within a few miles of Plymouth; and this is likely to be extended to embrace Prince Town and some of the more accessible pre-historic remains of Devon's great central waste, which stretches for many a mile almost a trackless wild—a weird region, but full of charm and interest. Finally, those who cannot take part in either of these excursions will be able, through the kindness of the Earl of Mount Edgcumbe, to visit his enchanting domain, unrivalled in its loveliness even in this rightly named “garden of England.” The chief local excursion on the Thursday will be up the river Tamar to Merwhellam, and thence to the famous Devon Consols copper-mines. The Tamar is one of the pleasantest rivers in England; and very few present such a combination and variety of charms. Above Saltash, where it is spanned by the Albert Bridge, it spreads into a wide lake-like expanse, beyond which the channel suddenly contracts and commences to wind in the most romantic fashion, the meadows which had lined its banks giving place to steep descents clad with wood down to the water's edge. At Cotehele Quay, which is in the heart of scenery of this description, the party will land for the purpose of visiting Cotehele House—an ancient seat of the Mount Edgcumbe family, and one of the most perfect examples of the baronial mansion now in existence. It has remained unchanged almost from the first, and still contains the arms and the furniture, the tapestry and the fittings, which it held back in the fourteenth and fifteenth centuries. For the opportunity of seeing this fine old house the members of the Association are again indebted to the noble owner. A little above Cotehele is Calstock,

and about four miles beyond this, Merwhellam, where the Tamar flows through a tree-shrouded gorge. From the precipitous hill-sides, rising to a height of over 200 feet above the river, jut out a series of crags known as the Morwell Rocks. Here is the grandest scenery on the river. From Merwhellam there is a mineral railway to the Devon Consols mines. These mines are noted for having paid considerably over a million in dividends, for the magnitude of their operations, and for the extent and completeness of their machinery. The largest waterwheels in the West of England are here, and the arsenic-works are the most extensive in the world. The arsenic is driven off from the arsenical pyrites in calciners, which obtain all the heat required from the combustion of the sulphur and arsenic in the ore itself. It is perhaps worth noting that when the British Association visited Plymouth in 1841, its only excursion was to the Tavistock mining district. Devon Consols, however, was not then in being. Another excursion will be to Torquay, but this will be by invitation. Following the excellent precedent set at the Exeter meeting, the Torquay folk intend to play the part of hosts, and to issue invitations to a distinguished party, whom they will conduct over the manifold attractions of that lovely watering-place,—in a scientific point of view chiefly famed for the celebrated Kent's Cavern, to which, of course, a visit will be paid. The mechanics of the party will feel a special interest in the experimental works of Mr. Froude, F.R.S., wherein the conditions of stability in various forms of vessels are exhaustively investigated. The pleasantest way of getting from Plymouth to Torquay will be to go to Totness by rail, thence down the enchanting river Dart by steamer, and thence again by rail skirting Torbay. Lastly, those who prefer to go West will find themselves consulted also. Arrangements are being made for an excursion to Penzance, the most interestingly situated town in all Cornwall: hemmed in by the beauties of sea and land; environed by antiquities dating back to the earliest times of recorded history, and far beyond; and with some of the most important mines in the whole county in the immediate vicinity. St. Michael's Mount, the Logan Rock, the Lizard, the Land's End, Botallack Mine, are the best-known points of interest in this far-west region; but they are only a few of many. What Penzance will do in the way of welcome is not yet definitely settled.—*R. N. Worth.*

NEW SPECIES OF CARNIVORA.—At a late meeting of the Zoological Society, Dr. Sclater described a new species of Cheetah from South Africa. It differs from *Felis jubata* in having its body covered with spots of a dark yellow colour, instead of black; and the body is also more thickly covered with hair. Dr. Sclater has given the name of *Felis canea* to this species.

HOW TO PRESERVE CRUSTACEANS.—Separate the upper from the under shell with a strong knife, remove the contents, and anoint the inside with corrosive sublimate dissolved in methylated spirits; then fasten the shells together with strong glue; if the crab is large, remove a little of the under side of the claw, and clear it out with a hooked wire; then fasten the piece in, place the limbs in position, and let it dry; varnish is not required. *Echini* simply require to be hung up to dry without any preparing. —G. Currie.

COLIAS EDUSA.—We have received upwards of thirty letters announcing the early appearance of this beautiful butterfly in nearly all parts of England. The greatest surprise seems to be connected with its unusually early appearance.

THE HOOPOE.—A fine specimen (male) of this bird has been shot this summer at Tockwith, near York. One wishes either that our rare birds should learn wisdom and keep away, or that their shooters might learn a little more mercy and common sense.

THE "CHALLENGER" RESULTS.—At a recent meeting of the Zoological Society of London, Mr. John Murray, naturalist to the *Challenger* expedition, exhibited and made remarks on a series of sharks' teeth, whales' ear-bones, and other specimens, dredged up at great depths during the *Challenger* expedition. Dr. P. L. Sclater, F.R.S., then read the first of a series of reports on the collection of birds made during the voyage of H.M.S. *Challenger*, containing general remarks on the collection, which was stated to consist of about 679 skins of terrestrial and 198 of oceanic birds, besides a considerable series of specimens in salt and in spirit, and a collection of eggs, principally of the oceanic species. A communication was also read from the Marquis of Tweeddale, F.R.S., containing a report on the collection of birds made during the voyage of H.M.S. *Challenger* in the Philippine Islands. Amongst them were examples of seven species new to science. Mr. P. L. Sclater read another paper giving a description of the birds collected at the Admiralty Islands during the visit of the *Challenger* expedition to that place. Amongst these were examples of six species hitherto unknown to naturalists.

CURRENT SCIENTIFIC LITERATURE.—The *Popular Science Review* for July has a very important article, by Prof. Duncan, called "Studies among the *Amabe*," which will be diligently read by all naturalists who use the microscope. A very readable article is that by Mr. W. F. Kirby, on "The Geographical Distribution of Animals." The Rev. W. R. Symonds has a very interesting paper, based chiefly on personal investigations, on "The Volcanoes of the Haute Loire and the Ardèche." Besides the above papers, there are others on various branches of

physical science, by Prof. Osborne Reynolds and Messrs. R. A. Proctor and W. N. Hartley. The scientific summary of the quarter is always a strong and attractive feature in this excellent magazine.

PROPAGATION OF FOOD-FISHES.—We have received Part III. of the "Report of the United States Commission on Fish and Fisheries," consisting of nearly 800 pages of printed matter relating to this important subject. The Report is in two parts, one of which is devoted to an inquiry into the decrease of our food-fishes, and the other into the propagation of food-fishes in the waters of the United States. The generous manner with which the United States Government distribute copies of all Government printed books on science contrasts severely with the miserable stinginess of our own Stationery Office, where the Reports of the Geological Surveys are not even sent to scientific journals for review.

SPIRIT PINASTRI.—Early in July last a fine specimen of this exceedingly rare moth was captured in the gardens of Tuddenham Rectory, near Ipswich, by the Rev. Mr. Long. A few days previously a specimen had been caught at Waldringfield, a parish about seven miles from Tuddenham.

CAPTURE OF A SEAL IN THE SOLWAY.—A specimen of the common seal was captured by the fishers at Port Carlisle on the 29th of June last; it was four feet long, and weighed 84 lb.—W. D.

CLEANING THE SHELLS OF THE SMALLER SPECIES OF MOLLUSKS.—I have recently adopted the following method of extracting the animal from some of the smaller species of land and fresh-water shells. After killing them by immersion in boiling water, they are placed in a large test-tube, with a solution of caustic potash, and heated to the boiling point; in a short time the animal is completely dissolved, and the shells are freed from the potash by boiling in plenty of distilled water. The method may not be new, but suggested itself to me whilst preparing some of the lingual ribbons of the mollusca with potash for microscopic examination; and, so far as I have at present tried it, I am pleased with the result. The epidermis of some species is injured by it, but for many kinds it seems to answer admirably.—T. E. Dogg, *Evesham*.

THE BLYBOROUGH TICK.—This arachnid, which has been lately described either as *Argas formosus* or *Argas Fischeri*, and depicted in two plates of the "Journal of the Microscopic Club," and several woodcuts in SCIENCE-GOSSIP, turns out to be the *Argas pipistrilla*, described in the "Proceedings of the Entomological Society of London" for 1872, by Professor Westwood. Mr. Gulliver, jun., took specimens, obtained from Mr. C. F. George, to Oxford, and the result was the determination of the species just named, which was made the subject of a communication to a late meeting of the East Kent Natural History Society at Canterbury.—Q. F.

BOTANY.

PLANT-CRYSTALS.—At the last meeting of the East Kent National History Society, at Canterbury, Mr. W. H. Hammond read a paper on this subject, and illustrated his observations by numerous admirably-prepared slides, exhibiting excellent specimens of true Raphides, long crystal prisms, short prismatic crystals, and Sphæraphides, so as to show the different forms of the various kinds of plant-crystals. And in order to give a bird's-eye view of them, he laid before the meeting the numerous engravings which had been published thereon by Professor Gulliver in the "Annals of Natural History," November, 1863, the "Monthly Microscopical Journal," December, 1873, and SCIENCE-GOSSIP, May, 1873. After observing the gross errors both of omission and commission in our current botanical treatises, including even the last edition of the "Microscopical Dictionary," Mr. Hammond proceeded to show the importance of a subject so lamentably neglected or maltreated by botanical writers. These crystals afford an inexhaustible supply of beautiful objects for microscopic examination, as regards both pleasure and profit; and this is in itself a great recommendation, now that the microscope is happily rivalling or superseding the piano in so many intelligent families. But these crystals are by no means mere curiosities. They are one of the means by which nature so bountifully provides stores of calcareous salts as food for animals to build up their solid tissues, and as manure when restored to the earth in the decaying leaves and other parts of plants. And Raphides afford such valuable characters in systematic botany that by them alone such orders in the British Flora as *Onagraceæ*, *Galiaceæ*, and *Balsaminaceæ* may be at once, at any stage of their existence, distinguished from their nearest allies in the same flora. And yet these plain and important characters have not yet been even noticed in our systematic books! Hence the whole subject requires that further ventilation which may be given to it by the readers of SCIENCE-GOSSIP, and which it has not yet received from our metropolitan societies, nor indeed, according to Mr. Hammond, from any society except that already mentioned. But the crystals are so numerous and beautiful, and so exquisitely adapted for the preparation of slides for the microscope, that they are not likely to be much longer neglected.

FORESTRY.—There are few of the specializations of practical science which have, of late years, been so little studied as that of Forestry. We are therefore glad to welcome another literary *confrère*, which has just appeared under the title of *The Journal of Forestry*. We have received two numbers of this shilling monthly, and believe, from its solid, and attractive table of contents, that it will be welcomed by all who love arboriculture.

EPIPHYTAL PLANTS.—On the 9th of June, while walking with two friends through Stone Fenny, a wooded dingle near Kidderminster, we observed the Wild Raspberry (*Ribes idæus*) and the Red Campion (*Lychnis diurna*), the latter in flower, growing epiphytally upon an old pollard willow, at a height of about eight feet from the ground.—*Horace Pearce, F.L.S.*

ORIGIN OF LONG STAMENS IN CRUCIFERÆ.—From a plant of the common watercress, I have just gathered a raceme of unripe pods, one of which has at its base a lateral flower, which appears to have been developed within the original flower, perhaps in the axil of one of the sepals. Having never read of such a formation, I send you so much of the raceme as may enable you to perceive its character; and I also enclose a similar pod which I gathered from the same plant, more than a week ago, with two lateral flowers at its base. As the origin of the two pairs of long stamens in cruciferous plants has been the subject of much discussion among botanists, may I suggest a possibility that they may be the leaves of lateral buds within the flower, which buds are capable, under exceptional circumstances, of being developed into actual blossoms.—*John Gibbs, Essex and Chelmsford Museum.*

SUSSEX OAKS.—In my "Rambles in Cowdray Park," published in vol. xiii. of the new series (1867) of the *Journal of Horticulture*, I made mention of several famous oaks, among which, in particular, one individual called "Queen Elizabeth's Oak," so called because traditionally said to be that under which her Majesty stood to shoot at the deer with a crossbow. This lordly tree had, at the time I visited the neighbourhood of Cowdray Park and Midhurst, a very picturesque appearance, and it was sound from top to bottom. The trunk, at four feet from the ground, measured 36 feet in circumference. In quoting this measurement, I alluded to that given in "Murray's Handbook of Yorkshire," of the celebrated Cowthorpe Oak, which was stated to be 36 feet 8 in. in girth, consequently, if correct, only 8 inches superior in circumference to that of "Queen Elizabeth's." But there appears to be an error somewhere, for there is a very wide difference between the above-mentioned figure and that given by Dr. Hooker in his excellent little work, "The Student's Flora of the British Isles" (1870), who quotes the girth of that forest monster as 70 feet.—*George Nevlyn.*

THE "EDELWEISS" (*GNAPHALIUM LEONTOPODIUM*).—There appears a probability of the extinction of this beautiful rare Alpine plant, which was so much noticed in the press, including SCIENCE GOSSIP, two or three years back, in consequence of a lady staying at Pontresina, in the Engadine, being said to have been killed by an accident while searching for the plants by the side of a glacier. In a paragraph in the *Times* of the 3rd July, copied from the *Echo*, it is said that

the Italian herdsmen and boys pluck up the flower by the roots, and offer it for sale to travellers; and no doubt they destroy every plant they can find. The local authorities and the Austrian Alpine Club have taken the matter in hand, in the hope of preserving the plant on the mountains; but it is hardly likely they will succeed, so long as travellers can be met with who are willing to become purchasers.—*T.B.W.*

SHINING MOSS.—If you think the following would be in any way interesting to the readers of SCIENCE-GOSSIP, will you kindly insert it in your August number. There is near Portsmouth, Lancashire, a narrow tunnel, made by miners for the purpose of working the coal. This tunnel is many years old, and its sides are covered with a very minute moss, which, when seen from the mouth of the tunnel, has a very delicate green metallic lustre. On going into the tunnel (about 5 feet high) this lustre is not seen, and the moss itself is nearly invisible. Its botanical name is *Schistostega pennata*. Could any correspondent give other instances of shining moss? Is not the moss very rare?—*T. Watson*, 54, *Bank Parade, Burnley*.

ALTHEA HIRSUTA IN GLOUCESTERSHIRE.—The readers of SCIENCE-GOSSIP may be interested in the occurrence of this rare plant. Yesterday, in a ramble in search of some of the botanical treasures which abound in our neighbourhood, I passed over Pur Down towards Stapleton, and was delighted to find this rare member of the Mallow tribe. From its situation I see no reason to doubt its claim to a place in our flora. The south side of the Down was covered with a splendid grove of old beeches, and I have repeatedly observed the almost entire absence of vegetation under their shade; some time ago most of these trees were felled, and it was round one of the old stumps the marsh mallow sprung up. The stems of all the plants are procumbent, and the colour and general appearance of the flowers similar to the common marsh-mallow (*A. officinalis*), but smaller, while the calyx, bracts, and the whole plant, are rough with erect hairs. Bentham describes the flowers as pale purplish-blue: these are a pale pink, with white stamens. In a shady lane leading from the Down into the Stapleton road, many plants of *Cardamine impatiens* were in fine flower.—*W. E. Green, Bristol*.

GEOLOGY.

VOLCANIC CONES.—At the last meeting of the Geological Society, Mr. Robert Mallet, F.R.S., read a paper on "A hitherto Unnoticed Circumstance affecting the Piling-up of Volcanic Cones." After some remarks upon the two forms of volcanic activity, the earlier system of "fissure eruption," and the present one of "eruption at explosive foci," which

he did not think could be carried back much beyond the Tertiary epoch, the author discussed the ordinary method of formation of a volcanic cone, and pointed out that the effect of the piling up of material must produce a pressure on the original surface commensurate with the amount of material heaped up on it, and therefore increasing gradually from the circumference nearly to the centre of the cone, where the loftiest column of material presses upon the unit of space. When the supporting rock is unyielding, such as the granite which bears the Puy of Auvergne, it will probably maintain its original position; but when it is of a more yielding nature, as in the case of the ordinary stratified rocks, the pressure of the cone will produce a saucer-shaped depression, deepest in the centre where the greatest pressure occurs; and this tendency to sink will be aided materially by the honeycombing and evisceration of the subjacent rock-masses exposed to the action of the volcano. The consequence of this depression of the surface supporting the cone will be to diminish the original slope of the successive superimposed deposits, and even in some cases cause the lowest beds to slope from the circumference towards the centre. If the strata upon which the volcano stands be particularly plastic, its pressure may cause an uprise of the strata into protuberances round the foot of the mountain. Similar phenomena may occur when the support of the cone is formed by older volcanic deposits.

THE INSECT FAUNA OF THE SECONDARY PERIOD.—A short time ago we stated that Mr. H. Goss, F.L.S., had read a very important paper on the Insect Fauna of the Tertiary Period before the Brighton and Sussex Natural History Society. The latter society has recently had the opportunity of hearing another paper by the same industrious naturalist, on "The Insect Fauna of the Secondary Period," which is even a better geological summary of all that is known of insect fossils than the preceding. Our knowledge of this department of palæontology has been very vague and untrustworthy, and we are therefore pleased to see Mr. Goss devoting his time and abilities to the subject. The latter paper is reported in full in the *Sussex Daily News* of June 15th.

NEW SPECIES OF FOSSIL BIRD.—Mr. W. H. Shrubsole, of Sheerness, has been fortunate enough to discover in the London clay of the Isle of Sheppy some large fossil bones, which Professor Owen states are those of a gigantic bird called *Lithornis cruiuus*.

NOTE ON A PROBABLE CAUSE OF FAULTS IN LIMESTONE.—I have for some time strongly suspected that some of the Faults and dislocations so frequent in limestone rocks may not be due to plutonic agency, but to a cause more constantly at work, and which is chemical, rather than mechanical. It is well known that the water falling in the form of rain

obtains by contact with decaying vegetable matter a certain amount of carbonic acid, capable of dissolving a portion of the limestone rocks through which it passes, and of carrying off in solution no small quantity of bicarbonate of lime, and in so doing acquires the character known as "hard." The same process would also doubtless occur to some extent in its horizontal passage through softer beds. Many springs carry off as much as 17 grains of lime to the gallon, and it is probable other material is being carried off in a similar manner. Now when we consider that springs frequently deliver from 1 to 100 gallons of water per hour, we must own that the denuding of the strata along certain lines must be considerable, and we cannot do other than suppose that the beds thus denuded would form an unequal support for the bands of rock overlying them, which would sink and crack, forming those joints and synclinals so common in limestone beds. At the surface these joints in the neighbourhood of Godalming are frequently filled with the sandy loam of the field; at others they probably form a line of surface drainage. The last stage of all, when the two causes had met, would probably be one of those deep ravines, sometimes having a stream at their bottom, which are so common among our Green-sand Hills. I should only add that I do not intend that all Faults have been caused by the agency of water, but I think the question is not so much what water cannot do, as what water can, and has done.—*H. W. Küll.*

OCCURRENCE OF THE REMAINS OF *Hyenarctos* IN THE RED CRAG OF SUFFOLK.—At a recent meeting of the Geological Society a paper was read on the above subject by Prof. William Henry Flower, F.R.S., F.G.S. The traces of *Hyenarctos* described by the author consist of a right and a left first upper molar, which were obtained from the Red Crag of Waldringfield, and are so much alike, that, but for the former being rather more worn, they might have belonged to the same animal. On comparison, these teeth were found to show no appreciable difference from the corresponding teeth of the original specimen of *Hyenarctos sivalensis* from the Sewalik Hills; and hence the author did not venture to regard them as representing a species distinct from the Indian one. The author discussed the synonymy of this species, which was first described by Falconer and Cautley in 1836, under the name of *Ursus sivalensis*. The genus *Agriotherium* was established for it by Wagner in 1837, and the names *Amphiarctos* and *Sivalarctos* were given to the genus by Blainville in 1841; but Falconer and Cautley's name *Hyenarctos*, although certainly of later date, has been generally adopted. Remains of the genus have been found in the Pliocene marine sands of Montpellier (*H. insignis*, Gerv.), and in Miocene beds at Sansans (*H. hemicyon*), and at Alcoy, in Spain. An early perfect mandible of *H. sivalensis* has recently been obtained in its original locality by Mr. Theobald.

NOTES AND QUERIES.

THE CORMORANT.—I have lately been engaged in the study and observation of the common Cormorant (*Phalacrocorax carbo*), and perhaps some of the results thereof will prove not uninteresting to the readers of SCIENCE-GOSSIP. 1. In the first place, after a rather extensive experience, I may say that I never saw any cormorant execute the juggling feat of tossing in the air a fish captured tail foremost, so as to cause it to be caught again and swallowed in the more approved fashion of head foremost. 2. Ornithological writers, in treating of the habits of this bird, would lead us to suppose, that, after fishing, it generally alights on a sand-bank, &c., and remains stationary in that position, with its wings held out to dry, for hours at a time. Now, I have frequently seen as many as twenty cormorants in the precise position now referred to, and in no single instance have I seen the wings expanded in order to dry for a longer period than a couple of minutes. The bird flies tolerably rapidly, presenting a sharp, lengthy appearance while suspended in the air, and alights upon an insulated bank of mud or sand. It tucks away its short "eutty" wings, commences to preen its feathers or its down, and presently expands its wings in a manner that clearly indicates that some effort is required for that purpose. Perhaps the bird revolves a point or two on its axis (as it were), so as to quicken the evaporating process. Perhaps also, too, he may flap the wings backwards and forwards two or three times; but I am convinced that to keep them fully expanded for any considerable time would involve a straining of the muscles and an expenditure of physical power which the bird, in its season of rest and relaxation, is barely competent to endure and to display. Moreover, the whole flock thuswise reposing do not *simultaneously* expand their wings in the manner described; perhaps two or three out of ten may do so at any one time. 3. Lastly, I wish to make some observations respecting the commonly accepted opinion that cormorants are "low" birds, and that hardly any of the other members of their order would be seen in their company. Now, on several occasions I have seen a great black-backed gull (*Larus marinus*) reposing on the same sand-bank with these "vulgar creatures." It is no exaggeration to say that if birds in general are at all capable of feeling emotions of pride and vanity, if they are anywise disposed to entertain an overweening opinion of themselves, then most assuredly the gull now mentioned can do so, for of all the birds that hover over the ocean, this one is the most pompous and the most imperious. Frequently have I observed this haughty gull strutting about with all its usual pomposity, or reposing in its usual "studious" manner upon a stone, within a few feet of where a company of ugly cormorants were resting themselves and preening their feathers, and expanding their wings with all customary eccentricity. Occasionally, too, specimens of that most indefatigable and most smart-looking of little birds, viz. the Oyster-catcher, would advance very near to the chosen resting-seats of these most powerful, vigilant, and enduring of Nataires.—*P. O'Keegan, LL.D.*

RED-WINGED STARLING.—Early in May last year, when commencing a collection of birds' eggs, I obtained in the village of Roundhay, near Leeds, a nest containing five eggs which were unlike any I ever saw before. The nest, which was placed in the fork of a hawthorn tree, was composed, as nearly as I can recollect, of twigs and stalks externally, and was lined with wool or hair. The eggs, which are of

a greenish grey, streaked with deep yellowish brown, I sent to Mr. T. W. Dealy, of Sheffield, for his opinion of them, and he informs me that, after comparing them with others in his own collection, he has come to the conclusion that they are those of the Red-winged Starling. As this is an American bird which seldom breeds in England, I thought the fact worth communicating to other egg-collectors through your valuable columns.—*A. Wyles, Leeds.*

HERONS AND ROOKS.—I take it that it is by no means general for herons and rooks to live peaceably in a common home. Heronries that I have known, notably the fine one at Dynevor Castle, Llandilo, the seat of the noble owner, Lord Dynevor, being situated upon taller trees than rooks care to build upon, that is, where such trees exist. I write more, however, to direct attention to a varying instance. At the old, and once high-regal residence, Wanstead-park, there is a very extensive island, overgrown with masses of aquatic and semi-aquatic vegetation. Here upon very low trees—mere saplings—herons build freely, and the young might be brought down with stones—sitting upon the branches—could the island be reached. Rooks nest abundantly amongst these trees, near to, if not quite beside, the herons' nests. I have shot the young rooks thereon, but I have not seen the least antagonism displayed between what appeared to be those highly friendly colonies, so anti-homogeneous notwithstanding.—*William Earley, Valentines.*

STRENGTH OF BEETLES.—A similar instance to that mentioned by Mr. Sclater a short time ago has happened during my own experience. A few summers ago I remember putting four or five male stag-beetles (*Lucanus Cervus*), *pro tem.*, into a good-sized chip-box. This box had an exceedingly tight-fitting cover, which I thought would resist all attempts made to escape on the part of their "Stagships." Great was my surprise, however, upon going to the box some two or three hours afterwards, to find it empty, with the cover off and lying on the table, and the fugitive beetles crawling about on the carpet. I know for a certainty that no one had been near the box in question during my absence, so that these insects must have pushed the cover off by main force. Another beetle which I have found to possess great muscular power is the curious *Typhaeus vulgaris*. I once captured a male specimen of this insect and lodged it in a small box until I was at leisure to examine it. As the cover, however, was rather large for the box, I took the precaution to place a heavy preserve-pot (which was close at hand) upon it to keep it down in its place. But I was greatly astonished sometime after to see the cover being raised several times and the jar tilting on one side, the result of the imprisoned insects' efforts to escape. The Dor-beetle (*Geotrupes vernalis*) is also said to have enormous strength, but I have had no opportunity of observing this.—*G. O. Howell.*

EGGS OF YAMA-MAI.—In answer to Mr. Doe's inquiry respecting Dr. Wallace's successor—he was a Mr. Teutschel, who in turn was succeeded by Mr. S. H. Gaskell, 147, Brimington, Stockport, where I have for years past obtained all the requirements of sericulture.—*Arthur Smyth, Parracombe, Devon.*

BES AND PAINT.—The other day, as I was painting a new beehive, not far from an apiary, a lot of bees hovered round me, some even alighting on the newly-painted hive, as though enjoying the paint. Can any of your readers give the cause of this, to me, somewhat remarkable occurrence?—*Arthur Smyth, Parracombe.*

DRYING BRITTLE PLANTS.—Most botanists will have observed that many plants, though quite supple when fresh, lose all their flexibility when dry, and have a provoking tendency to crumble to powder with very slight pressure indeed. This is the case with the various species of *Chara* and with the leaves of many flowering plants. It is very annoying, after sending a parcel of specimens carefully packed to a friend, to learn that on its arrival many of them were so much broken as to be scarcely recognizable; and if any correspondent can give a simple method of treating such species so that they will retain their pliability when dry, as many of our favourites are now blooming around us, the information will be both useful and opportune.—*D. Douglas.*

HYBRID PRIMULA.—I found the other day what I supposed to be an oxlip, but which seems to be a hybrid between a cowslip and a primrose, in a ditch between a field of cowslips and a wood containing primroses. The oxlip had a large thick stalk and flower, which was surrounded by half a dozen or more primroses, all springing from the same point and attached to the same root. Can any of your readers tell me if this is a common occurrence?—*B. W. Hant.*

IS THE LEMMING FOUND IN ENGLAND?—On the 14th of May in the present year, whilst walking from Pattendale into Mardale, over the High Street range, we observed, at a height of about 2,500 feet above the level of the sea, a great number of small holes in the ground. These holes were very irregularly disposed, but there was a continuous line of them (many evidently quite new) for some distance along what is nearly the highest part of the range, and they lay behind the shelter of the stone wall which runs parallel to the old Roman road from which this mountain derives its name. These holes excited our curiosity, for we had never seen anything exactly like them before. They were apparently too small to have been made by moles, being very little more than an inch in diameter, and were excavated in many cases through the snow, which was still lying in considerable quantities on this, the eastern side of the wall. All the newest holes were surrounded by a ring of the earth which had been thrown out, and carefully piled up. In the case of others which had evidently been buried for some time beneath the snow, the latter had pressed down and often partly or altogether removed the heaps of soil. On looking more closely, we discovered that the holes were connected by innumerable underground runs tunnelled as near as possible to the surface, for the roof of some of them had been displaced, allowing us to perceive the breadth and depth of the passage, which was about one inch or so in width, and was continued under the snow. Putting aside a mole—for these appearances were utterly unlike any mole-heaps we had ever seen—what animals could have made and inhabited these holes and runs in such an elevated position? We watched in vain for one to come forth: probably they were aware of our neighbourhood, for they took care not to show themselves. The only creatures we could think of whose homes would at all resemble those described, was the lemming. This curious little animal lives in communities, burrowing near the surface in search of the roots on which in winter it subsists, and is very shy of showing itself. But are there any lemmings in England? They are not supposed to inhabit these islands now, though their fossil remains are sometimes found. If, however, any do exist here still, perhaps the highest points of the Lake district would be as suitable a place for them as we could find; for Norway and Lapland

must, of course, be much colder than any part of England, and it is in the most northerly countries of Europe that they are found in any numbers now. If the little animals whose traces we thus noticed on High Street were not lemmings, as we are almost inclined to believe, what could they have been?—*E. Anna Clifton Ward.*

BIRDS' EGGS.—Can any reader tell me, from experience, whether rinsing birds' eggs with a solution of corrosive sublimate affects the colour of the egg in any way, or makes the shell more brittle? And can the solution, after having rinsed one egg, be used with effect for others? Any information will oblige. I should also be very glad to know the correct quantities of corrosive sublimate and spirit of wine to make the solution of.—*H. H. C.*

MIGRATION OF BIRDS.—On April 16 I was surprised to see upwards of two hundred ring-ousels (*Turdus torquatus*) on the moors near Sheffield: they were very shy, and feeding upon the marshy meadow land; they kept together when disturbed, and, after wheeling about in the air, again alighted in search of food. Were these birds bound for more northern regions, and alighted here merely as a stopping-place, or were they just arrived from their spring migration, to scatter over the moorlands of this district? On April 17 I observed the Redstart (*Phœnicura rubicilla*) once more amongst us, fresh from the sunny regions of Africa. Saw no females. On April 18 I saw the Blackcap Warbler (*Curruca atricapilla*) for the first time this season: it was perched upon a hedge, busily employed searching the twigs for insects. It was a male, very wary, and did not utter any notes. On April 22 the Cuckoo (*Cuculus canorus*) was first heard near Heeley, and on April 23 I saw this welcome harbinger of spring. It was very tame and admitted of close approach; it was accompanied by a female chaffinch (*F. caelebs*). When the cuckoo alighted, it was amusing to see how trustfully the little willow wrens (*S. trochilus*) approached him. What a lesson these little birds teach to those individuals (I have known several) who most absurdly believe the Cuckoo changes into a hawk for the winter months. Instinct would teach them never to trust him at any time, never knowing when his rapacious propensities might again break forth with fatal result to themselves. The Martin (*Hirundo urbana*)—upon the authority of a friend—was seen on April 27, skimming with graceful motions over a pool of water. They (the swallows) are very late this season. None arrived as yet—May 1.—*Charles Dixon.*

THE RING-OUSEL.—The Ring-Ousel, like many others of the rarer British birds, appears every year to become scarcer. In Morris's "British Birds" Lamborne, Berks, is given as one of the localities where it has been met. To this I can add Binfield and Warfield, in the same county, from my own observation. In the former of these places I shot a female, mistaking it for a blackbird, several years ago, when the snow was deep upon the ground; and a male was seen for three seasons in succession, feeding on the berries of the Portugal laurel and holly, in the rectory garden, close to the house. Since the year 1860 I have not met with the bird again. As there has been some discussion in your pages as to the breeding of the Hawfinch in England, I may mention that it certainly breeds in both the above-named parishes, which lie within the old Windsor Forest district. It used to be one of our commonest birds, and is still very frequently seen, but not so often as formerly. In Warfield it is still common. I have seen it in Binfield every month in

the year. The Mountain Finch and Crossbill are occasional visitors; and some years ago I saw, and nearly caught, in the garden of the Rectory, a Siskin, in beautiful plumage, feeding on the seeds of an annual, in the month of September. There are many other interesting and rare birds to be seen, at times, in this part of Berkshire.—*E. S., Binfield.*

HARVEST BUGS.—An effective means of allaying the irritation caused by these little pests, and which has been found to answer admirably, is as follows:—Cut a lemon in half, and, taking one piece up with the hand, rub the juice well over the part or parts affected, and continue the process whenever there is any feeling of irritation. It will be found that this is conducive to considerable ease, and very soon the appearances caused by the insect vanish, and tranquillity is restored to the sufferer.—*W. H. Ingall.*

CARBONIFEROUS PLANTS.—In the sandstones associated with the carboniferous measures of the South Wales coal-field, I have recently discovered specimens of plants, the margin or back of same being defined by a ring of pure coal, which, however, frequently remains attached to the stone when removal is attempted. On grinding down sections sufficiently thin to transmit light, the structure of the plant is most beautifully shown, whilst the genuineness of the same being carboniferous plants is undoubted. I shall be pleased to effect exchanges of either material or prepared slides for other objects of interest, if any of your readers should require same.—*W. H. Harris, Partridge-road, Cardiff.*

FUNGUS ON FLIES.—On passing the edge of a field this morning, I noticed a large number of flies dead and attached to grass, nettles, and other plants: they were so numerous as to call for special attention. On examination they seem to be affected by a species of fungus, not unlike that which in autumn attacks the common house fly. A few individuals would not, perhaps, be noticed, but these might have been counted by hundreds clinging to the plants for a distance of some yards in this particular spot. What could have caused this excessive mortality would be interesting to know.—*E. Wheeler.*

NEW FACT ABOUT RED GROUSE (*Tetrao britannicus vel scoticus*).—What will ornithologists think when I tell them that the Red Grouse perches on trees! My attention was first drawn to this fact in the winter of the year '75. I was, as may easily be surmised, very much astonished, as I had read in many standard works on Ornithology that the Red Grouse does *not* perch on trees; and I was more surprised when I saw that "Old Bushman," in his "Spring and Summer in Lapland," asks, when pointing out the difference between the Red and Willow Grouse, Does the Red Grouse perch on trees? It seems to me a most extraordinary circumstance that an ornithologist who has been so much and so often among grouse, should never have noticed this habit. Since I first observed this new fact in the habits of this bird, I have seen it several times in the same position.—*T. W. Dealy.*

THE SPARROW-HAWK.—Have any of the numerous ornithological or oological readers of SCIENCE-GOSSIP ever heard of five different lots of eggs being taken (within a month) from *one* sparrow-hawk's nest? I have this year. They were composed of one four, one three, one two, and two ones, making in all *eleven* eggs taken from one nest at various times.—*T. W. Dealy, Sheffield.*

WREN'S EGGS, &c.—A friend and correspondent (Mr. R. Standen, Goosnargh, Preston) informs me that he took a clutch of *seven* sparrow-hawks from one nest. A few days since a lad offered to sell me a wren's nest containing twenty-five eggs.—*T. W. Dealy, Sheffield.*

CHARITABLE BIRDS.—In a garden at Acton three young thrushes were found on the ground. Two were dead, and the old birds were also missing, supposed to have been killed by the cat; but one of the young thrushes, still alive but unable to fly, was picked up and put into a large cage, which was hung up outside the window. In a short time a Robin was observed to visit the cage, and presently returned again with a worm in its mouth, which it deposited in the cage for the benefit of the young thrush. The pair of Robins afterwards visited the cage, and have since continued to feed the young thrush. Is not this a somewhat remarkable occurrence?—*R. H. Nisbett Browne.*

THE notice in SCIENCE-GOSSIP for June, concerning the collection of birds' eggs, is well worthy the attention of all ornithologists. There are too many collectors and too few students in all branches of Natural History. How many, even of our genuine "bird-lovers," when they find some rare bird's nest refrain from taking all the eggs; and the demand for rare birds and eggs is so great that both are found in decreasing numbers year by year. The editor of the *Newcastle Weekly Chronicle* has instituted a "Dickey-Bird Society" among the children of England. There are already a large number of members. The editor received, a short time ago, the thanks of the "Society for Prevention of Cruelty to Animals." I believe that a copy of the rules may be had on application to the editor. Is there any reason why the ornithological readers of SCIENCE-GOSSIP cannot unite for the protection of birds? The "Wild Birds' Protection Act," incomplete as it is, does a great deal of good, as very few persons are to be seen with guns during close time, and even bird-catchers do not ply their avocation to the extent they used to. I hope that in a very short time a union of ornithologists will take place, and that the birds of England will not be allowed to become extinct.—*J. T. T. Reed.*

PEREGRINE.—ORNITHOLOGICAL ERRORS.—With regard to Mr. Dixon, it will be well remembered that he intruded himself into the fray in a very indiscreet manner. He has not attempted to solve the question which Mr. Southwell and I were discussing. He only threw insinuations at me; endeavoured to stir up bad blood, and did not try to do anything towards the discussion referred to; moreover, he has even been personal in his abuse. If I give reasons to support an opinion, I have a perfect right to express that opinion, and no one has any call to attack me for doing so, although, of course, any one has a right to attack my opinion.—*T. W. Dealy, Sheffield.*

THE GRAVE OF THE REV. GILBERT WHITE.—In reply to Mrs. Helen E. Watney's letter in your last number relative to the grave of the Rev. Gilbert White at Selborne, your readers may be informed that it is on the north side of the church chancel, and that the tablet inside directs to the south side, having been misplaced in repairing the church some years since. The grave is well known in Selborne. Mr. Blunden, of the Queen's Arms Hotel, took me to it on a delightful visit I paid the place about two years since.—*Robt. J. Lecky.*

C. EDUSA.—Over thirty *C. Edusa* have been captured within the last three weeks round about Hornsey,

Colney Hatch (New Southgate), and neighbourhood. They appear to have been very common this June all over the country. Some of the specimens are worn, but a good many appear to have only just emerged from the chrysalis. Can any of your readers make any suggestions as to the *great number* and early appearance? Some have undoubtedly hibernated, while others have not.—*Wm. J. Vandenbergh, jun., Hornsey.*

"EDUSA" AND HYALE.—No satisfactory answer to Mr. W. Hambrough's query seems yet to have been arrived at, but the matter is now taking up great attention in the *Entomologist*, to which journal I beg to refer him.—*Wm. J. Vandenbergh, jun., Hornsey.*

THE GOATSUCKER.—In an article on the Goatsucker in your last number (July, 1877, p. 149), it is stated in the concluding sentence that this bird is found only in the southern and south-eastern counties of England. This is a mistake, as the Goatsucker visits us here in Kirkcudbrightshire annually, in some years more plentifully than in others. The only nests I have found of this bird have been under bushes of heather growing in low, swampy places, and, as late as the middle of July, the eggs were still unhatched. The last one I saw was "jarring" while flying round a large beech-tree; it was apparently pursuing some insect, as its flight was in a jerky and zigzag manner. As a rule, I think its cry is uttered immediately before or after it has taken flight from a branch or fence where it has been sitting; but its shy nature, and the time of flying, are difficulties in the way of close observation of this interesting bird.—*Robert Service, Dumfries.*

PRONUNCIATION OF NAMES.—A scientific name is a Latin, not an English word, and must be pronounced, if not spelt, accordingly. If this were borne in mind, we should not have such words as "Richardsonia" or "Richardia," which might have been spelt as pronounced—Ricardia, Ricardsonia,—the "c" being hard. As cases in point, I would refer to the careful Latinizing of their own names by old authors, and suggest that "Brunii" is more euphonious than "Brownii," "Divisiensis" than "Deviensis, and "Trinobantum" than "Londinensis." Pleasing form, euphony, and correct formation, are objects worth aiming at in scientific terminology.—*G. S. Boulger.*

HARDY FLEAS.—On the servant cutting through a loaf of bread, the other week, she observed several fleas, which she put aside on a piece of paper and showed to me. On touching them, *two actually jumped* in proper flea fashion, after having been kneaded and baked! Some of the flour was Austrian, and the fleas were supposed to have got in during the voyage. So said the flour-dealer.—*T. W., B.*

BIRDS' NESTS.—A remarkable instance of trustfulness in the nest-building of birds came under my own notice a few days ago. For three years successively a pair (I presume the same) of the common Black-cap (*Curruca atricapilla*) have built their nest in the private letter-box of a friend of mine at Glendon, near Kettering, in this county. The box is situated inside a gate into a park, and of course the letters and newspapers are slipped in on to the birds below; but this they do not seem to object to, nor to be disturbed when the box is opened for the letters to be removed. Each year they have successfully reared their brood: last year seven flew away, and this year I saw *ten* nested at the bottom of the box, fully fledged, and I have no doubt flown by this time.—*W. A. Law, Northampton.*

NOTICES TO CORRESPONDENTS.

TO CORRESPONDENTS AND EXCHANGERS.—As we now publish SCIENCE-GOSSIP at least a week earlier than heretofore, we cannot possibly insert in the following number any communications which reach us later than the 8th of the previous month.

B. K.—We do not fear the extirpation of any rare plant by the members of the Exchange Club. They are all too genuine botanists to assist in such vandalism.

F. F. (Highbury New Park, N.).—Your plant belongs to the nat. ord. *Umbellifera*, and is a woodland species, commonly called Wood Sanicle (*Sanicula Europæa*, Linn.).

T. H. (Oldham).—It is probably a plant carried to its present habitat with ballast; however, it is the rare *Lepidium latifolium*.

W. J. H.—We believe the fern enclosed to us to be *Athyrium molle*. It is a very interesting variety.

H. W. T. (Rugby).—We always place finely powdered camphor, sewed in small flat bags, on all our herbarium shelves, and we are never troubled with insects. Your plants are as follows:—1. *Ficus lamprocarpus*. 2. Quite correct. 3. *Eranthe fluviatilis*; colour very rare. 4. Not to be found. Kindly send the latter, whatever it be, again.

M. H. R. (Newcastle).—Your specimens are very interesting. No. 1. *Cystopteris dentata*. No. 2. *C. fragilis*. They are now generally merged into a single species, though Francis names them as above.

E. F. C. (Leicester).—The neat specimens you sent are as follows: *Briaea media*, Linn. (common Quaking Grass); *Melanofyrum montanum*, Jousst, perhaps only a variety; *Phalaris canariensis*, Linn., not a true native, the product of some bird-ge; *Sphergula arvensis*, a very common weed in cultivated land. Farmers call it "Pickpocket," because it is injurious to most fields where it is found.

F. CRANFORD.—The monstrosity in the daisy you mention is that known to botanists by the name of "Hen-and-Chickens" Daisy. See Masters' "Vegetable Teratology."

J. INGLEBY.—The fragment of rock is a siliceous sandstone, but unlike the "gannister" rock of Lancashire in composition, but more granular in structure.

T. B. T.—The association referred to by Mr. Palmer in his communication to our columns is the "Postal Micro-Cabinet Club." It originated through a discussion in these columns in 1873, and you will find all that you require to know, as well as the rules, &c., of the Club, in the December number of SCIENCE-GOSSIP for that year.

E. GROVE.—The specimen is that of the common Tutsan (*Hypericum androsaemonum*).

T. TAYLOR.—One of the best books of its kind is Geikie's "Physical Geography," just published by Macmillan.

A. C. (Market Drayton).—Morris mentions the fact of several young cuckoos having been kept, by great care, throughout the winter. Worms or occasional chopped meat would serve as food.

J. E. PRITCHARD.—You may obtain artificial birds' eyes of all kinds and in any quantity, from J. Gardner's, naturalist, Holborn, London.

F. H. SWALLOW.—The objects enclosed in a small bottle are the larvæ of a species of Ephemera. The larvæ of several species of beetles are called "Wire-worms," but perhaps the commonest are the larvæ of *Elatér*, or "Skip-jack" beetles.

R. V. T.—Consult the "Micrographical Dictionary."

N. WILSON.—You will find a capital life-history of the common *Anaba*, and where to find it near London, in the last number of the *Popular Science Review*.

A SUBSCRIBER.—The cottony substance sent us was the seeds of the White Poplar (*Populus alba*), covered and surrounded with the usual silky hairs.

F. MOCKLER.—A solution of chloride of lime is one of the best means of cleaning corals, fossil or recent.

J. J. MORGAN.—The chalk-like dust found in a fissure of rock near a coal-seam appears to be *Arragonite*. Under the microscope the crystals appear very distinctly, and polarize beautifully. Can you send us a little more? There was not sufficient to analyze it.

EXCHANGES.

Will send *Schistostega pennata* (Shining Moss) in exchange for plants.—T. Watson, 54, Bank Parade, Burnley.

SPECIMENS of *Synaпта inhorrens* in exchange for good Micro. Slides.—William O. Firth, White-rock, Belfast.

DUPLICATES—Rubiginata, Radiata, Derivata, Propugnata, Fulvata, and others. Desiderata—many Noctue and Geometra.—J. Woodgate, New Barnet, Herts.

DUPLICATES—*Z. nitidula*, *H. fulva*, *H. rotundata* (white var.), *C. laminata*, *C. rugosa*, *C. minima*, for *Z. radiatulus*, *H. Cantiana*, *B. fragilis*, *C. Rolphii*, *P. glutinosa*, or British marine and foreign Land Shells.—Thos. H. Hedworth, Dunston, Gateshead.

Lavatera sylvestris, *Ophioglossum vulgatum*, *B. ambiguum*, *Viola Mackaia*, *Orbanche amethystea*, and *Orchis maculata*, for other rare plants.—W. Curnow, Pembroke Cottage, Newlyn Cliff, Penzance.

AQUARIA.—*Planorbis corneus* and *Paludina vivipara* in exchange for Shells or Fossils, &c.—Mrs. S., Brentford End, Middlessex.

FOR a small box of Foreign Cape Shells sent through the post, will send in exchange living Diatomaceæ on weeds. Will also exchange Polish Slabs of Madreporous for Trilobites.—A. J. K. Selater, 9, Bank-street, Teignmouth, Devon.

WANTED, to exchange, good Rhatic fossils, from Aust, for good Tertiary Fossils.—W. T. Ord, 13, Royal-park, Clifton, Bristol.

SILURIAN FOSSILS from Dudley, in exchange for British Birds' Eggs.—Address, D. M., Towns-end House, Kingswinford, near Dudley.

N. BAILEY'S "Etymological Dictionary," containing unique and scientific words, scarce. Wanted, Babington's "Manual of British Plants."—Medicus, Newferry, Birkenhead.

ONE-HOLED EGGS of P. Flycatcher, C. Sandpiper, W. Ousel, G. Wagtail, Dunlin, Oyster-catcher, Black-headed Gull, Arctic Tern, &c. &c. What others in exchange? Unaccepted offers not answered.—W. D., 17, Grey-street, Carlisle.

WANTED, other insects for Fuliginosa, Humuli, Velleda, Alsus, Atalanta.—E. T. Smith, 23, Watson-street, Aberdeen.

WANTED, Jukes & Geikie's "Manual of Geology." Please say condition and price.—G. A. O., 121, Golborne-road, North Kensington, W.

Nos. 233, 363, 682, 873b, 1263, and *Matva borealis*, seventh edition London Catalogue, for 106, 108, 137, 164b, 556, 588. Lists exchanged.—C. A. O., 5, Wenbau-terrace, Worthing, Sussex.

Volvox globator.—A supply sent to any address on receipt of bottle and postage. Spare material of any kind acceptable.—Edward Howell, Gas-works, Yeovil.

EGGS of Landrail, Grasshopper Warbler, Kestrel, Sparrowhawk, Stonechat, Spotted Flycatcher, Chiffchaff, all side-blown, one hole, for other good eggs.—A. H. Martin, 66, High-street, Evesham.

GOING to a Yorkshire watering-place, Advertiser will be happy to exchange Fossils from Neocomian Oolites or Lias of that county for specimens from some other district, or scientific exchange.—W. H. Herries, Trimley Park, Farnborough Station.

OFFERED to exchange for other rare Plants or Mosses. *Ran. tripartitus*, D. C., 161b, 315, 328, 330, 333, 334, 335, 363, 346, 611.—R. V. T., Bore-street, Bodmin.

A FEW Slides, illustrating the organisms of sedimentary deposits, recent and fossil, for exchange.—E. Lovett, Holly Mount, Croydon.

"BELL on Cow-pox," coloured plates; SCIENCE-GOSSIP, 1876-77; small Microscope, three powers. Wanted, a good Lens, or Books.—Medicus, Newferry, Birkenhead.

I HAVE EGGS of Guillemots, Razorbills, Kittiwakes, &c., to exchange for Dippers', Owls', or other good Eggs. Send list.—Address, J. W., 73, High-street, Bridlington, Yorks.

COMMUNICATIONS RECEIVED UP TO 6TH ULT. FROM:—F. K.—Prof. G.—H. M.—W. W. I.—R. A.—S. S.—J. D. W.—W. T. O.—P. D.—J. T. R.—J. S.—H. P.—A. J. R. S.—D. J.—W. R. H.—H. G.—W. J. H.—W. H. S.—J. S.—R. H. N. B.—J. M.—D. M.—J. W.—V. C.—W. G. T.—G. C.—R. W.—G. W., jun.—C. C. C.—A. D. M.—W. J. V., jun.—E. W.—T. H. S.—J. E. S.—J. B. G.—F. M.—W. G. G.—W. R. H.—F. W. F.—D. J.—A. P.—W. B.—J. W.—H. A.—H. L.—E. T. S.—H. W. K.—G. C. D.—W. B. A. F.—W. A. L.—W. H.—B. K.—C. D. B.—G. A. O.—J. W.—J. H. O.—H. W. K.—T. E. D.—T. B.—C. T. M.—T. B. T.—G. C.—G. N.—E. H.—C. A. O.—A. C.—A. H. M.—C. B. M.—J. L. M.—R. G.—R. J. L.—W. M. B.—J. G.—G. S. B.—R. H.—F. H. A.—H. C. R.—W. T. V. D.—F. H. M.—W. D.—T. W.—E. H.—R. S.—E. G.—E. F. C. L.—T. W. D.—E. E.—R. V. T.—E. L.—H. H.—M. S.—T. H. H.—J. F. R.—H. F. A.—J. A.—E. W. H.—C. E. D.—H. B.—P. B. M.—W. E. G.—I. C.—C. B.—&c. &c. &c.

BOOKS, &c., RECEIVED.

"A New London Flora." By Dr. De Crespigny. London: Hardwicke & Bogue.

"Ferns: British and Foreign." By John Smith, A.L.S. New and enlarged Edition. London: Hardwicke & Bogue.

"William Caxton, the First English Printer." By Charles Knight. New edition. London: Hardwicke & Bogue.

"Popular Science Review." July.

"Monthly Microscopical Journal." "

"Land and Water." "

"Journal of Applied Science." "

"Potter's American Monthly." June.

"American Naturalist." "

"Ben Brierley's Journal." July.

"Botanische Zeitung." June.

&c. &c. &c.



THE PRONUNCIATION OF SCIENTIFIC NAMES.

By GEORGE NEWLYN.



THE suggestion of "E. C.," who differs from Mr. Boulger (p. 164) in the pronunciation of *ch* in some botanical terms derived from English and French names, as in the two examples quoted—viz. *Richardsonia* and *Lachenalia*—seems not unreasonable. Much confusion

is caused by the fact that the rule applying the old Latin pronunciation to the corresponding characters of the Greek gutturals, as *c* (κ), *ch* (χ), and *g* (γ), does not, to some educated persons, appear admissible in all cases; whilst others, who may be a little fastidious about uniformity of pronunciation, pursue a rigid consistency in assimilating the *g* and *ch* sounds to those of the Greek *gamma* and *chi*, yet entirely ignoring the same guttural claim of the *kappa* representative. But it may be seen, on looking into the matter a little, that there is not, even among the latter authorities, that strict regard for the guttural rights for which they plead that one should expect to find. The *g* in *Geum* may be guttural or sibilant, but there seems to be no choice in the articulation of the same initial character in *Geranium*. Yet why? Both names have come to us through the Latin from the Greek by the same process, only the latter has crept into our English vocabulary, and is rendered a vernacular term, and botanists in this case yield to the common pronunciation. It may be urged in palliation that English orthoepists are not consistent with words adopted into the English language; to wit, Jameson and Knowles retain the Greek guttural sound in the initial letter of *gymnastic* and *gyves* respectively. Mr. Randal Alcock points out in a rule, that in words direct from the Greek, especially modern scientific terms, the *g* is pronounced hard. Really, this is implying that the older terms may go their own way as regards our dealing with this letter in any of them,

and the young student in botany must be utterly puzzled in his attempts at utterance of scientific language. Mr. Boulger argues (p. 191) that a scientific name being "Latin, not English," it "must be pronounced, if not spelt, accordingly." That would be all very well if we knew how the people of ancient Greece and Rome spoke Greek and Latin. We possess no certain guide beyond the information pointed out to us by the poets in mere *accentuation* of words; but even in this the precepts are often obscure. Scientific persons, who may be also classical scholars, now articulate, when reading those languages, according to the usage of their own, yet with the consciousness that such pronunciation would have sounded exceedingly strange to the ears of an ancient Greek or Roman.

Phonetic change is even going on in our own language; and although the printing-press and the Bible have combined to preserve intact the orthographic element, there is no doubt, as Mr. Peile observes, that the pronunciation has so much altered that our language would have scarcely any resemblance in sound to that as spoken contemporaneously with the discovery of the art of typography. Moreover, the guttural articulation which our ancestors liked—a noteworthy example in the old guttural *gh*—Englishmen of the present day dislike. What would the Greek and Latin purists say to this? And furthermore, critical opinion on the articulation and accentuation of those languages is constantly changing, to say nothing as to the impediment to correct Greek or Latin speaking (whereby international intercourse might be effected by the tongue of scientific men), owing to the peculiarities of speech that each people of a nation develops as its exclusive own; as, for instance, the consequence in the euphony of the French language by the dislike of the *h* or *w* by the people, or in the German by the same inability to master the *th* sound. University men know all these difficulties, and it seems utterly absurd to say that men of science can do more than university graduates in the laying down of rules for students' guidance in the mode of accurate pronunciation.

Mr. Boulger hints that botanists should modify, if necessary, the spelling of a modern substantive name, which they may adopt into the language of science as a generic term, and therefore he condemns the terms *Richardia* and *Richardsonia*, because the *h* has been retained. I cannot agree with him here. Such advice seems unwarrantable, and, if followed, would do irreparable mischief in the tendency to destroy the etymology, and likewise neutralize the complimentary idea associated with the adoption (if a person's name) of the word into scientific use. It is at variance, too, with the laws of nomenclature, as laid down by M. Alph. de Candolle, and as received as "the best guide for nomenclature in the vegetable kingdom" by the "International Botanical Congress of 1867." In this body of laws, Article 27 states that, "When the name of a genus, sub-genus, or section, is taken from the name of a person . . . the spelling of the syllables . . . is preserved without alteration, even with letters or diphthongs now employed in certain languages, but not in Latin." Moreover, in the above instances, the *h* in union with the *c* is in perfect harmony, in form at least, with that which combines with the *c* to represent the Greek *chi* in *Achillea*, *Orobanche*, &c. Again, the *ch* in *Fuchsia* has a totally different sound, and where is the propriety for altering the form? There seems something more edifying by retaining the form of the adopted name as whole as possible, and by following the correct pronunciation of it, than by subjecting it to mutilation both in form and sound for the purpose of rendering it in supposed uniformity with the simile of dead languages. There is not the vestige of fascination or interest in the latter course. Not that those languages can be undervalued for the purposes of science, and something might be perhaps urged against the introduction of spurious terms from a modern source into the vocabulary of science; but purists must take into consideration the importance and claims of association, though these may be after all inferior to those connected with names which express principal characters in the individual plant, or such as would call to mind the affinities or the analogies of the genus, and hence pursued on the plan adhered to mainly in the selection of names to designate the higher groups. In respect to the comparative euphony between the adjectival terms *Brownii* and *Brunii*, one must admit the preference for the latter; but any tendency to confusion by the modification, or to nullify the purpose for which the particular name was given, should be remembered. There are two genera of plants to which the terms *Brownea* and *Brunonia*—both distinct genera, but etymologically identical—are applied. *Brunonia* is far better, euphonically, as Mr. Boulger would point out. But there is also another genus named *Brunia*, derived from *C. Brun.* If the rule suggested, then, were followed, *Brunia* might have come from *Brown* or *Brun*, and if from the former, both the compliment-

ary importance and the etymological form be sacrificed for the sake of a sound that is a little more pleasing.

I have ventured to trespass beyond the limits of space I had intended, but my plea is an aim at reform. Although the pronunciation of botanical names is of but secondary importance, yet, if a free and sober discussion upon this subject would be the means of leading to a greater facility and uniformity of articulation, the object attained would be more than worthy the effort bestowed by authorities for instruction. Authorities, it is true, differ; but in words containing the Greek and Latin guttural representatives, the usage of our Universities is now pretty generally adopted; that is to say, by articulating those characters in scientific names in the same way as we do when reading English. *Geum*, *Potamogeton*, &c., should not accordingly be pronounced with a guttural *g*, as Mr. Alcock pleads, but after Withering rather, from whom he quotes that *c* and *g* before *e* and *i*, and before *æ* and *æ* should be rendered sibilant; before other diphthongs, guttural.

A WELSH MEADOW.

DURING the last week in June Mr. James Britten and I spent three days in North Wales, sometimes walking, sometimes travelling by rail, from Llangollen to Dolgelley. Whilst at the latter place we took an evening stroll along a road leading to the foot of Cader Idris, and some three miles or more from Dolgelley we came upon a small meadow, certainly not more than an acre in extent, which appeared from the road to be almost covered with various kinds of Orchids. On a closer inspection, we found great quantities of *Gymnadenia conopsea*, of *Habenaria chlorantha*, of *Listera ovata*, and of *Orchis maculata*, and such a profusion of many other pretty and some not very common plants, that we determined to search the place carefully, and for our own amusement to put down all the species we could find in this fertile little spot. The list soon became so large as to astonish ourselves, and I am tempted to send it for the edification of my fellow-readers of SCIENCE-GOSSIP. Probably there is scarcely another acre to be found containing not only so many species of wild plants, but so many individuals of certain species. It was the gayest little garden imaginable. At the time of our visit it was perhaps chiefly conspicuous for the Orchids, and for the amazing undergrowth of Fairy Flax; but at various times other plants will be in the ascendant. The moister portions will by this time be yellow over with the fragrant Asphodel, and the drier parts will soon be blue with Scabious; whilst the pretty pink Pedicularis will give it a rosy tint. The following is the list, set down without reference to arrangement, pretty much in the order in which the plants were found.

Gymnadenia conopsea, Habenaria chlorantha, Listera ovata, Orchis maculata, Scilla nutans, Veronica chamædrys, V. officinalis, Bunium flexuosum, Lotus corniculatus, Potentilla tormentilla, Rumex acetosa, Potentilla fragariastrum, Rubus fruticosus, R. Idæus, Scabiosa succisa, Achillea millefolium, Polygala vulgaris, Origanum vulgare, Hypericum montanum, Prenanthes muralis, Alchemilla vulgaris, Centaurea nigra, Prunella vulgaris, Hypochaeris radicata, Galium saxatile, Drosera rotundifolia, Pinguicula vulgaris, Rhinanthus crista-galli, Gentiana Amarella, Trifolium pratense, T. repens, T. filiforme, Linum catharticum, Ranunculus acris, R. bulbosus, R. flammula, Narthecium ossifragum, Cardamine pratensis, C. impatiens, Euphrasia officinalis, Heracleum sphondylium, Cœnanthe crocata, Anemone nemorosa, Ajuga reptans, Hieracium (sp. undetermined), H. pilosella, Carduus palustris, Chrysanthemum leucanthemum, Pedicularis palustris, P. sylvatica, Spiræa ulmaria, Plantago lanceolata, Hydrocotyle vulgaris, Caltha palustris, Myosotis repens, Calluna vulgaris, Orobus uberosus, Cerastium triviale, Melampyrum pratense, Viola sylvatica, Vicia cracca, Sanicula Europæa, Bellis perennis, Stellaria Holostea, Sphagnum, Juncus squarrosus, at least two Carices (sp. undetermined); of grasses, Festuca duriuscula, F. ovina, Anthoxanthum odoratum, Dactylis glomerata, Cynosurus cristatus, Briza media, Holcus lanatus, Aira cæspitosa; and of ferns, Pteris aquilina, Lastrea filix-mas, L. Oreopteris, Athyrium filix-fœmina.

In all eighty species; but we did not take into account the hedges nor the trees. It likewise grew too dark to see any more, and we were obliged to give up our search, no doubt missing several species which would probably have brought up the list to very nearly one hundred.

ROBERT HOLLAND.

Norton Hill, Runcorn.

THE PETREL SPECIES OF SEA-BIRDS.

By P. Q. KEEGAN, LL.D.

WHEN the broad bosom of the Atlantic is upheaved with storm, above the foamy crests of the waves may be discerned the dark, diminutive figure of the Stormy Petrel. The wings of the bird seem uplifted as if in flight, but his long black web-feet paddle playfully upon the surface of the water, as if in sport. With rapid flight, as of an arrow, he skims the waves, now settling for an instant on their foamy crests, now coursing swiftly o'er the watery waste. Far off among the rolling billows he spies a ship looming, and, prompted by instinct or a foregone pleasurable experience, he wends his way thereto, and hovers round about the stern and sails. The motion of the vessel, and the shelter furnished thereby, subserve the bird's purposes admirably; for as it ploughs its way amid the waves, stray mollusks

and crustaceans are frequently upturned, and these the petrel coveting, pounces down upon and consumes with evident relish. His vision is keen, too, for any oily matter thrown overboard the ship, and, prompted by his native partiality for it, he follows for days and days the source whence it flows.

When the storm abates, the Petrel disappears. His temperament prompts him to seek some lonely spot upon shore or islet, or, perhaps, among the masses of the seaweed that drift upon the bosom of the ocean. There he lies intrenched, till storm and darkness summon him to bear them company again.

The members of the Petrel genus of sea-birds are rarely to be discerned inland, or even upon the coasts of the larger continents and islands, except during the breeding season, which in our latitudes seems to occur twice in the year—viz. about June and August. Immediately after the occurrence of unusually severe storms, however, some stray specimens of Petrel have been discovered either dead or in a very exhausted condition at various places tolerably far inland, or adjacent to our coasts. I may mention that several breeding-places of the Stormy Petrel have been discovered along the western coast of Ireland; for instance, on Tory Island, the Galway and the Kerry coasts, &c.

The genus *Thalassidroma*, to which the Petrel tribe belongs, has been divided into four sub-genera—viz., *Daption*, *Thalassidroma*, *Ungellus*, and *Procellaria*. I propose, however, confining my attention exclusively to the four British species of the sub-genus *Thalassidroma*, and, in the first place, we shall specify some of their distinguishing characteristics, as follows:—

The Forked-tail Petrel (*Thalassidroma Leachii*), which occasionally occurs on the British coasts, is characterized by the possession of a black bill and dark-brown irides; while the head, neck, back, breast, and belly are of a sooty-black colour. The wing-coverts are of a rusty-brown colour, the tertials tipped with white; the upper tail-coverts white; the primaries and tail-feathers black; while behind each thigh there is an elongated patch of white. The tail is forked, the outer feathers being about half an inch longer than those in the middle. This species is about seven inches long. Wilson's Petrel (*T. Wilsonii*) has the head and all the lower parts, the back, scapulars, wings, feet, bill, and iris of a black colour; all the upper tail-coverts are pure white; the tail is nearly square, the three lateral feathers being white at their base. On the membranes of the feet there is a long yellow stain, and the edges of the toes are bordered with the same colour. This species is about six inches long. Bulwer's Petrel (*T. Bulweri*) is extremely rare in England. The Stormy Petrel (*T. pelagica*) is characterized by having the head, back, wings, and tail dull black; the lower parts, bill, and feet are sooty black. There is a large band of pure white on the rump, while the scapulars and

secondary quills are terminated with traces of the same colour. The tail is square, and the tips of the wings hardly reach beyond its extremity. The total length of this interesting bird is $5\frac{1}{2}$ inches.

Having specified the various characteristic features of the British department of this interesting genus of sea-birds, I shall now briefly discuss some questions that may be readily started upon the contemplation of their habits. In the first place, we may observe that the extraordinary vital energy and endurance exhibited by these tiny creatures may reasonably excite feelings of wonder, and demand some explanation. During stormy weather these petrels have been observed to follow in the wake of a particular ship for as long a period as one month.

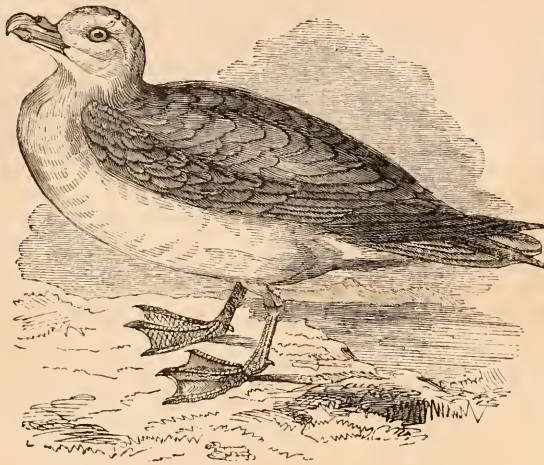

Fig. 154. The Fulmar Petrel (*Procellaria glacialis*).

During this time there is exhibited on their part an almost perpetual fluttering of the wings and exertion of the feet—a restless spontaneity of movement that necessarily involves an immense expenditure of animal energy. Now, from what source springs the fuel that feeds this vital machinery? Let us imagine a man who is compelled to exercise the muscles of his limbs incessantly every day, say for a period of twelve hours. Would his frame, however naturally robust, endure this treatment for any lengthened span of time? But the Petrel, in addition to this extensive and protracted limb-movement, is known to emit during the night-time its peculiar melancholy cry. Perhaps the incessant inhalation of the exhilarating air of the sea imparts to the nervous centres of the bird an energy and efficiency which men, living amid the smoke and foul air of cities and houses, can never experience. Physiologists inform us that the blood, being charged with certain ingredients, builds up the structure of the nervous centres, imparting thereto at the same time a store of *potential energy* which, at the command of the will, &c., is discharged or converted into *actual energy* through the

instrumentality of the oxygen contained in the red corpuscles of the same fluid. Now it follows, that the more thoroughly the blood is charged with these nerve-building materials and with oxygen, the more efficient and inexhaustible will be the supply of nerve or animal force. Perhaps the fresh air of the sea and the character of the Petrel's food furnish power to the nervous centres which minister to the digestive apparatus of the bird so thoroughly and efficiently as to enable it to digest and assimilate nutritive materials in a manner which other birds, differently situated, cannot experience. Moreover, we know that the stomachs, both of the Stormy and Wilson's Petrel, are exceedingly large in proportion to the size of the birds. There are two gizzards provided

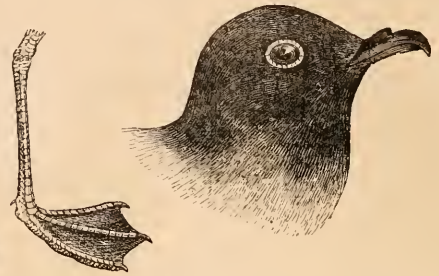

Fig. 155. Head and foot of the Stormy Petrel (*Thalassidroma pelagica*).

with a great number of glands, which secrete gastric juice, and they are curved in a very peculiar manner. The Petrels also subsist chiefly on fishy and oily matter, a species of nutriment which, in the human subject at least, is eminently adapted to the maintenance and stability of cerebral and nervous tissue.

In the next place, we may institute a brief inquiry regarding the cause of the manifest predilection for ships exhibited by the members of the Petrel tribe. Why do these birds follow ships for so lengthy a period? Some naturalists suppose that the hull of the vessel shelters their tiny bodies from the violence of the storm. Others think that the keel of the ship, in its motion through the water, ploughs up sundry mollusks, &c., and that the birds love to take advantage of this convenient provision for their bodily sustenance. In attempting to solve this difficulty, we must remember that the Petrels appear in the vicinity of ships only during stormy weather. But the turbulence of the seas at that period would, we might apprehend, be amply competent to stir up these marine animals to the surface, without the intervention of a ship's motion. The latter theory would, therefore, on this view of the matter, appear to be untenable; and on that account let us endeavour to contemplate the subject from a different standpoint. Latter-day physiologists have propounded the theory of the hereditary transmission of acquired psychical aptitudes. We know that upon desert,

uninhabited islands, birds do not exhibit those symptoms of fear at the approach of man which they commonly show in densely populated localities. It is maintained that this fear is not natural, but has been handed down from generation to generation, and when so transmitted, it is manifested on the *first* instance of men's approach, and without any previous experience of any of the disagreeable consequences thereof. Is it possible that the Petrel has come to regard ships as security against the dismal consequences of storm and tempest? Sometimes, indeed, the birds are captured and killed by the sailors; but even that apparently deterrent influence does not seem to divest them of their well-known partiality for ships. Their progenitors have sought and obtained food and shelter from them; and this experience, being transmitted hereditarily to their

ternate elevation and depression of the hull as it rides on the crest of a billow or sinks into the trough of the sea, the progressive movement through the force of the gale, and the general indications of bustle and animation exhibited thereby, may perhaps furnish a fund of pleasurable entertainment to the birds which love to live on the ocean.

We may endeavour to discover the cause of the peculiar sea-walking habits of this genus, whence they have derived their distinctive appellation of *Thalassidroma*. Whilst engaged in this operation, are they in quest of food, or is that the sole aim? Most naturalists incline to the affirmative answer; but with all due deference to their opinion, I am constrained to suspect that this is not the only reason for this course of conduct. We know that an abundant supply of Mollusks, Radiata, Fishes, Crustacea,

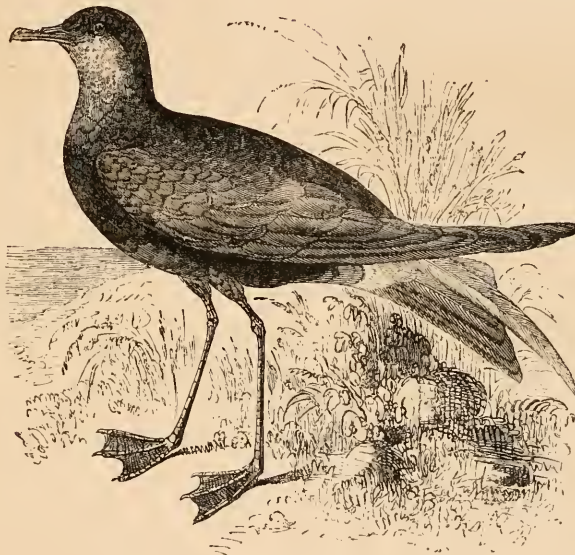

Fig. 156. Wilson's Petrel (*Thalassidroma Wilsonii*).

offspring, induces them to cling to a course of conduct of the risk and danger of which their own career furnishes no indication.

Again, if we take into account the indubitable act, that many of the lower animals, especially the Bird tribe, manifest an unequivocal sense of enjoyment in activity, we may perhaps be induced to consider that the Petrels regard the motion of a ship as a source of this pleasurable animal excitement. We know that the *sensori motor* system of nerves is especially developed among the Birds: and we might thence conclude that they derive a large proportion of their pleasure from its operation. A kitten pursuing a rolling cork, or ball, furnishes us with an illustration of this phenomenon among the Mammalia.

The spectacle of a ship in full sail is a source of nervous excitement of a pleasant description. The al-

and Zoophytes, may be readily found in the Sargasso Sea, and other detached masses of sea-wrack, which, borne up by their air-bladders, perpetually float upon the surface of the Atlantic Ocean. Why do not the Petrels satisfy their requirements there, and not commit their slender bodies to the fury of the winds and waves? A satisfactory explanation of this point is perhaps impossible; but I apprehend that the animal delight in excitement already alluded to in the preceding paragraph, and the sources whence it springs, will furnish at least a subsidiary clue towards the elucidation of the sea-walking habits.

The contemplation of the little sea-birds, whose habits, &c., we have been engaged in discussing, is profoundly interesting to the human heart. Their appearance in the vicinity of ships is regarded by sailors as indicative of a coming storm, with all the

dismal consequences that follow in its train. On this account, the birds were first dubbed by Spanish sailors "Mother Carey's Chickens," in allusion to the care and watchfulness which the Blessed Virgin (Span. *Madre cara*, i.e. Mother dear) is supposed to exercise over the wayfarers of the seas, in thus-wise warning them of impending danger.

THE SEALS AND WHALES OF THE BRITISH SEAS.

NO. IV.

By THOMAS SOUTHWELL, F.Z.S., &c.

THE occasional stranding upon our shores of some monster member of the order *Cetacea* serves from time to time to reawaken our interest in these wonderful animals, and sets us thinking how little we know about them, and how small is our acquaintance with their life-history.

Nor is this surprising at when we consider the difficulties in the way of studying the larger Cetacea, which are so great as to be almost insuperable to any ordinary person, and even to the leaders of zoological science rarely does the opportunity present itself of examining specimens in the flesh; for, of the rare instances in which they are cast ashore, the majority occur in wild and unfrequented parts of the coast, where they are probably cut up for their oil before a naturalist has an opportunity of examining them. Their unnatural position when cast up, and their altered appearance, from the falling in of some parts and distension of others, make correct portraiture almost impossible; and their great size renders it difficult and expensive to make them serviceable to science, whilst the putrid condition in which they are frequently found renders a close examination anything but desirable. If seen in their native element, where alone they *should* be seen duly to appreciate their grand proportions and perfect adaptation to their mode of life, the view must be brief and too often distant, certainly affording no opportunity for close observation. There is thus little left for naturalists to study, except the bony skeletons, and of these often mere fragments. Under these circumstances, we shall cease to wonder at the great confusion which, till recently, existed in the classification and nomenclature of the *Cetacea*, and which has been only partially cleared away by the labours of the late Dr. Gray and Professors Flower and Turner in this country, and by Professors Eschricht, Reinhardt, Van Beneden, and others on the continent. The literature of the subject is widely scattered and difficult of access; and although Dr. Gray and Professor Flower have done much to condense and systematize what is known, our acquaintance with the tropical and southern species of this interesting order is not at present sufficient to furnish materials for a monograph

worthy of the subject. No class of animals has, I believe, been called so many names, or so vilely caricatured in portraits, as the unfortunate Whales.

It is scarcely necessary now to say that the *Cetacea* hold a fully recognized place in the great class *Mammalia*, although this honour has not always been accorded to them. Ray classed them with the Fishes; and although Linnæus places them in their true position, Pennant failed to do so. The members of this order, which includes the Whales proper, Narwhal, Dolphins, and Porpoises (and, till recently, the Dugong and Manatees, which were styled herbivorous cetaceans), differ from the Fishes in bringing forth their young alive. They are nourished by the female, which, for this purpose, is furnished with two inguinal mammae. They are warm-blooded, and breathe by means of lungs, rendering frequent visits to the surface of the water necessary, as the animal can only respire when the orifice of the nostrils, called the blow-hole, which is placed on the top of the head, is above water. The breathing apparatus is very peculiar, being so modified that the air is admitted into the trachea without passing through the mouth; the whale can thus breathe freely, provided the blow-hole be above water, even when its mouth is submerged or filled with water. All the members of the family are carnivorous, feeding on marine animals, some possessing formidable teeth, which are, however, used only for purposes of prehension; others possess teeth in the lower jaw only; and in one section the teeth are never developed, but in their stead, from the upper jaw depend curious plates, arranged side by side, to which the name of *balæen* has been given. The body is encased in a layer of fat, called "blubber," which serves to maintain the heat of the body, and the skin is smooth, polished, and quite devoid of hair or scales. On the back of most species is found a fleshy dorsal fin, and the fore limbs are represented by flippers externally undivided; the hind limbs, so far as external appearance is concerned, are altogether absent, but a rudimentary pelvis is found embedded in the flesh. The tail forms the chief organ of locomotion: it is always fixed horizontally, and is of great size and power, enabling the animal, by its vigorous use, to attain great speed. There are many and striking peculiarities in the bony skeleton which I will not now enumerate.

I shall now proceed to give some account of the species which have been found in the British seas. It will, however, first be necessary to say a few words as to the arrangement of the genera and species; and in doing so, I shall follow the classification adopted in the second edition of Bell's "British Quadrupeds." I shall enter into this part of the subject so far only as is necessary for us clearly to understand the relative positions of the species which we shall have to consider.

Professor Flower divides the order *Cetacea* into two

sub-orders: First, *Mystacoceti*, or *Balænoidea*, in all the members of which baleen takes the place of teeth, which are never developed, disappearing before birth; second, *Odontoceti* or *Delphinoidea*, in which teeth, sometimes very numerous, are always developed after birth. The first sub-order is a very restricted one, embracing only two families, *Balænidæ* and *Balænoptæridæ*, to the former of which belong the two genera of Right-whales, *Balæna* and *Eubalæna*; and to the latter, two genera, namely, *Megaptera* and *Balænoptera*. To these two genera* belong the Rorquals, which occasionally occur in the British seas. The second sub-order, *Odontoceti*, contains the families of *Physeteridæ*, represented by the Sperm Whale, *Hyperoodon*, and several allied species; *Platanistidæ*, some curious forms found only in India and South America; and *Delphinidæ*, comprising the Narwhal, Beluga, or White Whale, Grampus, Porpoise, and Dolphins. The total number of British *Cetacea* has been variously estimated; Bell, whom we shall follow, enumerates twenty-two; Dr. Gray, in 1864, describes thirty species, and in 1873 thirty-three species.

The first species, both in order and importance, is undoubtedly the well-known *Balæna mysticetus*, the GREENLAND or RIGHT-WHALE (fig. 157), as it is called by the whalers. I use the term well-known perhaps unadvisedly; for although for centuries it has engaged the energies and industry of the merchant seamen of Northern Europe, so little was known of it scientifically that until Eschricht obtained a skeleton from Holsteinsborg, in Greenland, in 1846, not a single skeleton of this species had ever found its way into any European museum. That this species ever inhabited the British seas seems very doubtful, and the recorded instances of its occurrence are unsatisfactory in the extreme. The most positive record is that in Messrs. Paget's "Natural History of Great Yarmouth." They say: "*Balæna mysticetus*—common Whale—a small one taken near Yarmouth, July 8, 1784." Upon writing to Sir James Paget, if possible to obtain further information, he tells me, "I am sorry I can give you no information respecting the whale taken off Yarmouth in 1784; I have no notes as to the source from which I derived the statement, but probably it was from some MS. of Mr. Dawson Turner's. It is not likely that any bones of the whale were kept in Yarmouth, for there was no naturalist there at the time, and the whaling-trade, which was then actively carried on from the port, must have made whales' bones very common." This is all that is ever likely to be learned of the Yarmouth Right-whale; but the season at which it occurred would render the heated seas on our coast utterly unbearable to an ice-loving inhabitant of the Arctic circle. This, with its small size, would seem to point to a closely-allied species to be mentioned soon. Sibbold records what he considers was probably a

Right-whale at Peterhead in 1682; and a whale recorded at Tynemouth by Willughby may have been of this species. In the first edition of Bell's "Quadrupeds" is a communication from the Rev. Mr. Barclay to the effect that on the coast of Zetland dead or very lean whales of this species have several times been found or have run aground; but in the second edition of the same work the author states that "there is no proof these references do not apply to some other species." This is all we know of the Right-whale as occurring in British waters in recent times, and none of the instances are at all satisfactory.

The extreme northern habitat assigned to this species by those who have devoted much time and labour to the investigation of the subject, I think clearly proves that it must either have changed its habitat, which its present habits seem to render improbable, or that some other species formerly inhabited the temperate seas outside the Arctic circle extending southward to the Atlantic as far as latitude 40°, for it is beyond doubt that a brisk trade was carried on in former times by the Basque population in the Bay of Biscay and adjacent seas as far back as the 8th or 10th century. That such a southern species, distinct from the northern Right-whale did exist, is, I think, proved by Professors Eschricht and Reinhardt in their splendid memoir of the "Greenland Whale," a translation of which, edited by Professor Flower, was published by the *Ray Society* in 1866. This whale, which was formerly distinguished by the name of *Sardæ* by the French, and *Nordkaper* by the Dutch, they have called *Balæna biscayensis*: it was smaller than the northern species, probably about forty feet in length, the head not more than one-fourth of the entire length, the colour uniformly black, and the baleen much shorter in proportion than in the larger species. Of this whale, once abounding in the North Atlantic and North Sea, and finding employment for so many hardy and daring seamen, the only remains now known to exist are the cervical vertebræ dredged up off Lyme Regis, now in the British Museum,* and the skeleton of a young one which was taken in the harbour of St. Sebastian on the 17th January, 1854. The mother, which was seen with it, escaped, but the little one was caught, and a drawing of it made by Dr. Monedero; the skeleton was preserved for the museum of Pampeluna; thence it was removed by Prof. Eschricht in 1858 to the Copenhagen Museum, for which he purchased it. As there is every probability that any Right-whale occurring on our coast belonged to this species, it will at once be seen what interest is attached to any scrap of information on the subject, and how imperative it is to pursue to the uttermost any clue which might possibly throw light on the history of this probably now extinct species. It is worthy of remark, that in the Southern ocean

* The vertebræ in the British Museum is the type of *Hali-balæna britannica* (Gray); *B. cisarctica* (Cope) is also probably identical with *B. biscayensis*.

* *Physalus* and *Sibboldius* are now rejected by Prof. Flower.

there are two recognized species of Right-whale, one *Caperea antipodorum* (Gray), not found further north than 40° south latitude; the other, *Eubalena australis* (Gray), found as near the equator as 20° south latitude. Dr. Gray does not recognize *Balena biscayensis* as a good species, and accounts for the absence of the Right-whales, formerly found in British waters, from the disturbed state of the seas, owing to the great increase in traffic of ships, and especially steam-vessels, which, he says, "appears to restrict their visits, and especially their breeding, more to the Arctic portion; thus some whales, which were

been seen in summer as far north in Baffin's Bay as ships have succeeded in penetrating, whilst its southward range in winter was always limited by a rather northerly degree of latitude. This, they show, has gone on with the greatest regularity for at least 80 years, during which they have constantly made their appearance at the same places, at the same season, without the slightest alteration having taken place. The fact of the whales always following the ice floes will account for their being found in the spring in different latitudes; thus, on the Greenland coast, they are found, at this season, in latitude $65^{\circ} 25'$; but in Davis'

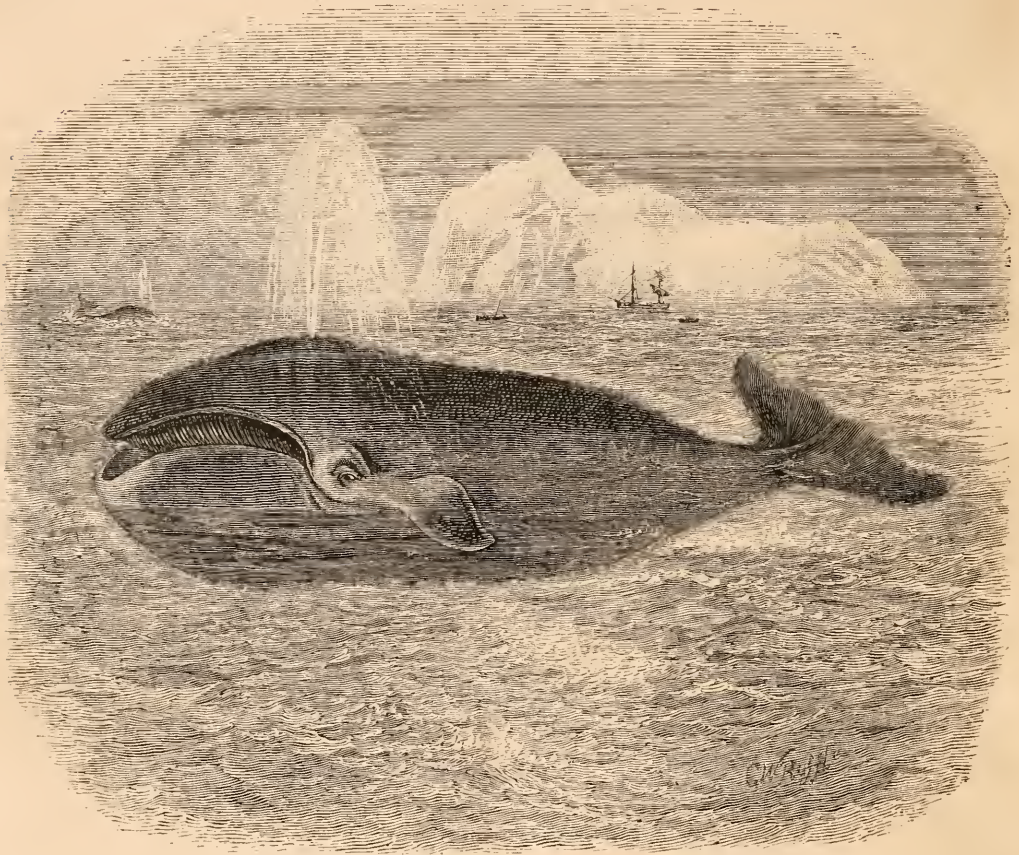

Fig. 157. The Greenland or Right-whale (*Balena Mysticetus*).

formerly said to be common on the coast of Britain as the Right-whales, no longer visit this country." Eschricht, however, has clearly shown that the habits and localities frequented by the northern Right-whale have remained unchanged for many years, as proved by the record kept by the whaling stations established by the Danish government on the west coast of Greenland. The fishery at these stations was prosecuted from the shore when the whales appeared upon the coast in the winter months; as the spring advanced they followed the receding ice, and have

Strait, in 61° to 62° , always, however, inseparable from the ice. Messrs. Eschricht and Reinhardt thus conclude: "It seems, therefore, that the whales have not retreated farther north, as they are still found within precisely the same limits in which they were found at the beginning of the persecution, but in numbers so diminished that the fishery will hardly repay the trouble and expense attending it." The southern limit of the Right-whale in the Northern ocean may be shown by a line drawn from the coast of Lapland at 70° , just touching the southern point of Iceland,

and ending on the coast of Labrador at about 55° north latitude.

The whale-trade, which once employed so many hardy seamen, is now reduced to very narrow limits, and appears to have passed almost entirely into the hands of the English, or rather Scotch. The Biscayans were not content with exterminating the whales found in their own seas, but followed them up to the north; in 1721 they had twenty vessels in the Greenland fishery from Biscay; the Dutch also took a large part in the trade; in Norfolk, Yarmouth and Lynn both sent out vessels. In 1801 twenty ships were employed from the port of Yarmouth in this fishery, and returned from Greenland with rich cargoes; but heavy losses subsequently occurred, and early in the present century the whale fishery from Yarmouth was abandoned. At Lynn it must have ceased about the same time. During the nine years ending 1818 there was an average of ninety-one English and forty-one Scotch ships employed in the trade; in 1830 they were reduced to forty-one English and fifty Scotch. 1830 was a very disastrous year in the whale trade; nineteen British ships were totally wrecked, and twelve seriously injured in that season. The number since then has been gradually decreasing, till at the present time Dundee and Peterhead are the only two ports in Great Britain which are engaged in the whale fishery. Dundee sends out ten powerful steam-vessels, which leave about the beginning of May, and if fortunate in filling up, return about the beginning of November. The expense now incurred renders it necessary that a large number of whales should be taken to make the voyage pay: the *Arctic*, in her voyage of 1873, captured twenty-eight whales, which were estimated to produce in oil and bone £18,925, or about £678 per whale, the best whale, a female with sucker, was estimated at £1,500, and the smallest at only £110. An average whale produces 9½ tons of oil, a ton measuring 252 gallons, and 7 ft. 6 in. of whalebone; the longest bone cut of the twenty-eight fish was 11 ft. 9 in. and the shortest 2 ft. 6 in. This was considered a very successful year. An interesting account of a whaling voyage in the ship *Arctic*, and full particulars of the mode pursued in taking, and subsequent treatment of the fish, is given by Captain A. H. Markham, in his "Whaler's Cruise to Baffin's Bay."

The usual length of a full-grown Right-whale is about 50 feet; but Dr. Brown, in his paper on the Cetaceans of the Greenland Seas (*P. Z. S.*, 1868, p. 539), gives the dimensions of one which measured 65 feet. The general colour is black. The mouth occupies about one-third of the entire length, and the baleen is from 10 to 12 feet long. This baleen, which is found depending from the upper jaw, consists of a number of horny plates, placed transversely along either side of the palate; they are arranged closely together, with the external edge smooth, and

gradually thinning off towards the inner margin, which ends in a fringe of long hair-like fibres: the number of laminae is about 360 on each side.* The whale whilst feeding swims along with its mouth open, until it has collected a quantity of the small marine animals which form its food; then, closing its capacious under-jaw, it forces out the water between the plates of baleen, leaving the captive prey stranded on its huge tongue, when it swallows them at leisure. The food of the Greenland whale consists entirely of small marine animals, particularly a kind of shrimp, found in great abundance in the Arctic seas. This species is believed by Eschricht and Reinhardt to bring forth its single young one (rarely two) about the end of March or beginning of May, and the time of gestation to be thirteen or fourteen months, so that it will bring forth only every other year; Scoresby considers that they go eight or nine months, and bring forth in February or March.† The young one is supposed to be suckled for twelve months. In disposition the Greenland whale is timid and retiring; the chief danger in its capture arises from its rapid descent when harpooned; the line is then carried out with such speed that, should it foul or all run out and not be immediately cut, the boat will be upset or carried under water. It has never been known to attack a boat, but accidents sometimes happen if approached too closely in its death "flurry," which is said to be very terrible to witness. Its fondness for its young is such that if the "sucker" is killed the old one readily falls a victim, and the whalers do not fail to avail themselves, for their own advantage, of this amiable trait in its character.

THE COLORADO POTATO-BEETLE.

(*Doryphora decemlineata*, Say.)

By E. C. RVE, F.Z.S.

LITTLE thought the American entomologist Say, when, in 1824, he characterized a comparatively insignificant *Chrysomela* from the Rocky Mountain region of the Upper Missouri, that his foster-beetle should, in less than the average life of man, so increase and multiply as to outrival the Egyptian plague of flies, or that this Yankee "bug" should scare the British lion. Yet so it is; and our Elizabethan arch-poet, who spoke of "the poor beetle that we tread upon," would, if his spirit revisited us, by the help of Dr. Slade, or any other medium, find that tables were indeed turned in the Victorian era, and that the beetle is likely to be the

* By an old feudal law, the *tail* of all whales belonged to the Queen, as a perquisite to furnish her Majesty's wardrobe with whalebone (Brown, quoting "Blackstone's Commentaries," vol. i. p. 233, ed. 1783).

† Dr. Brown, in the paper before quoted, states that they couple from June to August, and bring forth in March or April.

oppressor of us! Of a certainty, never before did *Chrysonela* cause such a commotion in this country or any other, let scholars argue as they may about the golden apples of Paris or of the Hesperides: of equal certainty is it, that no beetle ever before attained such notoriety. Its biography has been faithfully chronicled to the uttermost point; its goings and comings have been telegraphed and advertised; a Fellow of the Linnean Society has been sent by the Government to certify its arrival at Liverpool; it has been photographed, lithographed, drawn on wood, and otherwise depicted, in its natural size, and magnified up to the dimensions of an ordinary cat; it has been modelled in wax and other materials; it has had books, pamphlets, and newspaper notices written about it *ad nauseam*; it has inspired leading articles in the most powerful newspapers; it has been the subject of a large cartoon in *Punch*; it has occupied the serious attention of the Privy Council, and formed a bone of contention for savans and demi-savans; and, finally, has attained the dignity of an Act of Parliament, hurriedly pushed through the House of Lords, for its special behoof.

Entomologists, as a natural consequence of all this popular excitement, are just now considering themselves less than usually unimportant; and it would seem an excellent opportunity for the patrons of art and science who delight in South Kensington to obtain the foundation of some Government office, after the fashion of the American State Entomologists (only, of course, on a more lucrative scale, in inverse ratio to the work), to which one of their protégés could be duly appointed. The ordinary duties could, without much difficulty, be discharged after a careful study of Curtis's "Farm Insects" and one or two other works of a like nature; and the country would then be at rest, should an invasion by a foreign foe like that now imminent, ever again occur.

There can, however, be no doubt that earnest and energetic steps should be taken at the present unprecedented juncture, when the insect has succeeded in effecting a lodgment in two inland parts of Germany (though how that lodgment was effected we have no particle of evidence), and specimens have, after many false alarms, been proved to have at last arrived on the British shores; and it is with the idea of furthering a knowledge of the outward appearance of the dreaded beetle that the present article is penned. The majority of our readers have probably already formed a sufficient idea of it from other sources; but it is astonishing to what an extent fear will paralyze the faculties of unscientific observers, causing them in the present instance to think such vastly different insects as the common Tiger-beetle (*Cicindela campestris*), the Cockchafer (*Melolontha vulgaris*), the common banded burying-beetle (*Necrophorus vespillo*), the larvæ and pupæ of lady-birds (*Coccinella septempunctata*), &c., to be the

dreaded Colorado Beetle.* The following figures, therefore, may be of use:—

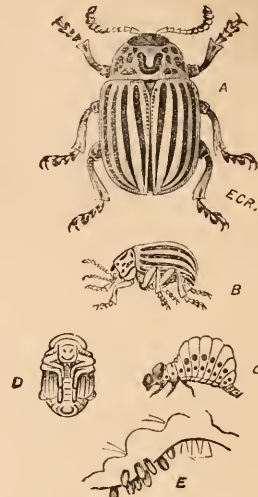

Fig. 158. Various stages, *A, B, C, D,* and *E,* in the development of the Colorado Potato-beetle, *Doryphora decemlineata* (Say).

A is the perfect beetle, a male (in which the legs and prehensile tarsi are more developed than in the female), magnified about twice the natural size; *B* is the same insect seen sideways, and of the natural size; *C* is the full-grown larva (in shape resembling somewhat our common "Bloody-nose Beetle" (*Timarcha tenebricosa*); *D* is the pupa, and *E* a batch of the yellow eggs. The beetle, when alive, is of a yellowish cream-colour (lighter when quite fresh), with five longitudinal black stripes on each wing-case, and some dark spots and markings, more or less confluent, on the thorax. The antennæ are black, with the basal joints more or less orange, and the legs are orange, with black knees and tarsi; the ample wings, seen when the insect flies, are, as in our common seaside dark purple species, *Chrysonela hemoptera*, rosy-red, especially along the nervures and upper portion. The colours of the beetle become much darker after death, and are entirely altered by immersion in spirits or benzine; and it is usually specimens so treated that are in the hands of English entomologists. It should also be observed that, according to Riley, the ground-colour varies considerably in specimens from different parts, from deep gamboge-yellow to almost pure white. The beetle appears also to vary much in size, marks of thorax, elytra, and legs, &c., according to the same authority. The larva may be described as Venetian-red, inclining to cream-colour, or rosy-red, slightly yellowish behind the head, which, with the back of the thoracic plate, the legs, two rows of conspicuous spots on the sides, and some other minute black dots, are black.

* Instances of all these mistakes have come under the writer's personal notice.

It does not always assume the position drawn, but lengthens itself out in the act of feeding.

The best and most elaborate account of the beetle is contained in a little work called "Potato Pests," published by the well-known Orange Judd Company, of New York, and written by our countryman Mr. C. V. Riley, the State entomologist of Missouri, to whose various reports all English writers on the subject are indebted. As this is not accessible to all, it may be mentioned that there is a good and illustrated account by Mr. H. W. Bates, in vol. xi. (second series) of the "Journal of the Royal Agricultural Society of England," 1875, pp. 361-375.

Space will not permit an extended notice in these columns; but the following may be given as a sketch of the progress of the beetle since its discovery. It was known to occur on a sand-bur or wild potato (*Solanum rostratum*) in the Rocky Mountains since 1820, or thereabouts. As the cultivated potato extended westwards, it acquired a preference for that plant, and spread eastward, until, in 1859, it was in Nebraska, in 1861 in Iowa, in 1864 and 1865 in Illinois, on at least five different points, in 1866 in Wisconsin, in 1868 in the centre of Indiana, and so on further eastward to the Atlantic, until it touched the seaboard at many different places in 1874, having travelled at an average annual rate of about eighty-eight miles. Having reached New York, it swarmed and extended north and south along the coast, and finally reached Canada, having spread over an area of nearly 1,500,000 square miles,—considerably more than one-third the area of the United States, and now occupying more or less completely thirty-four states and territories, besides a large portion of Canada.

Its western barrier appears to be the Rocky Mountains, and the Atlantic would, of course, prove an effectual limit to the east were it not for ships in the harbours, on which it has swarmed since 1874 to an incredible extent, even floating on the sea in vast numbers far from the shore. The wonder, therefore, is, not so much that the insect should succeed in reaching us on board ship, but that it should not long before this have done so, and in great numbers. There is no need for any material connected with the potato or its cultivation to be shipped in order to afford a cover for the beetle, which is ubiquitous on the American side, and can as easily be brought over *en masse* in a hat-box or secreted in unused clothing, as in a barrel of potato-haulm.

But whether, having arrived, it can succeed in becoming acclimatized in England, is another matter, upon which opinions are divided; though there would seem great danger of its effecting a lodgment in Southern Europe. To the writer, it seems that our much damper and colder climate, not affording opportunities for the rapid succession of broods which the insect develops in America, must materially militate against its obtaining a permanent hold; and the collateral arguments that no American beetle has

ever established itself in England, and that we possess no near ally of this particular one (the original home of whose special generic group appears to be almost tropical, in Central America), cannot fail to have some weight in the matter.

But the powers of exceptional vitality and extension of range possessed by the Colorado beetle are so great, that it would, even if all these objections were granted, be the height of folly to neglect all possible precautions against its encroachment; and of these the first is a dissemination of a knowledge of the foe. This has already been done to a large extent, both by the Government (according to its lights) and by private enterprise; and on this point it is somewhat amusing to find a paper like the *Standard* suggesting the publication and dispersal of drawings of the insect as a likely means of imparting knowledge, long after that course had been very extensively adopted. There are penal clauses in the Destructive Insects Bill above referred to against harbouring the beetle, or selling it, or offering it for sale alive, which seem to suspect its systematic introduction by naturalists, and with that idea would also seem opposed to the most certain method of obtaining accurate knowledge of the insect. It can scarcely be believed that entomologists would be so culpably careless as to permit the escape of living specimens; and it is to be hoped that no coleopterist will import the "Bogus potato-bug," *Doryphora juncta*, not included in the Act, but specifically very close to the Colorado beetle, for the purpose of puzzling the Government officials charged with the levying of the pains and penalties warranted by it.

Should the beetle by any evil chance obtain a footing in our fields, the method employed at Mülheim, as detailed in the *Cologne Gazette*, will prove most effective for its destruction: this, briefly, consists of isolation of the infested locality by ditches, and covering its surface with sawdust which is saturated with benzoyl, benzoyl also being poured into the ditches. After burning the surface, it is ploughed in close ridges, again saturated, and again burnt. When once the beetle has fairly settled itself over too large an area for such vigorous treatment, the best course appears to be, to take especial and energetic pains in systematically hunting for it in spring, before the parents have deposited their eggs. As a destructive dressing, the Americans find that a solution of Paris green in water, sprinkled by a machine over the plants, is the most effectual.

Of the various natural enemies to the beetle (chiefly other insects) occurring in America, it would be practically useless to speak, as they cannot well be found here, though, doubtless, some of our own predaceous and parasitic species (and also our insectivorous birds) would have something to say to the invader. The parasitic mite which has figured in various London papers (roughly copied from Riley's drawing of *Uropoda americana*), has, however, a

common European representative, *U. vegetans*, of similar habits, though it is not easy to see how these could materially affect the beetle.

In concluding these notes, it may not be out of place to observe that the generic name under which the beetle is usually mentioned is scarcely correct. *Doryphora* is based upon a character not possessed by the Colorado beetle, viz., a spear-point on the mesosternum (whence the American name "spearman," and also the allusion conveyed by the spear in *Punch's* cartoon, which, bad as it is, is not so gross a caricature as others not intended to be so); *Leptinotarsa* is founded upon an unstable groove in the tibiæ; *Polygramma* has only coloration to recommend it, and no structural points; *Myocoryna* is preoccupied by Dejean in the same family; and Riley proposes a new name, *Thlibocoryna*, for the group, which is closely allied to *Doryphora* in the shape of its palpi. No English beetle belongs to it, or is in any way really like it; our only large striped *Chrysomelâ* is the refulgent copper and green *C. cerialis*, found on wild thyme on Snowdon.

THE FERTILIZATION OF LESCHEN- AULTIA FORMOSA.

THE specific name of this plant was given by Robert Brown. It is a native of Australia. It is a small woody shrub, with linear, sub-coriaceous leaves, about half an inch long. Flowers solitary, terminal; corolla monopetalous, with a deep scarlet bilabiate limb; the upper lip divided into three rather irregular, slightly reflexed divisions; the lower almost boat-shaped, and partially surrounding the indusiate stigma. It is a very pretty, and certainly most interesting plant, and one admired by all plant-lovers.

The genus belongs to the family *Goodeniaceæ*: a family of peculiar and interesting structure. A great deal of interest resides in the indusium which sheaths the stigma. The same structure is developed in the genus *Brunonia*, and in the *Styleworts*. The indusium here referred to, and which is shown in fig. 160, *a*, is a prolongation of the disk, that is, adnate to the style; and it is to find out the object of this indusium that we here treat upon it.

Looking, then, at the front of the lower lip of the flower, we see the indusium (fig. 159, *a*; more enlarged fig. 160, *a*), which is two-lipped; when the flower is expanded, that upper lip is closed tight down; the lower lip is no doubt adnate to the stigma, or, according to some, the true stigma is outside the indusium entirely; but, whether the latter is correct or not, it is sufficient for our purpose to say that the lower portion is tufted with hairs, and between the hairs and the closed upper lip is the true stigmatic surface. When in this state, the whole affair resembles the mouth with the lips closed.

Now, suppose we open the upper lip with a pin,

we find a large quantity of pollen stored up in that part of the indusium. Finding this, we naturally look at the stamens, and only to find them shrivelled, with their anther-cells devoid of pollen. How, then, did the pollen get in the position we have found it? To obtain an answer to this question, a bud must be dissected. No doubt the first bud is too young. Another is dissected, almost ready to expand, and

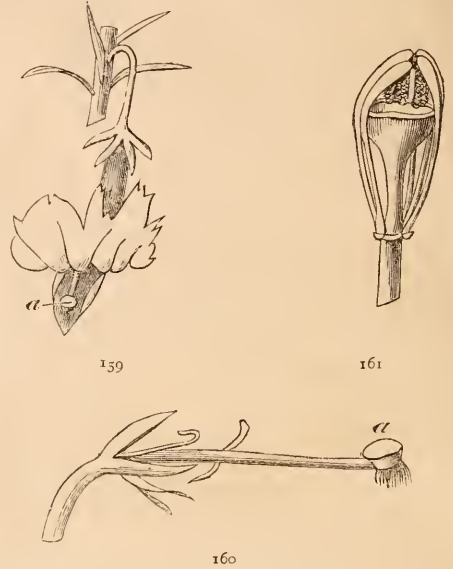

Fig. 159. *Leschenaultia formosa*, expanded flower. Fig. 160. calyx and pistil, showing the indusiate stigma, *a*, magnified. Fig. 161. stamens and pistil in a bud state, showing the pollen being discharged from the anthers into the indusium (mag.).

what satisfaction! we find the pollen being discharged from the anthers into the indusium (fig. 161), just as coals are discharged into the holds of a ship! How beautiful! It would be well to state here that the flowers in a bud state are nearly erect, thus facilitating the discharge of the pollen. After the indusium thus receives the pollen, it quickly closes, and covers the pollen, while the growth of the style is very rapid.

It is now time to ask Nature this question: why is the pollen thus stored up? First, that it should not be lost, since the anthers discharge their pollen before the stigma is ready to receive it. And, secondly, to ensure a most peculiar and beautiful method of cross-fertilization. And we must bear in mind, that although the pollen is in such close contiguity with the stigma, it cannot reach it, nor can the ovules be fertilized without some foreign agency. Suppose, then, a small insect to alight upon the lower lip of the corolla, and in search of nectar down the tube (although we have never found any nectar, but we are pleased to say that Mr. Darwin's observations differ in this respect, as he states that the flowers contain a copious supply of nectar), the under part of the insect would easily push back the indusium, thus exposing the pollen to the insect, and to which the

pollen would readily attach itself. Thus, upon visiting other flowers, the pollen would be carried to those flowers, while fresh supplies would be obtained. Suffice to say, that, by the conveyance of pollen from one flower to another, obtained by imitating an insect, seeds have been produced; and, of course, insects could do the work much more efficiently.

J. T. RICHES.

NOTES ON HOPLOPHORA FERRUGINEA.

DURING the month of March I found a few specimens of this most singular mite. The "Micrographic Dictionary" mentions the genus, but says "not British," adding, however, a query in a parenthesis. There is, however, no doubt about its being British, as not only have I found it alive myself, but a friend of mine also tells me that he found it

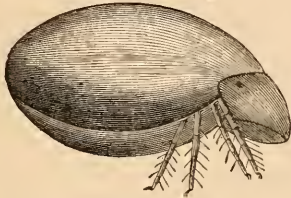

Fig. 162. *Hoplophora ferruginea*, side view.

some time ago. It looks like a little egg of polished cornelian, and is about $\frac{3}{100}$ ths of an inch in length: it belongs to the family Oribatea, and its chitinous covering is very brittle, so that it is easily broken by pressure. The body is covered with a bright, shining, egg-shaped case of chitine, deficient in front and on the under side. The thorax, legs, palpi, and proboscis are covered with a shield of the same material, joined above to the body part of the case by membrane, acting like a hinge; the deficiency underneath is also protected by four plates of chitine, moving towards each other, and meeting in the middle line, like two pairs of sliding doors. When the creature is placed on its back, on a glass slide, under the microscope, at first he lies still, and having closed his sliding doors and shut down his head-shield, he looks exactly like a highly-polished, egg-shaped piece of cornelian, only exhibiting marks of a somewhat darker colour at the edges of the different pieces of chitine, and some slight shades, produced by the body within this semitransparent case; but after a short time, the carapace slowly opens, the palpi and legs are protruded, and the creature commences to struggle, in order to regain its feet; but, in consequence of his short legs, he is rarely able to accomplish this feat unaided. Whilst watching this process when first examining the creature, I was astonished to see the

pieces of chitine covering the abdomen open like sliding doors, the vent then becoming conspicuous. If a slight jar was given to the stage, or the creature touched with a needle, the doors immediately closed, the legs and proboscis were withdrawn, the head-shield shut down, and the creature once more resumed the egg-like form.

The eyes were not apparent; the palpi are jointed and hairy; the mandibles chelate, and very powerful,

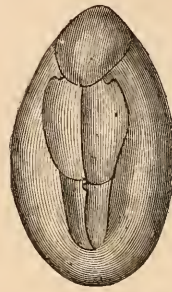

Fig. 163. *Hoplophora*, with carapace and abdominal egg-shaped plates closed.

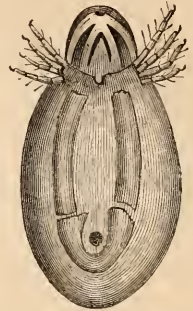

Fig. 164. *Hoplophora*; under side view; abdominal plates partly opened.

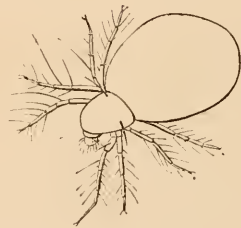

Fig. 165. *Hoplophora levigata* (traced from Koch).

resembling the claws of a lobster; the legs rather short, very hairy, and terminated by a single hooked claw.

They are found under damp stones and pieces of decaying wood: they move very slowly. When I first found them I thought they were common, but I have since looked for them in similar situations in vain; and I did not secure drawings of the legs, palpi, and chelæ, thinking to do so on a future occasion.

I am not sure that I have named the variety correctly. The only book in which I have found any information, besides the "Micrographic Dictionary," is in the third Heft of C. L. Koch's "Uebersicht des Arachnidensystems," where there is a figure of *H. levigata*. The legs appear to be much longer in this species than in the one examined by me. Koch names no less than thirteen varieties.

C. F. GEORGE, M.R.C.S.

Kirton-in-Lindsey.

A CHEAP MICROSCOPICAL CABINET FOR SLIDES.

AS I dare say some of the readers of SCIENCE-GOSSIP have felt the want of some more convenient mode of bestowing their microscopic slides than the old-fashioned racks, and have at the same time been unwilling to give the prices demanded by dealers for cabinets, I am anxious to give the results of an effort I made to supply myself with a set of five books, to hold 150 slides each.

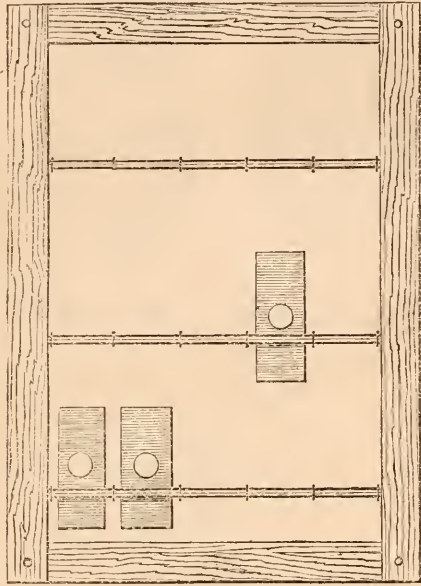

Fig 166. Microscopical Cabinet for Slides.

I procured at a stationer's twenty-five Welsh slates, such as are used in schools, carefully picking those having well-formed, clean frames, the size being $6\frac{1}{2}$ by 10 inches on the inside. I removed the slate from one of them, which is easily done by pressing out the pegs at two of the corners, and ordered twenty-five pieces of stiff milled-board, about as thick as that used for the backs of octavo books, to be cut to the exact size of the slate I removed, and then to have highly glazed white paper pasted over them.

When they were finished, I procured some of the best silk elastic, $\frac{1}{8}$ inch broad, and had it stitched on both sides of the boards, three bands on each sewn through and through at such intervals as to take five slides on each row, holes having been previously bored in the cardboard thus : : : : : the spaces being about an inch and a quarter wide.

In the meantime I took a sharp knife and a bit of sand-paper, and trimmed all projecting corners off my slate-frames, and then, without removing the slates, sent them to a French polisher to stain and

polish them like mahogany. When I got them back I removed the slates and substituted for them the pieces of cardboard I had prepared, carefully replacing the pegs exactly as I took them out. The next step was to take them to a bookbinder, with orders to bind five frames in each volume, securing them by tacking a piece of stout canvas to the edges of each frame in the volume. The results have surpassed my expectations, for the grain of the wood is so like mahogany that only careful observation could detect the difference; and the volumes filled with slides, fifteen on each "page," if I may use the term, look remarkably well, and, what is better, are most convenient.

Now as to cost :—

	£	s.	d.
25 slates, $6\frac{1}{2} \times 10$ in., at 4/6 per dozen	0	9	4½
25 milled boards, cut to size and covered with white paper ...	0	8	4
36 yards of elastic	0	8	6
French polishing slate-frames ...	0	6	0
Binding five volumes	0	15	0
Total, <u>£2 7 2½</u>			

I have not included the sewing on of the elastic, as most microscopists have lady friends who would do them.

The accompanying sketch gives a better idea than any amount of description.

I need hardly add that the cost of many of the items could be reduced. For instance, Berlin black might be applied to the frames instead of French polishing; and the cost of cutting and covering the boards might be dispensed with by any one taking the trouble to do it himself.

T. II. MOORHEAD.

MICROSCOPY.

THE "JOURNAL OF THE QUEKETT MICROSCOPICAL CLUB," Part 34.—The part just published is, perhaps, of more than usual interest, and we append a list of the papers read before the Society, several of them containing important practical information :— "On a New Form of Section-cutting Machine," by H. F. Hailes. 1 plate.— "On Black Moulds," by M. C. Cooke, M.A., LL.D., &c. 4 coloured plates.— "On the Absence of Stomata in certain Ferns," by W. H. Gilbert.— "A Contribution to the Life History of *Botrylloides*," by T. C. White, M.R.C.S., &c.— "Professor Giuseppe de Notaris."— "On Staining Vegetable Tissues," by W. H. Gilbert.— "Proceedings." Mr. Hailes' machine, which we have seen, seems to meet the requirements of those who are anxious to make their own sections (and which every one should do who really wishes to know something of the minute animal or vegetable

structure) : it is capable of cutting fresh, growing wood as thin as the 1100th of an inch, and sections of bone thin enough to mount at once. The paper on "Black Moulds" calls for no remark, the name of the writer being a sufficient guarantee of its value. Mr. Gilbert's papers are of considerable interest, particularly that on staining vegetable tissues. Mr. C. White's remarks on *Botrylloides* are valuable, as all contributions to our knowledge of the lower forms of life must be when they proceed from the actual observations of the writer. The "Proceedings," of course, consist of *vis à voce* remarks and discussions on the papers read at the various meetings. At one of these meetings, Mr. B. Lowne described a very ingenious instrument made by Lippmann in Germany : it is a very delicate form of electrometer, and is intended to measure minute currents of electricity, such as the most delicate galvanometer would fail to indicate. We would strongly recommend those interested in microscopical research to purchase the part.*

QUEKETT MICROSCOPICAL CLUB. — The twelfth annual meeting of this important society was held on July 26th, when the annual report was presented and elections for officers took place. From the report it appeared that satisfactory progress continued to be made ; many valuable papers had been read, much practical work accomplished, and many valuable additions to the library and cabinet had been made. The meetings, held fortnightly throughout the year, had been well attended, the field excursions were well conducted, and the *Journal* had taken its place amongst the microscopical literature of the day. Forty-five new members had been elected during the year, and after allowing for removals by death and default, the present number was stated to be 542. It was incidentally mentioned that the total number of members since the establishment of the club had been 1,050. The report of the treasurer showed the receipts from all sources to have been £387. 5s. 11d., with the satisfactory balance in hand of £71. 14s. 10d. The president then read the customary annual address, in which the distinctive features of the club were specially dwelt upon, and many valuable hints and suggestions were given. Votes of thanks to the president for his admirable address, to the officers and committee for past services, and to the Council of University College for continued permission to meet in the Library of that building, were unanimously carried. The election of officers for the ensuing year, and of four members to supply vacancies on the committee, was then proceeded with, and the result of the ballot was announced as follows :—President, Henry Lee, Esq. ; vice-presidents, Dr. Matthew, Messrs. Frank Crisp, E. T. Newton, and T. C. White ; treasurer, Mr. F. W. Gay ; hon. secretary, Mr. J. E. Inghen ; hon. foreign secretary,

Dr. M. C. Cooke ; committee, Messrs. Gilbert, Parsons, Priest, and Spencer.

ON MOUNTING SPIDER PREPARATIONS.—In the December number of last year's (1876) GOSSIP, a correspondent, signing himself F. E. Fletcher, inquires the best method of mounting spiders for microscopical research. No answer, as far as I can see, having been given to your correspondent's request, I thought my own experience and way of mounting may perhaps be useful to him and other microscopists. The class Arachnida, to which the Spiders belong (the name Arachnida being taken from the Greek *ἀραχνης*, a spider), have certain well-known characteristics which it may be well to note. Firstly, the body is not formed of three sections, as those of insects : it consists only of two ; the head and thorax are not separated, but form together the part called the cephalo-thorax. Secondly, they have always eight legs. Thirdly, they do not undergo changes. Fourthly, their eyes are never compound, though they vary in number and position. These, then, may be termed the chief characteristics of this order. As regards those spiders which most concern the microscopist, I may mention three groups : 1. The House Spider ; 2. the Garden Spider ; 3. the Wandering Spider. The latter two species, which are to be found in our gardens, though well adapted for mounting purposes, are not so easily obtained as our friends that take up their board and lodging with us in the house. It is no difficult matter to find the house spider ; any old cupboard, or disused room, will furnish plenty. If one keeps his eyes about him of a wet day, he is sure to see some large specimens crawling either on ceiling, wall, or floor. Having found your spider, the next thing is to catch him, and then kill him. A pair of curved forceps is what I generally use to catch specimens with. The best way of killing them is with the poison-bottle, which, I presume, every microscopist has ready at a moment's notice for use. Those who do not know of this contrivance may like to know the way to prepare it. Get, then, from your garden a lot of laurel-leaves ; chop them up fine, dry them in the oven a short time, and then put them in a small glass jar (there should be enough to half fill the bottle or jar) ; next cut a circular piece of cardboard, the size of the inside of the bottle ; punch this all over with small holes of the size of a pin's point, then place it on the laurels, and your engine of destruction is complete. Laurel is well known to contain prussic acid, and this kills in a short time all insects, and *small* animals of any kind, placed inside the bottle or jar, always providing the stopper is *firmly* in its place, which it always should be, whether the bottle be in or out of use. A very strange case is under my notice while writing this paper, a case in which, for the first time, I have found this poison-bottle to fail. I mention it here because it is con-

* Published by Hardwicke & Bogue. Price 1s.

nected with the subject I am dealing with. On Tuesday, May 22nd, I caught, in an old wine-cellar, which is quite dark and rather damp, a very large black-looking house spider. I at once put him in the above-described bottle and left him. Judge of my surprise to find, on inspection the following morning, that instead of being dead, he was alive and *very* lively; and at this present moment, Friday, May 25th, he appears inside the bottle as lively as ever! The bottle is air-tight, and the laurel *very* strong. On Sunday a large house spider placed in it was perfectly dead in fifteen minutes. My idea is that the gentleman now incarcerated must be of a poisonous class, and therefore impervious to prussic acid or anything else. Let me advise my readers who are going to mount spider preparations, to dissect, as quickly as possible after death, the bodies of the spiders they have captured; for, if kept long, they shrivel up, and become very difficult to manipulate. The dissection of a spider is by no means difficult, as those objects which the microscopist desires are *all* external, so to speak, and visible to the naked eye. Place the spider on your dissecting-board, and pin it down; then with a pair of sharp, fine scissors remove the eight legs, and put them aside; next with a scalpel cut off the spinnerets, which are to be found at the extremity of the abdomen, and are four in number. Then remove the maxillæ; and lastly, cut away the mandibles, if possible, with eyes attached. This plan of mounting the eyes and mandibles I have found to be highly satisfactory in every way. Having carefully dissected all the parts, put them in a gallipot, and pour liquor potassæ upon them. The best jars are those which Liebig's extract of meat is sold in. In about three to six days, take the preparations from the liquor potassæ, and place them in a saucer full of distilled water, and *well* wash; then press between two pieces of thin glass, the spinnerets excepted; and then wash again, always using a camel's-hair brush to cleanse the specimens with. Dry the specimens on clean blotting-paper, and then place in another gallipot full of spirits of turpentine. In a day or two you may mount. You must be careful that the mandibles and eyes are fairly flat, and that the jaws are not gaping too much apart: the novice will find this difficult of attainment; but, persevered in, good results will be obtained. In mounting the feet and legs, see that the combs of each foot are clear and distinct. The maxillæ are not particularly interesting, but should be mounted together. *Be careful not* to flatten the spinnerets by pressure. The best fluid for mounting in is damar; but if there can be found such a wonder as a microscopist who ignores its utility, why, then let him use Canada balsam. Thus, in a very brief manner, I have noted the chief things to be observed in mounting specimens of arachnida; and I certainly think they make good specimens for the cabinet. What with those who preserve spiders whole, and those who mount for microscopical re-

search, certainly the fair Lydian maiden's descendants, of fabulous record, are thought a little about, and also studied, in this age of learning and improvement—the nineteenth century.—*C. F. W. T. Williams, Bristol.*

STRUCTURE OF THE RED CORPUSCLES OF THE BLOOD.—It has long been a vexed question whether the nucleus of the red corpuscle may not be a mere coagulation after death, and not an entity within the living corpuscle. The former opinion is maintained by Professor Savory and other eminent physiologists, and the latter view is that of Professor Gulliver, who found on it his two great sections, Pyrenæmata and Apyrenæmata, of the vertebrate sub-kingdom of animals. In a late number of SCIENCE-GOSSIP, Mr. W. H. Hammond, of Milton Chapel, is reported to have proved the existence of the nucleus in the living red blood-corpuscle of fish; and at the last meeting of the East Kent Natural History Society he read a paper, illustrated by numerous drawings, on the same corpuscles of birds and batrachians, in which he concluded that the nucleus also really exists, and is plainly demonstrable, in the living animal. For observing the circulation in the bird, Mr. Hammond used the foot-web of young ducks, which he found, in the newly-hatched bird, sufficiently transparent to admit of the use of deep objectives; and this would appear to be a novel and interesting addition to our means of viewing the course of the blood, and the form of the corpuscles, in a class of vertebrates but rarely, if ever, before subjected to this kind of experimental examination. Mr. Hammond's paper, with the necessary details, will probably appear in a forthcoming number of the *Monthly Microscopical Journal*.

ZOOLOGY.

SPIDERS AND THEIR WEBS.—IN SCIENCE-GOSSIP, some time ago, the question was asked, Why do spiders make webs in dark corners of closets which are seldom opened, so that there can be no flies in them? My idea is—(1) Spiders are not designed to walk comfortably except on lines of their own spinning, and therefore make webs for their own convenience; (2) They need homes for themselves and their eggs, and therefore construct them of a material most readily accessible; (3) Perhaps there is a supply of web-material for which some outlet must be found, so that if they do not want to construct webs for the purpose of catching flies, they get rid of the surplus by making a mass of cobweb in out-of-the-way places. These webs are, as a rule, irregular masses, not constructed with that skill and evident economy of material that is seen in the fly-catching web.—*S. Hoorsly, Travancore.*

PRESERVING CRUSTACEANS.—Having successfully preserved some hundreds of crustaceans, I can confidently recommend the following method as giving good results:—First carefully take off the carapace, and with a pair of forceps remove the whole of the adherent flesh from the interior, completing the cleansing process by thoroughly rinsing with fresh water, for which purpose a bottle-syringe will be found extremely useful. All the soft matter is then to be removed from the body of the crab, picking out with the forceps as much as possible of the muscular fibres at the base of the legs, and finally wash away all the *débris* with water. The crab must then be placed in a current of air to dry, taking care that it is not exposed to the direct rays of the sun, as too much heat would alter the natural colour of the specimen. Before the crustacean is quite dry, the carapace should be replaced, and the legs pinned out on a cork setting-board, and the whole put in a warm place to dry. It is unnecessary to attempt to remove the flesh in the legs and claws, as the muscular fibre contained in them will entirely dry up if the foregoing instructions are properly carried out.—*Thomas D. Russell*, 48, *Essex-street, Strand*.

RESEARCHES AMONG THE ACARIDÆ.—In a recent number of *Nature* there appears an account of the researches made by M. Meguin among the Acaridæ, and particularly on that strange asexual form known as *Hypopes*. This is a form which is not absolutely necessary for reproduction, although it seems to occur under certain biological conditions for the conservation of species. In the aerial reservoir of birds, especially of the *Gallinacæ*, there is found an inoffensive species of acarus, called *Kytodites glaber*, which sends off colonies even to the bronchial branches, and the marrowless bones of the limbs which are in communication with the air-vessels. Another harmless acarus has been found in the cellular tissue of birds, living and dying there. A third species, which lives normally between the barbs of the feathers, produces in the skin of birds, especially of pigeons, at the time of moulting, a hypopial vermiform nymph. Without this latter precaution, the species would soon be annihilated, on account of the falling of the feathers during the moulting season.

THE NEW MUSEUM IN DUBLIN.—In the second part of *Industrial Art* (a capital new monthly shilling magazine devoted to technology and art, and profusely illustrated with highly artistic vignettes) there is a well-written article on this subject. It was a scheme of Mr. Sullivan, M.P., who seems to have wished for a science and art focus in Dublin which should equal that of South Kensington in England. The scheme seems to promise, however, that the new Dublin Museum, like that at Edinburgh, will simply be a satellite of that at South Kensington.

THE GORILLA.—A young gorilla, the first living specimen which has been exhibited in this country,

has for some time been shown at the Westminster Aquarium. It is about three years old. Those who have the opportunity should not neglect to see it.

THE ROTHISAY AQUARIUM.—We have received a copy of the official guide-book to this flourishing aquarium, compiled by the curator, Mr. Barker. The matter is well and popularly presented to the public, and the guide cannot fail to interest visitors in the objects exhibited to them.

NEW SPECIES OF BIRDS.—In the August number of the *Annals and Magazine of Natural History*, Lord Tweeddale has described four new species of birds from the Indian region, under the names of *Megalurus ruficeps*, *Niltava leucura*, *Dicaeum xanthopygium*, and *Oxycera Everetti*.

BOTANY.

FRUCTIFICATION OF SYCAMORE.—The Sycamore, *Acer pseudoplatanus*, belongs to the natural order *Sapindacæ*, the flowers of which are partly characterized by having eight stamens and a two-celled ovary. In the Sycamore, as every one knows, the two ovaries eventually become a fruit, formed of two diverging winged seeds, called a *Samara*. That there are only two winged seeds, by reason of the suppression, under ordinary circumstances, of several others, is clear from the fact that *occasionally* a sycamore fruit may be found in which three, four, five, and even six winged seeds have been developed. Perhaps eight should be the theoretical number, to correspond with the eight stamens. But the fact to which I wish to draw attention is that, for some reason or other, this year the suppressed cells of the ovary have been developed in a very remarkable manner. Sycamore fruits, with three, four, five, and six winged seeds are as common almost as with two. Those with three seeds are on some trees almost the rule rather than the exception; they are less frequent, with larger numbers of seeds, but still a bunch can scarcely be found that has not at least one fruit with four wings. My observations extend to Cheshire, and North Wales along the Vale of Llangollen, and on to Dolgelly. I observe that the abnormal growth is most marked in young and vigorous trees; but even old trees of a large size are, to a considerable extent, the same. It would be interesting to hear if this curious phenomenon has been general; and more interesting still if any correspondent can suggest a reason for it in this particular year.—*Robert Holland*.

ERICA MEDITERRANEA.—Mr. Stewart, in the June number, says that he believes *Erica mediterranea* to be extinct on Urrisbeg. This is a mistake; but it is very local, only growing in one small valley. I found it there in June abundantly, but with nearly all the flowers withered and brown. Any one going in search of it had better get a guide to the spot.

The plant is well known to many of the natives under the name of the French Heath.—*Philip B. Mason, F.L.S.*

THE "EDELWEISS."—I notice what I must interpret as a small "scare" in your last number, to the effect that Edelweiss is becoming all but extinct in the Swiss Alps. Two years ago I found it in plenty, and in several of the ranges of Alps, and that being my eighteenth or nineteenth visit to Switzerland, I found no perceptible falling off in the frequency of its occurrence. Although Edelweiss is not found only at such awful altitudes as Cockneys are wished to believe, it does grow at such heights that Italian boys and herdsmen are not in the least likely to exterminate the plant! Still, as there is seldom smoke without fire, it would be interesting to be informed by some Alpine man who is on the scramble this year what foundation may exist for the story copied by the *Times* from the *Echo*.—*Marshall Hall.*

BRITISH AND FOREIGN FERNS.—All true botanists will hail with pleasure a new and enlarged edition of John Smith's well-known work, "Ferns: British and Foreign." (London: Hardwicke & Bogue.) For amount as well as excellency of matter and illustrations, we have no equal to it. Mr. Smith has brought this edition to the front of all the botanical knowledge of the day.

SHINING MOSS.—In reply to your correspondent Mr. T. Watson, I beg to state that I have found the Shining Moss (*Schistostega pennata*) in an old quarry-hole near here; and its luminous appearance, accurately described by him, led me to believe it was some mineral substance, until I proved the contrary by closer examination. The hole in which it grew was very wet, from water constantly dripping from the roof; and the fact that it was a sandstone quarry led me to suppose that it was a growth peculiar to this stone, and I was not aware it was found in coal-measures.—*R. A. Gatty, Bradfield Rectory, near Sheffield.*

SHINING MOSS.—Last year, when staying near the Land's End, I was told by the fishermen of a cave not believed to be known to tourists, the sides of which, they said, were covered with gilded moss. I visited it, and found it to be a large cave, with a small and narrow entrance, very much blocked up by fallen rocks, so that the light came in through the upper part only, and fell in a sloping direction; the sides were very damp with constant dripping, and the *Asplenium marinum* hung in quantities from the roof; the sides of the cave, in many places where the light struck, shone really with as great brilliancy as if they had actually been gilded, and the same effect was seen in the small pools below. It was only seen when standing near the mouth of the cave, with one's back to the light. The lustre was decidedly greenish. I should think the sea only entered the cave at very

high spring tides. On approaching the places where the gilded effect was seen, it vanished, and only a thin shiny layer was seen. I gathered some of this both from the sides and from the pools, and examined it on my return, and in each instance found it to consist almost entirely of diatomaceæ of various kinds.—*Albert D. Michæl.*

SHINING MOSS.—In answer to Mr. Watson's notice of a Shining Moss, I would inform him that in *Loudon's Magazine*, vol. ii. p. 406, there is a long notice of the same plant in Derbyshire, in the shady recesses of some of the rocks. In case Mr. Watson has not the volume, I would mention one or two things Mr. Bowman, a well-known naturalist, says of it. He mentions the golden-green light, of a phosphorescent appearance, which showed best at a little distance, and was lost on close inspection. When brought into the light, there was a network of green, with cylindrical jointed stems and branches. It appeared to be a kind of conferva, nearly approaching *Conferva velutina*; and Mr. Bowman seemed to think that the light must have been concentrated and reflected by the convex form of the reticulations of the plant. In vol. iii. p. 152, a correspondent mentions a similar thing which he saw in a cavern by the roadside, near Penryn. It there seemed a small moss, apparently *Dicranum taxifolium*. In De Luc's "Geological Travels" the same thing was seen in the granite mountains about Beyreuth. When seen from a particular point, the part covered with the moss showed a fine emerald-green light.—*E. T. Scott.*

BOTANY OF CADER IDRIS.—I have read with considerable interest "Botanical Notes in the Neighbourhood of Cader Idris," published in your issue for August; but I was rather astonished at finding no mention made of the beautiful *Gentiana acullis*, or *Gentianella*, which I certainly noticed as growing on the Cader in July, 1862. There were several plants of it. I hope and trust it has not been exterminated. One seldom sees it even in gardens, and the only garden where I noticed it in great perfection belonged to a friend of mine at Guestling, Sussex. It formed a sort of edging for the flower-borders, and attained the greatest degree of beauty and perfection. In Babington's "Manual of Botany" it is stated that the *Cotonaster* is found on Great Orme Head. I traversed its length and breadth in July, 1862, but was unable to find a single plant; and Llandudno within the last twenty years having become a large town, I suppose its numerous visitors to Orme Head have sealed the fate of *Cotonaster*.—*John Colebrook.*

PHORMIUM TENAX (New Zealand flax), &c.—This plant is now in full flower at the Cliftonville Nursery, Brighton. Is not this an unusual circumstance? The same florist has had many plants for several years, but none have flowered before: the flower-stem is about eight feet high, and the flowers very abundant. The

Euonymus Japonica, also, which flowered at Brighton for the first time about three years ago upon only one or two plants, has this year flowered abundantly. Has any peculiarity in the weather, this season, occasioned this unusual inflorescence, or can the readers of SCIENCE-GOSSIP suggest the cause of it?—*T. B. W., Brighton.*

DRYING BRITTLE PLANTS.—The experience of Mr. D. Douglas, in his attempts to preserve Chara and similar fragile plants, is by no means uncommon. Last season I received a parcel of plants which had been some time dried, and, after passing through the postman's hands, they were reduced to a confused mass of fragments. I was induced by the difficulty of making even characteristic specimens of the *Crasula* family (to say nothing of beauty) to try a method which has, to say the least of it, the merit of keeping the parts of a plant together. After one of these troublesome subjects has been in the press long enough to flatten it (a day or two suffices), gum one side of the specimen carefully and lay upon it a sheet of mounting-paper of the required size. It can then be passed through the press, and dried in the usual way between blotting-paper. The plant is by this means secured to the paper during the process of drying. I have secured very good specimens of *Sedum dasyphyllum*, with all the leaves attached, a thing, I fancy, next to impossible if the plants are dried in the ordinary way. A friend suggests an improvement on this plan for delicate filamentous plants like the Charas. Lay the plant on paper that has been well gummed over, and while the gum is wet; then upon this place a sheet of dry paper, carefully turn upside down, and after drawing off the gummed sheet, replace it with a clean sheet of mounting-paper; turn over again and remove sheet No. 2; the plant is thus secured, and does not collapse or tangle.—*W. E. Green.*

A NEW LONDON FLORA.—This is the title of a capital hand-book of the flora of the metropolis and the neighbourhood, by Dr. Eyre de Crespigny, published by Hardwicke & Bogue, 192, Piccadilly. To practical botanists it is invaluable, as it serves all the purposes of a field guide. We have many capital collecting-grounds not far from London, in spite of the sure manner with which the capital is swelling its boundaries. Dr. Crespigny gives not only lists of flowering plants and their localities, but treats of ferns, mosses, and other cryptogamic plants. A list of seventy-five places is given, each place described as to its scenery, physical character, &c.; and then follows the lists of plants to be met with. It is with much pleasure we heartily commend this book.

GEOLOGY.

THE MICROSCOPIC CHARACTER OF ROCKS.—Professor Zirkel, in a recent review of the various kinds of crystalline rocks and their microscopic dis-

tinctions, says he generally uses the term *ground mass* for rock which is distinctly granular under the microscope, and *base* where there is an amorphous paste not crystallinely granular under the highest magnifying power, though containing crystalline minerals. The crystalline minerals in the *base*, he thinks, were formed while the *base* had still a flowing movement, as is shown by the minerals ranging in straight or wavy lines, and by their fractures or abrupt bends and displacements. Hence the positions and forms of the crystals have been partly determined by the flowing; and hence, also, the rock has not undergone any metamorphic changes since solidification took place. Those rocks whose micro-fluidal structure is particularly distinct are generally proportionally rich in broken crystals, shivered into detached sharply-angular fragments.

GEOLOGICAL PHENOMENON IN THE SAVOY ALPS.—A good deal of interest has lately been taken in a phenomenon reported from the Savoy Alps. A mountain in Tarentaise has been crumbling down, and this has been going on for nearly a month. Huge stones, some of them of fifty cubic yards' bulk, have been detached from the summit of the mountain, and been precipitated to the bottom from a height of five thousand feet, leaping a thousand feet at a bound. The air has been filled with the noises of falling stones, and two neighbouring villages have suffered disasters from the constant stony avalanches. The *débris* which has been thus detached has formed a huge conical mound in the valley nearly two thousand feet in diameter at the bottom, and six hundred feet wide at the top. Extensive pine forests have slipped from the mountain-side, or been shivered to pieces. It is well known to geologists that the Alpine range is one of the newest of mountain systems, and owes its existence to the folding or crumpling up of formerly horizontal strata. This process has been going on for a long time intermittingly, and it may be that the phenomenon we have referred to is due to a local dislocation of strata produced by forces tending to still further fold up the rocks.

“THE GEOLOGICAL RECORD FOR 1875.”—We are glad to see the second issue of this most useful volume to geologists. We are not surprised to notice that it is increased in size to more than forty pages over its predecessor. This is caused not only by increase of matter, but also by a most valuable feature; viz., an index of all species of fossils noticed in the work. The editor, Mr. W. Whitaker, B.A., F.G.S., is most competent to the task, and is assisted in his undertaking by about two dozen of the most notable geological writers of the day. Notwithstanding the increase in size, the price of the *Record* remains the same.

ANOTHER SPECIMEN OF ARCHÆOPTERYX.—It is announced that another specimen of the *Archæopteryx*, or fossil feathered animal originally discovered

in the Solenhofen slates, has been found at Pappenheim, near Solenhofen. It is said to be much more perfect than the former, and that the head is preserved. In the original specimen, parts of the head were missing. Some geologists have long been of opinion that this fossil bird or reptile (for the type is so intermediate that it is difficult to say which it is) must have had teeth implanted in the mandibles.

THE NEW FOSSIL TERTIARY BIRD.—The new species of fossil bird, called *Lithornis emuinus*, to which we referred in our last number, is believed by Professor Owen to have had enormous wings, and to have been closely allied to, but larger than, the albatross.

GEOLOGY OF PLYMOUTH.—In my sketch of the Geology of Plymouth (SCIENCE-GOSSIP, August, p. 170), I inadvertently committed Mr. Champernowne to an opinion which he never has held. In the sentence, "It is quite possible that the southern margin of the Plymouth limestone may be a faulted one, as suggested to me by Mr. Champernowne," the words here marked in italics should be erased.—H. B. Woodward.

NOTES AND QUERIES.

PEREGRINE FALCON, &c.—However much it is against my inclination to refer to books to assist me to solve the question in dispute, or, in fact, to pass an opinion at all upon the specific distinction of birds which I have never observed in their native wilds, still I will, as requested by Mr. Dealy, give the opinion of several trustworthy writers of recent date upon this subject. In the first place Dr. Elliott Coues, in his "Birds of the North-west," says: "The American Duck-hawk appears to have been first separated from the Old World Peregrine by Prince Bonaparte in 1838; but no characters were, to my knowledge, then ascribed to it, and it is very doubtful that any exist." It may be presumed that this author was misled by a then supposed, but since proved groundless, difference in the nidification; more likely, however, he proceeded upon some theory respecting geographical distribution. The name has, however, been very generally adopted, even by those who have demurred against it. One of the highest authorities on birds of prey, Dr. Schlegel, states, after examination of various examples from North and South America and Mexico, that "le Faucon commun de l'Amérique ne diffère en aucune façon du nôtre." Such is nearly my own view; and even Bonaparte, in 1850, confesses that his *anatum* is "forsan a *F. communi* spec. haud diversus." . . . Of the Australian *F. melanogenys* Dr. Schlegel has remarked: "La variété accidentelle fondée de l'Australie . . . ne mérite pas même le nom de conspécies." As to the Duck-hawk "retiring to swamps, &c.," Mr. Allen states (writing in 1864) that Mr. Bennett took the eggs of the Duck-hawk upon Mount Tom, Mass., U.S.A., and secured the female bird. I will quote a few of the remarks made by Mr. Allen. "Ten days later he made another visit, and, creeping carefully to the summit of the cliff, at a point near the eyrie already spoken of, he saw the female, on looking over the cliff, sitting on the nest, and but five or six yards distant. She eyed him fiercely for an instant, and

then, scrambling from the nest to the edge of the narrow shelf supporting it, launched into the air. In a twinkling Mr. Bennett's unerring aim sent her tumbling dead at the foot of the precipice several hundred feet below. The nest contained four eggs, which were soon safely secured, and the body of the female was obtained from the foot of the cliff." There is another matter to which I would call Mr. Dealy's attention—his recent assumed discovery of the Red Grouse perching upon trees,—if he will allow himself to remember that we were once discussing this matter, and that I informed him of this peculiar habit, which he has now published as *his own discovery*. I claim no merit for the so-called discovery, which, I have no doubt, many of the readers of SCIENCE-GOSSIP have repeatedly observed; but I cannot allow a person to claim honour which he has not earned by any of his own researches. As I have now endeavoured to reply fully to Mr. Dealy's remarks, I ask him to kindly express an opinion upon my own, as I previously wished. (See SCIENCE-GOSSIP, July 1, 1877.) By the way, will Mr. Dealy kindly inform me from what authority he has received the information respecting the numerous clutches of eggs in one sparrow-hawk's nest?—Charles Dixon, Healey, near Sheffield.

PEREGRINE.—I was particularly pleased with July number of SCIENCE-GOSSIP, inasmuch as Mr. Southwell's paragraph referring to the Peregrine entirely clears up, as it now stands, everything concerning *F. peregrinus* and *F. anatum*; and I might say with the Hon. Secretary of the Norwich Naturalists' Society, "I too am content to accept the opinion of modern ornithologists" as to the identity of the two above-named birds. Although the assertion of Willson regarding the so-called Duck-hawk always striking its prey to the ground may be strong, I do not consider the expression too strong, as he adds: "The circumstance of the hawk's never carrying off the duck on striking it, has given rise to the belief of that service being performed by means of the breast, which vulgar opinion has armed with a projecting bone." It would be interesting to know the grounds on which Gould based *his* opinion as to the distinction of these two birds. I candidly admit that, under the information brought to light by Mr. Southwell, I was using a very wide expression when I said that the Peregrine never "built" its nest on trees,—always on rocks." I see also that "Old Bushman," in his "Ten Years in Sweden," says that the Peregrine constructs its eyrie on trees; whether in a swamp or on the wild lonely sides of these rocky fells, he leaves us to conjecture. The fact of the Peregrine breeding on trees in Europe is not confined to North Germany alone, and I have little doubt that, if properly inquired into, it would be found that it, at times, nested on trees in various other parts of Europe. My heartiest thanks are due to the editor for the kindness and forbearance he has shown in allowing this discussion to take place, as it has been productive of much good, and has called opinions out of obscurity where they have long lain dormant.—T. W. Dealy, Sheffield.

THE RED-LEGGED PARTRIDGE.—I have in my collection an egg of the above, taken in May of this year, a few miles from here (Ripon, Yorkshire). I should like to know if any of the readers of SCIENCE-GOSSIP have ever known or heard tell of the Red-leg breeding so far north as this before, there being no preserves of this species anywhere near, at least not to my knowledge. I have not heard of them being preserved out of Norfolk. I can only set it down as being some bird or birds which, have strayed away, as I have made inquiries, but have never heard of

any one who had seen this species in the neighbourhood. Not being a bird noted for its flying powers, I am totally at a loss to account for its breeding here, and more so that it ever got here to breed.—*F. Pratt, Ripon.*

GILBERT WHITE.—Doubtless there are many who could endorse the remarks of Mrs. Watney about the ignorance of the Selborne rustics. Five years ago this summer, the plan of my holiday trip into Hampshire and West Sussex included Selborne in my homeward course, and on passing through the village from the southern end, I made inquiries of the first adult person (a woman) respecting the house in which the Rev. Gilbert White lived. Her answer was, as near as I can recollect: "I don't know who 'e is; I don't know 'im—never 'eard on 'im!" The church and graveyard are some distance up from the Rogate end of Selborne at which I entered, and wishing to avoid the possibility of having to retrace my steps, I interrogated one or two other persons before I was rightly informed; and, on this occasion, it was by an apparently intelligent workman, occupied then in cutting the grass on the "many a mould'ring heap" in the churchyard. The fact recorded of the Selborne folks is only one of the many instances that have for ever been observed in civilized countries since the words of Him who suffered more than any one his countrymen's disregard, were uttered—"A prophet hath no honour in his own country."—*George Newlyn.*

GILBERT WHITE'S GRAVE.—Allow me to thank Mr. R. F. Leckey for what, I have no doubt, he intended to be a well-meant correction of my statement respecting the grave of the above-mentioned widely-known writer on and lover of natural history. I sought Gilbert White's grave according to the directions given by Edward Jesse, Esq. I looked for the fifth grave from the north wall of the chancel, and I found it covered up (as I stated in the note alluded to by Mr. R. F. Leckey) between bricks, old mortar, slates, and rubbish. This was on my first visit to Selborne some six months ago. On my second visit, paid in June, to inspect the old stone coffins lately discovered between the nave and the south aisle, I was exceedingly pleased to find that all the *débris* had been removed from Gilbert White's grave. It looked clean and trim, the head-stone being uncovered, and the inscription

"G W
26 June
1793"

was readable. My remarks in a London paper had, I was told, been instrumental in effecting so desirable a result; and a friend of mine, a member of the Athenæum, tells me that there is a movement in the right direction amongst literary men towards erecting a proper monument to the good old naturalist's memory in Selborne churchyard. Did time permit, I should like to send you an account of the stone coffins and their contents.—*Helen E. Watney.*

BIRDS' EGGS.—As some time has now elapsed since the editor, in the June number of this paper, congratulated "The Woolhope Club" upon its having abolished its practice of giving a reward for the best collection of birds' eggs, and no abler pen than mine has made any comments upon this subject, although discussion was invited, I venture to make the following remarks in favour of birds-nesting:—
1. In no other way would so good a knowledge be likely to be obtained of the different kinds of nests built, and the places where they are to be found.
2. Were it not for birds-nesting, a great number of

persons would grow up in almost total ignorance of ornithology. 3. That as most wild birds lay at least twice during the season, it can be no greater hardship to take their eggs than to take ordinary hens' eggs. 4. Several of the commonest birds would become far too numerous were it not for this practice. In conclusion, I think it would have been far better if the Woolhope Club, instead of ceasing to give their reward for the best collection of eggs, had required each competitor, at the time of presenting his collection, to pass an easy examination in his knowledge of the birds whose eggs he had collected.—*A Birds-nester.*

THE GOATSUCKER.—Referring to the article on the above bird in your journal, No. 151, July 1st, 1877, it is there stated that "our one English representative is limited to the southern and south-eastern counties, seldom extending far inland." This, however, is pointed out as a mistake by a Dumfries correspondent in No. 152, August 1st, 1877, so far as concerns the south and south-eastern counties; and as it is always desirable to submit circumstantial evidence of a fact, I beg to point out that your readers will find, on page 101 of "The Life of a Scotch Naturalist," by Smiles, reference made to the bird as an inhabitant of the county of Banff. The work referred to is the Life of Edward, the now notorious shoemaker. The paragraph in which the reference is made is one of great beauty: "The sun went down. The mellow thrush, which had been pouring forth his requiem to the parting day, was now silent. The lark flew to its mossy bed, the swallow to its nest. The wood-pigeon had uttered his last coo before settling down for the night. The hum of the bee was no longer heard. The grasshopper had sounded his last chirp; and all seemed to have sunk to sleep. Yet Nature is never at rest. The owl began to utter his doleful and melancholy wail; the night-jar (*Caprimulgus Europæus*) was still out with his spinning-wheel-like *urr, urr*; and the lightsome roe, the pride of the lowland woods, was emitting his favourite night bark." I may add that I have myself seen this bird as far inland as North Wilts and North Gloucester.—*J. E. Stephens, Alloo, N.B.*

THE GOATSUCKER.—In Mr. Whistler's interesting paper on the goatsucker, he asks if the bird ever jars when on the wing. I am not an ornithologist, but the bird is a very frequent and very near neighbour of mine during summer evening walks, and I should have been inclined to say that it most decidedly does jar when on the wing; I should also feel tempted to add a note to the perfect noiselessness of the flight. The ordinary flight is certainly quite silent, but I have noticed that every now and then it will suddenly be accompanied by a loud flapping noise, which will last for a minute or so. My impression is, that this is produced voluntarily, and usually when a pair, male and female, are wheeling round after one another; but perhaps Mr. Whistler, or some of your readers, can give a better explanation.—*Albert D. Michael.*

THE GOATSUCKER.—I think Mr. C. W. Whistler has given rather too restricted a range to the Goatsucker. It is not at all an uncommon bird in the Westmoreland Lake district, where it is almost universally called the fern-owl, and I have heard its peculiar note very frequently near Lake Windermere.—*A. J. Adams, Rotherham.*

BIRDS' NESTS AND EGGS.—We hear and see and read a great deal these days about "Oölogy" and "Oölogists," but I am afraid that this *science of eggs*

and its votaries cannot stand a strict scientific scrutiny, unless when entirely shielded by, and made subservient to, true Ornithology. We are told that Mr. — has a very fine Oölogical collection. What does that mean? In nine cases out of ten it simply signifies that that scientifically inclined gentleman has accumulated a large quantity of birds' eggs, which he has blown, stuck on cords, and ranged in his cabinet, where visitors can see and admire them. No one can deny that the effect is truly very pretty, but the spirit of the work is not so admirable; it is exactly similar to the motives a school-boy has to collect postage-stamps, or buttons, or pieces of broken crockery; there is not a whit more true science in it than there would be in making a collection of birds' legs or tails. And at what cost is this fancy work carried on? At the sacrifice of hundreds of little songsters, to say nothing of the larger birds; at the cost of the local extermination of the rarer species, by the depopulation of the field, the garden, the orchard, and the woodlands of their most beautiful inhabitants, and of the consequent multiplication of a hundred forms of insect vermin. Take a moderate-sized collection of say 100 species, with an average of three eggs of a kind; add to this a hundred for eggs lost, owing to the unwillingness of the parent birds to return to a disturbed nest; add fifty for eggs broken or otherwise lost in preparation, and another hundred for companion eggs which have been transferred to another collection, and you have the equivalent of at least 500 birds slaughtered for mere amusement on a *British* holiday. Surely there is no utility in a collection of eggs, except when it constitutes a portion of a thorough ornithological collection, where the bird, its nest, and eggs, are placed in juxtaposition for scientific comparison and investigation: then indeed it fills an important position, for the history of a bird cannot be looked upon as complete until its habits of nidification and its Oölogy (if the term *must* be employed) are known. If egg-collecting as egg-collecting would be dropped by (so-called) naturalists, and the general rule laid down never to take an egg of whose parent bird the collector does not possess a specimen or a reasonable hope of obtaining one, it seems to me that a perceptible check would be given to this wholesale, useless, and cruel, but deplorably popular, method of waging war against some of our best friends.—*W. T. Van Dyck, Beyrout, Syria.*

TADPOLES.—As I have several times kept tadpoles, I can inform your correspondent of the plan I have found to succeed, though I am not thoroughly acquainted with their history. He is probably aware that it is now too late in the year to get any young tadpoles or spawn. The spawn can be found in great abundance at the edges of ponds in the early spring. The young tadpoles should be kept in a wide, shallow vessel, with a layer of gravel, earth, or sand at the bottom, and some water-weeds, such as you will find in the pond where they came from. The weeds serve both to keep the water sweet and for food for the tadpoles; for at the beginning of their career they are entirely herbivorous. You should get two or three kinds of weed, for they do not like every sort. But they seem to be very fond of the green slime generally to be found in ponds, and I take care to let mine have a pretty constant supply. The gravel serves to root the weeds, and I think helps to keep the water pure. In a short time (perhaps two or three weeks) they begin to become carnivorous, and must have a tiny piece of lean meat given them occasionally. In the wild state they doubtless supply themselves with insects. If animal food is not supplied, they do not develop at the proper time, and

will continue in nearly the same state for weeks; and finally begin to devour one another. They do not seem to mind whether the meat is raw or cooked, but prefer it tender. A little piece the size of a three-penny bit will feast a dozen tadpoles for perhaps a day or two. It is most interesting to watch them wrestling with the meat and struggling with each other to get at it. They are as eager and voracious as young kittens. As soon as they have four legs, they begin to want to come out into the air occasionally, and you must make a shelving bank, of stones or a tile, where they can climb out of the water easily. The gills are now giving place to lungs. If they cannot easily get out to take an airing, they will die, and the other younger tadpoles will act the part of cannibals. When they have begun to sit out in the air, it is surprising how fast the tail is absorbed. A single day will make a perceptible difference. When it is nearly gone they begin to hop; and it is as well, when they reach this stage, to keep them out of doors, putting the vessel (a pie-dish if you please) on a level with the ground, so that they can come back to the water if they wish. I give mine a change of water occasionally; but if there were more water and weeds in proportion to the number of tadpoles, it probably would not be necessary.—*R. A.*

AQUARIUM-KEEPING.—I have just seen your correspondent "P. E. C.'s" query (July number); and thinking some notes on my own experience might not be uninteresting, I send them for what they may be worth. My aquaria consist of a rectangular one, about 2 ft. by 1 ft. 4 in., flanked on either side by a small bell-glass about 9 in. in diameter. The centre aquarium has a fountain and waste-pipe. I have also fixed permanent siphons of fine glass tubing from it to each of the side-glasses, so that I can at any time, by drawing the water off from one of these, establish a stream of water right through. The fountain does not, I believe, meet with much favour from those who keep aquaria upon purely scientific principles, but it adds so much to the beauty of one, that I should advise all keepers of aquaria to introduce one. Mine is simply a tank on the top of a bookshelf, in one corner of the room, from which I have a few yards of tubing (India-rubber), passing through a metal pipe fixed to the bottom of the aquarium. The mouthpiece is a piece of glass tube, heated in a gas-jet, and drawn to a fine point. It throws a jet about 3 ft. in height, and passes little more than a gallon of water per hour. The waste-pipe conducts the water to a pitcher that stands behind the window-curtain, and all that is necessary is to empty the water back into the cistern some three or four times a day. The aquarium is further embellished with a strip of virgin cork, about 3 in. in width, running round the back and ends, and just touching the top of the water. On these I grow various kinds of moss and ferns, the spray from the fountain seeming to suit them very well. This, however, is only a recent addition, most of the ferns having been planted this year. And now for the contents of the aquaria: the bottom is covered with sand and broken spar, and I have some plants of *valisneria* in pots, the pots being concealed in the sand. I have also some plants of water starwort and anacharis. The latter sorts do not, however, do well in any place where there are fish,—at least that is my experience. If grown without fish, or where there are only very small ones, they will thrive very well. I have tried *Stratiotes aloides* twice, but find the snails are too fond of it; they eat the plants away. For fish, I have one goldfish, one tench, one ruffe, two perch, and minnows and sticklebacks. Roach I find not easy to keep, as sooner or later they are

always attacked with mould, the great pest of small fish. One of the side-glasses I keep entirely for Infusoria and other microscopical objects. The other contains fish too small to be trusted in the large one. Some time in March last I banished a large male stickleback from the centre aquarium to one of the side ones, on account of his quarrelsome habits; and knowing their nest-building propensities, I thought I would see if they would build in a small aquarium. I therefore caught a female heavy with spawn, and put her in the small glass with him, and in a very few days the male had built a rough kind of nest, in which were deposited the eggs. After this the male set up such a violent persecution of the female that I was obliged to remove her to a separate tank. I now thought a stream of water would be good for the eggs; so, instead of letting the water run through the waste-pipe, I fixed another siphon up, to draw the water out of the side-glass, nearly emptying it three or four times a day, by which means I got an almost constant current through the bell-glass, which the stickleback himself supplemented by poising over the nest, and setting his fins in motion, very much in the same way as that in which bees ventilate a hive in hot weather. Some three or four weeks after I was very pleased to see a lot of small sticklebacks hatch out. I immediately removed the old one, lest his appetite should overcome his parental affection. I fed the young fish on meat-flies' eggs and small water insects for some weeks, during which time they thrive well. One day, however, a friend brought me some very small minnows; these I placed in the large aquarium, but they were immediately set upon by the perch; one was captured and swallowed by a perch not more than half as long again as himself; and fearing the rest would go in the same way, I caught them again, and put them in the side-glass with the young sticklebacks, and on looking for them some time after, they (the sticklebacks) had all disappeared. I have now put three small roach in with the minnow, the largest of them all not being more than one inch long. With regard to food, I find small worms cut up are the best. I also give them vermicelli, which they all, except sticklebacks, eat greedily. Since writing the above, one of the perch has come to an untimely end, in endeavouring to swallow a small stickleback, a great many of which he had eaten before in safety. The spines had caught in his throat and killed it. Had I seen the difficulty before, I should doubtless have been able to relieve him, as I have frequently pulled sticklebacks out of the mouths of gold-fish when they have been unable to swallow them.—*T. Shipton, Chesterfield.*

STICKLEBACKS IN AQUARIA.—Perhaps my experience in keeping sticklebacks may interest "P. E. C." I have had an aquarium for many years, holding about eighty gallons, and hearing of the mischievous propensities of sticklebacks, I did not have any. However, one was brought me, a pretty creature in his bright colours. He was tame, came and took food from your hand, and became a favourite, but he soon began to pluck at the snails and killed them; he then bit pieces out of the tails and fins of the fish. Not satisfied with this, he used to meet the fish, swim under them, put up his stickles and rip them open. At first I could not imagine how it could be, but at last we saw it done. Of course he was taken out, but the fish all died off from wounds which he had inflicted, though not perceptible to me: I had no living thing left. After a while I put in some snails and tadpoles; a friend brought me four stickles, three males, one female; I put them in, and one of them began almost immediately to build a nest.

He was indefatigable in his attention to it night and day, hovering over it and fanning the water; meanwhile the others were killing the snails and biting off the tails of the tadpoles, so they could not swim, and fell to the bottom, dying one after the other. In about seven or eight days the young ones were swimming about over the nest; we counted seven; the parent kept them there and drove the others away furiously. However, they soon lost their protector; he was floating dead in about three days after the hatching, which I hear is always the case: I do not think he ate anything all the time. From that time we saw no more of the young ones until by chance we saw two behind a stone as though they were hiding; the female went up, put her head in, and swallowed them both; they were nearly half an inch long, and very slender. I had the cannibals taken out and sent down into the sewer.—*H. C. R.*

METROPOLITAN ENTOMOLOGY.—In reference to Mr. R. S. Gibbons' communication in your July number, I may say that some few years ago, when I lived at his collecting-ground, Cricklewood, I often saw *C. Edusa* in my own garden, and in the adjoining fields; I did not want it, and therefore did not capture it. With regard to *G. Rhamni*, which one may fairly expect to meet nearly everywhere near London, unless Cane Wood, Hampstead, has been even more hunted lately than it used to be,—Mr. Gibbons will find the pupæ pretty frequent there, and I doubt if there is any more beautiful chrysalis among British butterflies.—*Albert D. Michæl.*

HOW TO GET EGGS IN TREES.—A friend of mine in Canada would like to collect the eggs of various hawks and owls, which, as he informs me, breed in the woods near; but he is deterred from this by the great size of the trees in which these birds nidificate. What would be the best method (easiest) of climbing trees from 50 to 90 feet high and from 4 to 8 feet in diameter; for in such trees, he says, the much-wished-for eggs are located.—*T. W. Dealy, Sheffield.*

NOTES, &c.—May I call your attention to what seems to me a singular freak of nature in the case of a grey parrot? I have just seen one which, after being in the same family for 25 years, has within the past two months laid four eggs: it had never laid one before. The bird is a capital talker, and a great pet. The eggs are of the size and colour of a wood-pigeon's. The bird would be at the least nearly thirty years old: it has always lived alone in the usual large wire parrot's cage.—The question of early primroses has brought out many wonderful examples of the mildness of the season; but surely "Hawthorn," in "J. H. of Watford's" account, must be an error.—*W. E. Thompson.*

A CAT AND HER KITTENS.—In front of a certain public-house on the Abingdon road stands a row of elm-trees. In one of these trees, many feet from the ground, is a hollow, in which cackling jackdaws nest every year. One morning, before it was light, a cat was heard making a great noise in the tree, and was observed in the uncertain light to be bringing something down in its mouth. When a short distance from the ground pussy was seen to drop her burden very softly on the ground, and afterwards convey it very carefully into an outhouse. When the landlady came down stairs and went into the latter place, pussy had laid the last of her three kittens (for kittens they were) on the floor, and, looking up in her mistress's face, mewed most piteously, as if soliciting her protection, which was cheerfully given, it is needless to say. She had, perhaps, been driven up by some dog the night before, and had "kittened" in the jackdaws' haunt.—*W. H. Warner.*

NOTICES TO CORRESPONDENTS.

TO CORRESPONDENTS AND EXCHANGERS.—As we now publish SCIENCE-GOSSIP at least a week earlier than heretofore, we cannot possibly insert in the following number any communications which reach us later than the 8th of the previous month.

W. H. (Beeralston).—As you wished, we placed your *Geranium* in the hands of our greatest authority on British Botany, though we had no doubt it was *Geranium striatum*. Such it proves to be. We have met with it plentifully at Garth Ferry, Anglesea.

F. H. ARNOLD.—We should be pleased to have all the plants you suggest.

H. D.—The monstrosity in the rose you sent us is of that kind called *phylloidy* of the sepals by Dr. Masters. See his "Vegetable Teratology," published by the Ray Society.

TO "EXCHANGERS" AND OTHERS.—A correspondent kindly draws our attention to a supposed new regulation of the Post-Office, which forbids letters to be addressed to initials only. He states that he knows of one case in which a letter so addressed was returned.

C. V. SMITH.—The publishers of the *Annals and Magazine of Natural History* are Taylor & Francis, Red Lion-court, Fleet-street. The price is 2s. 6d. monthly.

C. D.—We must be allowed our editorial right to revise all such communications as we deem necessary.

W. MCA.—We have found soda-water to be a capital medium in which to keep freshly-cut flowers for a long time. Add a little fresh when they appear to droop.

J. WOODGATE.—We should be glad to have a specimen of *Actinocarpus Damasonium*.

B. KIRBY.—All the snails, land and fresh-water and marine, belong to the sub-kingdom *Mollusca*.

N. G.—The fern sent to us from Grange is the Bladder fern (*Cystopteris fragilis*).

M. FOWLER.—The shells are *Clausilia biplicata*.

FLATER NOCTILUCUS.—Would any of the numerous readers of SCIENCE-GOSSIP kindly inform me if *Flater noctilucus* is an inhabitant of the West Indies?—Clte. Lloyd, St. Thomas, D. W. I.

J. E. S.—Your mosses are:—1, *Bryum carneum*; 2, *Weissia controversa*; 3, *Ptychomitrium polyphyllum*; 4, *Hypnum lutescens*; 5, *Ceratodon purpureus*; 6, *Tortula subulata*; 7, *Didymodon luridus*; 8, *Lophocolea bidentata*; and 9, *Hypnum serpens* and *Swartzii*.

W. BURBRIDGE.—Your specimens are:—1, *Hypnum moluscum*; 2, *Polytrichum commune*; 3, *Madotieca platyphylla*; 4, *Hypnum loreum*; 5, *Hypnum rutabulum*; 6, *Thuidium tamariscinum*; and 7, *Anomodon viticulosus*.

E. WHEELER.—Your mosses are:—1, *Bryum murale*; 2, *Tortula unguiculata*; 3, *Hypnum piliferum*; 4, *Hypnum filicinum*; 5 and 6 next month.—R. B.

R. M. NORRIS.—Your fossils are all Silurian species, and are (1) *Rhynchonella Wilsoni*, (2) *Graptoites*, sp., (3) *Asaphus caudatus*, and (4) fragment of an *Orthoceras*.

S. P. O. (Warwick).—Send to the secretary of the Ray Society for copies of their rules and publications. Some of the most valuable monographs have been published under the society's auspices.

T. JONES (Lancaster).—The specimens are, No. 1, *Epipactis latifolia*, and 2, *Gentiana Pneumonanthe*.

EXCHANGES.

ONE-HOLED eggs of Kestrel, Sandpiper, Magpie, Long-tailed Tit, Kingfisher, Grey Wagtail, Stock Dove, Coot, &c., to exchange. Send list.—J. F. Pratt, Westgate, Ripon.

A FEW Shells to exchange for other shells, fossils, &c.—Address, A. H., Springfield House, Spring Bank, Hull.

SPECIMENS of fresh-water Crustacean (*Astacus fluviatilis*), prepared for the cabinet, offered for other Crustacea or Echinodermata.—Ed. Lovett, Holly Mount, Croydon.

FOR wing of green Indian Beetle sent mounted or unmounted Micro. object, with stamped and directed envelope to F. S., 22, East-parade, Rhyll.

SEND 20 stamps for sample of Diatoms prepared ready for mounting, to E. W. Wilton, 18, Lovell-grove, Leeds.

WANTED, *Popular Science Review*, from the commencement to end of year 1876, either in parts or bound, in exchange for Microscopic Objectives.—Address, T. C. Maggs, Yeovil.

SWAMMARDAM'S "Bybel der Natuur," 3 vols. folio, 36 plates, for other Natural History works (English).—A. Linskill, Falsgrave, Scarborough.

WELL-MOUNTED specimens of young of Swan Mussel *polari-scope*, Spicula of *Gorgia* and *Alcyonium*, in exchange for other good Slides or material.—Wm. Low Sarjeant, 6, Dagnell Park-terrace, Selhurst, S. E.

A FEW rare British and Foreign Birds' Skins and Eggs to exchange for rare eggs.—J. T. Reed, Ryhope, Sunderland.

Helianthemum polifolium, *Convolvulus*, *Soldanella*, for other rare plants. Lists exchanged.—T. Stock, 6, Lorne-street, Leith, N. B.

EGGS of C. Guillemot, Razorbill, Kitiwake, Herring Gull, C. Partridge, Red-legged Partridge, Pheasant, Skylark, Blue Tit, and Greenfinch, side-blown, one hole, for other good eggs.—Charles Wild, Hawthorn House, Eaton, Norwich.

Anthracoasis robusta, from Slamanann coal-measures.—I have a few specimens of the above for the cabinet, also a lot of broken pieces to make micro. slides. Will exchange for other Geological Fossils.—M. Fowler, 20, Burn-row, Slamanann, N. B.

WANTED, *Leucodon sciuroides*, two or three good fruiting specimens, in exchange for other mosses or flowering plants.—E. D. C., 25, Oxford-road, Kilburn, London.

BRITISH PLANTS, Nos. 45, 113, 121, 124, 147, 218, 366, 406, 521, 534, 539, 603, 814, 822, 924, 1040, 1124, 1264, 1349, 1361, 1384, 1429, 1458, 1473, 1537, seventh edition "London Catalogue," for other flowering plants.—Lists to Thomas Gough, Elmfield College, York.

NOEL HUMPHREY'S "Genera of British Moths," with coloured plates, good as new. Wanted, Object Glass or Eyepieces for Microscope.—W. Harper, Norfolk Park, Maidenhead.

GOOD specimens of *Cynthia cardui* in exchange for *Polyomatus Azon* or *Thelca quercus*.—F. C., 20, Hova-villas, Cliftonville, Brighton.

Genista tinctoria, *Actinocarpus Damasonium*, *Ruscus aculeatus*, *Fritillaria Melegris*, *Crocus vernus*, for other plants.—J. Woodgate, New Barnet, Herts.

Lagurus ovatus, *Polyopogon monspeliensis*, and *Juncus capitatus*, offered for *Juncus diffusus*, *Equisetum pratense*, and *Impatiens fulva*, &c.—G. C. Druce, Northampton.

CONCHOLOGY.—Wanted to exchange, *L. palustris*, *L. glabra*, *Aucylus lacustris*, *Zonites radiatus*, *Z. excavatus*, *Helix lamellata*, *Helix aculeata*, *H. lupicida*, *C. tridens*, &c., for British or foreign Unio or Anadontas, from well-authenticated localities.—Lister Peace, Crosland Moor Bottom, Huddersfield.

BOOKS, &c., RECEIVED.

"Forms of Flowers." By C. Darwin, F.R.S. London: John Murray.

"The Antelope and Deer of America." By Dr. J. D. Caton. London: Hurd & Houghton.

"Scepticism in Geology." By "Verifier." London: John Murray.

"Popular British Fungi." By Jas. Britten, F.L.S. London: Bazaar Office.

"Pollen." By M. P. Edgeworth. London: Hardwicke & Bogue.

"Monthly Microscopical Journal." August.

"Feuille des Jeunes Naturalistes." June.

"Botanische Zeitung." July.

"American Naturalist."

"Potter's American Monthly."

"Ben Brierley's Journal." August.

"Chambers' Journal."

"Western Journal of Literature and Science."

&c. &c. &c.

COMMUNICATIONS HAVE BEEN RECEIVED FROM:—F. K.—T. S.—Prof. G.—H. B. W.—C. D.—C. W.—G. C. D.—J. E. S.—T. S.—W. MCA.—W. V., jun.—L. P.—M. F.—C. W.—B. S.—W. M. P.—T. G.—W. K.—T. S.—A. W. S.—A. W. G.—J. F. P.—E. de C.—J. T. R.—G. N.—E. L.—T. D. R.—W. A. C.—B. K.—C. F. W. T. W.—H. E. W.—F. C. M.—J. C.—S. P.—C. V. S.—H. P.—A. L.—W. E. G.—F. W. B. N.—W. L. S.—A. D. M.—G. R. V.—R. W. S.—J. T. R.—W. J. B.—E. T. S.—Dr. M.—F. H. A.—M. H. S.—W. H.—E. H.—J. C. D.—W. H. P.—H. D.—J. J. M.—D. J. S.—C. H. G.—F. E. L.—T. W. D.—T. B. W.—&c. &c. &c.



ON MOUNTING DIATOMACEÆ.

By F. KITTON, HON. F.R.M.S.

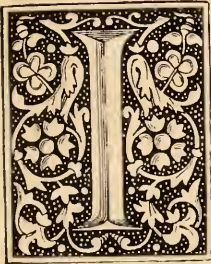

IN my former paper on "Cleaning Diatomaceæ," I omitted a somewhat important hint—viz., how to obtain these forms in a more or less clean condition without acid. If the diatoms are living in the gathering, it should be poured into a wide-necked bottle (similar to those in which pomade is sold), and placed close to the window. Under the influence of the light, the diatoms will make their way to the surface of the mud or vegetable débris, and will continue to propagate (sometimes for weeks). Their presence will be indicated by a film, more or less thick, of a dark yellowish-green colour: this must be removed from time to time by a small dipping-tube. As these papers are written for learners, I may perhaps be excused if I explain how to use it. Before inserting it in the bottle, the fore-finger should be firmly pressed on the top, the other end being placed over and almost touching the film; withdraw the finger, and the diatoms will rush into the tube; replace the finger, and drop the contents into distilled water or spirit. When a sufficient supply has been obtained, the remainder of the gathering can, if desirable, be cleaned as previously described.

The following is a list of essentials required for mounting diatoms:—

- Glass slips 3 × 1.
- Thin glass discs, $\frac{2}{3}$ and $\frac{1}{2}$ inch.
- Turn-table.
- Writing-diamond.
- Common brass forceps.
- Small camel-hair pencil.
- Canada balsam.
- Asphalt varnish.
- Gold size.
- Turpentine.
- Benzine collas.
- Gum arabic.
- Glycerine.

As the tyro should be content in the first instance with what are termed spread slides (and for the purposes of study these are the most valuable), we will endeavour to explain our plan of making them. The slide must be cleaned by dipping in a strong solution of common soda; wipe it dry with an old linen handkerchief: this ought to be thoroughly freed from soap grease by boiling in soda and water. Place the slide or slides on a level surface, spread evenly a small quantity of the material on the centre of each slide, and leave it to dry slowly. If held over the lamp it almost invariably dries in ripples, and the slide is spoilt.

But few gatherings are free from particles of sand, and as their presence is the *bête noire* of dry mounting, the following hints for their elimination may prove of service. If the sand grains consist of minute fragments of quartz, as is most frequently the case, they may be got rid of to a great extent by first placing the cleaned material in a porcelain saucer or watch-glass, and, after subsidence, giving it a lateral circular motion, which will produce a vortex: the diatoms will rise, and may be poured off into some distilled water: a repetition of the process will eliminate still more of the sand. Many valves will of course be lost; but this is of little consequence when they occur in abundance or the forms are large, such as *Eupodiscus*, *Coscinodiscus*, *Triceratium*, &c.; but these can be easily picked out. If the quantity to be operated upon is small, a large drop of the material may be placed on a slide, and similar motion given to it, and the drop tilted to one corner of the slide and poured into a drop of water on another slide: 75 per cent. of the sand will be left behind. If the sand largely predominates, two or three drops may be operated upon by pouring them into the drop of distilled water: repeat the process with this, and a good slide will be the result. If the sand is micaceous, I know of no plan that will enable us to get quit of it. The *rationale* of this may be thus explained. The diatom valve and the micaceous sand consist more or less of thin plates, both of which sink much less readily than the quartz sand,

which is principally composed of round or prismatic granules.

If the diatoms are to be mounted in balsam, I prefer that they should be on the slide; if for dry mounting, and for examination by high power (anything beyond an $\frac{1}{2}$), they ought to be mounted on the cover.

We will suppose that the gathering consists of diatoms requiring to be mounted dry. We must make a cell of asphalt varnish on the slide, taking care that it is of sufficient depth to prevent the fracture of the diatoms when the cover is pressed down.

Asphalt varnish should always be thinned with benzine, as it evaporates quickly, and the cell can be made hard in a short time. Cells made of turpentine and asphalt are objectionable for two reasons: the first is, that the cell never becomes thoroughly hard, and in consequence a deposit of oily globules takes place on the cover, and the slide is spoilt; secondly, the coloured varnishes used for finishing off (unless made of sealing-wax) are almost certain to run in. If the diatoms are large and heavy, a minute quantity of gum must be used to make them adhere, otherwise they are in danger of being detached. Mounting in Canada balsam generally gives the tyro no end of trouble, particularly if he tries to harden it; air-bubbles often appearing in considerable numbers. These are caused by the balsam having been mixed with turpentine. Pure balsam may be heated until it is brittle without the formation of bubbles. A little turpentine should be dropped on the diatoms, which should be allowed to permeate them before putting on the balsam. When this has penetrated, the slide should be heated until the balsam, when cold, is too hard to be indented with the nail. The slide should be again heated, and the cover applied to the edge of the balsam, but must not be allowed to fall suddenly upon it. I prefer to hold the cover in a slanting position, until the balsam is sufficiently hard to retain it. I then reverse the slide (the cover downwards) over the lamp, and as the balsam melts, the cover is gradually drawn up by capillary attraction, and the superfluous balsam may be gently pressed out, and when the slide is cold, carefully removed with a knife, and the slide cleaned with spirits of wine and ammonia, or benzole. The advantages of hard balsam are twofold: first, the covers are not likely to be displaced, particularly when they are sent to hot climates; secondly, the refractive index of the balsam is altered, and less nearly approaches that of the diatom-valve; consequently markings that would be invisible in soft balsam or damar are distinctly seen in the hard balsam. Unfortunately hard balsam cannot always be used—*e.g.*, when it is desirable to mount the frustule, or the valves are very convex. In these cases the heat drives out the fluid balsam, and as it thickens on cooling, it cannot re-enter, and a pseudo-bubble or vacuole makes its appearance. To avoid this I do not harden the balsam more than will

allow the nail to easily indent it. This is best done by subjecting the slide to a gentle heat (about 80° or 90°) for several hours after the cover is placed upon it. As much of the superfluous balsam as possible should be removed, taking care not to shift the cover: it should be allowed to remain for several days (if possible exposed to the above heat). To avoid accident, a ring of gum and whiting should be spun round the edge of the cover: this, when dry, will allow of a finish with asphalt or coloured varnish. Before mounting in slightly hardened balsam, the diatoms should be attached to the slide by a very weak solution of gum, to keep them in position if the slide should be placed in a racked cabinet. In no case should the cover be placed on the balsam or damar when quite soft: it never hardens afterwards, excepting at the edges; if it did, the slide would be much disfigured by vacuoles making their appearance. As balsam or damar owes its fluidity to the presence of turpentine (natural in new balsam) or benzole, it must inevitably occupy less space as it becomes harder, which can only take place through the escape of the spirit.

The desideratum of the diatomist is, or ought to be, gatherings containing only one species, or at most two or three. But as these are not of frequent occurrence, the plan of selecting or picking one and transferring to another slide has been adopted, particularly by professional mounters, some of whom have acquired considerable skill in arranging these tiny forms in various designs. To do this requires a great deal of practice and time, and no particular advantage is gained. All that the student need attempt is to pick out as many as he can of one species, place them close together in the centre of the slide, and in various positions. I trust the following hints and practice will enable the learner to prepare slides in this manner.

Selecting diatoms can only be done by the aid of a microscope, and the question is, whether the simple or compound instrument is the better for that purpose. Individually, I prefer the simple form; the powers I use are $\frac{1}{12}$, $\frac{3}{4}$, and 1 inch. The $\frac{1}{12}$ I use to search over the drop, and when I see a form I wish to select, I use the $\frac{3}{4}$ or 1 inch to push it on the clean part of the slide. I usually place a drop of water near the drop of material: the advantage of this is, the diatom may be freed from any extraneous matter hanging to it. If it is intended to remove it to another slide, it must be pushed out of the drop and allowed to dry, when it can be picked off and transferred to another drop of water, which should be about half an inch from the centre of the slide, or, if mounted on the cover, to a small drop near its edge. In this drop other specimens must be placed, and when the desired number are selected, pushed into the centre of the slide or cover. If the specimen appears to be new or very rare, it is better not to risk the removal to a fresh slide; the

drop of material can be wiped off, and the selected diatom pushed to the centre of the slide. Some species of diatoms are too transparent to be seen when in water. I then allow them to become dry, and place the slide (bottom upwards) under the compound microscope, and examine it with a $\frac{2}{8}$ objective, and if any form should be observed that I wish to select, I place a small ink-dot just above it; this enables me to detect it with the simple lens. The best instrument for picking out is a "feeler" from a hare or rabbit. As these gradually taper to a point, an opportunity is afforded of obtaining any stiffness that may be found desirable. It should be mounted on a light handle (like those used for camel-hair pencils) by slipping over it the quill of a small wing-feather from a pigeon or partridge; the hair can be adjusted by drawing it up or down, and when found to be satisfactory, press the handle tightly into the quill and cut off the superfluous hair. (Captain Lang, in *M. M. Z.*, December 1st, 1870, p. 308, recommends a badger hair, but I do not find it stiff enough to push the diatoms out of the drop, or detach them, if dried, on the slide.) The learner will probably find to his great annoyance that the diatoms are disturbed by the application of the balsam and heat, and exhibit a tendency to float in it, and worst of all, when the cover is put on, a large proportion of them escape with the squeezed-out balsam. This may be counteracted in two ways. First (my plan), let the drop of diatoms be as small as possible and very full, taking care that the turpentine does not disturb them; the quantity of balsam should be just enough to fill the space occupied by the cover-glass when pressed down. If this is carefully done, the diatoms will be evenly distributed, and the slide will not require cleaning. The second plan is to place a little gum in the last washing, or a better plan is to make a solution of it in distilled water ($1\frac{1}{2}$ grains of gum arabic to 1 grain of water), put a drop of this on the cover or slide, and then drop a little of the diatom material in it. When dry, the diatoms will be found firmly fixed to the glass. The gum-water can also be used for fixing selected specimens. The tyro will sometimes find to his intense disgust that his carefully selected specimens have become smashed; this is generally caused by too much pressure on the cover-glass. In order to avoid this risk, a little cell, about $\frac{1}{16}$ of an inch in diameter, should be spun on the slide: the gum and whiting before alluded to will be found very useful for this purpose; or a little lamp-black or vermilion may be mixed with it, and if the cell is neatly made, it will not injure the appearance of the slide, and it has the advantage of enabling the observer to find the objects without trouble. I, however, give the preference, myself, to cells made of thin glass, of the same diameter as the cover; these are not difficult to make, and when the cover-glass is very thin, it sometimes prevents a smash when the objective is focussed upon it. The cells are made in the follow-

ing manner:—A piece of brass, the size of an ordinary slide, and $\frac{1}{16}$ of an inch in thickness, is perforated in the centre (the size of the hole might be $\frac{1}{8}$ of an inch in diameter); a disc of thin glass is cemented over it with shell lac. When cold, the centre may be easily knocked out with a small round file or steel broach. Re-heat the brass and slip off the cell into some methylated spirit, which will speedily dissolve off the lac; by using five or six brass plates, a stock of cells can soon be made. In order to attach them to the slides, I spread a little balsam upon it and harden the balsam, place the cell in position, re-heat the slide and press it down, drop a little more balsam into the cell, which should be hardened, but in a less degree than for fixing the cell. The diatoms already placed on the cover and balsamed may be now finally placed over the cell, and the cover pressed without risk.

In using gum, care must be taken to avoid using more than is absolutely necessary for fixing the diatoms, as it injures their sharpness; in fact, I have long given up using it, and prefer the following method when the diatoms are not too delicate. We will suppose them picked out and clean. I put a drop of turpentine upon them, and then some balsam, which should be thin; on another slide I place some more balsam. I now slightly warm the slide containing the diatoms, and with a bristle rather stiffer than that used for picking out of water, I take them out of the balsam and transfer them to the balsam-slide No. 2. When they are all removed, I proceed to arrange them, which is easily done if the balsam is kept fluid by heating. The diatoms may be pressed down with the bristle, and as the balsam hardens they retain the position in which they are placed. This method would not answer for slides like Möller's Typen Platte: these are arranged and fixed to the cover with gum. Captain Lang approves highly of the following plan of his friend Captain Haig:—He smears the slide or cover with a little glycerine, to which a little gum has been added; into this the diatoms are placed and afterwards arranged. Glycerine has this advantage over water, that it does not dry up during the process of arrangement.

When diatoms are mounted on the cover, it is necessary to temporarily attach it to a slide: this is sometimes done with a little balsam. My own plan is to place a minute drop of water on the slide and drop the cover upon it: it will adhere firmly enough to allow of the necessary manipulations. Captain Haig's method is more elaborate. He first centres very carefully an ordinary slide, and then makes a ring the size of the cover he intends using with gold size; in the centre of this he makes another minute ring. He now heats the slide until the rings burn black; on the outer ring he places three little pieces of bees-wax; on these he fixes the cover by slight pressure. When the arrangement is completed, the slide or cover must be placed on the hot plate to evaporate the glycerine.

It is sometimes desirable to mount the parasitic or filamentous forms in fluid, in order to see the various attachments of the frustules. For this purpose an asphalt or thin glass cell must be used. I have used camphor-water as the medium, and it appears to answer the purpose. After the object has been arranged, and the cell fixed, the cover must be placed in position; this requires some little practice to do successfully. A thin ring of gold size must be made on the cell, upon which the cover must be placed (care being taken to exclude the air) and pressed down upon the ring of gold size. Wipe off the superfluous water, and spin a ring of shell-lac or sealing-wax varnish round the edge. When this is hard, a ring of varnish should be put over it. The best for this purpose is that described in a former number, viz. that made of litharge and red and white lead; or a mixture of flake-white and damar varnish (as used for mounting) will answer the purpose. The white, sold in tubes, is best, as no grinding is required. In all fluid mounts, care must be taken to fill up the angle formed by the slide and cover. This is better done by successive applications than all at once. In conclusion, I beg to observe that I do not give these instructions as the best. Their chief merit is that they are the results of experience, and that with *præctice* the manipulator will be able to produce well-mounted specimens.

CHAPTERS ON

CARBONIFEROUS POLYZOÄ.

No. III.

BY G. R. VINE.

THE genus *Polypora*, M^cCoy, is another of the fenestrate forms of Polyzoa which seems to have been confined entirely, so far as we are yet acquainted with the genus, to the Palæozoic rocks. It had, however, a wide geographical range, and though not so varied in specific character as the *Fenestella*, the individuals of certain species may have been equally numerous. The "corallum" or Polyzoary of the *Polypora* was either a delicate, or a robust, reticulated calcareous expansion. The interstices were round, bearing from three to five rows of cell-openings, the margins of which are usually not projecting. The interstices were connected by thin, transverse, non-poriferous, dissepiments.*

It is doubtful whether the genus had its origin further back than the Devonian era. One doubtful form, *P. erassa* (?), is named by Lonsdale as belonging to the Upper Silurian, Dudley. From the Devonian rocks of America, Prof. Nicholson has figured and described two new species, *P. pulchella* and *P. tenella*, from Ontario, † and Prout has described

two others, *P. Halliana* and *P. tuberculata*.* From the carboniferous limestone of Derby and Kildare, M^cCoy figures and describes two species, *P. dendroidea* and *P. verrucosa*; and *P. marginata* as *coexisting* at Killymeal, in Ireland, together with *P. papillata*. Morris refers two species described by Phillips to this genus,—*Retepora laxa* and *R. polyporata* (?), and also the species *Gorgonia fastuosa* of De Koninck. †

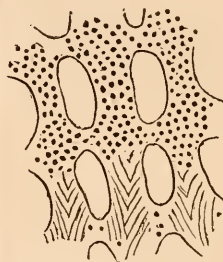
Fig. 167. *Polypora fastuosa*,
De Koninck (India).Fig. 168. *P. tuberculata*,
Prout, Hairmyres, Scotland.

The last of these species had a very wide geographical range, as it has been found in Ireland, Belgium, and in India. "I have not been able to perceive," says De Koninck, "any difference between the Indian specimen and those I discovered in the carboniferous limestone of the environs of Ecoussines." ‡

The species of *Polypora* most frequent in the shales of Scotland is the *P. tuberculata* of Prout. In the explanation of sheet 23 of the Geological Survey of Scotland, this species is referred to the *P. verrucosa* of M^cCoy. "There are important characters to show that it differs from M^cCoy's species. 1. Its manner of branching is different. M^cCoy says that *P. verrucosa* rarely bifurcates in its interstices, and that its fenestrules are equal. *P. tuberculata* has its fenestrules very unequal, and its interstices bifurcate nearly every fourth or fifth fenestrule. 2. M^cCoy's figures and descriptions do not show that the marginal pores encroach on the borders of the fenestrule; in *P. tuberculata* there are raised marginal pores. 3. *P. tuberculata* are characterized by the presence of a single row of raised tubercles along the middle of its branching interstices, a feature not observable in M^cCoy's species, and which of itself would mark it as distinct. On account of these differences Dr. and Mr. John Young say that the Scottish Hairmyres species agrees closely in all its important characters with the American *P. tuberculata* of Prout. §

As this species will be more frequently met with by the student, it may be advantageous to give the following extracts from Prout's description:—"The Bryozoom (polyzoary) a fan-like expansion; longitudinal rays moderately large, pretty uniform in size,

* "Transactions of the Academy of Science of St. Louis."

† Morris's Catalogue of British Fossils.

‡ De Koninck on Indian Fossils. *Journ. of Geol. Soc.*, Nov., 1862.§ "Transactions of the Edinburgh Geo. Soc.," pt. iii. vol. ii., 1874, and *Geol. Mag.*, June, 1874.* M^cCoy's "Carb. Fossils."† *Geological Mag.*, 1874, and "Ontario."

suddenly enlarged before and after bifurcation. Dissepiments small, about one-third the transverse diameter, and one-fifth the longitudinal diameter of the fenestrules. Fenestrules oblong sub-quadrangular, sometimes shortly spatulate or irregular near the bifurcations. Cell-pores small, round, with thin lips slightly raised above the surface, alternate, their own diameter apart. Reverse covered by a dense cortical substance, with a few scattered granules.”*



Fig. 160. *Polypora tuberculata*
(to show arrangement of Cells).



Fig. 170. *Synocladia* Sp.
Fenestrule to show arrange-
ment of pores.

In the Scottish species “the thin lip of the pores in well-prepared specimens is not circular, but sinks down on the lower edge of the aperture, which thus has a pyriform crater shape. In addition to the ridges mentioned by Prout, the intervening surface is covered with very fine short wrinkles, which are sinuous, and sometimes interrupted, so as to give a tubercular aspect. The fronds sometimes attain a size of three inches.”†

In the building-up of its cell, this Palæozoic Polyzoan differed in some particulars as to plan from its contemporaries. The pores with which its outward surface was ornamented were the openings to small tubes slightly incurved. These tubes had their origin on the axis of the principal branches, which diverged obliquely upwards on each side. Unlike *Retepora*, where the cells are separated one from another by a thick wall, the cells of *Polypora* are contiguous, the partition being so thin as to be inseparable under an inch power. The pores in the innermost portion of the branches are very much compressed into a diamond shape, whereas the cells of the edges present the appearance of a blown bladder, some of them occupying just about double the space of the compressed cells. It would be folly, however, to make too much of this economy of space, as I observe the cells in species of other genera—such as *Cerriopora* and *Glaucanome*—of the Carboniferous era. Some of the *Cerriopora* of the Greensand; and *Hornera reteporacea* of the Crag economized in the same way.

The other localities besides those named for *Polypora tuberculata* are Loxdale Limestone and Richmond in Yorkshire, and Hairmyres and Beith

quarries in Scotland; for *P. dendroides*, McCoy, Corrieburn and also Beith quarries.

The genus *Synocladia* of King is not so well known as many of the other forms of fenestrate *Polyzoa*. “The ‘corallum’ (polyzoary) was cup-shaped, with a small central root-like base, reticulated and composed of roundish, narrow, often branched interstices, bearing on the inner face from three to five alternately longitudinal rows of prominent edged pores, separated by narrow keels, studded with small irregular vesicles, alternating with the cell-pores; dissepiments thin; vesicles direct, usually forming short spur-shaped pinnæ, extending upwards from the sides and meeting those from the adjoining interstices at an angle directly upwards, bearing two alternate rows of cell-pores. It differs from *Fenestella* in the large number of rows of pores in each interstice.”*



Fig. 171. Cells in dissepiment of
Synocladia.



Fig. 172. Enlarged pore of
Polypora tuberculata.

In the *Annals and Magazine of Nat. History*,† Robert Etheridge, jun., has described from the Lower Limestone series of Gilmerton, a most peculiar polyzoan, under the name of *Synocladia carbonaria*. This species agrees in its main characters with a species already described by Mr. Meek as *S. biserialis* of Swallow.‡ “To the latter Mr. Meek also refers the *Septopora cestriensis*, Prout, a form which appears to differ only from the typical species of *Synocladia* by having from one to four rows of cell-apertures on the dissepiments instead of two. On a comparison of photographs of American specimens, kindly lent by Professor King, all those from Scotch beds appear to have a much greater irregularity of branching, and there are never more than two rows of cell-apertures on the dissepiments, one row on each side the keel: these characters are so constant that the varietal term *carbonaria* is here used to distinguish the American and the British forms.§

In the shales from Capelrig quarry two species of *Synocladia* may be obtained. The other localities are High Blantyre and Gillfoot in Scotland, and minute fragments (?) may be found among the Carboniferous shales of Yorkshire.

The most delicate and beautiful of all the forms of fenestrate *Polyzoa* that have ever come under my notice is the new genus described and figured in vol. 30 of the “*Quart. Jour. of the Geo. Society*,” by Professor Young and John Young, of the Hunterian Museum of Glasgow. I have tried in vain to get the especial part of the journal in which the description is given, and to which my attention was directed by

* “Permian Fossils.”

† September, 1873.

‡ “*Trans. of St. Louis Acad.*,” 1858.

§ Robert Etheridge, jun. Expl. of Sheet 23, Scot. Geo. Survey.

* *Geol. Mag.*, June, 1874.

† *Ibid.*, p. 258.

Professor Duncan, of King's College, London. But I have before me a beautiful specimen from the Hairmyres shale of Scotland, and this compensates, to some extent, the want of the paper. The genus and species is called *Actinostoma fenestratum*, Young & Young, and has only been found, so far as I am yet aware, in Scotland, at Hairmyres and High Blantyre. I can easily account for its having escaped so long the keen eyes of Scottish palæontologists. The fragments are so minute as to be, in ordinary specimens, only observable in all its beauty under a one-inch power. When the character of the genus and species is once known, it is easy then to pick out specimens from the shale with an ordinary hand-glass.

I will not venture on the generic description of this Polyzoan, but simply direct the attention of the reader to the article in question; but the authors are perfectly justified in removing the former from the genus *Fenestella*, and erecting for it a new genus. The cells are somewhat corallaceous in character, and the cell-mouth is protected by star-like spines, similar in some respects to the starry-mouth of some species of *Foraminifera*, *Polymorphina*, and *Peneroplis*. The same cell-aperture is also seen in another of Messrs. Young's new species, described in the same journal, called *Glauconome stellipora*. This, too, will form a new genus under the title of *Acanthopora*, Young & Young, and very justly so, because the cell-aperture is a character of itself, unlike any of the characters found in ordinary species of *Glauconome*.

Acanthopora stellipora nobis, Young & Young. "Stems nearly cylindrical, branching irregularly, bearing two rows of alternate cells, with prominent circular orifices, over which eight radial denticles converge, as in *Actinostoma*, a smaller orifice being placed at one end of the cell on the side of the prominence, and separated from the larger aperture by an interval, which never exceeds the diameter of the larger cell. The stem is ornamented with a sinuous mesial ridge, and sinuous ridges likewise pass from cell to cell. All these ridges are finely tuberculated, or, more correctly, beaded.

The non-poriferous face is traversed by longitudinal parallel ridges, which are also finely tuberculated. Occasionally a larger cell occurs in the angles of the branches; but the small size of the fragments hitherto obtained, showing the poriferous face, renders it impossible to say whether they are of frequent occurrence. They are possibly ovi-cells."

There are varieties in the mode of branching of several specimens sufficient to distinguish them by a varietal term; but the general characters are the same in all the specimens, all of which may be characterized by the adjectives delicate and beautiful.

The localities of the genus are the limestone shales at Hairmyres, where it is pretty abundant, Rob-

royston, Gare, and Boghead. I have not yet detected the merest fragment in any of my English material.

To those friends and well-wishers who have kindly favoured me with advice, information, and material, I again tender my thanks. I would be glad, however, if students fresh at the work of discovery among the limestone Polyzoa would communicate results from their different localities.

(To be continued.)

NOTES FROM THE BRITISH ASSOCIATION.

THE intense scientific vigour which has characterized the meetings of the British Association for twelve years past has at length given way to a short reaction. The Plymouth meeting this year has not been a success, either in point of numbers attending (a secondary consideration) or in the quality, importance, or character of the papers read or the addresses given. Perhaps the short pause in the long-continued high pressure of years will be advantageous in the future. All work and no play makes even the scientific "Jack" but a dull boy.

The inaugural address of the President, Professor Allen Thomson, was chiefly remarkable for the bold and decisive declaration he made in favour of the doctrine of Evolution, declaring, as he did, that no student of embryology could understand his subject except in the lights afforded by this modern doctrine. On the other hand, the President of the Biological Section, Dr. Gwyn Jeffreys, the celebrated conchologist, avowed it as his opinion that the long-continued characters of deep-sea mollusca were not in favour of Darwinism. It is more than probable, however, that equally good naturalists would argue quite the contrary, and decide that the reason why deep-sea mollusca did not alter their specific characters was because their surroundings had not altered; for, according to the doctrine of evolution, varietal modifications are simply the result of responsive adaptations to any changes which take place in the environment. If there are no changes in the one, there are none required in the other. One set thus becomes more or less of an index to the rate of intensity of the other. Dr. Jeffreys was almost by himself in defending the old lights, for most of the zoological and botanical papers read were based on the new philosophy, or were expositions of it. Notably among these were the addresses of Mr. F. Galton, to the department of Anthropology, and that of Professor McAlister to the department of Anatomy and Physiology. The address of the President of the Geological Section, Mr. W. Pengelly, F.R.S., turned almost entirely upon the geological history and antiquity of caverns in general and those of Kent's Hole and Brixham Cave in particular. Mr. Pengelly showed his reasons for believing that man had made his appearance in England before the hyæna (although the latter is a notorious cave-

* "Proceedings of the Nat. Hist. Soc., Glasgow." Prof. J. Young, M.D., and Mr. J. Young, F.G.S.

dwellers); and that man, in Devonshire at least, was of *inter-* if not of *pre-glacial* antiquity. A capital paper read in the Geological Section was that by Mr. R. N. Worth, on the "Palæontology of Plymouth"; whilst Mr. Champemowne presented one on "The Succession of Palæozoic Deposits of South Devon," and Mr. H. B. Woodward another on "The Devonian Rocks near Newton Abbott and Torquay," with remarks on the subject of their classification. Mr. R. H. Tiddeman presented the Fifth Annual Report of the Committee for assisting in the Exploration of the Settle Caves ("Victoria" Cave), and still insisted on the inter-glacial age of the deposits. Another important geological report was that by Mr. C. De Rance, on the Investigation of the Circulation of Underground Waters in the New Red Sandstone and Permian Formations. The Report by Professors A. S. Herschel and G. A. Lebour, on "The Thermal Conductivity of Rocks," was received with merited attention. Perhaps the most important papers in the Geological Section were the following: "On the Post-Tertiary Fossils procured in the late Arctic Expedition," with notes of some of the recent or living Mollusca from the same expedition, which was read by Dr. Gwyn Jeffreys; and another by Mr. C. De Rance, on "The Correlation of Certain Post-Glacial Deposits in West Lancashire." Mr. Molyneux's paper on the occurrence of *Aviculo-pecten*, and other marine shells, in deposits associated with seams of coal containing salt-water, in the Ashby-de-la-Zouche coal-field, wherein he contended that these salt-water reservoirs were the remnants of the ancient carboniferous seas, was productive of much discussion, although not generally in favour of the author's views. Mr. Morton's paper on the Carboniferous Limestone and Millstone Grit in the country around Llangollen, North Wales, was full of personal labour and investigation, and was very properly regarded as a valuable contribution to stratigraphical geology. Such was also the conclusion respecting Mr. W. Gunn's contribution announcing the discovery of Silurian rocks in Teesdale. On the last day of the meeting there were papers by Professor Heer, of Zurich, on the Fossil Flora of the Arctic Regions, and a very important one by that most accurate and diligent of observers, Mr. H. C. Sorby, F.R.S., on a "New Method for Studying the Optical Characters of Minerals." Mr. Henry Woodward, F.R.S., announced the discovery of *Branchippus*, in a fossil state, in the freshwater Eocene limestone of Gurnet Bay, in the Isle of Wight. Mr. R. A. C. Godwin-Austen then showed the geological significance of the well-boring at Messrs. Meux's brewery, Tottenham-court-road, an account of which we published in a short article in our July number.

Some excellent, thoughtful, and suggestive papers were read in the Biological Sections. Noticeable among these were the following: "On Anticipatory Inheritance in Plants, especially with reference to the

Embryology of Parasites." Another was by Mr. A. S. Wilson, B. Sc., "On Structural Characters in Relation to Habitat in Plants." Professor McNab, of Dublin, read two most important communications, one on the Classification of the Vegetable Kingdom, and the other on "The Classification of Flowering Plants considered *Phylogenetically*"; that is, according to their descent. Professor Rolleston's address on "New Points in the Zoology of New Guinea," of which we give a short abstract elsewhere, was listened to with great attention, as was also Mr. W. Ackroyd's paper on the Colours of Animals. Of course the *Colorado* Beetle turned up, and indeed this ubiquitous insect and the *Telephone*, or sounding telegraph, were the "lions" of this year's meeting. But the Beetle was in good hands, for Mr. R. McLachlan, F.R.S., the celebrated entomologist, introduced the subject, and spoke strongly against the panic existing in this country regarding its appearance. Mr. McLachlan's remarks were most timely, and we have been pleased to see they have not been without due influence in the country. Among other papers of interest to naturalists, we may mention that by Dr. G. Bennett, on the Habits of the Pearly Nautilus (*Nautilus pompilio*); another by Mr. W. Thomson, on a "Method for excluding Germs from Rooms used for Surgical Operations"; an important communication by the Rev. W. H. Dallinger, entitled "Researches on the Life History of the Simplest Organisms," a short account of which will be found elsewhere in our columns; on "Transcendental Anatomy, or a geometrical Investigation of the best possible Number of Hints for Terrestrial and Aquatic Animals," by the Rev. Professor Haughton, F.R.S., of Dublin; and one on "The Possibility of Life on a Meteoric Stone falling on the Earth," by Sir W. Thomson, wherein the author repeated the absurd idea that life could be brought to our planet by a meteor, although the latter had been fused by the heat attending its passage through the atmosphere! Professor Haughton also read a paper in the Mechanical Section, on a "New Method of Calculating the Absolute Duration of Geological Periods."

The excursions were all of them very satisfactory, and to places famed for geological, zoological, or archæological interest. Indeed, the excursions formed perhaps a more important element of this year's meetings than heretofore. Another fact of significance was the prominent place which the local scientific men took in the readings of papers and discussions thereon.

COLIAS EDUSA.—Post after post has continued to bring us in letters from observant and obliging correspondents in every part of the country announcing the special abundance of this pretty butterfly this summer. We mention this because it would be impossible to publish a title of the communications we have thus received.

ON THE POST-GLACIAL DEPOSITS OF THE THAMES VALLEY.

THE Post-Glacial period is beautifully represented by the brick-earths of the Thames Valley. Undoubtedly this is one of the most completely developed deposits which occurred during that period to be found in England. The brick-earth pits at Erith and Crayford afford very good sections of this formation. It is here, as many of my readers will probably know, that remains of the Mammoth and several other extinct mammals have been found. In excavating the loam for the purpose of brick-making, teeth of the Mammoth are occasionally met with, and discoveries of bones of other animals are not rare. The Thames Valley, in which these deposits occur, is a very fair specimen of the effects of denudation. It was partly scooped out by the retreating waters of the sea which covered it during part of the Glacial Period. The immense thickness of super-

bed, called "Lower Brick-earth," contains many beautifully preserved shells. *Cyrena fluminalis* may be found in abundance, as well as species of *Planorbis*, *Limnæa*, *Unio*, &c. But the discoveries which have excited the most interest are the remains of mammals which have been found in this stratum. The succeeding deposit, "Thames Gravel," is of a very different nature. It consists of rounded pebbles enclosed in a somewhat clayey sand. During the period of this deposit, it seems to me that icebergs passed down the valley. At Crayford I have found boulders and pebbles of quartz in the Thames Gravel, the presence of which appears inexplicable unless we accept this explanation. The Thames Gravel, like the underlying brick-earth, contains bands of shells and mammalian remains, which, however, are of rarer occurrence. Its thickness is from twelve to twenty feet, and it covers a much wider tract of country than the preceding deposit. The third bed, called "Upper Brick-earth," rests conformably on

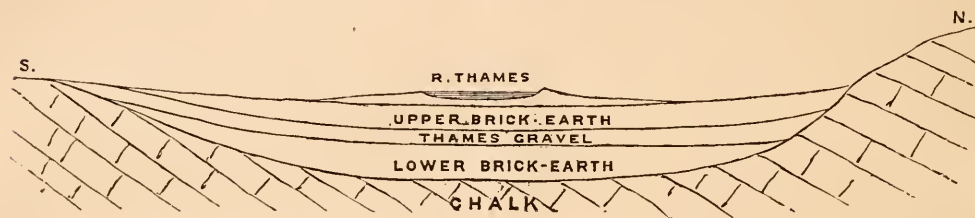

Fig. 173. Section illustrating Post-glacial Structure of the Thames Valley.

incumbent strata was denuded away by water, and it was not till the chalk had been reached and exposed that this abated. It has been imagined by some that the valley lying between the Essex hills and the hills of the north coast of Kent was entirely formed by the river Thames, but I do not favour this belief. It appears clear to me that a river never forms the valley through which it flows; but that, on the contrary, it is continually helping to raise the level of its bed. As an example I may mention the river Thames, the bed of which is gradually but unmistakably rising, and as often as the tide rises higher than usual, the waters overflow their banks and the results are often disastrous. It cannot be denied that the principal agent employed in the excavation of the valley is water, but I think it was water in the shape of glaciers that acted most powerfully in breaking up the chalk. I think it probable that a glacier commenced forming the valley during part of the Glacial Period. Subsequently a change of level flooded the valley with water, and when it had become sufficiently pacific, it deposited the sand and loam held in suspension; and thus the first deposit commenced upon the denuded chalk. The deposition of the sediment extended over a somewhat lengthy period, as this deposit has a thickness of thirty feet,—no inconsiderable thickness in comparison to the more recent deposits. This

the Thames Gravel. The thickness is only eight feet, and in some places even less. The loam is worked for brick-making. This deposit at one time covered a large tract of land, but subsequent denudations have materially lessened its extent.

After the deposition of these strata, oscillations of level occurred which exposed the Upper Brick-earth to the action of denudation, and dislocated some parts of the valley. Upon the Thames Gravel and Upper Brick-earth there has been found a bed of peat containing the stems of trees, and the river Thames now runs over part of this ancient forest. Remains of the following animals have been found in the Post-Glacial strata of the Thames Valley:—*Felis spelæa*, *Hyæna spelæa*, *Bos primigenius*, *Elephas primigenius*, *Ovibos moschatus*, &c.

There are few places so near London where a day may be more profitably spent than at Erith or Crayford. At these places shells may be found in abundance: species of *Helix*, *Cyrena*, *Planorbis*, *Unio*, &c., in excellent preservation. These shells, with the exception of *Unio*, are exceedingly minute; but a well-arranged collection of them will repay all the trouble which may be spent in procuring them.

GEO. CLINCH.

West Wickham, Kent.

CANADIAN "NOTES."

I HAVE been looking over, with considerable interest, the back numbers, for the current year, of your SCIENCE-GOSSIP, which I have just received; and it occurs to me that perhaps a few occasional notes from our distant colony, on various subjects comprised therein, may not prove altogether unacceptable to your readers.

No. I., p. 11. An Article on *Trilobites*, &c.

We have a number of remarkably fine specimens in the Trenton limestone of the county of Peterboro'. One which I found I took to Professor Chapman, of the University of Toronto, for identification. He assured me that it was a new species, *i.e.*, new to his experienced eye. He named it *Asaphus Halli* after Professor Hall.

It would occupy too much of your space were I to describe it minutely: suffice it to say that it differs, in some respects, from all others previously examined: *e.g.*, by "its divided *glabella*, and by the presence of furrows on its *pygidium*"; by "its *thorax* and *pygidium* being of equal length," &c. It is a broad oval in shape: total length five inches.

P. 18. "Another insectivorous plant."

The *Apocynum androsaemifolium* is a member of the Dogbane family, of which family America possesses, I believe, but three *genera*; *viz.*, *Amsonia*, *Forsteronia*, and *Apocynum*. The *A. androsaemifolium* is the "Spreading Dogbane," and common enough with us. The *corolla* is of a pale rose-colour.

I was not aware of the peculiarity alluded to by your correspondent, Thomas Brittain; but the juice of all these plants is poisonous, being, in fact, *strychnia*.

P. 23. "The Cuckoo."

We also have a bird in Canada, the "Cow Bunting," *Emberiza pecoris*, the female of which invariably lays her eggs in the nest of some small bird, of a species different from her own.

Not long ago I found, in my own garden, the nest of a "chipping sparrow," *Fringilla socialis*, containing, in addition to her own eggs, one laid by a cow bunting.

The American Cuckoos make nests of their own, in which they lay their eggs. I have seen the flat, rough nest of a "black-billed cuckoo," *Cuculus erythrophthalmus*, with the female sitting on her eggs.

No. II., p. 42. "Our American Cousin, the Robin."

Your correspondent *Apis* gives correctly the scientific name of this bird, *Turdus migratorius*, which should have told him that our Robin is in fact a thrush. It is not in *any* point similar to the English "redbreast," save only in the colour of its breast, which, however, is more of a dark orange than of a red colour. It has not a "chocolate-coloured dress," its prevailing upper tint being *ash* with black mark-

ings. It is at least nine inches in length. At the present moment several of them are running over my lawn in quest of worms.

Like its English congener, the Missel-Thrush, the American Robin perches, in showery weather, upon the topmost branch of a tree, and carols forth its wildest notes. Before migrating, we see numbers of them upon the Mountain Ash trees, literally gorging themselves with rowan-berries. They may frequently be seen with their upraised beaks wide open, as if at the last gasp, having taken in a larger number of berries than they can conveniently swallow.

The English Robin, our childhood's pet, is so intimately and so pleasantly associated with all our thoughts and recollections of "Home"—as we in Canada always term the dear old island across the Atlantic—that it has ever been a source of regret to me that the *Turdus migratorius*, a bird so widely differing in every respect from the British Redbreast, has been selected as its American confrère. And this regret is enhanced by the consideration that another choice might have been made, in every way more satisfactory, in the Blue Bird, *Sylvia sialis*—a bird named by Buffon *le Rouge Gorge Bleu*, or the Blue Redbreast.

I cannot but fancy that the name of Robin was given to the *Turdus migratorius* by some enthusiast who had not, up to that time, seen a "Blue Bird," and who, resolved that we should at all events possess the luxury of a Robin on this continent, gave that name to the first bird adorned with a rufous breast that presented itself to his view.

The Blue Bird is about the size of the English Robin, and very much resembles that much-loved bird in its shape and in its characteristics. It has a blue instead of a brown back, and a red breast, and is one of our earliest and most welcome visitants.

VINCENT CLEMENTI, B.A.

Peterboro', Ontario, Canada.

ON CERTAIN GENERA OF LIVING FISH AND THEIR FOSSIL AFFINITIES.

THE following very interesting and able paper, by Miss Crane, was recently read before the Brighton and Sussex Natural History Society:—

On first thoughts, it may seem that the lowest group of vertebrates, of all the divisions comprised in the animal kingdom, might be most easily described, and its zoological limits defined; but, on examination, the fishes prove to be most curiously linked to the invertebrata below and the amphibian reptiles above. In fact, it is not easy to draw the lines positively between them, and to say where the true vertebrates begin, or where the piscine characters are merged in the reptilian.

It is now proposed to refer to some of the most aberrant forms of living fish and their fossil affinities; then, briefly passing in review the distribution of the various families in geological time, to see how far descent with modification is traceable in this class of vertebrates.

It is well known that the lowest vertebral form is the anomalous lancelet (*Amphioxus lanceolatus*), which is found burrowing in sandbanks on our southern shores and in the Mediterranean. The position which this singular species should occupy in the animal kingdom has long been a subject of debate among naturalists. Some, like Agassiz, separate it entirely from all other fishes, while Haeckel proposes to place it in a distinct division of the *Vertebrata*, and Professor Semper removes it from the vertebrates altogether. But Professors Owen and Huxley, considering it to possess the rudiments of a skull and brain, with the elements of a vertebral column, retain it among the fishes, and it forms the first or lowest orders of their respective systematic arrangements. In *Amphioxus*, which ranges from one inch and a half to two inches in length, the vertebral column is notochordal throughout life,—that is to say, composed of a membranous sheath enclosed in cartilage,—and as there is no enlargement of the skull for the reception of the brain, the animal tapers nearly equally at either end. The skin is scaleless, lubricous, and so transparent that the internal structure is visible, and the eyes are not more fully developed than in the common leech. The mouth is vertical, jawless, and suctional, and is furnished with vibratile cilia. The lancelet possesses neither heart nor swimming bladder, and is without ribs and even rudimentary limbs. In all other fishes respiration is effected by means of water passing through the mouth and escaping by the gills, or their equivalents; in this species it traverses the whole interior of the animal, and escapes by a special pore on the under surface of the body. Prof. Goodsir long ago called attention to this peculiar mode of respiration, and noticed the resemblance between the enlarged pharyngeal sac of *Amphioxus* and that of the tunicated mollusks or sea squirts. He considered the lancelet also as allied to the *annulosa*, from the simple organization of its respiratory and circulatory system, and M. Kowalevsky has more recently traced a close affinity between this species and the early stages of some Ascidians. Thus, in *Amphioxus* are united characters belonging to the *Tunicates* and *Annelides*, and unexpected relations are revealed between the *Vertebrata* and the *Invertebrata*.

In the *Lepidosiren*, the highest of all the fishes, we find an organization of a no less complex nature. This genus was founded in 1837 by Dr. Natterer for the reception of a singular animal to which he gave the specific name of *paradoxa*, discovered by him in America, inhabiting the swamps in the vicinity of the river Amazon. This species, which attains a length of three feet, the body being eleven times as long as

the head, is now becoming very rare. In 1839, Professor Owen referred specimens from the river Gambia of West Africa to the same genus, under the designation of *Lepidosiren annectens*, and classed them in a provisional group between the reptiles and fishes. They are placed by Professor Huxley in the highest order of his classification of fish, namely, the *Dipnoi* or “double breathers,” and are popularly known as the mud-fishes. These paradoxical “scaled sirens” have well-developed reptilian lungs co-existing with functional internal branchiæ, and are capable of living either in the water or out of it. Their structure and habits are very peculiar. During the rainy season, the waters of the Gambia overflow its banks, and the mud-fish is carried out of the true bed of the river. When the waters retire it is left stranded; then, burrowing in the softened mud, it coils itself up, keeps open a communication with the air above its nest, and breathes by means of its modified swimming bladder. It thus remains inactive till the return of the floods soften the walls of its cell, when it emerges and resumes its former habits. They have been found in a semi-torpid state eighteen inches below the surface, in situations where the ground is dry and hard for months in the year, and are dug out by the natives with a sharp-pointed stick and used for food. A specimen of *L. annectens* has been on exhibition in the entrance-hall of the Brighton Aquarium for more than two years. It is kept at a regular temperature of 70 degrees, and is in a very thriving condition, having grown several inches since it has been in the Institution, and thickened proportionately. The animal generally lies quietly at the bottom of its tank, rising occasionally to the surface to take in air. It is fed three times weekly on small pieces of raw beef, which it can be observed to eat in a very unusual manner. When the food is thrown in the mud-fish stretches itself leisurely and seizes it, as it comes within reach, between its sharply-formed vomerine teeth. After masticating it slowly, it throws it out with a quick jerk, and, commencing at the other end, repeats the manœuvre; it then again rejects it and subjects it to a third process of mastication before finally swallowing it. The body of the *Lepidosiren* is fish-like, and covered with small cycloid scales; simply constructed pectoral and ventral limbs are present, with a dorso-caudal fin. The notochord is persistent, but the skull is partly bony, partly cartilaginous, and the costal arches and neural and hæmal spines are well ossified; thus it forms a link between the bony and cartilaginous types of fishes. The dentition is composed of a pair of vomerine teeth, and two molars in each jaw. The heart is three chambered, and true lungs exist with rudimentary external branchiæ and functional internal ones.

Among living fish, the *Lepidosiren* is most closely related to another “dipnoid,” discovered in the rivers of Queensland, Australia, in 1870. This species was at once, with singular accuracy, referred by Mr.

Gerard Krefft, the curator of the Sidney Museum, to *Ceratodus*, a genus till then only known by the fossil teeth occurring abundantly in Triassic and Jurassic strata. He also described it "as a gigantic amphibian, and as allied to *Lepidosiren*," the correctness of which determination has been fully demonstrated by the subsequent minute investigations of Dr. Günther and Professor Huxley, who have published exhaustive memoirs on this subject. Two species of living Ceratodonts are recognised, one named after its discoverer, the Hon. William Foster, *Ceratodus Fosteri*, and *Ceratodus miolopsis*, distinguishable only by its smaller and less ornate scales. These fish, known locally as "flat-heads," inhabit the fresh and brackish waters of the Queensland rivers, and "at night leave the streams, and go out on the flats, among the reeds and rushes, subject to tidal influence." Dr. Günther is, however, of opinion that they do not probably live freely on land, as the limbs are too flexible and feeble to support the heavy body, and considers that though they may be occasionally compelled to leave the water, they could not remain long in a lively condition without it. The species, which range up to six feet in length and twenty pounds in weight, appear to feed exclusively on the remains of plants *Myrtaceæ* and *Graminæ*, taken in a decomposing state. The body of *Ceratodus* is covered with large cycloid scales, and the limbs are structurally identical with those of *Lepidosiren*, but the axis and fringe are more dilated, and the fin scales distinctly visible. The internal skeleton, though of a more cartilaginous type, resembles that of the mud-fishes, and the skull is partly osseous. The anterior nasal openings are situated under the lip, in front of the vomerine teeth, while the posterior pair are placed in the cavity of the mouth, a little before the maxillary ones. The dentition is essentially that of *Lepidosiren*, slightly modified to suit herbivorous diet, being adapted rather for "cutting and crushing" instead of "piercing and cutting." It consists of a pair of vomerine teeth and two molars in each jaw, thus proving the correctness of the views of Pander and Agassiz, who had assigned that number of dental plates to the fossil forms of the middle geologic ages. The respiratory organs are twofold, as in *Lepidosiren*, but the gills are more developed in *Ceratodus*, and when inhabiting clear waters the fish probably breathes by them alone, the true lungs only coming into action when on the mud flats, or living in turbid waters. The shape of the body, the number, position, and structure of the fins, the elements of the internal skeleton, and above all the co-existence of a lung with gills, show how close is the affinity between the Australian *Ceratodus* and the mud-fishes of Africa and South America; and although the former approach less to the amphibian type than the latter, it is obvious that in a natural classification their place is side by side.

(To be continued.)

THE HARVEST-BUG.

(*Leptus autumnalis*.)

OF all the insects with which entomologists are acquainted, few are more troublesome than the tiny hexapod depicted in our sketch. In proportion to its size, it has, perhaps, greater powers of annoyance than any other insect indigenous to this country. A moment's reflection on the part of our readers will bring to their remembrance a host of troublesome insects, but should they ever have been attacked by an army of harvest-bugs, they will scarcely need to be informed that, in proportion to its size, its powers of punishment far exceed those of any other of our indoor or outdoor tormentors. The flea (*Pulex irritans*), the common bed-bug (*Cimex lectularius*), and the gnat (*Culex pipiens*) sometimes punish us severely, but in considering this, it must be remembered that the smallest fully-developed specimen of the smallest of these, namely, the flea, is at least one hundred times larger than the harvest-bug. The latter is, in fact, a near approach to a mathematical point? Three or four may be easily overlooked on the point of a needle.

As its name implies, this bug is found during the months of harvest. So far as our observations extend, its period of activity ranges from June to October; August and September being the months during which it is most active. A period of drought appears to contribute to its abundance and activity. In this respect it is exactly the reverse to a similar insect, said by Kirby and Spence to be found in Brazil, and to abound in the rainy season.

We believe that during the whole year this insect makes its home in our fields and gardens; the above period being that of its activity. As we should expect to find, this tiny creature has its preferences. In the harvest-fields it seems to prefer those of wheat. In our gardens, the French or kidney-bean plant and the leaves of the currant-tree appear to be its paradise. We have observed that whilst it may be found on nearly every vegetable in a garden, it is always most abundant on those above indicated; the bean plant being preferred to those of the currant-tree. We fancy, too, we hear our readers saying that the body of man must be preferred to the plant of the French bean. This may be so, but it is a point we have not yet been able to decide. Our experience thus far is against the proposition; for, unless the plant on which the little creature exists is disturbed, we have never known it to attack man, but the instant it is interfered with, by walking through the harvest-fields or brushing against the garden plants, it commences its attack. Its weight is so infinitesimal, and its motion so slight, that the body of man, sensitive as it is, is not aware of the presence of the enemy until the attack is fairly commenced.

But, before proceeding further, it may be as well to state that the harvest-bug has the power of adapting

its colour to that of the plant or animal on which it is feeding. We have found it of a reddish-straw colour in the harvest-field, quite green on green plants, and perfectly crimson on—or more correctly in the skin of—the human body. We have also placed the insect, when green, on the back of the hand, and watched its mode of attack and change of colour.

On being placed in a green state on the hand, it commences to use its pointed, spear-like mandibles (*M* in fig. 174) vigorously, and a sense of pain is quickly experienced. In two or three minutes it begins to imbibe the human blood, still vigorously working with its mandibles, and forcing its way

state of the blood. Once embedded in the skin, the harvest-bug appears to have no power of extricating itself. A state of torpidity soon sets in, perhaps at once, and after a few hours the little creature ceases to exist. The irritation may continue, however, in a sensitive person for two or three days.

The question now arises :—To what is the irritation due? To the mere puncture it can scarcely be. Is it, then, to a poisonous fluid injected, or is it to the numberless cilia-like spines or stilettos with which the body and legs of the insect are covered? We have not yet satisfied ourselves on this point, but are inclined to think that it is due to the latter. The

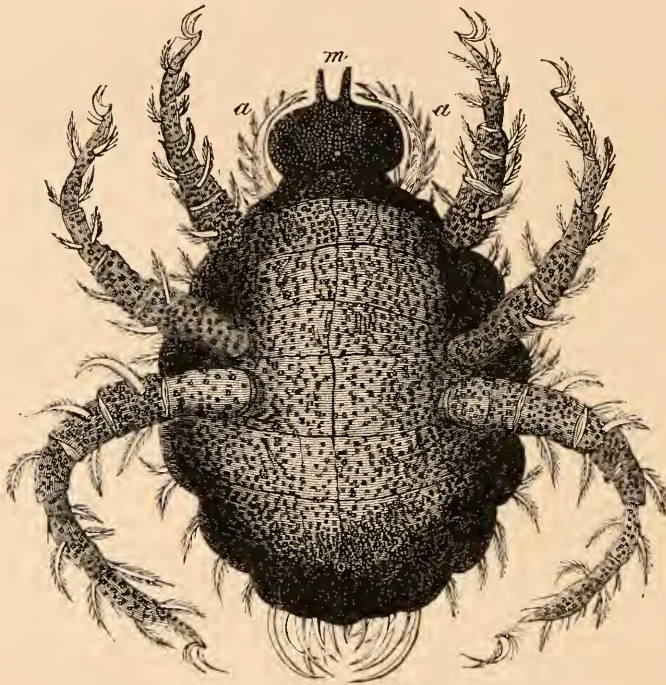

Fig. 174. The Harvest-bug (*Leptus autumnalis*), highly magnified.

under the skin. After the lapse of two or three more minutes it may be seen, by the aid of an ordinary pocket lens, to have sensibly changed colour, and in from fifteen to twenty minutes from the first, it will be seen to be quite crimson, and so thoroughly embedded in the skin that nothing short of a slight surgical operation, which may be performed with a sharp-pointed needle, will remove it. During this time a slight pain is experienced, but it is after the little creature is fairly embedded in the skin that the irritation is most painful, and the swelling commences. In many cases the swelling thus raised is two or three hundred times the size of the insect. By numbers of people these swellings are called *heat bumps*, and were believed to result from a heated or disordered

prolonged irritation may be in part, or altogether, due to the decomposing body of the insect in the skin; a poisonous fluid being thus generated. This hypothesis is borne out by the fact that the irritation of the punctures from which the insects have been removed ceases much sooner than that of those in which the insects are allowed to remain. At the same time it must be remembered that this may be due to the absence of the mechanical irritative body.

Another interesting question also arises :—Does the blood extracted from the human body by the insect, which imparts to it its crimson colour, undergo any change in the system of the insect? We believe it does, but only a mechanical change, the human blood corpuscles being broken up sufficiently fine to

circulate in the system of the insect. It may also undergo a chemical change, but as to this, it is not easy to decide.

A further question arises:—What becomes of the body of the insect imbedded in the skin? Is it, after decomposition, absorbed by the blood, or is it expelled by perspiration from the pores of the skin? We are inclined to think that the latter is the case. A still further question arises:—What is the best fluid to apply to the skin to allay irritation? Speaking from experience, we say, moderately strong acetic acid or concentrated common vinegar. Our knowledge of chemistry also points to this, acetic acid being a solvent of animal substances.

Finally, we may remark that the reproduction of species with this insect appears to be by the deposition of ova on the under parts of leaves, and underneath the bark of small garden trees and shrubs. The harvest-bug is believed to live one season only, as a rule, but we have found it in a dormant state in winter underneath the decaying bark of the garden currant-tree. We failed, however, to ascertain as a fact that it again became active in the succeeding summer or autumn.

In this, as in all the works of the Creator, we see infinite design; but the exact part this little creature is designed to fulfil in the economy of nature is as yet a mystery to man.

I should remark that my sketch is from a very fine specimen.

J. E. STEPHENS.

Inland Revenue, Alloa, N.B.

THE METAMORPHOSIS OF THE WHITE CABBAGE BUTTERFLY.

(*Pieris brassicae*.)

ON seeing the curious manner in which the chrysalis of the butterfly is suspended by a silken cord round its body, one would naturally ask how this was accomplished. There is something so wonderful that a creature like the caterpillar should spin a thread of silk, and so utilize it as to hang itself up by it in a position suitable for the future development of the butterfly, that I do not think it a waste of time or labour in attempting to explain the way it is accomplished: this I have endeavoured to do by the aid of the accompanying sketches. I procured a number of caterpillars and kept them until they were full-fed, when they leave their food and travel in search of a spot suited for them to undergo their metamorphosis. In this case, being kept in a glass box, they had to travel up the smooth glass. This they easily accomplished by spinning a ladder of silk in a zig-zag form. Having fixed themselves to a

spot, they then rested quiet for some time, hanging in the position of fig. 175. When about to commence forming the silk cord that is to support the future chrysalis, they do so by bending the head backward to about the fourth segment of the body (fig. 176), and then turning the head downwards on the right side, so as to bring the mouth to the point *a*, fig. 176. The caterpillar there fixes the first line of silk, and then carries the head over to the left side, spinning a line of silk at the time, and fastening it down on the left side; again bringing a line of silk back over to the right side, and fastening it down. This process is continued and repeated until about forty lines of silk are in this manner drawn across the body and the head. At this time the silk is drawn so tight that, to appearance, the head of the creature is in danger

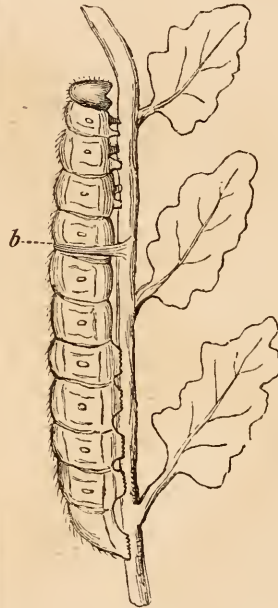

Fig. 175. Stage of metamorphosis of *P. brassicae*.

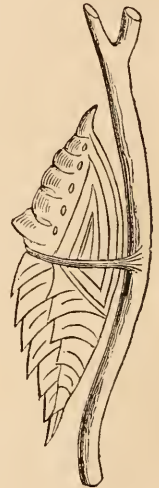

Fig. 177. Chrysalis of *P. brassicae*.

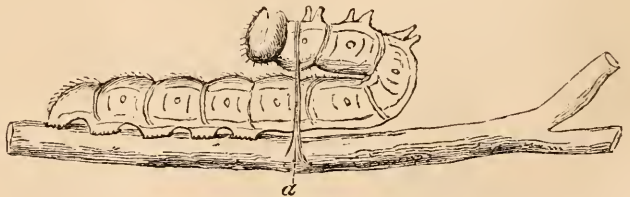

Fig. 176. Another stage in ditto.

of being severed from the body; but this does not happen, as the caterpillar is very soft and flexible, and will bear a large amount of pressure. Now comes the task of releasing the head from this bent-back and tied-down portion. I confess that I watched this movement with a degree of curiosity, and was

surprised to see the creature adroitly bring the head down to the spot (fig. 176, *a*) where there appeared more space between the body and the silk cord than at any other point, and it quickly withdrew the head out from under the cord, and placed itself in the position of fig. 175, with the cord, at *b*, complete: this process occupied about twenty-five minutes. In this state it rested until the chrysalis was formed, when the old skin was thrown off from under the cord, and the chrysalis left as shown (fig. 177), from which in due time the butterfly will emerge.

Canterbury.

J. FULLAGAR.

MICROSCOPY.

RAPHIDES.—Would one of the many readers of SCIENCE-GOSSIP kindly inform me in what way turpentine acts on *vegetable* tissues, so as to make them transparent? Some time ago, being desirous of obtaining a good slide of the outer coating of an onion, showing the raphides for the polariscope, I soaked it for several weeks in spirits of turpentine, after which, when taken out to mount, it was, with the exception of a few very small opaque spots, transparent. However, when it had been in balsam for some hours, these spots which were left became larger, so that in time the structure would have regained its original opacity. I therefore repeated the experiment, but with the same results. I may add that it was mounted in balsam dissolved in benzole. Of course it was of no very great consequence, as it still shows the crystals pretty well; but I suppose, as a general rule, for the polariscope tissues cannot be made too transparent. While upon the subject of Raphides, may I suggest a plan which I have found answers well for making very interesting slides of those from the rhubarb. Take a stick of rhubarb, and, after peeling it, cut about two inches off, and again divide this into pieces a quarter of an inch thick. Put these into a test-tube and half fill with distilled water; boil or simmer till they become quite stringy, then, after emptying the tube of its contents, gently pour off the surplus fluid. Now, if a drop of liquid be squeezed from the remaining mass, put on to a slide with a covering-glass, and submitted to the microscope, isolated cells will be seen, many of them having in their interior the aforesaid raphides. Generally there are some loose ones as well, so that one has the opportunity of seeing them singly or *in situ*. As to preserving, my way of mounting is in fluid, by mixing the liquid containing them with a solution of carbolic acid, adopting Mr. Suffolk's plan of making a cell of thick damar varnish, and putting on the cover while it is yet sticky. The only fear is, I think, whether enough carbolic acid can be introduced into the cell to preserve its contents. There is, perhaps, nothing very new in all this; but for those who are only beginners

in mounting their own objects, the foregoing directions may prove useful.—*E. W. W., Lewisham.*

PLANTS FOR RAPHIDES, &c.—In last September number of the "Monthly Microscopical Journal" Professor Gulliver gives a list of the plants, chiefly British, in which these and other microscopic crystals may be most conveniently examined and discriminated. The orders and families are noted according to Babington's "Manual of British Botany," so that the student may at any time select a plant in which to examine any of the particular forms of crystals. These are as follow:—For i., *Raphides*—Balsaminaceæ, Onagraceæ, Rubiaceæ, Dioscoreaceæ, Trilliaceæ, Orchidaceæ, Amaryllidaceæ, Asparagaceæ, Liliaceæ (part of), Typhaceæ, Araceæ (part of), Lemnaceæ (except *Wolffia*), Vitaceæ, Hydrangia, *Veratrum*. For ii., *Spheraphides*—Caryophyllaceæ, Geraniaceæ, Celastraceæ, Rhamnaceæ, Myriophyllum, Paronychiaceæ, *Viburnum*, *Mercurialis annua*, Chenopodiaceæ (part of), *Rhubarb*, *Urticeæ*, *Passifloraceæ*, *Cactaceæ*, *New Zealand Spinach*, *Pulp of Pear*. For iii., *Long Crystal Prisms*—The pericarps of *Compositæ*, leaves of *Iridaceæ*, *Fourcroya*, *Sweet Orris*, *Guaiaicum bark*, *Quillaja bark*, *bulb-scales of Onion*, *Shallot*, *Garlic*, and *Leek*. For iv., *Short Prismatic Crystals*—Pericarps of many *Compositæ*, leaves, &c., of *Tiliaceæ*, *Aceraceæ*, *Amentiferæ*, *Leguminosæ*, *testa of the Elm*, *Anagallis*, and *Tamus*. Figures of the different crystals were given in SCIENCE-GOSSIP, May, 1873, except the short prisms, of which there is a plate in the "Monthly Microscopical Journal" for December of the same year. But the present list will afford an inexhaustible collection of materials for microscopical amusement and instruction, all remarkable, too, for their interest and beauty. As regards their distinctive characters and taxonomic value, remarks are added in the "Monthly Microscopical Journal." When not otherwise mentioned, the raphides, &c., are to be looked for in the leaves or sepals.

LIFE HISTORY OF THE SIMPLEST ORGANISMS.—At the recent British Association meeting the Rev. W. H. Dallinger delivered an exceedingly interesting lecture on "Researches in the Life History of the simplest Organisms." He stated that he had worked out the life histories of six monads, and then proceeded to give the results of numerous experiments in connection with the same. Motion was, perhaps, nowhere so universal as in the most minute forms of life, and here it was that we often found movement of the most graceful kind. It had now been made quite certain that the degrees of ease and force of motion of these animals depended upon the number of their flagella, which, so far as investigation had yet gone, ranged from one to four. With regard to the most minute forms of life, Mr. Dallinger said that the study of their life histories showed that these forms were perfectly complete and definite; there was no mutation nor anything unnatural. The results of his

experiments with certain life-germs showed that when ordinary air was charged with given germs, any nutritive fluid receiving these germs would produce monads, while when the air was kept perfectly pure the same fluid would not produce a single monad. With the air at a temperature of 310° Fahrenheit and charged with germs, the fluid produced no monads. As to the theory of the "survival of the fittest," he stated that he was a perfect convert to it. At a temperature of 45° the six monads with which he had been experimenting were found to live and flourish, and they could bear a sudden increase of temperature up to 60°, without exhibiting any signs of inconvenience; but if, upon reaching this point, the temperature was suddenly increased by five degrees, the monads showed a faintness. The temperature might, however, by a slow process, be increased to 127°, in which the monads would live, and multiply even more rapidly than in a temperature of 45°. The results of similar experiments also seemed to show that it took a much longer time to produce a modification in the ovum than to produce a modification in the parent. At the conclusion of the lecture Professor Macalister remarked that the questions raised by Mr. Dallinger were of incalculable importance.

ZOOLOGY.

THE ZOOLOGY OF NEW GUINEA.—At the recent meeting of the British Association at Plymouth, Prof. Rolleston, F.R.S., read a paper on the above subject. He commenced by saying that the zoology of New Guinea has had a great deal of research bestowed on it, and will yet have a great deal more, as a consequence of the profit which has already resulted. A point which recent zoological discoveries in New Guinea throw light upon, is, that there was a dry-land passage at one time between Australia and New Guinea; recent discoveries in the latter country having revealed the presence there of animals similar to, or identical with, some found in Australia. This is held as proof that where Torres Straits now is, there was once dry land. But against this hypothesis is urged the difference between the vegetation of the two islands. This, however, is accounted for by what Herbert Spencer calls the circumambient medium. Though people are inclined to think vegetables considerably less sensitive than animals, sometimes they are more sensitive to heat and dryness; and Professor Rolleston believes that it is the greater susceptibility of the vegetation at the antipodes which accounts for the disparity observable between the vegetable growths of New Guinea and those of Australia. In the centre of New Guinea there is a high range of mountains, which attract and impart moisture to the surrounding country; while the interior of Australia consists of great barren plains, which harbour no

moisture. The plants, as they have not had the means to protect themselves available to animals, have gradually altered their form to accommodate themselves to circumstances. A curious creature, covered with prickles, living on ants and other insects, and unprovided with means of militant operations, is found on both sides of the Straits. Two kinds of *Echidna* have also been discovered in New Guinea, and corresponding with them is one in Tasmania, and another in Australia. As these creatures could not travel over water, there must have been land communication at the period of their original distribution. Quite lately an *Echidna* has been found in the south-west corner of New Guinea, and sent to Professor Rolleston by the Rev. Mr. Lawes, the discoverer, accompanied by a letter, in which the statement is made that this is the first ever found. For this species the name *Echidna Lawesei* is proposed. The Cassowary has also been found on both sides of Torres Straits, and the existence of the Tree Kangaroo, both in Australia and New Guinea, Prof. Rolleston also considered reliable. At its conclusion, the paper treated of the Admiralty Island pig, in the fore part of which Professor Rolleston pointed out the peculiarity of a glabellum. Dr. Bennett proposed a vote of thanks to Professor Rolleston, and took opportunity to explain that there had been no tree-kangaroo actually found in Australia, though there is little room left for doubt that the species has inhabited the place, as marks left on trees could only have been produced by it. Dr. Sclater thought it would have been well if the Professor had informed them that the *Echidna*, together with that wonderful animal the Duckbill, constituted by themselves a third class of mammals. Professor Rolleston was, he thought, to be congratulated on being the first in England to possess that most interesting animal, the *Echidna*. Professor Newton exhibited an engraving in *Nature* of the skull of an *echidna*, and expressed a desire to learn something by which to discriminate between the *Tachglossi* of the northern part of New Guinea and those of the southern part. He thought they should pause before accepting the fact that this *echidna*, just arrived, was really something novel, and deserved classification as a new species. Professor Rolleston, in answer to the remarks of Professor Newton, said the specimen had been sent to him by Mr. Ramsey, of the Museum, Sydney, to be classified and named.

LARVÆ OF PAPILO MACHAON AT BRIGHTON.—About the second week in July a couple of caterpillars of the Swallow-tail butterfly (*Papilio Machaon*) were found by two little boys in a garden near the race-course, and taken to Messrs. Pratt & Sons, North Street Quadrant, Brighton. The larvæ were feeding on the carrot when taken, and continued feeding on it for four days, when one turned to a *chrysalis* and the other died. The *chrysalis* was of a light-brown colour with black stripes, instead of the ordinary

green colour. It is stated that when caterpillars of this butterfly feed on the cultivated carrot, the chrysalides are usually brown. On August 6th a very fine female emerged. The question naturally arises, how came the caterpillars in a garden near Brighton? Has some entomologist been trying an experiment? Did a female escape from captivity and lay her eggs? Or has an impregnated female flown across the Channel? Any way, we may possibly hear of the perfect insect being seen or caught in the neighbourhood of Brighton during the present month. The emergence of this female confirms the opinion of continental entomologists that *P. Machaon* is double-brooded.—*T. W. Woufor.*

THE AQUARIUM AND WINTER GARDEN at Tynemouth, near Newcastle, is rapidly approaching completion. The building occupies a commanding position on the Long Sands between the town of Tynemouth and the little fishing village of Cullercoats. The entire basement is devoted to the Aquarium, with its reservoirs and pumping-machinery, and the show-tanks, of which there will be both a sea and a fresh-water series, will contain upwards of 140,000 gallons of water. The plan adopted is the circulation system, which has proved so successful in the maintenance of aquatic life at the Crystal Palace, Naples, and elsewhere. Special arrangements are being made for the culture of salmon and trout, and in conjunction with the Aquarium, but out of doors, there will be an enormous seal-pond, into which a supply of sea-water will be pumped direct from the sea when required. Mr. E. Howard Birchall has been appointed curator.

THE SHARP-WINGED HAWK-MOTH.—On the 29th of August I caught a specimen of the Sharp-winged Hawk-moth (*Charocampa Celerio*) in one of the rooms of our house. It is in splendid condition. Is not this early for it to make its appearance?—*H. Molony, Seaton, South Devon.*

"POTATO PESTS."—Under this head a cheap but well got-up *brochure* has been published by Orange, Judd, & Co., New York, the author being Dr. C. V. Riley, the State entomologist of Missouri. It was Dr. Riley who, three or four years ago, worked out the life-history of the Colorado Beetle (*Doryphora 10-lineata*, Say). In this little work we find the entire story as to its progress and migrations re-told. Nobody is better able to tell the story than Dr. Riley, and from his publications anent this pest most of the matter published in England has been obtained. Dr. Riley has also just written another work, entitled "The Locust Plague in the United States," wherein he has worked out the popular life-history of the insect causing it, as he had done that of the Colorado Beetle.

RORQUALS OFF FILEY?—A Mr. Haxby, smack owner, of Filey, told me, about a week ago, that

some days previously, when fishing for herrings off the Yorkshire coast, between Scarborough and Whitby, he saw three large whales, but was rather vague as to their size; they were as large or larger than his smack, and might be perhaps nearly 100 feet long. Might they not be Rorquals?—*R. M. Gordon.*

CLOSE TIME FOR SEA-FOWL.—The "close time" for sea-fowl has been extended to the 1st of September for the county of Northumberland and the Fern Islands; and to the 15th of August for the East Coast of Yorkshire. Is there any reason why the sea-fowl on other parts of our coast should not share in this amnesty? It is a grave reflection on the ornithologists of Great Britain that we cannot preserve our native birds from destruction!

BOTANY.

SHINING MOSS.—A correspondent, in a recent number of SCIENCE-GOSSIP, asks for instances of the growth of *Schistostega pennata*. There is, near this place, a group of gritstone rocks, through which there is a natural passage, on the sides of which this beautiful moss grows in profusion. I have noticed that the bright green metallic lustre is much increased in damp weather.—*Rev. H. Milnes, Winstar Vicarage.*

"POLLEN."—By this name an attractive-looking book has just been published by Messrs. Hardwicke & Bogue, 192, Piccadilly. It is written by M. P. Edgeworth, F.L.S., and embellished by twenty-four lithographed plates of pollen-grains, giving no fewer than 440 objects. Since the division has been made of all flowers into insect- and wind-fertilized, and the fact made known that even the pollen-grains of these two groups are strikingly different, the shapes and ornamentations of pollen-grains have assumed a new interest. We have long thought that in the delineation and description of pollen-grains there lay an unworked field for the microscope, and we are glad to see that Mr. Edgeworth has taken up the subject. All botanists will welcome this book.

POPULAR BRITISH FUNGI.—This is the title of a well-got-up little work, by James Britten, F.L.S., published at the Bazaar office. It contains descriptions and histories of the principal fungi, both edible and poisonous, found in Great Britain. Mr. Britten is a well-known botanical author, and therefore such a work as this, which ought not to be intrusted to any other than experienced hands, may be thoroughly depended upon. The illustrations are excellent, and the style in which the book is written is clear and attractive.

"VERONICA SPICATA," VAR. "HYBRIDA," is now in full bloom on the St. Vincent's Rocks, near Bristol. We saw it recently, on a very dangerous part of the rocks, where we hope it will remain un-

disturbed, and subsequently in a more accessible position, whence a fine spike of flowers was obtained, though not without difficulty. We had no time for further search. Bentham mentions this rare plant as having been found on limestone in Somersetshire: we gathered it on the Gloucestershire side of the Avon. The sloping rock on which *Sedum rupestre* once grew luxuriantly has been utterly destroyed in blasting for the new railroad. I hope the latter plant has other habitats not far distant.—*H. M. C. Allen, Barcombe Rectory, Leves.*

EDELWEISS.—I have this year found the Edelweiss to be as abundant in certain localities in the neighbourhood of Zermatt as on any former occasion, with the exception of a few places where I remembered having seen it growing by the roadside. The newspaper article to which Mr. Hall refers has been freely translated and copied into most of the Swiss papers, and has led to the imposition of restrictive penalties by some of the local authorities, against the wholesale uprooting of the plant in endangered districts; it has also called forth many suggestions for the protection and preservation of this and other botanical rarities. Fortunately for the Edelweiss, it does not grow in such localities as those usually indicated by the guide-books, and those persons who are not acquainted with its habitat are generally obliged to content themselves by purchasing their supplies from the natives, who, for obvious reasons, are naturally reticent as to its whereabouts. So far, however, from being extinct, I may say that in several places (well known to me in former years), at no great elevation above Zermatt, it would have been easily possible, in August last, to have collected enough of the plant in full bloom to have filled a bushel basket, within the space of a few hundred yards.—*R. T. Lewis.*

ORIGIN OF LONG STAMENS IN CRUCIFERÆ.—Mr. Gibbs is very possibly right in his explanation of the "lateral" flowers he has observed in the Watercress, but I fail to see how their occurrence explains in any way the origin of the long stamens. Everybody knows that a stamen is a modified leaf or leaflet, *i.e.* a lateral organ, and that it forms a member of a modified leaf-bud, known as the flower. Any leaf may, I believe, produce an axillary bud, and instances similar to those observed by Mr. Gibbs have been previously recorded. Such a bud may form a flower, or not; but it will most probably consist of more than one, if not more than two leaves; so that it is not a very satisfactory explanation of the origin of a pair of stamens, which, as I recently showed in your columns, are often but branches of one. Moreover, if axillary, the long pairs must be in the axils of the sepals to which they are superposed or opposite. How then do they occur within the petal and not alternating with them in the same whorl?—*G. S. Boulger.*

NOTES ON VEGETABLE TERATOLOGY.—Probably no genera of British plants display as many vagaries as the Plantains. Dr. Masters, in his valuable work, often refers to the various species. The one here figured is *Plantago lanceolata*. At the summit of the spike, three perfect leaves are seen growing; it is simply the bracts transformed into leaves: it teaches a lesson about which there can be little doubt—that the bracts are only modified leaves, which, under certain favourable circumstances, such as a continuance of humid weather, like what has recently taken place, will again revert to the original form. Our botanical friends might keep a sharp look-out, and when they find any peculiar abnormal forms, they would confer a favour if they would send them in a fresh state by an early post.—*James F. Robinson, Frodsham.*



Fig. 178. Flowering spike of *Plantago lanceolata*.

THE COTONEASTER.—In answer to your correspondent, I might say that last year I searched the Orme's Head, and found the *Cotoneaster* in the locality described by Mr. Lees, of Worcester, in an interesting paper which appeared in SCIENCE-GOSSIP for 1874, though very sparingly. The same ledge of rocks yielded many other good plants, such as *Helianthemum canum*, *Epipactis ovalis*, *Rubia peregrina*, &c., which would repay a visit. *Gentiana acaulis* is acknowledged to possess no claims as an English plant, and if it occurs on Cader Idris, it is evidently planted. I saw nothing of it when there last.—*G. C. Druce.*

ALLIUM AMPELOPRASUM.—Is not your correspondent, Mr. H. Pearce, mistaken in saying this plant "carpets the ground of woods in some places (about Cader Idris) where it has gained the mastery over other plants"? If this be indeed the case, it is a grand discovery in English botany. Hitherto, *A. ampeloprasum* has been ranked among our native plants only as growing on the Steep Holms, a rocky islet in the Severn estuary, where Ray was the first to notice it; and even there Borrer considers it to be "only a remnant of ancient cultivation." Is not the Cader Idris plant most probably *Allium ursinum*?—*E. S.*

NOTES UPON CADER IDRIS BOTANY.—I believe that if there be a thankless task in connection with such a pleasant subject as field botany it is surely the throwing of a doubt upon the accuracy of the printed records of a fellow "follower" of Flora. Yet at times, when one sees evident mistakes gaining currency as scientific facts, one feels constrained to put in a word for the benefit of travellers in the

future. Herein is my justification for the following remarks upon a paper in the August number of SCIENCE-GOSSIP, entitled "Botanical Notes in the Neighbourhood of Cader Idris." It is upon the *internal evidence* of the paper in question, to be found upon pages 174 and 175, that I ground my convictions as to the incorrect determination of some of the plant names whose discovery it records; for none of those to which I allude have been previously known in the Cader Idris district. I will take the species to which I demur, in the paper referred to, in the same order as there found:—1. *Hypericum montanum*: upon an old wall, just outside the town of Dôlgelly. An old wall, and that in a slate district, is a most unusual station for a plant xerophilous—dry or limestone-loving—in its distribution. It is unrecorded for Merioneth, both in "Topographical Botany" and in the Rev. A. Ley's supplementary list of Merioneth plants in the Bot. Loc. Record Club Report for 1875. I fancy *dubium* may be the species really found. 2. *Epilobium tetragonum* is recorded as "so attractive with its long flower-stems, of a rich rose-colour, constituting a very showy wild flower"! The writer very evidently intends some other plant, if his description is correct; for *E. tetragonum*, both in the type-form and in the variety *obscurum*, is a very weedy, small-flowered, inconspicuous sort of plant. I cannot guess at the plant really found, if it was not the showy Rosebay Willow-herb (*E. angustifolium*) of gardens, and of rocky sub-alpine districts. 3. *Allium Ampeloprasum* is described as "carpeting the woods. . . . really pretty in its delicate white flowers, whilst assailing the nose fearfully," when clearly the too common Ramson or Ramp is intended. The puzzle here is how the familiar *A. ursinum* got called by the name of the Leek of South and Central Europe: a species rarely found in England, and very doubtfully indigenous where it does occur. 4. *Drosera intermedia*, written of as observed about the "lower ridges of Cader," is a somewhat singular discovery, if the name be the correct one. I greatly doubt it, and for this reason,—*D. intermedia* is a species of restricted vertical range, hitherto found only below 100 yards in elevation, upon the sandy heaths and peat mosses of our island, and chiefly upon its eastern side. I am inclined to accept a *long-leaved* Sundew as having been observed; but in all probability it was *D. anglica*, which, when dwarfed in size from elevation of site, is in physiognomy very similar to *intermedia*. In such a condition the bowed shank of the flowering-stem, springing laterally from the rosette of leaves, would alone readily distinguish between them. 5. *Asplenium septentrionale* under the precipices of Cader in such plenty as to be obtainable by the "basketful"! There is a much greater probability of this fern having been seen—if it was seen and not recorded on hearsay evidence—than is the case with the four previously questioned species; still, in face of the other evident errors in

the paper I am referring to, one cannot help doubting. I will say nothing as to my own personal knowledge of the mountain in question; but it seems somewhat curious that the Rev. A. Ley, an indefatigable and experienced botanist, accustomed to climbing, should never have seen it when exploring the district, prior to furnishing a fairly exhaustive list of Merioneth plants for the Bot. Loc. Record Club. This gentleman, writing to me in regard to this supposed discovery, with leave to quote his opinion, remarks:—"Of course one would hesitate to say it did not *exist* on the mountain"; but if so, it must be in very small quantity, and difficult to find." The mountain has also been well worked by others, and yet this fern still stands unrecorded for Merioneth in "Topographical Botany." 6. *Saxifraga nivalis* not far from the summit of the mountain, is far more likely to have been one of those dwarfed examples of *Saxifraga stellaris*, with the branches of the cyme bearing the flowers *suppressed* or aborted (giving an appearance as of blooms clustered in a *capitulum* or head), which are so often mistaken for *nivalis*. This opinion is strengthened by the fact of *stellaris* never being mentioned at all as a Cader species; whereas it is on all parts of the Cader, at the proper season, "singularly abundant and of all sizes and developments." I quote from Mr. Ley, who searched diligently, he writes me, for *nivalis* "in the two most likely spots, viz. the precipices of Llyn Can and of Llyn-y-Cader." Lastly, *Linaria Cymbalaria*,—a South European species, nowhere *indigenous*, although freely naturalized in England,—is written of as "growing where we could not doubt it was truly wild." This is an error, having its origin in want of knowledge as to distribution of European plants. I trust the author of the article I have animadverted upon will pardon my remarks, since prompted only by a profound desire for strict accuracy, even in what some may regard as "little" matters, and by no wish to display critical acumen for its own sake. I should be very glad to be proved in error as to my surmises with regard to the *Asplenium* and the *Drosera*, for both of these records, if correct, are valuable and interesting, as adding to our knowledge of the distribution of the former, and of the climatal conditions under which the latter species can survive. ADDITIONAL NOTE:—Mr. John Colebrook records of *Gentiana acaulis* (SCIENCE-GOSSIP, p. 210), that the species is one most unlikely, from its geographical range, to occur as an indigenous plant in any part of Great Britain. If it were really that species which Mr. Colebrook saw in 1862 (and not *G. amarella*), then, where he saw it, it must most certainly have been a garden-escape. Mr. Colebrook quotes from Babington's "Manual" a reference to *Cotoneaster* on Great Orme Head (where a single bush of it still exists in an almost inaccessible situation on the side overlooking the town of Llandudno), but omits to say how Mr. Babington dismisses *G. acaulis* on p. 236 of his

“Manual” (7th edit.) with the remark “not a native.” In our island the Gentian is a garden or rockery plant only, and has its headquarters in the Pyrenees, Alps, and Apennines. I have received from Mr. Pearce, who had it from the lame guide, Pugh, of Dolgelly, a specimen of *Asplenium septentrionale*. That record, therefore, I now no longer see any reason for doubting. In July last, Mr. James Backhouse, of York, found *Woodsia ilvensis* on the Cader, —another rare fern, and one hitherto unrecorded. The grand precipices under “the saddle” of this mountain would, from these notable discoveries, seem to be as yet imperfectly explored, notwithstanding the Rev. Mr. Ley’s assiduous investigations in past years. I also note that *Hypericum montanum* was amongst the eighty species of wild flowers observed by Mr. Robert Holland in “a Welsh Meadow” near Dolgelly in June.—*F. Arnold Lees, M.R.C.S., L.R.C.P., Lond.*

CORNISH PLANTS.—In the course of my walks round Newquay I have found the following plants, many rare, I believe :—On Pentire Head, a barren tract, carpeted with *Erodium maritimum* and tiny *Glechoma hederacea*, another space with *Radiola millegrana*, *Cochlearia Grœnlandica*, and *Anagallis arvensis* (with unusually large flowers of every shade of salmon-pink). An equally large space was covered with pink and white *Erica cinerea*, *Scilla verna* in seed, and white *Geranium molle*, whilst the stone boundary-walls were hung with *Arenaria rubra* and *Erodium moschatum*, pink and white, with bright blue Alkanet and Borage. But the spot most attractive to botanists was a bog formed by a clear little trout-stream running through land red with iron-ore. In this charming spot I gathered *Drosera rotundifolia* with its lovely blossoms wide open, like alabaster cups mingling with the dainty lilac-tinted *Pinguicula Lusitanica* and rosy Sphagnum to form cushions fit for fairies, whilst by searching could be found *Drosera longifolia*, also in bloom, amidst quantities of the sweet-scented *Anagallis tenella*. The numerous seed-spikes of Bog-orchis, Buckbean, and Asphodel showed that it was not wanting in the earliest spring flowers. Hidden under the flowering sprays of the waxy *Erica tetralix* were masses of seedling *Osmunda regalis*. On my way down the stream I gathered *Bartsia viscosa* and *Neottia spiralis*. Under a hedge we gathered very fine *Scilla autumnalis*; on one spike I counted no less than 45 flowers over and coming out, every plant bearing on an average three such spikes of the rosy-purple flowers on slender pink-tinted scapes. I am still keeping the *Droseras* in a saucer of water, and feeding them every few days with tiny scraps of meat, over which they close greedily, and seem to thrive on it. In fact, I have seldom been in a spot more interesting to the botanist, and at the same time to the geologist, than this new and rather primitive bathing-place of Newquay, which is within reach of both Plymouth and Tintagel.—*M. Conybeare.*

GEOLOGY.

POST-TERTIARY ARCTIC FOSSILS.—At the British Association Meeting a paper was read by Dr. J. Gwyn Jeffreys, on “The Post-Tertiary Fossils procured in the late Arctic Expedition, with Notes on some of the Recent or Living Mollusca from the same Expedition.” The author remarked that the fossils were collected by Captain Fielden and Mr. Hart, the naturalists of the expedition, and by Lieutenant Egerton and Dr. Moss, two of the officers of Her Majesty’s ship *Alert*, in very high latitudes, namely, between 82° and 83° N. The highest point reached by the expedition was 83° 20′ 26″. These fossils were found in mud-banks or raised sea-beds, at heights varying from the level of the sea to 400 feet above it. They consisted of eighteen species of mollusca, one of hydrozoa, one of foraminifera, and one of marine plants; being altogether twenty-one species, all of which now live in the Arctic seas. The author then gave a list of the species, and showed their distribution in a recent or living as well as a fossil state; and he added some remarks as to the recent mollusca procured in the expedition, and as to the apparent abundance of marine animals in the “Palæocrystic Sea” of Sir George Nares. Professor T. R. Jones remarked on the single species of foraminifera found in the expedition, and referred to the importance of these lowly-organized fossils in throwing light upon the physical condition in which they lived. Dr. Moss, of the Arctic Expedition, described the shells and driftwood found on a bank at the margin of the Palæocrystic Sea, and regarded them as strictly recent; the shells, indeed, living almost on the spot where they were found. Foraminifera were frequently found in bottom-soundings. Mr. De Rance gave an account of the sketches and specimens brought by Captain Fielden from the Arctic regions. The valleys had been partly filled up by a deposit closely resembling the boulder clay of Lancashire. Shells were exceedingly rare in the Arctic clay. Sands and gravels resembling the middle drifts of Lancashire were not observed by the expedition. Major Woodall mentioned that on the shores of Norway and Shetland anchorage could only be found where deposits of clay occurred near the mouth of the valley. These clays were generally unfossiliferous. Dr. Jeffreys, in reply, stated that the single species of foraminifera mentioned by him ranged throughout the North Atlantic, and also occurred in the Mediterranean. He believed there was no necessary difference in appearance between the recent and fossil shells. If on a raised beach they found shells not now living in the neighbouring seas, they ranked them as fossils.

INTERESTING DISCOVERY OF A MOA SKELETON.—The discovery of the skeleton of a moa is reported to have taken place on Mr. M’Tier’s farm in the Awitu district, New Zealand. Mr. M’Tier had some

men employed draining a swamp on his farm, and they found, at the depth of four feet from the surface, a number of large bones, which they supposed at first to be those of a bullock. Mr. M'Tier examined the bones, and identified them as being those of a moa. A careful search was then made for the remainder of the skeleton, and the whole of the bones, with the exception of one or two small ones, have been found. The skeleton has been sent to the Museum at Auckland; and it will probably prove to be the most complete skeleton of this extinct bird that has ever been found in the North Island.

THE GEOLOGY OF WATER-SUPPLY.—An interesting experiment is being made by the Stafford Town Council, in order to obtain a good water-supply for the town. By boring to a depth of about 600 feet by means of the Diamond Rock-boring process they hope to penetrate the water-bearing rocks of the New Red Sandstone formation, which exist widely in Staffordshire, and in many places lie at an elevated level. A depth of 300 feet has already been bored. It was asserted by many eminent geologists that extensive beds of rock salt existed in the variegated marls above the bunter rocks. This opinion has been found to be correct, for a bed of rock salt 40 feet in thickness has been perforated, as well as various smaller veins; but the engineers find that the brine can be effectually "tubbed out" by means of iron lining tubes. A considerable length of time must necessarily elapse before the water-bearing rocks are entered.

GEOLOGICAL PHENOMENON IN THE SAVOY ALPS.—This crumbling down of mountains, as noticed in the September number of SCIENCE-GOSSIP, has gone on from unknown time. The mass of matter now falling in Tarentaise is said to have formed a "mound 2,000 ft. in diameter at the bottom, and 600 feet wide at the top." In the Tyrolean Alps such masses of fallen rock extend to great distances, and are of great thickness. Rocks of varied sorts and of varied size are found in them, the whole mass conglomerated together by a silicious-calcareous natural cement, due to the constant percolation of water holding silica and calcium in solution. As a rule the lower portions of mountains are formed from material that has rolled down from the top. Railways in the Alpine districts are constructed on this *débris*: great skill and constant care are required in their construction, and in preventing the whole hillside from slipping down. The vibration of the traffic loosens the surface, while the natural erosion of the foundation by subterranean water slowly but surely undermines the whole. To counteract this natural tendency, great works are now going on at the French end of the Mont Cenis tunnel. The preventive works on the Brenner pass, for the purpose of stopping slips and intercepting avalanches of rock, are frequent and of great magnitude. The causes of these avalanches and slips are due to natural agents always

at work. Both happen most frequently in wet seasons; water percolates the crevices very common in calcareous rocks; the adhesion is destroyed, and the masses gravitate, breaking up in their fall. As rain falls on the bare rock-face of the mountain-height, it runs down below the *débris*, resting on the lower slopes. This subterranean water-force even eats away the bottom of the *débris*, which inevitably sinks into the undulation beneath it, or slips down the face of the mountain at some time or other. We do not require any "folding or crumpling of formerly horizontal strata" to cause these local dislocations: they are unavoidable under the laws of nature, and we must recollect that the formation of mountains by crumpling and folding is only an unfounded theory of man. Our mountain tunnels might be very dangerous if the rocks were in the habit of folding up.—*H. P. Malet.*

[Mr. Malet forgets that the entire region of the Alps is folded nevertheless.—ED. S.-G.]

"CAVE-HUNTING."—We have received a copy of Mr. Rooke Pennington's "Notes on the Barrows and Bone Caves of Derbyshire," published by Macmillan. Mr. Pennington is well known as an ardent cave-explorer, and those who have seen the Museum at Castleton, containing the results of his labours, will acknowledge that large contributions to our geological knowledge may be made from "Cave-hunting." This book also contains a well-written account of a descent into Eldon Hole—one of the wonders of the Peak—made by the author some time ago. Mr. Pennington writes like one who has a story to tell, and he tells his well and unaffectedly.

RECENT WORKS ON PHYSICAL GEOGRAPHY.—There are few modern sciences which have made more rapid progress in breadth and clearness of views than that of Physical Geography. This is due to the auxiliary aid received from other sciences, and especially to the fact that it can only thoroughly be understood from a geological point of view. We have received a copy of "Elementary Lessons in Physical Geography," by Professor Geikie, F.R.S. (London: Macmillan), uniform with the series on Botany by Hooker, on Chemistry by Roscoe, and on Physiology by Huxley. An elementary work on Physical Geography, written from a geologist's standpoint, was much needed, and we therefore welcome this work. The reputation of the author is sufficient recommendation for its scientific value, and the idlest of literary triflers will have nothing to complain of on the score of interest. "Physiography and Physical Geography" is the title of another little manual by the Rev. Dr. Alexander Mackay (Edinburgh and London: W. Blackwood & Sons). It is compiled with special reference to the instructions recently issued by the Science and Art Department, by whom the needless name of "Physiography" has been adopted. Dr. Mackay's little manual is very

full and effective, and students intending examination by the South Kensington system will find it exceedingly useful. It is not *au courant*, however, with many of the leading views, and some old ones are re-narrated with charming simplicity. Thus, at p. 112, we have more of theology than ethnology, where the author adopts the *literal* account of the dispersal of nations after the Deluge, and the part which the sons of Noah took in the several migrations of the human race. A new edition (the seventh) of the late Mrs. Somerville's "Physical Geography," well and ably revised, and brought up to the knowledge of the present day, is a more acceptable recent publication by John Murray, Albemarle-street. Those who never studied Mrs. Somerville's most charming book will now have the opportunity of doing so with even greater advantage than when that important work was first published.

NOTES AND QUERIES.

BEEES IN A SHOWER.—It has been asserted that bees are never caught in a sudden shower, unless it be at a very great distance from the hive; that by "instinct," or by due attention to the signs of the weather they know when to return to shelter. This statement is endorsed by Mr. John Hunter in his excellent "Manual of Bee-keeping." On the 5th July I witnessed a curious exception to this rule, which I nevertheless believe to hold good in almost every instance. It was a mile or so from St. Ives, in Huntingdonshire, the sun shining brightly at the time, but an innocent-looking cloud had crept up from the north. It thus cast no shadow, and its presence was unnoticed until asserted by the sudden pattering down of large drops of rain. I ran to the nearest hedge, and from its friendly shelter observed a stream of bees, rising apparently from the field of white clover, passing over the fence, and making a regular "bee-line" for a farm half a mile away. Each insect was about a yard from those on either side, and the same distance from those in front and rear. The stampede continued for two or three minutes, during which time some hundreds of bees must have passed over the hedge. A few wheeled round above my head, but generally they rose a little at the fence, and continued their course. The rain ceased, and the number of homeward-bound insects immediately decreased, while those which could not in the time have reached home began to return, looking, one might almost fancy, ashamed of their false alarm. A few still made for home, so that for a minute or two there were lines going in each direction; but the sun again shone as brightly as ever, and the insects went skimming here, there, and everywhere in their usual manner. This occurrence seems to show that it is not through "instinct" that the bee seeks its home on the approach of rain, but through close observation. In this particular case it was at fault, owing to the rather unusual circumstance of the rain beginning to fall in the midst of bright sunshine. Another point which struck me at the time was that the bees seemed to rise from the clover, a plant, the flowers of which are robbed and fertilized by the humble bee, and there were many of these insects so employed on this occasion. The clover was poor and the flowers were small, so that it is perhaps possible for the bees to

have profitably expended their time thereon, but I failed to verify this by actual observation.—*W. Henry Penning.*

RATS AND ROSES.—I reside in a house which once formed part of a great abbey, and is now included in the precincts or close of a renowned cathedral. Its venerable walls are clothed, and greatly adorned, by a luxuriant growth of clustering roses, of ivy, and of white jasmine and clematis, the two latter now in charming perfection, the admiration of all beholders. The clematis, especially, regales our eyes by its wealth of blossoms immediately beneath the sill of our drawing-room window, on the first floor of the house, some fifteen feet above the level of the garden below. That birds, bees, and butterflies should hover around the creepers, and share our enjoyment of their beauty, is quite according to the best precedents, and has our full acquiescence and approval. If a few earwigs extend their walks beyond the leafy shelter, we know how to pardon such indiscretions. But we are not superior to old-fashioned prejudices against mischievous vermin of a much more formidable kind; and you may imagine our surprise, when quaffing our tea yesterday evening, to have ocular proof that rats avail themselves of our climbing plants for the purpose of invading our upper decks, and that they use them as sailors use the shrouds of their ships; in short, that the boughs and tendrils of our creepers are converted into rat-lines! The tranquillity of tea-time might well be interrupted when a whiskered Rodent appeared at the window, tried it with his clever paws, and, finding it closed, retired with a discomfited air! You and your readers will feel for us in our serious dilemma, threatened, perhaps, with the fate of Bishop Hatta in the Mause-thurm. What is to be done? We cannot trice up boarding-nettings! Must we really cut away our charming clematis? Can we by no sacrifice less harrowing to our best affections place ourselves beyond the reach of renewed attacks by unscrupulous and crafty invaders?—*W. E. D.*

PLANTS FOR REPTILE VIVARIA.—Will some correspondent oblige me with a few hints as to the most likely plants to succeed in a reptile vivarium? Our case is large and oblong, as for ferns, with free ventilation by means of a sheet of perforated zinc at top. Lizards, salamanders, blindworm, and frogs, are the present occupants, and appear to do very well; but the plants are mostly a failure. Ferns wither up and die off,—I think because the atmosphere is not sufficiently humid; and I doubt if ferns and reptiles would, under any circumstances, thrive under similar artificial conditions. But there are surely some plants of moderate size which might be cultivated in the case with success? Any practical suggestion on this point, as also information on the best food for reptilia *not* hibernating during the winter months, would be thankfully received.—*W. H. Groser, B. Sc.*

IS THE LEMMING FOUND IN ENGLAND?—If the holes seen in the Lake district by your correspondent (*SCIENCE-GOSSIP*, p. 189) were made by the Lemming, it would be a most interesting discovery. But it is more likely that they would be the work of the field vole (*Arvicola agrestis*). Although usually frequenting lower grounds than that mentioned ("2,500 feet"), this destructive little animal sometimes does a great amount of damage on the higher grounds, as, for instance, in the upper parts of Teviotdale in the spring of 1876. Perhaps some one living in the district may be able to say what animal made the holes.—*A. B., Kelso.*

THE GORILLA AT THE WESTMINSTER AQUARIUM.—Possibly a few brief notes on the Gorilla now

exhibiting at the Royal Aquarium may interest some of the readers of SCIENCE-GOSSIP, as it is believed to be the only living specimen ever shown in Europe as such, though it is stated that an example once figured in an English travelling menagerie under the title of *Chimpanzee*, being duly appreciated, like many of the genus *Homo*, only after its death. Soon after taking a front seat at one of Mr. Pongo's public receptions he was carried in by an attendant and placed in a chair, where, with his obese body and short tucked-up legs, he looked not unlike a Hindoo idol, contrasting with the lighter form of a chimpanzee brought in at the same time. One could not help regretting that an orang outang was not also present to complete a trio of anthropoid apes. The animals are exhibited on an earth-covered platform surrounded with a light framework of iron, the bars, sufficiently wide apart to allow the attendants to pass in and out with ease; but the gorilla and his companion seemed little inclined to go beyond the boundary. Ropes dangled from the ceiling, and a strong ladder was reared against the bars, at an angle of about 45°, up which the gorilla would occasionally go with a slow and careful movement, always descending by grasping the two sides of the ladder and sliding down head foremost. This would appear to be an acquired movement, as a tree could hardly be descended in such fashion. He frequently seized one of the hanging ropes and gave himself a slight swing, but never to clear the ground, while the chimpanzee would often climb nimbly up a rope to a considerable height and pass from one rope to another. The difference in the activity of the two animals was marked. In one of his restless excursions aloft, the chimpanzee dislodged a heavy brass gas sconce which narrowly escaped one of the spectators in its fall. The gorilla seems incapable of advancing on the hinder feet alone, always assisting himself along by the knuckles of his fore limbs, but the arms are so much longer than the legs that the back is not nearly so horizontal as it would be in a man progressing in a similar manner. He would shuffle along in this way at a pretty good pace, sometimes dodging his keeper round a chair for some while before being caught. His dog Flock seemed to suit him better as a playmate than the chimpanzee, and an amusing struggle took place when a piece of rag was thrown down and carried off by the dog, clumsily pursued by the gorilla. When the latter grasped it, a tug of war ensued, the dog of course holding on by its teeth but Pongo using his hands. Flock could drag his opponent along on his three limbs, but when the gorilla lay down, his dead weight proved victorious. Once or twice the attendant placed his own hat on Pongo's head, of course bonneting him completely, when the latter would gravely remove it, and placing it in front of him, commence drumming on the crown with his fists with a vigour that threatened destruction to the article if it were not snatched away quickly. Sometimes, apparently when pleased, Pongo claps his hands so naturally that one almost expects to hear him cry "encore!" A mug of some drink was brought to the gorilla and a bottle to the chimpanzee, and both creatures held the vessels to their mouths, but appeared to imbibe the contents with some difficulty. Soon after his introduction the attendant set Pongo on a chair among the audience, whence he quickly escaped and climbing along the backs of the seats caused some commotion among the ladies. When, however, his peaceable nature was recognized, he became a general favourite, and one young lady went out and procured him some grapes, but he seemed to care little about them, though she placed them in his mouth, an orange being more to his taste.

He evidently possesses considerable strength, as, though his height cannot much exceed three feet, he repeatedly turned over the heavy ladder with ease. His weight was said to be about 42 pounds, which I should fancy an under-statement. Though seemingly mild and docile, the attendant said he would not bear correction, and that he had been known to snap; at present, however, he appears to be a very gentle example of the terrible gorilla, reputed to be untamable and ferocious in the extreme. How it may be if he lives to attain his full stature and strength is another matter. These disjointed notes of what was observed at one of Pongo's receptions may amuse some who have not been able to have a personal interview with one of the greatest zoological rarities of the day. He is the sole representative of his race in Europe, and it may be a lifetime before we see another.—*G. Guyon.*

ARSENICATED WALL-PAPER.—I should be very much obliged if you would tell me whether you know of any solution that, on being applied to a wall-paper containing arsenic, would render it harmless. I have just taken a house in which the hall, corridors, and passages are all papered with a green marble-paper containing arsenic, and as I have a large family of young children, I am anxious to know whether any harm is likely to result. No bed-rooms or sitting-rooms are papered with the paper, or in fact any green paper at all.—*Gerion.*

QUERY AS TO WATERCRESS.—In the "Génie du Christianisme," by Chateaubriand, I find the following passage:—"On nous a montré au bord de l'Yar, petite rivière du comté de Suffolk, en Angleterre, une espèce de cresson fort curieux: il change de place, et s'avance comme par bonds et par sauts. Il porte plusieurs chevelus dans ses cimes; lorsque ceux qui se trouvent à l'une des extrémités de la masse sont assez longs pour atteindre au fond de l'eau, ils y prennent racine. Tirés par l'action de la plante qui s'abaisse sur son nouveau pied, les griffes du côté opposé lâchent prise, et la cressonnière, tournant sur son pivot, se déplace de toute la longueur de son banc. Le lendemain on cherche la plante dans l'endroit où on l'a laissée la veille, et on l'aperçoit plus haut ou plus bas sur les ours de l'onde," &c. &c. Does this refer to the common watercress? Is it a correct description of its habits? I have never noticed these strange motions myself nor ever heard them referred to by any botanist. The plant, like all creepers, throws out adventitious roots which become new centres of life; the older portions of the plant gradually die, and thus the plant moves slowly from its original seat. But surely the graphic statement that it "s'avance comme par bonds et par sauts" is somewhat overdrawn. Perhaps some Suffolk correspondent can throw a little light on this passage.—*J. Hefworth.*

WHITE BIRDS.—In 1871, while on a visit to Norton, a village eight miles from Lincoln, I noticed a perfectly snowy-white bird fly past and alight on the ground before me: it was in size and shape like a sparrow; it hopped and flew on, and I traced it for some time, till it flew into a barn-yard, and did not reappear. I never saw it again during my three weeks' sojourn at the Rectory, but I inquired some months after, when revisiting Norton, if such a bird was known to be about the park and Rectory grounds adjoining, when I was told that there had been a nest of them; and from the schoolmaster I have gained the perfect information, as detailed to me, but which I could not remember with sufficient accuracy without reference to the first authority.—*C. M. V.*

SKATE AND DOG FISH.—I have no doubt but that your correspondent "N. P." will be able to obtain all the information he seeks on the above subjects from the courteous manager of the Brighton Aquarium, although I certainly do not remember having ever seen any published record of the number of eggs produced by the skate. The dog fish produces its young alive, and they are often seen swimming with the yolk-bag, or case, attached to them: so says an American authority on the subject, the same writer who states that the eggs of skates are found to be of different sizes and various degrees of development in the ovary; therefore he is of opinion that it is probable several years are required for their maturity. The young of the smooth ray found on the northern coast of America are produced twice a year—in spring and autumn.—*Helen E. Watney.*

DOUBLE ORANGE.—Twice lately, opening an orange, I found in its centre another orange, perfectly formed, only pipless and rindless—two whorls of carpels combining to form one fruit, the inner consolidated into a central orange and the outer whorl growing over it.—*C. M. V.*

THE SQUIRREL.—A short time ago I saw a squirrel creeping from spray to spray in a cherry-tree, which was in full bloom. Curious to know his business, I got as near as possible without being observed by him, when I discovered it was feeding on the ovary and dropping the petals to the ground, which was strewn with hundreds of petals. The sepals, petals, and stamens on some boughs were entirely stripped of flowers in a few seconds.—*John Onions, Dymock.*

DEVELOPMENT OF THE NEWT.—Your correspondent H. E. Forrest, in the April number of your journal, makes some statements which seem to me to deserve attention, respecting the early stages of development of the common newt. Every observant aquarium naturalist is well aware that the ova of the newt are not always enfolded by leaves, but this is an unnatural method, and is resorted to only where proper—i.e. *pliable*—leaves are not accessible. Whether they ever come to maturity under these exceptional circumstances is an interesting point to decide. H. E. F. states that they do; but in describing their development he makes some statements which cast a doubt upon the accuracy of his observations. "By the 24th of April," he says, "branchiate gills had disappeared, and five weeks later the front limbs appeared." Now the branchiæ of the newt persist long after the creature (though not full grown) is fully developed, while the gills of the frog-tadpole are absorbed before the limbs appear. If they were newt-tadpoles the rapid absorption of the branchiæ was an unnatural circumstance, and if they were frog-tadpoles, as the rapid absorption would seem to show, the primary development of the thoracic limbs is contrary to the usual metamorphosis of ranidæ. Taken either way, it will be seen H. E. F.'s statements do not agree with well-established observations.—*Edward E. Prince.*

SPARROW-HAWK AND CANARY.—A short time since two ladies were seated in the house of Mr. Burton, Habergham, near Padliham, Lancashire, when they were startled by the sudden smashing of one of the window-panes (14 in. by 10 in.) by a female sparrow-hawk, in endeavouring to obtain a canary which was in a cage between the curtains, three feet from the window. It was stunned by the concussion, and fell to the bottom of the window, where it was caught, not before making several attempts to bite its captor, Mr. D. Mitchell, who has stuffed and mounted it for Mr. Burton.—*W. Wilcox.*

NOTICES TO CORRESPONDENTS.

TO CORRESPONDENTS AND EXCHANGERS.—As we now publish SCIENCE-GOSSIP at least a week earlier than heretofore, we cannot possibly insert in the following number any communications which reach us later than the 8th of the previous month.

W. RATCLIFFE.—Slide No. 1062 contains: *Drafnarnaldia glomerata*; 1068, *Protococcus nivalis*; and 1101, *Hemiatococcus vulgaris*. The only standard work on the "British Fresh Water Algae," is Hassell's, published in 1845; on Desmids, "Ralf's British Desmidiæ," 1848. Both are now rare and expensive. "Bissex," we should imagine, is a mistake.

WILL the lady or gentleman who sent me *Mytilus edulis* for "Scotch Anodous" hereby accept my thanks, as I have unfortunately mislaid the address.—G. S. T.

W. E. LEGGE.—The larger of your exceedingly well-painted egg is that of the Lapwing or Green Plover (*Vanellus cristatus*). The smaller is that of the Goldfinch (*Carduelis elegans*).

W. H. HARRIS.—Thanks for the well-cut slides of Coal Plants. There is no doubt, we think, that the tissue is that of *Sigillaria*. See Prof. Williamson's paper, published in Transactions of the Royal Society, on Carboniferous Plants.

W. A. F.—The name on your slide (Spicules of *Gorgonia flagellum*) is correct.

W. HOWCHIN.—Your fossils are as follow:—No. 1. *Producta semireticulata*. 2. *Spirifer rotundata*. 3. *Spirifer striata*. 4. (Absent.) 5. A young specimen of *Orthis*, perhaps *respinata*. Always send entire specimens of fossils to be named, if possible. We cannot undertake to correctly name fragments.

H. M. D.—No. 1 specimen is the Fir Club-Moss (*Lycopodium selago*). No. 2 is the common Club-Moss (*Lycopodium clavatum*).

J. WOODGATE.—Many thanks for *Actinocarpus Damonium*.

F. W. B. N.—Many thanks for your valuable hints.

J. H.—You will find no difficulty in getting your fossils named at the Edinburgh Museum, where one of our best palæontologists is engaged.

J. A. FLOYD.—Get Nicholson's "Manual of Palæontology," price 15s., published by W. Blackwood & Sons.

CONUS.—Woodward's "Recent and Fossil Shells" is one of the best books we have on the subject. For British Seas, Gwyn Jeffrey's "British Conchology," in five volumes. Chenu's "Manuel de Conchyliologie" is one of the best in Europe. It is in French, but the woodcuts are the most exquisite we have ever seen. Damon, of Weymouth, is one of our chief dealers in Conchology.

G. V. GREEN (Ashby-de-la-Zouch).—Your fungi ought to have been wrapped up separately in oiled silk. They had deliquesced in the tin box, and reached us in a state of semi-catsup—not an uncommon condition!

MRS. E. C. R. (Somerton).—All that we have received from you is a part of a case marked, "Found at Taunton, without contents."

R. G. C.—Get Newman's "Butterflies and Moths," published by Hardwicke & Bogue, 192, Piccadilly, London. It contains figures of every species, and full descriptions. *Vulcanite* is the best material out of which to make pipes and valves for the aquarium.

E. HOWELL.—The stone you sent us is not "Meteoric," but the half of a nodule of iron pyrites (Ferric sulphide). These nodules are common in the Lower Chalk, and are often found on the surface, having been removed by denudation.

Z. Y. X.—The bivalve shell enclosed was *Cyclas corneus* (young specimen). The other specimen was a species of *Pupa*.

A. M. G.—From your description and sketch we should imagine the "curious cells" you speak of are those of one of the Mason Bees (*Osmia*).

D. J. STUART.—The eggs in the caterpillar are those of a species of *Ichneumon*. They have developed since you sent the specimens. Most caterpillars are liable to be the victims of the larvæ of certain ichneumons.

A. HARKEH.—Your shells are—1, *Pholas candida*; 2, *Pholas crispata*; and 3, *Artemis exoleta*.

J. HORNER.—From your description we are inclined to believe that the "jelly-like deposits scattered" in the yard are *Nostoc*, one of the algae, perhaps *Nostoc commune*, which frequently makes its appearance thus. They certainly are not a "descent of Sponge gemmules."

W. E. HAMBOROUGH.—We are afraid we cannot help you in identifying the Moth from the imperfect description of the caterpillar. There will be no help but to wait till the moth emerges.

C. WILD.—The general description of the caterpillar answers in many respects to that of the Elephant Hawk Moth (*Cherocampa elpenor*).

G. B. (Leominster).—Your specimen of fungus was remarkably "high" when it reached us, and no wonder, for it was an early stage in the development of the fearfully loathsome *Phallus impudicus*.

MISS E. M. B. M.—Your fungus is the rather rare *Hysterangium Thwaitesii*. See Cooke's "Handbook of British Fungi," vol. 1, page 358.

W. J. HORN.—The stem of the common white lily, terminating in a bulb, is one of the most noticeable of teratological features we have hitherto come across. It would appear as if the floral parts had become metamorphosed into the ordinary fleshy bracts of a bulb.

F. W. FOSTER.—The "healing-up" in old or unworked coal-mines is simply the effect of the rising up of the lower strata, and the depression of the upper, until both meet and fill up the places excavated. This phenomenon is well known under the name of "creep," and you will find an account of it in any of our larger and fuller Manuals of Geology, including Lyell's. The modifications of figures engraved or scratched on the surface of rock-salt is a surface change alone. The interior of the salt mass is not affected.

EXCHANGES.

SLIDE of Amphibian Blood Discs for other objects.—J. B. 36, Windsor-terrace, Glasgow.

FORAMINIFERA or Zoophytes, mounted or unmounted, wanted in exchange for good Slides of American material of various kinds.—R. Hitchcock, 8, Beekman-place, New York City, U.S.A.

POTAMOGETON mucronatus, Schud. (true), for Nos. 106, 511, 536, 546, 913, 997, 1035, 1121, 1200, 1312, 1622.—A. Bennett, 107, High-street, Croydon.

WANTED living specimens of *Helix pomatia*.—Address, J. E. Palmer, Lucan, Co. Dublin.

L. C.—ed.—Nos. 167, 432, 461, 852, 922b, 991, 1058, 1114, 1121, 1180, 1356b, 1548, 1589, 1654, 1665b, &c., for others. Send lists.—J. Harbord Lewis, 145, Windsor-street, Liverpool.

WANTED, Bell's Monograph of Fossil Crustacea, Part 1 (London Clay), in exchange for Sheppey Fossils, or cash.—W. H. Shrubsole, Sheerness-on-Sea.

WANTED Allman's "Fresh-water Polyzoa." State what required in exchange, to W. H. Beby, Outram-road, Addiscombe, Croydon.

SEVENTH LONDON CATALOGUE.—Nos. 54, 171, 632b, 861, 1280, 1341c, 1469b, for Nos. 4, 9, 15, 23, 25, 32, 37, 39, 77, 78, 106. Lists exchanged.—C. A. O., 19, Eardley-crescent, South Kensington.

For a few spines of Sea-urchin (violet) from St. Helier, send a stamped directed envelope to W. H. Gomm, Somerton, Somerset.

WANTED a 3-in. Microscope Objective in exchange for 1 1/2 or 1-in. ditto.—T. Workman, Belfast.

LONDON CATALOGUE, Nos. of Plants, 120, 144, 218, 268, 273, 295, 296, 297, 299, 352, 380, 458, 464, 475, 515, 543, 551, 589, 632, 671, 761, 815, 831, 858, 1040, 1205, 1317, 1501, 1598, 1657, for other plants.—Win. West, Chemist, Bradford. Send list.

Limnaea glutinosa, *Planorbis lineatus*, *Helix cartusiana*, &c., offered for *Vertigo alpestris*, *V. moulinsiana*, *V. substriata*, *V. pusilla*, *Helix hispida* var., *Albida*, *Limnaea involuta*, rare British marine or foreign shells, or small glass tubes.—Address, E. R. F., 82, Abbey-street, Faversham.

DUPLICATES.—*C. cardui*, *C. Edusa*, *V. Atalanta*, *V. polychloros*, *V. arctica*, *A. Galathea*, *P. gamma*, *M. stellatarum*, &c. Desiderata, *C. hyale*, *E. blaudina*, *E. Cassiope*, *C. davus*, *L. Sybilla*, *S. ligustri*, *S. ocellatus*, *S. convoluti*, *Ch. Elpenor*, and others.—R. T. Gibbons, 175, Albany-street, Regent-street, N.W.

UNMOUNTED spines of *Aphrodita aculeata*, *Flustra foliacea*, Scales of Lizard wanted. Good Slide of Diatoms, Injections, or Foraminifera.—W. H. Cheesman, Coolinge, Folkestone.

ONE Porcupine fish (*Diodon Heptrix*), one Parrot fish, and one Globe fish, all stuffed, and in good condition (from Jeddah). Micro-slides or a good 1/2 object-glass preferred.—Address, Dr. Partridge, Stroud, Gloucestershire.

I HAVE a large stock of Diatoms and Foraminifera, which I will gladly send to any reader on receipt of two stamps for each.—E. W. Wilton, 18, Lovel-grove, Leeds.

A LIBERAL exchange in American Land and Freshwater Shells (univalve or bivalve) to any one who will send me a few good examples of Scotch *Anodons* (unios not required).—G. Sheriff Tye, 62, Villa-road, Handsworth, near Birmingham.

A FEW rare British and Foreign Birds' Eggs for others not in collection.—S. T. T. Reed, Ryhope, Sunderland.

WANTED rare Ticks (ixodes) Fleas, *Animal* Parasites and Acari, in exchange for good Slides of similar objects, or others of more general interest.—H. E. Freeman, 48, Woodstock-road, Finsbury-park, N.

Blasmus compressus, Panz, *Dianthus prolifer*, and *Lotus diffusus*, offered for *Ligusticum scoticum*, *Galium anglicum*, and *Poa bulbosa*.—G. C. Druce, Northampton.

"FLUSTRA FOLIACEA."—Spines of "Echinus" and Teeth from Shark, in exchange for Fossils, or other specimens of Zoology, &c.—J. A. Floyd, Mission House, Alcester, Warwick.

ONE hundred or more—according to arrangement—of slides, illustrative of the micro-botany, Polyzoa, Foraminifera, Entomostraca, and other Microzoa of the Carboniferous era, for the *Micrographical Dictionary*, in parts or vol.—G. R. Vine, Attercliffe, Sheffield.

A VERY rare collection of British Land and Freshwater Shells for disposal (exchange or otherwise). Suitable for museum or private collection; many duplicates and rarities.—A. Knowles, S. W. B., Tobacconist, Swinegate, Halifax, Yorks.

I HAVE a quantity of Fossils from Oolite and Coral Crag, some of them labelled. Will exchange for good Micro-slides.—Charles Wild, Eaton, Norwich.

HELIX CAPARATA, Virgata, Rufescens, Arbustorum, Bulimus Acutus, Clausilia, Laminata, Limnea Palustris, also various Anodonta and Unios, in exchange for other shells. Send lists to J. Hagger, Repton, Burton-on-Trent.

OFFERED *Chara fragifera*, new to Britain, and *C. crinita*, for either Nos. 1669, 1670, 1671, 1672, and a-b, 1673, and a-b, 1674, 1678, 1679, London Catalogue, 7th ed.—W. Curzon, Pembroke Cottage, Newlyn Cliff, Penzance.

A FEW *L. involuta* and other good shells for exchange. Desiderata numerous.—Henry Laver, F.L.S., Trinity-street, Colchester.

I HAVE eggs of Guillemot, Redstart, Lapwing, Ring Ousel, Sand Marten, Tree Sparrow, Black-Headed Bunting, Kingdove, &c., for other good eggs. Send list. Unaccepted offers not answered.—Jas. Alf. Wheldon, South Parade, Northallerton.

LIVING specimens of *L. stagnalis*, *L. peregra*, *Planorbis cornuus*, *P. complanatus*, *P. vortex*, and *Bithinia tentaculata*, in exchange for shells or any objects of interest.—Mrs. S., Brentford End, Middlesex.

DUPLICATES:—*Rhamnii*, *Edusa*, *Cardamines*, *Galathea*, *Argera*, *Semele*, *Sibylla*, *Cardui*, *Atalanta*, *Polychloros*, *Paphia*, *Agalya*, *Adyffe*, *Quercus*, *Corydon*, *Tages*, *Sylvanus*, *Jacobae*, *Cyramidea*, *Sponsa*.—Desiderata:—*Machaon*, *Cyrtogis*, *Davus*, *C. album*, *W. album*, *Proni*, *Lucini*, *Artemis*, *Cinctia*, *Athalia*, *Argus*, *Actaeon*, *Panicus*, *Ocellatus*, *Tilla*, *Atropos*, the *Gesiade*, and many *Noctuae*, and *Geometrae*.—H. C. Dent, 20, Thurloe-square, London, S.W.

BOOKS, &c., RECEIVED.

"Half Hours in the Green Lanes:" a book for a country stroll. Fourth edition. By J. E. Taylor, F.L.S., &c. London: Hardwicke & Bogue.

"Potato Pests." By C. V. Riley, Ph.D. New York: Orange, Judd, & Co.

"The Locust or Grasshopper Plague." By C. V. Riley, Ph.D. Chicago: Rand, McNally, & Co.

"American Palaeozoic Fossils." By S. A. Millar. London: Trubner & Co.

"Monthly Microscopical Journal." September.

"Land and Water." "

"Law Times." "

"Potter's American Monthly." August.

"Scientific Zeitung." "

"Botanische Zeitung." "

"Feuille des Jeunes Naturalistes." September.

"Ben Brierley's Journal." "

&c. &c. &c.

COMMUNICATIONS HAVE BEEN RECEIVED UP TO THE 7TH, FROM:—F. K.—T. S.—W. B. G.—G. H. K.—D. F.—A. L.—H. P.—R. C.—R. H. N. B.—A. B.—A. H.—J. B.—M. C.—E. S.—T. B.—W. B.—F. J. A., jun.—J. P. G.—H. G.—J. E. F.—G. C.—F. M.—J. P.—C. M. B.—W. H. H.—F. W. F.—R. H.—W. E. D.—W. H. P.—T. B. W.—G. C.—H. M.—E. W. W.—J. H.—G. G.—J. W. S.—W. H. W.—W. H. G.—J. H. Z.—J. B. B.—L. T.—J. F.—W. E. H.—W. A. C.—H. P. M.—W. F. P.—J. T. E.—M. J. W.—W. B.—R. C. C.—A. J. F.—W. H. S.—H. E. W.—G. N.—C. H. G.—Prof. G.—H. B. R.—W. H. B.—H. M. D.—J. W.—C. A. O.—W. D. G.—E. J. H.—H. M. S.—F. R. S.—G. C. D.—R. J. S.—G. E. H. B.—W. E. G.—W. H. G.—R. T. L.—J. P. S.—T. J. W.—H. McA.—W. H. L.—F. W. E.—F. B.—C. W.—J. P.—R. A.—H. W. K.—L. W.—S. A.—Dr. P. Q. K.—G. T. B.—J. H.—F. W. B. E.—J. A. F.—G. C. D.—T. S. W.—T. W.—D.—H. R.—H. E. F.—T. T. R.—G. S. T.—R. M. G.—A. W.—A. J. E.—G. V. G.—E. W. W.—A. K.—J. F. P.—Dr. P.—J. G.—W. H. C.—C. J. H.—R. T. G.—W. E. T.—W. C.—W. A. F., &c., &c.



THE HARD PARTS OF ANIMALS.

By H. F. PARSONS, M.D.



THE words "Hard Parts" I use in their common acceptance, without regard to strict scientific homologies. Thus the satin-like skin of an infant is homologous with the scaly hide of the crocodile, but for our present purpose, the former may be classed

with soft, the latter with hard parts.

The uses of hard parts are numerous; the chief are:—

1st. To protect soft tissues and important organs: thus in many of the invertebrate animals, *e.g.* the Sea-urchin, Oyster, and Crab, the soft parts are entirely enclosed in a hard shell. Fishes and reptiles are protected by a scaly armour, more or less dense, sometimes, as in the Sturgeon and Crocodile, consisting of strong bony plates. In the Turtles, the expanded ribs and breast-bone blend with the horny skin to form a carapace or shell, in which the soft parts of the trunk are wholly enclosed. Even in the higher vertebrates, as ourselves, in whom the hard skeleton is entirely internal, we find the most important vital organs, those which have been called the tripod of life, the brain, heart, and lungs, placed within the bony cases of the skull and thorax. The extremities of the limbs which come in contact with the ground are protected with pads and hoofs.

2nd. To form a framework or skeleton for the support of the soft tissues. In vertebrates, the true skeleton is internal, in many invertebrates external. In sedentary compound animals, as corals, sponges, and polyzoa, the skeleton serves both to connect the different members of the community together, and to attach the whole compound organism to the rock or other substance on which it grows.

3rd. As levers or passive instruments of motion, the active agents being the muscles. Each muscle is, as a rule, attached at either end, usually by means of a tendon, to some portion of the hard skeleton; the

more fixed point of attachment, or the nearest to the trunk, being termed the "origin"; the more movable, or farthest, the "insertion." With few exceptions, the bones in our bodies form levers of the 3rd order; *i.e.*, the power—the muscle—is applied between the joint or fulcrum and the weight. Levers of this kind always act at a "mechanical disadvantage"; *i.e.*, a large power moving through a small space is required in order to raise a small weight through a large space. Nevertheless this form of lever is for the purposes of the animal economy the most useful that could be chosen, for the muscles contract with enormous force, but through a limited space (about $\frac{1}{3}$ of their length), and it is plainly more convenient for us to be able to move our limbs with a moderate degree of force rapidly over a large area, rather than with irresistible force through a small range. In vertebrate animals, the muscles lie external to the skeleton; in articulate animals, as the Crab, in which the skeleton is external, the muscles lie inside it. In the Crab, the tendons are bony, and so they are in birds, as any one will have observed who has watched the cook drawing the sinews out of a turkey's leg through the crack of the kitchen door.

4th. For the seizing and mastication of food. Those animals in which the food is ground small in a strong muscular stomach or gizzard have frequently hard plates or teeth to assist this process. In birds which live on hard seeds, this object is effected by swallowing small stones with the food, but some mollusks and some insects, as the Cockroach, have teeth inside the gizzard. About the last animal in which one would expect to meet with a muscular gizzard furnished with teeth, is the Flea, living, as it does, wholly on liquid food; but this active little creature is nevertheless so provided. We must infer that, to an animal of that size a blood-corpuscle is a tough morsel, requiring careful mastication before it can be digested. In most animals, however, the hard organs of mastication are placed in the neighbourhood of the mouth. The simplest form of teeth is the circle of hooklets which surrounds the mouth of some of the Entozoa, *e.g.*, the tape-worm. In the

Sea-urchin there are five pointed teeth arranged in a circle round the mouth, and attached above to a complicated mechanism of arches and levers, called "Aristotle's Lantern." The Leech has three horny serrated jaws, in shape like segments of a circular saw, and which produce the well-known three-rayed bite. In crustaceans and insects the masticatory organs are modified limbs; in insects they vary very much in shape according to the nature of the food, from the short, strong jaws of the Wasp to the long, slender proboscis of the Moth. The lower or headless mollusks have no teeth; in the higher mollusks, as the Snail, the dentition is very curious: there is a band, the lingual ribbon, which is set with innumerable minute teeth, and which, being drawn backwards and forwards over a cartilaginous pulley, rasps the food. In the Limpet, this ribbon is nearly twice the length of the entire body. As the teeth in front wear away, their place is supplied by fresh ones from behind. In vertebrates, we most frequently find the jaws set with teeth: in birds, however, the jaw-bones are covered with horn, and form a pointed beak; and this form is again met with in the Turtles, and even among mollusks, as in the Cuttle-fish. In fish and most reptiles the teeth are of a piece with the jaw-bones, and grow in a continuous succession: as one drops off, another comes forward to take its place. In crocodiles and mammals, the teeth are implanted in sockets in the jawbone. In mammalia, the shape, number, and arrangement of the teeth vary greatly, according to the nature of the food; so that from the teeth the habits of the animal to which they belong may be deduced. Carnivorous animals have strong canine teeth for holding their prey, and sharp-edged molars for mincing up the flesh. Herbivorous animals have, on the other hand, broad flat molars, adapted for grinding, and the harder and softer tissues of the tooth are so arranged that the unequal wear shall preserve a rough surface, like that of a millstone.

5th. As weapons of offence; *e.g.*, the sharp fin-spines of some fishes, as the Stickleback; the claws of the carnivora; the horns of the Rhinoceros and the ruminant animals; and the strongly-developed tusks or canine teeth of many others. In venomous snakes, certain of the teeth are channelled and furnished with poison-glands at the base. In many animals which fight for the possession of the females, these weapons of offence are only met with in the male sex, as the horns of the stag, and the tusks of the boar and male ape. This fact has furnished Mr. Darwin with a strong argument in favour of the modifying operation of "sexual selection."

6th. They form part of the mechanism of many special organs; as those of the senses and voice. As examples, I may quote the ossicles and otoliths of the ear, the bony plates met with in the eyes of birds, and still more strongly developed in those of the extinct Ichthyosaurus, the spongy bones of the nose, the hyoid bone which forms the fulcrum for the tongue,

the cartilages of the larynx or organ of voice, and the bony centre in the bullock's heart.

I propose briefly to run through the animal kingdom, and note the different materials and mechanisms which we find in the different classes.

The simplest animals of all, Rhizopoda, consist merely of homogeneous specks of animated jelly, of which every part is capable of performing all the functions of the animal. Some of them, as *Amœba*, have no hard parts at all; others form minute calcareous shells of the most varied and beautiful forms. The Foraminifera are so called from the fact that in one division of the order the shells are pierced by numerous minute holes for the extension of the radiating tentacles. In some Foraminifera the shell, however, is not perforated. In the perforated species the shells are often transparent, in the imperforate kinds they are of porcelain-like texture, or covered with grains of sand cemented together. The shells are sometimes single-chambered; more often many chambers, each rather larger than its predecessors, are clustered together, forming shells which frequently resemble a nautilus in shape. The great variety of forms, through apparently very complicated, are produced by variations in the shape, relative size, and relative position of the chambers.

The Polycistina possess shells of equal beauty with those of the Foraminifera, but differing from them in shape, and in being composed of silica instead of carbonate of lime.

Scarcely higher in the scale of animal life are the Sponges, the possession of which indeed the Botanists long disputed with the Zoologists. The Sponges consist merely of a framework covered with a soft animal jelly. The skeleton differs in nature in different classes of Sponges: in some, as the sponge of commerce and the little freshwater *Spongilla*, it is composed of horny fibres mixed with flinty needles or spicules; in others it is calcareous, as many of the fossil forms; while in a third class, including deep-sea forms, as the beautiful Venus's flower-basket (*Euplectella*), it is wholly composed of interlaced siliceous spicules. Spicules are a kind of hard structure met with in animals of other orders, differing widely from the Sponges: they are of very various forms; some needle-shaped, others like a toasting-fork, or thorny stick, or two wheels and an axle. Some are composed of carbonate of lime, others of silica. They are embedded in the soft flesh of the animal, and their use is commonly believed to be to give consistence and support to the soft tissues; but Mr. Wallace believes that they also serve to render the animal uneatable, and thus protect it from those creatures who would otherwise devour it.

Passing to the Cœlenterata or Polypes, we find very frequently in the Hydrozoa, of which *Sertularia pinnata*, the zoophyte commonly found on oysters, may be taken as an example, a horny branched polydipidom, or common skeleton, furnished with a number

of cup-shaped cavities, in which the Polypes of the united colony are lodged. In the Actinozoa we find hard structures of great variety and interest, and which have even borne an important part in the formation of our earth; I mean those commonly known as Corals. Corals are of two kinds, sclerobasic and sclerodermic. The difference between these I will try to explain. Let us take the common Sea-anemone as a type of the class, although it has no hard parts. We find that this animal has a cylindrical body with a disk-shaped foot below, by which it can adhere to the rocks and move from place to place, and above, a crown of tentacles, in the centre of which is the mouth. If we took a slice across the body, we should find in the interior a number of radiating partitions like those seen when a poppy-head is cut across. Now if we had a number of sea-anemones united together by the edges of the foot, so as to form a hollow cylinder, the inner surface of which was formed by the feet, and that the feet then secreted calcareous matter, so as to fill up the interior of this tube and convert it into a hard axis, we should get a coral like the red and black corals of which ornaments are made. If, however, the tissues of the body wall and of the radiating partitions were converted into hard stony tissue, we should get a coral of the other or sclerodermic class. Corals of the second class are sometimes simple, as many of the cup corals, sometimes compound, like the brain coral; corals of the first kind are always formed by compound animals, and they may be distinguished from the others by not showing any cup with radiating partitions.

In the subkingdom Annuloida, the Scolecida are soft-bodied animals, many of which inhabit the bodies of other animals. They are almost devoid of any hard parts, although one kind of tapeworm has, as I mentioned, a circle of hooks, and the wheel animalcules have a rather complicated set of horny jaws.

In the Echinodermata, on the other hand, the hard parts form a prominent and important feature. The sea-urchin, for instance, has a globular shell composed of hundreds of plates, which are arranged in ten double alternately-dissimilar rows, reaching nearly from pole to pole. At the apex of the shell are inserted small plates which are perforated for the eyes, genital apertures, and anus; at the base is a gap, closed in by membrane, in the centre of which is the mouth armed with five teeth worked by the apparatus of which I have before spoken. The plates of five of the double rows are perforated with numerous holes for the passage of the tubular feet. The surface is studded with tubercles, on which are jointed movable spines: in some urchins, as *Cidaris*, the spines are very large in proportion, and are attached by a ball-and-socket joint, which reminds one very strongly, in its arrangements of ligaments, of the human hip-joint. There are also "pedicellariæ," very singular little organs with three snapping jaws, the use of which is unknown. The shell of the Sea-urchin grows by addition to the edges of the plates;

hence it does not need to be cast off like that of the Lobster. The Star-fishes resemble the Sea-urchins, but their plates are less closely attached together and the spines are smaller. In the Sea-cucumbers there is no distinct shell, but the plates of the Sea-urchins are represented by scattered granules or spicules, often of remarkable shapes; thus in *Myriotrochus* they are wheel-shaped, in *Synapta* like anchors jointed to perforated plates. The shells of the Echinoderms are composed of carbonate of lime in the form of earthy granules, which in the spines are arranged in a beautiful radiating pattern with concentric zones like a section of an exogenous tree. In the fossil state, however, the hard tissues of the Echinoderms always break with an oblique crystalline fracture.

In the subkingdom Annulosa, the material usually made use of for the construction of the hard organs is *chitine*, a substance resembling horn, but devoid of any structure, and with little effect on polarized light. Chitine, although a nitrogenous substance, is one of the most indestructible of organic matters. Caustic alkalis, prolonged boiling, and acids unless concentrated, have no effect upon it; strong sulphuric acid dissolves it without charring. In the Annulosa the skeleton is external and jointed, and in all but the Annelids, as the Leech, provided with jointed limbs. The segmentation, as might be supposed, is more or less marked, in proportion to the hardness of the skeleton; thus in the soft bodies of the Leech and Spider it is much less conspicuous than in the hard armour of the Lobster: sometimes, however, as in the Crab, several segments are fused together into a shell or carapace.

The Hermit-crabs, which have a soft unprotected body, seek a protection by taking lodgings in the vacant shell of some mollusk. In one order of Annelids, the Tubicola, to which the *Serpula* belongs, the integument is soft and smooth, but has the power of secreting calcareous matter, which forms a fixed tube or sheath, into which the animal can retire for safety.

The Caddisworm, which is the larva of an insect allied to the Dragon-flies, forms for itself a somewhat similar but movable case by cementing together grains of sand, shells, and other small particles of matter.

In the larger Crustacea, as the Crab and Lobster, the shell is hardened with carbonate of lime. The shell has a radiating fibrous texture, with contour-markings indicating the layers of growth. As the shell of the Crustacea forms a complete rigid case, in order to allow of the growth of the animal, it has to be cast off from time to time, and a new one formed. Prior to the casting off of the old shell, a store of material for the new one is laid up in the form of deposits of carbonate of lime in various parts of the body. The tendons are also calcareous.

In Insects the external skeleton is chitinous, and is modified in different species to form implements of various kinds, of wonderful elegance of form and exquisite adaptation to use.

(To be continued.)

THE SEALS AND WHALES OF THE
BRITISH SEAS.

No. V.

By THOMAS SOUTHWELL, F.Z.S., &c.

THE next family, *Balenopteride*, is represented by two genera, *Megaptera* and *Balenoptera*. Like the Right-whales, they all have two blow-holes, but may readily be distinguished by having the throat and belly curiously marked with longitudinal furrows, like the ribs in a worsted stocking: they also possess a well-defined dorsal fin. *Megaptera longimana*, the HUMPBACKED WHALE, the only member of the first genus known to occur in the British seas, has twice been met with; first at Newcastle in September,

it is difficult of approach, and upon being harpooned, such is the velocity with which it shoots through the water that the danger is very great; Scoresby mentions one which took out 480 fathoms of line in about one minute. In addition to this, the whale-bone is short and of little value, and the yield of oil small; it is therefore avoided by the whalers, as more dangerous than profitable, and if struck at all, it is most likely a case of mistaken identity. From the port of Vadsö, however, the capture of this species is now successfully effected by means of an explosive shell or harpoon, which kills them at once, as many as 30 or 40 being obtained each summer. They are towed into Vadsö, where the blubber is refined and

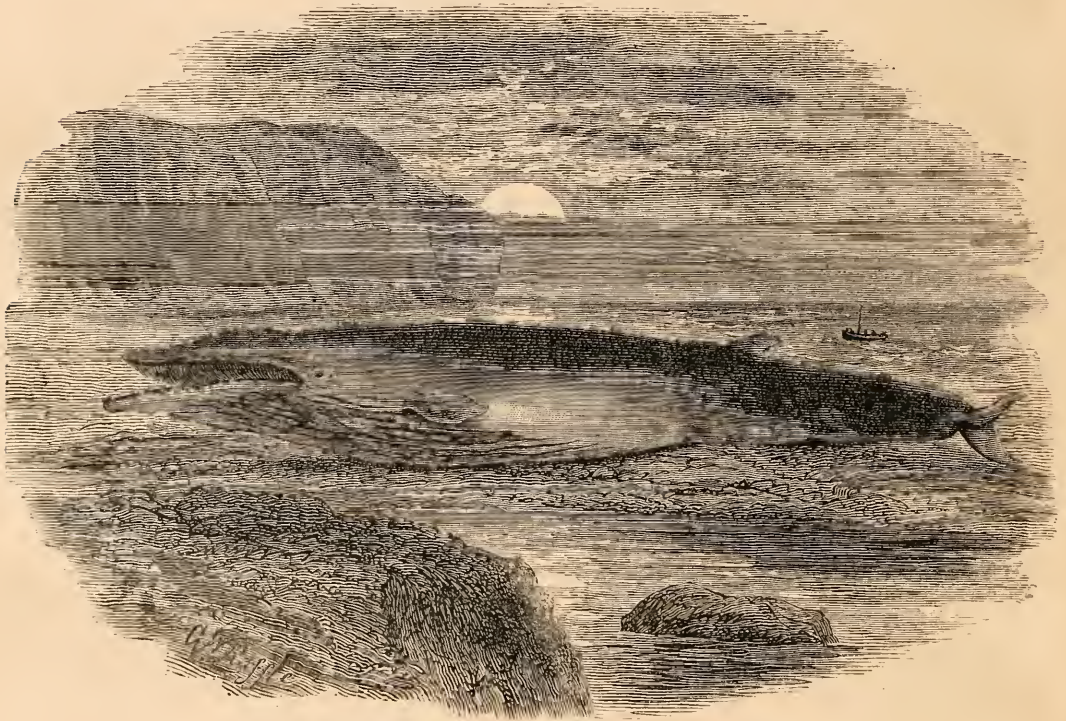
Fig. 179. The Common Rorqual (*Balenoptera musculus*, Linn.).

1839, and again in the estuary of the Dee, in 1863: both were females. It is possible other examples may have been mistaken for Rorquals, from which it may at once be distinguished externally by the great length of its flippers, which are white and very conspicuous. The total length of the animal is about 45 to 50 feet, its baleen is black, and the flippers, which are notched at the edge, about 10 feet in length.

We now come to the genus *Balenoptera*, the Rorquals or Fin-whales, the first species of which is the COMMON RORQUAL, *Balenoptera musculus* (Linn.), the *Balenoptera boops* of Bell's first edition, and *Physalus antiquorum* of Gray (fig. 179). This is a much more active animal than the Right-whale;

the carcase made into manure. The habitat of the Common Rorqual is the temperate Northern seas, from the Mediterranean, which it sometimes enters, to the 70° north latitude, and sometimes even farther north still. The range of this group is very great, and, according to Andrew Murray, it would appear that one or more of the *Balenopteridæ* is found over the whole world, although it is by no means certain that any particular species has a very wide geographical range. *Megaptera longimana*, which occurs in the North Sea, was also supposed to have been met with at the Cape, but Dr. Gray has pointed out differences in the cervical vertebrae of an individual from that locality, which he considers

constitute distinct specific characters ; on the other hand, a Fin-whale from Java so closely resembles our *Balænoptera laticeps* that Professor Flower, after the most careful examination and comparison almost bone by bone, hesitates to pronounce it distinct, and only separates it provisionally. On our own coast this species has been met with in numerous instances. In feeding, the Rorquals are not so restricted to minute marine animals as the Right-whales, but devour large quantities of fish of various sizes, from herrings up to cod. In the stomach of the Newcastle Humpbacked-whale (the species mentioned immediately before the present one) were found six cormorants, but a seventh, found in its throat, was

of the baleen is to form a screening apparatus through which the water is ejected, leaving its minute prey behind ; and in the toothed whales it would not be required. What appears like a jet of water is, in reality, dense vapour—in fact, the breath issuing from the lungs of the animal, highly charged with moisture, which becomes condensed upon exposure to the atmosphere. The figure of this species is copied, by kind permission of Professor Flower, from the illustration to his paper in the “Proceedings of the Zoological Society of London” for 1869, p. 604, *et seq.*

SIBBALD'S RORQUAL (*Balænoptera Sibbaldii*, J. E. Gray) has several times been met with in British

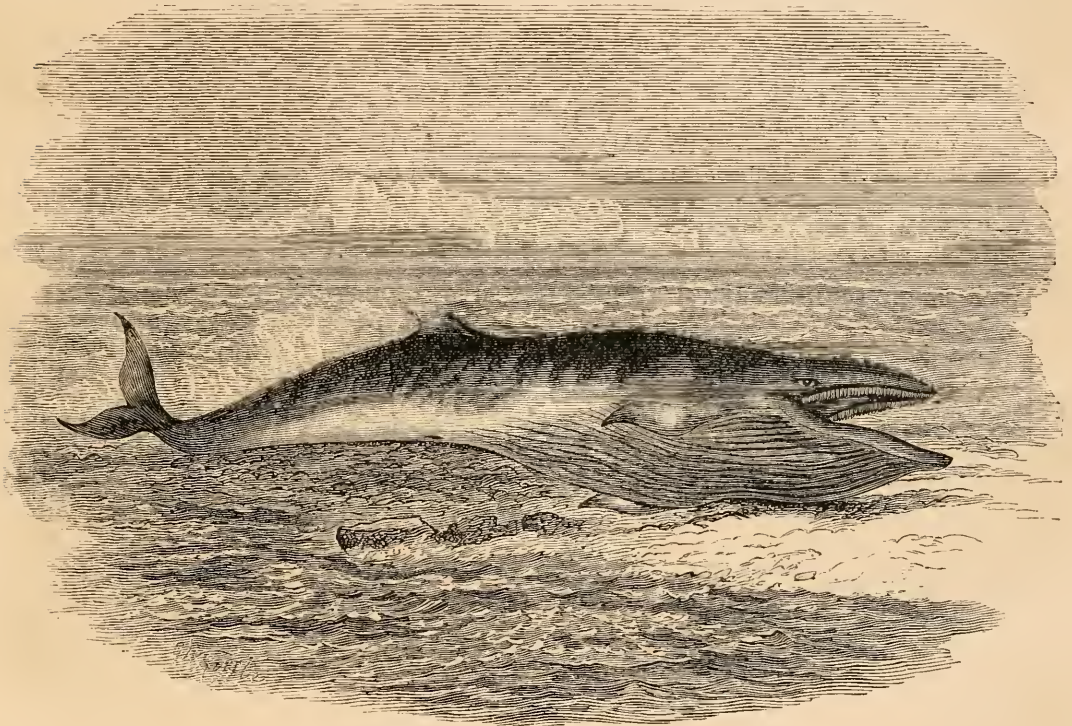

Fig. 180. The Lesser Rorqual (*Balænoptera rostrata*, Fab.).

supposed to have caused its death by choking it. The blowing is accompanied by a loud noise, which, on a still night, may be heard at a considerable distance. It was formerly supposed that in “blowing” the whale ejected from its nostrils a very considerable quantity of water, which might be seen to spout up into the air like a fountain ; and in the performance of this remarkable feat they were generally depicted. Beall, however, in his “Natural History of the Sperm Whale,” as early as 1838, shows that this is not the case, and the truth of his observations is now generally acknowledged. The power so to eject water taken into its capacious mouth could be of no service to the Whalebone-whales, as the very purpose

waters. It is the largest of this gigantic family, measuring from 80 to perhaps 100 feet in length. The famous “Ostend Whale,” which was found floating dead in the North Sea in 1827, and taken into Ostend, belonged to this species ; its skeleton was long exhibited in this country, and afterwards in America. Dr. Gray says it is now in St. Petersburg, and gives the total length as 102 feet ; as, however, several of the vertebrae are missing, the exact length is uncertain. Professor Turner gives the length of a specimen stranded in the Firth of Forth as 78 feet 9 inches, and the girth behind the flippers about 45 feet : this animal was gravid, but notwithstanding this fact, the bulk must have been enormous.

This species may be known by its low dorsal fin, black baleen, and long flippers, which are black above and whitish below : as it is said to be frequently met with in the neighbourhood of Iceland, its occasionally straying into our latitude is not at all improbable.

RUDOLPH'S RORQUAL (*Balænoptera laticeps*, J. E. Gray) is a small species which may be mistaken for the lesser Rorqual. A whale stranded at Charmouth in 1840 is believed to have been of this species, but the skeleton, although prepared at the time, is supposed to have been sold and converted into manure. Very little is known about the history or distribution of this species ; the flippers are entirely black above, wanting the white band found in the next species, and the baleen is believed to be black.

The next and last of the Whalebone-whales which we know to have occurred in the British seas is the LESSER RORQUAL (*Balænoptera rostrata*, Fab.), (fig. 180). Many individuals of this species have been obtained on various parts of the coast, from Cornwall to the north of Scotland. On the coast of Norway it is frequently met with, and is there called the "Bay-whale," from its habit of entering bays and estuaries ; this habit the natives take advantage of

for its destruction. Stretching a strong net across the inlet, they cut off its escape, and put a cruel and often protracted end to its existence with harpoons and arrows, the poor whale sometimes lingering from eight to fourteen days. This species is also known as the "Summer Whale," and does not appear to be so strictly a northern species as the *Balænoptera* generally are : it is believed, like the Common Rorqual, to have been taken in the Mediterranean. The Lesser Rorqual may be known at once by its small size (not exceeding 30 feet), and by the broad white band across its black flipper ; the baleen also is nearly white, which is another good distinction. The figure of this species is from an article by Messrs. Carte and Macalister, on the Anatomy of *Balænoptera rostrata*, in the "Philosophical Transactions of the Royal Society" for 1868, vol. clviii.

In the following table I have endeavoured to give the most striking external peculiarities of our British *Mystacoceti*. They are easily remembered, and may be useful in identifying specimens should no authority be at hand ; it also indicates the points to be observed by a person not acquainted with this class of animals, as most serviceable to enable others to identify doubtful specimens.

TABLE OF DIFFERENCES OF BRITISH MYSTACOCETI (Whalebone Whales).

SPECIES.	COLOUR.		Belly and Throat.	Flippers.	Dorsal Fin.	BALEEN.		Total Length.
	Upper Part.	Under Part.				Length.	Colour.	
<i>Balæna Mysticetus</i> , Northern Right Whale	Dark grey	Throat white	Smooth	Black	None	Long and narrow ; 10 or 12 feet	Blackish grey	50 or 60 feet
<i>Balæna Biscayensis</i> , Atlantic Right-Whale	Uniform black	Uniform black	Smooth	Black	None	Shorter than the above	...	40 feet (?)
<i>Megaptera longimana</i> , Humpbacked Whale	Black	Black and white	Plaited (plicæ)	Wholly white, about 10 feet long, and notched at the edge	Very low	Short	Black	About 50 feet
<i>Balænoptera musculus</i> , Common Rorqual	Black	White	Plaited	Black	Distinct	Short	Slate colour — shaded lighter to inner edge	About 70 feet
<i>Balænoptera Sibbaldii</i> , Sibbald's Rorqual	Black	Slate grey	Plaited	Dark above, White beneath	Very low	Short	Rich black	About 80 feet
<i>Balænoptera laticeps</i> , Rudolphi's Rorqual	Black	White	Plaited	Upper part black	...	Short	Black (?)	30 or 40 feet
<i>Balænoptera rostrata</i> , Lesser Rorqual	Black	White	Plaited	Black, with broad band of white across	...	Short	Yellowish white	25 to 30 feet

THE PAIRING INSTINCT OF BIRDS.

By CHARLES DIXON.

THIS subject has always been one of much dispute amongst naturalists, and indeed one of a very perplexing nature. I have found it to be a subject which few writers on ornithology treat with a proper amount of care, while others refrain entirely from introducing it into their works. I consider it to be one of the most important traits in the character of the feathered tribes—an amount of instinct given alike to the lordly eagle and the diminutive wren; I cannot believe, with some persons, that instinct is only a certain power inherited from the parent birds. Of its manifold uses I am not going to treat, they being at variance with the present subject. But if birds inherited this power from their parents, as some assert, they would all employ these powers in the same manner peculiar to their species, as their kind have done before them for ages; but witness the many different forms of instinct displayed by birds which are only applicable to the surrounding circumstances, powers which perhaps no other birds of their race have had to exert before.

Birds may be divided into three classes; viz., firstly, those birds which, having once paired, remain together for life; secondly, birds which pair annually; and, thirdly, birds which never pair, but are polygamous. I will briefly glance at these three divisions, and give the opinions I have arrived at in a matter to which I have paid special attention.

We will take firstly those birds which pair for life. Swallows are an excellent type of this class, returning annually to their old *nesting-sites*, for the same purpose as previously. The Martin returns to its old *nest*. But to some this may appear incredulous, knowing that these birds perform long migrations, and may get separated while upon them. Do these birds get finally separated when in large companies they are searching the air for their food? or do Rooks, Starlings, and Jackdaws fail to remember the position of their nests? The same instinct which informs the Swallows when to leave Africa in like manner urges them onwards to their old nests; and again the same pair of birds will perform the duties of incubation. We all know that the same nesting-site will be yearly tenanted by its former owners, provided they are left unmolested. This must be by the same pair of birds, for what ornithologist has ever, in the course of his observations, seen swallows prying about into barns and outbuildings in search of some old nest, which will save them the labour of constructing one themselves? The time would be so taken up in this search, that no brood would be reared. Young birds pair most likely before their migration to us, and search out nesting-sites upon their arrival in this country.

Again, the Rook is another bird which I believe pairs for life. At the commencement of the breeding season rooks (unmolested by the other members of the rookery) return to their old nests, and commence doing the necessary repairs required for the comfort of their future brood; while others, whose nests have been destroyed, diligently set to work to reconstruct them, in company with many of the last year's brood which have paired some time during the previous six months. Can any ornithologist inform me of any combat he has been witness to for the choice of the nests which have withstood the storms of winter? A few pairs of rooks will sometimes desert the general rookery and build their nests in neighbouring trees, returning to them yearly.

Ravens, Magpies, Jackdaws, Starlings, House Sparrows, several of the *Falconide* and *Paride*, have all been known to return to their nests of the previous season. I have known the Robin and the Wren return to their old sites (but not to the old nests) for several years. From these instances I would infer that all birds which return to their old nests or nesting-sites for the same purpose every season pair for life.

In the second place, those birds which pair annually; the birds which form this division are the most numerous of any. We have many instances of this class: as a good type, we will take the Willow Warbler. When these birds first arrive in this country they are never in pairs. But observe them a few weeks later; they have all found a mate, and are employed in domestic duties. It is the nature of these birds to make fresh nests every season, and never in the same position or locality. When once these birds have left their nests and the young can forage for themselves, I firmly believe all connection between the two birds ceases; the nests are abandoned, never to be returned to, and the birds roam about searching for food, very often solitary, until the time of migration arrives. Several of the Thrushes are for the most part solitary in their habits, except in the breeding season, while others roam about in flocks, very often the males or females being predominant, but as spring arrives, separating into pairs for incubation; after which the same routine is again repeated. The Chaffinch is the same—in flocks during the winter, the sexes not at all social; but as the breeding season approaches they are again seen in pairs for the propagation of their species. The Pigeons, Partridges, Snipes, Plovers, and Rails, all pair annually. In the same manner the Buntings, Larks, many of the Finches, Warblers, all pair in their due season.

All these birds' nests, after once serving their purpose, are abandoned for ever: a walk round the leafless hedges will confirm this. Will the frail little Whitethroat use *yon* abode again? or the Sandpiper return to the cavity which once contained her eggs? These birds pair annually, and of course select each

successive year a fresh situation for the birthplace of their young. In the third place, we will take that class of birds which never pair, or are polygamous. It is only in one division of our present classification that we can trace those of polygamous habits—in the first section of the Gallinaceous birds. In this arrangement we can observe one of the wisest provisions of Nature: the flesh of all these birds forms a wholesome and substantial article of food for man, from the savage in his boundless wilds to the man of civilization. But what can keep this demand supplied? Clear-thinking readers will at once assert that to keep up this supply the birds must multiply quickly: the only way is by polygamy. It is well known how prolific all birds are which, endowed with this peculiar instinct, can propagate their species equal to the demand made upon them.

In all birds which are polygamous the female alone is intrusted with all care of the eggs or young, and she, through a wise provision of Nature, is made equal to the emergency. The male shows little or no affection for them. From this I would infer that all birds of the Gallinaceous order, with few exceptions, are polygamous.

I proceed now to give exceptions, which tend greatly to perplex and bewilder the observer in the study of this interesting subject. This matter presents very little uniformity in its arrangement. In the Gallinaceous order the first section are polygamous in their habits; but even to this the Grouse form an exception, while the latter section of these birds (the *Columbidae*) are decidedly monogamous.

The House Sparrow returns to its nesting-site, and is thus at variance with its congeners of the same family. The tame duck is polygamous; but observe its wild representative, the Mallard, which separate into pairs for nidification. The Long-tailed Titmouse never returns to its beautiful abode, while the Blue Titmouse appears annually at its hole in the hollow tree. The Goatsucker annually pairs, while Swallows, Swifts, &c., I believe, remain united for life. The Rook I have once observed practising polygamous propensities, a fact perhaps never before recorded.

Are those birds which pair for life gifted with a greater amount of affection than those which pair every season? While those who pair every season, as soon as the young are sufficiently matured to take care of themselves, do the ties which previously united them together entirely cease? Is this peculiar instinct wanting in polygamous birds, and why? In many species of birds—notably the *Natatores* and *Ardeide*—it is difficult to say under which of my two first divisions they fall. This subject only tends to show us upon what an intricate foundation the system of Nature is based.

Healey, near Sheffield.

THE ARRANGEMENT'S FOR CROSS-FERTILIZATION IN THE DELPHINIUM.

THE adaptation in most of the *Delphinium* to bring about cross-fertilization is perhaps one of the most beautiful Nature has ever planned. To understand it fully, we must know at least some of the generic characters, as we all know ordinal characters are too variable in the peculiar family *Ranunculaceae*. Sepals 5, petaloid, unequal, partially cohering at their base; the posterior one developed into a spur. Petals 2-4, small; the two upper prolonged into a pointed spur, enclosed in that of the posterior sepal; the 2 lateral not spurred, or absent. Stamens numerous. Carpels 1-5, distinct, many-ovuled; follicular when ripe.

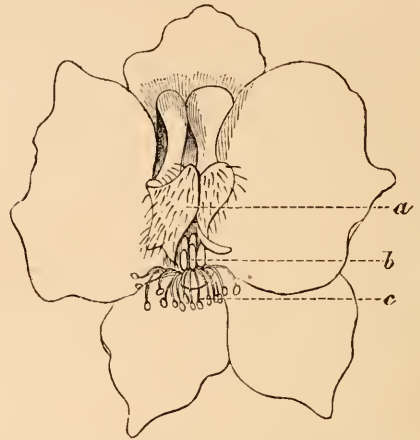

Fig. 181. Flower of *Delphinium*. *a*, front petals; *b*, pistils; *c*, stamens.

The structure we are about to refer to is especially present in *D. elatum* and *D. formosum*, and their varieties. After the expansion of the flowers, and the consequent secretion of nectar in the hornlike appendages of the two upper petals—where, it is evident, there is sufficient at least for luncheon for a humble-bee,—about four or five of the stamens stand erect, immediately under the two front petals (fig. 185, *b*): in this position the anthers dehisce, and expose the pollen. When the anthers have thus discharged their pollen, they shrivel and die, while another set of stamens arise, and fill their positions, until all have had their turn, and all alike droop and die (fig. 181, *c*, and fig. 182).

Now, as the two front or lateral petals (fig. 181, *a*, and fig. 182, *b*) serve as a good landing-place for the bee, and for which it is admirably adapted, being copiously covered with long hairs, it is obvious enough that the throat and the under part of the bee's body will become dusted with pollen, exposed by the stamens in their erect position, under the landing-stage, where the bee rests while seeking the nectar, and frequently

struggling there: as, for instance, if its proboscis is too short to reach the coveted nectar. It is most amusing to watch a small humble-bee working at *Delphinium*, with a proboscis not long enough to reach the nectar. With what rage he flies from one flower to another, until he finds out the best method of getting at the nectar is to bore a small hole at the back, or thrust his proboscis in a hole made by that energetic little depredator the ant!



Fig. 182. Flower of *Delphinium*. *a*, nectar-tube; *b*, front petal; *c*, pistils.



183.
Fig. 183. Pistil when the first anthers open.
184.
Fig. 184. Pistil when all the anthers have discharged their pollen.

Well, how is fertilization effected? and in what way does the bee perform it? To answer the question we must seek the position of the stigma. Let us suppose, then, we examine a flower where the first lot of stamens are shedding their pollen (fig. 185). Cut away the stamens, and we find the pistils quite immature, with scarcely any style developed (fig. 183);

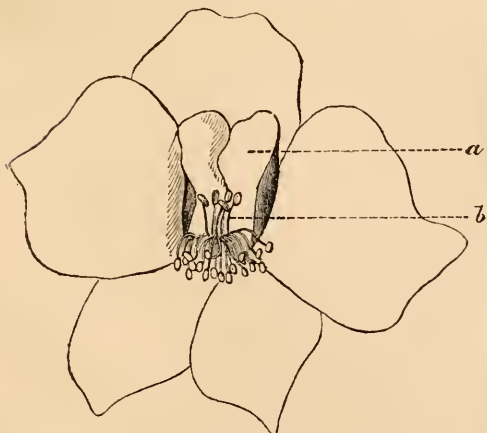

Fig. 185. Flower of *Delphinium*. *a*, upper petals (the front ones removed); *b*, five stamens, erect and shedding their pollen.

and it is not until all the anthers have discharged their pollen that the pistils arrive at maturity, *i.e.*, with the style lengthened out so as to bring the stigma within easy reach of the pollen (fig. 184). Well, what is the advantage gained by such a delay in the development of the pistils? It is certainly for no other purpose than that cross-fertilization may be effected; and, to secure that end, the stigmas are placed in precisely the same position as that previously held by the stamens (fig. 182, *c*). Thus, the bee which has become dusted with pollen from newly-expanded flowers, when visiting others which had been longer open, would carry the pollen to the waiting stigmas! It is almost, if not quite, impossible for the stigmas to be fertilized with the pollen of the same flower, and this will account for the copious supply of seed always produced upon *Delphiniums* in our gardens. It is very difficult to imagine a more simple, and yet more effectual arrangement to bring about cross-fertilization!

J. T. RICHES.

ON CERTAIN GENERA OF LIVING FISH AND THEIR FOSSIL ALLIES.

No. II.

HAVING shown the close connection between the two genera of living Dipnoids, let us now consider the relations of the living and fossil Ceratodonts. No remains of this genus have as yet been found in the Tertiary or Cretaceous formations, but the fossil teeth, of which several varieties are recognizable, possibly the relics of numerous species, occur abundantly in the Triassic beds of Aust Cliff, near Bristol; in the Stonesfield Slate of Oxford; and in the Muschelkalk of Germany. They have also been obtained from strata now determined to be of Triassic age at Maledi, South of Nagpur, in India, and associated, as in Europe, with the reptilian remains *Hyperodapedon*. Many of these fossil teeth are much larger than those of the existing species (specimens of one Triassic form measure over two inches in length), and must necessarily have belonged to individuals of a gigantic race. The dental plates only have been found fossil, but the structure of *Ceratodus Fosteri* indicates that they alone of a like-constructed animal would be susceptible of preservation in sedimentary strata, and the classification of the recent forms with those of the Mesozoic rocks, separated by so wide a gulf of geological time, though founded on the similarity of the dentition alone, is the only reasonable one, as there is no evidence that the living and fossil Ceratodonts differed from each other. The teeth of this genus resemble in general shape and structure those of *Ctenodus*, which are widely distributed in Carboniferous strata, species occurring in America being identical with those of the British rocks of contemporaneous age. The dentition of the Devonian

Dipterus is also closely related to that of *Ceratodus*, as well as *Lepidosiren*.

Thus the history of the *Dipnoi*, an order before the discovery of the Australian *Ceratodus* only represented by the mud-fishes of Africa and South America, is carried back to remote geological ages, and the four living representatives at present known are found to be the survivors of a well-defined and characteristic group of fishes first appearing in the Devonian age. They can be traced up from *Dipterus*, through the Carboniferous *Ctenodus*, to the Jurassic Ceratodonts, and then the link is lost sight of until their lineal descendants reappear widely distributed on the surface of the present world. This is but an illustration of the truth that species which have the greatest vertical range in time have also the widest geographical distribution, or that a wide distribution proves the antiquity of the genus. It is certainly a very significant fact that the group of living fish most closely allied to the amphibian reptiles should be represented in the Devonian rocks long before the most simply constructed amphibians appeared on the scene of life in the swamps of the Carboniferous period. The *Dipnoi*, as at present constituted, comprise the following families: *Protopterina*, *Ceratodontina*, *Ctenodipteridae*, and possibly *Phaneropleuridae*. They are closely allied to the Ganoids, and especially to that sub-order termed by Prof. Huxley the *Crossopterygidae*, or "fringe-finned," to be presently referred to. Dr. Günther, indeed, proposes to unite the Dipnoids with the Ganoids, as a distinct family; but Prof. Huxley considers that, though nearly related to that order, they yet possess many important differences. It seems as if the *Dipnoi* had also some affinities with the group of fishes known as *Placoderms*, for a most remarkable fossil fish has recently been discovered in America, the dentition of which is almost exactly like that of *Lepidosiren*, except that it is about one hundred times greater. The genus *Dinichthys* was founded by Prof. Newberry for the reception of this gigantic *Placoderm*, of which two species at least are recognized and graphically described by him in vol. ii. of the State Reports of the Palæontology of Ohio. They occur in the Huron Shales of the Upper Devonian series, where they seem to have preponderated in number, fragments of over a hundred individuals having been detected, while the remains of other genera are found more rarely in the same horizon. The original specimens of *D. Terrelli* were destroyed by fire, but fortunately a photograph had been secured, from which the plates exhibited were taken. The jaws of this "terrible fish" were each two feet long, the breadth of the head was about three feet, and the cranium was composed of massive bony plates, the solid bone of the occipital portion being three inches in thickness. The length of the body is estimated by Prof. Newberry to have been about fifteen feet, and its diameter three. The anterior was protected by huge dorsal and ventral shields, resembling, in general shape and structure,

those of the genus *Coccosteus*, rendered classic by the pen of the lamented Hugh Miller. Very little is known with regard to the fins, "about six inches only of an apparently median fin, with well ossified rays as thick as one's little finger," having as yet been found, and, from the absence of scales, it is conjectured that the posterior portion of the body of the animal was covered with a tough skin, as in *Coccosteus*, a genus which possibly protected itself, like the modern sheat-fish of the Ganges, by burrowing in the mud, watching for prey with only its mail-clad parts exposed. The powerful dentition of *Dinichthys* is suggestive of carnivorous habits, and probably, being so heavily weighted by the thick shields encasing its vital organs, it would be compelled to obtain food rather by cunning than by swift pursuit. It is worthy of notice that the ponderously armed *Placoderms* had a comparatively short range in time, remains of the group being only found in the Silurian and Devonian rocks: thus it seems as though, unable to cope in the struggle for existence with the lighter armed and more active race of ganoids which predominated in the Devonian waters, they died out, leaving no immediate descendants. The vertebral column in the *Placoderms* was generally cartilaginous, a condition considered by some authors as indicative of a low organization; but as the quantity of bone composing their external shields was much greater than that forming the internal skeleton of the existing types of true bony fishes, and as traces of ossified caudal vertebræ have been discovered in one genus, they ought rather to be highly placed in a systematic classification. The group is considered by Professor Huxley to form a link between the Ganoids and the Teleosts, and as having most affinity with the living plated Siluroid Teleosts of the African rivers.

(To be continued.)

NOTES ON MARINE AQUARIA.

AS there were two communications in a recent number of SCIENCE-GOSSIP, relative to fresh-water aquaria, perhaps a few notes concerning the keeping of marine life will not be uninteresting. I have three tanks, made of wood, with plate glass fronts, the two larger of which have a false bottom of slate sloping from the front up to the back, and which are so made in order to obtain a varying depth of water. These contain respectively thirteen and nine gallons, and to efficiently aerate such a body of water, I have connected a double-acting pair of bellows with a pipe running along the bottom, and which is pierced at intervals with very small holes. The pipe most suitable for the purpose is that ordinarily used by gas-fitters, and known as "composition pipe," but lest the salt water should act upon the metal and prove injurious, it is advisable to varnish the inside with a solution of shellac in spirits of wine. This I did thoroughly, in addition to covering the outside with pitch, in fact, the whole of the interior of

each tank, with the exception of the glass front, is well pitched and covered with fragments of granite, arranged as fancy dictated. The slate bottom rests on the floor in front, at about four inches from the glass, thus leaving a sort of gutter running the whole length, and which is filled to a depth of about one and a half inch,—one part with shingle, and the remainder with sand. It is now more than six months since the first two tanks were completed, and they are in better condition than when freshly stocked. The water is kept at the proper density by means of two little specific gravity bulbs, so weighted, that one rises to the surface directly the water becomes too salt through evaporation, and the other sinks to the bottom if too much fresh water be added. The larger of these two tanks contains more than sixty anemones, principally the common *Actinia mesembryanthemum*, although there are several *Actinoloba dianthus*, *Cereus gemmaceus* and *Sagartia bellis*. The other inhabitants consist of about a dozen *Corynactis*, as many prawns, a starlet starfish, and a few common periwinkles. Of course, the greatest difficulty is in maintaining the balance between animal and vegetable life, and which is so essential to the well-being of the former. Now, although there is not sufficient weed to give off the necessary amount of oxygen, yet the loss is made up by the bellows arrangement, which forces a series of small jets of air through the water, and, rising in the form of minute bubbles, so give off their oxygen; thus burning out any impurities. I tried to keep a few "Opelets" (*Anthea cereus*) and succeeded in retaining them in a healthy condition for about three months, when they one by one sickened and had to be taken out: these, together with a few prawns who died a natural death, are all the losses I have sustained in my marine family, whilst on the other hand may be enumerated the frequent birth of anemones, of which there are now a considerable number. Several of the prawns have spawned; but the young fry were either cannibalized by their parents or became food for the anemones. In their early days they form most interesting microscopic objects and are easily preserved in glycerine. One peculiarity noticeable concerning them is, that they were invariably born in the night. The larger prawns occasionally cast their skins, and when fortunate enough to be a spectator of the process, nothing is more interesting. For some hours before the event takes place the prawn swims about apparently seeking some dark shelter; suddenly the poor thing seems seized with a series of rapid convulsive jerks, the head is drawn out of its shell and the body follows after a few more jerks. The whole performance is but the work of an instant, and then the fenceless prawn, with a few languid flaps of its tail, steers to a place of shelter, there to await the hardening of its new skin, which is soon accomplished, and once more it takes its place among its brethren, to fight the battle of life.

J. W. WORSTER.

OUR COMMON BRITISH FOSSILS AND WHERE TO FIND THEM.

No. VI.

By J. E. TAYLOR, F.G.S., &c.

HAVING given the general zoological structures and natural history habits of the *Encrinites* both recent and fossil (see June No.), let us now turn to their occurrence in the various formations. They are by far the most abundant in the Primary rocks, although they range upwards into the Secondary strata, and frequently occur there in very large numbers. But their distribution in the Primary rocks is more general and abundant, and the types, or generic forms, are more numerous than we find them in the Secondary strata. Indeed many of the limestones of the Silurian, Devonian, and especially of the Carboniferous formations, are chiefly built up of encrinital remains. As limestones are always indicative of what sailors call "blue water"—that is, water free from any muddy sediment and perfectly clear, it follows that such conditions must have favoured the growth of *Encrinites*. In this respect they were nearly related to the habits of reef-building corals, to whom muddy water is an abomination and sure death. A sudden surcharge of sea water with mud brought down by rivers will almost immediately kill off millions of living coral polypes. And from what we learn of the stony record, the same thing happened in Geological times to the immense groves of *Encrinites* which sometimes for square miles together covered the bottoms of the seas. In the clay bands which are often intercalated in the Silurian and other limestones, we have frequent geological evidence of how large numbers of young *Encrinites* were killed by the muddied water, and eventually buried in the muddy sediments which had first destroyed them. The same is often abundantly true of the fine clayey shales of the Yoredale beds of Lancashire and Yorkshire, where entire specimens, stems, heads, and fingers, of frail but lengthy-stalked *Encrinites* are to be disinterred in the most perfect condition. The best place we know of, where these *Encrinital* remains are to be found in the Yoredale series, may easily be discovered by following the bed of the river from Hebden Bridge, in Yorkshire, towards Higher Green Wood. The Yoredale shales crop out in cleanly cut sections, owing to the river frequently denuding them along the lines of natural joints. The geological student will there find, strewn about, huge cubical blocks of thin dark shale, crowded with fossils, such as *Goniatites*, *Orthoceratites*, *Nautili*, and *Encrinital* remains. He can while away many a pleasant hour in these secluded but exceedingly picturesque places, with the murmur of the stream playing somnolent music in his ears, and the most picturesque hilly scenery ready to greet his eyes, whenever he thinks proper to turn them away from the absorbing

employment of laying open, layer after layer, like the pages of a book, the thin laminae of the shale blocks he is working upon. They are verily written "within and without," and the iron sulphite into which nearly all the organic remains of these beds have been converted, looks as if they had been electrotyped on the surfaces of the black shales.

of natural casts, nobody will deny their abundance or beauty. We have here seen slabs of six feet in length completely crowded with these Encrinites, roots, stems, and heads, just as they grew, looking to all the world like a fossil tulip-bed!

Again, what geological student who has made a pilgrimage through the Peak district of Derbyshire, has not had his attention called to the "Encrinital



Fig. 186. Head of *Ichthyocrinus*, an American Silurian genus of Crinoids.



Fig. 187. Head of *Eucalyptocrinus*, a Devonian Encrinite.



Fig. 188. *Actinocrinus triacontadactylus*, a Carboniferous genus.



Fig. 189. Head of *Taxocrinus* (Devonian).



Fig. 190. *Glyptocrinus* (Silurian).

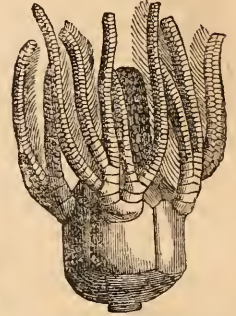

Fig. 191. *Platycrinus trigintidactylus* (carb. limestone).



Fig. 192. Head of *Actinocrinus cuspidatus* (carb. limestone).



Fig. 193. Head of *Rhodocrinus*.



Fig. 194. Lower part of stem of Encrinite, showing mode of attachment to sea-bottom.

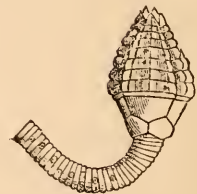

Fig. 195. *Cupressocrinus*.

At Bradford, near Bath, we have numerous Encrinites occurring in clayey rocks, instead of in limestone, their usual storehouse. This clay (60 feet thick) is in the Oolitic formation, and proves exactly the same conclusion as we have drawn from the Encrinites buried in the Primary rocks, namely that muddy sediments always kill them off and bury them where they are. In the hard slates (formerly *shales*) of the Upper Silurian formation, about a couple of miles from Llangollen, in North Wales, the student may find some beautiful specimens of the characteristic Upper Silurian Encrinite known as *Actinocrinus pulcher*. Well does it deserve its specific name, for no Encrinite exceeds it in gracefulness of shape. At the slate quarries visible on the hill side, as the reader walks towards Val Crucis Abbey, he may see abundance of these fossil Encrinites, and although all the structure of the fossils has been completely altered since they were alive, and they are now really in the condition

limestone," as everybody calls the rock, which is so completely filled or rather made up of Encrinite stems that we sometimes find nothing else? "Screw Stones," the county folk call them—that name being given in reality to those siliceous casts of Encrinital stems which occur abundantly in the Chert bands, where the original limy matter of the *ossicles* (as the individual joints of the stems are called) has been dissolved.

away, leaving only thin plates of flinty material, such as was deposited between the joints, so arranged around the filled-up hollow, or alimentary canal which ran down the whole length of the stem, as to give the appearance of the screwed end of a bolt. For mile after mile, the geologist may walk along the Derbyshire mountain roads, and find the stone walls on either hand composed of nothing else but Encrinital remains. Sometimes the rock containing them is very hard, and then it will be worked as marble, which, when polished,

splendid relief from the jet-black stone in which they are imbedded. The stones of the mountain roads are usually picked off the surface, where the limestone rocks have been most weathered. And, as the structure of most fossils imbedded in limestones is such that they are harder than the limestone itself, it follows that when surface weathering has gone on for some time, the fossils will stand out in relief. Millions of Encrinite stems may be found thus dispersed over the surfaces of the

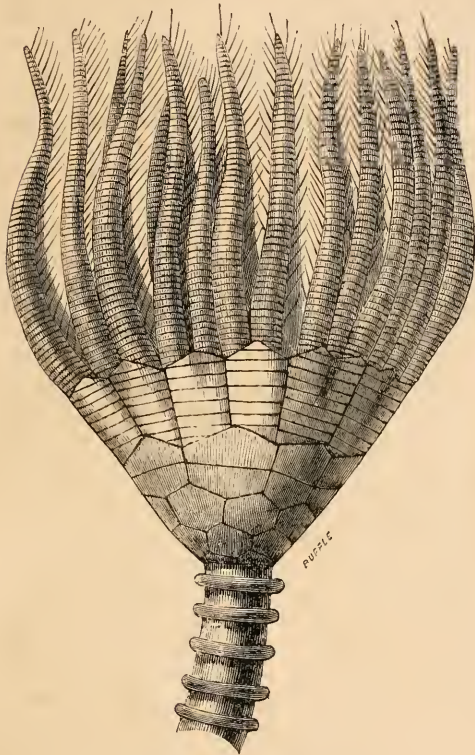

Fig. 196. *Woodocrinus macrodactylus*.

will be used for mantel-pieces. Many of my readers must be acquainted with this polished grey marble, full of all sorts of objects, but especially of these Encrinite stems, cut across, lengthwise, or at all kinds of angles, so that the appearance varies with each individual fossil. When the limy matrix is quite black (as it is at Ashford, near Bake-well), the marble is all the more valuable for economic purposes, for then the white fossils stand out in

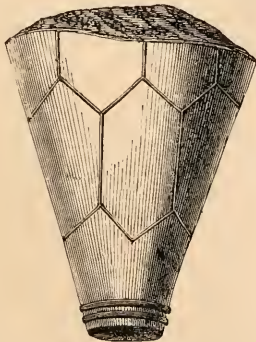

Fig. 197. Head of *Poteriocrinus*.

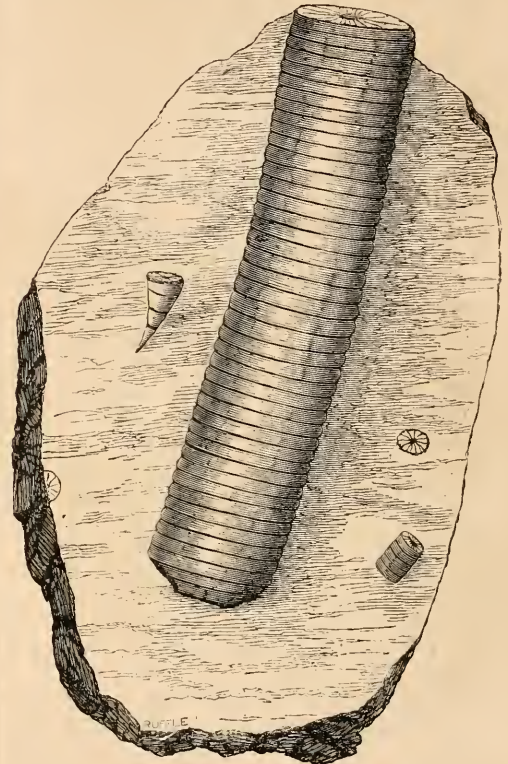

Fig. 198. Stem of Encrinite, most abundant in Carb. Limestone (*Poteriocrinus crassus*).

Carboniferous limestone whose fragments are used for wall-building. In Clithero, Lancashire, at a small elevation known as Salt Hill, the rock is also built up of Encrinite stems. In this case, however, the fossils are loose and incoherent, stems and ossicles lying together almost uncemented by any matrix, or by one which speedily weathers and liberates the fossils. The consequence is that joints and short stems of Encrinites are so loose and abundant, that they are procured as a kind of limy gravel to mend or make garden paths with!

Some of these abundant Encrinite stems in Derbyshire are often more than one inch in diameter. This species, known as *Poteriocrinus crassus*, was by far the most wide-spread and abundant of all the Carboniferous Crinoids. The head, or body of the Encrinite, was tapering, and in this respect it resembled the

singular little *Rhizocrinus lofotensis* brought up from the bottom of the North Sea, in the living state, by Messrs. Carpenter and Wyville Thomson, during one of their earlier dredging expeditions. This *Rhizocrinus* is one of the last survivors of a once cosmopolitan race of animals, now all but extinct, whose functions seem to be usurped by members of the Sea-urchin family. Stems, and sometimes small heads, and the joints of the arms of an Encrinite nearly allied to the living *Rhizocrinus*, and almost as small as it, are frequently found in the Chalk, and especially on the surfaces of the flint nodules imbedded in the chalk, in the neighbourhood of Norwich.

Glyptocrinus basalis is common almost everywhere in the Silurian rocks, but especially so in those of Wales. At Myndd Fronfrys, about two or three miles from Llangollen, large numbers of the remains of this fossil may be found, as indeed may those of other common Silurian Crinoids. The generic name of *Glyptocrinus* (signifying "sculptured") is in allusion to the highly ornamented basal plates of the body or pelvis. *Crotalocrinus* has the first part of its name derived from a Greek word signifying a "child's rattle," on account of its peculiar shape and appearance. The arms commence at the top of the body, and as the joints or *ossicles* are fastened to each other sidewise, as well as vertically, the arms have a subdivision resembling the meshes of a net, or the basket-work of a child's penny rattle. When portions of these arms are found, as they frequently are, on the surfaces of the Wenlock and Dudley limestones, they look like fossil *Polysoa* or "Sea-mats," and are frequently mistaken by young geological students for such. Another Silurian genus of Encrinites, called *Anthocrinus* from its flower-like appearance, has its arms subdivided, something after the fashion of those of the *Crotalocrinus*.

Periechocrinus, *Rhodocrinus*, *Taxocrinus*, and *Poteriocrinus* are other common Silurian genera, nearly always found in the various limestones of that formation. *Rhodocrinus*, or the "Rose Encrinite," ranges upwards in the Primary rocks to the Carboniferous limestone, in which it is found in Lancashire. The joints of its column may be known by the five-sided hole running through the middle. On examining the weathered surfaces of the Silurian limestones in the neighbourhood of Wenlock or Dudley, the student will often find splendid, sometimes perfect, specimens of one or another of the above-mentioned Crinoids. *Glyptocrinus* appears to be most abundant in the Caradoc beds, and may be found wherever they are well exposed.

In the neighbourhood of Newton Abbott, Torquay, and elsewhere, where the Devonian limestones crop out, remains of Encrinites peculiar to this formation in their specific character, may be found, although not abundantly. It would seem as if corals, having pretty much the same marine habits as Encrinites, competed with them. Hence, as a rule, wherever

fossil corals are very abundant, Encrinites are not so; and contrariwise. This is markedly the case with the Devonian limestones of England, where fossil corals are very abundant, and Encrinites comparatively rare, except in localities. In the Eifel Mountains, the Crinoid family is better represented. One of the few characteristic genera is *Cupressocrinus*, or "Cypress" Encrinite; *Haplocrinus* is another. *Platyocrinus*, a genus very abundant in the Carboniferous limestone, makes its first appearance in the Devonian strata. Its stem is naturally flattened or lenticular, instead of being round, as is usually the case with Palaeozoic Crinoids. The former part of its generic name signifies "breadth," and is given to it on account of the basal and radial plates of the body being unusually broad in comparison with those of other Encrinites.

The Carboniferous limestone is undoubtedly the metropolis of the Crinoids. During its deposition in Europe, the number of genera and species reached its maximum. They were never so numerous before; they have gradually been dwindling away ever since, until our own epoch would seem to be that when their final extinction would occur. Besides *Rhodocrinus*, *Platyocrinus*, and *Poteriocrinus* (already referred to), we have the remains of such genera as *Actinocrinus*, *Cyathocrinus*, *Gilbertocrinus*, *Taxocrinus*, *Woodocrinus*, &c. Sometimes, as in the neighbourhood of Clitheroe, Lancashire, we get limestone seams composed of heads of Encrinites, just as elsewhere we get beds formed of their stems and arms. *Cyathocrinus*, *Actinocrinus*, *Platyocrinus*, and *Poteriocrinus* are the commonest of Carboniferous genera, the latter being profusely abundant in Ireland and Scotland, as well as in every part of England where the Mountain or Carboniferous limestone appears. *Actinocrinus* is an abundant fossil in places; its name of "radiated" Encrinite being due to the thorn-like side-arms, which project, at irregular distances, from the main column. *Woodocrinus* was named after Mr. Edward Wood, of Richmond, in Yorkshire, its original discoverer. Although not a very widely-distributed fossil, it occurs in large quantities and in great perfection in the Carboniferous limestone at Richmond, whence most of the finest specimens to be seen in private and public collections have been obtained; thanks to the generosity of Mr. Wood, who worked a small quarry for the sole purpose of obtaining specimens.

The Secondary Encrinites are mainly distinguished from those of the Primary rocks by the fact that the grooves in the arms are not arched over, but are continued over the central or upper surfaces. In England, the only member of the New Red Sandstone which yields fossil Encrinites—the Muschelkalk—is absent. In Germany, especially in the hilly country about Jena, where the Muschelkalk limestone crops out, the well-known "Lily Encrinite" (*Encrinus moniliformis*), (fig. 118), abounds. In our Liassic

and Oolitic rocks, Crinoids are sometimes very common. This is notably the case in the shales of the Lias about Whitby and at Lyme Regis, where several species of the beautiful *Pentacrinus* occur profusely. The heads and the wonderfully complex arms, which must have expanded like a living net when the animals were alive, are preserved in the greatest perfection, and are frequently converted into iron pyrites. The joints of the stems have long been known under the name of "St. Cuthbert's Beads," and as such, Sir Walter Scott alludes to them in his "Marmion." In the Oolite we have such genera as *Millerocrinus* and *Apiocrinus*, the latter perhaps better known as the "Pear Encrinite." In the Bradford clay, near Bath, the thick seam swarms with joints and detached plates of the body, so that the student may here obtain material enough to exercise his ingenuity in reconstructing afresh the entire organism. The Apioerinites were usually fixed to some hard body by means of the base of the column being spread out, something after the way in which such limy seaweeds as the *Corallina officinalis* attach themselves to the sea-bed.

Species of Crinoids belonging to the genus *Bourgetocrinus* (allied to the living *Rhizocrinus*) occur scantily in the Chalk. In some places in the London clay, as at Witham, in Essex, we get joints of Encrinites allied to the *Pentacrinites* now common in West Indian seas. We have already seen the relationship which the Crinoids bear to the Star-fishes, through such forms as *Euryale* and *Comatula*. In like manner they are related to the Sea-urchins, through such fossil forms as the *Saccosoma* of the Oolite, and the *Marsupites* of the Chalk. To these we shall refer at greater length when we come to treat on fossil Echini.

MICROSCOPY.

THE LATE DR. HENRY LAWSON.—Many microscopists at home and abroad will be saddened to hear of the sudden death, at an early age, of Dr. Henry Lawson, editor of the *Monthly Microscopical Journal*. He was author and editor of several well-known works, and up to the end of last year was editor of the *Popular Science Review*.

CLEANING SPOILT SLIDES.—In the June number of SCIENCE-GOSSIP for this year, is a short article on "Cleaning Microscopic Slides," by W. M. Paterson, in which he advises the use of sulphuric acid. Now although I doubt not that his way may be very effectual, yet is there not a degree of danger and inconvenience arising from the use of this acid, especially if heated in large quantities? I therefore propose to give my experience in the following directions, which will I believe, if carried out, insure success to any one who may try it. Using up old slides at

least saves money if nothing else. In the first place, get a large earthenware pipkin, costing 2½d. (this when bought may seem rather too big, and it will therefore be best to wait till a quantity of slides have accumulated—say five or six dozen), however, the size is of no great consequence. Next, having placed the slides therein, pour in cold water till it rather more than covers them. I say cold, because there can be no danger then of their cracking. Put in a piece of yellow soap about the size of a walnut—though of course the size depends on the quantity of slides. Place this over a fire,—a range is best if it can be had; it may now be left to boil for three hours, occasionally stirring with a piece of stick, and adding water when necessary, *i.e.* when there is not enough of the soapy solution to cover the slides. They may now be taken off and tipped into another vessel containing warm water, when the slides should be scraped with an old knife, the blade of which should be made soft to prevent scratching the glass. If the first boiling has been sufficient, the balsam will come off almost by itself, and the varnish, &c., will be greatly loosened. If possible, they should now be put back into the pipkin, clean warm water and soap added, and left to boil for another three or at least two hours; it will do them no harm, and will more thoroughly cleanse them. Again tip them out, waiting till they have got cooler, when they must be rinsed in clean water two or three times, and wiped quite dry. I have cleaned seven dozen in this way, and have found it answer well. Of course there may be one or two scratched or otherwise spoilt, but could they not be used for opaque objects?—*E. W. W., Lewisham.*

BOROUGH OF HACKNEY MICROSCOPICAL AND NATURAL HISTORY SOCIETY.—At the last meeting, held October 2nd, Dr. R. C. Kibbler gave a valuable paper on the "Anatomy of Insects," the first of a series, beginning with the External Anatomy. It was illustrated with some beautifully executed diagrams. Six new members were balloted for and elected, and five nominations taken. At the last excursion of the Society to Epping Forest, Woodstreet Station, I was fortunate enough to secure *Plumatella repens*. I am informed that it has never been taken there before.—*Collis Willmott.*

A ONE-ARMED HYDROID.—M. Mereschkowsky has described a remarkable form of polyp found in the White Sea, adhering to the shell of *Tellina solidula*, and which is remarkable for the extraordinary length of its single tentacle. He has called it by the generic name of *Monobrachium*.

RAPHIDES.—"E. W. W., Lewisham," will find the following a good plan for mounting plant crystals *in situ*, and he will at the same time be able to obtain the tissues in a transparent state. If the object to be mounted should contain *chlorophyll*, such as a

leaf, sepal, &c., boil it for two or three minutes in a solution of caustic potass, then let it soak for a short time in cold water, after which place on a slide and draw off superfluous water with a pipette, pour on the object two or three drops of glycerine jelly, and warm it gently over a spirit-lamp, so as to allow the jelly to flow under the object; then put on the cover and fasten down with a wire clip; and to remove air-bubbles hold the slide over the flame of a spirit-lamp until the jelly boils: when cold, clean off the slide and finish as usual. Transparent objects do not require boiling in caustic potass. To mount the crystals in rhubarb I should prefer to make a thin section in a section-cutter, omit the boiling process and proceed as above. These crystals (*i.e.* in the rhubarb), are *Sphraphides*, and should not be confounded with *Raphides*; needle-shaped bodies usually occurring in bundles, and differing perhaps as much in chemical composition as they certainly do in value as a character in systematic botany. — *S. Baker, Chichester.*

ZOOLOGY.

CHAMELEON-LIKE CHANGES IN THE FROG.—On the 7th October I fed my pet frog Paul with a few choice worms, finishing off with a plump blue-bottle fly. I noticed at the time he was of a beautiful lemon-colour, with drab spots and markings. I may mention that, after a long search, I discovered him in a secluded spot in the vivarium. After partaking of his repast, he indulged in a bath. Within the hour I again visited Paul; he was then of a dark drab colour, or nearly black. I have frequently noticed this change of colour, but not so decided and in such a short space of time as in this instance. Paul has been with us now over six years. Is this sudden change commonly known? I have not read works on the frog (St. George Mivart's, for instance). If the above is of sufficient interest for your columns, oblige by recording it.—*F. J. M.*

PLANTS, &C., FOR REPTILE VIVARIA.—In answer to W. H. Groser, I shall be happy to give my experience, having kept reptiles many years. In the first place, my vivarium is an ordinary fern-case, 34 in. long, 20 in. deep, 18 in. wide, with a zinc trough at the bottom, 11 in. deep, filled with peat-mould; in the centre a water-tank, which may be formed out of a variety of articles; for instance, a common garden pan, lined with thin cement or well painted outside, simply to keep the water from weeping through; a glass fern-dish, or, what I consider has a better effect, I have an ornamental terra-cotta pan, 12 in. across, and about 3 in. deep, a small rustic ruin in the middle, the top of which is a recess for a small fern. As regards plants, I consider that ferns are decidedly best, as there are so many beautiful forms in the commoner sorts; for instance, *Lastrea*

Filix-mas, *Filix-femina*, *P. angularis*, *S. vulgare*, *B. spicant*, and many others, also many mosses; and one great advantage is, should any of your plants begin to look sickly, you can replace them, the only cost being a pleasurable afternoon's walk in the country lanes, it being a very poor locality where they cannot all be found. I generally trim up mine with a few fresh ferns once a year—not a very hard task. The inhabitants of my case are toads, frogs, salamanders, lizards, &c. For the lizards I have a piece of virgin cork placed in two of the corners, forming imaginary castles, the entire furniture being nice dry moss, which they seem to appreciate amazingly, and soon form their own apartments; and very pretty it is to see frequently some one or more of my reptile friends sitting, or, if you like it better, lying, with their heads out of the window (that is, holes made by cutting away bits of the cork). Lastly, the food: of course, in summer it is easily procured and various—earth-worms, insects, maggots—a fine food, for those not devoured in the maggoty state will in a short time emerge in the state of large flies, called, when I was a boy, blue-bottles; and it is wonderful to see the dexterity with which they are caught by the lizards, toads, &c. But in the winter, that is the time—well, it is the time when you can with very little trouble prove that your reptiles are useful as well as, to you, ornamental, by setting traps in the kitchen to catch the cockroaches, that is, supposing you have any; if not, most likely some of your friends or neighbours have, which no doubt they will very willingly part with. Should that fail, your baker will provide you with any amount for a small cost, to repay the boy for catching them. I should have also mentioned that, after watering the ferns occasionally, place a piece of glass over the perforated zinc, to steam and enliven the plants, which the reptiles do not at all object to.—*J. W. Clarke, Park-place, Clifton, Bristol.*

POPULAR SCIENCE.—The *Popular Science Review* well maintains its character in the last issue. Therein we find capital articles by the Rev. W. S. Symonds, F.G.S., on "The Volcanoes of the Haute Loire and the Ardèche"; on "Flint Implements," by Captain King; "The Song of the Cicada," by J. C. Galton, F.L.S.; "Caves and their Occupants," by the Rev. J. M. Mills, F. G. S.; and one on "Meteorites, and the Origin of Life," by Dr. W. Flight.

PHYSIOLOGICAL TABLES.—Dr. E. B. Aveling has prepared and published a set of Physiological Tables, whereby a student can see at a glance the various facts in physiology arranged in systematic order. To science teachers this little manual is indispensable. It is published by Hamilton, Adams, & Co.

BOURNEMOUTH INSECTS.—During several visits to this watering-place, I have been struck with the remarkable prevalence of the grayling (*H. Semcle*), certainly the commonest butterfly of the neighbour-

hood. Almost any number may be taken among the heather, and even in the town, on a summer day. *C. Edusa* is also somewhat abundant this season, and larvæ of the Emperor moth (*S. Carpinii*) are common on the heaths. Some years ago I used to find the larvæ of the Cinnabar (*E. Jacobæa*) in large numbers on the ragwort growing by the roadside; but I have not since been able to meet with a single specimen. Is this species known to be thus capricious in its appearance?—*W. H. Groser.*

PIED BLACKBIRD.—A very fine pied variety of the Blackbird (*Turdus merula*) was shot at Ryhope, co. Durham, on 27th September, 1877.—*J. T. T. R., Ryhope, Durham.*

SUPPOSED OCCURRENCE OF THE ATLANTIC RIGHT WHALE.—Since my article on the Greenland Whale, the following paragraph has appeared in *Nature*, which renders it extremely probable that the Atlantic Right Whale still lingers in its old haunts:—"Mr. P. J. Van Beneden has made a short communication to the Académie Royale de Belgique, published in that society's Bulletin, with reference to a letter by M. Capellini, on a true whale captured in the Mediterranean Sea, near Taranto. The Italian author suggests the new specific name, *Balæna tarantina*; but M. Van Beneden much more reasonably thinks it most probable that it is a stray specimen of *B. biscayensis*." I hope something more will be heard of the interesting stranger.—*T. Southwell, Norwich.*

BOTANY.

INFLORESCENCE OF GOURDS AND PUMPKINS.—Gourds and Pumpkins are an interesting group of plants, whose large yellow flowers, having the appearance of golden vases, richly ornament the trailing stems in the quiet months when summer is passing into autumn. The solitary flowers in the axils of their leaves form, what botanists call, the simplest form of indefinite inflorescence. But in every gourd or pumpkin plant that I have noticed, the simplicity of its inflorescence has been interrupted by the apparent impatience of the fruit-blossoms to expand. The male flowers, or, in popular language, false blossoms, are in the proportion to the fertile flowers of about ten to one; but the latter rigorously insist upon the rule of "ladies first" in the order of their expansion. A fruit-blossom will open while three or four other buds remain below it unexpanded, and a gourd acquires considerable size before its brother blossom next below it will have come to display its two stamens and a half. I should not have written about this perhaps familiar fact, but that I have never read of it, which may be in consequence of the very limited circle of my reading: but there may be among your readers others besides me, who have more ready access to plants themselves than to what learned men have written about them, and who may be able to

confirm what I say. But how is the phenomenon to be explained? At every node of the stem are three germs or buds. One of these becomes a branch, one a flower, and the third is developed as a tendril. I have been sometimes tempted to suppose that male and female flowers do not belong to the same series of buds, but was obliged to give up this hypothesis on observing that whenever two flowers appeared at the same joint, they were invariably similar, whether barren or fertile; so that the matter remains unexplained, except by consideration of the necessity for the fertile flowers to make haste, in order to ripen their fruit during the few days of hot weather in which they have to live.—*John Gibbs.*

ERICA MEDITERRANEANA.—Mr. Mason rather misunderstands my remarks in the July number of SCIENCE-GOSSIP, as to *Erica Mediterranea*. What I said was that I felt "considerable doubt" as to the continued existence of that plant on Urrisbeg, and that it was "nearly, if not altogether" extirpated in that station. I am glad to learn from Mr. Mason that my doubts were unfounded, and that this beautiful heath is still to be found at Roundstone, though I failed to find it. I observe that it has also been seen recently by Prof. Balfour (*vide Proc. Bot. Soc. Edin.*). This elegant heath appears, however, to be in very small quantity as compared with its former abundance. Mackey says, "covering a space of three acres," and Mr. Ogilby, who gave, in the pages of the *Phytologist*, a good account of this plant at Urrisbeg, says that it occurs for more than a mile along the stream. *Erica Mediterranea* does not seem to be well known to the common people of that region. The only native I met on the hill was an old man looking after cattle, and he rather thought I was a greenhorn to be looking for heather in bloom so early: he said there would be none in flower until July. I cannot concur in Mr. Mason's advice to procure a guide. I have never yet employed one, and would much rather miss my plant than have it shown to me by a professional guide. I spent another day at Roundstone in August of the present year, and before breakfast succeeded in finding *Nais flexilis* in some plenty. This plant should have been called *fragilis*, as it breaks off with a slight touch, and you usually get only the upper portion. I also found *Adiantum Capillus-Veneris*, but in very small quantity, and the plants insignificant. District VIII. is to be credited with *Elatine hexandra* and *Carex pallescens*: the former grows sparingly along with *Nais*, and the latter occurs at Killery Harbour, not far from Leenane.—*S. A. Stewart.*

FRUCTIFICATION OF SYCAMORE.—The large quantity of Sycamore fruits with more than the usual number of winged seeds that made their appearance this season, as noted by Mr. Holland in the August number of SCIENCE-GOSSIP, was also very noticeable in the neighbourhood of Bristol; but, so far as I observed, there were seldom more than three

or four wings to the fruit. It may, perhaps, suggest an explanation of this phenomenon that this year has been an unusually fruitful one for several other plants. The white Beam-tree (*Pyrus Aria*), which last year did not, I believe, flower at all with us, was this season loaded with blossoms. The common Nut, the Hornbeam, and also the wild Plum and Cherry, have borne much above the average. It is a common notion that a fruitful year is followed by a certain number of less fruitful ones in a regular series. Is this really the case? May not the mildness of last winter account for the vigorous growth of the recent season?—*Wm. E. Green.*

HYBRID PRIMULA.—As far as I can judge from his description, your correspondent B. W. Hant's "oxlip" or "hybrid" is a "common occurrence," but neither an oxlip nor a hybrid. The true Oxlip (*Primula elatior*), according to Hooker's "Student's Flora," occurs in Suffolk, Cambridge, and Essex; differs from the primrose (*Primula vulgaris*) in having inodorous flowers, a less inflated calyx, and a capsule longer than the calyx-tube; and from hybrids between the Primrose and Cowslip (*Primula veris*) in having a more downy calyx, paler flowers, and the mouth of the corolla-tube wide, and without the thickened folds seen in the Primrose. B. W. Hant's specimen seems to have been a simple primrose, but it is difficult to understand from his words, "the oxlip had a large thick stalk and flower," whether it was a case of "fasciation" or fusion of several flower-stalks, a phenomenon familiar to us in the Cockscomb (*Celosia cristata*), in which case several flowers would be also fused, or whether it was, as I expect, only a prolongation of the common flower-stalk or peduncle. This last I have often seen in the Primrose, wild and in gardens. It must not be wondered at, seeing that the inflorescence of the species is as truly an umbel as that of the Cowslip, the individual flower-stalks being only pedicels. The only difference in inflorescence between Primrose and Cowslip is that the umbel of the former is usually sub-sessile, not peduncled. In the Chinese and Japanese primulas we have further pedunculation, producing the tier-on-tier arrangement of the flowers.—*G. S. Boulger.*

MALVERN FOREST AND CHASE.—A deeply interesting little book has just been written by Mr. Edwin Lees, F.L.S., on "The Forest and Chase of Malvern, its Present and Ancient State"—botanical, archaeological, and historical. We have been delighted with its perusal, and with the accounts of the remarkable old trees still to be found within the confines of the Chase. Most of these trees have been artistically and vigorously sketched by Mr. Lees, and now illustrate his work. The pamphlet is a reprint from the "Transactions of the Malvern Naturalists' Field Club."

BOTANICAL NOTES IN THE NEIGHBOURHOOD OF CADER IDRIS.—In replying to the comments of

Dr. Lees upon my Notes, I would observe: 1. *Hypericum montanum*; this plant has since been recorded as also found by Mr. Robert Holland in the same locality. 2. *Epilobium tetragonum*; possibly another species, but certainly not *angustifolium*, which grows plentifully near here. 3. *Allium Ampeloprasum*; should manifestly have been *ursinum*, by an oversight. 4. *Drosera intermedia*; such I still consider were the plants found, as determined with the aid of three authorities, and not the larger *anglica*. Most of the two species of *Drosera* I found were from the boggy shores of Llyn Creigenen, a lake of moderate altitude, although but a short distance removed from the precipitous face of Cader Idris. I kept, for about six weeks, a number of both kinds alive at home, for observation with Darwin's work on Insectivorous Plants, after which time they slowly died. 5. *Asplenium septentrionale*; on the 24th of August I forwarded to Dr. Lees three pieces of this rare fern, in a living state, which Pugh of Dôlgelly had then sent me from Cader Idris. 6. *Saxifraga nivalis*; one specimen only is mentioned, which may have been a small form of *stellaris*, a species it much resembles. 7. *Linaria Cymbalaria*; the locality among the mountains was sufficiently wild, nevertheless this plant may not be truly indigenous in this country. Babington, in his seventh edition, 1874, is silent upon this point.—*Horace Pearce, F.L.S.*

COTONEASTER VULGARIS.—Mr. Colebrook, in September number of SCIENCE-GOSSIP, says that the above plant is extinct on the Great Ormes Head. This is not the case. Mr. Thomas Shortt, in the *Gardener's Chronicle*, 13th January, 1877, says: "In company with a friend, a few days back, I saw it growing in two distinct places. It is much relished by sheep, which devour every leaf they can obtain, which makes the plant now difficult to find. There is one plant growing in the centre of a Whitethorn bush, very 'healthy.'"—*M. King.*

GEOLOGY.

AMERICAN PALÆONTOLOGY.—Students of American Palæontology will find the work recently written by Mr. S. A. Miller on "American Palæozoic Fossils" exceedingly valuable. It contains a laboured catalogue of all the genera and species, together with names of authors, dates, places of publication, groups of rocks in which the fossils have been found, and the etymology of the words employed in nomenclature. Prefacing the catalogue of fossils is a capital introductory chapter on the stratigraphy of the American Palæozoic rocks. This work is published in London by Trübner & Co.

THE GEOLOGY OF LEICESTERSHIRE AND RUTLAND.—We have received a copy of a short, but compact and well-written *brochure* on the geology of the above

counties, by Mr. W. J. Harrison, F.G.S., of the Leicester Museum (published by Simpkin, Marshall, & Co.). It is a reprint from *White's Gazetteer, &c.*, of those counties. The author gives us an outline of each formation, its area and outcrops, fossils, &c., in the most compendious and, at the same time, lucid manner. To add to the scientific value of this little work, there are twelve large photographs of the most remarkable sections, both natural and those exposed in quarries. Geological students may here see how valuable an adjunct photography may become to students of field work. We sincerely congratulate Mr. Harrison on the success of his "Sketch," as he modestly terms it.

"SCEPTICISM IN GEOLOGY."—This is the title of a clever little book, by "Verifier," published by John Murray. The author attacks many prominent geological doctrines, although he seems to be hardly aware that in many cases he sets up his own skittles only for the sake of knocking them down. One of the most direct attacks he makes, in which we cannot for one moment agree with him, is that rivers never can and never did cut gorges in rocks. This leads us to believe that the author has worked very little in the field, or he would have seen the process for himself. The criticism of the book, however, is on the whole healthy and fair. It is certainly able, and would have been more so had the author been a *field* instead of evidently a *book* geologist.

THE ORIGIN OF MOUNTAIN CHAINS.—The Editor, SCIENCE-GOSSIP, notes on p. 236, "*Mr. Malet forgets that the entire region of the Alps is folded.*" With due deference, M. Malet begs to say he does not forget what he never knew. He is fully aware of present ideas of mountain formation, but the contraction and folding theory has not yet been proved to be a fact.—*H. P. Malet.*

FOSSIL "GLASS-ROPE" SPONGES.—Mr. Carter calls attention, in the September number of *Annals and Magazine of Natural History*, to the occurrence of the remains of certain fossil sponges allied to *Hyalonema*, or the well-known recent "Glass-rope Sponge" in the Carboniferous limestone of Dalry, Ayrshire.

FOSSIL LIZARDS.—Prof. O. Fraas has described an extraordinary group of fossil lizards, twenty-four in number, all found beautifully preserved in one slab of Triassic sandstone, at Heschach, in Germany. It has been named *Actosaurus*, or "Eagle Lizard," because of certain bird-like characters which this new genus presents.

NOTAMIA BURSARIA.—Having found *Notamia bursaria* at Hove, Brighton, I should be glad to know if it is still considered a rarity, and also where I can find a later and fuller description of it than that given in the last edition of Johnston's "British Zoophytes."—*Annie Michael.*

NOTES AND QUERIES.

THE GOATSUCKER (*Caprimulgus europæus*).—There is an interesting point in the history of this singular bird which is not referred to in the remarks on p. 149; namely, that it lays later than probably any other of our single-brooded birds. White of Selborne had eggs brought him on July 4th, "one of which had been laid this morning, as appears plainly, because there was only one in the nest the evening before"; and on another occasion two were given to him on July 14th, "full of young and just ready to be hatched." Four or five years ago I found a couple as late as the 5th of August. I was entomologizing in Darenth Wood when a nightjar rose from a slight hollow among the fern almost at my feet. After a close search, I discovered the eggs lying on the bare ground, unprotected by the smallest vestige of a nest. They could not have been laid more than four or five days. These eggs, which I have now in my collection, are dissimilar in marking, but not so strikingly as those described by Mr. Whistler. Both are beautifully marbled with bluish grey and yellowish brown on a white ground, and one of them has near one end a zone of pale brownish streaks and blotches: if this were washed away, the eggs would be as nearly alike as possible. The Nightjar arrives here punctually on the 17th of May, and retires during September. I never observed it uttering its note on the wing, but Gilbert White says, "I have always found that though sometimes it may chatter as it flies, as I know it does, yet, in general, it utters its jarring note sitting on a bough"; and the Rev. F. O. Morris says it jars "at times on the wing." Last year I timed one which had stationed itself in a clump of trees not far from my garden, and I was surprised to find that the song was begun almost every evening with the utmost punctuality. For instance, on three consecutive evenings the jarring commenced precisely at 8.27, and on the fourth at 8.26. Occasionally it would be five or ten minutes late, having perhaps overslept itself, or strayed away and got lost among the neighbouring trees. Is the song continued all the night through, and if not, at what hour does it recommence in the morning? I have heard the chattering half an hour before day-break at the end of May.—*E. D. Marquand, Brockenhurst.*

DOCTRINE OF EVOLUTION.—Your correspondent Dipton Burn refers (p. 167) to the very common mistake of attributing the doctrine of evolution solely to Mr. Darwin. If readers of "The Origin of Species" would take the trouble to read the historical summary prefixed to the 6th edition of works on the subject, previous to the first edition of Mr. Darwin's book, commencing with those of Lamarck, perhaps the mistake would not be so general.—*R. Egerton.*

BLISTER-BEETLE (p. 166).—I find it stated in Rye's "British Beetles" (p. 171), that the Blister-beetle (*Lytta vesicatoria*) is occasionally taken in the southern counties, but cannot be considered as truly indigenous.—*R. Egerton.*

EXUDATION FROM SYCAMORES (p. 165).—The exudation noticed by W. J. Horn is honey-fall, or honey-dew, which became remarkably abundant in this neighbourhood upon sycamore, and, indeed, all other trees during the hot weather we had a fortnight since, and at the present time still exists in very large quantities, in spite of several heavy showers of thunder rain. During the hot weather it dropped off the trees like rain, and if one stood under a sycamore-tree it

was at the risk of having one's clothes spoiled by the clammy shower. It is commonly supposed to be secreted by aphides, and it is rather strange that Mr. Horn should not have been able to find any of those insects. Aphides usually accompany the exudation of honey-dew, and in this neighbourhood, if a sycamore branch be shaken, a complete cloud of aphides falls to the ground.—*Robert Holland, Runcorn.*

HOUSE-SPARROW AND ITS YOUNG.—Will any of your readers kindly inform me whether it is usual for the House-sparrow to desert its young? I witnessed the following occurrence a few days ago. Bounding our garden is an ivy-covered wall, where quantities of sparrows build their nests; and the other day observing a young sparrow hopping about on the grass, I imagined it had been allured from the nest by the parent bird, but had not sufficient strength to fly up again. It could not feed itself, and towards night we caged it, in order to protect it from the cats. Early the following morning we liberated it, and had the satisfaction of seeing another bird come and feed it. It remained under the tree until night, when we placed it in the cage again, and in the morning put it in a bush, but the birds seemed to have deserted it. During the day many sparrows came under the bush for the crumbs placed there, and each time the little one fluttered to them, opening its mouth and chirruping, but not one would feed it. Several times we took it up and tried to give it crumbs, but the little thing had not sufficient knowledge to take the food, and I could not succeed in putting any into its mouth. We moistened its beak with a feather dipped in water, but it was not enough to sustain life; the bird grew hourly weaker, and before night it died. But it was piteous to see the poor little thing beg repeatedly for food from the other sparrows, and we could do nothing for it. I should be glad to know if this be a solitary case or not.—*Louisa Corrie.*

CUCKOOS.—On the 8th of June my nephew took me to see two young cuckoos in separate nests, and within 30 yards of one another; one as large as a young pigeon, and nearly full-feathered and still being fed by the Titlark (or, as called here, Pute); the other was about the size of a sparrow, but very few feathers on. The nests were small, and made of dried grass (called fog here), and evidently a titlark's. The cuckoos were much too large for the nests; the larger being very pugnacious, striking with its beak if you put your finger near it. They were in a hay-meadow at Wall Hill Bottom, Saddleworth.—*Charles Butterworth.*

AN INCIDENT IN THE LIFE OF A SCOTTISH NATURALIST.—In Smiles's "Life of a Scotch Naturalist," I find (p. 332) that "Edward also discovered a specimen of the *Leptoclinium punctatum*, which had been thrown on shore during a severe storm. It was of a most beautiful greenish colour, variegated with steel-blue. This specimen he sent to Mr. Alder, who answered him in the following letter:—"The Ascidian which you sent me is a *Leptoclinium*, and may probably be a new species. There are few of that genus with the star-shaped calcareous crystals embedded in them. The species you have sent me has the star-shaped crystals, and differs in colour from any I have seen, being of a greenish blue colour. I put it into water to moisten it after it came, and it stained the water of a blue colour. I therefore presume that it would be of that colour when fresh." As the habitat of "some of the ascidians is the Indian Ocean, the Red Sea, and the Mediterranean," could this have been the animal from which was extracted the celebrated Tyrian

dye, and have become scarce, and thus the art forgotten, through the scarceness caused by the great demand?—*B.* [No, a species of *Purpura*.—Ed. S.-G.]

SICK CAGE-BIRDS.—I should feel much obliged if any of your readers could suggest a remedy for a Paradise Parakeet which has lost its quill feathers for two years. He is in perfect health, but as fast as any feathers grow they drop out in a diseased state. This merely refers to the smaller; the long tail and wing quills never make any appearance. He is in a large aviary cage, and last summer was turned loose in an attic for several months. He is fed on millet and canary-seed.—*C. J. M.*

MISTLETOE ON LIME-TREES.—There are several flourishing branches of this parasite on the fine Lime-trees in Sutton Park, near Guildford.—*W. R. Tate, Blandford.*

QUERY ABOUT A FLOWER.—Two answers have been given in the July number of SCIENCE-GOSSIP to the question asked by "A. H.," headed as above, in the number for May. "G. S." thinks the plant meant is *Fritillaria imperialis*, which, I think, can hardly be the case, as it is not, so far as I am aware, a British plant at all. In the case of the *Arum*, which W. G. Horn suggests, I think it may be objected that the "tears" which flow from this remarkable flower are not "heaven-collected," and, moreover, the wind does not appear to have much influence in producing them. Does it not seem more likely that the "tall flower" intended by the poet, is the common Teasel (*Dipsacus sylvestris*), the leaves of which are so formed as to compose a kind of cup round the stem, which catches the rain, or, in rainless weather, the dew, so that the plant is never without a certain amount of moisture, and, of course, when bowed by the wind, it scatters the water on the earth around it?—*C. B. M.*

WILLOWS AND SPONTANEOUS COMBUSTION.—Can any of the readers of SCIENCE-GOSSIP explain the reason of a curious fact mentioned in a book, "English Forests and Forest Trees" (author's name not given), published in 1863, I believe, to the effect that the *Willow* is subject to spontaneous combustion? It was stated that a willow in full vigour would suddenly smoulder and begin to consume away; is it occasioned by an accumulation of gases, which take fire from various causes? I have unfortunately mislaid an extract I made of the statement *in extenso*.—*E. Hopkins.*

GULLIBILITY (OR PUGNACITY) OF SPIDERS.—Some naturalists maintain that a spider, if its web is touched or gently shaken, will rush out to seize the supposed prey, whilst others—the late Mr. Rennie included—hold the contrary opinion. The following incident, I think, speaks for the former opinion. Being much annoyed by a *Tegenaria*, which would persist in attaching its web to a burette-stand in my laboratory window, I unstopped a pint bottle of ammonia, and held it close to the web. The spider, instead of decamping as I expected, charged the intruding object with such fury that it nearly fell into the open bottle; but, checking itself just in time, and feeling the influence of the fumes, it fled. Now, the neck of a 20 oz. phial certainly bears no resemblance to any insect or other prey which the spider could ever have met with.—*J. W. Slater.*

A PREDATORY SLUG.—Taking a twilight walk in my garden after a mild, moist spring day, I observed, as I went along, the earthworms slipping into their holes on either side of the path. One huge fellow,

however, remained motionless. On stooping down to find out the reason, I saw that a large grey slug had seized him by the middle and was holding him fast. This proves, I think, that certain slugs are decidedly predaceous in their habits, since there were juicy young seedling plants all around the scene of action, upon which the slimy aggressor might have feasted if so disposed. It is somewhat surprising that so wary and so comparatively swift a creature as an earth-worm should allow itself to be seized by so slow-paced an enemy. Whilst on the subject of slugs and snails, I may remark that I have often found them feasting heartily upon the leaves of the foxglove. This is not merely a good example of the specific character of poisons—what is deadly to one animal being innocent to others—but may deserve the consideration of persons who use snails for food.—*J. W. Slater.*

BREVIPENNATE BIRDS.—I was reading over some back volumes of SCIENCE-GOSSIP the article headed Brevipennate Birds. The author says: "On Jan. 8, 1755, by an order of the vice-chancellor and his co-trustees, it was ordered to be burnt, the head and foot alone escaping destruction." Will you have the kindness to inform me, through the "Notes and Query" column, why this was done? You do not get many queries from so far, I suppose, but I think SCIENCE-GOSSIP is splendid, and a fellow-botanist of mine here thinks the same. Its special merit is its use to amateurs.—*Jas. A. Sandford, Toledo, Ohio.*

THE VETERAN EEL.—Your correspondent "E. L." will perhaps be interested to learn that the eel which has lived twenty-two years in my aquarium died on 1st August, I think of old age. It began to show signs of uneasiness about fourteen days ago, wandering about in a strange, unusual manner in the daytime; but as it managed to eat a loach about three inches long I thought it would be all right in a day or two; instead of which it became worse, seemed more languid and restless, would not bury itself in the shingle, and looked paler than usual. I gave it three small worms, which it ate greedily but did not revive; it did not show signs of distress, as fish usually do when dying, such as gasping, rising to the top of the water to breathe, and turning on their backs, but breathed slowly and regularly, not vigorously. I took it out gently and put it in a bowl, and let fresh water run on it for about fifteen minutes, but it had no effect. I then tested the water; it was as pure as a streamlet, and at a temperature of 65 deg. Fahr., which is not warm for water in summer. I put it into the aquarium again and it swam slowly and gently about, and then resting on the shingle lay still. So it remained for three days, getting paler and breathing slower; its eyes which were so bright and quick, became slimy and dim, I could see that it was all over, in a few hours its life was gone, yet it lay on the shingle in an ordinary way as if resting. It had been a pleasant companion for me for twenty-two years, had witnessed the death of many of his order, and had seemed to learn how to meet the inevitable with a calm philosophy which would have done credit to a higher order of vertebrata.—*Ben Plant.*

POLYZOA IN AQUARIA.—I should be much obliged if some of your readers would kindly give their experience in keeping alive fresh-water Polyzoa in aquaria. I have endeavoured to keep several kinds, *Plumatella repens*, *Lophopus crystallinus*, *Fredisella* and *Paludicella*, but invariably with the same result,—they died in a few weeks after being placed in the aquarium. My microscopic aquarium is but a small one, and that probably may have something to

do with it. That it is possible to keep them appears from Mr. Taylor's book on the aquarium, and from several writers in former numbers of SCIENCE-GOSSIP. I trouble you with less hesitation, as I know I am not alone in my hitherto fruitless attempts. On what and how should they be fed? I should like to know, too, the shape and size of any aquarium in which they have been successfully kept, and how long they have lived.—*A. Solictor.*

BLISTER-BEETLE (*Cantharis vesicatoria*).—In the July number of this magazine, Mr. G. O. Howell wishes to know whether this insect has ever been taken in Britain: it may interest him to know that I possess a specimen which was brought to me alive this summer, found in a garden near this city.—*R. Laddiman, Upper Hellesdon, Norwich.*

HOLES IN THE HEAD OF PIKE.—What is the use of the holes all about the head of the pike (*Esox lucius*)? Mr. Frank Buckland, in his "Curiosities of Natural History," third series, vol. i. p. 151, says, referring to the holes, "I do not think anybody knows." Perhaps some of your numerous correspondents can throw some light on the matter.—*Corylus.*

THE PETREL SPECIES OF SEA BIRDS.—Allow me to correct a typographical error which appears in my paper in the September No. on "The Petrel Species of Sea Birds." I am there represented as affirming that the Stormy and Wilson's Petrel possess two gizzards. What I said in my MS. was, that the stomachs of those birds were true gizzards furnished with scattered glands. The lower part of the oesophagus, which is called the proventriculus, is enormously dilated, and lavishly provided with organs secreting gastric juice. The stomach itself is very small, but the duodenum is peculiarly arched, and the remaining portion of the intestine, where the chyle is absorbed, is long and narrow. In every respect, therefore, it will be seen that the Petrels are amply provided with organs suitable to the digestion of fishy material. I may also mention that these birds sometimes follow in the wake of small fishing-boats, and even, it is said, that they hover in the vicinity of stranded hulks, or about where the masts of a ship indicate the vicinity of a sunken wreck. These facts would seem to demonstrate an innate partiality for the very body or appurtenances of a ship; and the numerous little acrobatic feats (such as hopping for a distance with the feet closely joined, &c.) which they execute upon the storm-vexed ocean, apparently for sheer sport and exercise, evince a liveliness of temperament which would specially relish the buoyant, bending, ever-moving vessel.—*P. Q. Regan, LL.D.*

ARSENICATED WALL-PAPER.—"Gerion" should varnish the green marble paper if afraid of poison, but there is little or no danger to be apprehended from wall-papers, as in nearly every case non-arsenical colours are used in the manufacture. It is only the bright emerald-green papers (such as are used in chemists' shops) that can be considered injurious if the colour rubs off easily. Many celebrated analysts, after testing samples, are of opinion that the majority of paper-hangings containing green are not in the least injurious.—*Paperstainer.*

BIRDS OF LINCOLNSHIRE.—Will any correspondent kindly give me (by letter or otherwise) a list of the common species of birds which are found on the coast of Lincolnshire in the winter months? Any hints as to the time of their appearance and habits will also be gladly received.—*Henry Turner, 90, Albert-road, Holey, Sheffield.*

RAISING AN OBELISK.—The *Graphic* of Sept. 29 gives an account of the mode adopted in raising the obelisk at Paris, and this reminds me of an incident that occurred during the lifting of the celebrated obelisk at Rome. At the instance of the chief engineer the Pope had issued an order that perfect silence should be preserved among the vast crowd, the severest penalties being threatened for the breach thereof. Slowly but steadily the oxen strained at the ropes, which passing over powerful pulleys, were fastened to the upper part of the case which enclosed the monolith—slowly but safely rises the end which is to point to the heavens—the anxiety is intense, but all goes well—the perpendicular is nearly attained, when suddenly the huge mass stops—the oxen have come to the boundary wall and can go no further. Destruction threatens the precious obelisk. In apportioning the length of the ropes to the available space, the engineer did not remember that they would stretch. All is consternation and despair!—when from among the crowd a voice is heard “Acqua! acqua!” The audacious offender is seized and awaits his punishment. But why are the engineer and his men hurrying with those vessels filled with water? Has he comprehended the meaning of that cry Acqua? Yes! the water is poured upon the ropes—the ropes contract—the obelisk attains the perpendicular, and is saved! Shall the man whose exclamation was its salvation endure his punishment? No, the engineer has represented to his Holiness that reward, not punishment, is due to that man: he is graciously pardoned, and informed that any reasonable request he may make will be granted. Who is he? and for what will he ask? He commands a small vessel that hails from Bordighera, a beautiful place on the lovely Riviera, between Mentone and San Remo, and has often brought palm-leaves from thence to Rome for Palm-Sunday; he claims for his native place the monopoly of that supply. His boon is granted, and the palm-leaves of Bordighera make a yearly descent upon Rome.—*M. M.*

MASSACRE OF COLIAS EDUSA.—This butterfly has been seen almost everywhere, even in such barren localities as St. James's Park and Trafalgar Square, but that does not justify the sweeping destruction which it experiences. Many brethren of the net have acted in a manner more like sportsmen than naturalists, and have indulged in what I cannot help calling wanton slaughter. The following facts need no comment. I have heard, on good authority, of a boy who had captured 130 specimens in a very short time. In Darenth Wood, my son was told by a rather rough-looking fellow that he and a party had caught 1,000 in one day in that neighbourhood; and I have seen an advertisement offering to supply perfect specimens, set and carefully packed at 1s. per dozen. If insects were only caught by those who wish to study them, or at any rate to make permanent *bonâ fide* collections, we need not fear the extirpation of any British species. But unfortunately multitudes—including sometimes rarities—are captured to be played with, or to be arranged in circles, triangles, half-moons, &c. And some who act thus pretend to be entomologists.—*J. W. Slater.*

PEREGRINE, RED GROUSE, &c.—I cannot do less than thank Mr. Dixon for his remarks about the Peregrine (*Falco Peregrinus*). It is, however, about the habit of Red Grouse mentioned by me in *SCIENCE-GOSSIP* last August, to which I would draw his attention for a brief period, as, in his remarks on my notice of this extraordinary habit, he brings some very serious charges against me. The first which

I refer to, is the following passage: “If he [myself] would allow himself to remember, that we were once discussing this matter, and that I informed him of this peculiar habit which he now publishes as his own discovery.” The manner in which the above statement is worded, particularly that portion of it in italics, would lead any one to infer that my communication of August last, viz., that my attention was first drawn to this important fact, in the *Nat. History* of the Red Grouse, in the winter of 1875, was a false assertion. Does Mr. Dixon mean to say that I did not see the fact above mentioned? I cannot conceive the uncharitable motives which impelled Mr. Dixon to contradict me so flatly. I was somewhat surprised to see him ask for information respecting the clutches of Sparrow-hawks' (*Accipiter nisus*) eggs! Mr. Dixon himself took clutches of four and three; a friend (Mr. J. Elvidge) and I took one; and another friend (Mr. Armitage), took two sets of two and one from the same nest; of which I have one of the first set. In conclusion, I again aver, that it was entirely by my own investigation that I obtained the information about which Mr. Dixon remarks.—*T. W. Dealy, Sheffield.*

[Mr. Dealy having replied to Mr. Dixon, we must now close this controversy.—*ED. S.-G.*]

MAGPIE, STARLINGS, AND SWIFT.—When I was walking near my father's house on Tuesday, May 15, I saw a magpie and two starlings surround and attack a small bird. I ran to its assistance and rescued it, and found it to be a swift. I took it into the house, and, having given it some brandy, put it outside the window, when it, much to my satisfaction, flew away. Is not it a remarkable thing for a magpie and starlings to attack a swift on the wing?—*S. E. A. W.*

LAPWING AND SPARROW-HAWK.—I beg to communicate what appears to me an interesting, if not an unprecedented, fact. The other evening, at about 7 P.M., when about a mile from the town of Alloa, on the Stirling road, I observed a lapwing, or peewit (*Vanellus cristatus*), pursuing a sparrow-hawk (*Accipiter fringillarius*). The pursuit lasted for the space of four or five minutes, during which the struggle between the birds appeared to be for position, but from first to last the lapwing soared above the hawk, and ever and anon descended and buffeted it. At length, however, the birds reached a wood in which the hawk took shelter, and left the lapwing to return to the meadows on the Firth of Forth, where probably nestled its young. Had there been several lapwings in pursuit, I should have thought the occurrence less worthy of note; but this was a combat between a single bird of each description.—*J. C. Stephens.*

SPOTTED SLUG (*L. maximus*).—A poor slug of this species, which had been crushed in two in the middle, and kept so for hours (unconsciously, of course), was so far lively on being released as to erect its horns and crawl slowly away. Thus this mollusk is very tenacious of life.—*W. H. Warner.*

COMMON SWIFT.—It is said here (Oxon.) that when the Swifts fly at a great rate in small parties, and screaming loudly the while, it is a sign that fine weather will continue.—*W. H. Warner.*

PHENOMENON OF WATER.—May I inquire, through your columns, the cause of a phenomenon, no doubt known to some of your readers, but of which I haven't met with an explanation? If a stream of water, or spirit, be allowed to fall on a surface of the same, numerous globules of liquid (not bubbles of air, since they possess more apparent weight and

momentum than air-bubbles would have) run rapidly over the surface, diverging in straight lines (on a calm surface) from the point of contact. I have seen them glide rapidly for many feet over the surface of a mill-pool. The waves of the sea may be often seen to be covered with them, darting in various directions. They have the appearance of beads of glass, and as soon as they lose a certain momentum immediately disappear, being absorbed into the main body of liquid. Is their separate existence maintained by a thin plate of air interposed between them and the surface of the water, &c., on which they roll?—*G. W., Jun.*

DENSITY OF SEA-WATER.—Your correspondent Mr. Macco admits the probability of misquotation, misprint, or slip of the pen, which is precisely that to which I desired to call attention. In doing so, the giving of "kind advice" I quite disclaim, nor did I think it courteous or otherwise desirable to assume in your previous correspondent either ignorance or forgetfulness of the elementary facts connected with the subject, with which, I suppose, all the world are sufficiently familiar.—*C. F. W.*

BLACKBIRD AND THRUSH.—About the middle of last April, as I was looking round the garden, I found a nest nearly finished, which I thought belonged to a blackbird, but I could not see the female bird. Two days after, looking into the nest, I found four eggs, all just like a blackbird's, except that one egg had the deep claret spots of a thrush; the female, being still very wary, had flown away before I could see her. Two or three days after, I again visited the nest and found that the bird sitting was a thrush; she was then very tame, for she let me watch her, standing within a few feet of her nest, and showing no signs of fear. The last week in April the eggs were hatched. I was unable to watch her again for ten days when, to my regret, I found only one young bird remained. The old bird was then very restless, flying all round me, but never going more than ten yards from her nest, and uttering incessantly a single, low, plaintive note. I had then ample opportunity of watching her, and can state with certainty that she was a Song Thrush (*Turdus musicus*). As soon as ever the young bird was able to fly, both the mother and her offspring disappeared. I saw the blackbird come and sing to her once, standing on a tree close to the nest. I see no reason why this blackbird should mate with the thrush, as there are plenty of blackbirds all around us, so that it could not be for want of one of its own species. Perhaps some of the correspondents of SCIENCE-GOSSIP will kindly give me some information on this subject.—*G. T. B.*

SPAWN OF NEWTS.—I have found the eggs of newts, not wrapped up, but deposited on stones or other convenient objects. Several of these I preserved until they were hatched out, when they fed freely on entomostraca, which they would catch by first lying still and then suddenly darting upon them. As the bodies of young newts are very transparent, many of your readers would doubtless find them to be interesting objects for observation during the coming spring.—*T. C.*

NORTH WINDS.—Before this question can be answered, it must be known whether the plants facing the north are situated on elevated ground and those facing the south in a valley, for if so it is quite in accordance with experience that the latter should, during calm serene nights, suffer from frost, although facing the south, whilst the former, under similar conditions of sky and air, would escape, in consequence of their position affording them a higher

temperature, although on the north side of a hill.—*C. C. Haviland.*

THE SUN.—The "little black balls rising out of the sun," observed by "Pater," were no doubt the effect of the insensibility to light produced on the retina by gazing at the sun. If one looks at the sun for a second or two, and then looks away, a black spot of about the same size as the sun will be seen. A similar effect is produced by looking at a red wafer on a sheet of paper; only in this case the spectral wafer appears of the complementary colour, green. I have observed the phenomena mentioned in his second query,—that plants on the north side of a garden are often less injured by frost than those on the south side. This is probably due to the fact that they are more screened from the sun. Plants often suffer not so much from frost as from alternations of frost and sunshine.—*R. H. N. B.*

"ALKANET.—This plant yields a red dye. The name seems to have been transferred from the Arabic name of another plant, also yielding dye, called *Henna*."

NOTICES TO CORRESPONDENTS.

TO CORRESPONDENTS AND EXCHANGERS.—As we now publish SCIENCE-GOSSIP at least a week earlier than heretofore, we cannot possibly insert in the following number any communications which reach us later than the 8th of the previous month.

J. H. (Idle, near Leeds).—The slide you sent us of Diatoms found at New Brighton, contains *Rhabdonema arcuatum*, *R. minutum*, and *Navicula tibellus*.

J. FRENCH.—You had best get the volumes on "Humming-Birds" (illustrated), price 9s., published in the "Naturalist's Library," Hardwicke & Bogue, 192, Piccadilly. They will furnish your American friend with all the information he wants.

T. P. B.—The specimen you sent is the chrysalis of the Death's-head Moth (*Acherontia atropos*).

C. C. (Coventry).—The specimen you enclosed in the envelope is an umbelliferous plant, *Astrantia major*.

H. A. FRANCIS.—No small tube containing Diatoms has as yet reached us.

H. J. R. (Westbury).—*Origanum vulgare*, frequent in Limestone districts.

A. H. B. (Wallingford).—Gipsywort, or *Lycopus Europæus*, L.

J. P. G.—You are quite right; it is *Habenaria albidia*. It differs much in size, and frequently the flowers are but faintly perfumed.

J. B. B. (Dudley).—It is *Spirea salicifolia*. Borrer believed it to be naturalized in the locality where you found your specimen. We have seen it both luxuriant and abundant on the margin of Lake Miosen, Norway.

A. P. (Doncaster).—The seedling fern is *Cystopteris fragilis*. It does sometimes produce bulbs on the margin of the pinnales.

C. U. (Croydon).—Your specimen is merely the bracts from beneath the flower. Could you kindly send us a more perfect example? then we could name it with certainty.

M. J. W.—We have not received any sea-weeds from you. If you have others, please to send them. We are constantly losing specimens which have been sent, through correspondents packing them in paper boxes, or match-boxes, or some other similar substances. Not only so, but these frail protections have the stamp placed on them, instead of on a label, the result being a smash the first time the Post-office clerk operates on them. Glass microscopic slides for naming are even foolishly put in envelopes! An editor soon becomes acquainted with practical physics!

IMPORTANT TO EXCHANGERS.—In one of those moods which only Postmasters-General indulge, it has been ordered that all letters addressed with initials only will be returned to the senders after October 1st, 1877. We sincerely hope the safety of the British empire is not endangered by correspondents of SCIENCE-GOSSIP, who desire to exchange one species of butterfly for another!

J. M. (Huddersfield).—From what we can make of your drawings, there is no doubt one is one of the genera of Starfishes called *Asterophyton*; the other drawing is that of a genus of sponges called *Halichondria*.

T. W. D.—The reason your reply was not inserted is, that the number was made up for the printers before your MS. arrived.

J. B.—R. Damon, of Weymouth, would supply you with any species of foreign shells you may require.

R. H. STEVENS.—The mineral sent is a lump of *Calcite*, or Calcic Carbonate, which assumes an enormous number of crystallized forms.

TO AUTHORS.—We have numerous manuscripts standing over, all of which are desirable articles; but as we can only insert a certain number each month, we are obliged to hold them over at our discretion. Should any writer desire his returned, we shall be happy to return it (if he cannot wait) on receipt of postage.

MISS A. W.—The fungus sent is *Agaricus procernus*, an edible species. After Cook's "Plain and Easy Account of British Fungi," you had better get his "Manual of British Fungi," in 2 vols., published at a guinea, by Macmillan.

W. A. CLARKE.—Your caterpillar had taken advantage of its dry journey by post to us to partially enter into the chrysalis stage. It is the caterpillar of the Poplar Hawk-moth (*Smerinthus populi*).

F. RAM.—Your fungus is undoubtedly a specimen of the Great Puff-ball (*Lycoperdon giganteum*). It is not uncommon in the Eastern counties, although rarer outside. We have seen several this summer quite as large as that you describe.

G. F. BENJAMIN.—There is no doubt your specimen is that of the Great Green Grasshopper (*Acrida viridissima*).

A. G. A.—The objects on the back of leaf sent to us are not *fungi*, but "oak-spangles," formed by an insect, a species of *Cynips*. See "Half-Hours in the Green Lanes," pp. 196 and 197.

EXCHANGES.

FOR fac-simile of "Warrant to Execute Charles I.," send rare British birds' eggs.—J. A. Wheldon, South Parade, North-allerton.

WANTED, Nos. 7, 9, 10, 11, 14, 15, 16, and 17 of the "Entomologist's Monthly Magazine" (the first four belonging to the first volume, and the others to the second volume). For numbers of the third volume, microscopic slides, or cash, or would like the first and second volumes, or either of them.—C. F. George, The Grove, Kirton Lindsey.

FOR *Douax anatinus*, *Venus exoleta*, *Nassa reticosa*, *Purpura lapillus*, *Trochus clineus*, or *Limnea stagnalis*, send any land or fresh-water shell to A. H., Springfield House, Spring Bank, Hull.

L. C.—7th ed.—Nos. 181, 812, 858, 923, 986, 1054, 1128, 1263, 1274, 1281, 1318, 1595. For Nos. 2, 3, 4, 15, 17, 286, 287, 420, 420, 421, 432, 433, or others, J. Comber, Southgate House, Winchester.

GOOD specimens of *P. machaon*, *C. hyale*, *C. edusa*, *A. adippe*, *T. quercus*, &c., for *G. album*, *M. bombyliiformis*, *M. factiformis*, *P. comma*, &c.—Address, H. T. Preston, Esq., Heatherfield, Bourne-mouth, Hants.

FOR slide of Diatoms, send slide of interest or material—Eg-sea soundings preferred—to T. Combridge, 5, Norfolk-street, Brighton.

WHITE'S "Natural History of Selborne," Bohn's edition. Wanted, live Lizards, or *Lepidoptera*.—J. E., 21, Dorset-road, Anfield, Liverpool.

WANTED, samples of New Nottingham and other good foreign Diatomaceous deposits. Two co. Antrim Earths and well-mounted Slides to offer in exchange.—Communicate with W. A. Firth, Whitecroft, Belfast.

WANTED, Nos. 141, 1244, 1247, 1494, 1418, 731, for Nos. 1220, 1221, 1222, 1223, 1220, 1243, or *Charnus*.—Rev. F. H. Arnold, Fishbourne, Chichester.

FOR pieces of *Fuflura foliacea* and Peacock Copper-ore, send stamped directed envelope, and Diatoms or other unmounted object, to G. W. Harfield, 24, Ryde-villas, St. Mary's-road, Peckham, S.E.

WANTED, Nos. 191, 560, 714, 386, for other plants.—Address, M. King, 120, Pitt-street, Bonnington, Edinburgh.

RARE Lias Fossils (*Montlivaltia*, *Victoria mucronata*, *Waldeimia Lycetti*, &c.), for books, papers, or magazine articles, on Lias.—W., 72, High-street, Banbury.

DUPLICATES:—*Polychloros*, *Jo. Z. trifolii*, *Filipendula*, and *L. dispar*.—Desiderata, very numerous to end of *Noctuae*,—H. Jones, Hawley, Farnborough Station.

A REAL Colorado Beetle sent in exchange for any good Entomological Slide.—J. C. T., 4, Lord-street, Liverpool.

"HOOG on the Microscope," and Mahogany Section-cutter, faced and lined with brass, for Carpenter's "Microscope and its Revelations," 2-inch Objective, Compressorium, or Double Nose-piece, &c. Will pay cash for extra value, if any. List of duplicate mounted Microscopic objects exchanged.—H. Morland, Cranford, Middlesex.

LONDON CATALOGUE, 7th ed.—Nos. 3, 97, 1306, 185, 206, 213, 361, 386, 515, 608, 753, 831, 944, 1059, 1092, 1263, 1516, 1537, for others.—Thomas Whitelegg, 58, Hillgate-street, Hurst Brook, Ashton-under-Lyne.

DUPLICATES:—*Edusa*, *Cardui*, *Atalanta*, *Io*, and *Dispar* (bred).—Desiderata:—*Sinapis*, *Cratagi*, *Paphia*, *Aglaia*, *Adippe*, *Lucina*, *Artemis*, *T. quercus*, *Betule*, *Rubi*, *Adonis*, *Argiolus*, *Alsus*, *Fagon*, *Coinia*, and *Alveolus*.—J. B. Pilley, 2, High Town, Hereford.

SOME splendid living Chrysalides of Death's-Head, *Acherontia Atropos*, to exchange for Microscopical injections.—W. Lane, Sear, Margate.

FOR slide of Diatoms, send object of interest, mounted, or good material, to T. Combridge, 5, Norfolk-street, Brighton.

DIATOMACEA, slides of, to exchange for injections or others.—T. B., 7, Spencer-street, London, E.C.

WANTED to borrow for a short time, "Entomologist's Monthly Magazine," vols. 1, 3, 4, 5, and 6; Newman's "Entomologist," the first 4 vols.; or the whole series of the "Naturalist," conducted by the Rev. F. O. Morris.—W. Denison Roebuck, 9, Sunny Bank, Leeds.

LIVE Moths wanted by J. E. Palmer, Lucan, co. Dublin.

DUPLICATES.—*Edusa*, *Cardamines*, *Ægeria*, *Semele*, *Atalanta*, *Polychloros*, *Paphia*, *Adippe*, *Jacobaa*, *Pyramidea*, *Spona*, &c.—Desiderata:—Local *Diurni*, *Ocellatus*, *Tilka*, *Atropos*, the *Sesidae*, many *Noctuae*, and *Geometra*.—H. C. Dent, 20, Thurlow-square, London, S.W.

LONDON CATALOGUE, 7th ed.—Offered, Nos. 335, 370, 372, 457, 568, 593, 598, 600, 766, 831, 999, 1140, 1265, 1282, 1327, 1387, 1480, for Nos. 325, 360, 367, 396, 566, 594, 588, 590, 746, 832, 1000, 1141, 1301, 1287, 1339, 1388, 1515.—E. D. C., 25, Oxford-road, Kilburn, London.

BARBADOES Earth, from Cambridge Estate, rich in *Polycistina* and *Spicula*, in exchange for first-class Balsam-mounts, at the rate of six slides per ounce.—Dr. Griffin, 66, Kingsdown Parade, Bristol.

H. erictorum, for other land or fresh-water shells; or *Ianthina communis*; latter especially desired.—J. B., 9, Royal-terrace West, Kingstown.

WANT to exchange good Limestone Corals for any other good fossil.—J. Mackenzie, Nursery Cottage, Huddersfield.

LONDON CATALOGUE, 7th ed.—Nos. 81, 82, 97, 98, 100, 111, 133, 141, 144, 177, 258, 280, 319, 354, 1342, 1349, 1447, 1448, 1502, &c., for other rare Plants, Mosses, or British Shells.—Lists to W. E. Green, 24, Triangle, Bristol.

WANTED Silurian and other Fossils. Geological exchange given.—Address, J. T. A., The Quay, Selby, Yorkshire.

ONE or two dried specimens of the *Menziesia carulea* and other Highland plants. I wish rare English plants in exchange.—A. Crawford, Norwood Lodge, Bridge of Allan, N.B.

STRONG-ROOTED leaves of various Gloxinias and seedling *Streptocarpus biflorus*, in exchange for other stove subjects, cuttings or otherwise; also some Achimenes bulbs.—G. Pim, Monkstown, co. Dublin.

WILL send Wings of Wasp (hooked together), *Phragmidium bulbosum*, &c., in exchange for other mounted micro. objects.—H. Stily, High-street, Yeovil, Somerset.

DUPLICATES.—*Adippe*, *Aglaia*, *Paphia*, *Sibylla*, and *Hemuli*.—Desiderata:—*Hyale*, *Cassiope*, *Orion*, *Paniseus*, *Acteon*, and many others.—C. Malyon, Lewisham, S.E.

BOOKS, &c., RECEIVED.

"American Naturalist."	September.
"Potter's American Monthly."	"
"Scottish Naturalist."	October.
"The Naturalist."	"
"Popular Science Review."	"
"Monthly Microscopical Journal."	"
"Land and Water."	"
"Feuille des Jeunes Naturalistes."	"
"Ben Brierley's Journal."	"
&c.	&c.

COMMUNICATIONS HAVE BEEN RECEIVED UP TO THE 9TH ULT., FROM:—F. K.—T. F.—J. C.—W. G.—Dr. J. H. G.—A. H.—C. F. G.—H. T.—P. S.—W. B. N.—J. A., Jun.—J. W. S.—W. H. W.—W. H. G.—E. W. W.—J. M. W.—J. C.—E. L. R.—H. C. D.—A. W.—R. L.—J. A. W.—M. M.—H. W. K.—W. E. G.—R. J. G.—J. F. P.—T. S.—F. K.—S. C. S.—T. K.—C. T. M.—F. A.—J. C.—J. H.—R.—A.—P.—J. C.—R. H. M.—S. A.—B.—E.—T.—B. W.—C.—N.—C. R. V.—T. B. P.—J. L.—M.—T.—W. J. H.—H. P. M.—J. E.—W. A. F.—F. H. A.—G. W. H.—M. K.—H. J.—H. M.—J. C. T.—W. L. S.—T. W.—J. B. P.—T. C.—J. B.—W. D. R.—J. A., Jun.—C. B. R.—A. H. P.—E. W. W.—E. E.—W. J. B.—C. W. M.—J. W.—A.—W.—C. O. H.—C. B.—H. T.—J. E. P.—J. W. C.—J. T. T. R.—Dr. F. V. P.—C. M.—Dr. E. D. C.—S. E. B.—H. C. D.—G. C.—S. B.—J. M.—T. W. D.—T. B. W.—R. W. C.—E. F. C.—F. W. G.—J. B.—Dr. G.—A. B.—W. S. G.—J. J. M.—W. V. A.—J. R. N.—F. R.—Capt. T. W.—B. J. T.—A. J.—C. R. H. S.—G. P.—M. G.—W. A. C.—J. F. R.—H. W. K.—A. C.—A. G.—M. G. F. B.—H. S.—H. M.—H. R.—R. T. G.—E. L.—A. S.—R. S. M. G., &c., &c.



THE HARD PARTS OF ANIMALS.—No. II.

BY DR. H. F. PARSONS, F.L.S.



In the Subkingdom Mollusca, the Bryozoa in external form closely resemble the Polypes, from which they have only of late years been separated. They have a common horny polyplidom closely resembling that of the Hydrozoa.

The Tunicata or Sea-squirts have no hard parts, but are enclosed in a leathery tunic, which deserves mention in this place on account of its remarkable chemical composition, being composed of cellulose, a non-nitrogenous substance which enters largely into the composition of plants, but which is hardly known to occur elsewhere in the animal kingdom.

In the Mollusca (with which I include the Brachiopoda) the integument or mantle very often secretes a calcareous shell which is considered to be a calcified epidermis. It consists of a basis of animal membrane, hardened by carbonate of lime. If the carbonate of lime be dissolved away by an acid, a soft flexible membrane is left, which exhibits a structure similar to that of the shell. Those Mollusks which have no distinct head, the Brachiopods and Lamellibranchs, are provided with a two-valved shell; the shell, however, presents marked differences in the two classes. In the former the shell is always equilateral but never equivalve, the valves are back and front, the ventral valve being the larger, and frequently prolonged beyond the other into a beak perforated at the end for the passage of a muscle by which the animal attaches itself to a rock. In the Lamellibranchs the shell is generally equivalve, but rarely equilateral, the hinder end being generally produced. The valves are right and left; the valves are closed by one or two powerful muscles, and opened by the recoil of an elastic ligament and a cartilaginous cushion, so that when dead the shell gapes. In the Brachiopoda the shell is both opened and shut by muscular effort. The Brachiopods have spiral fringed arms, which in some

of the fossil forms were supported by slender watch-spring-like processes of the shell. The structure of the shell consists of flattened prisms which lie very obliquely to the surface. In many of the species the shell is perforated by numerous minute canals containing prolongations of the mantle.

In the Lamellibranchs, the shell has two layers, the outer being made up of prismatic fibres, placed nearly perpendicular to the surface, the inner, or nacre, being laminated, and frequently reflecting iridescent colours. The shells of the headed Mollusks consist of a single valve, of a conical shape, and generally spirally coiled; in the Gasteropods, the spiral is generally drawn out on one side, most frequently the right; in the Cephalopods, the spiral is usually flat and symmetrical, as in the Nautilus. The structure of univalve shells resembles that of the inner layer of the bivalves. Some of the Gasteropods are without shells, others, as the slugs, have a thin shell embedded in the mantle.

In the higher Cephalopods, as the cuttle-fish, we begin to find an approach to vertebrates in the possession of an internal skeleton. The cuttle-fish bone is well known: it is calcareous, and its structure is very curious. It consists of flat plates parallel to the surface, the interstices being occupied by flexuous laminae at right angles to the others, like narrow strips of corrugated iron cut in a direction across the folds, and standing on edge between flat plates: this form combines strength with lightness. The Belemnite had an internal skeleton consisting of an elongated guard of a radiating fibrous texture, pointed at one end, and hollowed at the other into a conical cavity, in which was lodged a chambered internal shell or phragmacone; at the upper end it was prolonged into a horny wing-like expansion.

We are now arrived at the highest or vertebrate sub-kingdom. In this sub-kingdom, phosphate of lime takes the place of carbonate as the hardening material, the latter being seldom met with, though the shell of the eggs of birds is an instance. The hard parts of the body are grouped into two systems, the internal skeleton and the dermal skeleton. The

internal skeleton consists of a chain of bones, called vertebræ, in the axis of the body, and of appendages called limbs, never more than four. Each vertebra has a central mass, the "body," from which, in a typical vertebra, spring two arches—a dorsal arch, which, with the corresponding arches of the other vertebræ, forms a canal for the lodgment of the principal mass of the nervous system, the brain and spinal cord,—and a larger ventral arch, which encloses the principal blood-vessels of the body and the alimentary canal. Three, or perhaps four, vertebræ at the anterior end of the body are expanded and modified to form the skull, which contains the brain. The vertebræ from which the hinder limbs spring, are often fused together into a mass, called "os sacrum," and the vertebræ of the tail are often reduced to a body, and nothing else, the arches being absent,—as, indeed, the ventral arches are in most vertebræ. Except in the skull and sacrum, the vertebræ are jointed together by means of interlocking processes and an elastic fibro-cartilaginous pad, allowing a little motion between each vertebra and the next. They vary in number, from eight in some of the frogs to many hundreds in snakes. The limbs are not attached directly to the vertebral column, but to intermediate bones; they consist of long bones so jointed together as to allow of a large amount of movement.

The materials of which the internal skeleton is composed are cartilage and bone.

Cartilage is the substance of which the skeleton consists in the early stages of development of all vertebrate animals, and permanently in some of the fishes, as the sturgeon and lamprey. It is also met with throughout life in certain parts of the body, where firmness is required, yet with a certain amount of flexibility, as in the ribs, covering the ends of the bones where they form joints, in the larynx, ear, &c. Cartilage consists, chemically, of chondrin, a nitrogenous substance allied to gelatine, but scarcely dissolved on boiling. Microscopically, it consists of cells embedded in a matrix. In what is called simple cartilage, as that of the mouse's ear, the matrix is absent, or only just sufficient to bind the cells together, so that the microscope shows a mass of cells very like vegetable pith. In hyaline cartilage, as that of the ribs, the matrix is clear and structureless; in fibro-cartilage, the matrix is made up of white or yellow elastic fibres. When cartilage undergoes conversion into bone, the cells multiply and increase in size; they then arrange themselves in rows perpendicular to the surface of the bone. Particles of phosphate of lime then become deposited in the matrix, while the cells are believed to be converted into the "lacunæ" of bone. The flat bones of the skull are not formed from cartilage, but commence as a radiating network of bony fibres between two layers of membrane.

Bone consists, chemically, of $\frac{1}{3}$ by weight of gelatine and $\frac{2}{3}$ of earthy matter, mostly phosphate of lime. If we burn a bone in an open fire, we get a white,

brittle, earthy residue retaining the shape of the bone. If, on the other hand, we soak a bone in acid, we dissolve out the earthy matter and find the animal matter left, so that the bone becomes soft and flexible, like cartilage. The animal matter of bone, unlike that of cartilage, is readily soluble in water, especially when digested with it at a high temperature, as in making soup and glue. Cartilage contains no blood-vessels; bone, on the other hand, is highly vascular. The blood-vessels in the compact parts of bone run in channels termed Haversian canals, around which the laminae, of which the bone is made up, are arranged concentrically. Throughout the substance of the bone are scattered small cavities, called lacunæ, from which proceed extremely fine branching-tubes, called canaliculi. The lacunæ are arranged in concentric circles around the Haversian canals, with which the canaliculi are connected at their inner ends, while externally they anastomose with those of the next circle; thus a system of channels is formed for the nutrition of the bone.

Bones are of three classes, long bones, flat bones, and short bones. The long bones are found in the limbs; they have a more or less cylindrical hollow shaft of compact bone, and an expanded head of loose spongy bone at either end, the surface of which, where it enters into the joint, is covered with a layer of smooth cartilage, to break shocks, and enable the bones to glide easily one upon another. The flat bones, as those of the skull, have two layers of compact bone, with an intermediate spongy layer. The short square bones are composed of spongy tissue.

The nutrient blood-vessels enter the bone in three ways. 1st. Through a single large oblique canal near the middle of the shaft of long bones. 2nd. Through a series of holes at the articular ends, which convey blood-vessels into the spongy tissue. 3rd. Through a tough vascular membrane which lines the whole surface of the bone, and from which minute blood-vessels pass into its substance.

Bone has no power of interstitial growth, but can only increase in size by additions to its exterior. Consequently, in order to allow a bone to increase in length, the articular ends of long bones are ossified from independent centres, a layer of cartilage intervening between the bony ends and the bony shaft; by the growth of this layer the bone is increased in length, and it is not until adult age is reached and growth has ceased that the bone becomes welded into a solid piece.

The dermal skeleton or skin is, in different classes of animals, of very different degrees of density, from the hard bony scales of the ganoid fishes and the crocodile to the soft moist naked skin of the frog; but we almost always find it, in some parts of the body at least, modified into hard appendages, as nails and hoofs, scales, horns, and, what you will perhaps be surprised to hear mentioned as parts of the skin, teeth.

The deep portion of the skin, the "true skin," is a fibrous network; the superficial part is a cellular layer, called the cuticle. At the junction between the two is the "basement membrane," the seat of active growth, often thrown into ridges or papillæ. The cells, or epithelium, of which the cuticle is composed, are formed here. They are at first soft and gelatinous, but as they approach the surface, they become flattened hard horny scales, and they are at length cast off.

In amphibians, the skin is naked; in fishes and reptiles, covered with scales; in birds, with feathers; in mammalia, with hair. The scales of fishes are classed in four groups, placoid or plate-like, as in the shark; ganoid or enamelled, as in the sturgeon; cycloid or circular, as in the salmon; and ctenoid or comb-like, as in the perch. Each scale is embedded in a sac of the cutis. The cycloid and ctenoid scales, which are met with in the fishes with a bony skeleton, are of a horny texture. The placoid and ganoid scales are found in those fishes which have a cartilaginous vertebral column. The scales are hard, and composed either of bone, or of dentine, like that of teeth; the ganoid scales are also covered with a shining enamel. The scales of the Crocodile are plates of bone covered with a horny epidermis; the bony plates are curiously pitted, as if the top of the little finger had been pushed into them when soft.

Hairs consist of elongated and flattened epithelial scales. They spring from a single large papilla at the bottom of a sheath,—an inversion of the basement membrane, which may be compared to the finger of a glove pushed inside out, all but the tip, the latter representing the papilla. In the Hedge-hog and Porcupine, the hairs are very large, strong, and pointed, forming the well-known quills; they are hollow internally, and divided into a number of chambers by transverse and radiating partitions. The feathers of Birds are simply large pinnate or bipinnate hairs; they are developed from a large papilla or pulp; this is vascular in the young state, but in the full-grown feathers the base of the quill contracts around the root of the papilla, so as to cut off its supply of blood and stop further growth. The human nail consists of compact layers of flattened epithelial scales resting on close rows of fine papillæ. The hoofs of Ungulates and the claws of Carnivorous Animals are modified nails, and consist of compacted epithelium; that of the Horse springs from a layer of papillæ, which form flat laminæ, like the leaves of a book; this layer is plentifully supplied with blood-vessels and nerves, forming an important organ of sense, by which the Horse makes himself acquainted with the nature of the ground on which he treads. Horns are of three classes; the antlers of the Stag consist wholly of bone; they are covered at first with a soft skin, which dries and peels off; they are shed and reproduced every year, the horn of each year having one branch more than that of the year before. The horn of the Rhinoceros is wholly an epidermic

structure, resembling in microscopic characters the hoof of the Horse; it is not shed. The horn of the Cow consists externally of hard epidermis, but it has a bony core springing from the skull; between the two portions there is a layer of soft vascular tissue, which bleeds profusely when injured.

Horn, in its chemical nature, is allied to gelatine and chondrine; it contains sulphur. It is quite insoluble in water, but has the property of becoming soft when heated. It strongly rotates the plane of polarization of light, hence sections of horn are among the most brilliant of polariscope objects.

The horny plates or strainers of the Whale, the so-called whalebone, are epidermic organs, and in structure may be compared to large compound masses of compacted hairs, the ends of which alone are free, forming a fibrous fringe.

Teeth are found in most Vertebrates, except Birds and Turtles, in whom the jaws take the form of a horn-covered bill. In the higher Vertebrates the teeth are confined to the jaw-bones, but in many Fishes they are found on the palate as well, and indeed in some, as the Skate, the scales over the general surface of the body exactly resemble teeth both in form and structure. In Fishes and the lower Reptiles the teeth are united to the jaw and indefinite in number, being continually shed and reproduced. In the Crocodile and the Mammalia the teeth are implanted in sockets in the jaw. In most Mammalia we find four classes of teeth, incisors, canines, præmolars, and molars. There are two sets, a temporary or milk set and a permanent set. Each tooth has a body, an exposed crown, and one or more fangs implanted in the jaw. In the centre of the tooth is a cavity containing a soft pulp plentifully supplied with blood vessels and nerves through a minute hole at the apex of the fang. Teeth are highly sensitive; not only are they, when diseased, the seat of acute pain, as most of us have probably experienced to our sorrow, but they are important organs of touch; a gritty particle, however minute, getting between the teeth, is at once detected.

The structure of teeth is somewhat complicated. In each tooth there are three different hard tissues, the dentine or ivory, the enamel, and the cement. The ivory constitutes the main bulk of the tooth; it is composed of fine parallel wavy branched tubules; in the centre of the tooth there is a cavity, containing a soft vascular pulp, slender prolongations of which are continued into the dentinal tubules. The enamel forms a hard cap covering the exposed crown of the tooth; it consists of prismatic wavy striped fibres arranged perpendicularly to the surface; it is intensely hard. The cement covers the fang, that part of the tooth which is embedded in the jaw bone; it is of a yellowish colour, and softer than the dentine and enamel; under the microscope it shows lacunæ and canaliculi like those of bone: in old people it becomes thicker, and is traversed by Haversian canals.

This arrangement of the structures of the tooth is modified in many of the lower animals; in the Rodent or gnawing animals, as the Rat, the enamel, dentine, and cement are arranged in parallel layers; in order of hardness, the enamel, the hardest, being in front, the dentine in the middle, and the softer cement behind; hence the tooth, as it wears away, always preserves a sharp chisel-like edge. In Herbivorous Animals, as the Horse and Elephant, the dentine, enamel, and cement in the molar teeth form a series of parallel plates the unequal wear of which preserves a rough surface for grinding.

Teeth are formed, like hairs, from papillæ of the skin, or "mucous membrane" as it is termed when it lines the cavities of the body. In the embryo, at an early period, a groove is formed along the summit of the gums; this groove is then divided by transverse folds into a number of separate cells at the bottom of each of which is seated a papilla, the germ of the future tooth. The edges of the cell then grow over and convert them into shut sacs. The papillæ then take the form of the future tooth, and the surface becomes calcified, forming the dentine, while the base continues for a time to grow; when, however, the tooth has attained its full size the base of it closes around the root of the papilla, preventing any further increase in length, and leaving only a minute hole through which the vessels and nerves of the tooth pass. In certain cases, however, as the incisor teeth of the Rodents, and the canine teeth or tusks of the Elephant and other animals, this contraction of the base of the papilla does not occur, so that the tooth continues to increase in length for the whole of life, unless worn away by use. The enamel is probably the calcified epithelium of the inner surface of the tooth sac. The second set of teeth are formed in secondary sacs given off from the sacs of the milk teeth. The molar teeth however are exceptions, the first molar is formed in a primary sac like the milk teeth, but the second and third molars are formed in secondary sacs, successively given off from that of the first molar. Hence the first molar of the second set is developed like the teeth of the first set, which will perhaps account for the fact that it is usually the first tooth to decay.

In conclusion, I may remark that in no part of the animal body do we find more obvious and beautiful adaptations of structure to functions than in the hard organs.

The hard organs, being the most easily preserved parts of the body, are of the greatest value to the Zoologist and Palæontologist in determining the structure, habits, and affinities of existing and extinct animals. This value is due especially to the fact that they constantly exhibit characters from which the anatomy of the soft parts may be ascertained, as holes

for the passage of vessels and nerves, rough marks for the attachment of muscles and ligaments, &c. From the shape of the bones of the limbs the mode of progression may be ascertained, from that of the teeth the nature of the food, and so on. To the Palæontologist the hard parts are all important, for they are almost the only data which he has for obtaining any knowledge of the past inhabitants of our earth. Thus, of the early representatives of orders of animals composed wholly of soft tissues, as the Entozoa and Tunicata, we know nothing; whereas our knowledge of the Corals, Echinodermata, Brachiopods, and Reptiles, would be small compared to what it is, did we not take into consideration fossil as well as existing forms.

NOTES ON TERATOLOGY.

EXAMPLES of floral proliferation, or monstrosities in the vegetable kingdom, are often met with in one form or another; probably lateral proliferation is of more common occurrence than the median form. In one of the old stained-glass windows in the Bodleian picture-gallery at Oxford is a representation of a ranunculus, affected with median floral proliferation. It would appear from this that they have attracted a little attention.



Fig. 199. Cohesion of Leaflet in *Clematis*.

Some forms are very interesting; those figured above are worthy of notice. We are indebted to the kindness of our correspondents for the specimens. We also give an example of the cohesion of the margin of leaves. Dr. Masters gives a similar specimen of pelargonium leaf. The one here figured is more

rare ; it is the leaf of Traveller's Joy, or *Clematis vitalba*. Not unfrequently in some species the margin



Fig. 200. Floral Proliferation in Cowslip.

is joined the whole length, thus making a perfect pitcher-shaped leaf. It happens often on the lime-

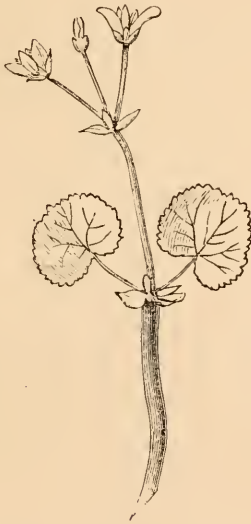

Fig. 201. Proliferation of *Pelargonium*.

tree (*Tilia*). It is reported a tree of this kind is growing in the cemetery of a Cistercian monastery at Sedlitz, on which certain monks were once hanged ; hence the legend has arisen that the peculiar form of the leaf was given in order to perpetuate the memory of the martyred monks.—*James F. Robinson, Frodsham*.

GIGANTIC DINOSAURIA.—Prof. Mudge has announced his discovery, during the past summer, of a new species of gigantic *Dinosauria*, in Colorado.

A FOSSIL FUNGUS.

THE potato disease is no new thing ; for Mr. Worthington Smith has discovered a fossil species belonging to this genus, which was found ramifying through the vascular structure of a *Lepidodendron*, one of the huge club-mosses of the Carboniferous epoch. Mr. Carruthers, of the British Museum, first noticed the fungus in a slide prepared to show the vascular structure of the axis of *Lepidodendron*. Mr. Smith has now discovered another specimen. The first contained both the mycelium and oogonia of the fungus, which he has named *Peronosporites antiquarius*. He believes that both the specimens belong to the same species. This is perhaps the oldest fungus on record. Mr. Carruthers had previously recognized the mycelial threads of a fossil species in the cells of a fossil fern found in the Eocene beds of Herne Bay ; and this comparatively late form was also ascribed to the genus *Peronospora*. The well-known botanist, Robert Brown, also discovered the mycelia of a fossil fungus many years ago.

Mr. Smith read a paper on this remarkable carboniferous fungus at the Woolhope Club early in October, which paper was printed at length in the *Gardener's Chronicle* shortly afterwards. He there stated,—“ I believe that the fungus I have named *Peronosporites antiquarius*, in the scalariform axis of the stem of a *Lepidodendron* from the Coal Measures, has up to the present time only been examined in a somewhat slight manner, and has never been searchingly looked into. No description, except that of a *Mucor*, also from the Coal Measures, has hitherto been published of any well-defined fungus belonging to the Palæozoic series of rocks. It is, however, possible that a paper in the *Annals and Magazine of Natural History*, 4th series, vol. iv. 1869, p. 221, and tabb. ix. and x., describes and illustrates a fungus of a somewhat similar nature with my *Peronosporites*. The paper in question is communicated by Messrs. Albany Hancock, F.L.S., and Thos. Atthey, and purports to describe five species of ‘Archagaricon’ from the Cramlington black shale. The authors state that the fossil fungus has been found at Newsham and in other localities. They, however, describe ‘lenticular swellings’ with a ‘reticulated surface,’ which I have never seen, and spore-like bodies within the mycelium, which is clearly an error of observation. The authors also refer their plant to *Sclerotium stipitatum*, and they say they can find no ‘important difference’ to distinguish this latter plant from their coal fungi. Of course, *Sclerotium* is not a fungus at all, but a mass of condensed mycelium, and the Cramlington plants do not resemble *Sclerotia*.

“ One of the most instructive groups of threads and fruit, or, more properly speaking, mycelia and zoosporangia (or oogonia), as seen within the vascular axis of the *Lepidodendron*, is shown in fig. 204, enlarged 250 diameters. Beginning with the mycelium,

a close examination of this shows that it is furnished with numerous joints or septa. If, therefore, any reliance is to be placed upon the modern distinguishing characters of the now living species of *Peronospora* and *Pythium*, as furnished by a septate or non-septate mycelium, then the fossil parasite belongs to *Peronospora*, and cannot belong to *Pythium* or any of the *Saprolegniæ*. The oogonia do not agree with those of *Cystopus*. Within many of the fossil oogonia of the group illustrated, the differentiation of the protoplasm into zoospores is clearly seen; but if any doubt could exist as to the exact nature of this differentiation, then other oogonia (or zoosporangia) on the same slide show the contained zoospores with a

especially with the same organisms belonging to *Peronospora infestans*. The contained zoospores are,



Fig. 203. Fruit of the Potato Fungus (*Peronospora infestans*), from the tuber of a potato, to show uniformity in size with the fossil fungus (enlarged 400 diam.).

moreover, the same in form and dimensions with the zoospores of *Peronospora infestans*, when measured to the ten-thousandth of an inch. For comparison, an oogonium and group of free zoospores enlarged 400 diameters, and belonging to the fungus of the Potato disease, is illustrated in fig. 203. On examination, it will be seen that the organisms are apparently identical. The average number of zoospores in each oogonium is also the same, viz., seven or eight. The aerial condition of the fungus has not yet been observed.

“In *Peronosporites antiquarius* we then, probably, have one of the simple primordial plants of the great family of fungi. The *Peronosporæ* are closely allied to the *Algæ*—so closely, indeed, that De Bary says the species of the former may with reason be compared with the species of one group of the latter named, the *Saprolegniæ*; other botanists place the *Saprolegniæ* amongst true fungi. If *Peronospora* is, therefore, an *Alga* (and its extremely close relationship is doubted by none), we have in *Peronosporites antiquarius* a plant which, from its extreme antiquity, lends some favour to the views of Sachs and other evolutionists. These observers place the lower *Algæ* amongst the primeval plants from which fungi and all other cellular *Cryptogams* have branched. This position is hardly invalidated by the presence of the more highly-organised vascular *Cryptogams* living at the same period of time with the prim-

ordial *Alga* or fungus.

“The evolution of animals and plants is quite comparable with the ages of stone, bronze, and iron, with reference to the different tribes of the human family. Because the stone age dates back to dim antiquity, it does not follow that it has entirely vanished from off the face of the earth. It is clear that

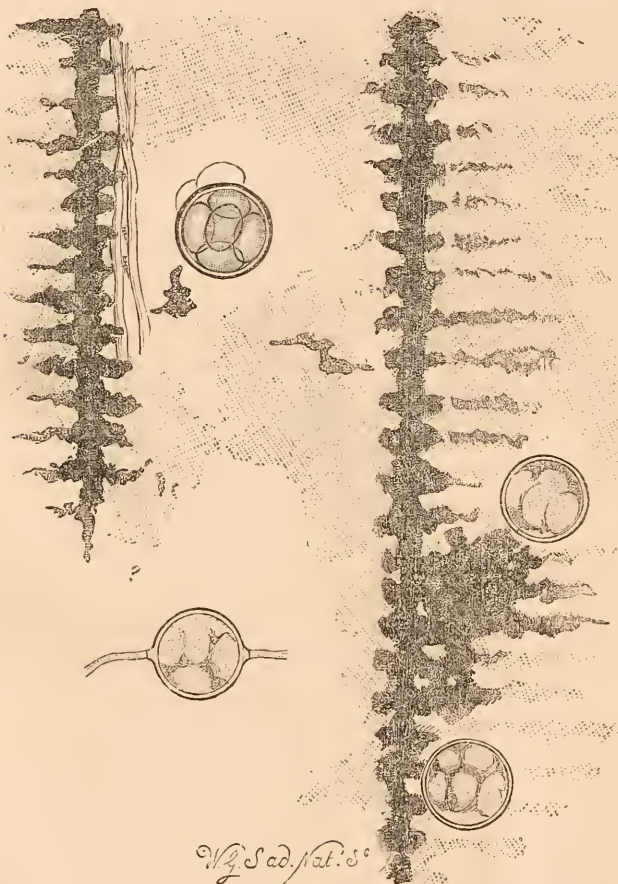

Fig. 202. The Fruit of a Fossil Fungus (*Peronosporites antiquarius*) containing zoospores *in situ* as seen amongst the scalariform vessels of a *Lepidodendron* from the Coal measures (enlarged 400 diam.).

clearness not to be exceeded by any living specimen of the present time. One of the most perfect groups of these Palæozoic bladders, containing the oncmobile spores, is shown in fig. 202, enlarged to 400 diameters, and the wonderful fact becomes manifest that the bladder is exactly the same in size and character with average oogonia of the present day,

the law which called the Peronosporites into existence countless ages ago is in force now, and that this law produces the same results now as then."

CHAPTERS ON
CARBONIFEROUS POLYZOA.

By G. R. VINE.

CHAPTER IV. AND LAST.

THE *Glauconome* of the carboniferous era comes next to the *Fenestella* in number of species and in the variation of pattern amongst the individuals of the several species. The genus was established by Goldfuss, and revised by Lonsdale, but so insufficiently characterized by M'Coy in his work on the Carboniferous Fossils of Ireland as to be scarcely of any advantage to the student. His description is, "stem elongate, oval, laterally branched; obverse, bearing longitudinal rows of pores; reverse, striated;"—a description sufficiently exact when you know the genus, but useless to a large extent when you do not. "The oval form is not universal; and the omission of any reference to the form of the cells has led to the inclusion under one generic designation of forms which should at least rank as sub-genera."*

The *Glauconome* seems to have come into existence in the Upper Silurian era; but the one solitary species of the genus given in Morris's Catalogue is very insufficient data on which to found an argument

* Prof. J. Young and Mr. John Young. Proceedings of the Nat. His. Soc. of Glasgow, March, 1875.

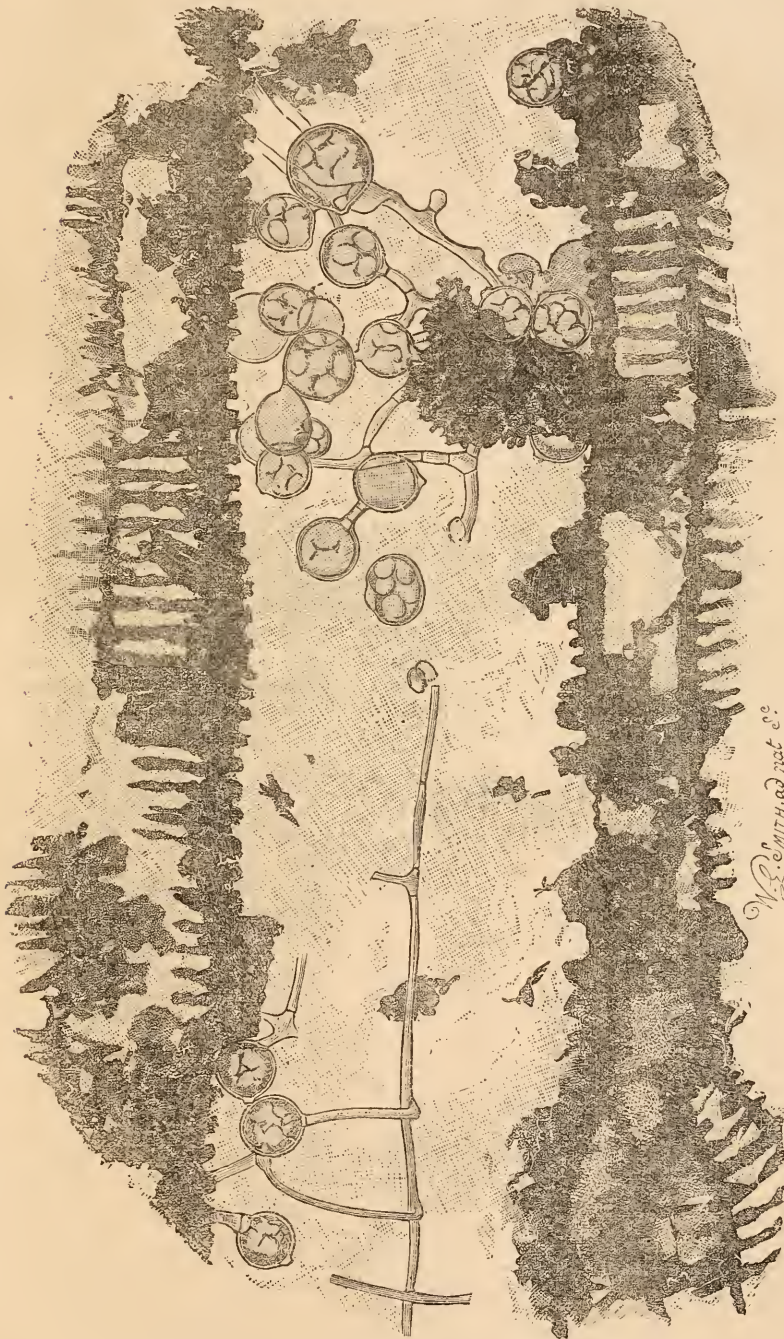

Fig. 204. A Fossil Fungus (*Peronosporites antiquarius*) with its Mycelium growing amid the vascular bundles of a *Lepidodendron* from the Coal measures (enlarged 250 diam.).

for the partially universal distribution of generic type. There is also a paucity of this type among Devonian fossils, and it is only when we arrive at the Carboniferous era that we come across the full development of the genus *Glaucanome*: and these, passing upwards into the Permian era, seem to have dwindled down to a single species and ultimately become extinct before the close of the period; so that the *Glaucanome* may be considered a peculiarly Palæozoic Polyzoan.

About fourteen species of this genus have been figured and described. One belonging to the Silurian era, one to the Devonian, eleven to the Carboniferous, and one to the Permian. This is in connection with our own formations in Great Britain, for on this genus I am unable to make any observations respecting foreign species.

Of the eleven British *Glaucanome*, seven are entirely new to science, and from MS. communications from Mr. J. Young, I learn that he has discovered another specie to add to the above list. Even now in all probability the number of distinct species and varieties are not exhausted: so numerous and so minute are some of the individuals. As the work on this genus has been so ably performed by Prof. Young, M.D., and Mr. John Young, F.G.S., of the Hunterian Museum of Glasgow, I can do no more than refer the student to their papers in the Proceedings of the Nat. His. Soc. of Glasgow, for March 1875. But for the general reader, and the student to whom the above may be inaccessible, I here reproduce a most useful list from the above paper, in which the authors sum up the principal points of distinction between the species:—

I have not satisfied myself yet as to the geographical range of the genus, as my material gives to me only a few scanty fragments from the several English localities with which I am familiar.

Until quite recently I was not aware of the existence of the *Glaucanome stellipora* in England, but examining more minutely than I had hitherto done my Richmond material, I came across several fragments of the variety named by Messrs. Young, *G. stellipora nobis*. The fragments of species are not so well preserved as are the Scottish fragments, neither are the stellar markings over the pores so perfect, but the habit of the species is as distinctly marked. I have not yet found *Actinostomia fenestratum*, another stellar species of the fenestrate forms of Polyzoa.

Under the two families of the *Cyclostomata*, given by Busk in his work on the Crag Polyzoa—*Diastoporide* and *Cerrioporide*—several genera may be given, but the species of these have not yet been so sufficiently worked out as to be as yet exhaustive. M'Coy, I believe, gives only one specie of *Diastopora*, the *D. megastoma* of the Carboniferous Limestone of Ireland. But the form of this parasitic Polyzoa varies so much that it is difficult to classify all the *Diastopora* under this one head. One specimen now before me from Richmond, in Yorkshire, is the finest I have ever seen, and the marginal edges of this are broken so that I have not a perfect specimen; another specimen, parasitic on *Fenestella*, is so delicate as to be scarcely more than $\frac{1}{4}$ of an inch in diameter; but all may be classed under the generic description given by M'Coy under the genus *Berinnicea* of Lamarck. "Corallum encrusting foreign

Name of species.	Pinnæ.	Cells in řin.	Cells in interval of branches.	Cells.	Pinnules.
<i>Glaucanome bipinnata</i> , Phillips	Bipin.
<i>G. gracilis</i> , M'Coy.....	Pin.	...	1	alternate	opposite
<i>G. grandis</i> ,,	,,	...	3	opposite	alternate
<i>G. pulcherima</i> ,,	Bipin.	...	1	sub-alternate	...
<i>G. (Diplopora) marginalis</i> Young & Young	Pin.	28	...	alternate	...
<i>G. elegans</i> ,,	Bipin.	21	2	,,	opposite or sub-alternate
<i>G. aspersa</i> ,,	,,	20	...	,,	irregular
<i>G. flesicannala</i> ,,	,,	18	1	,,	sub-alternate
<i>G. retioflexa</i> ,,	,,	18	1	,,	,,
<i>G. luxa</i> ,,	,,	18	2	,,	alternate
<i>G. (Acanthopora) stellipora</i> , Young & Young	,,	24	1	,,	sub-alternate

I have left out of the above list a few points more essential to the specialist than to the general student. All of the above species, together with many varieties, are found in the rich shales of Hairmyres; and as I have specimens of the whole of the species in my cabinet, I can speak positively of the accuracy with which both Dr. and Mr. J. Young have done their work. One species, however, I have only an MS. sketch of, and this Mr. John Young calls *G. diplopora*.

bodies, composed of very thin, calcareous foliaceous base, bearing numerous, ovate, distinctly separated cells, not piled; aperture round near the broad anterior ends."*

The generic character given by Busk of the *Cerrioporide* is "Polyzoarium, solid or lamellar, erect, or decumbent (sometimes encrusting?), simple or branched: cells contiguous, crowded."† But

* M'Coy's "Carb. Fossils of Ireland."

† Busk, Crag Polyzoa.

Prof. Nicholson, in describing his species *Ceripora* (?) *Hamiltonensis*, is more minute in particularizing the true character of the genus, but scarcely more concise than Busk. Prof. Phillips, to whom we owe much, as being the earliest investigator who patiently figured several species of Polyzoa, gives the following as the characteristic of the genus *Millepora*: "Branches cylindrical, with acute rhomboidal cells in quincunx." Since his time the genus has been more particularly studied, and the result of later investigations has led to a division of the genus into three genera, if we may place in this family the *Hyphasmopora* of Mr. Robert Etheridge, jun.

Ceripora interporosa (*Millepora* inter.) Phillips.

„ *gracilis* „ gra. „

„ *similis* „ „ „

Rhabdomeson gracile (*Millepora* Phill.), Young & Young.

Rhabdomeson rhombiferum (*Millepora* Phill.), Young & Young.

Hyphasmopora Buskii, Robt. Etheridge, jun.

account of the insufficiency of the work done. Phillips, in his "Geology of York," speaks of it doubtfully under the name *Flustra* (?) *parallela*, and his minute description is reproduced here without any comment:—"Linear: longitudinally and deeply furrowed, cells in the furrows; in quincunx, their apertures oval, prominent; side furrows without cells; it seems to have been a tubular or folded membrane, the number of rows of cells varies in different specimens. No sign of ramification."*

The genus has passed under the name of *Vincularia parallela* and *Sulcorettopora parallela*, and by the latter name it is now more generally known. I have specimens from several English and Scotch localities, some of which differ sufficiently as to be characterized as different species, three of which are given in the Catalogue of Western Scottish Fossils, compiled for the British Association of 1876. *Sulcorettopora parallela*, Phillips; *S. varicosta*, M'Coy; *S. Robertsouii*, Y. & Y., MS.



Fig. 205. *Glauconome* (Lowie).



Fig. 206. *Glauconome*, sp.



Fig. 207. *G. marginalis* (*Diplopora*).



Fig. 208. *Sulcorettopora* (Hairmyres).

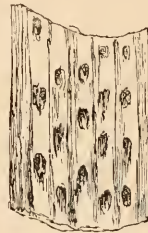

Fig. 209. *Sulcorettopora*, sp.



Fig. 210. *Sulcorettopora*, sp. (Redesdale).



Fig. 211. Cell-structure of Transparent *Glauconome*.



Fig. 212. *Thamniscus* (furrowed like *Sulcorettopora*), Young Form, magnified

The *Hyphasmopora Buskii* has always been considered by me a peculiarly Scottish species and of very local occurrence. It is found rather scantily in the shales of Capelrig. High Blantyre is given as another locality, but in the minute investigation of my Richmond material spoken of previously, I came across five small fragments, slightly differing from the more characteristic Scottish species, of this beautifully delicate genus.

Another genus of Carboniferous Polyzoa had a very wide geographical range, although the species of the genus were very few, or apparently so, on

Another of Messrs. Young's new species is one called by them *Thamniscus* (?) *Rankini*. "The stem is free, dichotomous, circular, about $\frac{1}{8}$ inch in diameter, branches in one plane. Celluliferous face, equal to two-thirds of circumference, cells arranged in spirals, the left-handed series longer than the right-handed; cell apertures circular when entire, becoming oval when worn; lower lip prominent, margins of aperture tuberculate. Intercellular surface covered with finely tubercular ridges, whose termina-

* Phillips's "Geology of York."

tions form the marginal denticles. Non-celluliferous aspect finely granular, faintly striate."*

At first Mr. Robert Etheridge was disposed to class the species among the genus *Polyzora* with the specific definition of *P. fastulata*. Better specimens having been received from Dr. Rankin, of Carlisle, by the Messrs. Young, they have been able to give the above characters, together with the generic and specific name. But wisely the authors say: "The generic position of the fossil is uncertain. It is not a *Polyzora* since it is not reticulate. *Thamniscus*, King, shows a tendency to reticulation; but the junctions are at small angles. *Synocladia* presents the next step towards the *Fenestella* type. If the gemmuliferous vesicles described by King are essential to his *Thamniscus*, this character is wanting in our species, even in the best preserved specimens. Longitudinal sections show the cells starting from an imaginary axis, and reaching the surface at various levels; but the tendency to an arrangement in transverse series is apparent. Meanwhile, though strongly disposed to regard this fossil as a true *Hornera* or a member of a closely-allied genus, we think it safer to leave it in the Palaeozoic genus *Thamniscus*, and to name it *Th. (?) Rankini*, after the gentleman to whom we owe the finest examples."†

The testimony of these eminent specialists in connecting the present with the past, if only by a single species, is of double advantage to the student in the present state of scientific nomenclature. Certain authors attach too great a value to apparently essential characters in a species, so that minute specific nomenclature often prevents a correlation of the ancient types with the recent types of the same genus; hence I am glad to make a note of any desire on the part of Palaeontologists to bring the past historic life of animal or vegetable nearer to the present. This desire to bridge over the wide gulf has been followed by Mr. Brady also in his "Monograph of Carboniferous and Permian Foraminifera," for one species named by him as *Trochammina gordealis* is very similar to the figure of the same genus and species found among the Arctic Foraminifera of Messrs. Rupert Jones, &c.

Are the *Hornera* the real descendants of the supposed extinct tribes of *Fenestella Polyzora* and *Thamniscus*? The question is one open to much debate, but one to which I shall return at some future time.

There are a few other genera belonging to the Carboniferous Polyzoa of which I am unable to speak with any degree of authority. My desire has been to clear the way for intending students living in isolated localities, and I have here merely glanced at a few of the riches without at all exhausting the mine. The genera *Archaeopora* of De Konick, *Hemitrypa Hibernica*, and *Pilozora* of M'Coy, I have left un-

touched, because I have not yet satisfied myself of the true value of their descriptions, and because the old work on these special genera will have to undergo severe revision before long. I here indicate their existence, and keen eyes must go to work to discover fresh material for the revision.

I have now come to the end of my catalogue of Carboniferous Polyzoa. The task I set myself has been a pleasant one rather than a burthen, and had I not had the opportunity given to me of publishing the results of my investigations, I should have given it up in despair long ago. In my own locality, I have had no specialist to sympathize with me in the work, and the fragments that I have had to work upon have not been the most encouraging as furnishing matter for a special study. But perseverance has made me familiar with generic and specific types, so that the merest fragment from any locality is sufficient to indicate the presence of the species. This has been one of the chief charms about the study, to build up a type from the merest fragment; and although I have not given a vast variety of localities, I have endeavoured to indicate the presence of species wherever they were most abundant. To the student I will say that I should be happy to name any and every specimen sent to me from different localities; and to my American friends I will gladly avail myself of this opportunity of asking from them Devonian or other Polyzoa in exchange for Carboniferous species. According to Prof. Nicholson, many genera are plentiful in the Devonian strata of America, though others are more rare. And to those interested in the subject in this country, who desire the continuation of articles similar to these, I shall also be glad to exchange for Polyzoa from all the various formations in which Polyzoa is known, to form a percentage of the fossils. I shall be glad to receive the material unmounted, but with the localities and strata carefully given.

My sincere thanks are due to all those friends who have so kindly assisted me in these articles.

ON CERTAIN GENERA OF LIVING FISH, AND THEIR FOSSIL AFFINITIES.

No. III.

IN considering the distribution and range of the various families in geological time, we find that authenticated remains of sharks, *Placoderms*, and Cephalaspids have been obtained from the Lower Ludlow beds of the Upper Silurian rocks of Europe, but in America it is singular that no fossil fishes have as yet been discovered before the Devonian epoch, when the relics of numerous genera occur abundantly, differing, however, from the European forms. This dissimilarity in the fauna is probably owing to the differences existing in the physical geography of the two areas at the time of the deposition of the series.

* "Ann. and Mag. of Nat. Hist.," May 1875.

† *Ibid.*

The Devonian formation is built up of freshwater, estuarine, and marine strata, each group characterised by its peculiar forms of life. In the Old Red Sandstone of Scotland and Russia, freshwater species predominate, while in the marine limestones of Devonshire and the Eifel, Mollusca, Corals, and the remains of genera of inshore-dwelling fish indicate a shallower marine deposit. The greater part of the American Devonian, on the contrary, was apparently laid down in a deep sea, and thus a monster marine fauna flourished, not so generally represented in Europe; but it is interesting to note the identity of a few species occurring in localities where the beds are of similar structure to those of contemporaneous age in Europe. In both worlds the formation is alike distinguished by the great preponderance of ganoid over elasmobranchiate fishes. The conditions existing during the formation of the Devonian rocks are well illustrated at the present day by the freshwater lakes, mighty rivers, and extended coast line of the African and American continents, and it is a most suggestive and significant fact that the genera of living ganoid and dipnoid fishes most resembling the palæozoic forms are now, with two exceptions, found on those continents alone. Taking the various orders of Professor Huxley's comprehensive classification in succession, we find that no traces of the first or lowest order, the *Pharyngobranchii*, which contains only the "gullet breathing" Lancelet, have been found in a fossil state. This is easily accounted for, however, by the soft and perishable structure of the species, of which no remains could possibly be preserved in the finest sedimentary strata, and therefore the non-representation of this lowest form of ichthyic life in "the records of the rocks" becomes less remarkable. Of the cartilaginous *Marsipobranchii*, comprising the hag fishes and lampreys, the horny teeth alone would be susceptible of preservation, and their absence has been commented on as negating the evidence of progressive development among fishes, as it is obvious the most simply constructed forms should appear first on the scene of life, in order to give place to their more highly organized descendants. In 1856, Pander, in his magnificent work on the Silurian and Devonian fishes of the Russian Baltic provinces, gave numerous figures of what he supposed to be the teeth of small sharks from the Lower Silurian rocks; but these so termed conodonts have not been accepted as of true ichthyic origin. Professor Owen* retains only three species as possibly the teeth of fishes, and is of opinion that the remainder might be either the ornaments of crustaceans, "or the spines, or hooklets, or denticles of naked mollusks or annelides." Great numbers of these "cone teeth" have recently been detected in carboniferous strata both in England and America, and it is suggested that they may be the teeth of cyclostomous fishes like the hags and lampreys,

and thus be the representatives of the *Marsipobranchii* of the ancient Silurian seas. They seem most to resemble in shape and structure the teeth of the *Myxinoïds*, in which the dentition is peculiar, being composed of one horny conical tooth situated in the roof of the mouth, with two serrated dental plates on the tongue. It has been objected that the teeth of living cyclostomous fishes are horny or chitonous, while the fossil cone teeth are calcareous; but this applies with equal force to the theory that they are the teeth of mollusks, as the modern shell-fish have siliceous teeth. The piscine derivation of the conodonts is, however, still a debated question requiring careful investigation, as it would antedate the appearance of ichthyic life in geologic history; but if it cannot be asserted that they are the teeth of fishes, neither as yet can it be positively proved that they are not. The next order, the *Elasmobranchii*, embraces the sharks, dog-fishes, rays, and *Chimæroids*. The first of these families has enjoyed a long range from the Upper Silurian epoch to the present day, and one genus seems to have varied but slightly, the *Cestracion Phillippi*, or Port Jackson shark of Australia, being a descendant of the old time *Cestraciontes*, a once numerous family now verging towards extinction. The *Chimæroids* appeared first in the Devonian, and live on, but the Rays were not represented until the Jurassic age. The *Placoderms*, as we have seen, enjoyed but a transient existence, dying out at the close of the Devonian, while the *Teleostei*, or true bony fishes, which so largely predominate at the present day, did not appear on the scene of life until the formation of the cretaceous rocks. Seven living genera alone survive of the *Ganoidei*, which prevailed so numerously in Palæozoic times, and but one of these, the Sturgeon, the least characteristic of the group, is found in European waters. Two of the six remaining forms, which are all dwellers in fresh water, occur in Africa, and four inhabit the lakes and rivers of North America. The preservation of the majority of living ganoids in America is probably owing to the fact that some portions of this ancient continent, truly the old world of *geologists*, have never been submerged since their upheaval from the first Silurian seas: thus some representatives of this ancient race of fishes were able to find a refuge in its bays and rivers, and the chain of descent has been kept unbroken from the early ages of the incalculably remote past. The large-spined, shagreen-scaled *Acanthodidæ*, which are considered by Professor Huxley to link the Ganoids to the Elasmobranchs, range only in the Devonian and carboniferous rocks. The "thick-toothed" *Pycnodonts* lived from the coal-measures to the Tertiaries, and are now extinct, while the buckler-headed *Cephalaspids*, like the *Placoderms*, existed only in Devonian times. The *Chondrosteidæ*, to which group the Sturgeons belong, were certainly represented in the Jurassic seas, and possibly by the gigantic *Macropetalichthys* in the Devonian. *Ania calva*, the dog-fish of the American

* Enc. Brit., vol. xvii., part i. 1859, art. "Palæontology."

lakes, is the sole member of the sub-order *Amiade*. The *Lepidosteide* include the living bony pikes, inhabitants of the rivers of the same continent, and fossil forms in all the formations reaching back to the Devonian. There remains for discussion but the sub-order *Crossopterygide*, that important group of fringe-finned ganoids, through which Professor Huxley considers the passage from the fishes to the reptiles took place. All the families of this well-defined sub-order are characterized by the possession of two dorsal fins, and by lobate paired fins having a central axis or stem covered with scales like the body walls, and surrounded by a fringe of fin rays. Jugular plates always replace the branchiostegal rays, and the scales are either rhomboidal or cycloid. The families *Saurodipterini*, *Glyptodipterini*, and *Phaneropteurini* are restricted to the Palæozoic rocks. The *Cœlacanthini* range from the Carboniferous to the Chalk, and the *Polypterini*, comprising only the living *Polypterus* and *Calamoichthys* of Africa, alone represent this numerous race of fishes at the present day. The genus *Polypterus* is remarkable for the unique arrangement of its subdivided dorsal fin, and by the possession of a double cellular air-bladder, which most nearly approximates to the true lungs of the *Dipnoi*. It has least structural affinities with the *Cœlacanth*s, its nearest allies in time, and is most closely zoologically related to the rhomboidal scaled *Saurodipterines* of the Devonian, from which it is separated by an enormous gulf of geological time, as no intermediate links have been discovered. In the notochordal *Phaneropteurini* we find forms which most closely resemble the acutely lobate-finned *Lepidosiren*. The shape of the body, number, position, and structure of the fins, and all the elements of the internal skeleton, exactly foreshadow those of the mud fishes. Like them *Phaneropteuron* was covered with thin cycloid scales, through which the long and well-ossified ribs show so plainly in the fossil state as to suggest the name of the genus. The dentition, however, differs from that of *Ceratodus* and *Lepidosiren*, being composed of a row of short conical teeth in each jaw, and in the absence of the grooved dental plates so characteristic of the true *Dipnoi*, it is uncertain whether this family can be associated with the other members of that order. The chain of descent is carried on by the *Cœlacanthini*, the only fringed-finned ganoids occurring in the mesozoic rocks. They can be traced up from *Cœlacanthus*, in the Carboniferous, through *Holophagus* in the Lias and *Undina* in the Oolites, up to *Macropoma* in the Chalk. The family is distinguished by cycloid scales, hollow fin-supports, and a notochordal skeleton built on the same principle as that of the mud fishes. In some genera the walls of the air-bladder are ossified. This peculiarity, which was first suspected by Mantell, is especially remarkable in *Undina* and *Macropoma*. No fossil *Crossopterygids* have been discovered in Tertiary strata, but it is the opinion of Professor Huxley that,

as the rhomboidal scaled *Saurodipterines* of the Devonian rocks are now represented by the living *Polypterus*, so the stiff-walled lungs of the *Lepidosiren* are the homologues of the ossified air-bladder of the *Cœlacanth*s; and thus that genus carried up the cycloid branch of the *Crossopterygids* to the present day. Such, in the abstract, is the life-history of fishes, a class characterized, like other divisions of the animal kingdom, by the extinction of some groups after a brief existence, and by the persistent endurance of others through untold ages. In the few genera of living ganoids we have undoubtedly the surviving descendants of a numerous and powerful race, which prevailed in the Devonian epoch, and by the discovery of fossil dipnoal forms, the progenitors of *Ceratodus* and *Lepidosiren*, the *Dipnoi* are likewise proved to be of ancient lineage. The greater part of the existing piscine fauna, on the contrary, is shown to be of comparatively modern date. Moreover, in considering the fact that the early fishes are remarkable from a combination of diverse characteristics which subsequently become the distinguishing peculiarities of distinct families, and of a higher order, we find further evidence that the ancient ganoids formed the parent stocks from which the succeeding fishes, amphibians, and reptiles have diverged. In some sauroid Devonian fishes the position and structure of the teeth foreshadow those of the *Labrinthodont* reptiles; in others the throat is protected by gular plates, a fashion retained in the Carboniferous amphibia. Again, in some species the scales are surface-pitted, like the scutes of crocodiles. While, in the notochordal weak-limbed amphibians of the coal-measures, with minute body-scales, and partly osseous skulls, we cannot fail to recognize structural peculiarities now found in the swamp-dwelling mud fishes. Thus in the anomalous "scaled sirens" we have the "persistent type" of an ancient group of fishes, in which now, as in the old time, the piscine and amphibian characters are so united as to completely efface the line of demarcation between the orders, and effectually link the fishes to the reptiles.

MICROSCOPY.

CLEANING GLASS SLIDES.—I am not sure whether the following method of cleaning used glass slides and covering glasses has been mentioned before in your columns; if it has I can bear testimony to its utility. I had tried previously to remove the hardened balsam in many ways, and had succeeded fairly with a mixture of prepared chalk, methylated spirit, and liquid ammonia, but found this objectionable because it was such a dirty job. I now simply warm the slides over a flame, and push off the covers into strong sulphuric acid (oil of vitriol), and leave them therein for a short time; when clean, I drain off, and rinse with a little fresh acid, and finish off by washing

well in water. As much balsam as possible is removed from the slides by scraping with a knife, and then sulphuric acid is rubbed upon them with a glass rod. They are then well washed. If necessary a finishing touch may be given with a warm solution of washing soda or methylated spirit and ammonia, to remove all trace of grease. Sulphuric acid should be added to water, or water to sulphuric acid *very gradually*.—*Thos. H. Powell.*

OPAQUE GLASS SLIDES.—American microscopists are using white porcelain glass slides for mounting opaque objects, and black glass slides for white objects.

AXES OF DOUBLE REFRACTING SUBSTANCES.—At a recent meeting of the Royal Microscopical Society, the President, H. C. Sorby, F.R.S., read a paper on an improved method for distinguishing substances which consist of a wedge-shaped piece of quartz, cut parallel to the positive axis of the crystal, and made to slide into the eye-piece of the microscope. When this passed across the field of view in polarized light, every gradation of tint was successively produced by the varying thickness of the quartz; and by viewing crystals through this it was easy at once to determine the position of their axes, by noting the effect upon the series of coloured bands produced by the quartz scale.

DIATOMS.—We have received a capital little *brochure*, published by the Industrial Publication Company, New York, entitled "Practical Directions for Collecting, Preserving, Transporting, Preparing, and Mounting Diatoms." The articles are by Professor A. Mead-Edwards, Professor C. Johnston, and Professor Hamilton L. Smith—all well-known American microscopists.

ZOOLOGY.

WATFORD NATURAL HISTORY SOCIETY.—The Rev. Dr. Gee recently read a lengthy and exhaustive paper before this society on "Famous Trees in Hertfordshire." Afterwards the members gave their Hon. Secretary, Mr. J. J. Hopkinson, a handsome testimonial, as a tribute of their esteem, and their appreciation of the energy he has displayed since the society was founded a few years ago. Mr. Hopkinson's labours in making the Watford Society so successful shows what can be done by a man who is in earnest.

THE STUDY OF PRACTICAL ZOOLOGY.—Under the name of "The Channel Islands Museum and Institute of Pisciculture Society," a limited liability company is being formed for the establishment, at Jersey, of an Aquarium which shall also be a "Zoological Station," similar to that founded by Dr. A. Dohrn, at Naples, where young zoologists can study their science practically. Biological research

will there be encouraged to the utmost, and lectures, laboratories, apparatus, &c., will be provided for students. A Museum, as well as a popular Aquarium, will be established in connection, in the Zoological School, for the use of the public. The technical control of this promising and much required institution will be undertaken by Mr. Saville Kent, F.L.S., whose experience in marine aquaria, and wide reputation as a marine zoologist, eminently fit him for the post.

PROVINCIAL SOCIETIES.—We have received a copy of the "Transactions of the Cumberland Association for the Advancement of Literature and Science"—an organization which we should be glad to see imitated in every part of Great Britain, as it proves what can be done in the way of scientific propagandism by co-operative effort. The volume contains some capital papers by Dr. Dodgson, J. F. Crosthwaite, R. F. Martin, R. Russell, J. Clifton Ward, J. Richardson, W. Fletcher, J. Birkett, J. D. Harington, &c., and is edited by Mr. J. Clifton Ward, F.G.S., the President of the Association.

COLOURS OF BIRDS' EGGS.—In an article on this subject Von Reichenan concludes that birds which build open nests uniformly have *coloured* eggs; and that those which possess concealed or covered nests have white eggs. He further states that in open and ground nests the colour of the eggs has a protective function.

THE SENSE OF HEARING.—Prof. Jäger has published an article on this subject, in which he expresses his opinion that in animals possessing nerve fibres, the organs of hearing are but a specialisation of the general tactile sense.

SPOTTED CRAKE.—On the 18th September I had brought to me a beautiful male specimen of the Spotted Crake (*Crex porzana*). It had been killed by a lad who mistook it for a rat, and threw a stone at it as it ran along the side of a ditch. Though by no means a rare bird in some districts, this is the first instance that has come under my notice of its capture in this part of Lancashire.—*R. Standen, Gossnargh.*

REMARKABLE SAGACITY OF A LOBSTER.—A few days ago we had occasion to empty a tank containing flat-fishes, and a flounder of eight inches in length was inadvertently left buried in the shingle, where it died. On refilling the tank, it was tenanted by three lobsters (*Homarus marinus*), one of which is an aged veteran of unusual size, bearing an honourable array of barnacles; and he soon brought to light the hidden flounder, with which he retired to a corner. In a short time it was noticed that the flounder was *non est*. It was impossible the lobster could have eaten it all in the interim, and the handle of a net revealed the fact that, upon the approach of the two smaller

lobsters, the larger one had buried the flounder beneath a heap of shingle, on which he now mounted guard. Five times within two hours was the fish unearthed, and as often did the lobster shovel the gravel over it with his huge claws, each time ascending the pile and turning his bold, defensive front to his companions.—*Ernest E. Barker, Rothesay Aquarium, Bute.*

BOTANY.

GENTIANA ACAULIS.—In your issue for Oct. 1, page 234, one of the correspondents appears to express some doubts about my having seen *Gentiana acaulis* on the Cader Idris, or, if I had seen it, that it must have been a garden escape. On referring to my diary for 1862, I find that I ascended the Cader in August of that year, and recorded "*Gentiana acaulis*, found on the slopes." I have the most vivid recollection of having noticed it, and am as certain as I am of my own existence that it was then there. It was certainly not *Gentiana amarella*, for that, as an autumn gentian, would probably flower in the autumn. Moreover, it was as unlike it as chalk is to cheese in other respects. In the *Botanical Magazine*, or *Flower-garden Displayed*, by W. Curtis, 1796, it is stated that "*G. acaulis* is a plant growing in mountainous situations, where it is constantly exposed to strong-blowing winds. Such plants are always dwarfish in such situations. The present plant has no stalk, whence its name *acaulis*, but cultivated in gardens it becomes one. As most alpine plants do, this loves a pure air, an elevated situation, and a loamy soil, moderately moist; it is, however, somewhat capricious, thriving without the least care in some gardens, and not succeeding in others." Sowerby's "English Botany," vol. vi., states that "*G. amarella* grows in pastures, especially in chalky and limestone districts; stem 3 to 15 inches high; flowers of a dull lurid purple." Mr. Bentham, in his "Handbook of the British Flora," writes: "*G. amarella*, diffused over the greater part of Britain. Flowers at the end of summer and autumn."—*John Colebrook.*

HOW TO DRY FADED LEAVES FOR DECORATIONS.—Get a variety of the most beautiful, in different states of decay. Be careful not to have the slightest injury in any. Iron them with an iron, *not* too hot, till quite flat, and then with a camel's-hair pencil brush lightly over the whole. Some leaves, such as oak, pear, chestnut, alder, birch, and poplar, are better than the softer kinds. If carefully done, they should look very nice, and last long.—*Harriet Moore, Canterbury.*

COTONEASTER.—With reference to your correspondent M. King's letter relative to the existence of *Cotoneaster* upon Great Orme's Head, I stated (see my remarks, page 210, SCIENCE-GOSSIP, September 17),

not in such *positive* terms that it did *not* grow there, but that I was wholly unable to find it anywhere. When I considered what numbers of people, independent of sheep, traverse that promontory annually, the inference as regards its extinction was a fair one. I do not remember when Professor Babington's Manual was first published, but suspect it must have been long before my first and only visit to Orme's Head, in August, 1862, so that there was ample time for its extinction. Your correspondent has quoted a letter of Mr. Thomas Shortt's, which happily shows that it was seen by himself and friend to grow in two distinct places upon the Head. My doubts, therefore, as to its extinction are at an end.—*John Colebrook.*

THE ORIGIN OF FLOWERS.—H. Müller, in an article on this subject, expresses it as his opinion that the first Angiospermous flowers to appear on the surface of the globe were diclinous, and fertilized by the wind; that is, supposing them to have originated from a single stock.

ORIGIN OF LONG STAMENS IN CRUCIFERÆ.—In suggesting a possibility that the long stamens of cruciferous plants may be the leaves of lateral buds within the flower, I am prepared to admit that such buds cannot be regarded as axillary to the sepals. They would, in such a case, be extra-axillary, as the flower-buds of cruciferous plants mostly are, flowers in a raceme without bracts being almost as characteristic of that order as tetradynamous stamens. That a flower should consist of only two stamens cannot seem incredible to one who knows that the male flower of *Euphorbia* or *Callitriche* consists of only one. It may seem unlikely that throughout a large and very natural order lateral buds should be constantly found within the floral envelopes, giving origin to some of the essential organs of reproduction. But in those coniferous trees, in the branches of which we find a cluster of leaves in the place of one, it is usual to regard them as the leaves of an axillary bud. When such a phenomenon occurs within the flower as two or more stamens in the place of one, why should we not adopt a similar explanation of it? Collateral chorisis is an hypothesis not easily illustrated by reference to foliage leaves. In the work A. P. Candolle on Vegetable Organography, the author observes that the hypogynous scales found in some *Ranunculaceous* flowers have the appearance of carpellary bracts. If they be so indeed, the carpels must belong to their axillary buds.—*John Gibbs.*

GEOLOGY.

SWISS LAKE DWELLINGS.—Dr. Gross exhibited at the meeting of the German Anthropological Society, held at Constance, some hatchets of *Nephrite*, a mineral now only found in China, which had been found among the remains of the Swiss Lake dwellings. Professor Desor expressed his opinion

that these nephrite implements had been originally brought from Asia by the lake inhabitants as "valuables."

AFRICAN GEOGRAPHY.—The latest discovery of Mr. Stanley, that the River Congo is identical with the Lualaba, is one of the most important which has yet been made, for the Lualaba was known to be connected with the immense lake Tanganyika. Mr. Stanley has made his way from that lake down the Lualaba, and found the latter to be the Congo.

MID-SILURIAN VEGETATION.—M. de Saporta has recently called attention to a fossil found in Middle Silurian rocks at Angers, which represents the oldest known land plant. It indicates a large fern, allied to *Cyclopteris*, which is preserved in iron sulphite.

TERTIARY MAN.—In a paper published in the last number of the *Geological Magazine*, Professor Mantorani discusses this question. He refers chiefly to the antiquity of man as adduced by the discoveries in the valley of the Tiber. The hills around are formed of Pliocene beds, and flint implements have been found in the upper gravels capping these.

METALS ACCOMPANYING IRON.—M. Terreil has shown, from numerous analyses made from the principal ores of iron, that this metal, like platinum, is always accompanied in its ores by other metals, among which are manganese, nickel, cobalt, vanadium, titanium, tungsten, chromium, and copper.

EXTINCT LAND SAURIAN.—Prof. Cope has called attention to the teeth of a new species of huge land Saurian, named *Paleoconus Appalachianus*, which inhabited Pennsylvania at an early geological period. This reptile was probably thirty feet long, and had a bulky body, supported by strong and heavy limbs. In point of time it was the oldest of land reptiles, and Prof. Cope thinks it was probably the most formidable, for the character of the teeth indicate carnivorous habits.

MIOCENE ANIMALS OF THE FAR WEST.—Prof. Marsh has described several new species of *Edentate* animals (the first discovered in that country), from the Lower Pliocene. A species of *Rhinoceros* has also been found in Eocene beds. Another fossil is intermediate between the Rodents and Ungulates, and is called *Allomys*.

THE LARGEST KNOWN SAURIAN.—The *American Naturalist* gives an account of Prof. Cope's new genus of land Saurians (*Camacosaurus supremus*), found near Canyon City, Colorado, and which he says is the largest known. Its size may be gathered from that of one of the Dorsal Vertebrae, which has an expanse of three feet and a half. The former measures over six feet in length. If the cervical series included six vertebrae of the proportions of the one preserved, the neck of the animal must have been ten feet long.

NOTES AND QUERIES.

THE MISTLETOE.—The various notes on the Mistletoe in the February number of *SCIENCE-GOSSIP* have suggested to me other notes and queries. Perhaps you will find room for them, as it is always best to strike the iron while it is hot, and to finish one horse-shoe before beginning another. In Norfolk the Mistletoe is very rare; so much so that I have only seen one specimen within a radius of six or seven miles from Norwich. Consequently, as I endeavoured to make plain in my former paper, I had to depend on printed records such as came to my hand, for my facts concerning the age of the Mistletoe. Such records are extremely scanty. The relations of plants to time are not often considered. It would be interesting to know when the Mistletoe first appeared in the world, and how long the leaves remain on the branches. The casts of the insertion of mistletoe roots, which I mentioned in my paper as being in the South Kensington Museum, prove that the Mistletoe does occasionally die on its supporting tree. How long it is before this occurs does not seem to be known. I remember seeing a note of the disappearance by death of a mistletoe plant from an oak (?). It grew on an inaccessible branch quite out of the reach of collectors, and it was observed gradually to diminish, and at last disappear. Unfortunately I cannot lay my hands on the reference. Certainly such cases are, as asserted by Mr. Lees, of rare occurrence. Mr. Lees's facts prove that the Mistletoe attains the age of at least forty years. Are there any records of older plants? The relations of the Mistletoe to space have not been mentioned in any of the notes in *SCIENCE-GOSSIP*. To what size does it grow? The legend of Baldr seems to prove that it grows large enough to form a small javelin; but I have seen no direct statements of its size. What are the geographical limits of the Mistletoe, and to what height is it found on mountains? Druidic remains are found, e.g., in Shetland and the Channel Islands. Was Druidic worship carried on there, and if so, whence did they get their Mistletoe? I believe it does not grow in either of these island groups. Mr. Lees says that the Romans upset the Druidic superstitions, and that during their sway it was not likely that the Mistletoe would be allowed to be held in much honour. I believe it is generally supposed that the Romans invariably respected the religions of the countries they conquered—witness the religious liberty of the Jews at the time of Christ. It was only after repeated rebellions that the temple was desecrated. If the Romans let the Jews alone, they would be much less likely to trouble themselves about the barbaric Britons. Nevertheless, it is probable that we derive our use of the Mistletoe at Christmas from the northern nations; for they so thoroughly conquered our British ancestors that it is very unlikely any of their customs have come down to us. Can Mr. Lees give us any more detailed account of the origin of our present customs under the Mistletoe-bough? It is curious that in England and France this plant has very few names, while in Wales and Germany it has many. All the really English names are variants of Mistltan. In France it seems to be only called "Gui." Now, such well-known plants as the Oak, Ash, and Elm are somewhat analogous. Each in English is known by but one name; probably the case is the same in other languages. On the other hand, less-known but still conspicuous plants, such as the Pansy and the Ground Ivy, have numerous names. May we argue from this the Mistletoe was less generally known and prized by the Germans and Welsh than by the

northern colonizers of France and England? Were the old English and French so familiar with the plant from their childhood up that they never wanted to coin a name for it, but always had one ready to hand. And, on the other hand, was the plant only known to the more observant of the Welsh and Germans, so that there would be difficulty in talking about it? I think that the facts support this idea. Until direct observations are brought forward, I think that the idea of the method of propagation, so prevalent in the older writers, and which is expressed in the Latin adage quoted in my paper, has, at least, as much probability as Mr. Lees' suggestion: observation in this case is, it is true, almost impossible. We know that the Mistletoe can be propagated by rubbing its seeds on the bark of trees; whether it is also propagated by the excrements of birds, we cannot say. That the nutmeg is thus propagated by the nutmeg-pigeon is, I believe, proved by Mr. Wallace, in his "Malay Archipelago." Mr. Macco, in his interesting list of German names for the Mistletoe says that Geinster is applied not only to the Mistletoe but also "to a plant the flower of which is use, for dyeing purposes." May I suggest to him and other writers in SCIENCE-GOSSIP, that this kind of reference is most tantalizing? It seems almost dog-in-the-mangerish. It seems to tell us that the writer knows something that he had rather keep to himself, or that he thinks we cannot appreciate. It would be much pleasanter to me, and I doubt not to other readers of SCIENCE-GOSSIP, to have the full facts, even if they were not quite relevant. Speaking now of botanical facts alone: supposing this dye-plant is an English one, the mere mention of its name and use would be interesting. If, again, it is not British, the genus and natural order, or the most nearly allied natural order, would enable us all to place the fact in its proper place in our already collected store. A similar plan would apply to all branches of knowledge. I hope Mr. Macco will take the hint and tell us to what plant he refers. "H. M. M." says that a friend once showed him a series of photographs of the various mistletoe oaks. Can he tell us where copies of them may be obtained? I am sure that many would be glad to get such a series. One other name for this plant has occurred to me since writing my paper. In Norfolk, according to Wright's "Provincial Dictionary," the plant is called Mislin-bush; Mastlin, or Meslin, is a name still given to mixed corn and barley, or peas and beans; so that this name supplies a needless confirmation of Mr. Lees's derivation of the name Mistletoe.—*W. G. Piper.*

THE MISTLETOE ("W. T. E.," p. 43).—In most mythological systems the Ash, Hazel, Mistletoe, and Whitethorn were symbolical of fire, the light and life-giving force of Nature. Hence the fire-gods were patrons of love and marriage, and their symbols were endowed with special virtues. The wedding-torches of old were made of whitethorn; hazel-nuts are a common medium of divination respecting a lover; and it is in virtue of this symbolism also that the Mistletoe confers its privilege (Comp. Fiske, "Myths and Myth-makers").—*P. W. Britton.*

THE MISTLETOE.—Some very interesting communications formerly appeared in your valuable periodical on *Mistletoe*. One is led to believe it is a plant, always found on trees in the country, and not in any populous district. I should be glad to know if that is the case, and therefore, perhaps, the following fact may be interesting:—Some years ago I lived about half a mile nearer the Crystal Palace than I do at present, and consequently I was surrounded by houses. One day I observed a curious protube-

rance on one of the branches of an apple-tree in my garden. I was led to watch it, and very soon a leaf burst forth, shortly followed by others; and presently a good-sized plant of Mistletoe appeared. If the increase of this plant be chiefly due to birds dropping the seeds, when wiping their beaks after eating the berries, how does it happen that it is found so rarely on the Oak or the Elm, or any shrub, which are so common everywhere?—*H. E. Wilkinson.*

DESTROYING MITES.—Can any of the readers of SCIENCE-GOSSIP give a recipe for destroying mites in a collection of lepidoptera. I have tried "kyanizing" the specimens with bichloride of mercury and spirits of wine, as recommended by Dr. Knaggs, but without success.—*A. F.*

ESCAPE OF A CAT.—Nearly every one knows what a remarkable tenacity of life there is in the cat; and most people probably are familiar with the saying it has given rise to—viz., "as many lives as a cat." A better example, perhaps, has never been met with of what a cat can go through than the following. A few weeks since two relatives called at a friend's house in Bath; the owner proved to be out, and they, having come from Bristol, resolved to wait until his return, which the servant assured them would be shortly, and were accordingly shown into the dining-room, the window of which happened to overlook the street. They had waited about a quarter of an hour when suddenly they heard a dull thud on the pavement outside, shortly followed by the remarks of a sympathetic crowd which had collected:—"Poor thing!" "Better kill it," "It is dead," and several others, which I have not room to chronicle. On rushing out of the house they found the servants of the establishment and the aforementioned crowd looking at a sorry object. Poor Grimalkin, the pet of the house generally, and the property of a little girl particularly—who luckily was spending the afternoon from home,—was lying on the flagstones, to all appearance lifeless, except three small streams of blood, which slowly trickled from its mouth and ears. By some means or other it had fallen from a third-story window, a distance of considerably over FORTY FEET. When lifted up it hung quite limp, as if its back were broken. The general verdict of the bystanders, on seeing it give a slight shudder, was, "Kill it and put it out of its sufferings," but this the servants objected to, until its mistress—the little girl—returned: so it was taken into the kitchen and put into a basket. Just as my relatives were starting for home, about three hours after the accident—during which time the cat had not been mentioned,—they were astounded by seeing puss feebly crawl into the room, curl up on the rug and go to sleep. On making inquiries, I find that it caught a mouse the next morning, and is, at the time I write, livelier than ever. I am quite certain that if any other animal—cats excepted—had fallen the same height, and on as hard a substance as a paving-stone, it would have been killed in an instant.—*E. B. L. Brayley, Bristol.*

COLIAS EDUSA AND ITS VARIETIES.—Quite an excitement has been caused amongst Lepidopterists by the appearance in extraordinary profusion of this, perhaps, the most beautiful of our *Papilionide*. It has been reported from most parts of the kingdom, from places indeed where till this season it had never previously been observed. The earliest recorded date amongst the communications to the *Entomologist* is that of May 30th. The question arises, whether the specimens seen were hibernated ones? and I am inclined to believe that this was the case with by far the greater portion, though the perfect condition of

some would lead one to think that a few might have only recently emerged. I much doubt whether *Edusa* could have anywhere been seen in greater numbers than in this neighbourhood. North, south, east, or west, whichever way one might walk there they were flying about. They seemed to have a peculiar penchant for fields of *Trifolium incarnatum*; neither *repens* nor *pratense* possessed anything like the attraction. My brother was fortunate in taking two of the rare white varieties to which the name of *Helice* has been given. I myself secured a female of an intermediate tint between the white and the ordinary orange. But my especial object in writing these few notes is to elicit some information as to a very beautiful form of the male insect which fell into my net. In this case the hind wings are suffused with a rosy-purple lustre, which, except that it is redder, much resembles that of *Apatura Ilia*, or the shining purple tips on the fore wings of several African species of *Pieris* or *Anthocharis*. May not this alteration of the orange into violet in each instance be due to the effects of heat? I have one other similar to it in my cabinet, though not so brilliant, taken last season. I am anxious to ascertain the opinions and observations of entomologists concerning it. I have captured and set numbers of *Edusa*, but have never seen this particular colour on any other specimen; judging then from my own experience, I am led to believe that it is decidedly uncommon. Is not the butterfly itself, however, becoming far more generally distributed? It used to be considered a prize, and for years I collected without seeing a specimen, and then it suddenly swarmed, and lately not a season has passed without its occurrence in greater or less abundance.—*Joseph Anderson, Jun., Chichester.*

MISTLETOE ON PINK HAWTHORN.—Some time ago several letters appeared in *SCIENCE-GOSSIP* respecting the trees on which mistletoe was known to grow, and one of your correspondents asked if it was ever known upon the Pink Hawthorn. It may interest some of your readers to know that it does grow upon the Pink Hawthorn, and that I have some now growing upon one in my garden at Bewdley, Worcestershire. I have never seen it upon pear-trees, although I have some old ones in my orchard quite close to apple-trees upon which a large quantity of mistletoe is and has been growing for years.—*Charles H. Westley.*

RUSCIUS ACULEATUS (*Cneo-wholen*).—It may interest some readers to know that the ancient name of this plant, as mentioned by Mr. Kitton in his notice of "An Anglo-Saxon Herbal" (page 50), still survives. I have known it for many years as *Nehome* or *Nehone* (I could not profess to spell it properly, as the name has only come to me orally), and have often wondered whence the word was derived. A bundle tied as a brush is used by tanners to sprinkle hides in some process of manufacture when it is found necessary to moisten them but a little. A regular brush would hold and transmit too much water, whilst a single drop only is shaken off the sharp point of each leaf; it is also used by tobacco manufacturers for the same reason. It is an instance of the superiority of Nature to Art in some manufactures, similar to the use of teasels in dressing cloth.—*Alph. Smith.*

MOONLIGHT PHENOMENA.—Any one who has visited the promontory of Lleyn, in South Carnarvonshire, will doubtless remember the picturesque little village of Llanbedrag, the church and few surrounding houses being snugly nestled at the

foot of the fine projecting headland of Mynydd-Cwmwd, on the shore of Cardigan Bay. Upon a bright moonlight night, some time ago, a phenomenon was observed by a resident there, which I venture to bring before your readers, wondering whether any of them may have seen a parallel case, and can explain the cause. The moon was shining in its full brilliancy about nine o'clock p.m., its rays being condensed, as it were, into a path of light across the bay in the direction of Barmouth, giving the appearance of a line of water, raised considerably higher than the shadowed portion on each side; along this luminous pathway the water seemed full of life, as it might be shoals of fish sporting themselves; or else bounding silvery waves playing across each other, full of motion, whilst the sea on both sides of this strange line of light remained perfectly smooth. This has been observed more than once.—*M. L. W.*

EGG COLLECTING.—In reference to Mr. W. T. Van Dyck's unwarranted wholesale attack upon Oölogists as he somewhat sneeringly terms them, in a recent number of *SCIENCE-GOSSIP*, I should like to make a few remarks as to the utility and scientific worth of making a collection of eggs alone; not as he would have it done, together with specimens of the birds as well. Being a collector, and I flatter myself an enthusiastic one, he has rather touched me in a tender place. Firstly, looking at his theory of having both birds, nest, and eggs, from a pecuniary point of view. There are a good many collectors of eggs, and real earnest collectors, not robbers of nests, with whom it would be an utter impossibility to procure the old birds as well as the eggs; for it is not every one who is able to walk about with a gun in his hand, ready at any moment to bring down some luckless bird whose egg he may have in his collection, besides taking into account its preserving when he has got it. It requires no small share of this world's riches, as perhaps Mr. Van Dyck will know, before a man can carry a gun and use it, and it is not only the mere carrying it, but also being able to stand upon and walk over ground upon which he may with safety discharge it; I should say that it is altogether a different thing carrying firearms in Syria and doing the same in England (it means 10s. for carrying it alone, without taking into account its use). Again, many of the birds which breed with us, whose eggs we could procure with safety, are no longer here when we might do the same with them; for I must remind him that there is such a thing in England as a law for the "Protection of Wild Birds," which restricts their being either captured or killed within a certain time, and before that time is passed many of them have flown to warmer regions, or at least have left their breeding places. There are also many persons who could without feeling any pain or compunction take one or two eggs from a nest, who could not slaughter a poor unoffending bird in the same even-minded manner. Looking at his argument from any point of view I am inclined to think that his method of getting a truly scientific knowledge of birds and their habits is by far the cruellest; for he would have a collection in which should be both bird, eggs, and nest; to procure which wanton robbery must be committed. He would also wish us to believe that scientific knowledge could not be obtained without a stuffed specimen. I think differently, for there is far more real knowledge to be gained by a contemplation of birds and their manners in their wild, unfettered and unstuffed state; as I think every earnest collector of eggs is in the habit of doing, than any number of cotton-padded skins could give. Does not many a collector when he is looking

over his well-stocked cabinet recall to his memory as his eye rests on a certain egg, a whole train of long-forgotten events connected with how, when, and where he took it; what peculiar habits the bird which laid it had, and many other little things which to an uninterested spectator are as nothing, but to him fond memories of bygone days! In conclusion, I must say that if Mr. Van Dyck had used a little more discernment in distinguishing between a "collector" and a "robber of eggs," he would at least have gained my good opinion in his attempt to put a stop to egg-collecting; for I think with him the making a collection for the mere sake of the eggs (as he seems to think all collectors do) is not at all to be approved of; but he must remember when he uses such an expression, as, "500 birds slaughtered for mere amusement on a British holiday," however much it may be partaking of Byron's style (I believe the sentence is a crib from the "Dying Gladiator" slightly altered), that he is attaching a kind of odium to all collectors of eggs who do not, as he would have them, collect birds and nests as well. I think that he would find very few collectors of eggs who have been collecting for a few years, who, if he asked them what a certain egg was, could not only tell him its name, but also give him an account of the bird, its place of nidification, habits, and an accurate description of it; together with a number of interesting facts, which they would never have known if they had not been, as I have, and shall remain,—*A Collector of Eggs.*

AQUARIUM-KEEPING.—If you would allow me space, I should be glad to say a few things on this subject, from my own experience, in answer to "P. E. C." (July No.). "P. E. C." could not, I believe, have chosen more troublesome inmates of his aquarium than sticklebacks, for they are great fighters, and, in all my attempts to keep them, have continued at enmity until only one remained alive. I should advise him to substitute carp for these creatures. The best plant for an aquarium is undoubtedly *Vallisneria*, which is to be preferred to all others for the quantity of oxygen it gives out. Univalve mollusks are far better than bivalve, as being more migratory: those most commonly kept are *Linnæa stagnalis* and *Planorbis cornuus*. "P. E. C." asks whether any one has succeeded in rearing caddis-worms to their final stage. I cannot say that I have; but I know why, and think I can state the cause of failure. It is necessary to place caddis-worms in very shallow water when the time of their perfection approaches. If they are kept instead in deep water, the creature cannot get itself to the surface, though they often struggle to do so, and will stand upright at the bottom of the aquarium, holding on to some plant, but of course all this is in vain. The truth is, they are drowned; for, when they are on the point of leaving their case, they must also leave the water, or they cannot come to perfection. If "P. E. C." guards against this, I think he will achieve success.—*S.*

NEW FACT ABOUT RED GROUSE.—I can confirm, from personal observation, Mr. Dealy's statement, that the Red Grouse do sometimes perch upon trees, and, like him, have often thought it strange the fact should be unmentioned in any of the works on ornithology to which I have had access. I first observed the fact in 1873. A friend and I were walking down a lonely "clough" on Saddle Fell, when we suddenly came upon a pack of grouse comfortably perched amongst the branches of a dead mountain ash. They were all "preening" their feathers, and, as they did not see us at first, we lay quietly down behind a piece of rock, and had a good look at them before they

took flight. Since then I have several times seen grouse perch upon trees. I have also observed a still more unlikely bird than the grouse perch—the common snipe (*S. gallinago*). There is near here a boggy piece of ground, covered with rush and long grass, and surrounded with stunted alders, which is a favourite haunt of the snipe. Some years ago I was lying concealed under a bush in this place, hoping to see a snipe alight, and thus discover a nest, when a female snipe, after flying several times over me, to my extreme surprise, alighted upon a tree close by. It remained in this strange position for some time, all the while uttering its note, *click-a, click-a*. On two other occasions I have observed snipe perch upon trees in this place. As this seems to be a very unusual habit, I should be glad to hear whether any of the ornithological readers of *SCIENCE-GOSSIP* have ever observed the like.—*R. Standen, Goosnargh.*

CAPTURE OF A MOOSE-DEER AT SEA.—A relative who has for many years resided on and in the neighbourhood of a beautiful North American island, still so rich in bird life and otherwise attractive to the lover of natural history, forwarded me lately the following account of the capture of a Moose-deer, which may probably interest some of your readers. "Since the departure of winter and the return of our long-looked-for spring my youngest son, John, with a companion, has been fishing off the north-western coast of this island, portions of which are uninhabited, and are rarely visited except by the fowler or seal-hunting Indian. He was preparing his boat for a pull round North Head to his home, it being Saturday, when, after roving along shore quietly for about half a mile from his starting-post, he saw something swimming from this island and heading to the more distant one of Campobello, seven miles off. Unable to make it out, and supposing it to be one of the great Loons, a bird not very uncommon in these waters at this season of the year, he put on a little extra steam, hoping to come up to it, and soon discovered it was not a bird, but a large dark-looking animal nearly submerged, and swimming vigorously. After a moment's calculation about the length of daylight, he determined to try and intercept it, alone as he was, and set off in full pursuit; but as the animal swam well and John was rather tired with his morning's work, quite an hour elapsed before he succeeded in heading it inshore and towards a small cove, where lay at anchor a schooner, whose crew he was acquainted with. These men, who it appears had for some time observed John's movements from the deck of their vessel, dropped into a yawl, with three oars, they had alongside, and having made out it was a Moose-deer showing symptoms of great fright and exhaustion, shot out from the cove and turned the animal again seawards. John now pulled straight for it, seized the Moose by the ears, and managed to hold him until the sailors came up, when they assisted in raising the deer's fore feet on to the gunwale of his boat, tied its fore legs, and dragged the unwilling passenger on board. Though so far successful in shipping their captive, they soon found out they had a regular Tartar to deal with, and it required the united strength of these four men to prevent the Moose staving in the bottom of the boat with its horny hoofs. At last the dangerous hind legs were secured, and as the schooner was on the point of sailing to Eastport, and admiring John's pluck and courage, the sailors cheerfully gave up all claim to their share of the prize, and left him to land it in the best way he could. After they were gone, John found it no easy thing to pull the boat with this ugly companion on board, for it could still butt unpleasantly

with its head, and make itself disagreeable in many ways. Daylight was just departing when I heard of John's return to North Head, and the sort of fish he had hooked. I hired a neighbour's cart, had the deer at once landed and carefully conveyed to my barn, where he was made fast to a strong post used for tethering cows. After letting him rest awhile undisturbed, we thought we might venture to cut the cords which bound his feet, when he again made the most violent efforts to escape, but, finding that escape was impossible, he lay quietly down, and apparently resigned to his fate. We got together some food I thought he would like, knowing their habits and the plants they principally live upon in the woods, but nothing would tempt him to eat, so, before leaving him for the night, I poured a cow mash (*volens volens*) down his throat. Early next morning we hid the deer a visit; the food we had left for him remained untouched. He, who had roamed the primitive forests of New Brunswick, and knew what sweet liberty was, could not live a prisoner in a cow-shed. Towards evening the eyes showed great weariness, and as we thought he could not survive another day, we had him slaughtered as mercifully as possible. This Moose, when deprived of his skin, proved to be in fine condition, weighing 135 lb., and was sold by John for nine dollars, without the skin. I was presented with the head, which I have preserved for some Boston friends who are at present collecting objects of natural history on this island, and who have promised to send me in exchange some birds I cannot procure here. John tells me I have omitted to inform you that this deer swam at the rate of five miles an hour, and frequently sprang half his length out of the water. Had it not been intercepted we have little doubt it would have reached Campobello safely, and perhaps returned to this island when the object of its visit had been accomplished. We have many touching and curious instances brought under our notice proving the strong affection the large migratory birds have for one another, especially the gregarious. A broken-winged gull will often gather a cloud of sympathizing companions around it when the nature of its affliction is understood, and it is rarely it is left entirely alone so long as life continues. When unable to rise from the ocean, two or more birds are sure to alight near and swim around it, as if to cheer and encourage it, and will continue to do so until the receding tide has carried the party far out of sight. Before the winter of 1876-7 had terminated a large flock of wild geese, on their annual migration to the great lakes, was observed making its way to our island, and a man I know, who is constantly on the look-out for stray shots, and who keeps his rifle ready loaded, noticing their direction, rushed into his house and fired at a venture at the birds then over head. It was a random sort of shot, but there was no doubt he had hit one of them, as it fell out of the line of flight, dropped some distance below the others, yet still feebly continued its journey. The instant it did this a confusion of goose-notes was heard, when some of its companions swooped down, got under the wounded bird, and bore it up on a level with the others. Being too weak to sustain itself, again it fell, and again it was buoyed up by the relief party. It fell for the third time, but not before it reached the earth did these affectionate birds join the lagging flock, finding further efforts useless to sustain it in the air. Writing about sea-gulls, I am reminded of a rather unique way they are caught alive by the good, or bad, people at Mount Desert, Maine. A rather long stick is run through the tail of a small fresh fish, and then it is left on the sea-shore, where it can be seen by the birds. A hungry gull, who has perhaps been unsus-

cessful in his day's fishing, seizes it and attempts to swallow it in the usual way, head first. He succeeds remarkably well until he comes to the stick, when a stop is made, and further progress is arrested. Determined not to give up what he has already pinched, extraordinary efforts are made to bolt the stick, and so he chokes, strangles, and falls over, when he is easily captured. Hooks attached to lines are baited with fish with the same object, proving how cruel man is in exercising his boasted power over the lower animals, particularly those of no value to him as food. Another scrap, and I must close this long letter. Various are the ways birds are deprived of life. A short time ago I was informed that a wild duck had been found floating dead in Chesapeake Bay with a large oyster firmly attached to its bill. It was thought the bird when diving had purposely captured the bivalve for food, but I think it more probable the duck had been seeking its usual food at the bottom, and had accidentally put its bill between the gaping shells of the oyster, and so was compelled to bring it to the surface, and not having strength to support it there or to fly away with it, the head drooped, and the bird was drowned.—H. M., *Redlands, Bristol.*

NOTICES TO CORRESPONDENTS.

TO CORRESPONDENTS AND EXCHANGERS.—As we now publish SCIENCE-GOSSIP at least a week earlier than heretofore, we cannot possibly insert in the following number any communications which reach us later than the 9th of the previous month.

R. G. (Stoke-upon-Trent).—Your Manx plant is the *Potentilla hirta*; as you suspect, a "foreigner." It is recorded in the *Phytologist*, as found on the Wutchill, Perth, by Mr. John Sim.

G. D. P.—The specimens you sent us, so neatly mounted, are, No. 1, a seedling plant of the Sea Spennwort (*Asplenium marinum*); No. 2, a pretty seaweed of the *Florida* group, named *Dalseria sanguinea*. Both from North Devon.

E. F. C. (Leicester).—It is one of the protean forms of the Batrachian *Ranunculi*. Without doubt, if it can be made into a species, the *R. floribundus*, Bab. These varieties are a very interesting study.

E. F. C. (Leicester).—Your seedling Fern is difficult to name in its present state; you may, however, name it *Pteris*. The species will be seen in time.

J. B. N. (Kingston).—Thanks for the neat examples sent, which are as follows:—No. 1, *Anthriscus vulgaris*; No. 2, *Trifolium repens*; No. 3, *Rosa micrantha*, Smith—a very great rarity; No. 4, *Hieracium nigrorum*; No. 5, *Epipactis palustris*, L. We advise you to procure Hooker's "Student's Flora," as the best for your purpose.

COL. F. A. D.—The best photographs of the Moon are those by Rutherford, enlarged by Brothers. See "The Moon; her Motions, Aspect, Scenery, and Physical Condition," by R. A. Proctor. London: Longmans, Green, & Co. (in which the reduced photographs of the Moon are employed for illustration).

E. B. TURNER.—We are not aware of the existence of any cheap work on British *Diptera*.

J. E. STEPHENS.—Your specimen is the Field Cockroach (*Blattella germanica*).

A SUBSCRIBER.—Rye's "British Beetles," published by Lovell Reeve at 10s. 6d., with coloured plates, is the best popular work of the kind.

W. B. M.—Get "The British Bird Preserver," by Samuel Wood, published at rs. G. F. Warne. Swainson's "Taxidermist" treats on stuffing all kinds of animals.

C. FOOD.—The insect is, as far as one can judge from the sketch, *Trichosoma lucorum*, one of the large Saw-flies, the cocoons of which may be found attached to the ends of the branches of the white thorn during the winter. The larva is smooth, green, and looks as if it had been covered with meal.

R. G. GOODWIN (Walsall).—We have examined the so-called "growth" on *Athyris*, but it is not organic. It must be simply an efflorescence, caused by the acetic acid probably combining with traces of argillaceous matter.

W. H. GOMM.—The spines sent us are those of *Echinus mitis*.

W. K.—We are sorry to say your specimens have been mislaid. Can you send us others?

R. V.—You will arrive in Australia at the wrong time of year for collecting.

Geo. Nicholson.—The "SCIENCE-GOSSIP Botanical Exchange Club" has not only been founded, but has distributed all the collected specimens among the members, which number about one hundred.

M. B.—Put some damp Moss in with your Green Tree Frogs, and give them an occasional worm when they wake up.

S. G. S.—In addition to those dredged up off the Essex coasts, and found beneath the London Clay of Suffolk, the localities where remains of the *Corphyodon* have been found in the Woolwich beds are two places in the neighbourhood of Camberwell.

T. E. W.—Your insect is the Great Sawfly (*Sirex gigas*).
JAS. THOMPSON.—Your fungus is the rather rare "Herules Club" (*Clavaria pistillaris*).

MACDONALD STEEL.—The thistle sent us is very interesting. The peculiar growth is due to the development of the upper parts of the capitulum into leaves.

G. O. HOWELL.—The objects found on the garden-path are gasteromycetous fungi, and a species of *Nidularia*.

M. B. (Dudley).—Your specimen is a *Sedum*, or more popularly named Stonecrop; but in the absence of flowers we cannot give you its specific name.

F. W. (Old Broad-street).—From your description, we should think the shrub is *Veronica Andersonii*. We were not, however, aware of its peculiar intoxicating properties. It would be interesting, especially so to entomologists, if, when you have correctly ascertained its name, you would make it public.

H. H. (West Ashling).—The true *Polygonum dumetorum* has highly-polished seeds, not unlike ebony. We have carefully examined the specimens sent, and find it is *P. convolvulus*, *P. pseudo-dumetorum*, Wats. The angular stem, although this is not always to be relied upon, and dull, striated fruit; if you slightly magnify the fruit, you will observe it to be covered with minute points, whereas in *P. dumetorum* it is smooth. This character you may rely upon with certainty.

ELATION (Radcliffe).—The true Shamrock seems to be a disputed point. Whilst one would declare it to be Wood Sorrel (*Oxalis*), another just as stoutly clings to the Clover; the latter, however, is the plant mostly selected by the Irish peasantry to be worn on St. Patrick's day. Write to Mr. Wheldon, Great Queen-street, London; he will probably supply you with Galpine's book.

J. C. (Oscott, Birmingham).—By holding up the leaf to the light, the veins running from the midrib to the margin are seen to be forked. This simple plan will point out a fern, apart from the fructification. It is the Hart's-tongue Fern, although we have never seen the stipe so long in British specimens.

(HARROW).—Get "Geological Stories," price 4s., published by Hardwicke & Bogue, 102, Piccadilly, W.

EXCHANGES.

A FEW *Galathea*, *Edusa*, and *Corydon*, in exchange for *Euprosyne*, *Rubi*, *Argiolus*, *Argon*, or *Paniscus*, or many common Moths (unset preferred).—A. W. Rosling, 20, Bootham, York.

I HAVE about 600 species of Brachiopoda, and wish to add species I have not got. I would give in exchange Trilobites, or one or two American Brachiopoda.—C. Callaway, Wellington, Salop.

WANTED Microscopic Objectives, in exchange for "Microscopical Dictionary."—T. C. Maggs, Yeovil.

SEA-SHELLS for exchange, and shall be glad to hear of any one who is willing to exchange.—J. Backhouse, junr., 20, Bootham, York.

I HAVE Diatoms, Spicules, Spines, Skins and Scales, Palates, &c., mounted or unmounted. Shall be glad to exchange for any unmounted material really good.—E. Barker, Aquarium, Rothesay, N.B.

Crocus nudiflorus, growing or dried plants offered in exchange for any rare dried plant.—Lists to W. Jones, Manchester-street, Oldham.

A GOOD writing-diamond, for glass slides for mounting.—Apply, sending sample slide, to Wm. Sargent, junr., Caverswall, Stoke-on-Trent.

WILL exchange Eggs of Guillemot, Razorbill, &c., for British Lepidoptera.—List to J. Wrangham, 73, High-street, Bridlington.

SOME living Chrysalides of Emperor Moth (*S. carpini*), in exchange for Sea-birds' Eggs.—Jas. Ingleby, Eavestone, near Ripon.

WANTED, Animal Parasites, either mounted or unmounted.—Apply to W. A. Hyslop, 22, Palmerston-place, Edinburgh.

HAWORTH'S "Lepidoptera Britannica," Stainton's "Manual," Samouelle's "Entomological Cabinet," Newman's "Butterflies," Carpenter's "Microscope," 4th ed., and others. Wanted, Hassall's "Fresh-water Algae," Johnston's "Zoo-phyes," or Ross's 4-roth Condenser. Cash or by arrangement.—J. C. Hodkinson, 101, Mill-street, Macclesfield.

L. C., 7th ed.—Nos. 858, 923, &c., and for other Plants.—Send lists to J. Comber, Southgate House, Winchester.

EGGS of *H. dispar* and *O. antiqua*, for other Eggs.—J. T. Rodgers, 222, Chadderton-road, Oldham.

ONE-HOLED EGGS of Heron, Hooded Crow, Stockdove, Jackdaw, Magpie, Garden Warbler, L. Redpole, Long-tailed Tit, Pipets, Coot, Kestrel, Blue Tit, Razorbill, Guillemot, &c., &c., to exchange for Nightingales, Owls, Cormorants, Shag, C. Gull, Grasshopper Warbler, C. Bunting, Wryneck, Crested Grebe, or other rare eggs.—J. F. Pratt, Westgate, Ripon.

FOR *Hypanum Swartzii* (in fruit), send other Moss or object of interest, on stamped envelope, to Mrs. Skilton, Brentford End, Middlesex.

Cyclus rivicola, *Zua lubrica*, *Helix nemoralis*, var. *hoitensis*, for any other common Shell not in collection.—Mrs. Skilton, Brentford End, Middlesex.

L. C., 7th ed.—Nos. 120, 257, 273, 282, 383, 389, 390, 576, 634, 651, 720, 820, 865, 1015, 1036, 1040, 1131, 1501, 1571, 1597, 1639, for other British Plants.—W. J. Hannan, 6, Tatton-street, Ashton-under-Lyne.

FOR deep-sea sounding from Mediterranean, send some object of interest or good material.—A. Alletsee, 11, Foley-street, Portland-place, London.

DUPLICATES.—19, 72, 93, 111, 157^b, 169, 196, 198, 203, 285, 279, 326, 363, 338, 354, 622, 722, 760, 1264, 1281, 1283, 1297, 1584, 1586, and others, for local plants.—Send lists to J. H. A. Jenner, 4, East-street, Lewes.

FOR *Pumularia cristata* and *Anquinaria spatula* (unmounted), send stamped envelope or object of interest to J. Wooller, 7, Farm-road, Hove, Brighton.

DUPLICATES.—Eggs of Pied Flycatcher, Whinchat, Wheatear, Yellow Wagtail, Lesser Redpole, Carrion and Hooded Crow, Brown Snipe, Common and Lesser Tern. Desiderata—any Frutillaries (except dark-green and pearl-bordered), Skippers, Blues (except Chalkhill and Common), Hair-streaks (except Green), Sybilla (*G. album*), *Polychloros*, *Maclaon*, *Rhamni*, *Cardamines*.—R. McAlldowie, 82, Nabaccord-street, Aberdeen.

Lepidium latifolium, *Filago gallica*, *Spiranthes autumnalis*, *Dipsacus picosus*, *Centaurea solstitialis*, &c., for other rare plants or microscopic material.—Send list to G. Tenyère, 23, Crouch-street, Colchester, Essex.

BOOKS wanted.—Johnson's "Spongidiæ and Lithophytes," Edinburgh, 1842; "British Spongidiæ," by Bowerbank, London, 1864.—Address, R. Allen, Troy, New York, U.S.A.

A GENTLEMAN, having a well-stocked laboratory of Chemical Apparatus, in value exceeding £50, wishes to exchange the same for a good Microscope, Slides, and Apparatus.—H. Hilder, 33, St. Andrew's-road, Hastings.

S. rivicola, *P. annicum*, *P. vortex*, *P. carinatus*, *P. cornutus*, *P. contortus*, *L. palustris*, *L. glabra*, *H. virgata*, *H. capitata*, *H. ericorum*, *H. lapidica*, and *B. acutus*, offered for *N. fluviatilis*, *H. concinna*, *H. revelata*, *H. obvoluta*, *P. ringens*, or any *Vertigos*.—Edward Collier, 7, Dale-street, Manchester.

WANTED, exchange in Birds' Eggs with American, Colonial, and Continental collection, by William Stoute, Wembdon, Bridgwater.

BOOKS, &c., RECEIVED.

"The Origin of the World," by Dr. J. W. Dawson, F.R.S. London: Hodder & Stoughton.

"Proteus; or Unity in Nature," by Dr. Radcliffe. Second Edition. London: Macmillan.

"Monthly Microscopical Journal." November.

"Land and Water." "

"The Naturalist." "

"American Naturalist." October.

"American Journal of Microscopy." "

"Western Journal of Science and Industry." September.

"Botanische Zeitung." October.

"Land and Water." November.

"Law Journal." "

"Industrial Art." "

 &c. &c. &c.

COMMUNICATIONS HAVE BEEN RECEIVED UP TO THE 7TH ULT., FROM:—T. S.—V. M. G.—G. R. V.—H. M.—J. C.—F. C.—E. A. W.—A. W. R.—M. B.—T. C. M.—C. C.—M. S.—C. J. A.—H. B.—W. G. H. C.—G. L.—J. B., jun.—E. B. T.—E. B.—A. J. F.—J. M. H.—J. A., jun.—G. O. H.—C. B. R. A.—W. R. T.—R. T. G.—A. W.—W. E. T.—W. V. A.—G. T. B.—M. J. W.—C. W. H.—S. E. B.—E. L. R.—F. R. B.—J. F. R.—C. W. H.—F. V. P.—W. S. K.—F. W. B.—R. S.—Col. F. A. D.—Prof. C. S. B.—Dr. B.—E. E.—W. S., jun.—W. J.—J. G. C.—F. E. F. C.—J. E. S.—I. C.—A. S. H.—J. W. W.—W. H. G.—T. B.—J. F. P.—R. H.—J. H.—G. T. B.—S. G. S.—J. A. S.—E. B. K. W.—W. A. H.—J. W.—J. I.—T. H. P.—J. C.—M. K.—W. K.—R. V.—G. F. C.—J. T. R.—S. T.—Dr. H. F. P.—G. T. B.—H. G.—W. I. H.—J. I. N.—J. T.—A. A.—J. C.—E. H.—R.—T. H. A. J.—J. W.—J. T.—A. B.—T. W. D.—D. A. K.—J. C.—W. R. T.—H. H. C.—C. R. H. N. B.—T. L.—R. A.—T. E. W.—F. Q.—E. C.—J. S.—W. S.—J. R. N. G.—&c., &c.

INDEX TO VOL. XIII.

- ABERDAVINE** (Siskin), 71
Acaridae, Researches among the, 209
Acidium depauperans, 125
Actinomyces ediles, 46
 African Geography, the latest Discovery in, 279
 Alkanet, 263
Allium ampeloprasum, 233
Allium porrum (Leek), Crystal Prisms of, 65, 90
Althaea hirsuta, 187
 American Antiquities, 45
 American Palæontology, 258
 Amphibians, Metamorphoses of, 114
Amphitetras autediluviana, 15
 Aræone, Cluster-cup, 162
 Anglo-Saxon Herbal, an, 49
 Animals, Destruction of Rare, 143
 Animals, the Hard Parts of, 241, 265
 Animals of the Miocene Period, 279
 Animals, Names of, 143
 Anthropoid Ape, Conjecture as to Existence of in South America, 47
 Ants in South America, 41
 Ants, Intelligence of, 89
 Ant-eaters in South America, 41
Apocynum androsæmifolium, 18, 44, 60, 70, 92
 Aquarium, Notes on the, 6, 66, 89, 118, 166, 214, 215, 282
 Aquarium, Marine, 38, 250
 Aquarium, a Public, 89
 Aquarium at Tynemouth, 232
 Archæopteryx, 211
 Arctic Expedition, Collection of Insects by the, 38
 Arctic Expedition, Collection of Fishes by the, 113
Argas Fischerii (Blyborough Tick), 104
 Ascidians, new, observed on Cruise of *Challenger*, 67
 Atlantic Right Whale, 257
- BAT, THE**, 166
 Bathybius, 38, 89
 Bees attracted by Paint, 189
 Bees, Conduct of, in a Shower, 237
 Bees and Flowers, 20, 44
 Beetles, Strength of, 180, 281
 Birds, Albinism among, 14, 23, 164, 166, 238
 Birds, brevipennate, 261
 Birds, Instance of Charity among, 191
 Birds' Eggs, Collection of, 139, 191, 213, 215, 281
 Birds' Eggs, Colour of, 277
 Birds' Eggs, Effect of Corrosive Sublimate on, 190
 Birds of Lincolnshire, 261
 Birds, Local Names of, 46, 261
 Birds, Migration of, 142, 190
 Birds, Nests of, Instance of Trust in Building, 191
 Birds of New Guinea, 106
 Birds, New Species of, in India, 209
 Birds, Pairing, Instinct of, 247
 Birds, Shooting of Rare, 22, 92
 Bird, an Unidentified, 21
 Blackbird, Pairing with Thrush, 263
- Blackbird, Pied, Variety of, 257
 Blister-beetle, the, 166, 259, 261
 Blyborough Tick: see *Argas Fischerii*, 104
 Botany, 18, 39, 67, 90, 114, 140, 161, 186, 209, 232, 257, 278
 Botanical Notes in Neighbourhood of Cader Idris, 173, 210, 233
 Botanists, Death of Celebrated, 140
 Bournemouth, Notes on Insects at, 256
 Bowerbank, Dr., 116
 Botree, the, 40, 71
 British Association, Notes from the, 183, 222
 British Botany, Field Notes on, 39
 Brittle Plants, Modes of Drying, 211
 Butterfly-boxes, Directions for Lining, 164
- CADER IDRIS, BOTANY OF**, 210, 233
 Cage-birds, Remedy for Sick, 260
 Calderon, Professor, as to Absorption of Organic Matter by Plants, 18
Caurosaorus supreuius, 279
 Canadian Notes, 225
 Canadian Phlogophite, 110
 Carboniferous Plants, 190
 Carboniferous Polyzoa, 108, 220, 271
 Cat, the Domestic, 43, 95, 215
 Cat, remarkable Vitality of a, 280
 Caterpillars, Victims of Larvæ of Ichneumonids, 239
 Cave-hunting, 236
 Centrine Shark, the, 139
Cetonia aurata, early Appearance of, 113
Challenger, Ascidians observed during Voyage of the, 67
Challenger, Zoological Results of Expedition of, 185
 Cheetah, new Species of, from South Africa, 184
Chelidonium magus, Alkaloids of the, 141
Claytonia perfoliata, 163
 Clubs, see "Societies"
 Cockroaches, Colour of, 144
 Coffee, Use of for watering Window-plants, 2(note)
Collis edusa, 185, 223
Collis edusa, Massacre of, 262
 Colorado Beetle, 175 (note), 201
 Coloration, causes of, 45, 94
 Coloured Butterflies and Flowers, 139
Coryvolvulus arvensis, 47
 Cooked Meat, Discoloration of, 40
 Corals, cleaned by Chloride of Lime, 192
 Cormorant, the, 188
 Cornelian Cherry, 90, 140
 Cornish Plants, 235
 Corphyodon, 284
 Cotoneaster, the, 233, 278
Cotoneaster vulgaris, 258
 "Creep" in unworked Coal-mines, 240
 Cresswell Crags, the Bone Caves of, 163
Cribella rosea, 16, 38
 Crow, Animosity of, to Sparrow-Hawk, 21, 44, 71, 143
 Crow, the Nut-cracker, or Black and White, 70
Crucifera, Origin of Long Stamens in, 186, 233, 278
- Crucifera*, Teratology among, 162
 Crustaceans, Preservation of, 166, 185, 209
 Crystals, Fluid Cavities in, 37
 Crystals of *Allium porrum* (Leek), 65, 90
 Cuckoos, Habits of, 21, 22, 23, 43, 192, 260
 Cumberland and Westmoreland, Flora of, 162
Cyclas cornea, 93
- DAFFODILS**, 55, 119
 Damar, as a Mounting Medium, 16, 87, 112, 159, 183
 Damar, Crystal Forms in, 148
Dauria Archippus, 89
 Darwin's Theory, Facts in Support of, 117
 Death's-head Moth, Use of Cotton-wool by the, 21, 44
 Delphinium, Arrangement for Cross-fertilization in the, 248
 Diatomaceæ, on Cleaning, 145
 Diatomaceæ, on Mounting, 217
 Diatoms, 16, 37, 88, 277
 Dinosauria, Discovery of, 269 (note)
 Dispar, 45
 Dogwood, 118
 Domestic Cat, the: see "Cat"
 Doubleday Collection, the, 17
 Double Orange, a, 239
 Double Refracting Substances, 277
 Dry Mounting, 160
 Dublin New Museum, 209
 Duckweeds, a Chapter on, 34
Dytiscus marginalis, 96
- EARED SEALS**, 79
 East Anglia, Geology of, 19
 Echidna in New Guinea, 66
 Edelweiss, 186, 210, 233
 Edusa and Hyale, 161, 191
 Eel, Longevity of the, 261
 Eggs of Birds, Colour of, 22, 277; and see "Birds"
 Eggs, intra-oval, 17
 Eggs of Yama-Mai Silkworm, 118
 Electric Plant, 116
 Endive, 165
 Entomology, Notes on, 67
 Entomology of Epping Forest, 75
 Entomology, Metropolitan, 161, 215
Eolis postulata, 113
 Epiphytal Plants, 186
Erica Mediterranea, 209, 257
Erica vagans, 18
 Eurypterus, a New Species of, 40
 Evolution, 239
- FADED LEAVES AS DECORATIONS**, 278
 False Light Excluder, the, 112
 Ferns, a Few Words on, 7, 115
 Ferns, Modes of Bleaching, 44
 Fish, certain Genera of Living, and their Fossil Affinities, 225, 249, 274
 Fish, Embryology of, 38
 Fleas, Vitality of, 191
 Flies, Plague of, 46, 93
 Flies, Fungus on, 190
 Flowers, Change of Colour of, 24, 79

- Flowers, Fertilisation of, by Insects, 21,
39, 92, 114, 115, 128, 140
Flowers, Origin of, 278
Flower, Query as to a, mentioned by
Shelley, 118, 165, 260
Flowers, Symmetry of, 67
Food-fishes, Propagation of, 185
Foreign Insects, &c., how introduced, 117
Forest Pathology, 1
Fossils, common British, and Where to find
them, 11, 60, 131, 251
Fossil, Crustacean, a new, 40
Fossil Fungus, a, 269
Fossil Glass Rope Sponges, 259
Fossil, Lizard, 259
Fossils, Mode of Strengthening, 69
Fossils, Mode of Cleaning, 141, 159
Fossils, Upper Devonian, at Torbay, 116
Fowls, Lead-poisoning of, 71
Frog, Chameleon-like Changes in the,
256
Fruit Culture, 143
Fungi, Distinction between Poisonous and
Edible, 18
Fungi, Fossil, 269
Fungi, new, on Violets, 125
- "GAPES," TREATMENT FOR MALADY OF,
16
Gasteropoda, Vitality of, 161
Gentiana acanthis, 278
Geology, 19, 40, 69, 90, 116, 141, 163, 187,
211, 235, 258, 279
Geology of Harwich and Walton-on-Naze,
69
Geology of Hertfordshire, 91
Geology of Leicestershire, 258
Geology of the Planet Mars, 91
Geology of Plymouth, 169, 212
Geology of Rutland, 258
Geology of the Savoy Alps, 236
Geology of Underground London, 147
Geology of Water-supply, 236
Geology, Scepticism in, 259
Geological Honours, 90
Geologists' Association, Proceedings of, 41
Gilbert White, the Rev., Grave of, 167,
213, 191
Glass Rope Sponges, Fossil, 259
Glastonbury Thorn, 45, 94
Glaucum luteum, 140
Goatsucker, the, 149, 191, 213, 259
Gold-fish, 46
Golden Pheasant, Breeding of Domestic
Fowl with the, 22
Gorilla, the, at Westminster Aquarium,
209, 237
Gourds, History of, 9
Gourds and Pumpkins, Inflorescence of,
257
Grey Parrot, singular Fact as to a, 215
- HAIRY RHINOCERI AND SIBERIAN MAM-
MOTHS, 20
Hard Parts of Animals, the, 241, 265
Harvest Bugs, 44, 227
Harvest Bugs, Mode of Destroying, 190
Hawfinch, the, 44, 193, 166
Hearing, the Sense of, 277
Hedgehog, Food of the, 21
Hedge-sparrow, a White, 14 (note)
Heliopelta, 37, 65
Herb-paris, 104 (note)
Herons, Habits of, 47, 71, 92
Herons and Rooks, 94, 189
Holy-grass, Northern, 44
Hoopoe, the Rarity of, 22, 185
Hypophora ferruginea, Notes on, 205
House Sparrow, Desertion of Young by
a, 260
Hymenoceros in the Red Crag of Suffolk,
188
Hybrid Primula, 189
Hydroid, a One-armed, 255
- ICE AGE, THE, 167
Illumination, new Mode of, 87
Irish Botanist, Holiday Tour of a, 150
Iron, Metals accompanying, 279
Ivy, early Flowering, 69
Ivy, Notes on, 164
- KENT, SUMMER RAMBLE ON EAST
COAST OF, 29
- LAMPYRIS NOCTILUCA, 113
Land Tortoises, from Ossiferous Caverns
of Malta, 69
Lawson, Dr. H., Death of, 255
Lemming, Migration of the, 105
Lemming, Probability of Existence in
British Isles of the, 180, 237
Lepidoptera of the Black Forest, 118
Leptoclinium punctatum, 260
Leschenaultia formosa, Fertilization of, 204
Limestone, probable Cause of Faults in, 187
Linnean Society, Particulars of Admission
to the, 144
Lithornis emuinus in the Isle of Sheppey,
187
Lizards recently extinct of the Mascarene
Islands, 113
Lizard Fossil, 259
Lobster, Sagacity of a, 278
Locusts in British Isles, 21, 45, 67
Lyons, Query as to Geology of, 71
- MAGPIE AND STARLINGS, ATTACK ON A
SWIFT BY, 262
Mammots, Siberian, 20
Marigold, Query as to, 47
Marion Island, Flora on, 18
Marmozet, a new, 17
Meduse, Varieties of, 67
Mermaid's Purses, 117
Metropolitan Well Borings, 141
Metropolitan Societies, 139
Mexican Grasses, Sexual Modification of
the Glumes of, 140
Mica, Discovery of, in Arctic Regions, 69
Microscope, how to choose a, 66
Microscope, Application of, in Geology, 78
Microscopical Society of Bath, 83
Microscopical, Use of Term, 117
Microspectrosopes, 137
Microscopy, 15, 36, 65, 86, 112, 137, 159,
183, 206, 230, 255, 276
Mid-Silurian Vegetation, 279
Miocene Period, Animals of the, 279
Mistletoe, Celtic Names of the, 39
Mistletoe, Growth, Age, &c., of, 25, 43,
44, 279, 280
Mistletoe on Lime-trees, 143, 260
Mistletoe on Pink Hawthorn-tree, 281
Mites, Destruction of, 280
Moa Skeleton, Discovery of a, 235
Mollusks, Methods for Cleaning Shells of
Smaller Species of, 185
Moon, Photographs of the, 283
Moonlight, Phenomena connected with,
281
Moose-deer, Capture of, at Sea, 282
Morse or Walrus, 3
Mountain Chains, Origin of, 259
Mystacoceli, Table of Differences of
British, 246
- NAMES OF BIRDS, 46
Names of Plants, 46
Names, Pronunciation of, 45, 118, 164, 193
Nettle, the Common, 46, 92, 115
Nettle, the Uncommon, 164
New Forest, Sport in the, 26
New Fossil Tertiary Bird, 212
New Guinea, Birds of, 106, 221
New Guinea, Zoology of, 231
Newt, Development of, 239
Newt, Spawn of, 94, 161, 263
Newt, Water Currents on Gills of, 114
New Zealand, Flowers in, 161
North Wind, Effects of, on Plants, 95, 263
Notes and Queries, 21, 41, 69, 91, 117, 142,
164, 188, 212, 237, 259, 279
Notices to Correspondents, 24, 48, 72,
96, 120, 144, 168, 192, 216, 239, 263, 283
Notices and Reviews.—
Across Africa (Cameron), 83
Animals, Uses of to Men (Dr. Lan-
kester), 67
Botany, Structural and Physiological
(Thomé), 86
Botanical Excursion to the Grampians,
4, 140
- British Bird-preserver (Wood), 113
Cross- and Self-Fertilization of Plants
(Darwin), 31
Diatoms, Practical Directions for Col-
lecting, Preserving, Mounting, &c.,
277
Earthquakes and Volcanoes, Causes of
Activity in (Peacock), 91
Elementary Zoology (Wilson), 161
English Antiquities, Half-hours with
(Jewitt), 85
Ferns, British and Foreign (Smith), 210
Folk Lore of Natural History (Holland),
139
Forest and Chase of Malvern, its
Present and Ancient State (Lees), 258
Geology of East Anglia, 19
Geology of England and Wales (Wood-
ward), 31
Geology of Walton-on-the-Naze and
Harwich, 69
Geological Record for 1875, 24
Insect Fauna of the Second Tertiary
Period (Goss), 117, 187
Journal of Forestry, 186
Journal of the Quekett Microscopical
Club, 206
Large and Small Game of Bengal and
North-Western Provinces of India
(Capt. Baldwin), 31
Lias in Warwickshire (Beesley), 117
Life (Garner), 89
Life of a Scotch Naturalist (Smiles), 83
London Flora, a New (De Crespigny),
211
Microscope, how to Choose a (Demon-
strator), 66
Microscopical Society of Bath, Annual
Address of the President, 88
Norfolk and Norwich Naturalist Society's
Transactions of, 161
Orchids, Fertilisation of (Darwin), 67
Physiological Tables (Aveling), 256
Popular Science Review, 185, 256
Primeval World of Switzerland (Profes-
sor Heer), 83
Reminiscences of Animals, Birds, Fishes,
and Meteorology (Kingsford), 89
Royal School of Mines Magazine, 69
Sun Birds, the (Shelley), 130
Symmetry of Flowers (Gibbs), 67
Watford Natural History Society, Trans-
actions of, 89
Winds and their Story of the World
(Jordan), 163
Zoological Classification, Handbook of
Reference on (Pascoe), 113
- OAKS IN SUSSEX, 186
Obelisk, raising an, 262
Orchids in Surrey, 44, 92
Orchids, Fertilization of, 67
Oriental Plane, suited for Cultivation in
Towns, 48
Ornithology, Errors in, 165, 191
Orbanche minor, 68
- PALÆOCTONUS APPALACHIANUS, 279
Palæopalax magnus, 69
Papilio machaon, Larvæ of, at Brighton,
231
Parasites on the common Cyclops, 46, 93,
112
Parasites in Egg Cocoon of the Spider, 17
Parasites on Alder, 15
Parasites on Plants, 167
Parthenogenesis, 140
Peregrine Falcon, the, 51, 91, 142, 165, 212,
262
Petrel Species of Sea Birds, Notes on the,
105, 261
Phormium tenax (New Zealand Flax), 210
Physiography and Physical Geography,
226
Physical Geography (Mrs. Somerville), 237
Pike, Holes in the Head of, 261
Plants, Absorption of Organic Matter
by, 18
Plant Crystals, 66, 90, 186
Plants, economical Products of, 77, 129, 181
Plants exposed to North Winds, Effect on,
95, 263

- Plants, early Flowering, 45, 69, 70, 71, 91, 92, 119
 Plants, Insectivorous, 18, 70, 90, 93
 Plants, Mode of Drying, *if*, 189
 Plants, sudden Re-appearance of, 142
 Plymouth, Geology of, 212
 Pollen, 232
Polygonum dumetorum, 284
 Polyzoa, 141, 152, 153
 Polyzoa in Aquaria, 261
Popular Science Review, the, 38
 Porcupine from Borneo, new Variety of, 17
 Post Tertiary, Arctic Fossils, 235
 Post Glacial, Deposit of, Thames Valley, 224
 Potato Beetle, of Colorado, 166
 Primroses, Double-headed, 142
 Primroses, early flowering, 70
 Primula, hybrid, 258
 Pronunciation of Scientific Names, 193
 Provincial Museums, 89
 Provincial Societies, 138, 277
 Psychoda, infested with Parasites, 15
 Pygidium, Notes on the, 15, 66
- QUARTZ, VARIETIES AND MODES OF FORMATION OF, 73, 97
 Quekett Microscopical Club, the, 88, 159, 207
- RABIES IN WILD CANINE ANIMALS, 119
 Radiolaria in Carboniferous Limestone, 116
 Raphides, 230, 255
 Raphides, Plants for, 230
 Rats and Roses, 237
 Red Blood-Corpuscles, Identity of, in different Races, 113
 Red Blood-Corpuscles, Structure of, 113, 208
 Red Grouse, 190, 262, 282
 Red-legged Partridge, 212
 Red-winged Starling, 188
 Reflector, Bramhall's, Horizontal Super- or Sub-stage, 87
 Reil, History of the Island of, 183
 Reptile Vivaria, Plants for, 237, 256
 Rhinoceros, the Two-horned, 113
 Ring Ousel, the, 101, 190
 Robin, the, in America, 42
 Rocks, the Microscopic Character of, 211
 Rorquals off Filey, 232
 Rothsay Aquarium, 209
 Royal School of Mines Magazine, 69
Ruscus aculeatus, 281
- SALAD HERBS, A HISTORY OF OUR, 102, 123
 Saurian, Discovery of a new Land, 279
 Savoy Alps, Geological Phenomena in the, 211, 236
 Scales of Insects, Errors of Interpretation as to Examination of, 57, 88
 Scour Water, Notes on a Ramble up, 2
Science Gossip, Note on General Index of, 113
Science Gossip Botanical Exchange Club, Rules of the, 115
Science Gossip Section Machine, 22
 Science in the Provinces, 33
 Scotland, New Geological Map of, 20
- Sea Birds, the Petrel Species of, 195
 Seals and Whales of the British Seas, 125, 156, 176, 198, 244
 Seal in the Solway, 185
 Sea-fowl, a Close Time for, 232
 Sea-water, Density of, 45, 164, 263
 Seeds, Indigestible Nature of, 21, 45, 115
 Seeds, Vitality in, 164
 Shadows, Colours of, 44, 92, 93
 Sharp-winged Hawk Moths, 232
 Shining Moss, 187, 210, 232
 Siberian Mammoths, 20
 Sivatherium, Specimen of in Spain, 20
 Skate and Dog-fish, 239
 Slides, Microscopical, Box for, 182
 Slides, Microscopical, Cabinet for, 206
 Slides, Microscopical, Directions for Cleaning, 138, 255, 276
 Slides, Use of Opaque Glass, 277
 Slug (Maximus), Tenacity of Life of, 262
 Slug, Predatory Nature of, 260
 Smith, Lady, Notice of Death of, 90
 Snowdrops, 45
 Societies and Clubs:—
 Amateur Botanists' Exchange Club, Proposal to found, 19, 68
 Borough of Hackney Microscopical and Natural History Society, 255
 Channel Islands Museum and Institute of Pisciculture, 277
 List of, in London devoted to Natural History Pursuits, 64
 Medical Microscopical, 64
 Quekett Microscopical, 88, 159
 Sydenham and Forest Hill Natural History and Microscopical, 112, 137
 Watford Natural History, 277
 West Kent Natural History, Microscopical, and Photographical, 113
 Soda-water a good Medium for keeping Flowers in, 216
 Southern France, Notes on Flora of, 116
 Sparrow-hawk breaking Window to obtain Canary, 239
 Sparrow-hawk, Animosity of Crow to, 21, 44, 71, 143
 Sparrow-hawk, Eggs of, 190
 Sparrow-hawk pursued by Lapwing, 262
Sphinx pinastri, 185
 Spiders, Friendliness of, 42
 Spiders, Parasites in Egg Cocoon of the, 17
 Spiders' Preparations, Mounting of, 207
 Spiders, Venomous Nature of, in New Zealand, 46
 Spiders, Webs of, how constructed, 208
 Sponge, Fresh-water, 138
 Spontaneous Generation, 160
 Spotted Crane, the, 277
 Spring Ramble, Notes on a, 99
 Squirrel, the, 239
 Stag Beetle, Strength of the, 94, 281
 Star Fish, the, 94, 114
 Star Fish, how to Preserve, 103 (note)
 Star Fish, how to Skeletonize, 21
 Starlings, Peculiarities of, 118
 Stickleback, Common, 118
 Stone Age, the, in New Jersey, 69
 Sun, Phenomena connected with, 95, 143, 263
 Swift (common), Flight of a, Sign of Weather Change, 262
 Swiss Lake Dwellings, 279
 Sussex Oaks, 143
 Sycamore, Exudation from, 165, 259
 Sycamore, Fructification of, 209, 257
- TADPOLES, 143, 214
 Tea Leaves, Use of, as Manure, 69, 119
 Teasel, Structure of the, 116
 Tenynson and his "Sea-blue Bird of March," 47
 Teratology, Notes on, 268
 Tertiary Mammal, a New, 40
 Tertiary Man, 279
Tetacellus haliotideus, 114
Telovox chamaedrys, 46, 90, 92
 Tulip, the Wild, 166
- UNIO, SPECIMEN OF, NEAR REPTON, 67
 Upper Cambrians in South Shropshire, Notes on, 116
- VANESSA ANTIOPA, 66
 Varnishing Cells, Directions for, 66
 Vegetable Teratology, Notes on, 233
 Ventrilites, 119
 "*Veronica Spicata*," var. "*Hybrida*," 232
 "Vestiges of Creation," Query as to Authorship of, 48, 70, 119, 167
 Viviparous Blenny, the, 15
 Volcanic Cones, 187
Volvox globator, 21, 40, 43, 45, 71, 93
 Vorticellæ, 112
- WALL PAPER, ARSENICATED, 238, 261
 Walrus or Morse, Notes on the, 3
 Water, Mode of Filtration of, 37, 87
 Water, Phenomena connected with, 262
 Water Glass, 68 (note)
 Waterproof Cement, 15, 65
 Watercress, Query as to Powers of Progression of, 238
 Water-supply, Geology of, 236
 Water Tortoises, 91, 118
 Watford Natural History Society, Transactions of, 89
 Water-vole, 46
 Welsh Meadow, Botanical Notes in a, 194
 West of Ireland, Sketch in, 178
 Whales and Seals of the British Seas, 125, 156, 176, 198
 Whin Sill Basalt Beds, the, 41
 White Cabbage Butterfly, Metamorphoses of the, 229
 White Copal as a Mounting Medium, 183
 Wild Strawberries in January, 93
 Willows, spontaneous Combustion of, 260
 Woollen Moths, Destruction of, 23
 Wren, Eggs of the, 191
 Wryneck, Habits of the, 23
- YAMA MAI SILKWORM, EGGS OF THE, 118, 189
 Yew Poisoning, 141
- ZOARCES VIVIPARUS, 15
 Zoology, 16, 38, 66, 89, 113, 138, 161, 183, 208, 231, 256, 277
 Zoology, elementary (Wilson), 161
 Zoology of New Guinea, 231
 Zoology, Study of Practical,

10593

MBL/WHOI LIBRARY



WH I A Q N N

