

# APPENDIX B(1) SUBDIVISION STREET DESIGN GUIDE

## TABLE OF CONTENTS

### SECTION 1 – INTRODUCTION

Introduction.....	B(1)-1
-------------------	--------

### SECTION 2 – DESIGN REQUIREMENTS

Projected Traffic / Operational / Capacity Analysis.....	B(1)-2
Functional Classification.....	B(1)-2
Terrain.....	B(1)-4

### SECTION 3 – ROADWAY GEOMETRIC DESIGN CRITERIA

A. Collector and Arterial Roadways.....	B(1)-5
B. Local Roadways.....	B(1)-5
C. Turn Lanes.....	B(1)-6
D. Transitions, Merging Tapers and Speed Change Lengths.....	B(1)-6
E. Sight Distance.....	B(1)-19

### SECTION 4 – ELEMENTS OF TYPICAL SECTION

A. Pavement Design.....	B(1)-21
B. Pavement Width.....	B(1)-21
C. Parallel Parking Lane Widths.....	B(1)-21
D. Perpendicular and Angle Parking.....	B(1)-21
E. Intersections.....	B(1)-22
F. Concentric design.....	B(1)-23
G. Culs-de-sac and turnarounds.....	B(1)-24
H. Curb and Gutter Designs.....	B(1)-26
I. Private Entrances.....	B(1)-28
J. Pedestrian and Bicycle Facilities.....	B(1)-31
K. Bridge and Culvert Design Criteria.....	B(1)-37
L. Roadway Drainage.....	B(1)-37
M. Right-of-way.....	B(1)-39

### SECTION 5 – OTHER DESIGN CONSIDERATIONS

A. Clear Zone.....	B(1)-41
B. Guardrail.....	B(1)-43
C. Traffic Control.....	B(1)-43
D. Streetscape and Landscape.....	B(1)-43
E. Landscape Considerations.....	B(1)-45
F. Traffic Calming.....	B(1)-51
G. Roundabouts.....	B(1)-52
H. Utilities.....	B(1)-53
I. Roadway Lighting.....	B(1)-54
J. Mailboxes & Cluster Box Units.....	B(1)-56

### SECTION 6 – TRADITIONAL NEIGHBORHOOD DESIGN

General.....	B(1)-58
--------------	---------

## SECTION 7 – INNOVATIVE DESIGN PROPOSALS

General.....	B(1)-61
--------------	---------

## SECTION 8 – SCHOOL BUS LOOPS AND DROP OFF / PICK UP AREAS

General.....	B(1)-62
Design Criteria.....	B(1)-62
Bus Loops.....	B(1)-62
Bus Drop Off/ Pick Up Areas.....	B(1)-63
Parent Drop Off / Pick Up Area.....	B(1)-63
Accessible design.....	B(1)-64
Vertical Alignment.....	B(1)-64
Signs and Pavement Markings.....	B(1)-64
Pavement Design.....	B(1)-64
Resources.....	B(1)-64

## LIST OF FIGURES

Figure B(1)-1 Minimum Turning Path for Single Unit Truck SU-30.....	B(1)-5
Figure B(1)-2 Curb to Curb No Parking / Parking on One Side.....	B(1)-10
Figure B(1)-3 29 ft. Curb to Curb Parking on Both Sides.....	B(1)-11
Figure B(1)-4 36 ft. Curb to Curb Parking on Both Sides.....	B(1)-12
Figure B(1)-5 29 ft. Curb to Curb Parking on Both Sides.....	B(1)-13
Figure B(1)-6 24 ft. Outside Width Parking One Side.....	B(1)-14
Figure B(1)-7 29 ft. Outside Width Parking on Both Sides.....	B(1)-15
Figure B(1)-8 36 ft. Outside Width Parking on Both Sides.....	B(1)-16
Figure B(1)-9 29 ft. Stabilized Shoulder and Ditch with Ribbon Curb.....	B(1)-17
Figure B(1)-10 Sight Distance Triangles.....	B(1)-20
Figure B(1)-11 Intersection Design.....	B(1)-22
Figure B(1)-12 Cul de Sac and Turnaround Details.....	B(1)-25
Figure B(1)-13 Curb and Gutter Details.....	B(1)-26
Figure B(1)-14 Detail Back of Curbs.....	B(1)-28
Figure B(1)-15 Roll Top Curb Entrance Detail.....	B(1)-29
Figure B(1)-16 Roll Top Curb Entrance Detail Section.....	B(1)-29
Figure B(1)-17 Private Entrance Detail.....	B(1)-30
Figure B(1)-18 Setback Details with Curb and Gutter.....	B(1)-42
Figure B(1)-19 Setback Details with Shoulder and Ditch.....	B(1)-42
Figure B(1)-20 Sight Distance for Two Lane Major Road.....	B(1)-44
Figure B(1)-21 Landscape Items Within Sight Triangle.....	B(1)-45
Figure B(1)-22 Traffic Calming Details.....	B(1)-52
Figure B(1)-23 Lighting Along Curb and Gutter Section.....	B(1)-55
Figure B(1)-24 Lighting Along Shoulder and Ditch Section.....	B(1)-55
Figure B(1)-25 Cluster Box Turnout – Curb and Gutter.....	B(1)-56
Figure B(1)-26 Cluster Box without Turnout – Curb and Gutter*.....	B(1)-57
Figure B(1)-27 Cluster Box Turnout – Shoulder and Ditch.....	B(1)-57
Figure B(1)-28 Curb Extension (Bulb Out) Detail.....	B(1)-60

**LIST OF TABLES**

Table B(1)-1 Curb and Gutter Section..... 7  
Table B(1)-2 Shoulder and Ditch Section ..... 8  
Table B(1)-3 One Lane (One Way) Subdivision Streets..... 9  
Table B(1)-4 School Bus Access Road ..... 18  
Table B(1)-6 American National Standards for Nursery Stock ..... 50

## **SECTION 1 – INTRODUCTION**

### **INTRODUCTION**

This document is an appendix of VDOT's [Road Design Manual](#) and is intended for users of VDOT's Secondary Street Acceptance Requirements for the development of new residential and mixed-use streets functionally classified as "local" streets. All other streets must be developed in accordance with appropriate provisions of the Road Design Manual for the appropriate functional classification.

For the purposes of this document, "District **Engineer/Administrator's Designee**" means that employee who oversees the land development functions in a particular geographic area. This may be the Residency **Engineer/Administrator**, area engineer or that employee designated to perform the "responsible charge" duties for land development as designated by the District **Engineer/Administrator**. In cities or towns choosing to use this design guide for the design of their subdivision streets, it means the local official responsible for the review and approval of subdivision street design.

In the event of conflict between this Appendix and other provisions of the [Road Design Manual](#) and [Road and Bridge Standards](#), the District **Engineer/Administrator's Designee** shall determine the governing provision. As indicated in the Secondary Street Acceptance Requirements, any requirements of the subdivision ordinance of the locality that are not in conflict with these requirements shall govern. The District **Engineer/Administrator's Designee** is provided considerable discretionary authority in the application of standards related to local subdivision streets.

The District **Engineer/Administrator** is authorized to consider and render a decision on unresolved issues between the developer and the District **Engineer/Administrator's Designee** that pertain to the interpretation and application of this appendix. All appeals shall be made in writing describing the unresolved issue and include copies of all prior relative correspondence.

All land development proposals should be submitted to the local jurisdiction, which will then coordinate with the District **Engineer/Administrator's Designee** for VDOT review and approval. The District **Engineer/Administrator's Designee** will coordinate with other VDOT sections as needed.

## **SECTION 2 – DESIGN REQUIREMENTS**

### **PROJECTED TRAFFIC / OPERATIONAL / CAPACITY ANALYSIS\***

For the purposes of these requirements, "projected traffic" includes the traffic resulting from the complete development of all land to be served by the subject roadway facility, including traffic forecast to be generated by development, both internal and external, to the site under consideration.

Traffic generation developed to meet Chapter 527 (Traffic Impact Analysis Regulations) may be utilized to meet this requirement, at the engineer of record's discretion. The basis for this forecast will be the governing body's current comprehensive plan or other available information pertinent to the permitted land use and transportation planning for the site and adjacent properties. The trip generation rates in the current version of Trip Generation, published by the Institute of Transportation Engineers (ITE) should be utilized in determining the projection of traffic. The ITE trip generation rate for a single-family detached residential dwelling unit is currently 10 vehicle trips per day. The use of other bona fide traffic studies in determining projected traffic for all types of land development may be considered, subject to their submission for review and approval by the Department.

As an alternative to the application of the projected traffic to the applicable geometric design criteria of these requirements, the Department will consider secondary street design based on a capacity analysis concept provided:

1. The governing body permits the utilization of this concept in the design of subdivision streets in the county, city or town.
2. The developer furnishes full rationale, to support the recommendations of this analysis. The submission should include all pertinent traffic data and computations affecting the design proposal for the streets involved.
3. An acceptable level of service should be accommodated in the street design proposed under the capacity analysis concept. A minimum level of service "D" as defined by the Highway Capacity Manual is generally acceptable for the design of local streets. To maintain an acceptable level of service, additional travel lanes, channelized roadways, etc., may be required.

### **FUNCTIONAL CLASSIFICATION**

The characteristics and magnitude of the service to be provided will be the basis for the Department's determination of the functional classification for each subdivision street intended for acceptance into the secondary system. AASHTO's Geometric Design of Highways and Streets provides guidance in the classification of roads.

---

\* Rev. 1/12

The hierarchy of the functional systems consists of principal arterials (for main movement), minor arterials (distributors), collectors and local roads and streets.

Local streets are defined as those streets that provide direct access to adjacent land and serve travel of short distances as compared to the higher systems. Most subdivision streets fall in the Local Street classification. The geometric design standards contained in this guide shall be used for all new residential and mixed-use streets functionally classified as “local” roads. All other street classifications should use VDOT’s Road Design Manual for geometric design.

### 1. Criteria

Urban and rural areas have fundamentally different characteristics. Consequently, urban and rural functional systems are classified separately. Most subdivision streets function similar to an urban area; therefore, the urban classification can be used for high-density development with the concurrence of the locality and District **Engineer/Administrator’s Designee**.

### 2. Procedures

The Department’s concurrence of the functional classification for each street within a subdivision should be made prior to departmental approval of a subdivision concept plan. To facilitate the effective development of the plats or plans and permit an expeditious review, this concurrence is recommended prior to the initiation of a detail design for the subdivision. To initiate the functional classification process, the developer should submit the following information:

Conceptual sketch “A” conceptual sketch of the development that shows sufficient information for the Department to review and concur with the proposed functional classification for each street in the development shall be provided to the District **Engineer/Administrator’s Designee** by the local official prior to preparing detailed construction plans for review. Any preliminary or conceptual plat, plan or sketch that conforms to the locality’s zoning requirements or subdivision ordinance is acceptable if the information required by this subsection is shown. For information to be included in the submittal, see [Secondary Street Acceptance Requirements, Chapter 382, 24 VAC30- 92-70, page 19](#).

### 3. Approval

The District **Engineer/Administrator’s Designee** will provide written concurrence to the appropriate county official and the developer, if applicable, regarding the approved functional classification for each street in the subdivision. Approval of the conceptual plan or subdivision sketch should be considered concurrence of the functional classification and general layout of the streets. This approval shall be valid as long as the basic concept for the subdivision’s development, as submitted for review, remains unchanged. Response is required per SSAR within 45 calendar days.

---

\* Rev. 7/15

## TERRAIN

The desired vertical curve alignment for subdivision street design can be accommodated within most terrains. However, in very rugged areas where the terrain can be classified mountainous, some design exceptions may be allowed. Mountainous terrain is defined as terrain in which longitudinal and transverse changes in the elevation of the ground with respect to a roadway are abrupt, and where the roadbed is obtained by frequent benching or side hill excavation to obtain acceptable horizontal and vertical alignment. The slope, which means the rise and fall of the grade measured both parallel and perpendicular to the centerline of the roadway, generally ranges over 15%.

Geographical location should not be the determining factor in terrain classification. For example, a subdivision street in the Bristol District may or may not have land characteristics of mountainous terrain. Each subdivision should be reviewed individually. Mountainous terrain exceptions are noted on the Geometric Design Tables: [Tables B\(1\)-1, B\(1\)-2, and B\(1\)-3](#). The mountainous terrain classification may be used upon approval by the District \*Engineer/Administrator's Designee.

---

\* Rev. 7/15

## SECTION 3 – ROADWAY GEOMETRIC DESIGN CRITERIA

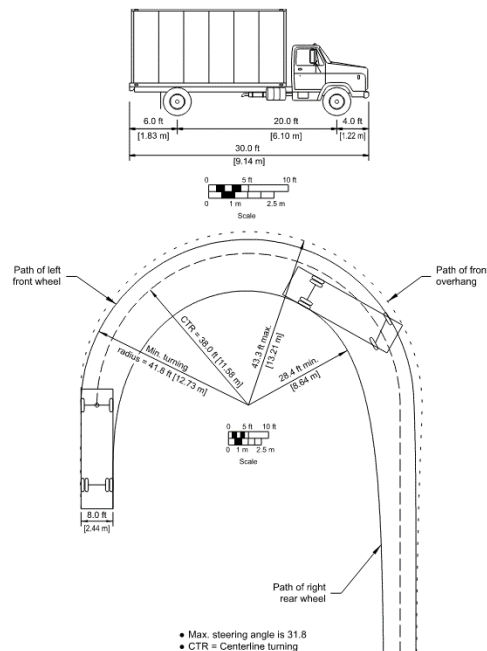
### A. COLLECTOR AND ARTERIAL ROADWAYS

Streets functionally classified as a "collector" and "arterial" should be designed in accordance with applicable provisions in [Appendix A1](#) of this Manual.

### B. LOCAL ROADWAYS

The following Geometric Design Standards shown in [Tables B\(1\)-1, B\(1\)-2, and B\(1\)-3\\*](#) are the minimum design criteria that shall apply to the design of all new residential and mixed-use streets functionally classified as "local" streets. Mixed-use is a single unified development with 0-2000 ADT that incorporates two or more different land uses within walking distance of one another; may include office, retail, public entertainment and a variety of housing types with some commercial usage. In mixed-use areas with 0-2000 ADT and truck traffic is less than or equal to 5%, the designer may utilize pavement widths for 0-2000 ADT shown in [Table B\(1\)-1\\*](#) and [Table B\(1\)-2\\*](#). If truck traffic is greater than 5%, the designer should utilize pavement widths for 2001-4000 ADT shown in [Table B\(1\)-1](#) and [Table B\(1\)-2\\*](#).

1. A single-unit (SU) truck design vehicle, as defined by AASHTO, should be used for the design of all local subdivision streets. Dimensions for this vehicle are depicted in Figure 2-11 of the AASHTO Geometric Design of Highways and Streets 2018, shown as [Figure B\(1\)-1\\*](#).



**FIGURE B(1)-1 MINIMUM TURNING PATH FOR SINGLE UNIT TRUCK SU-30**



2. The typical design criteria for each street should be uniform between intersections. The District **Engineer/Administrator's Designee** may consider modifications as required to satisfy changes in traffic volume or as necessary to address environmentally sensitive areas.
3. Roadway designs should be broadly based on two categories, as depicted in [Table B\(1\)-1](#) and [Table B\(1\)-2](#)\*.
  - a. Shoulder and Ditch Design
  - b. Curb and Gutter Design, further defined by the land use served by the street – residential or nonresidential. (See Appendix B Section 4 (H) Curb and Gutter Design).
4. One-way street design criterion is depicted in [Table B\(1\)-3](#)\*.

### **C. TURN LANES**

See Appendix "F"

### **D. TRANSITIONS, MERGING TAPERS AND SPEED CHANGE LENGTHS**

See Appendix "F"

---

\* Rev 10/20

**GEOMETRIC DESIGN STANDARDS FOR RESIDENTIAL AND MIXED USE SUBDIVISION STREETS (GS- SSAR)**

PROJECTED TRAFFIC VOLUME (ADT)	MINIMUM DESIGN SPEED (MPH)  (NOT POSTED SPEED)	HORIZONTAL AND VERTICAL CONTROLS					CURB AND GUTTER ROADWAYS		
		Maximum 2:1 Cut or Fill Slope Preferred 3:1 Cut or Fill Slopes					(Minimum Widths Measured Face of Curb to Face of Curb)		
		CURVE DATA		MAXIMUM % GRADE	MINIMUM SIGHT DISTANCE		NO PARKING (6)	PARKING 1 SIDE (2)	PARKING BOTH SIDES (2)
MINIMUM CENTERLINE RADIUS (5)	SUPER-ELEV.	STOPPING (3)	INTERSECTIONS (4)						
UP TO 2000	25	200'	NONE	NOTE (7)	155'	280'	24' (1)	24' (1)	29' (1)
2001 TO 4000	30	335'	NONE	NOTE (8)	200'	335'	26' (9)	31' (9)	36' (9)
<p>Notes:</p> <p>For streets with volumes over 4000 or serving heavy commercial or Industrial traffic; use the appropriate geometric design standard. (See VDOT's Road Design Manual).</p> <p>The roadway with the highest volume will govern the sight distance.</p> <p>Right of Way requirements can be found in <a href="#">Section 4.M Right Of Way</a></p> <p>For volumes 2001 – 4000 vpd, design criteria for the Collector functional class was utilized to determine minimum design values.</p> <p>Lower design speeds (and street widths) may be utilized provided they are designed in accordance with the AASHTO Green Book or AASHTO's Guidelines for Geometric Design of Low-Volume Roads*. The designer should coordinate with VDOT in advance of design (e.g. sketch plan stage) if this alternative criteria is being utilized.</p> <p>If 20 mph minimum design speed is utilized, a 20 mph advisory speed limit sign shall be posted along with any other horizontal or vertical curve warning signs as warranted.</p> <p>An engineering speed study sealed and signed by a licensed professional engineer, using VDOT's standard speed study report, must be provided by the developer and approved by VDOT for any roads posted at other than the statutory speed limit and planned for acceptance into the state system.</p>					<ol style="list-style-type: none"> <li>1. If the Local Street has 1 point of access and ADT&gt;400 vpd, then the roadway width must meet design values (2001 to 4000 vpd).</li> <li>2. With parking lanes, the horizontal clearance (measured from face of curb) is 1.5' (Min). 2018 AASHTO Green Book Chapter 5 (Section 5.3.4). However, VDOT has established a 3' minimum setback requirement behind the curb (This Manual, Section 5, Figure B(1)-18).</li> <li>3. 2018 AASHTO Green Book Chapter 3 (Table 3-1)</li> <li>4. 2018 AASHTO Green Book Chapter 9 (Table 9-7). For grades greater than 3%, the time gap must be adjusted and required sight distance recalculated.</li> <li>5. 2018 AASHTO Green Book Chapter 3 (Page 3-55, Table 3-13)</li> <li>6. Lateral offset (measured from face of curb) should be a minimum of 1.5' (Min) 2018 AASHTO Green Book Chapter 5 (Page 5-20). Gutter pan is <u>not</u> a portion of the travelway, but is a portion of the parking lane.</li> <li>7. 2018 AASHTO Green Book Chapter 5 (Section 5.3).</li> <li>8. 2018 AASHTO Green Book Chapter 6 (Section 6.3).</li> <li>9. Lane widths may vary between 10'-12' feet for collectors with 2001-4000 ADT. Widths shown may be decreased by 2 feet (26 feet to 24 feet), (31 feet to 29 feet) and (36 feet to 34 feet) based upon engineering judgment subject to VDOT approval.</li> </ol>				

**TABLE B(1)-1 CURB AND GUTTER SECTION**

\*Rev. 1/21

**GEOMETRIC DESIGN STANDARDS FOR RESIDENTIAL AND MIXED USE SUBDIVISION STREETS (GS- SSAR)**

PROJECTED TRAFFIC VOLUME (ADT)	MINIMUM DESIGN SPEED (MPH)  (NOT POSTED SPEED)	HORIZONTAL AND VERTICAL CONTROLS				SHOULDER AND DITCH ROADWAYS				
		Maximum 2:1 Cut or Fill Slope				Minimum ditch width (front slope) should be 4 feet or greater, based on slopes of 3:1 or flatter (Gentler slopes promote homeowner maintenance of ditches)				
		CURVE DATA		MAXIMUM % GRADE	MINIMUM SIGHT DISTANCE		MINIMUM PAVEMENT WIDTH			MIN. TOTAL WIDTH OF SHOULDER (8) (9)
MINIMUM CENTERLINE RADIUS (4)	SUPER-ELEV. (4)	STOPPING (2)	INTER-SECTION (3)		NO PARKING (5)	PARKING 1 SIDE (5)	PARKING BOTH SIDES (5)			
UP TO 2000	25	200'	NONE	NOTE (6)	155'	280'	24' (1) (11)	24' (1)	29' (1)	3'
2001 TO 4000	30	335'	NONE	NOTE (7)	200'	335'	26' (10)	31' (10)	36' (10)	6'
<p>Notes:</p> <p>For streets with volumes over 4000 or serving heavy commercial or Industrial traffic; use the appropriate geometric design standard. (see <a href="#">VDOT's Road Design Manual</a>)</p> <p>The roadway with the highest volume will govern the sight distance.</p> <p>Right of Way requirements can be found in <a href="#">Section 4.M Right Of Way</a></p> <p>For volumes 2001 – 4000 vpd, design criteria for the Collector functional class was utilized to determine minimum design values.</p> <p>Lower design speeds (and street widths) may be utilized provided they are designed in accordance with the AASHTO Green Book or AASHTO's Guidelines for Geometric Design of Low-Volume Roads*. The designer should coordinate with VDOT in advance of design (e.g. sketch plan stage) if this alternative criteria is being utilized.</p> <p>If 20 mph minimum design speed is utilized, a 20 mph advisory speed limit sign shall be posted along with any other horizontal or vertical curve warning signs as warranted.</p> <p>An engineering speed study sealed and signed by a licensed professional engineer, using VDOT's standard speed study report, must be provided by the developer and approved by VDOT for any roads posted at other than the statutory speed limit and planned for acceptance into the state system.</p>				<ol style="list-style-type: none"> <li>1. If the Local Street has 1 point of access and ADT&gt;400 vpd, then the roadway width must meet design values (2001 TO 4000 vpd).</li> <li>2. 2018 AASHTO Green Book Chapter 3 (Table 3-1)</li> <li>3. 2018 AASHTO Green Book Chapter 9 (Table 9-7). For grades greater than 3%, the time gap must be adjusted and required sight distance recalculated.</li> <li>4. 2018 AASHTO Green Book Chapter 3 (Table 3-13)</li> <li>5. Clear zone width for UP TO 2000 vpd is 7' and clear zone values for 2001 TO 4000 vpd is 10'.</li> <li>6. 2018 AASHTO Green Book Chapter 5 (Section 5.3).</li> <li>7. 2018 AASHTO Green Book Chapter 6 (Section 6.3).</li> <li>8. 2018 AASHTO Green Book Chapter 5 (Table 5-5)</li> <li>9. Add an additional '4' if guardrail is required.</li> <li>10. Lane widths may vary between 10'-12' feet for collectors with 2001-4000 ADT. Widths shown may be decreased by 2 feet (26 feet to 24 feet), (31 feet to 29 feet) and (36 feet to 34 feet) based upon engineering judgment subject to VDOT approval.</li> <li>11. For 0-400 ADT and "No Parking" <u>ONLY</u> minimum pavement width may be reduced from 24 feet to 18 feet and shoulder width may be reduced in accordance with Note 8 above.</li> </ol>						

**TABLE B(1)-2 SHOULDER AND DITCH SECTION**

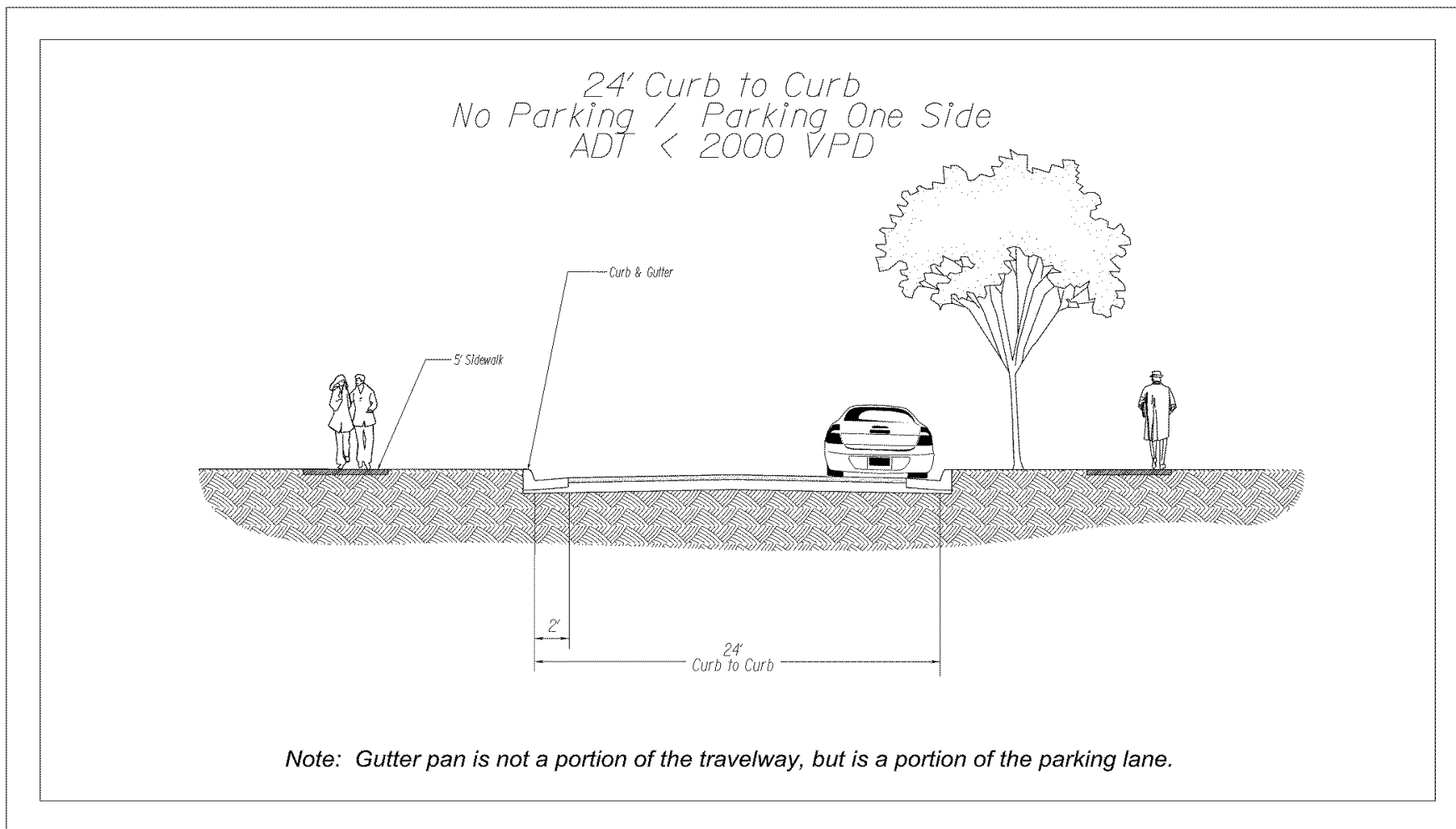
\* Rev. 1/21

**GEOMETRIC DESIGN STANDARDS FOR RESIDENTIAL AND MIXED USE SUBDIVISION STREETS (GS- SSAR)**

TRAFFIC	PROJECTED TRAFFIC VOLUME (ADT)	DESIGN SPEED (MPH) (NOT POSTED SPEED)	HORIZONTAL AND VERTICAL CONTROLS Maximum 2:1 cut or fill slope				ROADWAY SECTION CRITERIA						
			MINIMUM CURVE RADIUS (WITHOUT SUPERLEV.)	MAXIMUM % GRADE	MINIMUM SIGHT DISTANCE		SHOULDER AND DITCH ROADWAYS Minimum ditch width (front slope) should be 4 feet or greater, based on slopes of 3:1 (Gentler slopes promote homeowner maintenance of ditches) (NO PARKING)				CURB AND GUTTER ROADWAYS (NO PARKING)		
					STOPPING	INTERSECTION	MINIMUM ROADWAY WIDTH	SHOULDER WIDTH WITH G.R.	SHOULDER WIDTH W/O G.R.	CLEAR ZONE (FROM EDGE OF TRAVELWAY)	WIDTH MEASURED FROM FACE OF CURB TO FACE OF CURB	HORIZONTAL CLEARANCE (FROM FACE OF CURB)	
ONE-WAY (1-LANE)	≤ 400	25	198' (4)	NOTE (2)	(5) *	95' (6)*	15' (7)	6'	2' (1)	6' (3)	15' (7)	1.5'	
<p>Notes:</p> <p>These design standards may also be used for one-way divided pairs, such as subdivision entrances with wide medians.</p> <p>On-street parking is anticipated; a parking lane width not less than 7 feet should be used.</p> <p>Right Of Way requirements can be found in <a href="#">Section 4.M Right Of Way</a>.</p> <p>Lower design speeds (and street widths) may be utilized provided they are designed in accordance with the AASHTO Green Book or AASHTO's Guidelines for Geometric Design of Low-Volume Roads*. The designer should coordinate with VDOT in advance of design (e.g. sketch plan stage) if this alternative criteria is being utilized.</p> <p>If 20 mph minimum design speed is utilized, a 20 mph advisory speed limit sign shall be posted along with any other horizontal or vertical curve warning signs as warranted.</p> <p>An engineering speed study sealed and signed by a licensed professional engineer, using VDOT's standard speed study report, must be provided by the developer and approved by VDOT for any roads posted at other than the statutory speed limit and planned for acceptance into the state system.</p>							<ol style="list-style-type: none"> <li>1. 2018 AASHTO Green Book Chapter 5 (Table 5-5)</li> <li>2. 2018 AASHTO Green Book Chapter 5 (*Section 5.3.1.5)</li> <li>3. Clear zone widths may be reduced with the concurrence of the District Engineer/Administrator's Designee where terrain or social/environmental impact considerations are appropriate. (AASHTO 2019 Guidelines for Geometric Design of Low-Volume Roads, Chapter 4).*</li> <li>4. AASHTO 2018 Green Book Chapter 3 (Table 3-13)</li> <li>5. AASHTO 2019 Guidelines for Geometric Design of Low-Volume Roads, Chapter 4 (Page 4-18, Table 4-7).*</li> <li>6. AASHTO 2019 Guidelines for Geometric Design of Low Volume Local Roads, Chapter 4 (Page 4-32, Table 4-10).*</li> <li>7. ) If on-street parking is allowed the appropriate additional paved width needs to be provided.</li> </ol>						

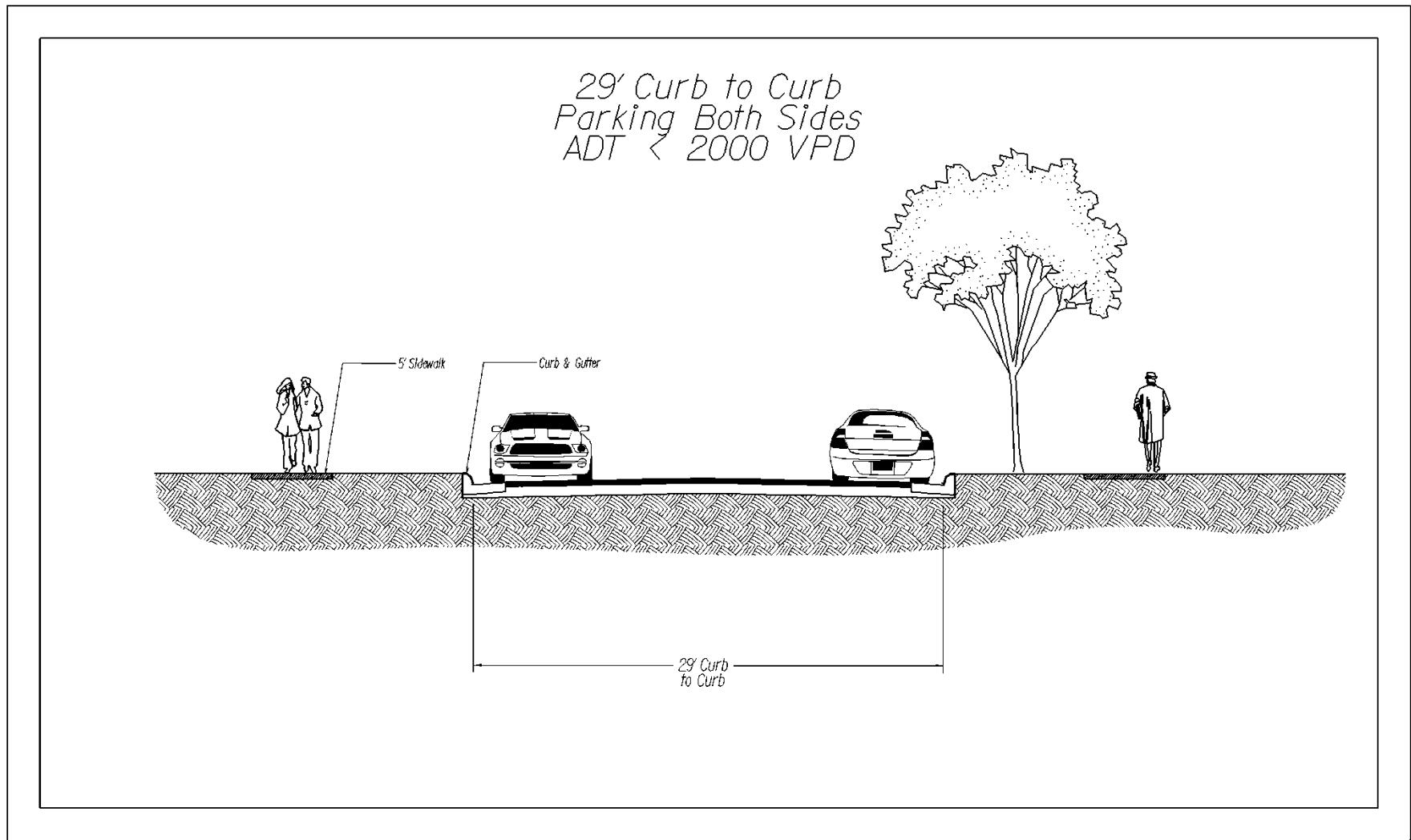
**TABLE B(1)-3 ONE LANE (ONE WAY) SUBDIVISION STREETS**

\* Rev 1/21



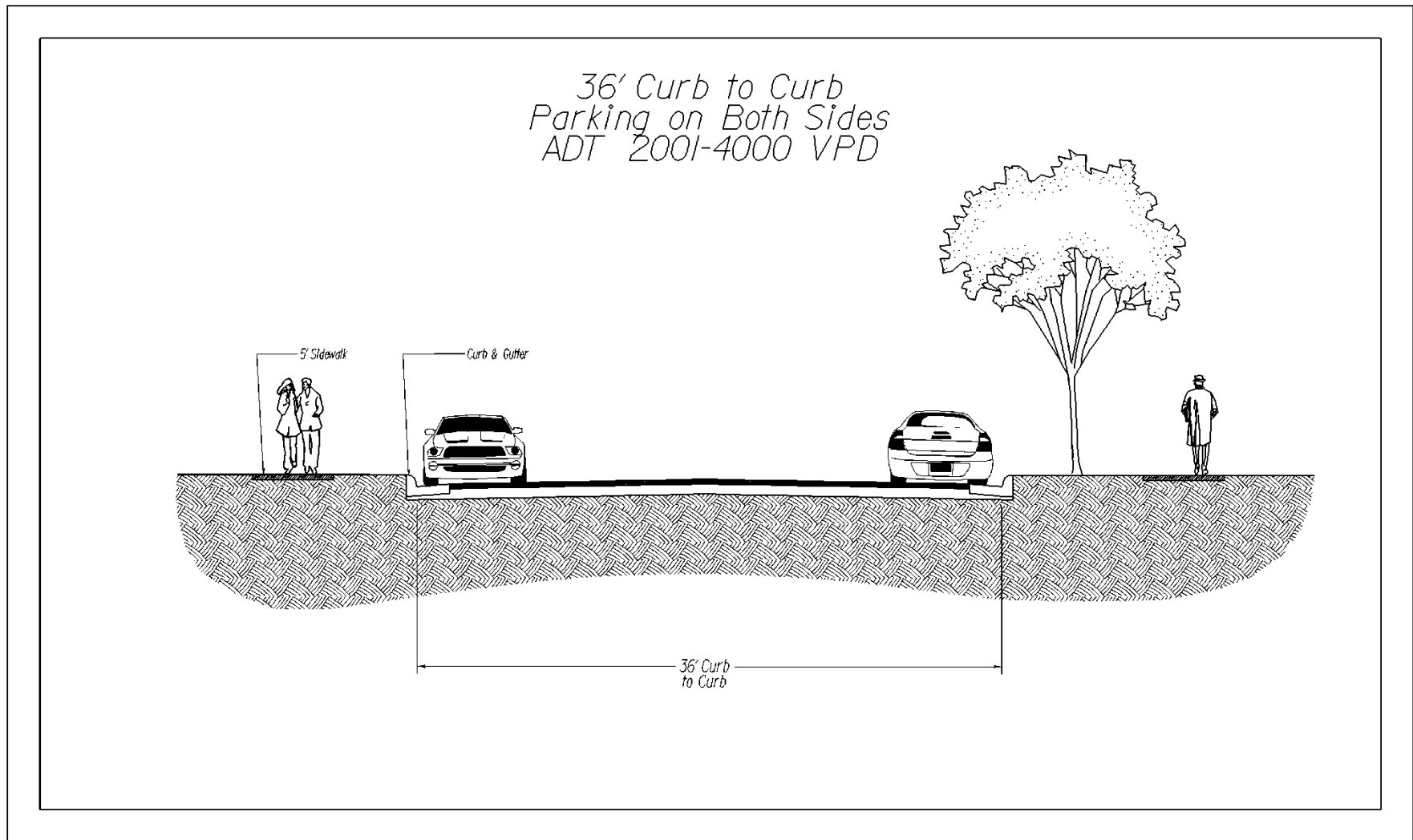
**FIGURE B(1)-2\* CURB TO CURB NO PARKING / PARKING ON ONE SIDE**

\* Rev 10/20



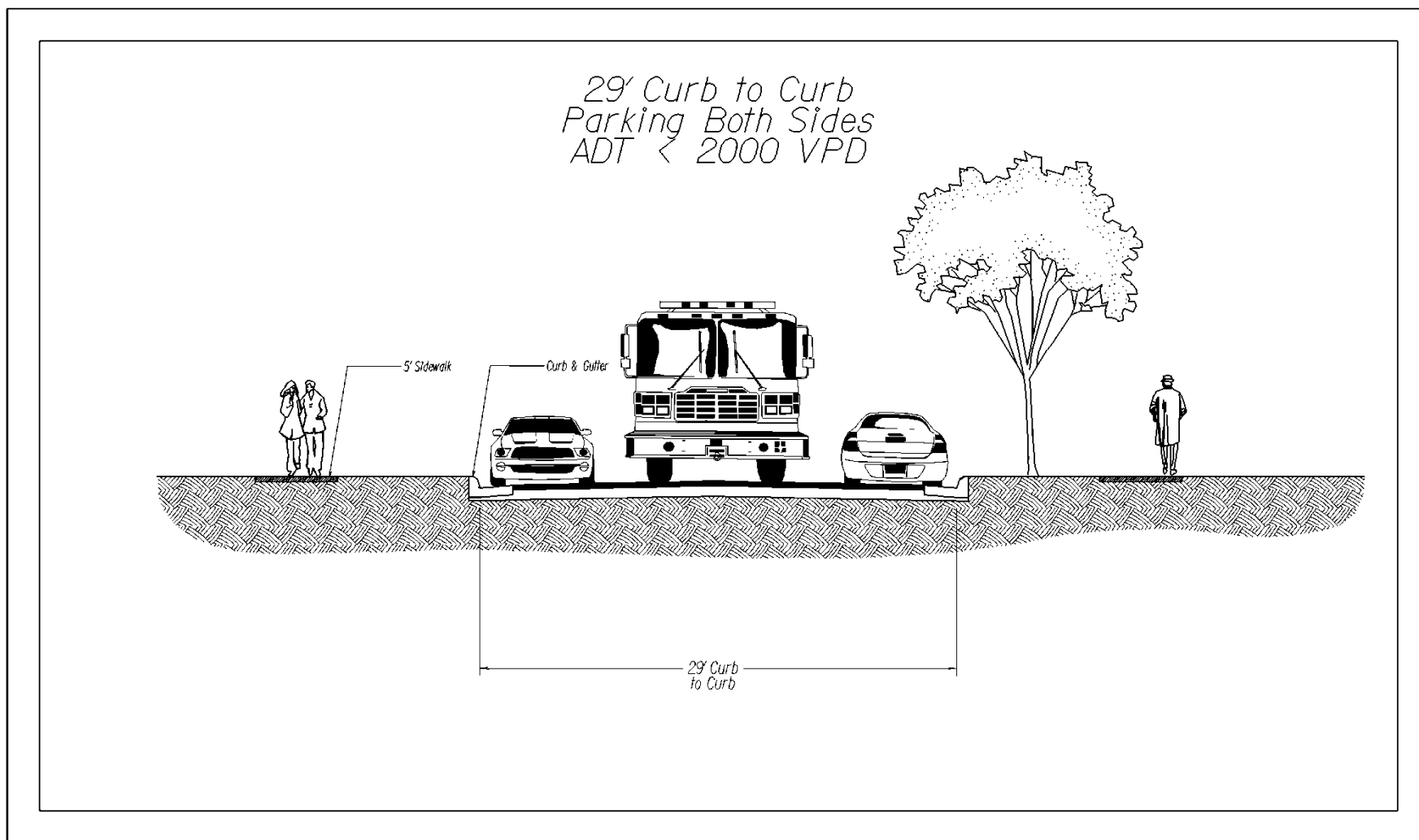
**FIGURE B(1)-3\* 29 FT. CURB TO CURB PARKING ON BOTH SIDES**

\* Rev 10/20



**FIGURE B(1)-4\* 36 FT. CURB TO CURB PARKING ON BOTH SIDES**

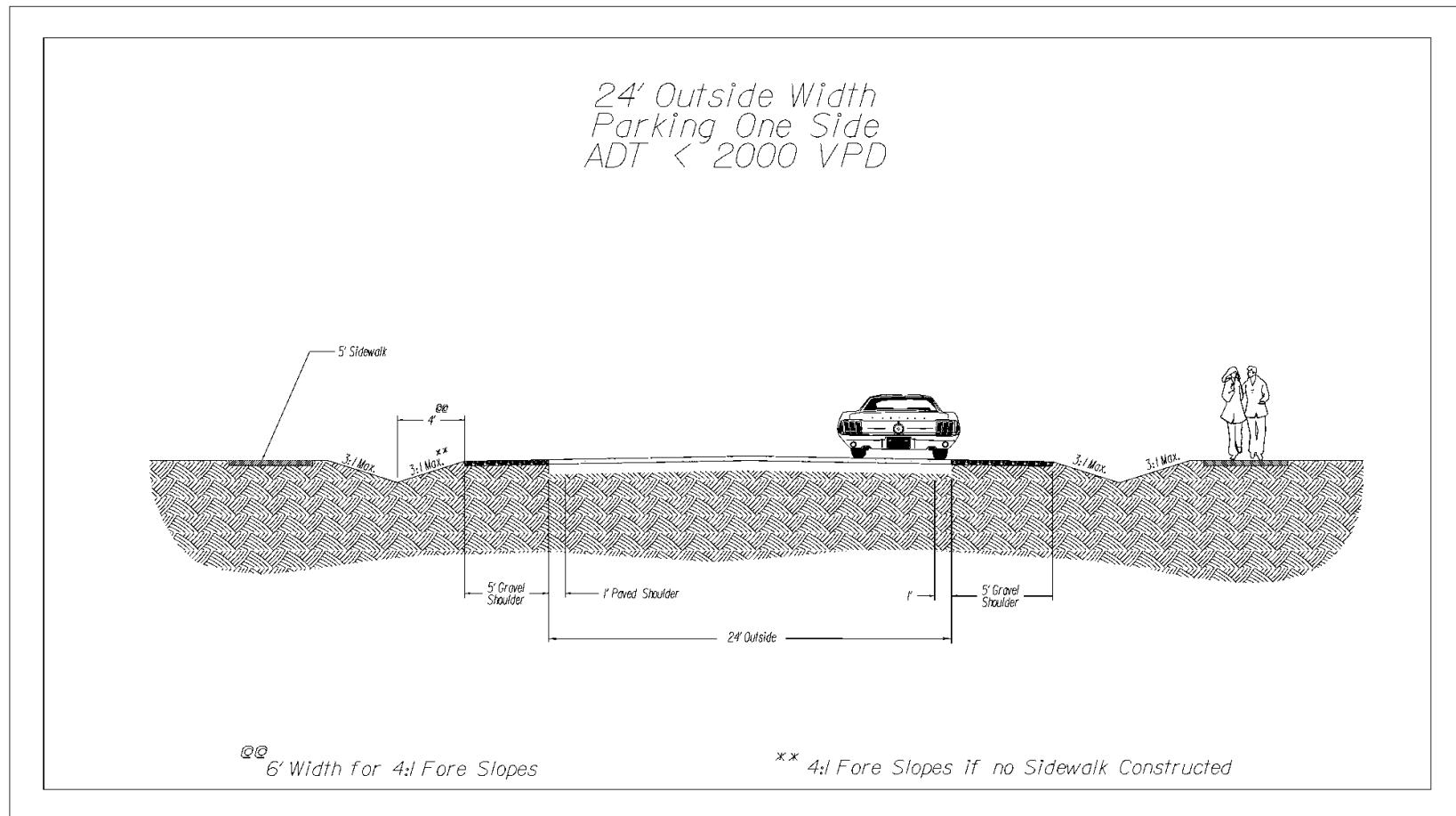
\* Rev 10/20



**FIGURE B(1)-5\* 29 FT. CURB TO CURB PARKING ON BOTH SIDES**

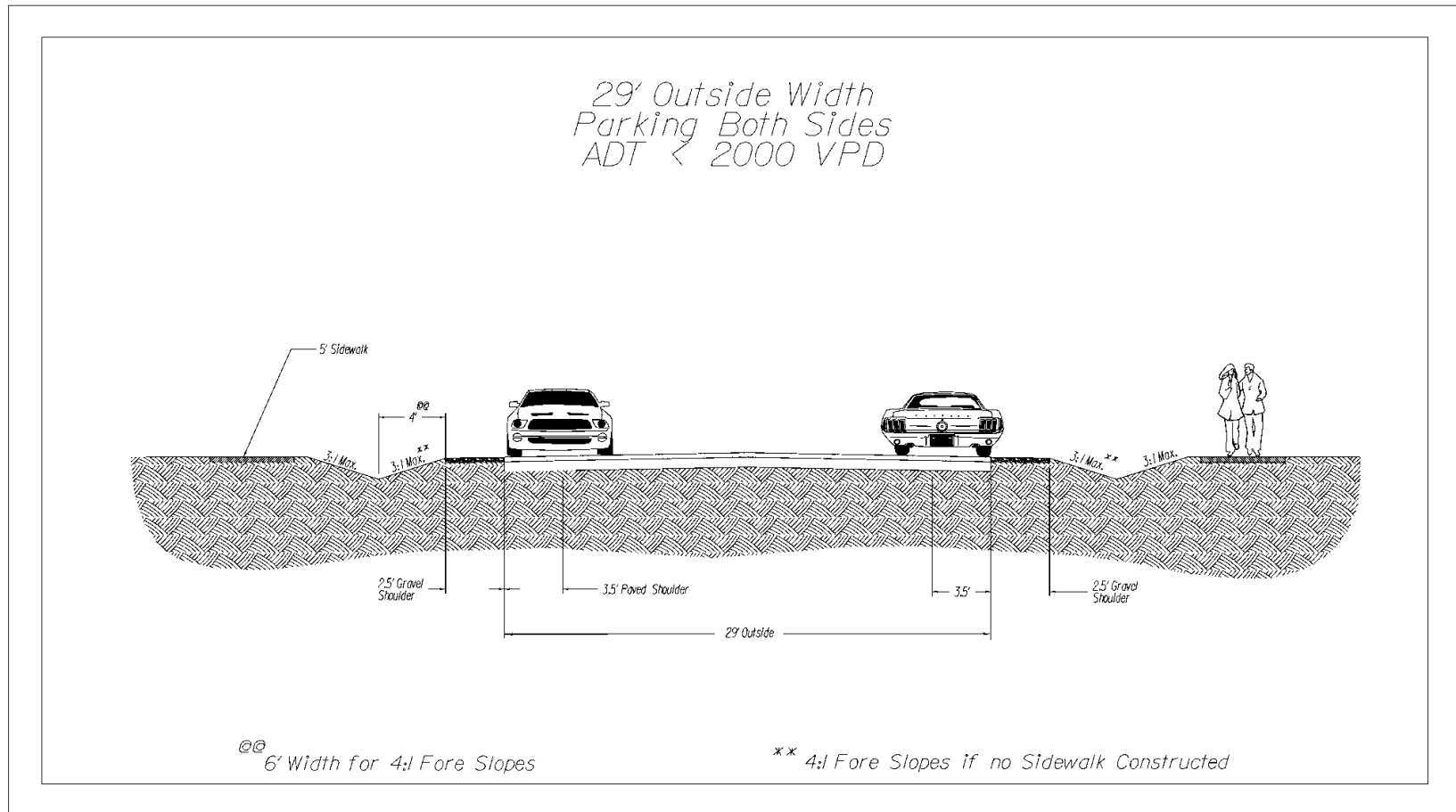
\* Rev 10/20





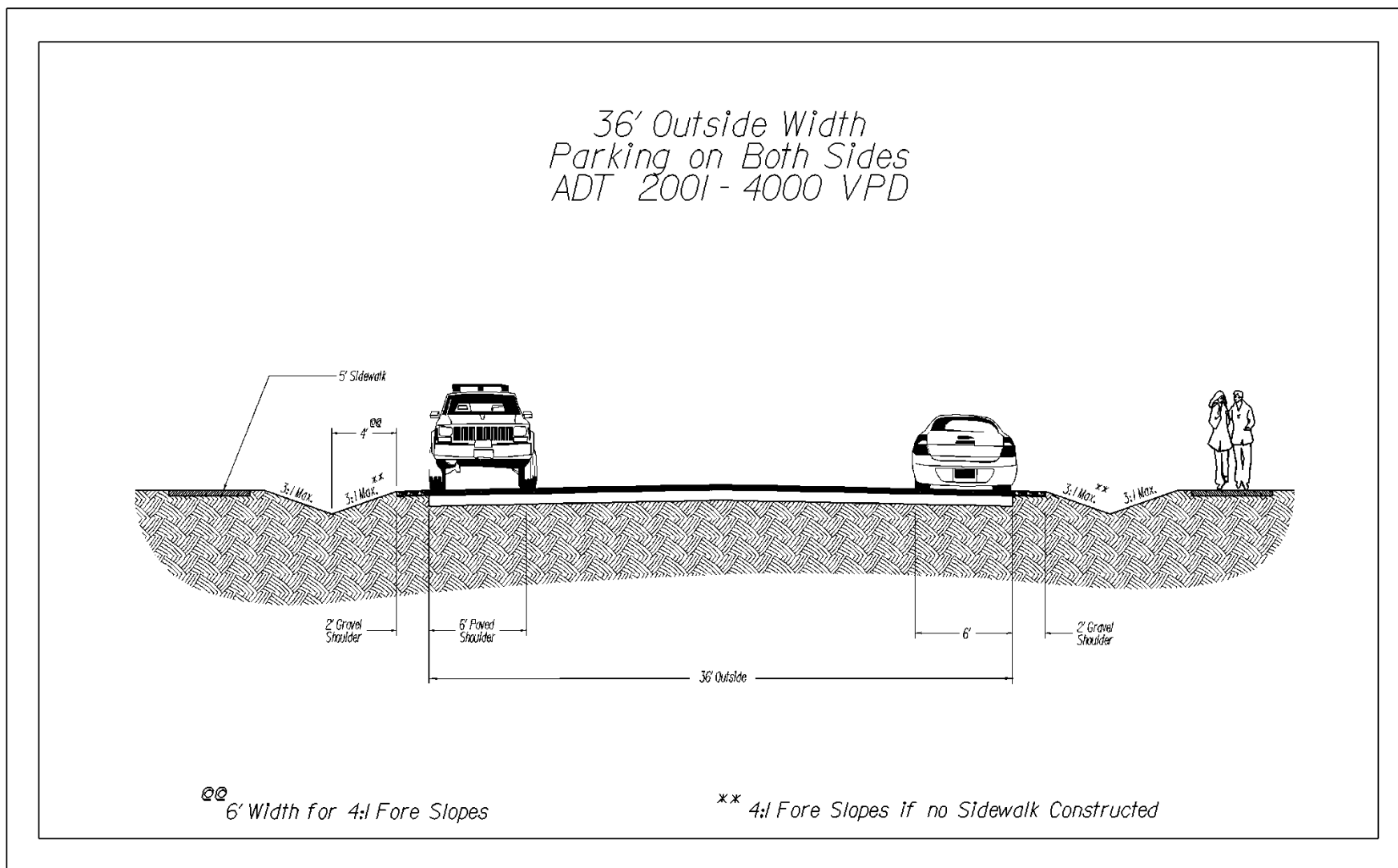
**FIGURE B(1)-6\* 24 FT. OUTSIDE WIDTH PARKING ONE SIDE**

\* Rev 10/20



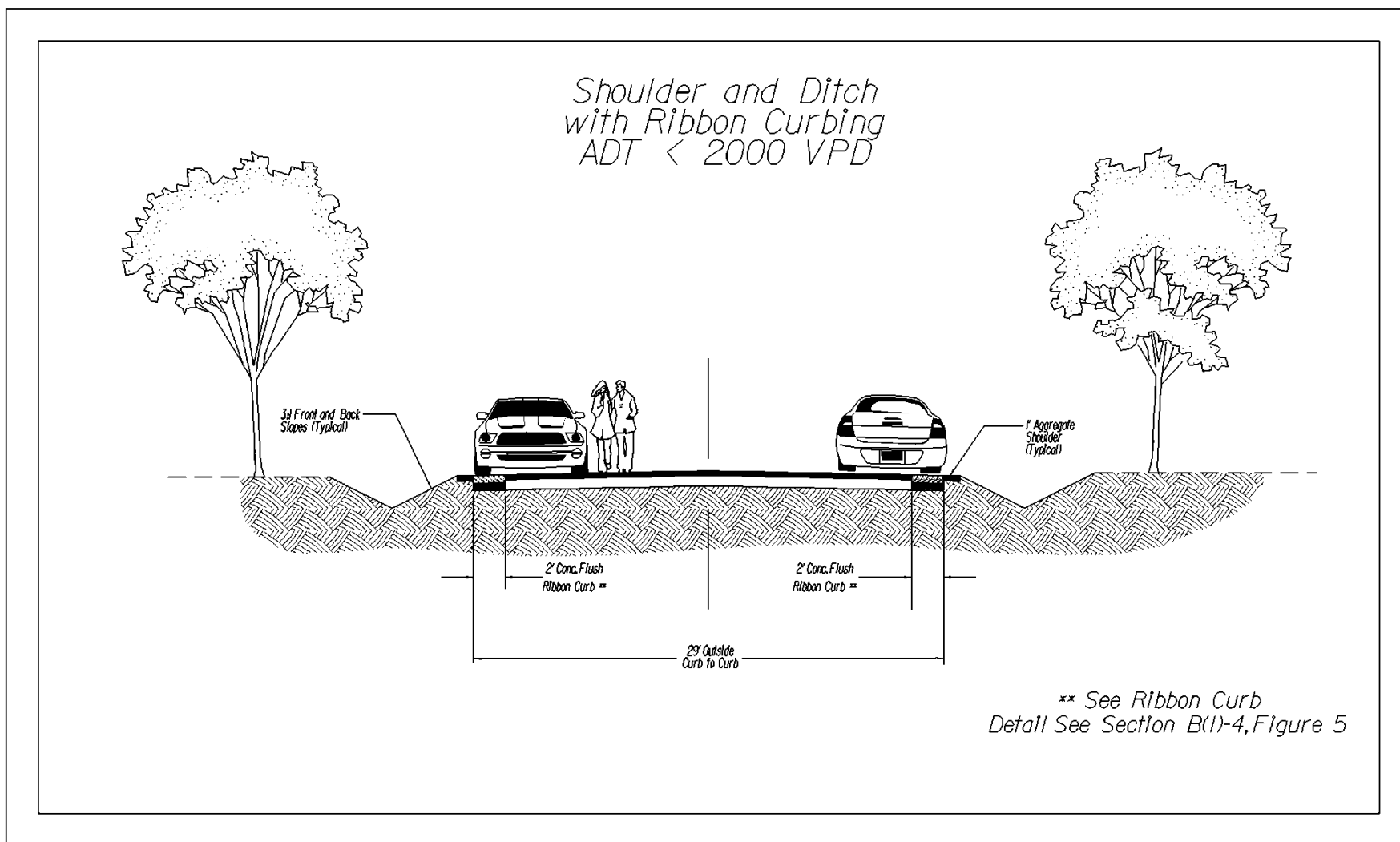
**FIGURE B(1)-7\* 29 FT. OUTSIDE WIDTH PARKING ON BOTH SIDES**

\* Rev 10/20



**FIGURE B(1)-8\* 36 FT. OUTSIDE WIDTH PARKING ON BOTH SIDES**

\* Rev 10/20



**FIGURE B(1)-9\* 29 FT. STABILIZED SHOULDER AND DITCH WITH RIBBON CURB**

\* Rev 10/20

## GEOMETRIC DESIGN STANDARDS FOR SCHOOL BUS ACCESS ROAD

The minimum pavement widths for school bus access roads, by section type.

<b>One Way</b>	<b>Rural (Shoulder)</b>	<b>Urban (Curb or Curb and Gutter) (4)</b>
Pavement	15 feet	15 feet (2)
Shoulder	2 feet (1) each side	-
Parking	Prohibited	Permitted (3)
Minimum Turning Radius	45 feet	45 feet
<b>Two Way</b>	<b>Rural (Shoulder)</b>	<b>Urban (Curb or Curb and Gutter) (4)</b>
Pavement	24 feet	24 feet (2)
Shoulder	6 feet (1) each side	-
Parking	Prohibited	Permitted (3)
Minimum Turning Radius	45 feet	45 feet

**TABLE B(1)-4 SCHOOL BUS ACCESS ROAD**

Note: (1) Without Guardrail. With Guardrail add an additional 4 feet.

(2) Minimum 40 feet Right of Way.\*

(3) Parking lanes are 7 feet wide and include the gutter pan when curb and gutter is used.

(4) Gutter pan is not a portion of the travelway, but is a portion of the parking lane.

## E. SIGHT DISTANCE

1. **Stopping sight distance** – Stopping sight distance shall be based on a height of eye of 3.5 feet and an object height of 2.0 feet along the center of the travel lane.
2. **Intersection sight distance** – Intersection sight distance should be measured presuming a stop condition of the minor roadway. Sight distance shall be based on a height of eye of 3.5 feet and an object height of 3.5 feet. Dedicated right of way may be required to preserve appropriate sight distance at intersections. The District Engineer/Administrator's Designee may consider an easement as an alternative to dedicated right of way.
3. **Sight Distance Triangles** – The intersection sight distance is measured along the major roadway, based on the major roadway's design or, in the case of existing roadways, the operation speed limit.

Decision points (A, B and C shown in [Figure B\(1\)-10\\*](#) - Sight Distance Triangles) represent the position of drivers along the major and minor roadways. Two sight distance triangles are considered, one in each direction of the major roadway from decision point A, which represents the driver exiting the minor roadway.

Decision point A (driver's eye) is located 4 feet from the centerline or left edge of pavement of the minor roadway 14.5 to 18.0 feet from the edge of the travel lane of the major roadway (See AASHTO, Chapter 9).

Where practical, Decision Point A should be determined by the location of the stop bar and may exceed 18.0 feet from the edge of the travel lane.

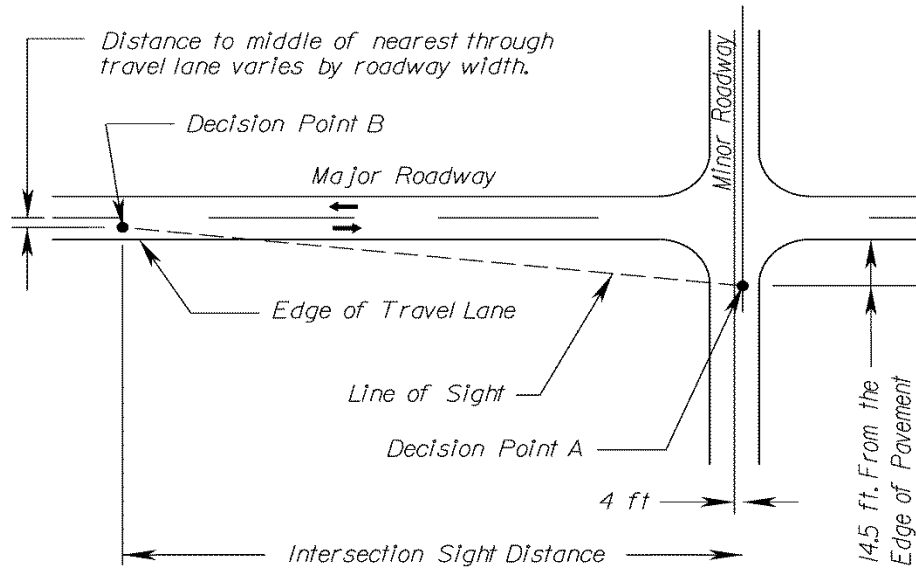
Decision point B is located in the middle of the nearest travel lane of the major roadway.

Decision point C is located in the nearest right to left movement lane of the major roadway.

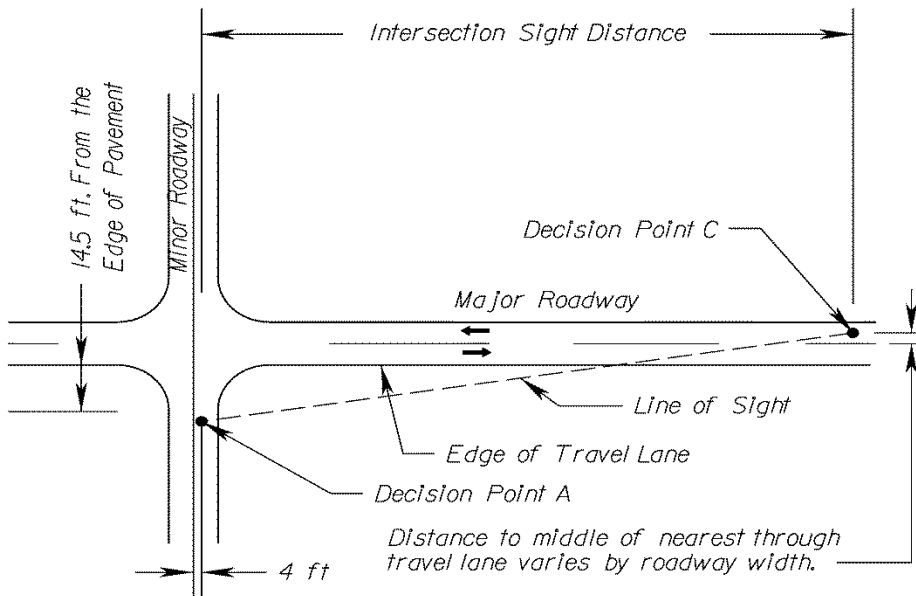
**For more information on Sight Distances see [Appendix F](#).**

---

\* Rev. 10/20



*Left Sight Distance Triangle*



*Right Sight Distance Triangle*

**FIGURE B(1)-10\* SIGHT DISTANCE TRIANGLES**

Additional information regarding sight distance requirements is available in [Appendix E](#) and AASHTO's A Policy on Geometric Design of Highways and Streets, Chapter 9.

\* Rev 10/20

## **SECTION 4 – ELEMENTS OF TYPICAL SECTION**

### **A. PAVEMENT DESIGN**

1. Pavement design for new subdivision streets shall be developed using the Pavement Design Guide for Subdivision and Secondary Roads in Virginia.
2. “Normal crown” means the cross slope of the roadway pavement and should be 1/4 inch per foot (2%), unless otherwise increased by the District Engineer/Administrator’s Designee. Blot and seal pavements should have a crown of 3/8 inch per foot.

### **B. PAVEMENT WIDTH**

1. Except as may be permitted in this subsection, the minimum pavement widths shall be as shown in [Tables B\(1\)-1, B\(1\)-2, and B\(1\)-3\\*](#). Also see Typical Sections Figures [B\(1\)-2 through B\(1\)-8\\*](#).
2. Unless otherwise indicated, the use of curb and gutter anticipates on street parking. Parking along streets with shoulder and ditch design is not desirable. However, if the locality desires to allow parking on a shoulder and ditch design, a minimum 15 ft. of clear roadway width for emergency vehicles must be maintained at all times.
3. Designated parking widths may be utilized in lieu of shoulders; however, the minimum width of travel way must be maintained.
4. Pavement width (Travelway) does not include the gutter pan when used.

### **C. PARALLEL PARKING LANE WIDTHS**

(See [Appendix A\(1\)](#) for details)

### **D. PERPENDICULAR AND ANGLE PARKING**

(See [Appendix A\(1\)](#) for details)

---

\* Rev 10/20



## E. INTERSECTIONS

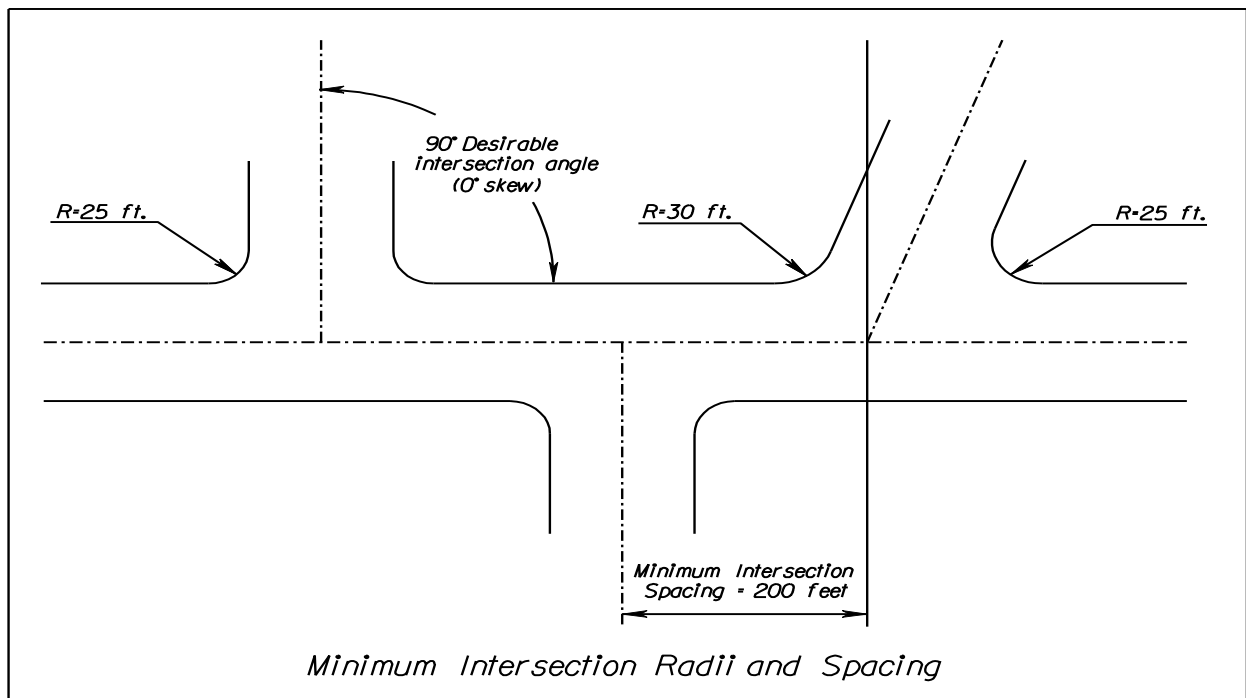
### 1. Angle of intersection

Streets should intersect at right angles; however, intersecting angles between 75\* and 90 degrees are allowed.

A landing, having a minimum of 50' in length and a maximum vertical grade of 2%, should be provided at each intersection. Sign islands may be permitted if approved by the District Engineer/Administrator's Designee.

### 2. Spacing (i.e. Minimum distance between intersecting roadways)

Offset intersections are discouraged. Intersections or intersecting streets on the same side or opposite sides shall be spaced a minimum of 200 feet and this distance shall be adjusted upward based on upstream and downstream intersection turning movement volumes. [Figure B\(1\)-11](#) illustrates the desirable spacing.



**FIGURE B(1)-11 INTERSECTION DESIGN**

### 3. Minimum Radii

Intersection radii should be the same on all quadrants of an intersection. However, roadway alignments, traffic volumes along the respective legs, and other factors may warrant consideration of using different radii and may be considered. For skew intersections, radii shall be not less than 25 feet for the acute angle and 30 feet for the obtuse angle of the intersection street.

\* Rev. 7/23

At street intersections, there are two distinct radii that need to be considered, the effective turning radius of the turning vehicle and the radius of the curb return (actual curb radius). (See 2018 AASHTO Green Book, Figure 5-3).

The effective turning radius is the minimum radius appropriate for turning from the right-hand travel lane on the approach street to the appropriate lane of the receiving street. This radius is determined by the selection of a design vehicle appropriate for the streets being designed and the lane on the receiving street into which that design vehicle will turn. **The minimum effective turning radius at street intersections on subdivision streets shall not be less than 25 feet.**

The radius of the curb return (actual curb radius) should be no greater than that needed to accommodate the design turning radius. The actual curb radius shall be such that the design vehicle does not encroach into the adjacent or opposite lanes when making a turn. **The minimum radius of the curb return (actual curb radius) shall not be less than 15 feet. In industrial areas with no on-street parking, the radius of the curb return shall not be less than 30 feet.**

If intercity buses, standard 84 passenger school buses or semitrailers are expected to use the street, the minimum radius should be increased to accommodate the turning radius of such vehicles. However, all subdivision streets shall be designed to accommodate, at a minimum, S-BUS-36 school buses and SU-30 single-unit trucks. Minimal encroachment into the opposing lane of traffic of the receiving street by the design vehicle is expected. The minimum radius of the curb return shall not be less than 15\* feet.

A larger radius or additional pavement at the intersection may be required on shoulder and ditch sections to avoid shoulder rutting.

Auto-TURN® diagrams should be used to demonstrate the impact on the opposing lane of the receiving street and the sufficiency of the street widths to accommodate the vehicles without running off of pavement or scrubbing curbs.

## F. CONCENTRIC DESIGN

Normally, the design of principal roadway elements of subdivision streets should be concentric about the center of the right-of-way. However, certain circumstances and special development goals, such as phased development may justify arrangements that require one side of the right of way to differ from the other, when based on a typical centerline between travel lanes. The normal typical section may be varied as necessary to provide for vehicular or pedestrian safety or both and traffic channelization features, e.g., turn lanes, intersection radius, etc.

---

\* Rev 7/22

## G. CULS-DE-SAC\* AND TURNAROUNDS

To afford the greatest flexibility in design, various types of turnaround designs may be used on subdivision streets. Additional right-of-way shall be provided as required by the turnaround design to continue the right of way limits around the perimeter of the turnaround. Roadways in industrial and commercial areas using Cul-de-sac designs shall accommodate a WB-67 design vehicle. Acceptable Cul-de-sac designs include:

### a. Circular Type Turnarounds

For circular turnarounds, a well-defined identifiable street segment, equal to the normal lot width along the intersected street that serves the cul-de-sac or 50 feet whichever is greater, shall extend from the intersected street to the turning area. A minimum radius of 45 feet, measured to the edge of pavement or face of curb, shall be used for circular turnarounds on residential cul-de-sac streets serving more than 25 dwellings and greater than 0.25 mile in length. A 45 foot radius should also be used if standard 65 passenger school buses are expected to use the cul-de-sac, or for any nonresidential use. For circular turnarounds on short low volume residential cul-de-sac streets, this minimum radius may be reduced to 30 feet when specifically approved by the locality in consultation with emergency services. (See [Figure B\(1\)-12 CULS-DE-SAC AND TURNAROUNDS](#))

### b. Culs-de-sac with unpaved centers (Islands)

When a circular turnaround is proposed with an unpaved area in the center, the roadway around the center should be considered a one-way street and designed according to [Table B\(1\)-3](#) for Roadway Section Criteria. Pavement widths shall accommodate the turning radii of an SU-40 single unit truck design vehicle. Parking should be restricted to the outside of the curve. The pavement width shall accommodate an SU-40 when passing a parked vehicle within the cul-de-sac. Culs-de-sac with curb and gutter should have a raised curb along the circumference of the island, unless the cul-de-sac is being developed to accommodate low impact development techniques. (See [Figure B\(1\)-12 CULS-DE-SAC AND TURNAROUNDS](#))

The unpaved area should have a minimum radius 30 feet and maximum radius of 120 feet. Unpaved center areas should have a ten-foot clear zone around the circumference of the circle. Any non-travel areas included within turnarounds should be included in the dedicated right-of-way of the facility.

If the center radius is greater than 120 feet, the street will be considered a loop street and should be designed in accordance with [Tables B\(1\)-1](#) and [B\(1\)-2](#) for two-way traffic.

### c. Alternative Turnarounds (for Residential streets only)

“T and Branch” type turnarounds may be considered for short streets less than 0.25 miles in length. Other proposals must be judged on their merits. However,

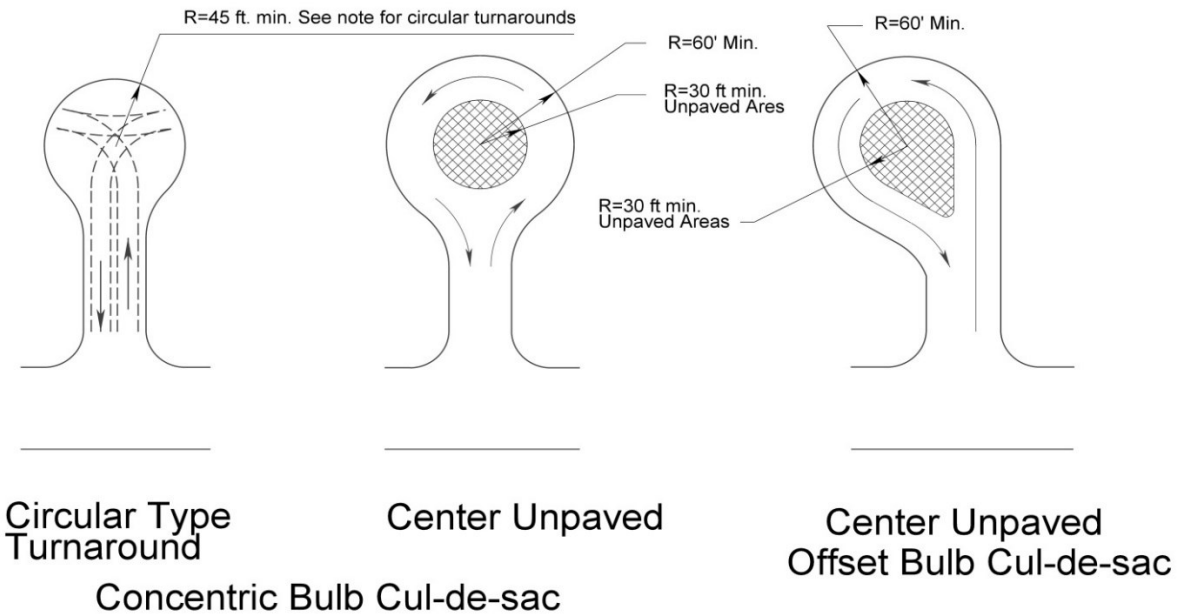
---

\* Rev. 7/22

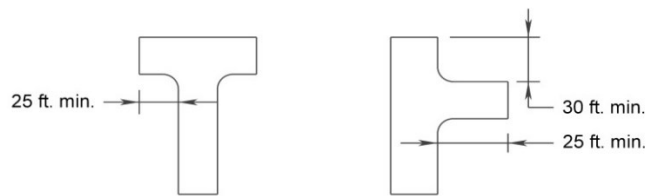
when proposed, the ability of single unit truck design vehicles to reverse direction on these alternative types of turnarounds, without leaving the pavement area should be proven. (See [Figure B\(1\)-12 CULS-DE-SAC AND TURNAROUNDS](#))

d. Temporary turnarounds and stub streets.

A turnaround should be provided for any temporary or stub street longer than 150' from the point of intersection to the end of pavement. Any portion of the turnaround outside the dedicated right of way for the stub street may be placed in an easement. (See [Figure B\(1\)-12 CULS-DE-SAC AND TURNAROUNDS](#))\*



Note: For circular turnarounds on short low volume residential cul-de-sac streets, the 45 ft. minimum radius may be reduced to 30 feet when specifically approved by the locality in consultation with emergency services.



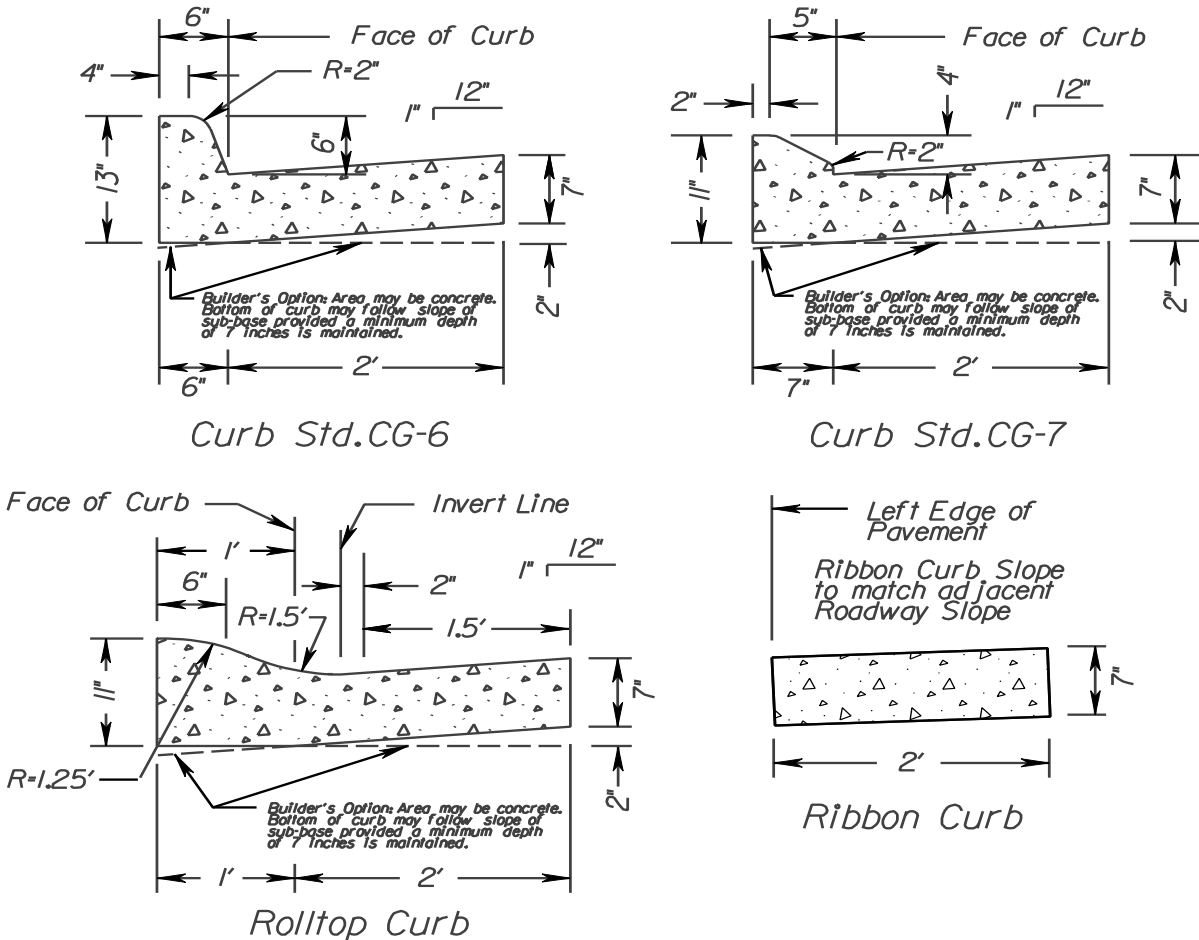
T - Type      Branch Type  
Alternative Turnaround

**FIGURE B(1)-12 CULS-DE-SAC AND TURNAROUND DETAILS**

\* Rev. 7/23

**H. CURB AND GUTTER DESIGNS**

The Department does not require the use of curb and gutter on subdivision streets but recognizes that it is an acceptable design alternative and preferred in high density developments. Curb and gutter designs shown in [Figure B\(1\)-13\\*](#) are appropriate for Subdivision streets.



**FIGURE B(1)-13\* CURB AND GUTTER DETAILS**

The following notes apply to CG-6, CG-7 and Rolltop curb:

1. Curb and gutter may be precast of Class A4 hydraulic cement concrete or cast in place using Class A3 hydraulic cement concrete.
2. When used with stabilized, open-graded drainage layers, the bottom of the curb and gutter shall be constructed parallel to the slope of the sub-base courses and to the depth of the pavement but not less than the thickness shown.

\* Rev 10/20

### 3. Use of curb and gutter:

- a. See appropriate GS Standards in [Appendix A1](#).
- b. Rolltop curb and gutter and Ribbon curb may be used along subdivision streets having a design speed not greater than 25 mph.

### 4. All curb and gutter designs shall transition to match entrance gutters or another curb and gutter type or standard curb openings within 10 feet of the change in gutter type.

### 5. Curb ramps

All streets that incorporate accessible routes for pedestrian use shall include curb ramps at intersections for use by persons with disabilities, without regard to the curb design used. Curb ramps should be constructed in accordance with Standard CG-12. Further guidance on the design of curb ramps may be found in Location and Design [IIM-LD-55](#).

### 6. Treatment behind curbs

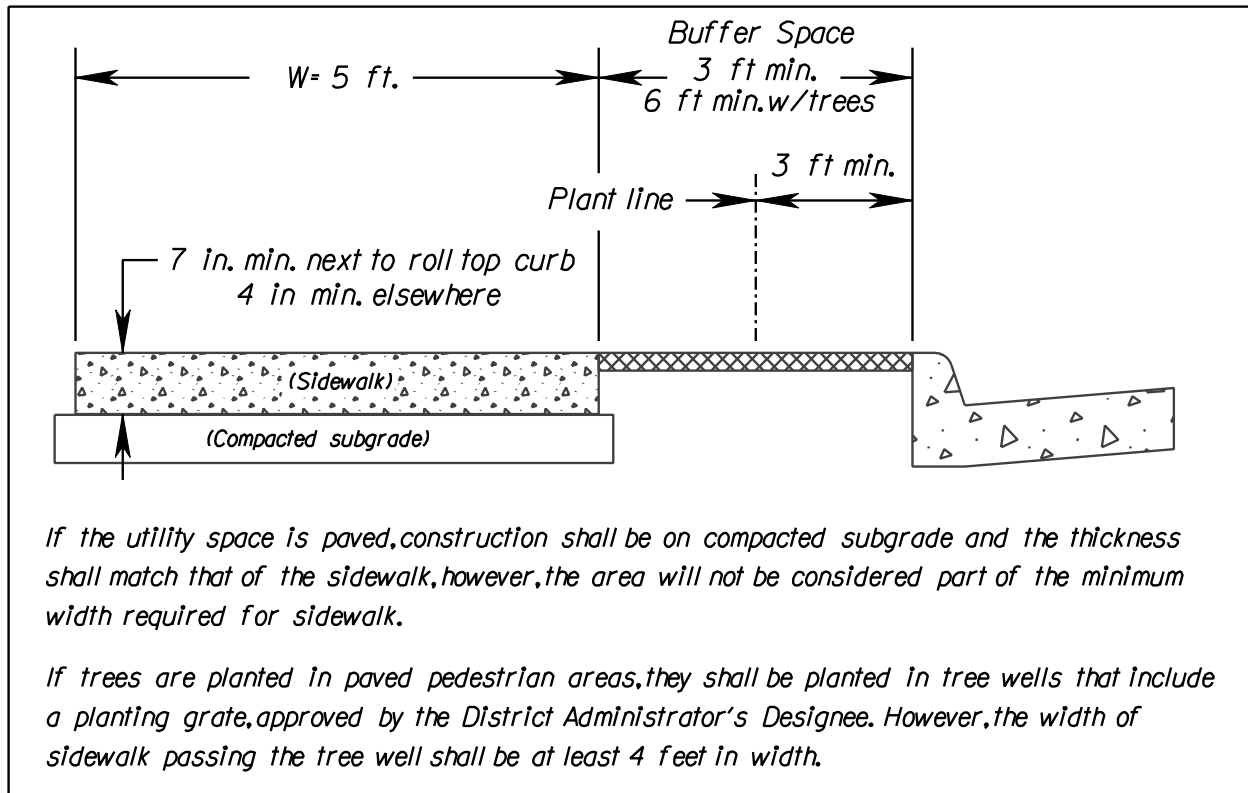
Where curb and gutter is used, a 3 feet minimum buffer strip graded at 1/4 inch per foot (2% Max.) shall\* be provided behind the back of curb.

Where sidewalk is used in conjunction with curb and gutter, a 3 feet minimum buffer strip graded at 1/4 inch per foot (2% Max.) shall be provided behind the curb as shown in [Figure B\(1\)-14](#) . This buffer strip may be paved with a suitable material approved by the District Engineer/Administrator's Designee, but the paved portion of the buffer strip should not be considered to be part of the prescribed width for sidewalks. Sidewalk placed adjacent to curb shall be 8 feet in width to allow vehicle doors to open and people to exit from the vehicle without blocking the pedestrian access route.

See Appendix A(1) Buffer Strip for additional information.

---

\* Added 1/21



**FIGURE B(1)-14.\* DETAIL BACK OF CURBS**

## I. PRIVATE ENTRANCES

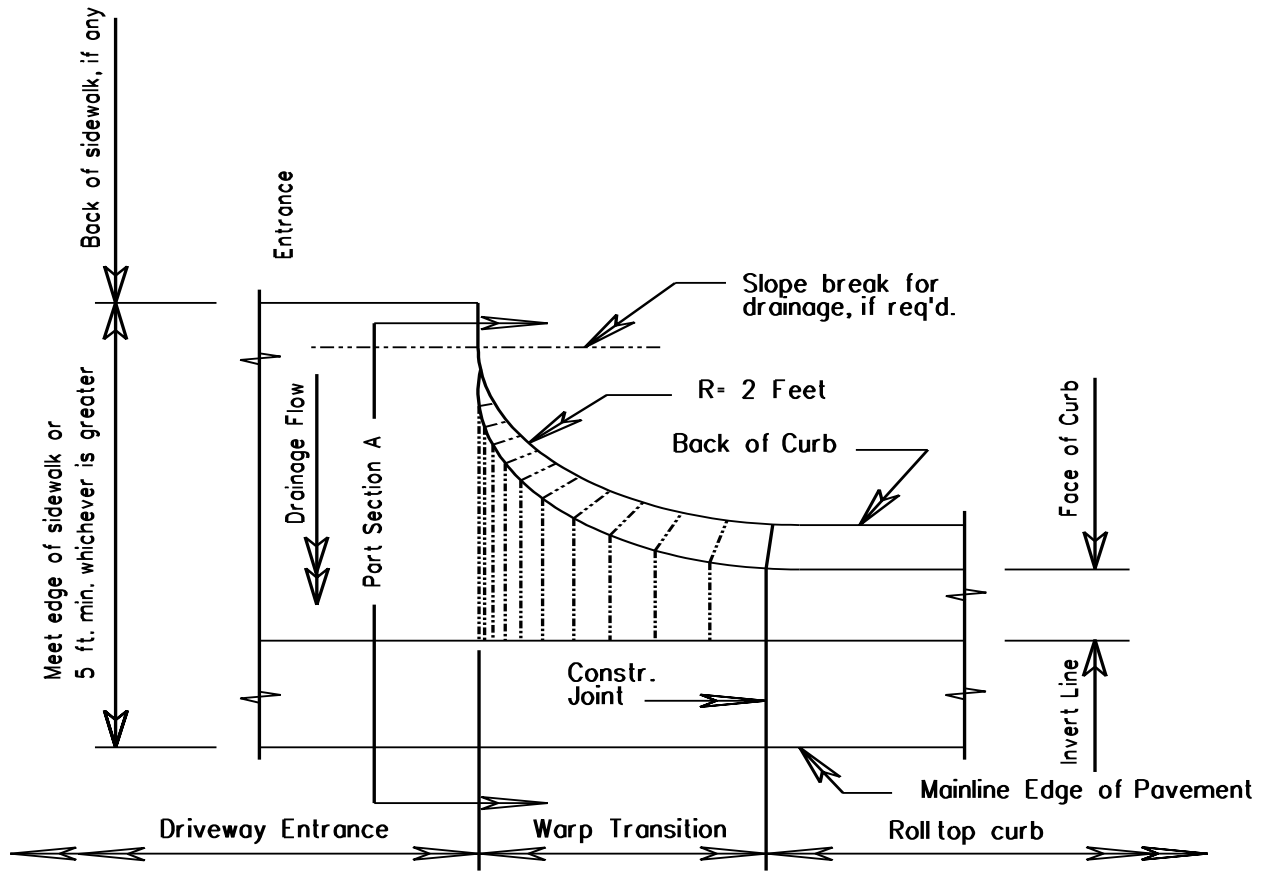
### 1. Curb and gutter private entrances

The Standard CG-9D entrance gutter is to be used for most single family residential entrances with curb and gutter.

The Standard CG-9A and 9B entrance gutters should be considered only as a last resort in situations where the access into the property is too narrow to accommodate a Standard CG-9D, or if it is known that the lane adjacent to the curb will be used as a parking lane **AT ALL TIMES**

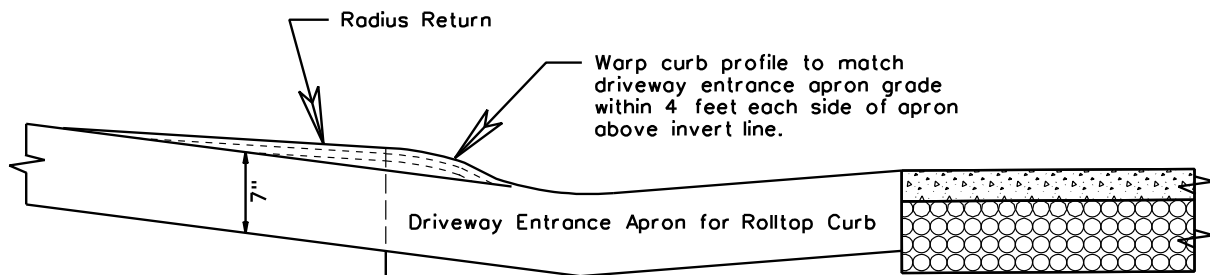
A special design entrance gutter shall be submitted to the District Engineer/Administrator's Designee for approval when roll top curb is used, similar to that shown in [Figure B\(1\)-15](#) and [Figure B\(1\)-16\\*](#).

\* Rev. 10/20



Part Plan of Entrance Transition

**FIGURE B(1)-15\* ROLL TOP CURB ENTRANCE DETAIL**



Part Section A

**FIGURE B(1)-16\* ROLL TOP CURB ENTRANCE DETAIL SECTION**

\* Rev 10/20



2. Ditch section private entrances

All private entrances shall be designed to serve one or two individual lots on a local subdivision street. All private entrances should be designed and constructed as shown in [Figure B\(1\)-17\\*](#). Entrance radius should be 20' except in high density areas where a 12' radius can be allowed. All entrance pipe culverts will be sized to accommodate the run off expected from a 10-year frequency storm.

If drainage is necessary, the ditch line may be moved back to provide cover for pipe. Entrances shall be at least 12 ft. wide and shall be tied into the roadway smoothly. The driveway entrance surface shall extend from the edge of the roadway to the right of way line. Entrance surface can be crusher run aggregate or paved.

3. Driveway entrance grades

In the interest of assuring an adequate, convenient, and safe access to public roads, VDOT recommends the grades along driveways not exceed 10%.

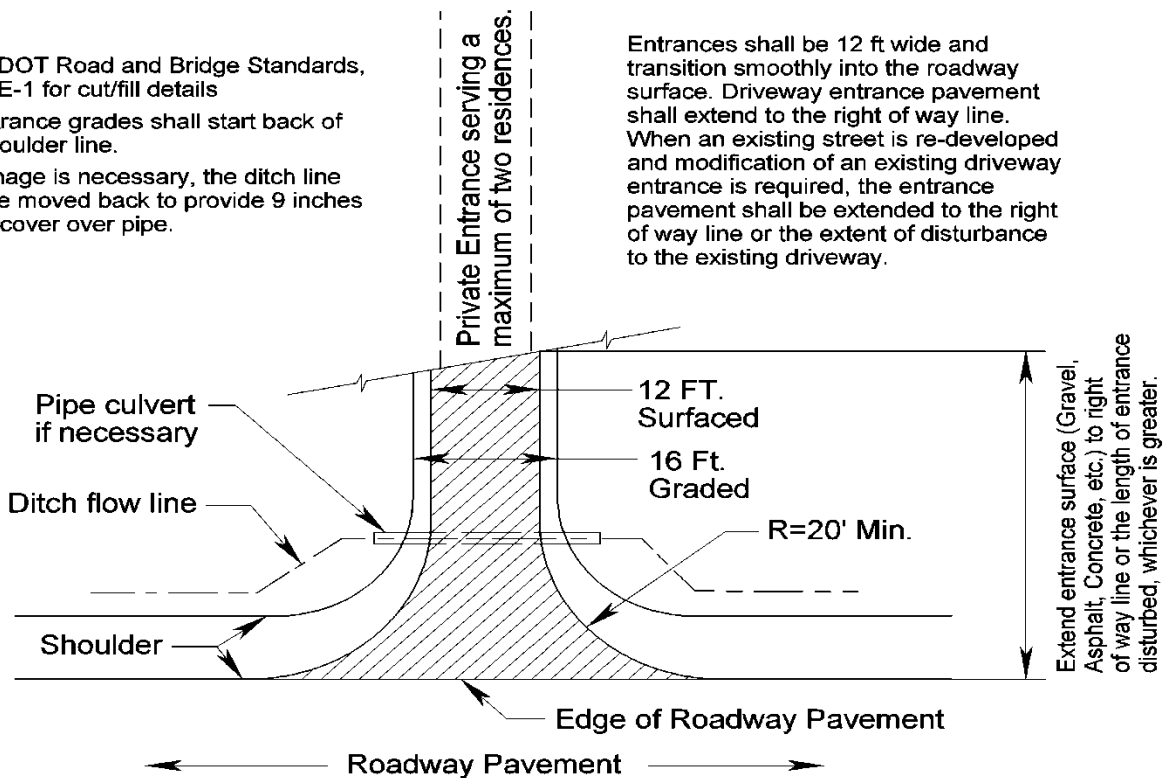
Note:

See VDOT Road and Bridge Standards, Std; PE-1 for cut/fill details

All entrance grades shall start back of the shoulder line.

If drainage is necessary, the ditch line may be moved back to provide 9 inches (min.) cover over pipe.

Entrances shall be 12 ft wide and transition smoothly into the roadway surface. Driveway entrance pavement shall extend to the right of way line. When an existing street is re-developed and modification of an existing driveway entrance is required, the entrance pavement shall be extended to the right of way line or the extent of disturbance to the existing driveway.



**FIGURE B(1)-17\* PRIVATE ENTRANCE DETAIL**

\* Rev 10/20

## J. PEDESTRIAN AND BICYCLE FACILITIES

See VDOT's "Policy for Integrating Bicycle and Pedestrian Accommodations". This policy is available on the web:

[http://www.virginiadot.org/programs/resources/bike\\_ped\\_policy.pdf](http://www.virginiadot.org/programs/resources/bike_ped_policy.pdf), [Appendix A\(1\), Section 1](#) and [IIM-LD-55](#).

### 1. Sidewalk Standards

#### A. General

- (1) Sidewalks proposed for VDOT maintenance shall be completely contained within the right of way. Sidewalks should generally conform to the vertical alignment of the adjacent roadway.
- (2) Sidewalks shall be a minimum of 5 feet in width. Sidewalks shall be designed in accordance with ADA requirements and VDOT's Location and Design Instructional Memoranda [IIM-LD-55](#), Curb Ramps and Sidewalks.
- (3) Sidewalks shall not be less than 4 inches thick, except when used in conjunction with roll top curb, in which case the thickness shall be 7 inches. See Section 4.H Curb and Gutter Designs, [Figure B\(1\)-14](#) Detail Back of Curbs.
- (4) Sidewalks shall be a minimum of 3 feet behind the back of curb on curb and gutter sections, however, if posted speed is greater than 25 mph a 4 foot buffer is required to allow for the placement of signs in accordance with the [Manual on Uniform Traffic Control Devices \(MUTCD\)](#), Part 2 and, if trees are to be planted between the curb and the sidewalk, the buffer strip shall not be less than 6 feet wide with the trees planted so that the center of the tree trunk is not less than 3 feet behind the curb (See [Figure B\(1\)-10](#) and [B\(1\)-14](#)). Sidewalk placed adjacent to the curb shall be 8 feet in width to accommodate the opening of car doors.
- (5) Sidewalks located on a fill section requiring guardrail shall be located in front of the guardrail.

#### B. Sidewalks along curb and gutter streets

- (1) Sidewalks along curb and gutter streets shall be constructed with hydraulic cement concrete sidewalk and have a 1 foot wide minimum graded area (same cross slope as sidewalk, 2.0% max.) behind the back of the sidewalk.  
\*
- (2) Sidewalks shall be constructed in accordance with VDOT's [Road and Bridge Specifications](#) for hydraulic cement concrete sidewalk, on a compacted subgrade, and include underdrains in accordance with VDOT's [Road and Bridge Standards](#), Section 100, Standard UD-3.

---

\* Rev. 7/23

- (3) Solid paver unit sidewalks shall be constructed in accordance with VDOT's Location and Design Instructional & Information Memoranda [IIM-LD-218](#), Paver Units (Sidewalk and crosswalk).

#### C. Sidewalks along shoulder and ditch section streets

- (1) Sidewalks along a shoulder and ditch section shall be constructed behind the ditch and have a 1 foot wide minimum graded area (same cross slope as sidewalk, 2.0% max.) between the ditch and the sidewalk as well as a 1 foot wide minimum graded area (same cross slope as sidewalk, 2.0% max.) behind the back of the sidewalk\* in a manner that will be compatible with the roadway if the roadway is converted to a curb and gutter section. (Note: Placement of sidewalk within the shoulder area is not permitted.)
- (2) Sidewalks shall be constructed in accordance with VDOT's [Road and Bridge Specifications](#) for hydraulic cement concrete sidewalk, on a compacted subgrade, and include underdrains in accordance with VDOT's [Road and Bridge Standards](#), Standard UD-3.

#### 2. Shared use paths

Shared use paths are facilities physically separated from motorized vehicular traffic by an open space (buffer) or barrier and either within the highway right of way or within an independent right of way. Users are non-motorized and may include bicyclists, inline skaters, roller skaters, wheelchair users (both non-motorized and motorized) and pedestrians including walkers, runners, and people with baby strollers and people waking dogs. Shared use paths are most commonly designed for two-way travel, and the following guidance assumes a two-way facility is planned unless otherwise stated. See [Figure A\(1\)-7](#) for cross section of two-way shared use path. When paths are planned, it is desirable to provide paths on both sides of the roadway to decrease the likelihood of children crossing the road. Pavement design for shared use paths are recommended by the Materials Division.

- Separation Between Shared Use Paths and Roadways

##### Shoulder and Ditch Typical Section:

When two-directional shared use paths are located adjacent to a roadway, wide separation between a shared use path and the adjacent highway is desirable to demonstrate to both the bicyclist and the motorist that the path functions as an independent facility for bicyclists and others. On shoulder and ditch typical sections shared-use paths should be placed behind the ditch in a manner that will be compatible with the roadway if the roadway is converted to a curb and/or curb and gutter typical section.

---

\* Rev. 7/23

### Curb and/or Curb and Gutter Typical Sections:

For curb and/or curb and gutter streets, the separation between face of the curb to the edge of the shared use path shall be a minimum of 8 feet in order to meet the minimum lateral offset distance to install signs for the roadway and the shared use path in accordance with [Manual on Uniform Traffic Control Devices \(MUTCD\)](#) Part 2 and Part 9. If signs are required on the outside of the shared use path due to horizontal and vertical grade changes then a minimum of 6.5' of right of way from the edge of the path shall be provided otherwise, a minimum 3' of right of way shall be provided. See [Appendix A\(1\), Figure A\(1\)-6](#).

- Width and Clearance

The paved width and the operating width required for a shared use path are primary design considerations. The minimum paved width for a two-directional shared use path is 10 feet.\* A minimum 2 foot wide graded area with a maximum 6:1 slope, shall be maintained adjacent to both sides of the path. A minimum 3 foot clearance shall be maintained from the edge of the path to signs, trees, poles, walls, fences, railing, guardrail, or other lateral obstructions. See [Appendix A\(1\), Figure A\(1\)-7](#).

Under certain conditions it may be necessary or desirable to increase the width of a shared use path to 11 feet, or even 14 feet, due to substantial use by bicycles, joggers, skaters and pedestrians, use by large maintenance vehicles, and steep grades. However in rare instances, a reduced width of 8 feet can be adequate. This reduced width should be used only where the following conditions prevail:

- (1) Bicycle traffic is expected to be low, even on peak days or during peak hours.
- (2) Pedestrian use of the facility is not expected to be more than occasional.
- (3) There will be good horizontal and vertical alignment providing safe and frequent passing opportunities, and
- (4) During normal maintenance activities the path will not be subjected to maintenance vehicle loading conditions that would cause pavement edge damage.

- Railing Requirements

See [Appendix A\(1\), Figure A\(1\)-8 Physical Barrier for Shared-Use Path](#).

Further design details for shared use paths such as Vertical Clearance, Design Speed, Horizontal Alignment, Grade, Sight Distance, etc. may be found in [Appendix A\(1\), Section A\(1\)-1 BICYCLE AND PEDESTRIAN FACILITY GUIDELINES](#) of VDOT's Road Design Manual.

---

\* Rev. 7/23

This page is intentionally left blank

\*

\*Deleted Language

---

\* Rev. 7/23

### 3. Pedestrian tunnels

- a. Pedestrian tunnels to separate pedestrian crossings from roadway traffic are being encouraged by some localities to improve pedestrian safety on high volume streets. The Subdivision Street Requirements provide criteria for VDOT acceptance of these pedestrian tunnels under certain conditions. All underpass structures intended for pedestrian use, whether they are accepted for maintenance as part of the roadway or accepted under the terms of an agreement should have the following characteristics:
  - (1) Have entrances visible from the side of the roadway above.
  - (2) Be aligned to the pedestrian corridor such that the interior of the tunnel is visible to pedestrians from a distance of not less than 25 feet and preferably for its entire length.
  - (3) If located at a school, be equipped with security gates so that school authorities may regulate the hours it is available for use.
  
- b. All underpass structures intended for acceptance of maintenance by the Department as an integral part of the roadway, even if some features are to remain the responsibility of local government, should also include the following:
  - (1) Have a grade not greater than 3%.
  - (2) Have a non-skid paved surface comparable to the finish of a sidewalk.
  - (3) Have continuous handrails.
  - (4) Have a clear height not less than 8 feet.
  - (5) Have a clear width, exclusive of any area used or reserved as a utility corridor, not less than 10 feet.
  - (6) Have security lights with explosion proof fixtures if the tunnel is more than 25 feet in length or if the tunnel is available for use after dark.
  - (7) Be accessible to persons with disabilities from sidewalks associated with the roadway above or, as an alternative, by a circuitous route.
  - (8) Pedestrian ramps should be provided at all pedestrian separation structures.

- (9) When warranted and possible, a stairway can be provided in addition to a ramp. Ramps should be deleted only when it would be infeasible for mobility-limited persons to reach the pedestrian separation structures due to unusual topographical or architectural obstacles or when alternate safe and reasonably convenient means are provided to cross the highway.
- (10) The ramp should have a maximum slope of 12:1 with a maximum rise of 30 in. between landings. Landings should have a minimum length of 5 ft. and should be of sufficient width to allow wheelchairs to maneuver.

#### 4. Bicycle lanes

On local streets, bicyclists should be considered a normal part of the vehicle mix on the street. On collector roads, bike lanes may be established with appropriate pavement markings and signing. Bike lanes should be one-way facilities and carry bike traffic in the same direction as adjacent motor vehicle traffic. See [Appendix A\(1\), Section 1 – BICYCLE AND PEDESTRIAN FACILITY GUIDELINES](#).\*

The recommended width of a bike lane is 5 feet from the face of a curb to the bike lane stripe. If parking is permitted, the bike lane should be placed between the parking area and the travel lane and have a minimum width of 5 feet. Bike lanes should never be placed between the parking lane and the curb line. Further design details for Bicycle lanes may be found in [Appendix A\(1\), Section 1 – BICYCLE AND PEDESTRIAN FACILITY GUIDELINES](#) of VDOT's Road Design Manual.

#### 5. Non-compliant sidewalks

As indicated in the Subdivision Street Requirements, non-compliant sidewalks that are not built in accordance with these standards or meander on and off the right of way may be permitted; however, the Department will not accept responsibility for their maintenance. A permit, which clearly specifies the applicant's responsibility for the sidewalk's maintenance and related activities, shall be obtained from the Department to the extent it encroaches upon the street's right-of-way. The permit applicant shall be a county, incorporated town, or other entity, which has perpetual maintenance capability. These sidewalks may be constructed of asphalt, concrete, gravel, or other stabilizer convenient to the applicant.

---

\* Rev. 7/18

## K. BRIDGE AND CULVERT DESIGN CRITERIA

### 1. Loading

All bridges and culverts shall be of HS 20-44 loading or alternate military loading, or both, in accordance with the current AASHTO Bridge design specifications and VDOT modifications. To facilitate the Department's review, all pertinent calculations for a structure's design shall be submitted with each bridge plan or other nonstandard drainage structure.

### 2. Width

Clear roadway widths of all structures shall be in accordance with the Department's design manual.

## L. ROADWAY DRAINAGE

### 1. Policy and Procedures

All drainage facilities shall be designed in accordance with VDOT's Drainage Manual and supplemental directives as amended, and the [Virginia Erosion and Sediment Control Handbook](#), shall also be used in designing drainage systems.

Low Impact Development (LID) Techniques such as Buffers Strips, Bioretention, Rain Gardens, Vegetated Swales, and Tree Preservation should also be considered. The use of LID practices offers both economic and environmental benefits. LID measures result in less disturbance of the development area, conservation of natural features and can be less cost intensive than traditional stormwater control mechanisms. Cost savings for control mechanisms are not only for construction, but also for long-term maintenance and life cycle cost considerations.

For additional information on LID techniques see DEQ's Virginia Stormwater Management Program website at:

<http://www.deq.virginia.gov/Programs/Water/StormwaterManagement.aspx>

U.S. EPA's Low Impact Development website at: <http://www.epa.gov/nps/lid/> and

The National Resource Defense Council website at

<http://www.nrdc.org/water/pollution/storm/chap12.asp>.

Maintenance of roadway drainage is addressed in the Secondary Street Acceptance Requirements.



## 2. Criteria

Standards appropriate to the functional classification of the street and the potential impact on adjacent property shall apply.

## 3. Design

Specific reference is made to the following design requirements:

- a. Roadside and median ditches should provide sufficient hydraulic capacity to contain the estimated runoff from a 10-year frequency storm. The estimated runoff and attendant velocity for the 2-year frequency storm is to be used for determining the needs, type and dimensions of special ditch lining for erosion control. Geometric configurations shall conform to appropriate safety standards.

Where standard ditches have insufficient capacity for the 10-year runoff, a storm sewer system shall be provided. Open channels may be considered in lieu of a storm water system, if their construction can be accomplished without creating a hazard or condition detrimental to the appearance of the subdivision.

- b. An acceptable easement shall be provided from all drainage outfalls to a natural watercourse, as opposed to a swale (See 24 VAC 30-92-10\* for definitions). The Department normally accepts and maintains only that portion of a drainage system that falls within the limits of the dedicated right of way for a street. The Department's responsibility to enter drainage easements outside of the dedicated right of way shall be limited to undertaking corrective measures to alleviate problems that may adversely affect the safe operation or integrity of the roadway. In the event drainage to a natural watercourse is not accomplished or is interrupted, an acceptable agreement from the governing body may be considered as an alternative to providing an easement to a natural watercourse, provided the agreement acknowledges that the Department is neither responsible nor liable for drainage from the roadway.
- c. Curb drop inlets – the spread of water on the pavement shall be limited to the width of one-half of the travel lane and the gutter width (if any) in each direction or 8 to 10 feet from the face of curb, whichever is less, for a rainfall intensity of 4 inches per hour.
- d. Where the roll-top or mountable curb and gutter section is used, drop inlets must be spaced so that the 10-year frequency gutter flow does not exceed a four inch depth at the face of curb.
- e. Storm Sewers should be designed to convey the 10-year runoff without surcharge; however, the system should be designed for the 50-year runoff and checked for the 100 year runoff in situations where it would be necessary to prevent flooding of interstate highways, underpasses or other depressed

---

\* Rev. 3/09

roadways where ponded water can only be removed through the storm sewer system.

- f. Storm Sewer System Pipe sizes – 15” pipe or equivalent elliptical shape shall be considered the minimum acceptable size. 12” or equivalent size may only be used as the initial pipe in a system or as a lateral line when necessary, provided there is 50 ft. or less between access points.
- g. Access points – Generally, distance between points of access in storm sewer trunk lines shall be limited, based on pipe diameter, to:
 

12” pipes,	50 feet
15” to 42” pipes,	300 feet
48” and larger pipes,	800 feet

#### 4. Documentation

All drainage design computation shall be complete, properly documented and presented to the District <sup>\*</sup>Engineer/Administrator’s Designee for review.

#### 5. Storm water management

All storm water management facilities located on the right of way must be designed in accordance with [Chapter 11 of the VDOT Drainage Manual](#). See the Secondary Street Acceptance Requirements to determine the need for any special agreements related to stormwater management.

#### 6. Dams

In addition to the VDOT Drainage Manual, all dams must be designed in accordance with all applicable provisions of the Department of Conservation and Recreation’s Virginia stormwater Management Handbook and Virginia’s Dam Safety program, which is administered by the Department of Conservation and Recreation located at ([www.dcr.virginia.gov](http://www.dcr.virginia.gov)) Pertinent information is posted on their web site. See the Subdivision Street Requirements to determine the need for any agreements related to dams.

### M. RIGHT-OF-WAY

#### 1. Width

The minimum width of right of way shall be sufficient to accommodate all roadway elements, including pedestrians, multiuse trails, bicyclist, shared use paths and the clear zone and extend at least one (1) foot behind any feature intended to be maintained by VDOT as part of the roadway. However, the minimum width of right of way shall be no less than 30 feet. As indicated in the Secondary Street

---

\* Rev. 7/15

Acceptance Requirements, easements may be used in lieu of dedicated right of way to accommodate slopes and sight distances.

Dedicated right of way for roadways to the extent they occupy dams is not acceptable. All such right of way shall be platted as an ingress/egress easement.

## 2. Spite strips

Plans that include a reserved or "spite" strip which prohibits otherwise lawful vehicular access to a street from the adjacent properties, whether within or outside the subdivision, will not be approved.

## **SECTION 5 – OTHER DESIGN CONSIDERATIONS**

### **A. CLEAR ZONE**

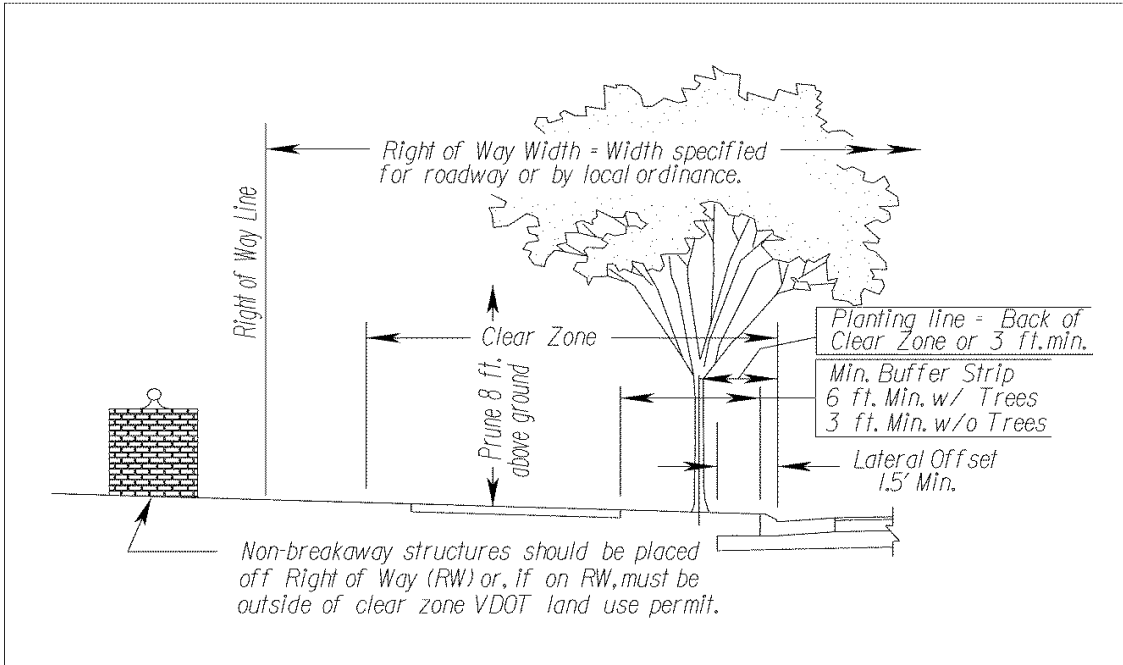
(i.e. Setback for non-breakaway fixed objects)

Except as may be authorized by land use permit, the right of way along public streets and highways maintained by VDOT must remain clear of all obstacles that are not designed to break away under impact. For the purposes of this section, breakaway structures are defined as a single 4"x4" square or 4" diameter wooden post or a standard strength, metal pipe post no greater than a 2" diameter. When curbing is used, the clear zone is measured from the face of the curb, except where a bike lane or parking lane exists between the curb and the traveled way. In such a case, clear zone may be measured from the edge of the traveled way. For shoulder and ditch sections, clear zone is measured from the edge of travel way.

Traffic volume, operational or design speed of the street, and the typical cross section of the street determines the required clear zone. The geometric design [Tables B\(1\)-1, B\(1\)-2, and B\(1\)-3](#) in Section 3\* - Roadway Geometric Design Criteria provide clear zone requirements for subdivision streets. Any structures or landscaping, including fences, stone or brick mailbox posts, columns or walls that do not meet breakaway requirements may not be located within the clear zone and will require review by the District Engineer/Administrator's Designee to be placed on the right of way. If approved by the District Engineer/Administrator's Designee, a land use permit must be issued for any such obstacle. However, no obstacles, even if they meet breakaway requirements, shall be placed within the 3-foot clear zone of a shared use path. For curb and gutter streets with parking lanes, the clear zone is accommodated within the parking lane. However, VDOT has established a 3' minimum setback requirement behind the curb for the placement of signs in accordance with the [Manual on Uniform Traffic Control Devices \(MUTCD\)](#), Part 2. See Note 2 on [Table B\(1\)-1](#) in Section -3- Roadway Geometric Design Criteria.

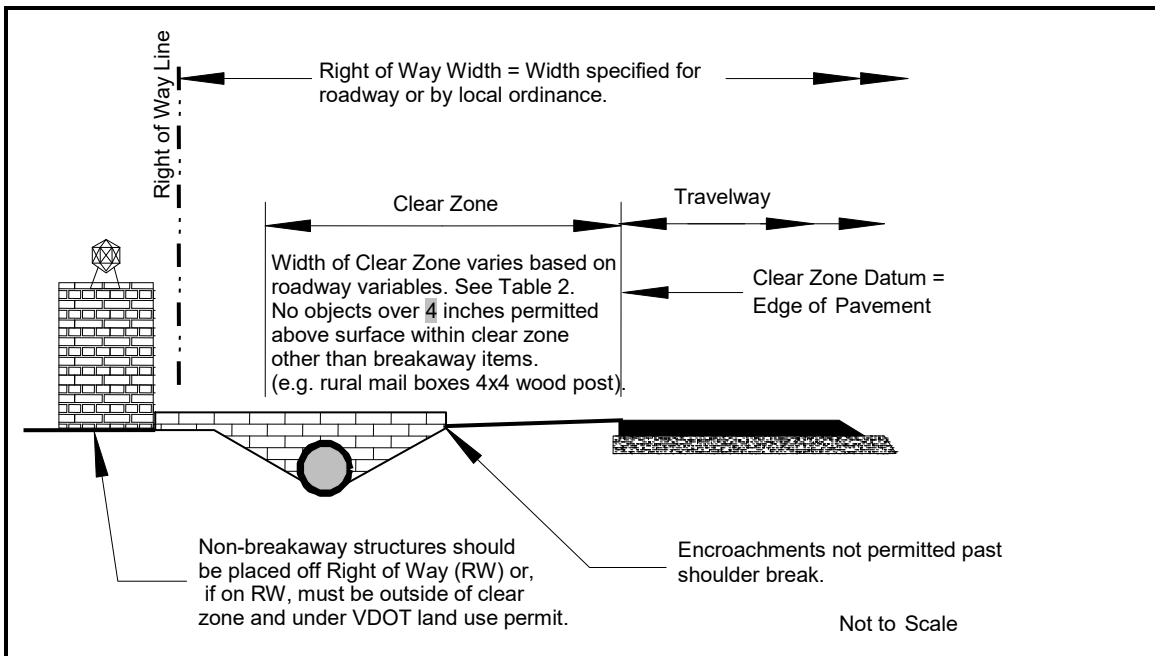
---

\* Rev 10/20



**FIGURE B(1)-18\* SETBACK DETAILS WITH CURB AND GUTTER**

Note: Driveway entrance curbing, regardless of height, shall not be permitted past sidewalks or within the area 3 feet behind curb and gutter.



**FIGURE B(1)-19\* SETBACK DETAILS WITH SHOULDER AND DITCH**

**B. GUARDRAIL**

For design and application of guardrail, refer to [Appendix J](#)\* and the current VDOT [Road and Bridge Standards](#).

**C. TRAFFIC CONTROL**

All plans should indicate appropriate traffic control signage and devices as designated by the [Manual on Uniform Traffic Control Devices \(MUTCD\)](#) and the [Virginia Supplement to the MUTCD](#).

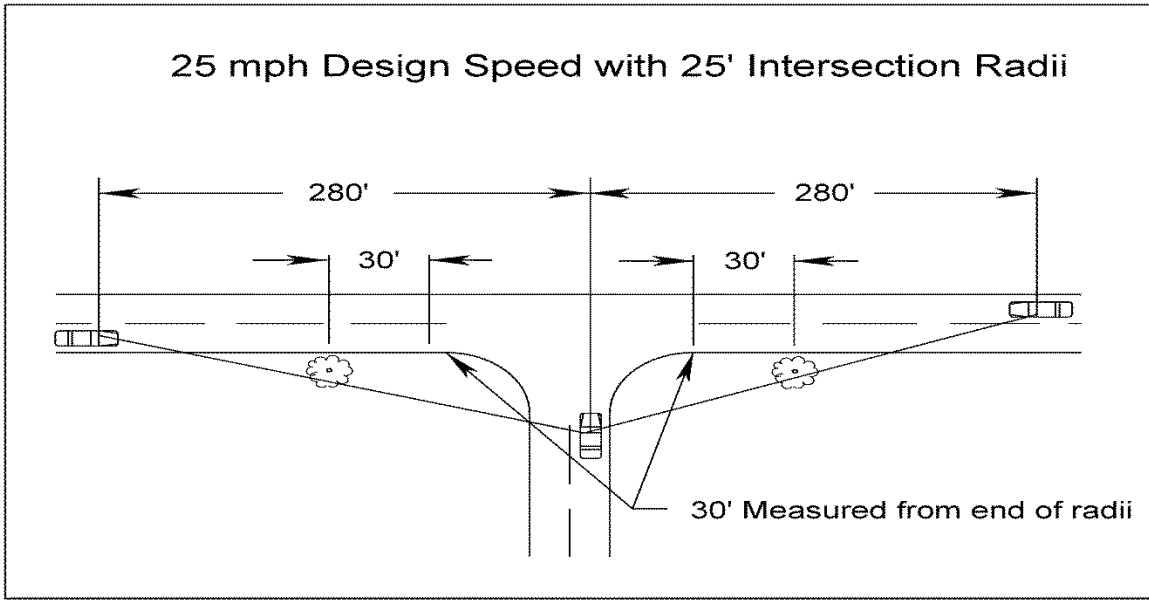
**D. STREETScape AND LANDSCAPE**

Development trends promote the use of trees, sidewalks, bicycle facilities, and shared paths adjacent to but typically set back from vehicle corridors. Trees may also be proposed within unpaved medians and center islands in cul-de-sac designs. Landscaping within the right of way is often allowed by land use permit and maintained by the permittee.

Planting strips, located between the curb and sidewalk and within unpaved medians parallel with the street, shall be 6 feet or more in width. All plantings shall be located a minimum of 3 feet from the back of curb. Care should be taken to ensure that larger planting strips do not push pedestrian crossing areas back from the intersections by requiring a larger curb radius. Trees, vegetation and other objects shall be spaced so that the sight distance triangle for intersection sight distance or stopping sight distance is free of any obstructions that may block the driver's view of potential conflicting vehicles and/or pedestrians. To maintain sight lines, trees, vegetation and other objects shall be restricted from corners for distances of 30 feet on all sides measured from the end of the curb return radii as shown in the diagram below.

---

\* Rev. 7/18



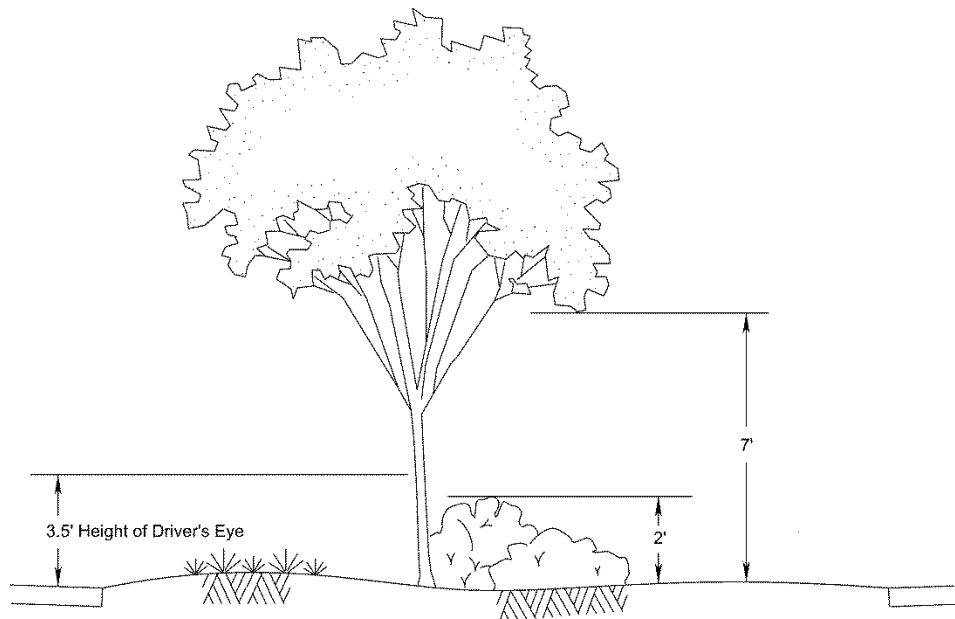
**FIGURE B(1)-20\* SIGHT DISTANCE FOR TWO LANE MAJOR ROAD**

The diagram above illustrates intersection sight distance for a two lane major road where  $SDL=SDR$ .

**For more information on Sight Distances see Appendix "F".**

Trees, landscaping, and other encroachments onto the right of way can obscure pedestrians or other vehicles preparing to enter the roadway from adjacent property or side streets. To protect the safety of pedestrians, bicyclist, and motorists alike, it is appropriate for vehicle operators to have an unobstructed view along the full length required by the sight distance triangle.

Along all planting strips, the area between 2 and 7 feet above ground shall be maintained free of any obstructions that may block the driver's view to preserve motorists and pedestrian sight lines to avoid potential conflicts. See diagram below.



**FIGURE B(1)-21\* LANDSCAPE ITEMS WITHIN SIGHT TRIANGLE**

When trees are planted along streets, especially in association with sidewalks, species selection is critical. Care should be taken with regard to the species selection so that the roots do not damage the curb or sidewalk. Congregations of birds may be attracted to fruits, nuts and berries produced by some species, which may cause potentially undesirable conditions for pedestrians. Also, species that leach sap may damage the finishes on parked cars and, when wet, the leaves of some species may damage automotive finishes.

## **E. LANDSCAPE CONSIDERATIONS**

Listed below are trees that have been successfully used as street trees in Virginia. This list is only general guidance as to the type of tree to be considered for street plantings, and should not be considered an exclusive list of approved trees for landscaping. Other considerations should be made with any landscape plan.

Due to the constant improvement of varieties as well as the spread of disease and plant pathogens via interstate and intrastate trade, no tree should be utilized without the verification of local factors. Thus, developers or their representatives should have their plan prepared by a local certified landscape architect, and/or confirmed by a certified arborist, nurseryman, or agricultural extension office for advice on site suitability with regard to plant hardiness, soils, soil moisture, available root zone, exposure, known diseases in the area, etc.

---

\* Rev. 1/14



A general list does not take into consideration the fact that Virginia spans six temperature zones. Trees listed are not all appropriate for all temperature zones. The temperature range of areas in which a plant performs the best is defined as its “hardiness zone.” Thus, while the list below represents a broad array of possible species, it does not indicate any division of use based upon “hardiness zone.”

Actual species selection for a given project is often based upon availability. It is strongly suggested, therefore, that developers or their representatives check on availability of species prior to submitting a plan as to prevent last minute changes to the contract and the possible provision of undesirable species.

Considerable care should be exercised in the selection of plantings for placement within the proximity of utilities and should be coordinated with the utility companies potentially affected to ensure the selection of species will be compatible with the needs of the utility companies.

- a. Medium to Large Street Trees: These trees are a few examples of perhaps hundreds that have been shown to have good qualities for use as “Street Trees,” such as less obstructive leaf litter, mostly due to a smaller and/or thinner leaf structure. Though all trees will have some amount of leaf drop and other “litter”, these selections have shown superior form and tolerance of urban conditions that should outweigh concern over other issues. These trees may be placed in planting strips or medians provided they are located outside the clear zone; however, care should be taken to ensure these trees have space for adequate root development.

- |                          |                            |
|--------------------------|----------------------------|
| • Acer rubrum            | Red Maple                  |
| • Acer saccharum         | Sugar Maple                |
| • Betula nigra           | River Birch (Single Trunk) |
| • Fraxinus pennsylvanica | Green Ash                  |
| • Fraxinus americana     | White Ash                  |
| • Ginko biloba           | Ginko (Male Only)          |
| • Platanus acerifolia    | London Planetree           |
| • Quercus phellos        | Willow Oak                 |
| • Quercus palustris      | Pin Oak                    |
| • Tilia cordata          | Little leaf linden         |
| • Ulmus parvifolia       | Lacebark Elm               |
| • Zelkova serrata        | Zelkova                    |

- b. Small to Medium Street Trees: These trees are also suitable for street tree planting where overhead utilities may be nearby, thus requiring a smaller crown. These trees may be planted in the planting strip between the roadway and the sidewalk, provided they are outside the clear zone.

- *Cercidiphyllum japonicum*      Katsuratree
- *Pistacia chinensis*              Chinese Pistache (Male Only)
- *Acer buergerianum*              Trident Maple
- *Koelreutaria panniculata*      Golden Raintree
- *Quercus acutissima*            Sawtooth Oak

- c. Flowering Trees suitable for accent or focal area: While having a low branching pattern, these trees are generally large enough at maturity to reach above the height above a pedestrian, or compact enough to remain within a confined space. Care should be taken when locating very low branched or multi-stem varieties as not to obstruct sight lines, and to keep heavily fruiting varieties away from sidewalks. These trees may be planted in the planting strip between the roadway and the sidewalk.

- *Aesculus x carnea*                Red Horse Chestnut
- *Aesculus parvifolia*            Bottlebrush Buckeye
- *Amelanchier canadensis*      Serviceberry
- *Cercis canadensis*              Eastern Redbud
- *Cercis chinensis*                Chinese Redbud
- *Cornus florida*                    Flowering Dogwood
- *Cornus kousa*                    Korean Dogwood
- *Chionanthus virginicus*        White Fringetree
- *Halesia tetraptera*                Carolina Silverbell
- *Lagerstromia indica*            Crape Myrtle
- Improved fruitless varieties of *Pyrus calleryana*  
such as “Chanticleer” or “Cleveland Select”
- *Prunus yedoensis*                Yoshino Cherry
- *Prunus serrulata*                Kwanzan Cherry

- d. Other Large Trees suitable for use in large open spaces: These trees are appropriate for use where setbacks are available for the growth of very large trees; where trees with attractive qualities other than “Street Tree” form is desired; where bark texture and color for seasonal interest is desirable; and/or where leaf litter will not obstruct storm drainage, or drop onto a sidewalk. Such species, while appropriate for the backdrop of a subdivision entrance, or other open “common space”, would not, however, be desirable between a sidewalk and street.

- |                                  |                           |
|----------------------------------|---------------------------|
| • <i>Betula nigra</i>            | River Birch (Multi-Trunk) |
| • <i>Cedrus deodora</i>          | Deodar Cedar              |
| • <i>Celtis occidentalis</i>     | Common Hackberry          |
| • <i>Platanus occidentalis</i>   | Sycamore                  |
| • <i>Liriodendron tulipifera</i> | Tulip Poplar              |
| • <i>Magnolia grandiflora</i>    | Southern Magnolia         |
| • <i>Juniperus virginiana</i>    | Red Cedar                 |

This list literally represents thousands of new and improved varieties and cultivars of available species in the industry. For this reason, only the common or “generic” species names are given above. Any selection must take into consideration all the factors of a given site, plant availability, and conform to any applicable local ordinance as well as these guidelines. These considerations should be confirmed by a local expert.

- e. Planting Design in the vicinity of Bridge Structures.\*

Planting in the roadway environment is a challenge given the competition for space among utilities, drainage systems, bridge structures and other design features of the roadway environment. While these guidelines are intended to provide the designer a palette of plant types that are suitable for planting in proximity to bridge structures in particular, good engineering judgment should always be used when siting trees that takes into account plant form, root structure and ultimate size.

For example, trees with an ascending vase shape crown at maturity would be more suitable than a descending branch pattern where the tree is planted downslope from the roadway (bridge) elevation as not to conflict with the pedestrian space or vehicles crossing the bridge as the tree matures. A tree with a descending branch pattern at maturity should generally be spaced further away. Also of note is the fact that a number of species change from a descending branch pattern to an ascending branch pattern as they mature.

The following table lists trees and evergreens as classified by the American National Standards for Nursery Stock (the Specification reference for VDOT approved plant materials) relative to the recommended set back from the headwall, abutment or bridge parapet of a bridge structure. Tree and plant

---

\* Rev. 1/16

types not listed below are not subject to a particular setback. Planting designs that deviate from this guideline shall require the use of a continuous 24 inch depth "Root Barrier" parallel to the edge of the bridge structure with at least a two foot offset from the structure.\*

---

\* Rev. 1/16

ANSI Plant Type*	Examples	<b>Minimum</b> Distance from Bridge/Structure
<b>Type 1 Shade Trees</b> (Spreading, pendulous or irregular form)	Quercus phellos; Quercus palustris; Quercus virginiana; Platanus occidentalis; Salix babylonica	<b>20' to center of the Tree **</b> <ul style="list-style-type: none"> <li>assumes a 40' Diameter spread in 30 – 50 years</li> </ul>
<b>Type 1 Shade Trees</b> (vase shape, columnar, oval or rounded form)	Acer rubrum; Betula nigra; Ginkgo biloba; Liriodendron tulipifera; Zelkova serrata; Ulmus parvifolia	<b>15' to center of the Tree</b> <ul style="list-style-type: none"> <li>assumes a 30' Diameter spread in 30 - 50 years</li> </ul>
<b>Type 2 Shade Trees</b> (Spreading or irregular form)	Magnolia grandiflora; Quercus alba; liquidamber styraciflua; Fagus sylvatica	<b>25' to center of the Tree</b> <ul style="list-style-type: none"> <li>assumes a 50' Diameter spread in 30 - 50 years</li> </ul>
<b>Type 2 Shade Trees</b> (vase shape, columnar, oval or rounded form)	Aesculus pavia; Koelreuteria paniculata; Magnolia grandiflora upright cultivars (Brackens Brown, Little Gem, etc.); Syringa reticulata; Tilia cordata	<b>15' to center of the Tree</b> <ul style="list-style-type: none"> <li>assumes a 30' Diameter spread in 30 - 50 years</li> </ul>
<b>Type 3 Small Upright Trees</b> (small upright or multi-stem)	Acer campestre; Cercis Canadensis; Chionanthus virginicus; Malus and Prunus species	<ul style="list-style-type: none"> <li>Place trees with respect to potential crown growth. ***</li> </ul>
<b>Type 4 Small Spreading Trees</b>	Acer palmatum; Cornus florida; Lagerstroemia indica; magnolia stellata, Vitex agnuscastus	<ul style="list-style-type: none"> <li>Place trees with respect to potential crown growth.***</li> </ul>
<b>Type 4 Conifers</b>	Abies concolor; Cedrus deodora; Picea abies; Pinus palustris; Taxus cuspidata	<b>15' to center of the Tree</b> <ul style="list-style-type: none"> <li>assumes a 30' Diameter spread in 30 - 50 years.</li> </ul>
<b>Type 5 Broad Upright Conifers</b>	Chamaeyparis pisifera; Juniperus scopuorum 'Wichata Blue'; Taxus media 'Hicksii'; Thuja occidentalis 'Wareana'	<b>6' to center of the Tree</b> <ul style="list-style-type: none"> <li>assumes a 12' Diameter spread in 30 - 50 years.</li> </ul>
<b>Type 6 Columnar Conifers</b>	Cupressocyparis leylandii; Juniperus communis 'Suecica'; J. virginiana (columnar var.); Taxus baccata 'Fastigiata'; Thuja occidentalis 'Smaragd'	<b>6' to center of the Tree</b> <ul style="list-style-type: none"> <li>assumes a 12' Diameter spread in 30 - 50 years.</li> </ul>
<b>Type 5 or 6 Broadleaf Evergreens</b> (Tree-like varieties only)	Ilex opaca; Ilex attanuata 'foster No. 2'; Ilex x 'Nellie R' Stephens'; Prunus caroliniana	<b>6'-10' to center of the Tree</b> <ul style="list-style-type: none"> <li>depending on the species - assumes a 12' to 20' Diameter spread in 30 - 50 years.</li> </ul>

**TABLE B(1)-5\* AMERICAN NATIONAL STANDARDS FOR NURSERY STOCK**

American National Standards for Nursery Stock (ANSI-Z60.1, most current issue).

<https://www.americanhort.org/page/standards>

\*\*Trees whose ultimate crown diameter may exceed 40' in 30 years shall be planted 30' or more based upon projected growth patterns.

\*\*\* The root structure on type 3 and type 4 trees is not a concern with respect to the structural integrity of a bridge foundation.

## F. TRAFFIC CALMING

During street layout and design, the issue of traffic calming should be considered. Early consideration can minimize future speeding problems and improve the livability of the neighborhood. If the street layout cannot be designed to encourage target speeds, traffic calming treatments may be appropriate. The type of treatment chosen for incorporation in the design depends on the function and traffic volume of the roadway segment.

Subdivision streets shall be designed to in accordance with Geometric Design Standard [Tables B\(1\)-1, B\(1\)-2, and B\(1\)-3\\*](#) in this Appendix. This can be accomplished with attention to three major design areas – the width of the paved roadway surface, the length of tangent sections and the vertical grade.

The width of pavement should be the minimum to safely accommodate the proposed traffic. If this is not practical for other reasons, the road width can also be restricted at specific points through the use of chokers or raised median islands.

Tangent lengths should ideally not exceed 500 feet. Studies indicate that operating speeds were 30 mph or less when the tangent sections were no longer than 500 feet. Long tangent sections can be segmented by conditions that require a complete stop, such as T intersection or by conditions that require reduced speeds such as a traffic calming device. Devices that are suggested for new subdivisions with an average daily traffic between 600 and 4,000 vehicles per day include roundabouts, chokers, raised median/island, crosswalk refuges or raised pedestrian crosswalks.

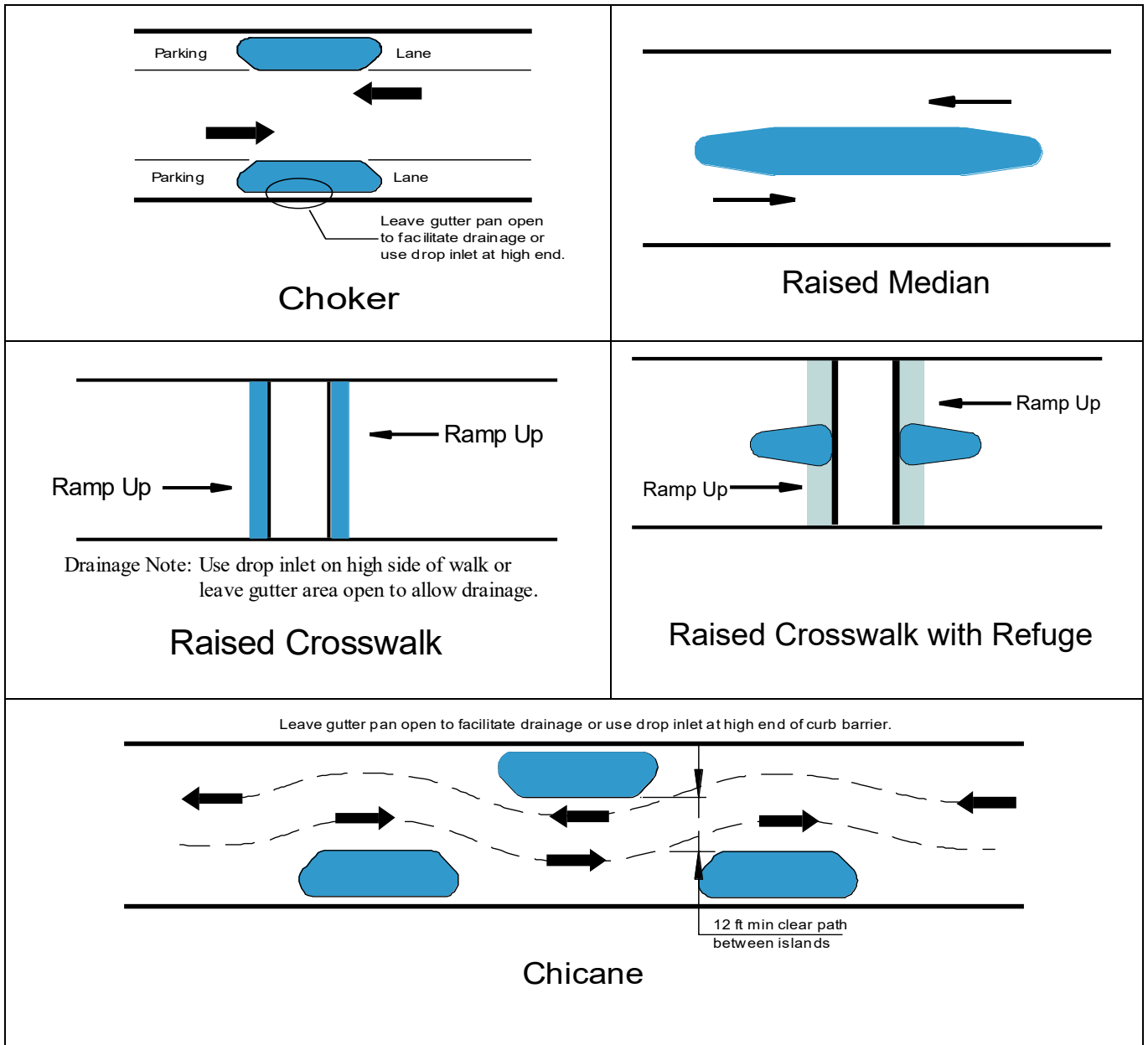
Steep downgrades should be avoided in subdivision street design as vehicle speeds tend to increase on downward slopes and vehicles can quickly exceed desirable speeds. Speed humps should be avoided in favor of raised crosswalks.

Further design details for all types of traffic calming measures may be found in [VDOT's Traffic Calming Guide](#). Since the Traffic Calming Guide primarily represents retrofit designs, not all traffic calming design features in the guide are appropriate for new construction. [Figure B\(1\)-22\\*](#) illustrates certain types of traffic calming treatments that are appropriate for new construction. For additional information, see [ITE Traffic Calming Measures Fact Sheets, May 2018](#).

Curb Extension (Bulb-outs) are traffic-calming devices that narrow the street by widening the curb and sidewalk, landscaped planting strip, or parking area. This device works well when constructed at intersections or at mid-block locations to make the street appear narrow thereby reducing speeds. See Appendix B(2), Section 3 Elements of Typical Section for details.

---

\* Rev. 10/20



**FIGURE B(1)-22\* TRAFFIC CALMING DETAILS**

**G. ROUNDABOUTS**

See Appendix "F" for Roundabout Information.

\* Rev. 10/20

## H. UTILITIES

As indicated in the Secondary Street Acceptance Requirements, local governments, the development community, and the utility community are encouraged to coordinate and consolidate their interests as part of the initial development plan. All utility locations should be indicated on the plans. Utility lines should be located to minimize need for later adjustment and to permit servicing such lines with minimum interference to traffic or destruction of roadway surfaces.

### a. Underground utilities

The Department allows the placement of underground utilities within the dedicated right of way of streets.

Underground utilities should normally be located outside of the travel lanes and desirably beyond the pavement. However, if the governing body has established adequate requirements for the design, location, and construction of underground utilities within the right-of-way of subdivision streets, including provisions that ensure adequate testing and inspection is performed to minimize future settlement, those requirements shall become the Department's requirements and govern unless those requirements conflict with a requirement of the Department.

When location of the utilities outside of the pavement area is not practical such as in high density developments incorporating the principles of new urbanism as described in [15.2-2223.1 of the Code of Virginia](#), such installations:\*

- (1) Are acceptable within the parking area and the shoulders along the street.
- (2) May be acceptable beneath the travel lanes of the street when provisions are made to ensure adequate inspection and compaction tests and
  - (a) Longitudinal installations and manholes are located outside of the normal travel lanes, or
  - (b) Longitudinal installations and manholes are placed in the center of an undivided roadway out of the wheel path.

However, manholes shall not be placed in sidewalk, multiuse trail, or shared use path facilities within five feet of curb ramps or within driveway entrances.

---

\* Rev. 7/09



(3) Open-cutting of hard-surfaced roadways

The Department usually prohibits the open-cutting of hard-surfaced roads except in extenuating circumstances. Therefore, all underground utilities within the right-of-way, as determined necessary by good engineering practice to serve the complete development of adjacent properties, shall be installed during the street's initial construction and prior to the application of its final pavement surface course. This shall include extensions of all necessary cross-street connections or service lines to an appropriate location beyond the pavement and preferably the right of way line.

In the event it is necessary to open the street pavement to work on utilities after the surface has been placed, additional compaction tests and paving as necessary to restore the integrity and appearance of the roadway may be required at the discretion of the District Engineer/Administrator's Designee.

(4) Cross-street conduits

To facilitate the placement of future underground utilities, cross-street conduits are encouraged with placement of such conduits occurring on each street at intersections and approximate every 1000 feet along the length of a street.

b. Above ground utilities

All above ground utilities shall be installed behind the sidewalk or as close as possible to the limits of the street's right-of-way, but shall not encroach on the sidewalk, the shared use path, or any clear zone.

## I. ROADWAY LIGHTING

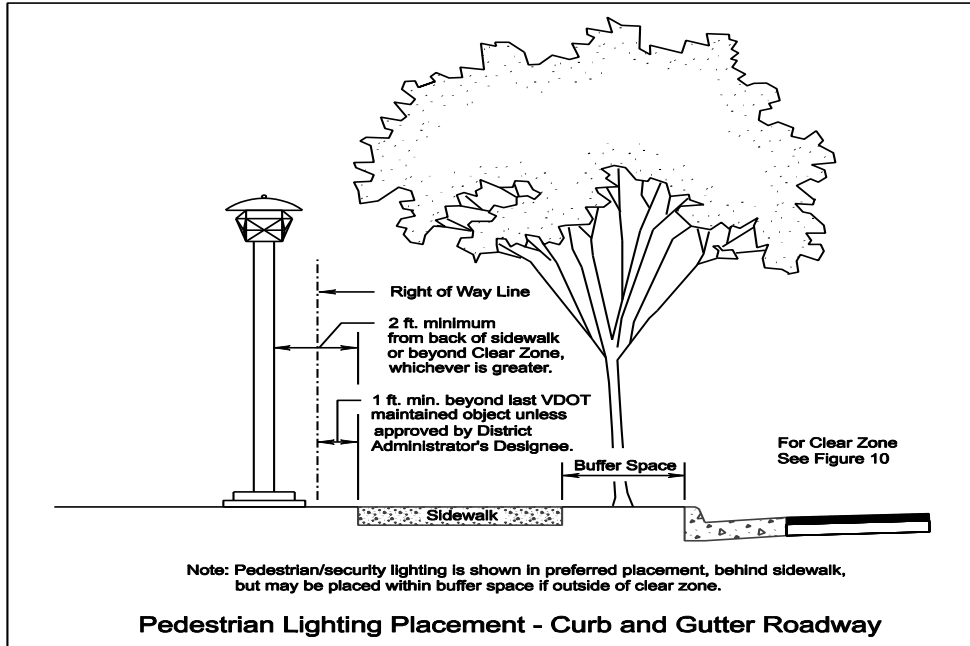
The installation, maintenance and operation of the lighting shall be provided by and at the sole expense of others.

VDOT will allow roadway lighting within the rights of way by land use permit only. VDOT will review and approve all roadway lighting plans regardless of maintenance and operational responsibility. On curb sections, poles shall be placed behind the curb and preferably behind the sidewalk. For shoulder sections, the pole shall be placed a minimum of 10 feet from the edge of pavement and behind the ditch line. The lighting plans shall identify whether conventional light poles are breakaway or non-breakaway. All conventional light poles within the clear zone shall be breakaway.\*

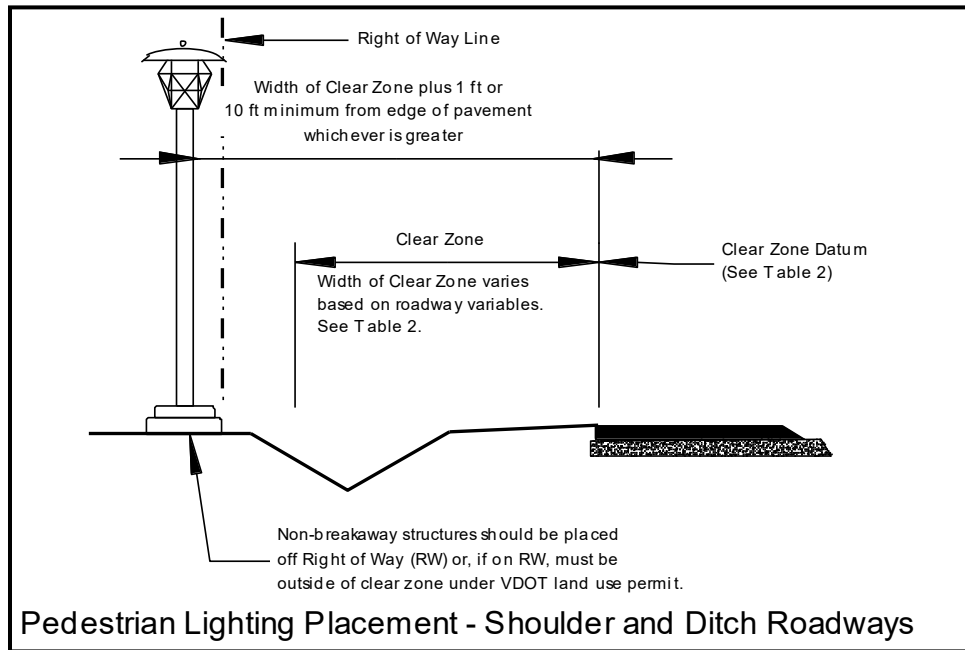
All lighting proposed within the rights of way must be designed in accordance with the AASHTO guide for Roadway Lighting and shall meet the current Illuminating Engineering Society of North America (IESNA) Standards.

---

\* Rev. 1/19



**FIGURE B(1)-23\* LIGHTING ALONG CURB AND GUTTER SECTION**



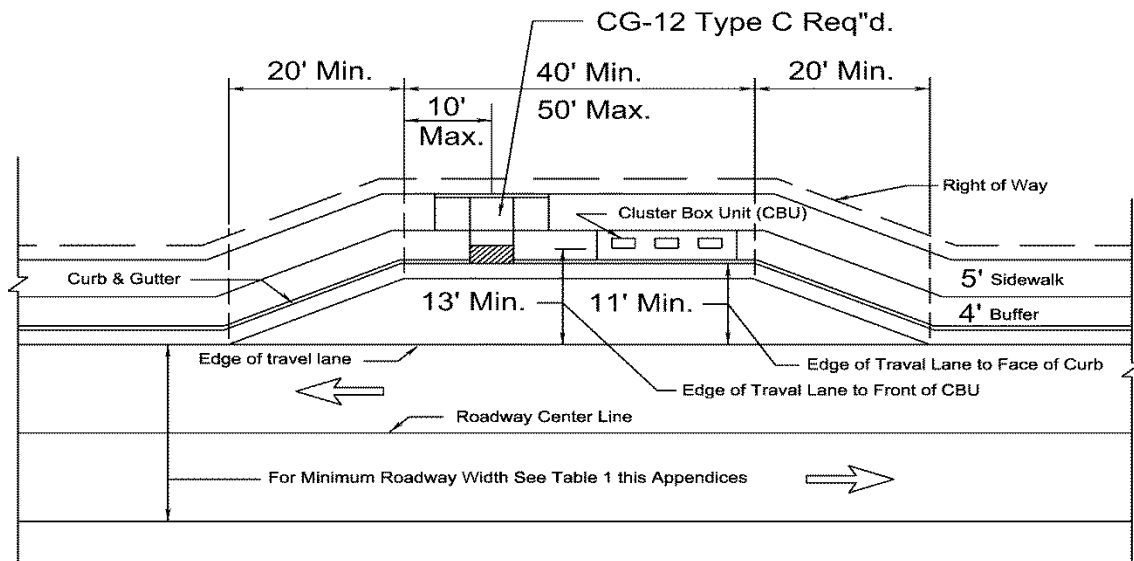
**FIGURE B(1)-24\* LIGHTING ALONG SHOULDER AND DITCH SECTION**

\* Rev 10/20

## J. MAILBOXES & CLUSTER BOX UNITS

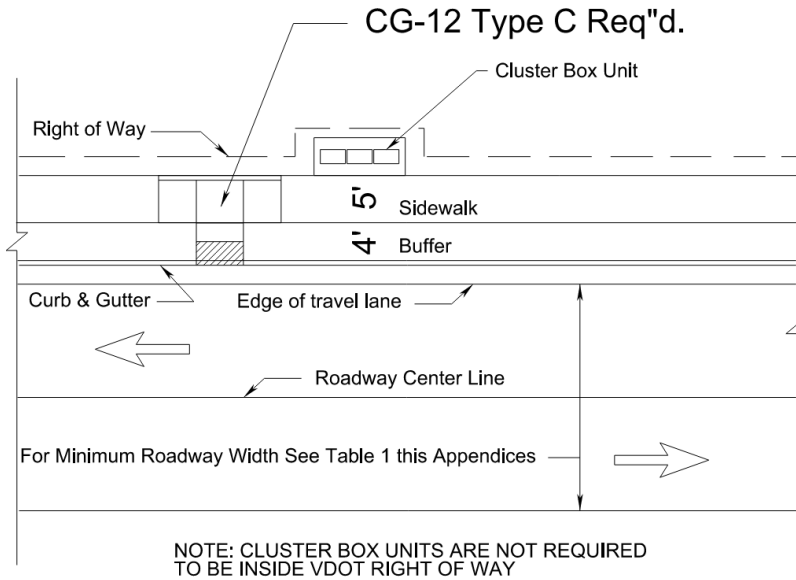
Mailboxes and newspaper boxes may be placed on VDOT right of way. Placement should not interfere with safety, maintenance and use of the roadway. Support structures for multiple mailboxes shall be designed and constructed in accordance with VDOT's Road and Bridge Standard RFD-1 located at [http://www.virginiadot.org/business/locdes/vdot\\_road\\_and\\_bridge\\_standards.asp](http://www.virginiadot.org/business/locdes/vdot_road_and_bridge_standards.asp). However, lightweight newspaper boxes may be mounted on the side of the support structure. Breakaway structures noted above will be acceptable as a mailbox post. Cluster Box Units (CBUs) may be required by the U.S. Postal Service in subdivisions. If so, the placement of CBUs will be restricted to subdivision streets with design speeds of 30 mph or less and shall be located outside the clear zone (7 feet minimum measured from the face of curb or 9 feet minimum from the edge of travel lane on a shoulder and ditch typical section).

Contact your local USPS representative for USPS Approved Specifications for the Concrete Pad for Single or Multiple Units as well as the CBU orientation (access for USPS delivery and customer) relative to the roadway. CBUs shall be ADA accessible in accordance with IIM-LD-55 (Curb Ramps and Sidewalks). See Details for CBU Turnout and CBU Without Turnout below.

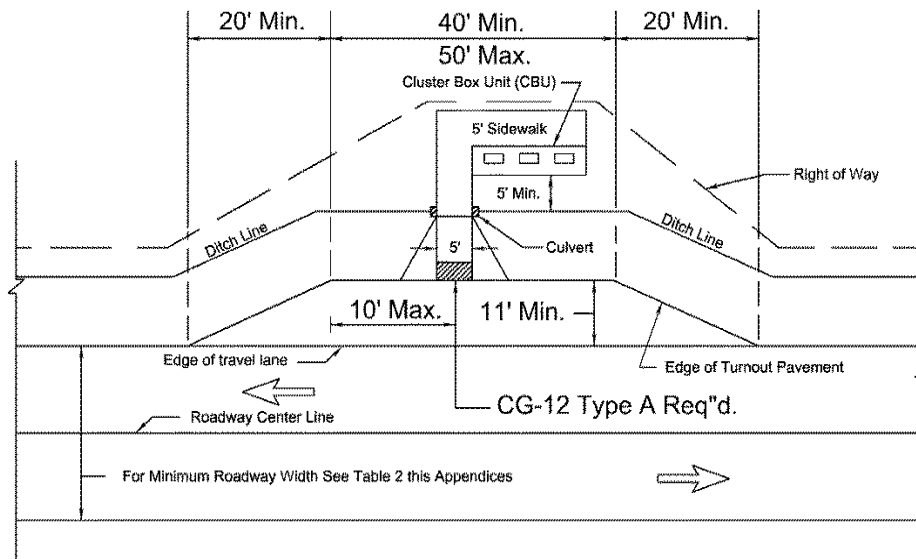


**FIGURE B(1)-25\* CLUSTER BOX TURNOUT – CURB AND GUTTER**

\* Rev 10/20



**FIGURE B(1)-26 CLUSTER BOX WITHOUT TURNOUT – CURB AND GUTTER\***



**FIGURE B(1)-27 CLUSTER BOX TURNOUT – SHOULDER AND DITCH**

\* Rev 7/21

## **SECTION 6 –TRADITIONAL NEIGHBORHOOD DESIGN**

### **GENERAL**

Any Traditional Neighborhood Development proposal should be presented to the locality and VDOT in its entirety. It is recognized that each traditional development is unique and will require individual review, discussion and approval of unique features. However, any county interested in traditional development is encouraged to submit their county wide proposal of the basic features they would like to see allowed in Traditional type development for VDOT review.

A Traditional Neighborhood Development is a multiuse, walkable community with moderate to high residential densities and a mixed-use core. Compared with conventional suburban developments, Traditional have a higher potential to increase modal split by encouraging and accommodating alternate transportation modes. Traditional also have a higher potential for capturing internal trips due to the increased employment, educational, and recreational facilities located within the development, thus reducing vehicles miles traveled.

A dense network of narrower streets with reduced curb radii is a key feature of Traditional Neighborhood Development design. This network serves to both slow and disperse vehicular traffic and provide a pedestrian friendly atmosphere. Such alternate guidelines are encouraged when the overall design ensures that non-vehicular travel is to be afforded very practical accommodation that does not adversely affect safety considerations.

Traditional Neighborhood Developments have a high proportion of interconnected streets, sidewalks and paths. Street and rights of way are shared between vehicles (moving and parked), bicycles, pedestrians, and Transit.\* The dense network of Traditional Neighborhood Development streets functions in an interdependent manner, providing continuous routes that enhance non-vehicular traffic. Most Traditional Neighborhood Development streets are designed to minimize the impact of through traffic by the design of the street and the location of the land uses. Streets are designed to only be as wide as needed to accommodate the usual vehicular mix for that street while providing adequate access for moving vans, garbage trucks, emergency vehicles and school busses.

Alleys are encouraged to provide site access, though alleys will not be accepted by VDOT for maintenance in the secondary system. The alley network also ensures minimal service vehicle access on the neighborhood street. Alley widths are to be determined by the locality. Alley entrances should be designed in accordance with Standard CG-11 and be a minimum width of 20 feet measured from face of curb to face of curb with a minimum radius of 12.5 feet. However, the selected radius shall accommodate the anticipated type of vehicle usage.

In addition, the following features are characteristic of Traditional Neighborhood Developments and may be allowed within these subdivision guidelines.

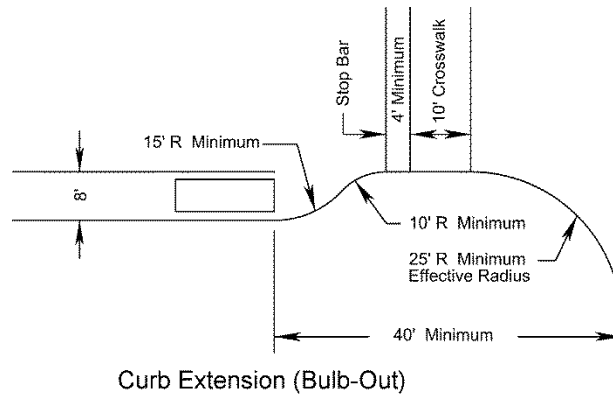
---

\* Rev. 7/13

- A. All or most streets must be part of a dense interconnected pattern. The degree of interconnectivity should be maximized to permit multiple routes, diffuse traffic and shorten walking distances. Most Traditional Neighborhood Development streets are designed to minimize the impact of through traffic.
- B. One-way street pairs are often used. The design features for one-way streets are shown on [Table B\(1\)-3\\*](#).
- C. Large vehicular corridors are usually found within the core area and near the perimeter of the proposed development. Traditional Neighborhood Developments typically include transit availability within a 15-minute walk of most areas of the development so a good network of streets that can accommodate busses is important.
- D. All or most local streets should have short block lengths of between 250 and 500 feet.
- E. Traffic calming – Many of the previously identified traffic calming devices may be utilized in a Traditional Neighborhood Development to promote pedestrian movement. Loop streets or eyebrows are often used in Traditional Neighborhood Development and may be considered acceptable ancillary pavement areas used only with curb and gutter sections. These features are not normally considered separate streets but may be used within the internal subdivision street network and should not adjoin any existing road. See [Figure B\(1\)-22\\*](#) – Traffic Calming Details.
- F. Curb Extensions – Curb extensions at intersections are frequently used in Traditional Neighborhood Developments. Curb Extensions are also used to protect parking areas and to reduce pedestrian crossing times.

---

\* Rev 10/20



**FIGURE B(1)-28\* CURB EXTENSION (BULB OUT) DETAIL**

Note:

1. The sight distance triangle shall be free of any obstructions that block a driver's view of potential conflicting vehicles or pedestrians entering the traveled way. Examples of obstructions that limits sight distance include vehicles in adjacent lanes, parked vehicles, bridge piers and abutments, large signs, poorly pruned trees, tall shrubs and hedges, walls fences and buildings.
2. Curb extensions shall only be used where there is on-street parking and where only a small percentage of turning vehicles are larger than the design vehicle.
3. Curb extensions are not applicable to intersections with exclusive right-turn lanes adjacent to the curb, or intersections with a high volume of right-turning trucks or buses turning into narrow cross streets.

## **SECTION 7 – INNOVATIVE DESIGN PROPOSALS**

### **GENERAL**

This Guide sets out design criteria and guidance for local subdivision streets based on VDOT standards and other applicable design references. If a development proposes use of a recognized acceptable concept or material not previously approved for VDOT use, a request shall be submitted to VDOT's District \*Engineer/Administrator's Designee or designee for review. The District Engineer/Administrator's Designee or designee, through consultation with appropriate divisions, will determine if the request will be approved for a VDOT maintained street. If it is determined that the non-standard item may be installed within the dedicated right of way and should be maintained by others, a permit will be required.

---

\* Rev. 7/15



## **SECTION 8 – SCHOOL BUS LOOPS AND DROP OFF / PICK UP AREAS**

### **GENERAL**

Roadways servicing school sites shall be designed to accommodate locality approved school buses and emergency vehicles. The design of roadway access to the school site and school bus drop off / pick up areas shall comply with VDOT requirements. Entrances to school sites from adjacent roadways shall be designed as commercial entrances in accordance with [Appendix F](#) of the RDM. The geometric design criteria detailed in Appendix B(1) Section 3 [Table B\(1\)-4](#) for school access roads do not apply to bus loops or bus drop off / pick up areas. The following design criteria shall be used for the design of bus loops and drop off / pick up areas. \*

### **DESIGN CRITERIA**

The design of school bus facilities (Loops and Drop Off / Pick Up Areas) shall meet the minimum criteria set forth in addition to review and approval by the Area Land Use Engineer.

School sites shall be designed so that roads, bus loops, and drop off / pick up areas are not required to be crossed to access buildings and facilities within the school site.

Student loading or unloading on school buses and private vehicles shall occur on the school site, a minimum of 50 feet away from a public roadway.

### **BUS LOOPS**

Within the school site, roads serving buses should have a minimum 45-foot radius on inner edge of pavement on all curves. A 100-foot tangent section should be provided between reverse curves. Pavement width may need to be wider in curves. If necessary concrete aprons similar to those used in roundabout design may be used on the inside of the curve in constrained environments.

A continuous loop design is preferred for all drop off/ pick up areas. The following dimensions are minimum widths not including gutter pans.

All designs:

- 26' minimum pavement width excluding gutter pan
- One-way operation in a counterclockwise direction

One Way Cul-de-sac Design:

- Cul-de-sac shall be designed to accommodate an SU-40 design vehicle

---

\* Added 1/20

- Minimum 6' median separating opposing directions of bus traffic
- Absolute Minimum cul-de-sac radius of 60'

### **BUS DROP OFF/ PICK UP AREAS**

- Single file right wheel to the curb is the preferred staging method for buses; \*
- Drop off area design shall not allow backward movement by buses;
- Drop off / pick up areas shall be one-way in a counterclockwise direction to ensure that the drop off / pick up of students occurs from the right-hand side of the vehicle adjacent to the building;
- Sufficient space shall be provided for buses to pass a disabled bus within the bus drop off / pick up area without crossing into oncoming lanes. Sufficient width shall be provided for emergency vehicles to pass parked buses;
- Drop off / pick up areas should be separated from the traffic flow associated with student, parent / visitor, teacher and administrative parking and service delivery. Traffic other than school buses, should not be allowed to operate near the drop off / pick up areas;
- The design of the Drop off areas shall not require children to walk between buses;
- The bus loading zone should not straddle a pedestrian crossing.

### **PARENT DROP OFF / PICK UP AREA**

- Drop off / pick up area should be one-way in a counterclockwise direction so that students are dropped off and picked up directly on the sidewalk;
- Maximize sidewalk space by locating the drop off / pick up area at the far end of the zone;
- Provide an adequate driveway length for queuing cars on site. The length of the car pick-up zone should be determined as a function of the expected number of cars;
- Drop off area should not require backward movement by vehicles;
- Do not load or unload students where they have to cross a vehicular path before entering the building;
- Raised Crosswalks should be used where pedestrian routes cross drop off / pick

---

\* Added 1/20

up areas.

### **ACCESSIBLE DESIGN**

Sidewalk access to the school site and within the school site should be designed to eliminate student crosswalks in bus drop off / pick up areas.\*

### **VERTICAL ALIGNMENT**

All bus loops within the school site should be graded to avoid configurations that could impair a motorist's sight distance including buildings and landscaping. A maximum grade of 5% should be used on all bus loops within the site, entrance and exit points shall have a maximum 2% grade. The minimum stopping sight distance provided for all vertical curves will be based on a 25 mph design speed.

Intersection sight distance – see [Appendix F of the Road Design Manual](#).

### **SIGNS AND PAVEMENT MARKINGS**

All signs and markings within school sites shall comply with the current [Manual on Uniform Traffic Control Devices \(MUTCD\)](#) and with the [Virginia Supplement to the MUTCD](#).

.

### **PAVEMENT DESIGN**

For drive and parking areas that will be utilized by school buses, the type of pavement and base shall conform to VDOT specifications.

### **RESOURCES**

1. Scott A. Cooner, Kay Fitzpatrick, Mark D. Wooldridge, and Garry L. Ford. Texas Transportation Institute, TRAFFIC OPERATIONS AND SAFETY AT SCHOOLS: RECOMMENDED GUIDELINES, Report number FHWA/TX-04/4286-2, January 2004  
<http://www.pedbikeinfo.org/cms/downloads/4286-2.pdf>
2. Institute of Transportation Engineers, 1627 Eye Street, NW, Suite 600 | Washington, DC 20006, Safe Routes to School Briefing Sheets: School On-Site Design  
<https://www.ite.org/resources/library/search/?event=getSimpleSearch&mode=simpleSearch>  
<https://www.ite.org/pub/?id=e2660aa0%2D2354%2Dd714%2D510d%2D6a9aed049d40>
3. Safe Routes to School Student Drop Off and Pick Up  
[http://guide.saferoutesinfo.org/dropoff\\_pickup/index.cfm](http://guide.saferoutesinfo.org/dropoff_pickup/index.cfm)

---

\* Added 1/20