



The Intelligent Surveillance Solution

Titan NVR

Server User Manual

Ver. 1.2.0.120203.00

Table of Contents

1.	Installation	4
1.1	Installation Process.....	4
1.2	LED Status Definitions.....	12
2.	Settings	13
2.1	Camera Setup	14
2.1.1	Add Cameras by Camera Search	14
2.1.2	Add Cameras Manually.....	15
2.1.3	Modify Camera Information	17
2.1.4	Modify Camera Parameters	17
2.1.5	Set up Lens Settings.....	17
2.1.6	Set up 2nd Stream	18
2.1.7	View Camera Status.....	19
2.2	Recording & Event Setup.....	21
2.2.1	Recording Mode Setup	21
2.2.2	Recording Schedule / Event Setup.....	21
2.2.3	Camera Events and Responding Actions Setup.....	25
2.2.4	I/O Box Input and Responding Action Setup	27
2.2.5	System Events and Responding Actions Setup	28
2.2.6	SMTP Server Setup.....	29
2.2.7	Add Event Contacts	30
2.3	RAID & File Settings.....	31
2.3.1	Create a RAID Volume	31
2.3.2	View RAID Volume Status.....	33
2.3.3	View Disk Drive Information	34
2.3.4	Modify RAID Volume	34
2.3.5	Delete a RAID Volume.....	36
2.3.6	Format	37
2.4	Auto Backup	38
2.4.1	Set up Backup Schedule.....	38
2.4.2	Set up Backup Server.....	39
2.5	Network Setup.....	40
2.5.1	View Network Status.....	40
2.5.2	Network Settings.....	41
2.5.3	Auto Port-Forwarding.....	42
2.5.4	Network Service Setup.....	44
2.5.5	Master/Slave Configuration.....	45

2.6	Management.....	46
2.6.1	View the List of Users.....	46
2.6.2	Create New Users.....	46
2.6.3	Modify User Information.....	47
2.6.4	Change a User's Password.....	48
2.6.5	Delete Users.....	48
2.6.6	Import/Export User Account.....	49
2.6.7	Online License Activation.....	50
2.6.8	Offline License Activation.....	51
2.6.9	View the Event Log.....	53
2.6.10	Save Unit Configuration.....	54
2.6.11	Load Unit Configuration / Default Settings.....	55
2.7	System.....	56
2.7.1	View System Information.....	56
2.7.2	Smart Fan Control.....	56
2.7.3	UPS Setup.....	57
2.7.4	Upgrade the System.....	58
2.7.5	Upgrade Notification.....	58
2.7.6	System Date and Time Setup.....	59
2.7.7	Daylight Saving Time Setup.....	60
2.7.8	Local Display.....	60
2.7.9	Restart the Unit.....	61
2.7.10	Shut Down the Unit.....	62
3.	I/O.....	63
3.1	Introduction.....	63
3.1.1	System Introduction.....	63
3.1.2	HW Installation.....	63
3.1.3	Software Installation – SCB-C31.....	64
3.1.4	Software Installation – SCB-C24/26/28.....	65
3.2	Software Setup.....	67
3.2.1	Add I/O Box.....	67
3.2.2	Modify I/O Box Information.....	68
3.2.3	I/O Pin Setting.....	68
3.3	Relative Configuration and Application.....	69
3.3.1	Record on Input Trigger.....	69
3.3.2	Input and Responding Actions.....	69
3.3.3	I/O Control Panel in Live View.....	69
4.	External Storage.....	70

4.1	Create a Volume on DAS	70
4.2	Create an External Storage	70
4.3	Create an External Storage on iSCSI	71
5.	Log out	73
6.	Remote PC System Requirements	74
7.	Troubleshooting	75
7.1	Replace a Failed Disk Drive	75
7.2	Respond to a Critical RAID Volume	75
7.3	Respond to a File System Error RAID Volume	75
7.4	Install ActiveX	75
7.5	Cannot Log in to the Unit with Internet Explorer	76
Appendix – RAID System		77
Introduction to RAID		77
RAID 0 – Stripe		77
RAID 1 – Mirror		78
RAID 5 – Block Striping with Distributed Parity		79
RAID 10 – Mirror / Stripe		79
Choosing a RAID Level		80
Appendix – Camera Integration		82
Camera Supporting List		82
Camera Search Tool		82
Stream Profile		82

1. Installation

1.1 Installation Process

Step 1: Unpack the Unit

This package contains the following items:

- The unit
- Quick Start Guide
- Screws for disk drives
- Key
- Power cord
- Warranty card
- CD with **Install Wizard**, **NuClient** and **Offline License Tool** application, user manual, and quick start guide



The electronic components within the unit can be damaged by Electrostatic Discharge (ESD). Please take precautions at all times when handling the unit or its sub-assemblies.



To configure the unit, you must install the software onto a desktop/ laptop running Windows XP-SP3 32bit, Windows 7 32/64bit, Mac OS X v10.6/10.7

Unit front/rear view (Tower)

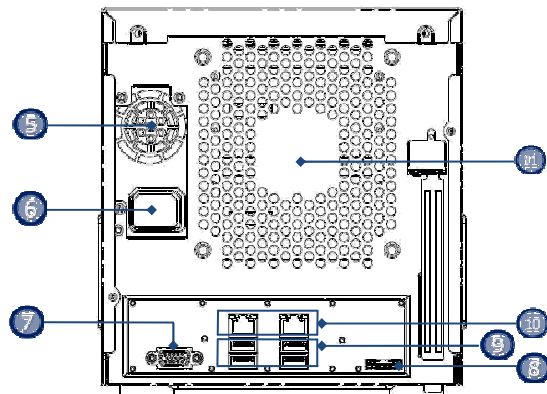
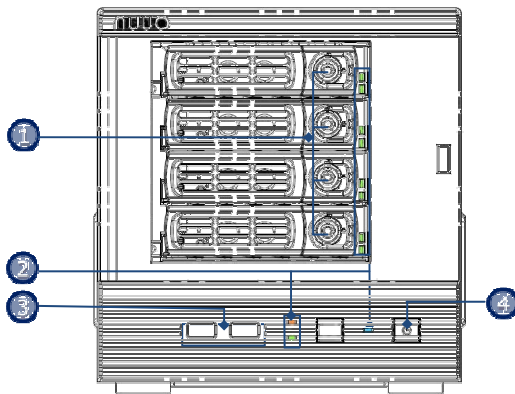

(Rackmount)

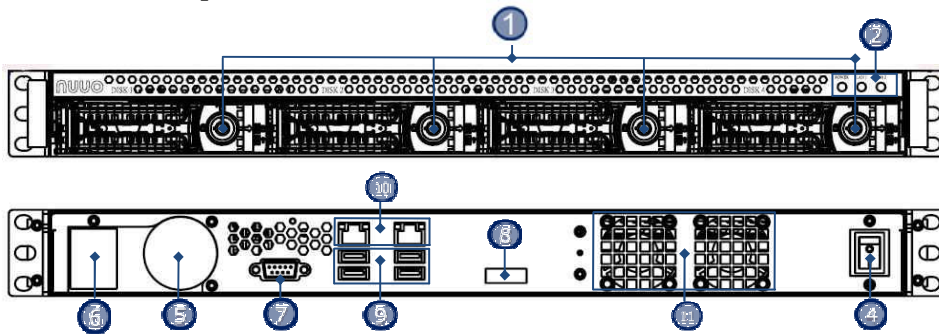

- | | |
|---|----------------------|
| 1. Key Lock | 6. Power Connector |
| 2. LED Indicators: Power,
LAN1-2, HDD1-4 | 7. VGA |
| 3. USB x2 | 8. eSATA Connector |
| 4. Power Button | 9. USB x 4 |
| 5. PSU Cooling Fan | 10. Gigabit LAN x 2 |
| | 11. Main Cooling Fan |

Step 2: Install Hard Drives

Refer to compatibility list and install HDDs. For optimal performance consideration, install disks with the same model and storage capacity. The available RAID level depends on the amount of disks installed.

1. Open the lid on the front of the unit enclosure.
2. Pull a HDD tray from the enclosure. See the front view figure.
3. Carefully lock the disks into the HDD tray with screws. 3 screws for each disk. We recommend locking the screws on the bottom of the disk, instead of the side of tray. Put the HDD tray back once you finished.

Step 3: Connect to the Network

1. Attach one end of the network cable to the RJ45 network connection. See the rear view figure.
2. Attach the other end of the network cable to your Ethernet hub or switch.



If there are multiple networks at your facility, note the network to which you connect the unit. You will need this information during the setup process. Please also enable the DHCP function within the network, as the unit will retrieve an IP address through DHCP by default.

Step 4: Connect the Power

1. Attach the power cord to the power source.
2. Connect the power cord to the back of the unit enclosure. See the rear view figure.
3. On the front of the unit, press the power button. See the front view figure.

It takes about a minute for the unit to fully power up. Once it is powered up, the Power Status LED turns blue. See the front view figure.

Step 5: Install the Software

1. Insert the CD into your CDROM.
2. Double-click **Setup.exe** to begin installation.
3. Follow the instruction of **Setup.exe**, and click the **Finish** button to close the installer.

Step 6: Set up the Unit

The software **Installation Wizard** performs the setup procedures on the unit. After the procedure, you can begin using it.

1. Go to Start > NUUO Titan Series > NUUO Install Wizard.
2. This program will show the default language setting and initiation mode.
3. Choose your preferred language and initiation mode, and then click the  button.

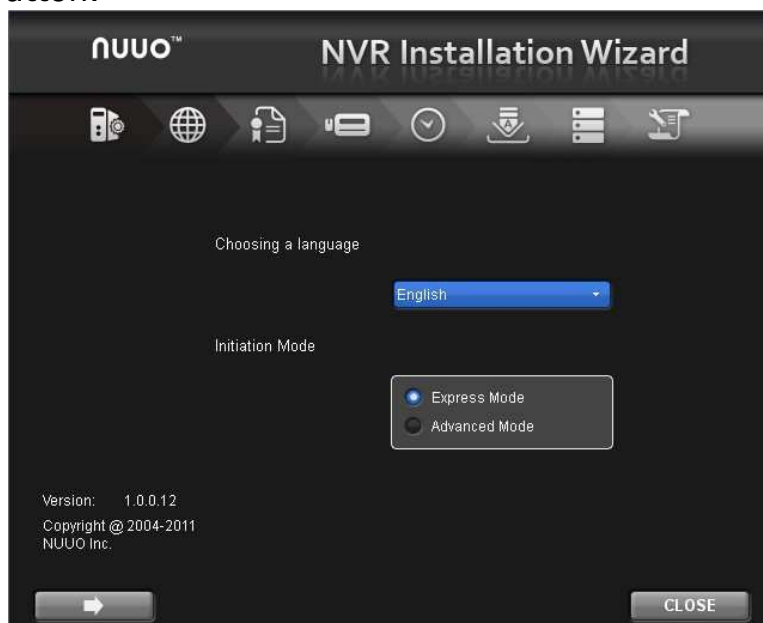

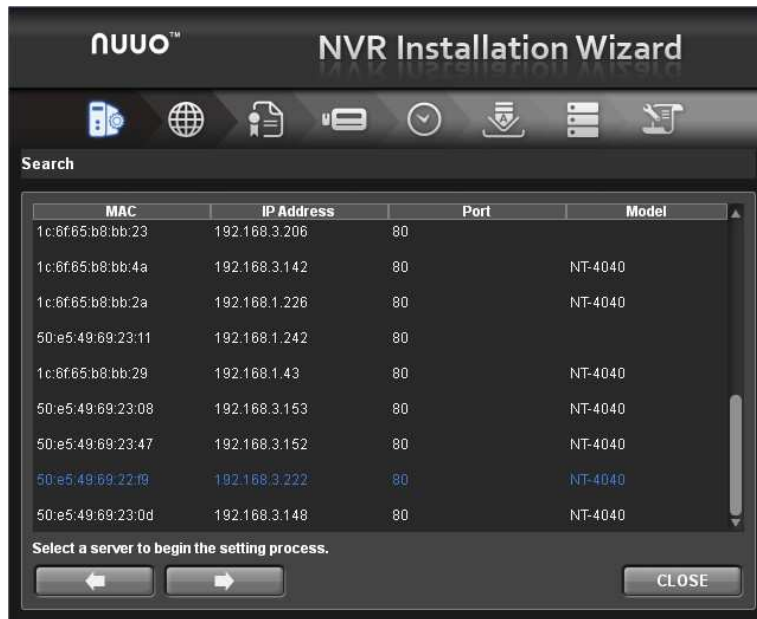

- **Express Mode:** you don't need to set up the network settings, Date/Time and RAID level.
 - **Advanced Mode:** configure all settings manually: network, license, camera, Date/Time, upgrade notification, and RAID level
4. The **Installation Wizard** program starts searching for all the units on the internet currently. Choose one of them, and then click the  button.



5. Type in the password, and then click the **OK** button.



 The default Administrator password is "admin".

6. Name this server and select the network type, and then click the  button.



- **Obtain network settings automatically from external DHCP server:** apply all settings which are automatically generated by the DHCP server, such as IP, subnet mask, gateway, and DNS.
- **Configure network settings manually:** configure the preferred settings one by one.

7. Activate camera license to have more channel capacity, and click the  button.



8. Add cameras for this server. There are two ways of adding cameras,

selecting the searched cameras and manually configuring the cameras. Click the  button after completing camera list.

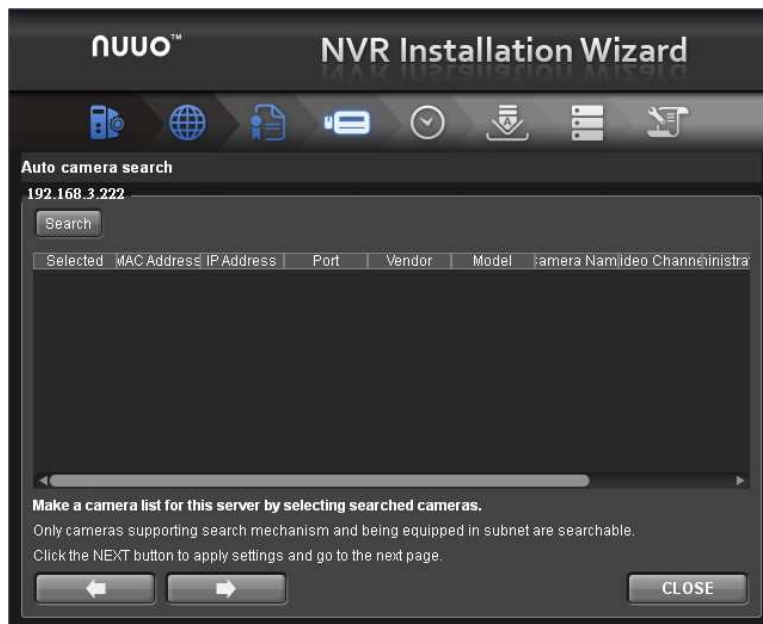

Click the **Search** button.



Select camera and type the camera name, username and password.



Add cameras manually.

- Set up the time zone, date, and time, and adjust daylight saving changes if needed. Click the  button.



- Check **“Enable Upgrade Notification”** box if you want to receive notification when there is a newer FW version. Click the  button.



11. Follow the following instruction and select the RAID type you want to create. Click the  button.



12. Review your settings. If the settings are correct, click the **Finish** button to exit the settings procedure and activate the system.



Once the "FINISH" button is clicked, the unit will start working. In order to ensure the stability of the unit, never pull any disks out when the system is running.

1.2 LED Status Definitions

Function	LED Status
Power Status	<ul style="list-style-type: none"> ■ Power-on: blue ■ Power-off: dark
HDD Status (top)	<ul style="list-style-type: none"> ■ Power-on: blue ■ Power-off: dark
HDD Activity Status (bottom)	<ul style="list-style-type: none"> ■ Healthy: blue with blinking ■ No disk: dark
Ethernet Status	<ul style="list-style-type: none"> ■ Linking: blue ■ Accessing: blue with blinking ■ No linking: dark

2.Settings

After setting up the unit, log in to the system by entering its IP address in the browser (Internet Explorer 8 and later, Safari 5.1 7534.48.3, and Firefox 7.0.1). When connecting, choose your language, enter the user name and password, and then begin using this system.

Take IE as the demonstration browser of this manual.



There are four main functions of this unit: Settings, NuClient, Help Page, and Logout button. They will be shown on the top of the page. [Currently, NuClient is supported on IE and Firefox only.](#)



Current firmware version and free storage capacity are shown above the function list.



2.1 Camera Setup

2.1.1 Add Cameras by Camera Search

The function enables user to automatically search and add cameras in the same network. There are two search mechanisms, one is UPnP, another is **camera search tool**. Before searching UPnP cameras, make sure that the cameras possess UPnP function.

1. Log in to the unit.
2. Click **IP Camera/ Camera Settings**.
3. Click the **Camera Search** tab.
4. Click the **Search** button.

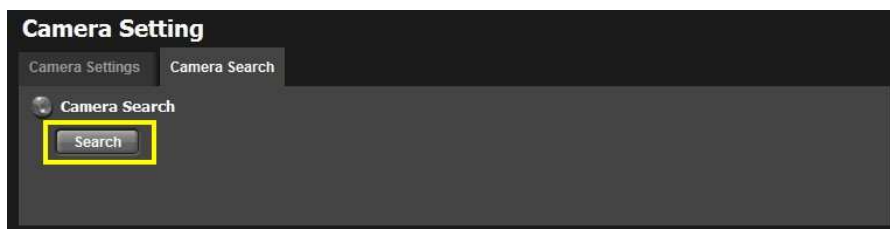

5. The system will list all the currently available cameras. The inserted cameras are shown in blue. Click the **+** icon to add a camera into your camera list.



6. After clicking the **+** icon, the camera setting page will pop up. Click the item to which you want to add a camera.

Add IP Camera

Camera Name:

Address: 192.168.1.85 Port: 80

Administrator Name: Password:

Add to channel: 2 Protocol: UDP

Vendor: Vendor Model: Model

Current Camera Settings

1-16 17-32 33-48 49-64

Channel	Camera Name	Address	Vendor	Model
1	Camera Name	192.168.2.79	Vendor	Model
2			-- none --	-- none --
3			-- none --	-- none --
4			-- none --	-- none --

7. Insert the camera name, user name, and password.

To have better compatibility between camera and system, please make sure the privilege of camera credential is admin-level.

8. Click the **Add** button to add it.

9. After clicking the **Add** button, the updated camera list will be displayed in the **Camera Setting** tab.

Camera List

1-16 17-32 33-48 49-64

No.	Camera Name	Address	Port	Vendor	Model
1	Camera Name	192.168.2.79	80	Vendor	Model
2	Camera Name	192.168.1.85	80	Vendor	Model
3			80	-- none --	-- none --
4			80	-- none --	-- none --

2.1.2 Add Cameras Manually

1. Log in to the unit.
2. Click **IP Camera / Camera Settings**.
3. Click the **Camera Settings** tab, and the camera list will be displayed on the bottom of the page.
4. Click on the camera list for the channel you want to add and enter the camera's information.

Camera List					
No.	Camera Name	Address	Port	Vendor	Model
1			80	-- none --	-- none --
2			80	-- none --	-- none --
3			80	-- none --	-- none --
4			80	-- none --	-- none --

Camera Settings

Camera Settings Camera Search

Camera Settings

Camera No.	Camera 2				
Camera Name	<input type="text"/>				
Address	<input type="text"/>	Port	80 <input type="text"/>		
Administrator Name	<input type="text"/>	Password	<input type="text"/>		
Video Channel	<input type="text"/>	Protocol	<input type="radio"/> TCP <input type="radio"/> UDP <input checked="" type="radio"/> HTTP		
Vendor	-- none -- <input type="text"/>	Model	-- none -- <input type="text"/>		

- **Camera name:** The name of the camera.
- **Address:** The IP address.
- **Port:** The transmission port.
- **Administrator Name:** Login username.
- **Password:** Login password.
- **Camera Channel:** Select the number of analog cameras supported by one video server or select the number of IP cameras possessing multiple lens/channels.
- **Protocol:** Data transmission protocol.
- **Vendor:** Camera vendor name.
- **Model:** Camera model name.



To have better compatibility between camera and system, please make sure the privilege of camera credential is admin-level.

5. Click the **Save** button.

- **Save:** Save the information of this camera.
- **Reset:** Return to the latest saved settings of the selected camera.
- **Clear:** Set all the settings to default value.
- **Auto Detection:** After inserting IP address, port, username, and password, click this button to automatically detect other camera information, including Channel, Protocol, Vendor, and Model.

2.1.3 Modify Camera Information

1. Log in to the unit.
2. Click **IP Camera / Camera Settings**.
3. Click the **Camera Settings** tab.
4. Click the camera which you want to modify.
5. Modify the information of this camera.
6. Click the **Save** button.
7. Use the same method to replace a camera if needed.

2.1.4 Modify Camera Parameters

1. Log in to the unit.
2. Click **IP Camera / Camera Parameters**.
3. Click the **Camera Parameter** tab.
4. Click the camera which you want to modify on the camera list.
5. Modify the information of this camera.
6. Click the **Save** button.

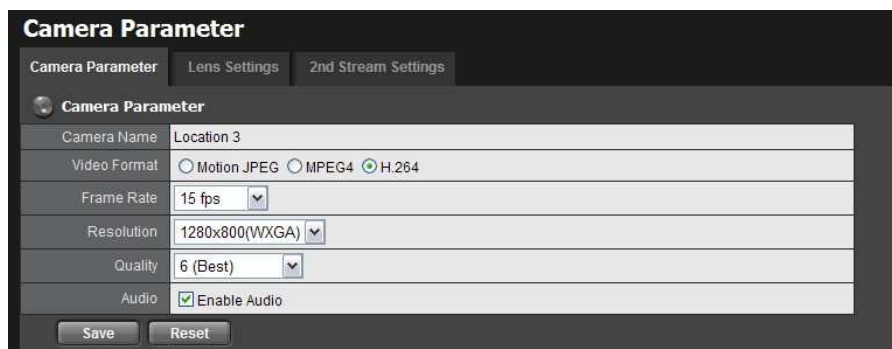

The screenshot shows a web interface titled "Camera Parameter" with three tabs: "Camera Parameter", "Lens Settings", and "2nd Stream Settings". The "Camera Parameter" tab is active. Below the tabs, there is a "Camera Parameter" section with a refresh icon. The configuration fields are as follows:

Camera Name	Location 3
Video Format	<input type="radio"/> Motion JPEG <input type="radio"/> MPEG4 <input checked="" type="radio"/> H.264
Frame Rate	15 fps
Resolution	1280x800(WXGA)
Quality	6 (Best)
Audio	<input checked="" type="checkbox"/> Enable Audio

At the bottom of the form, there are two buttons: "Save" and "Reset".

- **Camera Name**: The name of the camera.
- **Video Format**: Choose the type of format which this camera supports.
- **Frame rate**: Select the frame rate of the camera.
- **Resolution**: Select the resolution of the camera.
- **Quality**: Select the image quality of the camera.
- **Audio**: Check the **Enable Audio** option to view and enable audio recording.

2.1.5 Set up Lens Settings

1. Log in to the unit.
2. Click **IP Camera / Camera Parameters**.

3. Click the **Lens Settings** tab.
4. Click the camera which you want to modify in the camera list.
5. Modify the information of this camera.
6. Click the **Save** button.

No.	Camera Name	ImmerVision Lens	Camera Position
1	Location 1	Enable	Wall
2	Location 2	Disable	-- none --
3	Location 3	Disable	-- none --
4		Disable	-- none --

- **Camera Name**: The name of the camera.
- **ImmerVision Lens**: Enable the option if ImmerVision lens is installed.
- **Camera Position**: Select the position of the camera.



If users enable the lens while lens is not installed correctly or not even installed, a warning message will pop up as a notification if users are trying to operate lens on liveview page.

2.1.6 Set up 2nd Stream

Stream profile is designed for mobile client and lower fps live stream display. Without stream profile integration, users cannot watch live video on mobile client nor select lower fps stream on liveview. Further, for performance consideration, we fix the resolution and framerate for each brand/series. You can refer to **appendix** for supporting list.

1. Log in to the unit.
2. Click **IP Camera / Camera Parameters**.
3. Click the **2nd Stream Settings** tab.

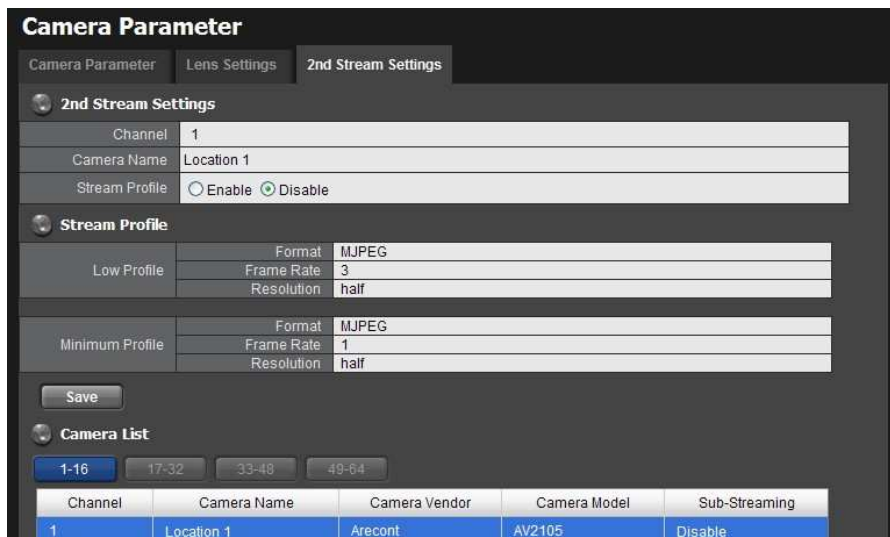





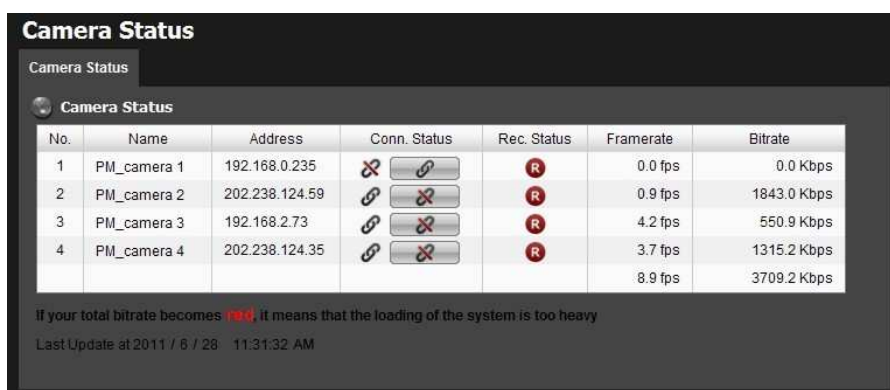

- **Stream Profile:** The default status is **Disable**. If you want mobile client user to access to this camera, you can select **Enable**, and click **Save** button in the middle of the page.
- **Low Profile:** The stream profile, under 300kbps, is designed for mobile client single-view.
- **Minimum Profile:** The stream profile, under 100 kbps, is designed for mobile client multi-view.

2.1.7 View Camera Status







1. Log in to the unit.
2. Click **IP Camera / Camera Status**.



- **Conn. Status:** The status of the connection. Click the **Connect** or **Disconnect** button to change the connection status.

	Status	Icon
Connection Status	Connected	
Connection Status	Disconnected	
Connection Status	Connecting	
Connection Button	Connected: Normal	
	Connected: Over	
Connection Button	Disconnected: Normal	
	Disconnected: Over	

- **Rec. Status:** The set recording schedule of this camera in this time.

	Status	Icon
Recording Status	No Recording	
Recording Status	Always Recording – Recording	
Recording Status	Always Recording – Stopped	
Recording Status	Schedule Recording – Recording	
Recording Status	Schedule Recording – Stopped	
Recording Status	Manual Recording – Recording	
Recording Status	Manual Recording – Stopped	

- **Framerate:** The frame rate of this camera.
- **Bitrate:** The transmission bit rate of this camera.



If your total bitrate becomes red, it means that the loading of the system is too heavy.

2.2 Recording & Event Setup

2.2.1 Recording Mode Setup

1. Log in to the unit.
2. Click **Recording & Event / Recording settings**.
3. Click the **Recording Mode** tab.
4. If selecting **Always Recording**, the chosen cameras will begin to record immediately.

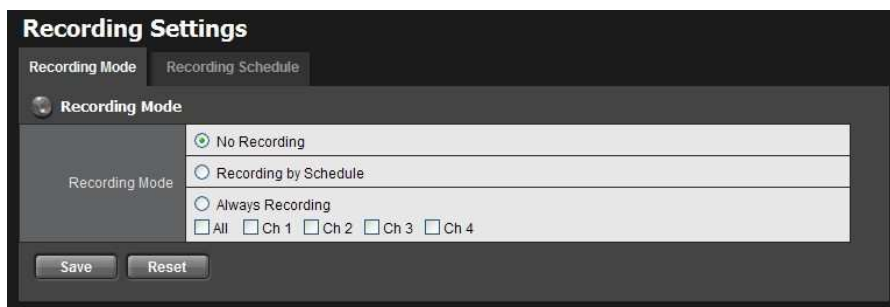

- **No Recording**: Turn off the recording.
- **Recording by Schedule**: Recording by schedule.
- **Always Recording**: Permanently turn on the chosen cameras.



System will do recycling automatically when disks are full.

2.2.2 Recording Schedule / Event Setup

Instead of **Always Recording**, you can begin the recording by setting the **Recording Schedule**.

1. Log in to the unit.
2. Click **Recording & Event / Recording Settings**.
3. Click the **Recording Schedule** tab.
4. Check the **Day** or **Week** mode.
 - **Day**: Schedule the recording to turn the recorder on and off at the same time every day according to your setting.
 - **Week**: Schedule the recording for each day of the week differently.
5. Click the schedule of the camera which needs to be modified.
6. Click the column at the bottom of the page.

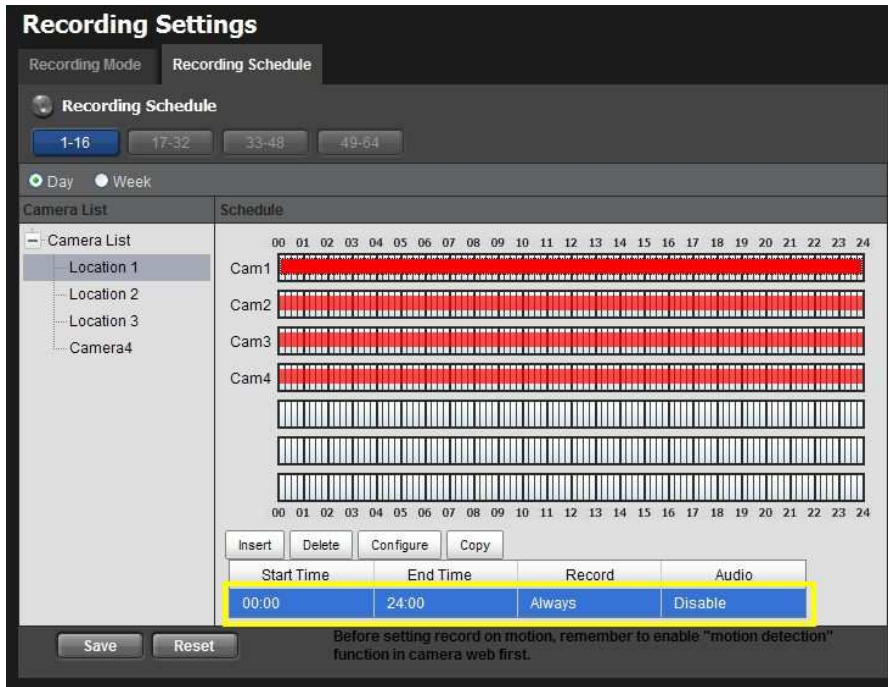

- **Insert:** Insert new schedules.
- **Delete:** Delete the selected schedule.
- **Configure:** Modify the schedule and recording mode settings.
- **Copy:** Copy current **Day Schedule** to other channel(s); copy current **Week Schedule** to other day(s) of a week or to other channel(s).

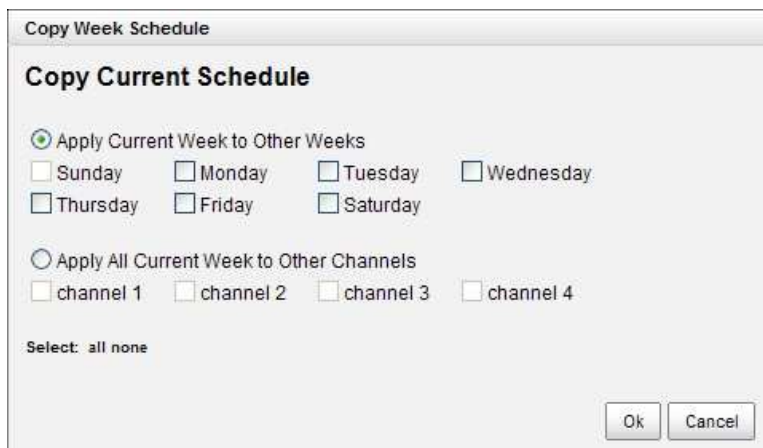

7. The default setting of the camera's recording schedule is from 00:00 to 24:00. If you want to modify the time slot, click the **Configure** button to modify the default settings first.

Schedule Configuration

Time

Start Time: 00:00

End Time: 24:00

Pre-record: 5 Sec. (Max.: 180)

Post-record: 5 Sec. (Max.: 180)

Audio

Enable Audio

Mode

Always Record

Record on Event

Ok Cancel

8. Choose the recording mode.

Schedule Configuration

Time

Start Time: 00:00

End Time: 24:00

Pre-record: 5 Sec. (Max.: 180)

Post-record: 5 Sec. (Max.: 180)

Audio

Enable Audio

Mode

Always Record

Record on Event

Motion

Motion on Location 1

Motion on Location 2

Motion on Location 3

Digital Input

Expand All Digital Inputs

+ Location 1

+ Location 2

Ok Cancel

- **Always Record**: Always record.
- **Record on Event**: Record when events triggered. The event can be triggered by **Motion** or **Digital input**.



When setting the event Motion, please first ensure that the motion detection function of the camera has been enabled.

9. If you want to add another new schedule, click the **Insert** button to add a new one.

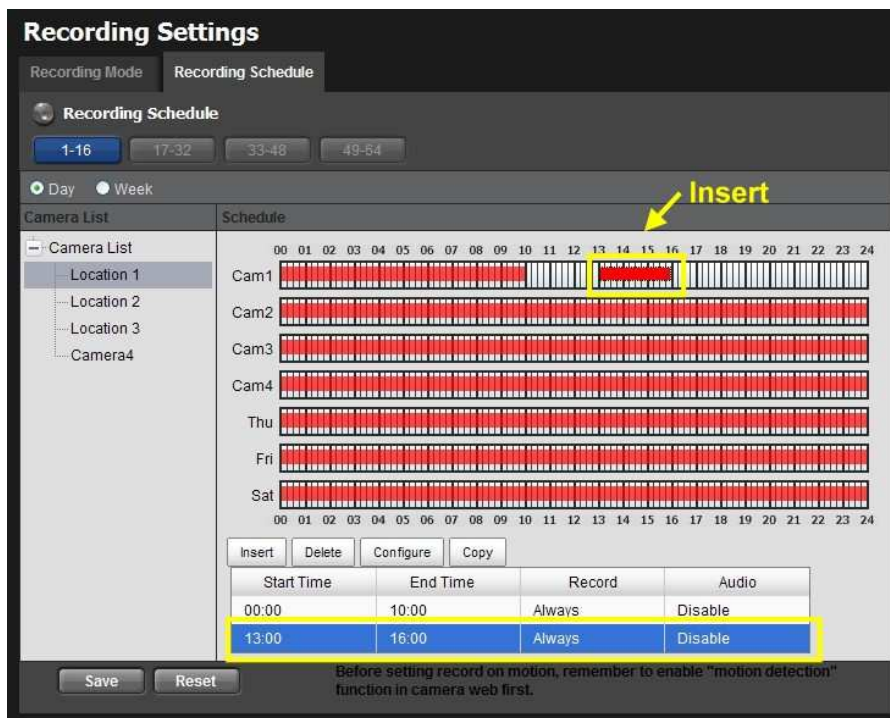

10. Click the **Save** button.



When changing the motion detection settings of a camera, make sure to disconnect your unit and that camera first. Once you have finished, re-connecting them will update the settings in your unit.



When setting an event, **Motion** or **Digital input** can be triggered from other cameras. This means that if the system detects motion or digital input from other cameras or I/O Box, the camera will begin recording.



There is another way to set the schedule. If you want to change the recording time length, drag the end of the time bar from 24:00 back to the length you wish, and then drag the beginning of the time bar to the point at which you would like it to commence recording. (You may also click the **Insert** button to add new schedules.)

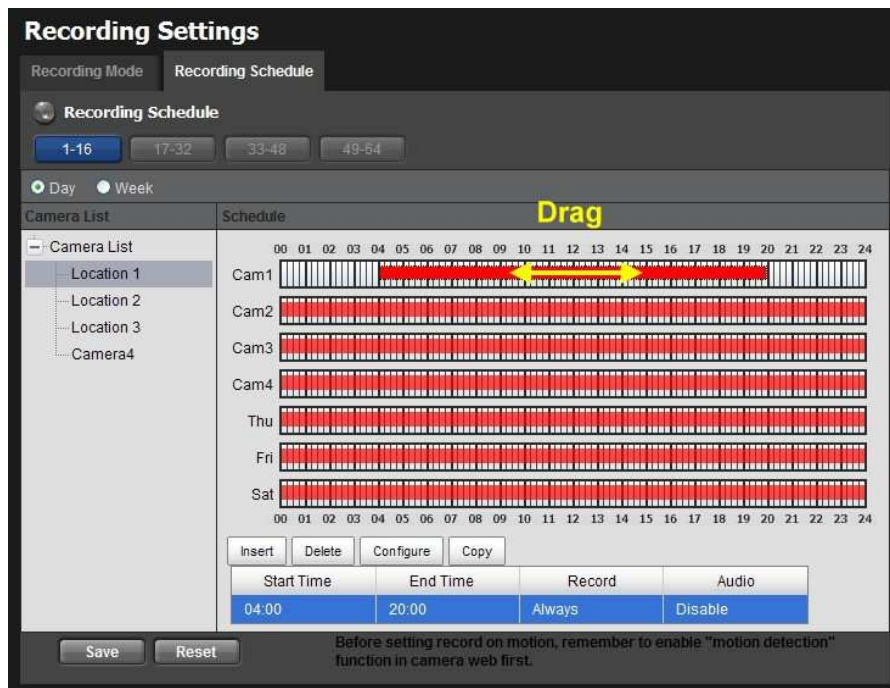
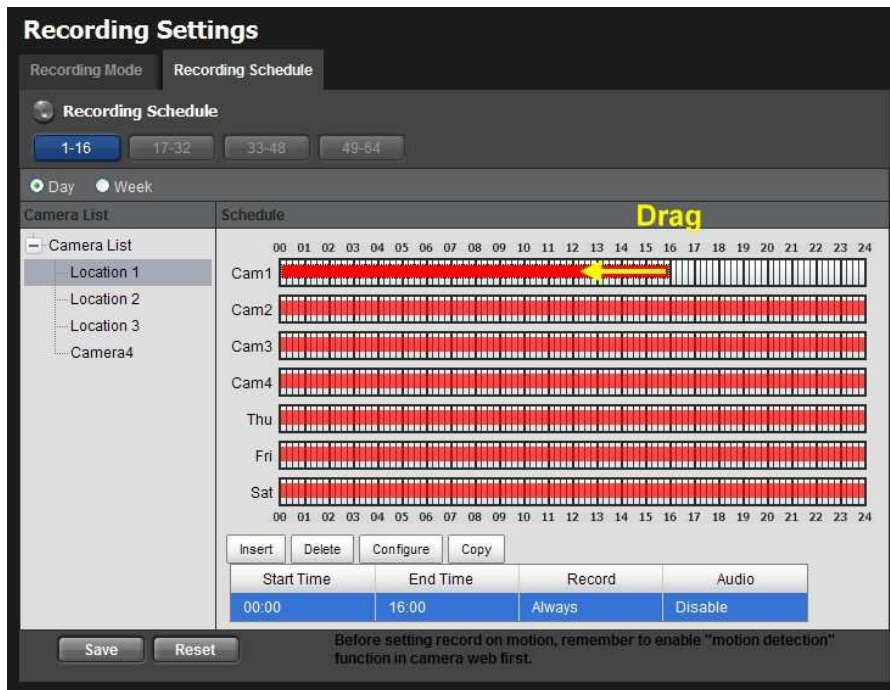

2.2.3 Camera Events and Responding Actions Setup

1. Log in to the unit.
2. Click **Recording & Event / Event & Action Management**.
3. Choose the camera, and then select one of the events. The event list depends on camera its own ability.

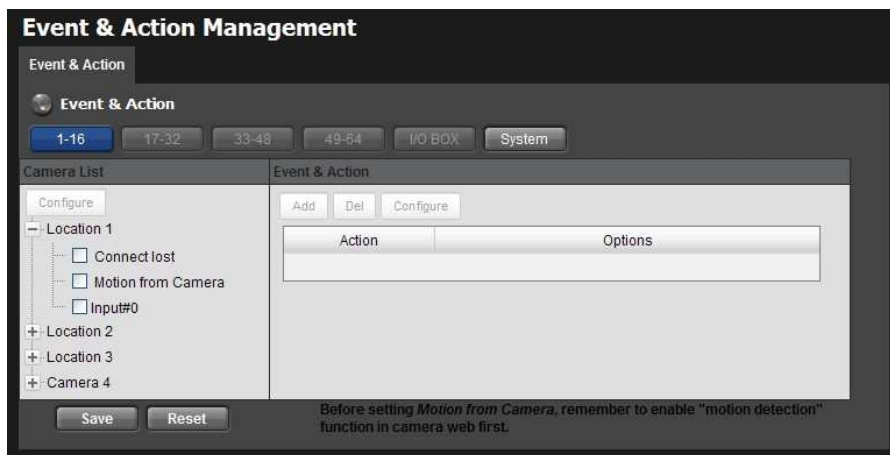

- **Connect lost**: When a connection between the camera and this unit is lost, the system will trigger an action.
- **Motion from Camera**: When video motion is detected, the camera triggers an action.
- **Input**: Any external input can trigger an action.



When setting the event **Motion from Camera**, make sure to set up the camera's motion detection function first. Besides, event log will be recorded only if event is selected on this page.

4. Click the **Configure** button to enable the event and select the active period.

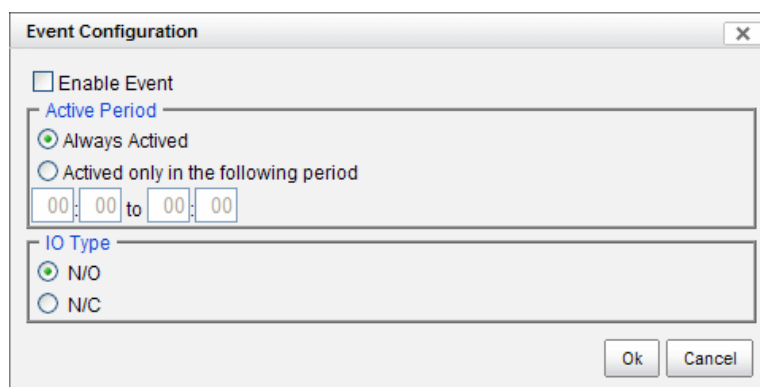

- **Always Active**: The selected event is always active.
- **Active only in the following period**: The selected event is only active in the designated time, which able to cover two days e.g. from 18:00 to 09:00.
- **I/O Type**: Check one of the options of I/O type. N/O means normal open, while N/C means normal close.

5. Click the **Add** button to set up the responding actions of this event.

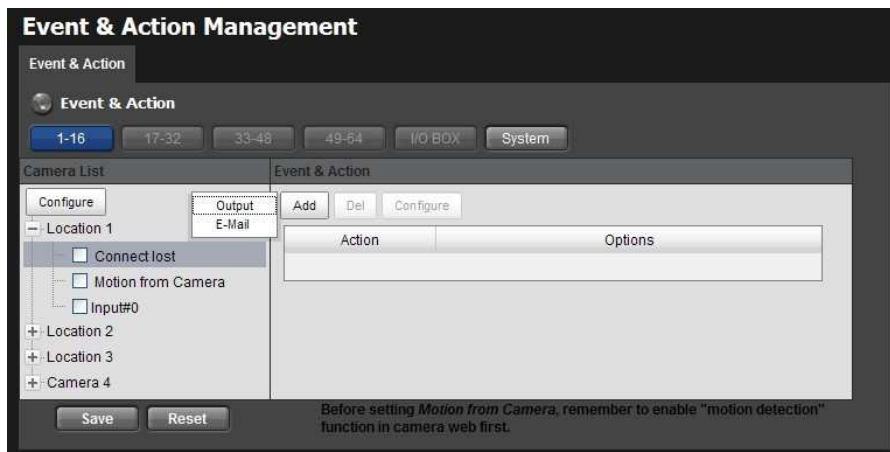

- **Output:** When an event occurs, the system will send an output signal to other connected devices.
- **E-Mail:** When an event occurs, the system will send e-mail notifications. Make sure to add an e-mail address first.

6. Click the action, and then click the **Configure** button to modify the details of that action if necessary.

7. Click the **Save** button.



After selecting camera events, the event information will display on the screen when it's triggered.

2.2.4 I/O Box Input and Responding Action Setup

1. Log in to the unit.
2. Click **Recording & Event / Event & Action Management**.
3. Select an input of I/O Box from list.
4. Click the **Add** button to set up the responding actions of this event.
5. Click the action, and then click the **Configure** button to modify the details of that action if necessary.

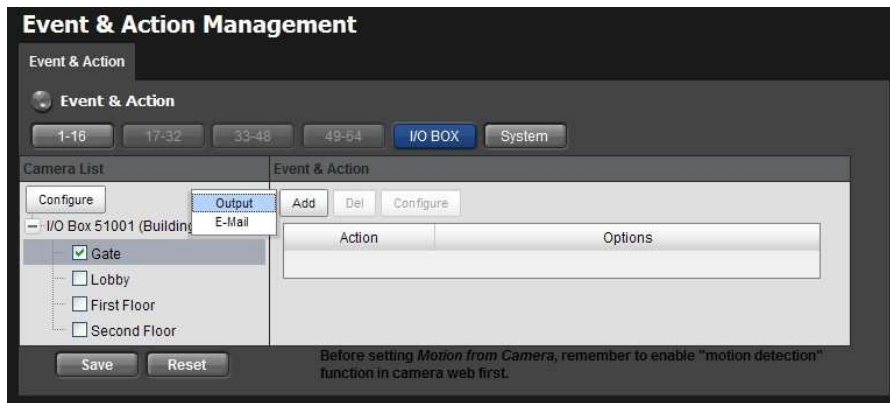

- **Output:** When an input is triggered, the system will send an output signal to other connected devices.
- **E-Mail:** When an input is triggered, the system will send e-mail notifications. Make sure to add an e-mail address first.

6. Click the **Save** button.

2.2.5 System Events and Responding Actions Setup

1. Log in to the unit.
2. Click **Recording & Event / Event & Action Management**.
3. Click the **Event & Action** tab.
4. Click **System** to unfold the list of system events, and then select one of the five events.

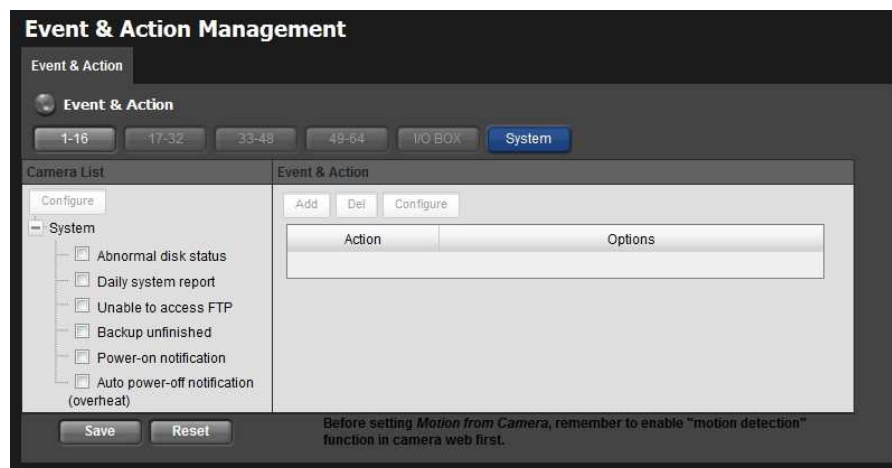

- **Abnormal disk status:** When there is no enough disk space for recording or when disk is abnormal for accessing, the system will trigger an action.
- **Daily system report:** Enable users to know the system information,

HDD usage, and Disk status everyday through E-mail without accessing to the unit to check.

- **Unable to access FTP**: The action will be triggered when the connection between the unit and FTP server is lost.
- **Backup unfinished**: If there is any file which the system didn't complete the backup process, the file(s) name will be listed and send out through E-mail after finishing the last file of this backup schedule.
- **Power-on notification**: Record the time as power was turning on.
- **Auto power-off notification (overheat)**: Turn off the system power automatically to protect the unit from damage when it's overheated.

5. Click the **Add** button to set up the responding actions of this event. Follow the steps in the previous section.

6. Click the **Save** button.



E-Mail is the only one action to the event **Daily system report, Unable to access FTP, Backup unfinished, Power-on notification** and **Auto power-off notification (overheat)**. In addition to select a contact, remember to insert the time of sending daily system report.

Daily System Report Configuration

Automatically Send Daily System Report

18:48

Contact List

NUUO CSD <service@nuuo.com>

Ok Cancel

2.2.6 SMTP Server Setup

1. Log in to the unit.
2. Click **Recording & Event / E-Mail**.
3. Click the **SMTP Server** tab.

E-Mail

SMTP Server Contactors

SMTP Server

Server Address Port use ssl

Sender

Subject

Body

SMTP Authentication

User Name Password

- **Server Address:** SMTP (Simple Mail Transport Protocol) server IP address.
- **Port:** SMTP port.
- **Sender:** Sender information.
- **Subject:** The subject of the mail.
- **Body:** E-Mail content.
- **SMTP Authentication:** Before sending out an E-Mail, enter the user name and password for SMTP authentication.
- **Username**
- **Password**

4. Click the **Send Test Mail** button and the system will send a test mail to the sender. Check it after testing.
5. Click the **Save** button.

2.2.7 Add Event Contacts

1. Log in to the unit.
2. Click **Recording & Event / E-Mail**.
3. Click the **Contactors** tab.

- **Add Contactor**: Add this new contact into the contact list.
- **Reset**: Return to the latest saved settings of the contact list.
- **Save**: Save this time modification of the contact list.

4. Insert the name of a new contact.
5. Insert the e-mail address of this new contact.
6. Click the **Add Contactor** button.
7. Click the **Save** button to save this modification of the contact list.

2.3 RAID & File Settings

2.3.1 Create a RAID Volume

In this system, the term RAID volume refers to one or more disk drives working together as a RAID logical drive. You must create a RAID volume before starting to record.



The maximum volume size to create RAID on Titan NVR is 16T. Please make sure every volume you are going to add as a external storage is under 16T.

1. Log in to the unit.
2. Click **RAID & File System / RAID Management**.
3. Click the **Create** tab.

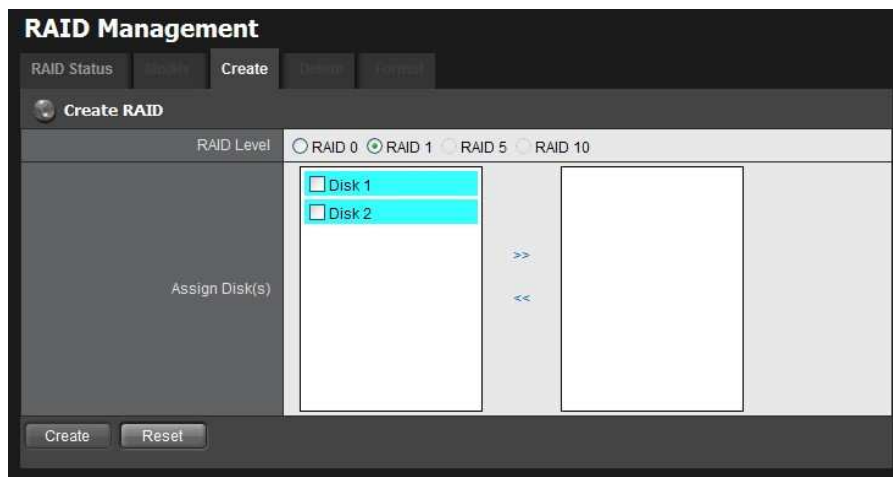

4. Choose the RAID level you prefer for your disk array.
5. Check boxes of disks and click the >> button to assign disk drives for this volume.
6. Click the **Create** button.
7. A confirmation dialog pops up. Check the **Yes, I want to create volume with those disk(s)** box, and click the **Yes, create it** button.



8. Creating RAID volume takes a while, depending on the size of disks and the RAID level you choose. You can start recording during RAID creation.

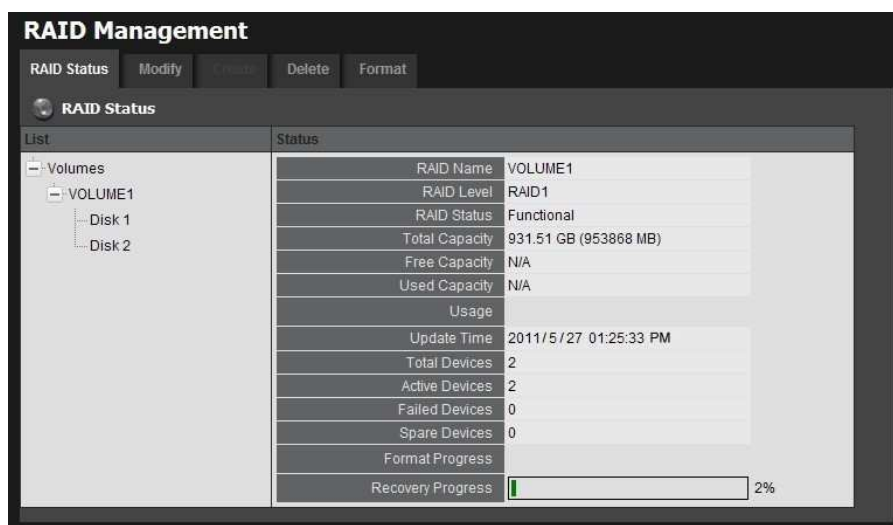



The RAID Volume will be functional on another unit if all disks of this volume are moved to the unit.



After setting RAID level, you are not allowed to change neither the RAID level nor the number of disks containing in this volume.



If you choose Express Mode when using the **Installation Wizard**, the disk(s) will be set to RAID 1 (2 bay) or RAID 5 (4 bay) automatically unless the number of disks is not enough for this RAID level.

2.3.2 View RAID Volume Status

RAID status refers to the disk drives on your unit and how they are arranged into a RAID volume.

1. Log in to the unit.
2. Click **RAID & File System / RAID Management**.
3. Click the **RAID Status** tab to view the status of your RAID Volume.

The screenshot displays the RAID Management interface. At the top, there are tabs for RAID Status, Modify, Create, Delete, and Format. The RAID Status tab is selected. Below the tabs, there is a tree view on the left showing 'Volumes' with 'VOLUME1' expanded to show 'Disk 1' and 'Disk 2'. The main area shows the status of VOLUME1 in a table format.

RAID Status	
RAID Name	VOLUME1
RAID Level	RAID1
RAID Status	Functional
Total Capacity	931.51 GB (953868 MB)
Free Capacity	907.38 GB (929160 MB)
Used Capacity	9.5 GB (9736 MB)
Usage	<div style="width: 2%;"><div style="width: 2%;"></div></div> 2%
Update Time	2011/5/27 08:11:13 PM
Total Devices	2
Active Devices	2
Failed Devices	0
Spare Devices	0
Format Progress	
Recovery Progress	

- **RAID Name:** Name of your RAID, automatically assigned when it was created.
- **RAID Level:** RAID 0, 1, 5, or 10, specified when it was created.
- **RAID Status:** **Functional** is normal. **Critical** means there are some problems on RAID volume, but the recording status is normal. **Offline** means that no volume is found, so recording is stopped and you cannot access your data either. **File system error** means that RAID volume is existed but unmounted, so recording is stopped and you cannot access

your data either.

- **Capacity**: Total, free, used data capacity of the RAID volume.
- **Update Time**: The time of volume created/updated.
- **Devices**: Total number of disks and the number of active, failed, spare disks.
- **Format Progress**: The status of RAID format
- **Recovery Progress**: The status of RAID recovery

2.3.3 View Disk Drive Information

1. Log in to the unit.
2. Click **RAID & File System / RAID Management**.
3. Click the **RAID Status** tab.
4. Click on a disk directly to view the information.

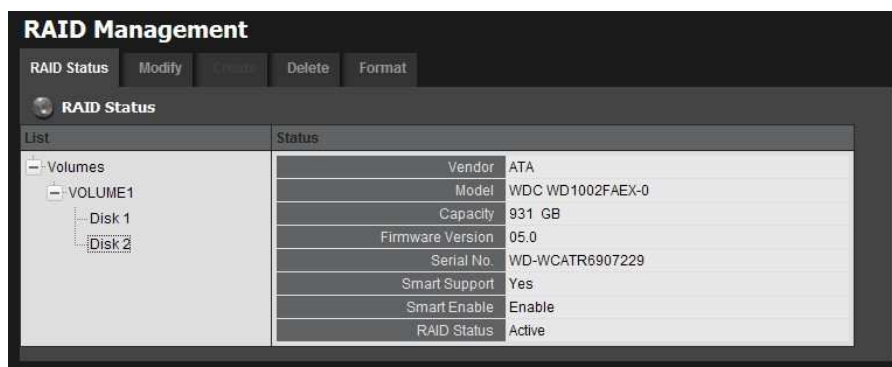

2.3.4 Modify RAID Volume

This function is designed for replacing a broken hard drive with a new one, instead of modifying RAID level.

In the condition of critical RAID status, it's a warning to show that one of disks of this RAID volume may be damaged. Even though it's no impact on the recording function, you'd better to replace a new disk to make sure the volume with data protection mechanism.



This function is not applied to RAID 0, since there is no data protection mechanism by its nature.



In case of any unexpected damage, we recommend users to unplug running HDD by this method, which can be viewed as security hard drive remove.

1. Log in to the unit.
2. Click **RAID & File System / RAID Management**.
3. Click the **Modify** tab.

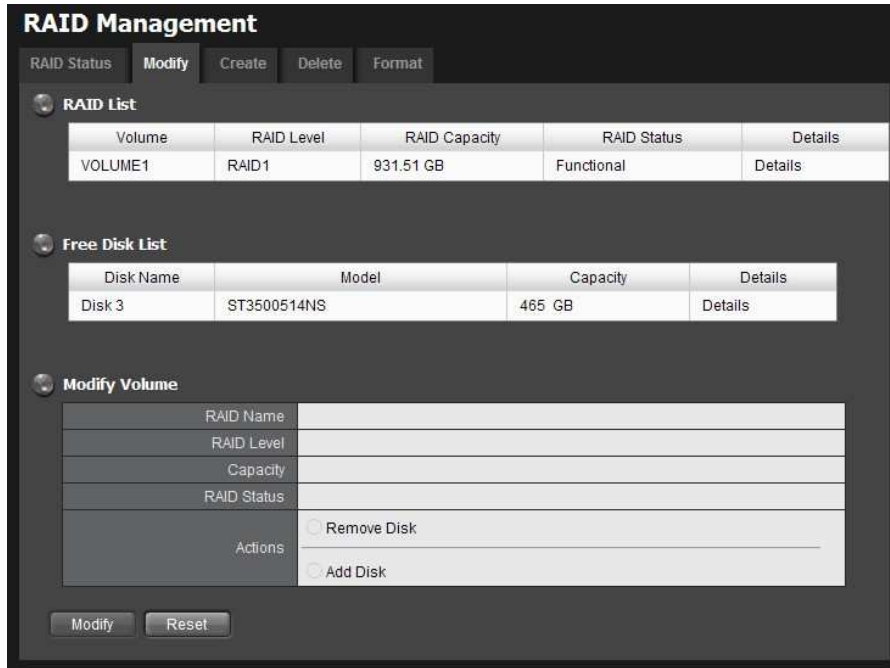

4. Click on the volume you want to modify. The information of this volume will be displayed under the **Modify Volume** section.

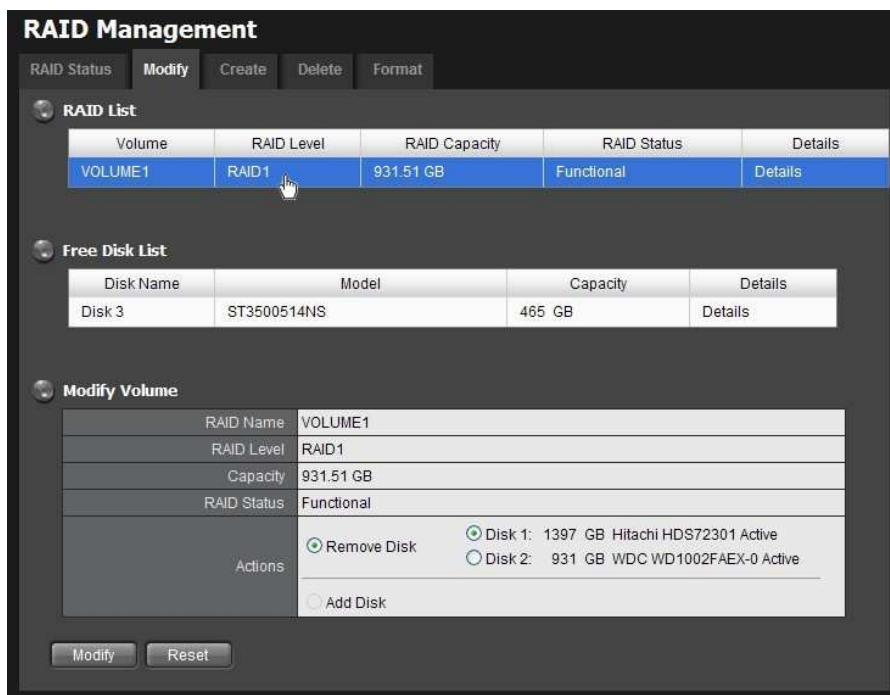

5. After removing the damaged disk. Add a free disk to replace the damaged,

and click the **Modify** button.

6. A confirmation dialog pops up. Check the **Yes, I want to modify this volume** box, and click the **Yes, modify it** button.

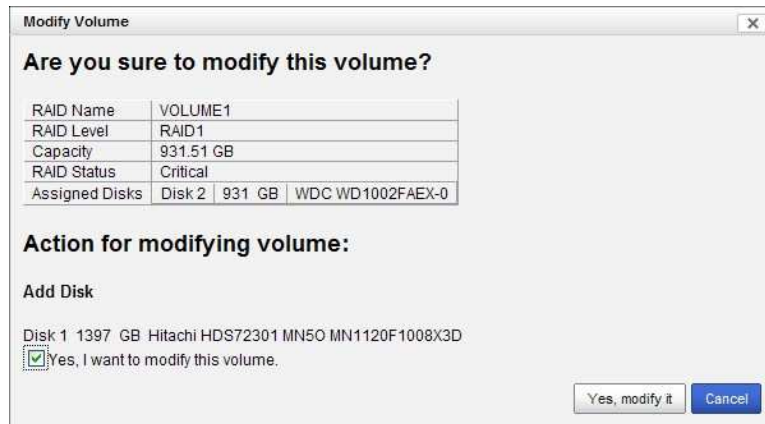

7. Modifying RAID volume takes a while, depending on the size of disks you choose. Recording won't be stopped during the modification, and the data of this RAID volume is fully accessible.

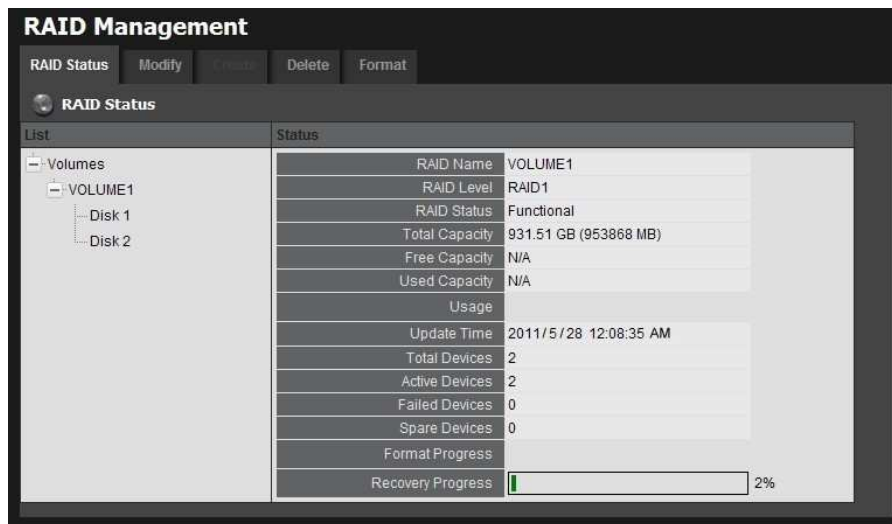

2.3.5 Delete a RAID Volume

1. Log in to the unit.
2. Click **RAID & File System / RAID Management**.
3. Click the **Delete** tab.

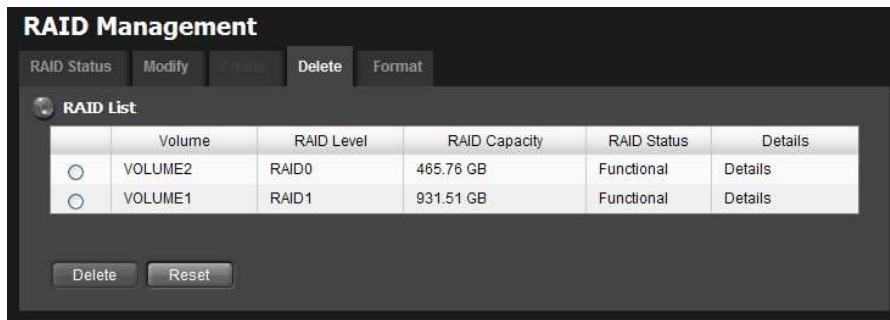

4. Click the option button beside the RAID Volume you want to delete.
5. Click the **Delete** button.
6. A confirmation dialog pops up. Check the **Yes, I want to delete this volume** box, and click the **Yes, delete it** button.



7. System will restart automatically after RAID volume is deleted



When you delete a RAID Volume, all the folders in the RAID volume and all the data saved in the folders will be deleted. Backup any important data before deleting a RAID Volume.

2.3.6 Format

Neither pressing reset button nor loading default setting, the data of RAID volume won't be deleted, which implies that format is the only way to clean the RAID information from disks.

1. Log in to the unit.
2. Click **RAID & File System / RAID Management**.
3. Click the **Format** tab.

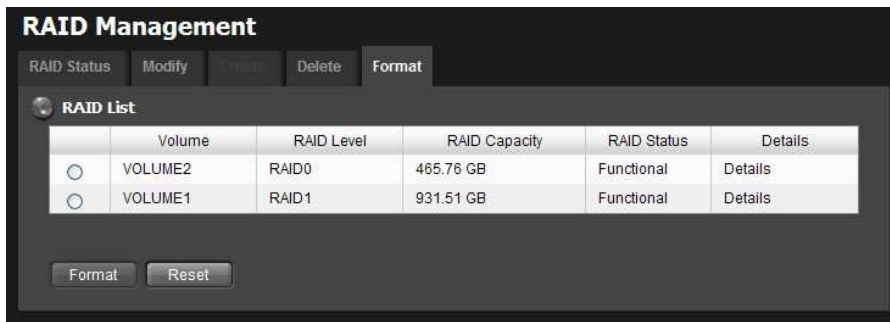

4. Click the option button beside the RAID Volume you want to format.
5. Click the **Format** button.
6. A confirmation dialog pops up. Check the **Yes, I want to format this volume** box, and click the **Yes, format it** button.

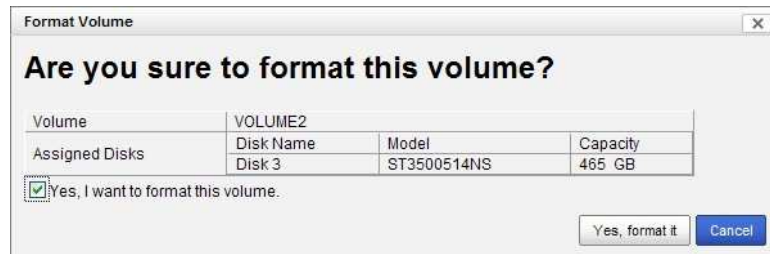

7. System will restart automatically after volume format is complete.

2.4 Auto Backup

This feature enables you to automatically backup the recorded video of the previous date to FTP site. There are two steps to enable the function, one is **Set up Backup Schedule**, another is **Set up Backup Server**.

2.4.1 Set up Backup Schedule

1. Log in to the unit.
2. Click **RAID & File System / Auto Backup Management**.
3. Click the **Backup Schedule** tab.
4. Set up backup schedule, select the backup channels, and check the **Enable** option to enable **Auto Backup**.

- **Auto Backup:** Check the **Enable** option to enable this function.
- **Daily Backup Time:** The daily scheduled time to start backup process.
- **Start Time:** The start time of recorded video of the previous date.
- **End Time:** The end time of recorded video of the previous date.
- **Camera:** Select the channel(s) to backup.

5. **Current Event Settings** shows the condition of the events of auto backup – enable or disable. Follow the steps of **System Events and Responding Actions Setup** to configure the event & action.



The system backs up recorded video files one by one. If the connection between the unit and FTP server is normal, but some problems of FTP causes the system unable to write files on FTP, the system would try each file three times before starting to backup the next file. If the connection is lost, the system would wait for the connection, so no file would be skipped.

2.4.2 Set up Backup Server

1. Log in to the unit.
2. Click **RAID & File System / Auto Backup Management**.
3. Click the **Backup Server** tab.
4. Set up the FTP server and create a folder for backup files. The folder format is "FolderName", "FolderName/SubFolderName", and so on.

For example: AutoBackup/NVR

Auto Backup Management

Backup Schedule | Backup Server

Backup Server

FTP Site: nuuo.dnsalias.com

FTP Port: 21

Username: FAE

Password: ••••••••

Backup to Remote Folder: AutoBackup/NVR

Save | Reset | Test FTP

- After setting up all the information, click the **Test FTP** button and the system will create a folder to FTP. Check it after testing. In this case, the route of the tested file will be:
ftp://nuuo.dnsalias.com/AutoBackup/NVR/TitanNVR_ComputerName



- Click the **Save** button.

	Make sure the FTP account with privileges of administrator who is able to upload, rewrite, delete files, and create new folder. Besides, make sure the FTP server has enough space for auto backup.
--	---

	To avoid the failure of auto backup, please check the normality of FTP server regularly (e.g., enough space for video, system conditions.)
--	--

2.5 Network Setup

2.5.1 View Network Status

- Log in to the unit.

2. Click **Network Setup / Network Setup**.
3. Click the **Information** tab to view the unit's network information.

Network Setup

Information | Setup | DDNS Setup | UPnP Port Forwarding

Common Information

Computer Name	NVRTitan_PM
---------------	-------------

Ethernet Adapter 1 Information

IP Address	
Subnet Mask	
Default Gateway IP Address	
Primary DNS	
Secondary DNS	

Ethernet Adapter 2 Information

IP Address	192.168.3.222
Subnet Mask	255.255.252.0
Default Gateway IP Address	192.168.1.1
Primary DNS	192.168.1.1
Secondary DNS	

2.5.2 Network Settings

1. Log in to the unit.
2. Click **Network Setup / Network Setup**.
3. Click the **Setup** tab to set up the network settings of your unit.

Network Setup

Information | **Setup** | DDNS Setup | UPnP Port Forwarding

Common Setting

Computer Name	NVRTitan_PM
---------------	-------------

Ethernet Adapter 1 Setting

Internet Protocol: Obtain an IP address automatically Specify an IP address

IP Address	
Subnet Mask	
Default Gateway IP Address	
Primary DNS	
Secondary DNS	

Ethernet Adapter 2 Setting

Internet Protocol: Obtain an IP address automatically Specify an IP address

IP Address	192.168.3.222
Subnet Mask	255.255.252.0
Default Gateway IP Address	192.168.1.1
Primary DNS	192.168.1.1
Secondary DNS	

OK Cancel

- **Server Name:** Name your unit.



Because of the internal data modifications required, it takes a few seconds to change the name of your unit. Log in again after configuration activated.

- **Internet Protocol:** Choose to obtain an IP address from external DHCP server automatically, or configure the IP address manually.
 - **IP Address:** IP address of this unit.
 - **Subnet Mask:** Subnet mask address.
 - **Default Gateway IP Address:** Gateway IP address.
 - **Primary DNS:** Primary DNS (Domain Name System) address.
 - **Secondary DNS:** Secondary DNS address.
4. Click the **DDNS Setup** tab to enable Dynamic Domain Name Server function, allowing you to connect unit with dynamic IP address.

The screenshot shows the 'Network Setup' page with the 'DDNS Setup' tab selected. The 'Dynamic DNS Setting' section is visible, containing the following fields:

DDNS	<input type="checkbox"/> Enable
Ethernet Interface	LAN1 (192.168.3.222)
Provider	DynDns
User name	<input type="text"/>
Password	<input type="password"/>
Host name	<input type="text"/>
Update Period	16 minutes

At the bottom of the form are 'Save' and 'Reset' buttons.

2.5.3 Auto Port-Forwarding

This function is designed for saving time in port configuration on router if users want to access the unit (in LAN) from WAN. Once enabling UPnP Service on router, users can do port-forwarding for web server (default: 80) and streaming server (default: 5250) automatically.

1. Log in to the unit.
2. Click **Network Setup / Network Setup**.
3. Click the **UPnP Port-Forwarding** tab.
4. Click the **Search** button, and the searched routers will be listed. Also, the list may indicate which LAN of the unit searches this router.

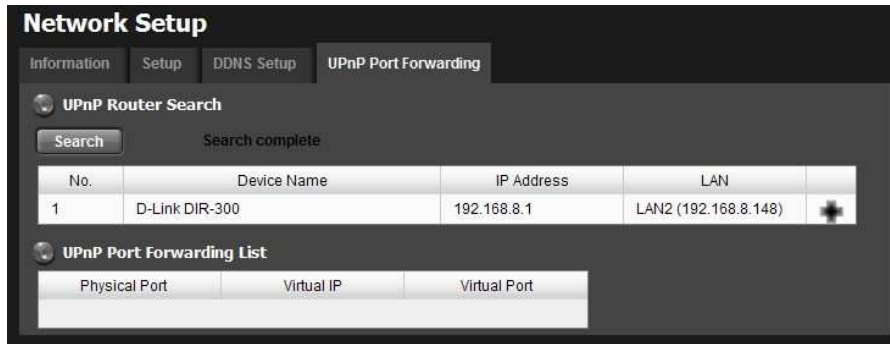

- Select the searched router, and all UPnP ports configured on this router will show under the **UPnP Port Forwarding List**.

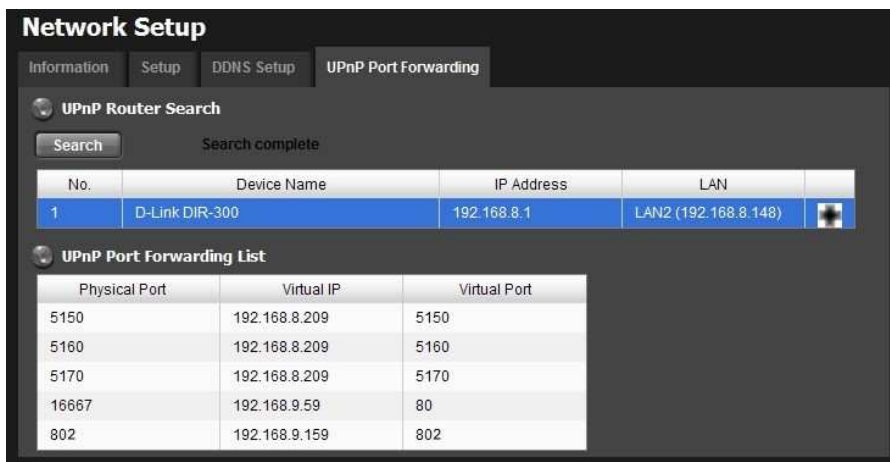

- After selecting one of searched routers, click the **+** icon to set up port-forwarding to this router automatically. You will find ports of web server and streaming server are listed.

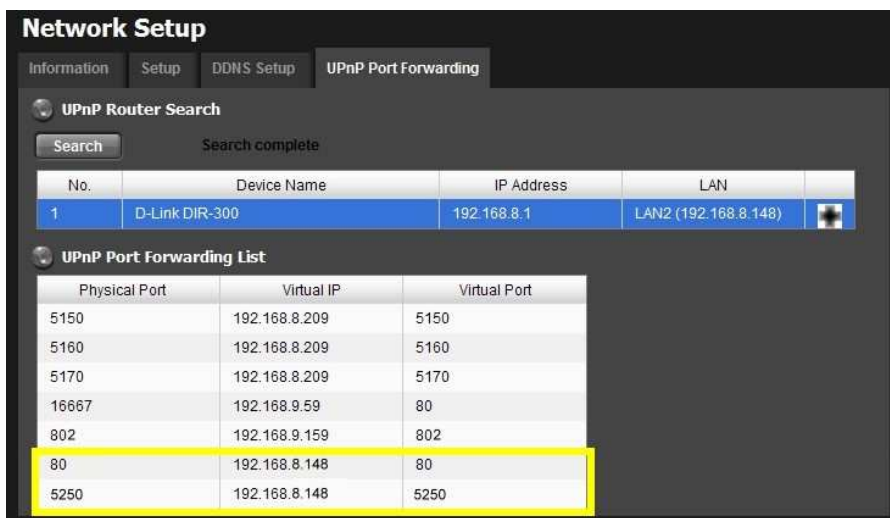



For security reason, the privilege of UPnP port-forwarding is LOWER than port-forwarding configured on router. Therefore, if the ports have been used on router, we are unable to know before finding out access failure.



UPnP port-forwarding is for temporarily use only. Most of UPnP router will clean up all UPnP ports after router reboots. Furthermore, for some routers, if the port you want to add has already been used for other devices in the same way (UPnP port forwarding), this "enable" action will cover over the settings.

2.5.4 Network Service Setup

1. Log in to the unit.
2. Click **Network Setup / Network Service**.
3. Click the **Network Service** tab.
4. Set up port and maximum connections of client and click the **Save** button.

Network Service

Network Service | Web Server

Streaming Server

Port: 5250

Live View Maximum Connections: 128

Black/White List

White List: Enable

Black List: Enable

IP Range: [] to []

Add to White List | Add to Black List

Index	IP	Access	Delete
-------	----	--------	--------

Save | Reset

- **Streaming Server**
 - **Port**: Live/playback streaming transmission port. (default: 5250)
 - **Live View Maximum Connections**: Maximum connections from remote access. (max: 256 connections; default: 64)
- **Black/White List**
 - **White List**: Only IP addresses from the allowed list are allowed to log in.
 - **Black List**: IP addresses from the blocked list will be unable to log in.



One connection means that one user connects to one camera. 4 users connect to a server with "16" Live View Maximum Connections, and the average connection for each user is 4, rather than 16.

5. Click the **Web Server** tab.

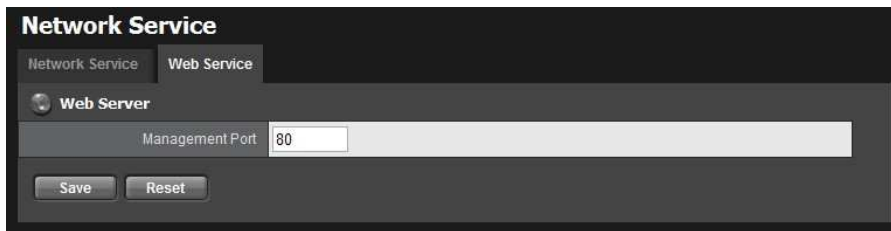

6. Set up a port for this unit and click the **Save** button

2.5.5 Master/Slave Configuration

This is a basic structure of management server and client. By adding slave servers in one master server, and configure same user account to master/slave server, user can get the camera list of slave servers when accessing master server with NuClient. Follow the steps to build up the connection between master and slaves.

1. Log in to the unit.
2. Click **Network Setup / Master / Slave**.
3. Click the **Master/Slave** tab.

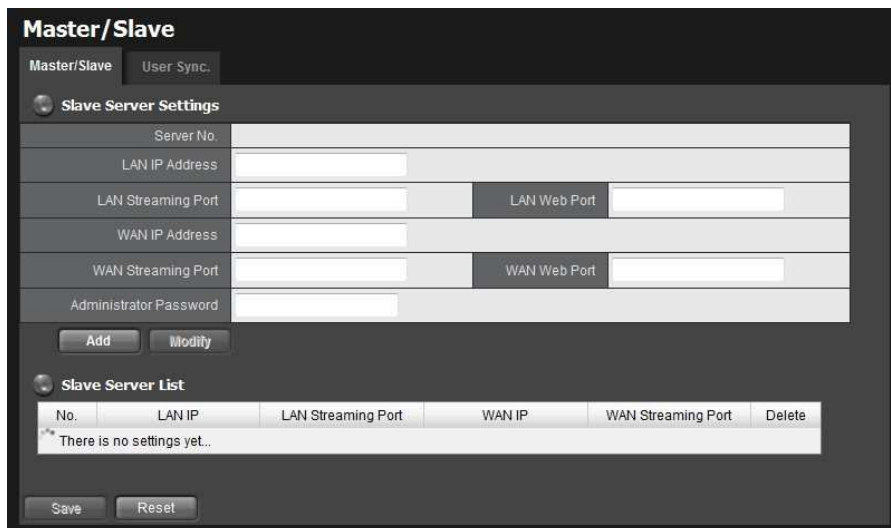

4. Type the LAN/WAN IP and port, administrator password and click the **Add** button.
5. Repeat the previous step to add more slave servers.
6. Click the **Save** button to apply the settings.
7. Click the **User Sync.** tab.



8. Select the slave servers with their web port and administrator password being filled in correctly on the page of master/slave, and click the **Synchronize** button to sync the user accounts of master server to slave servers.



The action is synchronizing user "accounts". If the user accounts are existed on slave servers, which privilege settings will be kept; if the user accounts are new to slaves, which privileges are as default.



There is another way to create same user account on multiple servers, please check section **Import/Export User Account** for details.

2.6 Management

2.6.1 View the List of Users

1. Open Internet Explorer and login the unit.
2. Click **Management/ User Management**.
3. Click the **Create New Users** tab.
4. The list will be displayed on the bottom of the page.

No.	Name	Group	Channel Access	PTZ	IO	E-Map	Backup Data
1	building_1	power user	1,2,3,4	0	0	0	0
2	building_2	user	1,2	0	0	0	0
3	building_3	guestuser	1,2,3,4	X	X	X	X

2.6.2 Create New Users

1. Open Internet Explorer and login the unit.
2. Click **Management/ User Management**.
3. Click the **Create New Users** tab.

User Management

Create New Users Modify Users Import/Export Change Password

Create User

User Name:

Password:

Group: power user

Channel Access: All Ch 1 Ch 2 Ch 3 Ch 4

Privilege: PTZ Control IO Control Backup Data
 E-map Settings Edit Public Views Image Fusion Settings
 Send Server Event to Client

Create New User Clear

4. Insert the username of this new user.
5. Insert the password of this new user.
6. Choose the group of this user.

- **Power user:** Power user can do all the settings and operation except the **Network Settings, RAID Settings, and Management function.**
- **User:** User just can change his/her password and operate client functions.
- **Guest user:** User can operation client function only.

7. Select the cameras which this user can access.
8. Manage the privilege for this user.
9. Click the **Create New User** button to finish it.



The Administrator will be the only user who can use all of the functions. There is a default administrator account in the system, and you cannot create neither another "Administrator" account, nor another username named "admin".

2.6.3 Modify User Information

1. Log in to the unit.
2. Click **Management / User Management.**
3. Click the **Modify Users** tab.
4. Click one of the users in the User List on the bottom of this page.

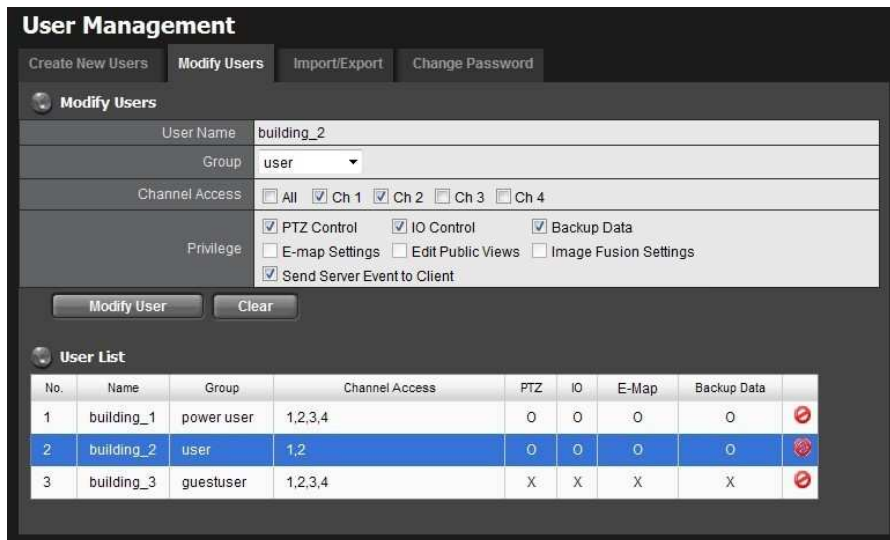

5. Change the group of this user.
6. Select the cameras which this user can access.
7. Manage the privilege for this user.
8. Click the **Modify User** button to finish it.

2.6.4 Change a User's Password

1. Log in to the unit.
2. Click **Management / User Management**.
3. Click the **Change Password** tab.

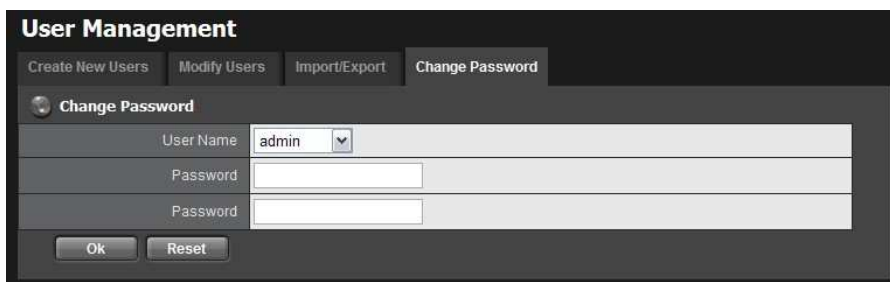

4. Choose the user.
5. Enter a new password.
6. Enter this new password again.
7. Click the **OK** button.

2.6.5 Delete Users

Except for the administrator, you can delete any users with the following steps.

1. Log in to the unit.
2. Click **Management / User Management**.
3. Click the **Modify Users** tab.
4. Click the Delete icon of the user you want to delete.

No.	Name	Group	Channel Access	PTZ	IO	E-Map	Backup Data	
1	building_1	power user	1,2,3,4	0	0	0	0	
2	building_2	user	1,2	0	0	0	0	
3	building_3	guestuser	1,2,3,4	X	X	X	X	

5. In the confirmation box, click the **OK** button.

2.6.6 Import/Export User Account

For large-scale projects, the locations are equipped with a lot of cameras and are under surveillance by many users. Since it's possible for users being assigned to check videos from multiple servers, adding same user accounts in multiple servers is unavoidable, which takes time definitely. In this case, we design an easier way to manage user accounts. Please refer to **Master/Slave Configuration**, or follow the steps below.

1. Log in to the unit.
2. Click **Management / User Management**.
3. Click the **Import / Export** tab.

4. For exporting user account, click the **Export** button to export current user account and privilege.
5. For importing user account, browse an user.cfg file and click the **Import** button to load user account and privilege.



If the user Carlton (username) is existed in this server, the user privilege WON'T be covered when importing an user.cfg with same user account Carlton.



When importing an user.cfg exported from a "less-channel" server to a "more-channel" server, 16ch and 32ch for example, which total numbers of channel access are different, in this case, only 16ch will be checked after importing .cfg. However, if the user account belongs to "power user", all privileges are defaulted checked even the number of channel access of original server is less than this server.

2.6.7 Online License Activation

Activate a camera license to have more camera capacity. There are two ways to activate license, online and offline.

1. Log in to the unit.
2. Click **Management / License Management**.

S/N	Channel	Product	Status
* There are no licenses yet.			

3. Select **Online** as the Activation Type, input serial number, and click the **Activate** button.
4. The license will be updated in License List if activated successfully. System will reboot automatically.

S/N	Channel	Product	Status
xxxx-xxxx-xxxx-xxxx	16	NVRTitan	Activated
xxxx-xxxx-xxxx-xxxx	12	NVRTitan	Activated

2.6.8 Offline License Activation

If the device is set up in Intranet (Local LAN) without Internet connection, there is another way to activate license.

1. Log in to the unit.
2. Click **Management / License Management**.

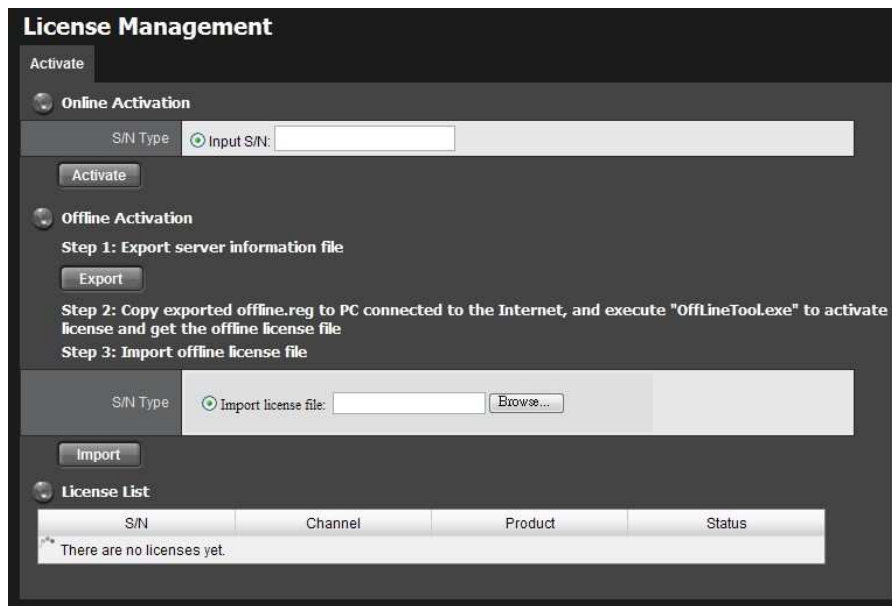

3. Click the **Export** button under the section of **Offline** Activation to export the information of this unit.
4. Download dialog pops up. Save the request file and take it to other PC which is connected to the Internet. Furthermore, the PC should be installed **OffLineTool.exe** which can be found from Titan NVR toolkit.



5. Execute the OffLineTool.exe in that PC with Internet connection, and select the request file **offline.reg**.



6. Input the serial number, click the **Activate** button, and save the .dll file **offline_license.dll**.

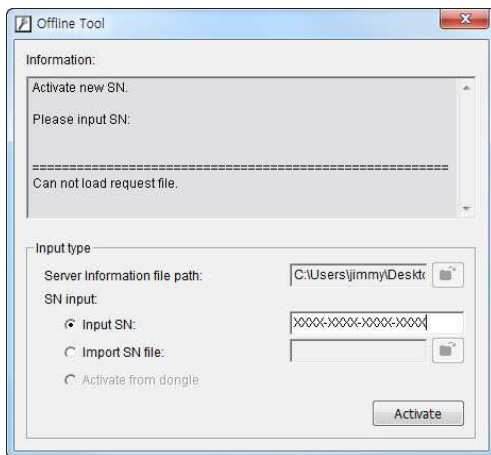

7. Import the license file to the unit.

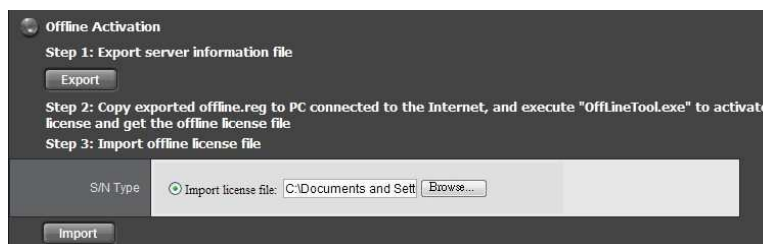

8. The license will be updated in License List if activated successfully. System will reboot automatically.

License List			
S/N	Channel	Product	Status
XXXX-XXXX-XXXX-XXXX	16	NVRTitan	Activated
XXXX-XXXX-XXXX-XXXX	12	NVRTitan	Activated

2.6.9 View the Event Log

1. Log in to the unit.
2. Click **Management / Log System** to find the event list of your unit.

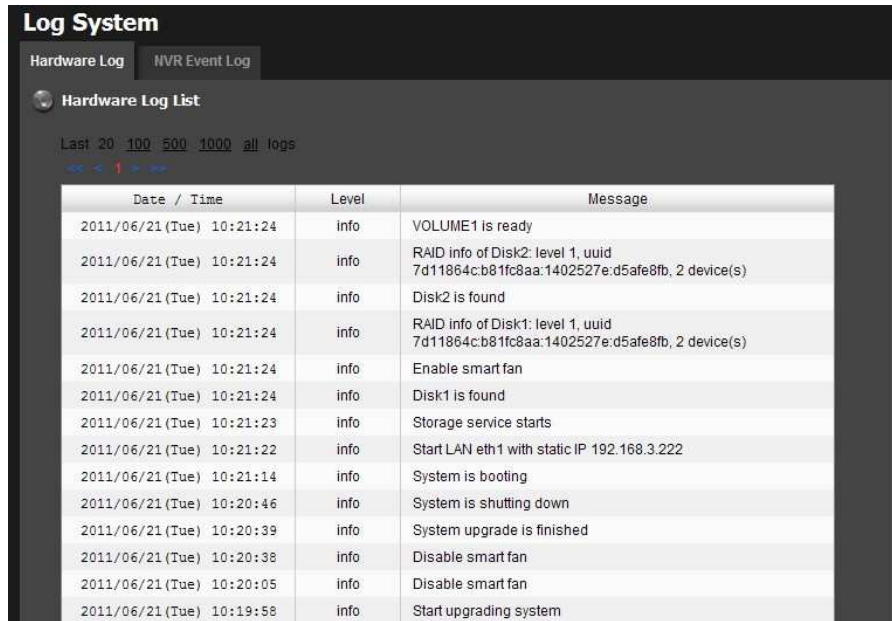

The screenshot shows the 'Log System' interface with the 'Hardware Log' tab selected. Below the tab is a 'Hardware Log List' section. It includes a filter for the number of logs (Last 20, 100, 500, 1000, all logs) and a table of log entries.

Date / Time	Level	Message
2011/06/21 (Tue) 10:21:24	info	VOLUME1 is ready
2011/06/21 (Tue) 10:21:24	info	RAID info of Disk2: level 1, uuid 7d11864c:b81fc8aa:1402527e:d5afe8fb, 2 device(s)
2011/06/21 (Tue) 10:21:24	info	Disk2 is found
2011/06/21 (Tue) 10:21:24	info	RAID info of Disk1: level 1, uuid 7d11864c:b81fc8aa:1402527e:d5afe8fb, 2 device(s)
2011/06/21 (Tue) 10:21:24	info	Enable smart fan
2011/06/21 (Tue) 10:21:24	info	Disk1 is found
2011/06/21 (Tue) 10:21:23	info	Storage service starts
2011/06/21 (Tue) 10:21:22	info	Start LAN eth1 with static IP 192.168.3.222
2011/06/21 (Tue) 10:21:14	info	System is booting
2011/06/21 (Tue) 10:20:46	info	System is shutting down
2011/06/21 (Tue) 10:20:39	info	System upgrade is finished
2011/06/21 (Tue) 10:20:38	info	Disable smart fan
2011/06/21 (Tue) 10:20:05	info	Disable smart fan
2011/06/21 (Tue) 10:19:58	info	Start upgrading system

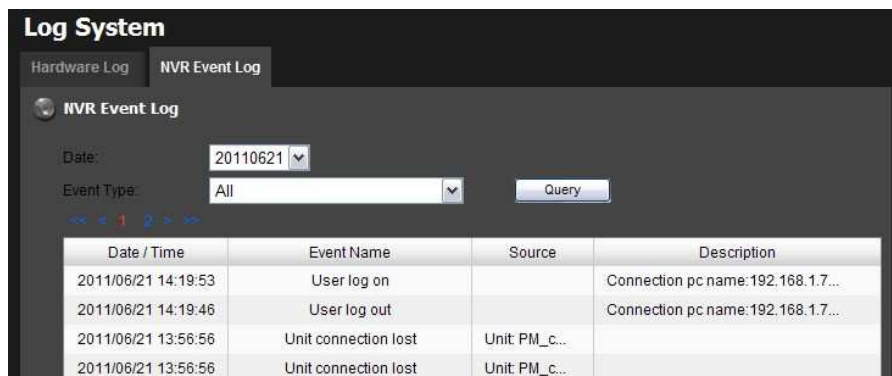

The screenshot shows the 'Log System' interface with the 'NVR Event Log' tab selected. It includes a 'Date' dropdown menu set to '20110621', an 'Event Type' dropdown menu set to 'All', and a 'Query' button. Below these is a table of event entries.

Date / Time	Event Name	Source	Description
2011/06/21 14:19:53	User log on		Connection pc name:192.168.1.7...
2011/06/21 14:19:46	User log out		Connection pc name:192.168.1.7...
2011/06/21 13:56:56	Unit connection lost	Unit: PM_c...	
2011/06/21 13:56:56	Unit connection lost	Unit: PM_c...	

There are two kinds of event which will be listed on this page.

- **Hardware Log**: The log information of the operations to your unit, such as reboot or shutdown.
- **NVR Event Log**: The log information of event, recording, backup, export, I/O, etc. Refer to the figure below for details.

All
Service started
Service stopped
Disk abnormal
DDNS updated
Recycle event log started
Recycle event log stopped
Recycle event log fail
Motion started
Motion stopped
Recording on manual started
Recording on manual stopped
Recording on schedule started
Recording on schedule stopped
Auto backup started
Auto backup stopped
Auto backup failed
Manual backup started
Manual backup stopped
Manual backup failed
Export started
Export stopped
Export fail
Input signal on
Input signal off
Output signal on
Output signal off
Unit connection lost
User log on
User log out



The camera Log will be recorded only if event is selected on **Event & Action Management** page.

2.6.10 Save Unit Configuration

Save configuration can let you save the settings of this unit. These settings can be applied to other units, which will let you set other units more easily.

1. Log in to the unit.
2. Click **Management / Save / Load Configuration**.
3. Click the **Save Configuration** tab.

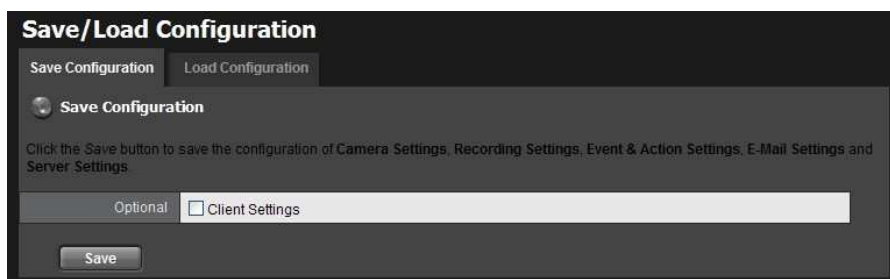

4. Check the box of **Client Settings** if you want to keep the configuration.
5. Click the **OK** button.
6. The configuration file will be generated into the chosen folder.

2.6.11 Load Unit Configuration / Default Settings

Load configuration can let you apply another unit's settings to the current unit; Load Default Settings will revert all of the unit's settings back to the default factory settings.

1. Click **Management / Save / Load Configuration**.
2. Click the **Load Configuration** tab.

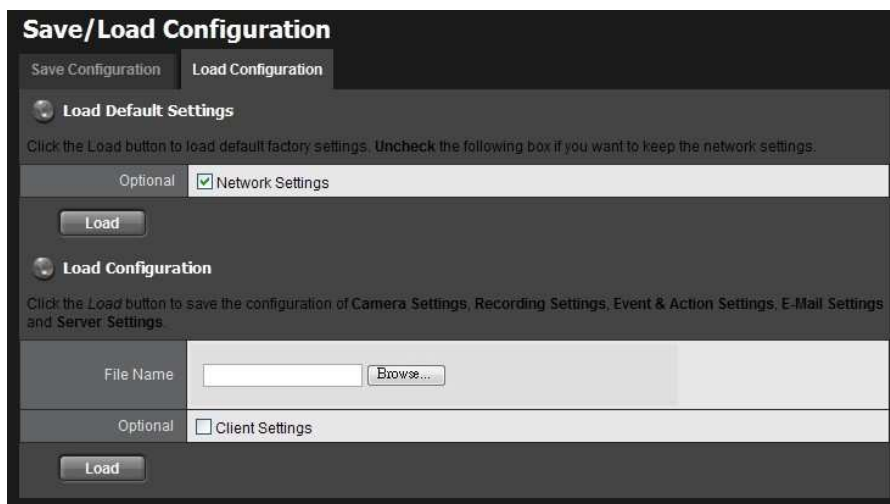

3. Follow the direction to **Load Default Settings** or **Load Configuration**. For the former, uncheck the box of **Network Settings** to keep the current IP address; for the latter, check the box of **Client Settings** if you want to restore the configuration.
4. Click the **Load** button.
5. A confirmation dialog pops up. Click the **OK** button to begin to load the settings into your unit.



If the saved configuration is without client settings, selecting loading configuration with client settings will lead you get the default. The original client settings (if any) are covered and untraceable.



User account and privilege will be kept even if loading default settings, while

camera settings, recording schedule, event & action settings, E-mail setting and server settings won't be. **RAID information** will always be kept whether loading default settings or loading configuration.



If you select to load default IP, system may guide you to the defaulted IP. However, if the guiding mechanism is failed, please try Installation Wizard.

2.7 System

2.7.1 View System Information

1. Log in to the unit.
2. Click **System / System Information**.

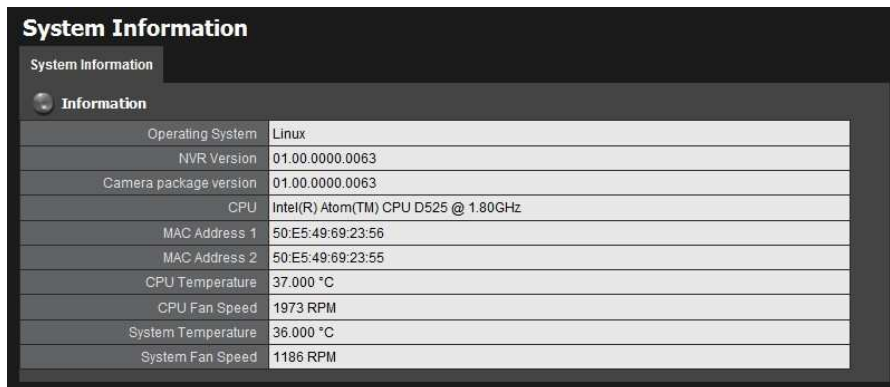

System Information	
Operating System	Linux
NVR Version	01.00.0000.0063
Camera package version	01.00.0000.0063
CPU	Intel(R) Atom(TM) CPU D525 @ 1.80GHz
MAC Address 1	50:E5:49:69:23:56
MAC Address 2	50:E5:49:69:23:55
CPU Temperature	37.000 °C
CPU Fan Speed	1973 RPM
System Temperature	36.000 °C
System Fan Speed	1186 RPM

The system information includes the following items.

- **Operating System**: Embedded Linux
- **NVR Version**: NVR system version
- **Camera package version**: Camera package version
- **CPU**: CPU model number
- **MAC Address 1**: First MAC address of this unit
- **MAC Address 2**: Second MAC address of this unit
- **CPU Temperature**
- **CPU Fan Speed**
- **System Temperature**
- **System Fan Speed**

2.7.2 Smart Fan Control

1. Log in to the unit.

2. Click **System / System Settings**.
3. Click the **Fan Control** tab.

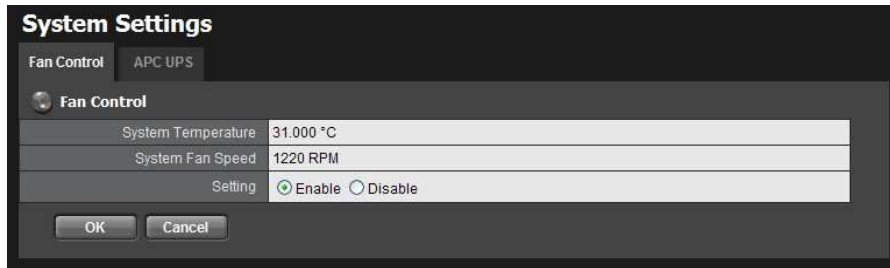

4. Check the **Enable** or **Disable** option.
5. Click the **OK** button.

2.7.3 UPS Setup

This feature enables you to tell your unit how long to run on APC Uninterruptable Power Supply (UPS) battery power and when to shutdown, after power failure.

1. Attach the APC UPS to one of the unit's USB ports.
2. Log in to the unit.
3. Click **System / Settings**.
4. Click the **APU UPS** tab.
5. Check one of the options:

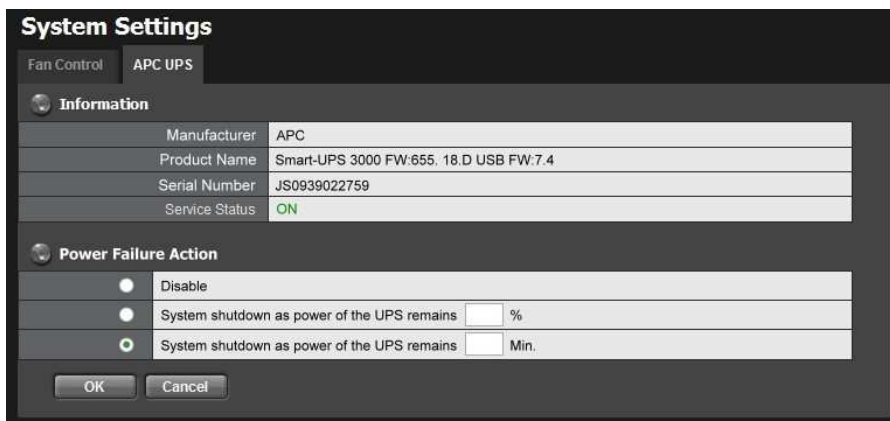

- **Disable**: Run until the UPS battery is depleted
- **System shutdown as power of the UPS remains ___ %**: Run until the UPS battery remains this percentage.
- **System shutdown as power of the UPS remains ___ min.**: Run until the UPS battery remains the certain period of time.

6. Fill in the specific value if you choose the last two options.
7. Click the **OK** button.

2.7.4 Upgrade the System

1. Log in to the unit.
2. Click **System / Upgrade**.
3. Click the **Firmware Upgrade** tab.

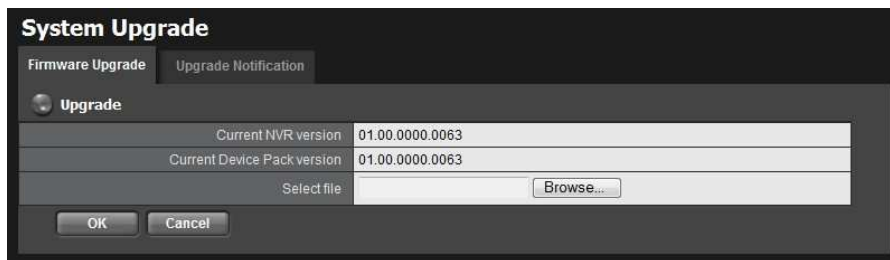

4. Browse the FW for upgrading and click the **OK** button.
5. A confirmation dialog pops up. Click the **OK** button to start upgrade process.
6. After upgrade, the system will restart. You need to re-access the unit again after this.

2.7.5 Upgrade Notification

Enable this function to allow us to notify you automatically when there are firmware updates (Recommended). This will help keep your system up to date. The updater will also collect info from your system that will be used for future system improvements.

1. Log in to the unit.
2. Click **System / Upgrade**.
3. Click the **Upgrade Notification** tab.

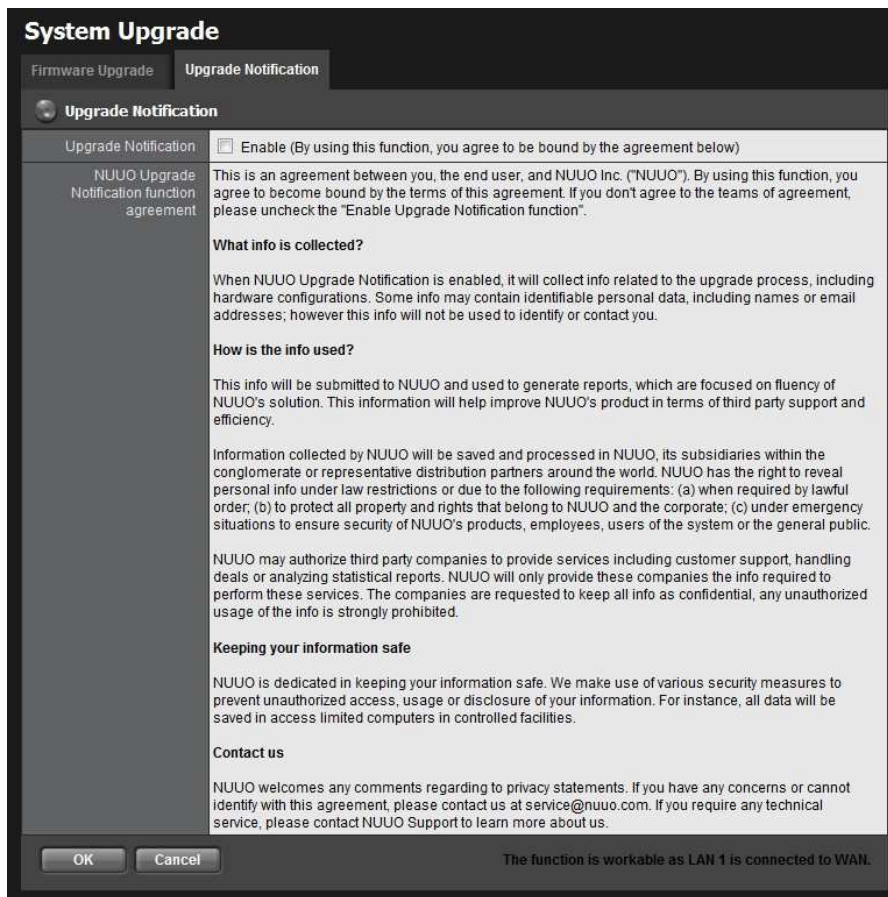

4. Check the option if you agree to be bound by the agreement.
5. Click the **OK** button.



The function only works as LAN 1 is connected to WAN, or our FW management server is unable to detect the current version of your systems.

2.7.6 System Date and Time Setup

1. Log in to the unit.
2. Click **System / Date/Time**.
3. Click the **Setup** tab.

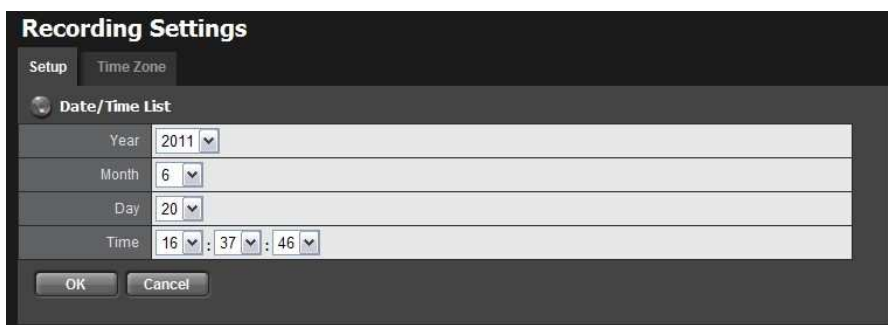

4. Choose the year, month, day and time.
5. Click the **OK** button to restart the system to activate the changes.



When you modify the date or time of the system, the system may find the wrong data when searching the recorded data. Backup the recorded data before changing the time.

2.7.7 Daylight Saving Time Setup

1. Log in to the unit.
2. Click **System / Date/Time**.
3. Click the **Time Zone** tab.

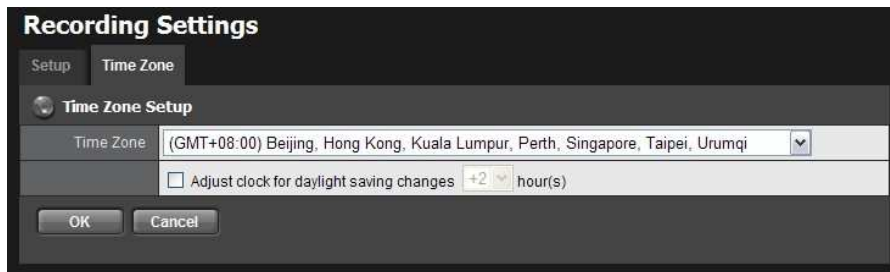

4. Check the **Adjust clock for daylight saving changes** option and select the time change of daylight saving time in your location.
5. Click the **OK** button.

2.7.8 Local Display

Titan NVR supports VGA out by connecting the D-SUB of the unit with a screen to watch live videos. You can do some operations on the monitor, such as switching grid layout and enabling auto scan, but you have to configure the settings on web. Please follow the steps to set up local display.

1. Log in to the unit.
2. Click **System / Local Display**.

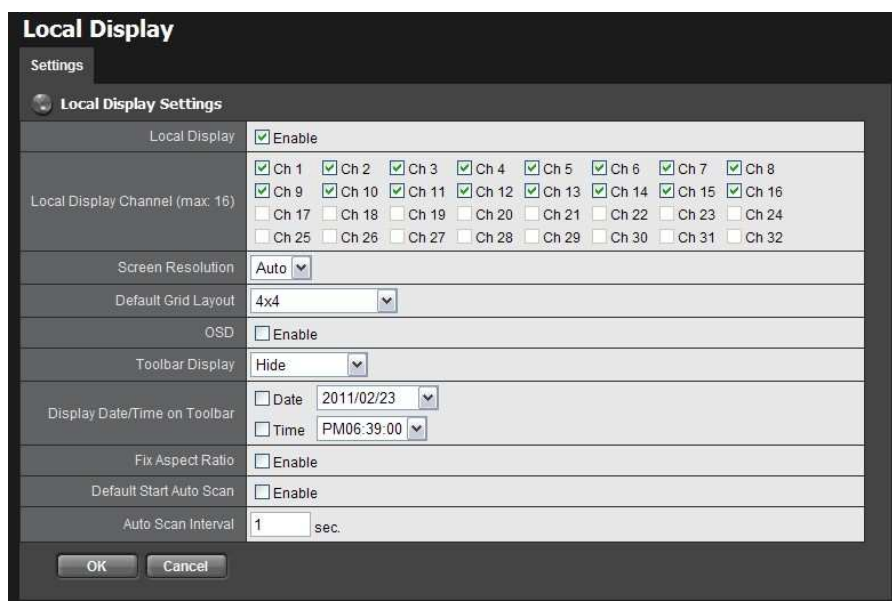

- **Local Display**: Check the box to enable local display. (default: checked)
- **Local Display Channel (max: 16)**: Select the channel you want to display. (default: 4 ch)
- **Screen Resolution**: Choose the resolution of screen display; the selections of resolutions will be shown when connecting with a screen. (default: auto; "auto" implies the best resolution system detects)
- **Default Grid Layout**: Choose the defaulted layout. (default: 2x2)
- **OSD**: Check the box to enable OSD of camera name. (default: checked)
- **Toolbar Display**: Choose to hide the toolbar or always show it on the screen. If you choose "Hide", toolbar can still be shown when moving the cursor. (default: hide)
- **Display Date/Time on Toolbar**: Check the boxes to display date/time on toolbar and change the formats if necessary. (default: checked)
- **Fix Aspect Ratio**: Check the box to make all videos fix the aspect ratio. (default: unchecked)
- **Default Start Auto Scan**: Check the box to enable auto scan when liveviewing. (default: unchecked)
- **Auto Scan Interval**: The time interval of auto scan. (default: 5 sec.)

3. Click the **OK** button.

2.7.9 Restart the Unit

1. Log in to the unit.
2. Click **System / Reboot/Shutdown**.



3. Check the **Reboot** option.
4. Click the **OK** button.
5. A confirmation dialog pops up. Click the **OK** button to reboot the unit.



During system restart, none of your files will be accessible from your desktops/laptops.

2.7.10 Shut Down the Unit

The only time you need to shut down the unit is to replace the disk drive cooling fan or the power supply. During and after the shutdown, none of your files will be accessible from your desktops/laptops. There are two ways to shutdown the unit.

- **Shutdown by Software**

1. Log in to the unit.
2. Click **System / Reboot / Shutdown**.



3. Check the **Shutdown** option.
4. Click the **OK** button.
5. A confirmation dialog pops up. Click the **OK** button to shutdown the unit.

- **Direct Shutdown**

Press the power button and hold it for 5 seconds to force to cut off the power directly.

3.I/O

3.1 Introduction

3.1.1 System Introduction

NUUO provides remote I/O solution for NVRmini/NVRmini 2/Titan NVR by connecting SCB-C31 with NUUO I/O Box SCB-C24/26/28. Refer to the below architecture, I/O device is connected directly with I/O Box, and input/output signal delivered in RS485 format are converted to Ethernet through SCB-C31. NVRmini/NVRmini 2/Titan NVR can use the signals to do more sophisticated setup, such as starting recording when input triggered, triggering output as an event happened, and much more.

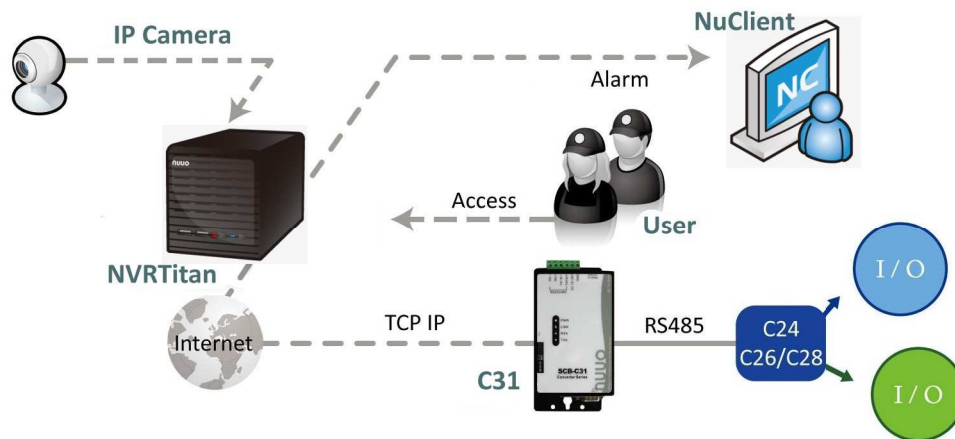

3.1.2 HW Installation

SCB-C24/26/28 must work with SCB-C31 (Ethernet-RS485 converter). Further, **the C31 Box cannot be used for POS and converter at the same time, and one C31 Box can be paired with one NVR unit only.** Please follow the steps below to configure the devices.

- Step 1: Check the system switch of SCB-C31 is switched to OFF-OFF position.
- Step 2: Connect SCB-C31 with power source.
- Step 3: Connect SCB-C31 with internet by RJ45 LAN cable.
- Step 4: Connect I/O Box with power source.
- Step 5: Connect SCB-C31 and I/O Box with cable, positive connection (TX+/D+ and DATA+) and negative connection (TX-/D- and DATA-). Take SCB-C31 with I/O Box SCB-C24 for example as below.

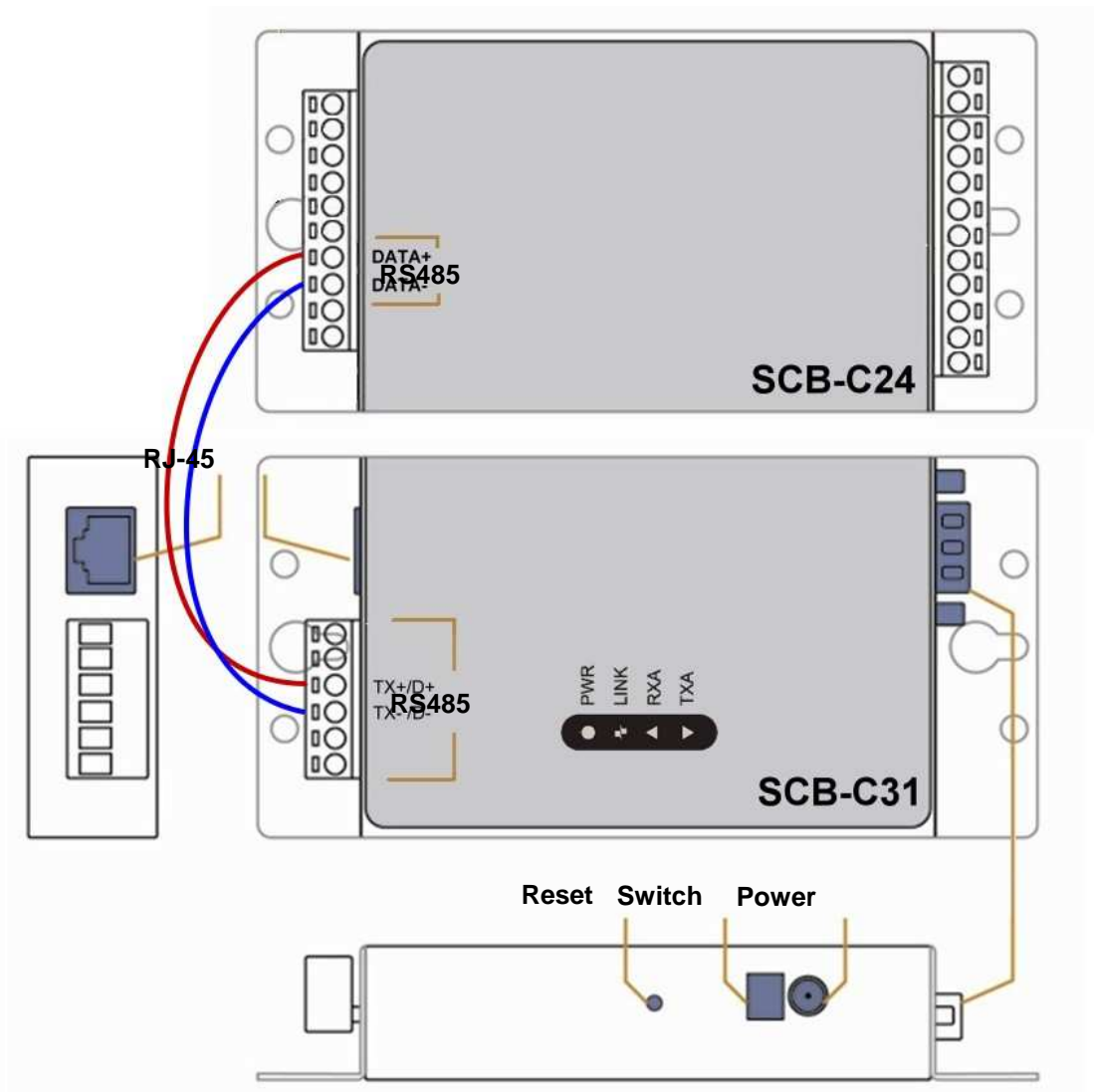

 **Multiple I/O Boxes can be connected to a single SCB-C31. However, series connection of I/O boxes is forbidden.** Furthermore, the default ID for each I/O Box is the same. Please follow the direction to setup I/O Box one by one.

3.1.3 Software Installation – SCB-C31

Step 1: Open Internet Explorer to setup SCB-C31. The default IP address is 192.168.1.1.

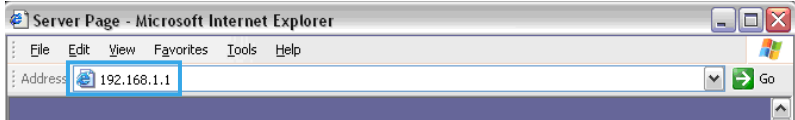

Step 2: Setup IP address and port.

1. Static IP Address

2. **Server Listening Port:** The default port is 4000, which is not the port for setting page, but for signal transmission.

Serial Settings	
Data Baud Rate	9600
Data Bits	8
Data Parity	None
Stop Bits	1
Flow Control	None
Network Settings	
	<input checked="" type="checkbox"/> Enable DHCP
Static IP Address	192.168.1.1
Static Subnet Mask	255.255.255.0
Static Default Gateway	192.168.1.3
Static DNS Server	168.95.1.1
Connection Type	TCP
Transmit Timer	30
Server/Client	
	Server
Server:	
Server Listening Port	4000
Client:	
Destination IP	192.168.1.2
Destination Port	4000
	<input type="checkbox"/> Enable Reboot
	<input type="button" value="Apply"/> <input type="button" value="Reset"/>
	<input type="button" value="Firmware Upgrade"/>

Step 3: Click the **Apply** button to activate configuration.



Due to the stability of data transmission, one SCB-C31 can be paired with one NVR unit only.

3.1.4 Software Installation – SCB-C24/26/28

The default ID of I/O Box is identical. To avoid the conflict between Boxes, please connect only one Box with SCB-C31 and execute the setup application to change the ID from the default value (1).

1. Execute IOConfig.exe, type in the IP address and port of SCB-C31, and click the **Scan** button.

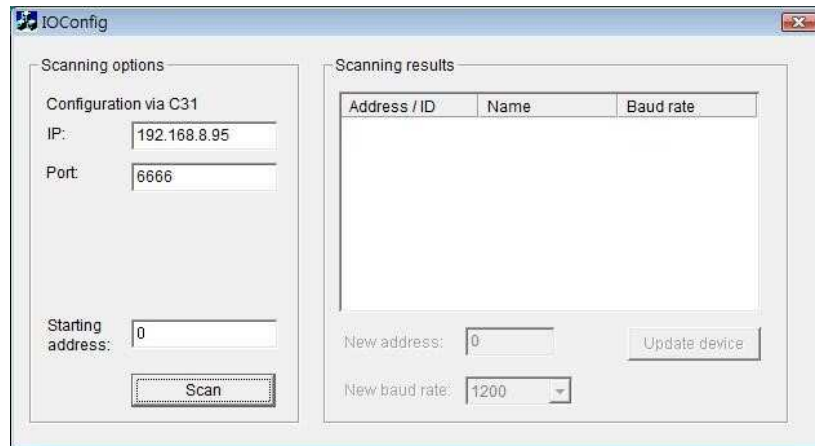

IOConfig.exe starts scanning the ID from 0 to 255, and it may take around a minute to finish scan.

- When the I/O Box is discovered, click on the item and change the ID from the **New Address** field. Click the **Update device** button to activate the settings.

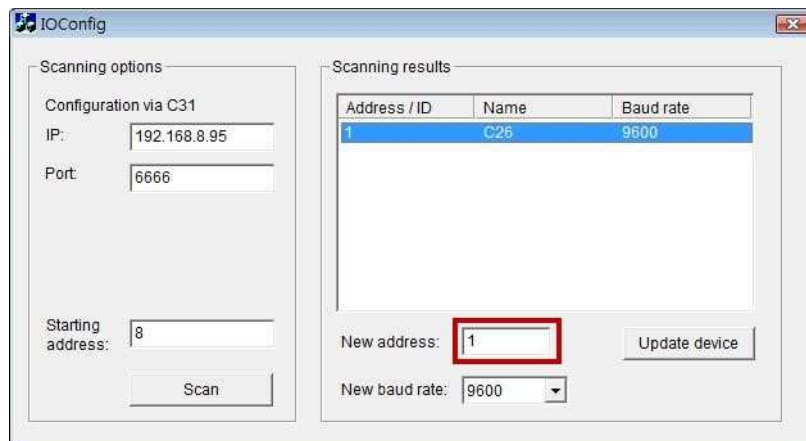

- Scan again to make sure the configuration is validated. In this case, we changed the ID to 10, so we can modify the number of "Starting address" to 10 to save the searching time.

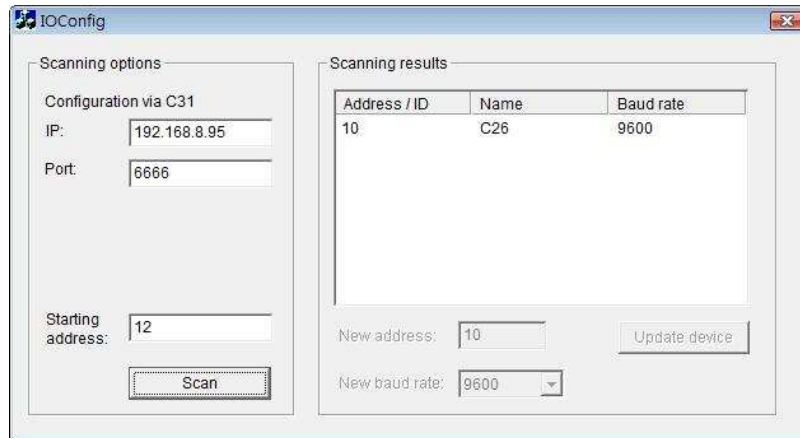

4. Refer to the **HW Installation** section to connect other I/O Box and repeat the steps 1 through 3 above to configure more I/O Boxes.

3.2 Software Setup

3.2.1 Add I/O Box

1. Log in to the unit.
2. Click **POS & I/O / I/O Settings / I/O Box Settings**.
3. Enter the information of I/O box.

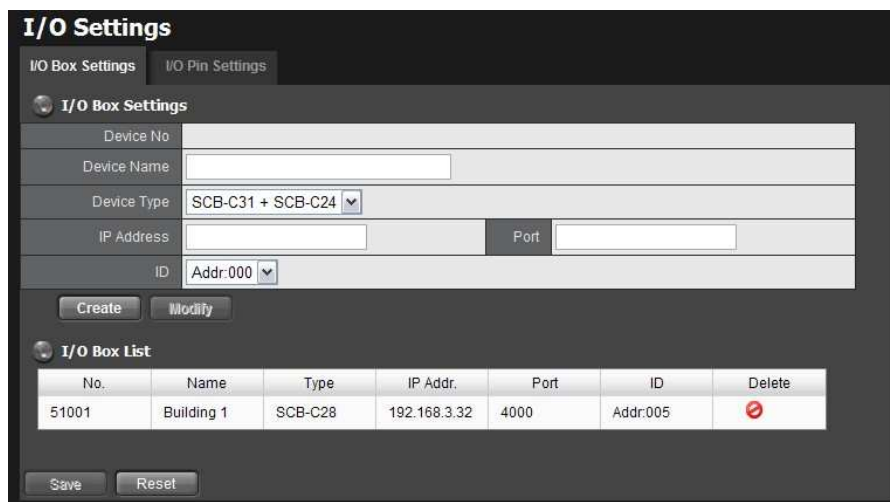

- **Device No**: The unique ID system distributes in sequence automatically.
- **Device Name**: The name of the I/O box.
- **Device Type**: The types of I/O box, including SCB-C24, SCB-C26, and SCB-C28.
- **IP Address**: The IP Address of SCB-C31.
- **Port**: The transmission port of SCB-C31.

- **ID**: The ID of the I/O box.

4. Click the **Create** button, and the information will be updated in I/O Box List.
5. Repeat steps 3 and 4 to add more I/O boxes in the list.
6. Click the **Save** button to activate the settings. Meanwhile, system will distribute an unique ID to each device.

3.2.2 Modify I/O Box Information

1. Log in to the unit.
2. Click **POS & I/O / I/O Settings / I/O Box Settings**.
3. Click the I/O box which you want to modify from the list.
4. Modify the information of this I/O box, and click the **Modify** button.
5. Click the **Save** button to activate the settings.

3.2.3 I/O Pin Setting

1. Log in to the unit.
2. Click **POS & I/O / I/O Settings / I/O Pin Settings**.
3. All input and output pins are shown in this page, including the ones from cameras and I/O boxes.

The screenshot shows the 'I/O Settings' window with the 'I/O Pin Settings' tab selected. It displays settings for 'I/O BOX 51001(Building 1)'. The table below shows the configuration for various pins:

Device Name	I/O Pin	Name	Associated Camera
I/O BOX 51001(Building 1)	<input checked="" type="checkbox"/> Input #0	Gate	Camera 1
	<input checked="" type="checkbox"/> Input #1	Lobby	Camera 1
	<input checked="" type="checkbox"/> Input #2	First Floor	Camera 2
	<input checked="" type="checkbox"/> Input #3	Second Floor	Camera 3
	<input type="checkbox"/> Output #0		N/A
	<input type="checkbox"/> Output #1		N/A
	<input type="checkbox"/> Output #2		N/A
	<input type="checkbox"/> Output #3		N/A

Buttons for 'Save' and 'Reset' are located at the bottom of the interface.

- **Device Name**: The name of the I/O box.
- **I/O Pin**: Check the box to enable a pin. (default: checked)
- **Name**: The name of the I/O pin.
- **Associated Camera**: You may assign one camera to each digital input

device. DI's included with IP cameras will keep its own camera as default associated camera.

4. Click the **Save** button.



If the box of I/O pin is unchecked, this pin won't be shown on relative application pages. In other words, you cannot do any setting/operation with this pin. See details in next section.

3.3 Relative Configuration and Application

3.3.1 Record on Input Trigger

Refer to **Recording Schedule / Event Setup**.

3.3.2 Input and Responding Actions

Refer to **I/O Box Input and Responding Action Setup**.

3.3.3 I/O Control Panel in Live View

Refer to NuClient user manual for details.

4. External Storage

4.1 Create a Volume on DAS

The current compatible DAS is AXUS FiT Series. We don't guarantee the quality of other DAS models. Please refer to the manual of AXUS FiT Series to create a single volume on DAS.



We are unable to create a volume on external storage in Titan NVR setting page, so do NOT skip this step before connecting to Titan NVR.



The maximum volume size to create RAID on Titan NVR is 16T. Please make sure every volume you are going to add as a external storage is under 16T.

4.2 Create an External Storage

1. Log in to the unit.
2. Click **RAID & File System / RAID Management**.
3. You will find External SATA Disk displayed in Disk List.

The screenshot shows the RAID Management interface. At the top, there are tabs for RAID Status, Modify, Create, Delete, and Format. Below the tabs, the RAID Status is displayed as Functional. The interface is divided into a List section on the left and a Status section on the right. The List section shows a tree view with Volumes (VOLUME1), Disk 2, Disk 1, Free Disks (Disk 5 (eSATA)), and Disk 1. The Status section shows a table of RAID information:

Property	Value
RAID Name	VOLUME1
RAID Level	RAID1
RAID Status	Functional
Total Capacity	931.51 GB (953868 MB)
Free Capacity	893.22 GB (914664 MB)
Used Capacity	23.66 GB (24232 MB)
Usage	3%
Update Time	2011/6/24 04:33:01 PM
Total Devices	2
Active Devices	2
Failed Devices	0
Spare Devices	0
Format Progress	
Recovery Progress	

4. Click on the eSATA disk directly to check the disk drive information.

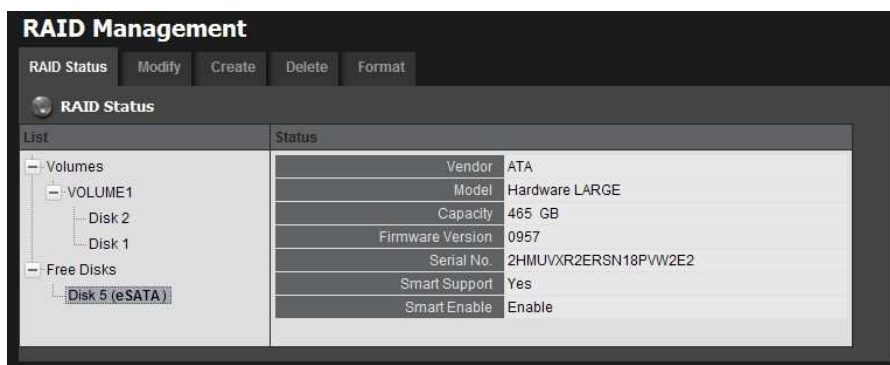

5. Refer to the section of **Create a RAID Volume** to create a volume for it. You can either create a volume with eSATA and embedded disk(s), or create an isolate volume with eSATA disk only.

4.3 Create an External Storage on iSCSI

1. Log in to the unit.
2. Click **RAID & File System / iSCSI initiator**
3. Fill in the IP address and port (default 3260) for iSCSI, and click "Discover"
4. You will see the iSCSI you discovered.

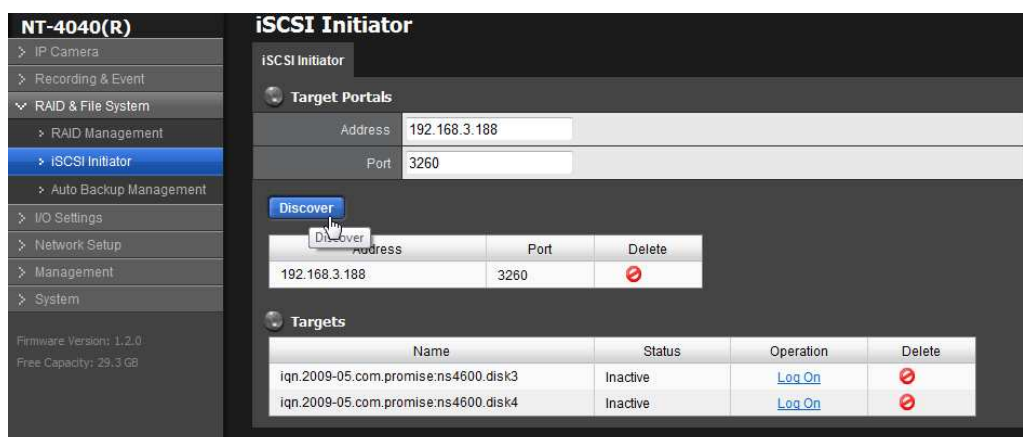

5. Log on each disk on Target. If you have set password on iSCSI, choose CHAP to log on. If not, choose "None".

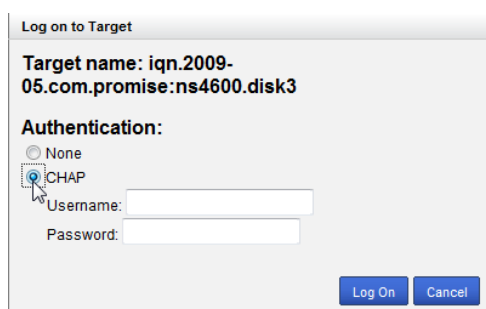

6. After log on the disk, choose RAID Management, you will see the iSCSI disk on Free disks.

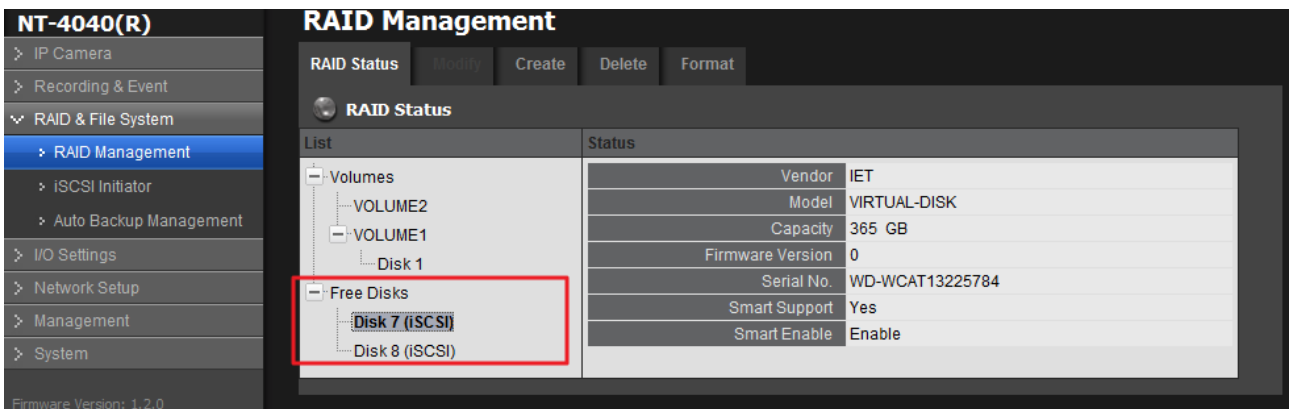

7. Refer to the section of **Create a RAID Volume** to create a volume for it. You can only create a volume with purely iSCSI disk.

 We suggest user use more HD to create one volume. Not use one HD to divide to more than 2 volume.

 If you log off the disk which has been created as a RAID, it may destroy the current recording file.

5. Log out

Click the **Logout** button on the top of the page to log out of the system. If there is no action in 10 minutes, the system will log out automatically to avoid unauthorized access.

6. Remote PC System Requirements

Remote PC Minimum Requirements		
CPU	Intel Core 2 Duo, 2.6GHz	
Display Card	OpenGL 2.0 and later	
OS Supported	Windows XP 32 bit	Windows 7 32/64 bit Mac 10.6/10.7
RAM	1GB	2GB
User Interface	1. HTTP Web browser - Internet Explorer 8 and later and Firefox 7.0.1 2. NUUO client application program	

7. Troubleshooting

7.1 Replace a Failed Disk Drive

If a disk drive fails, the Disk Status LED becomes orange. If the disk drive belongs to a RAID Volume, the Volume goes Critical or Offline, depending on RAID level. See **Check RAID Volume Status** for details.

Replace the failed disk drive with a new disk drive of the same or slightly greater capacity. You do not have to power down the unit. Refer to **Modify RAID Volume** to remove the failed disk and replace it with a new one.

7.2 Respond to a Critical RAID Volume

How the unit responding to a Critical RAID Volume depends on the RAID level of your Volume:

- For **RAID 1, 5, and 10** volumes, you must replace the failed disk drive with a new one. The RAID Volume will begin rebuilding itself when you install the new disk drive. See **Replace a Failed Disk Drive** for details.
- **RAID 0** volumes go offline after a disk drive failure. A **RAID 0** Volume cannot be recovery. All data of the volume is lost.

7.3 Respond to a File System Error RAID Volume

When encountering file system error, you are unable to keep the data anymore. It's likely due to abnormal usage and disk damage. In this case, if you want to keep recording, we suggest replacing new disks, or try the following methods.

1. Format this volume, and check if the status becomes ***functional***. If yes, you can start recording. If it doesn't, try the second method.
2. Delete this volume, and create volume again to see if the status is ***functional***.

7.4 Install ActiveX

If you cannot see the complete page of the system when using Internet Explorer, it may be because the ActiveX installation process is not completed.

1. Log in to the unit.

2. Click the **NuClient** button on the top right.
3. The browser will ask whether to install ActiveX.

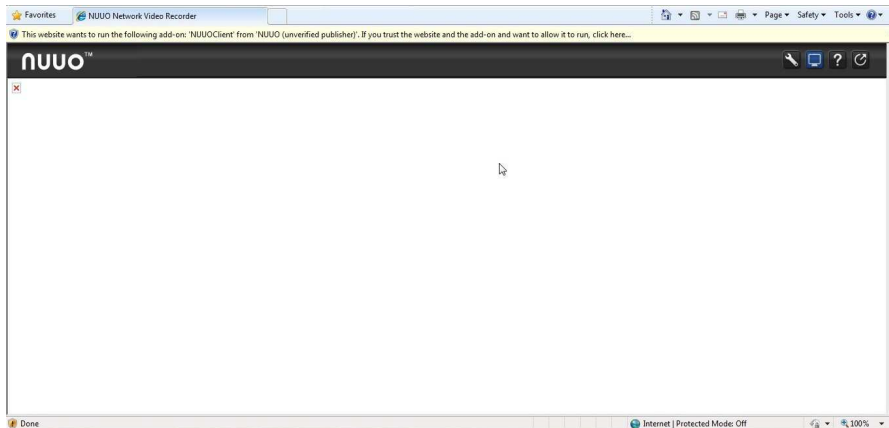

4. Click the **Run** button on popup dialog to begin the installation process.



7.5 Cannot Log in to the Unit with Internet Explorer

1. Check the settings of your antivirus software.
2. Change to appropriate settings or turn off this antivirus software.

Please visit NUUO wiki for more information.

http://support.nuuo.com/mediawiki/index.php/Main_Page

Appendix – RAID System

Introduction to RAID

RAID (Redundant Array of Independent Disks) allows multiple disk drives to be combined together into a RAID Volume. You will create a RAID Volume on your unit when you perform the setup procedure.

The benefits of a RAID can include:

- Higher data transfer rates for increased server performance
- Increased overall storage capacity for a single Volume
- Data redundancy/fault tolerance for ensuring continuous system operation in the event of a disk drive failure

Different RAID levels use different organizational models and have varying benefits. The following outline breaks down the properties for each RAID level supported on this unit:

RAID 0 – Stripe

When a RAID Volume is striped, the read and write blocks of data are interleaved between the sectors of multiple disk drives. Performance is increased, since the workload is balanced between drives or “members” that form the RAID Volume. Identical drives are recommended for performance as well as data storage efficiency.

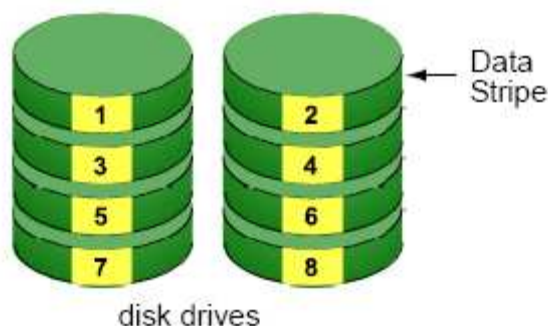

The RAID Volume’s data capacity equals the capacity of the smallest disk drive times the number of disk drives. For example, one 100 GB and three 120 GB drives will form a 400 GB (4 x 100 GB) RAID Volume instead of 460 GB.

If disk drives of different capacities are used, there will also be unused capacity on the larger drives.

Because RAID 0 does not offer Fault Tolerance, meaning that you cannot recover your data after a disk drive failure, we do not recommend a RAID 0 Volume for your unit.

RAID 0 Volumes on this unit consist of one or more disk drives.

RAID 1 – Mirror

When a RAID Volume is mirrored, identical data is written to a pair of disk drives, while reads are performed in parallel. The reads are performed using elevator seek and load balancing techniques where the workload is distributed in the most efficient manner. Whichever drive is not busy and is positioned closer to the data will be accessed first.

With RAID 1, if one disk drive fails or has errors, the other mirrored disk drive continues to function. This is called Fault Tolerance. Moreover, if a spare disk drive is present, the spare drive will be used as the replacement drive and data will begin to be mirrored to it from the remaining good drive.

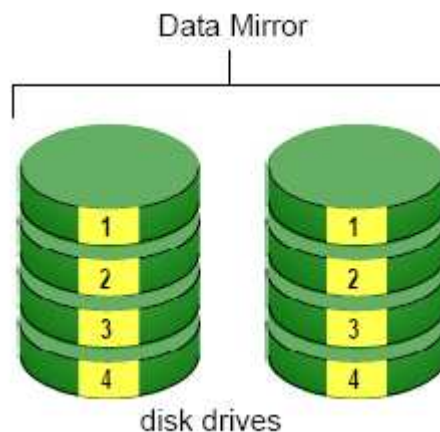

The RAID Volume's data capacity equals the smaller disk drive. For example, a 100 GB disk drive and a 120 GB disk drive have a combined capacity of 100 GB in a mirrored RAID Volume.

If disk drives of different capacities are used, there will also be unused capacity on the larger drive.

RAID 1 Volumes on this unit consist of two disk drives.

If you want a mirrored RAID Volume with more than two disk drives, see **RAID 10 – Mirror / Stripe** for details.

RAID 5 – Block Striping with Distributed Parity

RAID 5 organizes block data and parity data across the disk drives. Generally, RAID level 5 tends to exhibit lower random write performance due to the heavy workload of parity recalculation for each I/O. RAID 5 works well for file, database, application and web servers.

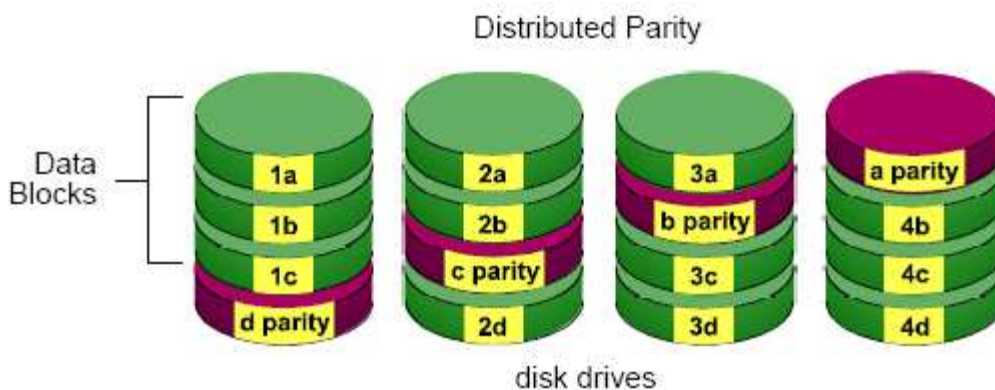

The capacity of a RAID 5 Volume equals the smallest disk drive times the number of disk drives, minus one. Hence, a RAID 5 Volume with four 100 GB disk drives will have a capacity of 300 GB. A RAID Volume with two 120 GB disk drives and one 100 GB disk drive will have a capacity of 200 GB.

RAID 5 is generally considered to be the most versatile RAID level.

RAID 5 requires a minimum of three disk drives.

RAID 10 – Mirror / Stripe

Mirror/Stripe combines both of the RAID 0 and RAID 1 types. RAID 10 can increase performance by reading and writing data in parallel while protecting data with duplication. At least four disk drives are needed for RAID 10 to be installed. With a four-disk-drive RAID Volume, one drive pair is mirrored together then striped over a second drive pair.

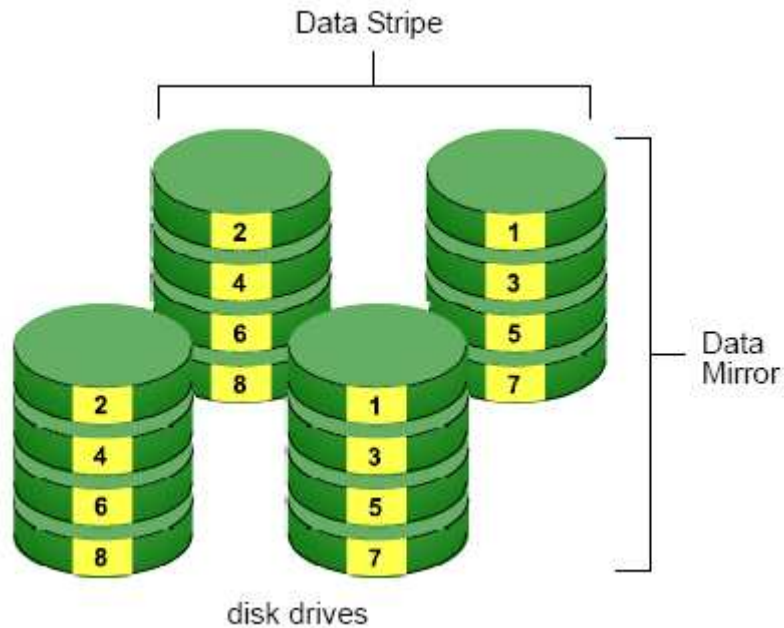

The data capacity RAID 10 Volume equals the capacity of the smallest disk drive times the number of disk drives, divided by two.

In some cases, RAID 10 offers double fault tolerance, depending on which disk drives fail.

RAID 10 Volumes on this unit consist of four disk drives.

Because all of the available disk drives are used for the RAID Volume, you cannot set up a spare drive with RAID 10.

Choosing a RAID Level

There are several issues to consider when choosing the RAID level. The following summarizes some advantages, disadvantages and applications for each choice.

- **RAID 0**

Advantage	Disadvantage
<ul style="list-style-type: none"> ● Implements a striped disk RAID Volume, the data is broken down into blocks and each block is written to a separate disk drive ● I/O performance is greatly 	<ul style="list-style-type: none"> ● Not a true RAID because it is not fault tolerant ● The failure of just one drive will result in all data in a RAID Volume

<p>improved by spreading the I/O load across many channels and drives</p> <ul style="list-style-type: none"> ● No parity calculation overhead is involved 	<p>being lost</p> <ul style="list-style-type: none"> ● Should not be used in mission critical environments
--	---

- **RAID 1**

Advantage	Disadvantage
<ul style="list-style-type: none"> ● Simplest RAID storage subsystem design ● Can increase read performance by processing data requests in parallel since the same data resides on two different drives 	<ul style="list-style-type: none"> ● Very high disk overhead - uses only 50% of total capacity

- **RAID 5**

Advantage	Disadvantage
<ul style="list-style-type: none"> ● High Read data transaction rate ● Medium Write data transaction rate ● Good aggregate transfer rate ● Most versatile RAID level 	<ul style="list-style-type: none"> ● Disk failure has a medium impact on throughput

- **RAID 10**

Advantage	Disadvantage
<ul style="list-style-type: none"> ● Implemented as a mirrored RAID ● Volume whose segments are RAID 0 RAID Volumes ● High I/O rates are achieved thanks to multiple stripe segments 	<ul style="list-style-type: none"> ● Very high disk overhead – uses only 50% of total capacity

Appendix – Camera Integration

Camera Supporting List

Refer to NUUO website: <http://www.nuuo.com/product.php?id=12>

Camera Search Tool

ACTi
Arecont
Sony

Stream Profile

- Original
- Low: under 300kbps; designed for mobile client single-view
- Minimum: under 100 kbps; designed for mobile client multi-view

Brand/Series	Low Profile		Minimum Profile	
	Resolution	Framerate	Resolution	Framerate
ACTi	CIF	3~6	CIF	1~2
Arecont	half	3	half	1
Axis	CIF	5	QCIF	5
Brickcom	CIF	10	CIF	4
CNB 1	CIF~SXGA	0.1~10	CIF~SXGA	0.1~10
CNB 2	QVGA~D1	0.1~10	QVGA~D1	0.1~10
CNB 3	QVGA~D1	0.1~10	QVGA~D1	0.1~10
Dahua	CIF	5	CIF	2
Dahua (HF3211P)	D1~1080p	0.1~10	D1~1080p	0.1~10
Dynacolor	QCIF~Full HD	0.1~10	QCIF~Full HD	0.1~10
Eneo 1	QCIF~Full D1	0.1~10	QCIF~Full D1	0.1~10
Eneo 2	QCIF~Half D1	0.1~10	QCIF~Half D1	0.1~10
Eneo 3	CIF~Full D1	0.1~10	CIF~Full D1	0.1~10
Eneo 4	CIF	5	CIF	2
Eneo 5	CIF	15	CIF	5
EverFocus (ONVIF)	QCIF~UXGA	0.1~6	QCIF~UXGA	0.1~6
EverFocus (Others)	QVGA	5	QVGA	1.5
Fine	CIF	1~3	CIF	0.1~1.5

Forenix	CIF	1~3	CIF	0.1~0.5
Grundig	QCIF~FullHD	0.1~10	QCIF~FullHD	0.1~10
Honeywell	640x368	15	640x368	5
LevelOne B1	CIF	10	CIF	4
LevelOne B2	QCIF~FullHD	0.1~10	QCIF~FullHD	0.1~10
LevelOne D	QCIF~FullHD	0.1~10	QCIF~FullHD	0.1~10
LevelOne S	CIF	10	CIF	3
LevelOne V	CIF	3	QCIF	3
Mobotix	CIF	3	QCIF	2
NetworkCamera	CIF	10	CIF	4
Panasonic BB/BL	CIF	4	QCIF	2
Panasonic i-pro 3 megapixel	VGA	1	VGA	0.5
Panasonic i-pro others	CIF	2	CIF	1
Pelco	CIF~D1	0.1~10	CIF~D1	0.1~10
Samsung	CIF	6	CIF	2
SANTEC (D1)	VGA	1~3	VGA	0.3~0.8
SANTEC (1.3 Mega)	VGA~D1	1~3	VGA~D1	0.3~0.8
SANTEC (3 Mega)	VGA~3M	1~3	VGA~3M	0.3~0.8
SANTEC (video server)	VGA~D1	1~3	VGA~D1	0.3~0.8
Sanyo HD1, HD3, HD4	CIF~VGA	3	CIF~VGA	1
Sanyo HD2	CIF~4 Mega	0.1~3	CIF~4 Mega	0.1~3
Sony	QCIF~Full HD	0.1~10	QCIF~Full HD	0.1~10
StarDot	CIF	3	CIF	1
Sunell	D1~QCIF	0.1~10	D1~QCIF	0.1~10
TRUEN	CIF~Full D1	0.1~10	CIF~Full D1	0.1~10
UDP	QVGA~VGA	0.1~10	QVAG~VGA	0.1~10
Vidosec 1	QVGA	5	QQVGA	5
Vidosec 2	CIF~Full HD	0.1 ~ 10	CIF~Full HD	0.1 ~ 10
Vivotek 7000v2/8000 (General)	CIF	5	CIF	2
Vivotek 7000v2/8000 (2 Mega)	CIF	3	QCIF	3

Vivotek 8000 (VS series)	QCIF~D1	0.1~10	QCIF~D1	0.1~10
Vivotek 8000 (IP8330/IP8332/IP 8352)	CIF	3	CIF	1
Vivotek 8000 (IP8362)	CIF	5	CIF	3
Zavio	CIF	5	QCIF	3
Zavio (Mega)	CIF	7	CIF	2

CNB 1: IGx10xx, ixP40xx ixP4000xx

CNB 2: INS2000/IBxxxx/Xpeed IP

CNB 3: IGx2050F, IDC4050xx, IXC8050IR, IVC5050xx, IVP5055xx, IDP5055xx, IXP3055VR

Eneo 1: GLS-1701/IR

Eneo 2: GLS-2104

Eneo 3: GLS-2301H

Eneo 4: NLC-1401, NLD-1401, NLS-1401

Eneo 5: NXC-1301M, NXC-1302M, NXC-1401M, NXC-1402M, NXD-1301M, NXD-1302M, NXD-1401M, NXD-1402M

EverFocus (ONVIF): EQN2200, EQN220

LevelOne B1: WCS-0030, FCS-0030, FCS-0031, FCS-1121, FCS-5041, FCS-6010

LevelOne B2: FCS-3061

LevelOne D: FCS-1131, FCS-1141, FCS-3071, FCS-3081, FCS-4041, FCS-5051, FCS-5061

LevelOne S: FCS-0040, WCS-0040

LevelOne V: FCS-1151

Samsung: SNB-1000, SNB-5000, SND-1010, SND-5080/F, SNO-5080R, SNP-3120/V/VH, SNP-3430H, SNP-5200, SNP-5200H, SNV-5080, SNV-5080R, SPE-100

Sanyo HD1: VCC-HD2500, VDC-HD3500

Sanyo HD2: VCC-HD2100, VCC-HD2300, VDC-HD3100, VDC-HD3300

Sanyo HD3: VCC-HD5400, VCC-HD5600

Sanyo HD4: VCC-HD4600

Vidosec 1: IBF-211, IDA-210, IP-206M, IS-240

Vidosec 2: ICS-13, ICS-20F, ID-20

The camera supported list in Titan NVR v1.2.0 is identical with NVRmini v1.3.2; please visit NUUO wiki for full Titan NVR supported cameras on mobile clients:

http://support.nuuo.com/mediawiki/index.php/NVRmini_supported_cameras_on_mobile_clients

Add: C Block, 18 Sihyuan St. Jhongjheng District, Taiwan (ROC)

TEL: +886-2-2362-2260

E-mail: service@nuuo.com