

VOXXSM Electronics Corporation

A VOXX INTERNATIONAL COMPANY



2021

Winter 2020 Retail Catalog



MOBILE VIDEO



1

12

ADAS



16

27

AUTO EXTRAS



13

15

TELEMATICS



30

31

OEM INTEGRATION



32

37

SECURITY ACCESSORIES



38

39

REPLACEMENT TRANSMITTER



41

55



FOUNDED 60 YEARS AGO by John Shalam, ***VOXX ELECTRONICS CORPORATION*** began in 1965 as Audiovox and has carried on the tradition of innovation for over five decades. For years, we have been the #1 supplier of in-vehicle rear-seat entertainment systems, vehicle remote start & security systems, distracted driver solutions, and telematics in the North American aftermarket. We have a diverse brand and product portfolio, a vast distribution network, and significant manufacturing and engineering capabilities. Today, we are proud to bring to market brands such as: Advent, Audiovox®, Movies2Go, Invision®, ADAS, Prestige, Pursuit, Code Alarm®, Omega, CarLink, and Flashlogic.

With the acquisition of Rostra® and the majority of Directed's automotive aftermarket business, consisting of Viper®, Autostart®, Astrostart®, Clifford®, Python®, Automate®, Avital, and Install Essentials we have become the unquestioned #1 supplier of remote start and security systems, while significantly enhancing our telematics offering. To round out our business we are the exclusive North American distributor of SiriusXM® products as well as Gentex® mirrors. Our focus has always been on innovation and exceeding customer needs.

Through our world-class manufacturing facilities and technology solution centers in Auburn Hills, MI and Orlando, FL, we provide a comprehensive suite of services.

Our 115,000 sq. ft. facility in Lake Nona houses our OEM engineering, quality, manufacturing, supply chain and operations teams, and the majority of OEM production and assembly for our security, keyless entry and remote start systems, as well as our award-winning rear-seat entertainment solutions. Both facilities house design and development, engineering and sales and program management teams, with full test and validation labs to oversee vehicle and systems integration. Throughout each stage, we maintain our international status in quality management systems to supply the very best in product applications to the broadest range of automotive partners all while being ISO 9000, ISO 14001, and TS16949-certified.

Today, ***VOXX ELECTRONICS CORPORATION*** services a distribution network of aftermarket specialists, wholesalers and distributors, consumer electronics & auto aftermarket retailers, car dealerships, and expeditors.



DOWNLOAD YOUR FAVORITE APPS, PLAY YOUR DVD COLLECTION AND CONTROL THE SEAT-BACK SYSTEM FROM ANYWHERE IN THE VEHICLE.

NOTE: ANDROID OS INCLUDES GOOGLE PLAY APP STORE TO DOWNLOAD AND ACCESS ALL APPS ON THE SYSTEM. ALL APPS SHOWN ARE TRADEMARKS OR REGISTERED TRADEMARKS OF THEIR RESPECTIVE OWNER.

BUILT-IN VOLTAGE STABILIZER FOR VEHICLES WITH FUEL SAVER (START/STOP) FEATURE

AVXSB10UHD2 DUAL 10.1" SEAT-BACK ENTERTAINMENT SYSTEM

DUAL ANDROID, DVD, HDMI, SD, USB, AND TOUCH SCREEN INTERFACE

- 10.1" Digital LCD Display (1024 x 600)
- Capacitive Multi-Touch Panel
- Android 8.1+ Operating System
- Quad Core Process – 8GB RAM
- 16GB Built-in Memory to Download Off-Line Content from Apps such as Netflix and Prime Video
- Intuitive User Interface
- WIFI: 802.11/b/n/g Dual Band (Hot Spot Required)
- VoxxLink Full System Remote Control and System Monitoring via Android & Apple Smartphones (Free App)
- Built-In Access to your Favorite Apps
- Google Play Store
- USB Input for Digital Media Playback and Smart Device Charging
- Built-in DVD Player
- HDMI Input to Connect an External Game System and Connect Smart Devices such as Smartphones and Smart TV Sticks (Amazon, Roku & Chromecast)
- Hi-Def Dual Screen Mirroring
- Micro SD Input
- Built-in Voltage Stabilizer for Vehicles with Fuel Saver (Start/Stop) Feature
- 100 Channel FM Modulator (Transmits Audio Through the Vehicle Sound System)
- (2) Dual Channel Wireless Headphones Included
- Universal Mounting Bracket (Does not Interfere with Factory Headrest Movement)
- Specialty Mounting Brackets Available as Optional Accessories (see application guide)

Additional Seatback Versions:

- AVXSB10DD2 (does not include HDMI)
- AVXSB10MM2 (does not include DVD)

* Wireless content streaming may be limited based upon device and app restrictions



FOR 10.1" SEAT-BACK ENTERTAINMENT SYSTEM



MODEL #SBK-AUDI

BRACKET ACCESSORY REQUIRED FOR THE FOLLOWING MODELS:

- 2018-19 Audi Q7
- 2018-19 Audi Q8



MODEL #SBK-VOLV

BRACKET ACCESSORY REQUIRED FOR THE FOLLOWING MODELS:

- 2018-19 Volvo S60
- 2019 Volvo S60 R
- 2018-19 Volvo V90
- 2018-19 Volvo XC60
- 2018-19 Volvo XC90



MODEL #SBK - LINC

MOUNTING BRACKET NEEDED FOR INSTALLATION OF THE LINCOLN MODELS WITH PERFECT POSITION SEAT & ACTIVE MOTION

- 2018-2019 Lincoln Navigator
- 2018-2019 Lincoln Continental
- 2020 Lincoln Aviator



GUIDE POST LOCKS

FOR VEHICLES WITH FLOATING GUIDE SLEEVE CAPS OR PLASTIC TRIM SEAT TOPS

- SBKGS127.....12.7 mm
- SBKGS14.....14 mm
- SBKGS16.....16 mm

*See Application Guide for Applicable Vehicle Makes & Models

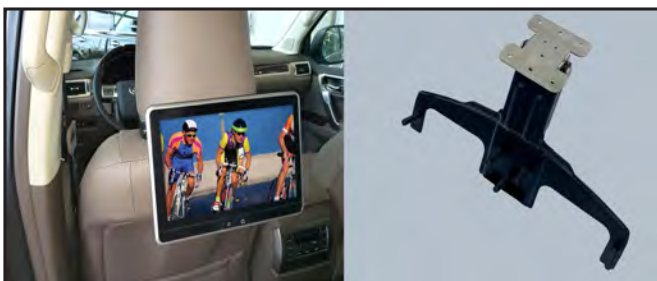

MODEL #SBK-EXT1

EXTENSION BRACKET USED FOR SELECT APPLICATIONS TOYOTA, LEXUS AND ACURA

*See Application Guide for Applicable Vehicle Makes & Models



MODEL #SBK-MBB1

BRACKET ACCESSORY REQUIRED FOR THE FOLLOWING MODELS

- 2020 Mercedes GLE
- 2020 Mercedes GLS

*Bracket mounts to the factory rear seat entertainment port in the seat-back



COMPLETE KIT CONFIGURATIONS



AVX8SS01

8" Dual Headrest Systems with DVD/HDMI/USB

- DVD players play DVD's and CD's in both monitors
- USB reader with charging in both monitors
- Hidden HDMI/USB inputs via supplied 6' extension cable with finished connector end

MONITOR FEATURES

- Headrest monitors with 8" Digital LED back-lit panels
- Resolution (800 x RGB x 480)
- Adjustable viewing angles
- Certified HDMI input
- A/V Input & Output
- RF Output for hard-wired FM modulator connection (FMDIRB required)
- USB input with charging
- Dual channel wireless headphones
- Full band FM transmitter
- 2 remote controls included



AVXSB8SS

8" Dual Seat-back Systems with DVD/HDMI/USB

- DVD players play DVD's and CD's in both monitors
- USB reader with charging in both monitors
- Hidden HDMI/USB input via supplied 6' extension cable with finished connector end

MONITOR FEATURES

- Headrest monitors with 8" Digital LED back-lit panels
- Resolution (800 x RGB x 480)
- Adjustable viewing angles
- Certified HDMI/MHL input
- A/V Input & Output
- RF Output for hard-wired FM modulator connection (FMDIRB required)
- USB input with charging
- Dual channel wireless headphones
- Full band FM transmitter
- 2 remote controls included

SUB-ASSEMBLY PACKAGES



SUB801

8" Replacement Headrest Buns

- Dual replacement custom headrests (material, color, grain, stitch, piping matches factory headrests)
- Monitor cables and sub tray pre-installed



SUBSB8

8" Active Seat-back Shells

- Dual seat-back with custom mounting brackets
- Monitor cables and sub tray pre-installed



AVX801SUBPKGSS

8" Dual Monitors with DVD/HDMI/USB

AVXSS7012

7" Dual Headrest Systems with DVD/HDMI/USB

- DVD players play DVD's and CD's in both monitors
- USB reader with charging in both monitors
- Hidden HDMI/USB input via supplied 6' extension cable with finished connector end.



AVXDD7012

7" Dual Headrest Systems with DVD

- Dual DVD players play DVD's and CD's
- USB reader with charging in both monitors
- RCA A/V input in both monitors
- Wired headphone output in both monitors



MONITOR FEATURES

- Dual replacement custom headrests (material, color, grain, stitch, piping match factory headrests)
- Dual 7" digital monitors with LED back-lighting
- Resolution (RGB 800 x 480)
- Adjustable viewing angles
- Both monitors incorporate dual channel wireless headphone transmitters
- 2 Wireless remote controls
- Both monitors incorporate wired headphone input
- Full band wireless FM modulator
- Hidden away junction box
 - RCA A/V input
 - RCA A/V output
 - RF output for hardwired FM modulation connection - FMDIRB

AVXSSB1SS

7" Dual Seat-back Systems with DVD/HDMI/USB

- DVD players play DVD's and CD's in both monitors
- USB reader with charging in both monitors
- Hidden HDMI/USB input via supplied 6' extension cable with finished connector end.



AVXSB1DD

7" Dual Seat-back Systems with DVD

- Dual DVD players play DVD's and CD's
- USB reader with charging in both monitors
- RCA A/V input in both monitors
- Wired headphone output in both monitors



MONITOR FEATURES

- Dual seat-back monitor with custom housing brackets (material color matches factory interior)
- Dual 7" digital monitors with LED back-lighting
- Resolution (RGB 800 x 480)
- Adjustable viewing angles
- Both monitors incorporate dual channel wireless headphone transmitters
- 2 Wireless remote controls
- Both monitors incorporate wired headphone input
- Full band wireless FM modulator
- Hidden away junction box
 - RCA A/V input
 - RCA A/V output
 - RF output for hardwired FM modulation connection - FMDIRB

SUB-ASSEMBLY PACKAGES



SUBHR7012

7" Replacement Headrest Buns

- Dual replacement custom headrests
- Monitor cables and sub tray pre-installed



AVX7012SUBPKGSS

7" Dual Monitors with DVD/HDMI/USB



AVX7012SUBPKGDD

7" Dual Monitors with DVD



SUBSB1

7" Active Seat-back Shells

- Dual seat-back with custom mounting brackets (material matches factory interior)
- Monitor cables and sub tray pre-installed

VODA10 - SMART TV OVERHEAD SYSTEMS

10.1" Hi-Def digital LED back-lit monitor with built-in DVD player and HDMI inputs

- 10.1" Hi-Res Digital LED Back-lit Touch Screen Monitor
- Android 8.1 Operating System
- Quad Core Processor - 8GB RAM
- 16GB Internal Memory for Offline Content Downloads
- WIFI: 802.11 b/n/g Dual Band (Hot Spot Required)
- Built-In Direct Access to your Favorite Apps
- Voxx Link Full System Remote Control and System Monitoring via Android & Apple Smartphones (Free App)
- HDMI Input to Connect an External Game System and Connect Smart Devices such as Smartphones & Smart TV sticks
- Built-in DVD player
- USB Input for Digital Media Playback. (USB will also provide charging for smartphones or power for HDMI streaming sticks)
- SD Input for Media Playback
- Audio Video Input/Output
- Built-In Dome Lights
- 100 Channel Wireless FM Modulator (Transmits Audio through the Vehicle Sound System)
- Mounting Bracket & Hardwire Included
- Includes Three Snap-on Bezels in Black, Shale and Pewter



BUILT-IN VOLTAGE STABILIZER FOR VEHICLES WITH FUEL SAVER (START/STOP) FEATURE



BUILT-IN VOLTAGE STABILIZER FOR VEHICLES WITH FUEL SAVER (START/STOP) FEATURE

VODP10 - SMART TV READY OVERHEAD SYSTEM

10.1" Hi-Def digital LED back-lit monitor with built-in DVD player

- 10.1" Hi-Res Digital LED Back-lit Monitor
- HDMI Inputs to connect Smart Devices such as Smartphones & SmartTV Streaming Sticks enabling access to your favorite apps
- Built-In DVD Player
- USB Input for Digital Media Playback. (USB will also provide charging for Smartphones or Power for HDMI Streaming Sticks)
- Audio Video Input
- Audio Video Output
- Built-In Dome Lights
- Remote Control
- Optional Hidden USB and HDMI input Capability via 24 pin Connector Located on top of the unit (optional HDH12)
- Optional Wireless Content Transfer Capability from SmartPhone or Tablet via SmartStream Module (optional WMI required)
- 100 Channel Wireless FM Modulator (Transmits Audio through Vehicle Sound System)
- FM Out (for adding an optional FM Adapter to hardwire the FM transmitter - Model: FMDIRB)
- Dual Channel IR Headphone Transmitter with (2) Headphones Included
- Mounting Bracket & Hardware Included
- Includes Three Snap-on Bezels in Black

HDMI CONNECTIVITY

STREAM LIVE PROGRAMMING INTO THE VEHICLE AND WATCH CRISP VIDEO ON THE SYSTEMS HD DISPLAYS. HDMI INPUT CONNECTS YOUR MEDIA SOURCE DEVICE (SMARTPHONE, TABLET OR OTHER HDMI DEVICES LIKE GOOGLE CHROMECAST, Roku STICK & AMAZON FIRE TV STICK) TO STREAM VIDEO VIA WIFI CONNECTION. A USB PORT IS INCLUDED AS A POWER SOURCE OR FOR CHARGING SMARTPHONES. NOTE: APPLE LIGHTNING OR ANDROID ADAPTORES ARE REQUIRED BUT NOT INCLUDED!



ADVXL12A - SMART TV READY OVERHEAD SYSTEM

12.1" Digital Hi-Def Overhead Monitor System with DVD and HDMI Inputs

- 12.1" Hi-Res Digital LED Back-lit Panel (1280 x 800 Resolution)
- Enhanced Graphical User Interface
- DVD Player with Auto-On
- User Accessible USB Reader w. 2.1amp charging support
- User Accessible HDMI/MHL input
- Optional Hidden USB and HDMI input capability via 24pin connector located on the top of the unit (Optional HDH12)
- Optional wireless content transfer capability from a smart-phone or tablet via SMARTstream module (optional WMI required)
- A/V Inputs and Outputs
- 100 Channel FM Transmitter
- FM Out to Hardwire the internal FM Transmitter to make a Hardwired FM Modulator solution for those who live in densely populated FM station broadcast areas (Optional FMDIRB Required)
- Dual Channel IR Headphone Support
- (2) Single Channel Headphones Included
- (1) IR Remote Control Included
- M1/M2 Capable for connecting (2) Overheads in (1) Vehicle allowing independent IR Remote Control and independent IR headphone Audio)
- Universal Snap on Bezels and Trim Rings (Black, Gray, Tan)
- Mounting Bracket and Hardware

ADD OPTIONAL SMARTSTREAM FOR WIRELESS CONNECTIVITY OF SELECT SMART PHONES

HDMI CONNECTIVITY

STREAM LIVE PROGRAMMING INTO THE VEHICLE AND WATCH CRISP VIDEO ON THE SYSTEMS HD DISPLAYS. HDMI INPUT CONNECTS YOUR MEDIA SOURCE DEVICE (SMARTPHONE, TABLET OR OTHER HDMI DEVICES LIKE GOOGLE CHROMECAST, Roku STICK & AMAZON FIRE TV STICK) TO STREAM VIDEO VIA WIFI CONNECTION. A USB PORT IS INCLUDED AS A POWER SOURCE OR FOR CHARGING SMARTPHONES. NOTE: APPLE LIGHTNING OR ANDROID ADAPTORES ARE REQUIRED BUT NOT INCLUDED!

OPTIONAL HIDDEN HDMI/USB INSTALLATION

THE HDMI HARNESS ALLOWS FOR CUSTOM MOUNTING. THE ADDED USB PORT IS FOR CHARGING ONLY AND SUPPORTS 5V.



HDMI CONNECTIVITY

STREAM LIVE PROGRAMMING INTO THE VEHICLE AND WATCH HDSP VIDEO ON THE SYSTEMS HD DISPLAYS. HDMI INPUT CONNECTS YOUR MEDIA SOURCE DEVICE (SMARTPHONE, TABLET OR OTHER HDMI DEVICES LIKE GOOGLE CHROMECAST, Roku STICK & AMAZON FIRE TV STICK) TO STREAM VIDEO VIA WIFI CONNECTION. A USB PORT IS INCLUDED AS A POWER SOURCE OR FOR CHARGING SMARTPHONES. NOTE: APPLE LIGHTNING OR ANDROID ADAPTORS ARE REQUIRED BUT NOT INCLUDED!

AVXMTGHR9HD SMART TV READY HEADREST SYSTEM

9" Headrest System with DVD/HDMI Input

- LED back-lit monitors for vibrant picture quality
 - Switchable 16:9 / 4:3 aspect ratio
 - Adjustable viewing angles
 - Audio / video inputs for additional source units
 - Audio / video output
 - USB inputs for digital media. USB will also provide charging for smart phones or power for HDMI streaming sticks.
 - Independent switching
 - Built-in FM modulator
 - Shale, pewter and black covers included
- Remote control
 - Built-in IR headphone transmitter (headphones optional)
 - 3.5mm wired headphone jack
 - Enclosed post wiring
 - Adjustable headrest pole distance -130mm - 170mm
 - Pole diameter (external size) -10mm, 12mm, 12.4mm, 13.8mm, 14mm and 16mm
 - Plastic pole adapter included

MTGHRD1 SMART TV READY HEADREST SYSTEM

7" Headrest System with DVD/HDMI Input

- Shale, Pewter and Black covers included
 - Switchable 16:9 / 4:3 aspect ratio
 - Adjustable viewing angles
 - Audio / Video inputs for additional source units
 - Audio / Video output
 - USB inputs for digital media. USB will also provide power for HDMI streaming sticks.
- Independent switching
 - Built-in FM modulator
 - Remote control
 - 3.5mm to RCA adapter cable (A/V in)
 - Enclosed post wiring
 - Adjustable Headrest Pole diameter



MTGHRM1

7" Headrest System

- Shale, Pewter and Black covers included
 - Switchable 16:9 / 4:3 aspect ratio
 - Adjustable viewing angles
 - Audio / Video inputs for additional source units
 - Independent switching
- Remote control
 - 3.5mm to RCA adapter cable (A/V in)
 - Enclosed post wiring
 - Adjustable Headrest Pole diameter

AVX10USB SMART TV READY SEAT-BACK SYSTEM

10.1" Universal Seat-Back System

- 10.1" Digital LED Back-lit Panel
 - 1024 x 600 Resolution
 - HDMI input for Smart Device Connectivity
 - Integrated DVD Player
 - Capacitive Touch Buttons
 - USB Input (for Media Playback)
 - Micro SD Card (for Media Playback)
- AV1 Input / AV2 Input / AV Output / Earphone Output
 - IR Transmitter (Dual Channel)
 - Wireless FM Modulator
 - Universal Mounting Bracket
 - 12V Power Adapter (can also be Hardwired)
 - Removable Design



KIT INCLUDES



VXMTG10 - SMART TV READY OVERHEAD SYSTEM

10.1" Digital Hi-Def Overhead Monitor System with Smart TV Ready, DVD and HDMI Inputs

- 10.1" Hi-Res Digital LED Back-lit Monitor
- HDMI Input to connect smart devices such as Smartphones & streaming sticks enabling access to your favorite apps
- USB Input for Digital Media Playback. (USB will also provide charging for Smartphones or Power for HDMI Streaming Sticks)
- Built-In DVD Player
- Audio Video Input
- Audio Video Output
- Built-In Voltage Stabilizer for Vehicles Equipped with Fuel Savings Mode (start/stop)
- Built-In Dome Lights
- 100 Channel Wireless FM Modulator (Transmits Audio through Vehicle Sound System)
- FM Out (for adding an optional FM Adapter to hardwire the FM transmitter - Model: FMDIRB)
- Mounting Bracket & Hardware Included
- Includes Three Snap-on Bezels in Black, Shale and Pewter
- Remote Control

MTGBAVX13 - SMART TV OVERHEAD SYSTEM

13.3" Digital Hi-Def Overhead Monitor System with DVD and HDMI Inputs

- 1 Year Warranty
- 13.3" Hi-Res Digital LED Back-lit Panel (1420 x 1080 Resolution)
- DVD Player
- User Accessible USB Reader w. 2.1 amp charging support
- User Accessible HDMI input
- Optional Hidden USB and HDMI input capability via (24) pin connector located on the top of the unit (Optional HDH12 Required)
- Optional wireless content transfer capability from a smart-phone or tablet via SMARTstream module (optional WM1 required)
- A/V Inputs and Output
- 100 Channel FM Transmitter
- FM Out to Hardwire the internal FM Transmitter to make a Hardwired FM Modulator solution for those who live in densely populated FM station broadcast areas (Optional FMDIRB Required)
- Dual Channel IR Headphone Support
- (1) IR Remote Control Included
- M1/M2 Capable for connecting (2) Overheads in (1) Vehicle allowing independent IR Remote Control and independent IR headphone Audio)
- Universal Snap on Bezels and Trim Rings (Black, Pewter, Shale)
- Mounting Bracket and Hardware Included





IR1
Premium Single channel fold-flat wireless headphones

IR2
Premium Dual channel fold-flat wireless headphones

- Auto shut-off
- Upgraded ear piece
- Batteries included



MTGHP1CA
Single channel fold-flat IR wireless headphones

MTGHP2CA
Dual channel fold-flat IR wireless headphones

- Auto shut off
- Batteries included

WM1
Wireless Content Streaming Module



- Wireless content transfer capability to our SMARTstream enabled overhead and headrests systems
- Upgradeable* as new operating systems are released from Apple® and Android™*(over the air updates via Wi-Fi)
- Simple Plug & Play Add-on

** Not all Apps or operating systems will allow wireless content streaming due to copyright protection or OS restrictions*

HDH12
12' HDMI/MHL/USB Extension Harness



- Allows for a Hidden Connection for HDMI/MHL Devices
- Offers Charging Support via USB
- Finished Connector end to replace an existing 12v socket or can be cut-in to add a remote connection location

FMDIRB
FM modulator relay box



- For use with Overheads that have RF outputs
- Converts our RSE system FM transmitter to an FM Modulator

FMM100A
FM modulator



- Wired FM modulator with isolation transformer

HDMI CONNECTIVITY OPTIONS (ACCESSORY PARTS SOLD SEPARATELY)

VISIBLE INPUT



WIRED CONNECTION



VISIBLE INPUT: CONNECTIVITY WITH A WIRED CONNECTION USING A VISIBLE INPUT

Overhead Models: ADVEXL12A, ADVEXL10HD, MTG13UHD & MTG10UHD
Headrest Models: AVXSS7012, ADVBZZ01, AVX8SS01, AXMTGHR9HD & MTGHR01

HIDDEN INPUT



WIRED CONNECTION



WIRELESS CONNECTION



HIDDEN INPUT: CONNECTIVITY WITH A WIRED OR WIRELESS CONNECTION USING A HIDDEN INPUT

Overhead Models: ADVEXL12A, ADVEXL10HD, MTG13UHD & MTG10UHD
Headrest Models: AVXSS7012 & AVX8SS01



DPAVXHR7012WD

Audiovox working headrest display

- Dimensions: 22" (H) x 13"(W) x 9 3/4"(D)
- Complete with stand, 7" DVD monitor, power supply and remote control

DPAVXHR7012NWD

Audiovox non-working headrest display

- Dimensions: 22" (H) x 13"(W) x 9 3/4"(D)
- Complete with stand/non-working 7" monitor



DPAVXHR8DWD

Audiovox working headrest display

- Dimensions: 22"(H) x 13"(W) x 9 3/4"(D)
- Complete with stand, 8" DVD monitor, power supply and remote control

DPMTGHR1

Movies-to-Go working headrest display

- Dimensions: 8 1/2"(H) x 13"(W) x 9 3/4"(D)
- Complete with stand, graphic, 7" headrest and power supply

DPMTGHR

Movies-to-Go non-working headrest display

- Dimensions: 8 1/2"(H) x 13"(W) x 9 3/4"(D)
- Complete with stand, graphic and 7" headrest



DPMTGHR9HDWD

Movies-to-Go working headrest display

- Dimensions: 8 1/2"(H) x 13"(W) x 9 3/4"(D)
- Complete with stand, graphic, 9" headrest and power supply

DPMTGHR9HDR

Movies-to-Go non-working headrest display

- Dimensions: 8 1/2"(H) x 13"(W) x 9 3/4"(D)
- Complete with stand, graphic and 9" headrest



OVCTDISPVXMTG10

MOVIES-TO-GO working Counter Top OVERHEAD display

- Dimensions: 30"(H) x 16"(W) x 20"(D)
- Complete with stand, 10.1" VXMTG10 Overhead, power supply and remote control

OVCTDISPVODA10

AUDIOVOX Working Counter Top OVERHEAD display

- Dimensions: 30"(H) x 16"(W) x 20"(D)
- Complete with stand, 10.1" VODA10 Overhead, power supply and remote control

OVCTDISPVODP10

AUDIOVOX Working Counter Top OVERHEAD display with HDH12

- Dimensions: 30"(H) x 16"(W) x 20"(D)
- Complete with stand, 10.1" VODP10 Overhead, power supply and remote control



MVFD4C

Mobile electronics display

- Dimensions: 82" (H) x 51" (W) x 21" (D)
- Branded Voxx Electronics
- Can hold: 8 Multimedia units, 1 Overhead & 2 headrests

SBI0TT1DAVX

Single monitor with DVD display

SBI0TT1AVX

Single monitor with no DVD

SBI0TT2AVX

Dual Seat-Back Monitor display



VEHICLE ENTERTAINMENT ON A WHOLE NEW LEVEL

DUAL 10.1" SMART VEHICLE SEAT-BACK ENTERTAINMENT SYSTEM
 DUAL ANDROID, DVD, HDMI, SD, USB, SMARTSTREAM & TOUCH-SCREEN INTERFACE

- 10.1" Digital LED Display (1024 x 600)
- Capacitive Multi-Touch Panel
- Android 4.4 - Operating System
- Full System Remote IPF Control (Internal & Apple)
- Super Capacitor Power with 10,000mAh
- 8GB 32GB for Expandable Memory (Up to 64GB)
- Headset/Charger
- Onlay Pay Stars
- 10000mAh
- Smart Stream Wireless Streaming for Android & Apple*
- Wi-Fi Seat Screen (Optional)
- Integrated DVD/MP3/Video Playback
- USB 2.0 (Direct Playback & Smart Device Charging)
- 100 Channel FM Presets
- CD Dual Channel Wireless Headphones
- Dual Channel 3D Bluetooth Transmitter
- Standard Warning System (Does not interfere with Factory Headrest Movement)

*Requires internet connection and compatible device.

HCITY | ANDROID | SMARTSTREAM | DVD | SD | USB | SMARTSTREAM | TOUCH-SCREEN INTERFACE

ASK ABOUT... Adding SMART TV To This Vehicle To Keep Your Passengers Entertained.

VOXX
 Electronics Corporation



LTVI16219V1

SB10UHD Window Cling

LTVI56017V1

SmartTV Window Cling

SB10UHD

SB10UHD Wrap Around piece

EPA REGISTERED
AGAINST COVID19.

PEACE OF MIND, IN AN UNCERTAIN TIME.



Protecting your employees and customers is more important than ever. Auto Oxide® (Enviro Bac-2) is an EPA registered disinfectant that is safe on all surfaces. Make sure you offer something your competition can't.



Auto Oxide

- SKU: AV1
- One Gallon bottles
- Disinfects up to 168 vehicles per case
- Must purchase case quantities only (4) bottles per case

*Sold in case quantities only



High Pressure Spray Gun

- SKU: VHP1
- Pre-calibrated pneumatic sprayer
- Specifically designed to work with Auto Oxide



Dealership P.O.P.

- SKU: PP168
- QTY - 168
- Consumer mirror hangers
- Steering wheel covers & gear shifter protectors for after disinfection



Rechargeable Handheld Fogger

- SKU: BHHF10
- Portable for off-site jobs
- Battery powered allows flexibility
- Quicker set up for smaller jobs

PRODUCT DETAILS

- No mixing required
- Safe for humans, animals, and aquatic life
- Odor-free
- Fast application

Effective for use against:

- SARS CoV-2 (COVID19)
- H1N1
- Staph
- Strep
- Herpes Simplex Type 1 & 2

- Salmonella
- Listeria
- Hep B & C
- HIV-1
- E. coli



- Set includes Front & Rear mats.
- Made from environmentally friendly non-toxic, odorless TPE material.
- Vehicle Specific – designed with exact vehicle contours to protect and contain spills.
- Raised edges for maximum coverage & protection.
- Waterproof & easy to clean.
- 5-Year Warranty.
- For a complete list of vehicle applications go to: www.adventfloormats.com.

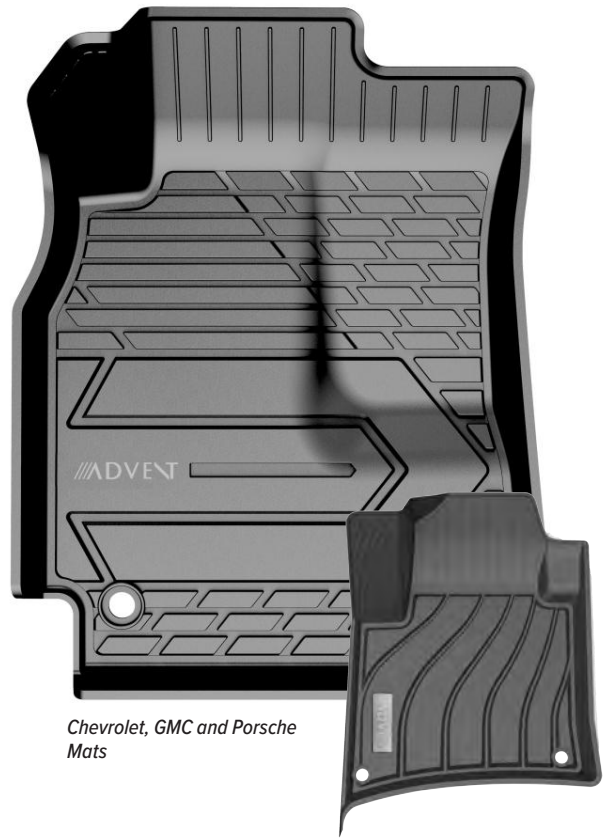

Chevrolet, GMC and Porsche Mats



VOXX

POWER SYSTEMS™

POWV3.5

The power you need,
when you need it most.



- Provides an emergency jump-start when your vehicle's battery is dead
- No need to rely on expensive Roadside Assistance, jumper cables, or portable jump packs
- Installed battery-backup system for piece of mind, every time
- Comfort & Convenience - Start your vehicle from the driver's seat with your Smartphone (iOS and Android)
- Worry-free & hassle-free operation
- Works with all gas and light diesel vehicles
- Great for teen drivers, elderly parents, emergency response vehicles, commercial fleets, and much more
- Versatile installation allows install under seats or in trunk
- On-Demand power when you need it
- Wires directly to the vehicle battery so you never need to go outside in the cold, heat, snow, or rain to hook up jumper cables
- Self-monitoring to prevent overcharging
- Easily controlled through Android and iOS Apps



Install under a seat, behind a seat, or in the trunk

GENFDM3LN The Best Of A Mirror And Display In One!



- New Gen III Design
- Full Display Mirror
- Auto-dimming for glare elimination at night
- MIRROR MODE: operates as standard mirror
- DISPLAY MODE: integrated LCD display for optimal rear vision
- Custom, interior-mounted, high-dynamic-range camera



Mirror Mode

- Mirror view available should camera or display become non-operational
- Allows driver to view vehicle interior, rear seats, passengers, etc.
- Fully functional auto-dimming mirror



Display Mode

- Radically improved rear view enhances driver safety
- Ideal for vehicles with limited rear visibility
- Camera view not hindered by headrests, pillars, small rear window, passengers, etc.



Backup Camera Mode

- All-new functionality!
- Provides rear vision and backup display simultaneously while reversing
- Inset backup camera display from any NTSC camera – CAMERA NOT INCLUDED
- Requires GENCAMHAR when using backup camera – NOT INCLUDED

GNTXR High Performance Rear Vision System For Professional Race Teams



From Gentex, the leader in digital vision systems and Full Display Mirrors comes the GNTXR!

- Ideal for closed cockpit environments
- Easily mounts to roll bar – **Mirror and Camera Mounts NOT INCLUDED and should be fabricated by the race team**
- Kit includes camera, display mirror and cables

SYSTEM SPECIFICATIONS:



Display

- High-definition display
- Anti-reflective (AR) coated glass
- Integrated pivot mount
- PC+ABS aluminum construction



Camera

- Excellent high dynamic range
- Best-in-class low-light performance
- Compact rugged design
- Designed for harsh environments
- Designed to IP6K9K automotive standards
- Waterproof

ADVGENFLCHLN

Available in the United States, Canada, and Mexico.



HomeLink®

HomeLink is the most widely used and trusted car-to-home automation system that uses RF and wireless cloud-based transmission to operate gates, garage doors, home lighting, thermostats, locks, security systems, and other compatible home automation devices.

- » **AUTO-DIMMING:** Automatically darkens to eliminate glare
- » **FRAMELESS DESIGN:** Enhanced aesthetics to complement any vehicle interior
- » **CAR-TO-HOME AUTOMATION:** Control garage doors, gates, home lighting, and more
- » **INTEGRATED HOMELINK 5:** 99% compatibility with garage door openers and security gates
- » **COMPATIBILITY:** Compatible with any wedge mount vehicle along with others using adaptors (GENMM1, GENMM2, GENMM3, GENMM4)



HomeLink Connect™

Drivers can take advantage of cloud-based wireless communication with the HomeLink Connect app — a new home automation app that grants drivers access to an increasing array of cloud-based home automation devices.

Once configured, the app pairs with your Bluetooth-enabled rearview mirror, allowing you to activate compatible home automation devices with your vehicle-integrated HomeLink buttons.



Download and configure the app by searching for HomeLink Connect in the App Store/ Google Play to control a myriad of individual home automation devices or set up entire home automation “scenes”. Available for iOS and Android, free for 1 year — \$1.99 renewal after first year (exchange rates apply.)

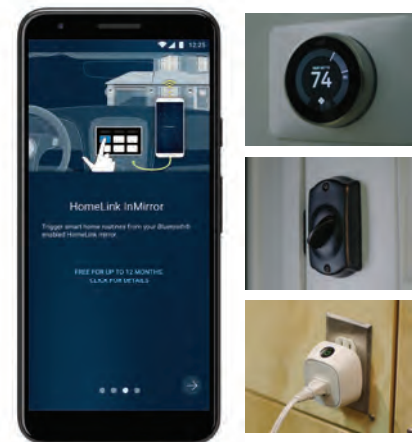

HomeLink® and the HomeLink House® logo are registered trademarks of Gentex Corporation. The Bluetooth® word mark and logos are registered trademarks owned by Bluetooth SIG, Inc. and any use of such marks by Gentex Corporation is under license.

AUTO-DIMMING MIRRORS / ELIMINATE DANGEROUS GLARE FROM REAR-APPROACHING HEADLIGHTS, USING SENSORS AND ELECTRONIC CIRCUITRY TO DETECT GLARE AND AUTOMATICALLY DIM THE MIRROR ACCORDINGLY.



ADVGEN2A

Gentex Rear-View Mirror

- Auto-Dimming
- 3-year warranty



ADVGEN40A4

Gentex Rear-View Mirror

- Auto-Dimming
- HomeLink® 4 button integration
- 3-year warranty



ADVGEN20A

Gentex Rear-View Mirror

- Auto-Dimming
- Self-calibrating outdoor temperature
- Self-calibrating Compass
- 3-year warranty



ADVGEN45AB5

Gentex Rear-View Mirror (Blue back-lit buttons)

- Auto-Dimming
- Self-calibrating Compass
- HomeLink® 5 button integration
- 3-year warranty

FRAMELESS MIRRORS / ALL NEW DESIGN THAT MAKES A GREAT ADDITION TO ANY AUTOMOTIVE INTERIOR AND NOT ONLY LOOKS THE PART BUT DELIVERS THE SAME AUTO-DIMMING TECHNOLOGY.



ADVPMHL1LN

Gentex Frameless Rear-View Mirror

- HomeLink® 5 button integration
- Battery Powered - No wires to install
- Manual Dimming Mirror
- 3-year warranty

ADVGENFL8EXP

Gentex Frameless Rear-View Mirror

- Auto-Dimming
- 3-year warranty



ADVGENFL85EXP

Gentex Frameless Rear-View Mirror

- Auto-Dimming
- Self-calibrating Compass
- HomeLink® 5 button integration
- 3-year warranty



AUTO-DIMMING MIRRORS WITH RCD / OFFERS A REAR CAMERA DISPLAY IN ADDITION TO DELIVERING THE SAME AUTO-DIMMING TECHNOLOGY.

ADVGENM2S

Gentex Rear-View Mirror

- Auto-Dimming
- 3.3" RCD
- 3-year warranty



ADVGENM5S

Gentex Rear-View Mirror

- Auto-Dimming
- Self-calibrating Compass (in RCD window)
- 3.3" RCD
- 3-year warranty



ADVGENM45S

Gentex Rear-View Mirror

- Auto-Dimming
- 3.3" RCD
- HomeLink® 4 button integration
- Self-calibrating Compass (in RCD window)
- 3-year warranty





UNIVERSAL GARAGE DOOR OPENER

HomeLink is a universal, programmable transmitter for operating garage doors, security gates and more. Millions of HomeLink units are sold annually on cars and trucks around the world. This unique utility module brings the safety and convenience of HomeLink to your tractor, utility vehicle, motorcycle or ATV.

GENHLBP1 HomeLink® Utility Module

- Two, easy-to-program buttons
- Acts as a universal remote for garage doors, state/security gates, home lighting and more
- Rugged, waterproof construction
- Works with over 99% of garage door and gate opening systems
- Conveniently replaces bulky remote transmitters
- Mounts easily in dash for factory-install look
- Long-life, self-contained battery
- 3-year warranty

DIMENSIONS:
HEIGHT: 2 IN. (5.07 CM)
WIDTH: 1 IN. (2.54 CM)
DEPTH: 3 IN. (7.62 CM)



3-BUTTON, RADIO-FREQUENCY TRANSMITTER, PROGRAMMED TO CONTROL HOME GARAGE DOORS, GATES, LIGHTING, SECURITY SYSTEMS, AND MORE.

ADVGENHL5ALL

Homelink® 5 Module

- Includes Module and Harness
- Includes all 3 colored bezels (Tan, Gray & Black)



HOMELINK® BEZELS

ADVGENHLBLK

Homelink® 5 - Black Bezel



ADVGENHL5TAN

Homelink® 5 - Tan Bezel



ADVGENHL5GRY

Homelink® 5 - Gray Bezel



GENTEX MIRROR MOUNTS

COMPATIBLE WITH ALL AVAILABLE VOXX REAR-VIEW MIRRORS

GENMM1

Volkswagen/ Audi Mount



GENMM2

Tri Lobe Adapter for Multiple Vehicle Applications



GENMM3

Cam Lock Adaptor primarily used on Honda/Subaru



GENMM4

Sprinter VAN Mount



GENMM5

Universal Wedge-to-Wedge Extension Mount



4120436

10 FT. FDM Camera Extension Harness



GENCAMHAR

Backup Camera Harness For Adding Backup Camera to FDM



RVM740SM

7.8" Wide-screen WVGA TFT Display Voxx Smart Mirror with full Android™ Operating System

- Built-In HD Driving Video Recorder - 1080 x 720 Pixels, 6 Layers Glass Lens Camera, real 180° Viewing Angle.
- Touch-Free Controls via Proximity Sensor - Touch-Less On/Off Control & Snapshot using the Built-In Proximity Sensor.
- Hands-Free Bluetooth® speaker phone - answer & end calls through Bluetooth® connection, built-in microphone helps to minimize noise & deliver clear voice prompts from the built-in speaker or through the vehicle's audio system.
- Enhanced Visual Safety - use (3) video inputs to connect one of Voxx's back-up cameras and/or to use as a blind spot camera to automatically see & view behind the vehicle when place in reverse or use the turn signal to turn on.



RVM744

OEM Style Replacement Mirror with 7.3" Wide-screen High Brightness Monitor

- (4) Video Inputs
- Automatic LCD Brightness control.
- Adjustable parking lines.
- Wireless Remote Control for easy setup of options.
- Wired Dash Mount Remote Control for easy setup of options
- Standard RCA type Video Connections.
- Full And Split Screen modes allow multiple camera connection.
- Includes mounts for standard slip on mount (Domestic vehicles) as well as Honda and Hyundai / Kia mounts.
- Compatible with PAL / NTSC systems.



RVM200

Replacement Rear-view Mirror with 4.3" High Brightness Monitor

- OEM style replacement mirror with 4.3" High Brightness monitor.
- Includes mounts for standard slip on mount (Domestic vehicles) as well as Honda and Hyundai / Kia mounts.
- Automatic monitor brightness adjustment.
- High brightness 1000 CD/m back-lit screen.
- Adjustable backup guide lines.
- Dual video inputs.
- Remote control.
- 480 x 272 resolution.
- Compatible with PAL / NTSC systems.
- 3 year warranty.

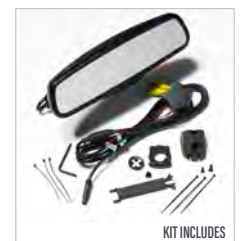

///ADVENT®

The POWER LIFT-GATE offers added convenience to the way you can open your rear LIFT-GATE. Offering you keyless solutions with buttons conveniently located at the front and rear of the vehicle. Simply press and go! Let the POWER LIFT-GATE take care of the rest.

ADVLFT Power lift-gate

- Remote Control that integrates Vehicle's Factory Keyless Entry System.
- Adjustable Height and Speed Allows Personal Control Over Your Lift-Gate.
- Smart Protection against Closing when objects are present.
- Front and Rear of Vehicle are equipped with OEM Style Buttons.
- Compatible with VOXX'S FOOT WAVE - Foot Activated Sensor System. (Add on Accessory - LFTFW)
- 3 Year Warranty.
- Available for Chevrolet, Ford, Honda, Toyota, KIA, Hyundai and more
- For the most up-to-date applications, go to our Power Lift-Gate Finder: adventproducts.com



FOOT WAVE is the add-on accessory for Power Lift-gate. This NEW added option allows your Foot to Activate the Power Lift-gate and open the trunk, giving you hands-free control for extra added convenience. The FOOT WAVE product is a sensor that must be professionally installed into the bottom of the vehicle's bumper in order to activate the Power Lift-gate/trunk release.

LFTFW Foot Activated Sensor System

- Hands-free activated accessory add-on for Power Lift-gate/trunk release Foot Activated feature.
- Simply move your foot beneath the rear bumper to open the Power Lift-gate/trunk release automatically.
- 24" - 30" distance for Smart Sensor activation to ensure safety of people and vehicle.
- Designed to be waterproof, dust-proof and anti-vibrational.
- Universal application for vehicles equipped with Smart Key Push-to-start Passive Key-less Entry. Compatible with Factory OEM Power Lift-Gates.
- 3 Year Warranty.

* Professional Installation Required

ADVENT

Voxx Blind Spot Detection systems are equipped with interior LED indicators for audio and visual alerts that are activated with rear cross traffic feature which senses vehicles approaching while in reverse as well as vehicles, people or objects entering the blind spot of the vehicle.

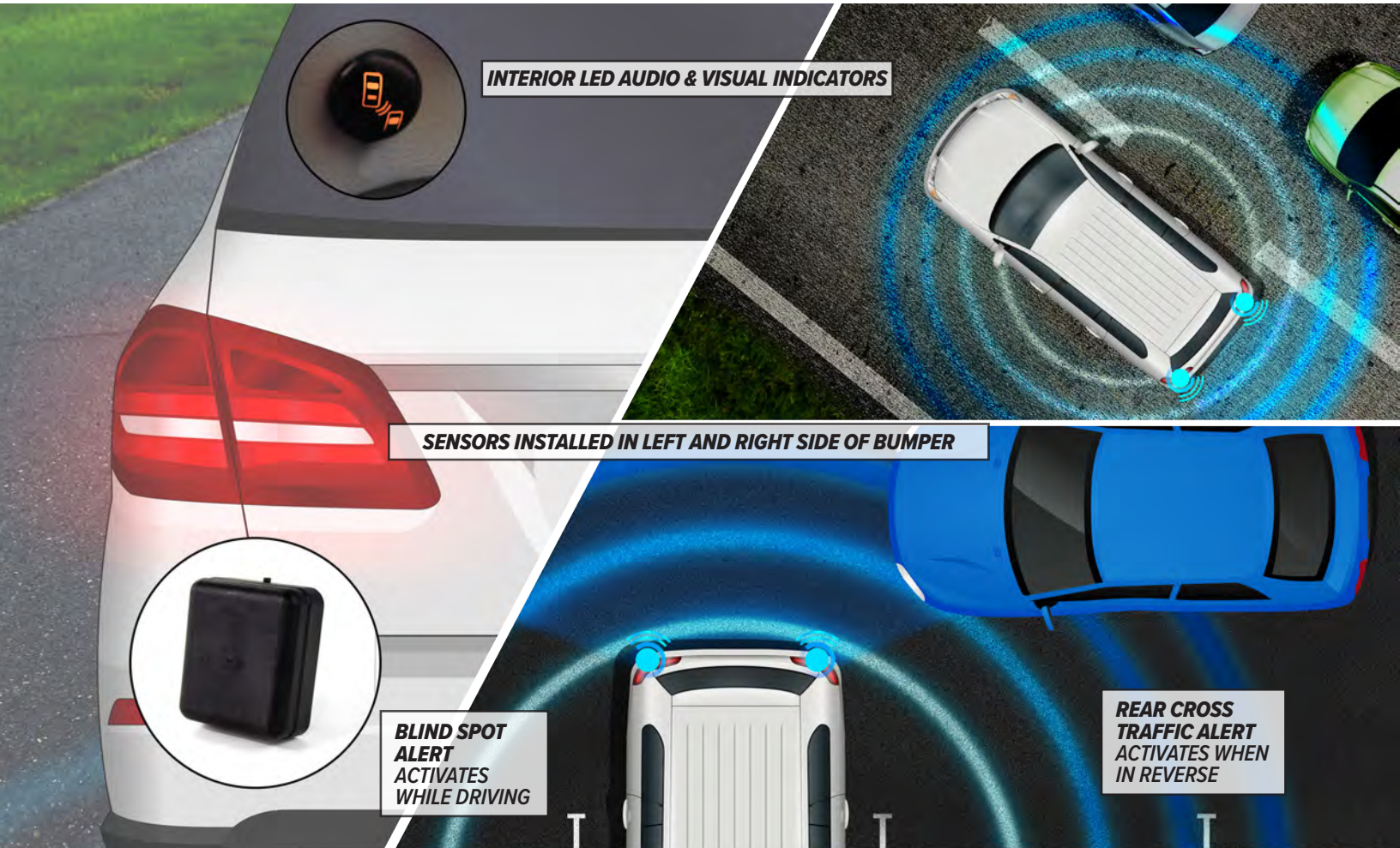

INTERIOR LED AUDIO & VISUAL INDICATORS

SENSORS INSTALLED IN LEFT AND RIGHT SIDE OF BUMPER

BLIND SPOT ALERT ACTIVATES WHILE DRIVING

REAR CROSS TRAFFIC ALERT ACTIVATES WHEN IN REVERSE

ADVBSD30

Voxx's **BLIND SPOT DETECTION 3.0** is equipped with interior LED indicators for audio and visual alerts that are activated with the new added overtaking feature which alerts when the equipped vehicle passes another vehicle, rear cross traffic feature which senses vehicles approaching while in reverse as well as the standard vehicles, people or objects entering the blind spot of the vehicle.

- New Overtaking alert - alerts when equipped vehicles passes another vehicle
- Standard driving Blind Spot alerts are shown when other vehicles, people or objects enter the Blind spot of the vehicle
- Equipped with Rear Cross Traffic which alerts the driver of vehicles approaching from the left or right while in reverse
- Blind spot radar sensors located behind the bumper for simplified professional installation
- Blind Spot Speed activation at 15mph via built-in GPS Technology
- Audible & Visual LED indicator alerts
- Waterproof IP67 rated
- Includes new mounting bracket options for faster installation
- Sensor Alignment tool included in every kit
- 3 year warranty



KIT INCLUDES

ADVBSD25

Voxx's **BLIND SPOT DETECTION 2.5** is equipped with interior LED indicators for audio and visual alert. The rear cross traffic feature which senses vehicles approaching while in reverse as well as the standard vehicles, people or objects entering the blind spot of the vehicle.

- Standard driving Blind Spot alerts are shown when other vehicles, people or objects enter the Blind spot of the vehicle.
- Equipped with Rear Cross Traffic which alerts the driver of vehicles approaching from the left or right while in reverse.
- Blind spot radar sensors located behind the bumper for simplified professional installation.
- Blind Spot Speed activation at 20mph via built-in GPS Technology.
- Audible & Visual LED indicator alerts.
- Waterproof IP67 rated.
- 3-year warranty.



KIT INCLUDES

The LICENSE PLATE BLIND SPOT SYSTEM is equipped with interior LED indicators for audio and visual alerts that is activated with the new added rear cross traffic feature which senses vehicles approaching while in reverse as well as the standard vehicles, people or objects entering the blind spot of the vehicle.



ACABSDLP

License Plate Blind Spot Detection System

- Equipped with Rear Cross Traffic which alerts the driver of vehicles approaching from the left or right while in reverse
- vBuilt-in Blind spot radar sensors located at the bottom for simplified professional installation
- Blind Spot Speed activation at 20mph via built-in GPS Technology
- Audible and Visual interior LED indicator alerts
- Includes Flush Mount LED indicator lights
- Waterproof IP67 rated
- 1 year warranty



* Professional Installation Required

ACABSDLP2

License Plate Blind Spot Detection System

- Standard Blind Spot alerts when vehicles, people or objects enter the Blind Spot of the vehicle
- Built-in Blind Spot radar sensor mounts to license plate.
- Blind Spot activation at 20mph via built-in GPS Technology.
- Audible and Visual indicator alerts.
- Includes Flush Mount and Surface Mount LED indicators.
- Waterproof IP67 rated
- 3 year warranty



* Professional Installation Required

LOOK-IT™ SMART WAY TO BACK-UP



WIRELESS BACK-UP CAMERA SYSTEM FOR PARALLEL PARKING USING YOUR SMARTPHONE

LI-850W Wireless Back-up Camera System

LOOK-IT Rear Vision System will assist you with a perfect parking experience. Parallel parking is a snap with the smart predictive backup lines showing in the destined path. Improve your safety and turn your iPhone or Android into a wireless backup camera rear vision system. LOOK-IT features one-touch operation for safe driving and instant activation.



INCLUDES:

- (1) LICENSE PLATE HOLDER WITH BUILT-IN WIRELESS CAMERA
- (1) QUICKVIEW WIRELESS REMOTE WITH DASHBOARD AND STEERING WHEEL MOUNT
- (1) HARDWARE KIT - INCLUDING LICENSE PLATE HOLDER, BRACKETS AND SCREWS
- (1) MAGNETIC UNIVERSAL SMARTPHONE HOLDER

- State-of-the-art technology connects wirelessly to your smartphone.
- Compatible with iOS and Android smartphones.
- One-touch QuickView technology - wireless remote automatically enables the camera and launches smartphone applications.
- Easy do-it-yourself installation.
- Smart grid line calibration and adjustable camera angle.
- Optional automatic activation when in reverse.
- Rugged, waterproof license plate holder, with long-lasting replaceable battery.



PSD100D includes multicolor indicator display in addition to audio warnings

PSD100/PSD100D Deluxe Digital Front or Rear (2) Sensor Upgradeable System

- Learning capable - this system can learn to ignore vehicle mounted objects (i.e. bike racks, mounted spare tires, and/or hitch mounted accessories)
- Sensors detect obstacles over 6 feet away from the bumper
- System can be installed as a front or rear sensor system
- Waterproof connectors allow replacement of individual sensors at the bumper
- System is upgradeable to a (4) sensor system using PSD200 (2) sensor add-on kit.
- Warning buzzer mute feature shuts off warning tones when towing or operating the vehicle off-road like OEM systems. Passive re-arming to maintain safety
- Both the sensitivity and the detection range are independently adjustable
- Includes 0°, 4°, 8°, and 16° angle sensor sleeves to fit most bumpers up to 16°
- Sensors can be flush installed without the sleeves for a more OEM look. Sleeves not required in 80% of installations on plastic bumpers
- Adjustable buzzer volume and tricolor LED warning module helps with object range notification - (PSD100D only)
- The front sensor system has a reduced range and uses 'active learning' to detect only obstacles which are getting closer to the vehicle, eliminating false warnings
- The front sensor system requires only accessory power to operate
- Sensors can be painted to match vehicle color
- 3 year warranty
- Three detection zones give the following warnings:
 1. Slow beep within 6.5 - 3.5 feet, flashing **GREEN LED** indicator
 2. Medium beep within 3.5 - 1.3 feet, flashing **YELLOW LED** indicator
 3. Steady tone within 1.3 feet, flashing **RED LED** indicator
 Ranges are approximate and will vary depending on installation, weather conditions, and object size and shape.



PSD200 (BLACK)

(2) Sensor Add-on Kit for PSD100/PSD100D

- Includes (2) sensors, cables, and hardware



SPC3 13/16" Hole saw

- For installing PSD100 sensors without the supporter ring



SPC4 26mm* Hole saw

- For use with PSD100 Sensors in metal bumpers
- *26mm For Sensors When Installed in Metal Bumpers - Always Use the Sensor Sleeve for Any Metal Bumper.



PSA08 Adapter sensor sleeves

- For use with any PSD100 Sensors when Replacing ASRSB Sensors
- Includes (4) Each of the 0° angle sensor sleeves
- Includes (4) Each of the 8° angle sensor sleeves



ACA101D

Flush Mount Back-up Camera

- Multiple Mounting Options
- Selectable Parking Lines: ON/OFF
- Selectable Image: Normal/Mirror
- 150° viewing angle
- Low Light Sensitivity 0.1 LUX
- Waterproof IP68 Rated
- 3-year warranty
- Dynamic Parking Lines

ACA501D / ACA502

Universal Mount Back-Up Camera

- High Performance 1089 HD CCD
- Easy-to-mount Low Profile Metal Housing
- Can be used in Front or Rear of Vehicle
- Selectable Image: Normal/Mirror
- Selectable Parking Lines: ON/OFF
- 180° Viewing Angle
- Low Light Sensitivity <0.1 Lux
- Waterproof IP68 Rated
- Video - NTSC/PAL
- 1-year warranty
- Dynamic Parking Lines

ACA502 Additional feature *Vertical Image Mirroring*

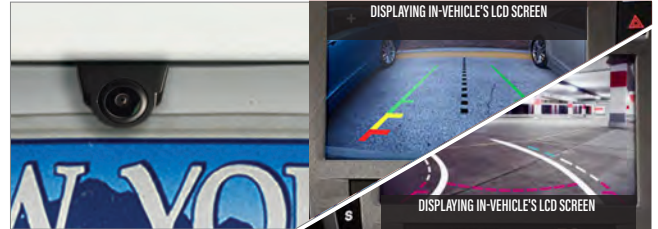
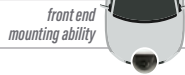

ACA800

License Plate Mounted Back-up Camera

- (2) Mounting Options - License Plate Mount or Adjustable Surface Mount
- Selectable Image: Normal/Mirror
- Selectable Parking Lines: ON/OFF
- 150° viewing angle
- Compact design
- Low light sensitivity <0.3 lux
- Waterproof IP67 Rated
- Resolution: 670 x 490
- 1-year warranty

ACA801

License Plate Mounted Back-Up Camera

- High Performance 1089 HD CCD
- Includes License Plate Bracket and Adjustable Surface Mount
- (2) Mounting Options - License Plate Mount or Adjustable Surface Mount
- Selectable Parking Lines: ON/OFF
- 180° Viewing Angle
- Compact Design
- Low Light Sensitivity <0.1 Lux
- Waterproof IP68 Rated
- Video - NTSC/PAL
- 1-year warranty



CAM336

Premium License Plate Mounted Back-up Camera

- 9 Selectable Styles of Parking Lines
- Low 0.1 LUX HD CCD Lens
- OEM Grade Waterproof Connector
- Two (2) Mounting Options - License Plate Mount or Adjustable Surface Mount
- 160° Viewing Angle
- IP69K Rated Waterproof and Dust Proof Housing
- 3-year warranty



ACAM2

Universal Mount Back-up Camera

- Selectable Image: Normal/Mirror
- (2) Mounting Options - License Plate Mount or Adjustable Surface Mount
- Selectable Parking Lines: ON/OFF
- 150° viewing angle
- Compact design
- Low light sensitivity <0.3 lux
- Waterproof IP67 Rated
- Resolution: 670 x 490
- 1-year warranty

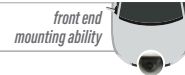

ACAJPCAM1

Jeep Wrangler Spare Tire Mount Camera & Bracket

- Wide-angle Vision: 150° viewing angle offers great visibility with virtually zero blind spots.
- Sight in Low Light: High-sensitivity optics provide excellent low-light performance for maximum visibility after dark.
- IP67 Waterproof: Camera is fully sealed inside a water-tight casing rated for immersion up to 1m.
- Guide Grid: Distance measurements are displayed as a grid overlay to assist with tricky parking.
- Mounts behind the spare tire.
- 1-year warranty

ACCESSORIES



USBCHG2

USB Charging Adapter

- Adds USB charging to any vehicle
- Charges up to 2 devices at one time
- Allows for 2.5 Amp charging
- Includes USB pre-wired Adapter
- Meets current cell phone standards for fast charging

ADAS POP DISPLAYS

LTAA31819V1

RVM740 Rear-view Mirror Non-working Display

- Dimensions: 10" (D) x 12" (W) x 9" (H)



RVM200DISP

RVM200 Rear-view Mirror Non-working Display

- Dimensions: 10" (D) x 12" (W) x 9" (H)



LTAA31419V1

Gentex HomeLink Display

- Dimensions: 12" (W) x 15" (H)



LTAA31619V1

ACABSDLP License Plate BSD Display

- Dimensions: 10" (D) x 12" (W) x 9" (H)



DPADASC

Display Promotion

- PURCHASE \$1000 OF VOXX/ADAS PRODUCTS AND RECEIVE OUR FREE STAND-UP FLOOR DISPLAY. (ALL PRODUCTS USED ON THE DISPLAY WILL BE DISCOUNTED BY 25%)
- Includes Video Screen and Power supply
- Dimensions: 30" (W) x 90" (H)
- Product Display Area: 21.5" (W) x 59.75" (H)
- Must Allow 4 weeks for delivery

AH-D300+

Detachable Train Horn

- 10.5", 14.5" & 15" trumpets
- Chrome-plated brass construction, LIKE A MUSICAL INSTRUMENT
- Compatible with AC-1.5, AC-200-PSI & AC-2.0
- 12V DC solenoid with 1/2" inlet fitting
- 130db @ 110 PSI
- Includes inlet hose
- Includes mounting hardware



AH-300

Chrome Train Horn

- 10.5", 14.5" & 15" trumpets
- Compatible with AC-1.5, AC-200-PSI & AC-2.0
- 12V DC solenoid with 1/2" inlet fitting
- Chrome-plated brass construction, LIKE A MUSICAL INSTRUMENT
- 130db @ 110 PSI
- Includes inlet hose
- Includes mounting hardware

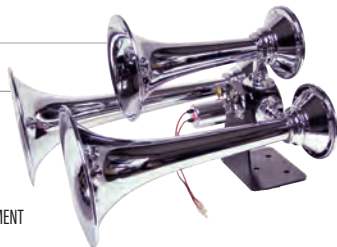

AH-300BLK

Black-Painted Steel Train Horn

- 10.5", 14.5" & 15" trumpets
- Compatible with AC-1.5, AC-200-PSI & AC-2.0
- Steel construction, coated with a corrosion-resistant black coating
- 12V DC solenoid with 1/2" inlet fitting
- 130db @ 110 PSI
- Includes inlet hose
- Includes mounting hardware



AH-250

Small Horn & Compressor Kit

- Dual horn assembly with 12" & 10" trumpets
- Chrome-plated brass
- Tank-less compressor included
- Mounting hardware included
- 110db



OMEGA STROBE LIGHT

OMEGA COMPRESSORS



STR-F09

Expandable, Push-In Style LED Kit

- Included 2 bulbs - white LEDs
- Bulbs can be inserted into headlight housing or surface mounted
- Selectable low or high power
- Operates on 12v power supply
- 9 flash patterns with 1 kit, 19 flash patterns with 2 kits
- Includes flange kit for surface mounting
- Includes compact, low heat controller
- Includes extension cable
- Wire multiple kits in parallel to synchronize
- Can use existing analog strobe wiring for upgrading
- "On" mode for fog light function

AC-1.5MP

1.5 Gallon Compressor - 110 PSI

- 150 PSI maximum working pressure
- 1.5 gallon tank
- 12V operation
- 25% duty cycle at 100 PSI & 72°F
- Tank refill rates: 0 to 120 PSI - 2 min. 15 sec.
- 90 to 120 PSI - 35 sec.
- Pressure switch: 90 PSI on, 120 PSI off
- Dimensions: 15" L x 6" W x 13" H
- Net weight: 15.65 lbs.
- Max amp draw: 20 amps
- Permanent magnetic motor
- Safety valve
- Drain cock
- Leader hose with check valve



AC-2.0MP

2.0 Gallon Compressor - 145 PSI

- 150 PSI maximum working pressure
- 2 gallon tank
- 12V operation
- 30% duty cycle at 100 PSI & 72°F
- Tank refill rates: 0 to 145 PSI - 3 min. 40 sec
- 110 to 145 PSI - 1 min. 15 sec
- Pressure switch: 110 PSI on, 145 PSI off
- Dimensions: 18.9" L x 5.9" W x 13.7" H
- Max amp draw: 20 amps
- Permanent magnetic motor
- Safety valve
- Drain cock
- Leader hose with check valve



OMEGA BRACKETS

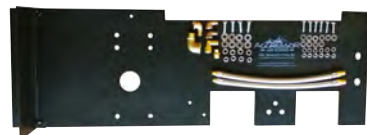

BRACKET-FORD-SD-KIT

- Fits 1999-2016 Ford Super Duty Trucks
- Mounting points for AC-1.5 or AC-2.0 compressor & tank with AH-D300+ Air Horn
- Black powder coated finish
- Built from 3/8 aluminum for strength and corrosion resistance
- Compressor and Horn mounting hardware included
- Hose extension and coupler included
- Also compatible with Vair 20003 & 20005 compressors



BRACKET-COMP-2-KIT

- Universal mounting bracket for separated AC-1.5 compressor & tank
- Allows slim mounting profile for mounting on vehicle frame
- Built from 3/8 aluminum for strength and corrosion resistance
- Black powder coated finish
- Access hole for tank drain
- Compressor mounting hardware included
- Hose extension and coupler included
- Optional 90air outlet fitting included

BRACKET-COMP-1-KIT

- Universal mounting bracket for full assembled AC-1.5, AC-2.0 or AC-200 PSI compressors
- Built from 3/8 aluminum for strength and corrosion resistance
- All compressor mounting hardware included
- Black powder coated finish
- Access hole for tank drain

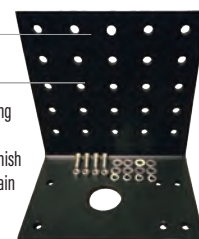

POWERSPORTS SECURITY SYSTEM

The Prestige Powersports Security system was developed for motorcycles, ATVs, boats, snowmobiles and other vehicles open to extreme conditions. The APSPS1 compact design is waterproof and IP65 rated. The system features (2) micro sized 2-button waterproof remote controls.

The APSPS1 also includes a closed loop trigger that can be used for protecting items like helmets. Once the closed loop trigger is broken, the system will activate. Additional features include an on-board tilt & shock sensor, extra trigger input, and (1) auxiliary output.

APSPS1

- Compact, Water-resistant Security System for Motorcycles, ATVs, Boats, and more
- (2) Micro Two-Button Waterproof Remote Controls
- On-board Tilt and Shock Sensor
- Mini Water-resistant Siren
- (1) Additional Trigger Input
- (1) Auxiliary Output
- Loop Trigger for protecting Helmets, etc. - if loop is broken, system triggers



Photo courtesy of Yamaha Motor Corporation USA. All rights reserved.

connect to. convenience



EXPAND YOUR REACH. Why not put your BRAND on REMOTE START?





NEW TO CARLINK 6 CELLULAR & CARLINK LONG RANGE

You now have the ability to offer your customers a Remote Start APP with your BRAND allowing you to raise brand awareness and connect your customers directly with specials and promotions via customized push notifications.

YOUR BRAND. YOUR APP.

TAKE YOUR BUSINESS TO A WHOLE NEW LEVEL BY OFFERING YOUR CUSTOMERS THEIR OWN BRANDED PERSONAL APP.

THE BENEFITS OF GETTING YOUR OWN CUSTOM BRANDED APP:

- 
INNOVATIVE PRODUCTS
 Offer unique connected products that will provide your customers with a new experience of connectivity between them and their vehicle.
- 
PERSONALIZED
 Provided a more personalized experience to your customers.
- 
PROFESSIONAL
 Get ahead of retailers who don't offer a Branded APP.
- 
BRANDED
 Raise more brand awareness and get discovered in the market. Connect directly to you customers through customized push notifications.
- 
CONVENIENT
 My Branded APP dashboard is easy to use and will create your custom APP in a simple breeze.



CONNECT WITH CELLULAR 6 Professional Installation Required

CARLINK™ 6 ASCL6

Cellular 6 offers today's most complete convenience and security solution. Cellular 6 transforms traditional smartphones into a virtual transmitter to communicate with vehicle when hardware is installed to allow smartphone app virtually unlimited range (based on cellular coverage) to operate remote start and security system.

- Remote Start/ Keyless Entry
- Door Lock/Unlock
- Door Lock Status
- Battery Voltage Status
- Vehicle Locator / GPS
- First Year Service Included (2nd Year \$ 29.95)



CONTROL	CONNECT	LOCATE
access your remote start & security vehicle control anywhere with cellular coverage.	set and configure your vehicle so no matter who is using it you stay connected.	track or share your vehicle, enabling you to be informed of it's current location.

ASCL63YR included features above except 3 YEAR SERVICE INCLUDED.

FLCL6HAR required when adding ASCL6 to stand alone FLCAN Applications. (Shown on pg 35)

CONNECT WITH LONG RANGE Professional Installation Required

CARLINK™

Long Range

Long Range when smartphone communicates with 2-way remote (150' range) to windshield mount LoRa BLE for over 1 mile of operating range to operate remote start and security system.

CLLRCC



ASCLBTLR



- No monthly fees
- Rapid response – Command confirmation in less than one second
- Real time smartphone interaction
- Intuitive user display
- Alarm notification with zone identification
- True runtime mode
- Cabin temperature
- Vehicle and transmitter battery level indicator
- Multi-vehicle operation

- 2-Way Remote with over 1 mile of operating range
- Micro USB rechargeable battery
- Alarm Notification
- Low Battery detection
- Multi vehicle operation

- True 2-way communications powered by LoRa technology
- Compatible with most digital remote start and security systems
- BLE Direct Connect pair up to (4) smartphones directly to transceiver

Optional Basic Content Protection*

- 3 axis accelerometer with shock sensor / Dual flashing LED's
- (+/-) Door/Horn input / Horn output
- Integrated valet/programming button

THE FLASHLOGIC LINE OF REMOTE START, VEHICLE SPECIFIC DATA START MODULES AND TRANSPONDER / DOOR LOCK INTERFACE MODULES ARE THE MOST ADVANCED AND COMPREHENSIVE LINE-UP IN THE INDUSTRY TODAY. THE PROGRAM CONSISTS OF THREE SEPARATE PRODUCT OFFERINGS, DESIGNED TO MEET THE NEEDS OF EVERY SECURITY & REMOTE START INSTALLATION FOR TODAY'S COMPLEX VEHICLES. THE ENTIRE FLASHLOGIC LINE-UP WAS DEVELOPED IN CONJUNCTION WITH AUTOMOTIVE DATA SOLUTIONS (ADS) AND BRINGS TOGETHER THE ADVANCED TECHNOLOGY OF ADS WITH THE CORE SECURITY AND REMOTE START FEATURES OF THE VOXX PRODUCT LINES. FLASHLOGIC IS THE GATEWAY TO THE VEHICLES ELECTRONIC SYSTEM - THE ULTIMATE IN VEHICLE INTEGRATION.

FLRSBA

Programmable Remote Start & Security System

The FLRSBA Security & Remote Start System can be updated with over 100 different firmware versions, covering 7600+ vehicle Applications, and installation is a breeze with the built-in dual FLCAN. It also incorporates dual built-in data converters allowing dealers to add any Prestige, Code Alarm or Pursuit transmitter kit without the need of an external data converter. The FLRSBA is also compatible with Carlink, for Telematics control. The FLRSBA is also compatible with available t-harnesses for thousands of plug-in vehicle applications.



FLRSBA COMPONENTS AND OPTIONAL ACCESSORIES

ADSAHRPWR

High Current 8-Pin Starter Harness

The High Current (HC) harness is used for analog remote start applications where the heavier gauge wire is required.



The installation instructions and programming are the most advanced, installer friendly instructions on the market today. Compatible with Weblink Mobile and FLPROG Web Based Programming.

DYNAMIC INSTALLATION GUIDES

- Application and vehicle specific based on flash-update selection
- Complete installation wiring information provided
 - Vehicle wire colors and location
 - Only required connection shown
 - Includes pre-configured inputs and outputs
- No more external wiring database required
- New format allows quick "pre-wire" and "bench prep"
- Improved and easy to read 1-page wiring schematic



AUTOMATIC SYSTEM CONFIGURATION

- System inputs and outputs will be auto configured when flashed
- The system will be configured per application
- Second IGN/ACC/STT
- Low power ignition harness
- (-) IGN/ACC/STT when required
- Parking lights lock/unlock confirmation



FLASHLOGIC Powered by ADS FLRSBA PROGRAMMERS

Update/Flash your FLRSBA & Flashlogic modules from your PC or compatible Smart-phone.

FLWLMAPI

FlashLogic Weblink Programmer for Apple

Update / Flash your Flashlogic module from your Smartphone. Apple iPhone, iPad compatible.

FLWLMANI

FlashLogic Weblink Programmer for Android

Programmer for Android Smartphones or Tablets.



FLPROG

FlashLogic Programmer / Updater

FlashLogic PC to Module USB interface cable. Required to program / upgrade FlashLogic transponder/ door lock interface kits, and new Prestige/Pursuit "z" series models.



The FLRSBA compatible t-harness program allows you to mix and match vehicle specific t-harness kits while using a single module (FLRSBA) controller solution. For a complete list of vehicle applications go to www.flashlogic.com.



FlashLogic FLRSBA Compatible T-Harness Kits

Model #	Description	"UPC Code	*MC QTY
ADSTHRCH4	Chrysler CH4 T-Harness Kit	6-27780-00519-5	16
ADSTHRCH5	Chrysler CH5 T-Harness Kit	6-27780-00520-1	16
ADSTHRCH12	Chrysler CH12 T-Harness Kit (replaces ADSTHRCH10)	6-27780-00330-6	16
ADSTHRFO1	Ford F01 T-Harness Kit	6-27780-00521-8	16
ADSTHRFM8	Ford FM8 T-Harness Kit	6-27780-00167-8	16
ADSTHRMA3	Mazda MA3 T-Harness Kit	6-27780-00522-5	16
ADSTHRGM2	GM GM2 T-Harness Kit	6-27780-00516-4	16
ADSTHRGM10	GM GM10 T-Harness Kit	6-27780-00518-8	16
ADSTHRGM12	GM GM12 T-Harness Kit	0-44476-13570-5	16
ADSTHRGM13	GM GM13 T-Harness Kit	6-27780-00346-7	16
ADSTHRHK3	Hyundai / Kia HK3 T-Harness Kit	6-27780-00278-1	16
ADSTHRHK4	Hyundai / Kia HK4 T-Harness Kit	6-27780-00279-8	16
ADSTHRHK5	Hyundai / Kia HK5 T-Harness Kit	6-27780-00250-7	16
ADSTHRHK6	Hyundai / Kia HK6 T-Harness Kit	6-27780-00282-8	16
ADSTHRHK7	Hyundai / Kia HK7 T-Harness Kit	6-27780-00281-1	16
ADSTHRHK8	Hyundai / Kia HK8 T-Harness Kit	6-27780-00280-4	16
ADSTHRHK9	Hyundai / Kia HK9 T-Harness Kit	6-27780-00308-5	16
ADSTHRHA2	Honda HA2 T-Harness Kit	6-27780-00086-2	16
ADSTHRHA3	Honda HA3 T-Harness Kit	6-27780-00616-1	16
ADSTHRHA8	Honda HA8 T-Harness Kit	6-27780-00238-5	16
ADSTHRHA9	Honda HA9 T-Harness Kit (replaces ADSTHRHA6)	6-27780-00239-2	16
ADSTHRHA10	Honda HA10 T-Harness Kit (replaces ADSTHRHA7)	6-27780-00240-8	16
ADSTHRNI3	Nissan NI3 T-Harness Kit	6-27780-00115-9	16
ADSTHRNI4	Nissan NI4 T-Harness Kit	6-27780-00614-7	16
ADSTHRNI5	Nissan NI5 T-Harness Kit	6-27780-00615-4	16
ADSTHRTL5	Toyota TL5 T-Harness Kit	6-27780-00617-8	16
ADSTHRTL7	Toyota TL7 T-Harness Kit	6-27780-00129-6	16
ADSTHRVW1	VW VW1 T-Harness Kit	6-27780-00127-2	16
ADSTHRAU2	VW / AUDI T-Harness Kit	6-27780-00266-8	16
ADSTHRAU3	VW / AUDI T-Harness Kit (replaces ADSTHRAU1)	6-27780-00330-6	16





REMOTE START DATA MODULES WITH CUSTOM T-HARNESS

The Flashlogic Data Start Modules with custom t-harness will allow you to remote start vehicles from the OEM keyless entry transmitter to create an affordable "factory like" remote start system, eliminating the need for a traditional remote start system. Please note that some systems require the optional RF kit to control remote start functions. Optional RF kits or Carlink can also be added for increased operating range. For a complete list of vehicle applications go to www.flashlogic.com.



DATA START SYSTEMS

- Enables remote start from factory key fob (3XLOCK) on most models
- Advanced, fully integrated remote start technology
- No need to relinquish or purchase a costly key
- 'Plug & Play' wiring harness for non-invasive installation
- Compatible with long range remote controls and smart phone solutions sold separately
- 3 Year Warranty

OEM INTEGRATION - PRODUCT INFORMATION

VEHICLE	PART NUMBER	YEAR / APPLICATIONS	MASTER CARTON QTY	RF UPGRADEABLE	CARLINK UPGRADEABLE
FORD	FLRSF01	2006 - UP / 315+ Models	8	Yes	Yes
	FLRSCH4	2007 - UP / 215+ Models	8	Yes	Yes
CHRYSLER	FLRSCH5	2005 - UP / 190+ Models	8	Yes	Yes
	FLRSCH10	2011 - UP / 185+ Models	8	Yes	Yes
GM	FLRSGM2	2004 - UP / 100+ Models	8	Yes	Yes
	FLRSGM7	2010 - UP / 175+ Models	8	Yes	Yes
	FLRGM10	2006 - UP / 515+ Models	8	Yes	Yes
	FLRSBMZ	Mercedes/BMW Control Module	8	Yes	N/A
BMW / MERCEDES	ADSTHRBM1	BMW T-Harness / Controller	8	N/A	N/ABM
	ADSTHRBZ1	Mercedes T-Harness / Controller	8	N/A	N/A
	ADSTHRBZ2	Mercedes T-Harness / Controller	8	N/A	N/A
	ADSTHRBZ3	Mercedes T-Harness / Controller	8	N/A	N/A
	ADSTHRBZ4	Mercedes T-Harness / Controller	8	N/A	N/A



FLCMVV

VW/AUDI Data Start Module

Data Start module for select Volkswagen and Audi models 2006 and up. Enables remote start, security, convenience integration and more. Compatible with long range RF kits and ADSTHRVW1, and ADSTHRAU2 T-harness sold separately.



ADSTHRVW1

VOLKSWAGEN / AUDI T-harnesses

Factory fit installation T-harness for select Volkswagen/Audi models from 2006 and up (VW1).



ADSTHRAU2 / ADSTHRAU3

AUDI/VW T-harnesses

Factory fit installation T-harness for select Audi/VW models.v

FLASHLOGIC TRANSPONDER AND DOOR LOCK INTERFACE MODULES AND EXCLUSIVE DBI PORT ARE THE GATEWAY TO THE VEHICLE'S ELECTRONIC SYSTEM-THE ULTIMATE IN INTEGRATION.

Our Smartphone App or long range transmitter kits can be paired with the FLCAN or Data Start Modules when long range operation is needed.

FLCAN

CAN Door Lock & Transponder Interface with KLon Technology

The FLCAN is a CAN BUS interface control module that has all of our Flashlogic Applications built into one programmable module. The FLCAN also enables remote start from the factory key fob (3XLOCK) for many vehicles. Compatible with long range remote controls and smart phone solutions sold separately. For a complete list of specific vehicle applications, go to www.flashlogic.com.



FLCART

CAN Door Lock & Transponder Interface with KLon Technology - Plug-in Cartridge

The FLCART is a CAN BUS interface control module that has all of our Flashlogic Applications built into one slide in cartridge. This solution allows for a cleaner installation, and is only compatible with Prestige, Pursuit or Code Alarm products with FLCART port. For a complete list of specific vehicle applications, go to www.flashlogic.com.



FLTB1

Transponder Data Interface

Data Transponder interface module that is programmable with specific Transponder Interface firmware from the FlashLogic library.



FLDL1

Door Lock / Convenience with GM & Honda Transponder Interface

Door lock interface module programmable with specific Door Lock firmware from the FlashLogic library. It also controls various convenience features and supports transponder interface where applicable.



ADSTBSLVW1

VW/AUDI Immobilizer Bypass

Web-programmable Immobilizer Bypass for multiple VW/Audi vehicle models from 2006 to present.

FLASHLOGIC by VOXX **ACCESSORIES**



MBTOOL

Mercedes Benz Ignition Switch Removal Tool

This tool allows for easy removal of the Mercedes Benz Ignition Switch for installation of our Mercedes Data Start Remote Start Systems.



KITB

Universal Transponder Interface Kits

Universal Remote Start Transponder Interface with key sense shut-off for most vehicles (key required). New larger case capable of holding larger key-headed transmitters.

FLCL6HAR

ASCL6 to FLCAN Harness

Required when adding the ASCL6 to the FLCAN in a stand alone FLCAN 3X lock to start application for Smartphone Control.



CADATA

RF to Data Converter

Required when adding Code Alarm transmitter kits to the AS9234E, FLCAN or FLRS Data Start Systems. The CADATA is NOT required for the Flashlogic FLRSBA system, and is NOT compatible with Prestige or Pursuit transmitter kits.



ADSHRNRSXL02

Adapter harness for DEI RF Kits for Data Start Systems (10 per pack)



ADSHRNSM01

Adapter harness for DEI Start for Data Start Systems (10 per pack)



HRNPKAL2

Complete Harness Pack for FLCAN (8 per pack)



PRESTIGE TRANSMITTER KITS



PE1BZ
One-Way 1-Button Remote Control
 • (2) 181BP One-Way Transmitters
 • (1) 4180074 Antenna/Receiver
 • (1) 4120464 Antenna/Receiver Harness



PE1BZLR
One-Way 1-Button Remote Control
 • (2) 181SP One-Way Transmitters
 • (1) 4180067 Antenna/Receiver
 • (1) 4120464 Antenna/Receiver Harness



PE1BTWZ2
Two-Way 1-Button Remote Control
 • (2) 181TWP Two-Way Transmitter
 • (1) 4180068 Antenna/Receiver
 • (1) 4120464 Antenna/Receiver Harness



PE5BZ
One-Way 5-Button Remote Control
 • (2) 185SP One-Way Transmitters
 • (1) 4180067 Antenna/Receiver
 • (1) 4120464 Antenna/Receiver Harness



PE2LEDZ
Two-Way LED Remote Control
 • (1) 185TWP Two-Way Transmitter
 • (1) 185SP One-Way Transmitter
 • (1) 4180075 Antenna/Receiver
 • (1) 4120464 Antenna/Receiver Harness



PEIM2LEDZ
Two-Way LED Remote Control
 • (2) 181WLR Two-Way Transmitters
 • (1) 4180069 Antenna/Receiver
 • (1) 4120464 Antenna/Receiver Harness



PE2LCDZ
Two-Way LCD Remote Control
 • (1) 18LCDSP Two-Way LCD Transmitter
 • (1) 185SP One-Way Transmitter
 • (1) 4180068 Antenna/Receiver
 • (1) 4120464 Antenna/Receiver Harness



PE2RELCDZ
Two-Way LCD Remote Control
 • (1) 18LCDRE Two-Way Rechargeable LCD Transmitter
 • (1) 185SP One-Way Transmitter
 • (1) 4180075 Antenna/Receiver
 • (1) 4120464 Antenna/Receiver Harness



PEIM2LCDZ
Two-Way LCD Remote Control
 • (1) 18LCDLOR Two-Way LCD Transmitter
 • (1) 181WLR Two-Way LED Transmitter
 • (1) 4180069 Antenna/Receiver
 • (1) 4120464 Antenna/Receiver Harness

PROFIT TRANSMITTER KITS



PR1BZ
One-way 1-Button Remote Control
 • (2) 181BPR One-Way Transmitters
 • (1) 4180074 Antenna/Receiver
 • (1) 4120464 Antenna/Receiver Harness



PR1BZLR
One-way 1-Button Remote Control
 • (2) 181XPR One-Way Transmitters
 • (1) 4180067 Antenna/Receiver
 • (1) 4120464 Antenna/Receiver Harness



PR1BTWZ
Two-way 1-Button Remote Control
 • (2) 181TWPX Two-Way Transmitters
 • (1) 4180075 Antenna/Receiver
 • (1) 4120464 Antenna/Receiver Harness



PR5BZ
One-way 5-Button Remote Control
 • (2) 185SPR One-Way Transmitters
 • (1) 4180067 Antenna/Receiver
 • (1) 4120464 Antenna/Receiver Harness

CODE//ALARM TRANSMITTER KITS



CA1B6
One-Way 1 Button Remote Control
 • (2) CAT1LR One-Way Remote Control
 • (1) 4180065 Antenna
 • (1) 4120388 Antenna Harness



CA1BTW6
Two-Way 1 Button Remote Control
 • (1) CAT1TW6 Two-Way Remote Control
 • (1) CAT1LR One-Way Remote Control
 • (1) 4180064 Antenna
 • (1) 4120388 Antenna Harness



CA4B5E
One-Way 4 Button Remote Control
 • (2) CAT4ME One-Way Remote
 • (1) 4180065 Antenna
 • (1) 4120388 Antenna Harness



CA2LED5E
Two-Way 5 Button Remote Control
 • (1) CATMLEDE Two-Way Remote Control
 • (1) CAT4ME One-Way Remote Control
 • (1) 4180064 Antenna
 • (1) 4120388 Antenna Harness



CA2LCD5E
Two-Way 5 Button Remote Control
 • (1) CATLCDE Two-Way Remote Control
 • (1) CAT4ME One-Way Remote Control
 • (1) 4180064 Antenna
 • (1) 4120388 Antenna Harness

MBS

The MBS is a compact Multi-tone siren designed for vehicles with limited space in the engine compartment. The built-in Back Up battery provides additional protection to your vehicle in the event the vehicle's battery becomes disconnected or discharged.



DA1

Single Door Lock Actuator. Standard 2 wire door lock actuator for adding power door locks to most vehicles.



DA2

Clutch type heavy duty Door Lock Actuator



PROPDL45

Four Door Heavy Duty Power Door Lock Kit. Includes everything you need to add power door locks to a four door vehicle.



DLRKP

Door Lock Relay Kit. Pre-wired door lock relays designed for easy, time saving installations.



NCTM

Simplifies door trigger connections on Ford, Lincoln and Mercury vehicles. 5 Normally closed trigger inputs. 1 Negative Trigger output. Connect to trailer wiring and detect trailer disconnect. Small compact housing - 55mm x 35mm x 13 mm.



AS9903E

Ultra Mini Alarm Siren.



PROPDA1

Single Door Lock Actuator. Deluxe 2 wire door lock actuator for adding power door locks to most vehicles.



PROPDL25

Two Door Heavy Duty Power Door Lock Kit. Includes everything you need to add power door locks to a two door vehicle.

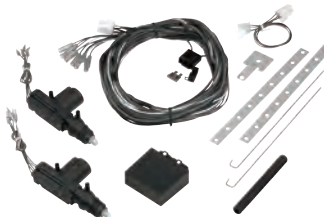

CLBK

Cable Lock Bracket Kit. Interfaces with door actuator and cable operated latch mechanism to provide door lock / unlock operation.

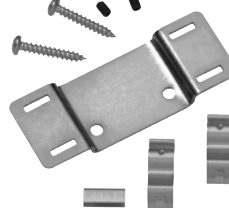

DLVI

Door Lock Voltage Inverter. Converts a negative input to a positive 1A output. Ideal for switching a (-) alarm door lock / unlock output to a (+).



DTD11

Door Trigger diode interface



DUB1

The DUB1 Digital Tilt Sensor is activated by the armed output of your vehicle's alarm system. Once activated, the DUB1 integrated microchip nanomechanics and a digital signal processing micro-processor to instantly and continually analyze all pitch, yaw and motion data. The result is a tilt sensor that, regardless of conditions, detects less than one degree of lifting or any motion of the vehicle without error.



CAGBS

The CAGBS provides protection against entry to the vehicle when the security system is armed by detecting the breaking of vehicle glass. The remote microphone is designed to analyze the frequency of breaking glass to eliminate false trigger conditions.



AS9492A

Dual Stage Piezo Shock Sensor. This dual stage sensor sounds the siren on "light touch" impact to the vehicle and instantly triggers the security system upon a harder "full" impact.



ASRLY

30/40 AMP S.P.D.T. Relay



MRLY

20 AMP Mini Relay. The MRLY is designed for low current applications.



AVXDATA

RF TO DATA CONVERTER

Required when adding any NON "Z" series Prestige/ Pursuit transmitter kits to the AS9234E, FLCAN or FLRS Data Start Systems.



MV3

The MV3 is the most reliable vehicle intrusion sensor on the market today. Detects moving objects within the vehicle using a unique RF technology. Ideal for convertibles.



AS94954P

Dual Stage infrasonic shock sensor. This dual stage sensor sounds the siren on "light touch" impact to the vehicle and instantly triggers the security system upon a harder "full" impact



CPT2

ADD ON INTERIOR THEFT & DIGITAL TILT SENSOR

The CPT2 sensor picks up where your factory (OEM) security sensor leaves off. If you don't know, most OEM security systems simply offer a device that prevents the vehicle from starting, and does little to protect the contents, wheels & tires and your personal belongings.



ASRLYH

Universal 5 wire relay socket with 12" wires. 5-pack - Price is for a package of 5.



CADATA

RF TO DATA CONVERTER

Required when adding Code Alarm transmitter kits to the AS9234E, FLCAN or FLRS Data Start Systems. The CADATA is NOT required for the Flashlogic FLRSBA system, and is NOT compatible with Prestige or Pursuit transmitter kits.



PBLED

Push button LED / valet button / combination blue LED light and valet switch designed for quick, easy accessibility.



1361287

Remote start valet toggle switch.



ASWRP

The ASWRP allows the operation of two windows in both directions. The system also can roll up two power windows when the security system is armed. Windows can also be vented or rolled down completely by remote control.



VEPROG

Computer programming tool used for feature programming on compatible Prestige / Pursuit "E" Series models and Code Alarm "5" Series Models. Also Includes harness to update the Code Alarm CADATA.



FLPROG

FlashLogic Programmer / Updater

FlashLogic PC to Module USB interface cable. Required to program / upgrade FlashLogic transponder/ door lock interface kits, and new Prestige/Pursuit "z" series models.



CAVL1

Module to program the CASEC, CARS or CASECRS component module when not using a transmitter kit.



PRLED

Push button LED / valet button / combination red LED light and valet switch designed for quick, easy accessibility.



1541090

Push button valet / override switch.



CAVHAR

Interface cable to program / update the Code Alarm CADATA using the VEPROG.



LCHAR

Low Current 22GA 6 Pin Remote Start Harness. Some new vehicles today are using smaller gauge wires at the ignition switch, and trying to connect a 14GA wire can be a hassle. Compatible with most Code Alarm models that use the 6 Pin Starter Harness.



ENHANCE YOUR DRIVING EXPERIENCE WITH THE ULTIMATE IN COMFORT AND WARMTH

These SEAT HEATER SYSTEMS can be installed in most vehicles to add warmth and comfort to either cloth or leather seats. They do not change the look of the seat and includes everything you need for one vehicle seat. All of our seat heaters come with a 3 Year Nationwide Travelers Warranty, or 4 Years if installed at a New Car Dealer.

SHSP1

Split Pad, Flex Wire

- (4) 17 by 4 ½ thin flex wire heating pads.
- (1) Position control switch (High/Low/Off).
- Quick heat-up time – less than 1 minute.
- Perfect for seats with occupant pressure sensors. Allows you to mount to the outer part of the seat.
- Continuous temperature monitoring to prevent overheating.
- Relay included.
- Harness with locking connectors and protective sleeve.



SHSB2

Large Kit, Flex Wire

- (2) 10 ½ by 18 ¾ thin flex wire heating pads.
- (1) Position control switch (High/Low/Off).
- Quick heat-up time – less than 1 minute.
- Continuous temperature monitoring to prevent overheating.
- Super strong adhesive for mounting heating pad to seat foam.
- Relay included.
- Harness with locking connectors and protective sleeve.



SHSB1

Large Kit, Carbon Fiber

- (2) 10 ½ by 18 ¾ thin carbon fiber heating pads.
- (1) Position control switch (High/Low/Off).
- Quick heat-up time – less than 1 minute.
- Continuous temperature monitoring to prevent overheating.
- Super strong adhesive for mounting heating pad to seat foam.
- Relay included.
- Harness with locking connectors and protective sleeve.



TOYOTA FACTORY-FIT SEAT HEATER SYSTEM

TOYOTA FACTORY FIT SEAT HEATER SYSTEM can be installed on select Toyota vehicles using the factory “knock-out” locations or any vehicle with a 27.8mm (1.1in) by 19.5mm (0.77in) opening. The SHTOY does not change the look of the seat and includes everything you need to add warmth and comfort to one vehicle seat. The system includes an illuminated adjustable control switch and comes with a 3 Year Nationwide Travelers Warranty or 4 Years if installed at a New Car Dealer.



SEAT HEATER BUTTONS (installed)

SHTOY

TOYOTA SWITCH SEAT HEATER

- (2) 10 ½ by 18 ¾ thin flex wire heating pads.
- Illuminated Adjustable Temp Switch.
- Toyota Factory fit on select models.
- Fits 27.8mm by 19.5mm “knock-out”.
- Quick heat-up time – less than 1 minute.
- Continuous temperature monitoring to prevent overheating.
- Super strong adhesive for mounting heating pad to seat foam.
- Relay controller included.
- Harness with locking connectors and protective sleeve.
- 3-Year Nationwide Travelers Warranty.



ADDITIONAL ACCESSORIES

SHHR1

36" Switch Extension Harness



SHSW1

Replacement Control Switch



Pursuit

CODE/ALARM®

PRESTIGE



REPLACEMENT GUIDE

The following transmitter replacement guide has been developed to guide you through the various replacement transmitters. Each section has been broken down into Group Types, any transmitter within these groups are interchangeable with each other. The transmitters marked "obsolete" are no longer available and should not be ordered. Please note, the transmitters shown on the following page, Transmitter Cross Reference Chart, are the actual transmitters that came with the kit shown. A specific transmitter may now be obsolete or discontinued and replaceable with a similar transmitter within the same "type" section.

KIT MODEL PART #	ONE-WAY TRANSMITTER PART#	TRANSMITTER TYPE	TWO-WAY TRANSMITTER PART#	TRANSMITTER TYPE
AA925	AVX01BT3CL360	Type 2		
APS101	101TXP	Type 13		
APS101N	91P	Type 13		
APS122E	3BP	Type 4		
APS155CH	APS99BT3BCF431	Type 3		
APS15CH	APS02BT2	Type 3		
APS20B	AVX01BT3CL360	Type 2		
APS255A	07S3BP	Type 4		
APS255C	APS99BT3BCF431	Type 3		
APS255CH	APS99BT3BCF431	Type 3		
APS25C	103BP	Type 9		
APS25CH	APS02BT2	Type 3		
APS25E	143BP	Type 20		
APS25HT	APS95BT3	Type 3		
APS25N	07S3BP	Type 4		
APS25Z	183BP	Type 23		
APS410A	APS2K4CF50	Type 3		
APS422E	1BP	Type 9		
APS45B	AVX01BT3CL360	Type 2		
APS45C	91P	Type 13		
APS45N	91P	Type 13		
APS510A	APS2K4MSFLCF110P	Type 6		
APS510B	07SP	Type 4		
APS510C	105BP	Type 9		
APS510E	145BP	Type 20		
APS510N	07SP	Type 4		
APS510Z	185BP	Type 23		
APS511C	APS2K4CF50	Type 3		
APS520	APS620CFP	Type 13	APS920CF2P	Type 13
APS551R	APS95BT3S	Type 4		
APS551RA	APS99BT3SBCF434	Type 4		
APS551TW	APS99BT3SBCF434	Type 4	5BLCR120	Type 8
APS57A	07S3BP	Type 4		
APS57C	103BP	Type 9		
APS57CA	103BP	Type 9		
APS57E	143BP	Type 20		
APS57N	07S3BP	Type 4		
APS57Z	183BP	Type 23		
APS590TWC	APS2K4MSFLCF110	Type 6	5BLCRA122	Type 8
APS596	APS2K4CF50	Type 4	5BCR03	Type 8
APS596A	07SP	Type 4	5BCR07P	Type 8
APS596C	105BP	Type 9	5BCR10P	Type 9
APS596E	145SP	Type 19	5BCR14SP	Type 19
APS596N	07SP	Type 4	5BCR07P	Type 8
APS596Z	185SP	Type 24	18LCDSP	Type 24
APS597	5WTXP	Type 4	UTXP	Type 8
APS610A	APS2K4MSFLCF110	Type 6		
APS610C	APS2K4CF50	Type 3		
APS620	620TXP	Type 13		
APS620N	91P	Type 13		
APS622E	3BP	Type 4		
APS650RS	APS95BT3S	Type 4		
APS686	APS2K4SBCF52	Type 4		
APS687	APS2K4SFLCF112P	Type 4		
APS687A	07SP	Type 4		
APS687C	105BP	Type 9		
APS687E	145SP	Type 19		
APS687N	07SP	Type 4		
APS687TWE	155SP	Type 21	5BER15SP	Type 21
APS786	APS2K4SBCF50	Type 4		
APS787	APS2K4SFLCF110P	Type 4		
APS787A	07SP	Type 4		
APS787C	105BP	Type 9		
APS787E	145SP	Type 19		
APS787N	07SP	Type 4		
APS787Z	185SP	Type 24		
APS800A	APS2K4MSFLCF110	Type 6		
APS800C	APS2K4MS50	Type 6		
APS875A	APS2K4MSFLCF110	Type 6		
APS875C	APS2K4MS50	Type 6		
APS876C	APS2K4MS50	Type 6		
APS900	07S1BP	Type 4		
APS901	A1BTXP	Type 4		
APS901C	101BP	Type 9		
APS901E	141BP	Type 20		
APS901N	A1BTXP	Type 4		
APS901TWE	151SP	Type 21	1BER15SP	Type 21
APS901Z	181BP	Type 23		
APS905	5WTXP	Type 4	UTXP	Type 8
APS920	APS620CFP	Type 13	APS920CF2P	Type 13
APS921	A1BTXP	Type 4	A1BTX2P	Type 4
APS922E	08SP	Type 9	5BCR14P	Type 9
APS995A	APS2K4MS50	Type 6	3BCRAM	Type 14
APS995C	APS2K4MS50	Type 6	5BCR	Type 15
APS996	APS2K4MS50	Type 6	5BCR03	Type 8
APS996A	APS2K4MS50	Type 6	5BCR03	Type 8
APS996C	APS2K4MSFLCF110	Type 6	5BCR03	Type 8
APS997	APS2K4MSFLCF110P	Type 6	5BCR05P	Type 8
APS997A	07SP	Type 4	5BCR07P	Type 8
APS997C	105BP	Type 9	5BCR10P	Type 9
APS997E	145SP	Type 19	5BCR14SP	Type 19
APS997N	07SP	Type 4	5BCR07P	Type 8
APS997Z	185SP	Type 24	18LCDSP	Type 24
APS998	5WTXP	Type 4	UTXP	Type 8
APSR51Z	171BP	Type 20		
APSR53Z	173BP	Type 20		
AS9050	AVX1B4S	Type 4		
AS9055	AVX1B4S	Type 4		
AS9055C	AVX1B4S	Type 4		
AS9055T	AVX1B4S	Type 4		
AS9233ST	S1BTXA	Type 4		
AX45	AVX01BT3CL360	Type 2		
JKRSI	AVX1B4S	Type 4		

KIT MODEL PART #	ONE-WAY TRANSMITTER PART#	TRANSMITTER TYPE	TWO-WAY TRANSMITTER PART#	TRANSMITTER TYPE
JKRSIT	AVX1B4S	Type 4		
PA120C	PA91	Type 18		
PA320C	PA91	Type 18	PA92	Type 18
PA420C	PN1	Type 13		
PA620C	PA91	Type 13		
PA720C	PA91	Type 13		
PA920C	PA91	Type 13	PA92	Type 18
PE1B	141BP	Type 20		
PE1BTW	151SP	Type 21	1BER15SP	Type 21
PE1BTWZ	181SP	Type 24	181TWS	Type 24
PE1BTWZZ		Type 24	181TWS	Type 24
PE1BZ	181BP	Type 23		
PE1BZLR	181SP	Type 24		
PE1M2LCD	PE51M	Type 22		
PE1M2LCDZ				
PE1M2LEDZ				
PE2LCD	145SP	Type 19		
PE2LCDZ	185SP	Type 24		
PE2LED	155SP	Type 21		
PE2LEDZ	185SP	Type 24		
PE2RELCDZ	185SP	Type 24		
PE2RELCD	145SP	Type 19		
PE5B	145SP	Type 19		
PE5BZ	185SP	Type 24		
PR1B	141BPR	Type 20		
PR1BTW	14XR1PR	Type 16	14XR2PR	Type 16
PR1BTWZ	181XPR	Type 24	181TWXPR	Type 24
PR1BZ	181BPR	Type 23		
PR1BZLR	181XPR	Type 24		
PR2LCD	175SPR	Type 19		
PR5B	145SPR	Type 19	5BCR17SPR	Type 19
PR5BZ	185SPR	Type 24		
PR71B	171BPR	Type 20		
PR71TW	171XPR	Type 21	1BER17XPR	Type 21
PR75B	175SPR	Type 19		
PRLED	175XPR	Type 21	5BER17XPR	Type 21
PRO2KAKD	AVX01BT3CL360	Type 2		
PRO2KKD	AVX01BT3CL360	Type 2		
PRO9051	07S1BPR	Type 4		
PRO9051E	18PR	Type 9		
PRO9051I	091BPR	Type 9		
PRO9051N	07S1BPR	Type 4		
PRO9051Z	171BPR	Type 20		
PRO9056	A1BTXPR	Type 4		
PRO9056C	091BPR	Type 9		
PRO9056E	141BPR	Type 20		
PRO9056I	091BPR	Type 9		
PRO9056N	A1BTXPR	Type 4		
PRO9056TW	09XR1PR	Type 16	09XR2PR	Type 16
PRO9056TWE	14XR1PR	Type 16	14XR2PR	Type 16
PRO9056Z	181BPR	Type 23		
PRO9246A	07S3BP	Type 4		
PRO9246CH	PROOE3B470	Type 3		
PRO9256	A1BTXPR	Type 4	A1BTX2PR	Type 4
PRO9276A	07SP	Type 4		
PRO9276C	095BPR	Type 9		
PRO9276E	145SPR	Type 19		
PRO9276I	095BPR	Type 9		
PRO9276N	08SPR	Type 4		
PRO9276TW	095BPR	Type 9	5BCR05PR	Type 8
PRO9276XR	XR91PR	Type 11	XR92PR	Type 11
PRO9555	PROOE2C4S80	Type 5		
PRO9556A	07S3BPR	Type 4		
PRO9556C	093BPR	Type 9		
PRO9556CA	093BPR	Type 9		
PRO9556E	143BPR	Type 20		
PRO9556I	093BPR	Type 9		
PRO9556N	07S3BPR	Type 4		
PRO9556Z	183BPR	Type 23		
PRO9642A	07S3BPR	Type 4		
PRO9642CH	PROOE3B471	Type 3		
PRO9642CHWOS	PROOE3B471	Type 3		
PRO9644A	PROOE3B471	Type 3		
PRO9644B	07S3BPR	Type 4		
PRO9644C	093BPR	Type 9		
PRO9644E	143BPR	Type 20		
PRO9644I	093BPR	Type 9		
PRO9644N	07S3BPR	Type 4		
PRO9649A	PROOE3B471	Type 3		
PRO9649B	07S3BPR	Type 4		
PRO9649N	07S3BPR	Type 4		
PRO9775	PROOE4BS41	Type 4		
PRO9775T	PROOE4BS41PR	Type 4		
PRO9776A	08SPR	Type 4		
PRO9776C	095BPR	Type 9		
PRO9776E	145SPR	Type 19		
PRO9776I	095BPR	Type 9		
PRO9776N	08SPR	Type 4		
PRO9776Z	185SPR	Type 24		
PRO9800	PROOE4BS41	Type 4	5BCR03B	Type 8
PRO9800A	07SPR	Type 4	5BCR05PR	Type 8
PRO9800C	095BPR	Type 9	5BCR05PR	Type 8
PRO9800I	095BPR	Type 9	5BCR05PR	Type 8
PRO9800N	08SPR	Type 4	5BCR05PR	Type 8
PRO9800XR	XR91PR	Type 11	XR92PR	Type 11
PRO9842B	AVX01BT3CL360	Type 2		
PRO9845B	AVX01BT3CL360	Type 2		
PRO9845N	91PR	Type 13		
PRO9900	PROOE4BS41PR	Type 4	UTXPR	Type 8
SS6900	SS91P	Type 12	SS92P	Type 12
SS9000	SS91P	Type 12	SS92P	Type 12
XR6900	XR91P	Type 11	XR92P	Type 11
XR9000	XR91P	Type 11	XR92P	Type 11
XR9100	XR91P	Type 10	XR92P	Type 10



APS92BT1
 FCC ID.....ELV55AAL757T
 PCB ID.....NA
 Battery Part.....GP23A

OBSOLETE TYPE 1 TRANSMITTER



PROBT48
 FCC ID.....ELV55AAL757T
 PCB ID.....757C
 Battery Part.....GP23A



0001201212
 FCC ID.....NA
 PCB ID.....NA
 Battery Part.....GP23A



APSBT1
 FCC ID.....NA
 PCB ID.....NA
 Battery Part.....GP23A



PROBT49
 FCC ID.....NA
 PCB ID.....NA
 Battery Part.....GP23A



PRO92BT2
 FCC ID.....NA
 PCB ID.....NA
 Battery Part.....GP23



APSBT2
 FCC ID.....NA
 PCB ID.....NA
 Battery Part.....GP23A



PSI92BTA
 FCC ID.....NA
 PCB ID.....NA
 Battery Part.....GP23A



PROBT46
 FCC ID.....NA
 PCB ID.....NA
 Battery Part.....GP23A



APS92BT2
 FCC ID.....ELVA777A
 PCB ID.....NA
 Battery Part.....GP23A

TYPE 2 TRANSMITTER



APS95BT2
 FCC ID.....ELVAT5C
 PCB ID.....ATOK
 Battery Part.....GP23A

OBSOLETE TYPE 2 TRANSMITTER



PRO94BT2
 FCC ID.....ELVAT5B
 PCB ID.....NA
 Battery Part.....GP23A



APS92BT
 FCC ID.....BGAAPS2T
 PCB ID.....NA
 Battery Part.....GP23A



PRO0E2
 FCC ID.....ELVAT8C
 PCB ID.....AT7E
 Battery Part.....GP23A



PRO0E221
 FCC ID.....ELVAT8C
 PCB ID.....AT0J
 Battery Part.....GP23A



PRO0E222
 FCC ID.....ELVAT8C
 PCB ID.....AT0J
 Battery Part.....GP23A



PRO92BT
 FCC ID.....ELVAL777A
 PCB ID.....777A2
 Battery Part.....GP23A



AA92BT
 FCC ID.....NA
 PCB ID.....NA
 Battery Part.....GP23A



AA94BT
 FCC ID.....ELVAA94TA
 PCB ID.....AT4A
 Battery Part.....GP23A



PRO0E3C17
 FCC ID.....ELVAT0F
 PCB ID.....AT0B
 Battery Part.....GP27A



PRO0E3C18
 FCC ID.....ELVAT0F
 PCB ID.....AT0B
 Battery Part.....GP27A



APS94FR
 FCC ID.....BGAAV2TF
 PCB ID.....NA
 Battery Part.....GP23A



AVX01BT3CL360
 FCC ID.....BGA0E3B
 PCB ID.....NA
 Battery Part.....GP23A

OBSOLETE TYPE 2 TRANSMITTER (CONTINUED)

REPLACEMENT TRANSMITTERS



PRO0E3B370
 FCC ID.....ELVAT1E
 PCB ID.....ATAF
 Battery Part.....GP23A



AVX01BT3CL3
 FCC ID.....BGA0E3B
 PCB ID.....NA
 Battery Part.....GP23A



PRO0E3B371
 FCC ID.....ELVAT1E
 PCB ID.....NA
 Battery Part.....GP23A



PS195BT3
 FCC ID.....NA
 PCB ID.....NA
 Battery Part.....GP23A



PRO94FR
 FCC ID.....BGA0V2T
 PCB ID.....NA
 Battery Part.....GP23A



APS99BT3BCF30
 FCC ID.....ELVAT0A
 PCB ID.....AT9J
 Battery Part.....GP23A



APS99BT3BCF31
 FCC ID.....ELVAT0A
 PCB ID.....AT9J
 Battery Part.....GP23A



APS99BT3
 FCC ID.....NA
 PCB ID.....NA
 Battery Part.....NA

OBSOLETE TYPE 2 (CONTINUED)

TYPE 3 TRANSMITTERS



PRO0E3FT317
 FCC ID.....ELVAT8A
 PCB ID.....ATOR
 Battery Part.....GP27A



APS02BT2
 FCC ID.....ELVATCE
 PCB ID.....ATCB
 Battery Part.....GP23A



APS99BT330
 FCC ID.....ELVAT0A
 PCB ID.....AT9J
 Battery Part.....GP23A



25CASE Replacement transmitter case for the APS02BT2

09BT3
 FCC ID.....ELVNTIC
 PCB ID.....ATID
 Battery Part.....CR2032

OBSOLETE TYPE 3 TRANSMITTER



AA95BT3
 FCC ID.....ELVAT5G
 PCB ID.....NA
 Battery Part.....GP23A



APS99BT3BCF434
 FCC ID.....ELVATCD
 PCB ID.....NA
 Battery Part.....GP23A



PRO0E4
 FCC ID.....ELVAT7A
 PCB ID.....ATOP
 Battery Part.....GP27A



APS2K451
 FCC ID.....ELVATOD
 PCB ID.....ATAL
 Battery Part.....GP27A



PRO0E3
 FCC ID.....ELVAT8A
 PCB ID.....ATOR
 Battery Part.....GP27A



APS95BT3
 FCC ID.....ELVAT5G
 PCB ID.....NA
 Battery Part.....GP23A



PRO0E314
 FCC ID.....ELVAT7A
 PCB ID.....NA
 Battery Part.....GP27AA



PRO0E3B471
 FCC ID.....ELVAT1F
 PCB ID.....ATAG
 Battery Part.....GP27A



PRO0E3B470
 FCC ID.....ELVAT1F
 PCB ID.....ATAG
 Battery Part.....GP27A



APS99BT3BCF433
 FCC ID.....ELVATIC
 PCB ID.....ATAE
 Battery Part.....GP23A



APS2K4CF50
 FCC ID.....ELVATOD
 PCB ID.....ATAL
 Battery Part.....GP27A



APS99BT3BCF431
 FCC ID.....ELVATIC
 PCB ID.....ATAE
 Battery Part.....GP23A

TYPE 4 TRANSMITTER



07S1BP
 FCC ID.....ELVATCC
 PCB ID.....ATCD
 Battery Part.....CR1220



07SP
 FCC ID.....ELVATGB
 PCB ID.....NTGDA
 Battery Part.....CR2032



09BT3

FCC ID.....ELVNTIC
PCB ID.....ATID
Battery Part.....CR2032



0E3B4S72

FCC ID.....ELVATCA
PCB ID.....ATCA
Battery Part.....GP27A



3BP

FCC ID.....ELVATGA
PCB ID.....ATGH
Battery Part.....CR2032



APS99BT3SBCF434

FCC ID.....ELVATCD
PCB ID.....ATCH
Battery Part.....GP23A



APS2K4SFLCF110P

FCC ID.....ELVATFG
PCB ID.....ATFF
Battery Part.....GP27A



APS2K4SCF50P

FCC ID.....ELVATOD
PCB ID.....NA
Battery Part.....GP27A



APS2K4SBCF50

FCC ID.....ELVATOC
PCB ID.....ATDH
Battery Part.....GP27A



PROOE4BS40

FCC ID.....ELVATOE
PCB ID.....ATDG
Battery Part.....GP27A



PROOE4BS41PR

FCC ID.....ELVATOE
PCB ID.....ATDG
Battery Part.....GP27A



APS2K4SBCF52P

FCC ID.....ELVATOC
PCB ID.....ATDH
Battery Part.....GP27A



APS2K4SBCF52

FCC ID.....ELVATOC
PCB ID.....ATDH
Battery Part.....GP27A



APS2K4S52

FCC ID.....ELVATOC
PCB ID.....ATDH
Battery Part.....GP27A



07SPR

FCC ID.....ELVATGB
PCB ID.....NTGDA
Battery Part.....CR2032



PROOE3S15

FCC ID.....ELVAT8B
PCB ID.....NA
Battery Part.....GP27A



PROOE3S

FCC ID.....ELVAT8B
PCB ID.....NA
Battery Part.....GP27A



APSOE3B4SCF73P

FCC ID.....ELVAT8B
PCB ID.....NA
Battery Part.....NA



07S1BPR

FCC ID.....ELVATCC
PCB ID.....ATCD
Battery Part.....CR1220



PROOE3S14

FCC ID.....ELVAT8B
PCB ID.....NA
Battery Part.....GP27A



APS99BT3SBCF435P

FCC ID.....ELVATCD
PCB ID.....NA
Battery Part.....GP23A

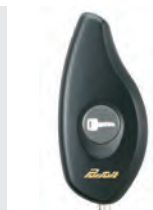

A1BTXPR

FCC ID.....ELVATFE
PCB ID.....ATFA
Battery Part.....CR1220



A1BTX2P

FCC ID.....ELVARGA
PCB ID.....AG05
Battery Part.....CR2032



A1BTX2PR

FCC ID.....ELVATGA
PCB ID.....AG05
Battery Part.....CR2032



07S3BPR

FCC ID.....ELVATGA
PCB ID.....ATGH
Battery Part.....CR2032



07S3BP

FCC ID.....ELVATGA
PCB ID.....ATGH
Battery Part.....CR2032



AA95BT3S

FCC ID.....NA
PCB ID.....NA
Battery Part.....GP23A



PROOE4BS41

FCC ID.....ELVATOE
PCB ID.....ATDG
Battery Part.....GP27A



08SPR

FCC ID.....ELVATGB
PCB ID.....NTGDA
Battery Part.....CR2032



0E3B4S73

FCC ID.....NA
PCB ID.....NA
Battery Part.....NA



0E3B4S71

FCC ID.....NA
PCB ID.....NA
Battery Part.....NA



APS2K4S50

FCC ID.....ELVATOC
PCB ID.....ATDH
Battery Part.....GP27A



PROOE4BS40PR

FCC ID.....ELVATOE
PCB ID.....ATDG
Battery Part.....GP27A

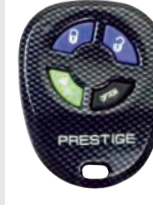

APS2K4SFLCF112P

FCC ID.....ELVATFG
PCB ID.....ATFF
Battery Part.....GP27A



AP95BT3S
 FCC ID.....ELVAT8D
 PCB ID.....AT8A
 Battery Part.....GP23A



AVX1B4S
 FCC ID.....NA
 PCB ID.....NA
 Battery Part.....CR1220



S1BTXA
 FCC ID.....ELVATIA
 PCB ID.....ATIA
 Battery Part.....GP27A



A1BTXP
 FCC ID.....ELVATFE
 PCB ID.....ATFA
 Battery Part.....CR1220

OBSOLETE TYPE 4 TRANSMITTER

OBSOLETE TYPE 5 TRANSMITTER



PROOE2C4S80
 FCC ID.....ELVATIG
 PCB ID.....ATAH
 Battery Part.....GP27A



5WTP
 FCC ID.....ELVATEA
 PCB ID.....NA
 Battery Part.....CR2025



PROOE2C4S80
 FCC ID.....ELVATIG
 PCB ID.....ATAH
 Battery Part.....GP27A



APS95BT
 FCC ID.....ELVAT56
 PCB ID.....ATODA
 Battery Part.....GP23

TYPE 6 TRANSMITTER



APS2K4MS50
 FCC ID.....ELVATOH
 PCB ID.....ATDJ
 Battery Part.....GP27A

OBSOLETE TYPE 6 TRANSMITTER



APS2K4MSFLCF110
 FCC ID.....ELVATCB
 PCB ID.....ATBD
 Battery Part.....GP23A



APS2K4MSFLCF110P
 FCC ID.....ELVATCB
 PCB ID.....ATBD
 Battery Part.....GP23A



APS2K4MS51
 FCC ID.....ELVATOH
 PCB ID.....ATDJ
 Battery Part.....GP27A



APS2K4MSFLCF112P
 FCC ID.....ELVATOH
 PCB ID.....ATDJ
 Battery Part.....GP27A

OBSOLETE TYPE 7 TRANSMITTER



3BCR
 FCC ID.....NA
 PCB ID.....NA
 Battery Part.....AAA



3BCR90
 FCC ID.....NA
 PCB ID.....NA
 Battery Part.....AAA

TYPE 8 TRANSMITTER

OBSOLETE TYPE 8 TRANSMITTER



5BCR07P
 FCC ID.....ELVATROF
 PCB ID.....AB15C+AC17
 Battery Part.....AAA



UTXPR
 FCC ID.....ELVNTREA
 PCB ID.....AE20+AE27
 Battery Part.....AAA



5BLCTX
 FCC ID.....ELVNTRCA
 PCB ID.....AB15B+AC17
 Battery Part.....AAA

REPLACEMENT TRANSMITTERS

OBSOLETE TYPE 8 TRANSMITTER



5BCR03

FCC ID.....ELVNTRCA
PCB ID.....AB15A+AC17
Battery Part.....AAA



5BCR03B

FCC ID.....ELVNTRCA
PCB ID.....AB15A+AC17
Battery Part.....AAA



5BCR05PR

FCC ID.....ELVATRBB
PCB ID.....AB15C+AC17
Battery Part.....AAA



5BLCR122

FCC ID.....ELVNTRCA
PCB ID.....NA
Battery Part.....AAA



5BLCR120

FCC ID.....ELVNTRCA
PCB ID.....NA
Battery Part.....AAA



UTXP

FCC ID.....ELVNTRCA
PCB ID.....AE20+AE27
Battery Part.....AAA



5BCR05P

FCC ID.....ELVATRBB
PCB ID.....AB15C+AC17
Battery Part.....AAA



5BLCRA122

FCC ID.....ELVNTRCA
PCB ID.....NA
Battery Part.....AAA

TYPE 9 TRANSMITTER



1BPR

FCC ID.....ELVATIE
PCB ID.....ATIF
Battery Part.....CR2032



095BPR

FCC ID.....ELVATID
PCB ID.....ATIEA
Battery Part.....CR2032



5BCR10P

FCC ID.....ELVATROE
PCB ID.....A121+A117
Battery Part.....AAA



105BP

FCC ID.....ELVATJA
PCB ID.....ATJC
Battery Part.....CR2032



5BCR14P

FCC ID.....ELVATRIA
PCB ID.....A121+A117
Battery Part.....AAA

OBSOLETE TYPE 9 TRANSMITTER



5BCR10PR

FCC ID.....ELVATROE
PCB ID.....A121+A117
Battery Part.....AAA



101BP

FCC ID.....ELVATJB
PCB ID.....ATJD
Battery Part.....CR2032



08SP

FCC ID.....ELVATJA
PCB ID.....ATJC
Battery Part.....CR2032



1BP

FCC ID.....ELVATIE
PCB ID.....ATIF
Battery Part.....CR2032



091BPR

FCC ID.....ELVATIE
PCB ID.....ATIF
Battery Part.....CR2032



093BPR

FCC ID.....ELVATID
PCB ID.....ATIE
Battery Part.....CR2032



103BP

FCC ID.....ELVATJA
PCB ID.....ATICA
Battery Part.....CR2032

TYPE 10 TRANSMITTER

OBSOLETE TYPE 10 TRANSMITTER



XR091P

FCC ID.....H50T35
PCB ID.....F122
Battery Part.....CR2032



XR092P

FCC ID.....H50TR23
PCB ID.....NA
Battery Part.....Rechargeable

TYPE 11 TRANSMITTER



XR91P

FCC ID.....ELVATFF
PCB ID.....ATFC
Battery Part.....CR2032A



XR92PR

FCC ID.....ELVATRFD
PCB ID.....AF08+NE07
Battery Part.....Rechargeable



XR92P

FCC ID.....ELVATRFD
PCB ID.....AF08+NE07
Battery Part.....Rechargeable



XR91PR

FCC ID.....ELVATFF
PCB ID.....ATFC
Battery Part.....CR2032

TYPE 12 TRANSMITTER



SS91P

FCC ID.....ELVATIC
PCB ID.....ATJE
Battery Part.....CR2032



SS92P

FCC ID.....ELVATRJB
PCB ID.....AJ12
Battery Part.....Rechargeable

TYPE 13 TRANSMITTER



91P

FCC ID.....H50T43
PCB ID.....F122-047-05A
Battery Part.....CR2016



PROPL4TX

FCC ID.....H50T58
PCB ID.....F122D48010
Battery Part.....CR2016*2

OBSOLETE TYPE 13 TRANSMITTER



101TXP

FCC ID.....H50T37
PCB ID.....F111-015-70A
Battery Part.....CR2032A



140TXP

FCC ID.....H50T37
PCB ID.....F111-015-70A
Battery Part.....CR2032



91MP

FCC ID.....H50T46
PCB ID.....F122-047-05A
Battery Part.....CR2016



620TXP

FCC ID.....H50T32
PCB ID.....F122-035-80B
Battery Part.....GP23A



PROPLTX

FCC ID.....H50T41
PCB ID.....A01-294-340D
Battery Part.....CR2032
.....3V X 2PS Lithium Cells



APS920TX2P

FCC ID.....H50TR14
PCB ID.....F122-033-41D
Battery Part.....AAA



APS620CFP

FCC ID.....H50T33
PCB ID.....F122-035-80B
Battery Part.....GP23A



APS920CF2P

FCC ID.....H50TR13
PCB ID.....F122-033-41D
Battery Part.....AAA



PA91

FCC ID.....JNA
PCB ID.....JNA
Battery Part.....CR2016*2



91PR

FCC ID.....H50T43
PCB ID.....F122-047-05A
Battery Part.....CR2016



PN1

FCC ID.....H50T45
PCB ID.....F12204720B
Battery Part.....CR2016*2

OBSOLETE TYPE 14



3BCRAM

FCC ID.....NJQL500HAA
PCB ID.....JNA
Battery Part.....AAA

OBSOLETE TYPE 15



5BCR

FCC ID.....ELVATRBB
PCB ID.....AB15-AC17
Battery Part.....AAA

TYPE 16 TRANSMITTER

OBSOLETE TYPE 16 TRANSMITTER



09XR1PR
 FCC ID.....ELVATJG
 PCB ID.....ATJF
 Battery Part.....CR2032*1



14XR1PR
 FCC ID.....ELVATJG
 PCB ID.....ATJF
 Battery Part.....CR2032



14XR2PR
 FCC ID.....ELVATRJG
 PCB ID.....AT23
 Battery Part.....CR203

OBSOLETE TYPE 16

TYPE 17

OBSOLETE TYPE 17

OBSOLETE TYPE 18



09XR2PR
 FCC ID.....ELVATRJG
 PCB ID.....AJ23
 Battery Part.....CR2032*2



APSOE4C
 FCC ID.....NA
 PCB ID.....F12204724B
 Battery Part.....CR2016*2



APSOE2B
 FCC ID.....NA
 PCB ID.....NA
 Battery Part.....GP23A



PA92
 FCC ID.....NA
 PCB ID.....NA
 Battery Part.....NA

TYPE 19 TRANSMITTER



145SP
 FCC ID.....ELVATNA
 PCB ID.....ATNA
 Battery Part.....CR2032



5BCR14SP
 FCC ID.....ELVATRNA
 PCB ID.....AN20+AN07
 Battery Part.....AAA



5BCR17SPR
 FCC ID.....ELVATRNA
 PCB ID.....AN20
 Battery Part.....AAA



175SPR
 FCC ID.....ELVATNE
 PCB ID.....ATNI
 Battery Part.....CR2032



5BCR14RE
 FCC ID.....ELVATRPF
 PCB ID.....AP20
 Battery Part.....Polymer

OBSOLETE TYPE 19



145SPR
 FCC ID.....ELVATNE
 PCB ID.....ATNE
 Battery Part.....CR2032

TYPE 20 TRANSMITTER

OBSOLETE TYPE 20



141BP
 FCC ID.....ELVATND
 PCB ID.....ATND
 Battery Part.....CR2032



141BPR
 FCC ID.....ELVATND
 PCB ID.....ATIFA
 Battery Part.....CR2032



171BP
 FCC ID.....ELVATNG
 PCB ID.....ATIFA
 Battery Part.....CR2032



143BPR
 FCC ID.....ELVATNB
 PCB ID.....ATNCA
 Battery Part.....CR2032



145BP
 FCC ID.....ELVATNB
 PCB ID.....ATNB
 Battery Part.....CR2032



171BPR
 FCC ID.....ELVATNG
 PCB ID.....ATIFA
 Battery Part.....CR2032



173BP
 FCC ID.....ELVATNC
 PCB ID.....ATNCA
 Battery Part.....CR2032



143BP
 FCC ID.....ELVATNB
 PCB ID.....ATNBA
 Battery Part.....CR2032

TYPE 21 TRANSMITTER



5BER15SP
 FCC ID.....ELVATRPC
 PCB ID.....AP08
 Battery Part.....CR2025 * 2



155SP
 FCC ID.....ELVATPC
 PCB ID.....ATNA
 Battery Part.....CR2032



151SP
 FCC ID.....ELVATQH
 PCB ID.....N/A
 Battery Part.....CR2032



1BER15SP
 FCC ID.....ELVTRQD
 PCB ID.....N/A
 Battery Part.....CR2025*2



5BER17XPR
 FCC ID.....ELVATRPC
 PCB ID.....AP08
 Battery Part.....CR2025 * 2



175XPR
 FCC ID.....ELVATRB
 PCB ID.....ATNIB
 Battery Part.....CR2032



171XPR
 FCC ID.....ELVATRA
 PCB ID.....ATRA
 Battery Part.....CR2032



1BER17XPR
 FCC ID.....ELVTRQD
 PCB ID.....AQ08
 Battery Part.....CR2025*2

TYPE 22 TRANSMITTER

REPLACEMENT TRANSMITTERS



PE51M

FCC ID.....ELVATRD
PCB ID.....ATNAC
Battery Part.....CR2032



5L017SP

FCC ID.....ELVATRE
PCB ID.....AN20A
Battery Part.....AAA

TYPE 23 TRANSMITTER



181BP

FCC ID.....TBQT4-AM1W
PCB ID.....T4-AM1-A1
Battery Part.....CR2032



183BP

FCC ID.....TBQT5-AM1W
PCB ID.....T5-AM1-A3
Battery Part.....CR2032



185BP

FCC ID.....TBQT12-AM1W
PCB ID.....T12-AM1-A1
Battery Part.....CR2032



181BPR

FCC ID.....TBQT4-AM1W
PCB ID.....T4-AM1-A1
Battery Part.....CR2032



183BPR

FCC ID.....TBQT5-AM1W
PCB ID.....T5-AM1-A3
Battery Part.....CR2032

TYPE 24 TRANSMITTER



181SP

FCC ID.....TBQT4-SS1WC
PCB ID.....T4-SST1-A1
Battery Part.....CR2032



185SP

FCC ID.....TBQT12-SS1W
PCB ID.....T12-SST1-A2
Battery Part.....CR2032



181TWS

FCC ID.....TBQT4-SS2W
PCB ID.....T4-SST2-B1
Battery Part.....CR2450



185TWS

FCC ID.....TBQT12-SS2W
PCB ID.....T12-SST2-B1
Battery Part.....CR2450



18LCDSP

FCC ID.....TBQT30-SS2W
PCB ID.....T30-SST2-A2
Battery Part.....CR2450



181XPR

FCC ID.....TBQT4-SS1W
PCB ID.....T4-SST1-A1
Battery Part.....CR2032



185SPR

FCC ID.....TBQT12-SS1W
PCB ID.....T12-SST1-A2
Battery Part.....CR2032



181TWXPR

FCC ID.....TBQT4-SS2W
PCB ID.....T4-SST2-B1
Battery Part.....CR2450



18LCDRE

FCC ID.....N/A
PCB ID.....N/A
Battery Part.....Rechargeable

TYPE 25 TRANSMITTER



18TWLOR

FCC ID.....TBQT12-LR2W
PCB ID.....T12-LORA-B1
Battery Part.....CR2450



18LCDLOR

FCC ID.....TBQT30-LR2W
PCB ID.....T12-LORA-A2
Battery Part.....CR2450

KIT MODEL PART #	ONE - WAY TRANSMITTER PART#	TRANSMITTER TYPE	TWO - WAY TRANSMITTER PART#	TRANSMITTER TYPE
CA100	CATX100	Type 9		
CA1045	CAT4P	Type 9		
CA1050	CATX50	Type 9		
CA1051	CATX4	Type 9		
CA1053	CATX4	Type 9		
CA1055	CAT4P	Type 9		
CA110	CATX110	Type 8		
CA1150	CATXMT	Type 9		
CA1151	CATXMT	Type 9		
CA1153	CATXMT	Type 9		
CA1155	CAT4P	Type 9		
CA120	CATX120	Type 8		
CA125	PROTX6	Type 7		
CA130	CATX130	Type 5		
CA135	PROTX6	Type 7	5BLETX	Type 7
CA140	CATXIWAY	Type 8	CATX2LED	Type 6
CA145	PROTX6	Type 7	5BLCTX	Type 7
CA150	PROTX6	Type 7		
CA1550	CATXMT	Type 9	CATXMLC	Type 9
CA1551	CATXMT	Type 9	CATXMLC	Type 9
CA1552	CATXMT	Type 9	CATXMLC	Type 9
CA1553	CATXMT	Type 9	CATXMLC	Type 9
CA1554	CAT4	Type 15	CATLCD	Type 15
CA160	PROTX6	Type 7	5BLCTX	Type 7
CA170	CATX120	Type 8	CATX650	Type 8
CA180	PROTX6	Type 7	UTXC	Type 7
CA18	CATX18	Type 9		
CA185	CAT1	Type 9		
CA186	CAT1LR	Type 15		
CA18TW	CATX18	Type 9	CATX1TW	Type 9
CA18TW5	CAT1	Type 9	CAT1MTW	Type 9
CA18TW6	CAT1LR	Type 15	CAT1TW6	Type 15
CA2050	CATX50	Type 9		
CA2051	CATX4	Type 9		
CA210	CATX610	Type 7		
CA2LCD	CAT4	Type 15	CATLCD	Type 15
CA2LCD5	CAT4M	Type 15	CATLCD	Type 15
CA2LCD5E	CAT4ME	Type 15	CATLCDE	Type 15
CA2LED	CAT4	Type 15	CATLED	Type 15
CA2LED5	CAT4M	Type 15	CATMLED	Type 15
CA2LED5E	CAT4ME	Type 15	CATMLEDE	Type 15
CA2RELCD	CAT4	Type 15	CA2RELCD	Type 15
CA2RELCD5	CAT4M	Type 15	CATRELCD	Type 15
CA4050	CATX18	Type 9		
CA4051	CATX18	Type 9		
CA4053	CATX18	Type 9		
CA4054	CATX18	Type 9		
CA4055	CAT1	Type 9		
CA420	CATX420	Type 7		
CA420A	CATX420	Type 7		
CA421	CATX420	Type 7		
CA440SS	SIBTXA	Type 7		
CA440TW	CATX420	Type 7	CATX4TW	Type 7
CA4552	CATX18	Type 9	CATX1TW	Type 9
CA4553	CATX18	Type 9	CATX1TW	Type 9
CA4554	CATX18	Type 9	CATX1TW	Type 9
CA4555	CAT1	Type 9	CAT1MTW	Type 9
CA4B	CAT4	Type 15		
CA4B5	CAT4M	Type 15		
CA4B5E	CAT4ME	Type 15		
CA500	CATX500	Type 7		
CA501	CATX500	Type 7		
CA5050	CATX50	Type 9		
CA5051	CATX4	Type 9		
CA5053	CATX4	Type 9		
CA5054	CATX4	Type 9		
CA5055	CAT4P	Type 9		
CA510	CATX510	Type 7		
CA510A	CATX510	Type 7		
CA5150	CATXMT	Type 9		
CA5152	CATXMT	Type 9		
CA5153	CATXMT	Type 9		
CA5153SST	CATXMSS	Type 12		
CA5154	CAT4	Type 15		
CA520	CATX520	Type 7		
CA520A	CATX520	Type 7		
CA521	CATX520	Type 7		
CA530	CATX630	Type 5		
CA535	PROTX6	Type 7		
CA5354	CAT4	Type 15	CATLED	Type 15
CA540	CATXIWAY	Type 8	CATX2LED	Type 6
CA545	PROTX6	Type 7	5BLETX	Type 7
CA550	PROTX6	Type 7		
CA5550SST	CATXMSS	Type 12	CATXMLSS	Type 12
CA5553SST	CATXMSS	Type 12	CATXMLSS	Type 12
CA5554	CAT4	Type 15	CATLCD	Type 15
CA610	CATX610	Type 7		
CA611	PROTX6	Type 7		

KIT MODEL PART #	ONE - WAY TRANSMITTER PART#	TRANSMITTER TYPE	TWO - WAY TRANSMITTER PART#	TRANSMITTER TYPE
CA6150	CATXMT	Type 9		
CA6151	CATXMT	Type 9		
CA6153	CATXMT	Type 9		
CA6154	CAT4	Type 15		
CA630	CATX630	Type 5		
CA640	CATXIWAY	Type 8	CATX2LCD	Type 6
CA645	PROTX6	Type 7	5BLCTX	Type 7
CA650	CATX120	Type 8	CATX650	Type 8
CA6550	CATXMT	Type 9	CATXMLC	Type 9
CA6551	CATXMT	Type 9	CATXMLC	Type 9
CA6551SST	CATXMSS	Type 12	CATXMLSS	Type 12
CA6552	CATXMT	Type 9	CATXMLC	Type 9
CA6552SST	CATXMSS	Type 12	CATXMLSS	Type 12
CA6553	CATXMT	Type 9	CATXMLC	Type 9
CA6553SST	CATXMSS	Type 12	CATXMLSS	Type 12
CA6554	CAT4	Type 15	CATLCD	Type 15
CA670	PROTX6	Type 7	5BLCTX	Type 7
CA671	PROTX6	Type 7	5BLCTX	Type 7
CA680	PROTX6	Type 7	UTXC	Type 7
CSI100	DIYTX	Type 7		
CSI200	DIYTX	Type 7		
CSI300	DIYTX	Type 7		
CSI400	DIYTX	Type 7		
CSM2.5	CRCX3	Type 1		
CSM3	PT4	Type 1		
CSM4	PT4	Type 1		
ELITE100	CRCX3	Type 1		
ELITE1500	CRCX3	Type 1		
ELITE2000SE	CRCX3	Type 1		
ELITE2100	PT6C	Type 2		
ELITE3100	PT7C	Type 2		
ELITE4100	1013465	Type 5		
ELITE4200	1013473	Type 5		
ELITE4300	1013481	Type 5		
ELITE4400	1021211	Type 5		
ELITE4500	CRCX3	Type 1		
ELITE4800	PT5	Type 13		
ELITE6100	1013499	Type 5		
ELITE6500	PT4	Type 1		
ELITE6800	PT5	Type 13		
ELITE7300	1013507	Type 5		
ELITE7400	1013515	Type 5		
ELITE7500	1013523	Type 5		
ELITE7600	1013531	Type 5		
ELITE911	CRCX3	Type 1		
ELITE950	CRCX3	Type 1		
ELITECOMPETITION	PT4	Type 1		
Panther P10	1021278	Type 8		
Panther P20	1021278	Type 8		
PRO100	CRCX3	Type 1		
PRO1000	CRCX3	Type 1		
PRO200	CRCX3	Type 1		
PRO300	PT6C	Type 2		
PRO3000	CRCX3	Type 1		
PRO3500	CRCX3	Type 1		
PRO3800	PT5	Type 13		
PRO400	PT7C	Type 2		
PRO5000	PT4	Type 1		
PRO5500	PT4	Type 1		
PRO7000	PT4	Type 1		
PRO750	CRCX3	Type 1		
PROCAMP	CAETX91	Type 14	CATXCOMP	Type 14
PROF10	101112	Type 5		
PROF12	1010686	Type 5		
PROF15	101112	Type 5		
PROF17	1010686	Type 5		
PROF20	101112	Type 5		
PROF25	101112	Type 5		
PROF50	101112	Type 5		
PROF55	101112	Type 5		
PROF60	1010686	Type 5		
PROF65	1010686	Type 5		
RCS2	CRCX3	Type 1		
RKE1	CRCX3	Type 1		
RKE1+	PT6C	Type 2		
SRT1600	CATXSRT1	Type 10	CATXSRT2	Type 10
SRT5500	CATXSRT1	Type 10		
SRT6700	CATXSRT1	Type 10	CATXSRT2	Type 10
SRT9000	CATX9000	Type 11	CATXOLED	Type 11
SURESTARTLX	PT7C	Type 2		
SURESTARTLXi	PT7C	Type 2		
SURESTARTRVS	PT4	Type 1		
SURESTARTRVSI	PT4	Type 1		
SURESTARTSE	CRCX3	Type 1		
SURESTARTSE433	CRCX3	Type 1		
TW1	1021284	Type 3	1021295	Type 3
TW2	APS2K4MS50	Type 4	3BCRAM	Type 4



CRCX3

FCC ID..... .GOH-M41-014
 PCB ID..... .PCB0202E
 Battery Part..... .GP23A

OBSOLETE TYPE 1 TRANSMITTER



TCB4C

Replacement transmitter case for the PT



TCB2

Replacement transmitter case for the CRCX3



PT4

FCC ID..... .GOH-M51-016
 PCB ID..... .PCB0215H/1
 Battery Part..... .GP23A

TYPE 2 TRANSMITTER

OBSOLETE TYPE 2 TRANSMITTER



PT6C

FCC ID..... .GOH-M41-014
 PCB ID..... .PCB0202E
 Battery Part..... .GP23A



PT7C

FCC ID..... .GOH-M51-016
 PCB ID..... .PCB0215H/1
 Battery Part..... .GP23A

OBSOLETE TYPE 3 TRANSMITTER



1021284

FCC ID..... .NA
 PCB ID..... .NA
 Battery Part..... .CR2032



1021295

FCC ID..... .NA
 PCB ID..... .NA
 Battery Part..... .AAA

TYPE 4 TRANSMITTER

OBSOLETE TYPE 4 TRANSMITTER



APS2K4MS50

FCC ID..... .ELVATOH
 PCB ID..... .ATOE
 Battery Part..... .GP23A



3BCRAM

FCC ID..... .NA
 PCB ID..... .NA
 Battery Part..... .AAA

TYPE 5 TRANSMITTER



CATX433

FCC ID..... .ELVATPA
 PCB ID..... .ATKD
 Battery Part..... .GP23A

REPLACEMENT TRANSMITTERS

OBSOLETE TYPE 5 TRANSMITTER



1020718

FCC ID.....GOH-TSM-23
PCB ID.....PCB0182M
Battery Part.....GP23A



1013465

FCC ID.....GOH-PCGEN2
PCB ID.....J012848
Battery Part.....CR2016



1013473

FCC ID.....GOH-PCGEN2
PCB ID.....J012848
Battery Part.....CR2016



1013481

FCC ID.....GOH-PCGEN2
PCB ID.....J012848
Battery Part.....CR2016



1021211

FCC ID.....GOH-PCGEN2
PCB ID.....J012848
Battery Part.....CR2016



1013499

FCC ID.....GOH-PCGEN2
PCB ID.....J012848
Battery Part.....CR2016



1013507

FCC ID.....GOH-PCGEN2
PCB ID.....J012848
Battery Part.....CR2016



1013515

FCC ID.....GOH-PCGEN2
PCB ID.....J012848
Battery Part.....CR2016



1013523

FCC ID.....GOH-PCGEN2
PCB ID.....J012848
Battery Part.....CR2016



1013531

FCC ID.....GOH-PCGEN2
PCB ID.....J012848
Battery Part.....CR2016



1011112

FCC ID.....GOH-TSM-23
PCB ID.....PCB0182M
Battery Part.....GP23A



1010686

FCC ID.....GOH-TSM-23
PCB ID.....PCB0182M
Battery Part.....GP23A



CATX630

FCC ID.....GOH-FRDPC2002
PCB ID.....D194V-0
Battery Part.....GP23A



CATX130

FCC ID.....GOH-FRDPC2002
PCB ID.....D194V-0
Battery Part.....GP23A

TYPE 6 TRANSMITTER

OBSOLETE TYPE 6 TRANSMITTER



CATX2LED

FCC ID.....GOH-PAN09
PCB ID.....F122-023-500
Battery Part.....CR2450



CATX2LCD

FCC ID.....GOH-PAN08
PCB ID.....CPU Board-F122-023-90C
.....RF Board-F122-023-80D
Battery Part.....AAA

TYPE 7 TRANSMITTER

OBSOLETE TYPE 7 TRANSMITTER



CATX420

FCC ID.....ELVATCC
PCB ID.....ATCD
Battery Part.....CR1220



CATX4TW

FCC ID.....ELVATID
PCB ID.....ATIE
Battery Part.....CR20320



UTXPR

FCC ID.....ELVNTREA
PCB ID.....AE20+AE27
Battery Part.....AAA



5BLCTX

FCC ID.....ELVNTRCA
PCB ID.....AB15B+AC17
Battery Part.....AAA



PROTX6

FCC ID.....ELVATDB
PCB ID.....ATCPB
Battery Part.....CR2025



5BCR07P

FCC ID.....ELVATROF
PCB ID.....AB15C+AC17
Battery Part.....AAA

OBSOLETE TYPE 7 TRANSMITTER



S1BTXA

FCC ID.....ELVATIA
PCB ID.....ATIA
Battery Part.....GP27A



CATX510

FCC ID.....ELVATRGA
PCB ID.....AG19
Battery Part.....CR1220



CATXSS

FCC ID.....ELVATFC
FCC ID.....ELVATIA
PCB ID.....ATED
PCB ID.....ATIA
Battery Part.....LR41



CATX610

FCC ID.....ELVATCG
PCB ID.....ATCG
Battery Part.....GP23A



CATX500

FCC ID.....ELVATDB
PCB ID.....ATCP
Battery Part.....CR2025



DIYTX

FCC ID.....ELVATDB
PCB ID.....ATCP
Battery Part.....CR2025



5BLETX

FCC ID.....ELVNTRCA
PCB ID.....AB20B+AC17
Battery Part.....AAA



UTXC

FCC ID.....ELVNTRCA
PCB ID.....AE20+AE27
Battery Part.....AAA



CATX520

FCC ID.....ELVATCG
PCB ID.....ATCG
Battery Part.....GP23A

OBSOLETE TYPE 8 TRANSMITTER



CATX1WAY

FCC ID.....GOH-PAN05
PCB ID.....F122-024-80A
Battery Part.....GP23A



CATX110

FCC ID.....GOH-PAN05
PCB ID.....F122-024-80A
Battery Part.....GP23A



CATX650

FCC ID.....H50TR13
PCB ID.....CPU Board-F122-033-41D
.....RF Board-F122-032-40F
Battery Part.....AAA



MMTX

FCC ID.....GOH-PAN05
PCB ID.....F122-024-80A
Battery Part.....GP23A



1021278

FCC ID.....GOH-PAN04
PCB ID.....F122-022-500
Battery Part.....GP23A



CATX120

FCC ID.....GOH-PAN05
PCB ID.....F122-024-80A
Battery Part.....GP23A

TYPE 9 TRANSMITTER



CATXMLC

FCC ID.....H50TR35
PCB ID.....F122-047-19A
Battery Part.....CR2450



CAT1

FCC ID.....H50T67
PCB ID.....F122-048-670
Battery Part.....CR2032



CAT1MTW

FCC ID.....H50TR71
PCB ID.....F122-048-780
Battery Part.....CR2032



CAT4P

FCC ID.....H50T66
PCB ID.....F122-048-47A
Battery Part.....CR2032

OBSOLETE TYPE 9 TRANSMITTER



CATX100

FCC ID.....H50T30
PCB ID.....F111-015-50A
Battery Part.....CR2032

PICTURE NOT AVAILABLE

CPL100TX

FCC ID.....H50T21
PCB ID.....F122-030-21A
Battery Part.....1 pc of CR2032
.....(3V) Battery



CATX50

FCC ID.....H50T43
PCB ID.....F122-047-240
Battery Part.....CR2016



TCBTX4

Replacement transmitter case for the CATX4



TCBMT

Replacement transmitter case for the CATXMT



TCBMLC

Replacement transmitter case for the CATXMTLC



CATXMT

FCC ID.....H50T46
PCB ID.....F122-047-05A
Battery Part.....CR2016



CATX1B

FCC ID.....H50T45
PCB ID.....F122-047-200
Battery Part.....CR2016



CATX1TW

FCC ID.....H50TR44
PCB ID.....NA
Battery Part.....CR2032



CATX4

FCC ID.....H50T49
PCB ID.....F122-047-17A
Battery Part.....CR2016



CATXSRT1

FCC ID.....ELAVTFF
PCB ID.....ATFC
Battery Part.....CR2032



CATXSRT2

FCC ID.....ELVATRFD
PCB ID.....AF08A+NE07
Battery Part.....AAA

TYPE 11 TRANSMITTER

OBSOLETE TYPE 11 TRANSMITTER



CATX9000

FCC ID.....H50T36
PCB ID.....F122-039-40A
Battery Part.....CR2032



CATXMLSS

FCC ID.....H50TR38
PCB ID.....F122-047-100
Battery Part.....NA-Rechargeable



CATXOLED

FCC ID.....H50TR24
PCB ID.....PU Board-F122-039-30D
.....RF Board-F122-039-20D
Battery Part.....NA-Rechargeable

TYPE 12 TRANSMITTER

OBSOLETE TYPE 12 TRANSMITTER



CATXMLSS

FCC ID.....H50TR38
PCB ID.....F122-047-100
Battery Part.....NA-Rechargeable



CATXMSS

FCC ID.....H50T48
PCB ID.....F122-047-080
Battery Part.....CR2032



TCBMSS

Replacement transmitter case for the CATXMSS

OBSOLETE TYPE 13

TYPE 14

OBSOLETE TYPE 14 TRANSMITTER



PT5

FCC ID.....NA
PCB ID.....NA
Battery Part.....GP23A



CAETX91

FCC ID.....ELVALTIF
PCB ID.....AT1B-1
Battery Part.....CR2032



CATXCOMP

FCC ID.....ELVALTRLB
PCB ID.....E103
Battery Part.....Rechargeable

TYPE 15 TRANSMITTER

OBSOLETE TYPE 15 TRANSMITTER



CAT1LR

FCC ID.....H50T69
PCB ID.....F122-048-860
Battery Part.....CR2032



CAT1TW6

FCC ID.....H50TR74
PCB ID.....F122-048-850
Battery Part.....CR2450



CAT4M

FCC ID.....H50T59
PCB ID.....F122-048-770
Battery Part.....CR2032



CATMLED

FCC ID.....H50T72
PCB ID.....F122-048-730
Battery Part.....CR2450



CATLCD

FCC ID.....H50TR51
PCB ID.....F122-048-00C
Battery Part.....AAA



CATRLCD

FCC ID.....H50T64
PCB ID.....F122-048-5300
Battery Part.....Rechargeable



CATLCD5

FCC ID.....H50TR51
PCB ID.....F122-048-00C
Battery Part.....AAA



CATLCD5E

FCC ID.....H50TR51
PCB ID.....F122-048-00C
Battery Part.....AAA



CATMLEDE

FCC ID.....H50T72
PCB ID.....F122-048-730
Battery Part.....CR2450



CAT4ME

FCC ID.....H50T59
PCB ID.....F122-048-770
Battery Part.....CR2032



CAT4

FCC ID.....H50T59
PCB ID.....F122048150
Battery Part.....CA2032



CATLED

FCC ID.....H50TR63
PCB ID.....F122048440
Battery Part.....CR2032



ABOUT VOXX ELECTRONICS CORPORATION (VEC)

VOXX Electronics Corporation (VEC) is a wholly-owned subsidiary of VOXX International Corporation (NASDAQ:VOXX), a global supplier of mobile and consumer electronics products. VEC is a recognized leader in the marketing of Automotive Entertainment, Vehicle Security/Tracking, Remote Start Systems, Telematics and Advanced Driver Assistance Systems (ADAS).

VEC sells its products through an extensive distribution network that includes expeditors, mass merchandisers, regional mobile electronics chains and independent specialist both domestic and internationally. VOXX Electronics possesses a strong brand portfolio and its products rank among the top ten in almost every category in which they sell. Primary brands include: Advent®, Audiovox®, Rosen®, Invision®, Movies to Go by VOXX®, CarLink®, Code Alarm®, Flashlogic®, Prestige®, Pursuit®, Pursuit SVR®, CrimeStopper and Omega® Rostra®, Viper®, Autostart®, AstroStart®, Automate®, Avital®, Clifford®, Directed®, and Python®. VOXX Electronics has strategic Distribution relationships with Gentex®, Look-it® Auto-Oxide and SiriusXM®

For additional information, please visit our website at www.voxxelectronics.com

ABOUT VOXX INTERNATIONAL CORPORATION

We are a leading global manufacturer and supplier of Automotive and Consumer Electronics products, with an expanding portfolio of iris-based authentication solutions for the rapidly growing biometrics industry. We have a broad range of products sold under a portfolio of over 35 well-known Consumer Electronics brands in the premium audio and accessories categories, including Klipsch®, RCA®, Acoustic Research®, Audiovox®, 808 Audio®, Magnat®, Heco®, Schwaiger®, Oehlbach®, and more. We also have an array of products within our Automotive Electronics segment, with brands such as Invision®, Rosen®, Advent®, and Code-Alarm® as well as the recently acquired brands of Rostra®, Vehicle Safety Manufacturing®, Viper®, Autostart®, AstroStart®, Automate®, Avital®, Clifford®, Directed®, and Python®. We supply our products to a diversified customer base consisting of automotive OEMs, specialty CE-retailers, mass merchandise and power retailers, 12-volt specialists, and other commercial entities.

We hold market-leading positions across many categories within our Automotive Electronics and Consumer Accessories segments. For years, we have been the #1 provider of rear-seat entertainment systems and believe we are the #1 supplier of vehicle security and remote start systems to domestic OEMs and to the automotive aftermarket. We are the #1 premium loudspeaker company in North America and believe we are the #1 supplier of antennas and TV remote controls at retail (also in North America). Our other brands typically hold top 5 or top 10 market positions within the categories we operate.

For additional information, please visit our website at www.voxxintl.com



Vision Zero Automotive Network is a 501(c)(3) non-profit entity dedicated to educating and encouraging the saving of lives through the addition of life saving technologies in existing vehicles.



VOXX International and all of its family of brands are committed to helping save our environment. To that end, all printed materials produced by us are printed on recyclable paper using only biodegradable ECO friendly coatings. We use soybean rather than petroleum based inks. Our printing presses have "Purge on Press" capability; use no alcohol and therefore result in no vapor pollutants in the air.

IMPORTANT SAFETY NOTICE

It is unlawful in most jurisdictions for a person to drive a motor vehicle which is equipped with a television viewer or screen that is located in the motor vehicle at any point forward of the back of the driver's seat, or that is visible, directly or indirectly, to the driver while operating the vehicle. This product should only be installed to the rear of the back of the driver's seat where it will not be visible, directly or indirectly, to the operator of the motor vehicle. In addition, the state of Rhode island forbids the installation of such a device in a motor vehicle.

Photos and specifications subject to change without notice. Illustration of product finish may vary from actual color. All network and programing images and logos are copyrighted and are the property of their respective owners; they are not affiliated with Voxx International Corporation. All trade names are registered trademarks of respective manufacturers listed. All rights reserved.

These products are distributed by VOXX International Corporation and or its subsidiaries, not in any way affiliated with or made or sponsored by its affiliates and or the owners for the Cadillac®, Chevrolet®, GMC®, Chrysler®, Ford® and GM® brands. The names of actual companies and products mentioned herein may be the trademark of their respective owner.



A VOXX INTERNATIONAL COMPANY

2351 J. Lawson Blvd, Orlando, FL 32824 - 800-290-6650 - www.voxxelectronics.com

