



Mechanics & Materials I

Chapter 9

Properties of Materials

FAMU-FSU College of Engineering
Department of Mechanical Engineering

Properties of Materials

- The design of machines and structures so that they will function properly requires that we understand the mechanical behavior of the materials being used.
- Ordinarily, the only way to determine how materials behave when they are subjected to loads is to perform experiments in the laboratory.

Tensile Test

- The tension test is commonly employed to determine such engineering properties as
 - 1- Young's modulus E
 - 2- Yield strength σ_y
 - 3- Ultimate strength σ_u
 - 4- Percent elongation, and percent reduction of area.
 - 5- Toughness
 - 6- Modulus of Resilience
 - 7- Ductile/brittle behavior

Tensile Test

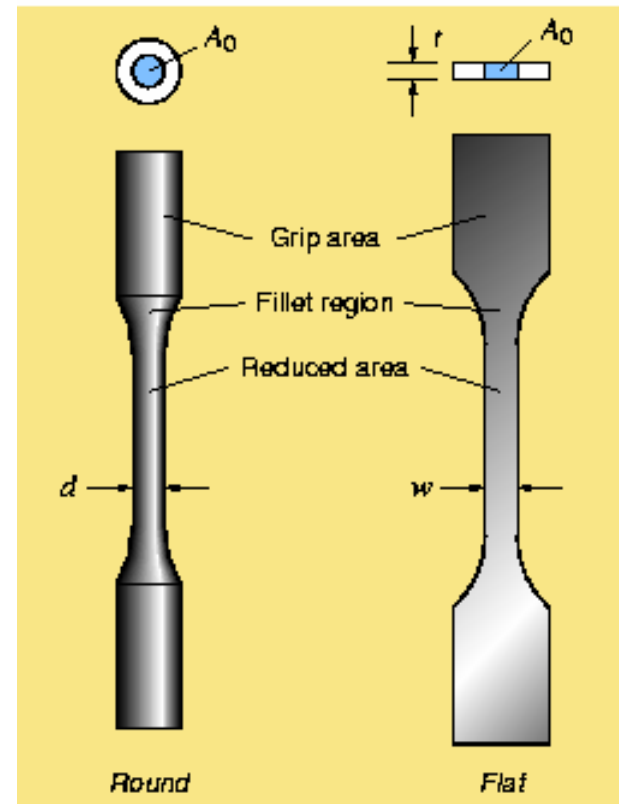

- One of the most common tests of material is the tension test.
- In the usual tension test the cross section of the specimen is round, square, or rectangular.

Tensile Test

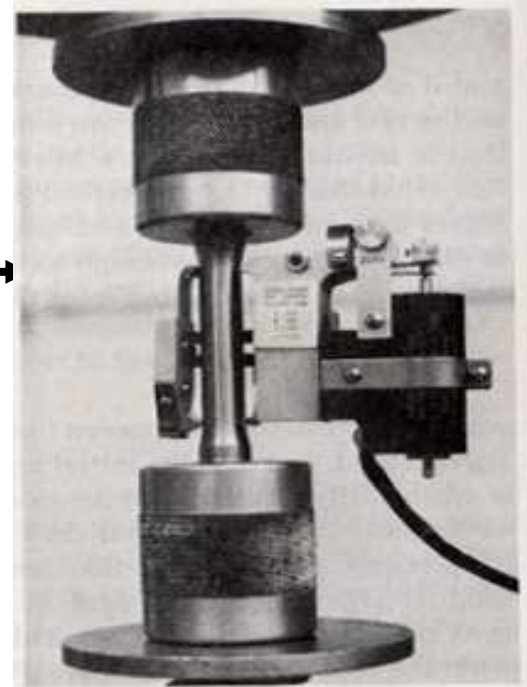
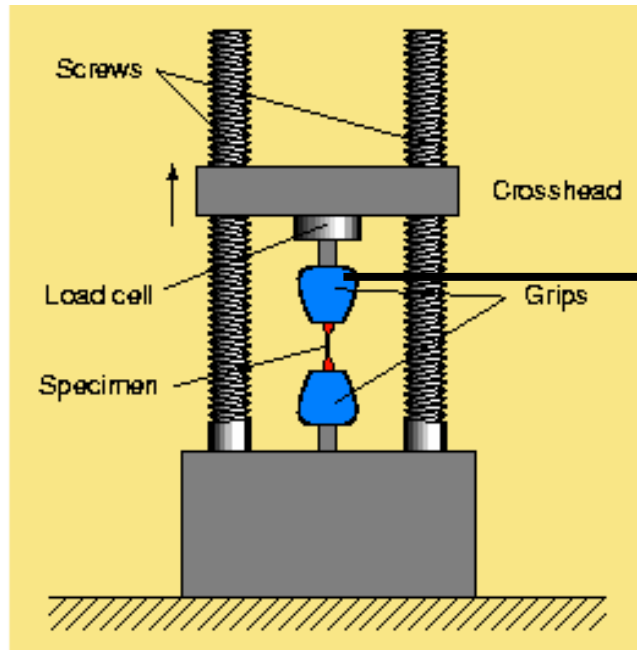

- The tensile-test specimen is placed in a test machine called tensile-test machine.
- The deformation is recorded by extensometer or strain gauge.

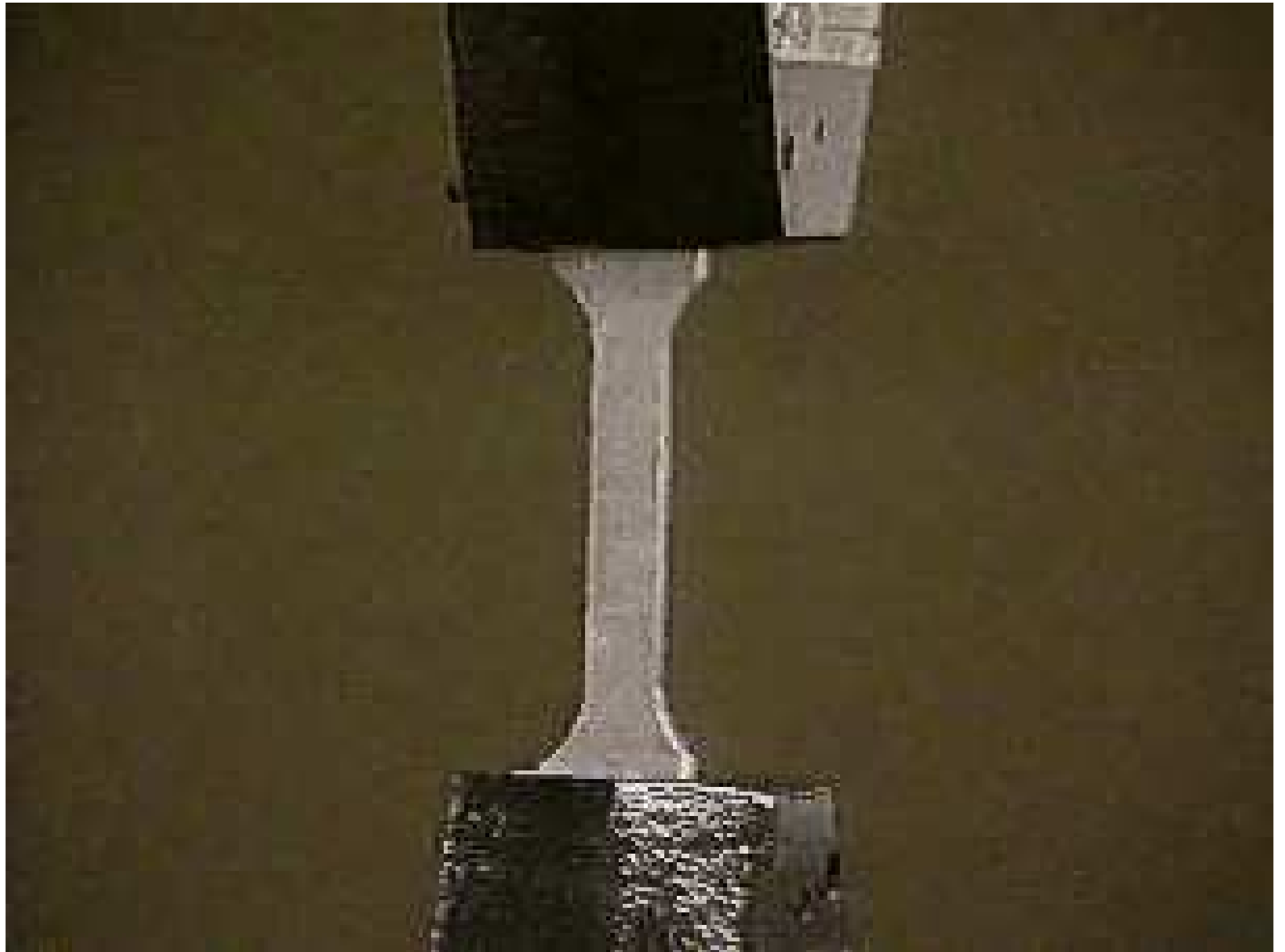

Tensile Test: Stress Calculation

Loads are gradually applied to the specimen and simultaneous readings of the load and deformation are taken at specified intervals.

- Nominal, or engineering, stress σ is determined by the formula

$$\sigma = \frac{P}{A_0}$$

where A_0 is the *original* cross-sectional area in the gage section and P is the applied load.

Tensile Test: Strain Calculation

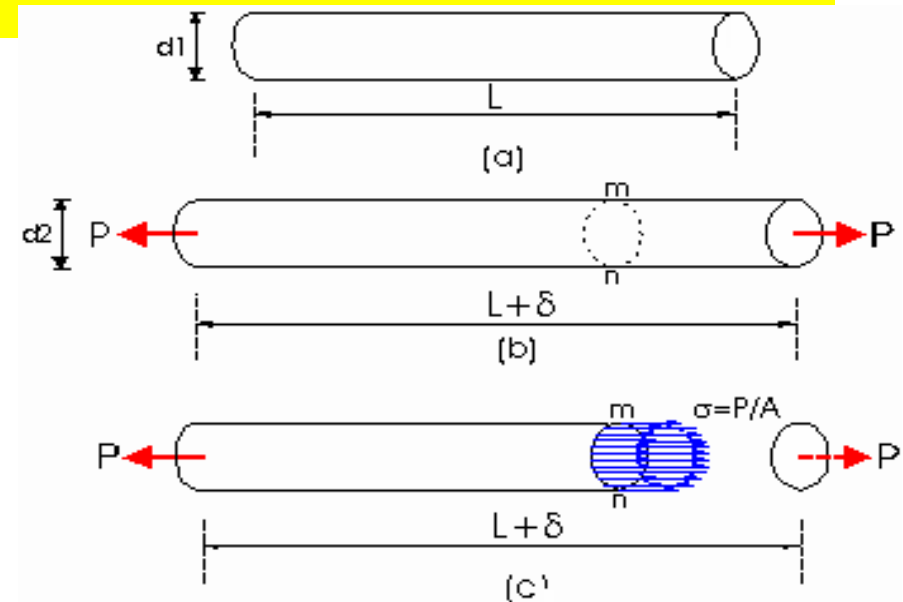
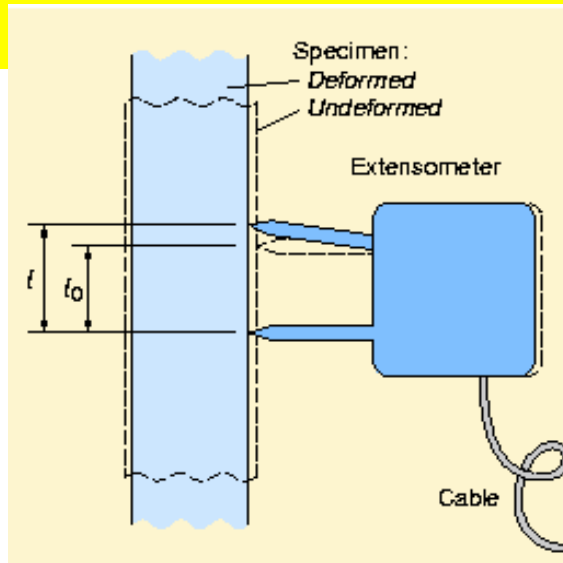

- Corresponding values of strain are found by dividing the deformation by the gauge length.

$$\epsilon = \frac{l - l_0}{l_0} = \frac{\Delta l}{l_0}$$

- Where l_0 is the *original* length of an axial line element and l is the current length of this element.

The convention for strain is that it is positive when l is greater than l_0 .

Tensile Stress – Strain Curve

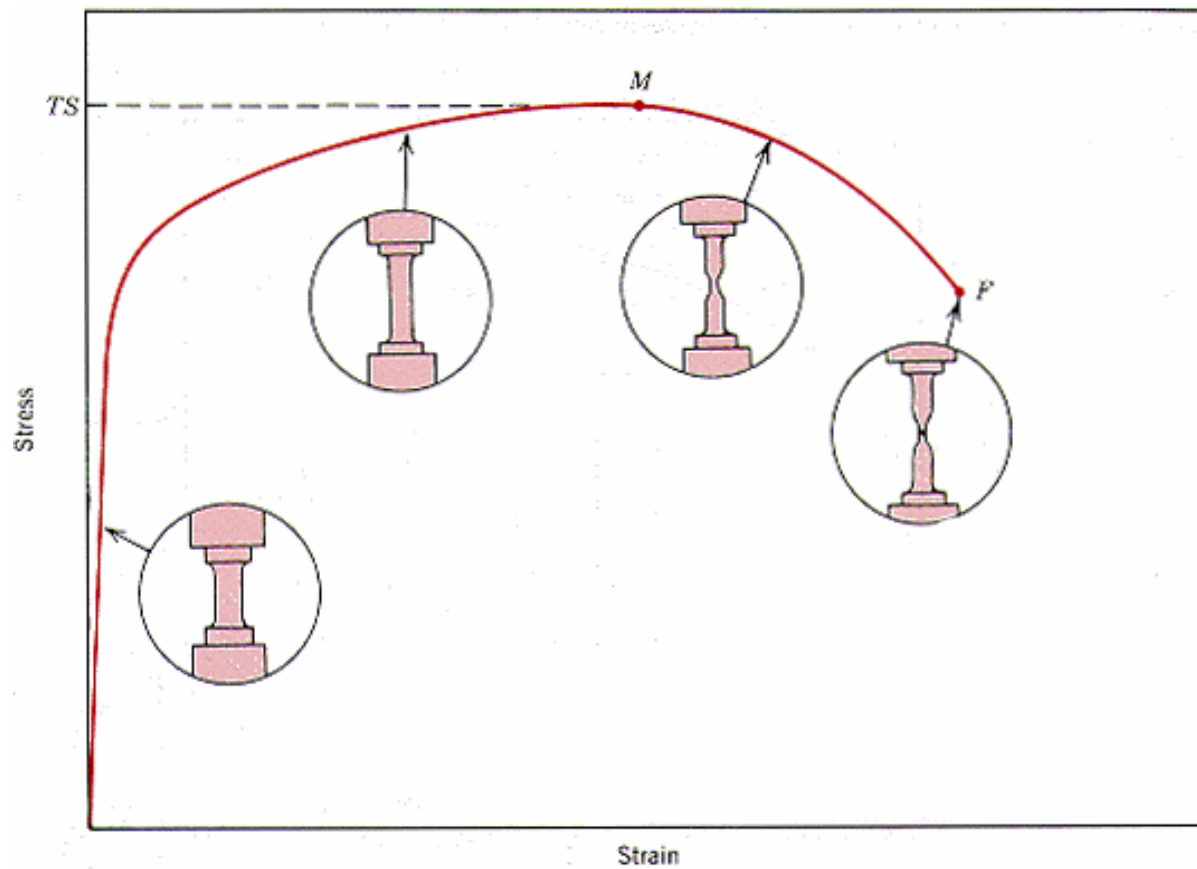

Tensile Test: Curve

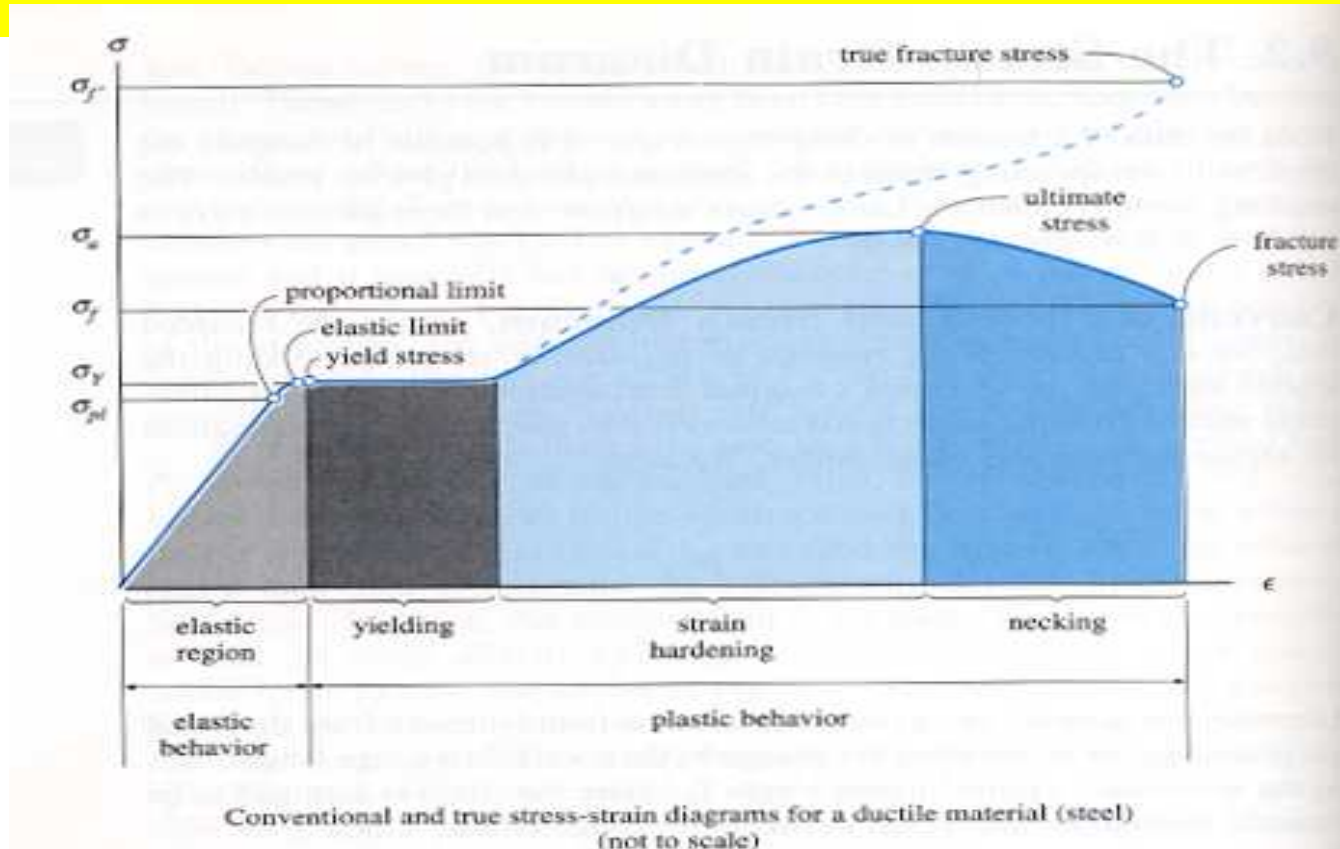

- The stress and strain values obtained can then be plotted in a stress-strain curve.
- The shape of the curve will depend on the kind of material tested.
- (The temperature and speed at which the test is performed also affect the results.)

Stress –Strain Curve: Regions

- **Elastic behavior:** The sample returns to its original shape/ length when the load is removed. Curve acts like straight line, the end of this region is the elastic limit.

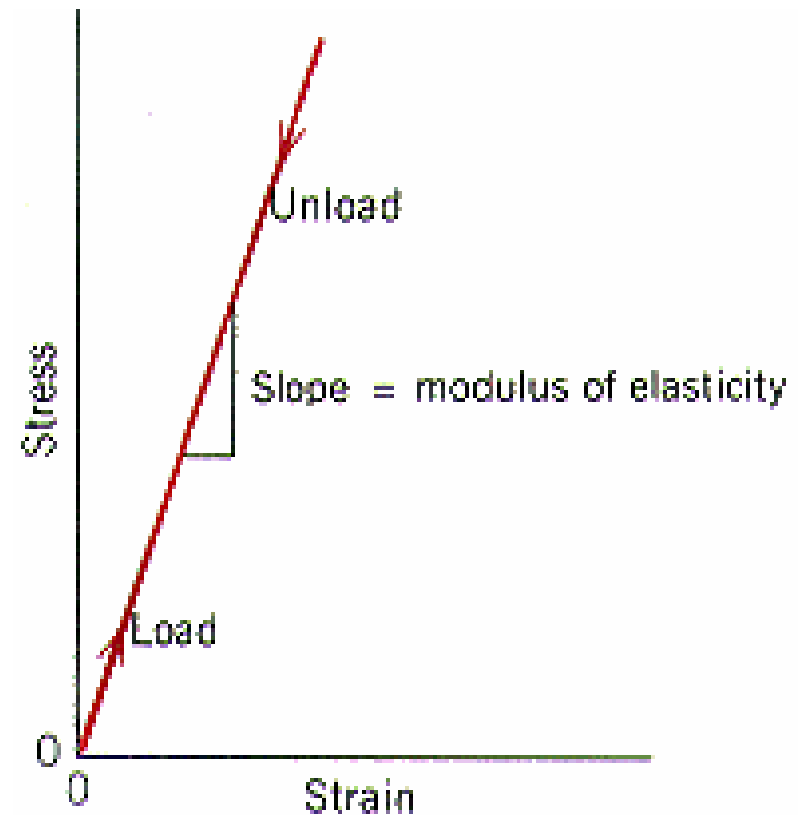

Stress – Strain Curve: Regions

- **Yielding:** An increase of the load above the elastic limit will result in a permanent deformation of the material. This behavior is called yielding. The stress that causes yielding is called “yield stress” and the strain that occurs is called a plastic strain.
- **Question:** How to determine the yield point if the curve not exactly linear??

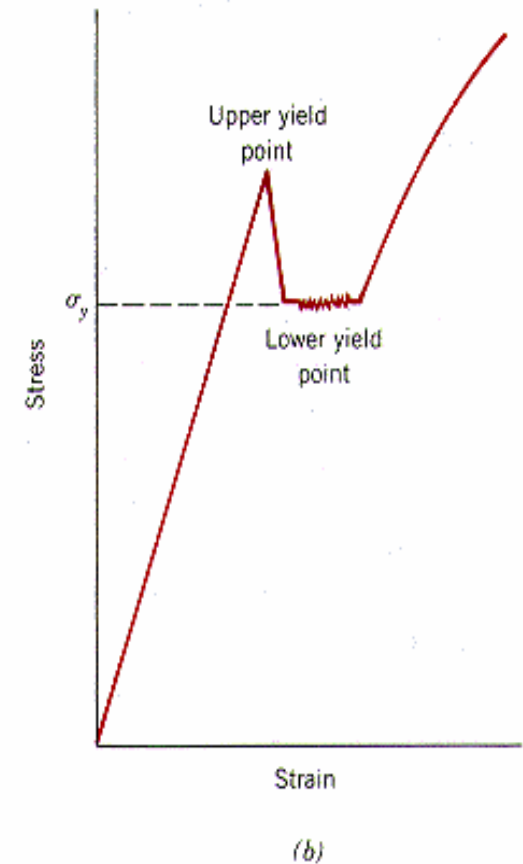
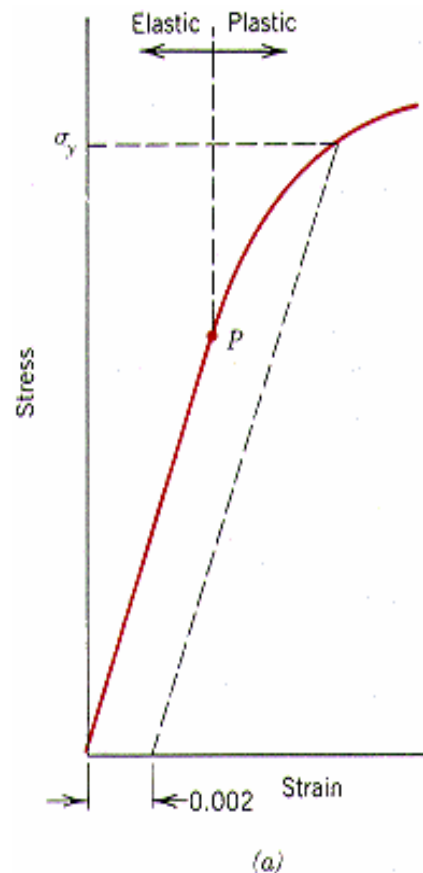

Stress – Strain Curve: Regions

- **Strain Hardening**: when yield has ended, an increase in the load will result in a stress rising until it reaches a maximum value of stress called the **ultimate stress, σ_u** . All materials have an ultimate strength given by

$$\sigma_u = \frac{P_{\max}}{A_0}$$

- where P_{\max} is the maximum load sustained in tension, and A_0 is the *original* cross-sectional area.

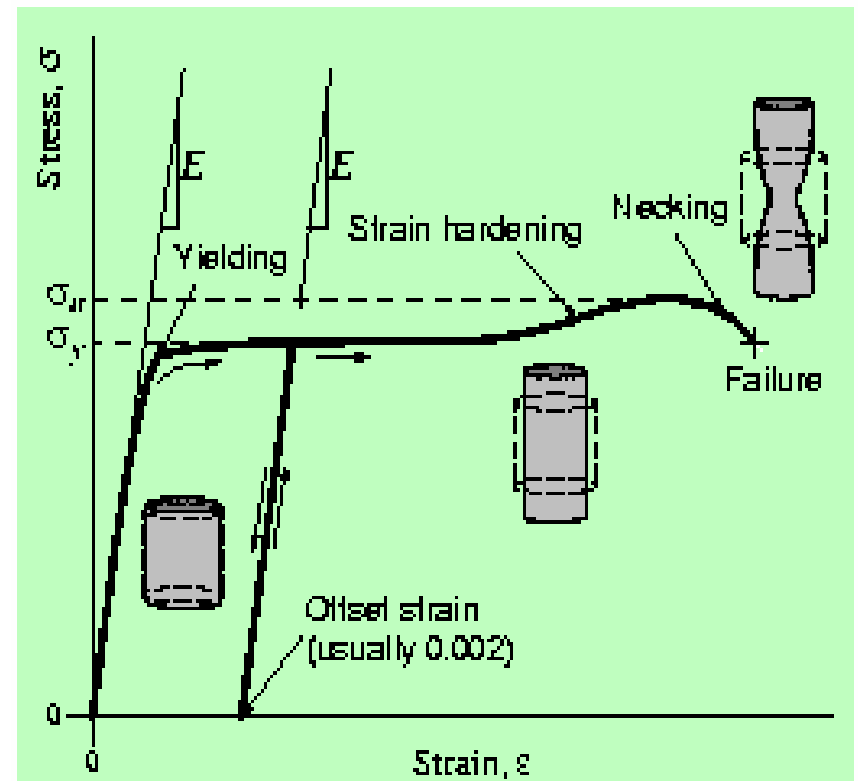

Stress – Strain Curve: Regions

- **Necking:**

After the stress exceeds the σ_u value, the cross sectional area of the sample starts to decrease rapidly at almost midpoint of the gauge length. Since the area decreases, it can't hold large loads so the stress strain-curve tends to curve downward until the material breaks at fracture stress σ_f



Young's Modulus: E

- For all materials, the slope E of the linear portion of the stress–strain curve for small strain is a characteristic of the material, called *Young's modulus*.
- For example, Young's modulus of most steels is about 200 GPa, while that of aluminum and glass is about 70 GPa.
- Young's modulus is an example of a *bulk property* of a material—one that is determined primarily by the major constituent of the material.

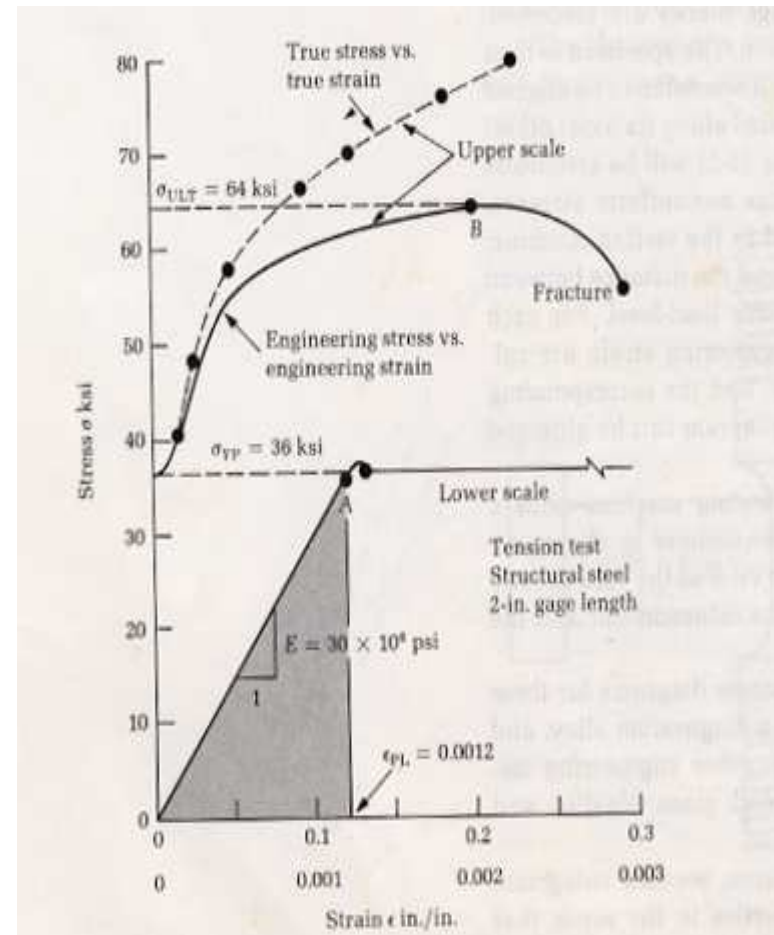

Young's Modulus

<i>Metal</i>	<i>Modulus of Elasticity</i> <i>[psi × 10⁶ (MPa × 10³)]</i>		
	<i>[100]</i>	<i>[110]</i>	<i>[111]</i>
Aluminum	9.2 (63.7)	10.5 (72.6)	11.0 (76.1)
Copper	9.7 (66.7)	18.9 (130.3)	27.7 (191.1)
Iron	18.1 (125.0)	30.5 (210.5)	39.6 (272.7)
Tungsten	55.8 (384.6)	55.8 (384.6)	55.8 (384.6)

Poisson's Ratio: ν

- When a bar of a material is stretched longitudinally, the bar extends in the direction of the applied load. This **longitudinal extension** is accompanied by a **lateral contraction** of the bar, as shown.
- In the linear-elastic range of a material the lateral strain is proportional to the longitudinal strain; if ϵ_x is the **longitudinal strain** of the bar, then the **lateral strain** is ϵ_y

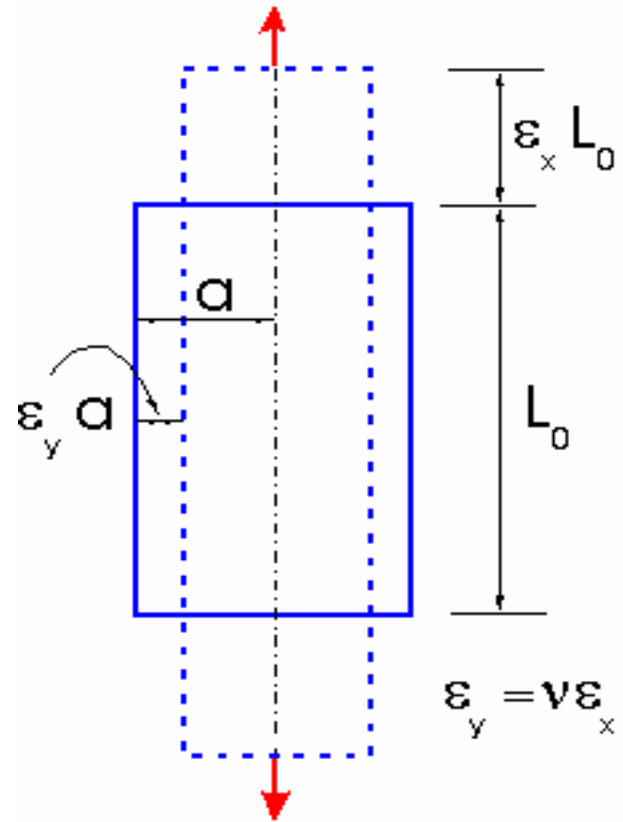

Poisson's Ratio Cont.

- $\nu = (\text{strain perpendicular to applied load}) / (\text{strain in direction of the applied load}) = \varepsilon_y / \varepsilon_x$
- The constant ν in this relation is known as **Poisson's ratio**, and for most metal has a value of about 0.3 in the linear-elastic range.
- If the longitudinal strain is tensile, the lateral strain is a contraction; for a compressed bar there is a lateral expansion.
- With a knowledge of the lateral contraction of a stretched bar it is possible to calculate the change in volume due to straining.

Ductile and Brittle Materials

- For a *brittle* material, the stress–strain curve is linear almost to failure. Glass, Gray cast iron, exhibit brittle behavior.
- For a *ductile* material, there is an easily distinguished *yield point* beyond which the stress grows very slowly (if at all) with strain. Ductile material can sustain large strains before fracture. Examples of ductile materials are mild steel, aluminum and rubber.

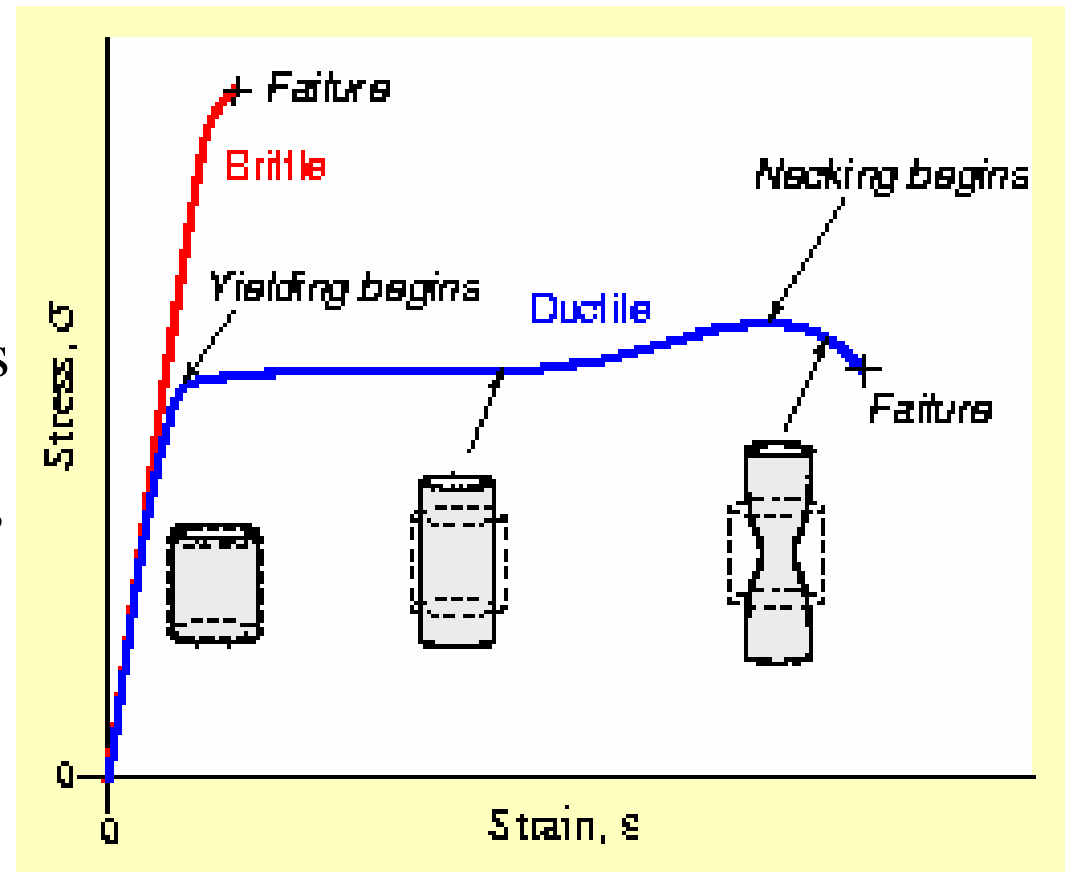

Ductility- Necking

- Ductile materials will often *neck* prior to failure
- The necking begins when the *ultimate strength* has been reached, at which point the stress begins to decrease with increasing strain.

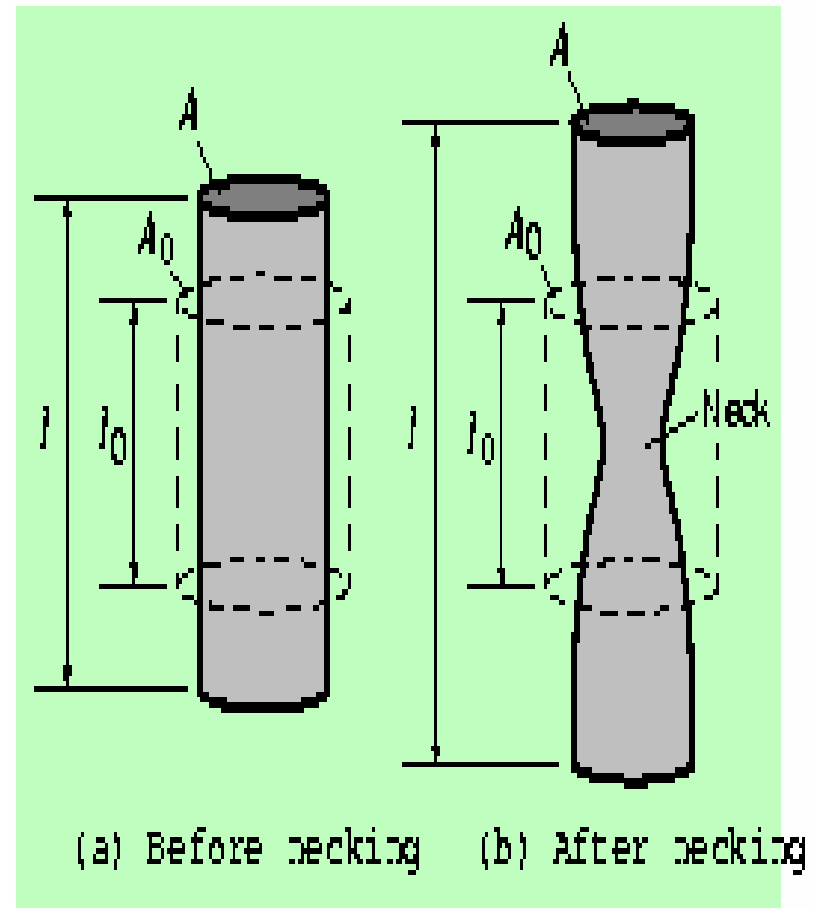

Measurement of Ductility

- Ductility is measured by **percent elongation** or **percent reduction of area**

$$\text{Percent elongation} = \frac{l_f - l_0}{l_0} (100\%)$$

$$\text{Percent reduction of area} = \frac{A_0 - A_f}{A_0} (100\%)$$

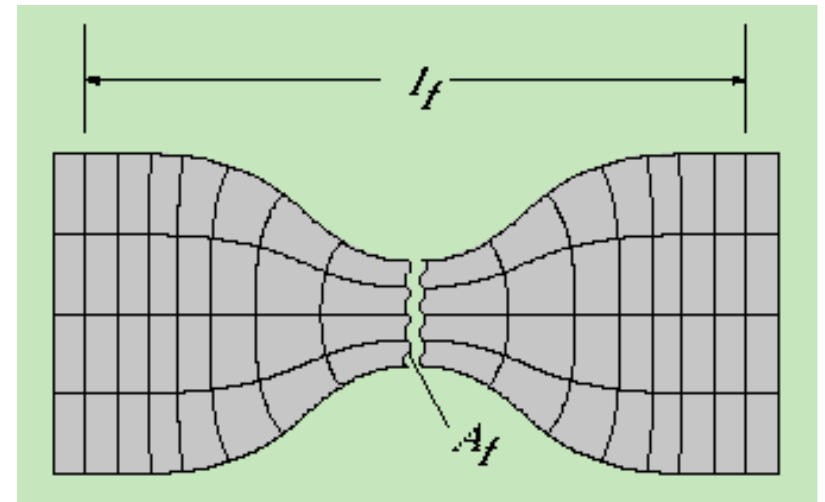

Strength and Ductility

<i>Metal</i>	<i>Yield Strength [psi (MPa)]</i>	<i>Tensile Strength [psi (MPa)]</i>	<i>Ductility, %EL (in 2 in.)</i>
Gold	Nil	19,000 (130)	45
Aluminum	4,000 (28)	10,000 (69)	45
Copper	10,000 (69)	29,000 (200)	45
Iron	19,000 (130)	38,000 (262)	45
Nickel	20,000 (138)	70,000 (480)	40
Titanium	35,000 (240)	48,000 (330)	30
Molybdenum	82,000 (565)	95,000 (655)	35

Brittle Fracture

- Brittle fractures are characterized by a flat fracture surface perpendicular to the maximum principal normal stress direction. The fracture originates at the surface, due to the presence of a suitable flaw, such as a scratch, machining mark, or crack
- Brittle materials fail at small strains and in tension.

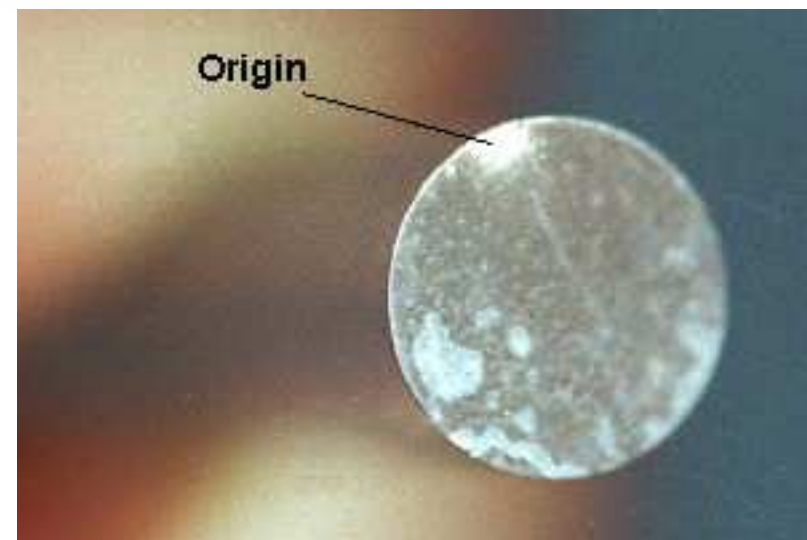
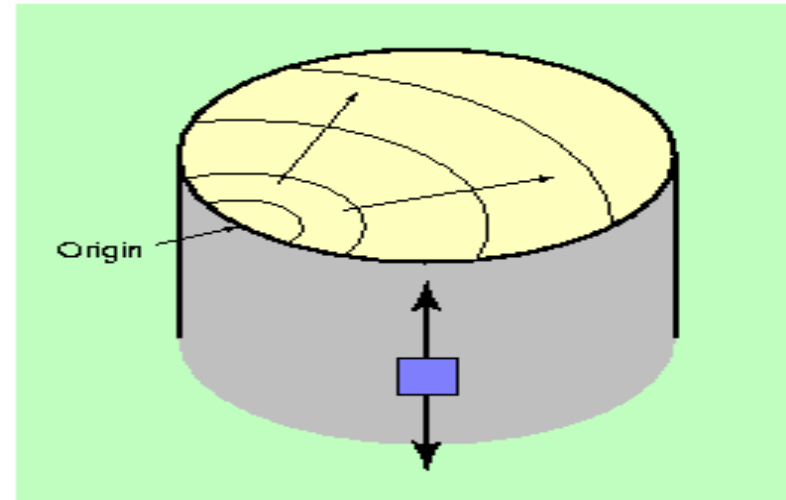

Ductile Fracture

- Ductile failures are often of **the cup-and-cone type**. Necking produces a triaxial state of stress that results in ductile tearing, starting at outward.
- As the fracture approaches the surface, the outside ring of unbroken material becomes loaded approximately uniaxially and may fail in shear along 45° surfaces.
- If this shear surface forms continuously around the specimen, then a cup forms on one side, and a cone on the other.
- **Ductile materials fail at large strains and in shear.**

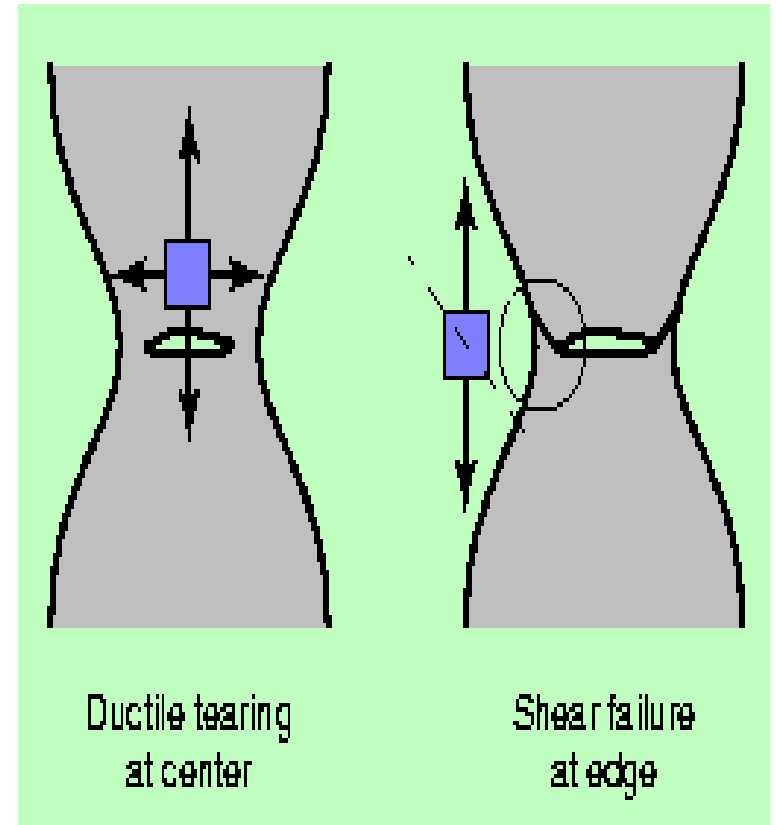

Ductile Fracture

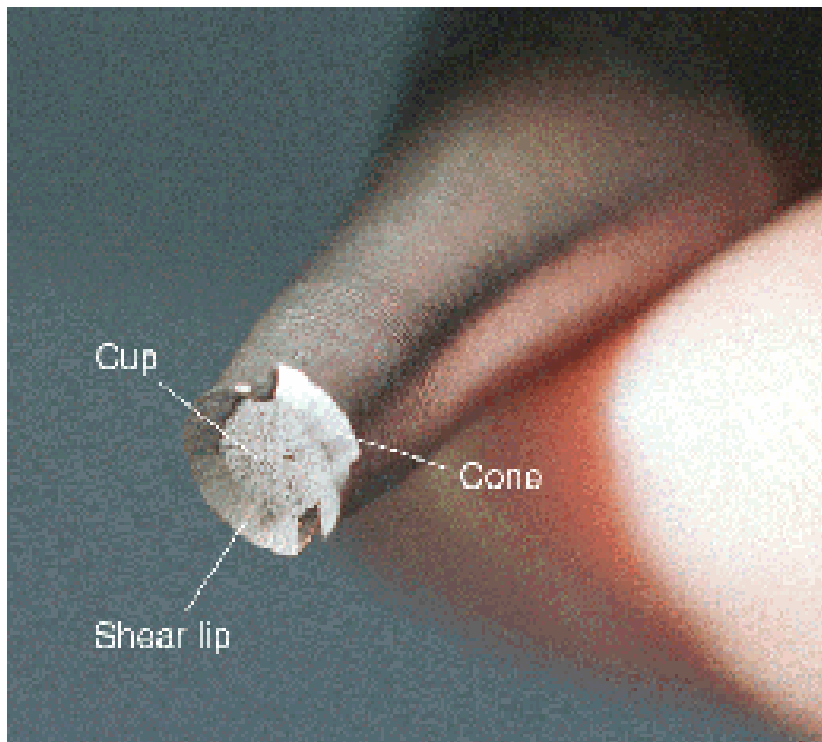

Cup-and-cone failure in 1045 steel

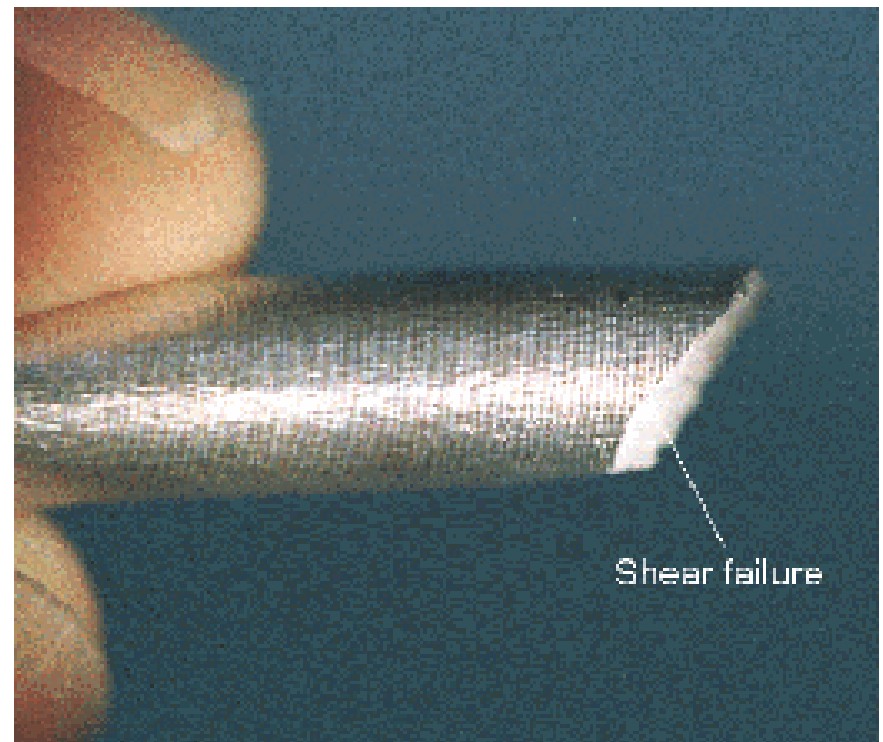

Shear failure in 2024-T6 aluminum

Hook's Law

- When a material behaves elastically and also shows a linear relationship between stress and strain (line starts from 0 stress up to proportional limit) it is said to be **linearly elastic material**.
- **Hooke's law**: stress is proportional to strain in the linear elastic region of a stress-strain diagram.

$$\sigma = E\varepsilon$$

- The slope of the stress-strain curve (E) is the elastic modulus or modulus of elasticity (Young's Modulus).

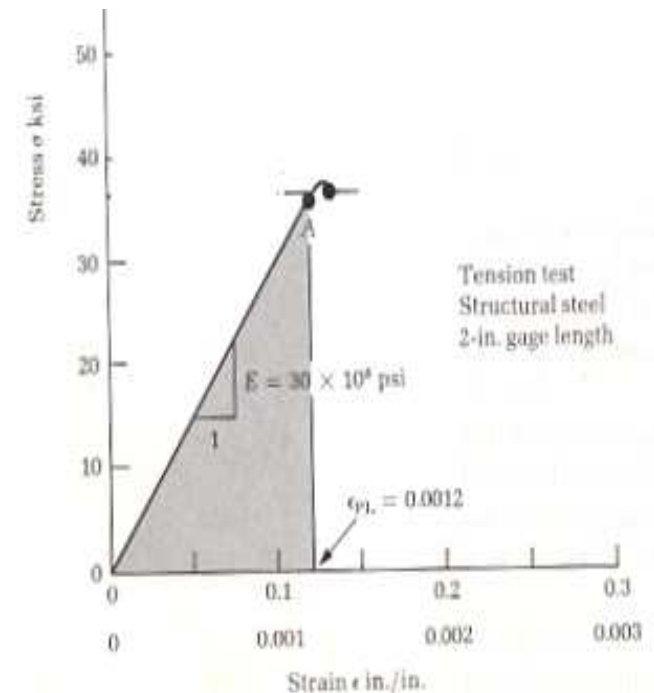

Strain Energy

- As the material is deformed by an external loading, the material tends to store energy internally through-out its volume. This energy is called strain energy.
- It is convenient to formulate strain energy per unit volume of materials. This is called the *strain energy density* and is given

as

$$u = \frac{1}{2} \sigma \epsilon$$

- Two Material's quantities related to the strain energy density:
Modulus of Resilience and Modulus of Toughness

Modulus of Resilience: u_r

- It is a measure of the capacity of the material to absorb (elastically) energy without undergoing permanent deformation .
- Modulus of resilience is **the area under the portion of the stress-strain curve that is delimited by the proportional limit.**

$$u_r = \frac{1}{2} \sigma_{pl} \epsilon_{pl} \quad \text{using Hook's law} \quad \Rightarrow \quad = \frac{1}{2} \frac{\sigma_{pl}^2}{E}$$

- the units of u_r : energy per volume.

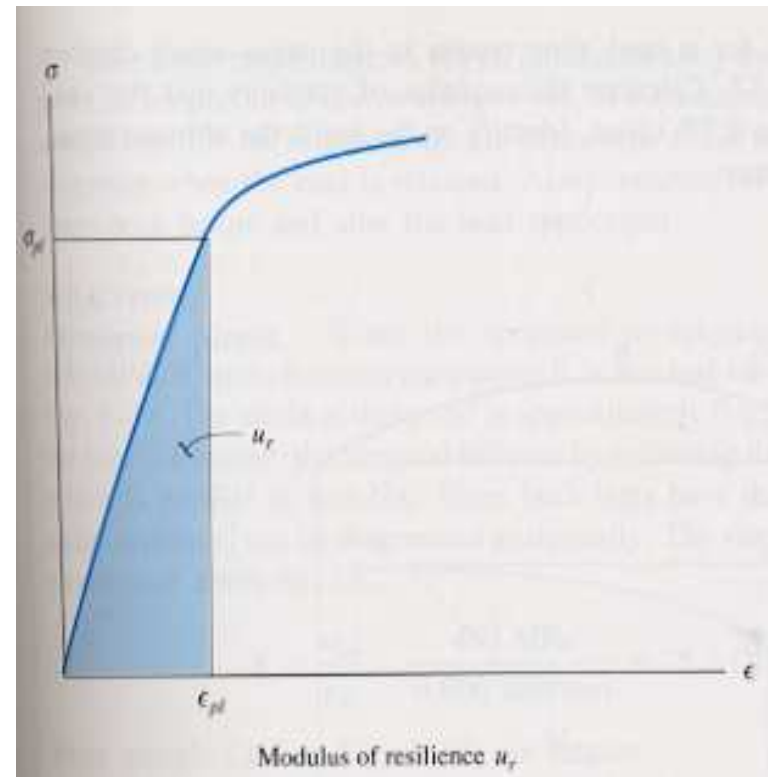

Modulus of Toughness: u_t

- It indicates the strain energy density of the material just before it fractures.
- The modulus of toughness is defined by the **total area under the stress-strain curve**
- Units of toughness are energy per volume

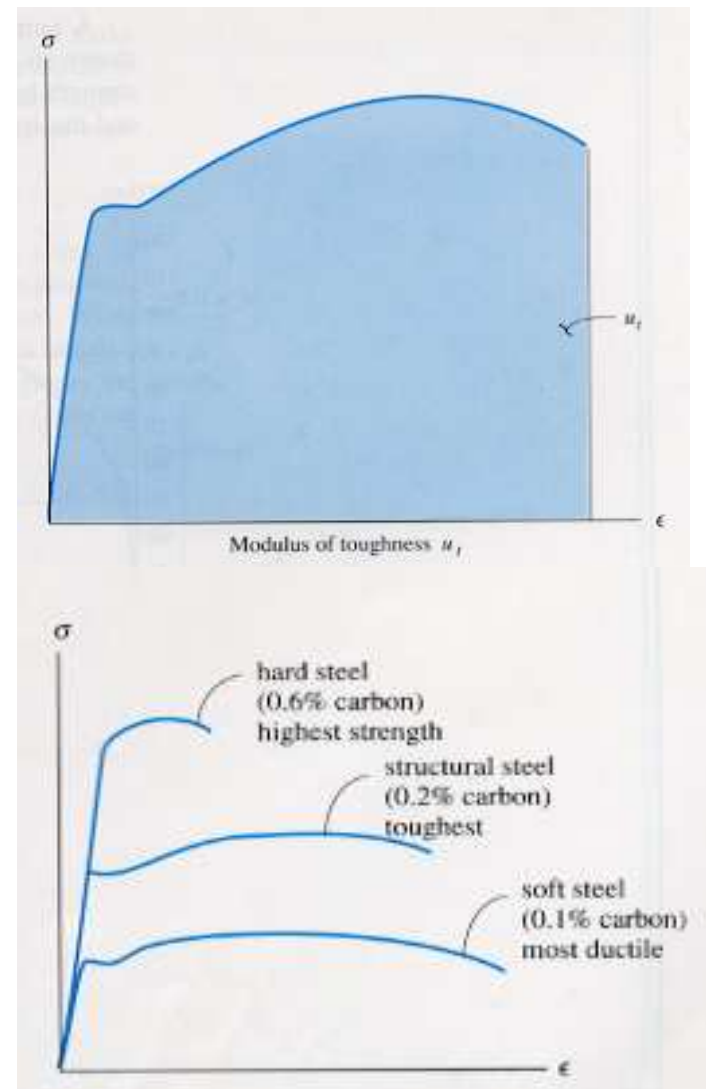

Ductility and Toughness Relation

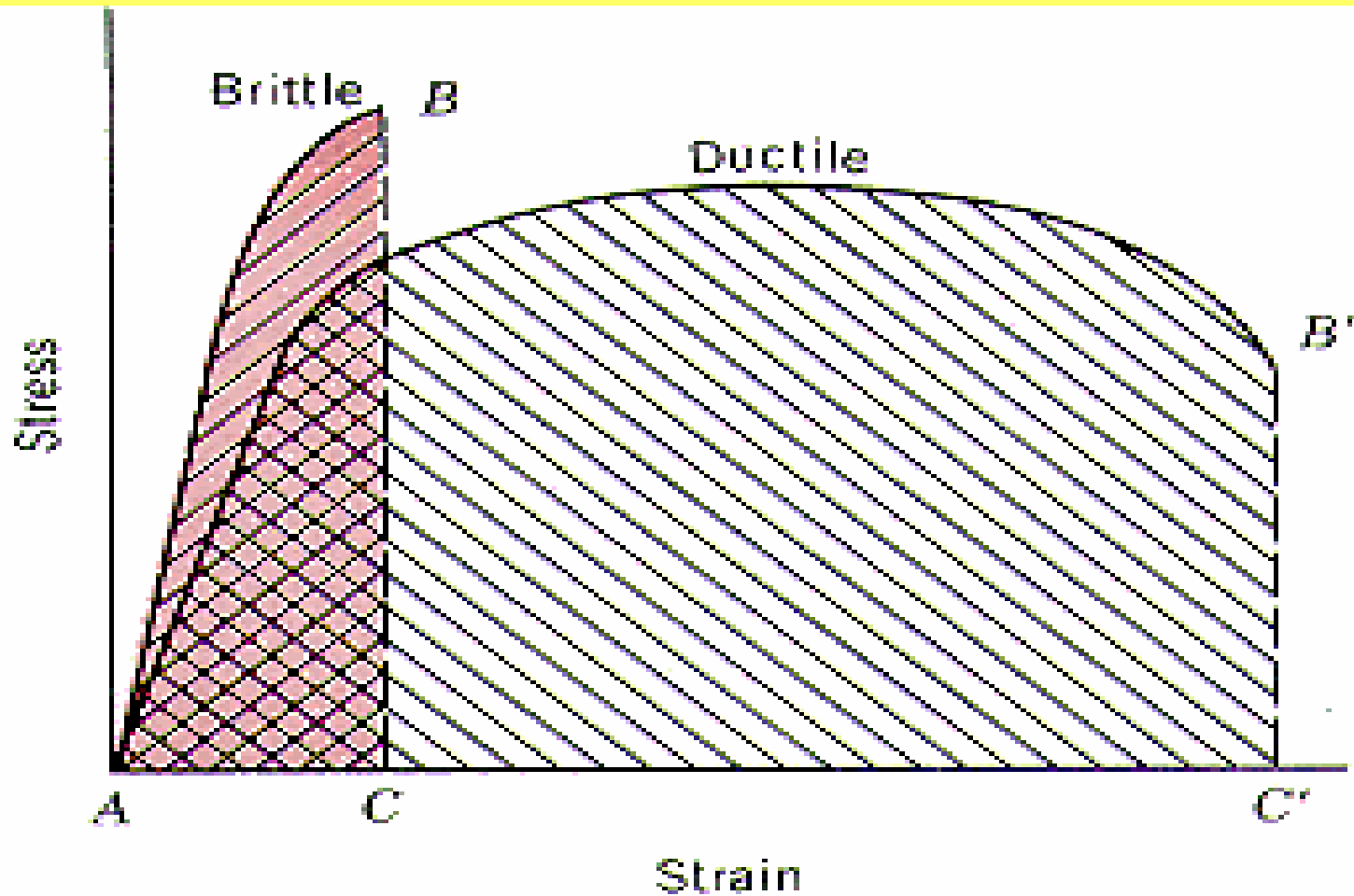

True Stress-Strain Curve

- “True stress” σ_t , is based on the actual load divided by the *current* area A rather than the initial area A_o .
- Notice that when the area A is reduced (as in the tension test), the “true stress” is larger than the nominal or engineering stress.
- “True strain,” ϵ_t is based on the summation of incremental strains based on *current* length l ,
- Since, in tension, the current length is larger than the initial length, the “true strain” ϵ_t is smaller than the nominal or engineering strain ϵ .

True Stress-Strain Curve

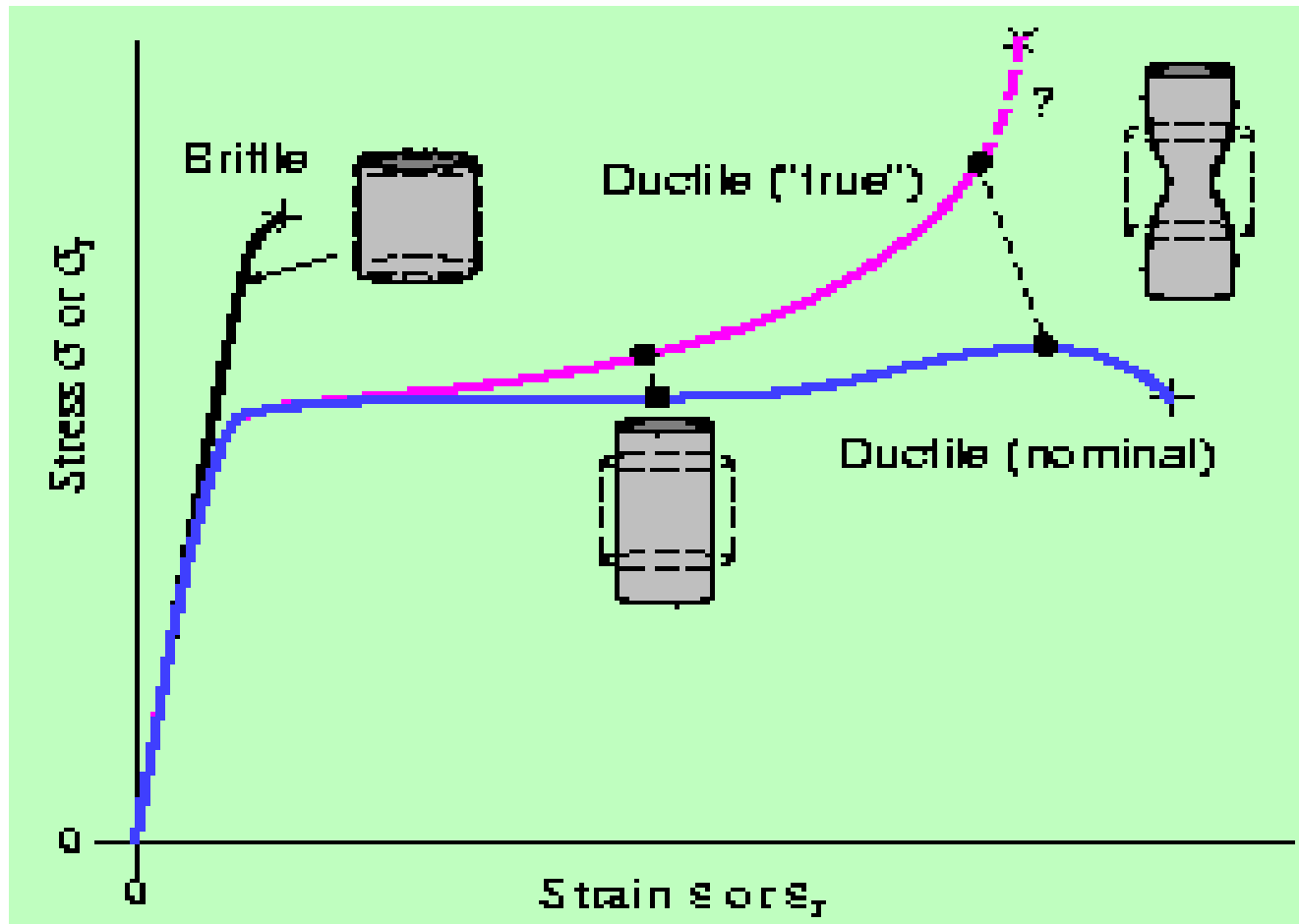

True vs. nominal stress-strain curves.

Shear Stress – Strain Diagram

- The pure shear stress is generated by applying a torque over a sample that has a circular shape. The measurement is made between the torque and the resulting angle of twist.

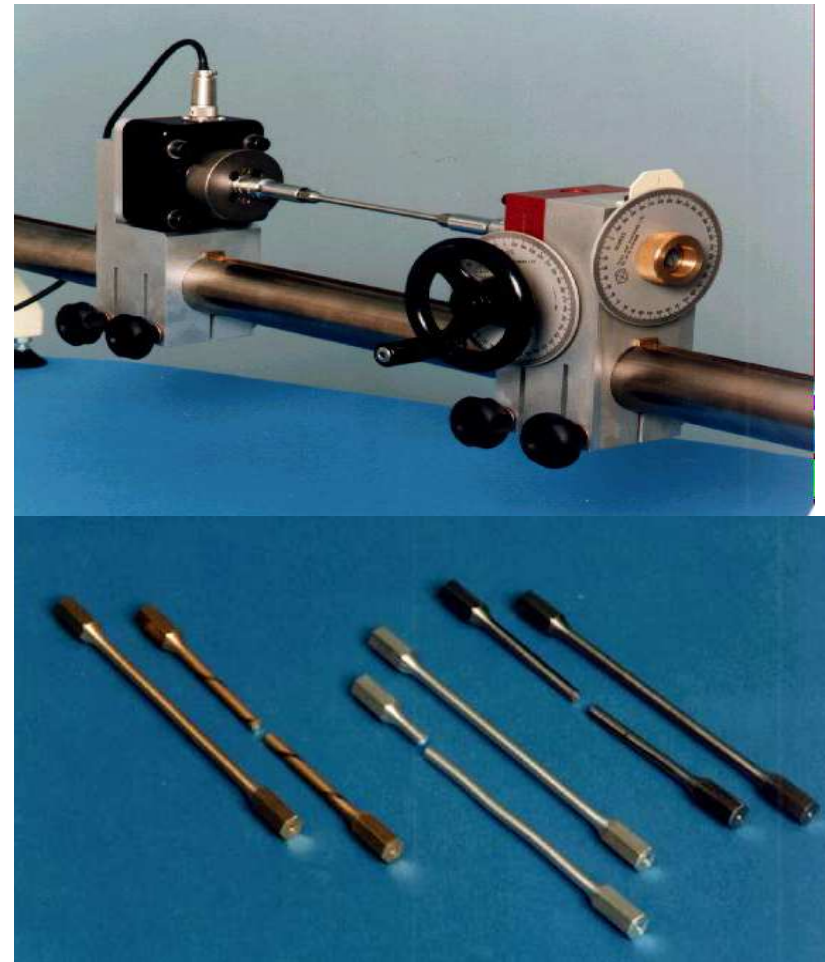

Torsion

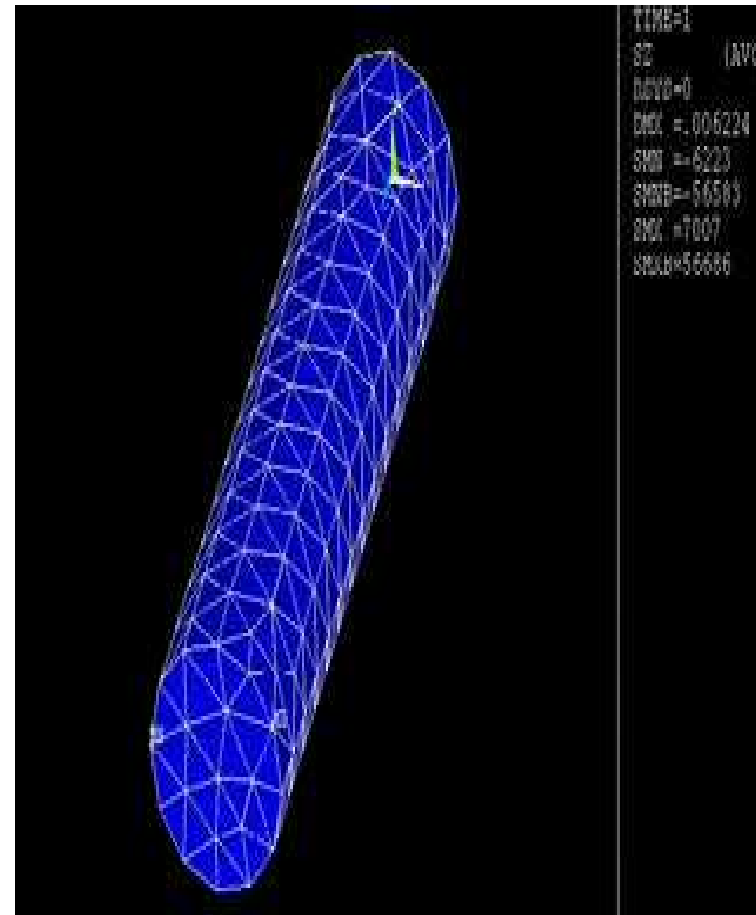
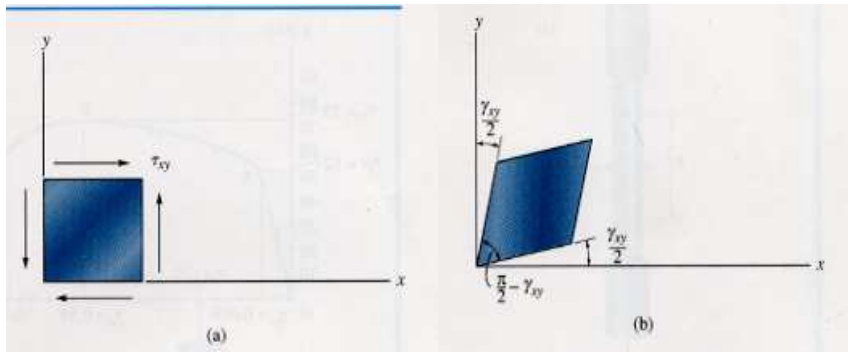
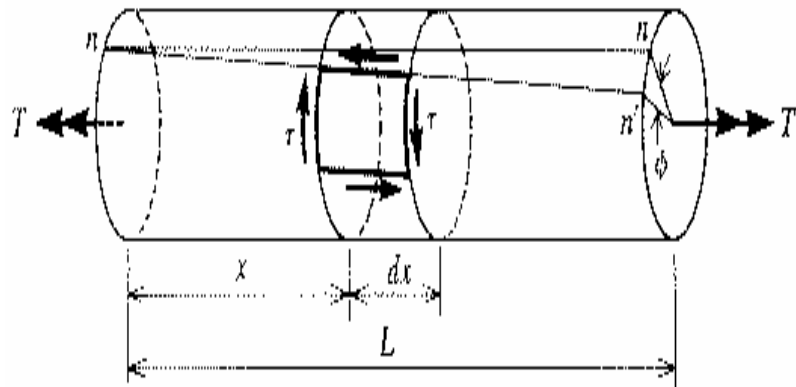

Shear Stress-Strain Diagram

- Hook's law for Shear

$$\tau = G\gamma$$

τ : shear stress

γ : Shear strain

G : Shear modulus(Modulus of Rigidity)

$$G = \frac{E}{2(1 + \nu)}$$

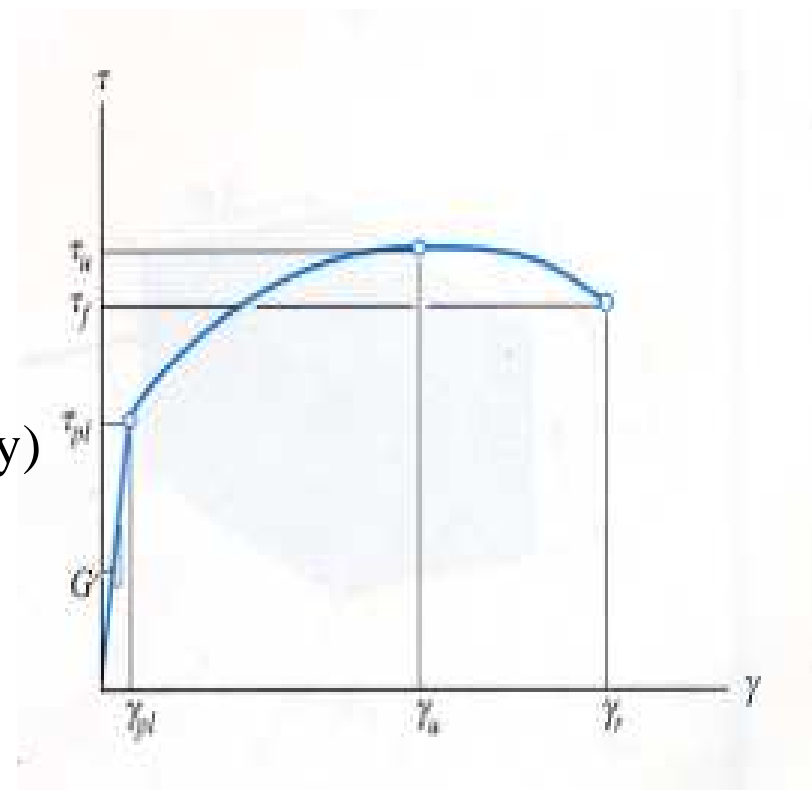

Values of E, G, and ν

<i>Metal Alloy</i>	<i>Modulus of Elasticity</i>		<i>Shear Modulus</i>		<i>Poisson's Ratio</i>
	<i>psi $\times 10^6$</i>	<i>MPa $\times 10^4$</i>	<i>psi $\times 10^6$</i>	<i>MPa $\times 10^4$</i>	
Aluminum	10.0	6.9	3.8	2.6	0.33
Brass	14.6	10.1	5.4	3.7	0.35
Copper	16.0	11.0	6.7	4.6	0.35
Magnesium	6.5	4.5	2.5	1.7	0.29
Nickel	30.0	20.7	11.0	7.6	0.31
Steel	30.0	20.7	12.0	8.3	0.27
Titanium	15.5	10.7	6.5	4.5	0.36
Tungsten	59.0	40.7	23.2	16.0	0.28