

# **RLreal LIGHT DESIGN**



## DESIGN



**Klare Formsprache, zeitloses Design, Innovation und hohe Flexibilität zeichnen WEGE-LICHT aus.**

Durch die Fertigung im eigenen Betrieb können wir schnell auf Sonderlösungen eingehen und in Absprache mit Bauherrn und Architekten die optimale Beleuchtungslösung anbieten.

**„ Wer aufhört besser zu werden hört auf gut zu sein. „**

( Robert Bosch )

## PRODUCTION



**Clear design language , timeless design, innovation and high flexibility is characterized of WEGE-LICHT.**

By manufacturing in-house, we can quickly respond to special solutions and, in consultation with customers and architects, offer the perfect lighting solution.

**„ If you stop getting better, you stop being good. „**

( Robert Bosch )

## ASSEMBLING



**Erklärung / declaration:**

10... Wandleuchte / wall luminaire

40... Hängeleuchte / pendant luminaire

70... Stehleuchte / floor luminaire

20... Zubehör / accessories

50... Einbauleuchte / recessed luminaire

80... Systemleuchte / system luminaire

30... Deckenleuchte / ceiling luminaire

60... Tischleuchte / table luminaire



**Wandleuchte /** wall luminaire

**Aluminium** mit asymmetrischem Lichtaustritt

**aluminium**, asymmetric light //

weißaluminium / aluminium // weiß / white // schwarz / black

**Abdeckung Microprismen /** cover microprismatic

**Leuchtmittel /** lamp:

**SMALL** LED 27W / 4300lm 27K / 30K / 40K / 50K // 230V

**BIG** LED 45W / 7100lm 27K / 30K / 40K / 50K // 230V

**BIG Power** LED 59W / 9500lm 30K / 40K / 50K // 230V ( **CRI > 80** )

**DIM...** DALI dimmbar/ DALI dimmable

**DIMTR...** TRIAC dimmbar / TRIAC dimmable  
( SMALL )

**DIMT...** tunable white

**IP 20 / CRI >90 / L80B10**

**CRI > 95 Anfrage / request**

**Artikelnummer /** reference no.:

10.0ROCK S.... ( SMALL )

10.0ROCK B... ( BIG )

10.0ROCK BP ... ( BIG POWER )



indirect light ( I )



SMALL



BIG

BIG POWER

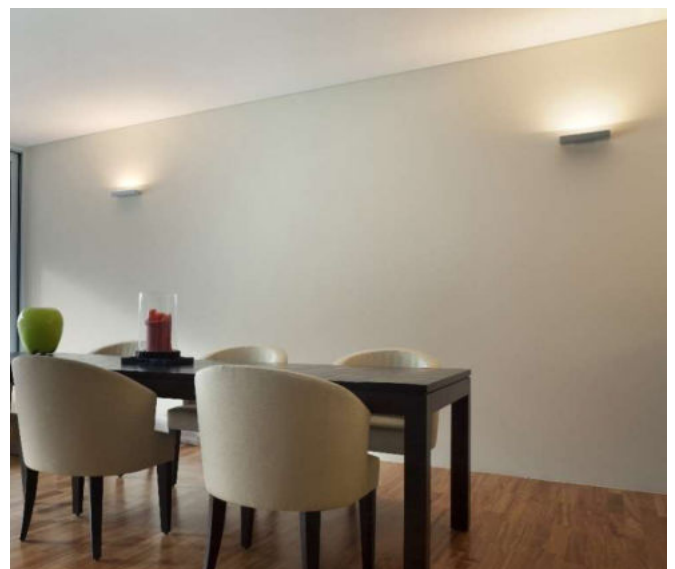
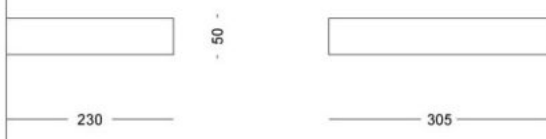



**Wandleuchte** / wall luminaire

**Aluminium eloxiert** / aluminium anodized // weiß / white // schwarz / black

**Leuchtmittel** / lamp:



SMALL LED 6W/ 600lm / 27K / 30K / 40K / 50K // 230V  
 MIDDLE LED 8W/ 950lm / 27K / 30K / 40K / 50K // 230V  
 BIG LED 16W/ 2100lm 27K / 30K / 40K / 50K // 230V  
 BIG PLUS LED 32W/ 3500lm / 27K / 30K / 40K / 50K // 230V

**Leuchtmittel** / lamp:



SMALL LED 3W / 300lm / 27K / 30K / 40K / 50K // 230V  
 MIDDLE LED 4W / 550lm / 27K / 30K / 40K / 50K // 230V  
 BIG LED 8W/ 1050lm / 27K / 30K / 40K / 50K // 230V  
 BIG PLUS LED 16W/ 2010lm / 27K / 30K / 40K / 50K // 230V

**DIM...** DALI dimmbar/ DALI dimmable  
 ( BIG / BIG PLUS )

**DIMTR...** TRIAC dimmbar / TRIAC dimmable  
 ( SMALL / MIDDLE / BIG )

**DIMT...** tunable white

**IP20 CRI >90 / L80B10**

**CRI > 95 Anfrage / request**

**Artikelnummer** / reference no. :

- 10.0BRICA S... ( SMALL )
- 10.0BRICA M... ( MIDDLE )
- 10.0BRICA B... ( BIG )
- 10.0BRICA BP... ( BIG PLUS )

**indirect light ( I )**



**direct/ indirect light ( D / I )**

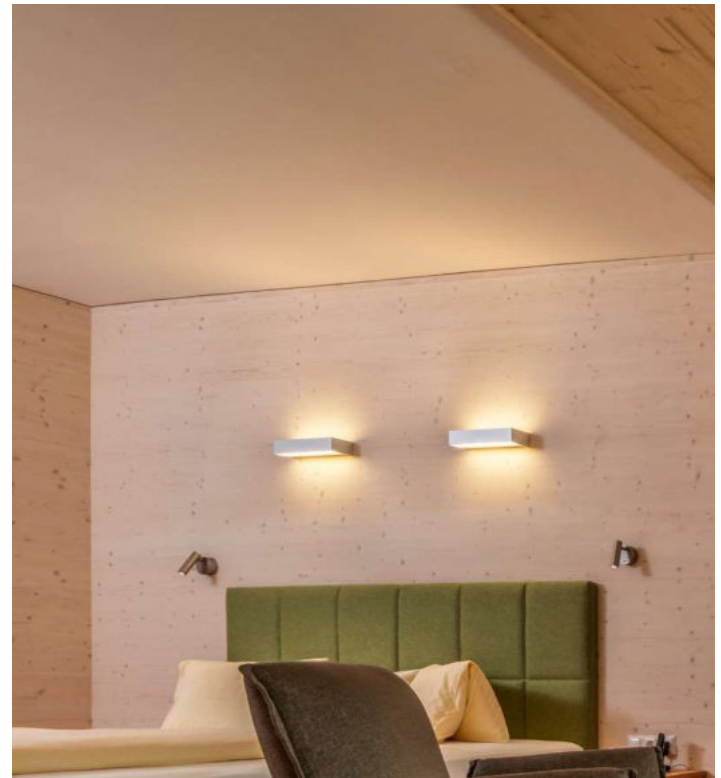

SMALL

MIDDLE

BIG

BIG PLUS

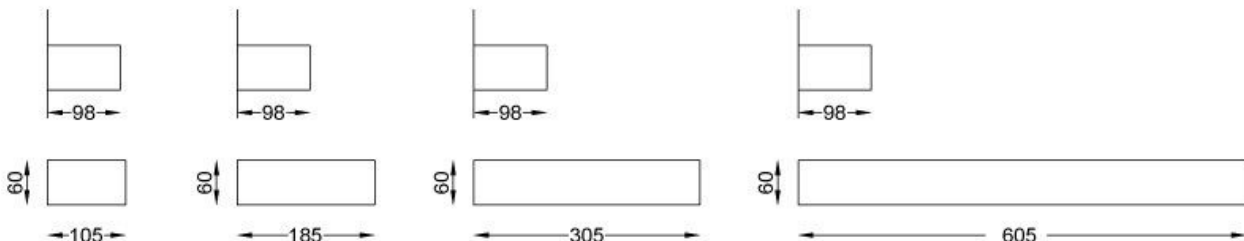



**Wandleuchte / wall luminaire**  
**Aluminium eloxiert / aluminium anodized //**  
 weiß / white // schwarz / black

**Leuchtmittel / lamp:**



POWER BIG LED 32W/ 4200lm 27K / 30K / 40K / 50K // 230V  
 POWER BIG PLUS LED 64W/ 7000lm 27K / 30K / 40K / 50K // 230V

**Leuchtmittel / lamp:**



POWER BIG LED 16W/ 2100lm 27K / 30K / 40K / 50K // 230V  
 POWER BIG PLUS LED 32W/ 4020lm 27K / 30K / 40K / 50K // 230V

**DIM... DALI dimmbar/ DALI dimmable**

**DIMT... tunable white**

**IP20 CRI >90 / L80B10**

**CRI > 95 Anfrage / request**

**Artikelnummer / reference no. :**

10.0BRICA PB... ( POWER BIG)

10.0BRICA PBP... ( POWER BIG PLUS )

**indirect light ( I )**



**direct/ indirect light ( D / I )**



POWER BIG

POWER BIG PLUS

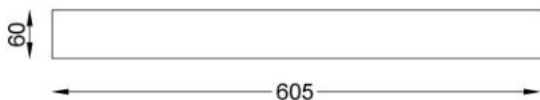
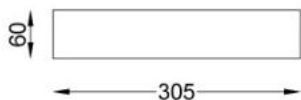
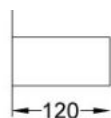
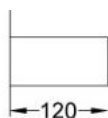

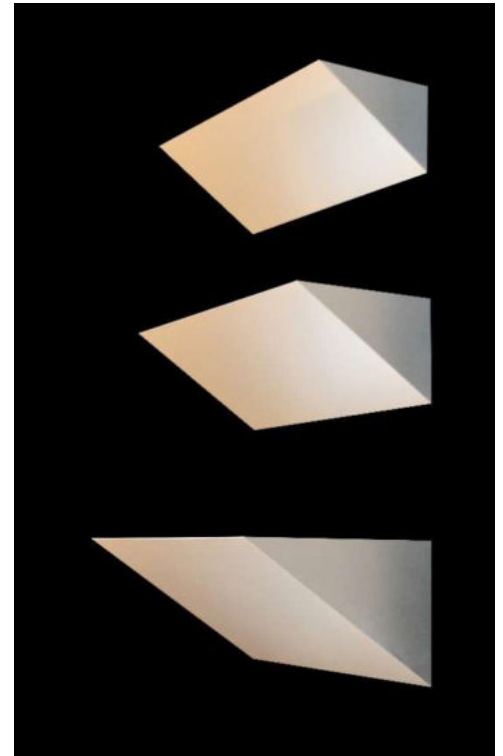
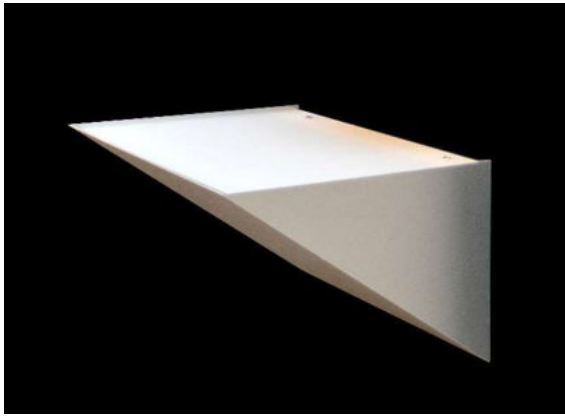

**Wandleuchte / wall luminaire**

**Aluminum eloxiert** mit asymmetrischen Lichtaustritt  
**aluminium anodized**, asymmetric light //

weiß / white // schwarz / black

**Abdeckung Microprismen / cover microprismatic**

**Leuchtmittel / lamp:**

- MINI** LED 8W / 1050lm 27K / 30K / 40K / 50K // 230V
- SMALL** LED 16W / 2100lm 27K / 30K / 40K / 50K // 230V
- MIDDLE** LED 32W / 4200lm 27K / 30K / 40K / 50K // 230V
- BIG** LED 69W / 10400lm 27K / 30K / 40K / 50K // 230V
- BIG POWER** LED 81W / 13200lm 30K / 40K / 50K // 230V ( CRI>80 )

**DIM...** DALI dimmbar/ DALI dimmable

**DIMTR...** TRIAC dimmbar / TRIAC dimmable  
 ( MINI / SMALL / MIDDLE )

**DIMT...** tunable white

**IP 20 / CRI >90 / L80B10**

**CRI > 95 Anfrage / request**

**Artikelnummer / reference no.:**

- 10.OZEN MI... ( MINI )
- 10.OZEN S.... ( SMALL )
- 10.OZEN M... ( MIDDLE )
- 10.OZEN B... ( BIG )
- 10.OZEN BP... ( BIG POWER )

indirect light ( I )

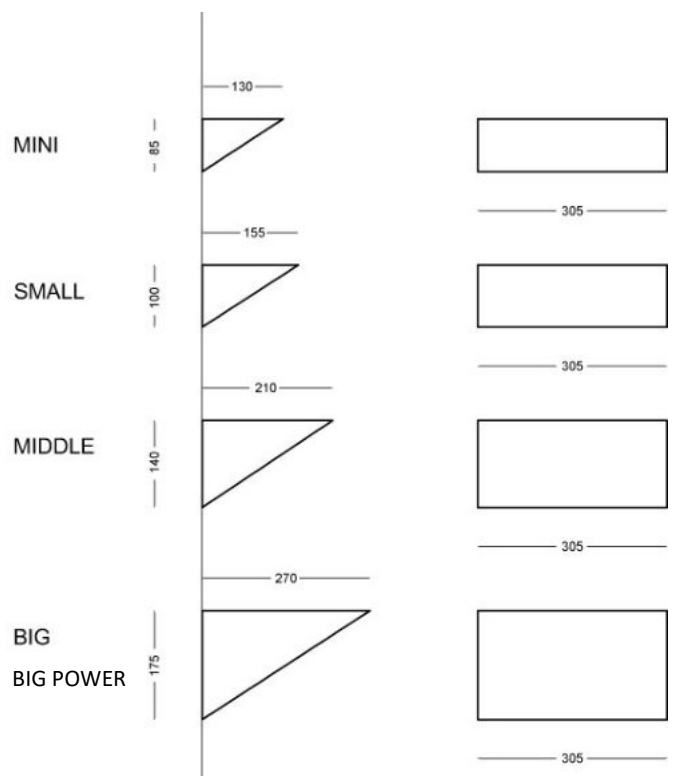

# LONG LINE

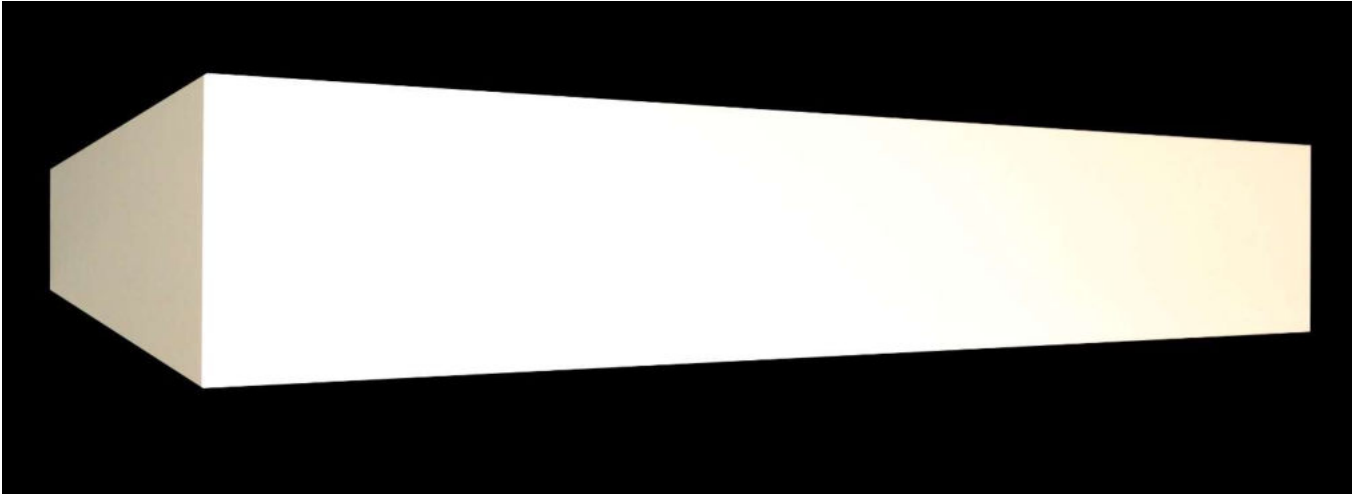

**Wandleuchte / wall luminaire**

**Aluminium eloxiert / aluminium anodized //**

weiß / white // schwarz / black

**Abdeckung Microprismen / cover microprismatic**

**Leuchtmittel / lamp:**

LONG LINE 870 LED 48W/ 2 x 3300lm 27K / 30K / 40K / 50K // 230V

LONG LINE 1150 LED 64W / 2 x 4500lm 27K / 30K / 40K / 50K // 230V

LONG LINE 1430 LED 80W/ 2 x 5500lm 27K / 30K / 40K / 50K // 230V

LONG LINE 2975 LED 160W/ 2 x 11100lm 27K / 30K / 40K / 50K // 230V

**DIM... DALI dimmbar/ DALI dimmable**

**DIMT... tunable white**

**IP20 CRI >90 / L80B10**

**CRI > 95 Anfrage / request**

**Artikelnummer / reference no. :**

10.0LONGL 870 ...

10.0LONGL 1150 ...

10.0LONGL 1430 ...

10.0LONGL 2975 ...

**direct/ indirect light ( D / I )**

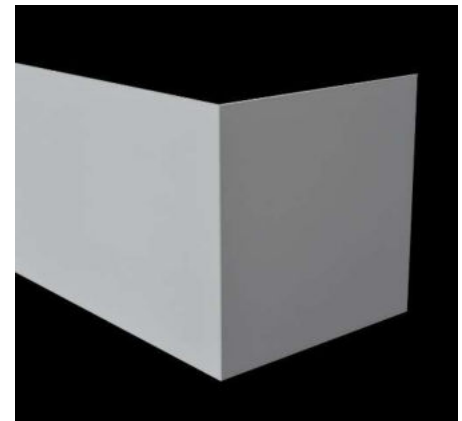
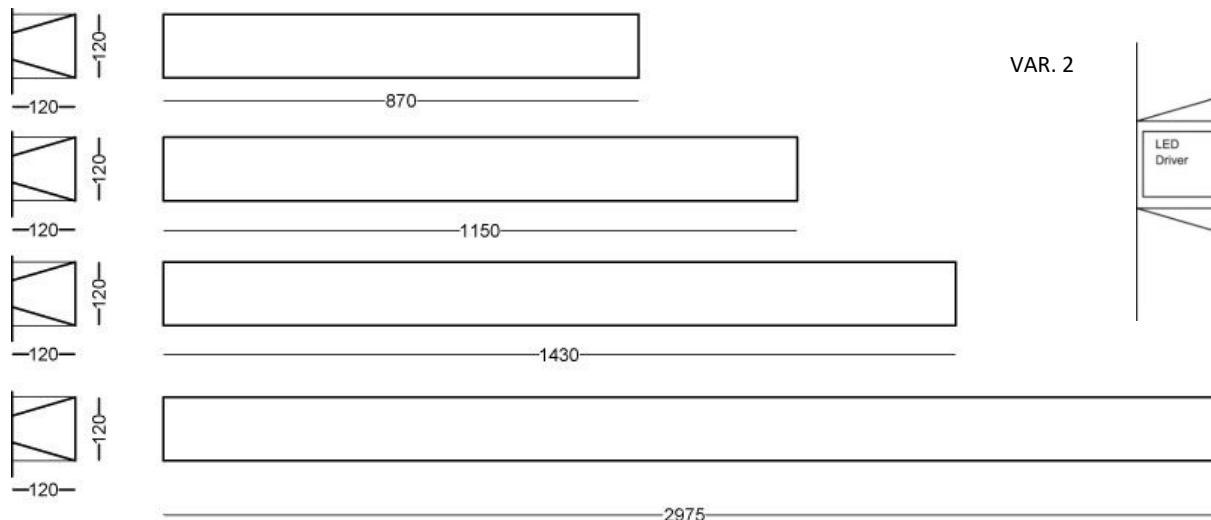

VAR. 1

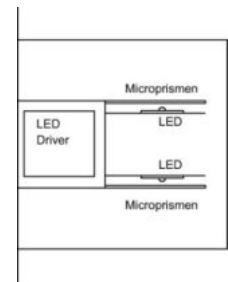

VAR. 2

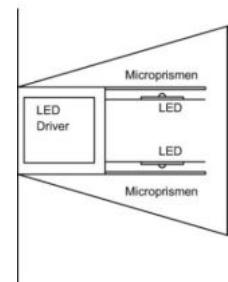

## CORNER



**Wandleuchte** / wall luminaire

**Aluminium eloxiert** / aluminium anodized //  
weiß / white // schwarz / black

**Leuchtmittel** / lamp:

LED 6W/ 600lm / 27K / 30K / 40K / 50K // 230V

**DIM...** DALI dimmbar/ DALI dimmable

**DIMTR...** TRIAC dimmbar / TRIAC dimmable

**DIMT...** tunable white

**IP20 CRI >90 / L80B10**

**CRI > 95 Anfrage / request**

**Artikelnummer** / reference no. :

10.0CORN...

**direct/ indirect light ( D / I )**

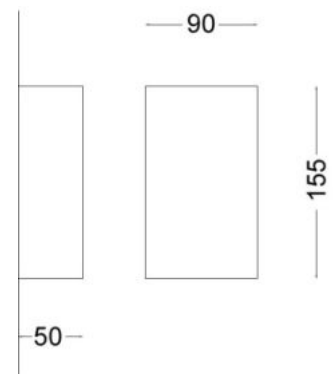
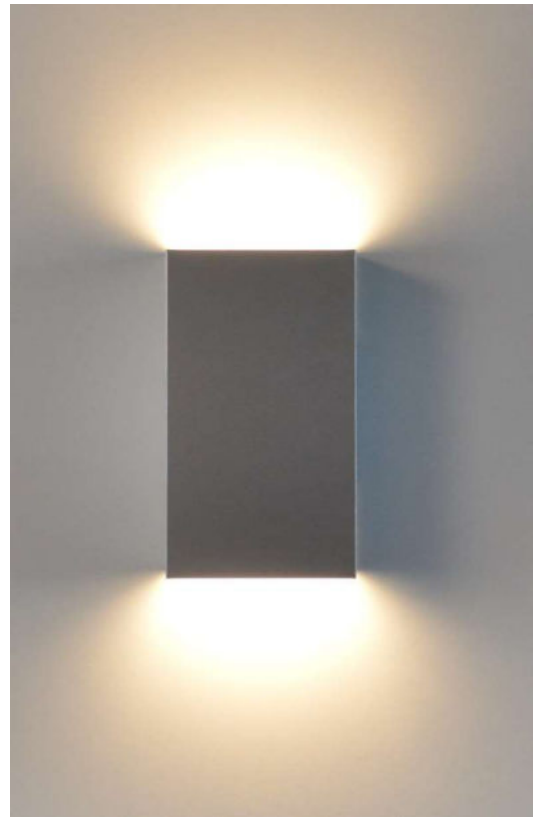





**Wandleuchte** / wall luminaire

**Aluminium eloxiert** / aluminium anodized //  
weiß / white // schwarz / black

**Leuchtmittel** / lamp:

LED 6W/ 600lm / 27K / 30K / 40K / 50K // 230V

**DIM...** DALI dimmbar/ DALI dimmable

**DIMTR...** TRIAC dimmbar / TRIAC dimmable

**DIMT...** tunable white

**IP20 CRI >90 / L80B10**

**CRI > 95 Anfrage / request**

**Artikelnummer** / reference no. :

10.0SIGN...

**direct/ indirect light ( D / I )**

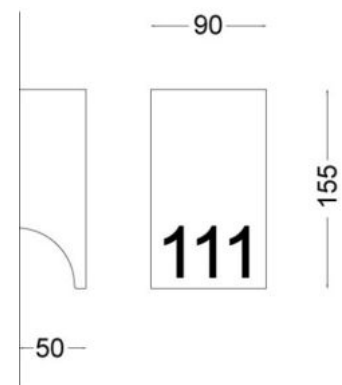

# CUP

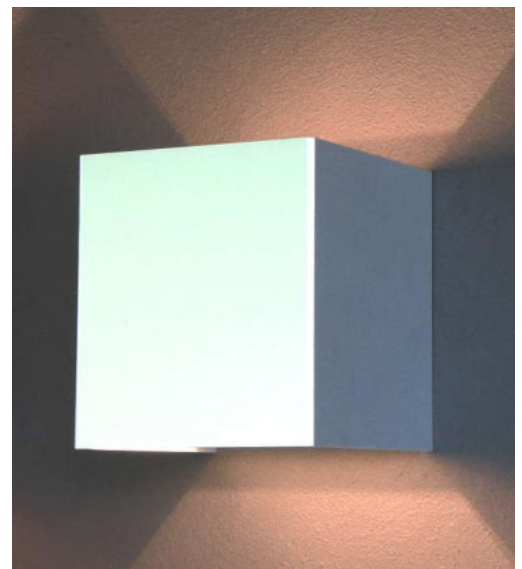
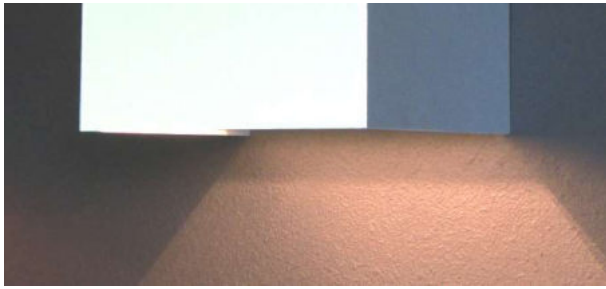

**Wandleuchte** / wall luminaire  
**Aluminium eloxiert** / aluminium anodized //  
weiß / white // schwarz / black

**Leuchtmittel** / lamp:  
LED 6W/ 600lm / 27K / 30K / 40K / 50K // 230V  
G9 QT 14 3W / 220lm / 27K / 30K / 40K // 230V

**DIM...** DALI dimmbar / DALI dimmable  
**DIMTR...** TRIAC dimmbar / TRIAC dimmable  
**DIMT...** tunable white

**IP20 CRI >90 / L80B10 ( LED )**  
**CRI > 95 Anfrage / request**

**Artikelnummer** / reference no. :  
10.0CUP...

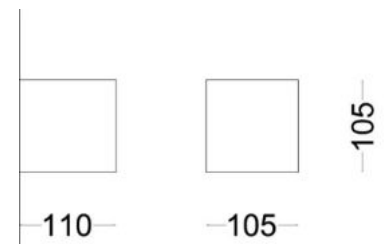

**direct/ indirect light ( D / I )**

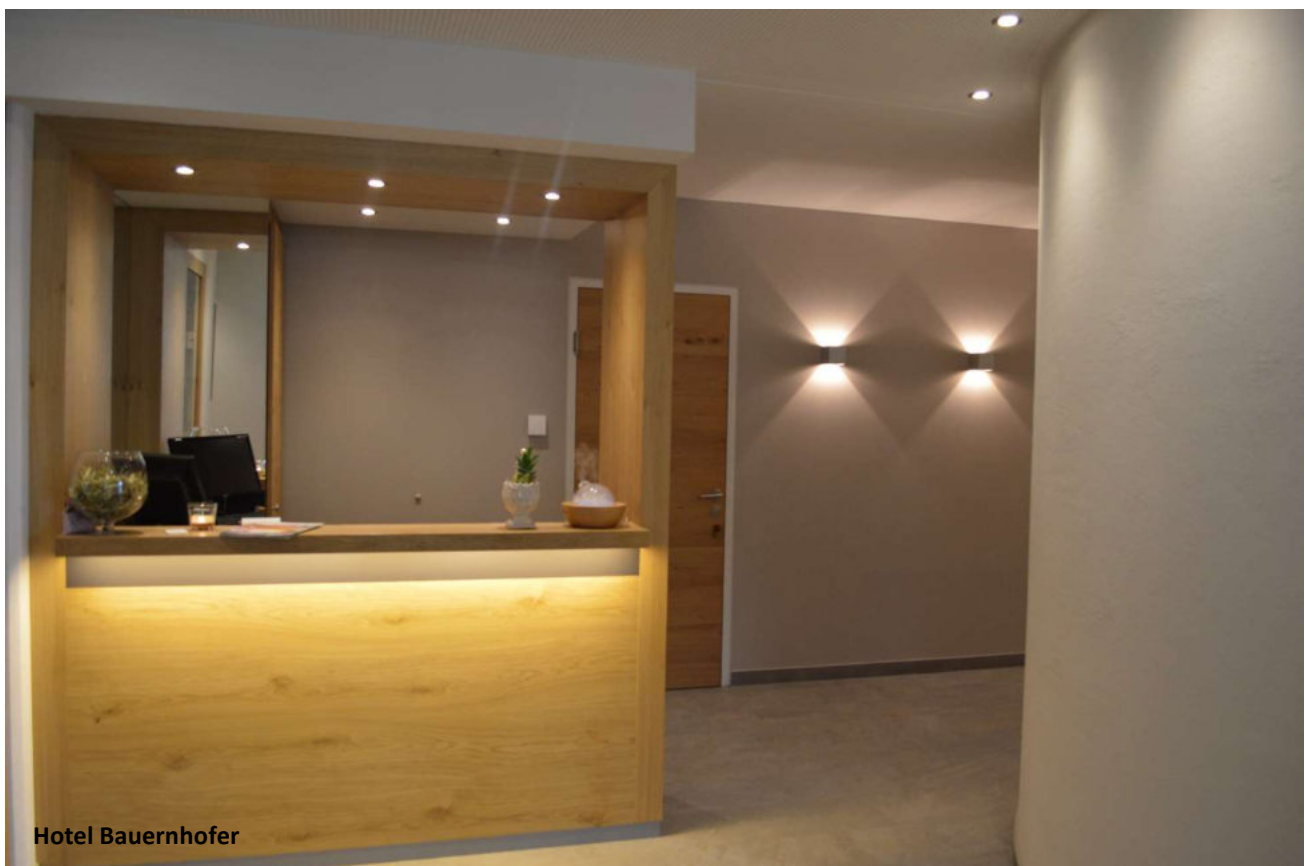

Hotel Bauernhofer

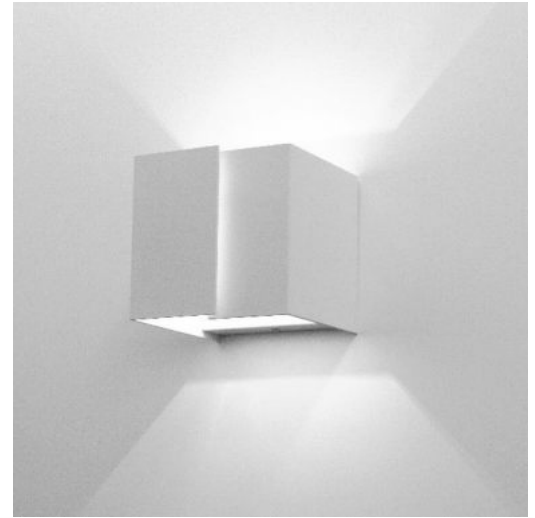
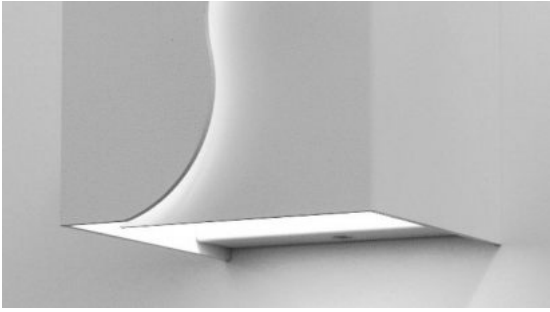

**Wandleuchte** / wall luminaire  
**Aluminium eloxiert** / aluminium anodized //  
 weiß / white // schwarz / black

**Leuchtmittel** / lamp:  
 LED 6W/ 600lm / 27K / 30K / 40K / 50K // 230V  
 G9 QT 14 3W / 220lm / 27K / 30K / 40K // 230V

**DIM...** DALI dimmbar / DALI dimmable  
**DIMTR...** TRIAC dimmbar / TRIAC dimmable  
**DIMT...** tunable white

**IP20 CRI >90 / L80B10 ( LED )**  
**CRI > 95 Anfrage / request**

**Artikelnummer** / reference no. :  
 10.0CUPP..



direct/ indirect light ( D / I )

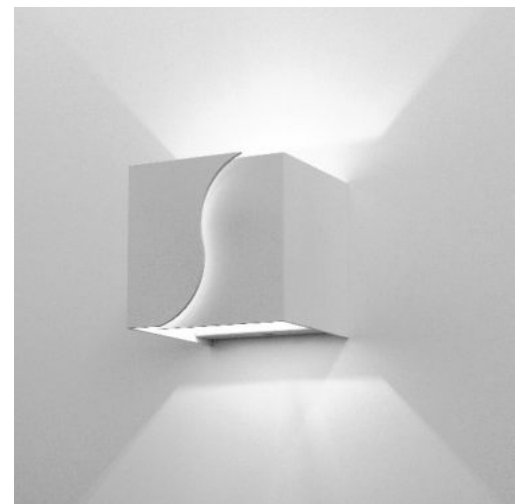
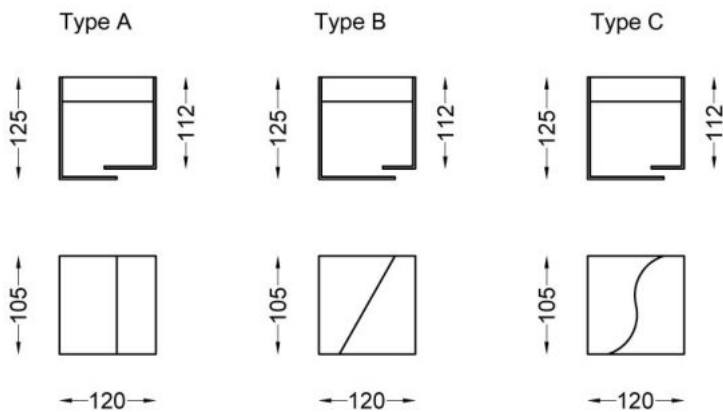

## SNAKE

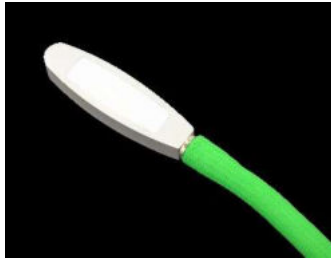

**Wandleuchte** / wall luminaire

**Aluminium** / aluminium

Flexarm mit Textilüberzug / flexarm with textile cover

**schwarz / grün / rot //** black / green / red

Andere Farben auf Anfrage / other colors by request

mit Schalter, inkl. LED Driver  
with switch, incl. LED Driver

**Leuchtmittel** / lamp:

LED 3W/ 250lm / 27K / 30K / 40K // 230V

nicht dimmbar / not dimmable

**IP20 CRI >90 / L80B10**

**Artikelnummer** / reference no. :

10.OSNAKE ...

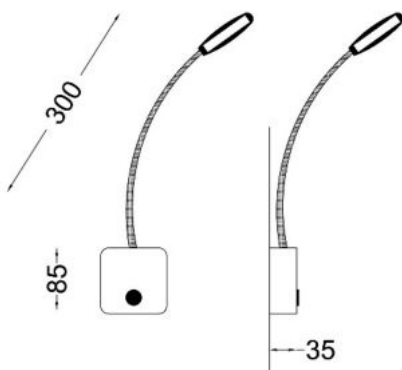
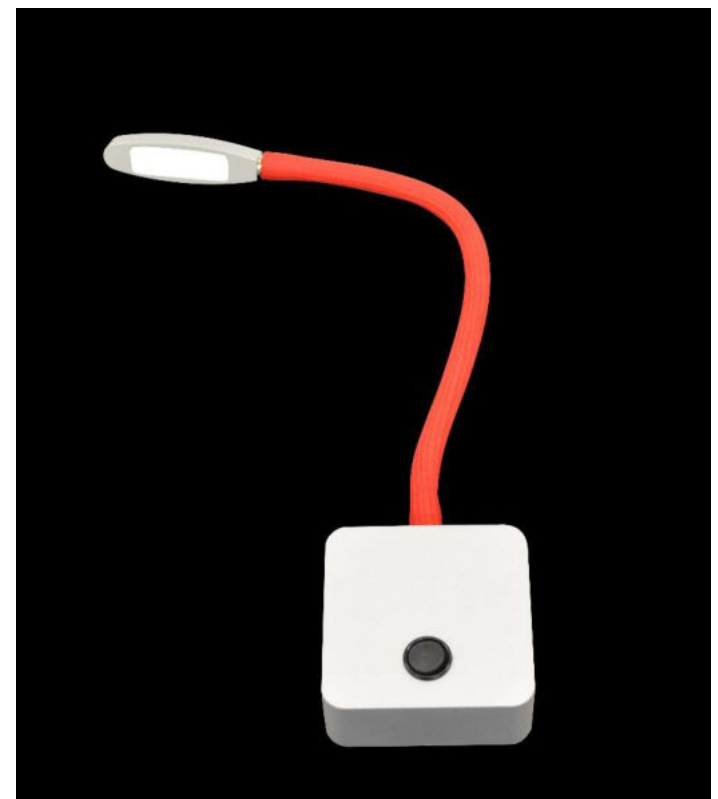
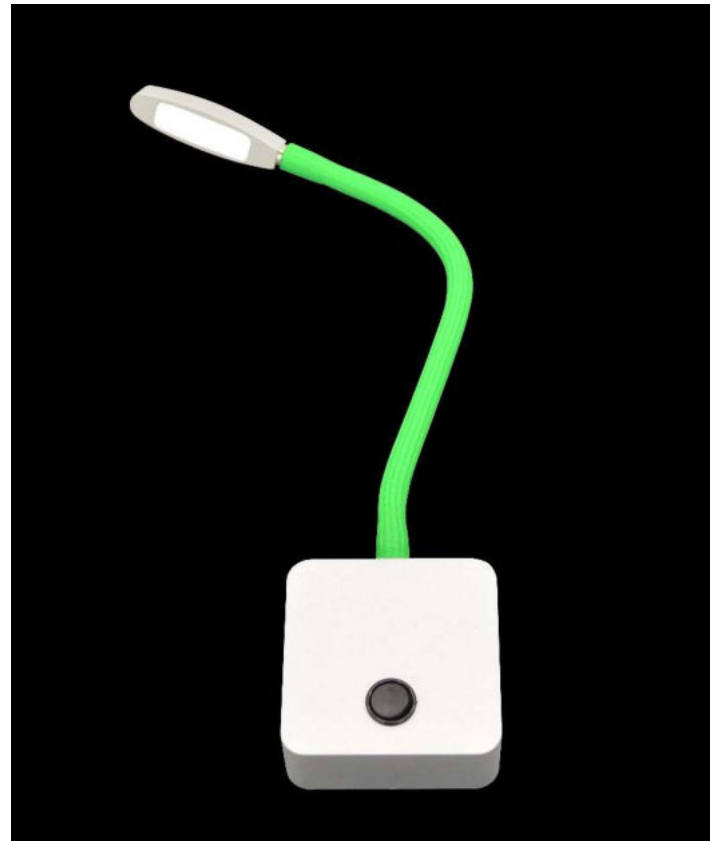



**Wandleuchte** / wall luminaire  
**Aluminium** / aluminium  
Flexarm metall/ flex metal  
**Silber / schwarz** // silver / black

mit Schalter, inkl. LED Driver  
with switch, incl. LED Driver

**Leuchtmittel** / lamp:  
LED 3W/ 250lm / 27K / 30K / 40K // 230V

Nicht dimmbar / not dimmable

**IP20 CRI >90 / L80B10**

**Artikelnummer** / reference no. :  
10.OSNAKE ECO...

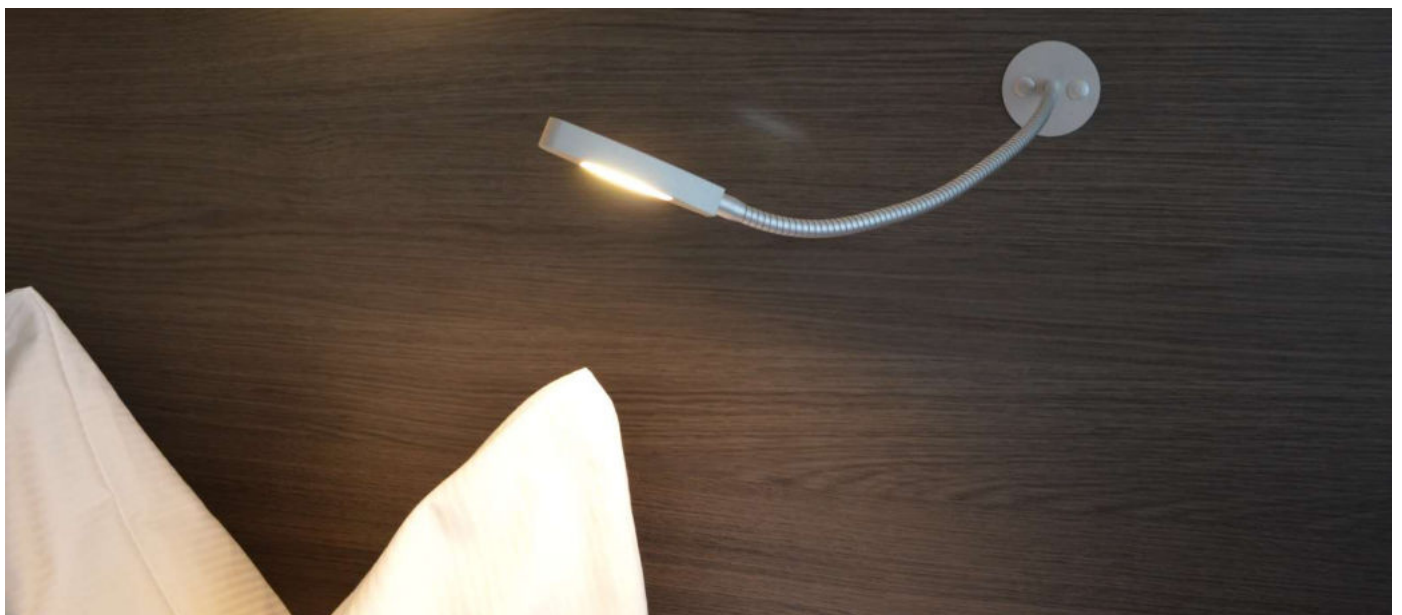
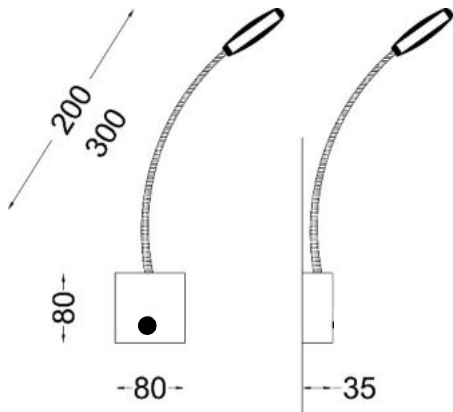
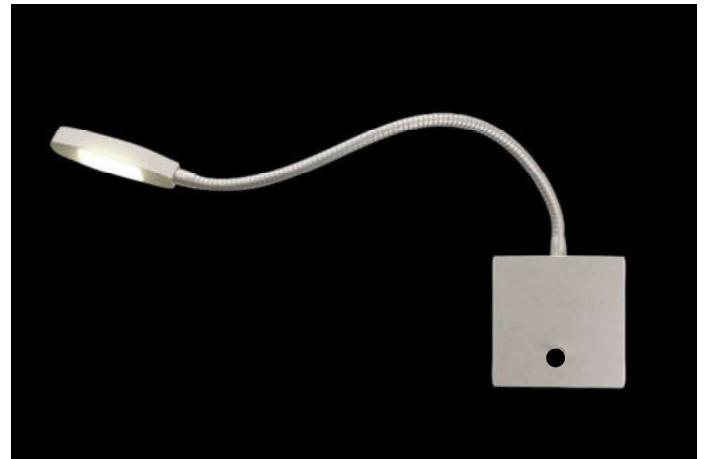
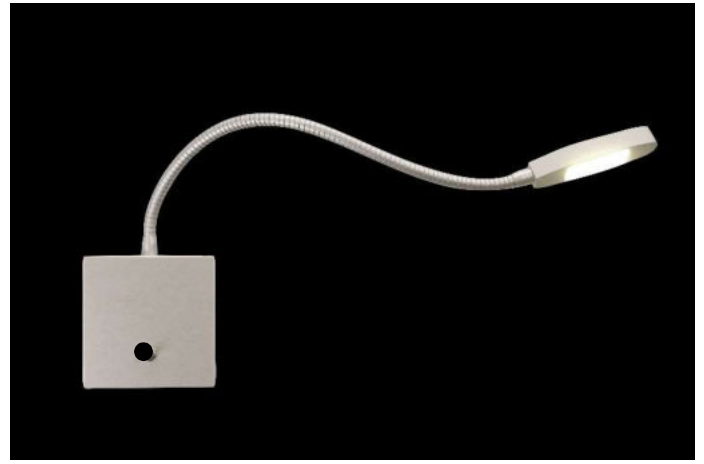

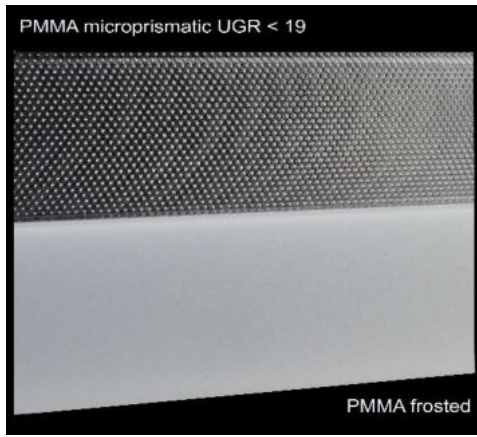

**Hängeleuchte /** pendant luminaire  
**Wandleuchte /** wall luminaire  
**Deckenleuchte /** ceiling luminaire  
**Aluminium eloxiert /** aluminium anodised  
**Acrylglas PMMA, Microprismen /** acryl frosted PMMA, microprismatic

**Leuchtmittel /** lamp:

- 591mm** LED 17W / 2000lm 27K / 30K / 40K / 50K // 230V
- 871mm** LED 24W / 3030lm 27K / 30K / 40K / 50K // 230V
- 1151mm** LED 33W / 4100lm 27K / 30K / 40K / 50K // 230V
- 1431mm** LED 42W / 5200lm 27K / 30K / 40K / 50K // 230V

Andere Längen auf Anfrage / other length on request

**DIM...** DALI dimmbar/ DALI dimmable

**DIMT...** tunable white

**IP 20 / CRI >90 / L80B10**

**CRI > 95 Anfrage / request**

**Artikelnummer /** reference no.:

Aufbau / surface mounting	Einbau / recessed mounting
10/30/40.0LBAB B591...	50.0LBEB B591...
10/30/40.0LBAB B871...	50.0LBEB B871...
10/30/40.0LBAB B1151...	50.0LBEB B1151...
10/30/40.0LBAB B1431...	50.0LBEB B1431...

Ausschnitte für Einbau / fitting hole for recessed mounting:

LED 17W 593 x 46mm Höhe / heigh 70mm

LED 24W 873 x 46mm Höhe / heigh 70mm

LED 33W 1153 x 46mm Höhe / heigh 70mm

LED 42W 1433 x 46mm Höhe / heigh 70mm

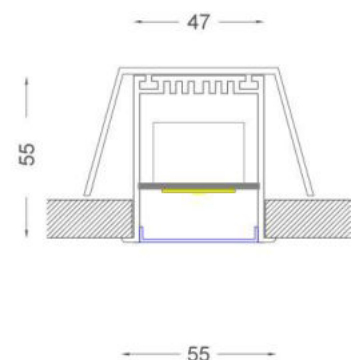
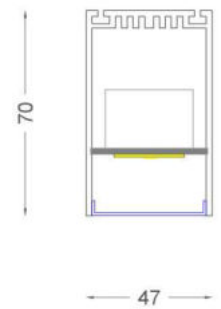

**direct light ( D )**



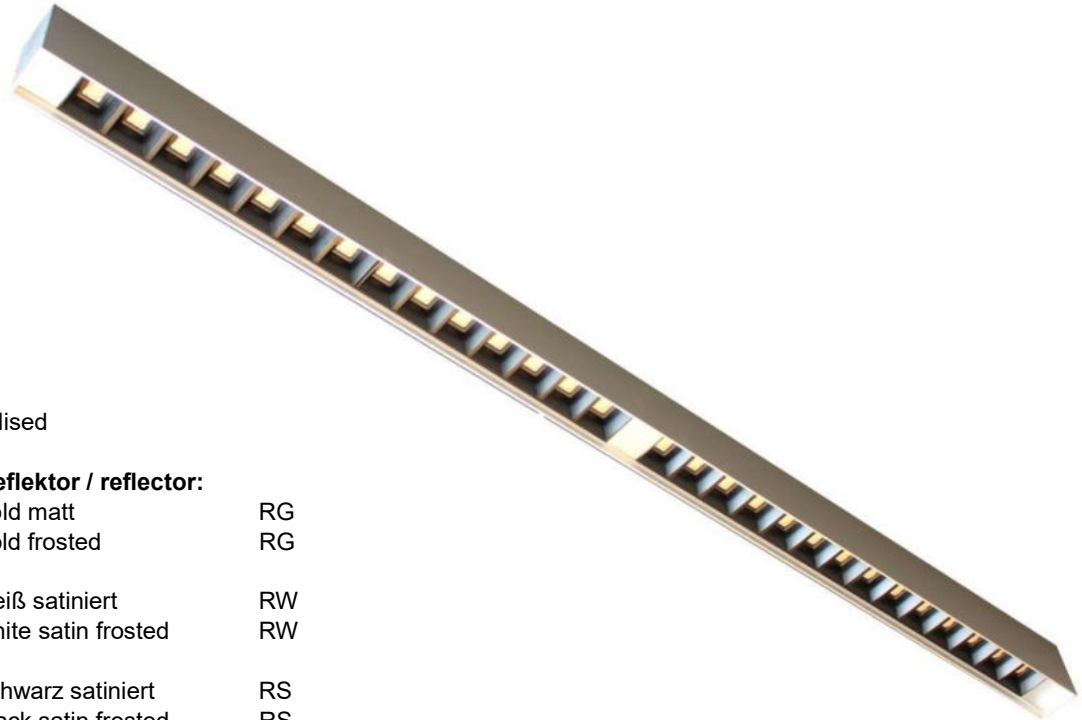

**Hängeleuchte /** pendant luminaire  
**Deckenleuchte /** ceiling luminaire  
**Aluminium eloxiert /** aluminium anodised

**Körper / body:**

weiß satiniert  
 white satin frosted

BW  
 BW

**Reflektor / reflector:**

gold matt  
 gold frosted

RG  
 RG

schwarz satiniert  
 black satin frosted

BS  
 BS

weiß satiniert  
 white satin frosted

RW  
 RW

schwarz satiniert  
 black satin frosted

RS  
 RS

**Blende / cover:**

weiß satiniert  
 white satin frosted

CW  
 CW

aluminium matt  
 aluminium frosted

RA  
 RA

schwarz satiniert  
 black satin frosted

CS  
 CS

**Optik / Beam:**

50° / UGR < 19

**Leuchtmittel / lamp:**

**LINE BIG DEEP 2** LED 21W / 3270lm 27K / 30K / 40K / 50K // 230V

**LINE BIG DEEP 3** LED 32W / 4900lm 27K / 30K / 40K / 50K // 230V

Andere Längen auf Anfrage / other length on request  
 Einbauversion auf Anfrage / recessed version on request

**DIM...** DALI dimmbar/ DALI dimmable  
**DIMT...** tunable white

**IP 20 / CRI >90 / L80B10**  
**CRI > 95 Anfrage / request**

**Artikelnummer /** reference no.:

Aufbau / surface mounting

30/40.0LBD 2...

30/40.0LBD 3...

LINE BIG DEEP 2

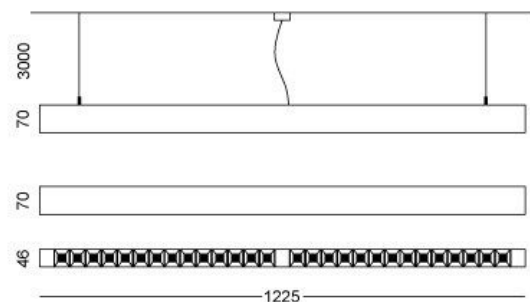

LINE BIG DEEP 3

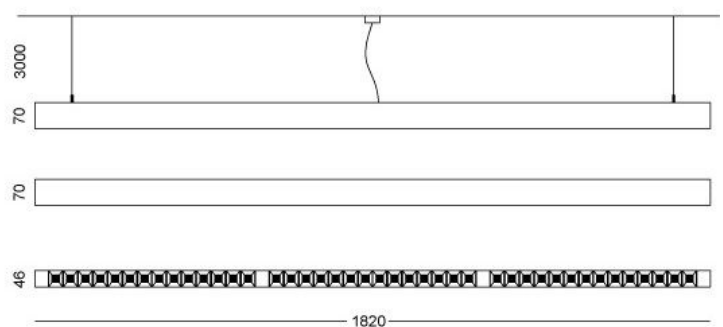

direct light ( D )



# LINE SMALL B

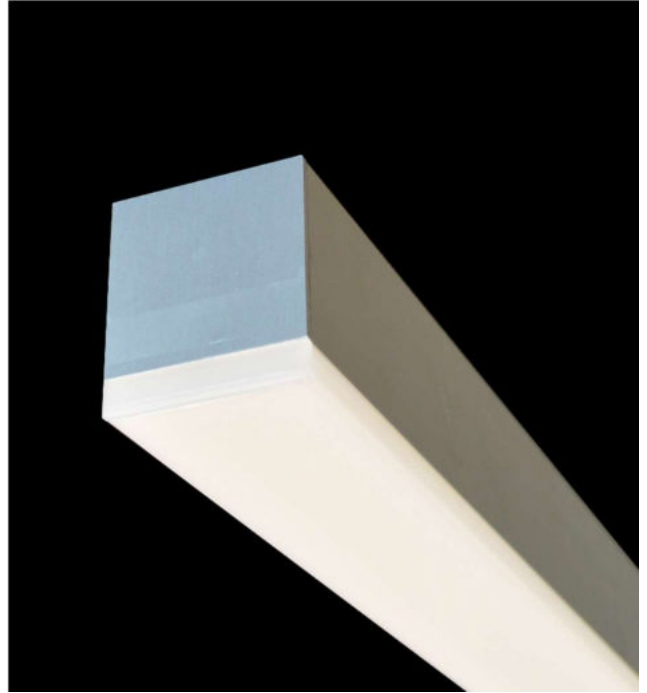

**Hängeleuchte** / pendant luminaire  
**Wandleuchte** / wall luminaire  
**Deckenleuchte** / ceiling luminaire  
**Aluminium eloxiert** / aluminium anodised  
**Acrylglas PMMA** / acryl frosted PMMA

**Leuchtmittel** / lamp:

**591mm** LED 17W / 2000lm 27K / 30K / 40K / 50K // 230V  
**871mm** LED 24W / 3030lm 27K / 30K / 40K / 50K // 230V  
**1151mm** LED 33W / 4100lm 27K / 30K / 40K / 50K // 230V  
**1431mm** LED 42W / 5200lm 27K / 30K / 40K / 50K // 230V

Andere Längen auf Anfrage / other length on request

**DIM...** DALI dimmbar/ DALI dimmable  
**DIMT...** tunable white

**IP 20 / CRI >90 / L80B10**  
**CRI > 95 Anfrage / request**

**Artikelnummer** / reference no.:

Aufbau / surface mounting	Einbau / recessed mounting
10/30/40.OLSAB B591...	50.0LSEB B591...
10/30/40.OLSAB B871...	50.0LSEB B871...
10/30/40.OLSAB B1151...	50.0LSEB B1151...
10/30/40.OLSAB B1431...	50.0LSEB B1431...

Ausschnitte für Einbau / fitting hole for recessed mounting:

LED 17W 593 x 46mm Höhe / heigh 70mm  
 LED 24W 873 x 46mm Höhe / heigh 70mm  
 LED 33W 1153 x 46mm Höhe / heigh 70mm  
 LED 42W 1433 x 46mm Höhe / heigh 70mm

**direct light ( D )**

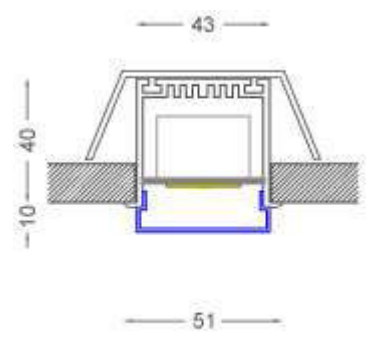
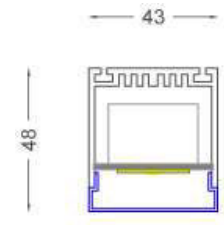



# LINE SMALL V



**Hängeleuchte** / pendant luminaire  
**Wandleuchte** / wall luminaire  
**Deckenleuchte** / ceiling luminaire  
**Aluminium eloxiert** / aluminium anodised  
**Acrylglas PMMA,** / acryl frosted PMMA

**Leuchtmittel** / lamp:

**591mm** LED 17W / 2000lm 27K / 30K / 40K / 50K // 230V  
**871mm** LED 24W / 3030lm 27K / 30K / 40K / 50K // 230V  
**1151mm** LED 33W / 4100lm 27K / 30K / 40K / 50K // 230V  
**1431mm** LED 42W / 5200lm 27K / 30K / 40K / 50K // 230V

Andere Längen auf Anfrage / other length on request

**DIM...** DALI dimmbar/ DALI dimmable  
**DIMT...** tunable white

**IP 20 / CRI >90 / L80B10**  
**CRI > 95 Anfrage / request**

**Artikelnummer** / reference no.:

Aufbau / surface mounting	Einbau / recessed mounting
10/30/40.OLSAV B591...	50.OLSEV B591...
10/30/40.OLSAV B871...	50.OLSEV B871...
10/30/40.OLSAV B1151...	50.OLSEV B1151...
10/30/40.OLSAV B1431...	50.OLSEV B1431...

Ausschnitte für Einbau / fitting hole for recessed mounting:

LED 17W 593 x 46mm Höhe / heigh 70mm  
 LED 24W 873 x 46mm Höhe / heigh 70mm  
 LED 33W 1153 x 46mm Höhe / heigh 70mm  
 LED 42W 1433 x 46mm Höhe / heigh 70mm

direct light ( D )

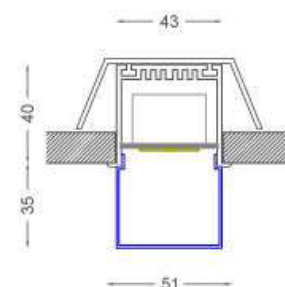
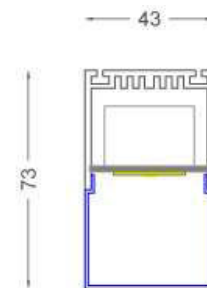

# LINA



**Hängeleuchte** / pendant luminaire

**Wandleuchte** / wall luminaire

**Deckenleuchte** / ceiling luminaire

**Acrylglas** / acryl frosted

**Metall silber** / metal white / silver

**Acrylglas PMMA, Microprismen** / acryl frosted PMMA, microprismatic

**Leuchtmittel** / lamp:

**600** LED 17W / 2000lm 27K / 30K / 40K / 50K // 230V

**900** LED 24W / 3030lm 27K / 30K / 40K / 50K // 230V

**1200** LED 33W / 4100lm 27K / 30K / 40K / 50K // 230V

**1500** LED 42W / 5200lm 27K / 30K / 40K / 50K // 230V

**DIM...** DALI dimmbar/ DALI dimmable

**DIMT...** tunable white

**IP 20 / CRI >90 / L80B10**

**CRI > 95 Anfrage / request**

**Artikelnummer** / reference no.:

10/30/40.0LINA 600...

10/30/40.0LINA 900...

10/30/40.0LINA 1200...

10/30/40.0LINA 1500..

**direct light ( D )**



VAR. 1

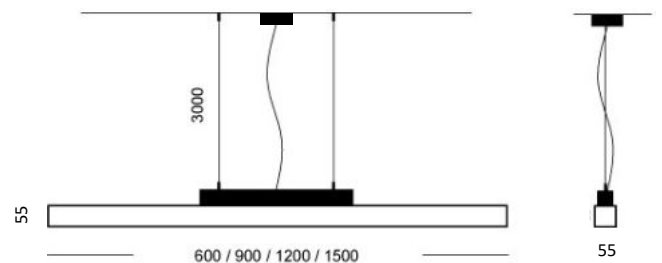

VAR. 2

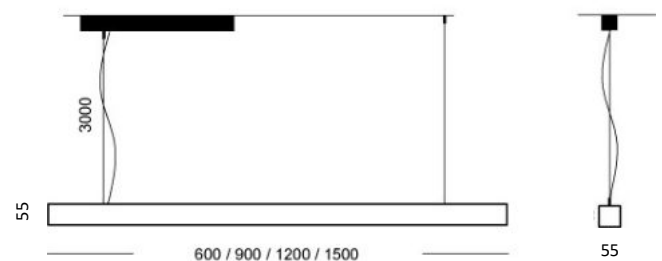



**Systemleuchte für 3-Phasen Stromschiene drehbar 275° mit Adapter mit integriertem LED-Driver/**

System luminaire for 3-phase lighting track rotating 275° with adapter with intergrated LED-Driver

**Acrylglas / acryl frosted**

**Metall silber / metal silver**

**Acrylglas satiniert ( S ), Microprismen ( M ) / acryl frosted, microprismatic**

**Leuchtmittel / lamp:**

**600mm LED 12W / 1300lm 27K / 30K / 40K / 50K // 230V**

**DIM... DALI dimmbar/ DALI dimmable**

**DIMT... tunable white**

**IP 20 / CRI >90 / L80B10**

**CRI > 95 Anfrage / request**

**Artikelnummer / reference no. / article:**

80.0LINA AD 600...



direct light ( D )

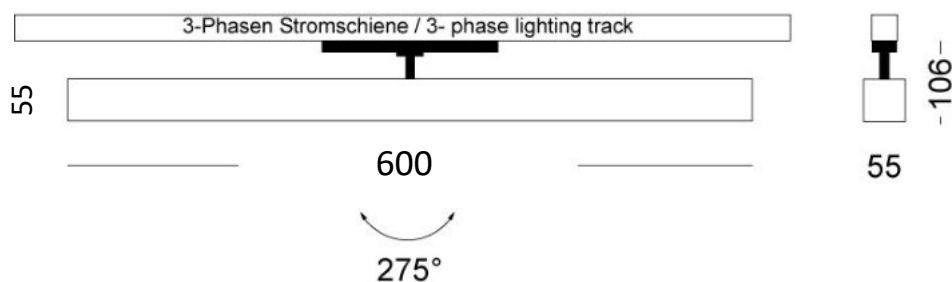

# TUBE

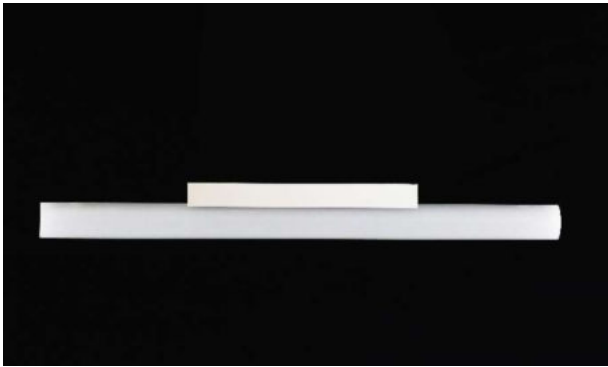

**Hängeleuchte** / pendant luminaire

**Wandleuchte** / wall luminaire

**Deckenleuchte** / ceiling luminaire

**Acrylglas** / acryl frosted

**Metall silber** / metal white / silver

**Leuchtmittel** / lamp:

**600** LED 17W / 2000lm 27K / 30K / 40K / 50K // 230V

**900** LED 24W / 3030lm 27K / 30K / 40K / 50K // 230V

**1200** LED 33W / 4100lm 27K / 30K / 40K / 50K // 230V

**1500** LED 42W / 5200lm 27K / 30K / 40K / 50K // 230V

**DIM...** DALI dimmbar/ DALI dimmable

**DIMT...** tunable white

**IP 20 / CRI >90 / L80B10**

**CRI > 95 Anfrage / request**

**Artikelnummer** / reference no.:

10/30/40.0TUBE 600...

10/30/40.0TUBE 900...

10/30/40.0TUBE 1200...

10/30/40.0TUBE 1500...

direct light ( D )



VAR. 1

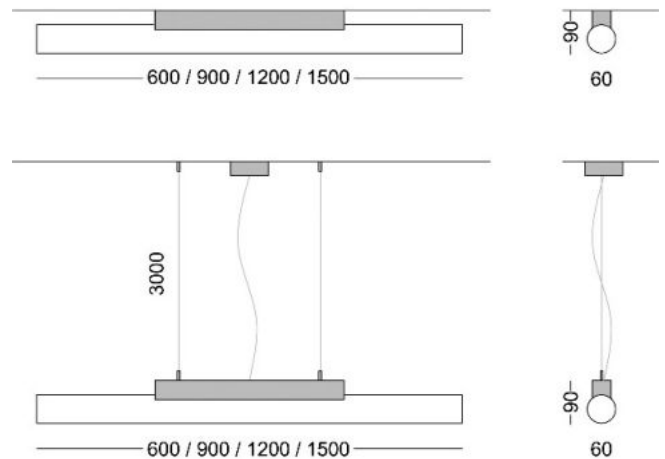

VAR. 2

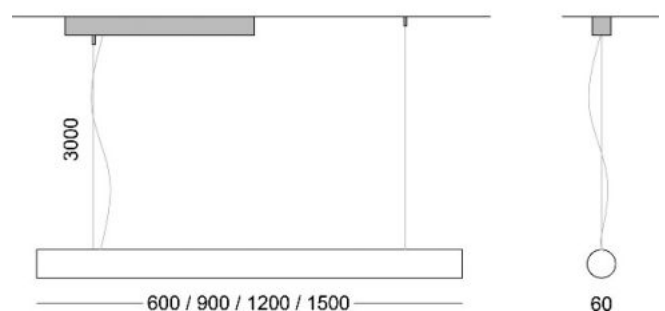



**Systemleuchte für 3-Phasen Stromschiene drehbar 275° mit Adapter mit integriertem LED-Driver/**  
 System luminaire for 3-phase lighting track rotating 275° with adapter with intergrated LED-Driver

**Acrylglas / acryl frosted**  
**Metall silber / metal silver**

**Leuchtmittel / lamp:**  
**600mm LED 12W / 1300lm 27K / 30K / 40K / 50K // 230V**

**DIM... DALI dimmbar/ DALI dimmable**  
**DIMT... tunable white**

**IP 20 / CRI >90 / L80B10**  
**CRI > 95 Anfrage / request**

**Artikelnummer / reference no.:**  
 80.0TUBE AD 600...



direct light ( D )

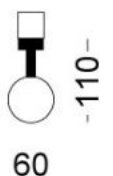
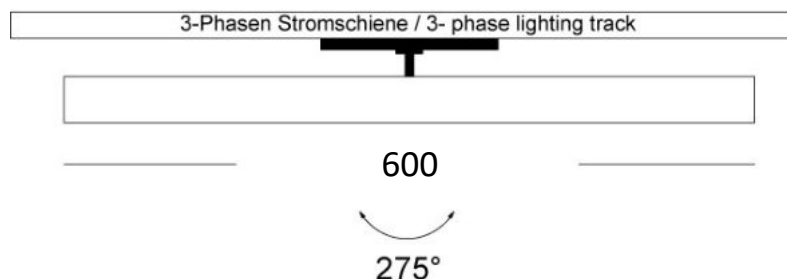

# CUPA CLOSE

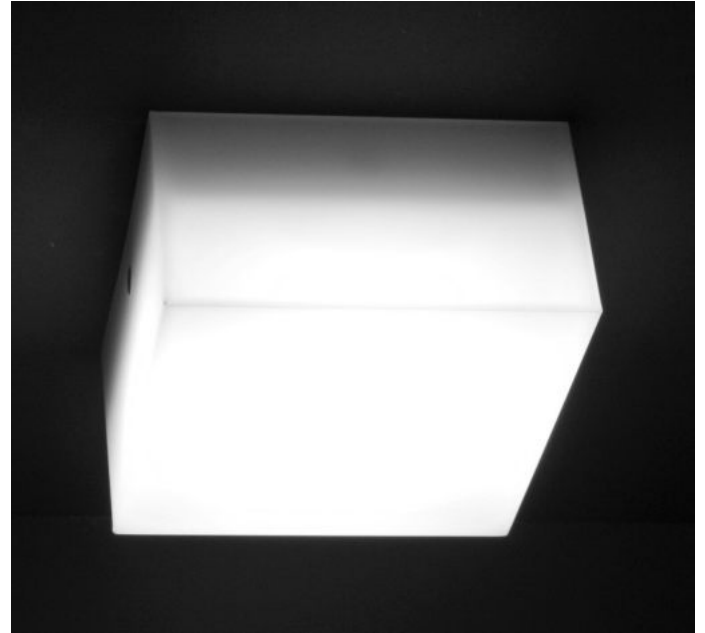
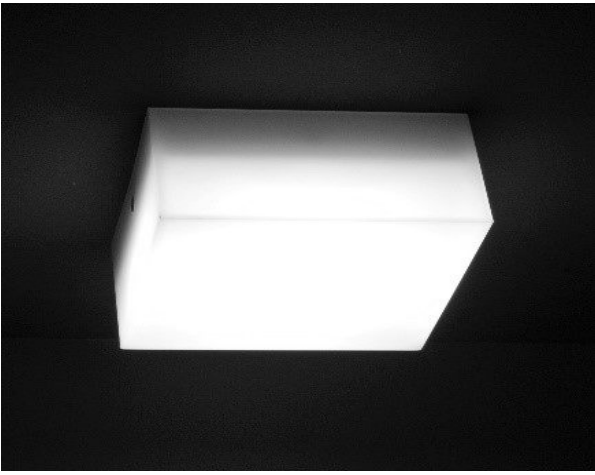

**Wandleuchte /** wall luminaire  
**Deckenleuchte /** ceiling luminaire  
**Acrylglas /** acryl frosted

**Leuchtmittel /** lamp:  
**SMALL** LED 7W / 600lm 27K / 30K / 40K / 50K // 230V  
**MIDDLE** LED 14W / 1290lm 27K / 30K / 40K / 50K // 230V  
**BIG** LED 24W / 2350lm 27K / 30K / 40K / 50K // 230V

**DIM...** DALI dimmbar/ DALI dimmable  
**DIMTR...** TRIAC dimmbar / TRIAC dimmable  
**DIMT...** tunable white

**IP 20 / CRI >90 / L80B10**  
**CRI > 95 Anfrage / request**

**Artikelnummer /** reference no.:  
 10/30.0CUPAC S... ( SMALL )  
 10/30.0CUPAC M...( MIDDLE )  
 10/30.0CUPAC B... ( BIG )

**Leuchte mit Notlicht /** luminaire emergency:  
 3h / Autotest / autotest ( BIG )

10/ 30.0CUPB EM ( BIG )



**direct light ( D )**

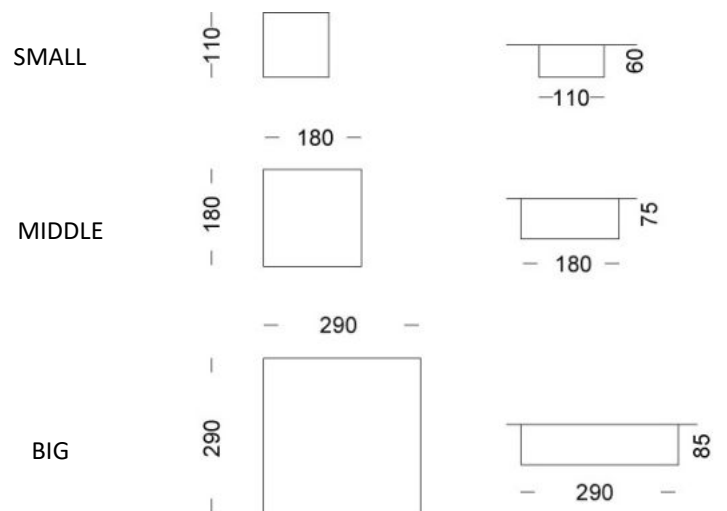



**Wandleuchte /** wall luminaire  
**Deckenleuchte /** ceiling luminaire  
**Einbauleuchte /** recessed luminaire

**Acrylglas /** acryl frosted

**Leuchtmittel /** lamp:

**SMALL** LED 7W / 600lm 27K / 30K / 40K / 50K // 230V  
**MIDDLE** LED 14W / 1290lm 27K / 30K / 40K / 50K // 230V  
**BIG** LED 24W / 2350lm 30K / 40K / 50K // 230V

**DIM...** DALI dimmbar/ DALI dimmable  
**DIMTR...** TRIAC dimmbar / TRIAC dimmable  
**DIMT...** tunable white

**IP 20 / CRI >90 / L80B10**  
**CRI > 95 Anfrage / request**

**Artikelnummer /** reference no.:

10/30/50.0FLATS... ( SMALL )  
 10/30/50.0FLATM... ( MIDDLE )  
 10/30/50.0FLATB... ( BIG )

**Leuchte mit Notlicht /** luminaire emergency:  
 3h / Autotest / autotest ( BIG )

10/ 30/50.0FLATB EM ( BIG )



SMALL

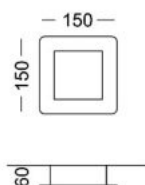
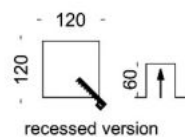

MIDDLE

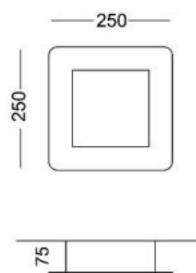
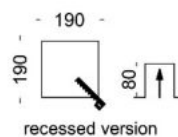

BIG

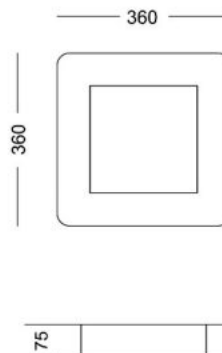
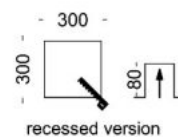

direct light ( D )



# LAMELLA PLANE



**Hängeleuchte /** pendant luminaire

**Deckenleuchte /** ceiling luminaire

**Acrylglas /** acryl frosted

**Metall silber /** metal white / silver

**Leuchtmittel /** lamp:

**670mm** LED 42W / 4900lm 30K / 40K / 50K // 230V

**1000mm** LED 89W / 10100lm 30K / 40K / 50K // 230V

**DIM...** DALI dimmbar/ DALI dimmable

**DIMT...** tunable white

**IP 20 / CRI >90 / L80B10**

**CRI > 95 Anfrage / request**

**Artikelnummer /** reference no.:

30/40.0LAMP. 670...

30/40.0LAMP. 1000...

direct light ( D )

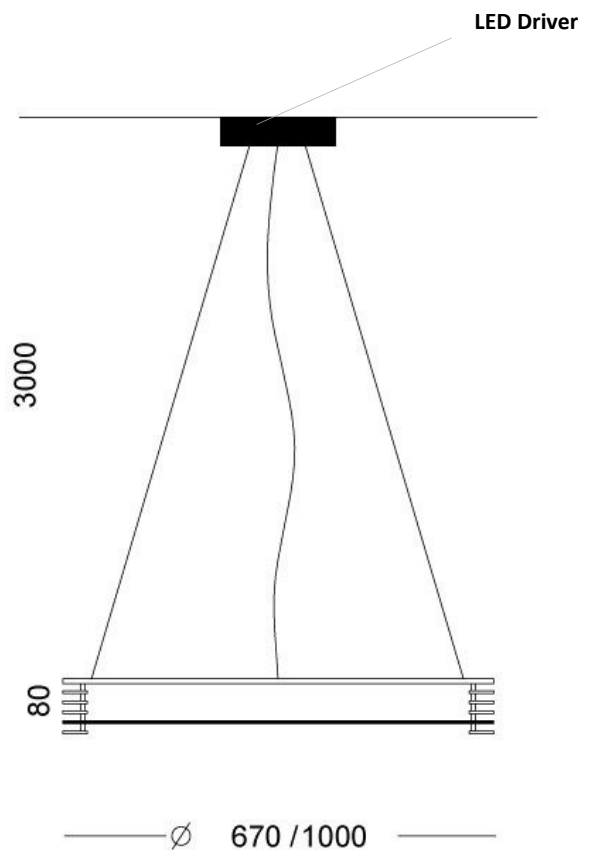
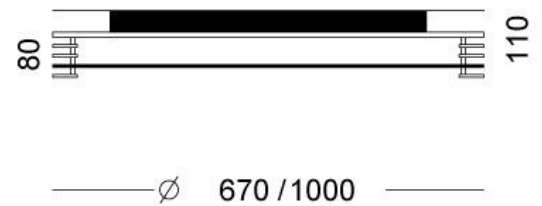



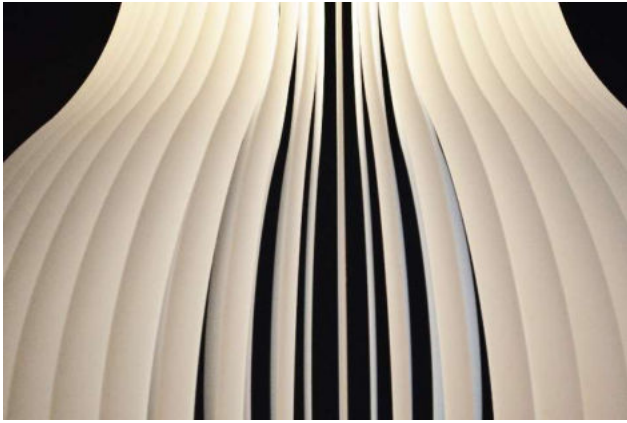

Hängeleuchte / pendant luminaire  
Acrylglas / acryl frosted

Leuchtmittel / lamp:  
LED 26W / 3300lm 27K / 30K / 40K / 50K // 230V

DIM... DALI dimmbar/ DALI dimmable  
DINT... tunable white

IP 20 / CRI >90 / L80B10  
CRI > 95 Anfrage / request

Artikelnummer / reference no.:  
40.0LAME...

direct light ( D )

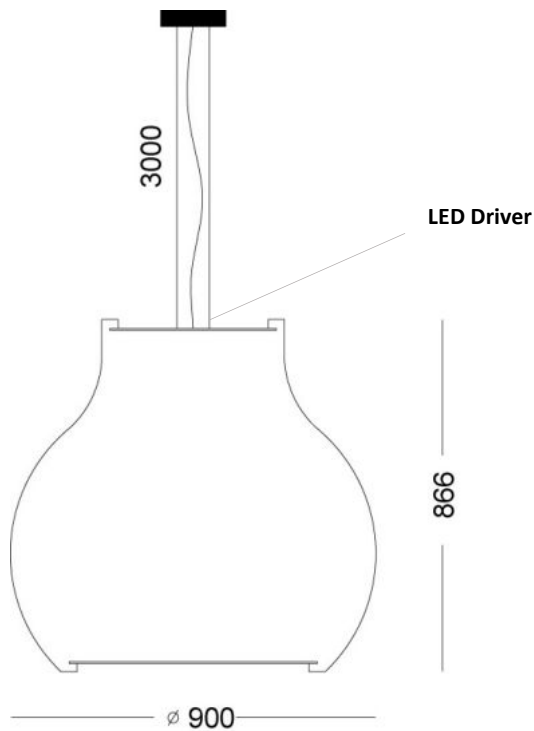

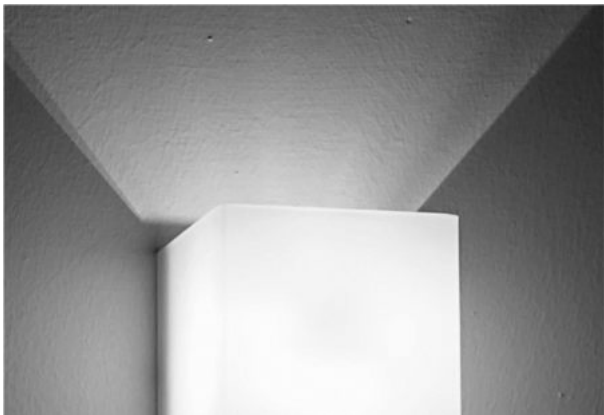

**Wandleuchte** / wall luminaire

**Acrylglas** / acryl frosted

**Leuchtmittel** / lamp:

LED 6W/ 600lm / 27K / 30K / 40K / 50K // 230V

G9 QT 14 3W / 220lm 27K / 30K / 40K // 230V

**DIM...** DALI dimmbar / DALI dimmable

**DIMTR...** TRIAC dimmbar / TRIAC dimmable

**DIMT...** tunable white

**IP20 CRI >90 / L80B10 ( LED )**

**CRI > 95 Anfrage / request**

**Artikelnummer** / reference no. :

10.OCUPA ...

**direct/ indirect light ( D / I )**

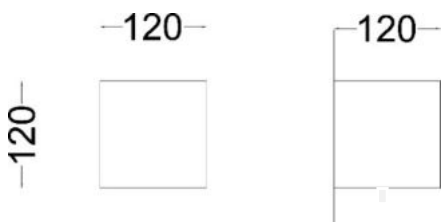

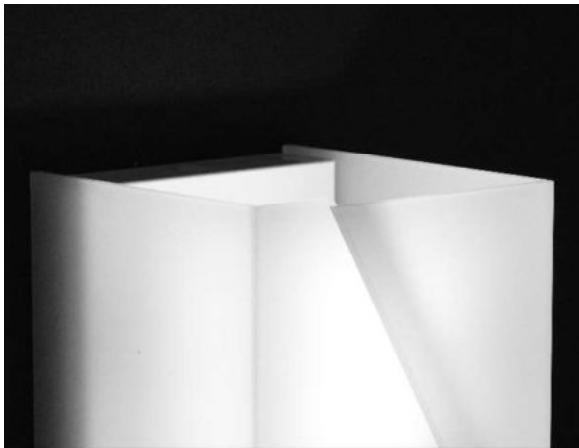

**Wandleuchte** / wall luminaire

**Acrylglas** / acryl frosted

**Leuchtmittel** / lamp:

LED 6W/ 600lm / 27K / 30K / 40K / 50K // 230V

G9 QT 14 3W / 220lm 27K / 30K / 40K // 230V

**DIM...** DALI dimmbar / DALI dimmable

**DIMTR...** TRIAC dimmbar / TRIAC dimmable

**DIMT...** tunable white

**IP20 CRI >90 / L80B10 ( LED )**

**CRI > 95 Anfrage / request**

**Artikelnummer** / reference no. :

10.0CUPA P...

**direct/ indirect light ( D / I )**



Type A



Type B



Type C

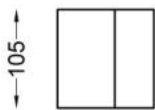

←120→



←120→



←120→

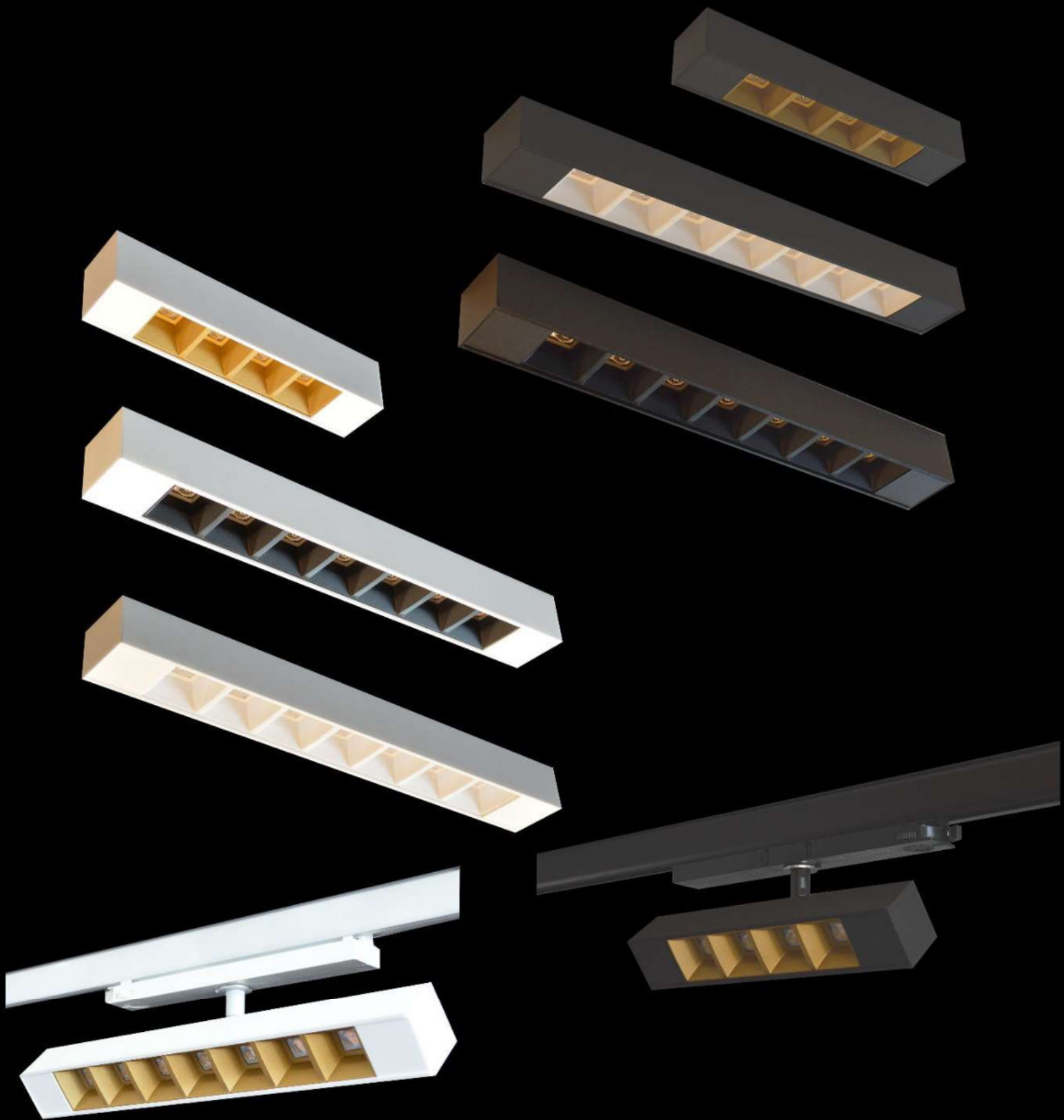

Die Systemleuchte „LINE DEEP“ zeichnet sich durch ihre klare Formsprache aus und bietet eine Vielzahl an Konfigurationsmöglichkeiten. Durch die vertiefte Position der LED-Module eignet sich die Leuchtenserie perfekt im Officebereich sowie im Shopbereich und wo blendfreie Beleuchtung und hohe Farbwiedergabe erwünscht ist. UGR < 19 / CRI > 90 / 95.

The system luminaire „LINE DEEP“ is characterized by a clear design language and offers a variety of configuration options. Due to the recessed position of the LED modules, the luminaire series is also perfect for office and shop area and wherever glare-free lighting and high color rendering is required. UGR < 19 / CRI > 90 / 95.



# LINE DEEP FLAT 140

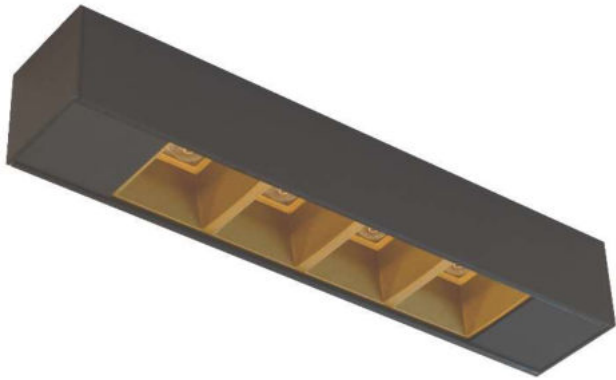

**Deckenleuchte** / ceiling luminaire

**LED Driver extern**

**Acryl satiniert** / acrylic frosted

**Körper / body:**

weiß satiniert            BW  
white satin frosted        BW

schwarz satiniert        BS  
black satin frosted        BS

**Blende / cover:**

weiß satiniert            CW  
white satin frosted        CW

schwarz satiniert        CS  
black satin frosted        CS

**Optik / Beam:**

50°  
UGR < 19

**Leuchtmittel / lamp:**

LED 4,4W / 710lm 27K / 30K / 40K / 50K // 230V

**DIM...** DALI dimmbar/ DALI dimmable

**DIMT...** tunable white

**IP 20 / CRI >90 / L80B10**

**CRI > 95 Anfrage / request**

**Artikelnummer** / reference no. / article:

30.0LDEEP.F.140....

**LED Driver:** ( separat bestellen / order separately )

**Artikelnummer** / reference no. / article:

20.0LDEEP140....

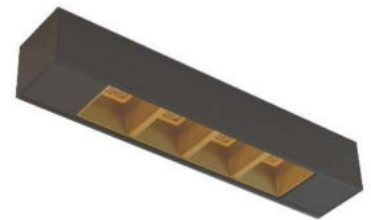

30.0LDEEP.F.140.BS.RG.CS

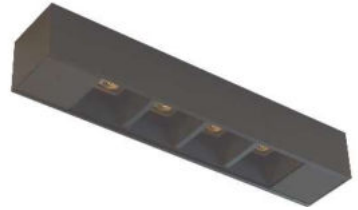

30.0LDEEP.F.140.BS.RS.CS



30.0LDEEP.F.140.BS.RW.CS



30.0LDEEP.F.140.BS.RW.CW



30.0LDEEP.F.140.BW.RG.CW



30.0LDEEP.F.140.BW.RW.CW



30.0LDEEP.F.140.BW.RS.CS

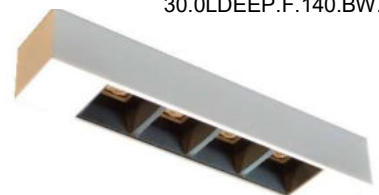

30.0LDEEP.F.140.BW.RS.CW



233

# LINE DEEP FLAT 280



**Deckenleuchte** / ceiling luminaire

**LED Driver extern**

**Acryl satiniert** / acrylic frosted

**Körper / body:**

weiß satiniert            BW  
white satin frosted      BW

schwarz satiniert        BS  
black satin frosted      BS

**Blende / cover:**

weiß satiniert            CW  
white satin frosted      CW

schwarz satiniert        CS  
black satin frosted      CS

**Optik / Beam:**

50°  
UGR < 19

**Leuchtmittel / lamp:**

LED 7,7W / 1250lm 27K / 30K / 40K / 50K // 230V

**DIM...** DALI dimmbar/ DALI dimmable

**DIMT...** tunable white

**IP 20 / CRI >90 / L80B10**

**CRI > 95 Anfrage / request**

**Artikelnummer** / reference no. / article:

30.0LDEEP.F.280....

**LED Driver:** ( separat bestellen / order separately )

**Artikelnummer** / reference no. / article:

20.0LDEEP280....



353

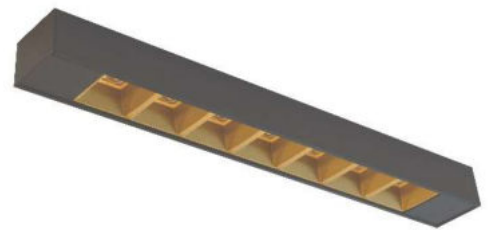

30.0LDEEP.F.280.BS.RG.CS



30.0LDEEP.F.280.BS.RS.CS



30.0LDEEP.F.280.BS.RW.CS



30.0LDEEP.F.280.BS.RW.CW

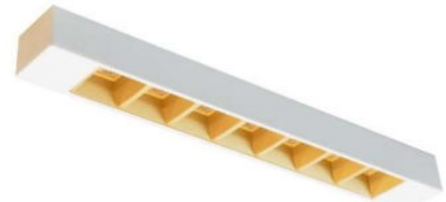

30.0LDEEP.F.280.BW.RG.CW



30.0LDEEP.F.280.BW.RW.CW



30.0LDEEP.F.280.BW.RS.CS

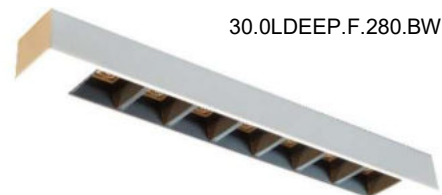

30.0LDEEP.F.280.BW.RS.CW



# LINE DEEP HIGH 140

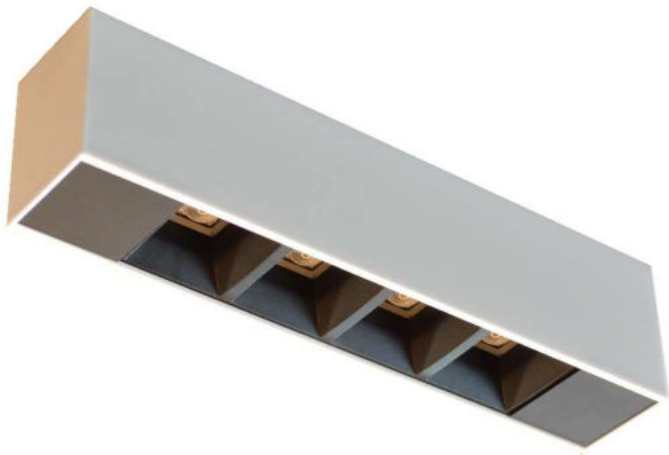

**Deckenleuchte** / ceiling luminaire

**inkl. LED Driver**

**Acryl satiniert** / acrylic frosted

**Körper / body:**

weiß satiniert      BW  
white satin frosted      BW

schwarz satiniert      BS  
black satin frosted      BS

**Blende / cover:**

weiß satiniert      CW  
white satin frosted      CW

schwarz satiniert      CS  
black satin frosted      CS

**Optik / Beam:**

50°

**UGR < 19**

**Leuchtmittel / lamp:**

LED 4,4W / 710lm 27K / 30K / 40K / 50K // 230V

**DIM... DALI dimmbar/ DALI dimmable**

**DIMT... tunable white**

**IP 20 / CRI >90 / L80B10**

**CRI > 95 Anfrage / request**

**Artikelnummer / reference no. / article:**

30.0LDEEP.H.140....



233

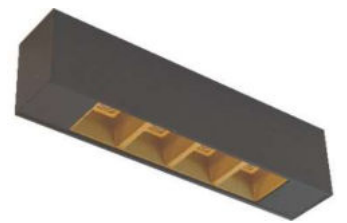

30.0LDEEP.H.140.BS.RG.CS



30.0LDEEP.H.140.BS.RS.CS

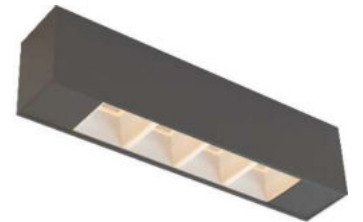

30.0LDEEP.H.140.BS.RW.CS



30.0LDEEP.H.140.BS.RW.CW

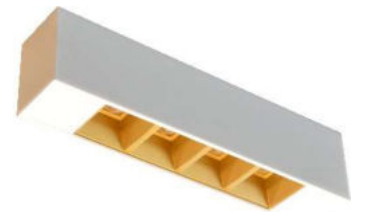

30.0LDEEP.H.140.BW.RG.CW

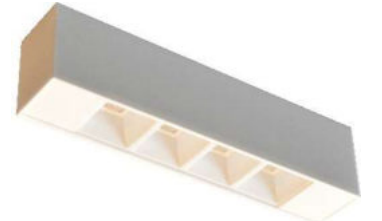

30.0LDEEP.H.140.BW.RW.CW

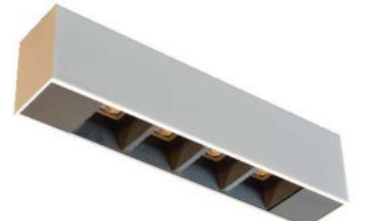

30.0LDEEP.H.140.BW.RS.CS

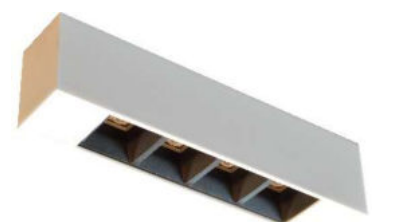

30.0LDEEP.H.140.BW.RS.CW



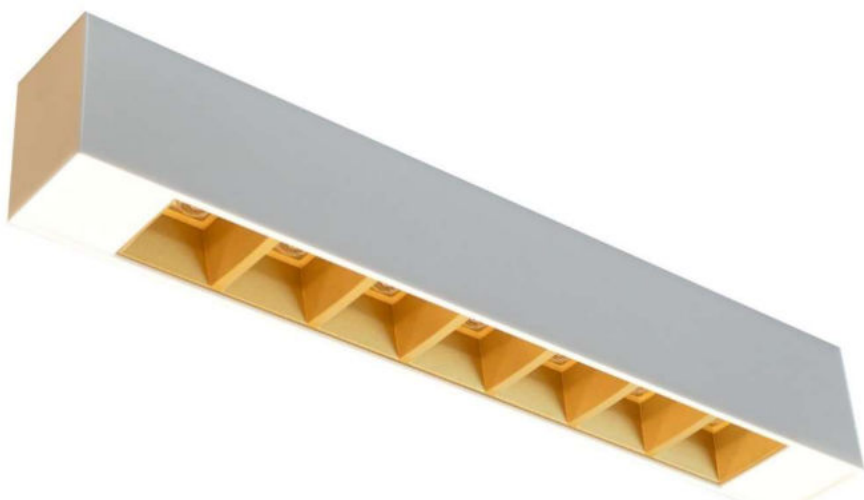

**Deckenleuchte** / ceiling luminaire

**inkl. LED Driver**

**Acryl satiniert** / acrylic frosted

**Körper / body:**

weiß satiniert      BW  
white satin frosted      BW

schwarz satiniert      BS  
black satin frosted      BS

**Blende / cover:**

weiß satiniert      CW  
white satin frosted      CW

schwarz satiniert      CS  
black satin frosted      CS

**Optik / Beam:**

50°

**UGR < 19**

**Leuchtmittel / lamp:**

LED 7,7W / 1250lm 27K / 30K / 40K / 50K // 230V

**DIM... DALI dimmbar** / DALI dimmable

**DIMT... tunable white**

**IP 20 / CRI >90 / L80B10**

**CRI > 95 Anfrage / request**

**Artikelnummer** / reference no. / article:

30.0LDEEP.H.280....



353

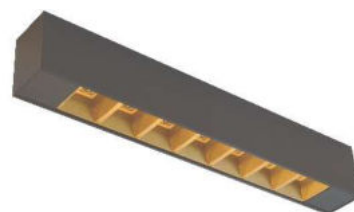

30.0LDEEP.H.280.BS.RG.CS

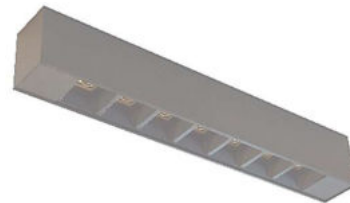

30.0LDEEP.H.280.BS.RS.CS

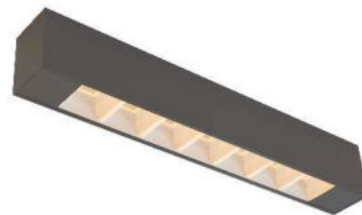

30.0LDEEP.H.280.BS.RW.CS



30.0LDEEP.H.280.BS.RW.CW

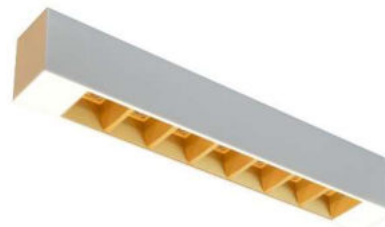

30.0LDEEP.H.280.BW.RG.CW



30.0LDEEP.H.280.BW.RW.CW

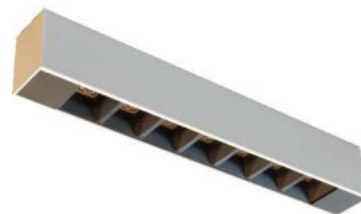

30.0LDEEP.H.280.BW.RS.CS

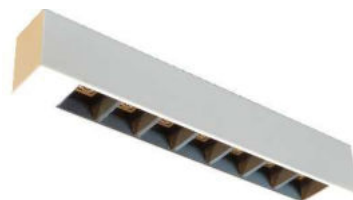

30.0LDEEP.H.280.BW.RS.CW



# LINE DEEP AD 140



## Systemleuchte für 3-Phasen Stromschiene drehbar 275° mit Adapter mit integriertem LED-Driver/

System luminaire for 3-phase lighting track rotating 275° with adapter with integrated LED-Driver **Acryl satiniert** / acrylic frosted

### Körper / body:

weiß satiniert BW  
white satin frosted BW

schwarz satiniert BS  
black satin frosted BS

### Blende / cover:

weiß satiniert CW  
white satin frosted CW

schwarz satiniert CS  
black satin frosted CS

### Optik / Beam:

50°  
UGR < 19

### Leuchtmittel / lamp:

LED 4,4W / 710lm 27K / 30K / 40K / 50K // 230V

**DIM...** DALI dimmbar/ DALI dimmable

**DIMT...** tunable white

**IP 20 / CRI >90 / L80B10**

**CRI > 95 Anfrage / request**

### Artikelnummer / reference no. / article:

80.0LDEEP.AD.140....

3-Phasen Stromschiene / 3 - phase lighting track

96



233



80.0LDEEP.AD.140.BS.RG.CS



80.0LDEEP.AD.140.BS.RS.CS



80.0LDEEP.AD.140.BS.RW.CS



80.0LDEEP.AD.140.BS.RW.CW



80.0LDEEP.AD.140.BW.RG.CW



80.0LDEEP.AD.140.BW.RW.CW



80.0LDEEP.AD.140.BW.RS.CS



80.0LDEEP.AD.140.BW.RS.CW

# LINE DEEP AD 280



## Systemleuchte für 3-Phasen Stromschiene drehbar 275° mit Adapter mit integriertem LED-Driver/

System luminaire for 3-phase lighting track rotating 275° with adapter with integrated LED-Driver **Acryl satiniert / acrylic frosted**

### Körper / body:

weiß satiniert BW  
white satin frosted BW

schwarz satiniert BS  
black satin frosted BS

### Blende / cover:

weiß satiniert CW  
white satin frosted CW

schwarz satiniert CS  
black satin frosted CS

### Optik / Beam:

50°  
UGR < 19

### Leuchtmittel / lamp:

LED 7,7W / 1250lm 27K / 30K / 40K / 50K // 230V

**DIM...** DALI dimmbar/ DALI dimmable

**DIMT...** tunable white

**IP 20 / CRI >90 / L80B10**

**CRI > 95 Anfrage / request**

**Artikelnummer / reference no. / article:**

80.0LDEEP.AD.280....

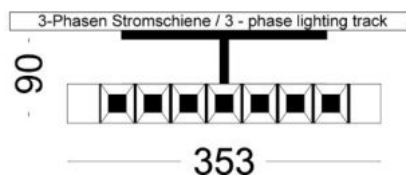

80.0LDEEP.AD.280.BS.RG.CS



80.0LDEEP.AD.280.BS.RS.CS



80.0LDEEP.AD.280.BS.RW.CS



80.0LDEEP.AD.280.BS.RW.CW



80.0LDEEP.AD.280.BW.RG.CW



80.0LDEEP.AD.280.BW.RW.CW



80.0LDEEP.AD.280.BW.RS.CS



80.0LDEEP.AD.280.BW.RS.CW

# SILENCE FLAT



**Hängeleuchte /** pendant luminaire

**Akustikleuchte /** acoustic luminaire

**Schallabsorber mit Filzoberfläche /**

Sound absorber with felt

**Stoff Chintz /** fabric chintz

**Metall silber /** metal silver

**Acrylglas satiniert ( S ), Microprismen ( M ) /** acryl

frosted, microprismatic

**Leuchtmittel /** lamp:

LED 66W / 8300lm 30K / 40K // 230V

**DIM... DALI dimmbar/** DALI dimmable

**DIMT... tunable white**

**IP 40 / CRI >90 / L80B10**

**CRI > 95 Anfrage /** request

**Absorberfläche /** absorber surface:

0,5m<sup>2</sup>

**Artikelnummer /** reference no. / article:

40.OSILE F...

**Schallabsorber /**sound absorber:

Mineralfaserfreies Akustikmaterial mit

Filzkaschierung / Brandklasse B2

Mineral fiber free acoustic material with felt cover /

fire class B2

Schallabsorbtionsgrad / sound absorbing level:

$\alpha = 0,76$  ( 500 Hz )



**direct light ( D )**

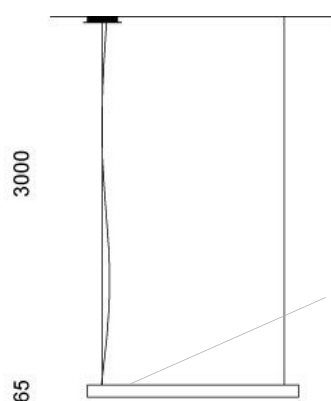
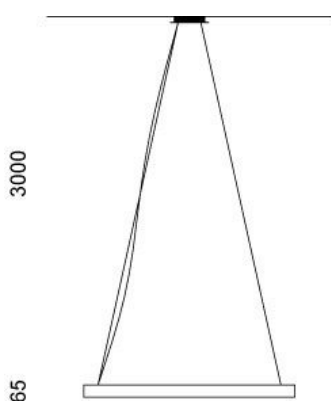

LED Driver

**Absorber:**

**Choose your color**



Graphitgrau  
marmoriert



Lichtgrau  
marmoriert



Creemeweiss  
marmoriert

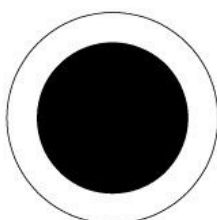

Ø 1112

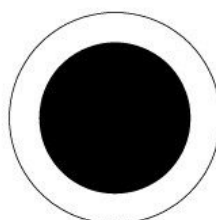

Ø 1112



Absorber

**Hängeleuchte /** pendant luminaire

**Akustikleuchte /** acoustic luminaire

**Schallabsorber mit Filzoberfläche /** Sound absorber with felt

**Stoff Chintz /** fabric chintz

**Metall silber /** metal silver

**Acrylglas satiniert ( S ), Microprismen ( M ) /** acryl frosted, microprismatic

**Leuchtmittel /** lamp:

**900mm** LED 72W / 8100lm 27K / 30K / 40K / 50K // 230V

**1200mm** LED 90W / 10125lm 27K / 30K / 40K / 50K // 230V

**1500mm** LED 120W / 13500lm 27K / 30K / 40K / 50K // 230V

**DIM... DALI dimmbar/ DALI dimmable**

**DIMT... tunable white**

**IP 20 / CRI >90 / L80B10**

**CRI > 95 Anfrage / request**

**Absorberfläche /** absorber surface:

900mm ... 0,5m<sup>2</sup>

1200mm... 1,14m<sup>2</sup>

1500mm... 1,78m<sup>2</sup>

**Artikelnummer /** reference no. / article:

40.0SILE N 900 ...

40.0SILE N 1200 ...

40.0SILE N 1500 ...

**direct light ( D )**



**Schallabsorber /**sound absorber:

Mineralfaserfreies Akustikmaterial mit Filzkaschierung / Brandklasse B2

Mineral fiber free acoustic material with felt cover / fire class B2

Schallabsorbtiionsgrad / sound absorbing level:

$\alpha = 0,76$  ( 500 Hz )

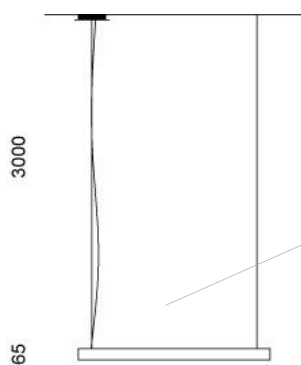
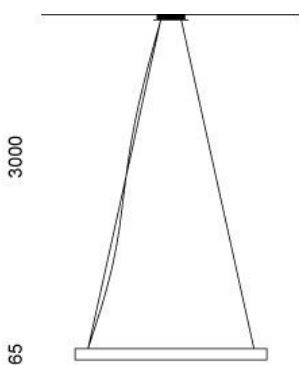

LED Driver

**Absorber:**

**Choose your color**



Graphitgrau marmoriert



Lichtgrau marmoriert



Cremeweiss marmoriert

— ∅ 900 —  
1200  
1500

— ∅ 900 —  
1200  
1500



# SILENCE DOME



**Hängeleuchte /** pendant luminaire

**Akustikleuchte /** acoustic luminaire

**Schallabsorber mit Filzoberfläche /** Sound absorber with felt

**Stoff Chintz /** fabric chintz

**Metall silber /** metal silver

**Acrylglas satiniert ( S ), Microprismen ( M ) /** acryl frosted, microprismatic

**Leuchtmittel /** lamp:

**DOME LED 90W / 10125lm 27K / 30K / 40K / 50K // 230V**

**DIM... DALI dimmbar/ DALI dimmable**

**DIMT... tunable white**

**IP 20 / CRI >90 / L80B10**

**CRI > 95 Anfrage / request**

**Absorberfläche /** absorber surface:

DOME ... 1,81m<sup>2</sup>

**Artikelnummer /** reference no. / article:

40.0SILE DOME ...

**Schallabsorber /**sound absorber:

Mineralfaserfreies Akustikmaterial mit Filzkaschierung / Brandklasse B2

Mineral fiber free acoustic material with felt cover / fire class B2

Schallabsorbtionsgrad / sound absorbing level:

$\alpha = 0,76$  ( 500 Hz )

direct light ( D )

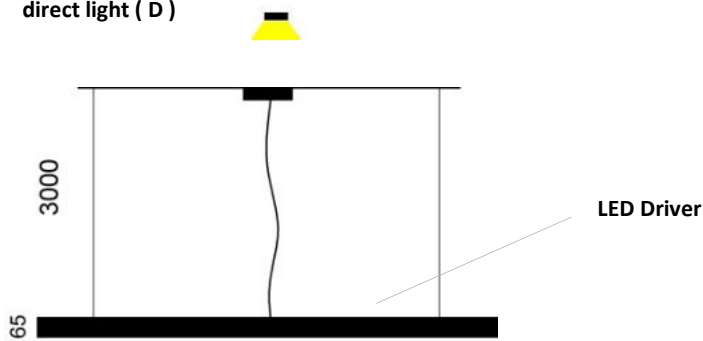

**Choose your color**



Graphitgrau  
marmoriert



Lichtgrau  
marmoriert



Cremeweiss  
marmoriert

# SILENCE DEEP SQUARE

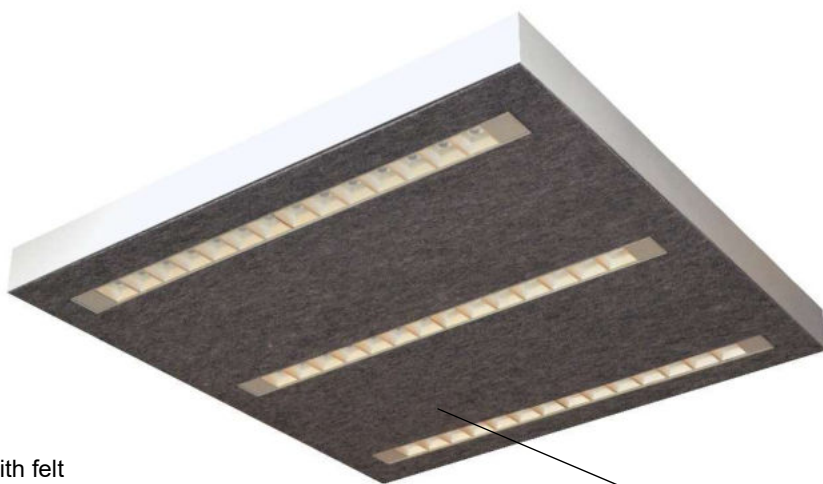
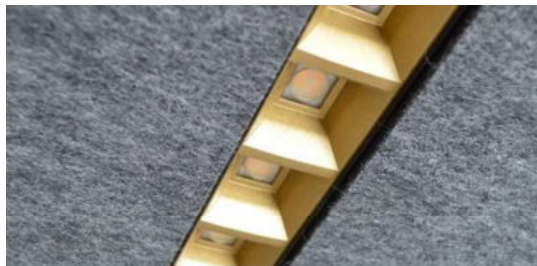

Absorber

**Hängeleuchte /** pendant luminaire

**Akustikleuchte /** acoustic luminaire

**Schallabsorber mit Filzoberfläche /** Sound absorber with felt

**Metall silber /** metal silver

**Optik / Beam:**

50° / UGR < 19

**Reflektor / reflector:**

gold matt	RG	weiß satiniert	RW
gold frosted	RG	white satin frosted	RW
schwarz satiniert	RS	aluminium matt	RA
black satin frosted	RS	aluminium frosted	RA

**Leuchtmittel / lamp:**

**SQUARE 3** LED 32W / 4900lm 27K / 30K / 40K / 50K // 230V

**SQUARE 5** LED 53W / 8200lm 27K / 30K / 40K / 50K // 230V

**DIM... DALI dimmbar/ DALI dimmable**

**DIMT... tunable white**

**IP 20 / CRI >90 / L80B10**

**CRI > 95 Anfrage / request**

**Absorberfläche / absorber surface:**

Square 3... 0,55m<sup>2</sup>

Square 5... 0,51m<sup>2</sup>

**Artikelnummer / reference no. / article:**

40.0SILEN. DS 3...

40.0SILEN. DS 5...

SILENCE DEEP SQUARE 3

SILENCE DEEP SQUARE 5

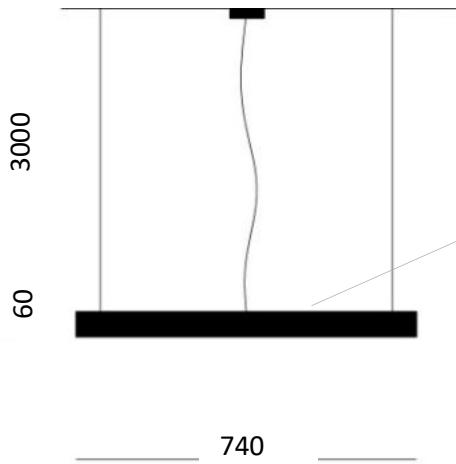
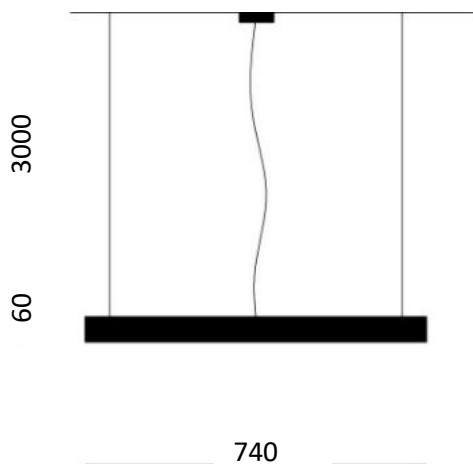

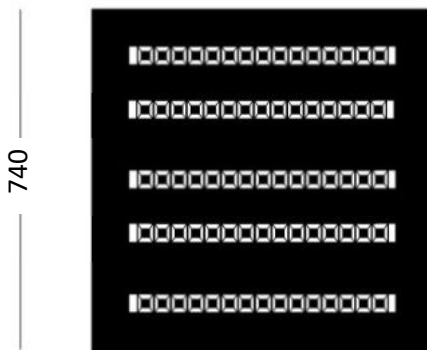
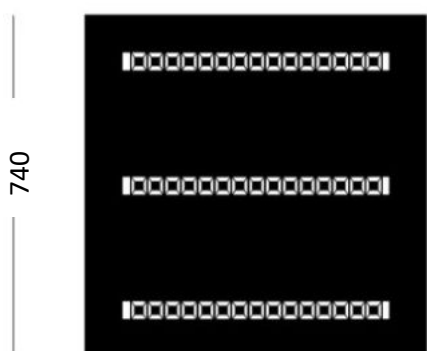

LED Driver

direct light ( D )



**Choose your color**

-  Graphitgrau marmoriert
-  Lichtgrau marmoriert
-  Cremeweiss marmoriert

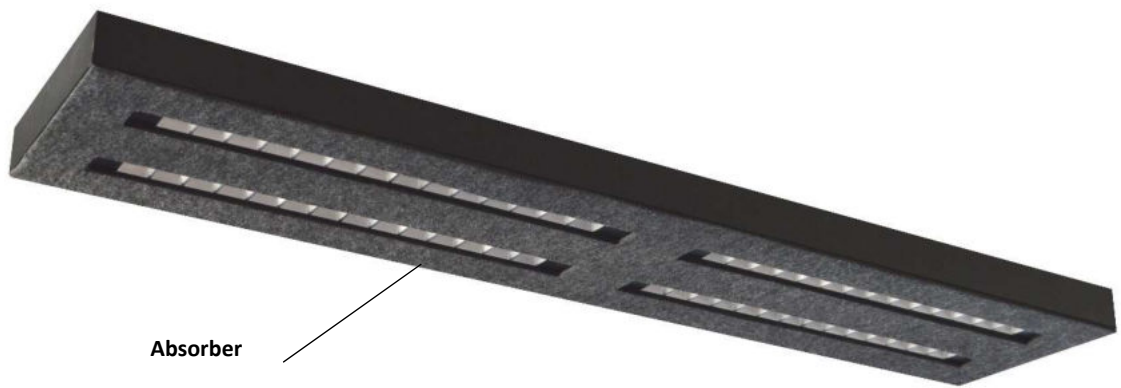

Absorber

**Hängeleuchte /** pendant luminaire

**Akustikleuchte /** acoustic luminaire

**Schallabsorber mit Filzoberfläche /** Sound absorber with felt

**Metall silber /** metal silver

**Optik / Beam:**

50° / UGR < 19

**Reflektor / reflector:**

gold matt	RG	weiß satiniert	RW
gold frosted	RG	white satin frosted	RW
schwarz satiniert	RS	aluminium matt	RA
black satin frosted	RS	aluminium frosted	RA

**Leuchtmittel / lamp:**

LED 42W / 6650lm 27K / 30K / 40K / 50K // 230V

**DIM... DALI dimmbar/** DALI dimmable

**DIMT... tunable white**

**IP 20 / CRI >90 / L80B10**

**CRI > 95 Anfrage / request**

**Absorberfläche / absorber surface:**

0,49m<sup>2</sup>

**Artikelnummer / reference no. / article:**

40.OSILEN. DL ...

**Schallabsorber /sound absorber:**

Mineralfaserfreies Akustikmaterial mit Filzkaschierung / Brandklasse B2

Mineral fiber free acoustic material with felt cover / fire class B2

Schallabsorbtionsgrad / sound absorbing level:

$\alpha = 0,76 ( 500 \text{ Hz} )$



direct light ( D )



**Choose your color**



Graphitgrau  
marmoriert



Lichtgrau  
marmoriert



Cremeweiss  
marmoriert

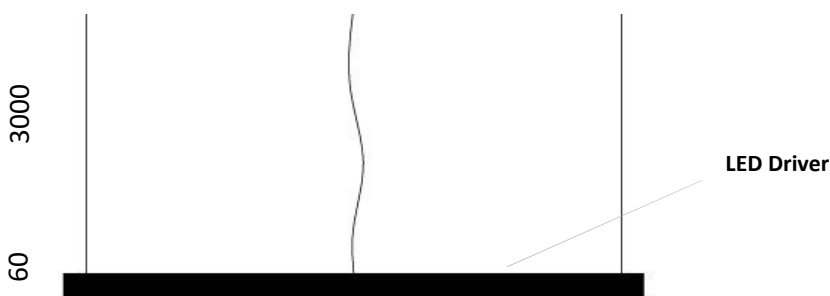

1490



# SILENCE GRID



Absorber

Einlegeleuchte für Rasterdecken 600 x 600mm / 625 x 625mm / recessed luminaire for grid ceiling 600 x 600mm / 625 x 625mm

**Akustikleuchte** / acoustic luminaire  
**Schallabsorber mit Filzoberfläche** / Sound absorber with felt  
**Metall silber** / metal silver

**Optik / Beam:**  
 50° / UGR < 19

**Reflektor / reflector:**

gold matt	RG	weiß satiniert	RW
gold frosted	RG	white satin frosted	RW
schwarz satiniert	RS	aluminium matt	RA
black satin frosted	RS	aluminium frosted	RA

**Leuchtmittel / lamp:**  
**GRD 3** LED 32W / 4900lm 27K / 30K / 40K / 50K // 230V  
**GRID 5** LED 53W / 8200lm 27K / 30K / 40K / 50K // 230V  
**GRID D** LED 38W / 2500lm 30K / 40K // 230V

**DIM...** DALI dimmbar/ DALI dimmable  
**DIMT...** tunable white  
**IP 20 / CRI >90 / L80B10**  
**CRI > 95 Anfrage / request**

**Absorberfläche / absorber surface:**  
 Grid 3... 0,27m<sup>2</sup>  
 Grid 5... 0,21m<sup>2</sup>  
 Grid D... 0,20 m<sup>2</sup>  
 Grid S... 0,36 m<sup>2</sup>

**Artikelnummer / reference no. / article:**  
 50.0SILEN. GR 3...  
 50.0SILEN. GR 5...  
 50.0SILEN. GR D...  
 50.0SILEN. GR S...

**Schallabsorber /sound absorber:**

Mineralfaserfreies Akustikmaterial mit Filzkaschierung / Brandklasse B2

Mineral fiber free acoustic material with felt cover / fire class B2

Schallabsorptionsgrad / sound absorbing level:  
 $\alpha = 0,76$  ( 500 Hz )

SILENCE GRID D

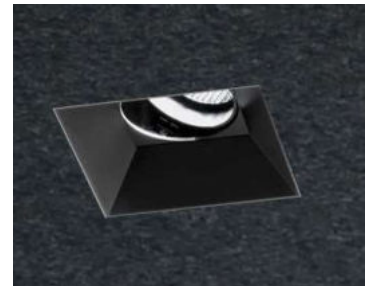

SILENCE GRID 3

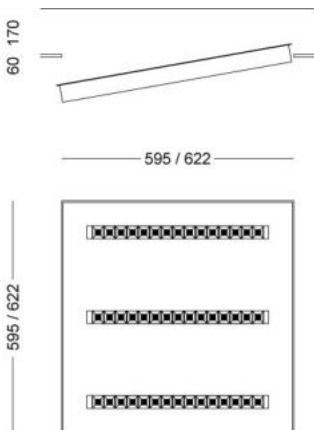

SILENCE GRID 5

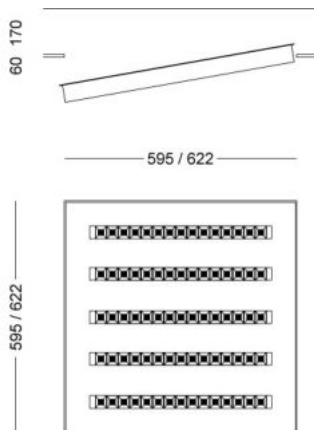

SILENCE GRID D

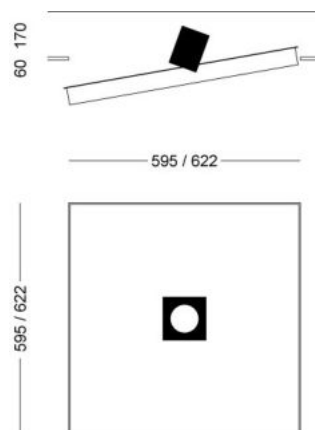

SILENCE GRID S

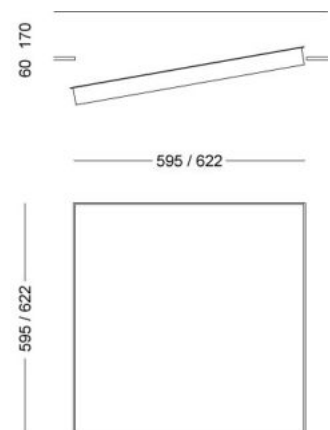

Graphitgrau marmoriert



Lichtgrau marmoriert



Cremeweiss marmoriert

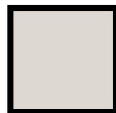

direct light ( D )



Choose your color

# SILENCE FIELD LINE 1

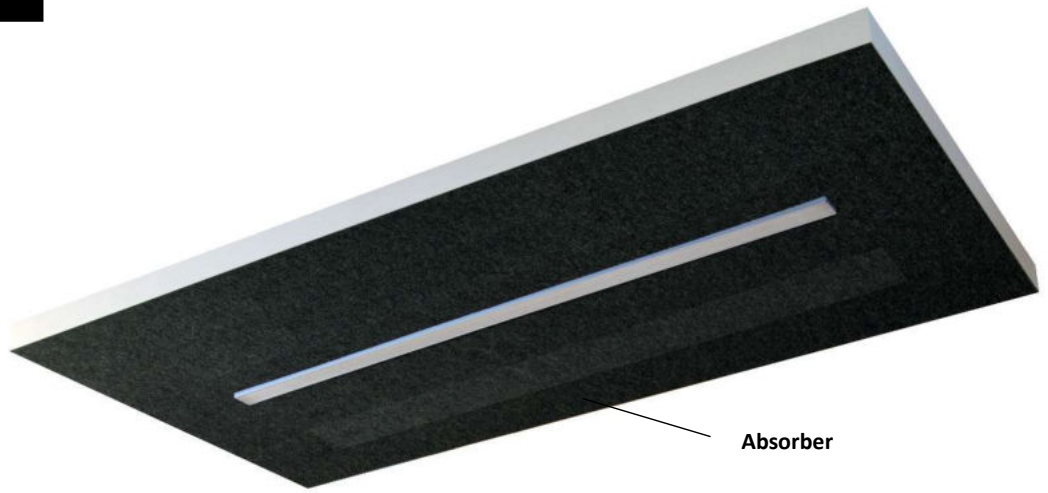
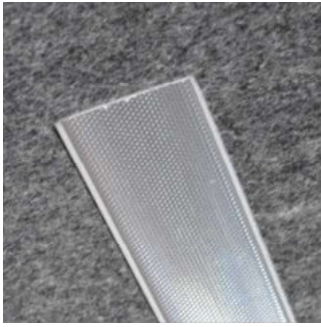

**B bündig / flush:**

**Hängeleuchte /** pendant luminaire

**Akustikleuchte /** acoustic luminaire

**Schallabsorber mit Filzoberfläche /** Sound absorber with felt

**Aluminiumgehäuse schwarz / silber//** metal case black / silver

**Acrylglas PMMA, Microprismen /** acryl frosted PMMA, microprismatic

**Leuchtmittel /** lamp:

LED 42W / 5200lm 27K / 30K / 40K / 50K // 230V

**DIM... DALI dimmbar/** DALI dimmable

**DIMT... tunable white**

**IP 20 / CRI >90 / L80B10**

**CRI > 95 Anfrage /** request

**Absorberfläche /** absorber surface:

1,92m<sup>2</sup>

**Artikelnummer /** reference no. / article:

40.OSILEN. FL1 V... ( vorstehend / protruding )

40.OSILEN. FL1 B... ( bündig / flush )

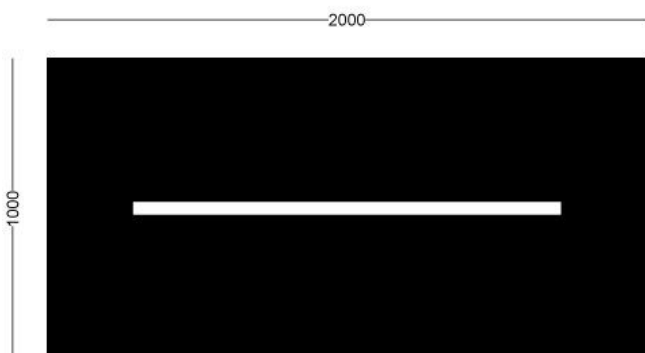
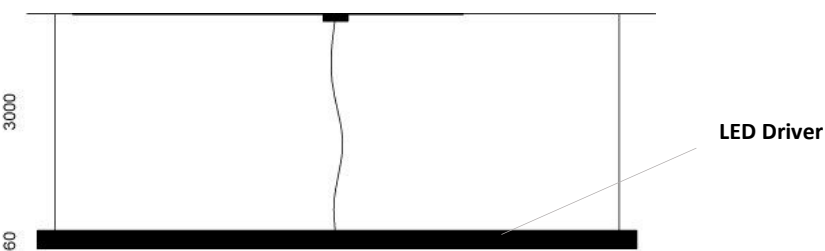

## Schallabsorber /sound absorber:

Mineralfaserfreies Akustikmaterial mit Filzkaschierung / Brandklasse B2

Mineral fiber free acoustic material with felt cover / fire class B2

Schallabsorbtiionsgrad / sound absorbing level:

$\alpha = 0,76$  ( 500 Hz )

**V vorstehend**  
**protruding:**

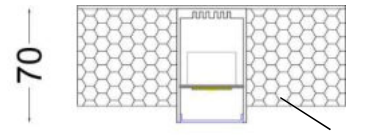

**B bündig**  
**flush:**

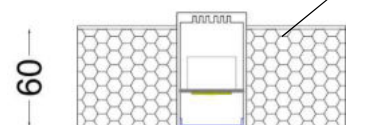

direct light ( D )



## Choose your color



Graphitgrau  
marmoriert



Lichtgrau  
marmoriert



Cremeweiss  
marmoriert

## SILENCE FIELD LINE 2



V vorstehend / protruding:

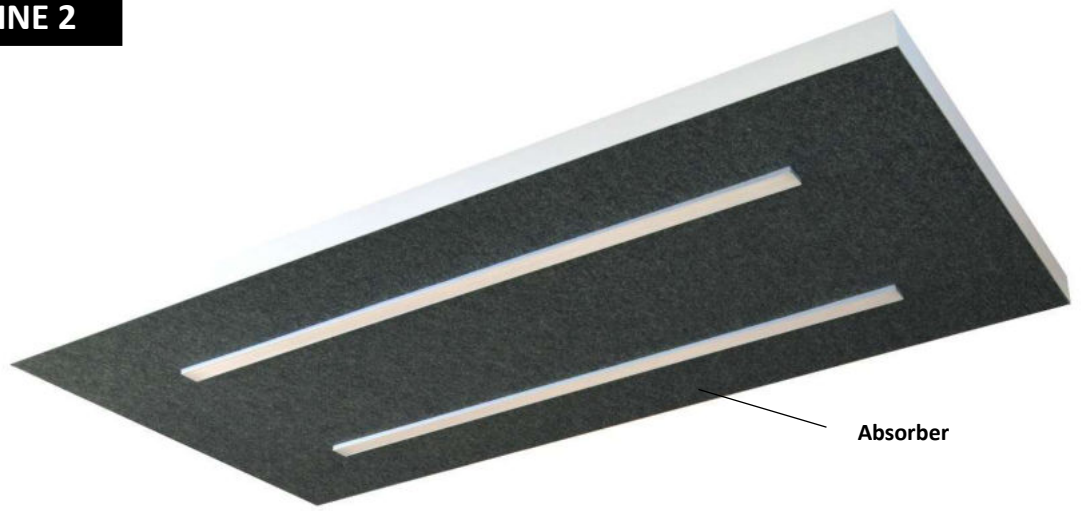

Absorber

Hängeleuchte / pendant luminaire

Akustikleuchte / acoustic luminaire

Schallabsorber mit Filzoberfläche / Sound absorber with felt

Aluminiumgehäuse Schwarz / silber // metal case black / silver

Acrylglas PMMA, Microprismen / acryl frosted PMMA, microprismatic

Leuchtmittel / lamp:

LED 84W / 10400lm 27K / 30K / 40K / 50K // 230V

DIM... DALI dimmbar/ DALI dimmable

DIMT... tunable white

IP 20 / CRI >90 / L80B10

CRI > 95 Anfrage / request

Absorberfläche / absorber surface:

1,85m<sup>2</sup>

Artikelnummer / reference no. / article:

40.OSILEN. FL2 V... ( vorstehend / protruding )

40.OSILEN. FL2 B... ( bündig / flush )

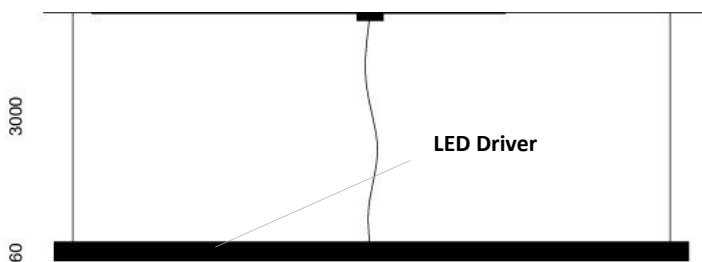

Schallabsorber / sound absorber:

Mineralfaserfreies Akustikmaterial mit Filzkaschierung / Brandklasse B2

Mineral fiber free acoustic material with felt cover / fire class B2

Schallabsorbtiionsgrad / sound absorbing level:

$\alpha = 0,76$  ( 500 Hz )

V vorstehend  
protruding:

70

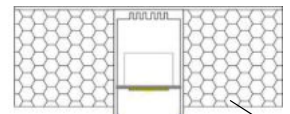

Absorber

B bündig  
flush:

60

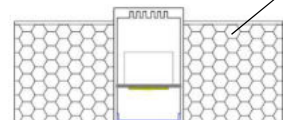

direct light ( D )



Choose your color



Graphitgrau  
marmoriert



Lichtgrau  
marmoriert



Cremeweiss  
marmoriert

# SILENCE FIELD DEEP 1

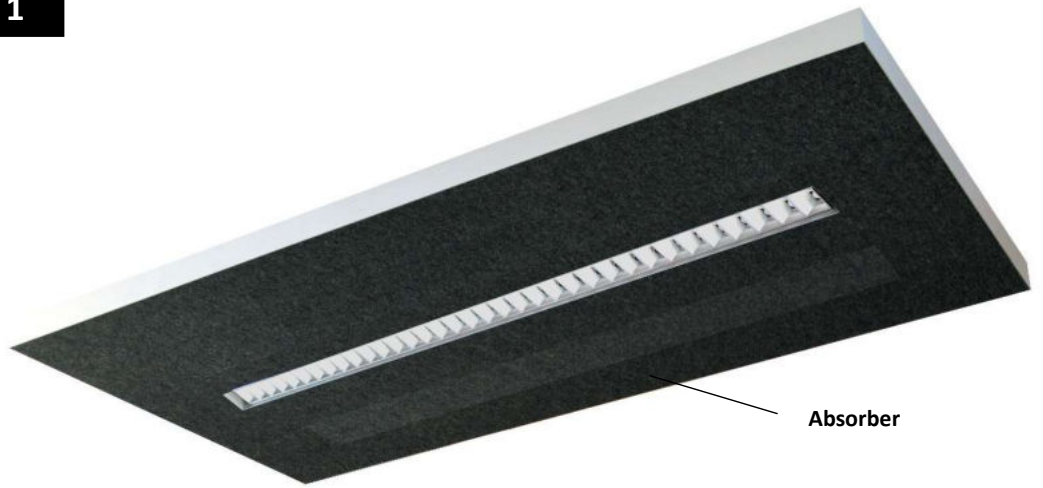

**V vorstehend / protruding:**

**Hängeleuchte /** pendant luminaire

**Akustikleuchte /** acoustic luminaire

**Schallabsorber mit Filzoberfläche /** Sound absorber with felt

**Aluminiumgehäuse schwarz silber //** metal case black / silver

**Optik / Beam:**

50° / UGR < 19

**Reflektor / reflector:**

gold matt	RG	weiß satiniert	RW
gold frosted	RG	white satin frosted	RW
schwarz satiniert	RS	aluminium matt	RA
black satin frosted	RS	aluminium frosted	RA

**Leuchtmittel / lamp:**

LED 27W / 4625lm 27K / 30K / 40K / 50K // 230V

**DIM... DALI dimmbar/** DALI dimmable

**DIMT... tunable white**

**IP 20 / CRI >90 / L80B10**

**CRI > 95 Anfrage / request**

**Absorberfläche / absorber surface:**

1,92m<sup>2</sup>

**Artikelnummer / reference no. / article:**

40.OSILEN. FD1 V... ( vorstehend / protruding )

40.OSILEN. FD1 B... ( bündig / flush )

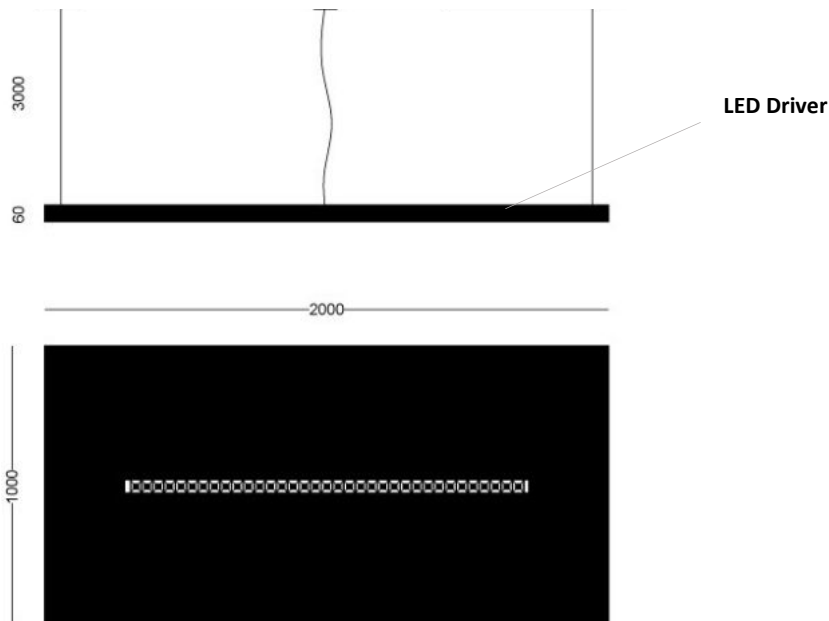

**Schallabsorber /sound absorber:**

Mineralfaserfreies Akustikmaterial mit Filzkaschierung / Brandklasse B2

Mineral fiber free acoustic material with felt cover / fire class B2

Schallabsorbtionsgrad / sound absorbing level:

$\alpha = 0,76$  ( 500 Hz )

**V vorstehend protruding:**

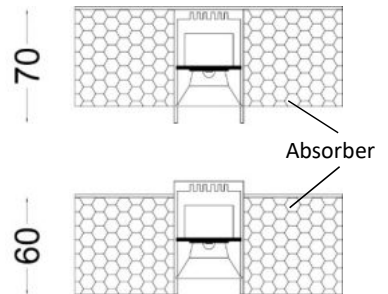

**B bündig flush:**

**direct light ( D )**



**Choose your color**



Graphitgrau marmoriert

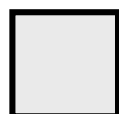

Lichtgrau marmoriert



Cremeweiss marmoriert

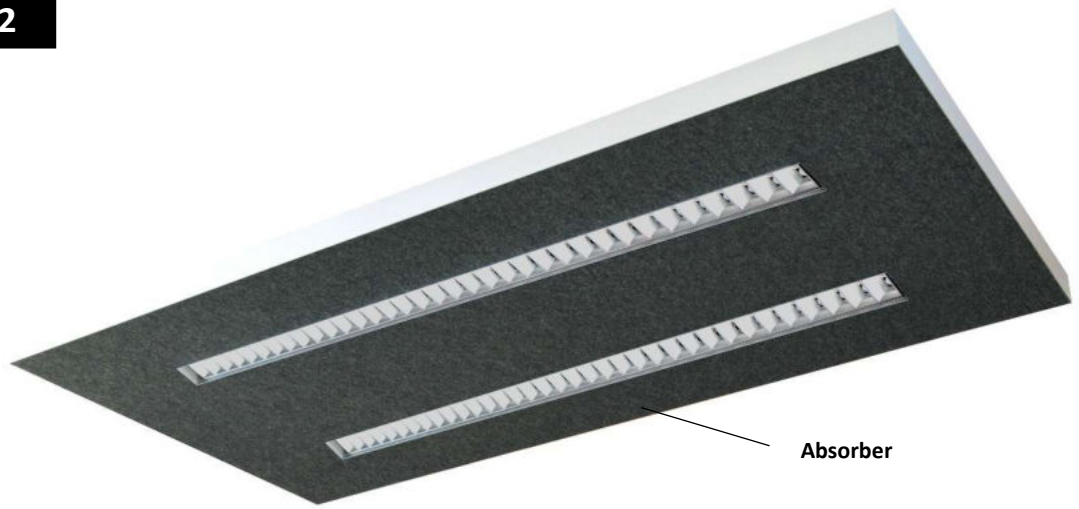

**B bündig / flush:**

**Hängeleuchte /** pendant luminaire

**Akustikleuchte /** acoustic luminaire

**Schallabsorber mit Filzoberfläche /** Sound absorber with felt

**Aluminiumgehäuse schwarz silber //** metal case black / silver

**Optik / Beam:**

50° / UGR < 19

**Reflektor / reflector:**

gold matt	RG	weiß satiniert	RW
gold frosted	RG	white satin frosted	RW
schwarz satiniert	RS	aluminium matt	RA
black satin frosted	RS	aluminium frosted	RA

**Leuchtmittel / lamp:**

LED 54W / 9250lm 27K / 30K / 40K / 50K // 230V

**DIM... DALI dimmbar/ DALI dimmable**

**DIMT... tunable white**

**IP 20 / CRI >90 / L80B10**

**CRI > 95 Anfrage / request**

**Absorberfläche / absorber surface:**

1,85m<sup>2</sup>

**Artikelnummer / reference no. / article:**

40.OSILEN. FL2 V... ( vorstehend / protruding )

40.OSILEN. FL2 B... ( bündig / flush )

**Schallabsorber /sound absorber:**

Mineralfaserfreies Akustikmaterial mit Filzkaschierung / Brandklasse B2

Mineral fiber free acoustic material with felt cover / fire class B2

Schallabsorptionsgrad / sound absorbing level:

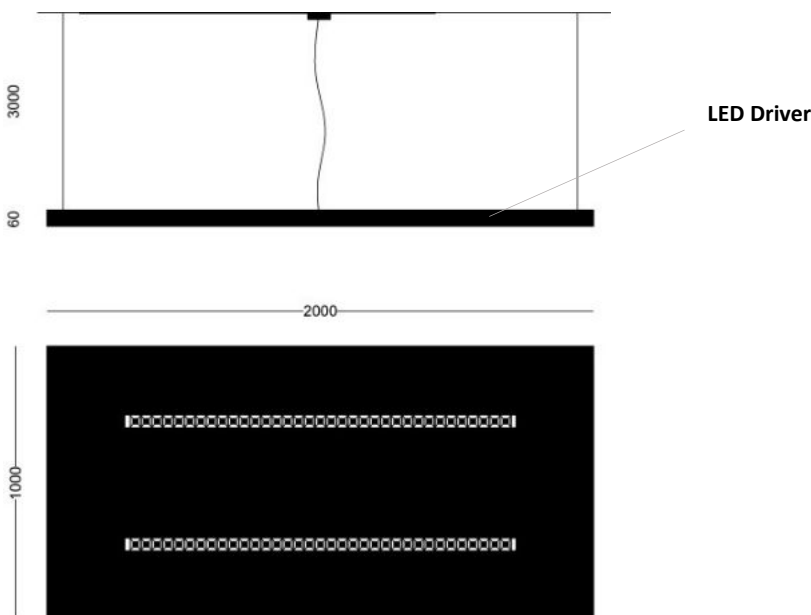
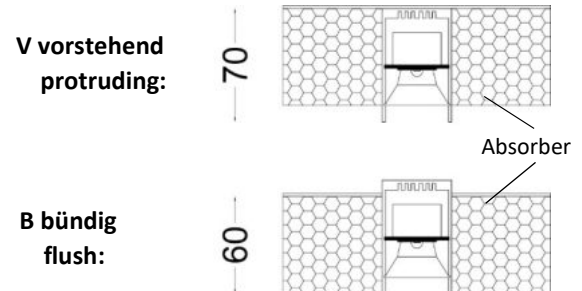

$\alpha = 0,76$  ( 500 Hz )



direct light ( D )

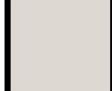

**Choose your color**

-  Graphitgrau marmoriert
-  Lichtgrau marmoriert
-  Cremeweiss marmoriert

# SILENCE WALL



**Wandleuchte / wall luminaire**

**Akustikleuchte / acoustic luminaire**

**Schallabsorber mit Filzoberfläche / Sound absorber with felt**

**Abdeckung Microprismen / cover microprismatic**

**Leuchtmittel / lamp:**

930mm LED 48W/ 2 x 3200lm 27K / 30K / 40K / 50K // 230V

1210mm LED 64W/ 2 x 4500lm 27K / 30K / 40K / 50K // 230V

**DIM... DALI dimmbar/ DALI dimmable**

**DIMT... tunable white**

**IP20 CRI >90 / L80B10**

**CRI > 95 Anfrage / request**

**Absorberfläche / absorber surface:**

930 H150mm ...0,19m<sup>2</sup>

930 H250mm ...0,31m<sup>2</sup>

1210 H150mm ...0,21m<sup>2</sup>

1210 H250mm ...0,36m<sup>2</sup>

**Artikelnummer / reference no. :**

10.OSILEN. W930 150 ...

10.OSILEN. W930 250 ...

10.OSILEN. W1210 150 ...

10.OSILEN. W1210 250 ...

**direct/ indirect light ( D / I )**



**Schallabsorber /sound absorber:**

Mineralfaserfreies Akustikmaterial mit Filzkaschierung / Brandklasse B2

Mineral fiber free acoustic material with felt cover / fire class B2

Schallabsorptionsgrad / sound absorbing level:

$\alpha = 0,76$  ( 500 Hz )

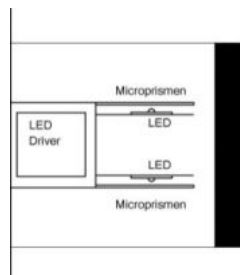
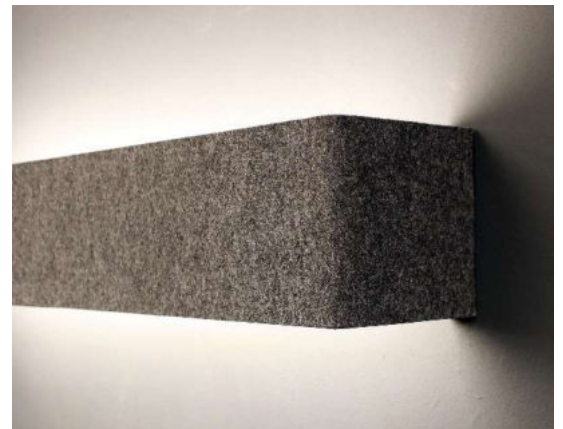

**Choose your color**



Graphitgrau  
marmoriert



Lichtgrau  
marmoriert



Cremeweiss  
marmoriert

## SILENCE SINGLE R

**Schallabsorber mit Filzoberfläche / Sound absorber with felt**  
**Metall silber / metal silver**

**Durchmesser / diameter: 900mm**

**Absorberfläche / absorber surface:**  
 0,64m<sup>2</sup>

**Artikelnummer / reference no. / article:**  
 30/40.OSILEN. SR 900 ...



**Schallabsorber /sound absorber:**

Mineralfaserfreies Akustikmaterial mit  
 Filzkaschierung / Brandklasse B2

Mineral fiber free acoustic material with felt cover /  
 fire class B2

Schallabsorptionsgrad / sound absorbing level:  
 $\alpha = 0,76$  ( 500 Hz )

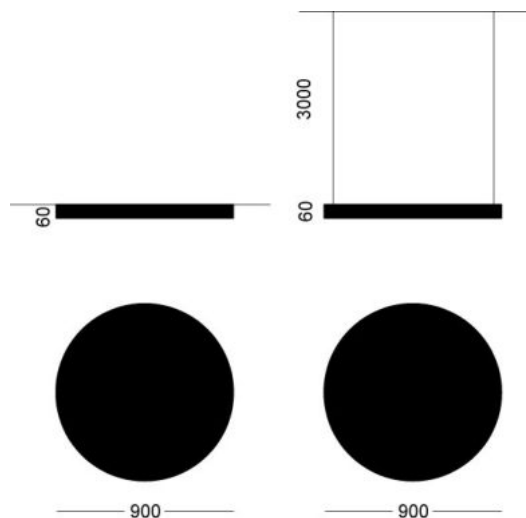

## SILENCE SINGLE S

**Schallabsorber mit Filzoberfläche / Sound absorber with felt**  
**Metall silber / metal silver**

**900mm x 900mm**

**Absorberfläche / absorber surface:**  
 0,81m<sup>2</sup>

**Artikelnummer / reference no. / article:**  
 30/40.OSILEN. SS 900

**Schallabsorber /sound absorber:**

Mineralfaserfreies Akustikmaterial mit  
 Filzkaschierung / Brandklasse B2

Mineral fiber free acoustic material with felt cover /  
 fire class B2

Schallabsorptionsgrad / sound absorbing level:  
 $\alpha = 0,76$  ( 500 Hz )

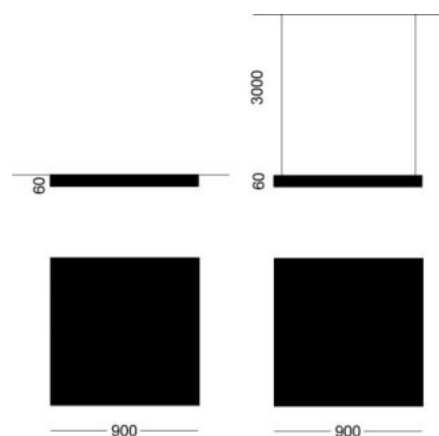

**Choose your color**



Graphitgrau  
 marmoriert



Lichtgrau  
 marmoriert



Cremeweiss  
 marmoriert

# SILENCE FELT

Graphitgrau  
marmoriert

Lichtgrau  
marmoriert

Cremeweiss  
marmoriert

Standardfarben:

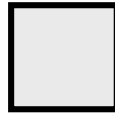

Standard colors:

Farben auf Anfrage:

Colors by request:



Mögliche Einsatzbereiche:

Schalldämmung in  
Kindergärten  
Schulen  
Krankenhäuser  
Besprechungsräume  
Büros  
Arztpraxen  
Gastronomie

Possible applications:

Soundproofing  
kindergarten  
schools  
hospitals  
meeting rooms  
offices  
medical practices  
restaurants



## Material Material:

- Mineralfaserfreies Akustikmaterial mit Filzkaschierung / Brandklasse B2 /
- mineral fiber-free acoustic material with felt / fire class B2.

## Eigenschaft / Characteristic:

- Sehr gute akustische Eigenschaften im Mittelfrequenzbereich
- Ideal zur Optimierung der Raumakustik
- Leichte Pflege
- Umwandlung des Schalls in Wärmeenergie dank feiner und offenzelliger Porenstruktur
- Very good acoustic properties in the medium frequency range
- Ideal for optimizing room acoustics
- Easy to clean
- Conversion of sound into thermal energy due to the fine and open-cell pore structure

**Temperaturbeständigkeit / Temperature resistance :** -40°C bis + 100°C

**Wärmeleitfähigkeit / Thermal conductivity:** 0,033W/mK - DIN 52612

## Physikalischer Effekt / Physical effect:

Die Schwingungen der Luftteilchen werden durch die Filzoberfläche und die spezielle Porenstruktur des Absorbers gebremst und in Wärmeenergie umgewandelt.

The vibrations of the particles in the air are slowed down by the felt surface and the special pore structure of the material and converted into thermal energy.

## Toleranz / Tolerance:

Das Akustikmaterial wird nach DIN 7715 Teil 5 P3 gefertigt

The acoustic material is manufactured in accordance with DIN 7715 Part 5 P3

## Schallabsorbtion / Sound absorbtion:

$\alpha = 0,25$  ( 125 Hz )

$\alpha = 0,78$  ( 250 Hz )

$\alpha = 0,76$  ( 500 Hz )

$\alpha = 0,65$  ( 1000 Hz )

$\alpha = 0,60$  ( 2000 Hz )

$\alpha = 0,72$  ( 4000 Hz )

## Prüfung der Absorber / Absorber Test:

Die Schallabsorber werden in Hallräumen auf Hertz und Poren geprüft.

In ausführlichen Messungen werden die Schallabsorptionsgrade nach DIN 52212 ermittelt.

The sound absorbers are checked of hertz and pores in reverberation rooms.

The sound absorbing levels according to DIN 522212 are determined in detailed measurements.

## Mögliche Einsatzbereiche / Possible applications:

Schalldämmung in

Kindergärten

kindergarden

Soundproofing

Schulen

schools

Krankenhäuser

hospoials

Büros

offices

Seminarräume.....

lecture halls.....

# PLANE SHADE ROUND HIGH



**Hängeleuchte /** pendant luminaire  
**Deckenleuchte /** ceiling luminaire

**Stoff Chintz /** fabric chintz

**Metall silber /** metal silver

**Acrylglas satiniert ( S ), Microprismen ( M ) /** acryl frosted, microprismatic

**Leuchtmittel /** lamp:

**400mm** LED 24W / 3000lm 27K / 30K / 40K / 50K // 230V

**600mm** LED 33W / 4000lm 27K / 30K / 40K / 50K // 230V

**900mm** LED 48W / 6000lm 27K / 30K / 40K / 50K // 230V

**1200mm** LED 96W / 11300lm 27K / 30K / 40K / 50K // 230V

Andere Durchmesser auf Anfrage /  
 other diameters by request ( max. 2m )

**DIM... DALI dimmbar/** DALI dimmable

**DIMT... tunable white**

**IP 40 / CRI >90 / L80B10**

**CRI > 95 Anfrage /** request

**Artikelnummer /** reference no. / article:

30/40.0PLANE. SRH 400...

30/40.0PLANE. SRH 600...

30/40.0PLANE. SRH 900...

30/40.0PLANE. SRH 1200...

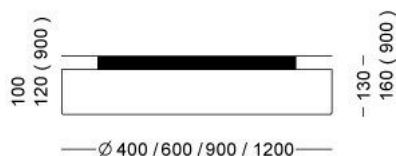

direct light ( D )



direct / indirect light ( D / I )

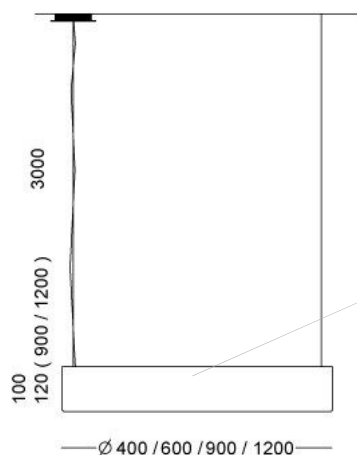
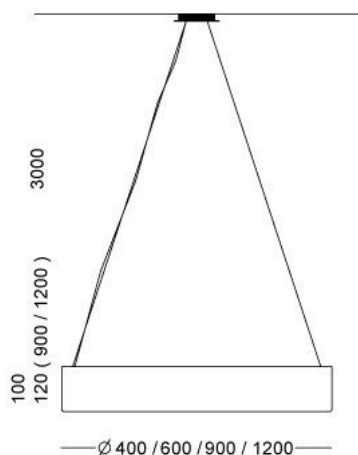

Choose your color





# PLANE SHADE ROUND FLAT



**Hängeleuchte /** pendant luminaire  
**Deckenleuchte /** ceiling luminaire

**Stoff Chintz /** fabric chintz

**Metall silber /** metal silver

**Acrylglas satiniert ( S ), Microprismen ( M ) /** acryl frosted, microprismatic

**Leuchtmittel /** lamp:

**400mm** LED 27W / 3200lm 30K / 40K // 230V

**600mm** LED 42W / 5500lm 30K / 40K // 230V

**900mm** LED 88W / 11010lm 30K / 40K // 230V

**1200mm** LED 110W / 14350lm 30K / 40K // 230V

**DIM... DALI dimmbar/** DALI dimmable

**DIMT... tunable white**

**IP 40 / CRI >90 / L80B10**

**CRI > 95 Anfrage /** request

**Artikelnummer /** reference no. / article:

30/40.OPLANE. SRF 400...

30/40.OPLANE. SRF 600...

30/40.OPLANE. SRF 900...

30/40.OPLANE. SRF 1200...

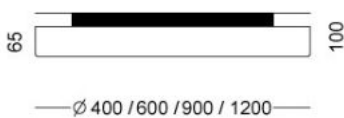
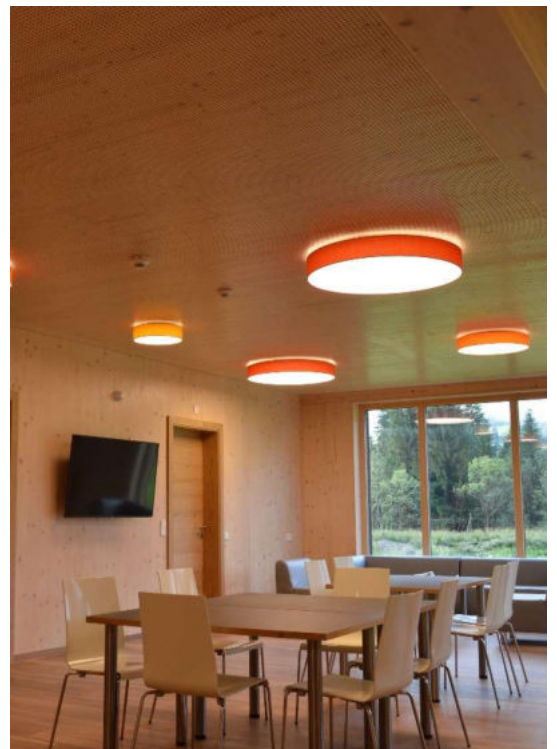

—  $\varnothing$  400 / 600 / 900 / 1200 —

LED Driver

direct light ( D )



direct / indirect light ( D / I )



Choose your color

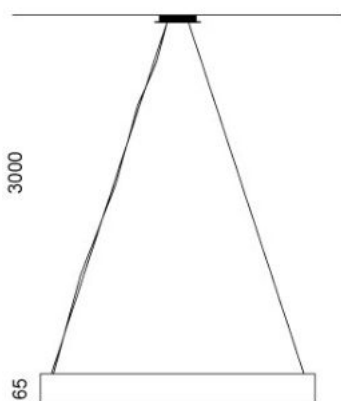

—  $\varnothing$  400 / 600 / 900 / 1200 —

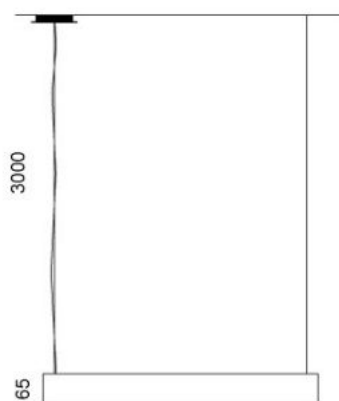

—  $\varnothing$  400 / 600 / 900 / 1200 —



Foto: J. Blassnig



Foto: KT-LIGHTING



Foto: RIX LICHT



Foto: RIX LICHT



# PLANE SHADE SQUARE HIGH



**Hängeleuchte /** pendant luminaire  
**Deckenleuchte /** ceiling luminaire

**Stoff Chintz /** fabric chintz

**Metall silber /** metal silver

**Acrylglas satiniert ( S ), Microprismen ( M ) /** acryl frosted, microprismatic

**Leuchtmittel /** lamp:

**400mm LED 24W / 3000lm 27K / 30K / 40K / 50K // 230V**

**600mm LED 48W / 6000lm 27K / 30K / 40K / 50K // 230V**

**900mm LED 72W / 9000lm 27K / 30K / 40K / 50K // 230V**

**DIM... DALI dimmbar/ DALI dimmable**

**DIMT... tunable white**

**IP 40 / CRI >90 / L80B10**

**CRI > 95 Anfrage / request**

**Artikelnummer /** reference no. / article:

30/40.OPLANE. SSH 400...

30/40.OPLANE. SSH 600...

30/40.OPLANE. SSH 900...

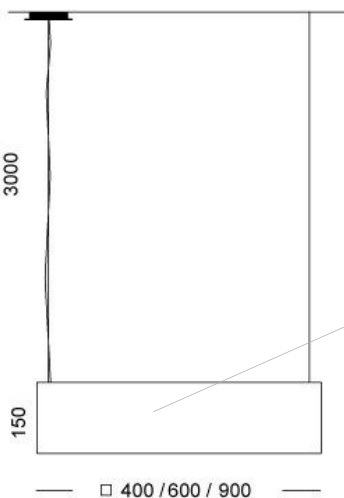
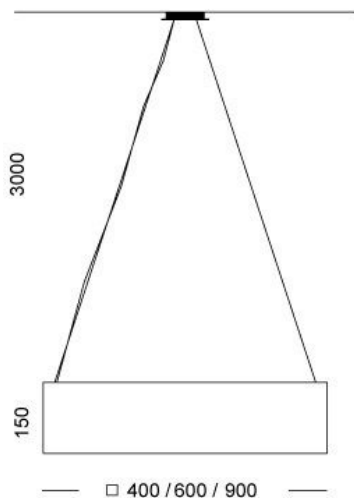
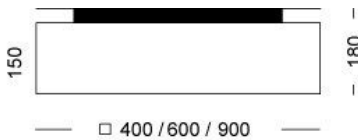

direct light ( D )



direct / indirect light ( D / I )



Choose your color





# PLANE SHADE SQUARE FLAT

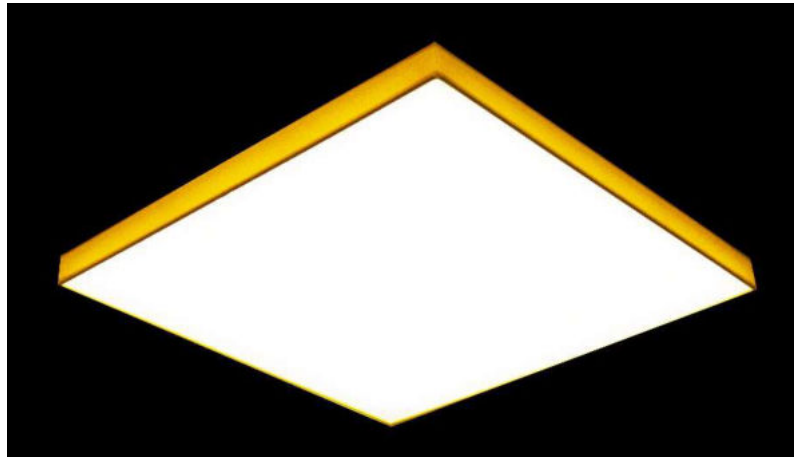
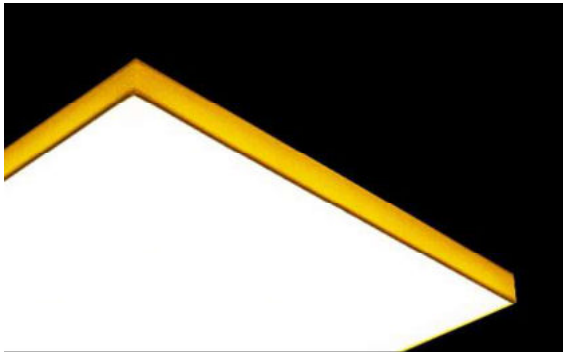

Hängeleuchte / pendant luminaire  
 Deckenleuchte / ceiling luminaire

Stoff Chintz / fabric chintz

Metall silber / metal silver

Acrylglas satiniert ( S ), Microprismen ( M ) / acryl frosted, microprismatic

Leuchtmittel / lamp:

400mm LED 23W / 3000lm 30K / 40K // 230V

600mm LED 44W / 5100lm 30K / 40K // 230V

900mm LED 98W / 11700lm 30K / 40K // 230V

DIM... DALI dimmbar/ DALI dimmable

DIMT... tunable white

IP 40 / CRI >90 / L80B10

CRI > 95 Anfrage / request

Artikelnummer / reference no. / article:

30/40.0PLANE. SSF 400...

30/40.0PLANE. SSF 600...

30/40.0PLANE. SSF 900...

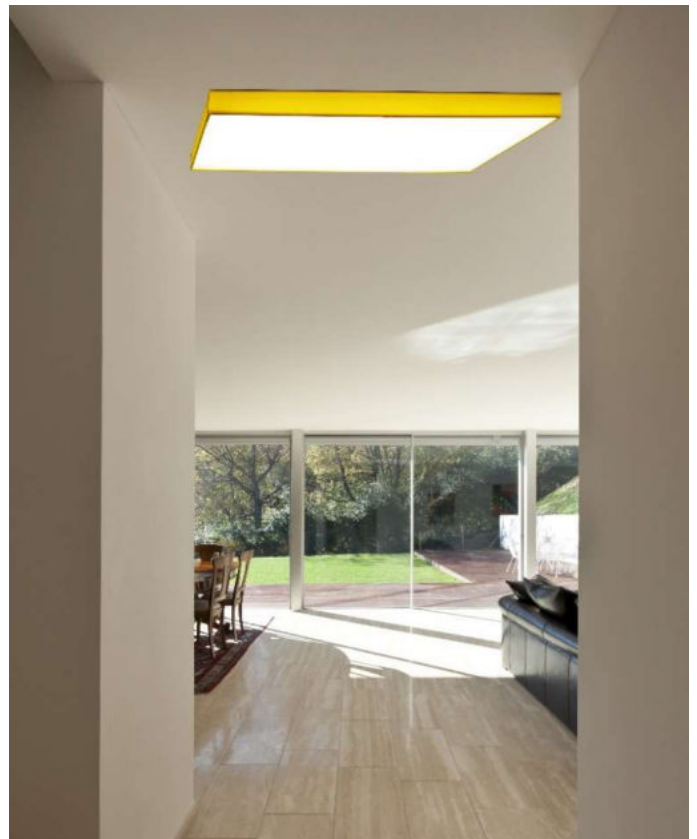

— □ 400 / 600 / 900 —

LED Driver

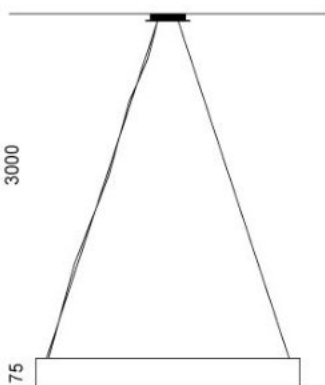

— □ 400 / 600 / 900 —

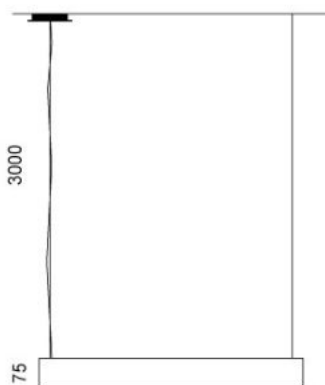

— □ 400 / 600 / 900 —

direct light ( D )



direct / indirect light ( D / I )



Choose your color



# PLANE SHADE MAGIC HIGH



**Hängeleuchte /** pendant luminaire  
**Deckenleuchte /** ceiling luminaire

**Stoff Chintz /** fabric chintz  
**Metall silber /** metal silver

**Acrylglas satiniert ( S ), Microprismen ( M ) /** acryl frosted, microprismatic

**Leuchtmittel /** lamp:

**600mm** LED 33W / 4000lm 27K / 30K / 40K / 50K // 230V

**900mm** LED 48W / 6000lm 27K / 30K / 40K / 50K // 230V

**1200mm** LED 96W / 11500lm 27K / 30K / 40K / 50K // 230V

Andere Durchmesser auf Anfrage /  
 other diameters by request ( max 2m )

**DIM... DALI dimmbar/** DALI dimmable

**DIMT... tunable white**

**IP 40 / CRI >90 / L80B10**

**CRI > 95 Anfrage / request**

**Artikelnummer /** reference no. / article:

30/40.OPLANE. SMH 600...

30/40.OPLANE. SMH 900...

30/40.OPLANE. SMH 1200...

ye... yellow



re... red



gr... green



go... gold

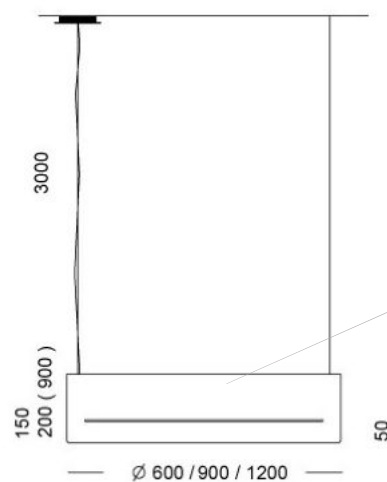
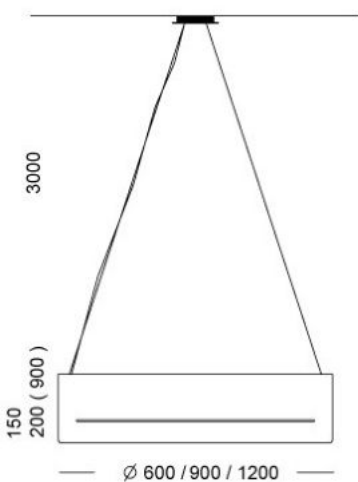
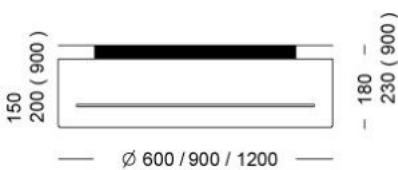
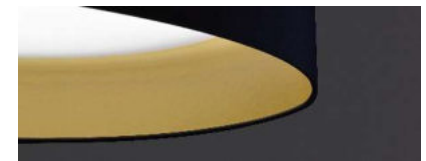

direct light ( D )



direct / indirect light ( D / I )



Choose your color



LED Driver

# PLANE SHADE MAGIC FLAT



**Hängeleuchte /** pendant luminaire  
**Deckenleuchte /** ceiling luminaire

**Stoff Chintz /** fabric chintz  
**Metall silber /** metal silver

**Acrylglas satiniert ( S ), Microprismen ( M ) /** acryl frosted, microprismatic

**Leuchtmittel /** lamp:

**600mm** LED 42W / 5500lm 30K / 40K // 230V

**900mm** LED 88W / 11010lm 30K / 40K // 230V

**1200mm** LED 110W / 14350lm 30K / 40K // 230V

**DIM... DALI dimmbar/** DALI dimmable

**DIMT... tunable white**

**IP 40 / CRI >90 / L80B10**

**CRI > 95 Anfrage /** request

**Artikelnummer /** reference no. / article:

30/40.0PLANE. SMF 600...

30/40.0PLANE. SMF 900...

30/40.0PLANE. SMF 1200...

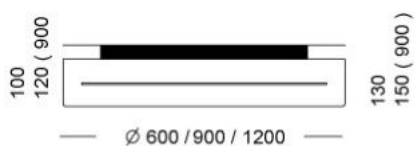

LED Driver

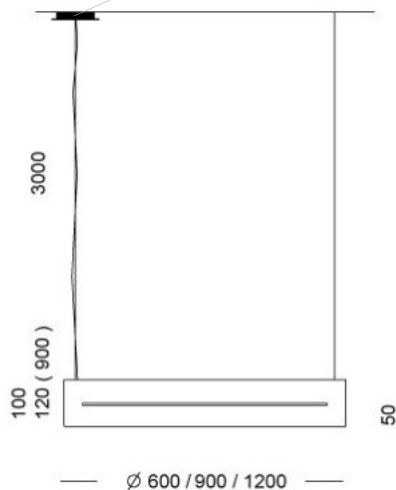
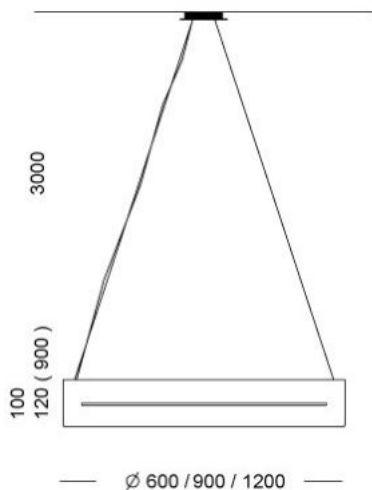

ye... yellow

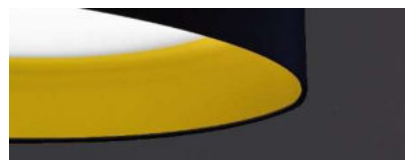

re... red



gr... green



go... gold

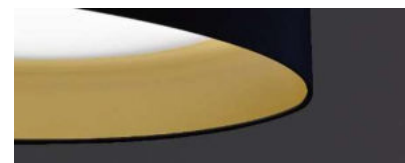

direct light ( D )



direct / indirect light ( D / I )



Choose your color



# CIRCLE HIGH

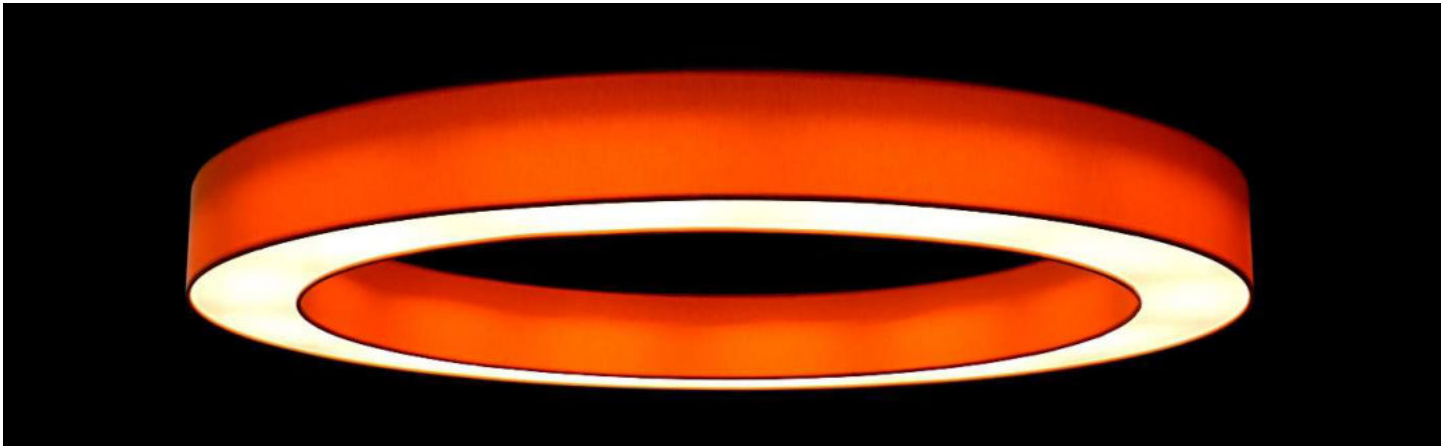

**Hängeleuchte /** pendant luminaire

**Deckenleuchte /** ceiling luminaire

**Stoff Chintz /** fabric chintz

**Metall silber /** metal silver

**Acrylglas satiniert ( S ), Microprismen ( M ) /** acryl frosted, microprismatic

**Leuchtmittel /** lamp:

**900mm** LED 41W / 7000lm 27K / 30K / 40K / 50K // 230V

**1200mm** LED 54W / 9000lm 27K / 30K / 40K / 50K // 230V

**1500mm** LED 96W / 12000lm 27K / 30K / 40K / 50K // 230V

Andere Durchmesser auf Anfrage /  
other diameters by request ( max 2m )

**DIM... DALI dimmbar /** DALI dimmable

**DIMT... tunable white**

**IP 40 / CRI >90 / L80B10**

**CRI > 95 Anfrage /** request

**Artikelnummer /** reference no. / article:

30/40.0CIRCLE. H 900...

30/40.0CIRCLE. H 1200...

30/40.0CIRCLE. H 1500...

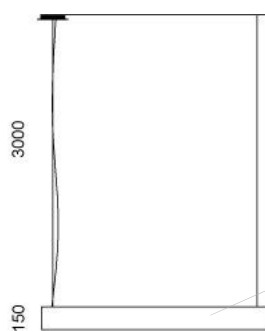
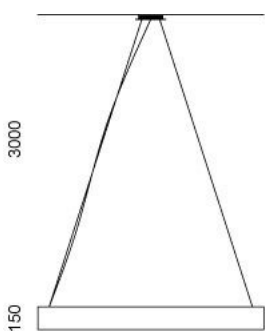

LED Driver

direct light ( D )



direct / indirect light ( D / I )



Choose your color

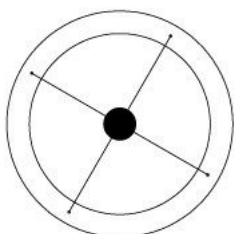

— ø 900 —

— ø 1200 —

— ø 1500 —

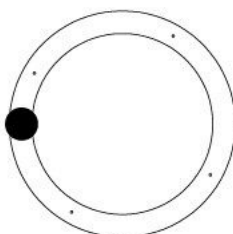

— ø 900 —

— ø 1200 —

— ø 1500 —



  
DOCTORES  
KAVALLAR





# CIRCLE FLAT

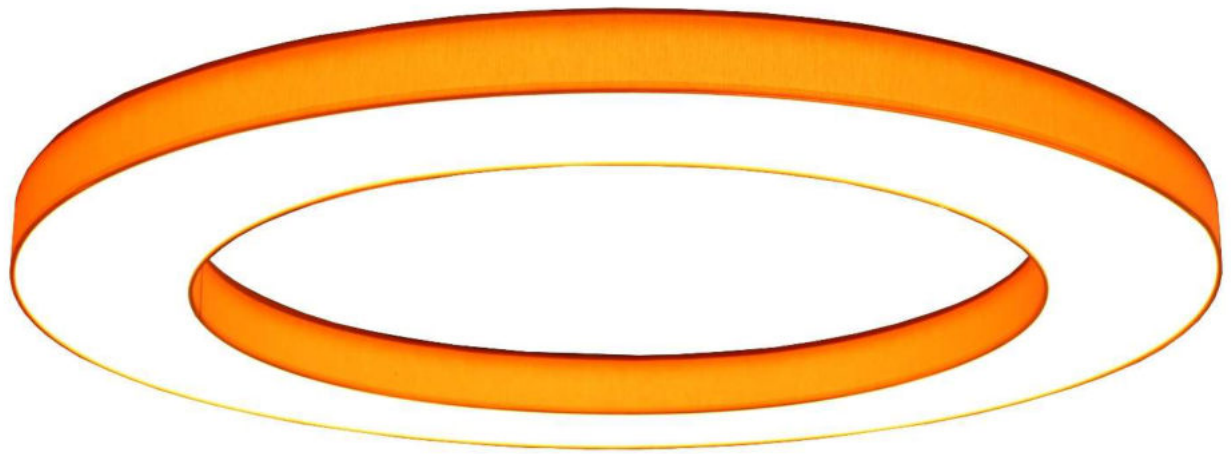

Hängeleuchte / pendant luminaire

Stoff Chintz / fabric chintz

Metall silber / metal silver

Acrylglas satiniert ( S ), Microprismen ( M ) / acryl  
frosted, microprismatic

Leuchtmittel / lamp:

LED 66W / 8300lm 30K / 40K // 230V

DIM... DALI dimmbar/ DALI dimmable

DIMT... tunable white

IP 40 / CRI >90 / L80B10

CRI > 95 Anfrage / request

Artikelnummer / reference no. / article:

40.0CIRCLE. F...



LED Driver

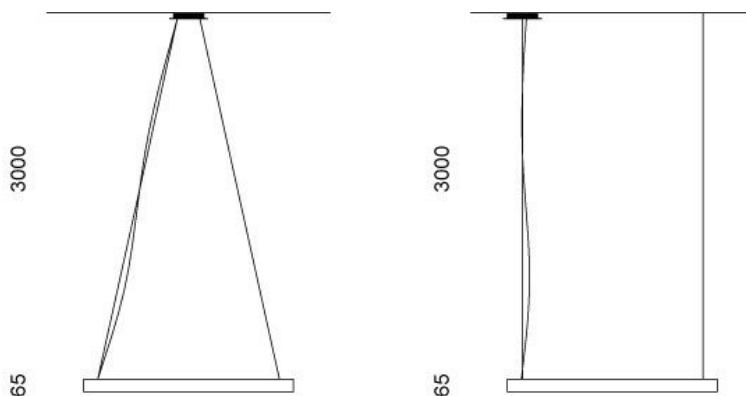

direct light ( D )

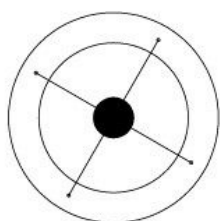

—ø1112—

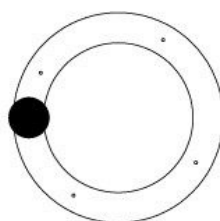

—ø1112—

Choose your color







# CIRCLE NARROW



Hängeleuchte / pendant luminaire

Stoff Chintz / fabric chintz

Metall silber / metal silver

Acrylglas satiniert ( S ), Microprismen ( M ) / acryl frosted, microprismatic

Leuchtmittel / lamp:

400mm LED 26W / 3000lm 27K / 30K / 40K / 50K // 230V

600mm LED 44W / 4800lm 27K / 30K / 40K / 50K // 230V

900mm LED 72W / 8600lm 27K / 30K / 40K / 50K // 230V

1200mm LED 90W / 10125lm 27K / 30K / 40K / 50K // 230V

1500mm LED 120W / 13500lm 27K / 30K / 40K / 50K // 230V

DIM... DALI dimmbar/ DALI dimmable

DIMT... tunable white

IP 40 / CRI >90 / L80B10

CRI > 95 Anfrage / request

Artikelnummer / reference no. / article:

40.0CIRCLE N 400...

40.0CIRCLE N 600...

40.0CIRCLE N 900...

40.0CIRCLE N 1200...

40.0CIRCLE N 1500...

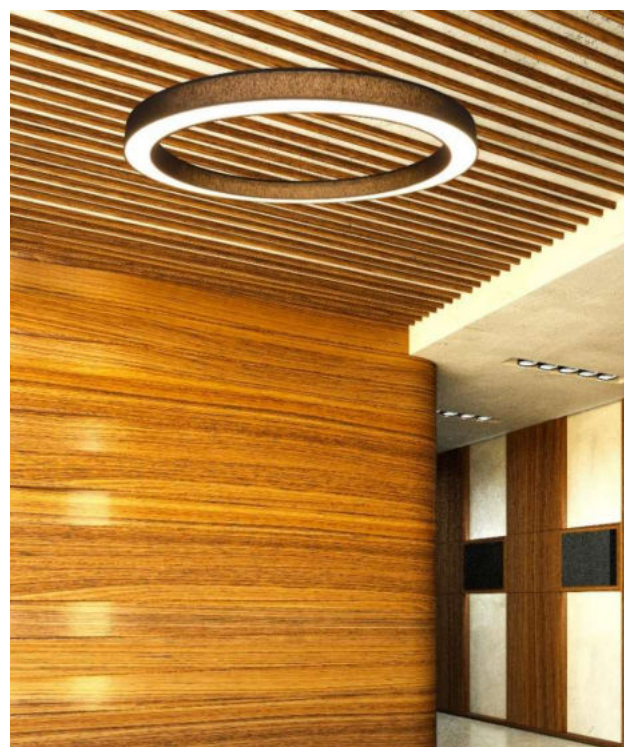

LED Driver

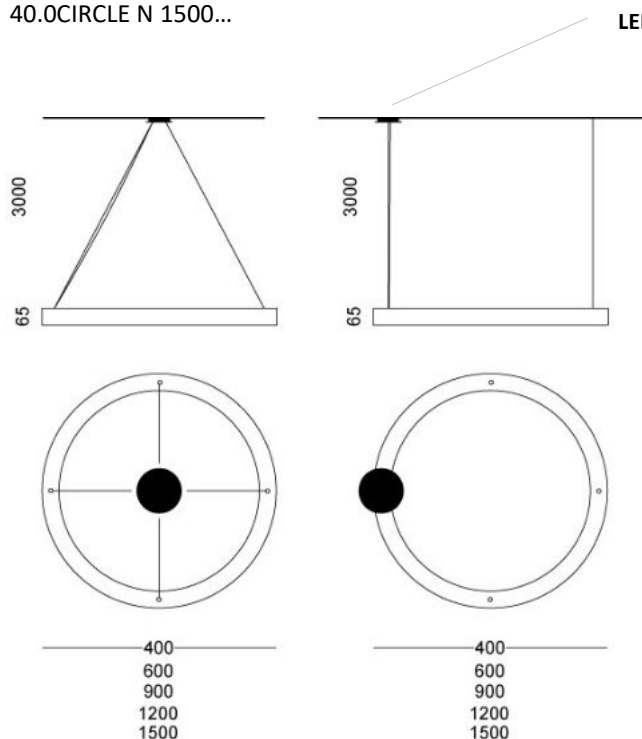

direct light ( D )



Choose your color





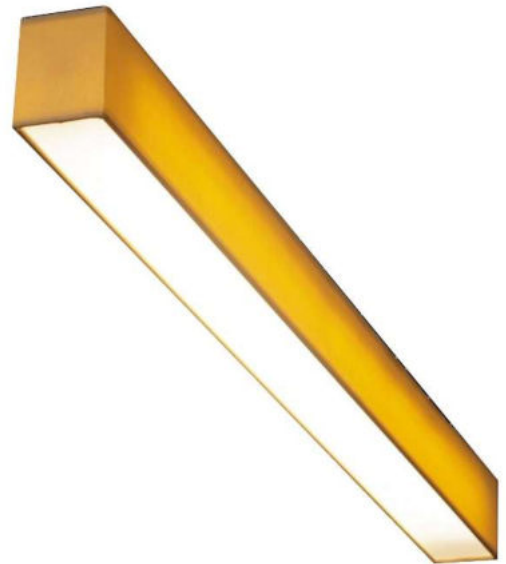

**Hängeleuchte /** pendant luminaire  
**Deckenleuchte /** ceiling luminaire

**Stoff Chintz /** fabric chintz  
**Metall silber /** metal silver

**Acrylglas satiniert ( S ), Microprismen ( M ) /** acryl frosted, microprismatic

**Leuchtmittel /** lamp:  
**1200mm LED 32W / 4100lm 27K / 30K / 40K / 50K // 230V**  
**1500mm LED 42W / 5200lm 27K / 30K / 40K / 50K // 230V**

**DIM... DALI dimmbar/ DALI dimmable**  
**DIMTR...TRIAC dimmbar / TRIAC dimmable**  
 ( 1200mm )  
**DIMT... tunable white**  
**IP 40 / CRI >90 / L80B10**  
**CRI > 95 Anfrage / request**

**Artikelnummer /** reference no. / article:  
 30/40.OLINE. 1200...  
 30/40.OLINE. 1500...

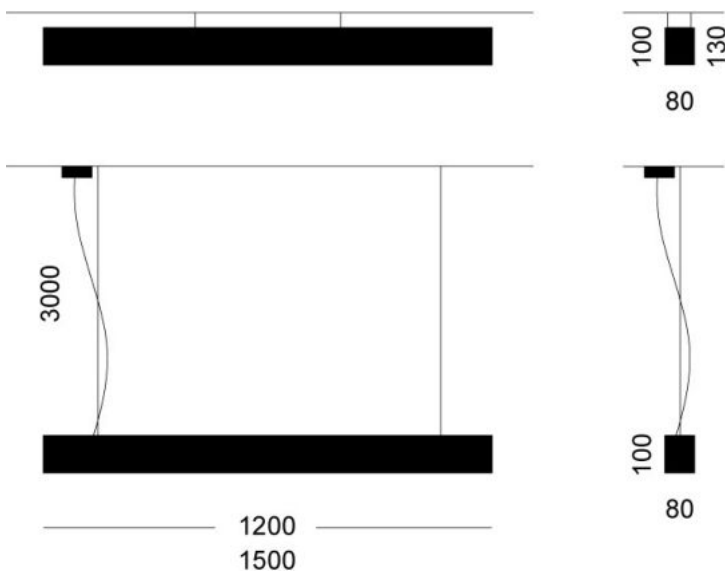

direct light ( D )



Choose your color





**Wandleuchte / wall luminaire**

**Stoff Chintz / fabric chintz**

**Metall silber / metal silver**

**Leuchtmittel / lamp:**

QUADRA LED 4W / 600lm 27K / 30K / 40K / 50K // 230V

QUADRA L LED 4W+ LED 3W // 230V / 600lm x 250lm 27K / 30K / 40K / 50K // 230V

**DIM... DALI dimmbar / DALI dimmable**

**DIMTR... TRIAC dimmbar / TRIAC dimmable**

**DIMT... tunable white**

**IP 20 / CRI >90 / L80B10**

**CRI > 95 Anfrage / request**

**Artikelnummer / reference no. / article:**

10.0QUADRA. ...

10.0QUADRA L. ...



QUADRA



QUADRA L

**Choose your color**



## BRIC BIG

**Wandleuchte /** wall luminaire

**Stoff Chintz /** fabric chintz

**Metall silber /** metal silver

**Leuchtmittel /** lamp:

LED 8W / 1200lm 2700K / 3000K / 4000K // 230V

**DIM...** DALI dimmbar/ DALI dimmable

**DIMTR...** TRIAC dimmbar / TRIAC dimmable

**DIMT...** tunable white

IP 20 / CRI >90 / L80B10

CRI > 95 Anfrage / request

**Artikelnummer /** reference no. / article:

10.0BRIC B ...

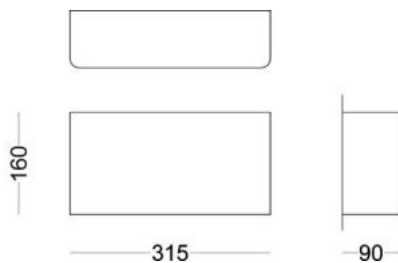

direct / indirect light ( D / I )



Choose your color



## BRIC SMALL

**Wandleuchte /** wall luminaire

**Stoff Chintz /** fabric chintz

**Metall silber /** metal silver

**Leuchtmittel /** lamp:

LED 8W / 1200lm 27K / 30K / 40K / 50K // 230V

**DIM...** DALI dimmbar/ DALI dimmable

**DIMTR...** TRIAC dimmbar / TRIAC dimmable

**DIMT...** tunable white

IP 20 / CRI >90 / L80B10

CRI > 95 Anfrage / request

**Artikelnummer /** reference no. / article:

10.0BRIC S ...

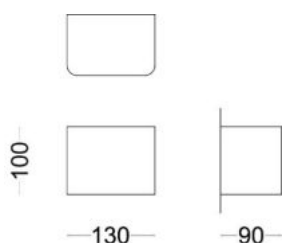

direct / indirect light ( D / I )



Choose your color





**9620 Hermagor**

**Siedlerweg 18**

**AUSTRIA**

**PRODUKTION:**

**Kühwegboden 26**

**Telefon +43(0) 4282-4447**

**Fax +43 (0) 4282-25207**

**e-mail: [office@wegelicht.com](mailto:office@wegelicht.com)**

**[www.wegelicht.com](http://www.wegelicht.com)**

**WEGE-LICHT**

**MADE IN AUSTRIA**

The logo consists of a stylized red and white graphic element resembling a mountain range or a series of parallel lines, positioned to the left of the text 'MADE IN AUSTRIA'. The word 'AUSTRIA' is written vertically in small letters below the graphic.