

Hypertherm[®]

Powermax45 XP[®]

Plasma Arc Cutting System



Operator Manual

809240 | Revision 1 | English

Register your new Hypertherm system

Register your product online at www.hypertherm.com/registration for easier technical and warranty support. You can also receive updates on new Hypertherm products and a free gift as a token of our appreciation.

For your records

Serial number: _____

Purchase date: _____

Distributor: _____

Maintenance notes:

Powermax, Duramax, FastConnect, Smart Sense, HyAccess, CopperPLUS, and Hypertherm are trademarks of Hypertherm Inc. and may be registered in the United States and other countries. All other trademarks are the property of their respective holders.

One of Hypertherm's long-standing core values is a focus on minimizing our impact on the environment. Doing so is critical to our, and our customers', success. We are always striving to become better environmental stewards; it is a process we care deeply about.

Powermax45 XP

Operator Manual

809240
Revision 1

English
Original instructions

September 2016

Hypertherm Inc.
Hanover, NH 03755 USA
www.hypertherm.com

Hypertherm Inc.

Etna Road, P.O. Box 5010
Hanover, NH 03755 USA
603-643-3441 Tel (Main Office)
603-643-5352 Fax (All Departments)
info@hypertherm.com (Main Office Email)

800-643-9878 Tel (Technical Service)

technical.service@hypertherm.com (Technical Service Email)

800-737-2978 Tel (Customer Service)

customer.service@hypertherm.com (Customer Service Email)

866-643-7711 Tel (Return Materials Authorization)**877-371-2876 Fax (Return Materials Authorization)**

return.materials@hypertherm.com (RMA email)

Hypertherm México, S.A. de C.V.

Avenida Toluca No. 444, Anexo 1,
Colonia Olivar de los Padres
Delegación Álvaro Obregón
México, D.F. C.P. 01780
52 55 5681 8109 Tel
52 55 5683 2127 Fax
Soporte.Tecnico@hypertherm.com (Technical Service Email)

Hypertherm Plasmatechnik GmbH

Sophie-Scholl-Platz 5
63452 Hanau
Germany

00 800 33 24 97 37 Tel
00 800 49 73 73 29 Fax

31 (0) 165 596900 Tel (Technical Service)**00 800 4973 7843 Tel (Technical Service)**

technicalservice.emea@hypertherm.com (Technical Service Email)

Hypertherm (Singapore) Pte Ltd.

82 Genting Lane
Media Centre
Annexe Block #A01-01
Singapore 349567, Republic of Singapore
65 6841 2489 Tel
65 6841 2490 Fax
Marketing.asia@hypertherm.com (Marketing Email)
TechSupportAPAC@hypertherm.com (Technical Service Email)

Hypertherm Japan Ltd.

Level 9, Edobori Center Building
2-1-1 Edobori, Nishi-ku
Osaka 550-0002 Japan
81 6 6225 1183 Tel
81 6 6225 1184 Fax
HTJapan.info@hypertherm.com (Main Office Email)
TechSupportAPAC@hypertherm.com (Technical Service Email)

Hypertherm Europe B.V.

Vaartveld 9, 4704 SE
Roosendaal, Nederland
31 165 596907 Tel
31 165 596901 Fax
31 165 596908 Tel (Marketing)
31 (0) 165 596900 Tel (Technical Service)
00 800 4973 7843 Tel (Technical Service)
technicalservice.emea@hypertherm.com
(Technical Service Email)

Hypertherm (Shanghai) Trading Co., Ltd.

B301, 495 ShangZhong Road
Shanghai, 200231
PR China
86-21-80231122 Tel
86-21-80231120 Fax
86-21-80231128 Tel (Technical Service)
techsupport.china@hypertherm.com
(Technical Service Email)

South America & Central America: Hypertherm Brasil Ltda.

Rua Bras Cubas, 231 – Jardim Maia
Guarulhos, SP – Brasil
CEP 07115-030
55 11 2409 2636 Tel
tecnico.sa@hypertherm.com (Technical Service Email)

Hypertherm Korea Branch

#3904. APEC-ro 17. Heaundae-gu. Busan.
Korea 48060
82 (0)51 747 0358 Tel
82 (0)51 701 0358 Fax
Marketing.korea@hypertherm.com (Marketing Email)
TechSupportAPAC@hypertherm.com
(Technical Service Email)

Hypertherm Pty Limited

GPO Box 4836
Sydney NSW 2001, Australia
61 (0) 437 606 995 Tel
61 7 3219 9010 Fax
au.sales@Hypertherm.com (Main Office Email)
TechSupportAPAC@hypertherm.com
(Technical Service Email)

Hypertherm (India) Thermal Cutting Pvt. Ltd

A-18 / B-1 Extension,
Mohan Co-Operative Industrial Estate,
Mathura Road, New Delhi 110044, India
91-11-40521201/ 2/ 3 Tel
91-11 40521204 Fax
HTIndia.info@hypertherm.com (Main Office Email)
TechSupportAPAC@hypertherm.com
(Technical Service Email)

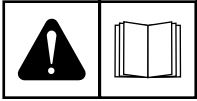

ENGLISH

WARNING! Before operating any Hypertherm equipment, read the safety instructions in your product's manual and in the *Safety and Compliance Manual* (80669C). Failure to follow safety instructions can result in personal injury or in damage to equipment.

Copies of the manuals may accompany the product in electronic and printed formats. You can also obtain copies of the manuals, in all languages available for each manual, from the "Documents library" at www.hypertherm.com.

DEUTSCH / GERMAN

WARNUNG! Bevor Sie ein Hypertherm-Gerät in Betrieb nehmen, lesen Sie bitte die Sicherheitsanweisungen in Ihrer Bedienungsanleitung sowie im *Handbuch für Sicherheit und Übereinstimmung* (80669C). Das Nichtbefolgen der Sicherheitsanweisungen kann zu Verletzungen von Personen oder Schäden am Gerät führen.

Bedienungsanleitungen und Handbücher können dem Gerät in elektronischer Form oder als Druckversion beiliegen. Alle Handbücher und Anleitungen können in den jeweils verfügbaren Sprachen auch in der „Dokumente-Bibliothek“ unter www.hypertherm.com heruntergeladen werden.

FRANÇAIS / FRENCH

AVERTISSEMENT! Avant d'utiliser tout équipement Hypertherm, lire les consignes de sécurité importantes dans le manuel de votre produit et dans le *Manuel de sécurité et de conformité* (80669C). Le non-respect des consignes de sécurité peut engendrer des blessures physiques ou des dommages à l'équipement.

Des copies de ces manuels peuvent accompagner le produit en format électronique et papier. Vous pouvez également obtenir des copies de chaque manuel dans toutes les langues disponibles à partir de la « Bibliothèque de documents » sur www.hypertherm.com.

ESPAÑOL / SPANISH

¡ADVERTENCIA! Antes de operar cualquier equipo Hypertherm, leer las instrucciones de seguridad del manual de su producto y del *Manual de Seguridad y Cumplimiento* (80669C). No cumplir las instrucciones de seguridad podría dar lugar a lesiones personales o daño a los equipos.

Pueden venir copias de los manuales en formato electrónico e impreso junto con el producto. También se pueden obtener copias de los manuales, en todos los idiomas disponibles para cada manual, de la "Biblioteca de documentos" en www.hypertherm.com.

ITALIANO / ITALIAN

AVVERTENZA! Prima di usare un'attrezzatura Hypertherm, leggere le istruzioni sulla sicurezza nel manuale del prodotto e nel *Manuale sulla sicurezza e la conformità* (80669C). Il mancato rispetto delle istruzioni sulla sicurezza può causare lesioni personali o danni all'attrezzatura.

Il prodotto può essere accompagnato da copie elettroniche e cartacee del manuale. È anche possibile ottenere copie del manuale, in tutte le lingue disponibili per ogni manuale, dall'"Archivio documenti" all'indirizzo www.hypertherm.com.

NEDERLANDS / DUTCH

WAARSCHUWING! Lees voordat u Hypertherm-apparatuur gebruikt de veiligheidsinstructies in de producthandleiding en in de *Veiligheids- en nalevingshandleiding* (80669C). Het niet volgen van de veiligheidsinstructies kan resulteren in persoonlijk letsel of schade aan apparatuur.

De handleidingen kunnen in elektronische en gedrukte vorm met het product worden meegeleverd. De handleidingen, elke handleiding beschikbaar in alle talen, zijn ook verkrijgbaar via de "Documentenbibliotheek" op www.hypertherm.com.

DANSK / DANISH

ADVARSEL! Inden Hypertherm udstyr tages i brug skal sikkerhedsinstruktionerne i produktets manual og i *Manual om sikkerhed og overholdelse af krav* (80669C), gennelæses. Følges sikkerhedsvejledningen ikke kan det resultere i personskade eller beskadigelse af udstyret.

Kopier af manualerne kan ledsage produktet i elektroniske og trykte formater. Du kan også få kopier af manualer, på alle sprog der er til rådighed for hver manuel, fra "Dokumentbiblioteket" på www.hypertherm.com.

PORTUGUÊS / PORTUGUESE

AVERTÊNCIA! Antes de operar qualquer equipamento Hypertherm, leia as instruções de segurança no manual do seu produto e no *Manual de Segurança e de Conformidade* (80669C). Não seguir as instruções de segurança pode resultar em lesões corporais ou danos ao equipamento.

Cópias dos manuais podem acompanhar os produtos nos formatos eletrônico e impresso. Também é possível obter cópias dos manuais em todos os idiomas disponíveis para cada manual na "Biblioteca de documentos" em www.hypertherm.com.

日本語 / JAPANESE

警告! Hypertherm 機器を操作する前に、安全に関する重要な情報について、この製品説明書にある安全情報、および製品に同梱されている別冊の「安全とコンプライアンスマニュアル」(80669C)をお読みください。安全情報に従わないと怪我や装置の損傷を招くことがあります。

説明書のコピーは、電子フォーマット、または印刷物として製品に同梱されています。各説明書は、www.hypertherm.com の「ドキュメントライブラリ」から各言語で入手できます。

简体中文 / CHINESE (SIMPLIFIED)

警告! 在操作任何海宝设备之前, 请阅读产品手册和《安全法规遵守手册》(80669C) 中的安全操作说明。若未能遵循安全操作说明, 可能会造成人员受伤或设备损坏。

随产品提供的手册可能提供电子版和印刷版两种格式。您也可从 "Documents library" (文档资料库) 中获取每本手册所有可用语言的副本, 网址为 www.hypertherm.com。

NORSK / NORWEGIAN

ADVARSEL! Før du bruker noe Hypertherm-utstyr, må du lese sikkerhetsinstruksjonene i produktets håndbok og i *Håndboken om sikkerhet og samsvar* (80669C). Unnlattelse av å følge sikkerhetsinstruksjoner kan føre til personskade eller skade på utstyr.

Eksemplarer av håndbøkene kan medfølge produktet i elektroniske og trykte utgaver. Du kan også få eksemplarer av håndbøkene i alle tilgjengelige språk for hver håndbok fra dokumentbiblioteket på www.hypertherm.com.

SVENSKA / SWEDISH

VARNING! Läs häftet *säkerhetsinformationen i din produkts säkerhets- och efterlevnadsmanual* (80669C) för viktig säkerhetsinformation innan du använder eller underhåller Hypertherm-utrustning. Underlåtenhet att följa dessa säkerhetsinstruktioner kan resultera i personskador eller skador på utrustningen.

Kopior av manualen kan medfölja produkten i elektronisk och tryckform. Du hittar även kopior av manualerna i alla tillgängliga språk i dokumentbiblioteket (Documents library) på www.hypertherm.com.

한국어 / KOREAN

경고! Hypertherm 장비를 사용하기 전에 제품 설명서와 안전 및 규정 준수 설명서 (80669C)에 나와 있는 안전 지침을 읽으십시오. 안전 지침을 준수하지 않으면 신체 부상이나 장비 손상을 초래할 수 있습니다.

전자 형식과 인쇄된 형식으로 설명서 사본이 제품과 함께 제공될 수 있습니다. www.hypertherm.com 의 'Documents library (문서 라이브러리)' 에서도 모든 언어로 이용할 수 있는 설명서 사본을 얻을 수 있습니다.

ČESKY / CZECH

VAROVÁNÍ! Před uvedením jakéhokoliv zařízení Hypertherm do provozu si přečtěte bezpečnostní pokyny v příručce k produktu a v *Manuálu pro bezpečnost a dodržování předpisů* (80669C). Nedodržování bezpečnostních pokynů může mít za následek zranění osob nebo poškození majetku.

Kopie příruček a manuálů mohou být součástí dodávky produktu, a to v elektronické i tištěné formě. Kopie příruček a manuálů ve všech jazykových verzích, v nichž byly dané příručky a manuály vytvořeny, naleznete v „Knihovně dokumentů“ na webových stránkách www.hypertherm.com.

POLSKI / POLISH

OSTRZEŻENIE! Przed rozpoczęciem obsługi jakiegokolwiek systemu firmy Hypertherm należy się zapoznać z instrukcjami bezpieczeństwa zamieszczonymi w podręczniku produktu oraz w *Podręczniku bezpieczeństwa i zgodności* (80669C). Nieprzestrzeganie instrukcji bezpieczeństwa może skutkować obrażeniami ciała i uszkodzeniem sprzętu.

Do produktu mogą być dołączone kopie podręczników w formie elektronicznej i drukowanej. Kopie podręczników, w każdym udostępnionym języku, można również znaleźć w „Bibliotece dokumentów” pod adresem www.hypertherm.com.

РУССКИЙ / RUSSIAN

БЕРЕГИСЬ! Перед работой с любым оборудованием Hypertherm ознакомьтесь с инструкциями по безопасности, представленными в руководстве, которое поставляется вместе с продуктом, а также в *Руководстве по безопасности и соответствию* (80669J). Невыполнение инструкций по безопасности может привести к телесным повреждениям или повреждению оборудования.

Копии руководств, которые поставляются вместе с продуктом, могут быть представлены в электронном и бумажном виде. Копии руководств на всех языках, на которые переведено то или иное руководство, можно также загрузить в разделе «Библиотека документов» на веб-сайте www.hypertherm.com.

SUOMI / FINNISH

VAROITUS! Ennen minkään Hypertherm-laitteen käyttöä lue tuotteen käyttöoppaassa olevat turvallisuusohjeet ja *turvallisuus- ja vaatimustenmukaisuusohje* (80669C). Turvallisuusohjeiden laiminlyönti voi aiheuttaa henkilökohtaisen loukkaantumisen tai laitevahingon.

Käyttöoppaiden kopiot voivat olla tuotteen mukana elektronisessa ja tulostetussa muodossa. Voit saada käyttöoppaiden kopiot kaikilla kielillä ”latauskirjastosta”, joka on osoitteessa www.hypertherm.com.

БЪЛГАРСКИ / BULGARIAN

ПРЕДУПРЕЖДЕНИЕ! Преди да работите с което и да е оборудване Hypertherm, прочетете инструкциите за безопасност в ръководството на вашия продукт и „Инструкция за безопасност и съответствие“ (80669C). Неспазването на инструкциите за безопасност би могло да доведе до телесно нараняване или до повреда на оборудването.

Копия на ръководствата може да придружават продукта в електронен и в печатен формат. Можете да получите копия на ръководствата, предлагани на всички езици, от „Documents library“ (Библиотека за документи) на адрес www.hypertherm.com.

ROMÂNĂ / ROMANIAN

AVERTIZARE! Înainte de utilizarea oricărui echipament Hypertherm, citiți instrucțiunile de siguranță din cadrul manualului produsului și din cadrul *Manualului de siguranță și conformitate* (80669C). Nerespectarea instrucțiilor de siguranță pot rezulta în vătămare personală sau în avarierea echipamentului.

Produsul poate fi însoțit de copii ale manualului în format tipărit și electronic. De asemenea, dumneavoastră puteți obține copii ale manualelor, în toate limbile disponibile pentru fiecare manual, din cadrul secțiunii „Biblioteca documente” afiată pe site-ul www.hypertherm.com.

TÜRKÇE / TURKISH

UYARI! Bir Hypertherm ekipmanını çalıştırmadan önce, ürün kullanım kılavuzunda ve *Güvenlik ve Uyumluluk Kılavuzu'nda* (80669C) yer alan güvenlik talimatlarını okuyun. Güvenlik talimatlarına uyulmaması durumunda kişisel yaralanmalar veya ekipman hasarı meydana gelebilir.

Kılavuzların kopyaları, elektronik ve basılı formatta ürünle birlikte verilebilir. Her biri tüm dillerde yayınlanan kılavuzların kopyalarını www.hypertherm.com adresindeki “Documents library” (Dosyalar kitaplığı) başlığından da elde edebilirsiniz.

MAGYAR / HUNGARIAN

VIGYÁZAT! Mielőtt bármilyen Hypertherm berendezést üzemeltetne, olvassa el a biztonsági információkat a termék kézikönyvében és a *Biztonsági és szabálykövetési kézikönyvben* (80669C). A biztonsági utasítások betartásának elmulasztása személyi sérüléshez vagy a berendezés károsodásához vezethet.

A termékhez a kézikönyv példányai elektronikus és nyomtatott formában is mellékelve lehetnek. A kézikönyvek példányai (minden nyelven) a www.hypertherm.com weboldalon a „Documents library” (Dokumentum könyvtár) részben is beszerezhető.

ΕΛΛΗΝΙΚΑ / GREEK

ΠΡΟΕΙΔΟΠΟΙΗΣΗ! Πριν θέσετε σε λειτουργία οποιοδήποτε εξοπλισμό της Hypertherm, διαβάστε τις οδηγίες ασφαλείας στο εγχειρίδιο του προϊόντος και στο *Εγχειρίδιο ασφαλείας και συμμόρφωσης* (80669C). Η μη τήρηση των οδηγιών ασφαλείας μπορεί να επιφέρει σωματική βλάβη ή ζημία στον εξοπλισμό.

Αντίγραφα των εγχειριδίων μπορεί να συνοδεύουν το προϊόν σε ηλεκτρονική και έντυπη μορφή. Μπορείτε, επίσης, να λάβετε αντίγραφα των εγχειριδίων σε όλες τις γλώσσες που διατίθενται για κάθε εγχειρίδιο από την ψηφιακή βιβλιοθήκη εγγράφων (Documents library) στη διαδικτυακή τοποθεσία www.hypertherm.com.

繁體中文 / CHINESE (TRADITIONAL)

警告！在操作任何 Hypertherm 設備前，請閱讀您產品手冊和《安全和法務遵從手冊》(80669C) 內的安全指示。不遵守安全指示可能會導致人身傷害或設備損壞。

手冊複本可能以電子和印刷格式隨附產品提供。您也可以從 www.hypertherm.com 的「文檔資料庫」內獲取所有手冊的多語種複本。

SLOVENŠČINA / SLOVENIAN

OPOZORILO! Pred uporabo katerekoli Hyperthermove opreme preberite varnostna navodila v priročniku vašega izdelka ter v *Priročniku za varnost in skladnost* (80669C). Neupoštevanje navodil za uporabo lahko povzroči telesne poškodbe ali materialno škodo.

Izdelku so lahko priloženi izvodi priročnikov v elektronski ali tiskani obliki. Izvode priročnikov v vseh razpoložljivih jezikih si lahko prenesete tudi iz knjižnice dokumentov “Documents library” na naslovu www.hypertherm.com.

SRPSKI / SERBIAN

UPOZORENJE! Pre rukovanja bilo kojom Hyperthermovom opremom pročitajte uputstva o bezbednosti u svom priručniku za proizvod i u *Priručniku o bezbednosti i usaglašenosti* (80669C). Oglašavanje o praćenje uputstava o bezbednosti može da ima za posledicu ličnu povredu ili oštećenje opreme.

Može se dogoditi da kopije priručnika prate proizvod u elektronskom i štampanom formatu. Takođe možete da pronađete kopije priručnika, na svim jezicima koji su dostupni za svaki od priručnika, u “Biblioteci dokumenata” (“Documents library”) na www.hypertherm.com.

SLOVENČINA / SLOVAK

VÝSTRAHA! Pred použitím akéhokoľvek zariadenia od spoločnosti Hypertherm si prečítajte bezpečnostné pokyny v návode na obsluhu vášho zariadenia a v *Manuáli o bezpečnosti a súlade s normami* (80669C). V prípade nedodržania bezpečnostných pokynov môže dôjsť k ujme na zdraví alebo poškodeniu zariadenia.

Kópia návodu, ktorá je dodávaná s produktom, môže mať elektronickú alebo tlačенú podobu. Kópie návodov, vo všetkých dostupných jazykoch, sú k dispozícii aj v sekcii z „knihnice Dokumenty“ na www.hypertherm.com.

Contents

Electromagnetic Compatibility (EMC)	SC-15
Introduction.....	SC-15
Installation and use	SC-15
Assessment of area	SC-15
Methods of reducing emissions.....	SC-15
Mains supply.....	SC-15
Maintenance of cutting equipment.....	SC-15
Cutting cables.....	SC-15
Equipotential bonding	SC-15
Earthing of the workpiece	SC-16
Screening and shielding.....	SC-16
Warranty	SC-17
Attention	SC-17
General	SC-17
Patent indemnity.....	SC-17
Limitation of liability.....	SC-17
National and local codes	SC-17
Liability cap	SC-18
Insurance.....	SC-18
Transfer of rights	SC-18

Waterjet product warranty coverage	SC-18
Product	SC-18
Parts coverage	SC-18
1 Installation and Setup.....	19
System contents.....	20
What to do if components are missing or damaged.....	21
Hypertherm plasma power supply ratings.....	21
Cutting specifications	22
Recommended cut capacity – handheld.....	22
Pierce capacity	22
Maximum cut speeds (mild steel).....	23
Gouge capacity	23
Noise levels.....	23
Position the plasma power supply	24
Power supply dimensions and weight.....	26
Work lead weights	26
Connect to electrical power	27
Install a line-disconnect switch.....	27
Requirements for grounding.....	28
The system's rated output (cutting power)	28
Voltage configurations	28
CSA/CE/CCC 200 V – 240 V (1-phase)	29
CSA 208 V (1-phase).....	29
CCC 220 V (1-phase).....	29
CE 230 V (1-phase).....	29
CCC 380 V (3-phase).....	30
CE 400 V (3-phase).....	30
CSA 480 V (3-phase).....	30
Decrease output current and arc stretch for lower rated electrical service	31
Example: 230 V input on 20 A electrical service.....	31
Prepare the power cord.....	32
CSA systems	32
1-phase (200 V – 240 V).....	32
3-phase (480 V).....	32
CE/CCC systems	32
1-phase (200 V – 240 V).....	32
3-phase (380 V / 400 V).....	32
Extension cord recommendations	33
Generator recommendations.....	33

Connect the gas supply	34
Gas supply source.....	35
High-pressure gas cylinders.....	36
Gas flow rates.....	37
Minimum inlet pressure (while gas is flowing).....	37
Cutting.....	37
Maximum control gouging (26 – 45 A).....	38
Precision gouging / Marking (10 – 25 A).....	38
Additional gas filtration.....	39
2 Operation.....	41
Controls and indicators	41
ON (I) / OFF (O) power switch	41
Cutting controls.....	42
Indicator LEDs	43
Disable the torch.....	44
Warning puffs of air.....	45
For hand torches	46
For machine torches.....	46
Operate the plasma system.....	46
Step 1 – Install consumables and activate torch	46
Step 2 – Connect torch lead	48
Step 3 – Connect gas supply.....	49
Step 4 – Connect work lead and work clamp	49
Work lead.....	49
Work clamp	50
Step 5 – Connect electric power and turn ON the system.....	51
Step 6 – Set mode and adjust output current (amperage).....	51
Cutting expanded metal.....	52
Step 7 – Check cut settings and indicator LEDs.....	52
What to expect during and after cutting.....	53
Adjust the gas pressure manually	54
Reset the gas pressure.....	56
Change the gas pressure values between <i>psi</i> and <i>bar</i>	57
Understand duty cycle to prevent overheating.....	58

3	Cut with the Hand Torch.....	59
	Hand torch components, dimensions, weights.....	60
	Components.....	60
	Dimensions	60
	75° hand torch	60
	15° hand torch	60
	Weights.....	61
	Choose the consumables	61
	Shielded drag-cutting consumables.....	62
	FineCut consumables	62
	Specialty consumables.....	62
	HyAccess cutting consumables	62
	CopperPLUS™ electrode	63
	Consumable life.....	63
	Prepare to fire the torch.....	65
	Hand torch cutting guidelines.....	66
	Start a cut from the edge of the workpiece	67
	Pierce a workpiece	68
4	Gouge with the Hand Torch and Machine Torch	71
	Gouging processes.....	71
	Maximum Control gouging.....	72
	Maximum Control gouging consumables (26 – 45 A)	72
	Precision gouging	72
	Precision gouging consumables (10 – 25 A)	72
	Specialty consumables.....	73
	HyAccess gouging consumables.....	73
	How to control the gouge profile	74
	Gouge with the hand torch.....	75
	Remove spot welds	76
	Tips.....	76
	Procedure	77
	Gouge with the machine torch	80
	Typical gouge profiles	81
	Maximum Control gouging consumables (45 A)	81
	Precision gouging consumables (10 A).....	83
	Troubleshooting tips for gouging	84

5	Set Up the Machine Torch	87
	Machine torch components, dimensions, weights	88
	Components.....	88
	Dimensions	88
	Weights	89
	Mount the torch	89
	Remove the gear rack	89
	Disassemble the machine torch.....	90
	Assemble the machine torch	92
	Align the torch.....	94
6	Configure Controls for Mechanized Cutting	95
	Machine torch setup overview	95
	Set up the plasma system and machine torch for mechanized cutting.....	96
	Connect the remote-start pendant	97
	Connect the machine interface cable	98
	External cables that do not use voltage divider board.....	98
	External cables that use voltage divider board.....	99
	Installation of the machine interface cable	100
	Machine interface pinout	100
	Machine interface cable signals.....	101
	Set the 5-position voltage divider	101
	Access raw arc voltage	102
	Connect an optional RS-485 serial interface cable	103
	External serial port cables	104
	Remote mode.....	104
7	Cut with the Machine Torch	105
	Choose the consumables	105
	Mechanized shielded consumables	106
	Mechanized shielded consumables with ohmic retaining cap.....	106
	FineCut shielded consumables with ohmic retaining cap.....	107
	FineCut unshielded consumables	107
	Consumable life.....	107
	Understand and optimize cut quality	108
	Cut or bevel angle.....	108
	Dross.....	109

Pierce a workpiece using the machine torch.....	110
Pierce delay	110
Pierce height	110
Pierce maximum thickness.....	110
Cut stainless steel with F5.....	111
8 Guidelines for Marking	113
Marking consumables (10 – 25 A).....	113
Process gas: air versus argon.....	114
How the system handles postflow for marking	114
Types of marking	115
Marking samples.....	115
Marking, scoring, and dimpling profiles	117
Marking process guidelines.....	118
Cornering guidelines	119
Marking troubleshooting tips	119
Common marking problems and solutions.....	120
9 Cut Charts and Marking Charts	121
Using the cut charts	122
Mild Steel – 45 A – Air – Shielded	124
Stainless Steel – 45 A – Air – Shielded	125
Aluminum – 45 A – Air – Shielded.....	126
Mild Steel – FineCut – Air – Shielded and Unshielded.....	127
Stainless Steel – FineCut – Air – Shielded and Unshielded.....	128
Mild Steel – FineCut Low Speed – Air – Shielded and Unshielded.....	129
Stainless Steel – FineCut Low Speed – Air – Shielded and Unshielded	130
Stainless Steel – 45 A – F5 – Shielded.....	131
Marking and Dimpling – Air – Shielded.....	132
Marking and Dimpling – Argon – Shielded.....	133
10 Troubleshooting Guide	135
Common cutting issues.....	136
Hand cutting issues.....	137
Mechanized cutting issues.....	138
Check the gas pressure	140
Check the gas quality.....	141

Cold restarts and quick restarts	142
Perform a cold restart.....	142
Perform a quick restart.....	142
Fault LEDs and fault codes.....	143
Gas Pressure fault LED	147
Torch Cap fault LED.....	148
Generator considerations.....	149
Run a gas test.....	149
Enter gas test mode	149
While gas test mode is active	150
Exit gas test mode.....	150
11 Routine Maintenance.....	151
Inspect the system and torch.....	151
Every use.....	152
Every consumable change or weekly (whichever is more frequent)	152
Every 3 months	153
Inspect the consumables	154
Replace the air filter bowl and filter element.....	155
12 Replacement Parts and Accessories	159
Plasma supply exterior, front.....	160
Plasma supply exterior, rear	161
Machine interface (CPC) and serial interface upgrade kits	162
External cables for machine interface port and serial port	163
75° hand torch replacement parts	164
15° hand torch replacement parts	165
Machine torch replacement parts.....	166
Accessory parts.....	168
Powermax45 XP Labels	169
Consumable labels and fault codes label.....	169
CSA warning label.....	170
CE/CCC warning label.....	171
Data plate.....	172
Symbols and marks	173
IEC symbols	174

Introduction

Hypertherm's CE-marked equipment is built in compliance with standard EN60974-10. The equipment should be installed and used in accordance with the information below to achieve electromagnetic compatibility.

The limits required by EN60974-10 may not be adequate to completely eliminate interference when the affected equipment is in close proximity or has a high degree of sensitivity. In such cases it may be necessary to use other measures to further reduce interference.

This cutting equipment is designed for use only in an industrial environment.

Installation and use

The user is responsible for installing and using the plasma equipment according to the manufacturer's instructions.

If electromagnetic disturbances are detected then it shall be the responsibility of the user to resolve the situation with the technical assistance of the manufacturer. In some cases this remedial action may be as simple as earthing the cutting circuit, see *Earthing of the workpiece*. In other cases, it could involve constructing an electromagnetic screen enclosing the power source and the work complete with associated input filters. In all cases, electromagnetic disturbances must be reduced to the point where they are no longer troublesome.

Assessment of area

Before installing the equipment, the user shall make an assessment of potential electromagnetic problems in the surrounding area. The following shall be taken into account:

- a. Other supply cables, control cables, signaling and telephone cables; above, below and adjacent to the cutting equipment.
- b. Radio and television transmitters and receivers.
- c. Computer and other control equipment.
- d. Safety critical equipment, for example guarding of industrial equipment.
- e. Health of the people around, for example the use of pacemakers and hearing aids.
- f. Equipment used for calibration or measurement.
- g. Immunity of other equipment in the environment. User shall ensure that other equipment being used in the environment is compatible. This may require additional protection measures.
- h. Time of day that cutting or other activities are to be carried out.

The size of the surrounding area to be considered will depend on the structure of the building and other activities that are taking place. The surrounding area may extend beyond the boundaries of the premises.

Methods of reducing emissions

Mains supply

Cutting equipment must be connected to the mains supply according to the manufacturer's recommendations. If interference occurs, it may be necessary to take additional precautions such as filtering of the mains supply.

Consideration should be given to shielding the supply cable of permanently installed cutting equipment, in metallic conduit or equivalent. Shielding should be electrically continuous throughout its length. The shielding should be connected to the cutting mains supply so that good electrical contact is maintained between the conduit and the cutting power source enclosure.

Maintenance of cutting equipment

The cutting equipment must be routinely maintained according to the manufacturer's recommendations. All access and service doors and covers should be closed and properly fastened when the cutting equipment is in operation. The cutting equipment should not be modified in any way, except as set forth in and in accordance with the manufacturer's written instructions. For example, the spark gaps of arc striking and stabilizing devices should be adjusted and maintained according to the manufacturer's recommendations.

Cutting cables

The cutting cables should be kept as short as possible and should be positioned close together, running at or close to the floor level.

Equipotential bonding

Bonding of all metallic components in the cutting installation and adjacent to it should be considered.

However, metallic components bonded to the workpiece will increase the risk that the operator could receive a shock by touching these metallic components and the electrode (nozzle for laser heads) at the same time.

The operator should be insulated from all such bonded metallic components.

Electromagnetic Compatibility (EMC)

Earthing of the workpiece

Where the workpiece is not bonded to earth for electrical safety, nor connected to earth because of its size and position, for example, ship's hull or building steel work, a connection bonding the workpiece to earth may reduce emissions in some, but not all instances. Care should be taken to prevent the earthing of the workpiece increasing the risk of injury to users, or damage to other electrical equipment. Where necessary, the connection of the workpiece to earth should be made by a direct connection to the workpiece, but in some countries where direct connection is not permitted, the bonding should be achieved by suitable capacitances selected according to national regulations.

Note: The cutting circuit may or may not be earthed for safety reasons. Changing the earthing arrangements should only be authorized by a person who is competent to assess whether the changes will increase the risk of injury, for example, by allowing parallel cutting current return paths which may damage the earth circuits of other equipment. Further guidance is provided in IEC 60974-9, Arc Welding Equipment, Part 9: Installation and Use.

Screening and shielding

Selective screening and shielding of other cables and equipment in the surrounding area may alleviate problems of interference. Screening of the entire plasma cutting installation may be considered for special applications.

Attention

Genuine Hypertherm parts are the factory-recommended replacement parts for your Hypertherm system. Any damage or injury caused by the use of other than genuine Hypertherm parts may not be covered by the Hypertherm warranty, and will constitute misuse of the Hypertherm Product.

You are solely responsible for the safe use of the Product. Hypertherm does not and cannot make any guarantee or warranty regarding the safe use of the product in your environment.

General

Hypertherm Inc. warrants that its Products shall be free from defects in materials and workmanship for the specific periods of time set forth herein and as follows: if Hypertherm is notified of a defect (i) with respect to the plasma power supply within a period of two (2) years from the date of its delivery to you, with the exception of Powermax brand power supplies, which shall be within a period of three (3) years from the date of delivery to you, and (ii) with respect to the torch and leads within a period of one (1) year from its date of delivery to you, with the exception of the HPRXD short torch with integrated lead, which shall be within a period of six (6) months from the date of delivery to you, and with respect to torch lifter assemblies within a period of one (1) year from its date of delivery to you, and with respect to Automation products one (1) year from its date of delivery to you, with the exception of the EDGE Connect CNC, EDGE Connect T CNC, EDGE Connect TC CNC, EDGE Pro CNC, EDGE Pro Ti CNC, MicroEDGE Pro CNC, and ArcGlide THC, which shall be within a period of two (2) years from the date of delivery to you, and (iii) with respect to HyIntensity fiber laser components within a period of two (2) years from the date of its delivery to you, with the exception of laser heads and beam delivery cables, which shall be within a period of one (1) year from its date of delivery to you.

This warranty shall not apply to any Powermax brand power supplies that have been used with phase converters. In addition, Hypertherm does not warranty systems that have been damaged as a result of poor power quality, whether from phase converters or incoming line power. This warranty shall not apply to any product which has been incorrectly installed, modified, or otherwise damaged.

Hypertherm provides repair, replacement or adjustment of the Product as the sole and exclusive remedy, if and only if the warranty set forth herein properly is invoked and applies. Hypertherm, at its sole option, shall repair, replace, or adjust, free of charge, any defective Products covered by this warranty which shall be returned with Hypertherm's prior authorization (which shall not be unreasonably withheld), properly packed, to Hypertherm's place of business in Hanover, New Hampshire, or to an authorized Hypertherm repair facility, all costs, insurance and freight pre paid by the customer. Hypertherm shall not be liable for any repairs, replacement, or adjustments of Products covered by this warranty, except those made pursuant to this paragraph and with Hypertherm's prior written consent.

The warranty set forth above is exclusive and is in lieu of all other warranties, express, implied, statutory, or otherwise with respect to the Products or as to the results which may be obtained therefrom, and all implied warranties or conditions of quality or of merchantability or fitness for a particular purpose or against infringement. The foregoing shall constitute the sole and exclusive remedy for any breach by Hypertherm of its warranty.

Distributors/OEMs may offer different or additional warranties, but Distributors/OEMs are not authorized to give any additional warranty protection to you or make any representation to you purporting to be binding upon Hypertherm.

Patent indemnity

Except only in cases of products not manufactured by Hypertherm or manufactured by a person other than Hypertherm not in strict conformity with Hypertherm's specifications and in cases of designs, processes, formulae, or combinations not developed or purported to be developed by Hypertherm, Hypertherm will have the right to defend or settle, at its own expense, any suit or proceeding brought against you alleging that the use of the Hypertherm product, alone and not in combination with any other product not supplied by Hypertherm, infringes any patent of any third party. You shall notify Hypertherm promptly upon learning of any action or threatened action in connection with any such alleged infringement (and in any event no longer than fourteen (14) days after learning of any action or threat of action), and Hypertherm's obligation to defend shall be conditioned upon Hypertherm's sole control of, and the indemnified party's cooperation and assistance in, the defense of the claim.

Limitation of liability

In no event shall Hypertherm be liable to any person or entity for any incidental, consequential direct, indirect, punitive or exemplary damages (including but not limited to lost profits) regardless of whether such liability is based on breach of contract, tort, strict liability, breach of warranty, failure of essential purpose, or otherwise, and even if advised of the possibility of such damages. Hypertherm shall not be liable for any losses to Distributor based on down time, lost production or lost profits. It is the intention of the Distributor and Hypertherm that this provision be construed by a court as being the broadest limitation of liability consistent with applicable law.

National and local codes

National and local codes governing plumbing and electrical installation shall take precedence over any instructions contained in this manual. In no event shall Hypertherm be liable for injury to persons or property damage by reason of any code violation or poor work practices.

Warranty

Liability cap

In no event shall Hypertherm's liability, if any, whether such liability is based on breach of contract, tort, strict liability, breach of warranties, failure of essential purpose or otherwise, for any claim, action, suit or proceeding (whether in court, arbitration, regulatory proceeding or otherwise) arising out of or relating to the use of the Products exceed in the aggregate the amount paid for the Products that gave rise to such claim.

Insurance

At all times you will have and maintain insurance in such quantities and types, and with coverage sufficient and appropriate to defend and to hold Hypertherm harmless in the event of any cause of action arising from the use of the products.

Transfer of rights

You may transfer any remaining rights you may have hereunder only in connection with the sale of all or substantially all of your assets or capital stock to a successor in interest who agrees to be bound by all of the terms and conditions of this Warranty. Within thirty (30) days before any such transfer occurs, you agree to notify in writing Hypertherm, which reserves the right of approval. Should you fail timely to notify Hypertherm and seek its approval as set forth herein, the Warranty set forth herein shall be null and void and you will have no further recourse against Hypertherm under the Warranty or otherwise.

Waterjet product warranty coverage

Product	Parts coverage
HyPrecision pumps	27 months from the ship date, or 24 months from the date of proven installation, or 4,000 hours, whichever occurs first
PowerDredge abrasive removal system	15 months from the ship date or 12 months from the date of proven installation, whichever occurs first
EcoSift abrasive recycling system	15 months from the ship date or 12 months from the date of proven installation, whichever occurs first
Abrasive metering devices	15 months from the ship date or 12 months from the date of proven installation, whichever occurs first
On/off valve air actuators	15 months from the ship date or 12 months from the date of proven installation, whichever occurs first
Diamond orifices	600 hours of use with the use of a thimble filter and compliance with Hypertherm's water quality requirements

Consumable parts are not covered by this warranty. Consumable parts include, but are not limited to, high-pressure water seals, check valves, cylinders, bleed-down valves, low-pressure seals, high-pressure tubing, low- and high-pressure water filters and abrasive collection bags. All third-party pumps, pump accessories, hoppers, hopper accessories, dryer boxes, dryer box accessories and plumbing accessories are covered by the respective manufacturers' warranties and not covered by this warranty.

1

Installation and Setup

The Powermax45 XP is a portable 45 A plasma cutting system that you can use for many handheld and mechanized cutting and gouging applications. The system's automatic gas and automatic voltage features make it easy to set up and use even if you have limited plasma cutting experience.

With the Powermax45 XP you can:

- Use air or nitrogen to cut electrically conductive metals such as mild steel, stainless steel, and aluminum
- Cut thicknesses up to 16 mm (5/8 inch)
- Pierce thicknesses up to 12 mm (1/2 inch)
- Sever thicknesses up to 29 mm (1-1/8 inch)
- Use 2 different gouging processes for a wide range of gouging applications: Maximum Control gouging (26 A – 45 A) and Precision gouging (10 A – 25 A)
- Mark metal surfaces using air or argon
- Use F5 to cut stainless steel
- Disable the Duramax Lock hand and machine torches without turning OFF the power supply using the torch-disable switch
- Quickly switch between torches using the FastConnect™ system (quick-disconnect)

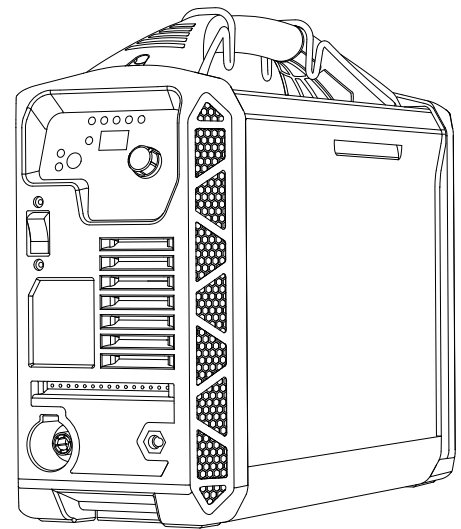

System contents

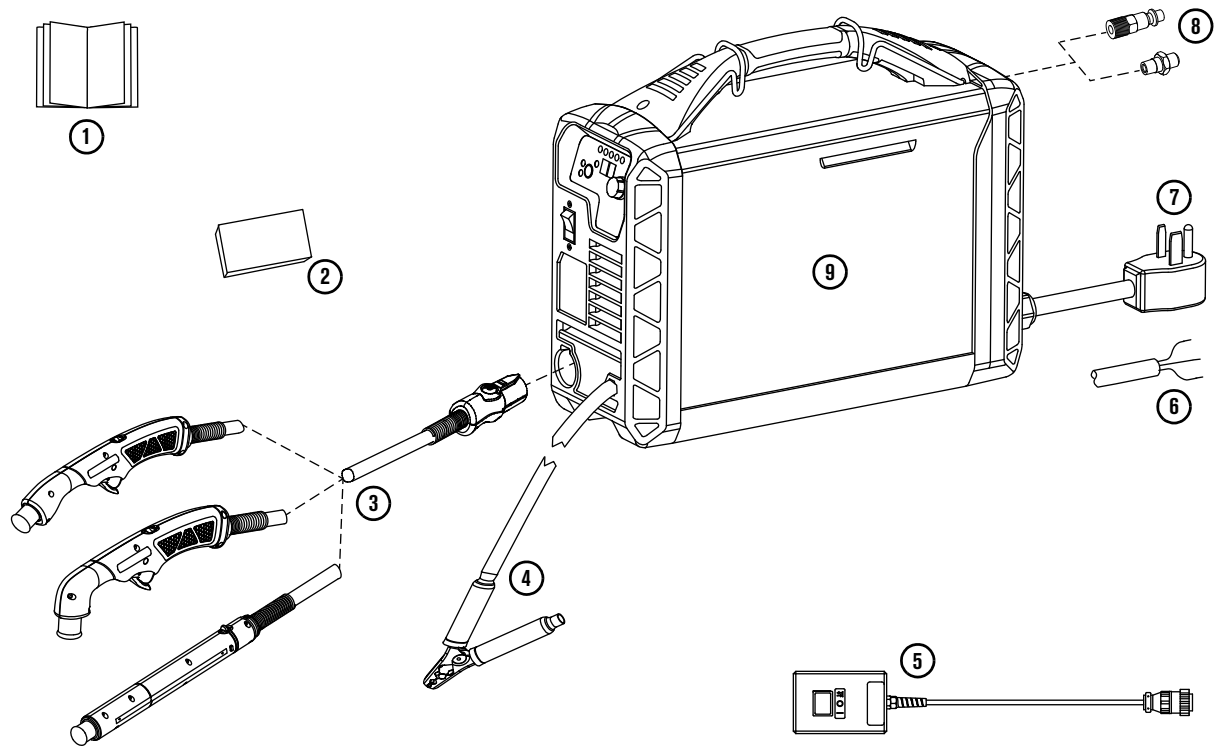

- | | |
|---|---|
| <p>1 Documentation:</p> <ul style="list-style-type: none"> ▪ Operator Manual ▪ Quick Setup Card ▪ Registration card ▪ Safety and Compliance Manual <p>2 Starter consumable kit</p> <p>3 15° or 75° hand torch with lead or machine torch with lead</p> <p>4 Work clamp with work lead</p> | <p>5 Remote-start pendant (optional – mechanized configurations only)</p> <p>6 CE/CCC and 480 V CSA models: power cord with no power plug</p> <p>7 CSA 200 V – 240 V models: power cord with 50 A, 250 V plug (NEMA 6-50P)</p> <p>8 Region-specific gas inlet fitting (may not be preinstalled)</p> <p>9 Plasma power supply</p> |
|---|---|



You can order additional consumables and accessories from any Hypertherm distributor. See *Replacement Parts and Accessories* on page 159.

What to do if components are missing or damaged

- **Claims for damage during shipment**
 - File a claim with the carrier if your system was damaged during shipment.
 - Obtain the system’s model number and serial number, located on the bottom of the plasma power supply.
 - Obtain a copy of the bill of lading from Hypertherm.
- **Claims for missing or damaged merchandise**
 - Contact your Hypertherm distributor if any component is missing or damaged.

If you need additional assistance, call the nearest Hypertherm office listed in the front of this manual.

Hypertherm plasma power supply ratings

Rated open-circuit voltage (U_0)	200 – 240 V, CSA/CE/CCC 400 V, CE/CCC 480 V, CSA	275 VDC 265 VDC 275 VDC		
Output characteristic*	Drooping			
Rated output current (I_2)	10 A – 45 A			
Rated output voltage (U_2)	145 VDC			
Duty cycle at 40°C (104°F) [†]	50% at 45 A (I_2) / 145 VDC (U_2) 60% at 41 A (I_2) / 145 VDC (U_2) 100% at 32 A (I_2) / 145 VDC (U_2)			
Operating temperature	-10°C – 40°C (14°F – 104°F)			
Storage temperature	-25°C – 55° C (-13°F – 131°F)			
Power factor	200 – 240 V, 1-phase, CSA/CE/CCC 400 V, 3-phase, CE/CCC 480 V, 3-phase, CSA	0.99 0.94 0.93		
R_{scc} – Short Circuit Ratio (CE systems only)	U_1 – Volts AC rms, 3-phase 400 V CE	R_{scc} 250		
EMC emissions classification CISPR 11 (CE models only) [‡]	Class A			
Input voltage (U_1) / Input current (I_1) at rated output ($U_{2\text{MAX}}$ $I_{2\text{MAX}}$) (See <i>Voltage configurations</i> on page 28.)	200 – 240 V CSA 230 V CE/CCC ^{**} , ^{††} 400 V CE/CCC ^{**} , ^{‡‡} 480 V CSA	200 – 240 V, 1-phase, 50/60 Hz, 39 – 32 A 230 V, 1-phase, 50/60 Hz, 33 A 400 V, 3-phase, 50/60 Hz, 11 A 480 V, 3-phase, 50/60 Hz, 9.4 A		
Gas type	Air	Nitrogen (N ₂)	F5 ^{***}	Argon ^{†††}

Gas quality	Clean, dry, oil-free per ISO 8573-1 Class 1.2.2	99.95% pure Clean, dry, oil-free	99.98% pure (F5 = 95% nitrogen [N ₂], 5% hydrogen [H])	99.99% pure Clean, dry, oil-free
Recommended gas inlet flow rate/pressure	Cutting		188.8 L/min at 5.9 bar (400 scfh at 85 psi)	
	Maximum control gouging		165.2 L/min at 4.1 bar (350 scfh at 60 psi)	
	Precision gouging, marking		165.2 L/min at 3.8 bar (350 scfh at 55 psi)	

- * Defined as a plot of output voltage versus output current.
- † See the data plate on the bottom of the power supply for more information on duty cycle and for IEC ratings.
- ‡ **WARNING:** This Class A equipment is not intended for use in residential locations where the electrical power is provided by the public low voltage supply system. There may be potential difficulties in delivering electromagnetic compatibility in those locations, due to conducted as well as radiated disturbances.
- ** This product meets the technical requirements of IEC 61000-3-3 and is not subject to conditional connection.
- †† Equipment complies with IEC 61000-3-12.
- ‡‡ Equipment complies with IEC 61000-3-12 provided that the short-circuit power S_{sc} is greater than or equal to 1911 KVA at the interface point between the user's supply and the public system. It is the responsibility of the installer or user of the equipment to ensure, by consultation with the distribution network operator if necessary, that the equipment is connected only to a supply with a short-circuit power S_{sc} greater than or equal to 1911 KVA.
- *** F5 recommended only for cutting stainless steel. See page 111.
- ††† Argon recommended only for marking applications at 10 – 25 A. See page 113.

Cutting specifications

Recommended cut capacity – handheld

Cut speed	Material thickness
500 mm/min (20 inches per minute [in/min])*	16 mm (5/8 inch)
250 mm/min (10 in/min)*	22 mm (7/8 inch)
125 mm/min (5 in/min)* – severance capacity	29 mm (1-1/8 inch)

* Cut capacity speeds are not necessarily maximum speeds. They are the speeds that must be achieved to be rated at that thickness.

Pierce capacity

Torch type	Material thickness
Handheld	12 mm (1/2 inch)
Mechanized with a programmable torch height control	12 mm (1/2 inch)

Maximum cut speeds (mild steel)

Maximum cut speeds are the results of Hypertherm's laboratory testing. Actual cutting speeds may vary based on different cutting applications.

Material thickness	Cut speed
6 mm (1/4 inch)	2286 mm/min (90 in/min)
9 mm (3/8 inch)	1219 mm/min (48 in/min)
12 mm (1/2 inch)	762 mm/min (30 in/min)
16 mm (5/8 inch)	508 mm/min (20 in/min)
19 mm (3/4 inch)	330 mm/min (13 in/min)
25 mm (1 inch)	178 mm/min (7 in/min)

Gouge capacity

Process	Metal type	Output current	Metal removal rate
Maximum Control gouging (26 – 45 A)	Mild steel	45 A	3.4 kg/hour (7.5 pounds/hour)
Precision gouging (10 – 25 A)	Mild steel	10 A	0.2 kg/hour (0.5 pounds/hour)

Noise levels

This plasma system may exceed acceptable noise levels as defined by national and local codes. Always wear proper ear protection when cutting or gouging. Any noise measurements taken depend on the specific environment in which the system is used. Refer to *Noise can damage hearing* in the *Safety and Compliance Manual* (80669C) included with your system.

In addition, you can find an Acoustical Noise Data Sheet for your system at www.hypertherm.com:

1. Click "Documents library" near the bottom of the page.
2. Select a product from the "Product type" menu in the "Search" section of the page.
3. Select "Regulatory" from the "All Categories" menu.
4. Select "Acoustical Noise Data Sheets" from the "All subcategories" menu.

Position the plasma power supply

WARNING



CHANCE OF ELECTRIC SHOCK

Never cut under water or submerge the torch in water. Electric shock can cause serious injury.

WARNING



TOXIC FUMES CAN CAUSE INJURY OR DEATH

Some metals, including stainless steel, may release toxic fumes when cut. Make sure your work site has adequate ventilation to ensure that the air quality level meets all local and national standards and regulations. Refer to the *Safety and Compliance Manual* (80669C) for more information.

- Do not use the system in rain or snow.
- Position the plasma power supply near an appropriate power receptacle. Its power cord is approximately 3.0 m (10 feet).
- Allow at least 0.25 m (10 inches) of space around the power supply for proper ventilation.

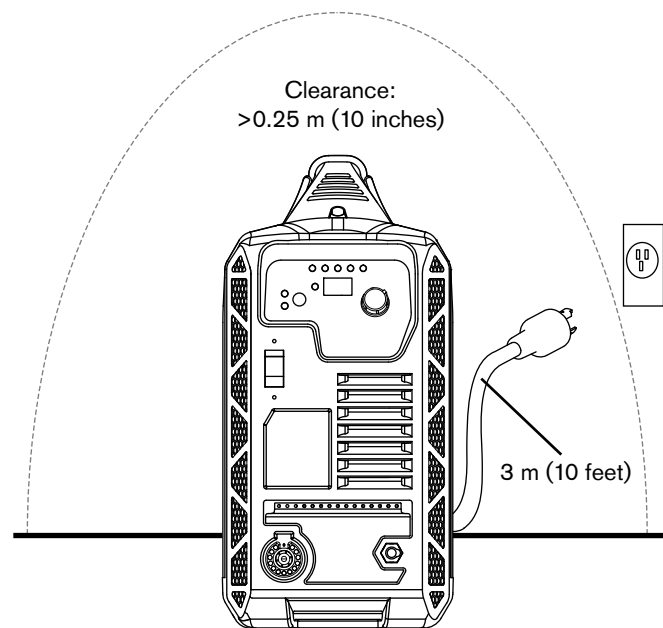

- Place the power supply on a stable, level surface before using. It can tip over if set at an angle greater than 10°.

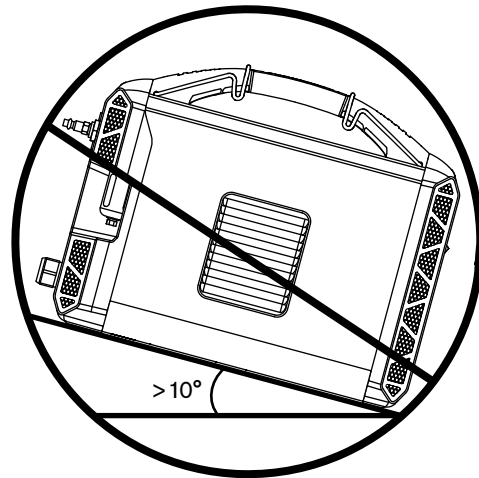

- Do not place the power supply on its side. Doing so can block the louvers on the side of the cover and prevent proper air circulation needed to cool internal components.

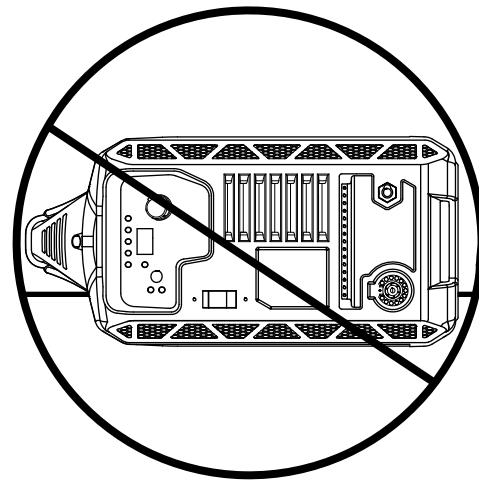

Power supply dimensions and weight

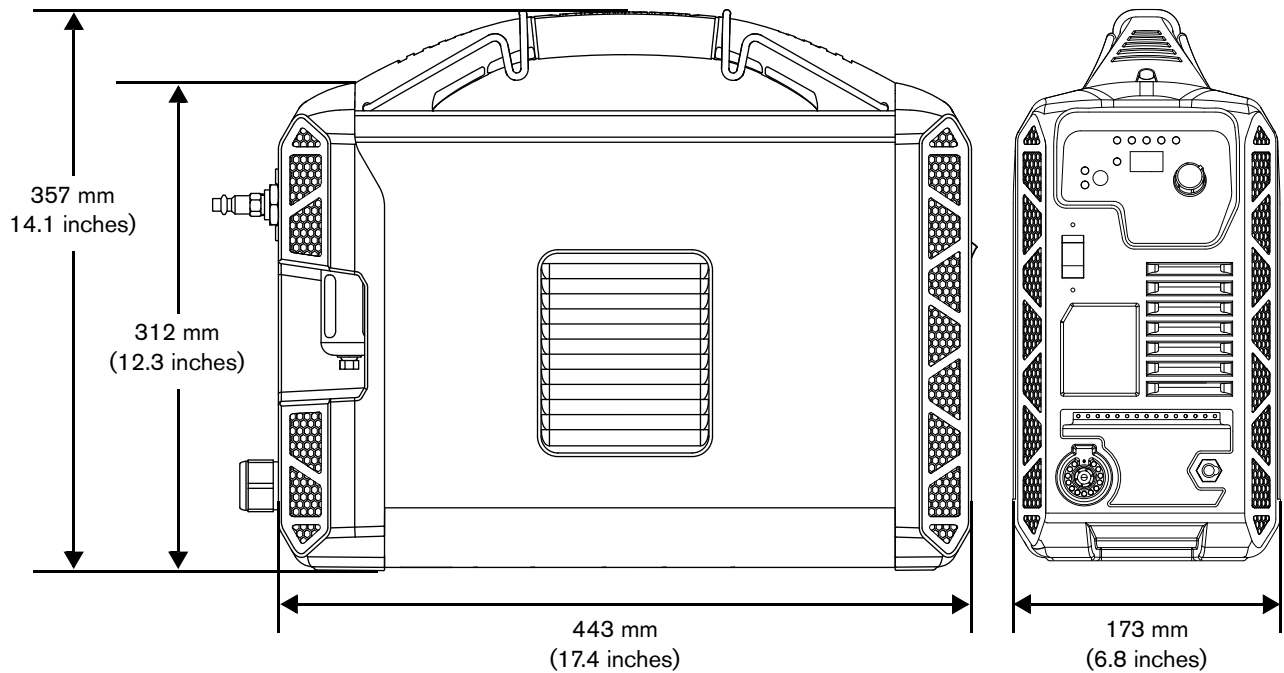

	Power supply with power cord	Power supply (and power cord) with 6.1 m (20 foot) hand torch and 7.6 m (25 foot) work lead
200 – 240 V CSA	12 kg (26 pounds)	15 kg (33 pounds)
230 V CE/CCC	12 kg (27 pounds)	15 kg (33 pounds)
400 V CE/CCC	11 kg (25 pounds)	14 kg (31 pounds)
480 V CSA	11 kg (25 pounds)	14 kg (31 pounds)

Work lead weights

Work lead	Weight
Work clamp with 7.6 m (25 foot) work lead	1.2 kg (2.6 pounds)
Work clamp with 15 m (50 foot) work lead	2.1 kg (4.7 pounds)



For hand torch weights, see page 61. For machine torch weights, see page 89.

Connect to electrical power

Use the Hypertherm input current ratings to determine conductor sizes for power connection and installation instructions. The Hypertherm ratings are designated *HYP* on the data plate on the bottom of the power supply. Use the higher HYP input current value for installation purposes. See page 172 for a sample data plate.

⚠ CAUTION

Protect the circuit with appropriately sized time-delay fuses and a line-disconnect switch.

The maximum output voltage varies based on input voltage and the circuit's amperage. Because the current draw varies during startup, time-delay fuses are recommended. See *Voltage configurations* on page 28. Time-delay fuses can withstand currents up to 10 times the rated value for short periods of time.

Install a line-disconnect switch

- Use a line-disconnect switch for each plasma power supply to allow the operator to turn off the incoming power quickly in an emergency.
- Place the switch so that it is easily accessible to the operator. Installation must be performed by a licensed electrician according to national and local codes.
- The interrupt level of the switch must equal or exceed the continuous rating of the fuses/breakers.
- The switch should also:
 - Isolate the electrical equipment and disconnect all live conductors from the incoming supply voltage when in the OFF position.
 - Have one OFF and one ON position that are clearly marked with **O** (OFF) and **I** (ON).
 - Have an external operating handle that can be locked in the OFF position.
 - Contain a power-operated mechanism that serves as an emergency stop.
 - Have appropriate slow-blow fuses installed. See *Voltage configurations* on page 28 for recommended fuse/breaker sizes.

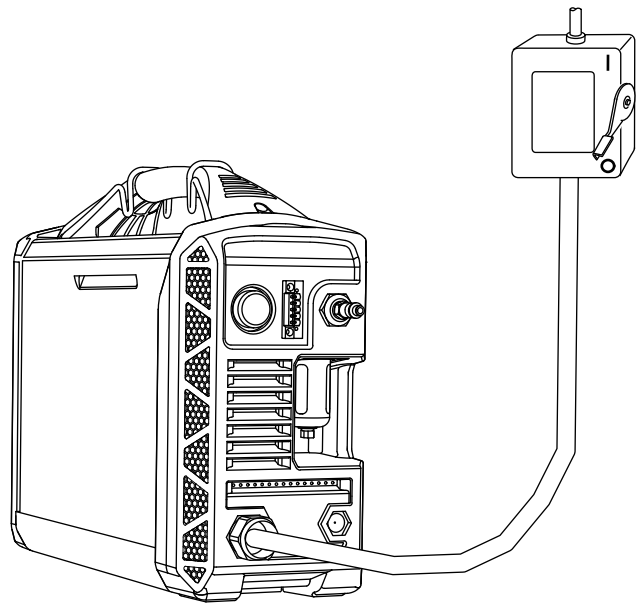

Requirements for grounding

To aid personal safety, proper operation, and to reduce electromagnetic interference (EMI), the power supply must be properly grounded.



- The power supply must be grounded through the power cord according to national and local electrical codes.
- Three-phase service must be of the 4-wire type with a green or green/yellow wire for protective earth ground and must comply with national and local requirements.
- Refer to the *Safety and Compliance Manual (80669C)* included with your system for more information on grounding.

The system's rated output (cutting power)

A plasma system's cutting power is determined more by its wattage output than by its amperage output. The rated output for this system is:

- 10 A – 45 A maximum output current
- 145 VDC maximum rated output voltage
- 6.5 kW cutting power

To determine the cutting power in watts (W), multiply the maximum output amperage (A) by the maximum rated output voltage (VDC):

$$45 \text{ A} \times 145 \text{ VDC} = 6,525 \text{ W (6.5 kW)}$$

Voltage configurations

The system automatically adjusts for proper operation at the current input voltage without requiring any switching or rewiring. However, you must:

- Install a set of consumables in the torch. See *Step 1 – Install consumables and activate torch* on page 46.
- Set the output current using the adjustment knob on the front panel. See *Step 6 – Set mode and adjust output current (amperage)* on page 51.

To operate the power supply at full output and 50% duty cycle as rated, you must size your electrical service accordingly. The following tables show the maximum rated output for typical input voltages. The output setting to use depends on the thickness of the metal and is limited by the input power to the system.



The recommended fuse/breaker sizes account for spikes in input current that occur when you stretch the plasma arc. Stretching the plasma arc is common in some applications, such as gouging.

CSA/CE/CCC 200 V – 240 V (1-phase)

Input voltage	200 V – 240 V
Input current at rated output (45 A x 145 V = 6.5 kW)	39 A – 32 A
Input current at arc stretch	44 A – 36 A
Recommended fuse/breaker size	50 A
Voltage tolerance	+10% / -10%

CSA 208 V (1-phase)

Input voltage	208 V
Input current at rated output (45 A x 145 V = 6.5 kW)	37 A
Input current at arc stretch	43 A
Recommended fuse/breaker size	50 A
Voltage tolerance	+10% / -10%

CCC 220 V (1-phase)

Input voltage	220 V
Input current at rated output (45 A x 145 V = 6.5 kW)	33 A
Input current at arc stretch	39 A
Recommended fuse/breaker size	50 A
Voltage tolerance	+10% / -10%

CE 230 V (1-phase)

Input voltage	230 V
Input current at rated output (45 A x 145 V = 6.5 kW)	33 A
Input current at arc stretch	37 A
Recommended fuse/breaker size	48 A
Voltage tolerance	+10% / -10%

CCC 380 V (3-phase)

Input voltage	380 V
Input current at rated output (45 A x 145 V = 6.5 kW)	12 A
Input current at arc stretch	20 – 15 A
Recommended fuse/breaker size	20 A
Voltage tolerance	+20% / -15%

CE 400 V (3-phase)

Input voltage	400 V
Input current at rated output (45 A x 145 V = 6.5 kW)	11 A
Input current at arc stretch	20 – 15 A
Recommended fuse/breaker size	20 A
Voltage tolerance	+20% / -15%

CSA 480 V (3-phase)

Input voltage	480 V
Input current at rated output (45 A x 145 V = 6.5 kW)	9.4 A
Input current at arc stretch	17 – 12 A
Recommended fuse/breaker size	20 A
Voltage tolerance	+20% / -15%

Decrease output current and arc stretch for lower rated electrical service

If you operate the power supply on an electrical service rated lower than what is recommended in *Voltage configurations* on page 28, you may need to:

- Turn down the cutting current (amperage setting). See *Step 6 – Set mode and adjust output current (amperage)* on page 51.
- Avoid stretching the plasma arc for prolonged periods. The more you stretch the plasma arc, the more current the system draws and the more likely you are to overheat the system or trip the circuit breaker.

CAUTION

Do not operate this system on a 15 A or 16 A circuit breaker.

Example: 230 V input on 20 A electrical service

If you use a 1-phase system with an input voltage of 230 V on a 20 A breaker, the recommended output current is 19 A.

Input voltage	230 V
Input current at rated output (19 A x 145 V = 2.8 kW)	18 A
Input current at arc stretch	19 A
Voltage tolerance	+10% / -10%

Prepare the power cord

CSA systems

1-phase (200 V – 240 V)

- 10 AWG 3-wire power cord
- 50 A, 250 V power plug (NEMA 6-50P) included

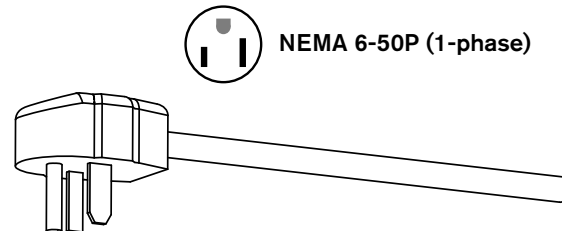

3-phase (480 V)

- 14 AWG 4-wire power cord
- Power plug not included*

* An appropriate plug must be installed on the power cord by a licensed electrician according to national and local codes.

CE/CCC systems

1-phase (200 V – 240 V)

- 6 mm² 3-wire H07RN-F power cord
- Power plug not included*

3-phase (380 V / 400 V)

- 2.5 mm² 4-wire H07RN-F power cord
- Power plug not included*

* An appropriate plug must be installed on the power cord by a licensed electrician according to national and local codes.

Extension cord recommendations

Use an extension cord that:

- Is an appropriate wire gauge for the cord length and system voltage
- Meets national and local codes



Extension cords can cause the machine to receive less input voltage than the output of the circuit. This can limit the operation of your system.

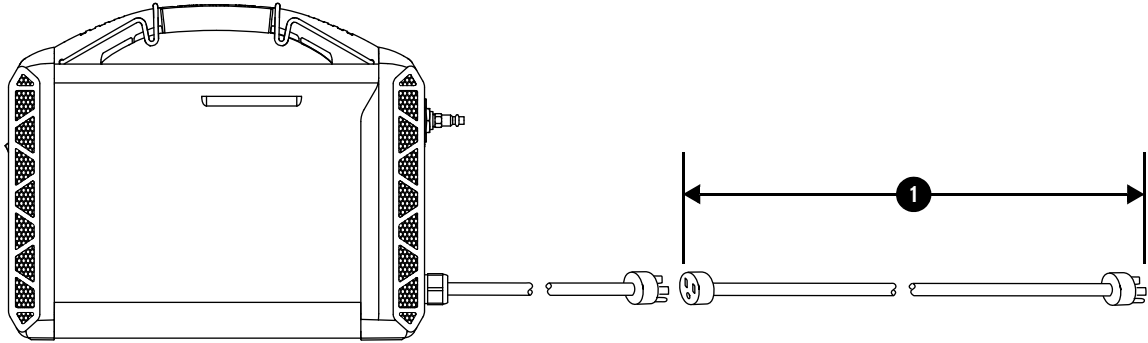

Input voltage	Phase	1	
		Cord Length	Cord Gauge
200 – 240 VAC	1	up to 15 m (50 feet)	10 mm ² (8 AWG)
		15 – 30 m (50 – 100 feet)	16 mm ² (6 AWG)
		30 – 45 m (100 – 150 feet)	25 mm ² (4 AWG)
380 – 480 VAC	3	up to 15 m (50 feet)	4 mm ² (12 AWG)
		15 – 45 m (50 – 150 feet)	6 mm ² (10 AWG)

Generator recommendations

Generators used with this system must meet the voltage requirements in the following table and in *Hypertherm plasma power supply ratings* on page 21.

Engine drive rating	Plasma system output current	Performance (arc stretch)
10 kW	45 A	Full
8 kW	45 A	Limited
6 kW	30 A	Full

- Adjust the cutting current (amperage) as needed based on the rating, age, and condition of the generator.

- A 10 kW generator is recommended for cutting applications that require full arc stretch, such as many gouging applications. It allows for the spikes in input current that occur when you stretch the plasma arc.
- If a fault occurs while using a generator, turn OFF (O) the system. Wait approximately 1 minute before you turn the system back ON (I).

Connect the gas supply

WARNING



The filter bowl in the power supply may explode if the gas pressure exceeds 9.3 bar (135 psi).

- **All models:** Use an inert gas hose with internal diameter of 9.5 mm (3/8 inch) or greater. **Do not use hoses with an internal diameter less than 9.5 mm (3/8 inch).** Hoses that are too small can cause issues with cut quality and cut performance.
- **CSA models:** An industrial interchange quick-disconnect nipple with 1/4 NPT threads ① comes with the system.
- **CE/CCC models:** A British Pipe Thread adapter G-1/4 BSPP with 1/4 NPT threads ② comes with the system.
- The gas inlet fitting that comes with the system may or may not be preinstalled. To install the fitting, screw it into place on the back of the power supply.
 - **CSA models:** Tighten the 1/4 NPT fitting to 115 kg-cm (100 inch-pounds). The fitting comes with thread sealant preapplied.
 - **CE/CCC models:** Tighten the G-1/4 BSPP adapter to 104 kg-cm (90 inch-pounds).

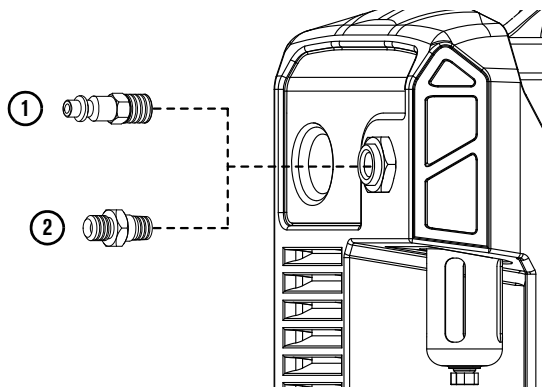

Gas supply source

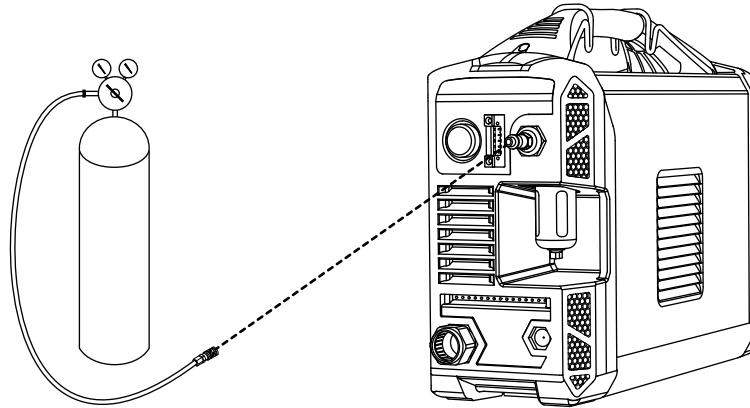

Recommended gas supply pressure: 5.5 – 6.9 bar (80 – 100 psi)

Maximum gas supply pressure: 9.3 bar (135 psi)

Recommended flow rate and pressure: 189 slpm at 5.9 bar (400 scfh at 85 psi)

Minimum flow rate: 165.2 slpm (350 scfh)

Maximum particle size: 0.1 micron at maximum concentration of 0.1 mg/m³*

Maximum water vapor dewpoint: -40°C (-40°F)

Maximum oil concentration: 0.1 mg/m³ (for aerosol, liquid, and vapor)

* Per ISO8573-1:2010, Class 1.2.2. That is, it should have a maximum number of solid particulate per meter cubed of 20,000 for particle sizes in the range of 0.1 – 0.5 microns, a maximum of 400 for particle sizes in the range of 0.5 – 1 microns, and a maximum of 10 for particle sizes in the range of 1 – 5 microns.

⚠ CAUTION

Synthetic lubricants containing esters that are used in some air compressors will damage polycarbonates used in the air filter bowl.

- Use shop-compressed gas or cylinder-compressed gas.
 - Use a high-pressure regulator on either type of gas supply. The regulator must be capable of delivering gas to the air inlet on the power supply at the flow rate and pressure specified above.
- **Use only clean, moisture-free gas.**
 - Oil, water, vapor, and other contaminants in the gas supply can damage internal components over time.
 - Poor gas supply quality results in:
 - Reduced cut quality and cut speeds
 - Reduced cut thickness capability
 - Reduced consumable life

High-pressure gas cylinders

WARNING



GAS CYLINDERS CAN EXPLODE IF DAMAGED

Gas cylinders contain gas under high pressure. If damaged, a cylinder can explode.

For high pressure regulators, adhere to the manufacturer's guidelines for safe installation, operation, and maintenance.

Before plasma cutting with compressed gas, read the safety instructions in the *Safety and Compliance Manual (80669C)*. Failure to follow safety instructions can result in personal injury or in damage to equipment.

WARNING



EXPLOSION HAZARD – CUTTING WITH FUEL GASES

Do not use combustible fuel gases or oxidizing gases with Powermax systems. These gases can result in explosive conditions during plasma cutting operations.

You can use the following gases to cut with this system. See *Hypertherm plasma power supply ratings* on page 21 for requirements on gas quality.

- Air
- Nitrogen
- F5 (stainless steel only – see page 111)
- Argon (recommended for marking applications only – see page 114)

If you use high-pressure gas cylinders as the gas supply:

- Refer to the manufacturer's specifications for installation and maintenance procedures of high-pressure regulators.
- Make sure the cylinder valves are clean and free of oil, grease, and other contaminants. Open each cylinder valve just long enough to blow out any dust that may be present.
- Make sure the cylinder is equipped with an adjustable high-pressure regulator that is capable of:
 - Gas outlet pressures up to 6.9 bar (100 psi). **Never exceed the maximum gas pressure of 9.3 bar (135 psi).**
 - Gas flow rates of 235.9 L/min (500 scfh).
- Connect the supply hose securely to the cylinder.

Gas flow rates

Refer to the cut charts starting on page 121 for flow rates specific to each cutting process specified (based on the type of metal, the type of gas, and the output current).

Process	Gas flow rate
Cutting	188.8 slpm (400 scfh) at a minimum 5.9 bar (85 psi)
Maximum control gouging (26 – 45 A)	165.2 slpm (350 scfh) at a minimum 4.1 bar (60 psi)
Precision gouging / marking (10 – 25 A)	165.2 slpm (350 scfh) at a minimum 3.8 bar (55 psi)

Minimum inlet pressure (while gas is flowing)

WARNING



The filter bowl in the power supply may explode if the gas pressure exceeds 9.3 bar (135 psi).

The following pressure specifications apply for air, nitrogen, F5, and argon. Never exceed an inlet gas supply pressure of 9.3 bar (135 psi).

You may need to adjust these pressures based on the equipment and conditions specific to your environment. For example, additional gas filtration installed between the gas supply and the plasma power supply may increase the required minimum inlet pressure. Consult the filter manufacturer.

Cutting

Torch lead length – hand torches	Minimum inlet pressure
6.1 m (20 feet)	5.5 bar (80 psi)
15 m (50 feet)	5.9 bar (80 psi)

Torch lead length – machine torches	Minimum inlet pressure
7.6 m (25 feet)	5.5 bar (80 psi)
11 m (35 feet)	5.5 bar (80 psi)
15 m (50 feet)	5.9 bar (85 psi)

Maximum control gouging (26 – 45 A)

Torch lead length – hand torches	Minimum inlet pressure
6.1 m (20 feet)	3.8 bar (55 psi)
15 m (50 feet)	4.1 bar (60 psi)

Torch lead length – machine torches	Minimum inlet pressure
7.6 m (25 feet)	3.8 bar (55 psi)
11 m (35 feet)	3.8 bar (55 psi)
15 m (50 feet)	4.1 bar (60 psi)

Precision gouging / Marking (10 – 25 A)

Torch lead length – hand torches	Minimum inlet pressure
6.1 m (20 feet)	3.5 bar (50 psi)
15 m (50 feet)	3.8 bar (55 psi)

Torch lead length – machine torches	Minimum inlet pressure
7.6 m (25 feet)	3.5 bar (50 psi)
11 m (35 feet)	3.5 bar (50 psi)
15 m (50 feet)	3.8 bar (55 psi)

Additional gas filtration

It is extremely important to maintain a clean, dry gas line in order to:

- Prevent oil, water, dirt, and other contaminants from damaging internal components.
- Achieve optimal cut quality and consumable life.

Dirty, oily air is the root cause of many common problems that occur in Powermax systems, and in some instances it can void the warranty on the power supply and on the torch. See the gas quality recommendations in the ratings table on page 21.

The power supply contains a built-in air filter. Regularly check the filter element inside the air filter bowl and replace as needed. See *Replace the air filter bowl and filter element* on page 155.

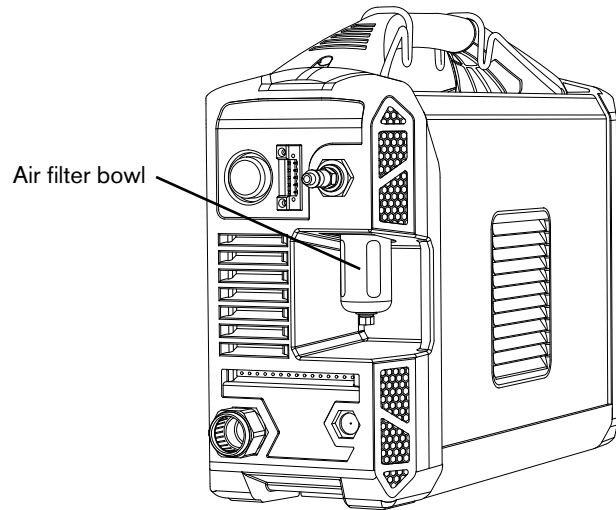

The built-in air filter should not take the place of adequate external filtration. If you work in an environment that is extremely warm and humid, or if work site conditions introduce oil, vapors, or other contaminants into the gas line, install an external filtration system that cleans the gas supply before it enters the plasma power supply.

A 3-stage coalescing filtration system is recommended. A 3-stage filtering system works as follows to clean contaminants from the gas supply.



Install the filtering system between the gas supply and the power supply. Additional gas filtration may require higher pressure from the source.

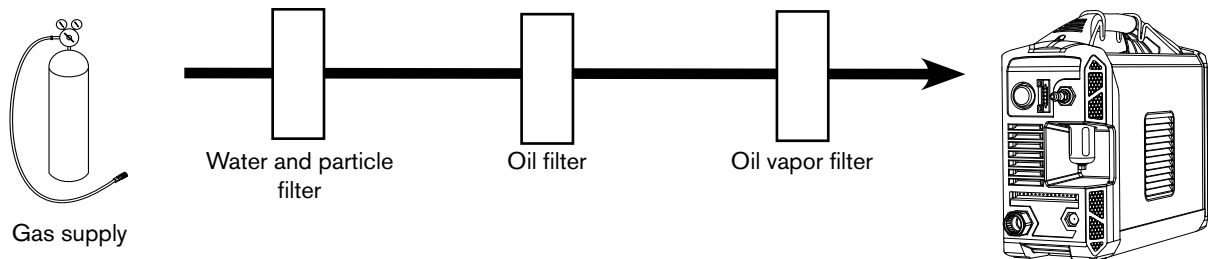

2

Operation

Controls and indicators

ON (I) / OFF (O) power switch

The power switch is located on the front panel.

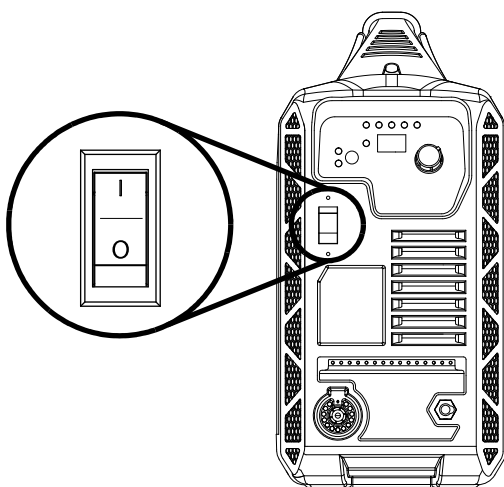

200 – 240 V

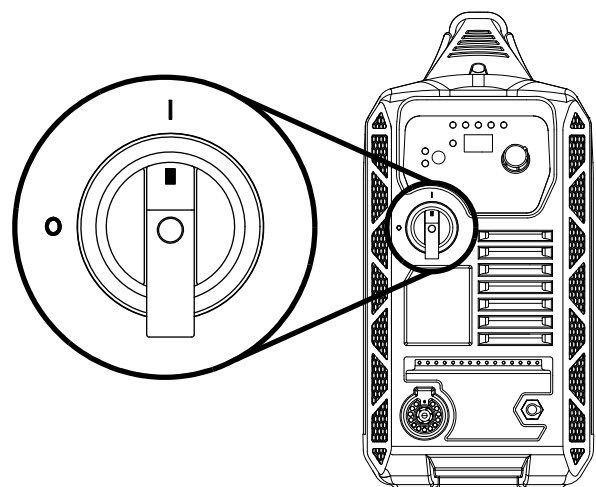

400 V, 480 V

Cutting controls

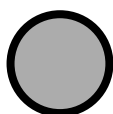
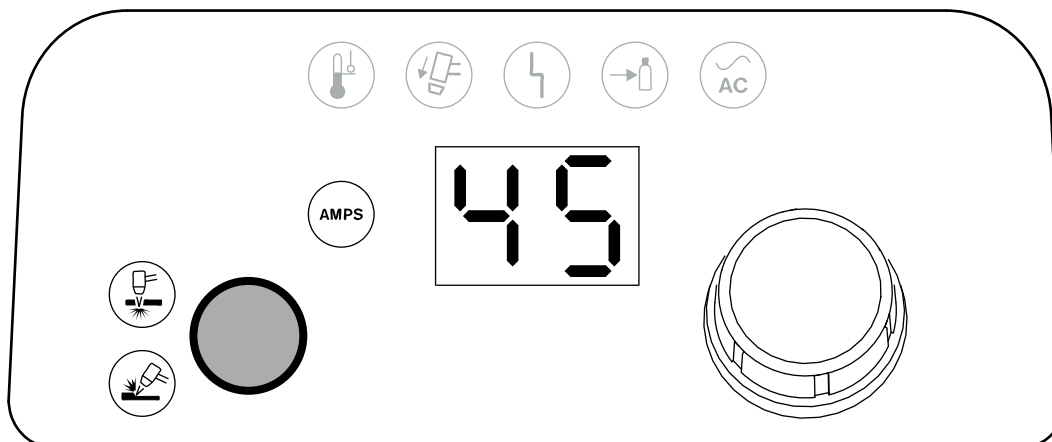

Mode button – Press this button to toggle between cut mode and gouge/marketing mode. The system automatically adjusts the gas pressure based on:

- ❑ The mode selected
- ❑ The torch connected to the power supply
- ❑ The length of the torch lead



Cut Mode LED (green) – When illuminated, this LED indicates that the system is ready to perform plasma cutting operations.



Gouge/Marking Mode LED (green) – When illuminated, this LED indicates that the system is ready to perform plasma gouging or marking operations.

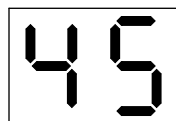

2-digit display – This display shows the output current (10 – 45 A) by default.

When certain system faults occur, this display shows a fault code. See *Fault LEDs and fault codes* on page 143.

If you manually adjust the gas pressure, this display shows the gas pressure. See *Adjust the gas pressure manually* on page 54.



AMPS LED (green) – When illuminated, this LED indicates that the 2-digit display shows the cutting current (amperage).

When the 2-digit display shows other values, such as gas pressure or a fault code, the AMPS LED is not illuminated.

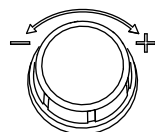

Adjustment knob – Use this knob to set the cutting current between 10 A and 45 A in 1-unit increments.

You can also use this knob to increase or decrease the gas pressure. See *Adjust the gas pressure manually* on page 54.

Indicator LEDs

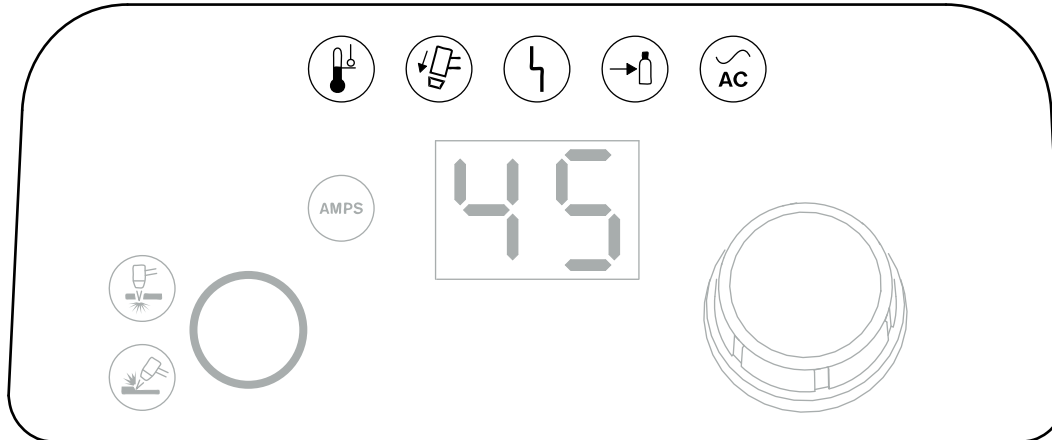

Power ON LED (green) – When illuminated, this LED indicates that the power switch is set to ON (I) and the system is ready to cut.



Gas Pressure LED (yellow) – When illuminated, this fault LED indicates that the inlet gas pressure is too low or that there is no inlet gas connection.



System Fault LED (yellow) – When illuminated, this fault LED indicates that there is a fault with the power supply. In many instances, when this LED illuminates, a fault code also flashes on the 2-digit display. See *Fault LEDs and fault codes* on page 143.



Torch Cap LED (yellow) – When illuminated, this fault LED indicates that the consumables are loose, improperly installed, or missing.



Temperature LED (yellow) – When illuminated, this fault LED indicates that the system's temperature is outside the acceptable operating range.



Some fault conditions cause multiple LEDs to illuminate or blink at the same time. For information on what these fault conditions are and how to clear them, see *Fault LEDs and fault codes* on page 143.

Disable the torch

The Duramax Lock torches include a switch that enables you to lock the torch. This torch-disable switch prevents the torch from firing accidentally even when the power supply is ON. Use this switch to lock the torch when it is not in use, when you need to change the consumables, or when you need to move the power supply or torch while the system is powered ON.

Torch **LOCK** position:

- The torch-disable switch is in the backward position, closer to the torch lead.
- The **yellow** label with the “X” indicates the torch is not ready to fire.
- Point the torch away from yourself and others, and pull the trigger to make sure it does not fire.
- Change the consumables (if needed).

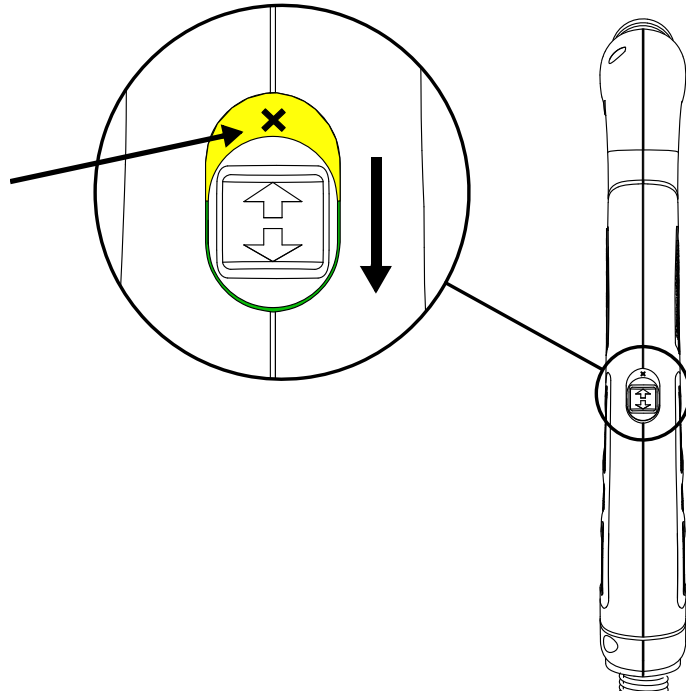

Torch “ready to fire” position:

- The torch-disable switch is in the forward position, closer to the torch head.
- The **green** label with the “✓” indicates the torch is ready to fire.
- Do NOT change the consumables.
 - To change the consumables without danger of the torch firing accidentally, lock the torch or turn OFF the power supply.

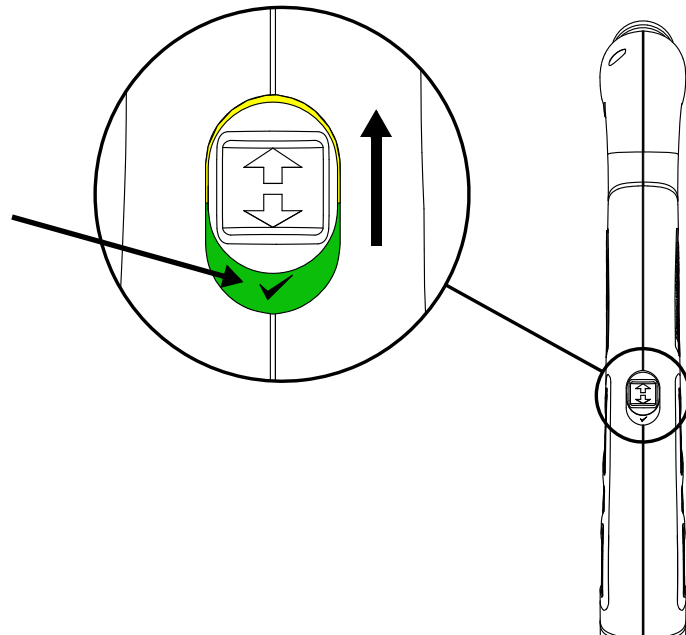

The first time you pull the torch trigger after you set the torch to the “ready to fire” position, the torch emits multiple puffs of air in quick succession. This warns you that the torch is active and will fire an arc the next time the trigger is pulled. See page 45.

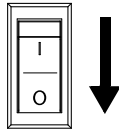
! WARNING**INSTANT-ON TORCHES – PLASMA ARC CAN CAUSE INJURY, BURNS**

The plasma arc ignites immediately when you pull the torch trigger. Before changing consumables, one of the following actions must be taken. Whenever possible, complete the first action.

- Turn OFF (O) the plasma power supply.
- OR
- Move the torch-disable switch to the yellow lock (X) position (closest to the torch lead). Pull the trigger to make sure the torch does not fire a plasma arc.

Warning puffs of air

The first time you try to fire the torch after moving the torch-disable switch to the yellow lock (X) position and then back to the green “ready to fire” (✓) position:

- The plasma arc does not fire. ①
- The torch emits multiple puffs of air in quick succession. The torch vibrates slightly with each puff of air. ②
- The power supply makes an audible pressure-release sound with each puff of air. ③

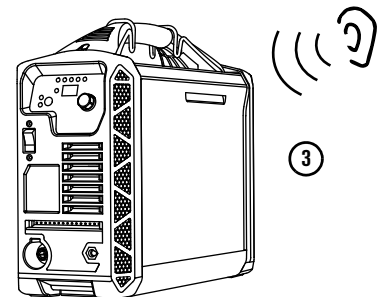
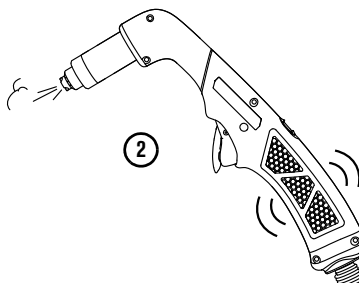
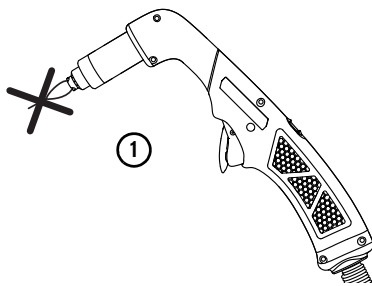

This feedback serves as a warning. It does not indicate a fault condition. It alerts you that the torch is activated and will produce a plasma arc the next time the torch is fired.



The Torch Cap LED on the front panel illuminates when you remove the consumables or set the torch-disable switch to the yellow lock (X) position while the plasma power supply is still ON. The LED extinguishes after the torch emits the warning puffs of air.



For hand torches

After moving the torch-disable switch to the green “ready to fire” (✓) position:

- a. Pull the torch trigger 1 time to get the warning puffs of air.
- b. Pull the torch trigger again to fire a plasma arc.

For machine torches

After moving the torch-disable switch to the green “ready to fire” (✓) position:

- a. Run a START/STOP command from the CNC to get the warning puffs of air.



If this feature is integrated into your CNC, there may be other steps to follow that are specific to the CNC.

- b. Start the torch again to fire a plasma arc.

Operate the plasma system

Step 1 – Install consumables and activate torch

WARNING

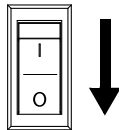

INSTANT-ON TORCHES – PLASMA ARC CAN CAUSE INJURY, BURNS

The plasma arc ignites immediately when you pull the torch trigger. Before changing consumables, one of the following actions must be taken. Whenever possible, complete the first action.

- Turn OFF (O) the plasma power supply.

OR

- Move the torch-disable switch to the yellow lock (X) position (closest to the torch lead). Pull the trigger to make sure the torch does not fire a plasma arc.

1. Turn OFF (O) the power switch on the power supply, or move the torch-disable switch on the torch to the yellow lock (X) position.
2. Point the torch away from yourself and others, and pull the trigger to make sure it does not fire.
3. Choose the correct consumables for your cutting, gouging, or marking application.

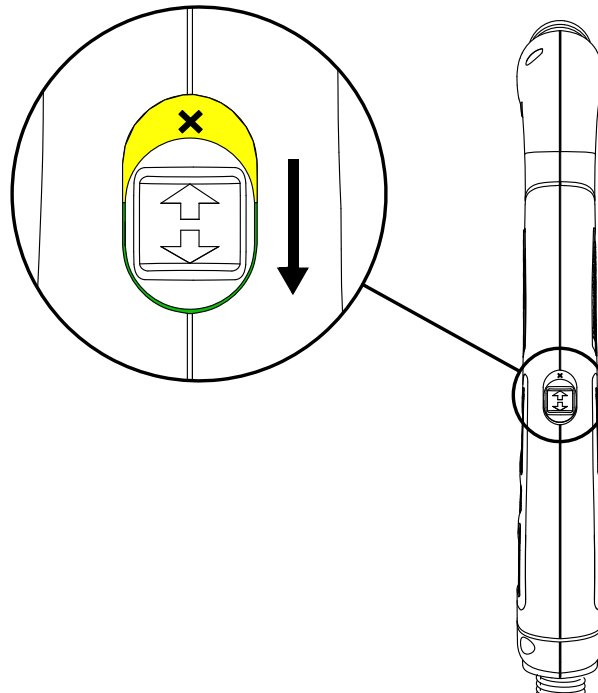

- ❑ **Cutting and piercing with a hand torch:**
See *Choose the consumables* on page 61.
- ❑ **Cutting and piercing with a machine torch:** See *Choose the consumables* on page 105.
- ❑ **Gouging:** See *Gouging processes* on page 71.
- ❑ **Marking:** See *Marking consumables (10 – 25 A)* on page 113.

4. Install a complete set of consumables in the hand torch or machine torch as shown:

- ① Swirl ring
- ② Electrode
- ③ Nozzle
- ④ Retaining cap
- ⑤ Shield (or deflector)

 Consumables are not preinstalled on new torches. Remove the vinyl cap from the torch before installing the consumables.

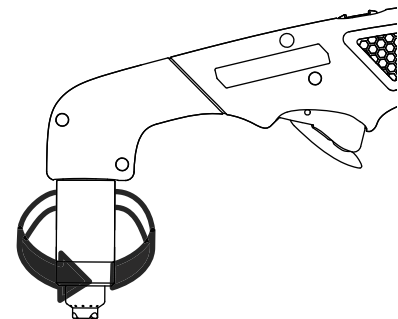
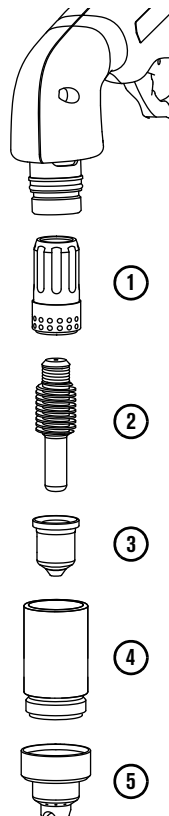

Tighten to finger tight.
Do not over-tighten.

2 Operation

5. Move the torch-disable switch on the torch to the green “ready to fire” (✓) position.

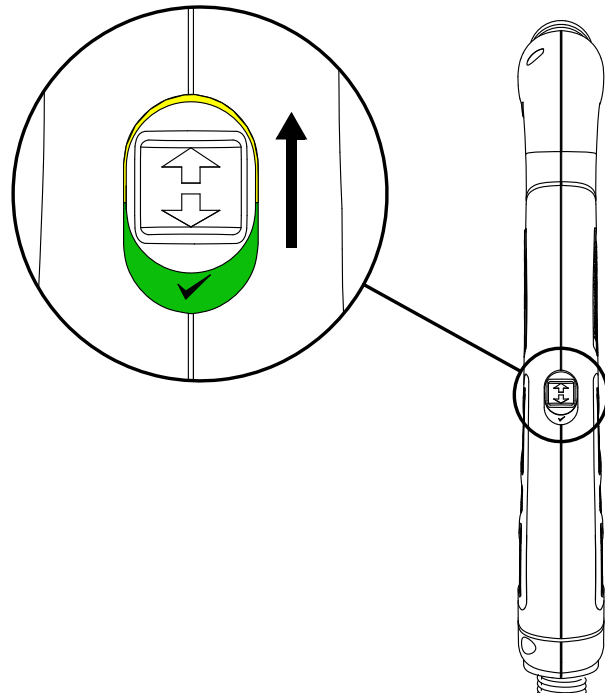

Step 2 – Connect torch lead

- Turn OFF (O) the power supply before you connect or disconnect a torch.
- To connect a hand torch or machine torch, push the connector into the receptacle on the front of the power supply.
- To disconnect the torch, press the red button on the connector and pull the connector out of the receptacle.

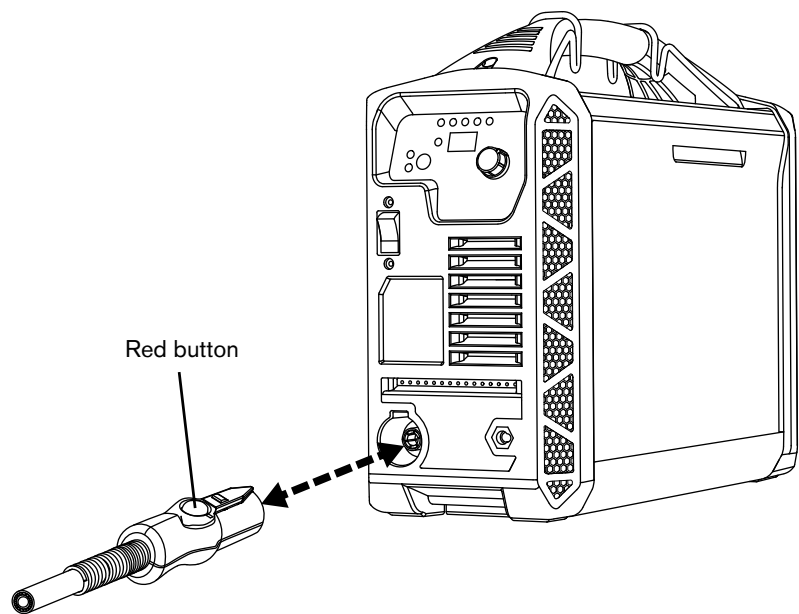

Step 3 – Connect gas supply

- If needed, install the gas inlet fitting that came with the system onto the back of the power supply. See page 34.
- Connect the gas supply line to the fitting on the back of the power supply.
- For gas supply requirements, see *Gas supply source* on page 35.

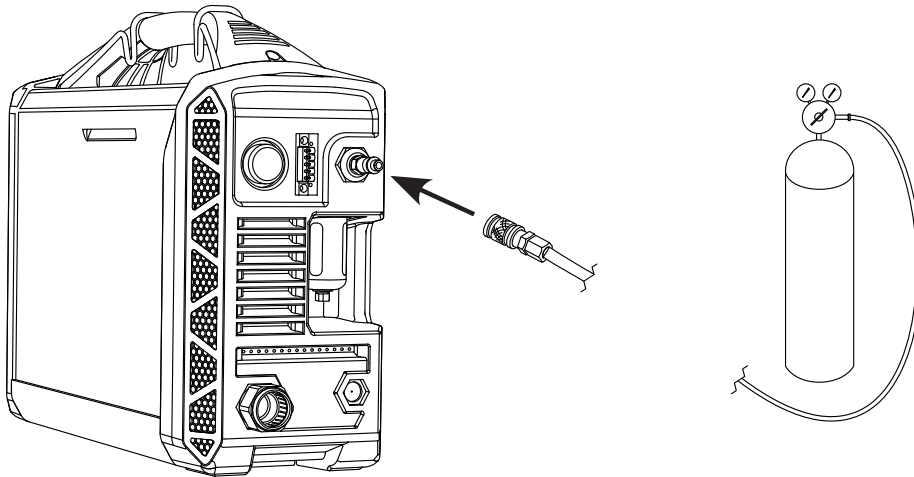

Step 4 – Connect work lead and work clamp

⚠ CAUTION

Make sure you use a work lead that is appropriate for your power supply. Use a 45 A work lead with the Powermax45 XP. The amperage is marked near the rubber boot of the work lead connector.

To prevent overheating, check the work lead often to make sure it is fully seated in the receptacle.

Work lead

1. Insert the work lead connector into the receptacle on the front of the power supply. Align the key on the connector with the opening on the right of the receptacle.
2. Push the work lead connector all the way into the receptacle. Turn the connector clockwise a 1/4 turn until the connector is fully seated against the stop.

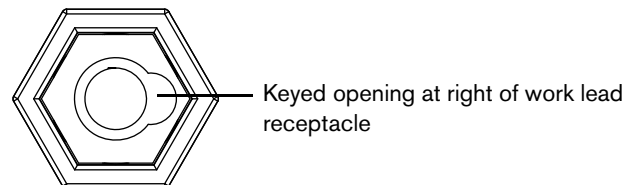

Work clamp

CAUTION

Do not attach the work clamp to a water table or in close proximity to water. If water runs through the work lead and into the power supply, severe damage to the power supply can result.

- **Hand cutting:** The work clamp must be connected to the workpiece you are cutting.
- **Mechanized cutting:** If you are using this system with a cutting table, you can connect the work clamp directly to the table or to the workpiece you are cutting. See your table manufacturer's instructions.
- Make sure the work clamp makes good metal-to-metal contact with the workpiece or cutting table.
- Remove rust, dirt, paint, coatings, and other debris so the work clamp makes proper contact with the workpiece or cutting table.
- To achieve the best cut quality, attach the work clamp as close as possible to the area being cut.

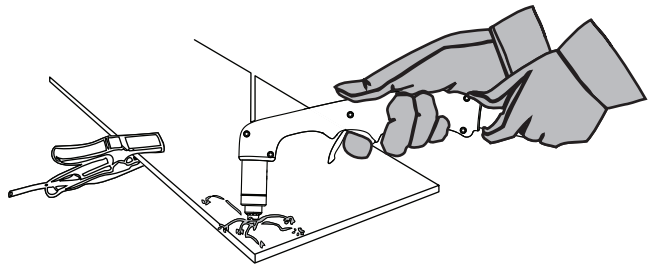

CAUTION

Do not attach the work clamp to the portion of the workpiece to be cut away.

Step 5 – Connect electric power and turn ON the system

1. Plug in the power cord.
 - When you first receive your system, the power cord may not have a power plug installed. For information on connecting the proper plug to the power cord, see *Prepare the power cord* on page 32.
 - For more information on the system's electrical requirements, see *Connect to electrical power* on page 27.
2. Set the power switch to the ON (I) position.

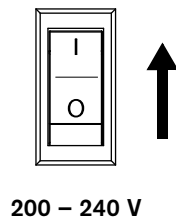

200 – 240 V

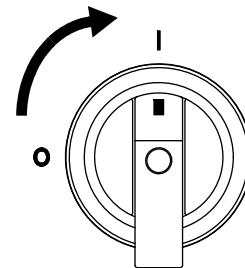

400 V, 480 V

Step 6 – Set mode and adjust output current (amperage)

1. Press the **Mode** button ① to toggle between Cut mode and Gouge/Marking mode.



The system's Smart Sense™ technology automatically regulates the gas pressure for optimum cutting according to the selected mode, the torch type, and the length of the torch lead.

2. Turn the adjustment knob ② to set the output current to a maximum of 45 A. The 2-digit display ③ shows the output current in amperage.

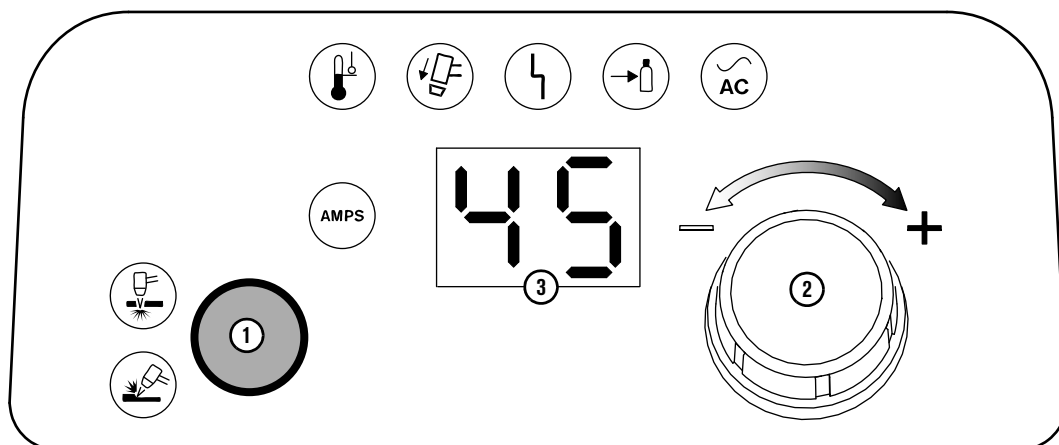

Cutting expanded metal

To cut expanded metal, use the consumables for shielded cutting that come with the system. The system does not require a dedicated mode for cutting expanded metal.



Expanded metal has a slotted or mesh pattern. Cutting expanded metal wears out consumables more quickly because it requires a continuous pilot arc. A pilot arc occurs when the torch is fired but the plasma arc is not in contact with the workpiece.

Step 7 – Check cut settings and indicator LEDs

Before you start to cut, make sure:

- ① The green power ON LED on the front of the power supply is illuminated.
- ② The correct mode LED is illuminated (cut or gouge/marking). Also make sure the consumables installed on the torch match the selected mode.
- ③ The output current (amperage) displayed on the front panel is correct, and the AMPS LED is illuminated.
- ④ None of the 4 fault LEDs are illuminated or blinking.

If any of the fault LEDs illuminate or blink, or if the power ON LED blinks, this indicates a fault. Correct the fault condition before continuing. See *Fault LEDs and fault codes* on page 143.

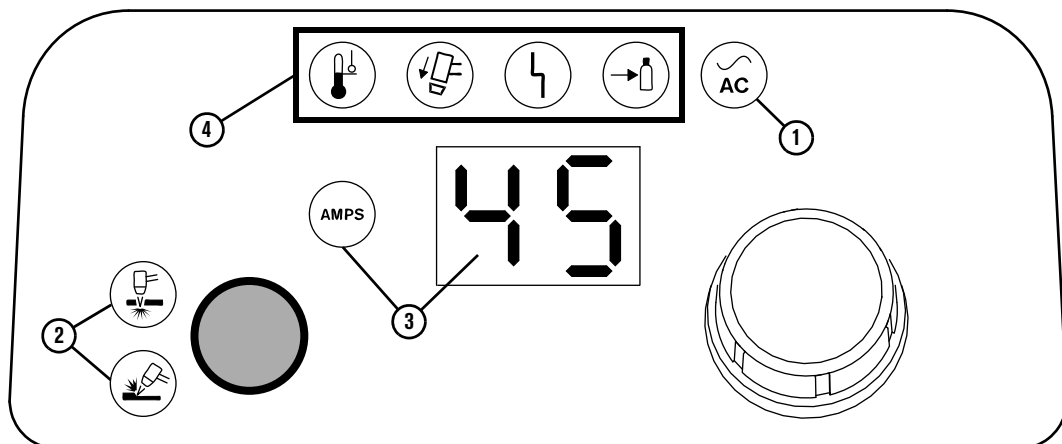

What to expect during and after cutting

Postflow – After you complete a cut and release the torch trigger, air continues to flow from the torch in order to cool the consumables. This is referred to as *postflow*.

The length of postflow depends on the mode and the output current. Under certain conditions, it also depends on the gas supply.

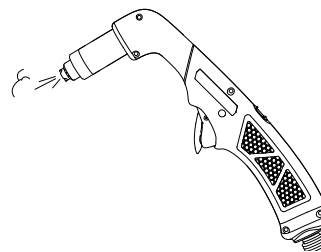

Mode	Output current	Length of postflow
Cut	10 – 45 A	20 seconds
Gouge/markig	26 – 45 A	20 seconds
Gouge/markig	10 – 25 A	10 seconds for air (or nitrogen) 3 seconds for argon

Exception for argon: The system recognizes when argon is being used and reduces postflow from 10 seconds to 3 seconds in order to minimize gas usage. To achieve 3-second postflow, the system must be set to Gouge/Marking mode with the output current set between 10 – 25 A. When the torch fires without transferring the pilot arc to the workpiece, postflow is 10 seconds even when the supply gas is argon.

Fan activity – The cooling fan inside the plasma power supply runs intermittently during and after cutting in order to cool internal components.

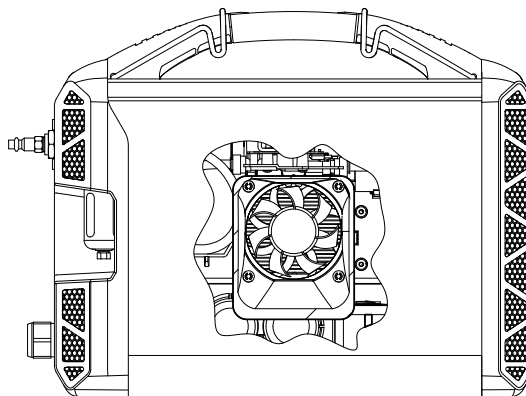

Warning puffs of air – When you set the torch-disable switch to the “ready to fire” (✓) position after the torch has been locked, the torch does not fire the first time you pull the trigger. Instead, the torch emits multiple puffs of air in quick succession. With each puff of air, the torch vibrates slightly, and the power supply emits an audible pressure-release sound. This serves as a warning to alert you that the torch is active and will fire an arc the next time you pull the trigger. See page 45.

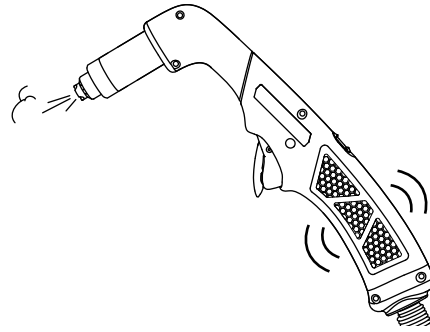

 For the machine torch, run a START/STOP command from the CNC to cause the torch to emit the puffs of air. On the next start signal, the torch will fire an arc.

 The Torch Cap LED on the front panel illuminates when you remove the consumables or set the torch-disable switch to the yellow lock (X) position while the plasma power supply is still ON. The LED extinguishes after the torch emits the warning puffs of air.



Adjust the gas pressure manually

The power supply automatically regulates the gas pressure for you. However, you can adjust the gas pressure manually if you need to for a specific application.

 Overriding the system’s gas pressure setting should be done only by experienced users who need to optimize the gas setting for a specific cutting application.

1. Select the mode, and set the output current. In this example, we selected gouge/marketing mode and set the output current to 45 A.

- Set the mode and output current first because doing so can reset the gas pressure. See page 56.

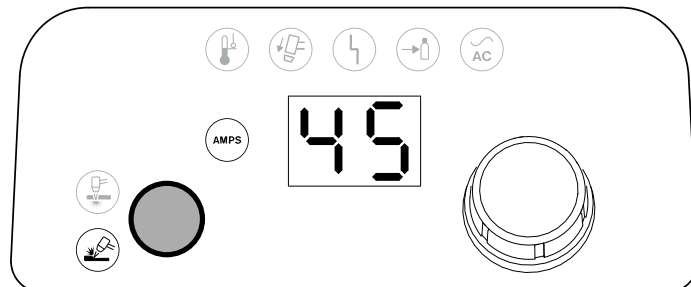

2. Press-and-hold the **Mode** button with one hand. Turn the adjustment knob to the desired gas pressure with the other hand. In this example, we turned down the gas pressure to 35 psi.

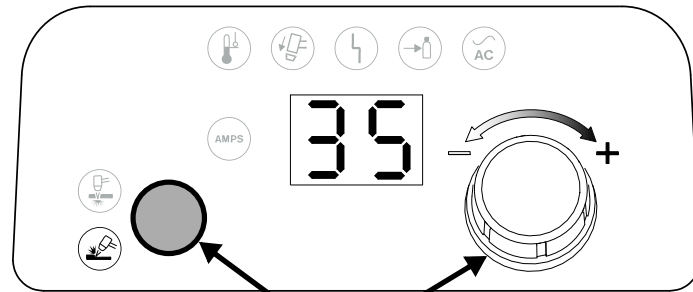

Press-and-hold the button while turning the knob.

- As you manually adjust the gas pressure, the AMPS LED turns off, and the 2-digit display changes from amperage to gas pressure, as follows:

- **CSA models:** The gas pressure displays in **psi** by default.
- **CE/CCC models:** The gas pressure displays in **bar** by default.



You can change the display values for gas pressure. See page 57.

3. Release the **Mode** button.

- After you release the **Mode** button, the AMPS LED illuminates again, and the 2-digit display changes from gas pressure back to amperage.

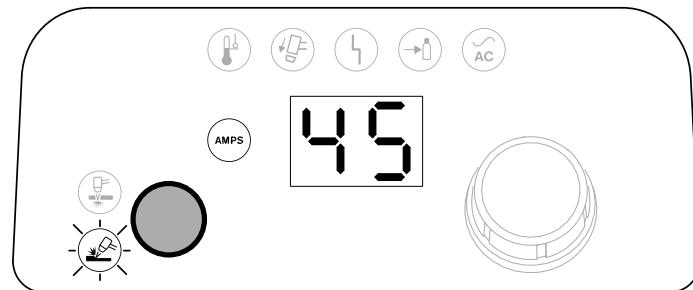

- The selected mode LED blinks to let you know that the gas pressure has been manually adjusted. It continues to blink until you reset the pressure.
- To view the gas pressure setting again, repeat *step 2* above, or enter gas test mode. See *Run a gas test* on page 149.

Reset the gas pressure

When you manually adjust the gas pressure, the pressure you set remains in place until you reset it. You can reset the gas pressure by pressing the **Mode** button.

 When you reset the gas pressure, the selected mode LED stops blinking.

The gas pressure also resets to the default setting when:

- You are in gouge/marking mode and you change the output current from:
 - The Maximum Control gouging process (26 – 45 A) to the Precision gouging process (10 – 25 A)
 - The Precision gouging process (10 – 25 A) to the Maximum Control gouging process (26 – 45 A)
- You connect a different torch to the power supply.

 Turning the power supply OFF and ON does not reset the gas pressure.

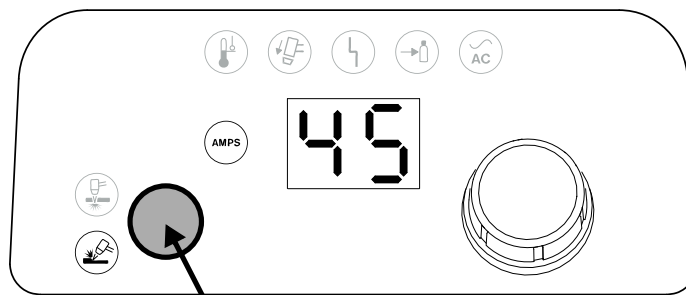

Press the button to reset the gas pressure.

Change the gas pressure values between *psi* and *bar*

- **CSA models:** The gas pressure displays in **psi** by default.
- **CE/CCC models:** The gas pressure displays in **bar** by default.

To change the gas pressure display values from *psi* to *bar* or from *bar* to *psi*:

1. Press-and-hold the **Mode** button for approximately 15 seconds until the 2-digit display shows **P.U.**

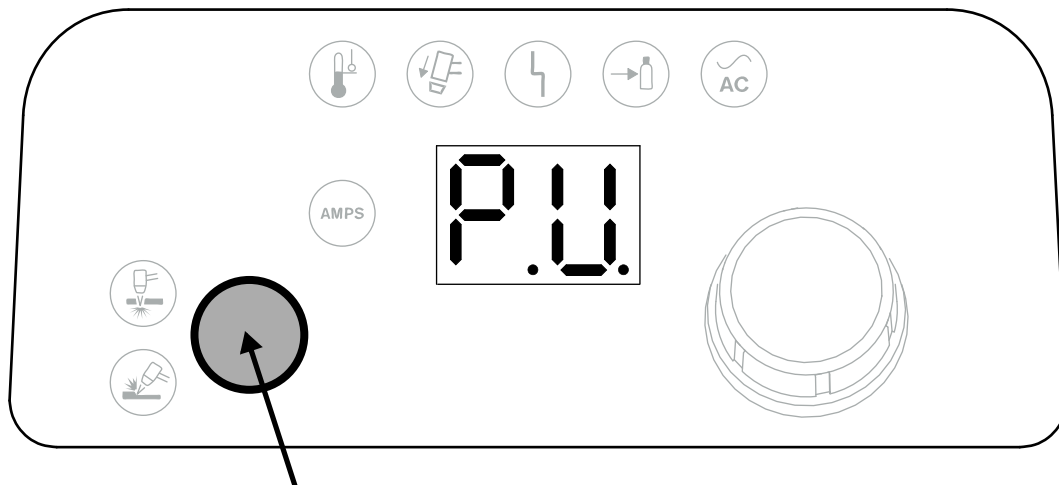

Press-and-hold for 15 seconds to toggle between **psi** and **bar**.

2. Release the **Mode** button. The system will now display gas pressure values in **bar** instead of **psi** or in **psi** instead of **bar**.

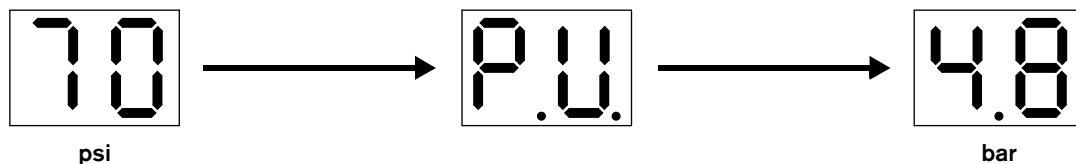

Understand duty cycle to prevent overheating

Duty cycle – Percentage of time during a 10-minute interval that a plasma arc can remain on without causing the system to overheat.

Output current	Duty cycle*
45 A	50%
41 A	60%
32 A	100%

* Assumes ambient operating temperature of 40°C (104°F).

When you exceed the duty cycle and the system overheats:

- The plasma arc shuts off.
- The Temperature LED illuminates. 
- The cooling fan inside the power supply runs.

When the system overheats:

- a. Leave the system on to allow the fan to cool the power supply.
- b. Wait for the Temperature LED to turn off before you start to cut again.

Stretching the plasma arc for prolonged periods negatively impacts duty cycle. Whenever possible, drag the torch on the workpiece. See *Start a cut from the edge of the workpiece* on page 67.

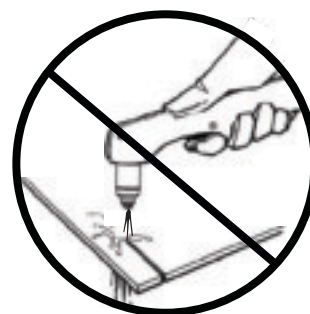
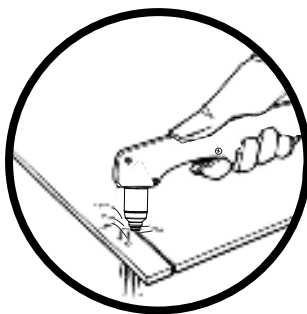

If you operate the system on a lower rated electrical service, stretching the plasma arc for prolonged periods can cause the system to overheat more quickly and can cause the circuit breaker to trip. See *Decrease output current and arc stretch for lower rated electrical service* on page 31.

3

Cut with the Hand Torch

Duramax Lock hand torches come in 15° and 75° models.

- The 75° hand torch is a general purpose torch designed for the widest range of applications.
- The 15° hand torch is designed to direct heat away from the operator during heavy gouging. It also facilitates cutting overhead or in hard to reach areas.

Duramax Lock torch features include:

- A torch-disable switch that prevents the torch from firing accidentally even when the power supply is ON. See *Disable the torch* on page 44.
- The FastConnect™ quick-disconnect system to easily remove the torch for transport or to switch from one torch to another.
- Automatic cooling with ambient air. Special cooling procedures are not needed.

This section provides an overview of hand torch parts, dimensions, consumables, cutting guidelines, and basic cutting methods. For gouging information, see *Gouge with the Hand Torch and Machine Torch* on page 71.



To resolve issues with cut quality, refer to *Common cutting issues* on page 136.

The Duramax Lock hand torches ship without consumables installed. To install the consumables, see page 46.

Hand torch components, dimensions, weights

Components

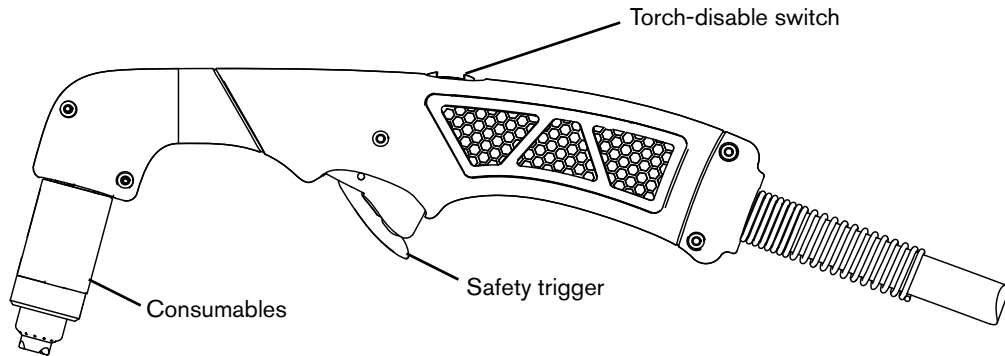

Dimensions

75° hand torch

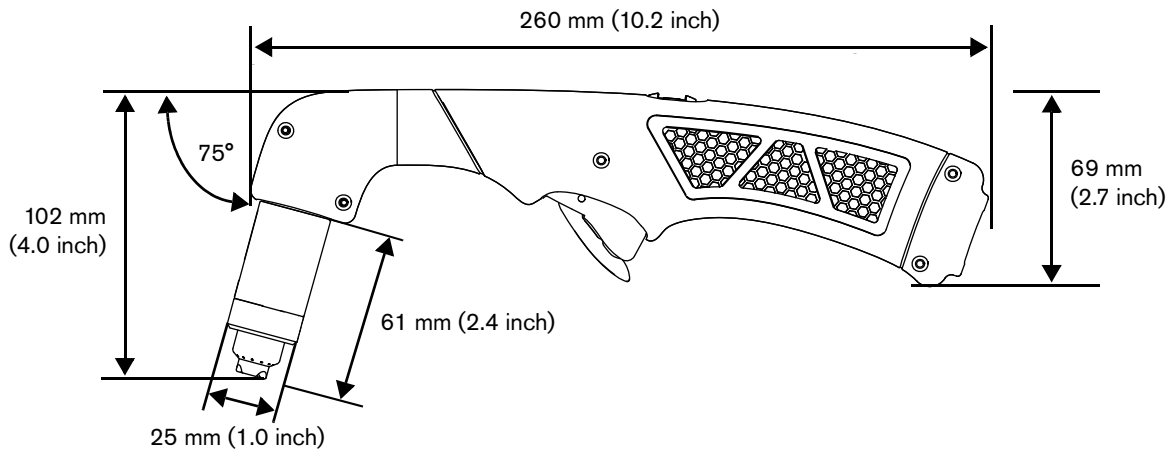

15° hand torch

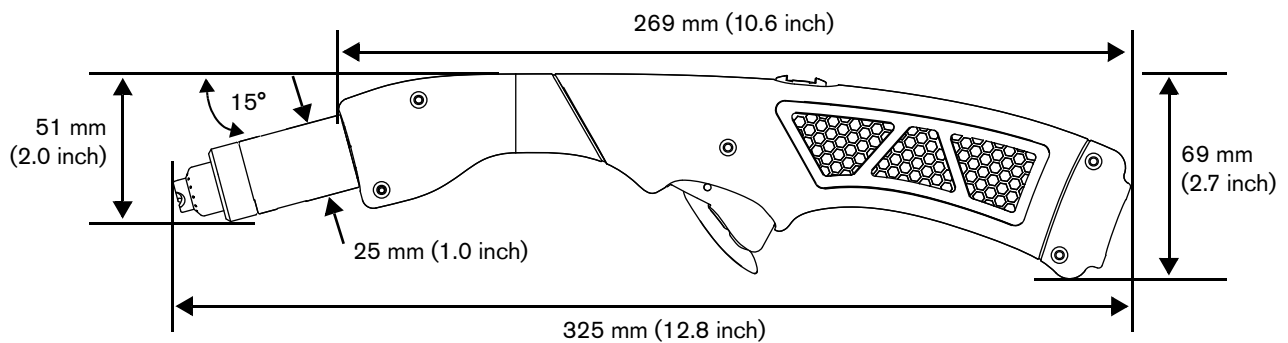

Weights

Torch	Weight
Hand torch with 6.1 m (20 foot) lead	1.8 kg (3.9 pounds)
Hand torch with 15 m (50 foot) lead	3.7 kg (8.1 pounds)

Choose the consumables

The 15° and 75° Duramax Lock hand torches use the same consumables.

Your system ships with a starter consumable kit that includes the shielded consumables on page 62 plus 1 extra electrode and 1 extra nozzle.

Consumable Type	Purpose
Shielded drag-cutting	Drag cut for the widest range of cutting applications.
FineCut®	Achieve narrower kerf on thin mild steel and stainless steel up to 3 mm (10 gauge).
HyAccess™	Cut or gouge in hard to reach areas or confined spaces.
Maximum Control gouging (26 – 45 A)*	Remove metal and achieve a controlled gouge profile.
Precision gouging (10 – 25 A)*	Achieve very shallow gouge and lower metal removal rate than with Maximum Control gouging, such as for spot weld removal.
Marking (10 – 25 A)†	Mark metal surfaces using air or argon.

* For details on gouging processes and consumables, see *Gouging processes* on page 71.

† For details on marking consumables, see *Marking consumables (10 – 25 A)* on page 113.

When you use the following shielded and FineCut consumables, select Cut mode on the front panel. See page 51.

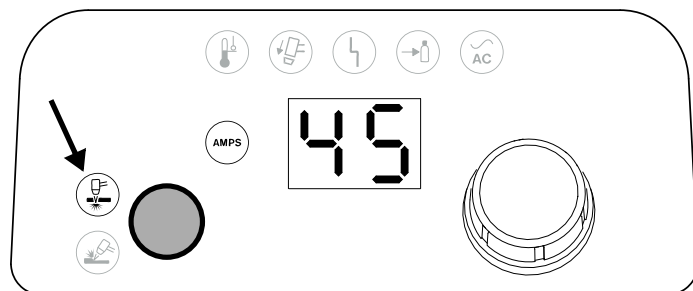

Shielded drag-cutting consumables

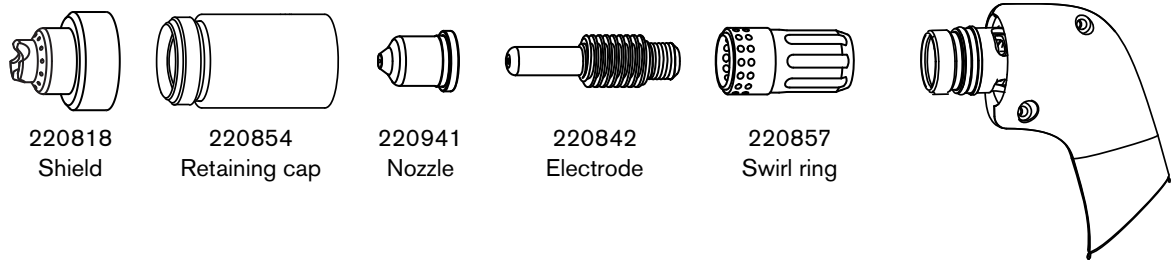

FineCut consumables

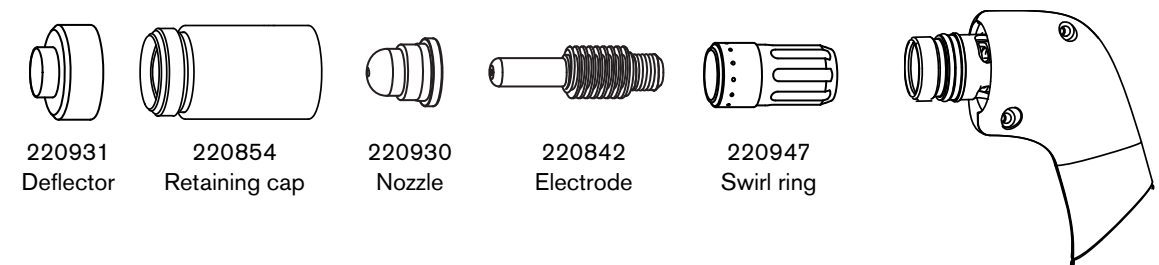

Specialty consumables

HyAccess cutting consumables

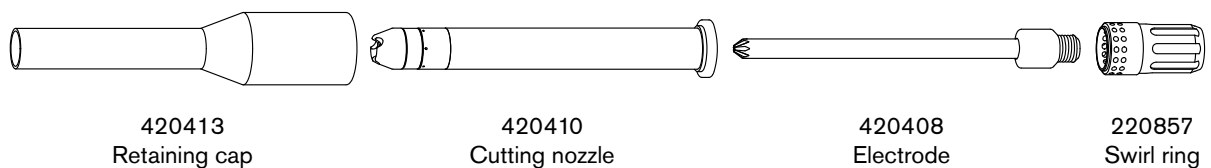

HyAccess consumables extend the reach of the regular shielded consumables by approximately 7.5 cm (3 inches). Use them with your hand torch to achieve greater reach and visibility.

 HyAccess gouging consumables are also available. See page 73.

You can expect to cut approximately the same thicknesses as with the regular shielded consumables. You may need to reduce your cut speed slightly to achieve the same cut quality. Typically, you can expect HyAccess consumables to last approximately half as long as the regular shielded consumables.

You can order each HyAccess consumable separately or in starter kits. When the tip of the nozzle wears out, replace the entire nozzle.

The 428445 cutting starter kit contains:

- 1 HyAccess electrode
- 1 HyAccess cutting nozzle
- 1 HyAccess retaining cap

The 428414 cutting/gouging starter kit contains:

- 2 HyAccess electrodes
- 1 HyAccess cutting nozzle
- 1 HyAccess gouging nozzle
- 1 HyAccess retaining cap
- 1 swirl ring (standard Powermax45 XP swirl ring)

CopperPLUS™ electrode

The CopperPLUS electrode (220777) delivers at least 2 times longer consumable life over standard consumables (Hypertherm consumables designed for the system). This electrode is designed exclusively for use with Duramax and Duramax Lock torches when cutting metal up to 12 mm (1/2 inch).

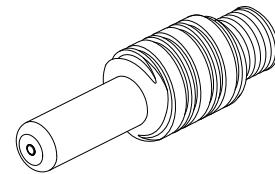

220777

Consumable life

Many factors influence how often you need to change the consumables on your hand torch:

- **Poor gas supply quality**
 - It is extremely important to maintain a clean, dry gas line. The presence of oil, water, vapor, and other contaminants in the gas supply can degrade cut quality and consumable life. See page 35 and page 39.
- **Cutting technique**
 - Whenever possible, start cuts from the edge of the workpiece. This helps to extend the life of the shield and the nozzle. See page 67.
 - Use the proper piercing technique for the thickness of metal you are cutting. In many instances, a rolling pierce technique is an efficient way to pierce the metal while minimizing the consumable wear that naturally occurs during piercing. See page 68 for an explanation of the straight pierce and rolling pierce techniques and when each is appropriate.

■ **Shielded versus non-shielded consumables**

- Non-shielded consumables use a deflector instead of a shield. They can provide better visibility and accessibility for some cutting applications. The trade-off is that non-shielded consumables generally have a shorter life than shielded consumables.

■ **Thickness of metal being cut**

- In general, the thicker the metal being cut, the more quickly the consumables become worn. For best results, do not exceed the thickness specifications for this system. See page 22.



See page 154 for guidelines on when to replace worn consumables.

■ **Expanded metal cutting**

- Expanded metal has a slotted or mesh pattern. Cutting expanded metal wears out consumables more quickly because it requires a continuous pilot arc. A pilot arc occurs when the torch is fired but the plasma arc is not in contact with the workpiece.

■ **Incorrect consumables for output current and mode**

- To optimize consumable life, make sure the consumables installed on the torch match the selected mode and output current. For example:
 - Do not use gouging consumables when the system is set to Cut mode. See page 51.
 - Do not set the output current between 26 A and 45 A with the Precision gouging consumables installed.

■ **Unnecessary arc stretch when cutting**

- To maximize consumable life, avoid stretching the arc when it is not necessary. Drag the torch on the workpiece whenever possible. See page 66.

■ **Insufficient arc stretch when gouging**

- A proper arc stretch while gouging maintains distance between the torch tip and the molten metal that builds up during the gouge. See page 75.
 - An arc stretch of 19 – 25 mm (3/4 – 1 inch) is recommended for gouging with the Maximum Control gouging consumables at 26 – 45 A.
 - An arc stretch of 10 – 11 mm (3/8 – 1/2 inch) is recommended for gouging with the Precision gouging consumables at 10 A– 25 A.

Prepare to fire the torch

WARNING

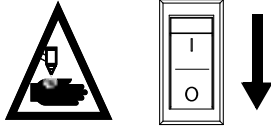

INSTANT-ON TORCHES – PLASMA ARC CAN CAUSE INJURY, BURNS

The plasma arc ignites immediately when you pull the torch trigger. Before changing consumables, one of the following actions must be taken. Whenever possible, complete the first action.

- Turn OFF (O) the plasma power supply.

OR

- Move the torch-disable switch to the yellow lock (X) position (closest to the torch lead). Pull the trigger to make sure the torch does not fire a plasma arc.

The plasma arc will cut quickly through gloves and skin.

- Wear correct and appropriate protective equipment.
- Keep hands, clothing, and objects away from the torch tip.
- Do not hold the workpiece. Keep your hands clear of the cutting path.
- Never point the torch toward yourself or others.

To prevent accidental firing, the hand torch is equipped with a torch-disable switch and a safety trigger. To fire the torch:

1. Install the correct consumables. See page 46.
2. Make sure the torch-disable switch is in the green “ready to fire” (✓) position.



The first time you pull the torch trigger after you set the torch to the “ready to fire” position, the torch may emit multiple puffs of air in quick succession. This warns you that the torch is active and will fire an arc the next time the trigger is pulled. See page 45.

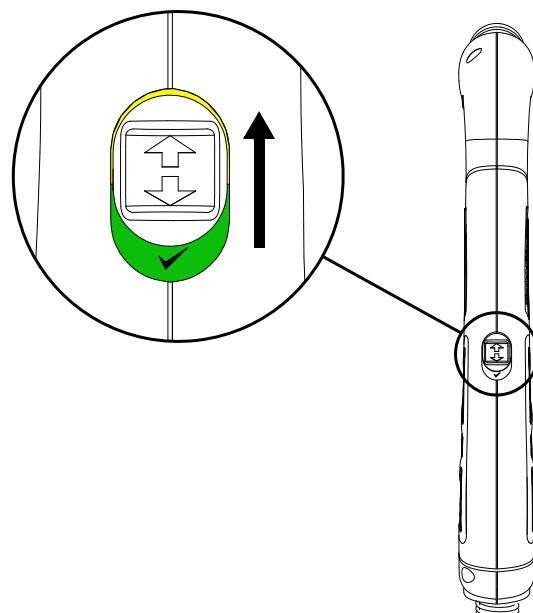

3 Cut with the Hand Torch

3. Flip the trigger's safety cover forward (toward the torch head) and press the red torch trigger.

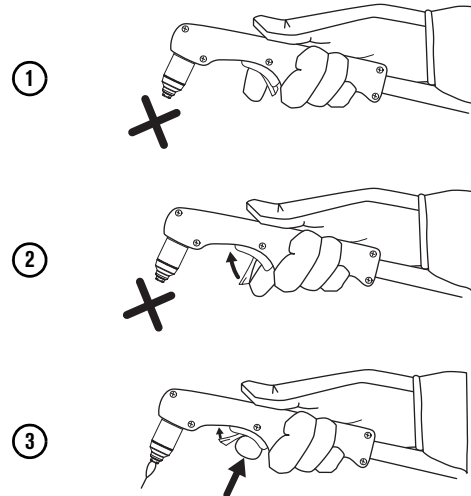

Hand torch cutting guidelines

- Drag the torch tip lightly along the workpiece to maintain a steady cut.



Sometimes the torch sticks slightly to the workpiece when you cut with FineCut consumables.

- Pulling, or dragging, the torch along the cut is easier than pushing it.
- If sparks spray up from the workpiece, move the torch more slowly, or set the output current higher.
- While cutting, make sure that sparks exit from the bottom of the workpiece. The sparks should lag slightly behind the torch as you cut (15° – 30° angle from vertical).
- Hold the torch tip perpendicular to the workpiece so that the head of the torch is at a 90° angle to the cutting surface. Observe the cutting arc as the torch cuts.

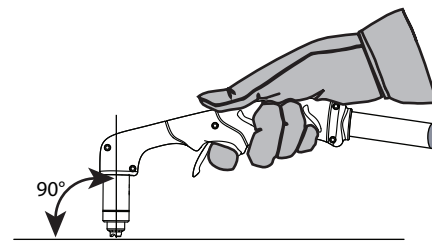

- If you fire the torch unnecessarily, you will shorten the life of the nozzle and electrode.
- For straight-line cuts, use a straight edge as a guide. To cut circles, use a template or a radius cutter attachment (a circle cutting guide). For beveled cuts, use a bevel cutting guide. See *Accessory parts* on page 168.

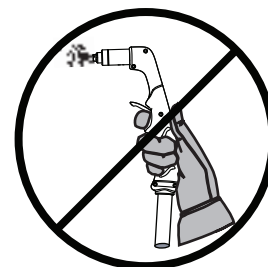



To troubleshoot issues with cut quality, see *Common cutting issues* on page 136.

Start a cut from the edge of the workpiece

Edge starting, when possible, is a good way to reduce damage to the shield and nozzle that can be caused by the slag produced during piercing. This helps to optimize consumable life.

1. With the work clamp attached to the workpiece, hold the torch tip perpendicular (90°) to the edge of the workpiece.



2. Press the torch's trigger to start the arc. Pause at the edge until the arc has cut completely through the workpiece.



3. Drag the torch lightly across the workpiece to proceed with the cut. Maintain a steady, even pace.



Pierce a workpiece

WARNING!



SPARKS AND HOT METAL CAN INJURE EYES AND BURN SKIN

When firing the torch at an angle, sparks and hot metal will spray out from the nozzle. Point the torch away from yourself and others. Always wear proper protective equipment including gloves and eye protection.

The hand torch can pierce interior features on metal with a thickness of up to 12 mm (1/2 inch).

The type of pierce to perform depends on the thickness of the metal.

- **Straight pierce** – To cut metal that is thinner than 8 mm (5/16 inch).
- **Rolling pierce** – To cut metal that is 8 mm (5/16 inch) or thicker.

1. Attach the work clamp to the workpiece.

2. **Straight pierce:** Hold the torch perpendicular (90°) to the workpiece.

Rolling pierce: Hold the torch at an approximate 30° angle to the workpiece with the torch tip within 1.5 mm (1/16 inch) of the workpiece before firing the torch.

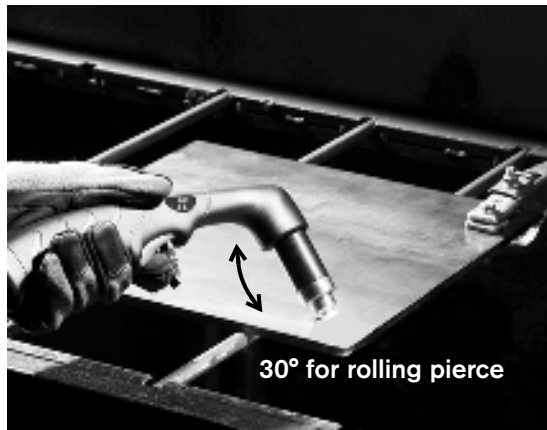

3. Straight pierce: Press the torch trigger to start the arc.

Rolling pierce: Press the torch trigger to start the arc while still at an angle to the workpiece, then rotate the torch to the perpendicular (90°) position.



4. Hold the torch in place while continuing to press the trigger. When sparks exit below the workpiece, the arc has pierced the material.



5. When the pierce is complete, drag the torch tip lightly along the workpiece to proceed with the cut.

3 *Cut with the Hand Torch*

4

Gouge with the Hand Torch and Machine Torch

Gouging processes

This system offers 2 gouging processes. Each process uses its own set of consumables:

- **Maximum Control gouging**
 - Use this process to remove metal and to achieve a controlled gouge profile.
- **Precision gouging**
 - Use this process to achieve a very shallow gouge and a lower metal removal rate than with Maximum Control gouging. For example, this process is useful for removing spot welds and for washing material at very low depths.

Before you use either process, press the **Mode** button on the front panel to set the plasma power supply to Gouge/Marking mode. See page 51.

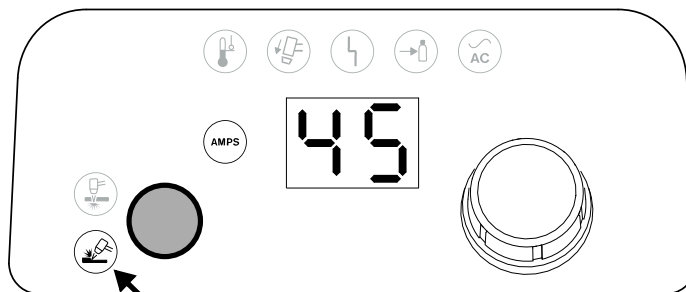

Make sure the Gouge/Marking Mode LED is illuminated.

Maximum Control gouging

- Use the Maximum Control gouging consumables.



Hypertherm also offers *Maximum Removal* gouging consumables. At higher amperages on other Powermax systems, you can use the Maximum Removal consumables for greater metal removal rate and deeper gouge profiles. However, at 45 A with this system and torch, the Maximum Removal consumables do not offer an advantage over the Maximum Control consumables in terms of metal removal rate. You can expect each set of consumables to produce similar results on this system.

- Set the output current between 26 A and 45 A.
 - Gouging at lower amperages (10 – 25 A) can limit the torch's arc stretch capability. In some instances it may also cause the arc to extinguish or trigger a “torch stuck open” (TSO) fault. See page 148.

Maximum Control gouging consumables (26 – 45 A)

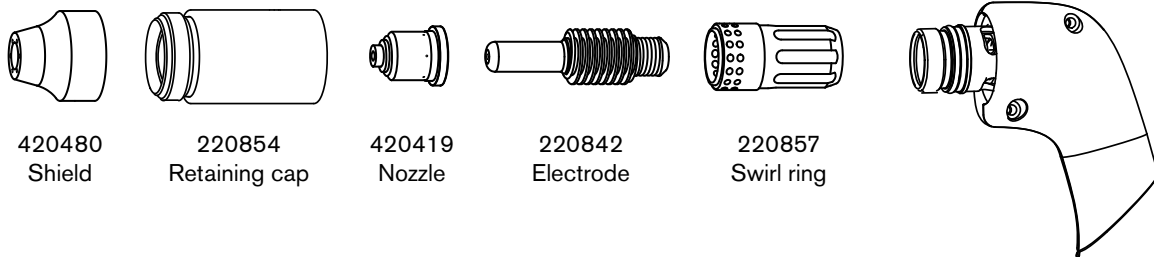

Precision gouging

- Use the Precision gouging consumables.
- Set the output current between 10 A and 25 A.
 - Gouging at higher amperages (26 – 45 A) can shorten the life of the nozzle.

Precision gouging consumables (10 – 25 A)

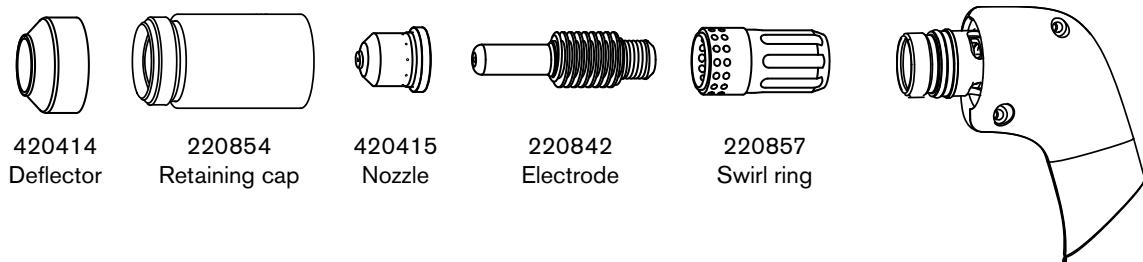

Specialty consumables

HyAccess gouging consumables

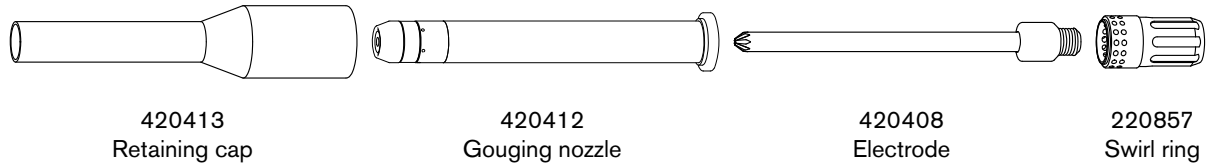

HyAccess consumables extend the reach of the regular shielded consumables by approximately 7.5 cm (3 inches). Use them with your hand torch to achieve greater reach and visibility.



HyAccess cutting consumables are also available. For more information on HyAccess consumables, see page 62.

You can order each HyAccess consumable separately or in starter kits. When the tip of the nozzle wears out, replace the entire nozzle.

The 428446 gouging starter kit contains:

- 1 HyAccess electrode
- 1 HyAccess gouging nozzle
- 1 HyAccess retaining cap

The 428414 cutting/gouging starter kit contains:

- 2 HyAccess electrodes
- 1 HyAccess cutting nozzle
- 1 HyAccess gouging nozzle
- 1 HyAccess retaining cap
- 1 swirl ring (standard Powermax45 XP swirl ring)

How to control the gouge profile

The following factors affect the width and the depth of the gouge profile. Adjust these elements to achieve the gouge you need.

- **Output current of the plasma power supply** – Turn down the amperage on the front panel to make the gouge narrower and more shallow.
 - If you are using the Maximum Control gouging consumables, keep the amperage between 26 – 45 A.
 - If you are using the Precision gouging consumables, keep the amperage between 10 – 25 A.
- **Angle of the torch to the workpiece** – Position the torch in a more upright position to make the gouge narrower and deeper. Tilt down the torch so that it is closer to the workpiece to make the gouge wider and more shallow.
- **Rotation of the torch** – Rotate the torch relative to the torch center line to make the gouge flatter and steeper on one side.
- **Torch-to-work standoff** – Move the torch further away from the workpiece to make the gouge wider and more shallow. Move the torch closer to the workpiece to make the gouge narrower and deeper.
- **Speed of the torch over the workpiece** – Slow down to make the gouge wider and deeper. Speed up to make the gouge narrower and more shallow.

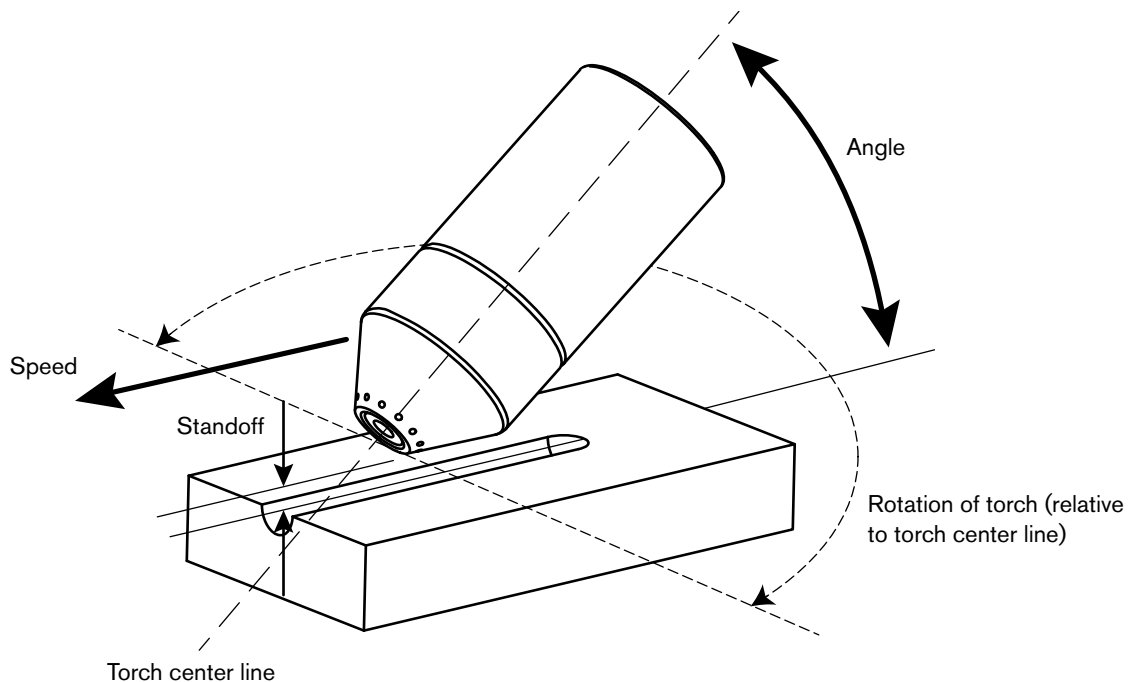

Gouge with the hand torch

WARNING!



SPARKS AND HOT METAL CAN INJURE EYES AND BURN SKIN

When firing the torch at an angle, sparks and hot metal will spray out from the nozzle. Point the torch away from yourself and others. Always wear proper protective equipment including gloves and eye protection.

1. Install the Maximum Control gouging consumables or the Precision gouging consumables.
2. Set the system to Gouge/Marking mode. See page 51.
3. Set the output current to match the consumables installed:
 - Maximum Control gouging consumables: 26 – 45 A
 - Precision gouging consumables: 10 – 25 A
4. Hold the torch at approximately a 40° angle to the workpiece before firing the torch.
 - Maximum Control gouging consumables: Hold the torch approximately 6 mm (1/4 inch) above the workpiece.
 - Precision gouging consumables: Hold the torch approximately 2 – 3 mm above the workpiece.

Press the trigger to obtain a pilot arc. Transfer the arc to the workpiece.

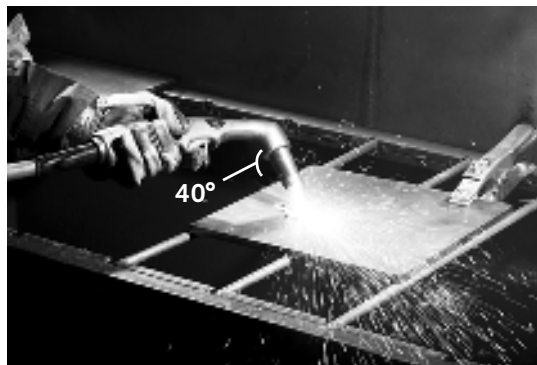

5. Stretch the arc as follows:
 - Maximum Control gouging consumables: 19 – 25 mm (3/4 – 1 inch)
 - Precision gouging consumables: 10 – 11 mm (3/8 – 1/2 inch)

6. Change the torch's angle as needed to achieve the desired dimensions for the gouge. Maintain the same angle to the workpiece as you feed into the gouge. Push the plasma arc in the direction of the gouge you want to create.

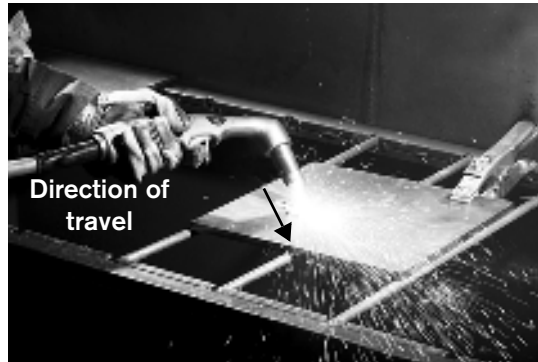

Keep at least a small distance between the torch tip and the molten metal to avoid reducing consumable life or damaging the torch.

Remove spot welds

To remove a spot weld, gouge around the weld in order to cut completely through the top layer of metal without damaging the layer underneath.

The Precision gouging consumables were designed specifically for applications like removing spot welds. When used at a lower amperage, these consumables provide:

- Very good visibility due to a plasma arc that is lighter and more opaque than with higher amperage gouging
- A very high width-to-depth ratio, which provides much better control of the metal removal rate

Tips

Many different techniques can be used to remove spot welds. The method described in the following procedure is recommended as a good starting point. It is intended to minimize possible damage to the underneath layer.

Regardless of technique, these tips can help you to successfully remove spot welds:

- **Keep the torch pointed in the same direction all the way around the spot weld.**
 - By keeping the torch pointed in the same direction, you avoid blowing slag over areas you already gouged. This reduces the clean-up needed on the underneath layer. It also makes the process more ergonomic and efficient, since you do not need to rotate the torch or the workpiece while gouging.
- **Maintain a proper arc stretch.**
 - Maintain an arc stretch of approximately 10 – 11 mm (3/8 – 1/2 inch) as you gouge around the weld. This provides good visibility and prevents the torch tip from hitting slag, which can shorten consumable life and interrupt the gouge.

- **Start at a lower output current, and gradually increase it.**
 - Start with the current set to 10 A if you have never removed a spot weld before. Once you develop a technique you are comfortable with, try gradually increasing the output current. This enables you to gouge with better speed and efficiency.

Procedure

This procedure describes how to separate 2 metal layers and then remove the spot weld from the underneath layer.



The pictures in this procedure show mild steel plates. The slag on stainless steel is darker, more jagged, and harder to remove.

1. Install the Precision gouging consumables.
2. On the front panel, select Gouge/Marking mode. Set the output current to 10 – 25 A.
3. Position the torch on one side of the spot weld. Hold the torch at approximately a 40° – 45° angle to the workpiece.

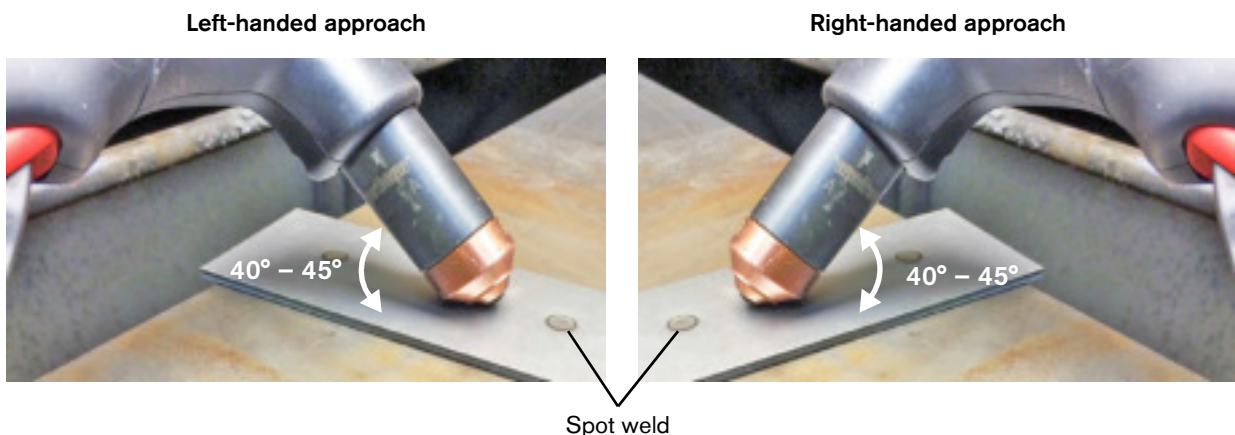

4. Press the trigger to obtain a pilot arc. Transfer the arc to the workpiece, then stretch the arc to approximately 10 – 11 mm (3/8 – 1/2 inch). Maintain this arc as you gouge.
5. Make 2 separate gouges in an “L”-shaped motion to gouge all the way around the spot weld. See *Table 1* on page 78.
 - *Table 1* shows one example of this technique (for both right-handed and left-handed gouging). You can start at different points around the spot weld. The important thing is to keep the torch pointed in the same direction all the way around the weld.
 - As you gouge, use very short strokes in a back-and-forth weaving motion until you have cut through the top layer.
 - You may need to adjust the angle of the torch slightly, depending on the thickness of the metal.

Table 1 – Gouging around the spot weld

Right-handed approach

Spot weld

Start

Stop

Start

Stop

Left-handed approach

Start

Spot weld

Stop

Start

Stop

6. Make sure you have gouged completely through the top layer. Pull the metal plates apart.

7. Use the same gouging process to remove the spot weld that remains on the bottom plate.

- ❑ To avoid damaging the bottom plate, you may want to turn down the output current to 10 A. Increase the current if needed based on the thickness of the metal.
- ❑ Hold the torch at a 40° – 45° angle. Slightly adjust the angle of the torch as needed based on the thickness of the metal.
- ❑ Stretch the arc to approximately 10 – 11 mm ($3/8$ – $1/2$ inch) as you gouge.
- ❑ Use very short strokes in a back-and-forth weaving motion until you have removed the spot weld.



Some scraping or grinding may be required to completely remove all remnants of the spot weld from the bottom plate.



Spot weld on bottom plate



Spot weld removed

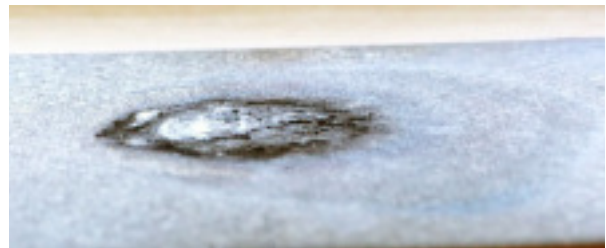

Gouge with the machine torch

You can vary the gouge profile by adjusting the:

- Output current (amperage) of the power supply
- Angle of the torch to the workpiece
- Rotation of the torch relative to the torch center line
- Torch-to-work standoff
- Speed of the torch over the workpiece

See page 74 for more details.

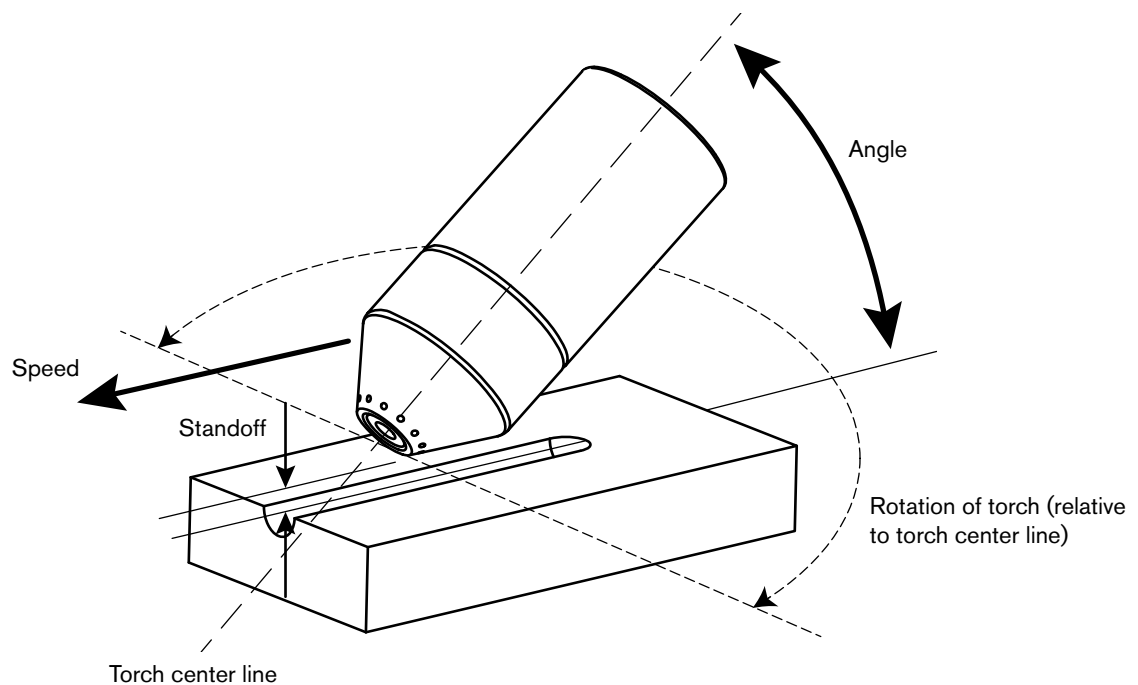

Typical gouge profiles

Maximum Control gouging consumables (45 A)

Operating parameters	
Speed	254 – 1016 mm/min (10 – 40 in/min)
Standoff	6 mm (1/4 inch)
Angle	40° – 50°
Output current	26 – 45 A
Consumables	Maximum Control gouging consumables
Gas	Air

45 A

Metal removal rate on mild steel:
3.4 kg/hour (7.5 pounds/hour)

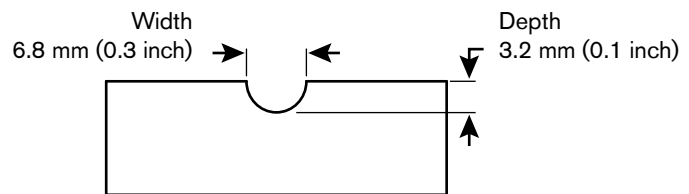

The following tables show the 45 A gouging profile at 40° and 50° on mild steel and stainless steel. These settings are intended to serve as a starting point to help you determine the best gouging profile for a given cutting job. Adjust these settings as needed for your application and table to obtain the desired result.

Table 2 – Mild steel (Metric)

Torch angle	Speed (mm/min)	Depth (mm)	Width (mm)	Width/depth ratio
40°	254	4.6	8.4	1.83
	508	3.2	6.8	2.13
	762	1.9	5.9	3.11
	1016	1.4	5.2	3.71
50°	254	5.0	6.7	1.34
	508	3.4	5.2	1.53
	762	2.7	4.9	1.81
	1016	2.2	4.6	2.09

4 Gouge with the Hand Torch and Machine Torch

Table 3 – Mild steel (English)

Torch angle	Speed (in/min)	Depth (inches)	Width (inches)	Width/depth ratio
40°	10	0.183	0.331	1.81
	20	0.126	0.268	2.13
	30	0.074	0.231	3.12
	40	0.055	0.206	3.74
50°	10	0.195	0.263	1.35
	20	0.132	0.205	1.55
	30	0.107	0.192	1.79
	40	0.088	0.181	2.06

Table 4 – Stainless steel (Metric)

Torch angle	Speed (mm/min)	Depth (mm)	Width (mm)	Width/depth ratio
40°	254	2.9	6.2	2.14
	508	2.0	5.7	2.85
	1016	1	4.8	4.8
50°	254	5.3	5.7	1.08
	508	3.5	5.0	1.43
	1016	2.0	3.8	1.90

Table 5 – Stainless steel (English)

Torch angle	Speed (in/min)	Depth (inches)	Width (inches)	Width/depth ratio
40°	10	0.114	0.245	2.15
	20	0.080	0.222	2.76
	40	0.048	0.190	3.96
50°	10	0.210	0.224	1.07
	20	0.139	0.199	1.43
	40	0.080	0.150	1.88

Precision gouging consumables (10 A)

Operating parameters	
Speed	254 – 762 mm/min (10 – 30 in/min)
Standoff	0.3 – 1.3 mm (0.01 – 0.05 inch)*
Angle	40° – 50°
Output current	10 – 25 A
Consumables	Precision gouging consumables
Gas	Air

* Increase the standoff to a maximum of 3 – 4 mm (0.12 – 0.16 inch) for a very light gouge.

10 A

Metal removal rate on mild steel:
0.2 kg/hour (0.5 pounds/hour)

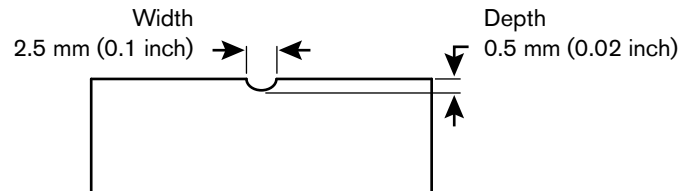

The following tables show the 10 A gouging profile at 40° and 50° on mild steel. These settings are intended to serve as a starting point to help you determine the best gouging profile for a given cutting job. Adjust these settings as needed for your application and table to obtain the desired result.

Table 6 – Mild steel (Metric)

Torch angle	Standoff (mm)	Speed (mm/min)	Depth (mm)	Width (mm)	Width/depth ratio
40°	0.3	254	0.5	3.3	6.6
	0.3	508	0.3	2.4	8
	0.3	762	0.1	2.2	22
	1.3	254	0.3	3	10
	1.3	508	0.1	2.2	22
	1.3	762	0.05	1.9	38

Torch angle	Standoff (mm)	Speed (mm/min)	Depth (mm)	Width (mm)	Width/depth ratio
50°	0.3	254	1.1	2.6	2.36
	0.3	508	0.6	2.3	3.83
	0.3	762	0.4	2.0	5
	1.3	254	1.1	2.8	2.55
	1.3	508	0.5	2.4	4.8
	1.3	762	0.25	2.1	8.4

Table 7 – Mild steel (English)

Torch angle	Standoff (inches)	Speed (in/min)	Depth (inches)	Width (inches)	Width/depth ratio
40°	0.01	10	0.0207	0.129	6.23
	0.01	20	0.0113	0.095	8.41
	0.01	30	0.0044	0.088	20
	0.05	10	0.0122	0.12	9.84
	0.05	20	0.004	0.088	22
	0.05	30	0.002	0.074	37
50°	0.01	10	0.0427	0.103	2.41
	0.01	20	0.0222	0.09	4.05
	0.01	30	0.0147	0.08	5.44
	0.05	10	0.043	0.11	2.56
	0.05	20	0.0208	0.095	4.57
	0.05	30	0.01	0.084	8.4

Troubleshooting tips for gouging

When gouging, always make sure:

- Gouging consumables are installed, and the output current matches those consumables.
- The power supply is set to Gouge/Marking mode.

Many common metal removal issues can be resolved by installing new consumables in the torch. Do not use worn or damaged consumables. See page 154.

Problem	Solution
The arc goes out during gouging.	<ul style="list-style-type: none"> ▪ Decrease the arc stretch (standoff). ▪ Increase the angle of the torch to the workpiece.
The torch tip bumps into slag.	<ul style="list-style-type: none"> ▪ Increase the arc stretch (standoff). ▪ Keep the torch tip pointed in the direction of the gouge you want to create.
The gouge is too deep.	<ul style="list-style-type: none"> ▪ Decrease the angle of the torch to the workpiece. ▪ Increase the arc stretch (standoff). ▪ Increase the gouging speed. ▪ Decrease the output current. Do not set the output current below 26 A if you are using the Maximum Control gouging consumables.
The gouge is too shallow.	<ul style="list-style-type: none"> ▪ Increase the angle of the torch to the workpiece. ▪ Decrease the arc stretch (standoff). ▪ Decrease the gouging speed. ▪ Increase the output current. Do not set the output current above 25 A if you are using the Precision gouging consumables.
The gouge is too wide.	<ul style="list-style-type: none"> ▪ Increase the angle of the torch to the workpiece. ▪ Decrease the arc stretch (standoff). ▪ Increase the gouging speed. ▪ Decrease the output current. Do not set the output current below 26 A if you are using the Maximum Control gouging consumables.
The gouge is too narrow.	<ul style="list-style-type: none"> ▪ Decrease the angle of the torch to the workpiece. ▪ Increase the arc stretch (standoff). ▪ Decrease the gouging speed. ▪ Increase output current. Do not set the output current above 25 A if you are using the Precision gouging consumables.
When removing a spot weld, the arc pierces the bottom metal plate.	<ul style="list-style-type: none"> ▪ Decrease the output current (amperage). ▪ Make sure the Precision gouging consumables are installed. ▪ Maintain a steady gouging speed and gouge only until the bottom metal plate is visible. ▪ Increase the arc stretch to approximately 10 – 11 mm (3/8 – 1/2 inch).
The spot weld is not visible while gouging.	<ul style="list-style-type: none"> ▪ Stretch the arc to approximately 10 – 11 mm (3/8 – 1/2 inch) for better visibility of the spot weld. ▪ Make sure the Precision gouging consumables are installed. ▪ Make sure the output current is not set above 25 A.

4 *Gouge with the Hand Torch and Machine Torch*

5

Set Up the Machine Torch

Duramax Lock machine torch features include:

- A torch-disable switch that prevents the torch from firing accidentally even when the power supply is ON. See *Disable the torch* on page 44.
- The FastConnect™ quick-disconnect system to easily remove the torch for transport or to switch from one torch to another.
- Automatic cooling with ambient air. Special cooling procedures are not needed.

This section provides information on:

- Machine torch components and dimensions
- Setup details for installing the torch on X-Y tables, track burners, pipe bevelers, or other mechanized equipment

Machine torch components, dimensions, weights

Components

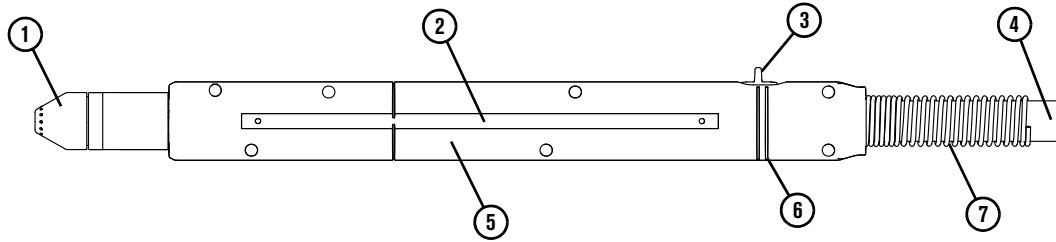

- | | |
|--------------------------------|--------------------------------|
| 1 Consumables | 5 Shell |
| 2 32-pitch removable gear rack | 6 Switch position lines |
| 3 Torch-disable switch | 7 Strain relief for torch lead |
| 4 Torch lead | |

Dimensions

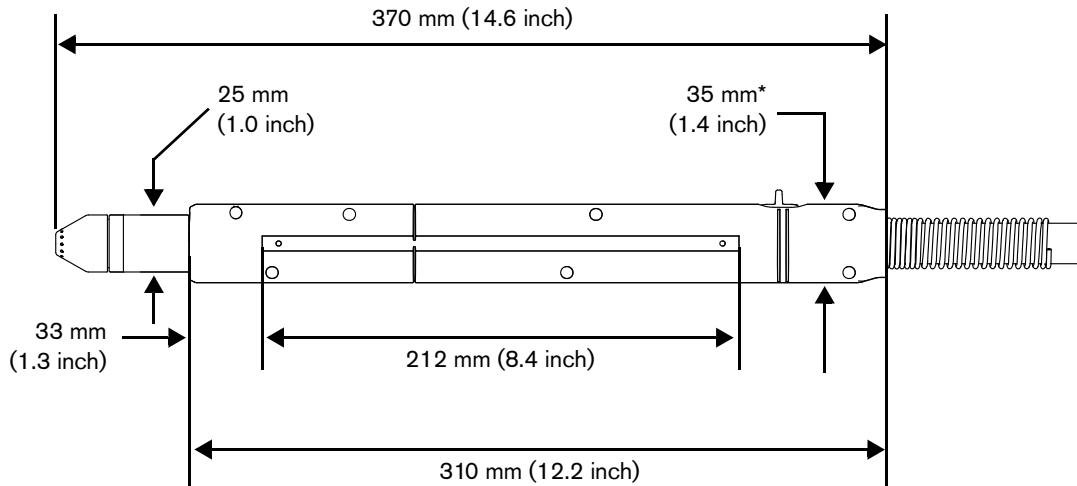

* This measurement is for the outer dimension of the torch. The height of the outer torch shell is 41 mm (1.6 inch) when the torch-disable switch is included.

Weights

Torch	Weight
Machine torch with 7.6 m (25 foot) lead	3.2 kg (7.1 pounds)
Machine torch with 10.7 m (35 foot) lead	4.2 kg (9.3 pounds)
Machine torch with 15 m (50 foot) lead	5.8 kg (12.7 pounds)

Mount the torch

The machine torch can be mounted on a wide variety of X-Y tables, track burners, pipe bevelers, and other equipment. Install the torch per the table or equipment manufacturer's instructions.

If your cutting table's track is large enough for you to route the torch through it without removing the torch shell, do so and then attach the torch to the lifter per the manufacturer's instructions.

Remove the gear rack

The gear rack can be mounted on either side of the torch. If you need to remove the gear rack, remove the 2 screws that secure the rack to the torch shell.



When you install the gear rack, tighten the screws by hand. To avoid stripping the screws, do not overtighten.

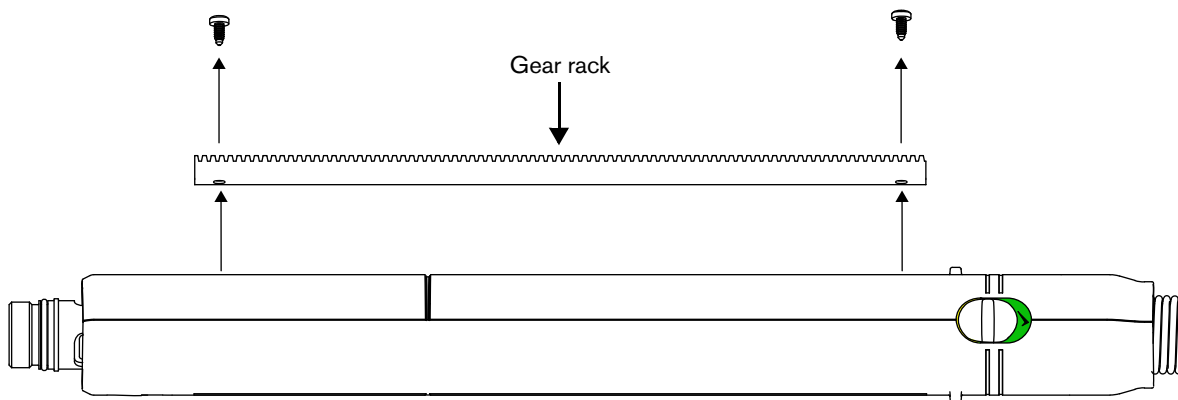

Disassemble the machine torch

Use the following procedure if you need to disassemble the torch to route the torch through the cutting table's track or other mounting system.



While disconnecting and reconnecting the torch parts, do not twist the torch or the lead. Maintain the same orientation between the torch head and torch lead. Twisting the torch head in relation to the torch lead can damage the torch wires.

1. Disconnect the torch from the plasma power supply.
2. Remove the consumables from the torch.
3. Place the torch on a flat surface with the left side of the shell facing up.



The left side of the shell is the side with the screws.

4. Remove the 7 screws from the torch shell. Set the screws aside.
5. Carefully pry the left side of the shell away from the torch.

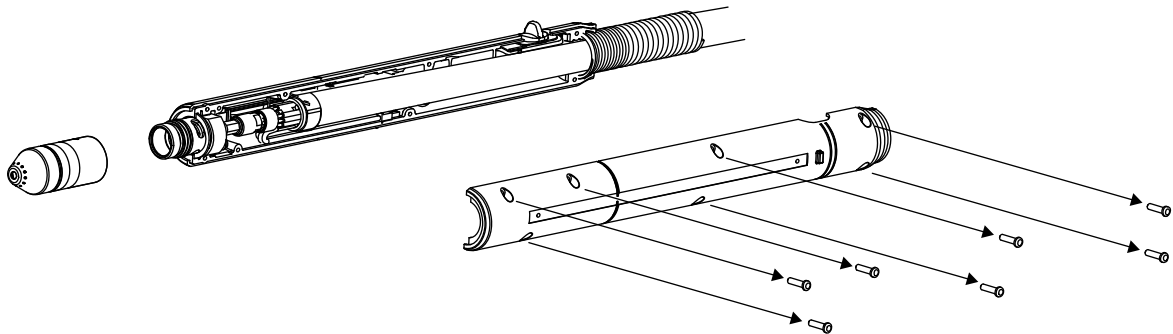

6. Remove the plastic slider ① for the torch-disable switch and set it aside.
7. The torch body fits snugly into the right side of the shell. Gently pry the head of the torch body out and away from the right side of the shell to remove it.

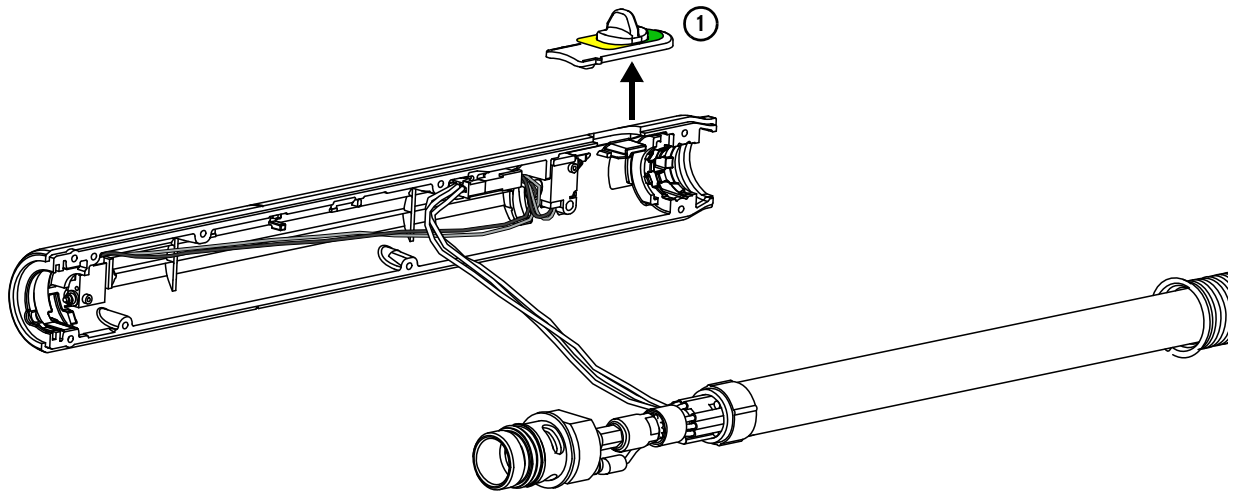

8. Disconnect the wires that sit in the right shell. Press down the tab on the wire connector to pull the 2 sides apart.

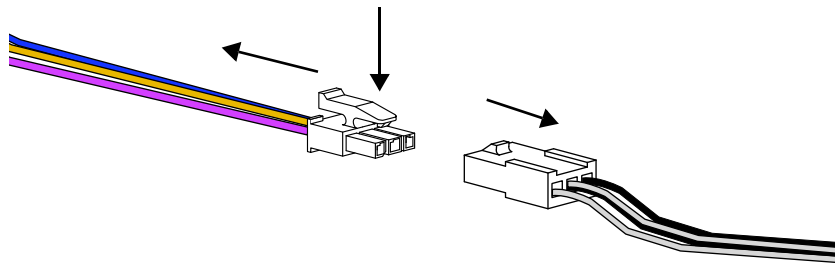

9. You can now route the torch body and the torch lead through the mounting system for the cutting table.



Slide the strain relief along the torch lead as needed to move it out of the way as you route the torch lead through the track.

Assemble the machine torch

If you disassembled the torch to route it through the cutting table's track or other mounting system, use the following procedure to reassemble the torch.

 While disconnecting and reconnecting the torch parts, do not twist the torch or the lead. Maintain the same orientation between the torch head and torch lead. Twisting the torch head in relation to the torch lead can cause damage to the torch wires.

1. Place the right torch shell on a flat surface.
2. Make sure the cap-sensor switch ① and the torch-disable switch ② sit in the right torch shell as shown. Mounting posts in the torch shell hold each switch in place.

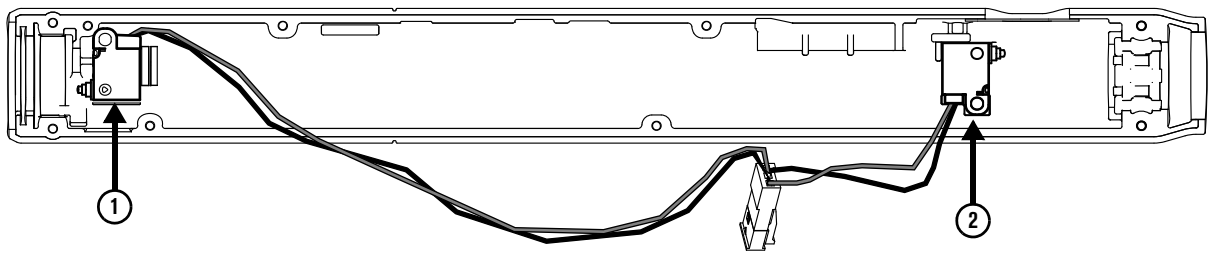

3. Connect the wires from the torch body ③ to the wires from the cap-sensor switch/torch-disable switch assembly ④.

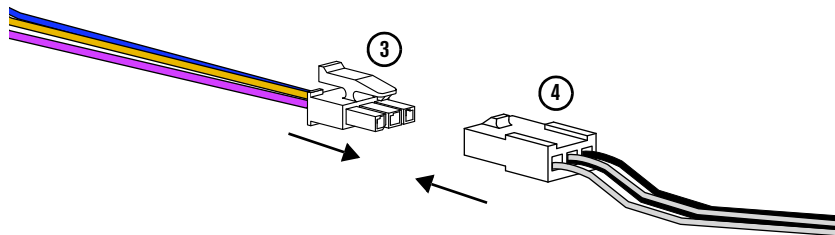

4. Place the wire connector ⑤ on the mounting shelf in the right torch shell as shown.
Route the blue and black wires from the cap-sensor switch and the torch-disable switch outside of and below the mounting shelf. This helps to prevent the wires from getting pinched and damaged when the torch is fully assembled.

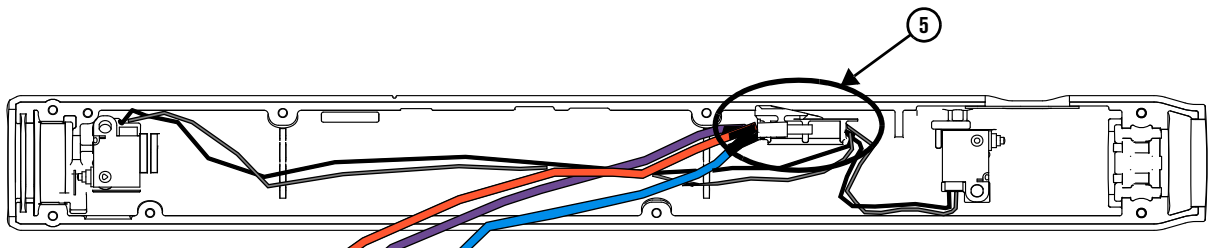

5. Push the right torch shell onto the head of the torch body as shown. Make sure:
- ❑ The torch shell fits over the flat edges of the torch head. The rounded edge of the torch head should be facing up.
 - ❑ The wire connector from the previous step remains in place on the mounting shelf. Hold the wire connector in place as you fit the torch body into the torch shell.



6. Fit the rest of the torch body into the right torch shell as shown. As you do, tuck all of the wires under the torch body. Do not pinch or crimp the wires. Make sure none of the wires are covering the screw holes in the torch shell.

7. Fit the strain relief ⑥ into the base of the right torch shell.



8. Put the plastic slider for the torch-disable switch into place in the yellow lock (X) position.

 If you try to put the torch back together with the slider in the green "ready to fire" (✓) position, you can damage the torch-disable switch that is inside the shell behind the torch body.

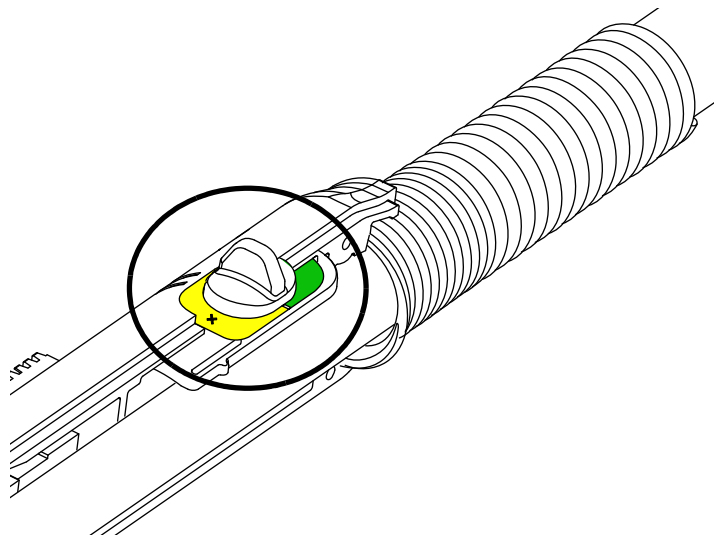

5 Set Up the Machine Torch

9. Attach the left torch shell to the right torch shell using the 7 screws. Firmly grasp the torch shells at the base near the strain relief and hold them together as you install the screws.

CAUTION

Be careful to avoid pinching the wires between the torch shells. This can damage the wires and prevent the torch from operating properly.

10. Examine the torch to make sure no wires are pinched where the torch shells meet.
11. Attach the torch to the lifter per the manufacturer's instructions.
12. Reinstall the consumables on the torch. See page 31.

Align the torch

Mount the machine torch perpendicular to the workpiece to get a vertical cut. Use a square to align the torch at 90° angles to the workpiece.

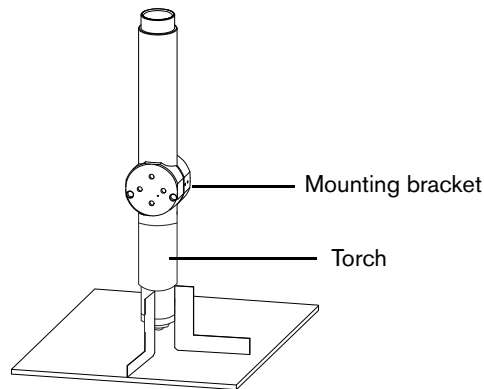

Position the mounting bracket as low on the torch as possible to minimize vibration at the tip of the torch.

6

Configure Controls for Mechanized Cutting

Machine torch setup overview

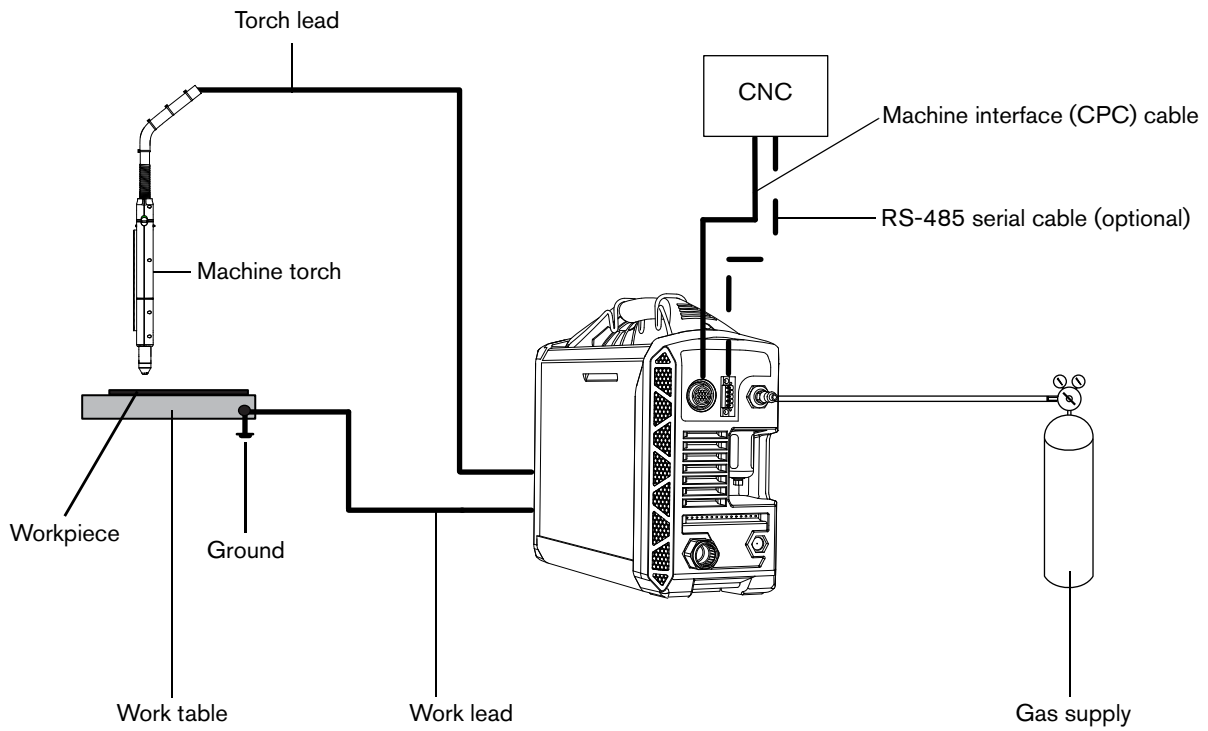

! WARNING



GAS CYLINDERS CAN EXPLODE IF DAMAGED

Gas cylinders contain gas under high pressure. If damaged, a cylinder can explode.

For high pressure regulators, adhere to the manufacturer's guidelines for safe installation, operation, and maintenance.

Before plasma cutting with compressed gas, read the safety instructions in the *Safety and Compliance Manual (80669C)*. Failure to follow safety instructions can result in personal injury or in damage to equipment.

! WARNING



EXPLOSION HAZARD – CUTTING WITH ALUMINUM NEAR WATER

Do not cut aluminum alloys underwater or on a water table unless you can prevent the accumulation of hydrogen gas. Never cut aluminum-lithium alloys in the presence of water.

Aluminum can react with water to produce hydrogen, resulting in a potentially explosive condition that can detonate during plasma cutting operations. Refer to the *Safety and Compliance Manual (80669C)* for more information.

Set up the plasma system and machine torch for mechanized cutting

1. Attach the work lead from the plasma power supply to the work table.
2. Connect the gas supply to the plasma power supply. See page 34.
 - ❑ Use compressed air to cut mild steel, stainless steel, aluminum, and other conductive metals.
 - ❑ Use F5 to cut stainless steel. See page 111.
 - ❑ Use argon for marking applications. See page 113.
3. Connect the plasma power supply to your CNC (or other controller) using the machine interface (CPC) connection.
 - ❑ Your plasma system must be equipped with a factory-installed (or user-installed) CPC port with internal voltage divider board. See page 98.
 - ❑ A CPC connection is required to fire the torch and to control the signals for arc transfer and arc voltage.

4. Optional: Connect the plasma power supply to your CNC using the RS-485 serial interface connection.
 - ❑ To use the optional RS-485 serial interface, make sure your plasma system is equipped with a factory-installed (or user-installed) RS-485 serial interface port. See page 103.
 - ❑ The RS-485 serial interface provides added capabilities for controlling the plasma system from the CNC, but it cannot be used to fire the torch.
5. Attach the torch to the table or other cutting equipment per the manufacturer's instructions. See page 89 for additional information.
6. Install the correct cutting, gouging, or marking consumables for your application:
 - ❑ **Cutting and piercing with a machine torch:** See *Choose the consumables* on page 105.
 - ❑ **Gouging:** See *Gouging processes* on page 71.
 - ❑ **Marking:** See *Marking consumables (10 – 25 A)* on page 113.
7. Select Cut mode or Gouge/Marking mode on the front panel of the plasma power supply to match the consumables you installed. See *Cutting controls* on page 42.
8. Adjust the torch speed and output current (amperage) as needed. See the cut charts starting on page 121.

Connect the remote-start pendant

Powermax45 XP configurations with a Duramax Lock machine torch can include an optional remote-start pendant.

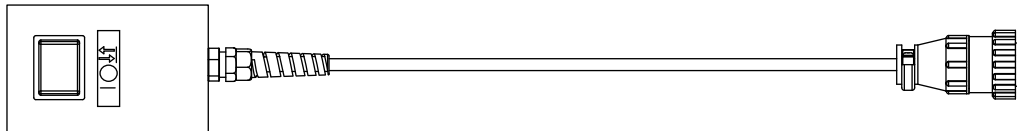

The remote-start pendant enables you to remotely start and stop the machine torch. For example, use it when you mount the torch on a simple track burner or cutting guide that does not have its own CNC or other controller.

To use the Hypertherm remote-start pendant, plug it into the CPC port on the rear of the power supply.

 The remote-start pendant is for use only with a machine torch. It will not operate if a hand torch is installed.

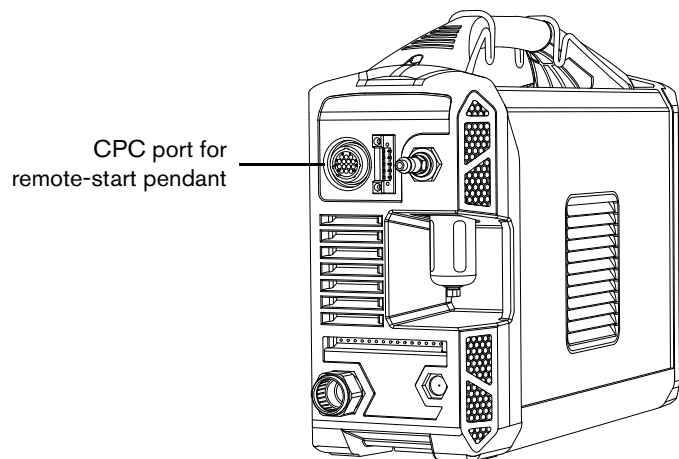

Connect the machine interface cable

To connect a machine interface cable to this system, a factory-installed (or user-installed) CPC port with 5-position voltage divider must be installed. The voltage divider provides a scaled down arc voltage of 20:1, 21.1:1, 30:1, 40:1, or 50:1 (maximum output of 16 V). The CPC port on the rear of the power supply provides access to the scaled down arc voltage and signals for arc transfer and plasma start.



The factory presets the voltage divider to 50:1. To change the voltage divider to a different setting, see page 101.

CAUTION

The internal voltage divider provides a maximum of 16 V under open circuit conditions. This is an impedance-protected functional extra low voltage (ELV) output to prevent shock, energy, and fire under normal conditions at the machine interface receptacle and under single fault conditions with the machine interface wiring. The voltage divider is not fault tolerant, and ELV outputs do not comply with safety extra low voltage (SELV) requirements for direct connection to computer products.

Hypertherm offers several choices of external machine interface cables.

External cables that do not use voltage divider board

To use signals for arc transfer and plasma start only, use one of the following cables:

- 023206 (7.5 m, 25 feet)
- 023279 (15 m, 50 feet)

These cables end in wires that are terminated with spade connectors.

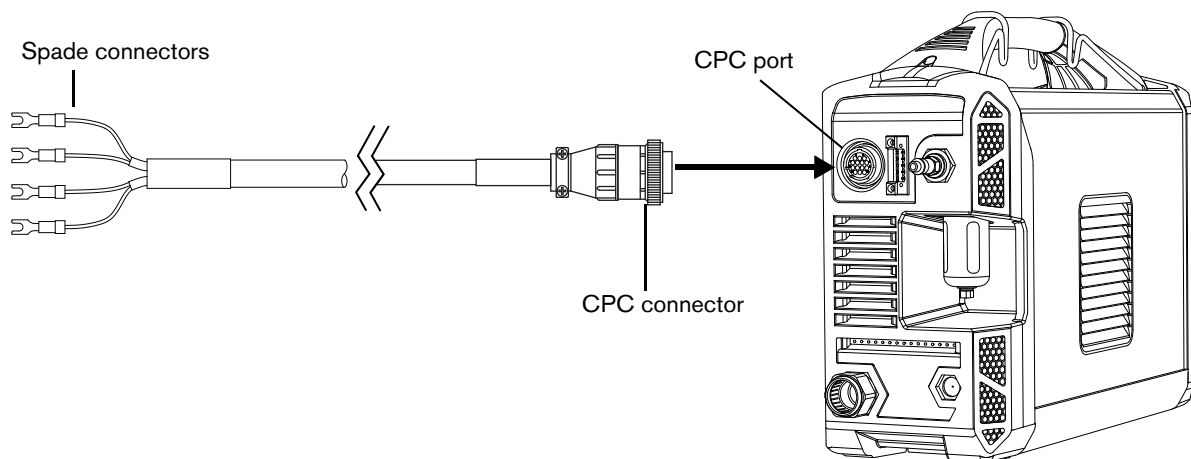

External cables that use voltage divider board

To use the built-in voltage divider that provides a scaled down arc voltage in addition to signals for arc transfer and plasma start:

- For wires terminated with spade connectors, use one of the following cables:
 - 228350 (7.6 m, 25 feet)
 - 228351 (15 m, 50 feet)
- For a cable with a D-sub connector, use one of the following cables:
 - 223354 (3.0 m, 10 feet)
 - 223355 (6.1 m, 20 feet)
 - 223048 (7.6 m, 25 feet)
 - 223356 (10.7 m, 35 feet)
 - 123896 (15 m, 50 feet)

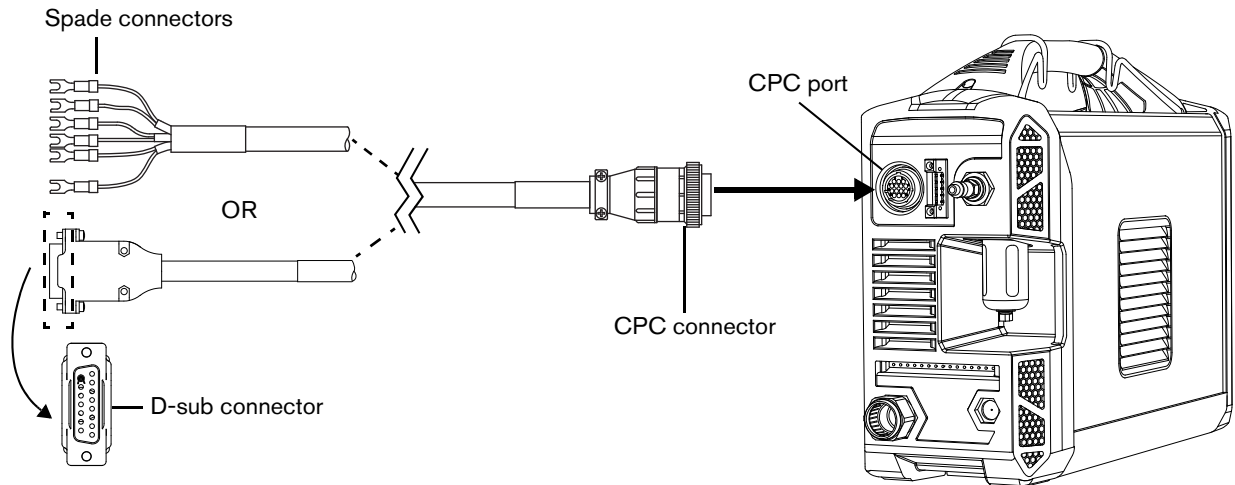

Installation of the machine interface cable

Installation of the machine interface cable must be performed by a qualified service technician. To install a machine interface cable:

1. Turn OFF (O) the power and disconnect the power cord.
2. Remove the machine interface receptacle's cover from the rear of the power supply.
3. Connect the Hypertherm machine interface cable to the power supply.
4. If you are using a cable with a D-sub connector on the other end:
 - a. Plug it into the appropriate pin connector on the torch height controller or CNC.
 - b. Secure it with the screws on the D-sub connector.

If you are using a cable with wires and spade connectors on the other end:

- a. Terminate the machine interface cable inside the electrical enclosure of the torch height controller or CNC controller. This prevents unauthorized access to the connections after installation.
- b. Verify that the connections are correct and that all live parts are enclosed and protected before operating the equipment.



The integration of Hypertherm equipment and customer-supplied equipment including interconnecting cords and cables, if not listed and certified as a system, is subject to inspection by local authorities at the final installation site.

Machine interface pinout

The following figure shows the connector sockets for each type of signal available through the machine interface cable.

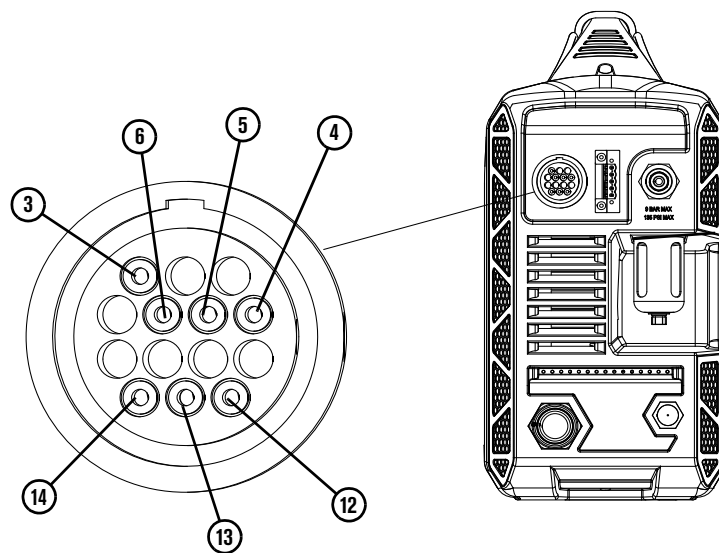

Machine interface cable signals

Refer to the following table for the cable signal details when connecting the power supply to a torch height controller or CNC controller with a machine interface cable.

Signal	Type	Notes	Connector sockets	External cable wires
Start (start plasma)	Input	Normally open. 15 VDC open circuit voltage at START terminals. Requires dry contact closure to activate.	3, 4	Green, black
Transfer (start machine motion)	Output	Normally open. Dry contact closure when the arc transfers. 120 VAC / 1 A maximum at the machine interface relay.	12, 14	Red, black
Ground	Ground		13	
Voltage divider	Output	Divided arc signal of 20:1, 21.1:1, 30:1, 40:1, 50:1 (provides a maximum of 16 V).	5 (-), 6 (+)	Black (-), white (+)

Set the 5-position voltage divider

To change the factory preset voltage divider from 50:1 to a different setting:

1. Turn OFF (O) the power supply and disconnect the power cord.
2. Remove the power supply cover.
3. Locate the voltage divider DIP switches on the fan side of the power supply.

This figure shows the voltage divider at the default setting (50:1) with the number 4 switch up.

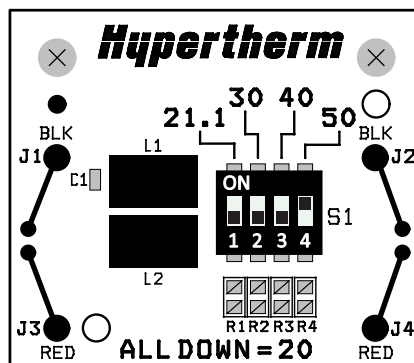

6 Configure Controls for Mechanized Cutting

4. Set the DIP switches to one of the following settings and replace the power supply cover.

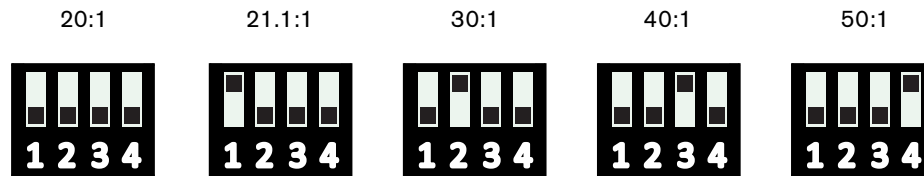

If the Hypertherm 5-position voltage divider does not supply the required voltage for your application, contact your system integrator for assistance.

Access raw arc voltage

To access divided raw arc voltage, refer to Field Service Bulletin 809520.

⚠ WARNING



SHOCK HAZARD, ENERGY HAZARD, AND FIRE HAZARD

Connecting directly to the plasma circuit for access to raw arc voltage increases the risk of shock hazard, energy hazard, and fire hazard in the event of a single fault. The output voltage and the output current of the circuit are specified on the data plate.

Connect an optional RS-485 serial interface cable

The RS-485 serial interface port on the back of the power supply allows you to connect an external device to your Powermax. For example, you can remotely operate the Powermax with a CNC controller.

- The Powermax power supply must be equipped with a factory-installed (or user-installed) RS-485 serial interface port on the rear panel.

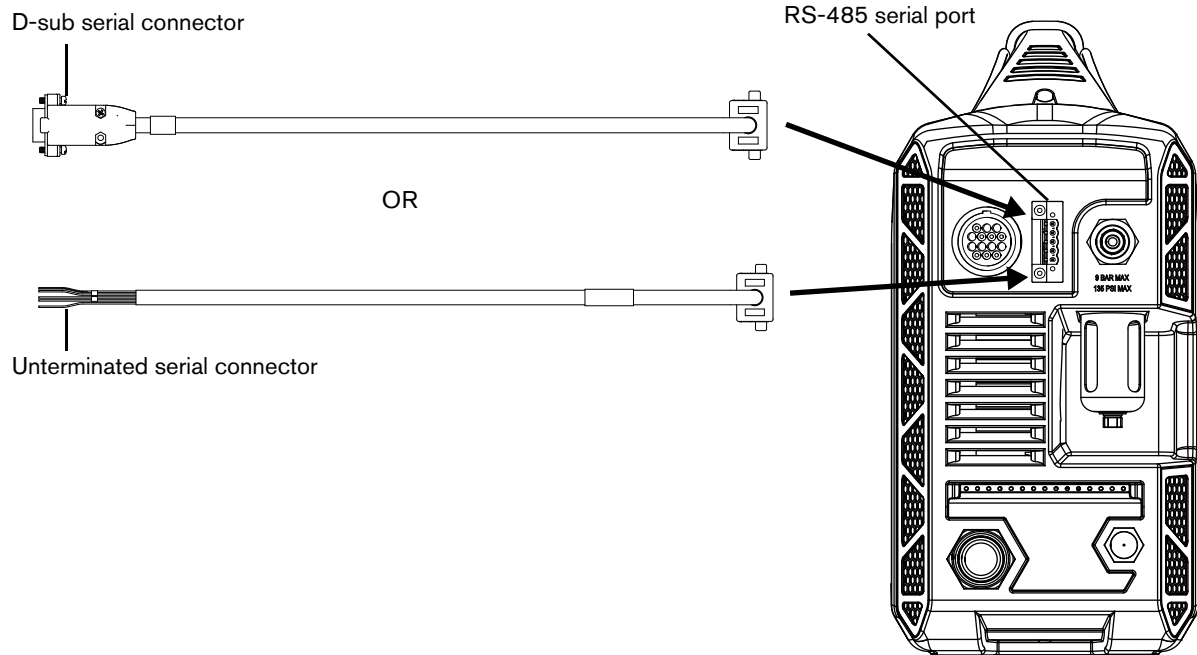

If your power supply is not equipped with the RS-485 port, order kit 428654. Follow the installation instructions in the *Powermax45 XP Service Manual* (809230), which you can download from the “Documents library” at www.hypertherm.com. (Look for the link at the bottom of the page.)

With the RS-485 port installed:

1. Turn OFF (O) the power supply.
2. Connect the RS-485 cable from your external device to the serial port on the back of the plasma power supply.

External serial port cables

The following external serial cables are available with the specified lengths and connectors:

- 223236 – RS-485 cable, unterminated, 7.6 m (25 feet)
- 223237 – RS-485 cable, unterminated, 15 m (50 feet)
- 223239 – RS-485 cable, 9-pin D-sub connector for Hypertherm controls, 7.6 m (25 feet)
- 223240 – RS-485 cable, 9-pin D-sub connector for Hypertherm controls, 15 m (50 feet)

Remote mode

When you operate the plasma system remotely using a CNC controller, the 2-digit display on the front panel shows “r.c.” This indicates that the power supply is being controlled remotely via serial communications and that all front panel controls are disabled until you exit remote mode.

 When the power supply is being remotely controlled, fault LEDs and fault codes still display as they would otherwise. See page 143.

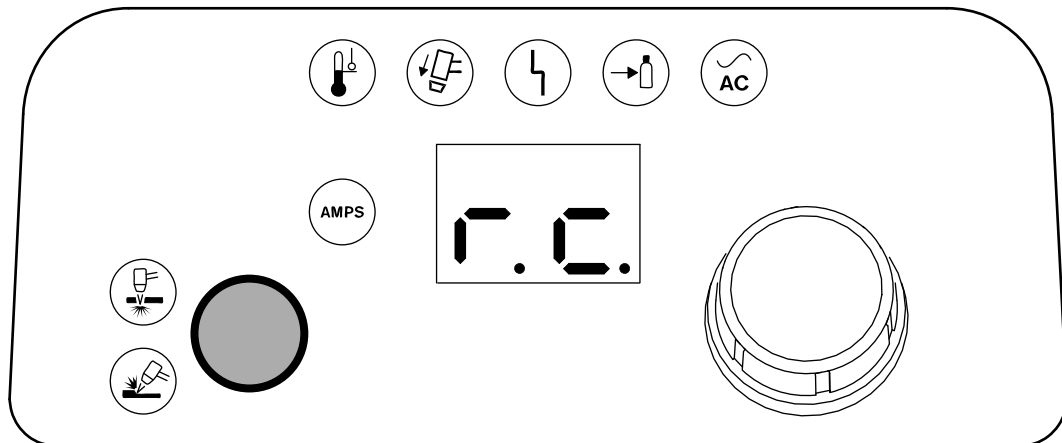



Cut with the Machine Torch

This section provides information to help you:

- Choose the correct consumables
- Optimize cut quality
- Pierce metal
- Cut stainless steel with F5 gas

Choose the consumables

Your Duramax Lock machine torch ships with a starter consumable kit that contains a complete set of shielded consumables plus 1 extra electrode and 1 extra nozzle. Consumables for gouging and marking are available to order separately.

- For details on **gouging** processes and consumables, see *Gouge with the Hand Torch and Machine Torch* on page 71.
- For details on the system's **marking** capabilities and consumables, see *Guidelines for Marking* on page 113.

Consumables are shielded or unshielded.

- **Shielded** consumables provide greater protection for the nozzle to minimize damage caused from slag during piercing. Hypertherm recommends the use of shielded consumables whenever possible.
- If you are using **unshielded** consumables (for example, a deflector instead of a shield), be careful to maintain the correct torch height in order to avoid damaging the nozzle from slag or from accidental contact with the workpiece.

7 Cut with the Machine Torch

- Hypertherm does not recommend the use of any other consumables in the Duramax Lock machine torch except for those listed in this manual. The use of any other consumables could adversely affect system performance.
- For help installing the consumables onto the torch, see page 46. Do not use worn or damaged consumables. See *Inspect the consumables* on page 154.

When you use the following shielded and FineCut consumables, select Cut mode on the front panel. See page 51.

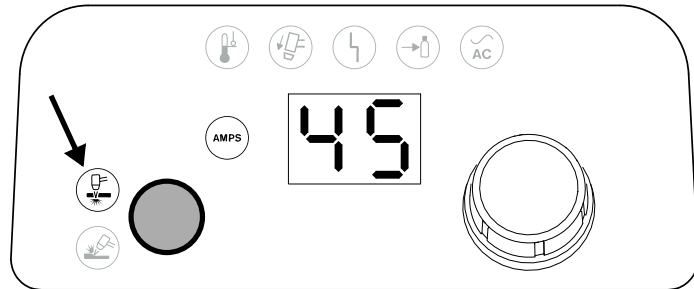

Mechanized shielded consumables

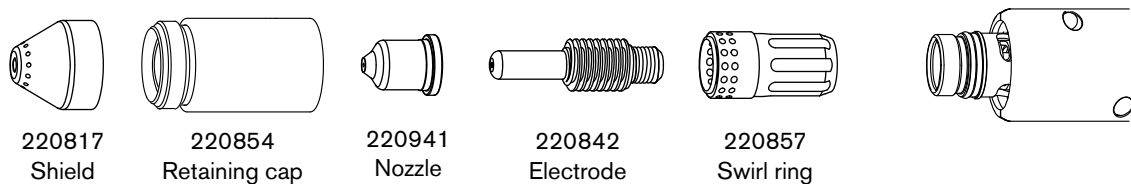

Mechanized shielded consumables with ohmic retaining cap

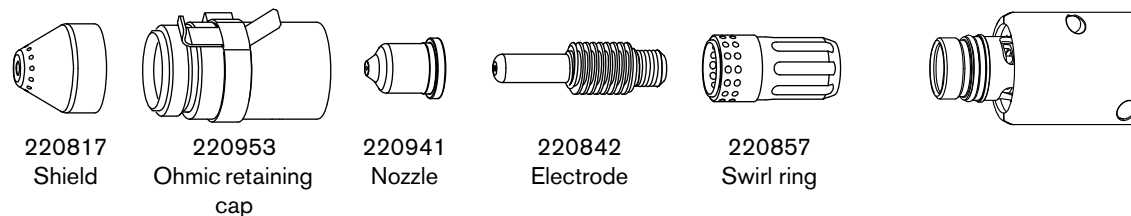

FineCut shielded consumables with ohmic retaining cap

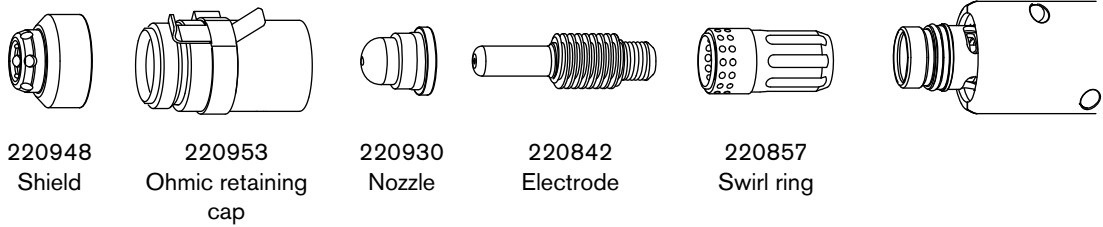

FineCut unshielded consumables

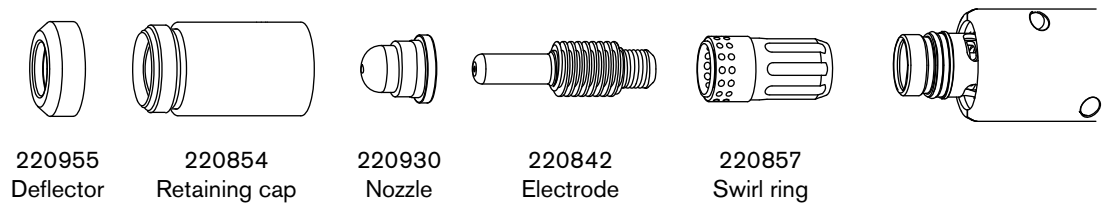

Consumable life

Many factors influence how often you need to change the consumables on your machine torch:

- **Poor gas supply quality**
 - It is extremely important to maintain a clean, dry gas line. The presence of oil, water, vapors, and other contaminants in the gas supply can degrade cut quality and consumable life. See page 35 and page 39.
- **Cutting and gouging technique**
 - Whenever possible, start cuts from the edge of the workpiece. This helps to extend the life of the shield and the nozzle.
 - Maintain a proper pierce height. Refer to the cut charts starting on page 121.
 - Maintain a proper torch-to-work distance (standoff) when gouging. See page 80.
- **Shielded versus non-shielded consumables**
 - Non-shielded consumables use a deflector instead of a shield. Non-shielded consumables generally have a shorter life than shielded consumables.
- **Thickness of metal being cut**
 - In general, the thicker the metal being cut, the more quickly the consumables become worn. For best results, do not exceed the thickness specifications for this system. See page 22.



See page 154 for guidelines on when to replace worn consumables.

■ **Expanded metal cutting**

- Expanded metal has a slotted or mesh pattern. Cutting expanded metal wears out consumables more quickly because it requires a continuous pilot arc. A pilot arc occurs when the torch is fired but the plasma arc is not in contact with the workpiece.

■ **Incorrect consumables for output current and mode**

- To optimize consumable life, make sure the consumables installed on the torch match the selected mode and output current. For example:
 - Do not use gouging consumables when the system is set to Cut mode. See page 51.
 - Do not set the output current between 26 A and 45 A with the Marking consumables or the Precision gouging consumables installed.

Understand and optimize cut quality

Several factors affect cut quality:

- **Cut angle** – The degree of angularity of the cut edge.
- **Dross** – The molten material that solidifies on the top or bottom of the workpiece.
- **Straightness of the cut surface** – The cut surface can be concave or convex.

Cut or bevel angle

- A positive cut angle results when more material is removed from the top of the cut than from the bottom.
- A negative cut angle results when more material is removed from the bottom of the cut.

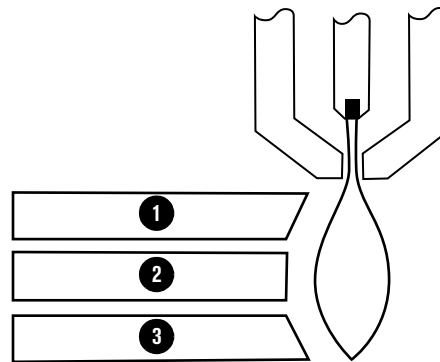

	Problem	Cause	Solution
①	Negative cut angle	The torch is too low.	Raise the torch; or if you are using a torch height control, increase the arc voltage.
②	Square cut		
③	Positive cut angle	The torch is too high.	Lower the torch; or if you are using a torch height control, decrease the arc voltage.



The squarest cut angle is on the right side with respect to the forward motion of the torch. The left side always has some degree of cut angle.

To determine whether a cut-angle problem is being caused by the plasma system or the drive system:

1. Make a test cut.



A square often works well for test cuts. It makes it easier to determine which side is affected by the cut-angle problem and if that side moved with the rotation of the torch.

2. Measure the angle of each side of the test cut.

3. Turn the torch 90° in its holder.

4. Repeat steps 1 – 3.

If the angles are the same in both tests:

- Verify that mechanical causes have been eliminated. See *Machine torch setup overview* on page 95.
- Check the torch-to-work distance (especially if the cut angles are all positive or all negative).
- Consider the material being cut. If the metal is magnetized or hardened, you are more likely to experience cut angle problems.

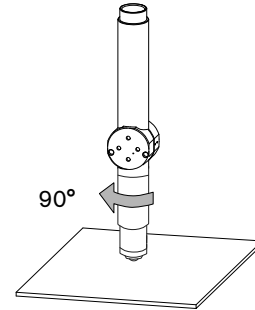

If the cut angle problem persists, consult with your cutting table manufacturer to verify that your automatic height control or torch height control is working properly.

Dross

Dross is molten metal created during the cut process that hardens on the bottom of the part. Some amount of dross will always result when cutting with air plasma. To minimize the amount and type of dross, adjust your system correctly for your application.

Problem	Cause	Solution
Excess dross on the top edge of both pieces of the plate.	<ul style="list-style-type: none"> ▪ The torch is too low. ▪ Voltage is too low when using a torch height control. 	<ul style="list-style-type: none"> ▪ Adjust the torch or adjust the voltage in small increments (5 volts or less) until the dross is reduced.
Low-speed dross on the bottom of the cut forming a heavy, bubbly deposit.	<ul style="list-style-type: none"> ▪ The torch's cutting speed is too slow. ▪ The arc angles ahead. 	<ul style="list-style-type: none"> ▪ Increase the cutting speed.
High-speed dross forms close to the cut as a thin, linear bead of solid metal. It is welded to the bottom of the cut and is difficult to remove.	<ul style="list-style-type: none"> ▪ The cutting speed is too fast. ▪ The arc angles behind. 	<ul style="list-style-type: none"> ▪ Decrease the cutting speed. ▪ Decrease the torch-to-work distance.

Pierce a workpiece using the machine torch

You can start a cut with the machine torch at the edge of the workpiece or by piercing the workpiece. Refer to the cut charts on page 121 and the piercing guidelines below.



Piercing may result in shorter consumable life than with edge starts.

Pierce delay

The pierce delay is the length of time the triggered torch remains stationary at the pierce height before the torch starts the cutting motion. The pierce delay must be long enough that the arc can pierce the material before the torch moves, but not so long that the pierce hole enlarges and causes the arc to “wander” or extinguish before the torch starts to move. As consumables wear, this delay time may need to be increased.

Pierce delay times given in the cut charts are based on average delay times throughout the life of the consumables.

Pierce height

For this system, the pierce height is generally between 1.5 and 4 times the cut height. Refer to the cut charts starting on page 121 for specific values.

Pierce maximum thickness

When piercing materials close to the maximum thickness for a specific process, consider the following important factors:

- Allow a lead-in distance approximately equal to the thickness of the material being pierced. For example, 12 mm (1/2 inch) material requires a 12 mm lead-in.
- To avoid damage to the shield from the buildup of molten material created by the pierce, do not allow the torch to descend to cut height until it has cleared the puddle of molten material.
- Different material chemistries can have an adverse effect on the pierce capability of the system. In particular, high-strength steel with a high manganese or silicon content can reduce the maximum pierce capability. Hypertherm derives mild steel parameters on thicknesses of 12 mm (1/2 inch) or less using certified A572 Grade 50 plate.

Cut stainless steel with F5

! WARNING



TOXIC FUMES CAN CAUSE INJURY OR DEATH

Some metals, including stainless steel, may release toxic fumes when cut. Make sure your work site has adequate ventilation to ensure that the air quality level meets all local and national standards and regulations. Refer to the *Safety and Compliance Manual (80669C)* for more information.

You can use F5 gas to cut stainless steel with Duramax Lock torches on the Powermax45 XP. When used with a Powermax system, F5 is recommended only for cutting stainless steel to achieve the advantages in cut quality listed below.



See page 131 for a cut chart on cutting stainless steel with F5.

Plasma cutting with F5 produces smooth, shiny cuts with silver edges that are close to the base color of the metal. F5 avoids the rough, dark finish that typically results with air plasma cutting.

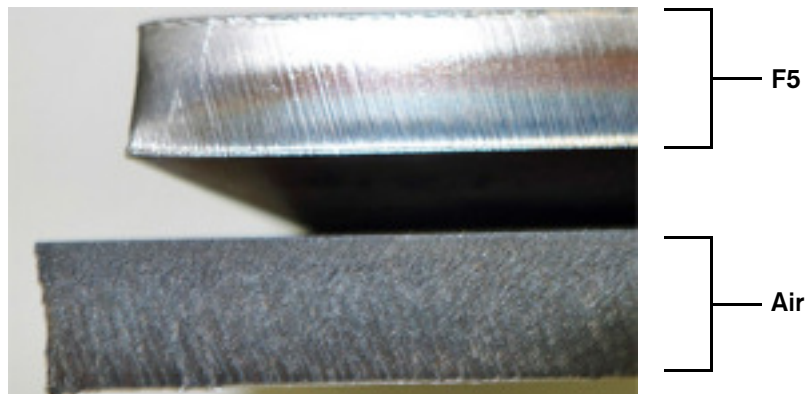

F5: Advantages	F5: Disadvantages	F5: Similarities to air
<ul style="list-style-type: none"> Smooth, shiny cut edge Silver cut edge, similar to the base color of the metal – does not leave the rough, dark surface that air produces No oxidation of the cut surface – the cut steel maintains its corrosion resistance Ability to use the same Duramax Lock consumables as for standard cutting and gouging with air (includes CopperPlus™ electrodes) 	<ul style="list-style-type: none"> Advantages limited to stainless steel Slower cut speeds F5 gas is more expensive than compressed air Not recommended for thicknesses less than 3 mm or 10 gauge (GA) or for use with FineCut® consumables Slightly degraded cut quality on bevel cuts 	<ul style="list-style-type: none"> Approximately the same amount of dross. With F5 and with air, stainless steel dross is dark in color and can be challenging to remove. Approximately the same gas pressure requirements

7 *Cut with the Machine Torch*

8

Guidelines for Marking

You can use the Marking consumables on the Duramax Lock machine torch to perform marking, scoring, and dimpling applications on mild steel, stainless steel, and aluminum using air or argon.



For marking cut charts, refer to page 132 and page 133.



The Marking consumables can also be used on the Duramax Lock hand torches for hand marking applications.

Marking consumables (10 – 25 A)

A maximum output current of 25 A is recommended for marking applications. Using the Marking consumables at higher amperages can shorten the life of the nozzle. It may also result in deeper marks than desired and poorer results overall.

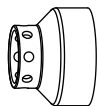

420542
Shield

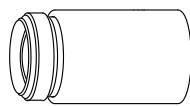

220854
Retaining cap



420415
Nozzle

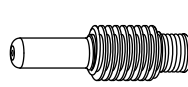

220842
Electrode



220857
Swirl ring

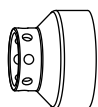
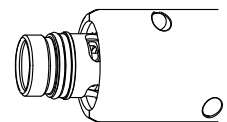

420542
Shield

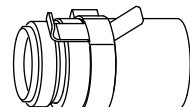

220953
Ohmic retaining cap



420415
Nozzle

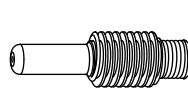

220842
Electrode

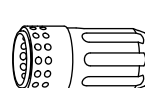

220857
Swirl ring

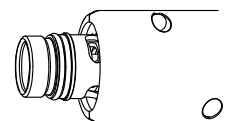

Process gas: air versus argon

WARNING



GAS CYLINDERS CAN EXPLODE IF DAMAGED

Gas cylinders contain gas under high pressure. If damaged, a cylinder can explode.

For high pressure regulators, adhere to the manufacturer's guidelines for safe installation, operation, and maintenance.

Before plasma cutting with compressed gas, read the safety instructions in the *Safety and Compliance Manual (80669C)*. Failure to follow safety instructions can result in personal injury or in damage to equipment.

With this system and torch, you can use air or argon for marking applications.

	Air	Argon
Advantages	<ul style="list-style-type: none"> ▪ Low cost ▪ Excellent all around process ▪ Little or no top-side slag on mild steel 	<ul style="list-style-type: none"> ▪ Low heat input lessens chance of material deformation ▪ Excellent high contrast for light scoring
Disadvantages	<ul style="list-style-type: none"> ▪ High heat input, especially on thin metal; may cause material deformation ▪ Mark edges may appear jagged on aluminum ▪ More dross and wider marks than with argon 	<ul style="list-style-type: none"> ▪ More expensive than air (see <i>How the system handles postflow for marking</i> below) ▪ Heavy scoring leaves top-side slag on steel

How the system handles postflow for marking

Postflow is gas that flows from the torch in order to cool the consumables after the plasma arc extinguishes. When you use air (or nitrogen) for marking applications, the duration of postflow is 10 seconds. The system recognizes when argon is being used and decreases postflow from 10 seconds to 3 seconds in order to minimize gas usage. To achieve 3-second postflow:

- The system must be set to Gouge/Marking mode.
- The output current must be set to 10 – 25 A.
- The plasma arc must be sustained for a minimum of 0.5 seconds.

There are 2 scenarios in which postflow is 10 seconds even when argon is used because the plasma arc is not sustained long enough to produce 3-second postflow:

- When the torch fires without transferring the pilot arc to the workpiece
- In some dimpling applications where the plasma arc is sustained for less than 0.5 seconds

Types of marking

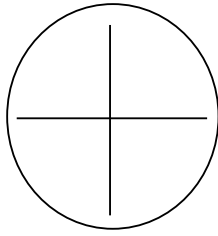

Light marking

- Thin, clean, slag-free lines with little depth
- Marks can be removed or covered by secondary operations as desired

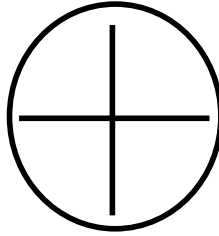

Heavy marking / scoring

- Heavier, deeper lines
- Very little slag beside the intended mark

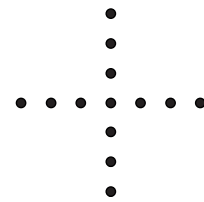







Dimpling

- Series of round marks
- Dimensions and spacing controlled by adjusting output current, gas type, torch height, and dwell time

Marking samples

The following pictures are intended to provide only a rough approximation of the differences between marking with air versus marking with argon with this system.

	Air	Argon
Light marking on mild steel		

	Air	Argon
Heavy marking on mild steel		
Light marking on stainless steel		
Heavy marking on stainless steel		

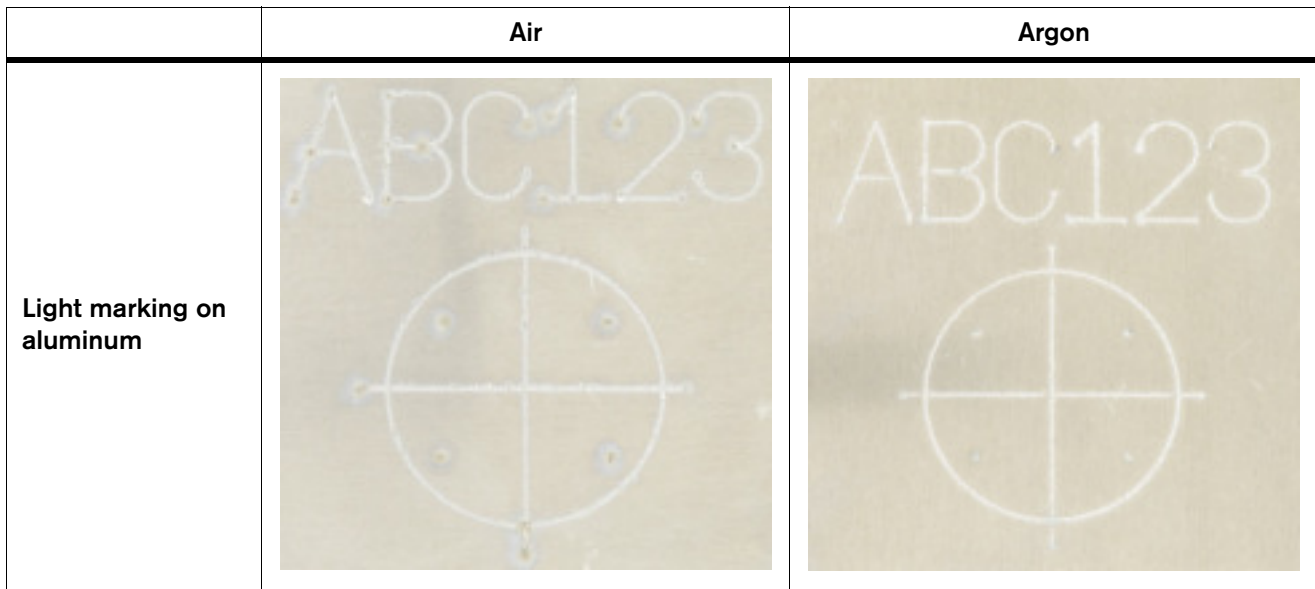

Marking, scoring, and dimpling profiles

The following tables show typical width and depth profiles for light marking, heavy marking and scoring, and dimpling on mild steel.



The width and depth of the marks change as you adjust the output current, gas type, torch standoff, and marking speed (or dwell time for dimpling).

Light marking		
	Air	Argon
Width	2.79 mm (0.11 inch)	1.22 mm (0.048 inch)
Depth	Less than 0.02 mm (0.001 inch)	Less than 0.02 mm (0.001 inch)
Travel speed	2.5 m/min (100 in/min)	3.2 m/min (125 in/min)

Heavy marking / Scoring		
	Air	Argon
Width	2.79 mm (0.11 inch)	1.22 mm (0.048 inch)
Depth	0.09 mm (0.0035 inch)	Less than 0.02 mm (0.001 inch)
Travel speed	2.5 m/min (100 in/min)	3.2 m/min (125 in/min)

Dimpling		
	Air	Argon
Width	1.98 mm (0.078 inch)	0.99 mm (0.039 inch)
Depth	0.25 mm (0.01 inch)	Less than 0.02 mm (0.001 inch)
Dwell time*	50 milliseconds	200 milliseconds

* The **dwell time** is the period of time that the torch fires at one spot on the workpiece to form a dimple. The longer the dwell time, the deeper the dimple that will form. Dwell times vary between CNC and table configurations. You may need to adjust your CNC/table setup accordingly.

Marking process guidelines

Before you begin marking, scoring, or dimpling:

- Choose a process gas: air or argon.
- Set up your machine torch and table. See *Machine torch setup overview* on page 95.
- Install the Marking consumables.
- Set the plasma power supply to Gouge/Marking mode. See page 51.
- Adjust the torch speed and power supply output current (amperage) for your marking or dimpling job. See the cut charts starting on page 132.
- Set the output current between 10 A and 25 A. **Do not exceed 25 A for marking applications.**

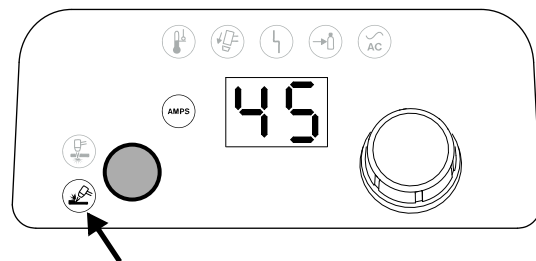

Make sure the Gouge/Marking Mode LED is illuminated.

Additional considerations:

- The power supply adjusts gas pressure for you automatically. Hypertherm recommends using these auto-gas settings for marking.
- Hypertherm strongly recommends that you use the Marking consumables with the power supply set to Gouge/Marking mode and the output current set to 10 – 25 A. These settings and consumables were designed specifically for marking applications.
- This system requires different consumables for marking and for regular cutting. Make sure you have the correct consumables installed if you switch between marking and cutting jobs. See page 105 for cutting consumable part numbers.
- You can vary the depth and width of marks by varying torch speed, output current, and torch height.
- You may need to try different cornering methods to optimize 90° corners for your CNC and table. See *Cornering guidelines* below.

Cornering guidelines

- Reduce both output current and marking speed for the entire marking operation.
- Depending on the capabilities of your cutting table and CNC, you may need to try different cornering methods to achieve the best possible results on 90° corners.
 - On many tables, it can be difficult to achieve a clean 90° corner. It requires the torch to come to a complete stop for some length of time, which can result in a corner that is wider and deeper than desired.
 - The rounded corner method shown below is recommended for most table/CNC configurations. This method does not require the torch to come to a complete stop in the corner.
 - If a sharper 90° corner is necessary, you can try the 2-step operation shown below. However, this method does leave dimples at the “start” and “stop” points.

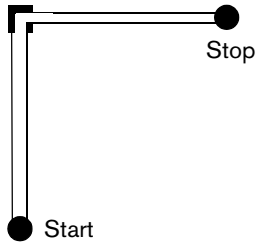
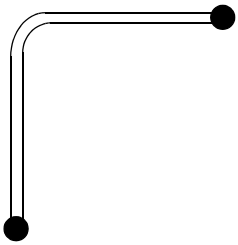
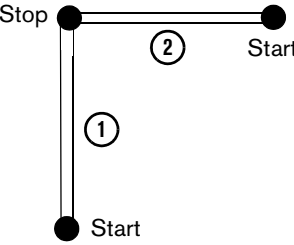
90° corner – difficult to achieve on many tables	Recommended method for most tables/CNCs	Alternate 2-step operation
		

Marking troubleshooting tips

Factors that affect marking width, depth, and quality include:

- Process gas – see the comparison of argon to air on page 114
- Material type (mild steel, stainless steel, or aluminum)
- Material thickness and surface finish
- Plasma power supply output current (amperage)
- Torch marking/dimpling speed
- Torch standoff
- Characteristics of the cutting table and CNC, such as how they handle delays, accelerations, and decelerations
- Gas pressure, if you manually adjusted the pressure to be outside the recommended range automatically set by the system – see page 54

To optimize your marking or dimpling process and results, use the troubleshooting tips on page 120 and the cut charts starting on page 132.

Common marking problems and solutions

For marking applications, always make sure:

- The Marking consumables are installed.
- The power supply is set to Gouge/Marking mode, and the output current is set between 10 – 25 A.

Many common marking issues can be resolved by installing new consumables in the torch. Do not use worn or damaged consumables. See page 154.

Problem	Solution
The arc goes out during marking.	<ul style="list-style-type: none"> ▪ Make sure that the torch-to-work distance (standoff) is not too high. ▪ Change worn or damaged consumables. See page 154.
The dimple diameter is wrong.	<ul style="list-style-type: none"> ▪ For a larger diameter dimple, increase the output current. ▪ For a smaller diameter dimple, decrease the output current. ▪ Adjust the torch-to-work distance (standoff). ▪ Change worn or damaged consumables. See page 154.
The dimple depth is wrong.	<ul style="list-style-type: none"> ▪ For a deeper dimple, increase the dwell time. ▪ For a shallower dimple, decrease the dwell time (if possible). ▪ Adjust the torch-to-work distance (standoff).
The mark is too wide or too deep.	<ul style="list-style-type: none"> ▪ Decrease the output current. ▪ Increase the marking speed. ▪ Inspect the consumables, especially the center hole of the nozzle. Change worn or damaged consumables. See page 154.
The mark is too narrow or too shallow.	<ul style="list-style-type: none"> ▪ Change worn or damaged consumables. See page 154. ▪ Increase the output current. ▪ Decrease the marking speed. ▪ Decrease the torch height.
The beginning of the mark is too large.	<ul style="list-style-type: none"> ▪ If the delay time between when the CNC receives the machine motion signal and when the machine motion actually occurs is significant, piercing may occur. If possible, decrease the delay time to 0 (zero). ▪ Check the table parameters, especially the acceleration parameter. It may need to be increased. ▪ Decrease the output current to reduce the size of the dimple at the beginning of the mark. The marking speed may also need to be adjusted for the lower output current. ▪ Check the torch-to-work distance (standoff) to make sure there is a good, fast transfer of the plasma arc to the workpiece.
The end of the mark is too large.	<ul style="list-style-type: none"> ▪ Check the cutting table parameters. If possible, increase the deceleration parameter.
The mark becomes too deep and too wide during cornering.	<ul style="list-style-type: none"> ▪ You may need to try a different method for cornering. See page 119.

Cut Charts and Marking Charts

WARNING



EXPLOSION HAZARD – CUTTING WITH ALUMINUM NEAR WATER

Do not cut aluminum alloys underwater or on a water table unless you can prevent the accumulation of hydrogen gas. Never cut aluminum-lithium alloys in the presence of water.

Aluminum can react with water to produce hydrogen, resulting in a potentially explosive condition that can detonate during plasma cutting operations. Refer to the *Safety and Compliance Manual (80669C)* for more information.

WARNING



EXPLOSION HAZARD – CUTTING WITH FUEL GASES

Do not use combustible fuel gases or oxidizing gases with Powermax systems. These gases can result in explosive conditions during plasma cutting operations.

WARNING



TOXIC FUMES CAN CAUSE INJURY OR DEATH

Some metals, including stainless steel, may release toxic fumes when cut. Make sure your work site has adequate ventilation to ensure that the air quality level meets all local and national standards and regulations. Refer to the *Safety and Compliance Manual (80669C)* for more information.

Using the cut charts

The cut charts in this section are intended to provide a good starting point. Adjust the variables in the cut charts as needed to achieve optimal results for your cutting equipment and environment.

Cut charts are provided for each set of mechanized cutting and marking consumables. A consumable diagram with part numbers precedes each cut chart.

Cut charts are included for:

- Cutting mild steel, stainless steel, and aluminum at 45 A with air using shielded consumables
- Cutting mild steel and stainless steel with air using FineCut consumables
- Cutting stainless steel at 45 A with F5 using shielded consumables
- Marking and dimpling at 10 – 25 A with air and argon using Marking consumables

Each cut chart may contain the following information:

- **Amperage setting** – The amperage setting at the top of the page applies to all the settings given on that page. In FineCut charts, the amperage setting for each thickness is included in the cut chart.
- **Material Thickness** – Thickness of the workpiece (metal plate being cut).
- **Torch-to-Work Distance** – For shielded consumables, the distance between the shield and the workpiece during cutting. For unshielded consumables, the distance between the nozzle and the workpiece during cutting. This is also known as cut height.
- **Initial Pierce Height** – Distance between the shield (shielded) or the nozzle (unshielded) and the workpiece when the torch is fired, prior to descending to the cut height. In marking charts, this is referred to as *Initial Marking Height*.
- **Pierce Delay Time** – Length of time the triggered torch remains stationary at the pierce height before the torch starts the cutting motion. In marking charts, this is referred to as *Delay Time*.
- **Best Quality Settings** (cut speed and voltage) – Settings that provide the starting point for finding the best cut quality (best angle, least dross, best cut-surface finish). Adjust the speed for your application and table to obtain the desired result.
- **Production Settings** (cut speed and voltage) – 70% to 80% of the maximum speed ratings. These speeds result in the greatest number of cut parts, but not necessarily the best possible cut quality.



The arc voltage increases as the consumables wear, so the voltage setting may need to be increased to maintain the correct torch-to-work distance. Some CNCs monitor the arc voltage and adjust the torch lifter automatically.

- **Kerf Width** – Width of material removed by the cutting process. The kerf widths were obtained with the “Best Quality” settings and are for reference only. Differences between installations and material composition may cause actual results to vary from those shown in the tables.
- **Width and Depth** – The marking and dimpling cut charts list the profile dimensions of the mark or dimple.

Each cut chart lists hot and cold gas flow rates.

- **Hot flow rate** – Plasma is on, the system is operating at running current, and the system is in a steady state at the default system pressure (cutflow, or automatic mode).
- **Cold flow rate** – Plasma is off and the system is in a steady state with gas flowing through the torch at the default system pressure (postflow).



Hypertherm collected the cut chart data under laboratory test conditions using new consumables.

Mild Steel – 45 A – Air – Shielded

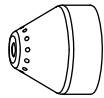

220817

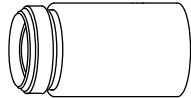

220854
(220953 for
ohmic sensing)



220941

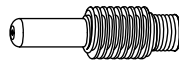

220842

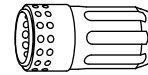

220857

Metric

Material Thickness	Torch-to-Work Distance	Initial Pierce Height		Pierce Delay Time	Best Quality Settings		Production Settings		Kerf Width			
					Cut Speed	Voltage	Cut Speed	Voltage				
mm	mm	mm	%	seconds	mm/min	volts	mm/min	volts	mm			
2	1.5	3.8	250	0.2	5560	128	7910	125	1.4			
3					3960	128	5590	127				
4				0.4	2800	128	3960	128	1.5			
6					1430	130	2110	127				
8					1020	133	1385	130		1.7		
10				Edge Start			0.8	780	136	920	134	1.8
12							1	540	140	690	138	1.9
16	310	146	400				141	2.1				
20	170	152	240				147	2.3				
25	110	157	145				154	3				

English

Material Thickness	Torch-to-Work Distance	Initial Pierce Height		Pierce Delay Time	Best Quality Settings		Production Settings		Kerf Width			
					Cut Speed	Voltage	Cut Speed	Voltage				
inches	inches	inches	%	seconds	in/min	volts	in/min	volts	inches			
16 GA	0.06	0.15	250	0.1	249	128	320	124	0.053			
14 GA					225	128	320	125	0.054			
10 GA				0.4	129	128	181	128	0.057			
3/16					85	129	122	127	0.059			
1/4					48	130	72	127	0.061			
3/8				Edge Start			0.8	33	136	38	133	0.069
1/2							1	18	141	24	139	0.077
5/8	13	146	16				141	0.082				
3/4	7	151	10				145	0.086				
7/8	6	154	7				151	0.103				
1	4	157	6	154	0.119							

Gas flow rate – slpm / scfh

151 / 320	Hot (cutflow)
184 / 390	Cold (postflow)

Stainless Steel – 45 A – Air – Shielded

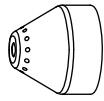

220817

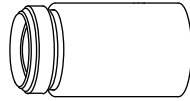

220854
(220953 for
ohmic sensing)



220941

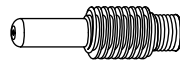

220842

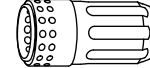

220857

Metric

Material Thickness	Torch-to-Work Distance	Initial Pierce Height		Pierce Delay Time	Best Quality Settings		Production Settings		Kerf Width
					Cut Speed	Voltage	Cut Speed	Voltage	
mm	mm	mm	%	seconds	mm/min	volts	mm/min	volts	mm
2	1.5	3.8	250	0.1	5620	126	7830	129	0.6
3				0.2	3285	129	4725	128	0.9
4				0.4	1995	130	2960	129	1.1
6				0.6	1145	131	1695	131	1.2
8					830	134	1100	134	1.4
10				0.8	605	137	870	137	1.6
12		4.6	300	1.2	380	141	540	139	1.8
16		Edge Start			240	145	320	142	2.4
20	Edge Start			160	149	205	146	3.1	

English

Material Thickness	Torch-to-Work Distance	Initial Pierce Height		Pierce Delay Time	Best Quality Settings		Production Settings		Kerf Width
					Cut Speed	Voltage	Cut Speed	Voltage	
inches	inches	inches	%	seconds	in/min	volts	in/min	volts	inches
16 GA	0.06	0.15	250	0.1	237	125	320	128	0.017
14 GA				0.2	230	126	320	129	0.022
10 GA				0.4	90	130	134	128	0.041
3/16				0.5	63	131	93	130	0.044
1/4					40	131	59	131	0.047
3/8				0.8	26	137	29	136	0.061
1/2		0.18	300	1.2	12	142	19	140	0.075
5/8		Edge Start			10	145	13	142	0.096
3/4	Edge Start			7	148	9	145	0.116	
7/8	Edge Start			5	151	6	149	0.137	

Gas flow rate – slpm / scfh

151 / 320	Hot (cutflow)
184 / 390	Cold (postflow)

Aluminum - 45 A - Air - Shielded

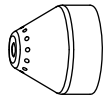

220817

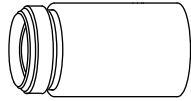

220854
(220953 for
ohmic sensing)



220941

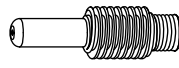

220842

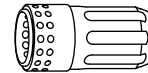

220857

Metric

Material Thickness	Torch-to-Work Distance	Initial Pierce Height		Pierce Delay Time	Best Quality Settings		Production Settings		Kerf Width			
					Cut Speed	Voltage	Cut Speed	Voltage				
mm	mm	mm	%	seconds	mm/min	volts	mm/min	volts	mm			
2	1.5	3.8	250	0.1	7890	121	9585	134	1.3			
3				0.2	4850	130	7120	129		1.5		
4				0.4	3670	133	5650	129				
6							0.5	2060	139	3095	132	1.6
8							0.6	1330	139	1830	136	1.7
10							0.7	860	142	1015	140	1.9
12					Edge Start			620	144	745	142	2
16					360	152	340	148	2.5			

English

Material Thickness	Torch-to-Work Distance	Initial Pierce Height		Pierce Delay Time	Best Quality Settings		Production Settings		Kerf Width		
					Cut Speed	Voltage	Cut Speed	Voltage			
inches	inches	inches	%	seconds	in/min	volts	in/min	volts	inches		
1/10	0.06	0.15	250	0.2	240	126	320	131	0.056		
1/8				0.4	170	131	263	128	0.060		
3/16					120	134	184	130	0.061		
1/4				0.5	70	137	104	132	0.063		
3/8					36	141	42	139	0.073		
1/2				Edge Start			21	145	26	143	0.082
5/8							15	152	14	148	0.100
3/4				8	158	9	153	0.117			

Gas flow rate - slpm / scfh

151 / 320	Hot (cutflow)
184 / 390	Cold (postflow)

Mild Steel – FineCut – Air – Shielded and Unshielded

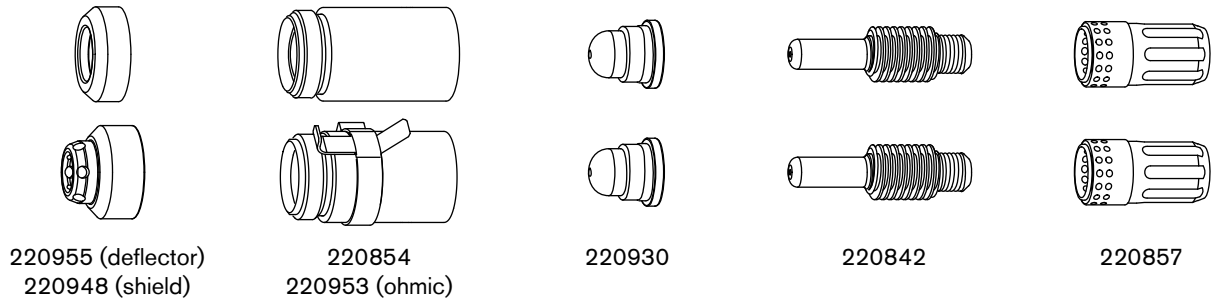

Metric

Material Thickness mm	Current A	Torch-to-Work Distance mm	Initial Pierce Height		Pierce Delay Time seconds	Recommended		Kerf Width mm	
			mm	%		Cut Speed mm/min	Voltage volts		
0.5	40	1.5	3.8	250	0.0	8250	78	0.7	
0.6						8250	78		
0.8						8250	78		
1	45				0.4	1.2	1.3	8250	78
1.5								6400	78
2								5250	82
3								2750	83
4								1900	84

English

Material Thickness inches	Current A	Torch-to-Work Distance inches	Initial Pierce Height		Pierce Delay Time seconds	Best Quality Settings		Kerf Width inches			
			inches	%		Cut Speed in/min	Voltage volts				
26 GA	40	0.06	0.15	250	0.0	325	78	0.025			
24 GA						325	78	0.029			
22 GA						325	78	0.024			
20 GA	45				0.2	0.043	0.046	0.1	325	78	0.020
18 GA									325	78	
16 GA								0.4	250	78	0.046
14 GA									220	82	0.049
12 GA									0.5	120	83
10 GA	95	84	0.051								

Gas flow rate – slpm / scfh

155 / 330	Hot (cutflow)
215 / 460	Cold (postflow)

Stainless Steel – FineCut – Air – Shielded and Unshielded

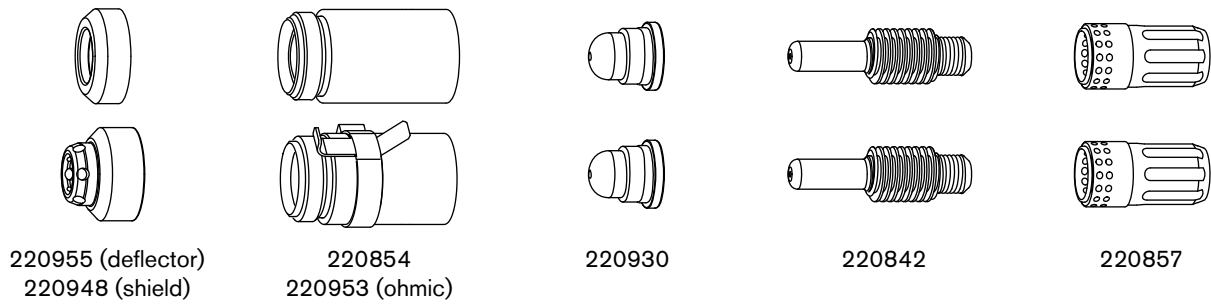

Metric

Material Thickness mm	Current A	Torch-to-Work Distance mm	Initial Pierce Height		Pierce Delay Time seconds	Recommended		Kerf Width mm			
			mm	%		Cut Speed mm/min	Voltage volts				
0.5	40	0.5	2.0	400	0.0	8250	68	0.6			
0.6						8250	68				
0.8						8250	68				
1	45				0.5	2.0	400	0.1	8250	68	0.5
1.5								0.2	8250	68	
2								0.4	6150	70	1.0
3									4800	71	
4									0.5	2550	
					0.6	1050	84	1.5			

English

Material Thickness inches	Current A	Torch-to-Work Distance inches	Initial Pierce Height		Pierce Delay Time seconds	Best Quality Settings		Kerf Width inches			
			inches	%		Cut Speed in/min	Voltage volts				
26 GA	40	0.02	0.08	400	0.0	325	68	0.024			
24 GA						325	68	0.021			
22 GA						325	68	0.018			
20 GA	45				0.02	0.08	400	0.1	325	68	0.017
18 GA								0.2	325	68	0.036
16 GA									0.4	240	70
14 GA								200		70	0.040
12 GA								0.5		120	80
10 GA	0.6	75	83	0.055							

Gas flow rate – slpm / scfh

155 / 330	Hot (cutflow)
215 / 460	Cold (postflow)

Mild Steel – FineCut Low Speed – Air – Shielded and Unshielded

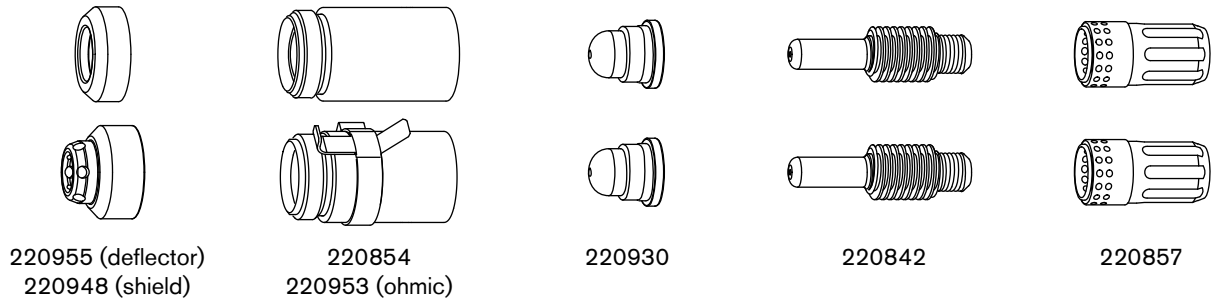

Metric

Material Thickness mm	Current A	Torch-to-Work Distance mm	Initial Pierce Height		Pierce Delay Time seconds	Recommended		Kerf Width mm
			mm	%		Cut Speed mm/min	Voltage volts	
0.5	30	1.5	2.25	150	0.0	3800	69	0.6
0.6						3800	68	
0.8						3800	70	
1*	40				0.4	3800	72	0.8
1.5*						3800	75	
2	45				0.5	3700	76	0.7
3						2750	78	1.3
4						1900	78	1.5

English

Material Thickness inches	Current A	Torch-to-Work Distance inches	Initial Pierce Height		Pierce Delay Time seconds	Best Quality Settings		Kerf Width inches
			inches	%		Cut Speed in/min	Voltage volts	
26 GA	30	0.06	0.09	150	0.0	150	70	0.026
24 GA						150	68	0.024
22 GA					0.1	150	70	0.025
20 GA	150					71		
18 GA	40				0.2	150	73	0.031
16 GA*						0.4	150	75
14 GA*	45				0.5		150	76
12 GA						120	78	0.052
10 GA		95	78	0.051				

Gas flow rate – slpm / scfh

155 / 330	Hot (cutflow)
215 / 460	Cold (postflow)

* Not a dress-free cut.

Stainless Steel – FineCut Low Speed – Air – Shielded and Unshielded

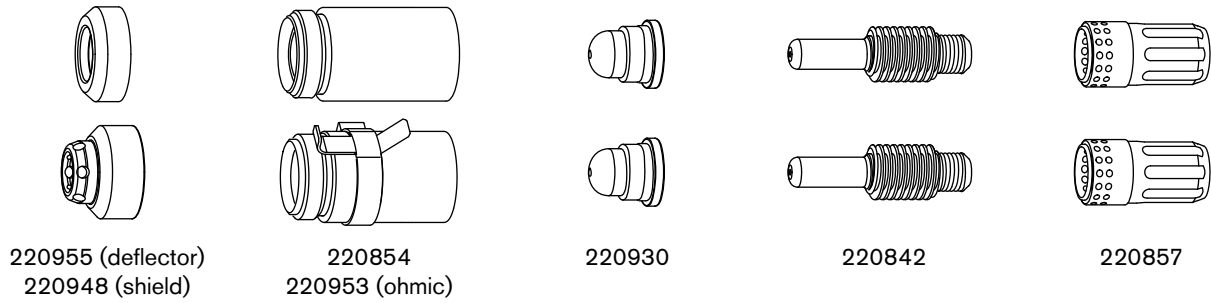

Metric

Material Thickness mm	Current A	Torch-to-Work Distance mm	Initial Pierce Height		Pierce Delay Time seconds	Recommended		Kerf Width mm			
			mm	%		Cut Speed mm/min	Voltage volts				
0.5	30	0.5	2.0	400	0.0	3800	69	0.7			
0.6						3800	69				
0.8						3800	69				
1	40				0.5	2.0	400	0.15	3800	69	0.6
1.5								0.4	2900	69	0.5
2									2750	69	1.3
3								45	0.5	2.0	400
4	0.6				1050	80	1.5				

English

Material Thickness inches	Current A	Torch-to-Work Distance inches	Initial Pierce Height		Pierce Delay Time seconds	Best Quality Settings		Kerf Width inches				
			inches	%		Cut Speed in/min	Voltage volts					
26 GA	30	0.02	0.08	400	0.0	150	69	0.028				
24 GA						150	69					
22 GA					0.1	150	69	0.025				
20 GA	150					69						
18 GA	40				0.02	0.08	400	0.2	145	69	0.023	
16 GA								0.4	115	69		0.022
14 GA									110	69		
12 GA	45				0.02	0.08	400	0.5	120	80	0.049	
10 GA		0.6	75	80				0.055				

Gas flow rate – slpm / scfh

155 / 330	Hot (cutflow)
215 / 460	Cold (postflow)

Stainless Steel – 45 A – F5 – Shielded

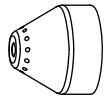

220817

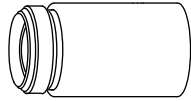

220854
(220953 for
ohmic sensing)



220941

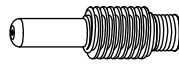

220842

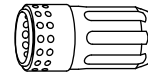

220857

Metric

Material Thickness	Torch-to-Work Distance	Initial Pierce Height		Pierce Delay Time	Best Quality Settings		Production Settings		Kerf Width
					Cut Speed	Voltage	Cut Speed	Voltage	
mm	mm	mm	%	seconds	mm/min	volts	mm/min	volts	mm
4	1.5	3.8	250	0.5	1550	139	2820	136	1.7
6				0.6	910	146	1380	140	
8				0.8	630	150	860	144	
10				435	153	525	147		
12		Edge Start			340	156	440	150	2.5

English

Material Thickness	Torch-to-Work Distance	Initial Pierce Height		Pierce Delay Time	Best Quality Settings		Production Settings		Kerf Width	
					Cut Speed	Voltage	Cut Speed	Voltage		
inches	inches	inches	%	seconds	in/min	volts	in/min	volts	inches	
10 GA	0.06	0.15	250	0.4	70	137	119	135	0.069	
3/16				0.5	49	142	80	138		
1/4				0.6	32	147	47	141		0.082
3/8				0.8	18	152	22	146		0.090
1/2		Edge Start			12	157	16	151	0.098	

Gas flow rate – slpm / scfh

149 / 315	Hot (cutflow)
184 / 390	Cold (postflow)



F5 is not recommended for thicknesses less than 3 mm (10 GA).

Marking and Dimpling – Air – Shielded

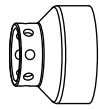

420542

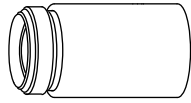

220854
(220953 for
ohmic sensing)



420415

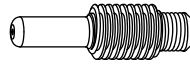

220842

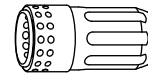

220857

Mild steel

Current A	Torch-to-Work Distance		Initial Marking Height		Delay Time seconds	Marking Speed		Arc Voltage volts	Width		Depth	
	mm	in	mm	in		mm/min	in/min		mm	in	mm	in
Light marking												
10	6.4	0.25	6.4	0.25	0	2540	100	134	2.79	0.11	<0.02	<0.001
Heavy marking												
10	4.6	0.18	4.6	0.18	0	2540	100	111	2.79	0.11	0.09	0.0035
Dimpling												
10	6.4	0.25	—	—	0.05	—	—	—	1.98	0.078	0.25	0.01

Stainless steel

Current A	Torch-to-Work Distance		Initial Marking Height		Delay Time seconds	Marking Speed		Arc Voltage volts	Width		Depth	
	mm	in	mm	in		mm/min	in/min		mm	in	mm	in
Light marking												
10	5.1	0.2	5.1	0.2	0	5080	200	98	2.03	0.08	<0.02	<0.001
Heavy marking												
10	6.4	0.25	6.4	0.25	0	3175	125	133	2.54	0.1	0.08	0.003
Dimpling												
10	6.4	0.25	—	—	0.05	—	—	—	2.03	0.08	0.23	0.009

Aluminum

Current A	Torch-to-Work Distance		Initial Marking Height		Delay Time seconds	Marking Speed		Arc Voltage volts	Width		Depth	
	mm	in	mm	in		mm/min	in/min		mm	in	mm	in
Marking												
11	2.5	0.1	5.1	0.2	0	5080	200	98	0.89	0.035	<0.02	<0.001
Dimpling												
10	3.2	0.125	—	—	0.1	—	—	—	0.89	0.035	0.09	0.0035

Gas flow rate – slpm / scfh

137 / 290	Hot (cutflow)
141 / 300	Cold (postflow)

Marking and Dimpling – Argon – Shielded

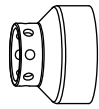

420542

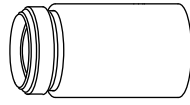

220854
(220953 for
ohmic sensing)



420415

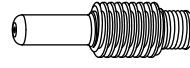

220842

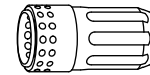

220857

Mild steel

Current A	Torch-to-Work Distance		Initial Marking Height		Delay Time seconds	Marking Speed		Arc Voltage volts	Width		Depth	
	mm	in	mm	in		mm/min	in/min		mm	in	mm	in
Light marking												
10	2.0	0.08	2.0	0.08	0	3175	125	44	1.22	0.048	<0.02	<0.001
Heavy marking												
15	1.5	0.06	1.5	0.06	0	3175	125	44	1.22	0.048	<0.02	<0.001
Dimpling												
20	3.2	0.125	—	—	0.2	—	—	—	0.99	0.039	<0.02	<0.001

Stainless steel

Current A	Torch-to-Work Distance		Initial Marking Height		Delay Time seconds	Marking Speed		Arc Voltage volts	Width		Depth	
	mm	in	mm	in		mm/min	in/min		mm	in	mm	in
Light marking												
12	2.5	0.1	2.5	0.1	0	3175	125	46	1.40	0.055	<0.02	<0.001
Heavy marking												
15	2.5	0.1	2.5	0.1	0	2540	100	46	2.16	0.085	0.02	0.001
Dimpling												
10	3.2	0.125	—	—	0.2	—	—	—	0.94	0.037	0.18	0.007

Aluminum

Current A	Torch-to-Work Distance		Initial Marking Height		Delay Time seconds	Marking Speed		Arc Voltage volts	Width		Depth	
	mm	in	mm	in		mm/min	in/min		mm	in	mm	in
Marking												
16	0.5	0.02	0.5	0.02	0	4445	175	42	0.63	0.025	<0.02	<0.001
Dimpling												
20	0.5	0.02	—	—	0.4	—	—	—	0.66	0.026	0.04	0.0015

Gas flow rate – slpm / scfh

120 / 255	Hot (cutflow)
123 / 260	Cold (postflow)

10

Troubleshooting Guide

The following sections provide an overview of the most common problems that may arise when using this system and suggest ways to solve them.

If you are unable to fix the problem by following this basic troubleshooting guide or if you need further assistance:

1. Call your Hypertherm distributor or authorized Hypertherm repair facility.
2. Call the nearest Hypertherm office listed in the front of this manual.

! WARNING

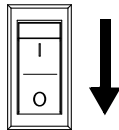

INSTANT-ON TORCHES – PLASMA ARC CAN CAUSE INJURY, BURNS

The plasma arc ignites immediately when you pull the torch trigger. Before changing consumables, one of the following actions must be taken. Whenever possible, complete the first action.

- Turn OFF (O) the plasma power supply.

OR

- Move the torch-disable switch to the yellow lock (X) position (closest to the torch lead). Pull the trigger to make sure the torch does not fire a plasma arc.

Common cutting issues

Problem	Solution
The cut quality is poor.	<ul style="list-style-type: none"> ▪ Make sure the correct consumables are installed. See page 61 for hand cutting consumables. See page 105 for mechanized cutting consumables. See page 71 for gouging consumables. See page 113 for marking consumables. ▪ Loosen the consumables about 1/8th of a turn and try again. Never tighten the consumables more than finger-tight. See page 46. It is normal for some gas to escape between the torch shell and the retaining cap during use. This is part of the torch design. ▪ Inspect and replace the consumable parts if they are worn or damaged, including the swirl ring. See page 154. Always replace the nozzle and electrode together. ▪ Make sure that the correct mode is selected: cut mode for cutting and piercing applications or gouge/marketing mode for gouging and marking applications. See page 51. ▪ Make sure that the work lead connection to the plasma power supply is secure. Make sure that there is no damage to the work lead. ▪ Make sure that the torch is being used correctly. See <i>Cut with the Hand Torch</i> on page 59 or <i>Cut with the Machine Torch</i> on page 105. ▪ Check the gas pressure and the gas supply hose. See page 140. ▪ Inspect the gas filtration system for signs of contaminants that may be interfering with system performance. See page 141. ▪ Adjust the cut speed. ▪ Operate the system without using an extension cord. If you must use an extension cord, use a heavy conductor cord of the shortest possible length. See page 33.
The arc sputters and hisses.	<ul style="list-style-type: none"> ▪ Inspect the gas filtration system for signs of moisture. See page 141.

Hand cutting issues

Problem	Solution
<p>Pulling the torch trigger does not fire an arc. Instead, the torch blows out short puffs of air and the power supply sounds like it is releasing pressure.</p>	<ul style="list-style-type: none"> ▪ The first time you pull the torch trigger after you set the torch-disable switch to the “ready to fire” (✓) position, the torch may emit multiple puffs of air in quick succession. With each puff of air, the torch vibrates slightly, and plasma power supply emits a pressure-release sound. This is a warning that occurs when you lock and then unlock the torch without turning OFF the power supply. (The Torch Cap LED also illuminates – see page 148.) This does not indicate a fault condition. The purpose of the warning is to alert you that the torch is activated and will fire a plasma arc the next time you pull the trigger. See page 45.
<p>The plasma arc sputters, and consumable life is shorter than expected.</p>	<ul style="list-style-type: none"> ▪ Make sure that the consumables are installed correctly. See page 46. ▪ Inspect and replace the consumable parts if they are worn or damaged. See page 154. Always replace the nozzle and electrode together. ▪ Check the gas pressure and the gas supply hose. See page 140. ▪ Inspect the gas filtration system for signs of moisture. See page 141.
<p>The torch does not fire an arc after repeated attempts. No issues with incoming power or gas supply are apparent. No fault LEDs or fault codes display.</p>	<ul style="list-style-type: none"> ▪ Test the torch-disable switch to see if it is working properly. See page 152. Replace the switch if it is broken or not working correctly.
<p>The plasma arc does not transfer to the workpiece.</p>	<ul style="list-style-type: none"> ▪ Clean the area where the work clamp contacts the workpiece. Remove any rust, paint, or other residue. Make sure there is good metal-to-metal contact. ▪ Inspect the work clamp for damage. Repair or replace it if necessary. ▪ Move the torch closer to the workpiece and fire the torch again. See <i>Cut with the Hand Torch</i> on page 59.
<p>The plasma arc blows out but re-ignites when the torch trigger is pulled again.</p>	<ul style="list-style-type: none"> ▪ Decrease the length of the arc stretch. Whenever possible, drag the torch on the workpiece. See page 67. ▪ If you are using the Maximum Control gouging consumables, make sure the system is set to gouge/marking mode and the output current is set to 26 – 45 A. Setting the output current below 26 A with these consumables can cause the arc to extinguish. ▪ Inspect and replace the consumable parts if they are worn or damaged. See page 154. Always replace the nozzle and electrode together. ▪ Make sure the incoming gas supply hose has an internal diameter of 9.5 mm (3/8 inch) or greater. ▪ Inspect the gas filtration system for signs of contaminants that may be interfering with system performance. See page 141. ▪ If you manually adjusted the gas pressure before this issue occurred, reset the gas pressure to the default setting. See page 56.

Problem	Solution
<p>The torch does not cut completely through the workpiece.</p>	<ul style="list-style-type: none"> ▪ Make sure the system is set to cut mode, not gouge/marketing mode. See page 51. ▪ Decrease your cut speed. ▪ Inspect and replace the consumable parts if they are worn or damaged. See page 154. Always replace the nozzle and electrode together. ▪ Make sure that the torch is being used correctly. See <i>Cut with the Hand Torch</i> on page 59. ▪ Make sure the consumables installed on the torch match the selected mode. For example, do not use gouging consumables when the system is set to cut mode. See page 51. ▪ Increase the output current (amperage) on the plasma power supply. See page 51. ▪ If the output current cannot be increased, determine if the metal being cut exceeds the maximum capacity for this system. See <i>Cutting specifications</i> on page 22. ▪ Clean the area where the work clamp contacts the workpiece. Remove any rust, paint, or other residue. Make sure there is good metal-to-metal contact. ▪ Inspect the torch lead. Straighten it out if it is twisted or kinked. Replace it if it is damaged. ▪ Check the gas pressure and the gas supply hose. See page 140. ▪ Adjust the gas flow rate. See <i>Gas supply source</i> on page 35.

Mechanized cutting issues

Problem	Solution
<p>The machine torch does not fire an arc. Instead, the torch blows out short puffs of air and the power supply sounds like it is releasing pressure.</p>	<ul style="list-style-type: none"> ▪ The first time you send a start signal to the torch after you set the torch-disable switch to the “ready to fire” (✓) position, the torch may emit multiple puffs of air in quick succession. With each puff of air, the torch vibrates slightly, and plasma power supply emits a pressure-release sound. This is a warning that occurs when you lock and then unlock the torch without turning OFF the power supply. (The Torch Cap LED also illuminates – see page 148.) This does not indicate a fault condition. The purpose of the warning is to alert you that the torch is activated and will fire a plasma arc the next time it receives a start signal. See page 45.
<p>The torch’s pilot arc initiates but does not transfer to the workpiece.</p>	<ul style="list-style-type: none"> ▪ Clean the metal surface of any rust, paint, or other residue that may prevent a good metal-to-metal connection. ▪ Make sure that the work lead is making good contact with the cutting table. ▪ Make sure that the cutting table is properly grounded and is making good contact with the workpiece. ▪ Decrease the torch-to-work distance (cut height). Refer to the cut charts starting on page 121.

Problem	Solution
<p>The cut angle is not square.</p>	<ul style="list-style-type: none"> ▪ Make sure that the torch is square to the workpiece. ▪ Check the gas pressure and the gas supply hose. See page 140. ▪ Inspect and replace the consumable parts if they are worn or damaged. See page 154. Always replace the nozzle and electrode together. ▪ Make sure the direction of the torch travel is correct. The best quality cut is always on the right with respect to the forward motion of the torch. ▪ Make sure the cut chart parameters or the program code values are correct. Adjust the torch-to-work distance (cut height) and the cut speed as needed. Refer to the cut charts starting on page 121.
<p>The torch does not completely pierce the workpiece, and there is excessive sparking on the top of the workpiece.</p>	<ul style="list-style-type: none"> ▪ Clean the metal surface of any rust, paint, or other residue that may prevent a good metal-to-metal connection. ▪ Make sure that the work lead is making good contact with the cutting table. Make sure that the cutting table is properly grounded and is making good contact with the workpiece. ▪ Inspect and replace the consumable parts if they are worn or damaged. See page 154. Always replace the nozzle and electrode together. ▪ Make sure the cut chart parameters or the program code values are correct. Try decreasing the cut speed. Refer to the cut charts starting on page 121. ▪ Increase the output current (amperage) on the plasma power supply. See page 51. ▪ If the output current cannot be increased, determine if the metal being cut exceeds the maximum capacity for this system. See <i>Cutting specifications</i> on page 22. ▪ Inspect the torch lead. Straighten it out if it is twisted or kinked. Replace it if it is damaged. ▪ Make sure the incoming gas supply hose has an internal diameter of 9.5 mm (3/8 inch) or greater.
<p>Excessive dross forms on the bottom of the cut.</p>	<ul style="list-style-type: none"> ▪ Check the gas pressure and the gas supply hose. See page 140. ▪ Inspect and replace the consumable parts if they are worn or damaged. See page 154. Always replace the nozzle and electrode together. ▪ Make sure the cut chart parameters or the program code values are correct. Try adjusting the cut speed. Refer to the cut charts starting on page 121. ▪ Increase the output current (amperage) on the plasma power supply. See page 51. ▪ Inspect the torch lead. Straighten it if it is twisted or kinked. Replace it if it is damaged.

Problem	Solution
<p>The consumables wear out more quickly than they used to.</p>	<ul style="list-style-type: none"> ▪ Check the gas pressure and the gas supply hose. See page 140. ▪ Do not start or end cuts off of the surface of the workpiece. Starting at the edge of the workpiece is acceptable as long as the arc makes contact with the workpiece when started. ▪ Inspect the torch lead. Straighten it if it is twisted or kinked. Replace it if it is damaged. ▪ Make sure the arc current, arc voltage, travel speed, and other cut settings are correct. Refer to the cut charts starting on page 121. ▪ Use the correct torch height for piercing. Refer to the cut charts starting on page 121 for the initial pierce height. ▪ Make sure that the pierce delay time is correct. Refer to the cut charts starting on page 121. ▪ Inspect the shield, swirl ring, and retaining cap. Replace them if they are worn or damaged. See page 154. ▪ Inspect the gas filtration system for signs of contaminants that may be interfering with system performance. See page 141. ▪ A faulty pilot arc IGBT may be shortening nozzle life. Contact your distributor or authorized repair facility.

Check the gas pressure

- **Gas supply:** Incorrect gas pressure can result in issues with cut quality and cut performance. Refer to *Gas supply source* on page 35 for details on the inlet gas supply requirements for this system. **Never exceed the maximum gas pressure of 9.3 bar (135 psi).**
- **Gas hose:** An incoming gas supply hose with too small a diameter can result in issues with cut quality and cut performance. Only use gas hoses with an internal diameter of 9.5 mm (3/8 inch) or greater.
- **Pressure setting:** The system regulates gas pressure automatically, but you can adjust the gas pressure manually if needed. See page 54.
- **Gas test:** You can run a gas test to see if adequate pressure is exiting the torch. The gas test lets you see the plasma system's actual gas pressure so that you can compare it to the inlet set pressure. See page 149.



If you manually adjusted the gas pressure and then started to notice issues with cut quality or cut performance, reset the gas pressure to the default setting. See page 56.

Check the gas quality

It is extremely important to maintain a clean, dry gas line in order to:

- Prevent oil, water, dirt, and other contaminants from damaging internal components.
- Achieve optimal cut quality and consumable life.

Dirty, oily air is the root cause of many common problems that occur in Powermax systems, and in some instances it can void the warranty on the power supply and on the torch. See the gas quality recommendations in the ratings table on page 21.

The system's built-in air filter is designed to filter out particulates as small as 5 microns. It can remove some moisture from the gas supply. However, if you work in an environment that is extremely warm and humid, or if work site conditions introduce oil, vapor, or other contaminants into the gas line, install an external filtration system that cleans the gas supply before it enters the plasma power supply. See page 39.

CAUTION

Synthetic lubricants containing esters that are used in some air compressors will damage polycarbonates used in the air filter bowl.

To maintain a clean gas line:

1. Examine the air filter element in the system's built-in air filter. Replace it if it is contaminated. See page 155.
2. Clean the air filter bowl that houses the air filter element. Make sure it is free from oil, dirt, and other contaminants.



A yellow residue on the filter bowl often indicates that oil is getting into the gas supply line.

3. Examine the O-ring at the top of the air filter bowl. Replace it if it is cracked or damaged. See page 155.
4. If you are using an external air filtration system, clean or replace any parts in it that may be contaminated.

Cold restarts and quick restarts

To restart the system, turn OFF (O) the power switch on the plasma power supply and then turn ON (I) the power switch again.

In some instances, you may be asked specifically to perform a “cold restart” or a “quick restart.”

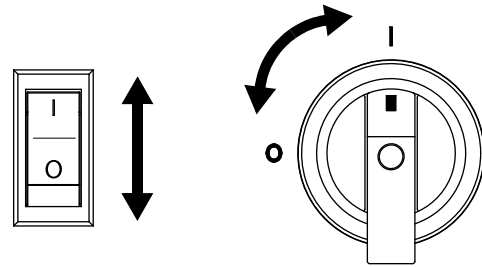

Perform a cold restart

1. Set the power switch on the plasma power supply to the OFF (O) position.
2. Wait a minimum of 30 seconds.
3. Set the power switch on the plasma power supply to the ON (I) position.

Perform a quick restart

1. Set the power switch on the plasma power supply to the OFF (O) position.
2. Immediately set the power switch on the plasma power supply back to the ON (I) position.



If a fault occurs while using a generator, a quick restart may not clear the fault. Instead, turn OFF (O) the plasma power supply and wait 60 – 70 seconds before turning it ON (I) again.

Fault LEDs and fault codes

- Some fault conditions cause one or more fault LEDs to illuminate or blink.



Temperature fault LED (yellow)



Torch Cap fault LED (yellow)



System Fault LED (yellow)



Gas Pressure fault LED (yellow)



Power ON LED (green)

- Other fault conditions display a fault code in addition to the fault LEDs. The fault code provides additional information when needed to make the source of the problem easier to identify.



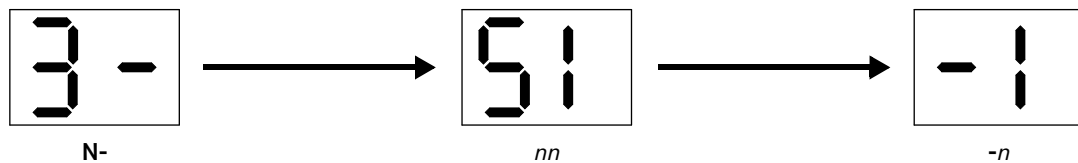



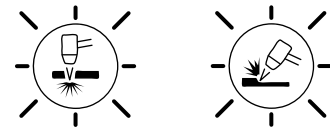







Fault codes follow the format **N-*nn*-*n***. They blink on the 2-digit display in increments:

















- If the Cut Mode LED or the Gouge/Marking Mode LED blinks, this indicates that the gas pressure has been manually adjusted. See page 54. It does not indicate a fault condition. When you reset the gas pressure to its default setting, the LED stops blinking. See page 56.

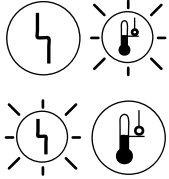

Refer to the following table to identify and troubleshoot each fault condition. A label with descriptions for several common fault codes can be found inside the front cover of the *Operator Manual*. Peel off the label and place it on the power supply or near your work area for reference.

Fault code	Description	LED behavior			Solutions
None	The ON/OFF power switch is set to ON (I), but the Power ON LED does not illuminate.	 OFF			<ul style="list-style-type: none"> ▪ Make sure that the power cord is plugged into the receptacle. ▪ Make sure that the power is on at the main power panel or at the disconnect-power switch box. ▪ Make sure that the line voltage is not too low (more than 10% below the rated voltage for 1-phase models or 15% below the rated voltage for 3-phase models). See page 21 and page 28.
None	Low gas pressure	 ON	 ON	<ul style="list-style-type: none"> ▪ The gas pressure is below the minimum pressure for that process, mode, torch, and lead length. ▪ Check the input gas supply. See <i>Gas Pressure fault LED</i> on page 147. 	
None	No gas input	 ON	 Blinks	<ul style="list-style-type: none"> ▪ Connect the input gas supply to the plasma power supply. Turn OFF (O) then turn ON (I) the power supply. See <i>Gas Pressure fault LED</i> on page 147. 	
None	Torch stuck open (TSO) The nozzle and electrode are not touching after a start signal is received.	 ON	 Blinks slowly	<ul style="list-style-type: none"> ▪ Turn OFF (O) the power supply. Make sure that the consumables are installed correctly and that they are in good condition. See <i>Torch Cap fault LED</i> on page 148. 	
None	Torch stuck closed (TSC) The nozzle and electrode will not separate after a start signal is received.	 ON	 Blinks rapidly	<ul style="list-style-type: none"> ▪ Turn OFF (O) the power supply. Make sure that the consumables are installed correctly and that they are in good condition. See <i>Torch Cap fault LED</i> on page 148. 	
None	Power supply is over temperature or under temperature	 ON	 ON	 ON	<ul style="list-style-type: none"> ▪ The system may have overheated. Leave the plasma power supply ON to allow the fan to cool the internal components. See <i>Understand duty cycle to prevent overheating</i> on page 58. ▪ The system may be too cold to operate. If the internal temperature of the plasma power supply approaches -30°C (-22°F), move the system to a warmer location.
None	Retaining cap off	 ON	 ON		<ul style="list-style-type: none"> ▪ Turn OFF (O) the power supply. Make sure that the torch is connected to the power supply and that consumables are installed correctly. See <i>Torch Cap fault LED</i> on page 148.

Fault code	Description	LED behavior		Solutions
0-11-0	Remote controller mode invalid. Valid remote modes for this system: <ul style="list-style-type: none"> ▪ 1, 2 – Continuous pilot arc ▪ 3 – Gouge 	 ON		There is a problem with the remote controller or the software interface to the system. The system cannot interpret the mode, output current, or gas pressure information coming from the controller. <ul style="list-style-type: none"> ▪ Fix the controller.
0-11-1	Remote controller current invalid. Valid remote current settings for this system: 10 – 45 A.	 ON		<ul style="list-style-type: none"> ▪ Check the RS-485 interface cable. ▪ Examine the programming code for incorrect process variables.
0-11-2	Remote controller pressure invalid. Valid remote pressure settings for this system depend on the process, mode, torch, and torch lead.	 ON		
0-12-1	Output gas pressure low	 ON		The 0-12- <i>n</i> fault codes do not appear on the 2-digit display. They display only on a CNC via an RS-485 serial interface. An 0-12- <i>n</i> fault does not stop the system from operating.
0-12-2	Output gas pressure high	 ON		<ul style="list-style-type: none"> ▪ Adjust the gas inlet pressure as needed. ▪ Make sure none of the gas lines are kinked or blocked.
0-12-3	Output gas pressure unstable	 ON		<ul style="list-style-type: none"> ▪ Run a gas test to see if the actual pressure is lower or higher than the set pressure. See <i>Run a gas test</i> on page 149. ▪ Have a qualified service technician examine the system. Contact your distributor or authorized repair facility.
0-13-0	Alternating current (AC) input power unstable (system continues to operate)	 Blinks		<ul style="list-style-type: none"> ▪ Perform a cold restart. ▪ If applicable, disconnect the system from generator power. See <i>Generator considerations</i> on page 149. ▪ If the fault does not clear, have an electrical technician correct the power source. See page 27.
0-51-0	Start/trigger signal on at power up This condition indicates that the power supply is receiving a start signal. It is sometimes referred to as a “stuck start.”	 ON	 Blinks alternately	<ul style="list-style-type: none"> ▪ Hand torch: The torch trigger was being held in the “fire” position while the plasma power supply was being powered ON (I). Release the trigger and restart the power supply. ▪ Machine torch: The plasma power supply was receiving a start signal when it was powered ON (I). Turn off the start signal and restart the power supply.

Fault code	Description	LED behavior		Solutions
0-60-0	Alternating current (AC) input voltage phase loss	 Blinks		<ul style="list-style-type: none"> ▪ Have an electrical technician check all input phases and fuses/breakers for proper voltage at the power source and at the plasma system. ▪ If applicable, disconnect the system from generator power. See <i>Generator considerations</i> on page 149.
0-60-1	Alternating current (AC) input voltage too low	 Blinks		<ul style="list-style-type: none"> ▪ The input line voltage is too low (more than 10% below the rated voltage for 1-phase models or 15% below the rated voltage for 3-phase models). Have an electrical technician check the line and increase the voltage. See page 21 and page 28. ▪ If applicable, disconnect the system from generator power. See <i>Generator considerations</i> on page 149.
0-60-2	Alternating current (AC) input voltage too high	 Blinks		<ul style="list-style-type: none"> ▪ The input line voltage is too high (more than 10% above the rated voltage for 1-phase models or 20% above the rated voltage for 3-phase models). Have an electrical technician check the line and decrease the voltage. See page 21 and page 28. ▪ If applicable, disconnect the system from generator power. See <i>Generator considerations</i> on page 149.
0-61-0	Alternating current (AC) input unstable – system shutdown	 Blinks		<ul style="list-style-type: none"> ▪ The current from the incoming power line is unstable. Power down and correct the line resonance problem before continuing. ▪ Make sure the plasma system is not being used on a phase converter. ▪ If applicable, disconnect the system from generator power. See <i>Generator considerations</i> on page 149.
1- <i>nn-n</i> 2- <i>nn-n</i> 3- <i>nn-n</i>	Major fault	 ON	 ON	<ul style="list-style-type: none"> ▪ An internal component may be faulty. Restart the plasma power supply. In some instances, a restart can clear the fault condition. ▪ If restarting the plasma power supply does not clear the fault, a qualified service technician must service the system. Contact your distributor or authorized repair facility.

Gas Pressure fault LED

The minimum gas pressure required varies based on:



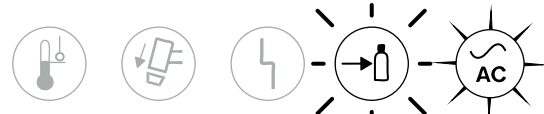

- Selected mode (cut or gouge)
- Type of torch
- Length of torch lead

For example, if you select cut mode and are using a hand torch with a 6 m (20 foot) lead, the Gas Pressure LED illuminates if the inlet gas pressure is less than 3.8 bar (55 psi).

	<p>The Gas Pressure LED illuminates while the system is powered ON.</p>
<p>The input gas pressure is too low.</p> <ul style="list-style-type: none"> ▪ Check all the connections for the input gas supply. Make sure there are no leaks or loose connections. ▪ Make sure the incoming gas supply hose has an internal diameter of 9.5 mm (3/8 inch) or greater. ▪ Check the inlet gas pressure. Adjust as needed. See page 34. ▪ Manually adjust the gas pressure on the plasma system. See page 54. Perform a quick restart. ▪ Run a gas test. See page 149. Compare the inlet set pressure against the actual output gas pressure. If there is no apparent issue with the inlet gas supply, check the air filter bowl and air filter element in the plasma power supply. Clean or replace as needed. See page 155. ▪ If the problem persists, have an authorized service technician examine the system. Contact your distributor or authorized repair facility. 	

	<p>The Gas Pressure LED blinks while the system is powered ON.</p>
<p>The input gas supply is not connected to the plasma power supply.</p> <ul style="list-style-type: none"> ▪ Make sure the input gas supply is properly connected to the plasma system. ▪ Check all the connections for the input gas supply. Make sure there are no leaks or loose connections. ▪ Restart the plasma power supply. 	

Torch Cap fault LED

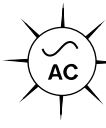





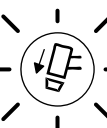

The Torch Cap LED illuminates while the system is powered ON.

- Make sure the torch lead is securely plugged into the plasma power supply. See page 48.
- Make sure the torch-disable switch on the torch is set to the green “ready to fire” (✓) position.
- Turn OFF (O) the power supply. Make sure that the consumables are installed correctly. See page 46. Turn ON (I) the power supply.

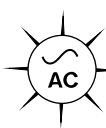
 If the consumables are not installed, or if they are not installed correctly, the Torch Cap LED illuminates even if the torch-disable switch is set to the green “ready to fire” (✓) position.

- Make sure the consumables are not too loose or too tight. Never tighten the consumables more than finger-tight. It is normal for some gas to escape between the torch shell and the retaining cap during use. This is part of the torch design.
- When you use the torch-disable switch to lock and then unlock the torch without turning OFF the plasma power supply, the Torch Cap LED illuminates until you fire the torch 1 time to start the warning puffs of air. See page 45.
- If the torch will not fire an arc, test the torch-disable switch to see if it is working properly. See page 152. Replace the switch if it is broken.
- If the consumables are in good condition and appear to be installed correctly, the torch may be damaged. Contact your distributor or authorized repair facility.







The Torch Cap LED blinks slowly (TSO) or rapidly (TSC) while the system is powered ON.

- If the consumables became loose or were removed while the plasma power supply was ON and the torch-disable switch remained ON, turn OFF (O) the power supply, correct the problem, and then turn ON (I) the power supply to clear the fault.
- **A slow blink rate (less than 1 blink per second) indicates a “torch stuck open” (TSO) condition.** Check the consumables, including the swirl ring. Make sure they are not worn or damaged. See page 154. If you are in gouge/marketing mode, make sure you are not using the Maximum Control gouging consumables with the output current set below 26 A. Either increase the output current above 25 A or install the Precision gouging consumables. See *Gouging processes* on page 71. Next, check the gas line. See *Check the gas pressure* on page 140 and *Check the gas quality* on page 141.
- **A rapid blink rate (multiple blinks per second) indicates a “torch stuck closed” (TSC) condition.** Check the consumables, including the swirl ring. Make sure they are not worn or damaged. See page 154. Next, check the gas line. See *Check the gas pressure* on page 140 and *Check the gas quality* on page 141.
- If the fault persists, change all of the consumables, including the swirl ring. If the consumables are in good condition and appear to be installed correctly, the torch may be damaged. Contact your distributor or authorized repair facility.

Generator considerations

- If a fault occurs while using a generator, turning the power switch quickly to OFF and then to ON again (a quick restart) may not clear the fault. Instead, turn OFF the power supply and wait 60 to 70 seconds before turning it ON again.
- Issues with input line voltage (fault codes 0-13-0, 0-60-*n*, and 0-61-0) can be more difficult to troubleshoot when you are operating the plasma system off of a generator. Disconnect the plasma system from the generator, and connect it to an appropriately sized power outlet.

 See page 33 for generator specifications.

Run a gas test

CAUTION

Point the torch away from you before performing a gas test. Always keep hands, clothes, and objects clear of the torch tip. Never point the torch toward yourself or others.

Use a gas test to determine if adequate gas pressure is exiting the torch. The gas test lets you see the plasma system's actual gas pressure so that you can compare it to the inlet set pressure.

Enter gas test mode

1. Press-and-hold the **Mode** button for approximately 5 seconds.
2. Release the **Mode** button when the 2-digit display shows **P.C.**
3. The set pressure blinks on the 2-digit display before the actual output gas pressure displays. Make note of the set pressure so that you can compare it to the actual pressure.

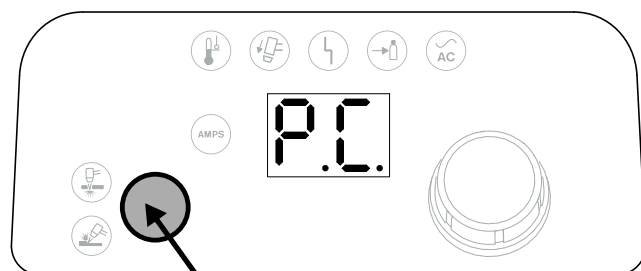

Press-and-hold for 5 seconds.

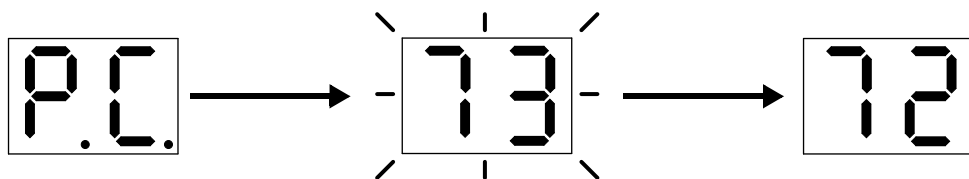

"P.C." displays when you enter gas test mode.

The set pressure blinks briefly.

The actual pressure displays.

- 
 If the 2-digit display shows “0.0” (for bar) or “00” (for psi) instead of the actual pressure, check to see if the trigger for the hand torch or the start signal for the machine torch needs to be released.

While gas test mode is active

- Air flows continuously from the torch tip.
- The 2-digit displays shows the output gas pressure (in psi or bar – see page 57).
- The AMPS LED remains off.

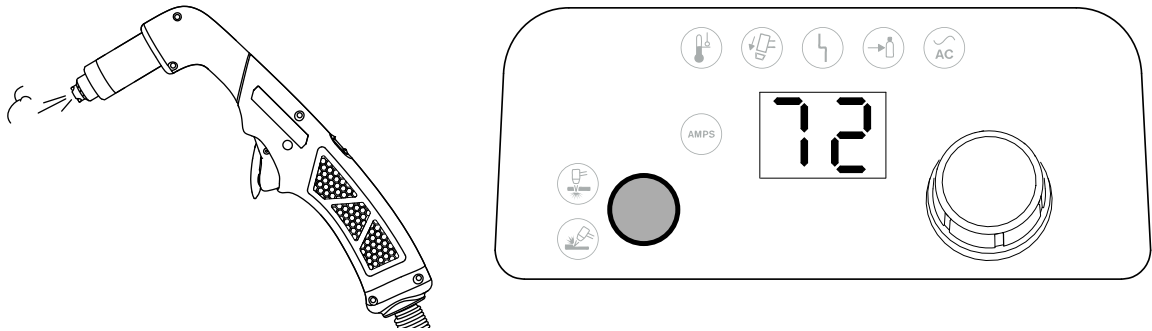

Exit gas test mode

You can do either of the following actions to exit gas test mode:

- Press the **Mode** button.
- Turn the adjustment knob.

After the system exits gas test mode:

- The 2-digit displays shows the cutting current (amperage).
- The AMPS LED illuminates.

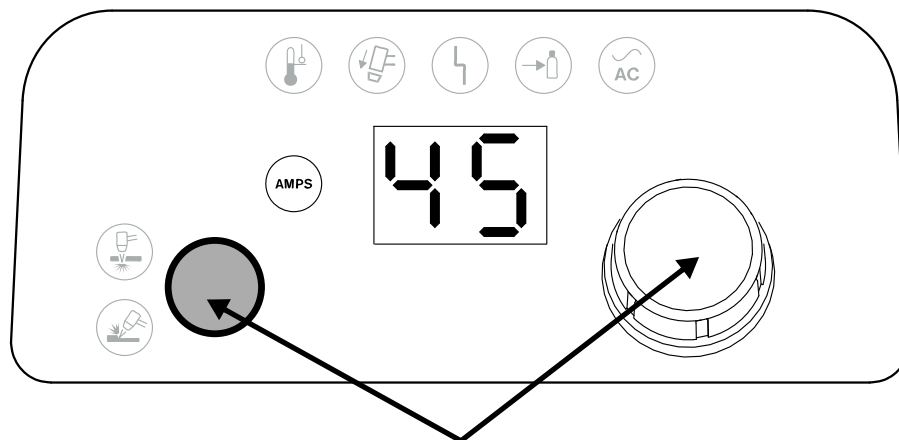

Press button or turn knob to exit gas test mode.

11

Routine Maintenance

Inspect the system and torch

! WARNING

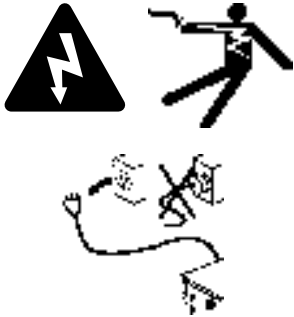

ELECTRIC SHOCK CAN KILL

Disconnect electric power before performing any maintenance.

All work requiring removal of the power supply cover must be performed by a qualified technician.

See the *Safety and Compliance Manual (80669C)* for more safety precautions.

! WARNING

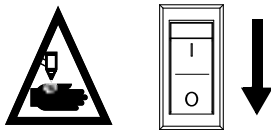

INSTANT-ON TORCHES – PLASMA ARC CAN CAUSE INJURY, BURNS

The plasma arc ignites immediately when you pull the torch trigger. Before changing consumables, one of the following actions must be taken. Whenever possible, complete the first action.

- Turn OFF (O) the plasma power supply.

OR

- Move the torch-disable switch to the yellow lock (X) position (closest to the torch lead). Pull the trigger to make sure the torch does not fire a plasma arc.

Every use

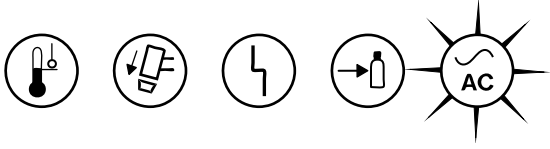
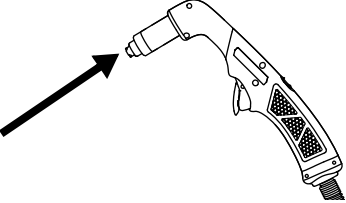
System	Torch
 <p data-bbox="175 600 704 663">Check the indicator LED lights and correct any fault conditions. See page 143.</p>	 <p data-bbox="906 600 1354 663">Inspect the consumables for proper installation and wear. See page 154.</p>

Every consumable change or weekly (whichever is more frequent)

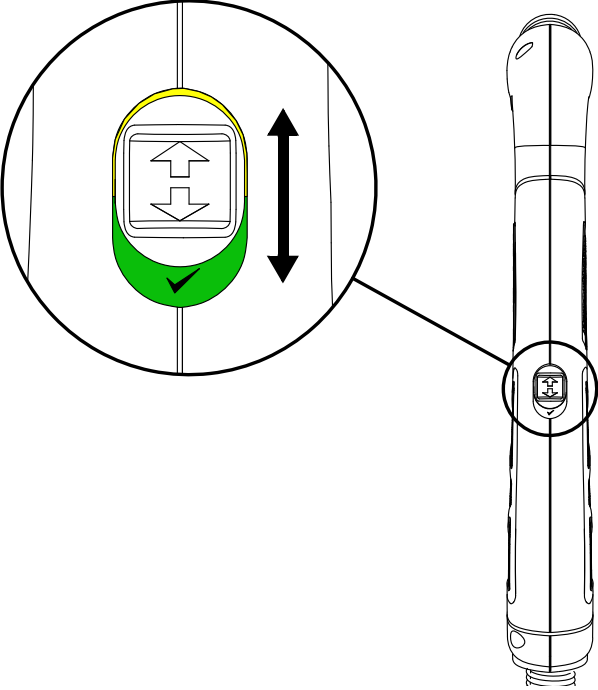
Torch	
<p data-bbox="175 932 711 995">Test the torch-disable switch to make sure it properly disables and activates the torch:</p> <ol data-bbox="181 1033 711 1747" style="list-style-type: none"> 1. With the plasma power supply turned ON, set the torch-disable switch to the yellow lock (X) position. 2. Point the torch away from yourself and others. Pull the trigger to make sure that the torch does not fire an arc. For the machine torch, run a START/STOP command from the CNC. 3. Set the torch-disable switch to the green “ready to fire” (✓) position. 4. Point the torch away from yourself and others. Pull the trigger 1 time. For the machine torch, run a START/STOP command from the CNC. Make sure that the torch does not fire an arc. Make sure that instead the torch emits multiple puffs of air in quick succession. See page 45. <p data-bbox="175 1785 704 1848">Replace the torch-disable switch if it is not working properly. See page 159.</p>	

Every 3 months

System	Torch
<div data-bbox="310 338 610 697" data-label="Image"> </div> <p data-bbox="175 743 623 810">Inspect the power cord and plug. Replace if damaged. See page 161.</p> <div data-bbox="300 1220 586 1346" data-label="Image"> </div> <p data-bbox="175 1472 537 1539">Replace any damaged labels. See page 169.</p>	<div data-bbox="1045 432 1289 638" data-label="Image"> </div> <p data-bbox="906 743 1365 810">Hand torches: inspect the trigger for damage.</p> <p data-bbox="906 848 1414 915">Hand and machine torches: inspect the torch body for cracks and exposed wires.</p> <p data-bbox="906 953 1260 1020">Replace any damaged parts. See page 159.</p> <div data-bbox="1045 1131 1414 1415" data-label="Image"> </div> <p data-bbox="906 1472 1442 1539">Inspect the torch lead. Replace if damaged. See page 159.</p>

Inspect the consumables

The best way to judge the condition of used consumables is to regularly check the cut edge quality of the metal. When the cut quality begins to deteriorate, inspect the consumables.

Many common cut issues can be resolved by installing new consumables in the torch. See page 46.

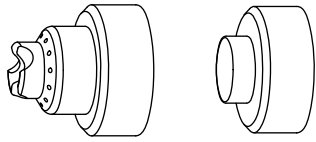
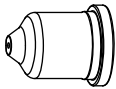
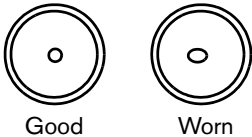
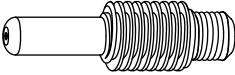
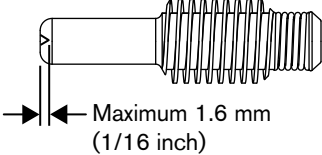
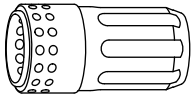
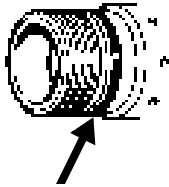
Part	Inspect	Action
 <p>Shield Deflector</p>	<p>Shield: The center hole for roundness.</p>	<p>Shield: Replace the shield if the center hole is no longer round.</p>
	<p>Deflector: The edges of the center hole for damage or noticeable wear.</p>	<p>Deflector: Replace the deflector if the center hole is worn or damaged.</p>
	<p>The gap between the nozzle and the shield or deflector for accumulated debris.</p>	<p>Remove the shield or deflector and clean away any debris.</p>
 <p>Nozzle</p>	<p>The center hole for roundness.</p>  <p>Good Worn</p>	<p>Replace the nozzle if the center hole is not round.</p> <p>Replace the nozzle and the electrode together.</p>
 <p>Electrode</p>	<p>The center surface for wear, and verify the pit depth.</p>  <p>Maximum 1.6 mm (1/16 inch)</p>	<p>Replace the electrode if the surface is severely worn or the pit depth is greater than 1.6 mm (1/16 inch) deep.</p> <p>Replace the nozzle and the electrode together.</p>
 <p>Swirl ring</p>	<p>The surface inside the swirl ring for damage or wear and the gas holes for blockages.</p>	<p>Replace the swirl ring if the surface is damaged or worn or any of the gas holes are blocked.</p>
	<p>The O-ring inside the swirl ring for damage or wear.</p>	<p>If the O-ring in the swirl ring is cracked, worn, or damaged, replace the swirl ring.</p> <p>Do not apply grease or other lubricants to the O-ring in the swirl ring.</p>
	<p>The length of the swirl ring.</p>	<p>If the length of the 220857 or 220947 swirl ring is less than 30.5 mm (1.2 inches), replace it.</p>
 <p>Torch O-ring</p>	<p>The surface for damage, wear, or a lack of lubrication.</p>	<p>If the torch O-ring is dry, apply a thin film of silicone lubricant on the O-ring and the threads. The O-ring should look shiny, but there should not be any excess or built-up lubricant.</p> <p>If the O-ring is cracked or worn, replace it.</p>

Replace the air filter bowl and filter element

It is extremely important to maintain a clean, dry gas line in order to:

- Prevent oil, water, dirt, and other contaminants from damaging internal components.
- Achieve optimal cut quality and consumable life.

Check the filter element inside the air filter bowl regularly, especially in environments that are very dusty or very warm and humid. Replace the filter element when it is dirty or starts to deteriorate. See page 161 for part numbers.



⚠ CAUTION

Synthetic lubricants containing esters that are used in some air compressors will damage polycarbonates used in the air filter bowl.

Keep the filter bowl and its O-ring free from oil, chemicals, dirt, and other contaminants. These contaminants can prevent a good seal, causing gas to leak and additional contaminants to enter the gas line. Over time, these contaminants can damage internal components.



-  If you are using an external filtration system – such as the Eliminer filter kit (128647) that Hypertherm provides – also check that filter regularly for required maintenance or cleaning.

It is normal to see a small amount of water in the bottom of the filter bowl. The filter bowl automatically purges excess moisture when enough water accumulates to engage the float mechanism inside the bowl.

1. Set the power switch on the power supply to OFF (O). Disconnect the power cord from the power source.
2. Disconnect the gas supply from the back of the power supply.
3. Remove the air filter bowl by unscrewing the metal guard ① until it detaches from the air filter assembly inside the power supply.

-  Use an adjustable wrench if needed to loosen the filter bowl. However, be careful not to damage the polycarbonate bowl inside the metal guard.

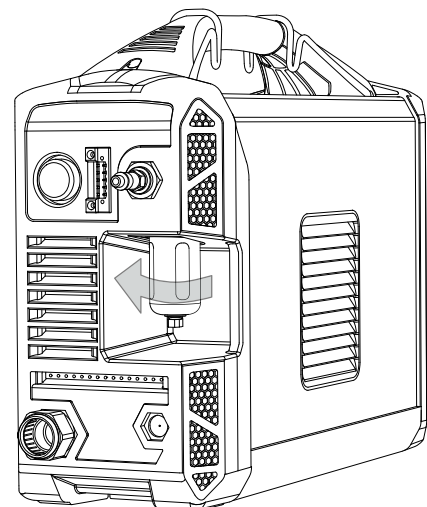

4. Remove the air filter bowl ② from the metal guard.
5. Gently pry the filter element ③ out of the filter bowl. Be careful not to damage the O-ring at the top of the bowl.



6. Are you replacing the filter element or the air filter bowl?
 - If you are replacing only the air filter bowl, skip to *step 11*.
 - If you are replacing the filter element inside the bowl, continue with the next step.
7. Twist the plastic fittings ④ until they come apart, approximately a 1/4 turn. Set the fittings aside.



8. Enclose the new air filter element in the plastic fittings. Twist the plastic fittings until they lock together, approximately a 1/4 turn.



9. Clean the air filter bowl by wiping away any oil, dirt, or other contaminants.



A yellow residue on the filter bowl often indicates that oil is getting into the gas supply line.

10. Examine the air filter bowl's O-ring. Replace it if it is cracked or damaged. Place the O-ring at the top of the filter bowl.
11. Place the filter element inside the air filter bowl. Press down on the top plastic fitting until you hear it snap into place.
12. Place the air filter bowl inside the metal guard.



13. Put the air filter bowl back into place by screwing the metal guard into the air filter assembly that is inside the power supply.



Make sure the air filter bowl remains straight as you install it. Otherwise, you may damage the threads on the bowl.

14. Reconnect the gas supply to the back of the power supply.
15. Reconnect the power cord, and set the power switch to ON (I).

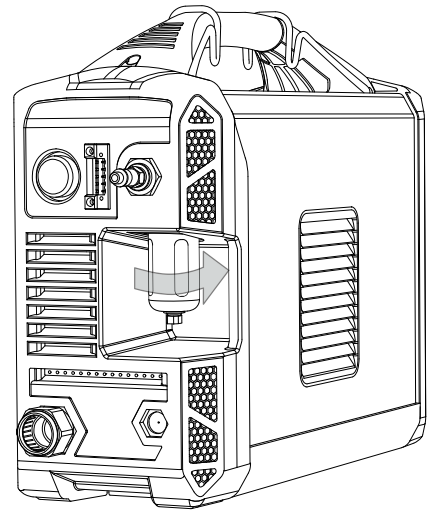

12

Replacement Parts and Accessories

Use the part numbers and kit numbers in this section to order replacement parts and accessories for your plasma power supply and torches.

For consumable part numbers:

- **Hand torch cutting and piercing:** see page 61
- **Gouging:** see page 71
- **Machine torch cutting and piercing:** see page 105
- **Marking:** see page 113



For instructions on installing the consumables, see *Step 1 – Install consumables and activate torch* on page 46.

For assistance with repairing or replacing internal components:

1. Call your Hypertherm distributor or authorized Hypertherm repair facility.
2. Call the nearest Hypertherm office listed in the front of this manual.

Plasma supply exterior, front

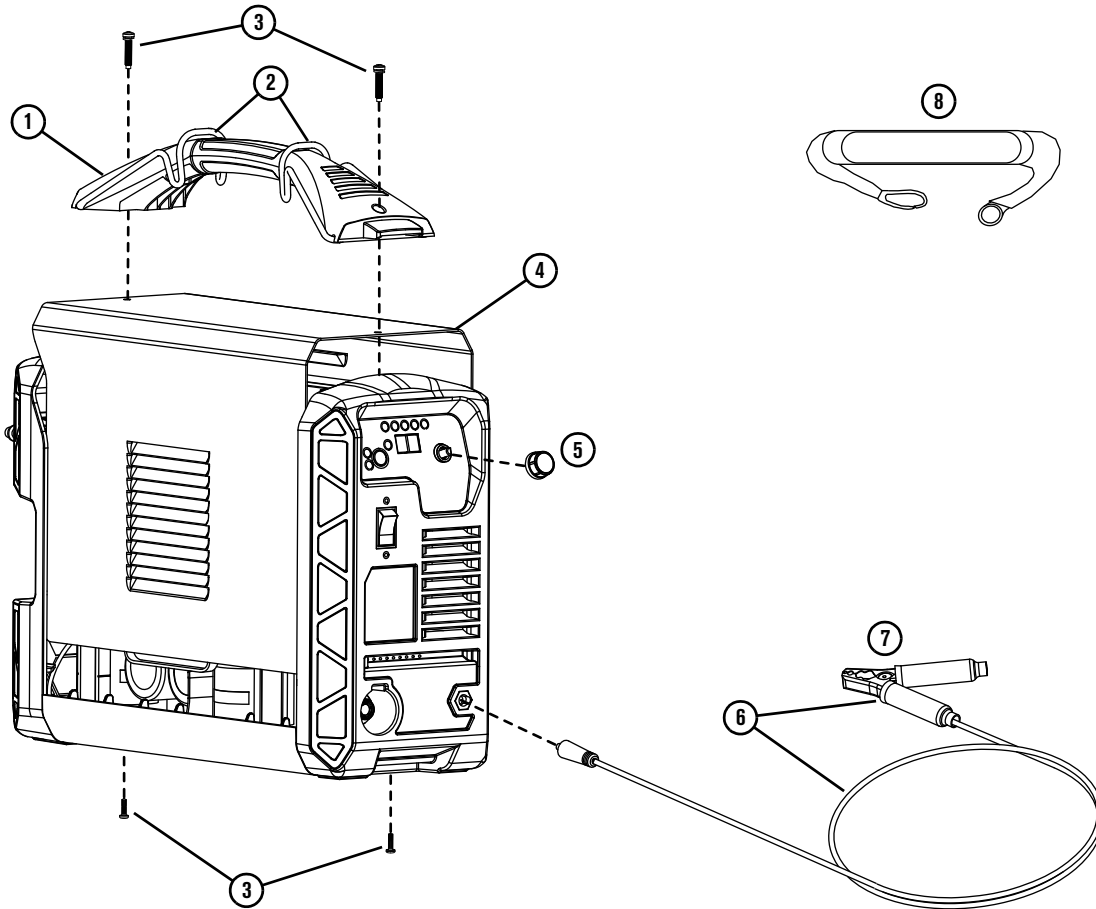

Item	Kit number	Description
1	428663	Kit: Power supply handle with screws (includes clips for shoulder straps)
2	104821	Replacement clips for shoulder strap*
3	428662	Kit: Replacement screws for power supply handle, front panel, and rear panel
4	428657	Kit: Power supply cover with labels, CSA (no screws included)
4	428658	Kit: Power supply cover with labels, CE/CCC (no screws included)
5	428143	Kit: Adjustment knob for control panel
6	223595	Work lead, 7.6 m (25 foot), with work clamp
6	223596	Work lead, 15 m (50 foot), with work clamp
7	228561	Kit: Work clamp, 200 A
8	127217	Shoulder strap (sold separately – not included with system)

* The clips for the shoulder strap come with the system. They are also included in the replacement kit for the power supply handle. They do not come with the shoulder strap itself.

Plasma supply exterior, rear

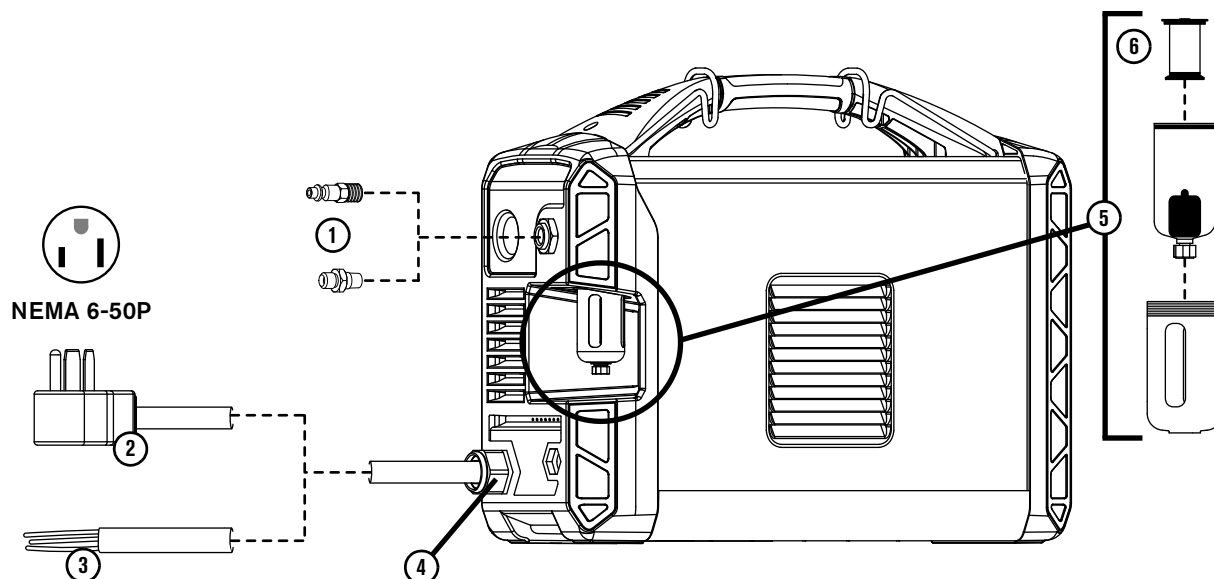

Item	Kit number	Description
1	428685	Kit: Gas inlet fittings: <ul style="list-style-type: none"> ▪ Industrial interchange quick-disconnect nipple with 1/4 NPT threads ▪ British Pipe Thread adapter G-1/4 BSPP with 1/4 NPT threads ▪ 1/4 NPT bulkhead fitting (inside the power supply – not shown)
2	428664	Kit: CSA power cord with strain relief, 1-phase, 3 m (10 foot) (includes NEMA 6-50P power plug)
3	428667	Kit: CE/CCC power cord with strain relief, 1-phase, 3 m (10 foot) (no power plug included)
3	428665	Kit: CSA power cord with strain relief, 3-phase, 3.5 m (11 foot) (no power plug included)
3	428666	Kit: CE/CCC power cord with strain relief, 3-phase, 3 m (10 foot) (no power plug included)
4	228680	Kit: Strain relief for power cords
5	428673	Kit: Air filter bowl (polycarbonate) with metal guard (includes air filter element and O-ring)
6	428378	Kit: Air filter element



See page 155 for instructions on replacing the air filter bowl and the filter element.

Machine interface (CPC) and serial interface upgrade kits

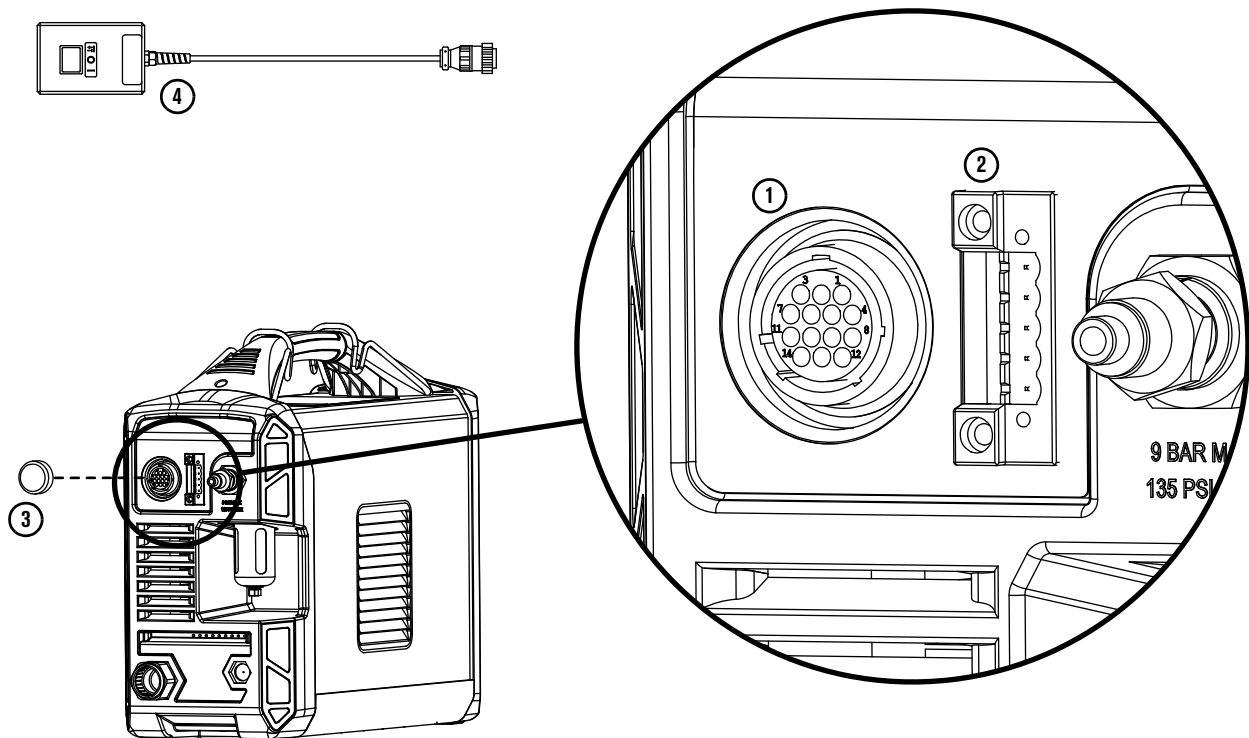

Item	Kit number	Description
1	428653	Kit: Machine interface (CPC) port with internal cables and voltage divider board (does not include cover for receptacle)
2	428654	Kit: Serial interface port with internal cables and RS-485 board
3	127204	Cover for machine interface (CPC) port
4	128650	Remote start pendant for machine torch, 7.6 m (25 feet)
4	128651	Remote start pendant for machine torch, 15 m (50 feet)
4	128652	Remote start pendant for machine torch, 23 m (75 feet)



The remote start pendants connect to the CPC port.

External cables for machine interface port and serial port

Hypertherm offers a variety of external cables that connect to the machine interface (CPC) port and the serial port. For pictures and for setup information, see:

- *Connect the machine interface cable on page 98*
- *Connect an optional RS-485 serial interface cable on page 103*

Part number	Description
023206	External machine interface cable (start, stop, arc transfer signals), 7.6 m (25 feet), spade connectors
023279	External machine interface cable (start, stop, arc transfer signals), 15 m (50 feet), spade connectors
228350	Kit: External machine interface cable (start, stop, arc transfer signals) for divided arc voltage, 7.6 m (25 feet), spade connectors
228351	Kit: External machine interface cable (start, stop, arc transfer signals) for divided arc voltage, 15 m (50 feet), spade connectors
223354	External machine interface cable (start, stop, arc transfer signals) for divided arc voltage, 3.0 m (10 feet), D-sub connector with screws
223355	External machine interface cable (start, stop, arc transfer signals) for divided arc voltage, 6.1 m (20 feet), D-sub connector with screws
223048	External machine interface cable (start, stop, arc transfer signals) for divided arc voltage, 7.6 m (25 feet), D-sub connector with screws
223356	External machine interface cable (start, stop, arc transfer signals) for divided arc voltage, 10.7 m (35 feet), D-sub connector with screws
123896	External machine interface cable (start, stop, arc transfer signals) for divided arc voltage, 15 m (50 feet), D-sub connector with screws
223236	External RS-485 cable, unterminated, 7.6 m (25 feet)
223237	External RS-485 cable, unterminated, 15 m (50 feet)
223239	External RS-485 cable, 9-pin D-sub connector for Hypertherm controls, 7.6 m (25 feet)
223240	External RS-485 cable, 9-pin D-sub connector for Hypertherm controls, 15 m (50 feet)

75° hand torch replacement parts

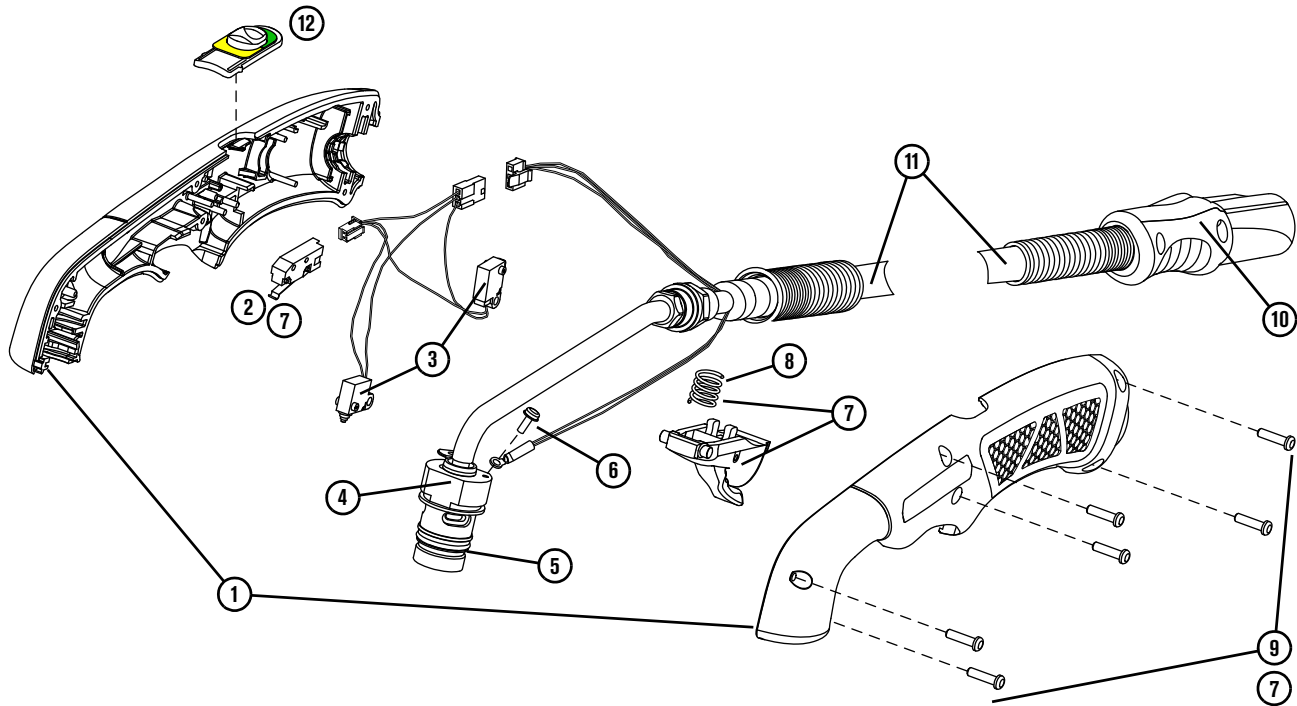

Item	Kit number	Description
	088164*	75° hand torch assembly with 6.1 m (20 foot) lead
	088165*	75° hand torch assembly with 15 m (50 foot) lead
1	428590	Kit: 75° hand torch handle (with screws)
2	428162	Kit: Hand torch start switch
3	428594	Kit: Cap-sensor switch/torch-disable switch assembly for hand torch (includes wires and connectors)
4	428588	Kit: 75° hand torch main body (with O-ring)
5	428180	Kit: Replacement O-rings for torch body
6	075504	Pilot terminal screw
7	428156	Kit: Hand torch trigger and spring – includes start switch and screws for torch handle
8	428182	Kit: Replacement springs for hand torch trigger
9	428148	Kit: Replacement screws for torch handle
10	228314	Kit: Torch quick-disconnect repair (shell with button – does not include torch lead)
11	428592	Kit: Hand torch lead replacement, 6.1 m (20 foot)
11	428593	Kit: Hand torch lead replacement, 15 m (50 foot)
12	428595	Kit: Torch-disable slider for hand torch (with yellow/green label)

* The torch assembly does not include consumables. See page 61 (cutting) and page 71 (gouging) for consumable part numbers.

15° hand torch replacement parts

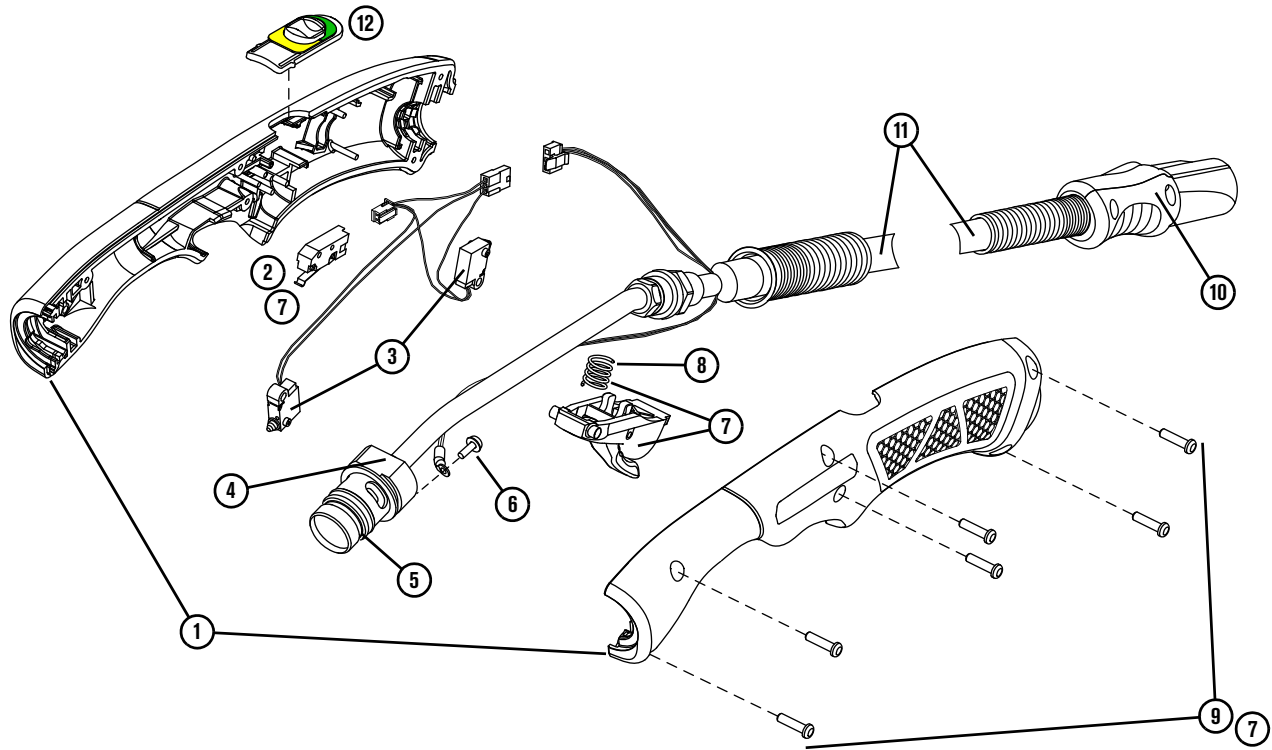

Item	Kit number	Description
	088162*	15° hand torch assembly with 6.1 m (20 foot) lead
	088163*	15° hand torch assembly with 15 m (50 foot) lead
1	428591	Kit: 15° hand torch handle (with screws)
2	428162	Kit: Hand torch start switch
3	428594	Kit: Cap-sensor switch/torch-disable switch assembly for hand torch (includes wires and connectors)
4	428589	Kit: 15° hand torch main body (with O-ring)
5	428180	Kit: Replacement O-rings for torch body
6	075504	Pilot terminal screw
7	428156	Kit: Hand torch trigger and spring – includes start switch and screws for torch handle
8	428182	Kit: Replacement springs for hand torch trigger
9	428148	Kit: Replacement screws for torch handle
10	228314	Kit: Torch quick-disconnect repair (shell with button – does not include torch lead)
11	428592	Kit: Hand torch lead replacement, 6.1 m (20 foot)
11	428593	Kit: Hand torch lead replacement, 15 m (50 foot)
12	428595	Kit: Torch-disable slider for hand torch (with yellow/green label)

* The torch assembly does not include consumables. See page 61 (cutting) and page 71 (gouging) for consumable part numbers.

Machine torch replacement parts

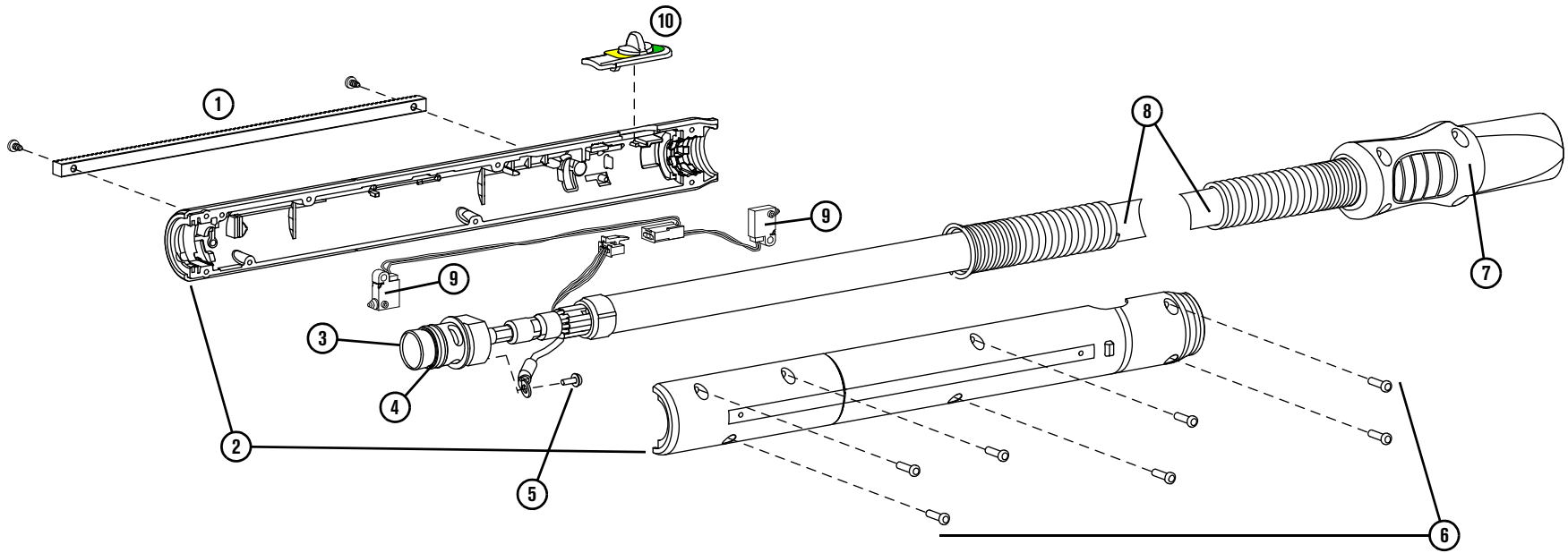

Item	Kit number	Description
	088167*	Kit: Machine torch assembly with 7.6 m (25 foot) lead
	088168*	Kit: Machine torch assembly with 10.7 m (35 foot) lead
	088169*	Kit: Machine torch assembly with 15 m (50 foot) lead
1	428703	Kit: Removable 32-pitch gear rack (with screws)
2	428596	Kit: Machine torch shell (with screws)
3	428704	Kit: Torch main body replacement for machine torch
4	428180	Kit: Replacement O-rings for torch body
5	075504	Pilot terminal screw
6	428148	Kit: Replacement screws for torch shell

Item	Kit number	Description
7	428260	Kit: Torch quick-disconnect repair (shell with button – does not include torch lead)
8	428699	Kit: Machine torch lead replacement, 7.6 m (25 foot)
8	428710	Kit: Machine torch lead replacement, 10.7 m (35 foot)
8	428700	Kit: Machine torch lead replacement, 15 m (50 foot)
9	428705	Kit: Cap-sensor switch/torch-disable switch assembly for machine torch (includes wires and connector)
10	428706	Kit: Torch-disable slider for machine torch (with yellow/green label)

* The torch assembly does not include consumables. See page 105 (cutting), page 71 (gouging), and page 113 (marking) for consumable part numbers.

Accessory parts

Part number	Description
128647	Eliminizer air filter kit
011092	Replacement filter element for Eliminizer air filter
127217	Shoulder strap (clips not included)
104821	Replacement clips for shoulder strap*
127169	Leather cutting gloves
127239	Face shield, shade 6 lens
127219	Dust cover for power supply
017060	Rolling tool bag (fits power supply, torch, consumables, and some accessories)
024548	Leather torch lead cover, brown, 7.6 m (25 feet)
024877	Leather torch lead cover, black with Hypertherm logo, 7.6 m (25 feet)
127102	Basic plasma (circle) cutting guide
027668	Deluxe plasma (circle) cutting guide
017059	Bevel cutting guide
027055	Silicone lubricant, 1/4 ounce (for O-ring on torch body and air filter bowl)

* The clips for the shoulder strap come with the system. They are also included in the replacement kit for the power supply handle. They do not come with the shoulder strap itself. See page 160.

Powermax45 XP Labels

Kit number	Description
428655	Kit: Powermax45 XP labels for 1-phase models
428656	Kit: Powermax45 XP labels for 3-phase models

The label kits include:

- Warning labels
- Decals for side panels
- Consumable labels

Consumable labels and fault codes label

The consumable labels and the fault codes label are removable stickers. The fault codes label is found inside the front cover of the Operator Manual. The consumable labels are included in the literature package that comes with the system. Place the labels on the side of the power supply or near your work area for ease of reference.

Fault Codes	
0-11-0	Invalid mode input from remote controller
0-11-1	Invalid current input from remote controller
0-11-2	Invalid pressure input from remote controller
0-12-1	Low output gas pressure: alert
0-12-2	High output gas pressure: alert
0-12-3	Output gas pressure unstable: alert
0-13-0	AC input unstable: alert
0-51-0	Start/trigger signal ON at power up
0-60-0	AC input voltage error – phase loss
0-60-1	AC input voltage error – voltage too low
0-60-2	AC input voltage error – voltage too high
0-61-0	AC input unstable: shutdown

See Operator Manual for details

Fault codes label

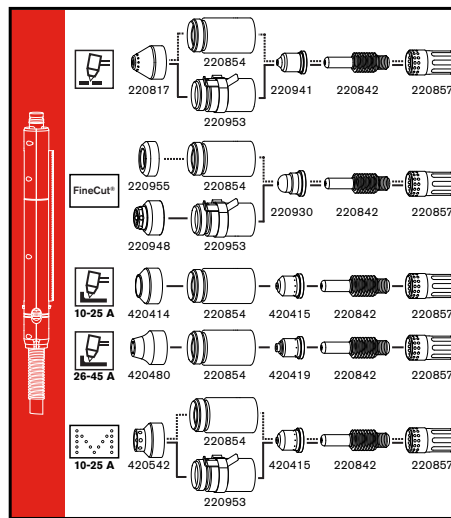



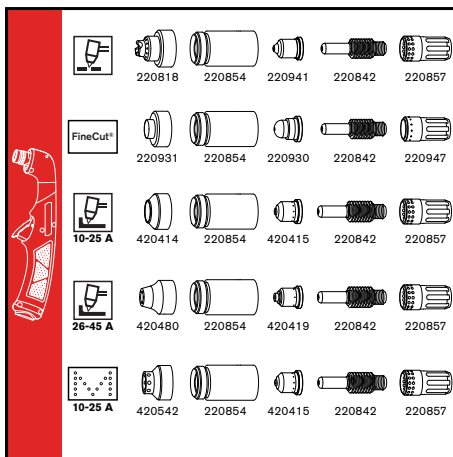







Consumable label – machine torch

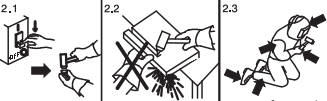

Consumable label – hand torch

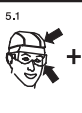
CSA warning label

This warning label is affixed to some power supplies. It is important that the operator and maintenance technician understand the intent of these warning symbols as described.

	Read and follow these instructions, employer safety practices, and material safety data sheets. Refer to ANS Z49.1, "Safety in Welding, Cutting and Allied Processes" from American Welding Society (http://www.aws.org) and OSHA Safety and Health Standards, 29 CFR 1910 (http://www.osha.gov).	 WARNING	 AVERTISSEMENT
1		Plasma cutting can be injurious to operator and persons in the work area. Consult manual before operating. Failure to follow all these safety instructions can result in death.	Le coupage plasma peut être préjudiciable pour l'opérateur et les personnes qui se trouvent sur les lieux de travail. Consulter le manuel avant de faire fonctionner. Le non respect des ces instructions de sécurité peut entraîner la mort.
1.1 1.2 1.3		1. Cutting sparks can cause explosion or fire. 1.1 Do not cut near flammables. 1.2 Have a fire extinguisher nearby and ready to use. 1.3 Do not use a drum or other closed container as a cutting table.	1. Les étincelles de coupage peuvent provoquer une explosion ou un incendie. 1.1 Ne pas couper près des matières inflammables. 1.2 Un extincteur doit être à proximité et prêt à être utilisé. 1.3 Ne pas utiliser un fût ou un autre contenant fermé comme table de coupage.
2		2. Plasma arc can injure and burn; point the nozzle away from yourself. Arc starts instantly when triggered. 2.1 Turn off power before disassembling torch. 2.2 Do not grip the workpiece near the cutting path. 2.3 Wear complete body protection.	2. L'arc plasma peut blesser et brûler; éloigner la buse de soi. Il s'allume instantanément quand on l'amorce. 2.1 Couper l'alimentation avant de démonter la torche. 2.2 Ne pas saisir la pièce à couper de la trajectoire de coupage. 2.3 Se protéger entièrement le corps.
3		3. Hazardous voltage. Risk of electric shock or burn. 3.1 Wear insulating gloves. Replace gloves when wet or damaged. 3.2 Protect from shock by insulating yourself from work and ground. 3.3 Disconnect power before servicing. Do not touch live parts.	3. Tension dangereuse. Risque de choc électrique ou de brûlure. 3.1 Porter des gants isolants. Remplacer les gants quand ils sont humides ou endommagés. 3.2 Se protéger contre les chocs en s'isolant de la pièce et de la terre. 3.3 Couper l'alimentation avant l'entretien. Ne pas toucher les pièces sous tension.
4		4. Plasma fumes can be hazardous. 4.1 Do not inhale fumes. 4.2 Use forced ventilation or local exhaust to remove the fumes. 4.3 Do not operate in closed spaces. Remove fumes with ventilation.	4. Les fumées plasma peuvent être dangereuses. 4.1 Ne pas inhaler les fumées. 4.2 Utiliser une ventilation forcée ou un extracteur local pour dissiper les fumées. 4.3 Ne pas couper dans des espaces clos. Chasser les fumées par ventilation.
5		5. Arc rays can burn eyes and injure skin. 5.1 Wear correct and appropriate protective equipment to protect head, eyes, ears, hands, and body. Button shirt collar. Protect ears from noise. Use welding helmet with the correct shade of filter.	5. Les rayons d'arc peuvent brûler les yeux et blesser la peau. 5.1 Porter un bon équipement de protection pour se protéger la tête, les yeux, les oreilles, les mains et le corps. Boutonner le col de la chemise. Protéger les oreilles contre le bruit. Utiliser un masque de soudeur avec un filtre de nuance appropriée.
6		6. Become trained. Only qualified personnel should operate this equipment. Use torches specified in the manual. Keep non-qualified personnel and children away.	6. Suivre une formation. Seul le personnel qualifié a le droit de faire fonctionner cet équipement. Utiliser exclusivement les torches indiquées dans le manuel. Le personnel non qualifié et les enfants doivent se tenir à l'écart.
7		7. Do not remove, destroy, or cover this label. Replace if it is missing, damaged, or worn.	7. Ne pas enlever, détruire ni couvrir cette étiquette. La remplacer si elle est absente, endommagée ou usée.

CE/CCC warning label

This warning label is affixed to some power supplies. It is important that the operator and maintenance technician understand the intent of these warning symbols as described. The numbered text corresponds to the numbered boxes on the label.



1. Cutting sparks can cause explosion or fire.
 - 1.1 Do not cut near flammables.
 - 1.2 Have a fire extinguisher nearby and ready to use.
 - 1.3 Do not use a drum or other closed container as a cutting table.
2. Plasma arc can injure and burn; point the nozzle away from yourself. Arc starts instantly when triggered.
 - 2.1 Turn off power before disassembling torch.
 - 2.2 Do not grip the workpiece near the cutting path.
 - 2.3 Wear complete body protection.
3. Hazardous voltage. Risk of electric shock or burn.
 - 3.1 Wear insulating gloves. Replace gloves when wet or damaged.
 - 3.2 Protect from shock by insulating yourself from work and ground.
 - 3.3 Disconnect power before servicing. Do not touch live parts.
4. Plasma fumes can be hazardous.
 - 4.1 Do not inhale fumes.
 - 4.2 Use forced ventilation or local exhaust to remove the fumes.
 - 4.3 Do not operate in closed spaces. Remove fumes with ventilation.
5. Arc rays can burn eyes and injure skin.
 - 5.1 Wear correct and appropriate protective equipment to protect head, eyes, ears, hands, and body. Button shirt collar. Protect ears from noise. Use welding helmet with the correct shade of filter.
6. Become trained. Only qualified personnel should operate this equipment. Use torches specified in the manual. Keep non-qualified personnel and children away.
7. Do not remove, destroy, or cover this label. Replace if it is missing, damaged, or worn.

Data plate

The data plate on the bottom of the plasma power supply contains 2 sets of ratings:

- The *HYP* ratings are Hypertherm power supply ratings. They reflect the capability of the system based on Hypertherm's internal testing.
- The *IEC* ratings are predefined minimum thresholds that the system was required to meet to fulfill IEC standard 60974-1.

CSA and CE/CCC data plates differ slightly. The following sample is a CE/CCC data plate.

Hypertherm		10A/84V - 45A / 98V							
powermax45 XP P/N: 088XXX		4	6	X@40°C	50%	60%	100%		
Plasma cutting system				HYP I ₂	8				
71 Heater Road				HYP U ₂					
Lebanon, NH 03766, USA				IEC I ₂	9				
Engineered and Assembled in USA		5	U ₀	X@40°C	50%	60%	100%		
Country of Origin: USA				HYP I ₂	10				
等离子切割机				HYP U ₂	11				
71号希特路黎巴嫩市				IEC I ₂					
新罕布什 03766		12		IP23S 210XXX REV X					
美国设计和组装		14		U ₁	HYP I ₁	PF@HYP I ₁	I _{1max} cutting	I _{1max} gouging	I _{1eff}
S/N 45XP-999999		2		50/60 Hz					
EN60974-1,-10		3							
GB15579.1-2013									
GOST 12.2-007.8-75									
GOST 12.2-007.0-75									
P ₁ = 3.5 kWh/h									
P _s = 0 Wh/h									
PATENTS:CURRENT LIST AT WWW.HYPERTHERM.COM/PATENTS/									

- | | |
|---|---|
| 1 S/N = serial number | 9 IEC = International Electrotechnical Commission rating |
| 2 Region-specific certification standards | 10 I₂ = Conventional welding current (A) |
| 3 Placeholders for region-specific certification symbols – see <i>Symbols and marks</i> on page 173 | 11 U₂ = Conventional welding voltage (V) |
| 4 Symbol for plasma cutting | 12 Symbol for inverter-based power source (1-phase or 3-phase) |
| 5 Symbol for plasma gouging | 13 Ingress Protection (IP) rating |
| 6 U₀ = Rated no load voltage (V) | 14 U₁ = Input voltage (V) |
| 7 X = Duty cycle (%) | I₁ = Input current (A) |
| 8 HYP = Hypertherm internal rating | PF = Power factor |

Symbols and marks

Your product may have one or more of the following marks on or near the data plate. Due to differences and conflicts in national regulations, not all marks are applied to every version of a product.



S mark

The S mark indicates that the power supply and torch are suitable for operations carried out in environments with increased hazard of electrical shock according to IEC 60974-1.



CSA mark

Products with a CSA mark meet the United States and Canadian regulations for product safety. The products were evaluated, tested, and certified by CSA-International. Alternatively, the product may have a mark by one of the other Nationally Recognized Testing Laboratories (NRTL) accredited in both the United States and Canada, such as UL or TÜV.



CE mark

The CE marking signifies the manufacturer's declaration of conformity to applicable European directives and standards. Only those versions of products with a CE marking located on or near the data plate have been tested for compliance with the European Low Voltage Directive and the European Electromagnetic Compatibility (EMC) Directive. EMC filters needed to comply with the European EMC Directive are incorporated within versions of the product with a CE marking.



Eurasian Customs Union (CU) mark

CE versions of products that include an EAC mark of conformity meet the product safety and EMC requirements for export to Russia, Belarus, and Kazakhstan.



GOST-TR mark

CE versions of products that include a GOST-TR mark of conformity meet the product safety and EMC requirements for export to the Russian Federation.



RCM mark

CE versions of products with a RCM mark comply with the EMC and safety regulations required for sale in Australia and New Zealand.



CCC mark

The China Compulsory Certification (CCC) mark indicates that the product has been tested and found compliant with product safety regulations required for sale in China.



UkrSEPRO mark

The CE versions of products that include a UkrSEPRO mark of conformity meet the product safety and EMC requirements for export to the Ukraine.











Serbian AAA mark

CE versions of products that include a AAA Serbian mark meet the product safety and EMC requirements for export to Serbia.

IEC symbols

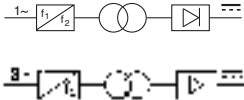
The following symbols may appear on the data plate, control labels, and switches. For information on the front panel LEDs, see *Controls and indicators* on page 41.

	Direct current (DC)		The terminal for the external protective (earth) conductor
	Alternating current (AC)		Power is ON
	Plasma torch cutting		Power is OFF
	Gouging		A 1-phase or 3-phase inverter-based power source
	AC input power connection		Volt/amperage curve, "drooping" characteristic