

OpenStage 40 SIP, OpenStage 40 G SIP OpenStage Key Module 40 OpenScape Voice

User Guide

A31003-S2030-U106-3-7619

Our Quality and Environmental Management Systems are implemented according to the requirements of the ISO9001 and ISO14001 standards and are certified by an external certification company.

Copyright © Unify GmbH & Co. KG 06/2015
Hofmannstr. 63, 81379 Munich/Germany

All rights reserved.

Reference No.: A31003-S2030-U106-3-7619



The information provided in this document contains merely general descriptions or characteristics of performance which in case of actual use do not always apply as described or which may change as a result of further development of the products.

An obligation to provide the respective characteristics shall only exist if expressly agreed in the terms of contract.



Availability and technical specifications are subject to change without notice.

Unify, OpenScape, OpenStage and HiPath are registered trademarks of Unify GmbH & Co. KG. All other company, brand, product and service names are trademarks or registered trademarks of their respective holders.

Important information

	<p>For safety reasons, the telephone should only be supplied with power:</p> <ul style="list-style-type: none"> • using the original power supply unit. Part number: L30250-F600-C14x (x: 1=EU, 2=UK, 3=US) or • in a LAN with PoE (Power over Ethernet) which complies with the IEEE 802.3af standard.
	<p>Never open the telephone or a key module. Should you encounter any problems, contact the administrator.</p>
	<p>Use only original accessories. The use of other accessories may be hazardous and will render the warranty, extended manufacturer's liability and the CE marking invalid.</p>

Trademarks

	<p>The device conforms to the EU directive 1999/5/EC as attested by the CE marking.</p>
	<p>All electrical and electronic products should be disposed of separately from the municipal waste stream via designated collection facilities appointed by the government or the local authorities.</p> <p>Proper disposal and separate collection of your old appliance will help prevent potential damage to the environment and human health. It is a prerequisite for reuse and recycling of used electrical and electronic equipment.</p> <p>For more detailed information about disposal of your old appliance, please contact your city office, waste disposal service, the shop where you purchased the product or your sales representative.</p> <p>The statements quoted above are only fully valid for equipment which is installed and sold in the countries of the European Union and is covered by the directive 2002/96/EC. Countries outside the European Union may impose other regulations regarding the disposal of electrical and electronic equipment.</p>

Location of the telephone

- The telephone should be operated in a controlled environment with an ambient temperature between 5°C and 40°C.
- To ensure good speakerphone quality, the area in front of the microphone (front right) should be kept clear. The optimum speakerphone distance is 50 cm
- Do not install the telephone in a room where large quantities of dust accumulate; this can considerably reduce the service life of the telephone.
- Do not expose the telephone to direct sunlight or any other source of heat, as this is liable to damage the electronic components and the plastic casing.
- Do not operate the telephone in damp environments, such as bathrooms.

Product support on the Internet

Information and support for our products can be found on the Internet at:

<http://www.unify.com/>.

Technical notes, current information about firmware updates, frequently asked questions and lots more can be found on the Internet at:

<http://wiki.unify.com/>.

Contents

Important information	3
Trademarks	3
Location of the telephone	4
Product support on the Internet	4
General information	12
About this manual	12
Symbols used in the manual	12
Service	13
Intended use	13
Telephone type	13
Speakerphone quality and display legibility	13
Single-line telephone/multi-line telephone	13
Getting to know your OpenStage phone	14
The user interface of your OpenStage 40/40 G	14
Ports on the underside of the phone	15
Using network ports more efficiently	16
OpenStage Manager	16
Features	16
Key Module	17
OpenStage Key Module	17
OpenStage Key Module 15	17
Keys	18
Function keys	18
Audio keys	18
Navigator	19
Programmable sensor keys	20
Trunk keys (on multi-line phones only)	21
Keypad	22
Display	24
Idle mode	24
Idle-display view and icons	24
Displays on the status line for adjusting the volume	25
Context-dependent displays	25
Telephony interface	27
Single-line view	27
Multi-line view	28
Phonebooks	30
Personal phonebook	30
Corporate directory	31
Messages	32
Voicemail (answering machine)	32
Calls	33
Telephone menu	35
Program/Service menu	35
User settings	36
Administration	36
Control and monitoring function	37
Contributing to environmental protection by saving energy	37

Basic functions	38
Secure voice transmission	38
Emergency mode	38
Answering a call	38
Answering a call via the handset	39
Answering a call via the loudspeaker (speakerphone mode)	39
Answering a call via the headset	39
Directed pickup	40
Accept call	40
Picking up the held call	40
Switching from handset to speakerphone mode	41
Switching from speakerphone mode to the handset	41
Switching from headset to speakerphone mode	42
In standard mode	42
In US mode	42
Open listening	42
Activating/deactivating the microphone	43
Ending a call	43
Group call	44
Listening to voicemail	46
Call control (2nd alert)	47
Two calls simultaneously	47
While dialling	47
Making calls	48
Off-hook dialling	48
On-hook dialling	49
Immediate dialling	50
Dialling using the hot or warm line function	51
Redial	51
Consulting a second party	52
Ending a consultation call	53
Switching to the held party (alternating)	54
Putting on hold and retrieving successively or simultaneously	55
Connecting parties	56
Callback	57
Requesting callback	57
Responding to a callback	58
Permitting a callback	58
Calling back missed calls	59

Call forwarding	60
Standard call forwarding	60
Using call forwarding	61
Activate or deactivate immediate forwarding	61
Saving destination phone numbers for call forwarding	63
Copy and insert destination phone numbers	63
Assign a destination phone number for call forwarding	65
Activate/deactivate call forwarding	66
Defining the ring duration before call forwarding on no reply	67
Call forwarding by call type	68
Forwarding menu	68
Using call forwarding	69
Activating or deactivating immediate call forwarding	69
Saving destination phone numbers for call forwarding	70
Preconfiguring or changing destination phone numbers	71
Copying and pasting destination phone numbers	71
Assigning a destination phone number to a call type	72
Activating/deactivating call forwarding	73
Call forwarding chain	74
Programmable sensor keys	75
List of available functions	75
Programming sensor keys	76
Starting programming	76
Beginning programming	76
Programming enhanced functions	77
Repertory dial	77
Feature toggle	78
Configuring a fixed forwarding key	79
Configuring a variable call forwarding key	80
Using sensor keys	80
Example 1: Calling saved number	80
Example 2: Call Waiting toggle Activating/deactivating	80
Example 3: Immediate ring	80
Resetting sensor keys	81
Enhanced phone functions	82
Incoming calls	82
Accepting calls via the headset	82
Deflecting a call	82
Rejecting calls	84
Configuring call forwarding	84
Placing a call on hold	86
Call waiting (second call)	91
Transferring a call	95
CTI calls	97
Making calls	99
Dialling with the DDS key	99
Dialling from the local phonebook	99
Dialling from the corporate directory	99
Dialling a phone number from a list	100
Using autodial delay	101
Conference	104
Local conference	104
System-based conference	106

Phonebooks and call lists	108
Personal directory	108
Creating a new contact	108
Editing a contact	108
Deleting a contact	109
Deleting all contacts	109
Searching for a contact	110
Corporate directory	111
Searching for a contact	111
Enhanced editing functions in the phonebook	112
Quick search	113
Call lists	114
Editing entries	114
Delete all entries	114
Call logging	115
Making calls with multiple lines	118
Incoming calls	118
Accepting calls for the primary line	118
Accepting calls for secondary lines	118
Making calls	119
Manual trunk seizure	119
Automatic trunk seizure	120
Dialling the last dialled number	120
Forwarding calls on primary line	120
During calls	121
Making and receiving calls on a single line	121
Making and receiving calls with multiple lines	121
Putting a line on hold	122
Lines with hot or warm line function	123
Busy override	124
Direct station selection keys	125
Calling a station directly	125
Call pickup	126
Deflecting a call to a DSS station	127
LED display on DSS keys	127
Making calls in an executive-secretary team	128
Sample scenarios	128
Accepting a call	129
Connecting a call	130
DSS keys can be used	132
Using line overview	132
Settings for MultiLine (keyset)	133
Displaying the line in the "Overview" tab	133
Setting the time for a delayed ringer	134
Setting the ringtone for lines	135
Configuring the "Overview" tab display	136
Line preview	137
Rollover for a line	138

Privacy/security	139
Activating and deactivating the ringer	139
Activating and deactivating the ringer permanently or setting to beep	139
Deactivating the ringer temporarily for incoming calls and reactivating it	140
Do not disturb	140
Enabling do not disturb via a key	140
Enabling do not disturb via the idle menu	140
Allowing "Do not disturb"	141
Security	142
User password	142
Phone locking	145
Mobility	147
Mobility scenarios	147
Logging on and off at the same phone	147
Logging on and off at different phones	147
Transferring user-defined settings and data	147
Logging on and off at the same phone	148
Logging on to the phone	148
Logging off from the phone	149
Logging on at different telephones	150
Logging on with forced logoff at a remote phone	150
Logging on with forced, delayed logoff at a remote phone	151
OpenScape Voice functions	152
Feature toggle key	152
Hunt group	152
Whispering	152
Making anonymous calls	153
Deactivating	153
Activating	153
Temporarily activating anonymous calling for the next call	154
Temporarily deactivating anonymous calling for the next call	154
Creating a list for selective calls	155
For call acceptance	155
For call rejection	155
Anonymous calls	156
Rejecting	156
Accepting	156
Using abbreviated dialling	157
Call tracing	157
Hunt group functions	158
Making a line busy	158
Marking the last line in the hunt group chain	159
Reachability	160
Serial call	160
Parallel call	161
Parking a call	162
Call park	162
Unparking	162
Silent Monitoring	163
Active silent monitoring	163
Muted silent monitoring	164

One-way Intercom and Two-way Intercom function	165
One-way Intercom	166
Two-way Intercom	166
Announcing the local phone number.	167
Dialling the last caller	167
Retrieving and dialling the last answered caller.	167
Retrieving and dialling the phone number of the last caller dialled	167
Picking up out-of-hours calls.	168
Code table for OpenScape Voice functions	168

Impact Levels 169

Answering a call with a lower Impact Level.	169
Answering a call.	169
Answering forwarded calls.	169
Answering a second call	170
Calls to a lower Impact Level	170
Off-hook dialling	170
Forwarding a call with a lower IL	170
Conducting a call with a lower Impact Level.	171
Conducting a call	171
Holding a call	171
Conference	171
Reconnecting	171
IL alarm	171

Individual phone configuration 172

Display	172
Adjusting the display to a comfortable reading angle	172
Setting contrast	172
Adjusting the brightness.	173
Backlight time.	174
Contrast for the OpenStage Key Module.	175
Date and time	176
Setting the time	176
Setting the date	176
Setting daylight saving time	177
Automatic daylight saving time	178
Time display format	179
Date display format	179
Audio.	180
Volumes	180
Settings	181
Special ringtones	185
Tone and indication with an unsecured voice connection	186
Key click	187
Setting the language and country	188
Selecting a language	188
Country-specific setting	190
Context menu	191
Activating/deactivating automatic menu display	191
Setting the display time	191
Alarm on changing the Impact Level.	192
Network information	193
Resetting user data.	194
Initiating the reset.	194

Call recording	195
Recording modes	195
Explanations of recording	196
Recordable calls	196
Non-recordable calls	196
Enhanced functions:	197
The following features are not supported:	197
Recording tips	197
Multiline	197
Recording conversations.	197
Using the call recording feature	197
Automatic call recording.	198
Manual call recording.	198
Call recording with AutoStart	198
Controlling call recording	199
Consultation during call recording	200
Second call during call recording	200
Call recording while alternating	201
Your call is paused and reconnected during the recording.	201
Setting up a conference during recording	202
Adding conference participants during the recording.	202
Your call is included in a conference during the recording.	203
Putting a line on hold manually during the recording	203
Diagnostic information.	204
Web interface (WBM)	206
General	206
Calling up the WBM interface	206
Administrator Pages.	206
User pages.	207
User menu	208
Fixing problems	212
Caring for your telephone	212
Troubleshooting	212
Contact partner in the case of problems	213
Labeling keys	213
Local user menu	214
Opening the user menu on the phone.	214
User menu display	214
Key functions	222
Index	224

General information

About this manual

This document contains general descriptions of the technical options, which may not always be available in individual cases. The respective features must therefore be individually defined in the terms of the contract.

If a particular function on your phone is not available to you, this may be due to one of the following reasons:

- The function is not configured for you or your telephone. Please contact your system support representative.
- Your communications platform does not feature this function. Please contact your sales partner for information on how to upgrade.

This user guide is intended to help you familiarise yourself with OpenStage and all of its functions. It contains important information on the safe and proper operation of your OpenStage phone. These instructions should be strictly complied with to avoid operating errors and ensure optimum use of your multifunctional telephone in the network.

These instructions should be read and followed by every person installing, operating or programming an OpenStage phone.

 For your own protection, please read the section dealing with safety in detail. Follow the safety instructions carefully in order to avoid endangering yourself or other persons and to prevent damage to the unit.

This user guide is designed to be simple and easy to understand, providing clear step-by-step instructions for operating your OpenStage phone.

Administrative tasks are dealt with in a separate manual. The Quick Reference Guide contains quick and reliable explanations of frequently used functions.

Symbols used in the manual

Settings

Operations and settings that can be made both at the phone and over the WBM interface are indicated by an icon and page reference.



is a reference to an operation or setting performed directly on the phone



is a reference to an operation or setting performed via the WBM interface

Service

-
-  Our service department can only help you if you experience problems or defects with the phone.
Should you have any questions regarding operation, your specialist retailer or network administrator will gladly help you.
For queries regarding connection of the telephone, please contact your network provider.
-

If you experience problems or defects with the phone, please dial the service number for your country.

Intended use

The OpenStage phone is a desktop unit designed for voice transmission and for connection to the LAN. It can also be used as a workstation device. Any other use is regarded as unauthorised.

Telephone type

The phone name data can be found on the name plate on the base of the device; The exact product name and serial number are specified here. Specific details concerning your communications platform can be obtained from your service technician.
Please have this information ready when you contact our service department regarding faults or problems with the product.

Speakerphone quality and display legibility

- To ensure good speakerphone quality, the area in front of the telephone (front right) should be kept clear).
The optimum handsfree distance is 20 inch (50 cm).
- Proceed as follows to optimise display legibility:
 - Turn the phone to tilt the display. This ensures you have a frontal view of the display while eliminating light reflexes.
 - Adjust the contrast as required → Page 172.

Single-line telephone/multi-line telephone

Your OpenStage 40 is a "multi-line telephone". This means that multiple lines can be configured, which is not the case with single-line phones. Each line is assigned an individual phone number which you can use to make and receive calls.

The programmable sensor keys function as line keys on multi-line phones → Page 21.

The "Overview" tab on the telephony interface provides information about the lines configured on your phone and the current status of each line → Page 28.

A number of specific features must be considered when using a multi-line phone to make and receive calls → Page 118.

Getting to know your OpenStage phone

The following sections describe the most frequently used operating elements and the displays on your OpenStage phone.

The user interface of your OpenStage 40/40 G



1	You can make and receive calls as normal using the handset .
2	The graphic display permits intuitive operation of the phone → Page 24.
3	You can customise your telephone by assigning phone numbers and functions to the programmable sensor keys → Page 24.
4	You can use function keys when conducting a call to access frequently used functions (such as, Disconnect) or to open the Program/Service menu and mailbox → Page 18.
5	Audio keys are also available, allowing you to optimally configure the audio features on your telephone → Page 18.
6	The 5-way navigator is a convenient navigation tool → Page 19.
7	The keypad can be used to enter phone numbers and text → Page 22.
8	Incoming calls, new voice messages or missed calls are visually signalled via the alert bar .

Ports on the underside of the phone

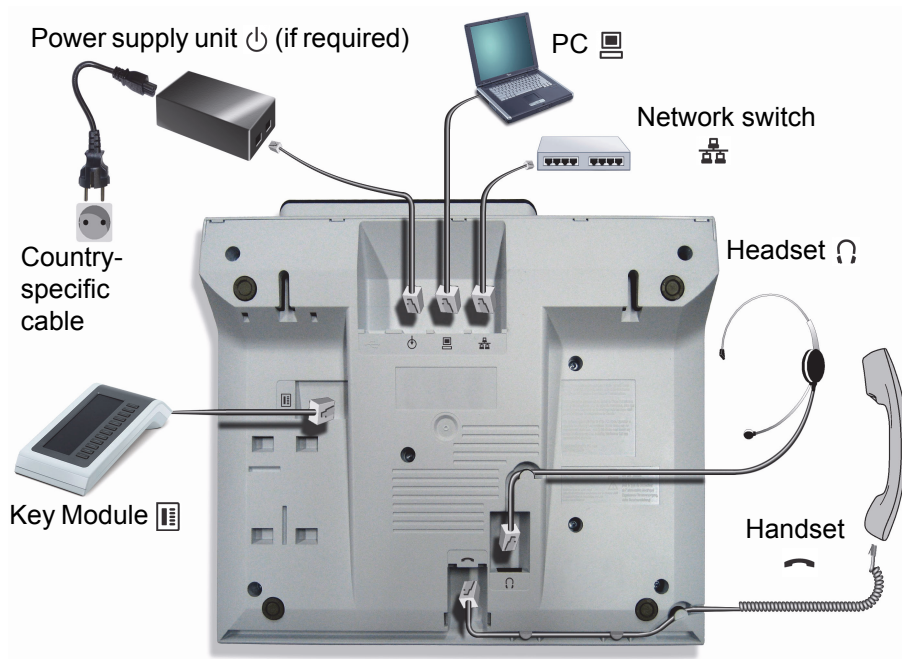

Properties of your OpenStage 40/40 G

OpenStage	40	40 G
LCD display, 40 x 6 characters	✓	✓
Illuminated display	✓	✓
Programmable sensor keys	6	6
Full-duplex speakerphone function	✓	✓
Headset	✓	✓
10/100 Mbps Ethernet switch → Page 16	✓	✓
1000 Mbps Ethernet switch → Page 16	-	✓
Interface for key modules	✓	✓
Wall mounting	✓	✓

Using network ports more efficiently

OpenStage 40 has a built-in 10/100 Mbps Ethernet switch. OpenStage 40 G has a 1000 Mbps Ethernet switch. This means that you can also connect a PC with a Gigabit LAN connection to the LAN directly via the phone. The telephone-PC connection option must first be activated on the telephone by administrator.



Using this connection option saves one network port for each switch used and requires fewer or shorter network cables when arranged correctly.

OpenStage Manager

This program offers you an additional option for tailoring your OpenStage to your personal needs. Further information is available at:

http://wiki.unify.com/wiki/OpenStage_Manager.

Features

- Phonebook management
- Synchronization of contacts
- Save and restore
- Key programming
- Ringtones



Contact your administrator for the latest version of OpenStage Manager. The range of features is dependent on the type of telephone.

Key Module

OpenStage Key Module

The OpenStage Key Module is a key module attached to the side of the phone that provides 12 additional illuminated, programmable keys.

Like keys on the phone, these keys can be programmed and used according to your needs → Page 20.



You can attach up to two OpenStage Key Modules to your OpenStage 40.

▶ To operate an OpenStage Key Module, you always require a power supply unit → Page 3.

OpenStage Key Module 15

The OpenStage Key Module 15 is a key module attached to the side of the phone that provides an additional 18 illuminated, programmable sensor keys.

Like keys on the phone, these keys can be programmed and used according to your needs. Labeling keys see → Page 213.

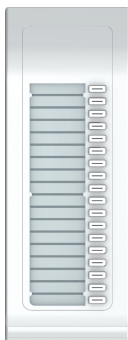

You can only attach one OpenStage Key Module 15 to your OpenStage 40. You **cannot** combine the OpenStage Key Module 15 with the OpenStage Key Module.

Keys

Function keys



Key	Function when key is pressed	LED display
	End (disconnect) call.	none
	Open redial list	none
	Activate/deactivate forwarding	Red: Call forwarding is activated
	Open phone menu → Page 35	Red: Menu is active
	View messages → Page 32	Red: New voicemail or missed calls

Audio keys

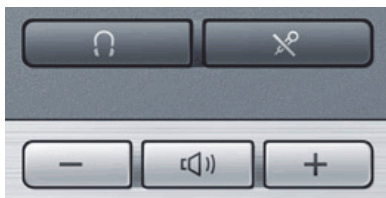











Key	Function when key is pressed
	Activate/deactivate microphone (also for speakerphone mode)
	Activate/deactivate the headset.
	Decrease the ringer, handset and loudspeaker volume → Page 25.
	Activate/deactivate loudspeaker for speakerphone mode and open listening
	Increase the ringer, handset and loudspeaker volume → Page 25.

Navigator

 Before using the telephone, remove the protective covering from the navigator surface.

With this control, you can manage most of your phone's functions, as well as its displays.

Operation	Functions when key is pressed
 Press the  key.	<ul style="list-style-type: none"> • Call up the context menu • Perform action • Go down a level • Call up the context menu in the idle display
 Press the  key.	<ul style="list-style-type: none"> • Short press: One level back • Long press (held down): Go back to the first level of the settings menu • Cancel function • Quit the context menu • In input fields: <ul style="list-style-type: none"> • Delete character to the left of the cursor • Open line overview in idle mode
 Press the  key.	<ul style="list-style-type: none"> • Scroll downwards • Select element below • Long press (held down): Jump to the end of the list/menu
 Press the  key.	<ul style="list-style-type: none"> • Scroll upwards • Select element above • Long press (held down): Jump to the start of the list/menu
 Press the  key.	<ul style="list-style-type: none"> • Confirm input • Perform action • Call up the context menu

Programmable sensor keys

Your OpenStage 40 telephone features six programmable lit sensor keys.

 Increase the number of programmable sensor keys by connecting a key module → Page 17.

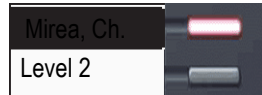

Touch the key briefly to activate the programmed function or dial the stored number → Page 80.

If you hold the key pressed, you are prompted as to whether to start programming this function key.

 If the prompt is not displayed or a programmed function is not executed, then you can only launch key programming via the user menu → Page 76 (ask your administrator about the current setting).

 Only for redial keys can you also program the second level for direct destination selection.



You can label these keys with internal and external phone numbers or frequently used functions (platform-dependent; please contact the responsible administrator).

The configured phone number or function name is displayed next to the key.

The status of a function is shown by the LED on the corresponding sensor key.

 Line and DDS keys can only be programmed by administrator via the service menu.

Meaning of LED displays on function keys

LED	Meaning of function key
 Off	The function is deactivated.
 Flashing ¹	Indicates the function status.
 On	The function is activated.

¹ In this manual, flashing sensor keys are identified by this icon, regardless of the flashing interval. The flashing interval represents different statuses, which are described in detail in the corresponding sections of the manual.

Trunk keys (on multi-line phones only)

Some of the programmable keys on multi-line phones can be set up as trunk keys by administrator. Each key programmed with the "Line" function is handled as a trunk. This means up to five lines can be configured.

A distinction is drawn here between primary, secondary and phantom lines. Each of these line types can be used on a private or shared basis → Page 21.

Primary line

All multi-line telephones have a primary line. This line can be reached in the usual manner via your public phone number. Incoming calls are signalled on this line.

 To avoid conflict between individual multi-line phones, the functions "Do not disturb" and "Call forwarding" can only be used for the primary line.

Secondary line

The secondary line on your phone is used as a primary line by another subscriber of the line trunk group. Your primary line, which is configured on another telephone in the line trunk group, simultaneously functions as the secondary line on that telephone.

Phantom line



Phantom lines are not used as primary lines by any telephones in the line trunk group. Phantom lines are established when the number of lines provided by a communications system exceeds the number of available telephones.

Line utilisation

- **Private line:** A line that is used by a single telephone. This line cannot be used as a secondary line by another telephone.
- **Shared line:** A line that is configured on multiple telephones. The line status (if configured) is displayed in the "Overview" tab for all telephones that share this line. If, for example, a shared line is being used by a telephone, a status message indicating that this line is busy is displayed on all other telephones.
- **Direct call line:** A line with a direct connection to another telephone.

The line status is indicated by the LED in addition to the display in the "Overview" tab → Page 28.

LED display



LED		Explanation
	Not lit	The phone is in idle mode.
	Flashing	<ul style="list-style-type: none"> • Incoming call on the line (→ Page 118) • "Hold reminder" is activated (→ Page 87)
	Flickering	<ul style="list-style-type: none"> • Outgoing call on the line • The incoming call was prioritised and selected in accordance with the "Automatic line selection for incoming calls" option
	Fast blinking	The line is on "Hold"
	Blinking	Call forwarding is activated
	Illuminated	The line is busy

Keypad













You can only use the digits 1 to 9 and 0 as well as the * and # characters when dialling a number. The  navigation key is used to delete from right to left.

In cases where text input is possible, you can use the keypad to input text, punctuation and special characters in addition to the digits 0 to 9 and the hash and asterisk symbols. To do this, press the numerical keys repeatedly.

Example: To enter the letter "h", press the number  key on the keypad twice. When entering the text, all available characters for this key are displayed. After a short while, the character in focus is displayed in the input field.

 To speed up the input, you can confirm your entry by pressing "" on the navigator after you have selected the required character.
To **enter a digit** in an alphanumeric input field, press the relevant key and hold it down. You no longer need to scroll through the entire list of possible characters.

Character overview (depends on the current language setting)

Key	1x	2x	3x	4x	5x	6x	7x	8x	9x	10x	11x	12x	13x	14x
 ¹	1	²	;	=	\$	\	&	[]	{	}	%		
 abc	a	b	c	²	ä									
 def	d	e	f	3										
 ghi	g	h	i	4										
 jkl	j	k	l	5										
 mno	m	n	o	6	ö									
 pqrs	p	q	r	s	7	ß								
 tuv	t	u	v	8	ü									
 wxyz	w	x	y	z	9									
 +	0	+												
 ³	.	*	¹	#	,	?	!	'	"	+	-	()	@
 ⁴	4													



¹ Additional special characters (not in 123 mode)

² Space

³ Additional special characters are available on the display keyboard

⁴ Switch between upper and lower-case text and number entry

Multi-function keys

Key	Function during text input	Function when held down
	Write special characters	Deactivate the ringtone
	Switch between upper and lower case	Activate the telephone lock
	Type special characters (not in 123 mode).	

Alphabetic labeling of dial keys is also useful when entering vanity numbers (letters associated with the phone number's digits as indicated on the telephone spell a name, e.g. 0700 - PATTERN = 0700 - 7288376).

Text editor

A function menu appears under the character selection field in certain situations (such as, when labeling programmable sensor keys). You can enter punctuation marks and special characters and switch between the entry of alphanumeric characters in lower and upper case and straightforward digit entry.

You can select further editor functions via the **navigator**:



- OK – Confirm and terminate the entire input
- Cancel – Cancel your entries without saving
- Mode Configuration via the key
 - 123 (# -> ABC) – Numerical entry
 - ABC (# -> Abc) – Upper-case characters
 - Abc (# -> abc) – Initial character upper case
 - abc (# -> 123) – Lower-case characters
- Move cursor left to add or delete characters
- Move cursor right to add or delete characters
- Copy – Copy a visible character string
- Paste – Insert a copied a character string at a cursor position

Display

Your OpenStage 40 comes with a tilt-and-swivel black-and-white LCD display. Adjust the tilt and contrast to suit your needs (→ Page 172).

Idle mode

If there are no calls taking place or settings being made, your OpenStage 40 is in idle mode.

➡ Press the  key to return to the idle display again, for example, from a call list (→ Page 32). To return to the idle display again from the phonebook (→ Page 35) or the Service menu (→ Page 35), press the  key. You can also configure a "Show telephone screen" function however for both cases (see → Page 75) to return to the idle mode screen again.

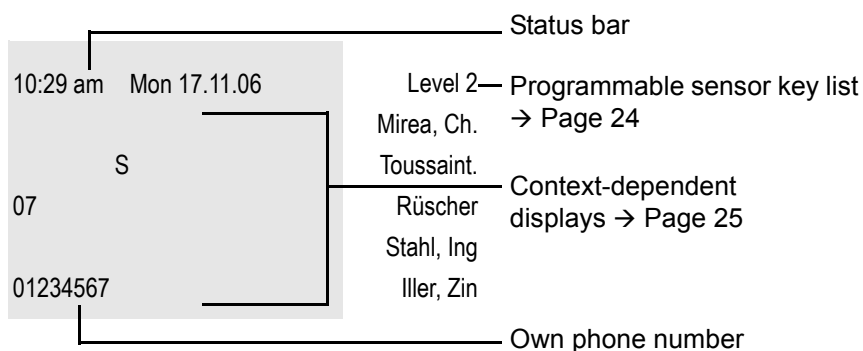





The left area contains the status bar on the first line and is followed by a five-line field for comprehensive context-specific displays. The right area is used for labeling the programmable sensor keys.



Idle-display view and icons







The time, weekday, and date are displayed in the status bar.

In addition, different icons represent different situations and switches:

Icon	Explanation
	The ringtone is deactivated.
	The ringtone is set to a beep.
	The "Do not disturb" function is activated.
	The phone lock is activated.
	A mobile user is logged on to the telephone.

Displays on the status line for adjusting the volume

When you adjust the ringtone, handset and speaker volume using the  and  keys, you will see the following displays in the status line:

Display	Meaning
 	Ringtone volume in 10 levels
 	Ringtone volume in 10 levels when the ringtone is switched off
 	Handset or speaker volume in 10 levels

Context-dependent displays

Depending on the situation at hand, the graphic display on your OpenStage phone displays different content, to which you can respond intuitively.

Information on actual events

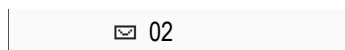

The following icons appear centered on the display when your phone is idle and signal current properties or events.

Example: You missed two calls in your absence.





You have two new voice messages that you can open by pressing  → Page 32.

Icons for events

Icon	Explanation
	You received new voice messages.
	New entries have been added to the call lists.
	Local call forwarding is active.

Context menus

An arrow beside a selected entry indicates the existence of a context menu that you can open by pressing the  or  buttons on the navigator (→ Page 19). The range of functions available is situation-specific.

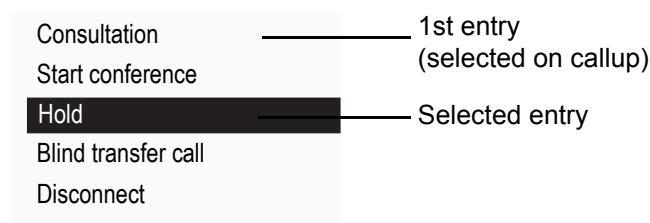

After a connection is set up – you are called or you make call – the context menu appears automatically under the current connection for the configured time (e.g. 20 seconds).

You can define how long the context menu should be displayed. You can deactivate the automatic display so that the  key on the navigator must be pressed to see the context menu of the connection → Page 191.

Idle display context menu

The following functions (where released) can be accessed by pressing the right key on the navigator:

Redial {1} 1234	—	First entry (selected when you call up the menu, if you have already dialled a phone number)
Ringer off		
Do not disturb off	—	Selected entry
Mobile logon	—	Only available when configured to support mobility
Cancel call backs		
Directed pickup		

Pop-up menus

In many operating situations, suitable functions or information is offered in an automatic pop-up window.

Example: You set up a consultation call. The pop-up menu opens and offers suitable functions for selection with the navigator.

012345	Level 2
Dial	Mirea, Ch.
Redial {1}	Toussaint.
Retrieve held call	Rüscher
	Stahl, Ing
	Iller, Zin

A pop-up window automatically closes as soon as you have performed an action.

To suppress information pop-up windows, press **OK** on the navigator.

Telephony interface

Single-line view

Additional information is displayed in the telephony interface when your phone rings, when you dial a number or during a call, for instance.

 The same information is available on multi-line telephones for the selected line in the line overview.

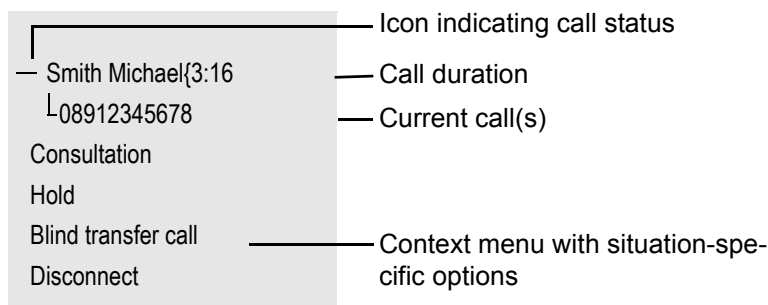

Example:



Icons for frequent call states

Icon	Explanation
—	The call is active
HD	High-quality voice connection (G.722).
↔	The call has been disconnected
→ ←	You have placed the call on hold (e.g. consultation hold).
←	Your call partner has placed the call on hold
🔒	The voice connection is secure.
🔓	The voice connection is not secure.

 Detailed descriptions of the various functions can be found in the sections "Basic phone functions" → Page 38 and "Enhanced phone functions" → Page 82.

 Press the  key to return to the telephony interface again, for example, from a call list (→ Page 32). To return to the telephony interface again from the phonebook (→ Page 35) or the Service menu (→ Page 35), press the  key. You can also configure a "Show telephone screen" function however for both cases (see → Page 75) to return to the telephony interface screen again.

Multi-line view

You can use the  key to switch between two tabs on the telephony interface:





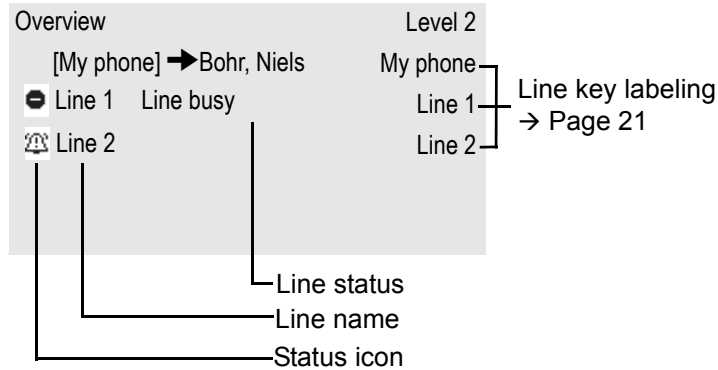

- "[My phone]" tab - represents the primary line or the line view of a selected line → Page 27
- "Overview" tab - configurable overview of the secondary lines → Page 21

In idle mode: Press the  key:

Example:



The status icons provide information about the state of the relevant line.

Icon	Explanation
	Call for the corresponding line.
	Call from a DSS line.
	Call for a line with suppressed ringtone → Page 138.
	"Hold reminder" is activated → Page 87.
	The line is currently not available.
	The line is busy.

 Please note the LED displays for the line keys → Page 21.

Context in the line overview

In the context menu of a selected line you have the following options with:

- Own free line
 - Select
 - View¹
- Own line with active call
 - Hold
 - Clear (replace handset)
 - View¹
- Own line with held call
 - Retrieve
 - View¹
- Other free line
 - Select
 - View¹
- Other line with active call
 - Hold
 - Clear (replace handset)
 - View¹
- Other line with held call
 - Retrieve
 - View¹
- Other line busy
 - View¹
 - Connecting²

1. The telephony view is displayed as a preview after a period of time set by the administrator.

2. The "connect" function must be activated by the administrator.

Phonebooks

In addition to a local phonebook, there is a connection to the LDAP corporate directory if administrator has made the necessary settings.

Both phonebooks can be accessed via the telephone menu (→ Page 35). You can configure sensor keys for the phonebooks.

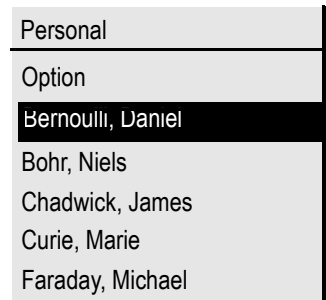

Search contacts

When in the phonebook or directory list view, press the keypad key that corresponds to the first letter of your search term.

A field opens for you to enter the search term:

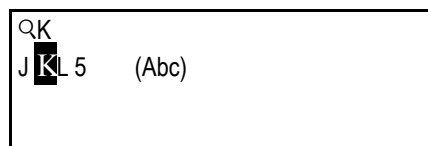

The cursor jumps to the first entry in the list that matches the character you entered in the search field.

Personal phonebook

You can store up to 100 private contacts in your personal phonebook. These are displayed in alphabetical order in the phonebook list. How to create contacts is described in → Page 108. A contact consists of an entry with a "Last name", "First name" and a number.

Managing contacts

All saved contacts are listed in alphabetical order on the "Personal" menu.

You can use the "Options" context menu to

- create new contacts → Page 108
- delete the entire phonebook list → Page 109

Using contacts

The following functions are available via the context menu of a selected contact:

- Calling a contact → Page 99
- Editing a contact → Page 108
- Deleting a contact → Page 109

Corporate directory

If you have access to a corporate directory (LDAP directory), you can search for contacts in it (consult relevant administrator). A simple and an advanced search function are available for this.

Searching for a contact

- Simple search → Page 111
- Quick search → Page 113.

Using a contact

Calling a contact → Page 99

Messages

Depending on the type and configuration of your communications platform (contact the relevant administrator), messages from services, such as, HiPath Xpressions can be displayed in this list.

A message (→ Page 25) appears on the idle display and the LED on the key  (→ Page 18) flashes to signal new messages or missed calls.



To access the menu: Press the  key and use the navigator to select and confirm the relevant submenu.



Voicemail (answering machine)

You will find voicemails in the directory **Messages** (→ Page 46).

New voicemails are signalled as follows depending on the settings made by administrator:

- Only the LED on the  key flashes
- The LED on the  key flashes and the alert bar illuminates
- Only the alert bar illuminates

Note also the setting options for missed calls → Page 33 and have the possible combinations explained to you by the administrator if necessary.

You will be shown the following for example:

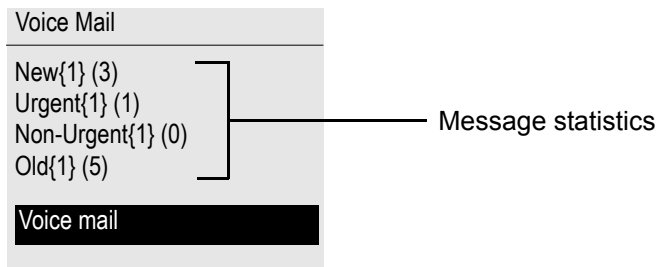

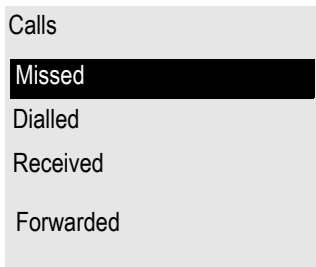

Calls

This list appears as soon as you receive **new** missed calls if you select the **Calls** option in the **Records** menu. You can then scroll back to the **Calls** submenu with the backspace key. The following calls or call attempts are logged as call lists:



The number of missed calls and unchecked calls is shown on the idle display. Missed calls are not saved and displayed if the call journal is disabled → Page 115.

Call lists

 The call journal function must be activated in order to display call lists → Page 115. The call journal must also be activated for the customary last number redial function. If the call journal is not activated, you are simply shown the voicemail selection when you press the  key.

All calls to your phone are time-stamped and logged in consecutive order in the call lists. Each call list may contain up to 30 entries. Once this limit is reached, the oldest entry in the log is deleted.

Multiple calls from the same number are only listed once. The number of call attempts is logged in the "Details" context menu and additionally in the "Missed Calls" log in the list display.

The list contains the phone number and the time of the last call attempt from each user listed, if made on the current day, otherwise the date of the last call attempt.

 If you connected a call partner with his/her consultation or second call partner, his/her phone number will be shown in the call list "Received".



 Callers with suppressed numbers are listed as "Unknown" in the call lists.

 Only calls to the primary line are received on multi-line phones (→ Page 13).

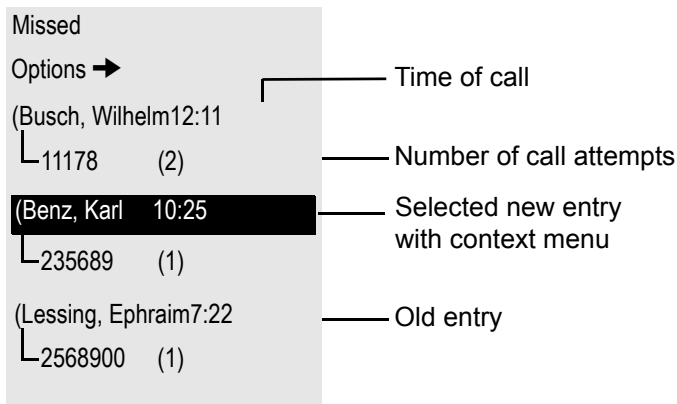
Example of the **Missed** call list:



The administrator may have made special settings for missed calls. The following keys flash or illuminate, depending on the setting, to indicate new missed calls:

- Only the LED on the  key
- The LED on the  key and the alert bar
- Only the alert bar
- Or neither

Note also the setting options for voice messages → Page 32 and have the possible combinations explained to you by the administrator if necessary.

Missed calls are not signalled if the call journal is disabled → Page 115.

Call list options

You can select the following function in the **Options** context menu:

Delete all → Page 114

Entry-specific context menu

You can select the following functions for an individual entry:

- Dial → Page 100
- Details → Page 114
 - Call attempts with date and time (up to ten can be saved)
- Delete → Page 114

Telephone menu

Open the telephone menu using the  key.

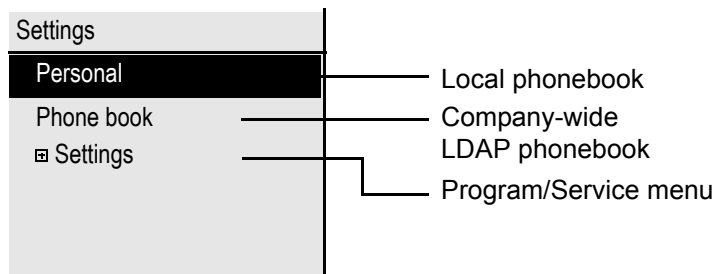

Personal

You can create your own local phonebook under Personal containing up to 100 entries → Page 108. The data for a subscriber includes the last name, first name, and phone number. You can configure a function key for opening the phonebook.

Corporate

If you have the option of using a corporate directory, you can use this option to find subscribers → Page 111. As a prerequisite for this, your administrator must have set up the appropriate access. The phonebook can likewise be opened via a programmed function key.

Program/Service menu

Accessing the menu: **Settings** select and confirm and then select and confirm the required menu using the navigator.

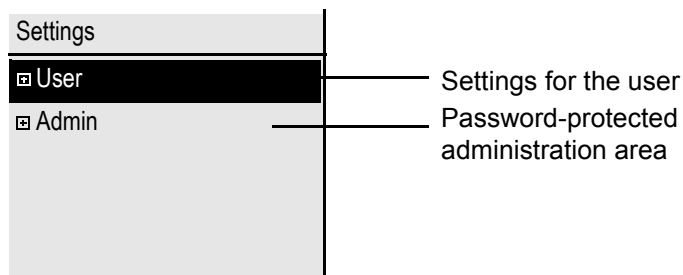

Settings → User

Setting options are provided here that allow you to adapt the telephone to your individual requirements.

Settings → Admin

Once the admin password has been entered, this menu is available to the relevant administrator.

User settings

You can use the "User" menu to make local function settings for your OpenStage and to configure the appearance of your display to your personal requirements.

Select one of the following menus with the navigator (→ Page 19):

- "Date and time" → Page 176
- "Audio" → Page 180
- "Configuration" e.g. → Page 83 or → Page 105
- "Phone" → Page 75 or → Page 172
- "Locality" → Page 176
- "Security" → Page 142
- "Network information" → Page 36
- "Diagnostic information" → Page 204
- "Reset" → Page 194

Network information

Information about the IP address or name which was assigned to the phone in the network and therefore the HTML address of the WBM interface.



View information on the phone → Page 193



Contact your administrator or refer to the OpenStage Administration Manual for more on the network information values listed here.

Diagnostic information



Provides information on all of the important settings of the telephone. Can provide valuable help in support situations → Page 204

Perform reset



Personal settings made via the telephone menu or the WBM interface can be reset to factory settings. → Page 194

Administration

You can access the administration area via the "Admin" function and by entering the administration password.

Refer to the administration manual supplied with your phone for more detailed information on this topic.

Control and monitoring function

A control or monitoring function can be activated on your phone for service purposes by remote maintenance.

Control function

The administrator has the option to activate and deactivate features of the phone via remote maintenance. During maintenance the handset, microphone, loudspeaker and headset are deactivated. You are additionally informed on the display that the control function is active.

Monitoring function

In order to detect malfunctioning of a phone for example, the administrator installs a monitoring function. You can use your phone as normal during monitoring. However you will first be informed about the operation with a message on the display and prompted to allow monitoring.

If the administrator has activated a function on your phone, which continuously transmits operating data to a server, you will see the flashing icon  in the upper display line.

Activating a diagnostic call

In the event of connection problems with a specific destination, the administrator may ask you to enter an activation code before the number of the subscriber, which can be used to initiate tracing of the call data on the phone. The activation code, which must be provided to you by the administrator and which comprises a leading asterisk, followed by three digits and the hash sign as the terminating character, must be entered before the actual phone number. At the end of the call, the call-related data is sent for further analysis to the DLS server, which then passes it to the "Open-Scape Voice Trace Manager".

Contributing to environmental protection by saving energy

The user can save energy actively using the energy settings on the telephone and in this way contribute to protecting the environment.

To reduce energy consumption, you can

- reduce the brightness of the display (the default setting is 50 percent and is preset → Page 174).
- set the background lighting to switch off automatically after a certain period of time. To save a large amount of energy, the time can be reduced to one minute. The default value is 5 minutes (→ Page 174).
- reduce the ring volume (set by default to 50 % → Page 180).

Basic functions

 Please read carefully the introductory chapter "Getting to know your OpenStage phone" → Page 14 before performing any of the steps described here on your phone.

Secure voice transmission

Prerequisite: The secure voice communication option must be activated by your administrator.

If you call a party or receive a call from a party over a secure connection, a padlock icon¹ appears on the other party's row on your graphic display. You can opt to have voice connections that are no longer secure indicated by a brief alerting tone and a window with the message "Unencrypted call" (see → Page 186).

Emergency mode

If a failover system has been set up for your OpenScape Voice, you can still make calls and use the functions of the failover system, for example, despite network faults.

If it happens that your telephone is no longer connected to OpenScape Voice, it is registered automatically on the configured failover system. The message "Emergency mode (B8)" then appears on the display.

Some functions may not be accessible while in emergency mode, for example:

- Call forwarding (→ Page 60)
- Voicemail (→ Page 46)
- Callback (→ Page 57)
- Group functions (→ Page 44)
- Multiline (→ Page 118)
- OpenScape Voice functions (→ Page 152)

Answering a call

The OpenStage rings. A call is also visually signalled on the call display. The call is also visually signalled on the alert bar.

If transmitted, calling party information (name, phone number) appears on the graphic display.

 If you have set a pattern melody or a ringtone → Page 182 on your phone, it is possible that administrator has preset a different pattern melody, pattern sequence or ringtone or deactivated the ringtone, depending on the call type (e.g. an external or internal call).

An incoming call will interrupt any ongoing telephone setting operations. When the call ends, you can press the  key to return to the point in the menu structure where you were interrupted.

1. Closed for secure or open for nonsecure voice communication

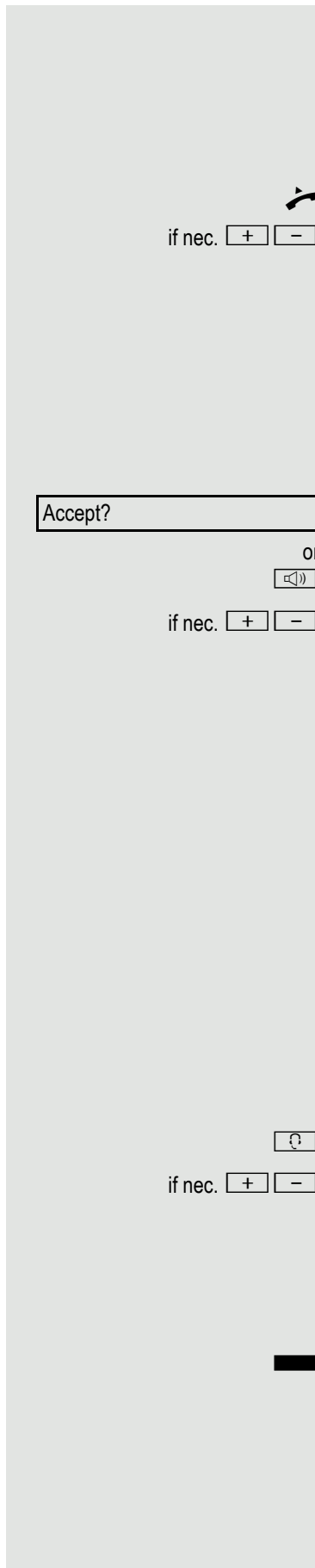

Answering a call via the handset

The phone is ringing. The caller is displayed.

 If the phone number is stored in the local telephone, the associated name is shown on the display (must be activated by administrator).

Lift the handset.

Set the call volume.

Answering a call via the loudspeaker (speakerphone mode)

The phone is ringing. The caller is displayed.

The pop-up menu opens:

Select and confirm the option shown. The  key lights up.

Press the key shown. The key lights up. The speakerphone function is activated.

Set the call volume.

Suggestions for using speakerphone mode:

- Tell the other party that speakerphone mode is active.
- Adjust the call volume while speakerphone mode is active.
- The ideal distance between the user and the phone in speakerphone mode is 50 cm.

Answering a call via the headset

Prerequisite: A headset is connected.

 Make sure your headset port is set up properly → Page 184.

The phone is ringing. The  key flashes.

Press the key shown.

Set the call volume.

Answering calls automatically via the headset

Prerequisite: The administrator has additionally configured a key with the "Auto-Headset" function (AICS Zip tone) (→ Page 75).

Press the "Auto-Headset" sensor key to activate automatic call answering. This key and the headset key illuminate.

A short acoustic signal is heard on the headset for a call and the connection is established. If you want to manually answer calls again, deactivate the automatic answering function using the "Auto-Headset" key. Both keys are off.

Directed pickup

You can pick up a call signalled at an absent coworker's phone. If a colleague has placed a call on hold on their multi-line phone you can also pick up this call.

Accept call

Prerequisite: You know the coworker's internal phone number and the function is configured for you in OpenScape Voice.

A coworker's phone rings.

Select and confirm the option shown in the idle phone's context menu.

Directed pickup?

or



Lift the handset.

or



Press the key shown.

Directed pickup?

Select and confirm the option shown.



Enter and confirm the relevant phone's internal number. You are connected to the calling party either via the handset or in speakerphone mode.

Picking up the held call

Prerequisite: Your colleague has placed a call on hold on their multiline phone → Page 122. You know the coworker's internal phone number and the function is configured for you in OpenScape Voice.

Select and confirm the option shown in the idle phone's context menu.

Directed pickup?

or



Lift the handset.

or



Press the key shown.

Directed pickup?

Select and confirm the option shown.



Enter and confirm the relevant phone's internal number. You are connected to your colleague's held call either via the handset or in speakerphone mode.

Switching from handset to speakerphone mode

 Make note of the two different processes and activate, if necessary, your preferred setting → Page 183.

Prerequisite: You are conducting a call via the handset and the microphone and loudspeaker functions have been activated by administrator.

Standard mode

Hold down the key and replace the handset. Then release the key and proceed with your call.

US mode

If the country setting is set to US, you do not have to hold down the loudspeaker key when replacing the handset to switch to speakerphone mode.

Press the key shown.

Replace the handset. Proceed with your call.

 A secure voice communication is indicated by a closed padlock icon on the graphic display; a nonsecure voice communication is indicated by an open padlock icon on the graphic display (see also → Page 38)

Switching from speakerphone mode to the handset

Prerequisite: You are conducting a call in speakerphone mode.

Lift the handset.

The key shown goes out.

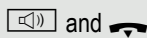

Switching from headset to speakerphone mode

In standard mode



Press and hold the key (open listening ist activated),



Press the key shown. Speakerphone mode is activated.

In US mode



Press the key shown.



Press the key shown. Speakerphone mode is activated.

Open listening

You can let other people in the room join in on the call. Let the other party know that you have turned on the loudspeaker.

Prerequisite: You are conducting a call via the handset.

Activating



Press the key shown.

Deactivating



Press the lit key.

Switching to speakerphone mode



Hold down the lit key and replace the handset.

Activating/deactivating the microphone

You can temporarily switch off the handset microphone to prevent the other party from listening in while you consult with someone in your office.

Prerequisite: You are conducting a call.

Deactivating the microphone



Press the key shown.

Activating the microphone



Press the lit key.

Ending a call



Press the key shown.

or

Disconnect?

Select and confirm the option shown in the connections's context menu.

or



Lit key pressed

or

In speakerphone mode



Press the lit key.

Group call

Your administrator can incorporate multiple telephones in a call pickup group. If your telephone belongs to a pickup group, you can also accept calls intended for other members of the group.

A group call is displayed on the phone. The administrator may have made the following settings for signalling:

Telephone status			Ring on group call = Yes	Ring on group call = No
Ringer on	Silent		Ringtone Loudspeaker	Beep Loudspeaker
	in Connection	Handset	Ringtone Loudspeaker	Beep Handset
		Handset Open listening	Beep Handset and loudspeaker	Beep Handset and loudspeaker
		Headset	Ringtone Loudspeaker	Beep Headset
		Headset Open listening	Beep Headset and loudspeaker	Beep Headset and loudspeaker
		Speaker-phone mode	Beep Loudspeaker	Beep Loudspeaker
Ringer off	Silent		Nothing	Nothing
	in Connection	Handset	Nothing	Beep Handset
		Handset Open listening	Beep Handset and loudspeaker	Beep Handset and loudspeaker
		Headset	Nothing	Beep Headset
		Headset open listening	Beep Headset and loudspeaker	Beep Headset and loudspeaker
		Speaker-phone mode	Beep Loudspeaker	Beep Loudspeaker

The volume settings can be found from → Page 180.

Further administrator settings for group calls:

- The group call can be picked up both by lifting the handset and via the "Pickup call" menu option.
- The group call be picked up via the "Pickup call" menu option but **not** by just lifting the handset.
- A key is programmed for call pickup.
- Open a pop-up menu with the Call pickup key when a group call is waiting.

Picking up a group call with the call pickup key

Prerequisite: The Call pickup key is configured. Your administrator has set up the group call such that it is only displayed through flashing of the Call pickup key. The phone can also ring when idle.

A group call is waiting. The Call pickup key flashes. The group call is not shown on the display.



Press the sensor key with the "Call pickup" function.

The group call is now shown on the display with

Pickup: *Caller*

for: *Party*

The pop-up menu opens:

Picking up a group call immediately via the pop-up menu

Prerequisite: Your administrator has set up the group call such that it will be shown immediately on the display and the pop-up menu will open.

A group call is waiting and is shown on the display with

Pickup: *Caller*

for: *Party*

Picking up a group call

The pop-up menu opens:

Confirm.

or



Lift the handset (only if the appropriate function is set by your administrator)

or



Press the sensor key programmed with the "Call pickup" function (if configured). The speakerphone function is activated.

Ignoring a group call



Select and confirm the option shown. The phone stops signalling the group call.

Pickup call?

Ignore?

Listening to voicemail

To use this function, you need to have a voice mailbox set up on your communication platform for voicemails (see → Page 32).

The message key  flashes and/or the alert bar illuminates and the  icon appears on the display (depending on the setting made by the administrator) to indicate new messages. The LED and/or the alert bar only extinguish again when all new messages have been picked up and there are no further missed calls.

Picking up messages

Press this key when the phone is in idle mode. The **Records** menu opens.

Select and confirm to open the menu for voicemail.

If messages are waiting, you will be shown a list with the new messages and the messages you have already listened to, sorted by status (see → Page 32). The number of the respective messages is indicated.

Confirm the option shown to call the mailbox. Follow the voice instructions. You may need to enter a password.

Calling the mailbox directly

You can also call the mailbox directly without using the menu. The mailbox answers even if there are no messages waiting.

Lift the handset.

Press this key. The mailbox answers. Follow the voice instructions. You may need to enter a password.



You can call the mailbox any time you see the "Please dial" prompt on the display.

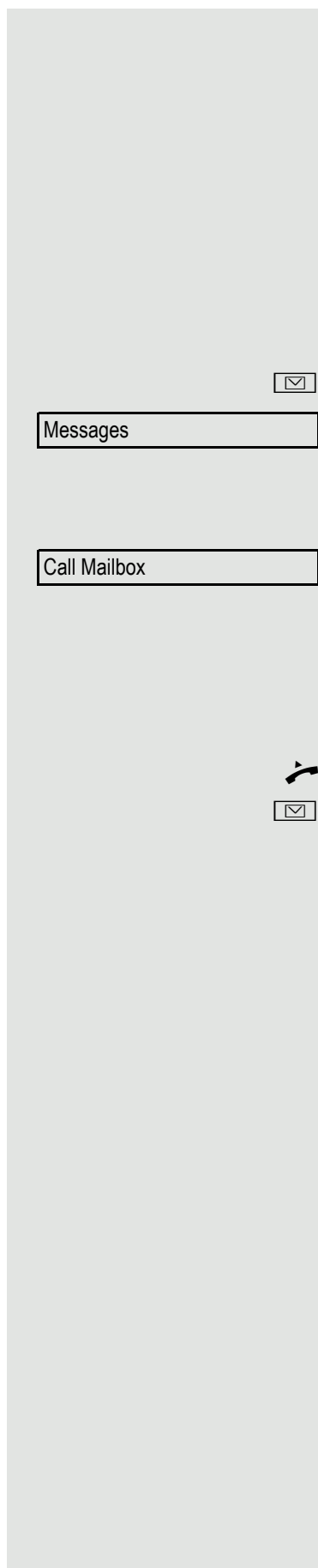

Call control (2nd alert)

To ensure that you do not miss any important calls, administrator can configure a key that blinks when a call is waiting, for instance, when you are dialling a number or when two calls come in simultaneously.

 Call control does **not** work with multi-line phones.

Two calls simultaneously

Prerequisite: The 2nd alert key is set up and "call waiting" is permitted (→ Page 93).

two calls ring at the same time.

Caller information from the first caller is displayed and you have the following options:

- Accept
- Reject
- Deflect

The "Call control" key is blinking and you hear a notification tone.

Display second caller

Pressing the blinking "Call control" key will display the second caller's information and you again have three options to choose from.

Return to first caller

Press the blinking "Call control" key again to return to the first caller's displayed information.

Accept a call

If you accept one of the calls, the other call is treated as a second call (see → Page 91)

While dialling

 Note that when you set up call control, the "Busy when dialling" → Page 103 function will be disabled. The exception is if you dial a number during a Consult → Page 52.

Prerequisite: The 2nd alert key is set up and "call waiting" is permitted (→ Page 93).

You receive a call while you are dialling. You hear an alerting tone and the "2nd alert" key flashes.

Press the blinking "Call control" key. Dialling is interrupted. The caller's information is displayed and you have the following options:

- Accept
- Reject
- Deflect



Making calls

 If you selected the option "Busy When Dialling" → Page 103, you will not be interrupted by an incoming call. In this case, the caller hears the busy signal.

You can also use enhanced functions, such as call lists or the personal or corporate directory, in order to call a subscriber → Page 99.

Off-hook dialling

Lift the handset.

Enter the number if nec. Use the navigator → Page 19 to correct entries as necessary.

In the pop-up menu:

Confirm or wait until the dial delay expires (see → Page 101).

In the pop-up menu

Select and confirm the option shown¹.

The connection is set up.

 If you are using a dial plan and Immediate dialling is set (see → Page 50), dialling is automatically performed as soon as the character string entered matches an entry in the dial plan.

 If a connection is temporarily unreachable, you will hear a special information tone (short tone sequence). The fault can be rectified quickly, so try again to dial this phone number after an appropriate time.



Dial

or

Redial {1}

1. Please note the information in relation to the call journal on → Page 51

On-hook dialling

The connection is set up with on-hook dialling via the loudspeaker (speaker-phone mode) or via a connected headset.



or



and/or



or

Redial {1}

Press the key shown.

Press the key if a headset is connected.

Enter the station number.

Press or wait until the dial delay expires (see → Page 101).

In the pop-up menu:

Confirm¹.

First enter the number

First enter the number. The loudspeaker or headset key illuminate when you enter the first digit.



Dial

Enter the station number. If nec. Use the navigator → Page 19 to correct entries as necessary.

Confirm or wait until the dial delay expires (see → Page 101).

The connection is set up.



If you are using a dial plan and Immediate dialling is set (see → Page 50), dialling is automatically performed as soon as the character string entered matches an entry in the dial plan.

1. Please note the information in relation to the call journal on → Page 51

Immediate dialling

Immediate dialling should only be activated if administrator has configured and approved a dial plan.

Immediate dialling is deactivated by default. For this reason after entering the number you must either confirm the "Dial" option or wait until the dial delay expires to set up the connection. If **Immediate dialling** is configured, your call is automatically dialled as soon as the string entered matches an entry in the dial plan.

Activating or deactivating immediate dialling

You can also configure this setting via the WBM interface → Page 206.

Press the key shown.

Select and confirm the option shown.

Select and confirm the option shown.

Enter and confirm the User password.

Select and confirm the option shown.

Select and confirm the option shown.

Select and confirm the option shown.

Select and confirm the option shown in the context menu.

Confirm

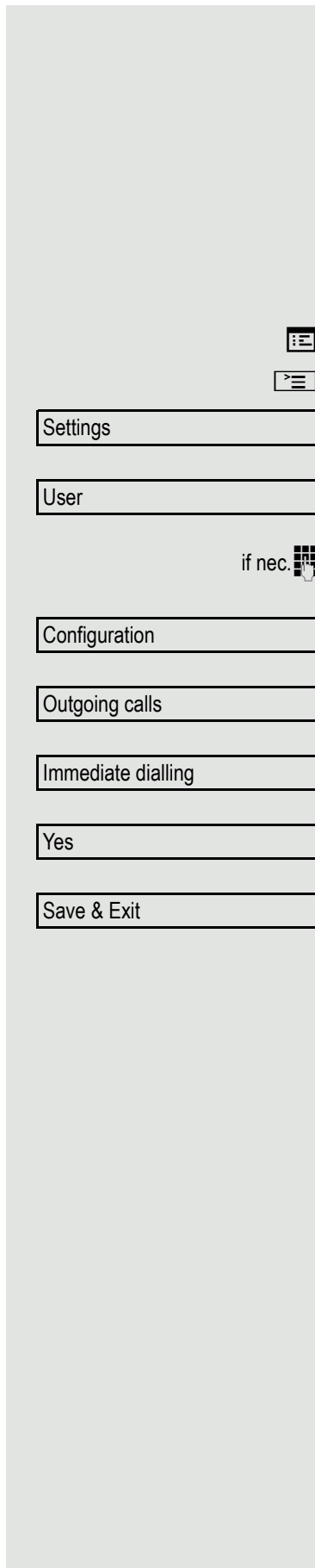

Dialling using the hot or warm line function

Your administrator can configure a hot or warm line for your phone.



If you lift the handset of the phone or press the loudspeaker key

- with a hot line immediately or
- with a warm line after a defined period of time,
- a number specified by administrator is dialled.

Examples:

- The phone in the lift immediately dials the reception number.
- The phone at a patient's bed dials the ward number e.g. after a minute if no other number is dialled.

Redial

 You must have activated the call journal in order to use the call list. This also applies for redialling the last number dialled → Page 115. If the call journal is disabled, you will be shown the message "Key function unavailable" on the display when you try to execute the last number redial function using the  key or a correspondingly programmed function key.

If you still want to access the function for redialling the last number dialled despite having disabled the call journal, you can alternatively use the OpenScope Voice "last caller redial" function, assuming this function has been activated by the administrator → Page 167.

Redialling from the call list

 Only calls to the primary line are received on multi-line phones (→ Page 13).

Press the key shown.

You are automatically directed to the **Dialled** list in the **Calls** menu.

Select and confirm the entry you want.

The phone number associated with the list entry is dialled.

Redialling from the pop-up menu

Lift the handset.

Press the key shown.

Confirm.

The last phone number entered is dialled.

Redialling from the idle menu

Select and confirm from the idle display context menu (→ Page 26). The last phone number entered is dialled.



Consulting a second party

You can call a second party while a call is in progress. The connection to the first party is placed on hold.

Prerequisite: You are conducting a call.

Select and confirm the option shown in the connections's context menu.

Start conference

Select and confirm the option shown in the context menu for the call connection when you intend to set up a conference with the new participant. You can also use an already configured **Conference** key in this instance.

Call the second party.

 If you are using a dial plan and Immediate dialling is set (see → Page 50), dialling is automatically performed as soon as the character string entered matches an entry in the dial plan.

In the pop-up menu:

Confirm the option shown¹.

 If you want to use a **call list** or one of the phonebooks for the consultation call, select **Hold** instead of Consult in the context menu and/or press the **Hold** key and then open a required call list (→ Page 108) or one of the phonebooks (→ Page 108/→ Page 111).

Alternatively you can also open a call list or phonebook without using the **Consult** or **Hold** functions – the active call is automatically placed on **Hold**.

Consult

or

Start conference



or

Repeat dialling S. Hawking

1. Please note the information in relation to the call journal on → Page 51



Disconnect & return

Retrieve held call

Ending a consultation call

You end the consultation

Select and confirm the option shown in the second party's context menu.

The consultation call is disconnected. The call with the first party is resumed.

The second party hangs up

If the second call partner hangs up, you will be prompted to retrieve the first call again if "Hold and hang-up" is disabled (→ Page 89). Otherwise, the first call will remain on hold until you receive this prompt after a defined time interval.

Confirm the option shown. You are reconnected with the first party.



If the call is kept on hold, you can retrieve the call via the context menu before the set time expires.

Ending the consultation with an active headset

Prerequisite: The administrator has additionally configured a key with the "Auto-Headset" function (AICS Zip tone) (→ Page 75).

Press the "Auto-Headset" sensor key to activate automatic call answering. This key and the headset key illuminate.

You make a consultation call and the second party hangs up. You are automatically reconnected with the waiting first party. The prompt "Retrieve held call" does not appear.

Alternate?

Disconnect?

Disconnect & return?

Switching to the held party (alternating)

Prerequisite: You are conducting a consultation call.

Select and confirm the option shown in the connection's context menu.



It does not matter which context menu is open when alternating. The "Alternate" function appears in both menus (active and passive connection).

You can switch back and forth between two subscribers by repeatedly selecting and confirming "Alternate".

Ending an alternate operation

Disconnecting the held call:

Select and confirm the option shown in the held connection's context menu. The held call is disconnected. The active call continues.

Disconnecting the active call:

Select and confirm the option shown in the active connection's context menu. The active call is disconnected. The held call remains on hold and can be managed via the context menu.

Putting on hold and retrieving successively or simultaneously

Putting an active call on hold

Prerequisite: You have a single-line phone and are conducting a consultation call → Page 52 or have answered a second call → Page 91. The sensor key "Hold" is configured → Page 75.

The "Hold" function can also be initiated from the context menu.



Press the "Hold" key. The key flashes. The consultation or second call **and** the first call are put on hold.

Retrieving the first call



Switch to the first call. Remove the context menu first if necessary by clicking with the left mouse button.



Press the flashing "Hold" key. You are connected with the other party. The consultation or second call continues on hold.

Retrieving the second call



Switch to the held consultation or second call. Remove the context menu first if necessary by clicking with the left mouse button.



Press the flashing "Hold" key. You are connected with the other party. The first called is put on "Hold" again.

Connecting parties

You can connect the first party with the party you consulted, clearing down your connection to both parties in the process.

Prerequisite: You are conducting a consultation call → Page 52 and call joining must be allowed → Page 56.

Select and confirm the option shown in the active connection's context menu. The active and held calls are joined. The active call and the consultation call are cleared down.

Connect by hanging up

Replace the handset or, if you are in speakerphone mode, press the loudspeaker key. The other two parties are now connected to one another.

Allowing call joining

You can also configure this setting via the WBM interface → Page 206.

Press the key shown.

Select and confirm the option shown.

Select and confirm the option shown.

Enter and confirm the User password.

Select and confirm the option shown.

Select and confirm the option shown.

Select and confirm the option shown.

Select and confirm the option shown in the context menu.

Confirm the option shown.

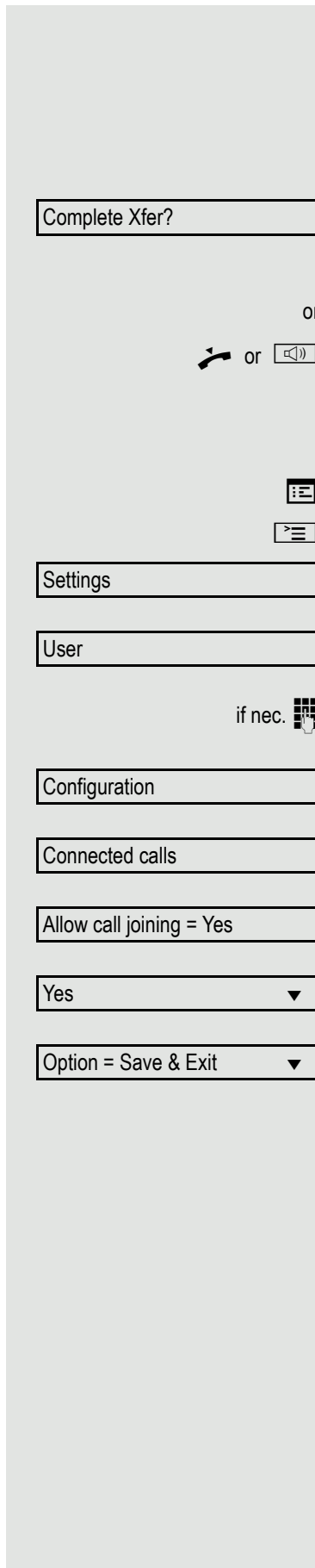

Callback

You can request a callback if the station called is busy or if nobody answers. You receive the callback as soon as the other party's line becomes free.

 This option is only available if both you and your administrator have activated the function (→ Page 58).

 Only the callback requests for your primary line are logged on multi-line telephones → Page 13.

Requesting callback

Prerequisite: The station called is busy or nobody answers.

In the pop-up menu:

Call back?

Select and confirm the option shown.

Deleting callback requests

You can delete scheduled callback requests if you no longer need to return a call, for example at the end of the working day.

Prerequisite: At least one callback was requested.

Cancel call backs?

Select and confirm the option shown in the idle display (→ Page 26) of the context menu.

Confirm in the pop-up menu. **All** callback requests are deleted.

Responding to a callback

Prerequisite: A callback was requested. Your phone rings and station information appears on the graphic display. The pop-up menu opens:

Accept?

Select and confirm the option shown.

Reject?

Select and confirm the option shown.

Rejecting a callback

Prerequisite: The Reject function has been activated by administrator.

Select and confirm the option shown.

The callback request is deleted. The caller's phone number is added to the missed calls list.

Permitting a callback

Prerequisite: The Callback function has been activated by administrator.

You can also configure this setting via the WBM interface → Page 206.

Press the key shown.

Settings

Select and confirm the option shown.

User

Confirm the option shown.

if nec.

Enter and confirm the User password.

Configuration

Select and confirm the option shown.

Outgoing calls

Select and confirm the option shown.

Callback: No

Select and confirm the option shown.

Yes

Select and confirm the option shown in the context menu.

Save & Exit

Select and confirm the option shown.

Calling back missed calls

Calls received while you are absent are indicated by a message on the idle display (→ Page 25). Moreover, the message key  and/or the call display flash or illuminate depending on the setting made by administrator. They only extinguish again when all new list entries have been queried.

Missed calls are logged in the missed calls list. This list provides information on the missed call and lets you call back the number directly (call lists, see also → Page 33). Missed calls are not saved and displayed if the call journal is disabled → Page 115.



Only the calls missed on your primary line are logged on multi-line telephones → Page 13.



Calls

Missed ▼

Niels, Bohr 20.0510:06

Press the key shown.

Select and confirm the option shown.

Confirm the option shown.

Select and confirm the appropriate list entry. The phone number associated with the list entry is dialled.

If no new calls are listed, the call list menu is offered under **Calls** → Page 114.

Call forwarding

Depending on the settings made by administrator, standard call forwarding is configured for the phone or alternatively call forwarding depending on incoming call type that is supported by OpenScape Voice → Page 68.

Standard call forwarding

You can forward calls for your phone to another phone. You can also change, activate, and deactivate call forwarding during a call. The function **Forwarding** must be authorised by administrator.

 On multi-line telephones (→ Page 13), you can only configure call forwarding for the primary line.

Three forwarding conditions can be programmed in the forwarding menu:

- Unconditional
- Busy
- On no reply

Because of its direct impact, "Unconditional" call forwarding has the highest priority followed by "No reply" and "Busy".

If active, "Unconditional" call forwarding is indicated on the graphic display when the phone is idle.

Forwarded calls can be logged in a call list (see → Page 33).

The menu **Forwarding** offers you three types of call forwarding:

- Unconditional → Destination phone number
- Busy → Destination phone number
- No reply (after {1}s) → Destination phone number

A phone number may already be assigned to each call forwarding type. For example, one Destination could be Destination 12345.

 Alternatively, call forwarding can be programmed on one or more keys with a fixed destination and a predefined forwarding or call type → Page 79.

Using call forwarding

The following functions are available for activating and deactivating call forwarding and configuring it in accordance with your requirements:

- "Activate or deactivate immediate forwarding" → Page 61
- "Saving destination phone numbers for call forwarding" → Page 63
- "Edit favourites" → Page 63
- "Copy and insert destination phone numbers" → Page 63
- "Assign a destination phone number for call forwarding" → Page 65
- "Activate/deactivate call forwarding" → Page 66
- "Defining the ring duration before call forwarding on no reply" → Page 67

Activate or deactivate immediate forwarding



Press the key shown.

Deactivating call forwarding

If call forwarding was activated for Unconditional, it will now be automatically deactivated.

or

Activate forwarding to last destination

The pop-up menu opens:

The message

"Set forward on to" is displayed with the number of the last forwarding destination and you have the following options:

- Accept
- Set a forwarding destination
- Edit call forwarding
- Cancel

Accept

or

Set a forwarding destination



or

Use last forwarding destination

Select and confirm the option to use the last saved destination for Unconditional again. Call forwarding to this destination is immediately activated for Unconditional and the key  illuminates.

Activate with variable destination phone numbers

If you want to use a new forwarding destination:

Select and confirm the option shown.

Enter and confirm the new destination phone number.

Confirm the last destination phone number saved (it will be displayed).

Call forwarding to this destination is immediately activated for Unconditional and the key  illuminates.

Saving destination phone numbers for call forwarding

 You can also enter the call forwarding settings via the user menu (→ Page 84) or via the WBM interface → Page 206.

Press the key shown.

The pop-up menu opens:

The message

"**Set forward on to**" is displayed with the number of the last forwarding destination and you have the following options:

- Accept
- Set a forwarding destination
- Edit call forwarding
- Cancel

Select and confirm the option shown.

Three types of call forwarding are offered in the settings menu:

- Unconditional
- Busy
- No reply (after {1}s)

 You can check whether **Busy** or **No reply** call forwarding is activated.

Save destination phone number

Select forwarding type (here for instance Unconditional)

Select forwarding type in context menu.

Enter/edit and confirm the destination phone number.

Edit favourites

You can configure up to five destination phone numbers for call forwarding. These destination phone numbers can then be assigned different forwarding conditions.

Select forwarding type (here for instance Unconditional)

Select and confirm forwarding type in context menu.

Select and confirm the option shown.

Enter/edit and confirm the destination phone number.
If necessary, define additional destination phone numbers.

Select and confirm the option shown

Copy and insert destination phone numbers

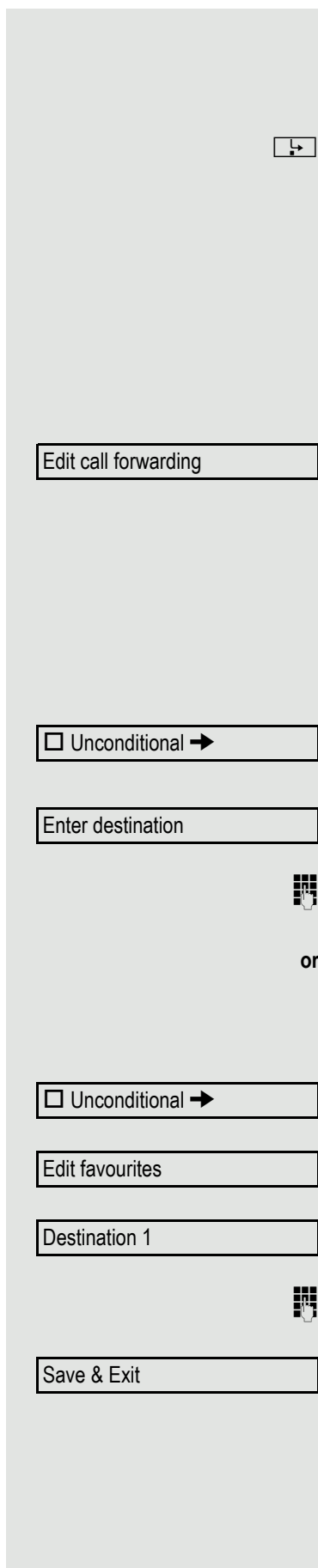

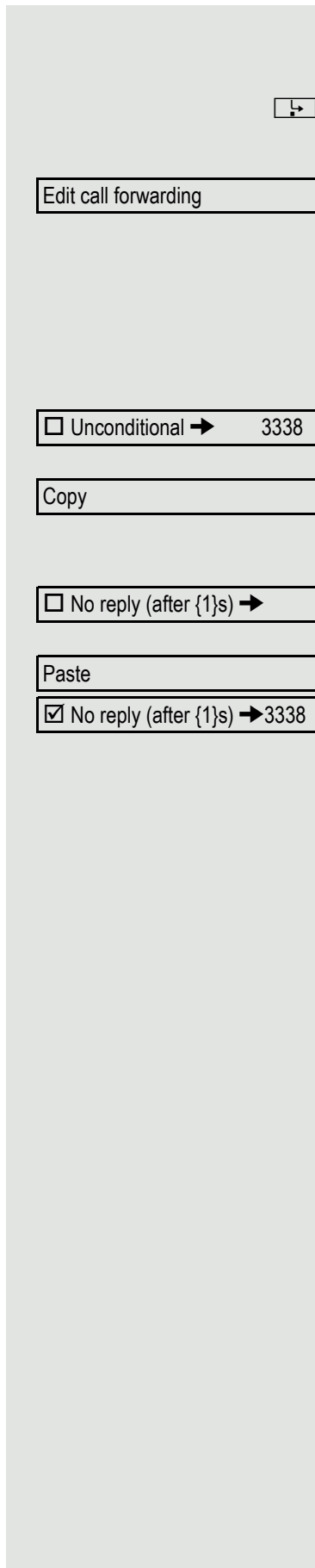

The current destination phone number for a call forwarding type is copied. For example, the current destination phone number for All calls should also become the current destination phone number for No reply.

Press the key shown.

The pop-up menu opens:

Select and confirm the option shown.

Three types of call forwarding are offered in the settings menu:

- Unconditional
- Busy
- No reply (after {1}s)

1. Copy

Select forwarding type (here for instance All calls)

Select and confirm forwarding type in context menu.

2. Insert

Select target forwarding type (here for instance No reply (after {1}s))

Select and confirm target forwarding type in context menu.

Both types of call forwarding now have the same destination phone number. The call forwarding type No reply (after {1}s) is automatically activated.

Assign a destination phone number for call forwarding

Prerequisite: At least one destination phone number has already been saved.

Press the key shown.

The pop-up menu opens:

The message

"**Set forward on to**" is displayed with the last forwarding destination used and you are offered the following options:

- Accept
- Set a forwarding destination
- Edit call forwarding
- Cancel

Select and confirm the option shown.

Select the forwarding type (here for instance Unconditional).

Select and confirm a saved destination in the context menu of the relevant forwarding type.

The forwarding type is activated and the new destination is displayed.

Press the illuminated key to open the call view. If All calls was activated, the forwarding destination is displayed with the forwarding icon and the  key illuminates. The Busy and No reply (after {1}s) types of call forwarding are not displayed.

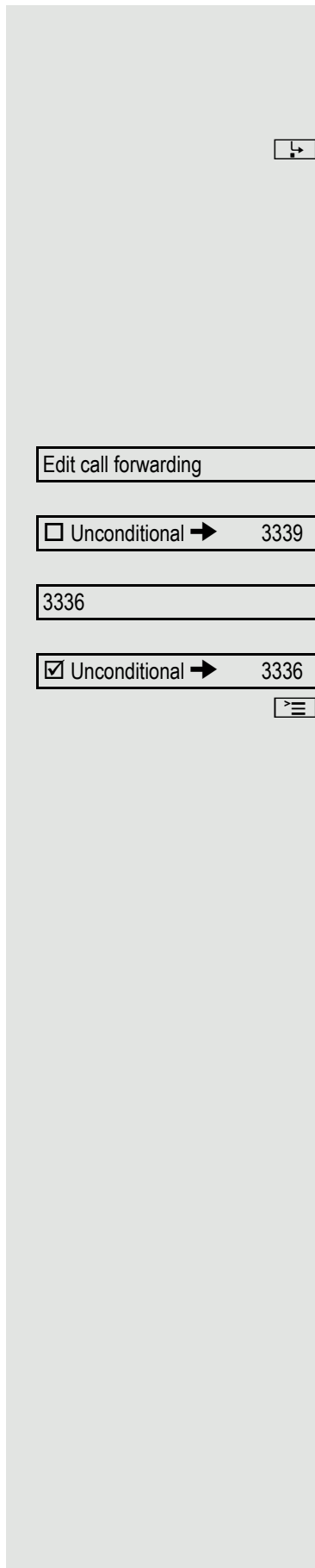

Activate/deactivate call forwarding

Prerequisite: A forwarding destination is already configured for the relevant forwarding type.

Press the key shown.

The pop-up menu opens:

The message

"**Set forward on to**" is displayed with the number of the last forwarding destination and you have the following options:

- Accept
- Set a forwarding destination
- Edit call forwarding
- Cancel

Select and confirm the option shown.

Choose one of the forwarding types offered

- Unconditional (default setting is off)
- Busy
- No reply (after {1}s)

Here e.g. Unconditional.

Confirm your selection. The forwarding type is activated or deactivated.

Call forwarding settings can appear as follows:

- Unconditional (default setting is off)
- Busy
- No reply (after {1}s)

Press the illuminated key to open the call display. If **Unconditional** was activated, the forwarding destination is displayed with the forwarding symbol and the  key illuminates.

The Busy and No reply (after {1}s) types of call forwarding are not displayed.



Edit call forwarding

Unconditional → 3339



Defining the ring duration before call forwarding on no reply

You can define how often the phone should ring before the "No reply" call forwarding is activated.



This setting is only available if the "Server features" function was deactivated by the administrator.

You can also configure this setting via the WBM interface → Page 206.

Press the key shown.

The pop-up menu opens:

Select and confirm the option shown.

Select forwarding type

Select and confirm forwarding type No reply in context menu.

Enter the desired time in seconds and confirm your entry. The set time is displayed with the option. Call forwarding is activated.

Press the illuminated key to open the call display.



Edit call forwarding

No reply (after {1}s) → 3335

Set delay



Call forwarding by call type

If server features has been enabled by administrator and the **Ext/int forwarding** function is activated, call forwarding by call type functionality will be available to you. Forwarding in this case is dependent on the forwarding type and additionally on the call type. The menu layout therefore deviates from that for standard forwarding → Page 60. You can also change, activate, and deactivate call forwarding during a call.

Forwarding menu

The Forwarding menu is opened either using the  key or via the user menu (→ Page 84) and contains the three forwarding types:

- Unconditional
- Busy
- No reply

Because of its direct impact, "**Unconditional**" call forwarding has the highest priority followed by "**No reply**" and "**Busy**".

If active, "**Unconditional**" call forwarding is indicated on the display when the phone is idle. Forwarded calls are logged in a call list if allowed (see → Page 115).

The three forwarding types are each assigned three call types in the **Forwarding** menu:

Unconditional

- Any call
- External
- Internal

Busy

- Any call
- External
- Internal

No reply

- Any call
- External
- Internal

Using call forwarding

The following functions are available for activating and deactivating call forwarding and configuring it in advance in accordance with your requirements:

- "Activating or deactivating immediate call forwarding" → Page 69
- "Saving destination phone numbers for call forwarding" → Page 70
- "Preconfiguring or changing destination phone numbers" → Page 71
- "Copying and pasting destination phone numbers" → Page 71
- "Assigning a destination phone number to a call type" → Page 72
- "Activating/deactivating call forwarding" → Page 73

Activating or deactivating immediate call forwarding

You can also configure the settings for call forwarding via the user menu (→ Page 84). It is recommended to use the call forwarding key however so that you can use the following enhanced functions.



Press the key shown.

Deactivating call forwarding

If call forwarding was activated for **Unconditional**, it is now automatically deactivated.

or

Activating forwarding to last destination

The pop-up menu opens. The message

"**Set forward on to**" is displayed with the last forwarding destination used and you are offered the following additional options:

- Accept
- Set a forwarding destination
- Edit call forwarding
- Cancel

Accept

Using last forwarding destination

Select and confirm within three seconds to reuse the last saved forwarding destination for **Unconditional**. Call forwarding to this destination is immediately activated for **Any call** and the  key illuminates.

If you do not confirm **Accept** immediately, call forwarding is activated automatically after a short time.

or

Activating with variable destination phone numbers

If you want to use a new forwarding destination:

Set a forwarding destination



Select and confirm within three seconds.

Enter and confirm the new destination phone number.

or

Confirm the last destination phone number saved (it will be displayed).

Call forwarding to the defined destination is immediately activated for **Unconditional** and **Any call** and the  key illuminates.

Saving destination phone numbers for call forwarding

 You can alternatively enter the call forwarding settings via the user menu (→ Page 84) or also using the WBM interface → Page 206.

Press the key shown.

The pop-up menu opens. The message, "**Set forward on to**" is displayed with the last forwarding destination used and you are offered the following options:

- Accept
- Set a forwarding destination
- Edit call forwarding
- Cancel

Select and confirm within three seconds. You are then offered three forwarding types in the Settings menu with three call types each and with frequently used destination numbers preassigned by default:

- Unconditional
 - Any call
 - External
 - Internal
- Busy
 - Any call
 - External
 - Internal
- No reply
 - Any call
 - External
 - Internal
- Edit favourites

Saving a destination phone number

Select and confirm the forwarding type (here for instance Unconditional).

Select the call type.

Select the option shown.

Select the option shown.

Select and confirm the option shown in the context menu for the call type.

Enter/edit and confirm the destination phone number.

You can now select another call type additionally and enter a destination phone number. If you assign destination phone numbers for **External** and **Internal** for example, both external and internal calls will be forwarded to the respective destinations.

If the destination phone numbers for **Any call** are assigned or changed, this call forwarding has priority and both external and internal calls are forwarded to this destination phone number.

Press the illuminated key to open the call view. Call forwarding for the selected call type is activated.

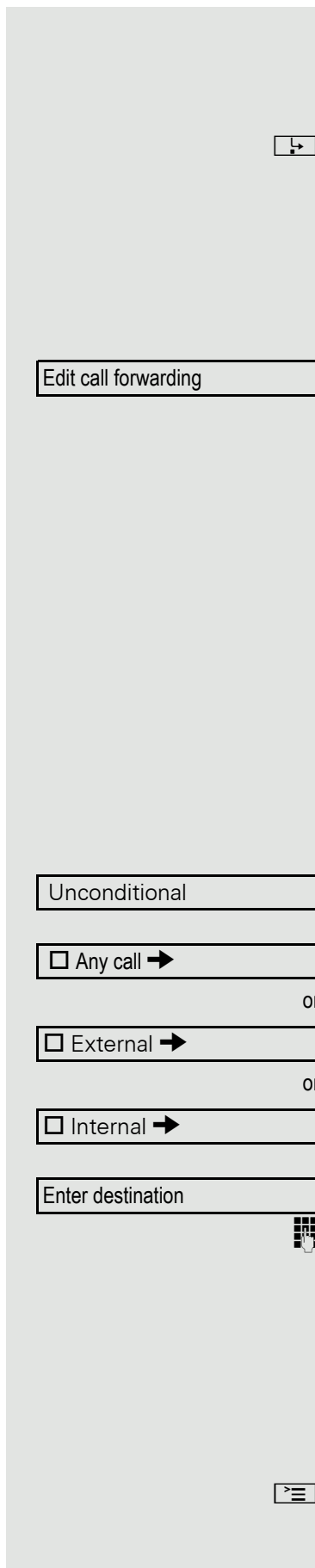

Preconfiguring or changing destination phone numbers

You can preconfigure up to five destination phone numbers for call forwarding. These destination phone numbers can then be assigned to the different call types.



Edit call forwarding

Press the key shown.

Select and confirm within three seconds.

Edit favourites

Select and confirm the option shown.

Destination 1

For instance, select and confirm the first destination.



Save & Exit

Enter/edit and confirm the destination phone number. If necessary, define additional destination phone numbers.

Select and confirm the option shown.



Press the illuminated key to open the call view.

Copying and pasting destination phone numbers

The current destination phone number for a call type is copied. For example, the current destination phone number for Any call should also become the current destination phone number for **Internal**.



Press the key shown.

Edit call forwarding

Select and confirm within three seconds.

The three forwarding types and associated call types are offered to you in the Settings menu:

- Unconditional
 - Any call
 - External
 - Internal
- Busy
 - Any call
 - External
 - Internal
- No reply
 - Any call
 - External
 - Internal

1. Copy

Select and confirm the forwarding type (here for instance Unconditional).

Unconditional

Select the call type (here for instance Any call).

Any call → 3339

Select and confirm the option shown in the context menu.

Copy

External →

Paste

External → 3339

Busy

Internal →

Paste

Internal → 3339





Edit call forwarding

Unconditional

Internal →

3336

Internal → 3336



2. Paste to a call type of the same forwarding type

Select the destination call type (here for instance External).

Select and confirm the option shown in the context menu.

Both call types now have the same destination phone number. The call type External is activated automatically.

3. Paste to a call type of a different forwarding type

Select and confirm the forwarding type (here for instance Busy).

Select the destination call type (here for instance Internal).

Select and confirm the option shown in the context menu.

Both call types now have the same destination phone number. The call type Internal for Busy is activated automatically.

Press the illuminated key to open the call view.

Assigning a destination phone number to a call type

Prerequisite: At least one destination phone number has already been saved.

Press the key shown.

Select and confirm within three seconds.

Select and confirm the forwarding type (here for instance Unconditional).

Select the destination call type (here for instance Internal).

Select and confirm a previously saved destination in the context menu.

The call type is activated and the new destination is displayed.

Press the illuminated key to open the call view.

Activating/deactivating call forwarding

Prerequisite: One or more forwarding destinations are already configured for the relevant call type(s).

Press the key shown.

The pop-up menu opens. The message

"Set forward on to" is displayed with the last forwarding destination used and you are offered the following options:

- Accept
- Set a forwarding destination
- Edit call forwarding
- Cancel

Select and confirm within three seconds.

The list of forwarding types is displayed:

- Unconditional
- Busy
- No reply

Select and confirm the option shown (e.g. **Unconditional**).

Choose one of the call types offered

- Any call 3339 (default setting is off)
- External 3335
- Internal 3336

and confirm your selection, for instance **External**. The call type is activated. Press once more to deactivate this call type again.

You can also activate all three call types. The call type **Any call** has priority in this case and all calls are forwarded to the defined destination phone number. Call forwarding for the call types **External** and **Internal** can be activated at the same time. **INT/EXT** is then shown on the display for the forwarding type **Unconditional**.

The call forwarding settings can appear as follows:

- Any call 3339 (default setting is off)
- External 3335
- Internal 3336

 All call types are deactivated automatically for the forwarding type **Unconditional**. Previously activated call forwarding for all call types remains activated with the forwarding types **Busy** and **No reply** until deactivated manually by you. Activated call forwarding for **Busy** and **No reply** is indicated in the list by the call forwarding icon.

Press the illuminated key to open the call view. If you selected the forwarding type **Unconditional** and activated a call type here, the call type is shown on the display with the call forwarding icon and the  key illuminates. Nothing is shown on the display for the forwarding types **Busy** and **No reply**.



Edit call forwarding

Unconditional

External → 3339



Call forwarding chain

Sometimes calls to a station are forwarded to another station that also has call forwarding or DND activated. This can create a call forwarding chain consisting of several telephones where the last member of the chain is your phone.

A popup window opens on your phone's display with the following information:

- Who is calling
- Who forwarded first or last
- The reason for the forwarding is displayed by an icon

You can set whether the station that forwarded first or last is displayed (see → Page 85).

Programmable sensor keys

The phone features a range of functions that can, if required, be stored on programmable sensor keys. The phone comes with six sensor keys, all of which can be programmed on two separate levels.

The "Shift" sensor key for switching between the two sensor key levels is preassigned. This sensor key should be maintained where possible so you can switch between the two levels. The labels for the sensor keys are displayed on the right edge of the display.

The sensor keys can also be programmed via the WBM interface (→ Page 206).

List of available functions

1. Unallocated
2. Selected dialling
3. Repeat dialling
4. CF unconditional
5. CF no reply
6. CF busy
7. CF unconditional - any
8. CF unconditional – int.
9. CF unconditional – ext.
10. CF busy - any
11. CF busy – int.
12. CF busy – ext.
13. CF no reply - any
14. CF no reply – int.
15. CF no reply – ext.
16. Ringer off
17. Hold
18. Alternate
19. Blind transfer call
20. Transfer call
21. Deflecting
22. Shift
23. Conference
24. Headset
25. Do not disturb
26. Group pickup
27. Repertory dial
28. Feature toggle
29. Show phone screen
30. Mobility
31. Directed pickup
32. Release
33. Callback
34. Cancel callbacks
35. Consultation
36. Call Waiting toggle
37. Immediate ring
38. PreView
39. Call recording
40. Built in fwd
41. Personal directory
42. Pause callbacks
43. Resume callbacks
44. Corporate directory

Programming sensor keys

The sensor keys can also be programmed via the WBM interface → Page 206.

Starting programming

Directly via a sensor key

Hold down the sensor key to which a function should be assigned until the programming prompt is displayed.

 If the prompt is not displayed or a programmed function is not executed, then you can only launch key programming via the user menu (ask your administrator about the current setting).

OK

or



Settings

User

if nec. 

Phone

Program keys

Normal

or

Shifted

Do not disturb

Label



Save & Exit

Confirm to begin programming. The sensor key illuminates continuously.

Via the user menu

You can also program keys via the user menu.

Press the key shown.

Select and confirm the option shown.

Select and confirm the option shown.

Enter and confirm the User password.

Select and confirm the option shown.

Select and confirm the option shown. You are prompted to press the key you wish to program.

Press the sensor key you want to program with a function. The sensor key illuminates continuously.

Beginning programming

Select and confirm the option shown to program the first level.

Select and confirm the option shown to program the second level.

Select and confirm the required function in the list (e. g. Do not disturb).

Select and confirm the option shown if you want to change the label on the graphic display.

Enter and confirm the label you want.

Select and confirm the option shown.

Programming enhanced functions

Repertory dial

Hold down the sensor key to which a function should be assigned until the programming prompt is displayed.

 If the prompt is not displayed or a programmed function is not executed, then you can only launch key programming via the user menu (ask your administrator about the current setting).

OK

Confirm to begin programming. The sensor key illuminates continuously.

Normal

Select and confirm the option shown to program the first level for instance.

Repertory dial

Select and confirm the function in the context menu.

Label

Select and confirm the option shown if you want to change the label on the graphic display.



Enter and confirm the label you want.

Setting

Select and confirm this option to enter a destination phone number.



Enter and confirm a stations's destination phone number.

You can select and insert special characters in the dialling sequence:

« Clear call

~ Make consultation

» Make normal call

¬ Pause

The pop-up menu also offers the following functions:

- Move cursor right and left
- Copy
- Paste
- Mode selection
- Cancel
- OK

Save & Exit

Select and confirm the option shown.

 The repertory dial can be up to 40 characters long.

Feature toggle

Only available for the hunt group functions (→ Page 158) and "whispering" in muted silent monitoring mode (→ Page 164).

Hold down the sensor key to which a function should be assigned until the programming prompt is displayed.

 If the prompt is not displayed or a programmed function is not executed, then you can only launch key programming via the user menu (ask your administrator about the current setting).

OK

Confirm to begin programming. The sensor key illuminates continuously.

Normal

Select and confirm the option shown to program the first level for instance.

Feature toggle

Select and confirm the function in the context menu.

Label

Select and confirm to change the key labeling.

Enter and confirm the label you want.

Setting

Select and confirm this option to enter a code.

Enter and confirm the code, for example: *96 (contact your administrator).

Save & Exit

Select and confirm the option shown.

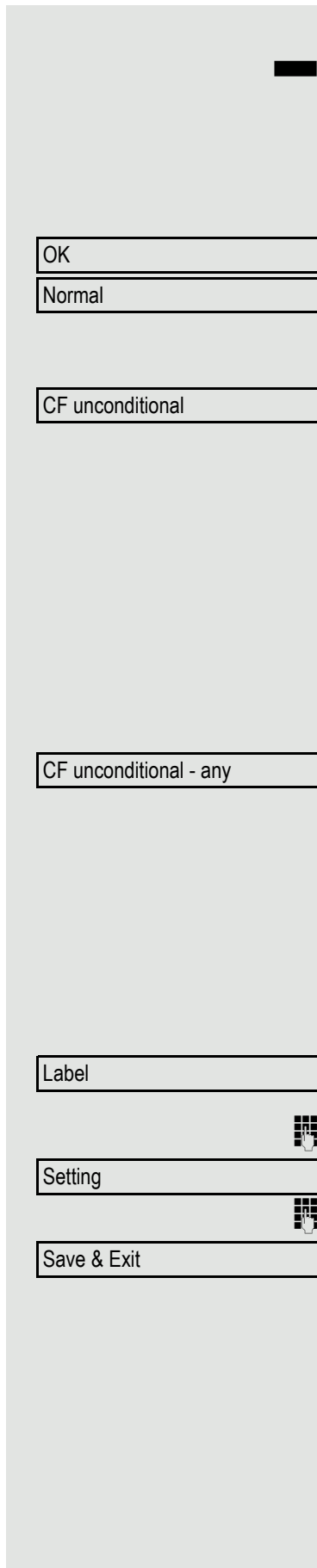

Configuring a fixed forwarding key

Hold down the sensor key to which a function should be assigned until the programming prompt is displayed.

 If the prompt is not displayed or a programmed function is not executed, then you can only launch key programming via the user menu (ask your administrator about the current setting).

Confirm to begin programming. The sensor key illuminates continuously.

Select and confirm the option shown to program the first level for instance.

Call forwarding depending on forwarding type

Select a forwarding type:

- CF unconditional
- CF no reply
- CF busy

Select and confirm the required function.

Call forwarding depending on incoming call type

If use of server feature has been enabled by administrator and the **Ext/int forwarding** function is activated, call forwarding by incoming call type functionality will be available to you. Forwarding in this case is dependent on the forwarding type and additionally on the call type.

Select a forwarding type:

- CF unconditional - any
- CF unconditional – int.
- CF unconditional – ext.
- CF busy - any
- CF busy – int.
- CF busy – ext.
- CF no reply - any
- CF no reply – int.
- CF no reply – ext.

Select and confirm the option shown if you want to change the label on the graphic display.

Accept or edit the label and confirm.

Select and confirm this option to enter the forwarding destination.

Enter and confirm the phone number of the forwarding destination.

Select and confirm the option shown.

Configuring a variable call forwarding key

If the call forwarding key  is not available to you, you can configure a key yourself for **Forwarding** which you can then use to

- immediately activate or deactivate call forwarding for "Any call" → Page 61
- edit the call forwarding → Page 63

Hold down the programmable key to which you want to assign a function until the programming prompt is displayed.



If the prompt is not displayed or a programmed function is not executed, you can only launch key programming via the user menu (consult your administrator about the current setting).

OK

Confirm to begin programming. The sensor key illuminates continuously.

Normal

Select and confirm the option shown to program the first level for instance.

Built in fwd

Select and confirm the option shown.

Save & Exit

Select and confirm the option shown.

Using sensor keys

The use of programmed functions depends on the phone's status. The relevant display appears once you have pressed a sensor key.

Example 1: Calling saved number

Prerequisite: The idle menu is displayed on the graphic display.

Press the sensor key for a saved number. The connection is set up.

Example 2: Call Waiting toggle Activating/deactivating

You can press a key to activate or deactivate call waiting functionality, even during a call. The prerequisite for this is that a second call is permitted (→ Page 93). By default a second call is permitted.



Press the "Call Waiting toggle" sensor key. The sensor key goes out. The second call function is deactivated. The call is rejected or forwarded.

Example 3: Immediate ring

This function allows you to switch the preset delay (→ Page 134) on and off for all line keys. By default the delay is set, the key does not illuminate.

Press the "Immediate ring" sensor key. The sensor key illuminates. The delay ringtone is disabled. An incoming call rings immediately regardless of what delay time is configured.

Resetting sensor keys

You can reset sensor keys you configured to factory settings (see also → Page 194).

Press the key shown.

Select and confirm the option shown.

Select and confirm the option shown.

Enter and confirm the user password.

Select and confirm the option shown to switch to the **Reset user data** menu.

Select the option shown.

Select and confirm the option shown in the context menu to delete the content of all sensor keys.

Select and confirm "Reset selected user data". The contents of the sensor keys you configured are deleted.

 Sensor keys which can only be configured by administrator remain unchanged

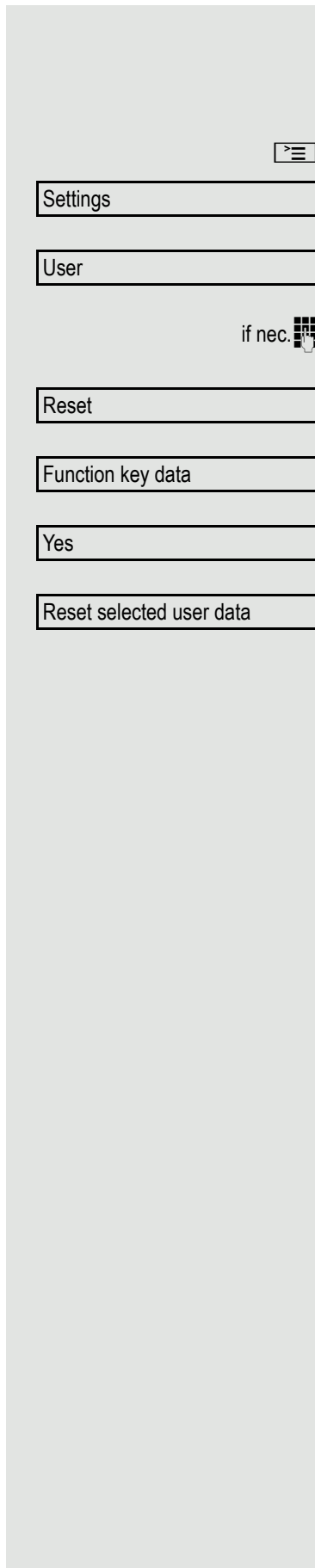

Enhanced phone functions

Incoming calls

Accepting calls via the headset

Prerequisite: The headset is connected.

The LED flashes when a call is received.
Press the key shown. Conduct call.



Ending the call:

Press the key shown. The LED goes out.



Deflecting a call

Using call deflection

Prerequisite: An incoming call is displayed or signalled. "Deflect" must be allowed.

In the pop-up menu

Deflect

Select and confirm the option shown.

The call is immediately deflected if a destination phone number is programmed (→ Page 83).

or

If you did not set a phone number when programming call deflection, a pop-up menu appears prompting you to enter a destination phone number for call deflection.



Enter and confirm the destination phone number.
The call is deflected.

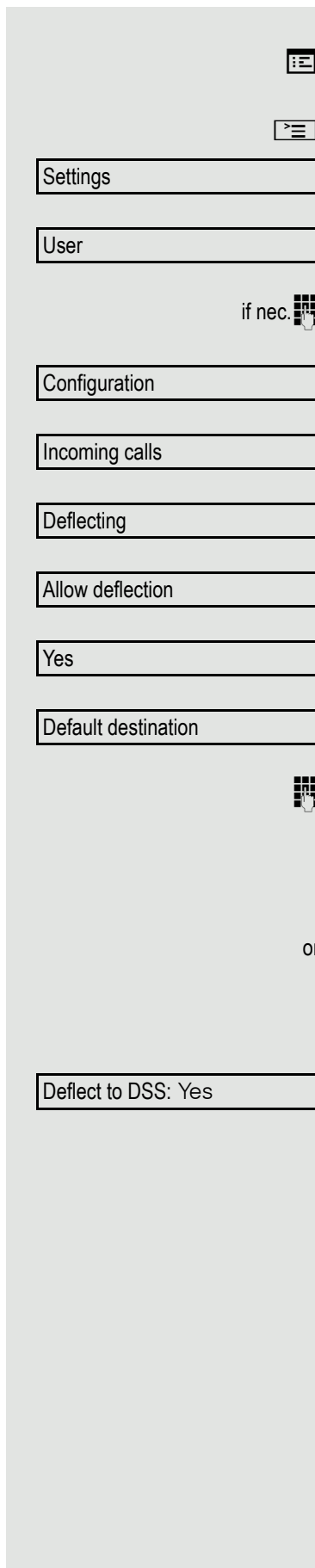

Permitting call deflection

You can also configure this setting via the WBM interface → Page 206. "Deflect" must be authorised by administrator.

Press the key shown.

Select and confirm the option shown.

Select and confirm the option shown.

Enter and confirm the User password.

Select and confirm the option shown.

Select and confirm the option shown.

Select and confirm the option shown.

Select and confirm the option shown.

Select and confirm the option shown in the context menu.

Select and confirm the option shown.

Enter and confirm the phone number to which the station should be deflected.



Entering a destination phone number is not mandatory when call deflection is active. If you want to deflect an incoming call, you are prompted to enter a destination phone number if there is none stored.

Deflecting to a DSS number

A call can be deflected to a direct station selection (DSS) subscriber using the DSS key, if the key is configured and the deflect function is activated by administrator → Page 127.

Information only, as set by administrator: Yes or No.



Reject

Rejecting calls

You can reject an incoming call. "Reject" must be activated by administrator.

In the pop-up menu

Select and confirm the option shown.
The caller hears a busy signal.



If the rejected caller's phone number is transmitted, it is saved in the call list. You can then call this party back at a later time.

Configuring call forwarding



You can also enter the call forwarding settings via the Forwarding key (→ Page 61).



Settings

Press the key shown.

Select and confirm the option shown.

User

Select and confirm the option shown.

if nec. 

Enter and confirm the User password.

Configuration

Select and confirm the option shown.

Incoming calls

Select and confirm the option shown.

Forwarding

Select and confirm the option shown.

Settings

Configuring forwarding

Select and confirm the option shown.

For a description of the settings, refer to section "Standard call forwarding" → Page 60 or "Call forwarding by call type" → Page 68.

Setting alerts

Use the Call forward alerts menu to enable and disable visual and audible alerts for call forwarding (not possible with the Forwarding key).

Alerts

Select and confirm the option shown.

Visual alerts= No

Select the option shown.

Yes

Select and confirm the option shown in the Yes/No context menu.

or

Audible alerts= No

Select the option shown.

Yes

Select and confirm the option shown in the Yes/No context menu.

or

Forwarding station... Last

Select the option shown.

Display last

Select and confirm **Display last/Display first**

Option = Save & Exit

Select and confirm the option shown.

Placing a call on hold

You can use this function to place an ongoing call on hold, for instance, to prevent the other party overhearing a conversation with a colleague in the same room. The held party hears music on hold if **Music on hold** is active on this party's phone (→ Page 90).

Prerequisite: You are conducting a call.

Select and confirm the option shown in the connections's context menu.

Hold

or

Press the "Hold" key. The key flashes. (The "Hold" sensor key must be configured → Page 75.)



If you do not retrieve the held call after a defined time interval, a reminder beep sounds three times and a prompt to retrieve the call or disconnect appears on the display. The settings for this can be found on → Page 87 and → Page 88.

Retrieving a held call:

Select and confirm the option shown in the connections's context menu.

Reconnect

or

Press the flashing "Hold" key. (The "Hold" sensor key must be configured → Page 75.)

Using line keys

On multi-line telephones you can use the line keys to place ongoing calls on hold.

Press the corresponding line key. The line key LED starts flickering. The call is now on hold.

Retrieving a held call:

Press the corresponding line key. The line key LED lights up. The call is retrieved.



The LED display → Page 21 or status display on the "Overview" tab → Page 28 indicates to other multi-line telephones on which this line is also configured, that the call is on hold. These phones can then pick up the call.

Held call wait status

After placing a call on hold, you can replace the handset and then decide whether to retrieve the call or disconnect.

Prerequisite: You placed a call on hold and replaced the **handset** or pressed the loudspeaker key in speakerphone mode.

A recall follows immediately and a pop-up menu appears on the display:

Select and confirm the option shown to resume the call in speakerphone mode.

Select and confirm the option shown to disconnect the call.

 If you enabled "Hold and hang-up" (→ Page 89), the call is placed on hold for a defined time interval (→ Page 88) before the prompt is displayed with a recall to retrieve the call or disconnect. You can however retrieve the call or disconnect via the context menu before the defined time expires.

This function **cannot** be used on multi-line phones.

Activating/deactivating the hold reminder tone

You can also configure this setting via the WBM interface → Page 206.

Press the key shown.

Select and confirm the option shown.

Select and confirm the option shown.

Enter and confirm the User password.

Select and confirm the option shown.

Select and confirm the option shown.

Select and confirm the option shown.

Select and confirm the option shown in the context menu.

Select and confirm the option shown.

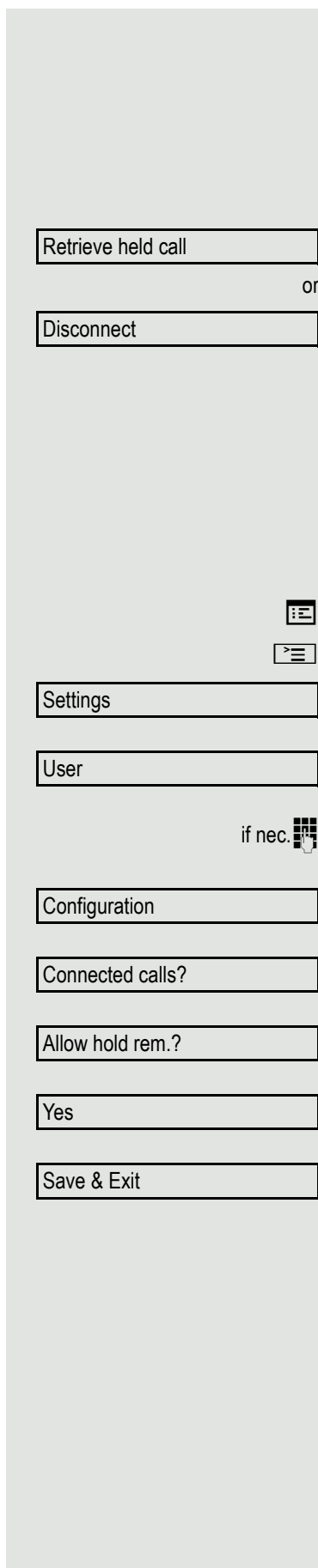

Setting the hold reminder time

Use the "Hold reminder" function to set the length of the timeout before an automatic reminder is issued about a held call.

The minimum value is 3, that is, the reminder is output after three minutes. The maximum value is 15 minutes.

You can also configure this setting via the WBM interface → Page 206.

Press the key shown.

Select and confirm the option shown.

Select and confirm the option shown.

Enter and confirm the User password.

Select and confirm the option shown.

Select and confirm the option shown.

Select and confirm the option shown.

Enter a value between 3 and 15 and confirm.

Select and confirm the option shown.

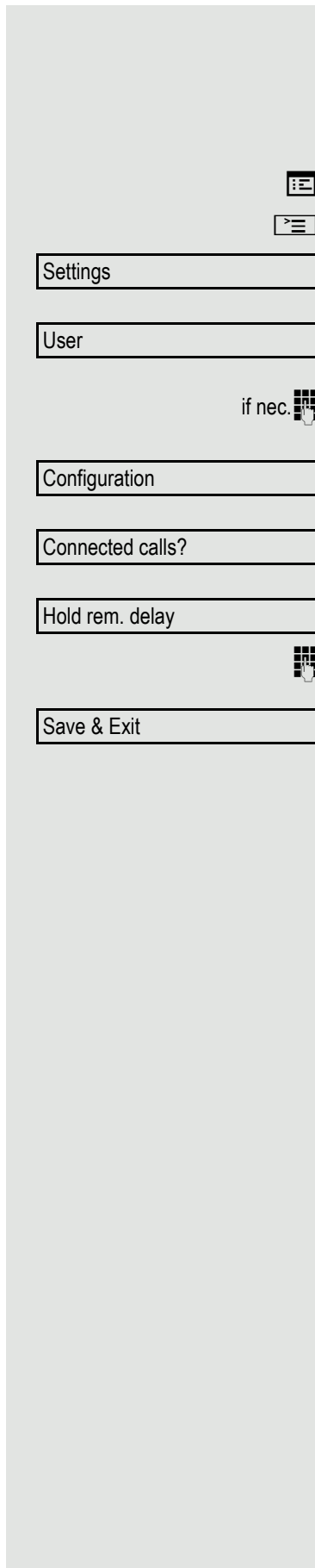

Activating/deactivating Hold and hang-up

This function works in the following call scenarios:

- You have placed a call on hold and hang up.
- You are conducting a consultation call and the second call partner hangs up.
- You accepted a second call, and you or the second participant hang up.

You can use "hold and hang up" to determine whether you will be prompted immediately or after a defined time to retrieve the held call.

 This function **cannot** be used on multi-line phones.

You can also configure this setting via the WBM interface → Page 206.

Press the key shown.

Select and confirm the option shown.

Select and confirm the option shown.

Enter and confirm the User password.

Select and confirm the option shown.

Select and confirm the option shown.

Select and confirm the option shown.

In the context menu select and confirm the option shown to activate the function or

Select and confirm the option shown to deactivate the function again. The function is always deactivated by default.

Select and confirm the option shown.

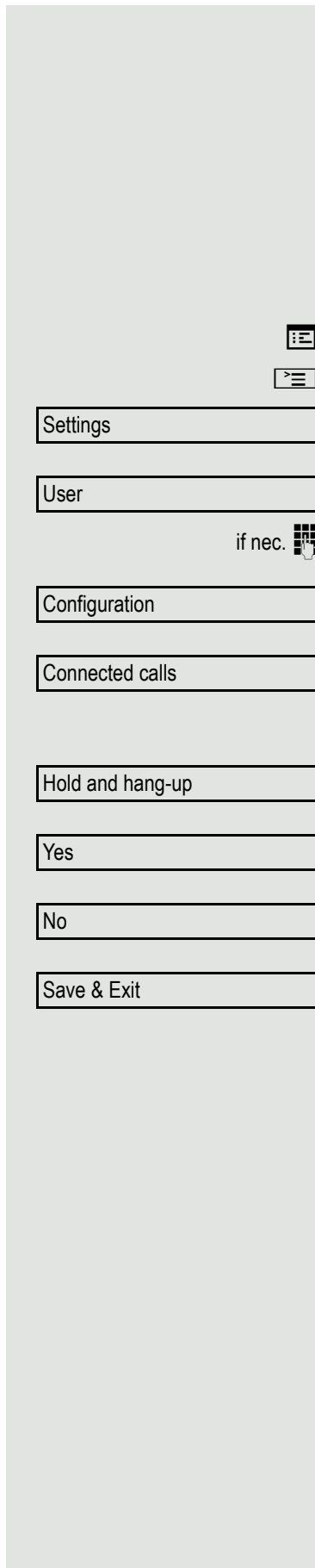

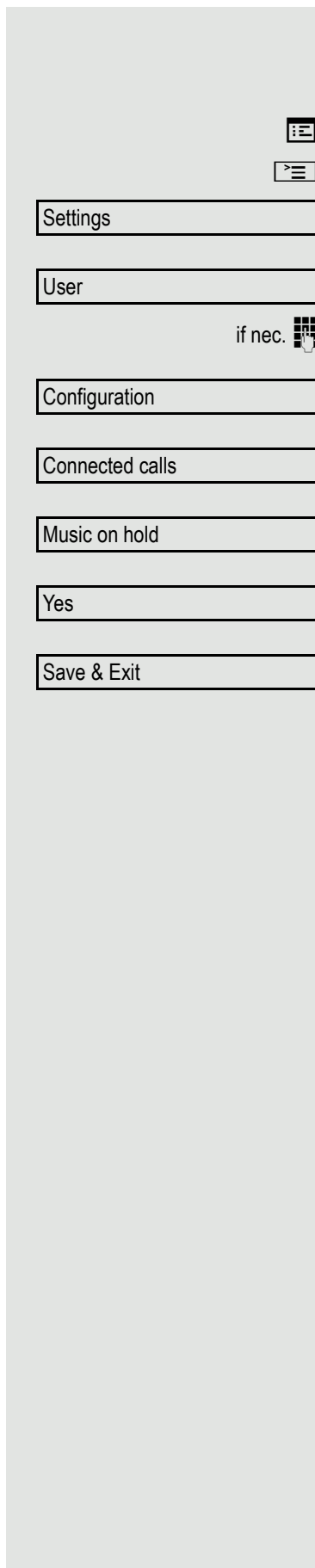

Music on hold

Music on hold is played back when you are placed on hold by another party, providing this option is active.

You can also configure this setting via the WBM interface → Page 206.

Press the key shown.

Select and confirm the option shown.

Select and confirm the option shown.

Enter and confirm the User password.

Select and confirm the option shown.

Select and confirm the option shown.

Select and confirm the option shown.

Select and confirm the option shown in the context menu.

Select and confirm the option shown.

Call waiting (second call)

You can accept a second incoming call in the course of an ongoing call. The caller hears the on-hook signal while you hear a call-waiting signal tone.

You can ignore or accept the second call. Before you accept the second call, you can end the first call or place it on hold for subsequent retrieval.

You can block the second call or the signal tone (→ Page 93).

Accepting a second call

Prerequisite: You are conducting a call and call waiting is allowed (→ Page 93).

In the pop-up menu:

Accept

Select and confirm the option shown.

You can talk to the second party.

The connection to the first party is on hold.

You can still

- toggle between an initial and second call or
- put on hold and retrieve second and first call successively → Page 55
or
- initiate a conference

Consultation call from second call

If the second call is your active call you can initiate a consultation call from it.

Prerequisite: The administrator must have approved the consultation in the second call.

From a consultation call in the second call you can

- initiate a conference
- toggle between the second call and a consultation call
- put on hold and retrieve second and first call successively → Page 55
- transfer a call
- disconnect the calls again

During a consultation in the second call, the first call is parked and can only be unparked when the consultation or second call ends or these calls were connected.

Disconnect & return

Disconnecting the second call

Select and confirm the option shown in the second call's context menu. The call to this station is disconnected and the call to the first station is reconnected.

Ending the second call by hanging up

If you or the second call partner hangs up, you will be prompted to retrieve the first call again if "Hold and hang-up" is disabled (→ Page 89). Otherwise, the first call will remain on hold until you receive this prompt after a defined time interval.

Ignoring second call

Prerequisite: You are conducting a call and call waiting is allowed (→ Page 93).

In the pop-up menu:

Select and confirm the option shown.

The caller still hears the on-hook signal. You can subsequently Accept, Reject or Deflect the second call.

While the ignored second call continues to wait, from the active call you can:

- make a consultation call
- initiate a conference
- toggle between the consultation call and your call party
- transfer a call

A third call would be rejected with the busy signal

If you have disconnected the first call, the ignored second call rings like a normal call.

Rejecting the second call

Prerequisite: You are conducting a call and call waiting is allowed (→ Page 93).

In the pop-up menu:

Select and confirm the option shown.

The second call is rejected. The caller hears the busy signal. The caller's phone number is added to the missed calls list.

Deflecting a second call

Prerequisite: You are conducting a call and call waiting is allowed (→ Page 93).

In the pop-up menu:

Select and confirm the option shown.

Enter and confirm the phone number.

The second call is deflected to the destination specified. You are reconnected with the first party.

Ignore

Reject

Deflect



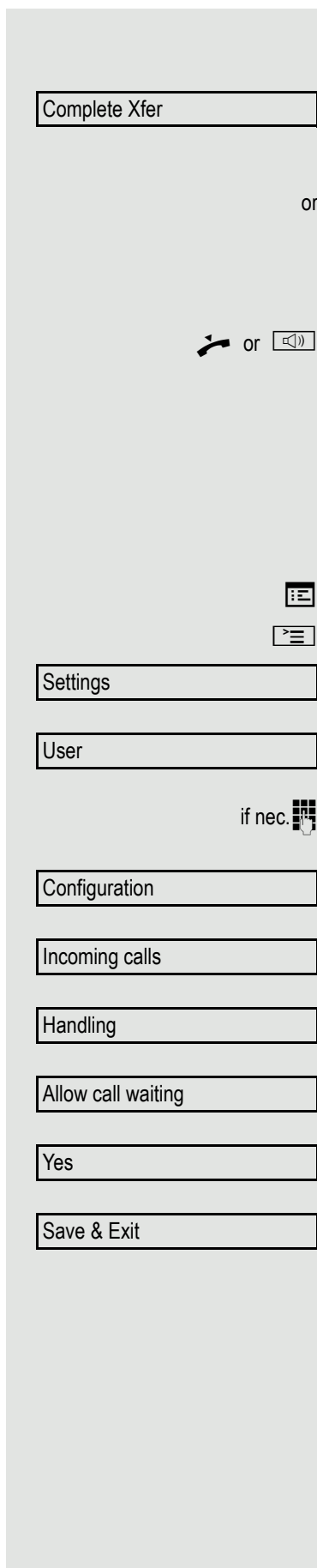

Connecting parties

Prerequisite: You have accepted the second call.

Select and confirm the option shown in the active connection's context menu. The other two parties are now connected to one another. You can now hang up or dial another number for instance.

Connect by hanging up

Prerequisite: Connecting by hanging up is activated (ask your administrator) and "Switch assignment" must be set to "Yes" (→ Page 94). Before you can be connected by hanging up you must have toggled at least twice (→ Page 54).

Replace the handset or, if you are in speakerphone mode, press the loudspeaker key. The other two parties are now connected to one another.

Allowing call waiting

 If the Call waiting (second call) function is deactivated, a caller hears the busy signal if you are already conducting a call.

Prerequisite: The option was programmed by your administrator.

You can also configure this setting via the WBM interface → Page 206.

Press the key shown.

Select and confirm the option shown.

Select and confirm the option shown.

Enter and confirm the User password.

Select and confirm the option shown.

Select and confirm the option shown.

Select and confirm the option shown.

Select and confirm the option shown.

Select and confirm the option shown.

Select and confirm the option shown.

Assuming **Allow call waiting** is generally activated, you can toggle the configured sensor key to switch call waiting on/off (→ Page 93).

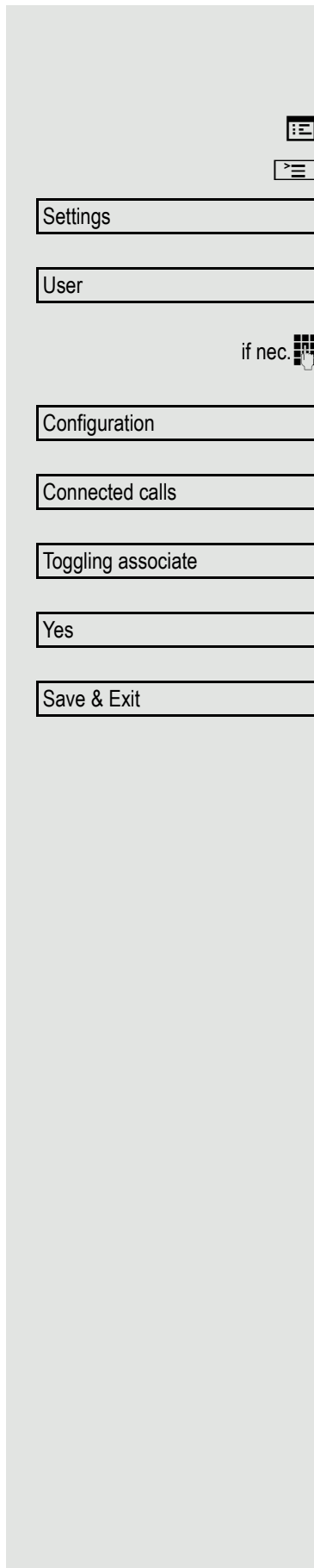

Toggling associate

Set the "Toggle associate" function to Yes if you want to connect to a second or pickup call by hanging up.

You can also configure this setting via the WBM interface → Page 206.

Press the key shown.

Select and confirm the option shown.

Select and confirm the option shown.

if nec.  Enter and confirm the User password.

Select and confirm the option shown.

Select and confirm the option shown.

Select and confirm the option shown.

Select and confirm the option shown in the context menu.

Select and confirm the option shown.

Transferring a call

You can transfer your current call to another party with or without consultation.

Blind transfer

Prerequisite: You are conducting a call. The options "Allow call transfer" and "Transfer on ring" were allowed (→ Page 96).

Select and confirm the option shown in the connections's context menu.

Enter and confirm the phone number of the second party to whom you want to transfer the call. You can also select and call a subscriber here from a call list or from one of the two phonebooks → Page 108.

 The graphic display returns to idle following successful transfer.

Transferring with consultation

You can announce a call to a recipient before transferring it.

Prerequisite: You are conducting a call. The options "Allow call transfer" and "Transfer on ring" were allowed (→ Page 96).

Select and confirm the option shown in the connections's context menu. The call is placed on hold.

Enter the phone number of the party to whom you want to transfer the call. You can also select and call a subscriber here from a call list or from one of the two phonebooks → Page 108.

Confirm.

If the party answers:

Announce the call you want to transfer.

Select and confirm the option shown in the connections's context menu.

If the party does not answer:

You do not have to wait for the second party to answer before you can transfer the call.

Select and confirm the option shown in the connections's context menu.

Replace the handset or, if speakerphone mode is active, press the lit  key to transfer the call.

If the party does not answer, you will be called back by the first party.

Blind transfer



Consultation



Dial

Complete Xfer

Complete transfer

or

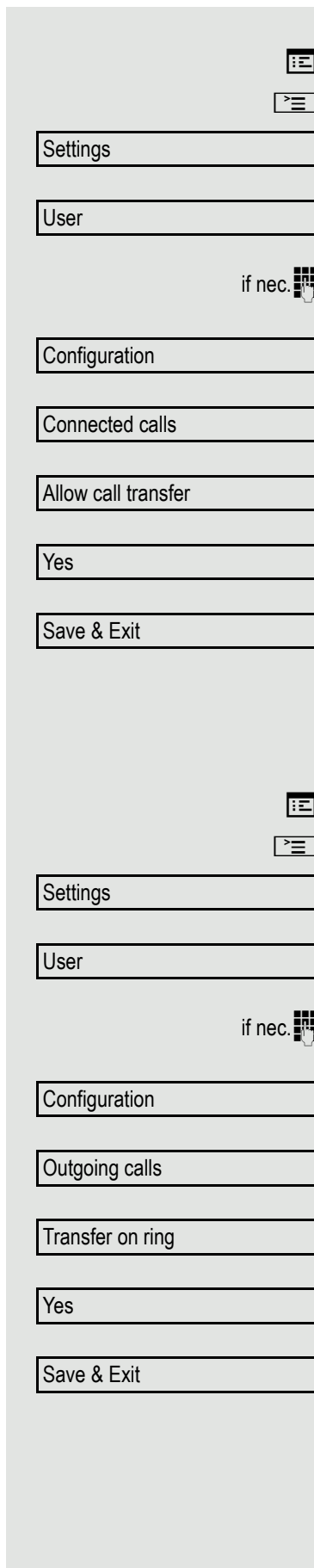

Allowing call transfer

You can also configure this setting via the WBM interface → Page 206.

Press the key shown.

Select and confirm the option shown.

Select and confirm the option shown.

Enter and confirm the User password.

Select and confirm the option shown.

Select and confirm the option shown.

Select and confirm the option shown.

Select and confirm the option shown in the context menu.

Select and confirm the option shown.

Allowing "Transfer on Ring"

If this option is allowed, you can activate call transfer by replacing the handset even before the called party answers.

You can also configure this setting via the WBM interface → Page 206.

Press the key shown.

Select and confirm the option shown.

Select and confirm the option shown.

Enter and confirm the User password.

Select and confirm the option shown.

Select and confirm the option shown.

Select and confirm the option shown.

Select and confirm the option shown in the context menu.

Select and confirm the option shown.

CTI calls

Beep on auto-answer

Speakerphone mode activates automatically on your phone if you use a CTI application (such as Outlook) to dial a number when Auto Answer is active. If Auto Answer is not active, the phone rings first and you have to press the loudspeaker key or lift the handset to set up the call. This setting also defines whether or not incoming calls are automatically accepted. If the function is active, an alert beep sounds when an incoming call is automatically accepted.

Information on the operation of the configured CTI application can be found in the corresponding user guide.

You can also configure this setting via the WBM interface → Page 206.

Prerequisite: The option was programmed by your administrator.

Press the key shown.

Select and confirm the option shown.

Select and confirm the option shown.

Enter and confirm the User password.

Select and confirm the option shown.

Select and confirm the option shown.

Select and confirm the option shown.

Select and confirm the option shown.

Select and confirm the option shown.

Select and confirm the option shown.

Select and confirm the option shown.

Select and confirm the option shown.

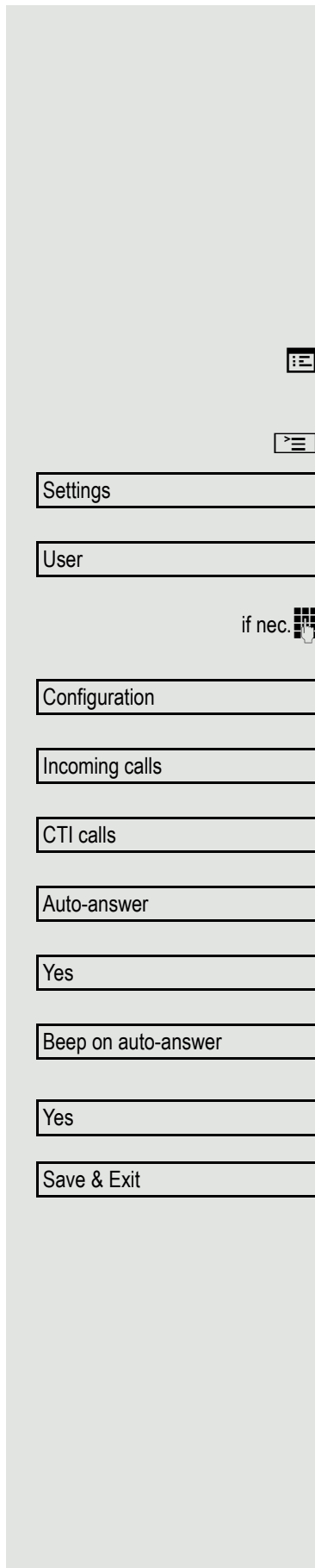

Beep on auto-reconnect

You can reconnect a held call both via the CTI application and via the phone. A beep sounds when you toggle between an active call and a held call when the function is active.

Prerequisite: The option was programmed by your administrator.

You can also configure this setting via the WBM interface → Page 206.

Press the key shown.

Select and confirm the option shown.

Select and confirm the option shown.

if nec.  Enter and confirm the User password.

Select and confirm the option shown.

Select and confirm the option shown.

Select and confirm the option shown.

Select and confirm the option shown.

Select and confirm the option shown.

Select and confirm the option shown.

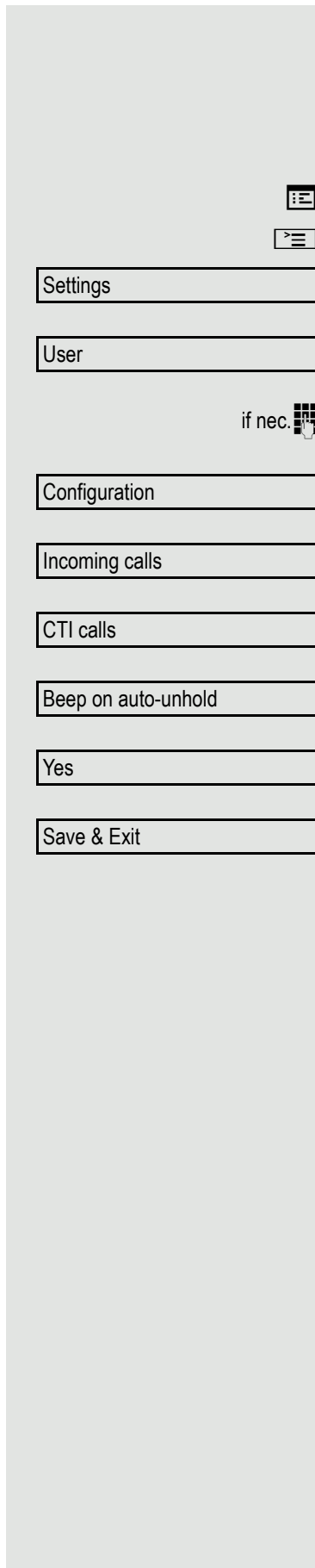

Making calls

If you want to dial a call from a phonebook or a call list, you should not lift the handset or press the loudspeaker or headset key before.

Dialling with the DDS key

You can program frequently used phone numbers on programmable keys (→ Page 75). If you press a DSS key, the associated contact or phone number appears and dialling is initiated.

Prerequisite: A direct destination key is programmed → Page 75.

Press the programmed DDS key. Dialling is initiated.

Dialling from the local phonebook

Press the key shown.

Confirm.

Press the configured sensor key "Personal" for the local phonebook (→ Page 75).

Select and confirm the entry you want. The phone number is dialled.

Extensive information on the local phonebook and on searching for stations can be found from → Page 108.

Dialling from the corporate directory

Prerequisite: You have found and selected an entry in the corporate directory → Page 111.

Select the entry you want.

Select and confirm the option shown in the context menu. The connection is set up.

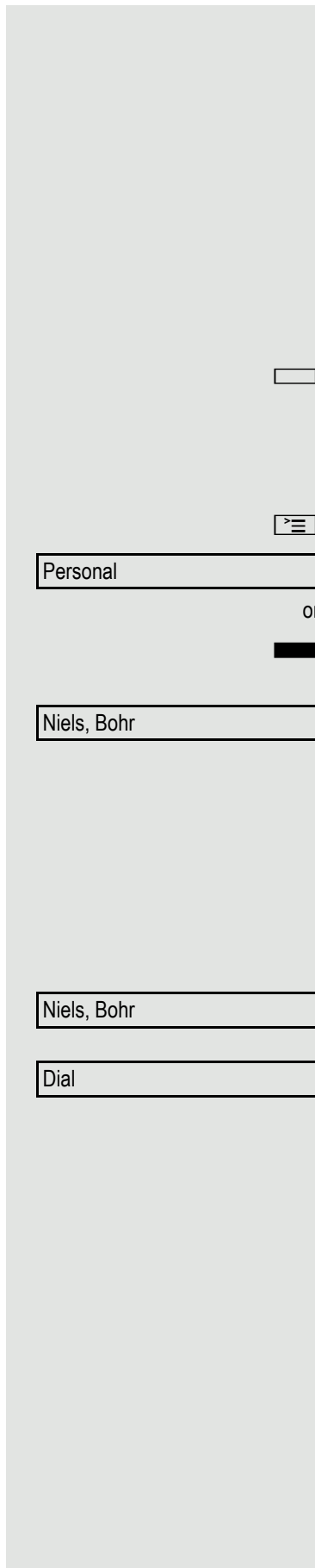

Dialling a phone number from a list

The following call lists are available in the "Calls" directory:

- Missed
- Dialed
- Received
- Forwarded



For a detailed description of the call lists, see → Page 33. Pay attention to the notes on → Page 114.



Press the key shown.

Calls

Select and confirm the option shown.

Dialed

Select and confirm the required call list.

Niels, Bohr 07:06am

Select and confirm the entry you want. The phone number associated with the list entry is dialed.

Using autodial delay

A number is automatically dialled after a set delay starting from the entry of the number's last digit. The autodial delay can be used:

- when dialling in idle mode
- when deflecting an incoming call
- Consultation
- when transferring an answered call.

The delay can be reduced by performing one of the following activities:



- Press the key shown. This always works.
- Lift the handset (off-hook). This only works if the phone number was entered when the phone was idle or if it was entered for a consultation call when the handset was off hook.
- Press the key shown. This only works if the phone number was entered when the phone was idle and the loudspeaker key was not lit or if the phone number was entered for a consultation call and the loudspeaker key was not lit.



If an emergency number is preset by your administrator, the autodial delay for this phone number is reduced to one second.



Automatic dial delay does not work if you are using a dial plan and **Immediate dialling** is configured (see → Page 50). The number is automatically dialled as soon as the string entered matches an entry in the dial plan.

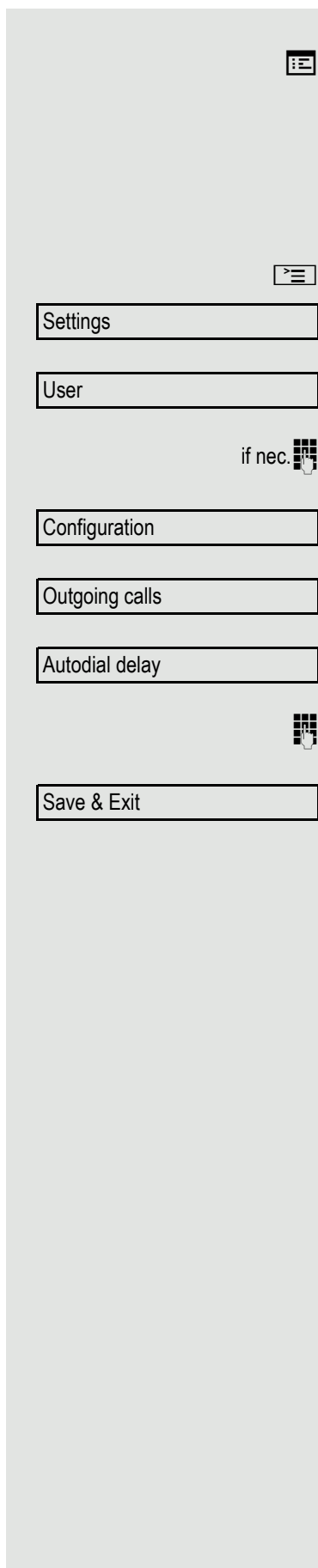

Settings for autodial delay

You can also configure this setting via the WBM interface → Page 206.

 The setting does not affect automatic emergency number dialling.

If you select **Autodial delay**, you must either confirm the "Dial" option, press the loudspeaker key or wait until the autodial delay expires to set up a call when dialling with the handset on hook.

Press the key shown.

Select and confirm the option shown.

Select and confirm the option shown.

Enter and confirm the User password.

Select and confirm the option shown.

Select and confirm the option shown.

Select and confirm the option shown.

Specify a value and confirm your entry.

Select and confirm the option shown.

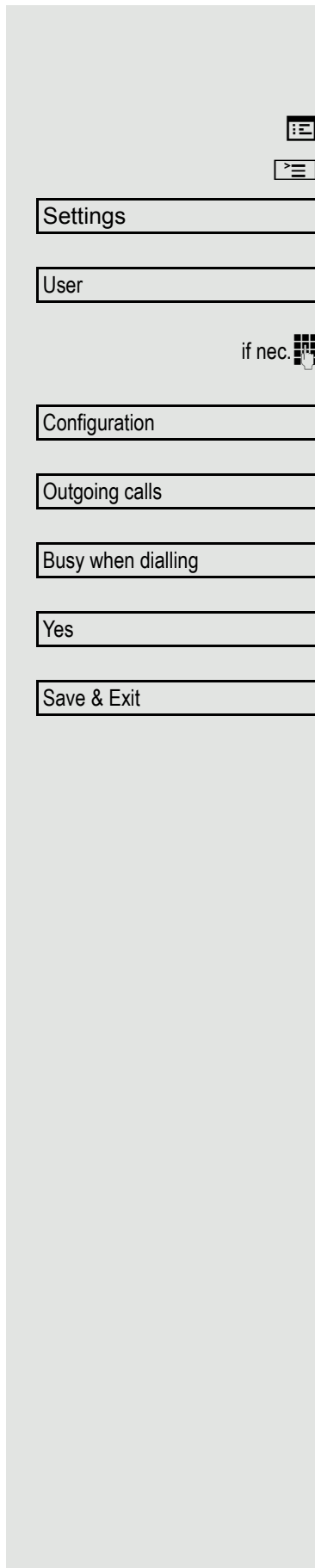

Allowing "Busy When Dialling"

If you activate this function, an incoming call received while you are performing dialling is rejected. The caller then hears the busy signal.

You can also configure this setting via the WBM interface → Page 206.

Press the key shown.

Select and confirm the option shown.

Select and confirm the option shown.

if nec.  Enter and confirm the User password.

Select and confirm the option shown.

Select and confirm the option shown.

Select and confirm the option shown.

Select and confirm the option shown in the context menu.

Select and confirm the option shown.

 This setup option can also be found under "Handling" in the "Incoming calls" menu.

Conference

Local conference

This type of conference is also referred to as a three-party conference. It involves up to three participants.

Prerequisite: You are conducting a consultation call → Page 52 or have accepted a second call → Page 91, and the conference function is active → Page 105.

Initiating a local conference



You can initiate a conference by calling the "Conference" function in the context menu of either the active or held call. Alternatively you can press an already configured **Conference** key.

Conference?

Select and confirm the option shown in the connection's context menu. You are connected to both parties at once.

User

Conducting one-on-one calls

Select the connection you want to clear down on the display.

Disconnect

Select and confirm the option shown in the context menu. You are now involved in a one-to-one call with the remaining call party.



If you already are involved in a secure connection with a party when you initiate a consultation call, the original party is placed on hold. The new consultation connection can be either secure or nonsecure. However, the first connection remains secure even if all three parties are now joined together in a conference.

The entire conference is nonsecure if the connection to at least one of the parties is not secure (see also → Page 38).

The relevant padlock icon appears on the "Conference" row.

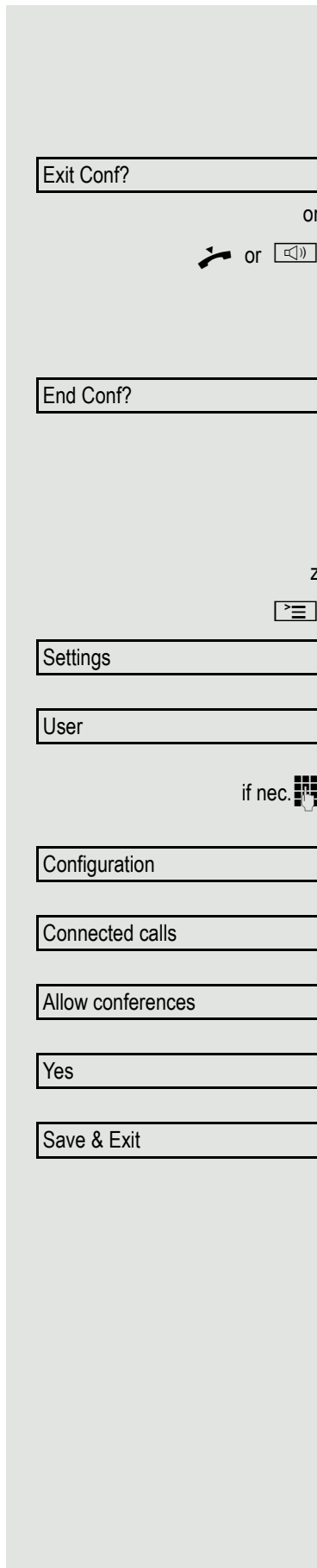

Ending a local conference

Allowing call partners to continue a conference after you exit

Prerequisite: The function "Allow joining in a local conference" (→ Page 106) was activated.

Select and confirm the option shown in the "Conference" context menu.

Lift the handset or press the loudspeaker key. Both call partners remain connected. You are disconnected from the conference call.

Disconnecting a party

Select and confirm any of the connections in the context menu. Both connections are cleared down – the conference is cleared down.

Allowing a local conference

This option allows or blocks the "Conference" function.

You can also configure this setting via the WBM interface → Page 206.

Press the key shown.

Select and confirm the option shown.

Select and confirm the option shown.

Enter and confirm the User password.

Select and confirm the option shown.

Select and confirm the option shown.

Select and confirm the option shown.

Select and confirm the option shown in the context menu.

Select and confirm the option shown.

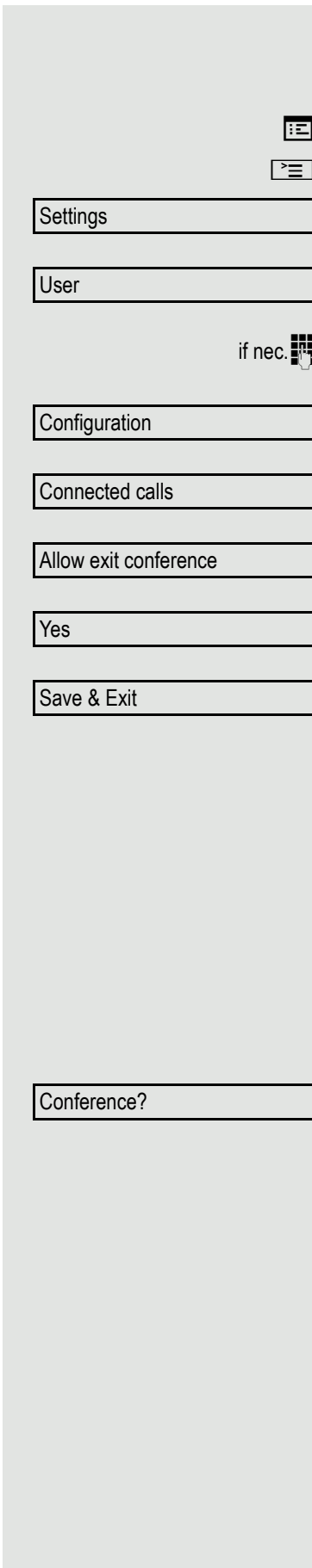

Allowing joining in a local conference

You can use this option to decide whether or not your call partners are allowed to join calls after you exit the conference call.

You can also configure this setting via the WBM interface → Page 206.

Press the key shown.

Select and confirm the option shown.

Select and confirm the option shown.

Enter and confirm the User password.

Select and confirm the option shown.

Select and confirm the option shown.

Select and confirm the option shown.

Select and confirm the option shown in the context menu.

Select and confirm the option shown.

System-based conference

This type of conference is also referred to as a large conference. It can include up to ten parties. It can include from three up to a maximum of 16 parties (depending on the configuration in OpenScape Voice).

Prerequisite: You are conducting a consultation call → Page 52 or you have accepted a second call → Page 91, and the "System conference" feature was configured by your administrator.

Establishing a conference

Select and confirm the option shown in the connection's context menu. You are connected to the first two parties at once. The conference is displayed with the current participants. You can now:

- initiate a consultation call
- add a party
- put the conference on hold
- leave the conference.

Consultation?

Conducting a consultation call

Select and confirm the option shown in the "Conference" context menu. If the party answers, you can:

- toggle between the party and the conference
- connect the consultation call to another called party
- end the consultation call and return to the conference
- add the consultation call party to the conference.

 If you want to add the consultation parties to the conference, use the "Add to conference" option instead of the "Consultation" option.

If you want to use the **phonebook** or a **call list** for a consultation call, select **Hold** instead of Consult (and/or Add to conference) in the context menu or press the **Hold** key and then open the phonebook or a required call list (→ Page 108) or one of the phonebooks (→ Page 108/ → Page 111).

Alternatively you can also open a call list or a phonebook without using the **Hold** functions – the conference is automatically placed on **Hold**.

Conference?

Add party

Prerequisite: You are conducting a consultation call and the conference is on hold.

Select and confirm the option shown in the consultation call's context menu. The party is added to the conference. Only the conference and all current participants are now displayed.

 You can also use an already configured **Conference** key instead of the Conference option in the context menu.

Hold?

Putting the conference on hold

Select and confirm the option shown in the "Conference" context menu. The conference is placed on hold and you can consult with someone in your office, for instance.

Exit Conf?

Leaving a conference

Select and confirm the option shown in the "Conference" context menu. You are disconnected from the conference call and can dial another number, for instance. The other call partners remain connected.

Phonebooks and call lists

Personal directory

The personal phonebook is restricted to 100 entries. If you have configured a sensor key for the local phonebook, you can open it using this sensor key (→ Page 75).

Creating a new contact

You can create contacts more conveniently via the WBM interface → Page 206.

Press the key shown.

Confirm to open the local phonebook.

Select the option shown.

Confirm the option shown in the context menu.

Fill in the three fields

- Last name
- First name
- Number

accordingly.

Select and confirm to save the phonebook entry.

Editing a contact

You can also edit contacts via the WBM interface → Page 206.

Press the key shown.

Confirm to open the local phonebook.

Select the required entry.

Select and confirm the option shown in the context menu.

Select and confirm, for example the Last name field.

Change and confirm .

Select and confirm the option shown.

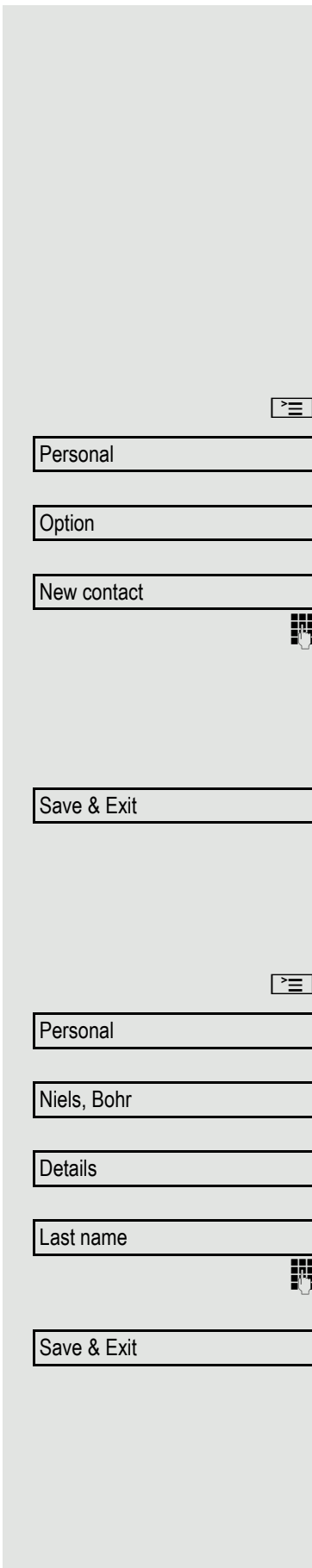

Deleting a contact

You can also delete contacts via the WBM interface → Page 206.

Press the key shown.

Confirm to open the local phonebook.

Select the required entry.

Select and confirm the option shown in the context menu. Then confirm the Delete or cancel the process.

Deleting all contacts

You can also delete the contacts via the WBM interface → Page 206.

Press the key shown.

Confirm to open the local phonebook.

Is displayed

Select and confirm the option shown in the context menu.

Confirm the option shown.

Select and confirm to cancel the process.

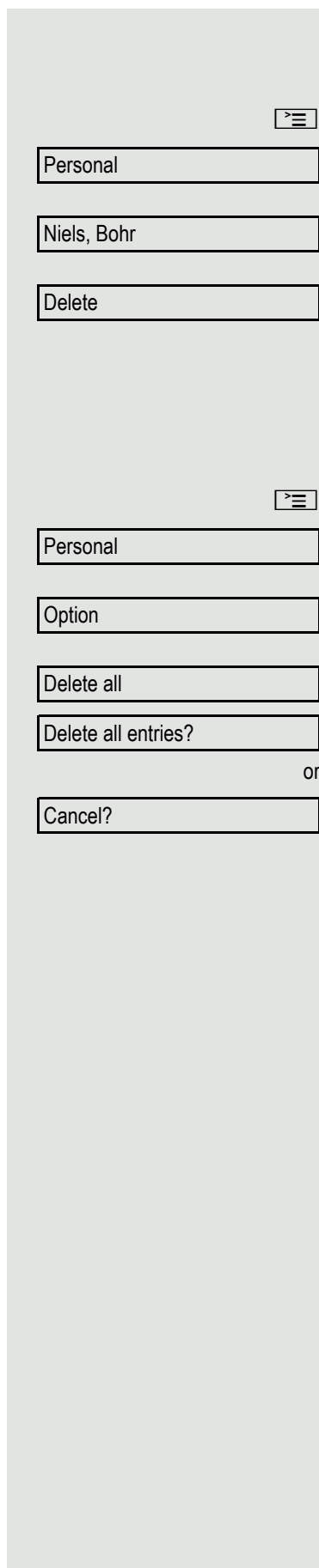

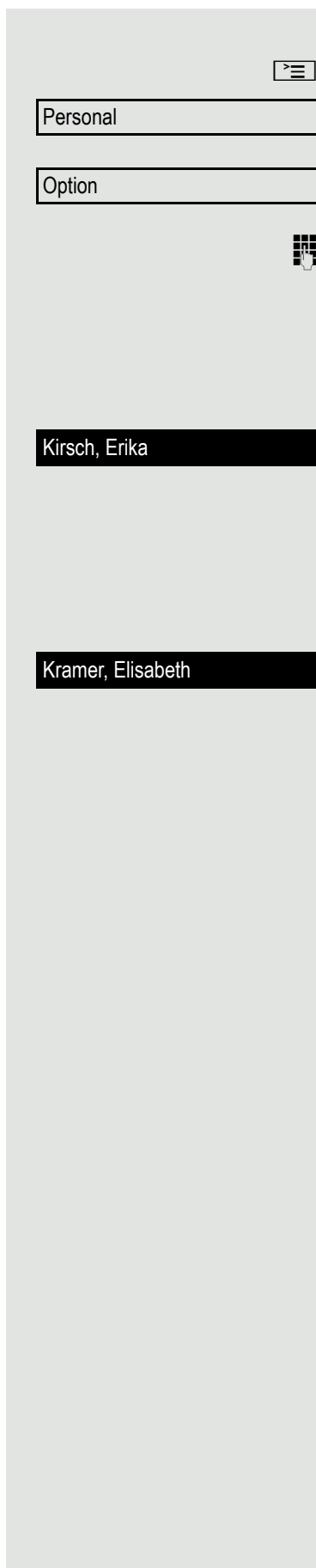

Searching for a contact

Press the key shown.

Confirm to open the local phonebook.

Is displayed

Enter the first letter of the name you are searching, e.g. k.

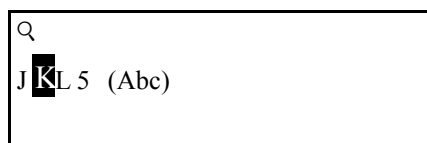

The name first found in which the first letter is K is displayed. If you are looking for a name that begins with Kr, also enter the second letter in the search field:

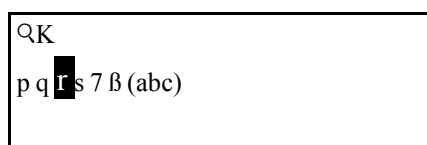

The first name with the initial letters Kr is displayed.

You can also browse the phonebook with the **navigator** until you reach the required station. → Page 19.

Corporate directory

The corporate directory is an LDAP database. It can be accessed via your network if access has been configured correctly by administrator.

You can search for the name (simple search) or for different entry information (advanced search) e. g. search for the job or department name.

Searching for a contact

Press the key shown.

Select and confirm to open the company-wide Phone book "Corporate".

Press the configured "Corporate directory" key for the corporate directory (→ Page 75).

Select and confirm the option shown in the **Options** context menu

Select and confirm the required search field (for example, "Last name").

Enter a search text. If you for example only enter the first letter of the last name, all entries with this initial letter are displayed.

Select and confirm when you have filled out one or more search fields. The search begins. If the entry you searched for is found, you can dial or view the entry details.



Enhanced editing functions in the phonebook

Viewing entries

Prerequisite: You found and selected an entry (see above).

Select and confirm the option shown in the context menu for the entry. All fields of the entry are displayed.

Resetting the search fields

Prerequisite: The search fields are listed.

Select and confirm the option shown in the **Options** context menu. You can now enter the search criteria for the search.

Defining a qualifier before a search

Prior to a search, you can select which qualifiers should also appear in the output list in the **Options** context menu.

Select and confirm the option shown. You may choose between the following criteria:

- No qualifier
- Job function
- Address 1
- Email
- Business 1
- Mobile
- Business 2
- Private
- Company
- Address 2

Select and confirm the desired qualifier.

Exit the list.

Details

Delete

Qualifier



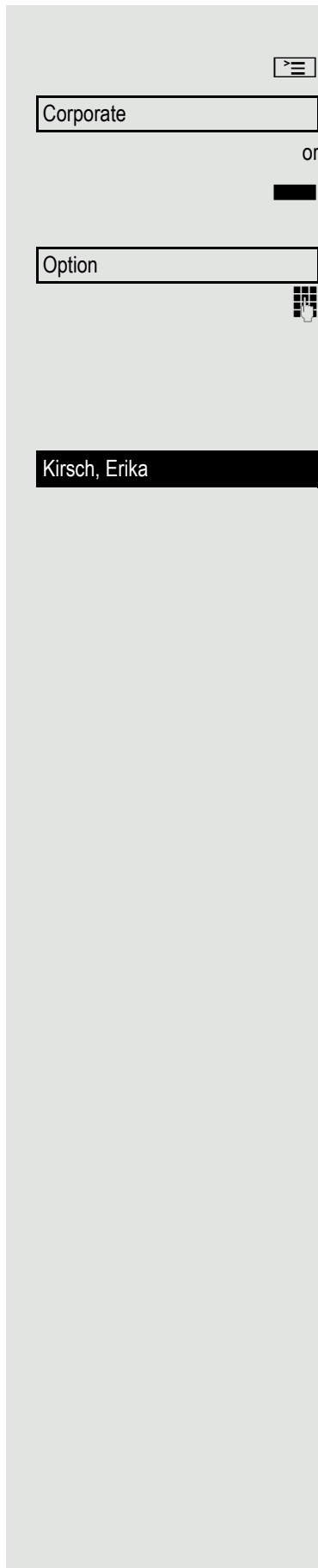

Quick search

Press the key shown.

Select and confirm to open the company-wide Phone book.

Press the configured "Corporate directory" key for the corporate directory (→ Page 75).

Is displayed

Enter the first letter of the name you are looking for, e.g. "k".

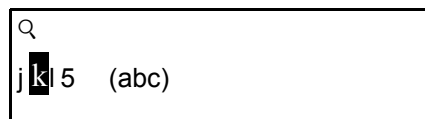

Do not enter any further characters. After a predefined period of time or after pressing the key all available names with the corresponding initial letter are displayed.

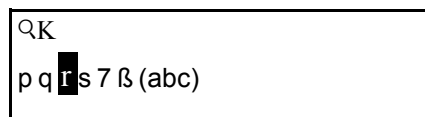

You can restrict the output by entering the second and other letters. The key is used to switch between letters and numbers. The key is used to delete individual characters.

When entering extended characters you can control the search individually. For the selection of extended characters firstly press the key.

Rule list:

Character	Description
#	Searches for the exact string before the extended character
,	You can enter first and last name separately using a comma. A search is carried out for the last name (possibly using a wildcard) and the first name with the first character after the comma.
*	Wildcard. This searches for the character entered and all possible subsequent characters

You enter these characters by selecting the special characters.

Quick search using parts of a search string

If the administrator adds a field to the template for the corporate directory and assigns this field to an existing search field, you can use any strings in a last name, for example, for the search.

To list all entries, for example, in which the string "er" appears in the **Last name** field, enter this character combination when prompted to enter the name. Once the output list is available with entries that match this condition, you can now skip to the first corresponding entry by entering the initial letter of the last name.

Please consult your administrator to establish whether an additional field has been added to the template for the corporate directory and which search field it has been assigned to. Note that a traditional quick search will return unintended results in this case.

Call lists

For a detailed description of the different call lists, see → Page 33. The function must be activated in order to view and manage call lists → Page 115, otherwise the menu option "Calls" is not offered.

Editing entries

Selecting an entry

Press the key shown.

Select and confirm the option shown.

For instance, select and confirm the list of missed calls → Page 59).

The list is sorted chronologically, with the most recent caller first. You can use the **navigator** to scroll through the list.

Select the list entry.

Displaying details

Select and confirm the option shown in the context menu. The phone number, date and time are displayed (→ Page 33).

Delete the entry

Select and confirm the option shown in the context menu. The entry is deleted.

Delete all entries

Press the key shown.

Select and confirm the option shown.

For instance, select and confirm the list of dialled numbers.

Select the option shown.

Select and confirm the option shown in the context menu. All entries in the list displayed are deleted.

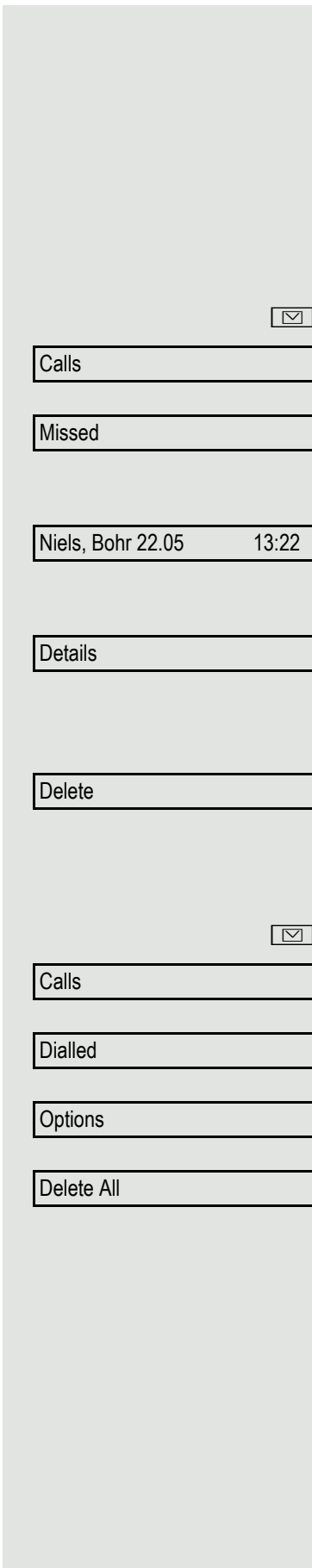

Call logging

Activating/deactivating the call journal

The function can be disabled in order to prevent unauthorised third parties gaining information on the other party involved in the call from the call lists. No further calls or conversations are then logged. The function is always activated by default.

 When you deactivate the call journal, please note that the customary last number redial function will also be affected by this. You can then no longer redial the last number dialled → Page 51.

You can also configure this setting via the WBM interface → Page 206.

Press the key shown.

Select and confirm the option shown.

Select and confirm the option shown.

Enter and confirm the User password.

Select and confirm the option shown.

Select and confirm the option shown.

Select and confirm the option shown.

Select

In the context menu select and confirm to deactivate the call journal. The message "Call Log is disabled" is shown on the display.

In the context menu select and confirm to reactivate the call journal.

Select and confirm the option shown.

 If the function is deactivated, all existing entries in the journal as well as messages for available missed calls on the display and via LEDs are deleted.

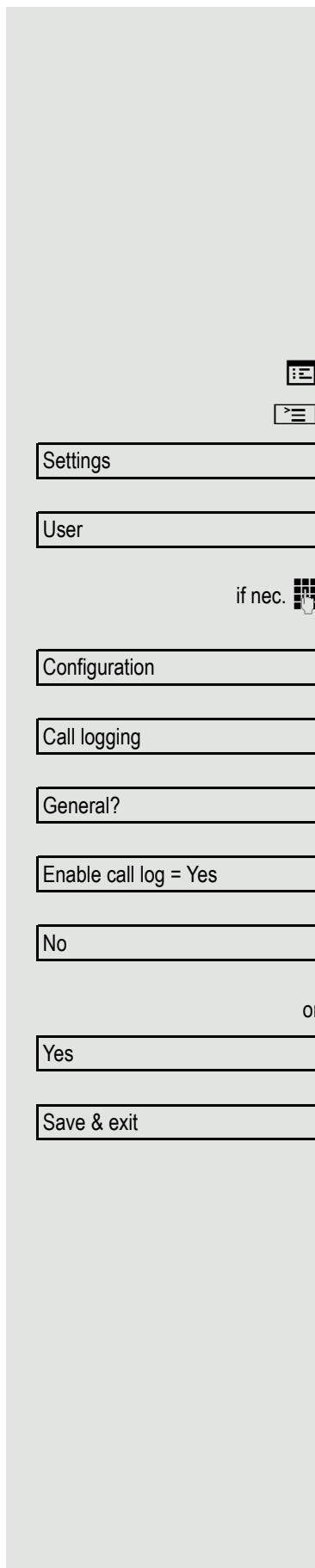

Logging missed calls

Two options are available to you for this function:

- Answered elsewhere
- Delete entry

All missed called intended for this line are logged and new missed calls are displayed. If the "Exclude" option is selected for "Answered elsewhere", missed calls for this line that were answered either by other subscribers in the group or with "Directed pickup" are neither displayed nor logged (see also → Page 44). The "Exclude" setting is recommended if groups are set up.

With the default setting "Delete manually" for "Delete entry", you can delete specific missed calls you called back yourself. If you select the option "Delete when called" instead, these calls will be deleted automatically.

You can also configure this setting via the WBM interface → Page 206.

Press the key shown.

Select and confirm the option shown.

Select and confirm the option shown.

Enter and confirm the User password.

Select and confirm the option shown.

Select and confirm the option shown.

Select the option shown.

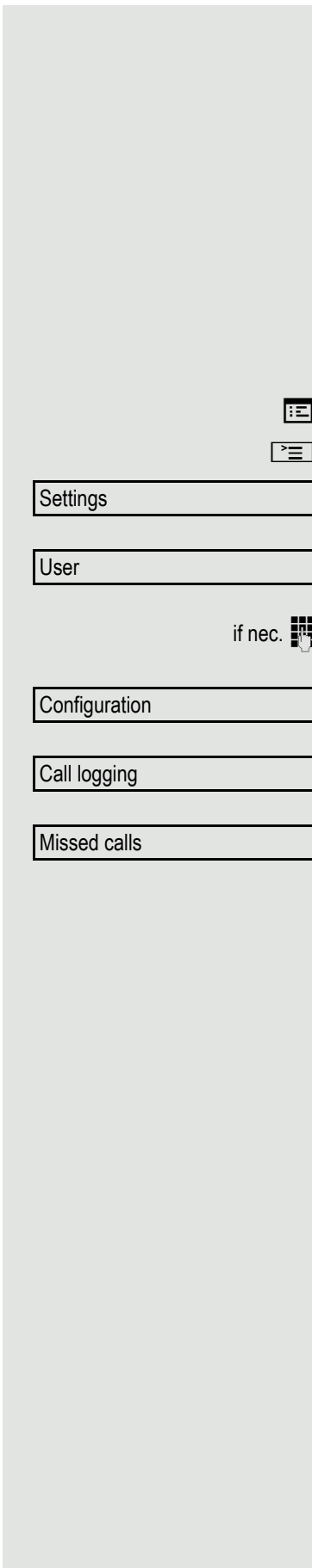

Answered elsewhere = Include

Exclude?

Save & exit

or

Delete entry = Delete when

Delete manually?

Save & exit

Displaying missed calls that were answered elsewhere

Missed calls that have been answered by other subscribers are indicated with a checkmark.

Select the option shown.

Select and confirm the option shown in the context menu to prevent calls answered by other subscribers being displayed in the list.

Select and confirm the option shown.

Deleting missed calls when called

Select "Delete when called".

Select and confirm the option shown in the context menu to delete entries manually when called.

Select and confirm the option shown.

Making calls with multiple lines

You can use your OpenStage 40 as a multi-line phone. If you have any questions regarding how to configure your OpenStage phone as a multi-line phone, please contact your administrator.

The following is a description of the telephony scenarios for multi-line phones. To facilitate comprehension, you should familiarise yourself with the enhanced telephony application and how to use the line keys beforehand. Furthermore, you can specify individual settings for your multi-line telephone. Refer to the following sections for a detailed description of the individual components:

- Introduction to multi-line phones → Page 13
- Lines and line keys → Page 21
- Multi-line telephony interface → Page 28
- Individual settings → Page 133

Incoming calls

Depending on your individual settings, you will be notified of incoming calls → Page 182.

Accepting calls for the primary line

In this case, the telephone behaves in the same way as a single-line telephone. See → Page 38 and → Page 82.

Accepting calls for secondary lines

Prerequisite: The secondary line is configured on your multi-line telephone.

Using the handset

Lift the handset.

Conduct call.



The line used for the ringtone is selected automatically. If there are calls on several lines, you are connected with the line that has been ringing the longest.

Using the line keys

Press the flashing line key.

Speakerphone mode.

Select and confirm the option shown.

Speakerphone mode.



Accept

Making calls

You must seize a line before you can make calls on a multi-line telephone.

Trunk seizure can be configured on an individual basis. Your administrator can determine if the lines on your telephone can be automatically seized and with which priority.

 If you have seized a secondary line, this line is reserved for you for making calls for a specific period as defined by the administrator. No other user can seize this line during this period, even if the line is also assigned to this user's telephone.

Manual trunk seizure

Lift the handset or press the speakerphone mode or headset key.

Press the required line key.

Press the key shown to open the **Overview** tab → Page 28.

Select and confirm the required line (e.g. line 2). The selected line is displayed on the screen.

Enter the phone number or use redial, for example. The connection is set up.

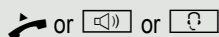

or



Line 2



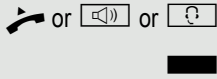
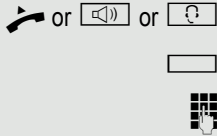

Redial {1} 12345

Automatic trunk seizure

Prerequisite: Your administrator has configured automatic trunk seizure.

Lift the handset or press the speakerphone mode or headset key.

The line defined during configuration is seized.

Enter the station number. The connection is set up.

Dialling the last dialled number

Regardless of the line used, the last number dialled on your telephone is displayed for redialling in the selected number's context menu.

Lift the handset or press the speakerphone mode or headset key.

Press the required line key (→ Page 119).

In the pop-up menu:

Confirm¹. The connection is set up.

Forwarding calls on primary line

The call forwarding can only be activated for the primary line. Which call forwards are possible, how they are configured and activated can be found from → Page 60.

Call forwarding information

Prerequisite: Your administrator has activated "Forwarding shown".

If you have activated one of the forwarding types on your phone for the primary line and a station calls, a popup window with the following information opens:

- Who is calling
- The forwarding destination.

1. Please note the information in relation to the call journal on → Page 51

During calls

Making and receiving calls on a single line

If you only use one line on your multi-line telephone to make calls, and you receive calls on the same line, the phone operates in the same way as a single-line telephone:

- Redial → Page 51
- Consultation → Page 52
- Alternate → Page 54
- Callback → Page 57
- Hold → Page 86
- Call waiting (second call) → Page 91
- Transferring a call → Page 95
- Conference → Page 104

Functions available exclusively for the primary line:

- Call lists → Page 33
- Voicemail → Page 32
- Call forwarding → Page 60
- Do not disturb → Page 140

 Depending on your individual settings, you will be notified of incoming calls → Page 138.

Making and receiving calls with multiple lines

Accepting a waiting call

 Depending on the settings for "Rollover", you will be notified of incoming calls → Page 138.

Prerequisite: You are conducting a call. At the same time, a call is incoming on another line.

Call on line 1.

Press the line key for line 2. The call on line 1 is placed on hold.

 All multi-line users that share the line on which the call is being held (→ Page 21) can now pick up the held call. To prevent other users from answering the held call, you must place the call on "Consultation" hold → Page 52.

Depending on the setting made by your administrator, you may have to press the trunk key twice to accept the call on the other line. The first call is either placed on hold or released depending on the setting.

Conduct call on line 2.

End call on line 2.

Press line key for line 1.

Retrieve call on line 1.



Putting a line on hold

On a multiline telephone you can use the line keys to place calls on hold.

Prerequisite: You are conducting a call.

Press the call-line sensor key.

- The LED line key flashes.
- The LED line displays the hold status on all multi-line phones to which the line is connected.
- On phones connected to the line, a user can press the relevant line key and accept the held call.

During a consultation call or after accepting a waiting call the hold function cannot be used.



Lines with hot or warm line function

Your administrator can configure a hot or warm line for the primary and secondary line.

The function is activated when on

- The Primary line
you pick up the phone's handset or press the line or loudspeaker key
- the Secondary line
you press the line key.

A number specified by you is dialled with a hot line immediately and with a warm line after a specific time.

Examples:

- The phone in the lift immediately dials the reception number.
- The phone at a patient's bed dials the ward number e.g. after a minute if no other number is dialled.

Entering a number for the hot and warm line function

Specify which number should be dialled when the hot or warm line function is activated.

You can also configure this setting via the WBM interface → Page 206.

Press the key shown.

Select and confirm the option shown.

Select and confirm the option shown.

Enter and confirm the User password.

Select and confirm the option shown.

Select and confirm the option shown.

Select and confirm the option shown.

Select and confirm the required line in the context menu.

Select and confirm the option shown.

Enter and confirm the destination.

Select and confirm the option shown.

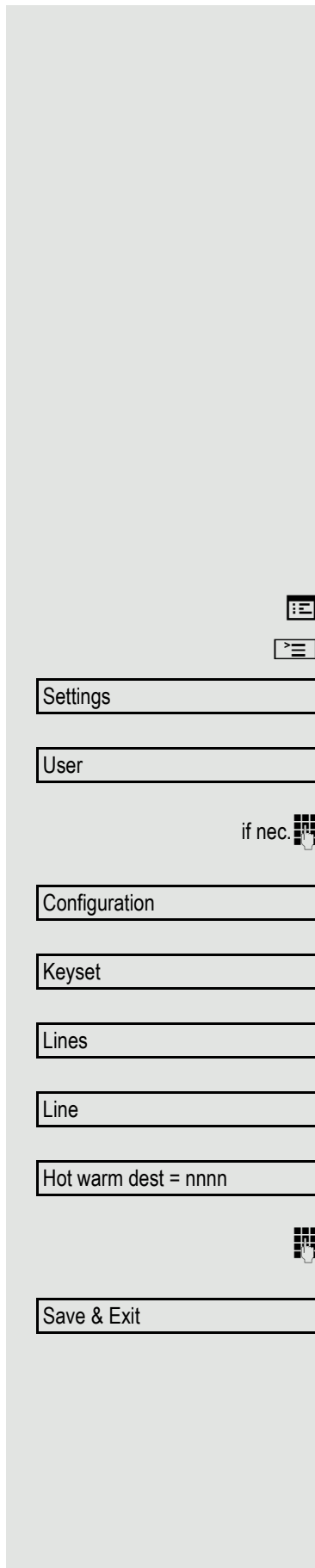

Busy override

A station of a line trunk group is on a call. Its primary line is configured as a secondary line on your phone. This line now has the status "busy." You can connect to the call by pressing the illuminated key for this line (see also → Page 21).

Prerequisite: A secondary line is set up on your multi-line phone, the option to connect to the call is activated for your phone and "system-based conference" is set up for your system (→ Page 106).

If a preview is set up and activated for the relevant line (→ Page 137), you have to press the line key a second time following the preview in order to connect.

The key of a secondary line illuminates – it is busy. You want to connect to the call.

Press the illuminated line key. A conference is established. You are connected to the parties on the secondary line. The key continues to illuminate and the conference is shown on the display.



If there is already a conference on the secondary line you are connected to this conference. The conference is shown on the display.

You can now:

- Put the secondary line on hold
- Leave the conference on the secondary line
- Make consultation call
- Accept a second call
- Alternate between a new call party and a conference on the secondary line.
- Include a call party from a consultation or a second call in the conference.

Direct station selection keys

Apart from line keys, administrator can also configure direct station selection (DSS) keys. You can use a DSS key to call an internal station directly, pick up calls for this station or forward calls directly to it.

Calling a station directly

You cannot use DSS if the user is on another call (flashing LED).

Calling from the idle menu

Press the relevant DSS key.

Press the key shown to open the **Overview** tab → Page 28.

Select and confirm the DSS line. The key lights up and a connection is established.

 Administrator can configure the DSS key so that the connection is also established when the DSS station has activated do-not-disturb or call forwarding.

Consultation with the DSS station

Prerequisite: You are conducting a call and administrator has configured the DSS key for consultation.

Press the relevant DSS key for the consultation. The key lights up and a connection is established. If the station answers, you can toggle, transfer the first call or initiate a conference.

 If administrator has configured transfer instead of consultation, you can only transfer the current call to the DSS station.

DSS call 1

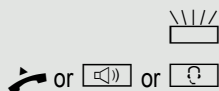

Call pickup

You can pick up calls for another DSS station. If a call is waiting on their line, the LED flashes.

Indirect pickup

Prerequisite: The auto-answer function must be deactivated → Page 97.

Press the DSS key. The call is routed to your primary line and rings.

Lift the handset or press the speakerphone mode or headset key. You are connected with the other party.

Rejecting a call

Prerequisite: Administrator must activate the reject option for DSS keys and auto-answer must be deactivated → Page 97.

Press the DSS key. The call is routed to your primary line and rings.

Select and confirm the option shown in the pop-up menu.
The caller hears a busy signal.

Direct pickup

Prerequisite: The auto-answer function must be activated → Page 97.

Press the DSS key. The call is routed to your primary line and you are immediately connected with the other party via speakerphone.

Deflecting a call to a DSS station

Prerequisite: The deflect function must be approved for DSS keys. For information on the current setting, see → Page 83.

If you receive a call on one of your lines, you can immediately deflect it to the DSS station.





Your phone rings and a line key flashes.



Press the relevant DSS key. The call is deflected to the DSS station. If the DSS station does not answer, you can pick up the call by pressing the DSS key.

LED display on DSS keys

DSS Key	Explanation
	Off: The line is in idle mode.
	Flashes: You can accept a call for the DSS station via the key. The call is routed to your primary line when the call is accepted.
	Illuminates: The line is busy. Provided that second call is activated you can still reach the DSS station via the key. It can accept your call as a second call.

Making calls in an executive-secretary team

An executive-secretary team is configured by the relevant administrator and may include up to four executive and up to two secretary telephones.

Sample scenarios

This example assumes that two executive and two secretary phones are configured. Calls for the executives are forwarded immediately to the respective secretary phone. A secretary then connects the call with or without consultation to the responsible executive using the direct station selection key.

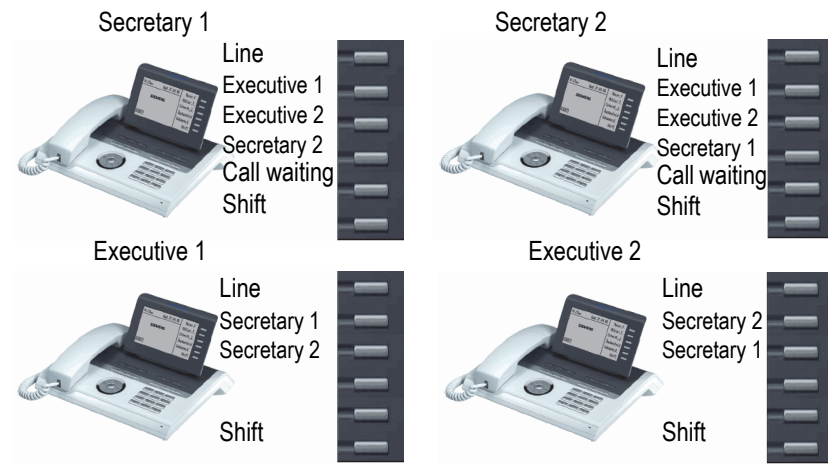

Prerequisites:

The following call forwards are configured (→ Page 60):

- For All calls from Executive 1 to Secretary 1
- For All calls from Executive 2 to Secretary 2
- Forward on Busy and forward on No reply from Secretary 1 to Secretary 2
- Forward on Busy and forward on No reply from Secretary 2 to Secretary 1

"Allow call waiting" should be activated on the secretaries' phones (→ Page 93). This function can optionally be activated and deactivated using a key if a key has been configured for it.

Line and direct station selection keys have been configured by administrator and "Transfer on hangup" and server features have been activated.

Accepting a call

Incoming calls for the executives should be forwarded immediately to the assigned secretary and answered there. The line overview (→ Page 132) shows whether the executive has activated call forwarding.

Accepting calls at the secretary phone

An incoming call for "Executive 1" rings at the assigned "Secretary 1".

The line key of the "Secretary 1" phone flashes.



The "Secretary 1" direct station selection key on the "Executive 1" phone also flashes.



Press the line key to answer the call. The station answers. The line key flashes **rapidly**.



The "Secretary 1" direct station selection key on the "Executive 1" phone illuminates.

Early call pickup by Executive 1

An incoming call for "Executive 1" rings on "Secretary 1". The "Secretary 1" direct station selection key on the "Executive 1" phone flashes. The "Secretary 1" has not yet answered the call. Before the call is forwarded to "Secretary 2", "Executive 1" picks up the call early.



Press the "Secretary 1" direct station selection key on the "Executive 1" key to answer the call.



If for example a call for "Executive 2" on "Secretary 2" is not answered, "Secretary 1" or "Executive 1" can pick up the call early



Forward to Secretary 2

An incoming call for "Executive 1" rings at the assigned "Secretary 1" . The call is **not** answered. After a specified period the call is forwarded to "Secretary 2". The line key of the "Secretary 2" flashes and it rings.

Press the line key on the "Secretary 2" phone to answer the call. The station answers. The "Secretary 2" direct station selection key on the "Executive 1" phone illuminates.



If "Secretary 1" is busy, the call is forwarded immediately to "Secretary 2" if:

- a consultation call is being made or
 - "Allow call waiting" is deactivated.
-

Second call

If "Secretary 1" receives a second call, this can be accepted, ignored, forwarded or rejected. Detailed information on this can be found from → Page 91.

If the second call is ignored, it is forwarded to "Secretary 2" after a certain period of time.

If the second call was answered, it can be forwarded using consultation or the direct station selection keys.

Connecting a call

If e. g. the "Secretary 1" answered a call, it can forward the call using the direct station selection keys to the following telephones:

- Executive 1
- Executive 2
- Secretary 2.

The following examples show connections to "Executive 1".

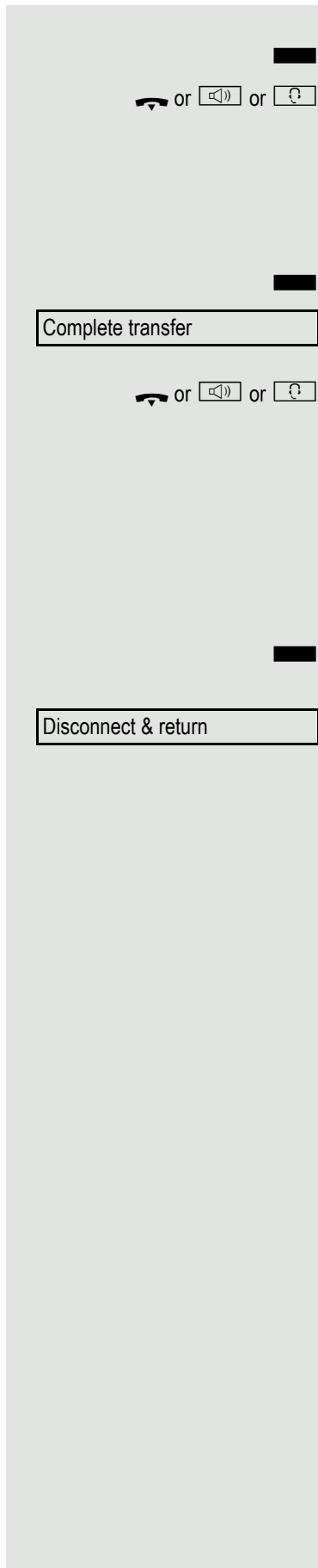

Connecting with consultation

Press the DSS "Executive 1" key. "Executive 1" answers. Announce the call.
 Press the hang-up, loudspeaker or headset key.

 You can also select "Complete Xfer" from the context menu.

Connecting without consultation

Press the DSS "Executive 1" key. "Executive 1" does not answer.
 Select and confirm the option shown in the pop-up menu.

Press the hang-up, loudspeaker or headset key. The "Executive 1" phone rings.
 If "Executive 1" does not answer the call, a callback (see also → Page 95) will ensue after a configured time.

 The "Executive 1" direct station selection key on the "Secretary 1" phone illuminates.

Consultation without connecting

Press the DSS "Executive 1" key. "Executive 1" answers. Transferring is not wanted. The "Secretary 1" takes the call back

Select and confirm the option shown in the pop-up menu. The "Secretary 1" is reconnected with the caller.

Toggle, disconnect or conference

During a consultation call "Secretary 1" can toggle between "Executive 1" and the caller, can initiate a conference or disconnect one of the two call parties. More on this subject can be found on pages → Page 54 and → Page 104.



DSS keys can be used

These keys are configured in such a way that every phone can be reached by every phone in the group. The DSS keys are also used for consultation calls.

Press a team member's DSS key. The relevant phone rings and the party answers.

Using line overview

To view the status of the lines, change from the "My phone" tab to the "Overview" tab on the phone screen using the  key.

Overview	Line
Line Bohr, Niels	Executive 1
 DSS:Executive 2 Line busy	Executive 2
 DSS:Secretary 20123456	Secretary 2
DSS:Executive 1 Line forward-	Shift key

Further information on the line status can be found on → Page 28.

The "executive-secretary" team can be expanded with line keys by the administrator. These lines keys however have no influence on the behavior of the "executive-secretary" configuration.

Settings for MultiLine (keyset)

The details for each keyset line contain supplementary information for the user. The following uneditable fields are displayed:

- Address
 - Displays the phone number for the line
- Ringtone on/off
 - Shows whether the ringer is activated for this line
- Selection sequence
 - Displays the priority of each line seizure when the handset is lifted or the loudspeaker key for this line is pressed

Displaying the line in the "Overview" tab

Specify here if the selected line should be displayed in the "Overview" tab.

You can also configure this setting via the WBM interface → Page 206.

Press the key shown.

Select and confirm the option shown.

Select and confirm the option shown.

Enter and confirm the User password.

Select and confirm the option shown.

Select and confirm the option shown.

Select and confirm the option shown.

Select and confirm the required line (for example, line 1).

Select and confirm the option shown.

Select and confirm the option shown in the context menu.

Select and confirm the option shown.

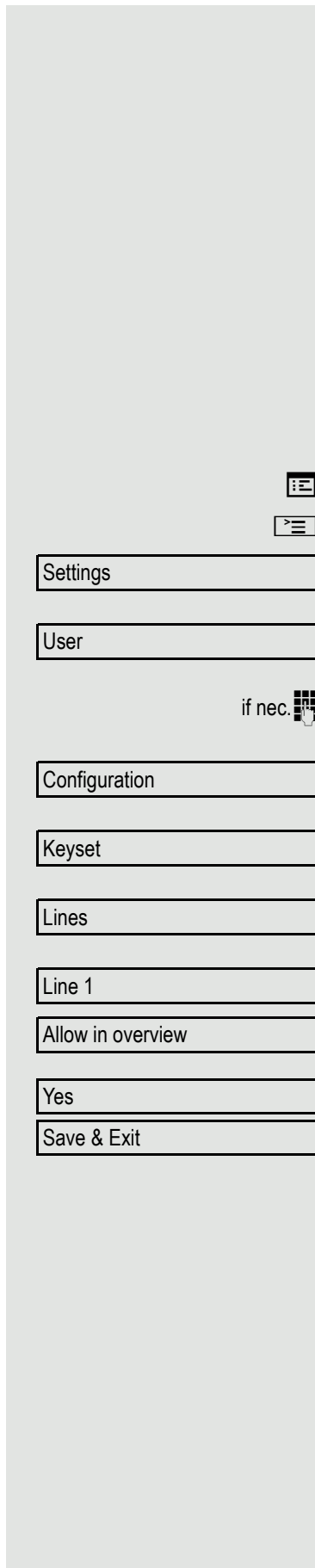

Setting the time for a delayed ringer

Specify the length of time before a held call should be signalled on a line.

You can also configure this setting via the WBM interface → Page 206.

Press the key shown.

Select and confirm the option shown.

Select and confirm the option shown.

Enter and confirm the User password.

Select and confirm the option shown.

Select and confirm the option shown.

Select and confirm the option shown.

Select and confirm the required line (for example, line 1).

Select and confirm the option shown.

Enter and confirm a delay value.

Select and confirm the option shown.

You can activate and deactivate the set delay time for all line keys using a function key → Page 80.

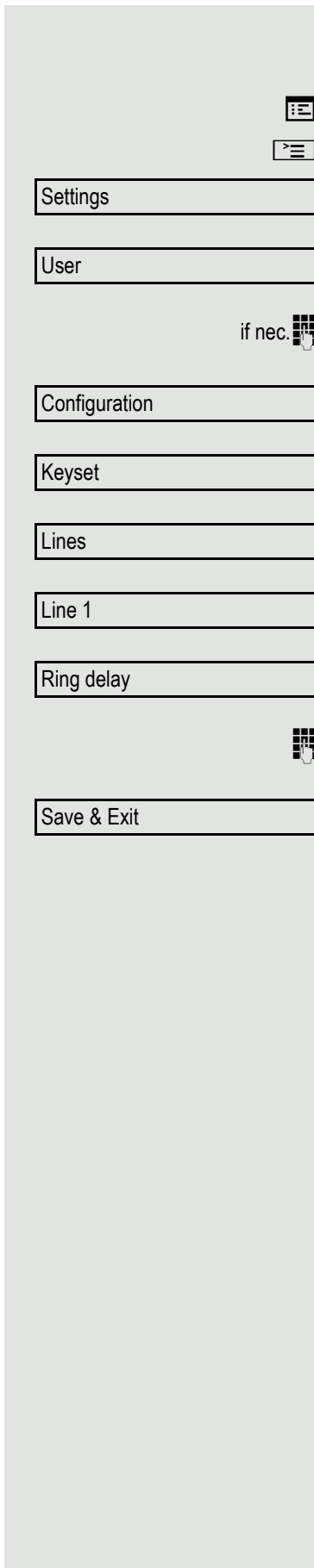

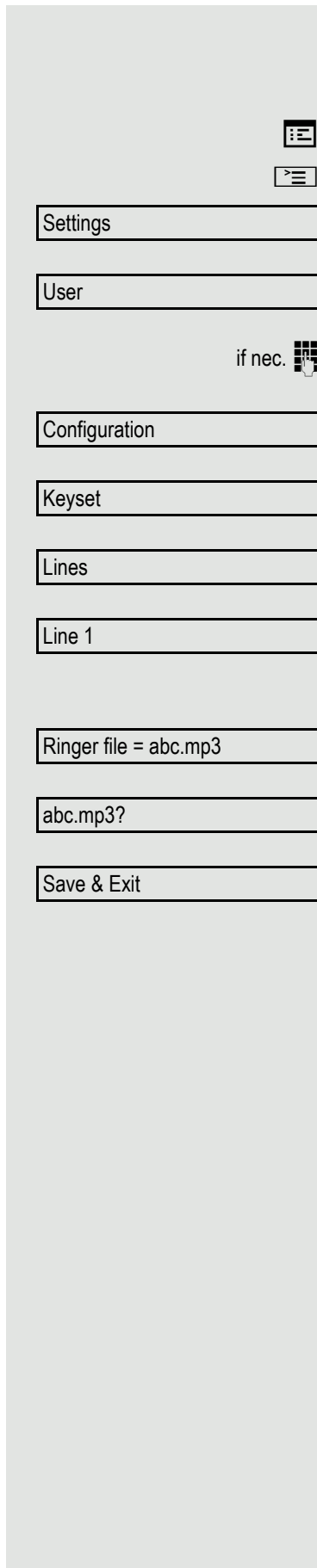

Setting the ringtone for lines

If special ringtones have been configured by administrator for lines, you can adjust these here to suit your requirements.

You can also configure this setting via the WBM interface → Page 206.

Press the key shown.

Select and confirm the option shown.

Select and confirm the option shown.

Enter and confirm the User password.

Select and confirm the option shown.

Select and confirm the option shown.

Select and confirm the option shown.

Select and confirm the required line (for example, line 1).

Selecting the ringer

Select the option shown.

Select the ringtone file^[1] or pattern you want in the context menu. You will immediately hear the associated ringer melody. Confirm the current ringtone file.

Select and confirm the option shown.

1. The phone displays the current setting.

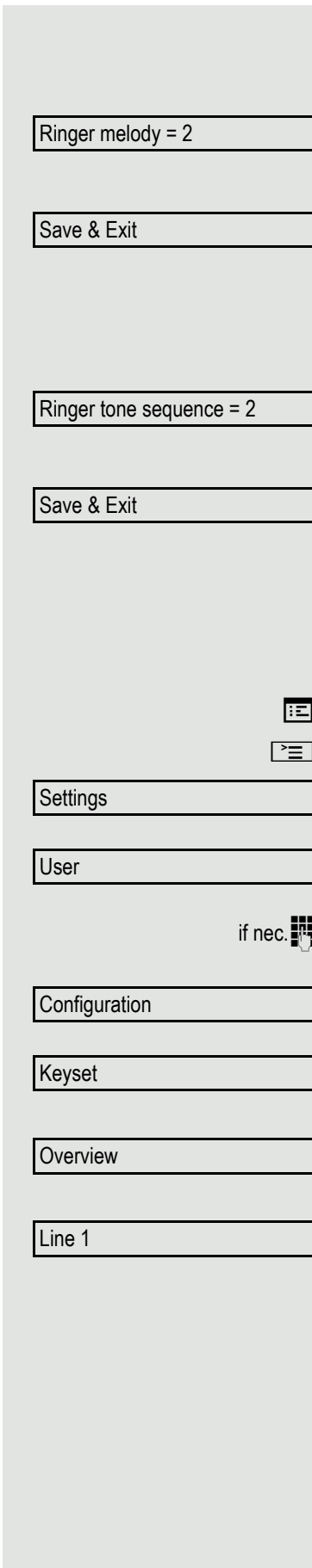

Selecting the pattern melody

The following setting is only effective if you selected "Pattern" under the ringer option.

Select the required pattern melody¹ between 1 and 8 in the context menu (e.g. **4**). You will immediately hear the corresponding Ringer melody. Confirm the selected Ringer melody.

Select and confirm the option shown.

Selecting the pattern sequence

The following setting is only effective if you selected "Pattern" under the ringer option.

Select the required Ringer tone sequence in the context menu between 1 and 6 (e.g. **2**). You will immediately hear the set Ringer melody with the selected Ringer tone sequence. Confirm the selected setting.

Select and confirm the option shown.

Configuring the "Overview" tab display

Specify here the sequence in which the individual lines in the "Overview" tab should appear on the display.

You can also configure this setting via the WBM interface → Page 206.

Press the key shown.

Select and confirm the option shown.

Select and confirm the option shown.

Enter and confirm the User password.

Select and confirm the option shown.

Select and confirm the option shown.

Select and confirm the option shown.

All lines that are displayed in the overview are listed.

Select and confirm the required line (for example, line 1).

1. The phone displays the current setting

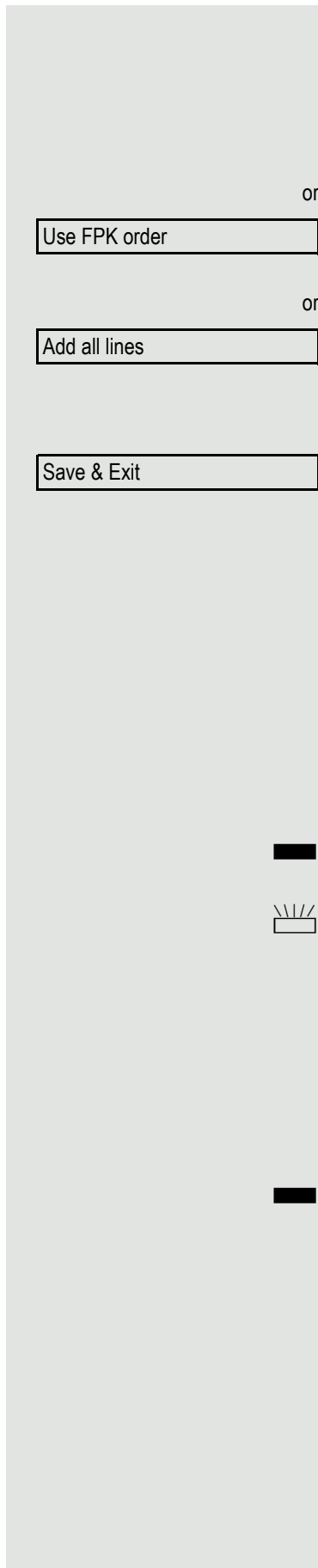

Select one of the following options from the context menu to move an individual line:

- Move up
- Move down
- Move to top
- Move to bottom

Use FPK order

Select and confirm the option shown to arrange the lines in the same sequence as the line keys

Add all lines

Select and confirm the option shown to display all line keys in the overview.

 The setting made for "Allow in overview" (→ Page 133) is disregarded here.

Save & Exit

Select and confirm the option shown.

Line preview

Prerequisite: You are already on a call on one line and a further call rings on a secondary line. You have programmed a sensor key with the "Preview" function → Page 75.

Preview for a call

Prerequisite: Your administrator has deactivated the permanent preview function.

Press the "Preview" sensor key. The key illuminates. The preview function is temporarily activated.

Press the flashing line key. A popup window opens and you receive information about the caller. Press the line key again to accept the call or wait until the popup closes itself after a specified period of time.

The preview function is switched off and has to be switched on again for a further operation.

Permanent preview

Prerequisite: Your administrator has activated the permanent preview function.

Press the "Preview" sensor key. This way the preview for all lines with "preview mode" remains active until you press the "Preview" sensor key again.

 If the line preview has been deactivated, a call is answered immediately on a line when the line key is pressed, without first showing caller information.

Rollover for a line

Your administrator can determine how rollover calls are to be signalled.

Only the relevant line key blinks.



or



You hear a **special advisory tone** via the currently active microphone and the corresponding line key blinks.

or



The **ringer melody set sounds briefly** (approx. 3 seconds) via the loudspeaker and the corresponding line key blinks.

or



You hear a short **notification tone**



The ringer melody is not played in speakerphone mode.



The telephone rings using the configured call signal, the corresponding line key blinks, and a pop-up menu containing the available information is displayed.

Privacy/security

Activating and deactivating the ringer

Activating and deactivating the ringer permanently or setting to beep

If you do not want to be disturbed by the phone ringing for an incoming call, you can deactivate the ringer permanently or set it so that you are only advised of a call by a beep every 25 seconds. You can also configure the settings while the phone is ringing.



Hold down the key (approx. 2 seconds) until the "Ringer off" icon appears on the status bar on the display (→ Page 24).

The ringtone is deactivated.



To switch the function off again, hold down the key until the "Ringer off" icon disappears from the status bar on the display.

You can also switch the function on and off using the option in the idle menu.

Select and confirm the option shown.

Ringer off?

Setting the ringer to a beep



Hold down the key (approx. 3 seconds) until the "Beep" icon appears on the status bar on the display (→ Page 24). You will hear a short beep every 25 seconds for as long as the caller stays on the line.



To switch the function off again, hold down the key until the "Beep" icon disappears from the status bar on the display.

or

Deactivating the ringtone via sensor key

Prerequisite: The "Ringer off" sensor key must be programmed (→ Page 75).



Press the "Ringer off" sensor key

An incoming call is signalled by a single ringtone burst.



Press the illuminated sensor key once more to deactivate the "Ringer off" function. The beep cannot be set using the sensor key.

Deactivating the ringer temporarily for incoming calls and reactivating it

If you are disturbed on an important call by the phone ringing, for example, you can deactivate the ringer temporarily and then activate it again.



Press the key briefly. The ringer is deactivated.



Now press the key again briefly. The ringer is reactivated.

Do not disturb

If "Do not disturb" is activated, your telephone will not ring. The caller hears the busy tone or an announcement that the called party cannot accept any calls at the moment.

The "Do not disturb" feature can be enabled or disabled by means of a specially programmed sensor key or also from the idle menu.



On multi-line telephones (→ Page 13) you can only activate the "Do not disturb" function for your primary line.

Prerequisite: A programmable key is assigned the function "Do not Disturb" (see → Page 75). "Do not disturb" must be activated (→ Page 141).

Enabling do not disturb via a key



Press the "Do not disturb" programmable key.



Press the lit programmable key once more to deactivate the "Do not disturb" function.



You can also use the programmable key to activate the "Do not disturb" function during a call or deactivate it when an incoming call is being signalled.

or

Enabling do not disturb via the idle menu

Do not disturb on

Select and confirm the option shown in the idle menu. The "Do not disturb" icon appears in the header.

or

Do not disturb off

Select and confirm the option shown in the idle menu. The "Do not disturb" icon is deleted.

Allowing "Do not disturb"

You can also configure this setting via the WBM interface → Page 206.

Press the key shown.

Select and confirm the option shown.

Select and confirm the option shown.

if nec.  Enter and confirm the User password.

Select and confirm the option shown.

Select and confirm the option shown.

Select and confirm the option shown.

Select and confirm the option shown.

Select and confirm the option shown.

Select and confirm the option shown.

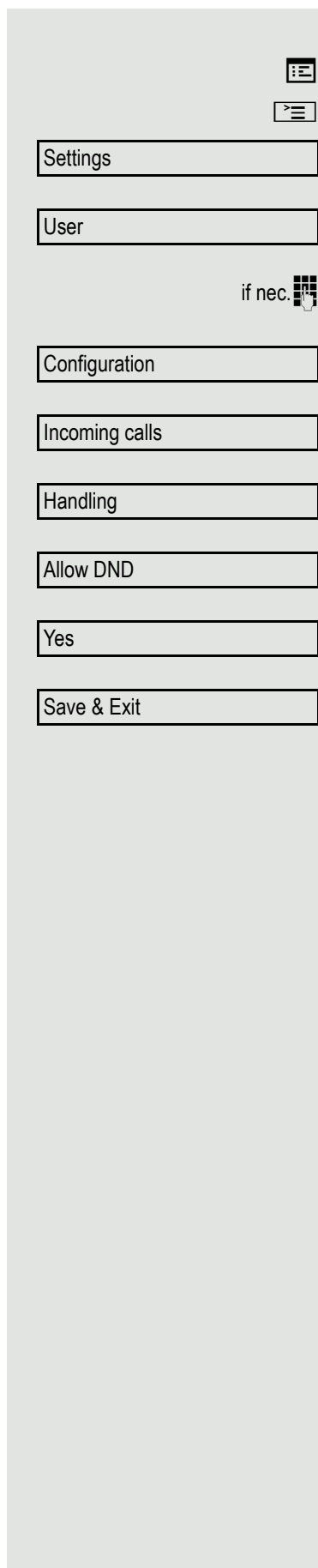

Security

User password

Your User password protects your individual configurations, including your language settings. You can also use the User password to lock your telephone → Page 145.

The administrator may have configured the following settings:

- The password is deactivated: You do not have the option of configuring user settings. The message "Password is disabled" is displayed.
- The password is temporarily blocked: You do not have the option of configuring user settings at this time. The message "Password.suspended" is displayed.
- After initialising logging onto a user area, you may have to replace the default password with a new password.
- A password can have a predefined period of validity: You will have to create a new password when the period ends. The message "Change Password ({1} days left)" will alert you to this at the appropriate time. The message "Password has expired" appears when the validity period is over. Confirm "Change password" and change the password as described in this section.
- If you repeatedly enter the wrong password (2 to 5 times), additional attempts are blocked. You can make another attempt after a predefined time.
- It is possible that you will not be able to re-use a previously used password for a long time, so you will have to create another "new password".
- Your administrator can tell you about the rules for what and how many characters can or must be used in the password.



The preset password "000000" corresponds to a blank password. In other words, the phone cannot be locked and the user menu is **not** password protected (see also → Page 144).

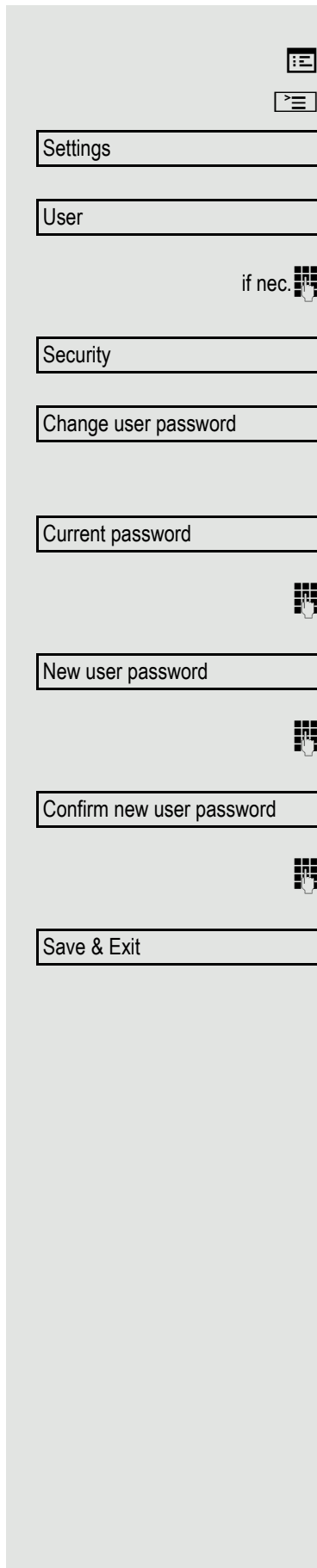

Change user password

You can also change the user password via the WBM interface → Page 206.

Press the key shown.

Select and confirm the option shown.

Select and confirm the option shown.

if nec.  Change and confirm User password.

Select and confirm the option shown.

Select and confirm the option shown.

Select and confirm the option shown.

 Enter the current password (at least six characters, text entry, see → Page 23) and confirm your entry.

Select and confirm the option shown.

 Enter a new password (at least six characters, text entry, see → Page 23) and confirm your entry.

Select and confirm the option shown.

 Enter and confirm the new password once more.

Select and confirm the option shown.

Deactivate user password

You can deactivate the phone's password prompt if a password has already been configured.

 The deactivation of the password prompt does not affect the WBM interface → Page 206 or CTI applications that use a password prompt. As long as the user password is deactivated, you do not have access to user settings via the WBM interface.

If you deactivate the user password, you are **not** able to lock the phone → Page 145 and the user menu is **not** password-protected.

Press the key shown.

Select and confirm the option shown.

Select and confirm the option shown.

Change and confirm User password.

Select and confirm the option shown.

Select and confirm the option shown.

Select and confirm the option shown.

Enter the current password (at least six characters, text entry, see → Page 23) and confirm your entry.

Select and confirm the option shown.

Enter six zeros ("000000") to deactivate the password. Confirm entry (at least 6 characters, (text entry, see → Page 23).

Select and confirm the option shown.

Enter six zeros ("000000") and confirm.

Select and confirm the option shown.

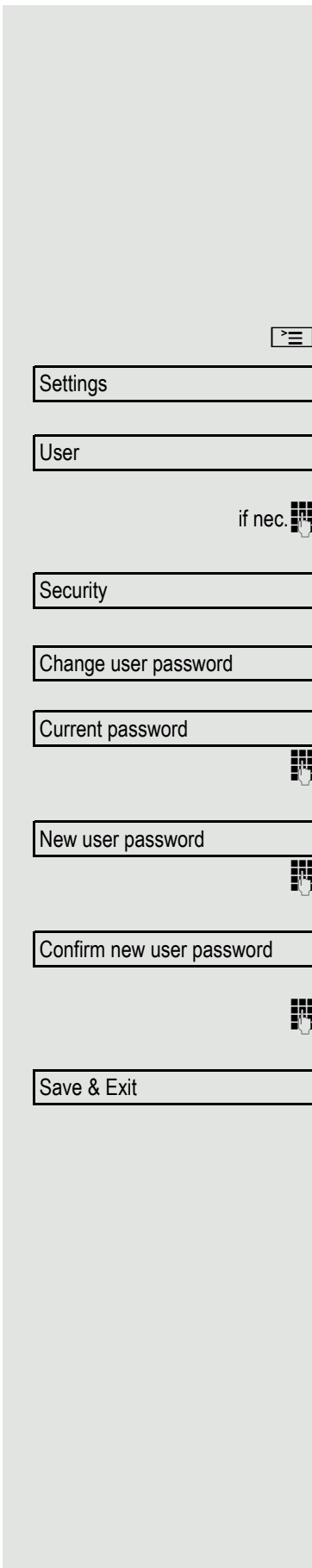

Phone locking

You can lock your phone to protect it against unauthorised access. In this way, no one can make calls or change your user settings unless they know your user password.

Predefined numbers from the dial plan can still be dialled when the phone is locked. For more information, contact your administrator.

If an emergency number has been entered on the phone by administrator, "emergency call" is then offered as an option on the display when the lock is activated. You can also enter the emergency number via the keypad.

 You can only lock the phone if you set a user password (→ Page 142). The password for this should not match the default "000000".

Check if necessary whether the telephone lock function has been activated for you by administrator.

Activating the phone lock

Hold down the key shown until "Phone lock: Confirm locking the phone" appears.

Confirm. The phone is locked.

Press the key shown.

Select and confirm the option shown.

Select and confirm the option shown.

Enter and confirm the User password.

Select and confirm the option shown.

Select and confirm the option shown.

Select and confirm the option shown.

Select and confirm the option shown.

Select and confirm the option shown. The phone is locked.

 If an emergency number has been entered on the telephone by administrator, **Emergency call** will be offered on the display once you have activated the phone lock. You can also dial the emergency number via the keypad.

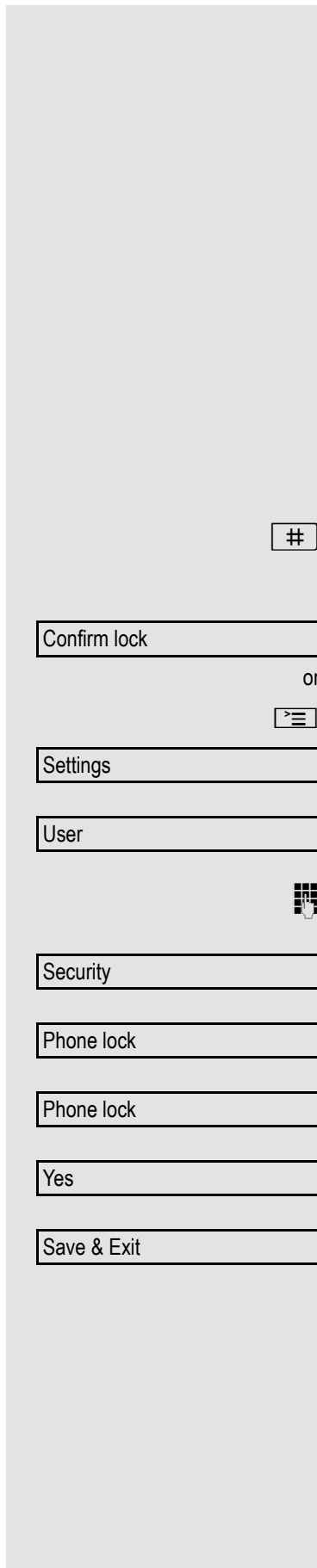

Unlocking the phone

The following is displayed: Phone locked.

There are two options available for unlocking the phone:

- User unlock
- Admin entsperren

Select and confirm if you know the user password. You are prompted to enter the user password.

Select and confirm if you only know the administrator password. You are prompted to enter the administrator password.

User password or enter and confirm the administrator password. The phone is unlocked if the password is correct.



If the telephone is locked, an emergency number entered by administrator can be dialled using the keypad or the option **Emergency call**.

If the telephone is locked redial keys cannot be used. This also applies if the emergency number is saved on it.

User unlock

or

Admin unlock



Mobility

Prerequisite: Your phone is configured to support mobility by administrator. A DLS server is available in the LAN and its address is entered in the phone.

Mobility scenarios

When you log on to your phone, or any other mobility-enabled phone, the following scenarios are possible:

Logging on and off at the same phone

- Log on as a mobility user → Page 148.
- Log off as a mobility user → Page 149.

Logging on and off at different phones

In these cases, administrator may have made the following settings:

- Log on at a remote phone with forced logon, when the user is still logged on at that phone → Page 150.
- Delayed logon at a remote phone with forced logon, when the user is still logged on at that phone and the phone is busy → Page 151.

Transferring user-defined settings and data

When you log off as a mobility user, your user-defined settings and data are saved in the DLS server so that they can be transferred to another telephone when you log on there. This also includes your contacts from your personal directory → Page 108. The personal directory can only be successfully transmitted if the destination telephone has a similarly structured phonebook. Your phonebook cannot be transmitted to an OpenStage 60, for example, because the destination phonebook has a different structure.

 If the error message "Mobility expired" appears on the display when logging on or off, please consult your administrator regarding what to do next.

Cause: The telephone is no longer receiving a response from the service computer for the data exchange (DLS).

Logging on and off at the same phone

Logging on to the phone

No other mobility user is logged on.

Logon via a key

If a sensor key is configured for Mobility .

Press the "Mobility" sensor key.

Logon via the context menu

Select and confirm the option shown in the idle display (→ Page 27) context menu.

The **Mobility logon** dialog appears.

You are prompted to enter your mobility ID.

Enter and confirm Mobility ID, usually a telephone number.

You are prompted to enter the password.

Enter and confirm the user password.

The following messages appear on the display:

- Logging on mobile user
- Validating
- Registering
- Downloading user data

Once logon is complete, the "Mobility" program key LED lights up and the mobility icon  appears in the graphic display next to the mobile phone number.





Logging off from the phone

Prerequisite: You are logged on as a mobility user.

Logoff via key

If a program key is configured for Mobility.

Press the illuminated "Mobility" program key.

Logon via the context menu

Select and confirm the option shown in the idle display context menu
→ Page 27.

Is displayed. You briefly have the option to cancel the logoff, otherwise the logoff process is launched.

In the graphic display, the following messages appear:

- Logging off mobile user
- Uploading user profile
- Registering
- Downloading user data

After you have logged off, the mobility icon  is hidden.

Logging off from a locked telephone

If the telephone is locked, it is still possible to log off from the telephone if no PIN is required for logging off.

The display shows: Phone locked.

Three options are available for selection:

- Nutzer entsperren
- Mobile logoff
- Admin entsperren

Select and confirm the option shown. The logoff procedure begins.

Logging on at different telephones

An attempted login is rejected if the user is already logged on to another phone and "Logon with forced logoff" is disabled for the mobility user.

Logging on with forced logoff at a remote phone

If the user is already logged on at another phone and the remote phone is busy, the logon is rejected.

If however, your administrator enabled "Forced logoff during call" without setting a time, the system does not consider whether or not the remote phone is busy.

Logon via a key

If a program key is configured for Mobility.

Press the "Mobility" program key.

Logon via the context menu

Select and confirm → Page 27 the option shown in the idle display context menu.

You are prompted to enter your mobility ID.

Enter and confirm Mobility ID, usually a telephone number.

You are prompted to enter the password.

Enter and confirm the user password.

The following mobility messages appear in the display:

- Validating
- Logging off elsewhere
- Registering
- Downloading user data

The logoff is simultaneously displayed on the remote phone. Once logon is complete, the "Mobility" program key LED lights up and the mobility icon appears in the graphic display .

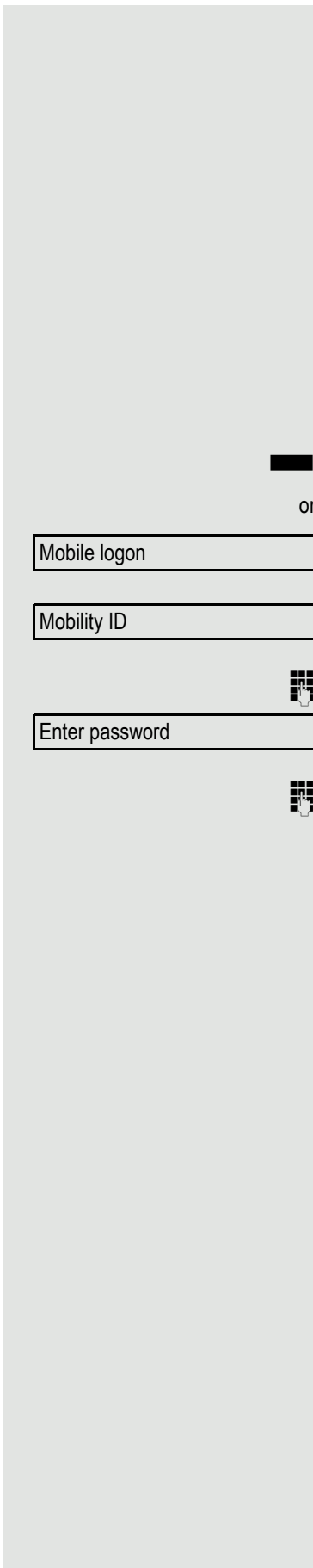

Logging on with forced, delayed logoff at a remote phone

If the remote phone is busy and your administrator enabled "Forced logoff during call" with a set timeout, forced logoff does not occur until this timeout expires.

Logon via a key

If a program key is configured for Mobility.

Press the "Mobility" program key.

Logon via the context menu

Select and confirm the option shown in the idle display context menu
→ Page 27.

You are prompted to enter your mobility ID.

Enter and confirm Mobility ID, usually a telephone number.

You are prompted to enter the password.

Enter and confirm the user password.

The following mobility messages appear in the display:

- Validating
- Logging off elsewhere

 At the same time, the graphic display on the busy remote phone shows "Forced logoff pending". After the set timeout, the active call is ended and remote logoff is performed.

- Registering
- Downloading user data

Once logon is complete, the "Mobility" program key LED lights up and the mobility icon appears in the graphic display .

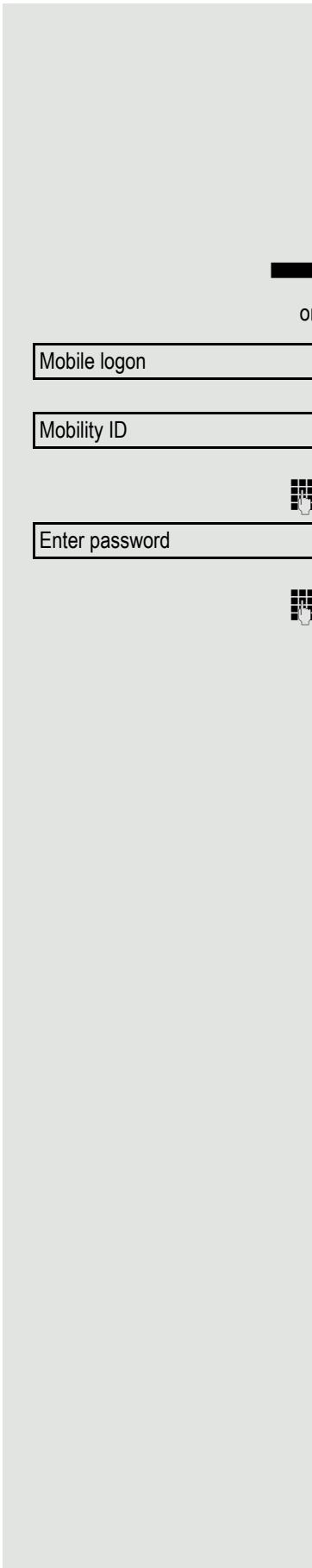

OpenScape Voice functions

The OpenScape Voice supports a number of functions that you can activate and deactivate from your phone.

 On multi-line telephones, the full scope of OpenScape Voice functions is only available for the primary line.

Feature toggle key

Hunt group

You can pick a programmable sensor key and program it as a feature toggle key for activating the "make line busy" and "stop hunt" functions.

You can then use the programmable sensor key to activate or deactivate the relevant OpenScape Voice function on the server for this phone.

You can only program first-level programmable sensor keys because those linked to LEDs are used to display function status as either **on** (LED on) or **off** (LED off). The LED indicates the status of the function on the server and can therefore change without any of the programmable sensor keys being pressed.

Example:

Switching between "Line busy" and "Line free" (see also → Page 158).

Prerequisite: Your administrator configured a programmable key with the function "Busy" ("make line busy" for the hunt group).



Press the programmable sensor key – the key lights up.



Press the illuminated programmable sensor key once again to release the line - the key stops illuminating.

Whispering

You can configure a feature toggle key for the "whisper" function → Page 78 in order to communicate unnoticed with the first internal caller when "muted silent monitoring" is activated → Page 164.

Prerequisite: Your administrator has configured and activated the "whisper" function in the system.



Press the sensor key shown – the key lights up. "Whispering" is activated.



Press the illuminated sensor key once again to disable "whispering" - the key stops illuminating.

Making anonymous calls

Your administrator decides whether or not your caller ID (name and phone number) is displayed on a called party's station. **Anonymous** calling is when your data is not transmitted. The settings configured can be deactivated, however, for specific calls.



- If your caller ID is transmitted: your caller ID is displayed.
- If your caller ID is suppressed: "unknown" is displayed.

Deactivating

If your administrator permanently activated **anonymous calling** for your phone, you can deactivate this setting as follows:

Lift the handset.

Enter the code (see the table of codes → Page 168) to transmit the caller information.

You hear a confirmation tone or an announcement.

Activating

If your administrator activated caller ID transmission for your phone, you can deactivate this setting as follows:

Lift the handset.

Enter the code (see the table of codes → Page 168) to suppress the caller ID.

Wait until you hear the confirmation tone or announcement.

Caller ID transfer is suppressed. "Private/Anonymous" appears on the called party's display instead of the caller ID.

Temporarily activating anonymous calling for the next call

If your administrator activated caller ID transmission for your phone, you can deactivate this setting for the next call as follows:

Lift the handset.

Enter the code (see the table of codes → Page 168).

Wait until you hear the confirmation tone or announcement.

Dial the phone number of the party you want to contact.

Caller ID transmission is reactivated after this call.

Temporarily deactivating anonymous calling for the next call

If your administrator suppressed caller ID transmission for your phone, you can enable this setting for the next call as follows:

Lift the handset.

Enter the code (see the table of codes → Page 168).

Wait until you hear the confirmation tone or announcement.

Dial the phone number of the party you want to contact. When you end this call, caller ID transmission is suppressed once again for the next call.

Creating a list for selective calls

For call acceptance

You can create a list of the phone numbers from which you are willing to accept calls (also known as a selection list). Your administrator knows how long this list may be in the OpenScape Voice used on site in your facility.

A connection is set up if a caller's phone number matches a number in the selection list. If there is a match:

- the caller receives a message that the party refuses to accept any calls with this number,
- the call is forwarded to an external phone number.

Contact your administrator for information on how your OpenScape Voice is configured on site.

Lift the handset.

Enter the code (see the table of codes → Page 168).

Various announcements deliver the following information:

- the name of the feature (selective call acceptance)
- the current status (active or inactive)
- the current scope of the selection list.

These announcements are followed by verbal user prompts that let you:

- add entries to the selection list
- delete entries in the selection list
- check the selection list
- activate or deactivate the function.

For call rejection

As for selective call acceptance, you can create a selection list with the phone numbers of parties from whom you are not willing to accept calls. Your administrator knows how long this list may be in the OpenScape Voice used on site in your facility.

A call is not connected if the caller's phone number matches a number in the selection list; the caller is notified that the called party rejects calls from this number. If the caller's number is not in the selection list, the call is to you as usual.

Lift the handset.

Enter the code (see the table of codes → Page 168).

Various announcements deliver the following information:

- the name of the feature (selective call rejection)
- the current status (active or inactive)
- the current scope of the selection list.

These announcements are followed by verbal user prompts that let you:

- add entries to the selection list
- delete entries in the selection list
- check the selection list
- activate or deactivate the function.

Anonymous calls

Rejecting

You can reject all calls from parties that activated a data protection feature (for example, caller ID suppression) to prevent their phone number from being transmitted. In this case, you are not informed that a call was rejected.



Lift the handset.

Enter the code (see the table of codes → Page 168).

Accepting

You can also accept calls from parties that activated a data protection feature (for example, caller ID suppression) to prevent their phone number from being transmitted.



Lift the handset.

Enter the code (see the table of codes → Page 168).

Using abbreviated dialling

Abbreviated dialling gives you access to a central list of frequently dialled phone numbers.

You can dial a specific phone number by simply entering a digit string. As these are three-digit numbers, you can store up to 1000 phone numbers. This list is stored centrally and managed by your administrator.

Lift the handset.

Enter the code (see the table of codes → Page 168) followed by a number between 0 and 999 for the phone number you want to dial.

The number is automatically dialled.

Call tracing

You can request automatic tracing of the last received internal call. This is particularly suitable for identifying malicious, irritating or troublesome calls.

Lift the handset.

Enter the code (see the table of codes → Page 168). The phone number is determined. Ask your administrator for the result.

Hunt group functions

To ensure optimum handling of specific calls, your telephone can be assigned to a pickup group → Page 44 and/or a hunt group.

Your administrator can incorporate multiple telephones in a hunt group. If your telephone is assigned to a hunt group, OpenScape Voice forwards calls for the members of your group in accordance with specific rules defined by your administrator. Hunt groups are a simple solution for distributing calls to a group of telephones.

If you want another member of the group to pick up an incoming call, you can set your telephone to signal the busy status for your line to the other members of the hunt group. Hunt group calls will then no longer be forwarded to your telephone.

This feature can also be configured using the programmable feature toggle key → Page 152.

Making a line busy

This prevents this line being used for calls in a hunt group.

Activating

Lift the handset.

Enter the code (see the table of codes → Page 168).

Wait until you hear the confirmation tone or announcement.

Deactivating

Make the line free once more for the hunt group.

Lift the handset.

Enter the code (see the table of codes → Page 168).

Wait until you hear the confirmation tone or announcement.



Marking the last line in the hunt group chain

Sets the "stop hunt" line in the hunt group chain. The system will stop looking for a free line in the hunt group chain after it reaches this line.

Activating

Lift the handset.

Enter the code (see the table of codes → Page 168).

Wait until you hear the confirmation tone or announcement.

Deactivating

Unmark the line as the end of the hunt group chain.

Lift the handset.

Enter the code (see the table of codes → Page 168).

Wait until you hear the confirmation tone or announcement.



Reachability

You can make either serial calls or simultaneous calls on several sites. The features for this are

- Serial call
- Parallel call

Prerequisite: The administrator has configured the respective feature for your main number in OpenScape Voice.

Serial call

Managing number lists/activating serial call

Before the serial call number can be activated, a serial call list must be created. This can be prepared either by administrator or you can create it yourself later. Up to six numbers can be entered in the list for sites on which incoming calls including your main number should be signalled sequentially. Each number can consist of up to 30 digits.

Lift the handset.

Enter the code for the edit mode (see code table → Page 168).

The edit mode opens and you hear an announcement with the following information:

- Feature name
- Current status (active/inactive)
- Number of numbers currently on the serial call list

You are prompted to do one of the following:

- Activate/deactivate the feature (only if numbers are already entered in the list)
- Call up the numbers currently entered in the list.
- Add or delete numbers
- Repeat the options in edit mode

If the serial call list is still empty, you are prompted to enter numbers in the list. As soon as you have entered a valid number, the serial call can be activated.

If the serial call is activated, incoming calls are first routed to your phone. If you do not answer within the timeframe defined by the administrator, the next destination phone rings for the configured period of time. The caller is informed that the call is being routed to another station. The connection is established with the first phone that accepts the call.

If the call is not answered by any phone, it is forwarded to the configured forwarding destination (on no reply) or to a "rejection announcement".



Parallel call

Managing number lists/activating parallel call

Before the parallel call feature can be activated, a parallel call list must be created. This can be prepared either by administrator or you can create it yourself later. Up to six numbers can be entered in the list for sites on which incoming calls including your main number should be signalled sequentially. Each number can consist of up to 30 digits.

Lift the handset.

Enter the code for the edit mode (see code table → Page 168).

The edit mode opens and you hear an announcement with the following information:

- Feature name
- Current status (active/inactive)
- Number of numbers currently on the parallel call list

You are prompted to do one of the following:

- Activate/deactivate the feature (only if numbers are already entered in the list)
- Call up the numbers currently entered in the list.
- Add or delete numbers
- Repeat the options in edit mode

If the parallel call list is still empty, you are prompted to enter numbers in the list. As soon as you have entered a valid number, the parallel call can be activated.

If the parallel call is activated, incoming calls are routed to your phone and all other destination phones in the parallel call list. The connection is established with the first phone that accepts the call.

If the call is not answered by any phone, it is forwarded to the configured forwarding destination (on no reply) or to a "rejection announcement".

Activating/deactivating parallel call via code

You can activate/deactivate the parallel call without having to change to edit mode.

Prerequisite: You have already entered numbers in the parallel call list.

Lift the handset.

Enter the code to activate or deactivate the parallel call (see code table → Page 168).

Parking a call

If you have answered a call for a colleague and cannot forward it to him, you can park the call.

Call park



You are conducting the call. Let the other party know, e.g. that you are trying to connect him.



Enter the code for parking followed by a line number (see code table → Page 168).



You receive a confirmation tone. The caller hears a waiting melody.

Replace the handset

Tell your colleague that a call for him is parked and give him the line number.

Unparking

To unpark the call, your colleague must proceed as follows:



Lift the handset.



Enter the unparking code (see code table → Page 168). He is prompted to enter a line number.



Enter the specified line number.



Your colleague is now connected with the waiting caller.

Silent Monitoring

If this function has been configured by the administrator and enabled for the destination phone, you can join an active call of an internal station and listen in with the knowledge of the target station (active) or unnoticed (muted).

Active silent monitoring

Station A and B are on a call. You want to listen to the call and talk to Station A and B.

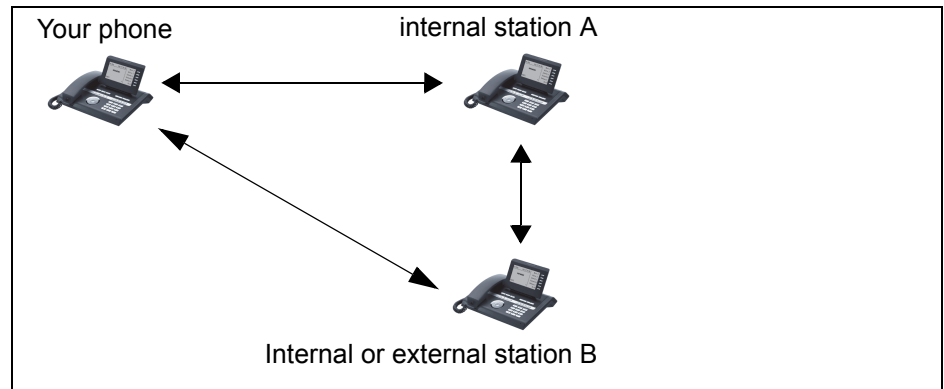

All callers can hear and speak to each other.



Lift the handset.



Enter the code for active silent monitoring and the destination number for station A (see code table → Page 168). You are connected to the call and can listen. If necessary make yourself known.

End the silent monitoring by replacing the handset.

Muted silent monitoring

Station A and B are on a call. You want to monitor the call but so that neither station notices.

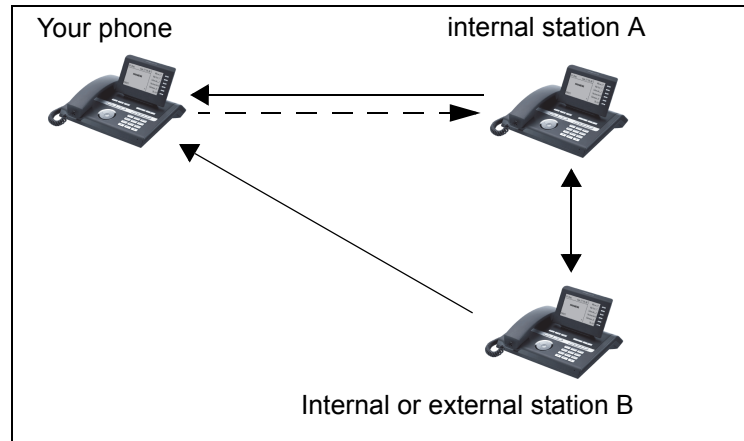

- You can hear station A but cannot talk to him because he cannot hear you
- You can hear station B but cannot talk to him because he cannot hear you.
- Station A and B can hear and speak to each other.
- You can communicate unnoticed with station A if you have enabled "whispering".



Lift the handset.



Enter the code for silent monitoring and the destination number for station A (see code table → Page 168). You are connected to the call and can listen unnoticed.

You can enable the "whisper" function using a feature toggle key in order to communicate unnoticed with the internal station A without station B hearing. The "whisper" key must be configured → Page 152.



Press the "whisper" sensor key – the key lights up. You can communicate unnoticed with station A.



Press the illuminated sensor key once again to disable "whispering" - the key stops illuminating.



End the silent monitoring unnoticed by replacing the handset.

One-way Intercom and Two-way Intercom function

With One-way Intercom or Two-way Intercom, the loudspeaker or speakerphone function of a destination phone is activated automatically when the connection is established. Use of these functions is conceivable for example between an executive and secretary or between a doctor and receptionist.

Possible functions include:

- One-way Intercom
 - with variable input of member number
 - to a saved member number
- Two-way Intercom
 - with variable input of member number
 - to a saved member number

Prerequisites:

- The team member belongs to the same collective group as you and has likewise been assigned a member number.
- The team member's phone has a loudspeaker (One-way Intercom) and/or a speakerphone function (Two-way Intercom).
- Automatic answering is activated for the team member.
- The team member's phone is idle.
- The member numbers of the callers are known for the One-way Intercom and Two-way Intercom functions.

You can cancel One-way Intercom or Two-way Intercom by replacing the handset or – during a consultation – resume the held call.

Two-way Intercom connections can be established from the following states:

- In idle status
- During manual call holding
- In a consultation



Functions such as "call forwarding" or "do-not-disturb" are temporarily disabled on the destination caller's phone by the One-way Intercom and Two-way Intercom functions.

One-way Intercom

From your phone, you can directly call any team member whose telephone has a loudspeaker.

One-way Intercom with variable input of member number

Lift the handset.

Enter the code for One-way Intercom (see code table → Page 168) followed by the one or two-digit member number of the respective team member.

As soon as the connection has been established, you will hear a confirmation tone and can speak to the other party via the loudspeaker.

To end the call, simply hang up.

One-way Intercom to a saved member number

Prerequisite: The code for One-way Intercom and the member number are programmed on a sensor key.

Press the programmed sensor key. A connection to that member's loudspeaker will immediately be established: You can speak to the destination caller via your speakerphone.

Two-way Intercom

From your phone, you can directly call any team member whose telephone has a speakerphone function. The loudspeaker and microphone of the destination phone are switched on automatically.

Two-way Intercom with variable input of member number

Press the key to use your speakerphone function.

Enter the code for Two-way Intercom (see code table → Page 168) followed by the one or two-digit member number of the respective team member.

As soon as the connection has been established, you will hear a confirmation tone and can reach the destination caller via this caller's speakerphone function.

Two-way Intercom to a saved member number

Prerequisite: The code for Two-way Intercom and the member number are programmed on a sensor key.

Press the programmed sensor key. A connection to the team member is established immediately and your speakerphone function will be switched on.

As soon as the connection has been established, you will hear a confirmation tone and can reach the destination caller via this caller's speakerphone function.

Announcing the local phone number

You can use this function in order, for example, to identify the phone number of a phone in a conference room if it is not indicated on the display.



Lift the handset.

Enter the code for "Announcing the local phone number" (see code table → Page 168). The phone number is announced.



Then hang up.

Dialling the last caller

You can retrieve and dial the phone number of the last answered or dialled caller. The following two functions could be used alternatively if you have disabled the call journal → Page 115.

Retrieving and dialling the last answered caller

The following phone numbers can be saved for retrieval:

- The last answered call
- The last missed call
- The last picked up call (group call)



Lift the handset.

Enter the code for dialling the last answered caller (see code table → Page 168). The phone number is dialled and the connection is established.

Retrieving and dialling the phone number of the last caller dialled

Instead, you can also use the normal redial functions of your phone as usual.



Lift the handset.

Enter the code for dialling the last caller dialled (see code table → Page 168). The phone number is dialled and the connection is established.

Picking up out-of-hours calls

If your switchboard is no longer attended after a certain time, an out-of-hours call function can be configured on one or more phones for this period.

For example, if you hear one of the phones that has an out-of-hours call function configured ringing when the office is closed, you can pick up the call early from your phone.

You can also forward your phone to the phone with the out-of-hours call function before leaving the office so that colleagues who have not yet left can pick up calls for you.

Lift the handset.

Enter the code (see code table → Page 168) for the out-of-hours call pickup in order to pick up the ringing call.

 You can also configure a key for picking up out-of-hours calls.

Code table for OpenScape Voice functions

Ask your administrator to enter the latest codes in the following table. Print this page as an overview.

Function	Code	Description
Making anonymous calls off		→ Page 153
Making anonymous calls on		→ Page 153
Making anonymous calls temporarily on		→ Page 154
Making anonymous calls temporarily off		→ Page 154
List for selective call acceptance		→ Page 155
List for selective call rejection		→ Page 155
Rejecting anonymous calls		→ Page 156
Accepting anonymous calls		→ Page 156
Using abbreviated dialling		→ Page 157
Call tracing		→ Page 157
Making a line busy on		→ Page 158
Making a line busy off		→ Page 158
End of hunt group chain on		→ Page 159
End of hunt group chain off		→ Page 159
Edit mode for serial call		→ Page 160
Edit mode for parallel call		→ Page 161
Activating a parallel call		→ Page 161
Deactivating a parallel call		→ Page 161
Parking a call		→ Page 162
Unparking a call		→ Page 162
Active silent monitoring (SILM barge-in)		→ Page 163
Muted silent monitoring (SILM monitoring)		→ Page 164
One-way Intercom		→ Page 166
Two-way Intercom		→ Page 166
Announcing the local phone number		→ Page 167
Last answered caller		→ Page 167
Last dialled caller		→ Page 167
Picking up out-of-hours calls		→ Page 168

Impact Levels

Communication in a Public Sector Network (PSN) is split into areas of different impact levels (IL). The Impact Level dictates how you as a user should conduct the telephone call in question. It is described below how to determine whether your call partner belongs to a lower Impact Level when the connection is being established or has been established.

Calls with a low Impact Level are treated in a particular way, either through their own icons, text labels and/or a special ringtone. It should be noted that the Impact Level causes no restriction when using the phone either during or prior to connection. Calls of the same or a higher IL are not identified in any particular way.

To ensure unrestricted functionality of the Impact Level function you have to:

- Deactivate advisory tones for unsecured voice connections (→ Page 186) and
- Deactivate automatic opening of the context menu (→ Page 191)

Answering a call with a lower Impact Level

Prerequisite: The administrator has assigned separate call signals for calls with a lower Impact Level.

Answering a call

The phone rings with the defined ringtone for calls with a lower Impact Level.

The caller is shown with a special icon and the advisory "**Lower IL**".

Lift the handset.

You can also answer the call if appropriate using the loudspeaker key or via the headset.

Answering forwarded calls

The phone rings with the defined ringtone for calls with a lower IL.

The caller is shown with a special icon, the forwarding icon and the advisory "**Lower IL**".

Lift the handset.

You can also answer the call if appropriate using the loudspeaker key or via the headset.

Answering a second call

The phone rings with the defined ringtone for second calls with a lower IL.

The caller is shown with a special icon and the advisory "**Lower IL**".

Lift the handset.

You can also answer the call if appropriate using the loudspeaker key or via the headset.

Calls to a lower Impact Level

If you are calling a partner with a lower IL, this will be displayed when the connection is established.

Off-hook dialling

Lift the handset.

Enter the station number.

In the pop-up menu:

Confirm or wait until the dial delay expires (see → Page 101).

In the pop-up menu:

Confirm the option shown¹.

The connection is set up. A special icon and the advisory "**Lower IL**" are shown on the display.

 You can also set up the connection with on-hook dialling via the loudspeaker (speakerphone mode) or via a connected headset.

Forwarding a call with a lower IL

If you are forwarding a partner with a lower IL to a partner with a higher IL, this will be displayed when the connection is established.

Prerequisite: The Deflect function is approved by the administrator.

A call with a lower IL rings.

Select and confirm the option shown.

Enter and confirm the phone number.

The connection is set up. A special icon, the forwarding icon and the advisory "**Lower IL**" are shown on the display.

1. Please note the information in relation to the call journal on → Page 51

Conducting a call with a lower Impact Level

If you have answered a call with a lower IL, this will be documented on the display.

Conducting a call

You are connected with the partner from a lower IL zone. The advisory "**Lower IL**" is displayed in the second call line.

Holding a call

If the held call has the status of a lower IL, the advisory "**Lower IL**" will also be displayed.

Conference

You are connected with two or more partners in a conference call. At least one of the partners belongs to the lower IL zone. The advisory "**Lower IL**" is displayed in the "Conference" line.

Reconnecting

You have ended a consultation call for example by replacing the handset. The held partner is awaiting retrieval.

If the held call has the status of a lower IL, the advisory "**Lower IL**" will also be displayed.

Confirm the option shown. You are reconnected with the first partner.

IL alarm

If you have activated an IL alarm (→ Page 192), you will see an advisory on the display and a defined ringtone rings if the IL changes from a higher to a lower IL. This can happen for example when a call is picked up.



Retrieve held call

Individual phone configuration

Display

Adjusting the display to a comfortable reading angle

You can swivel the display unit. Adjust the display unit so that you can clearly read the screen.

Setting contrast

The display has six contrast levels that you can set according to your light conditions.

You can also configure this setting via the WBM interface → Page 206.

Press the key shown.

Select and confirm the option shown.

Select and confirm the option shown.

Enter and confirm the User password.

Select and confirm the option shown.

Select and confirm the option shown.

Select and confirm the option shown.

Set and confirm the contrast.

Confirm.

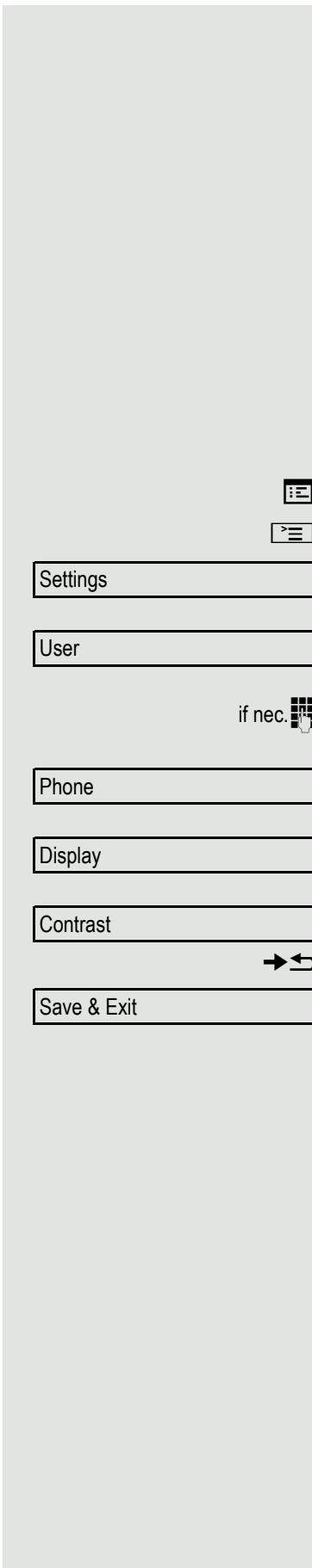

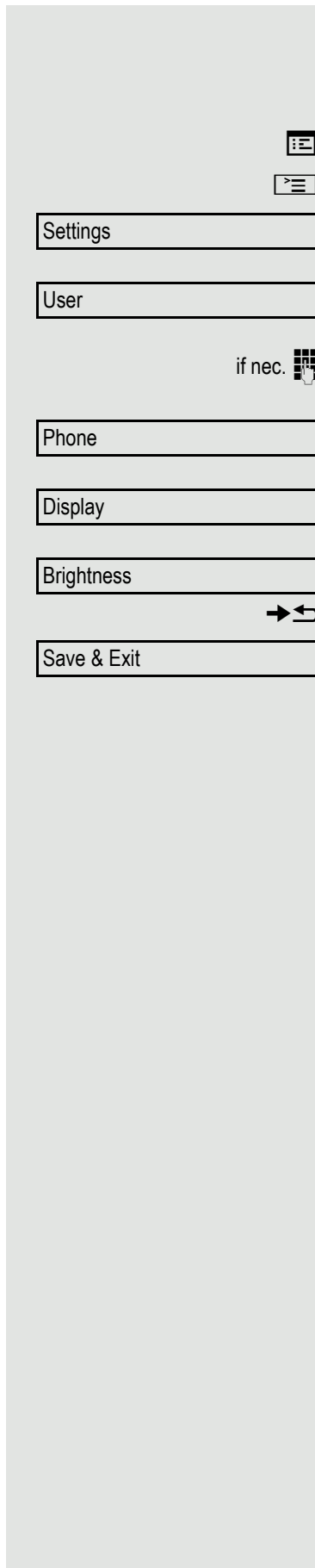

Adjusting the brightness

The display has seven contrast levels that you can set according to your light conditions.

You can also configure this setting via the WBM interface → Page 206.

Press the key shown.

Select and confirm the option shown.

Select and confirm the option shown.

Enter and confirm the User password.

Select and confirm the option shown.

Select and confirm the option shown.

Select and confirm the option shown.

Set and confirm the contrast.

Confirm.

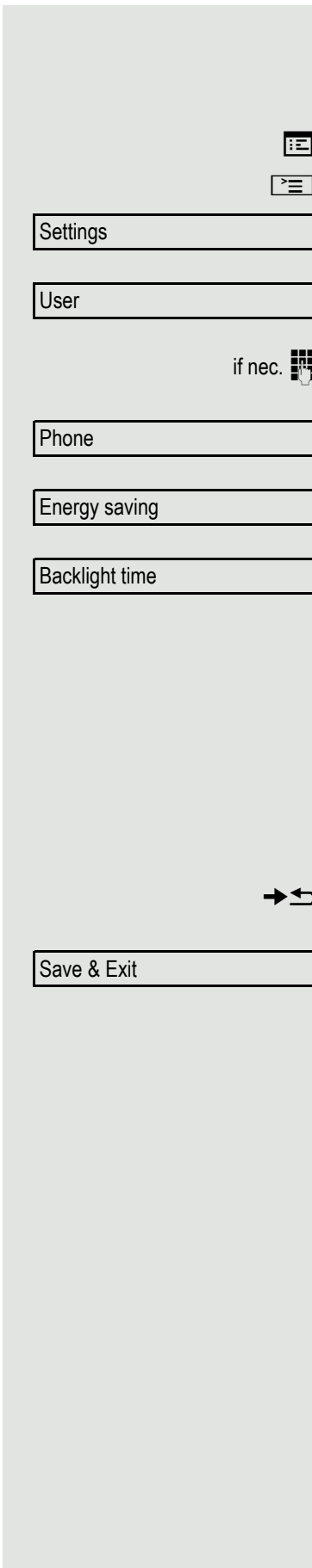

Backlight time

You can have the background lighting switch off automatically after a time defined by you.

You can also configure this setting via the WBM interface → Page 206.

Press the key shown.

Select and confirm the option shown.

Select and confirm the option shown.

Enter and confirm the User password.

Select and confirm the option shown.

Select and confirm the option shown.

Select and confirm the option shown.

The following time options are available to you:

- 1 minute
- 5 minutes
- 30 minutes
- 60 minutes
- 2 hours
- 4 hours
- 8 hours

The default setting is 1 minute.

Set and confirm the time.

Confirm the option shown.

Contrast for the OpenStage Key Module

If an OpenStage Key Module is connected to your OpenStage 40, you can set contrast for it.

Press the key shown.

Select and confirm the option shown.

Select and confirm the option shown.

Enter and confirm the User password.

Select and confirm the option shown.

Select and confirm the option shown.

Select and confirm the option shown.

Set and confirm the contrast.

Confirm.

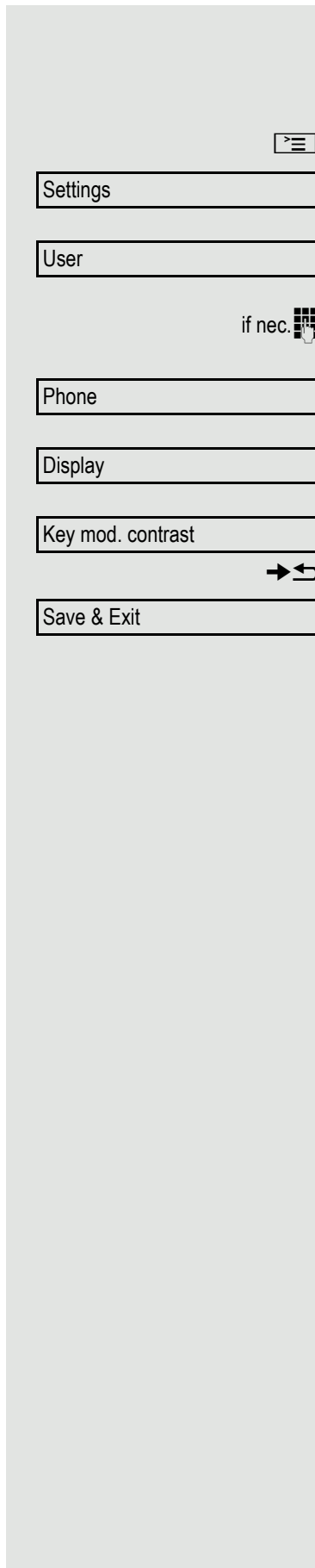

Date and time

You can set the date and time display here if necessary.

You can also configure these settings via the WBM interface → Page 206.

Setting the time

Press the key shown.

Select and confirm the option shown.

Select and confirm the option shown.

Enter and confirm the User password.

Select and confirm the option shown.

Select and confirm the option shown.

Enter and confirm the time.

Confirm.

Setting the date

Press the key shown.

Select and confirm the option shown.

Select and confirm the option shown.

Enter and confirm the User password.

Select and confirm the option shown.

Select and confirm the option shown.

Enter and confirm the date.

Confirm.



Setting daylight saving time

Prerequisite: Auto DST is deactivated → Page 178.

You can also configure this setting via the WBM interface → Page 206.

Press the key shown.

Select and confirm the option shown.

Select and confirm the option shown.

Enter and confirm the User password.

Select and confirm the option shown.

Select and confirm the option shown.

Select and confirm the option shown in the context menu.

Confirm.

Setting the difference between daylight saving and standard time

Prerequisite: Auto DST is deactivated → Page 178.

Enter the difference to be used for daylight saving time.

You can also configure this setting via the WBM interface → Page 206.

Press the key shown.

Select and confirm the option shown.

Select and confirm the option shown.

Enter and confirm the User password.

Select and confirm the option shown.

Select and confirm the option shown.

Enter and confirm the difference between daylight and standard time in minutes.

Confirm.

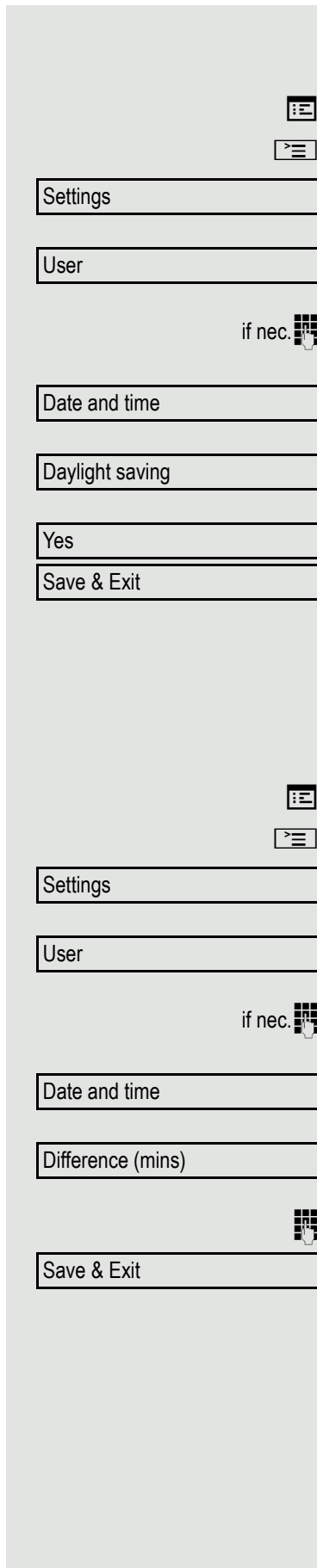

Automatic daylight saving time

The **Auto DST** setting (automatic time-update) is provided for information purposes and can only be changed by your administrator.

You can also access this information via the WBM interface → Page 206.

Press the key shown.

Select and confirm the option shown.

Select and confirm the option shown.

Enter and confirm the user password.

Select and confirm the option shown.

Daylight saving time must be manually set if a **No** is entered for **Auto DST** → Page 177.

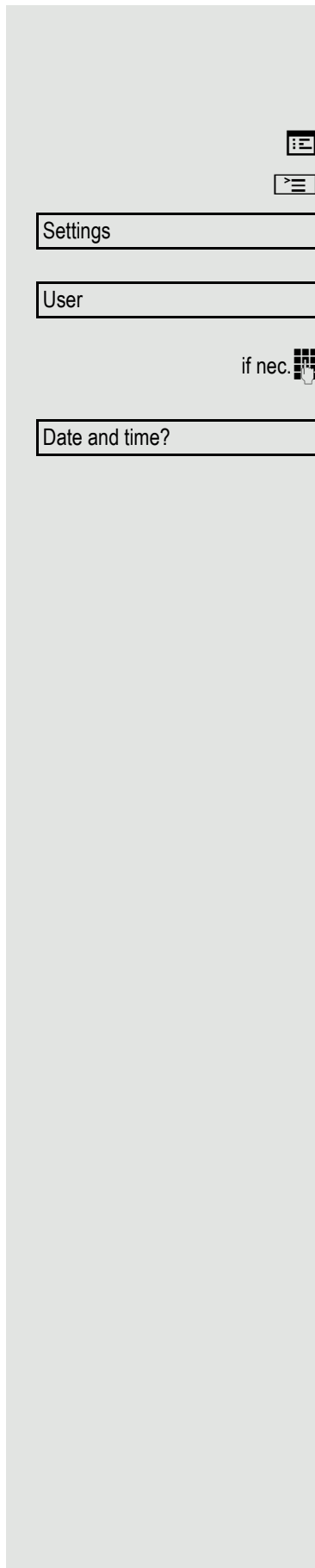

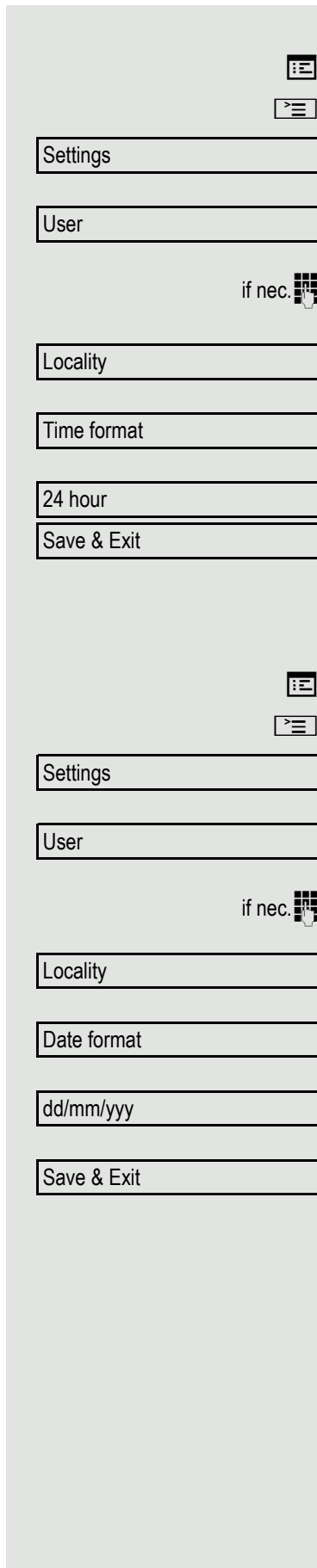

Time display format

You can also configure this setting via the WBM interface → Page 206.

Press the key shown.

Select and confirm the option shown.

Select and confirm the option shown.

if nec. Enter and confirm the User password.

Select and confirm the option shown.

Select and confirm the option shown.

Select and confirm the time format (12- or 24-hour display) in the context menu.

Confirm.

Date display format

You can also configure this setting via the WBM interface → Page 206.

Press the key shown.

Select and confirm the option shown.

Select and confirm the option shown.

if nec. Enter and confirm the User password.

Select and confirm the option shown.

Select and confirm the option shown.

Select and confirm the format you want.

Confirm.

Audio

Volumes

Use this selection to set the following volumes in 10 levels:

- Loudspeaker
- Ringer
- Handset
- Headset
- Handsfree
- Rollover

Example: **Handset**

Press the key shown.

Select and confirm the option shown.

Select and confirm the option shown.

Enter and confirm the User password.

Select and confirm the option shown.

Select and confirm the option shown.

Select and confirm the volume you want to adjust (for example, "Handset").

Set and confirm the volume.

An acoustic sample of the current volume is output via audio feedback when you adjust the volume.

Confirm.

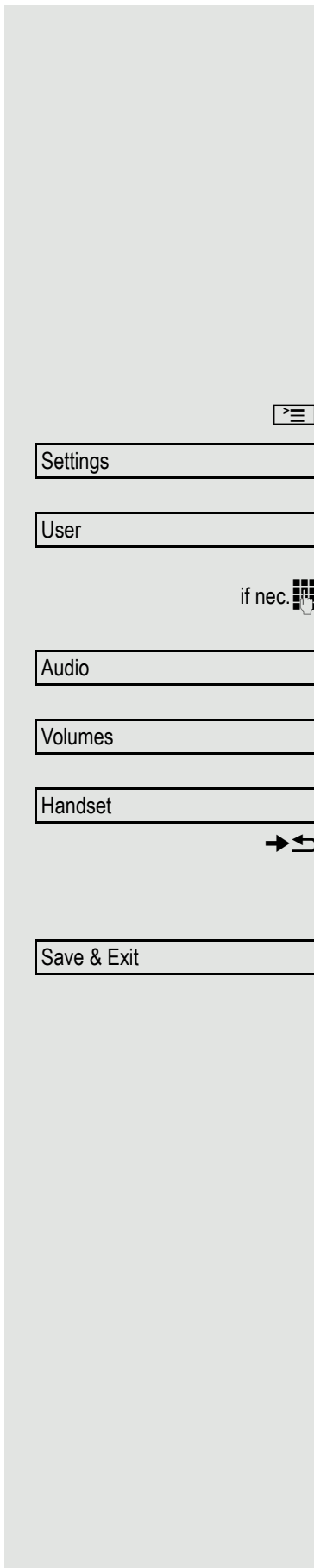

Settings

Room character

To ensure that the other party can hear you properly in speakerphone mode, you can adjust the phone to the room acoustics by choosing one of the following room character conditions: "Normal", "Echoing", "Muffled".

You can also configure this setting via the WBM interface → Page 206.

Press the key shown.

Select and confirm the option shown.

Select and confirm the option shown.

Enter and confirm the User password.

Select and confirm the option shown.

Select and confirm the option shown.

Select and confirm the option shown.

Select and confirm the room character in the context menu (for example, "Normal") ( → Page 208).

Confirm.

Ringtone

If your administrator has loaded suitable files to the phone, you can select a ringtone file in *.mp3 or *.wav format for the ringtone. If no individual audio files are available the "pattern" ringtone is preset.

You can also configure this setting via the WBM interface → Page 206.

Press the key shown.

Select and confirm the option shown.

Select and confirm the option shown.

Enter and confirm the user password.

Select and confirm the option shown.

Select and confirm the option shown.

Select and confirm the option shown.

Select and confirm the required ringer file¹ or "pattern." You will immediately hear the associated ringer melody. Confirm current ringtone file.

Confirm the selected ringtone to use it or try a different ringtone.

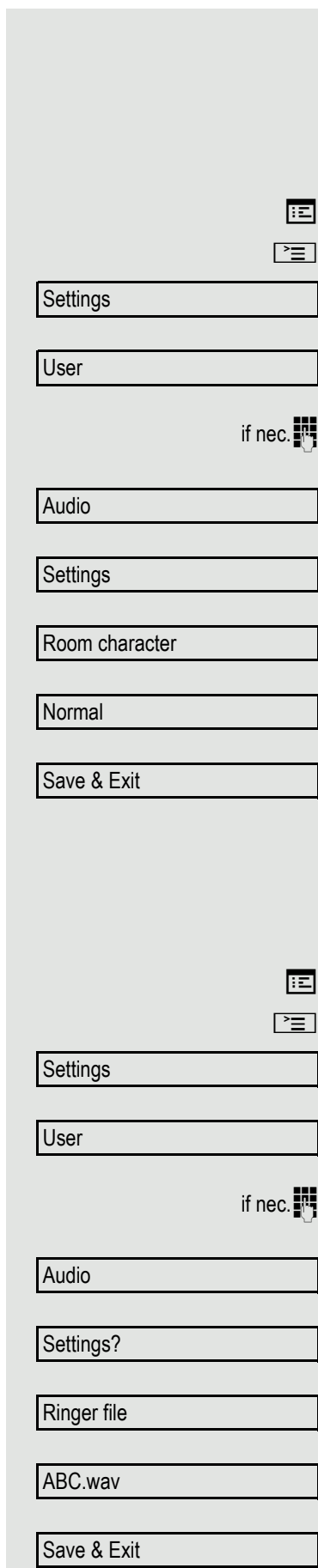

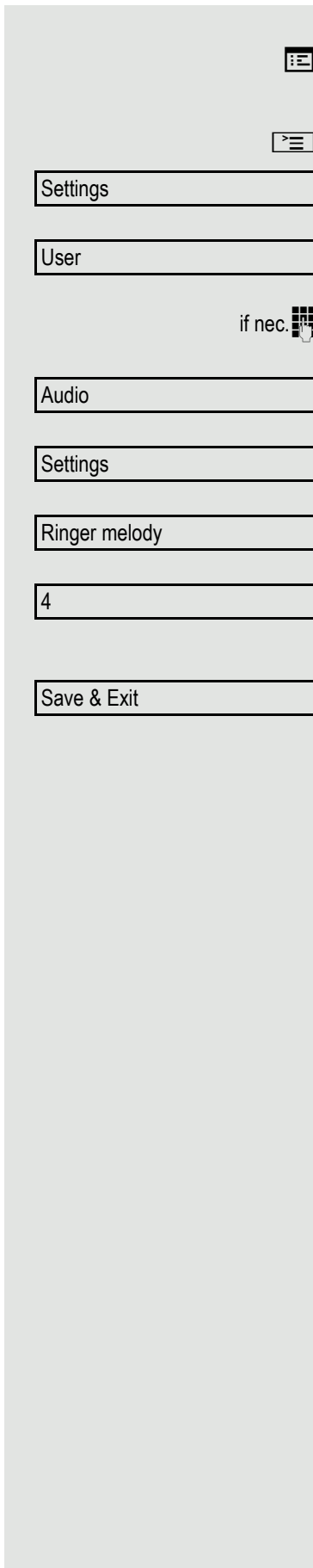

Pattern melody

You can also configure this setting via the WBM interface → Page 206.

Prerequisite: You have chosen the "pattern" ringtone, see → Page 181.

Press the key shown.

Select and confirm the option shown.

Select and confirm the option shown.

Enter and confirm the User password.

Select and confirm the option shown.

Select and confirm the option shown.

Select the option shown.

Select the required pattern melody^[1] between 1 and 8 in the context menu (e.g. **4**). You will immediately hear the corresponding Ringer melody. Confirm the selected Ringer melody.

Select and confirm the option shown.

1. The phone displays the current setting.

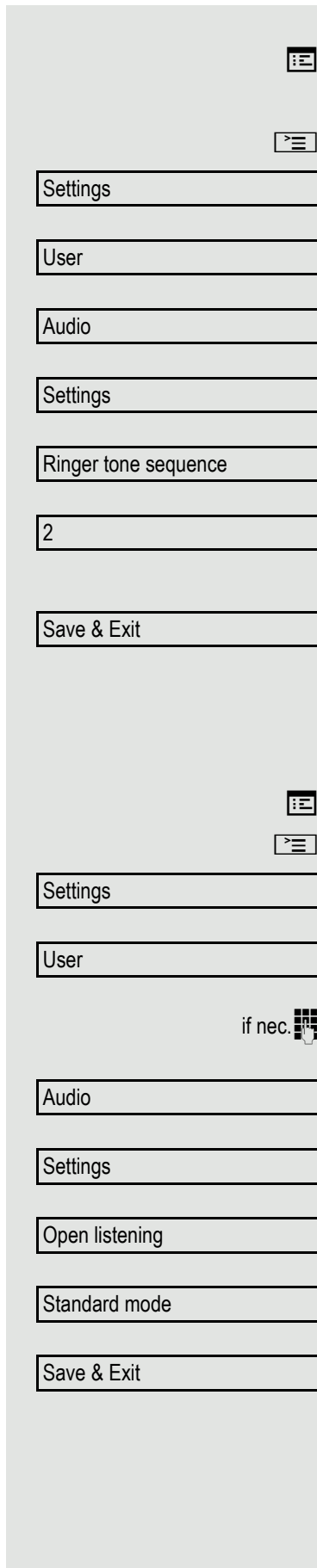

Pattern sequence

You can also configure this setting via the WBM interface → Page 206.

Prerequisite: You have chosen the "pattern" ringtone, see → Page 181.

Press the key shown.

Select and confirm the option shown.

Select and confirm the option shown.

Select and confirm the option shown.

Select and confirm the option shown.

Select the option shown.

Select the required Ringer tone sequence between 1 and 6 (e. g. **2**) You immediately hear the set Ringer melody with the chosen Ringer tone sequence. Confirm the selected setting.

Select and confirm the option shown.

Country setting for speakerphone mode

Enter the country setting you prefer for speakerphone mode here (see → Page 41).

You can also configure this setting via the WBM interface → Page 206.

Press the key shown.

Select and confirm the option shown.

Select and confirm the option shown.

if nec. Enter and confirm the User password.

Select and confirm the option shown.

Select and confirm the option shown.

Select the option shown.

Select and confirm the setting you want in the context menu ("Standard mode" or "US mode").

Confirm.

Setting headset port use

Here you set whether you are using a wired or cordless DECT headset.

You can also configure this setting via the WBM interface → Page 206.

Press the key shown.

Select and confirm the option shown.

Confirm.

Enter and confirm the user password.

Select and confirm the option shown.

Select and confirm the option shown.

Select the option shown.

From the following setting^[1] select and confirm the option shown in the context menu.

- Wired headset
- Cordless headset
- Conference unit

Select and confirm the option shown.

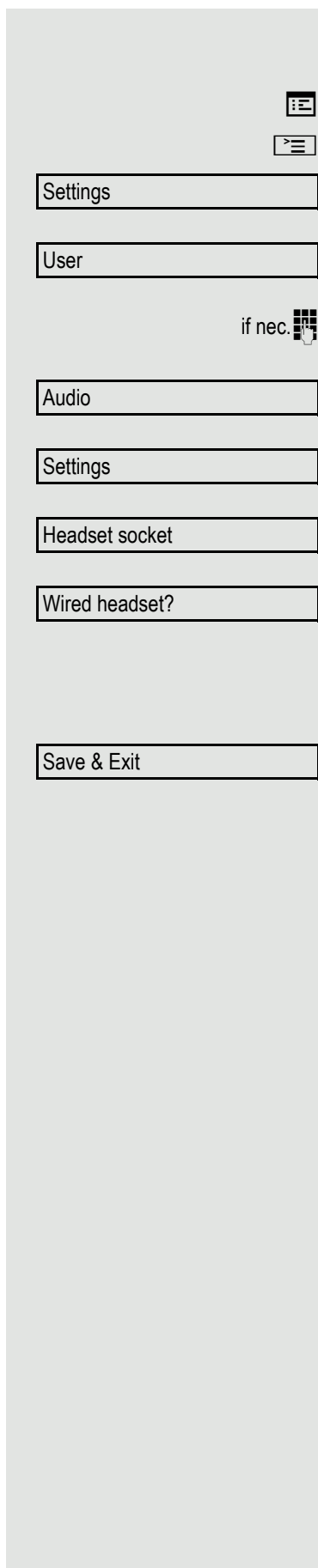

1. The phone displays the current setting.

Special ringtones

You can assign a special, individual ringtone to the following incoming calls and events in order to differentiate more easily between them:

- Internal call
- External call
- Recall (e.g. callback)
- Emergency call
- Special 1
- Special 2
- Special 3

Prerequisite: Administrator has activated and assigned the special ringtones.

You can also configure this setting via the WBM interface → Page 206.

Press the key shown.

Select and confirm the option shown.

Confirm the option shown.

Enter and confirm the user password.

Select and confirm the option shown.

Select and confirm the option shown.

The setting is made in the same way for all four types.

The setting for "Internal call" is described below by way of example.

Select and confirm the option shown.

"Yes" indicates that the special ringtone has been activated.

Select the option shown.

Select the ringtone file^[1] or "pattern" you want in the context menu. You will hear the associated ringtone melody. Confirm the current ringtone file.

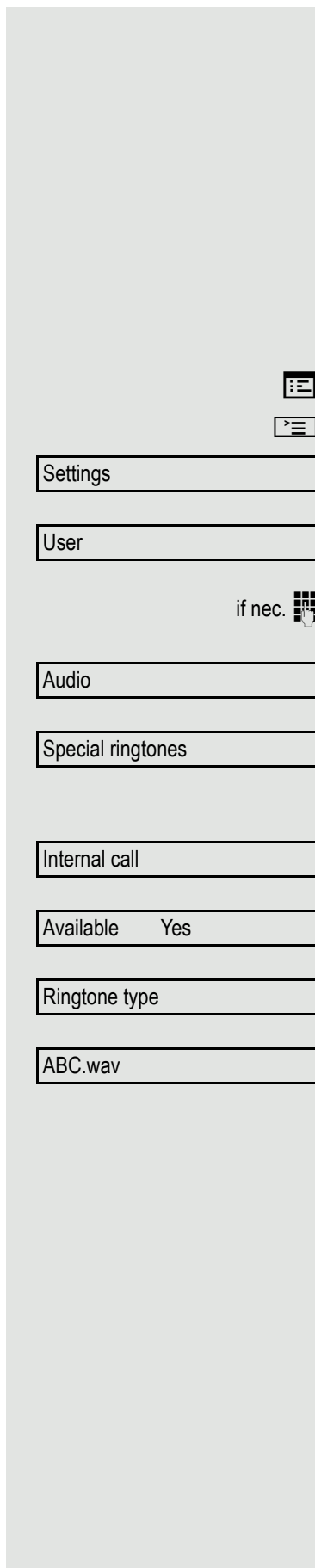

1. The phone displays the current setting

Settings for the "Pattern" ringtone type

If you selected "pattern" as the ringtone type, you can make further settings for the pattern melody and pattern sequence:

Ringer melody

Select the option shown.

4

Select the required pattern melody between 1 and 8 in the context menu (e.g. **4**). You will hear the associated Ringer melody. Confirm the selected Ringer melody.

Ringer tone sequence

Select the option shown.

2

Select the required Ringer tone sequence in the context menu between 1 and 6 (e.g. **2**). You will immediately hear the set Ringer melody with the selected Ringer tone sequence. Confirm the selected setting.

Save & Exit

Select and confirm the option shown.

Tone and indication with an unsecured voice connection

Use this option to activate an alerting tone that you hear when a secure voice connection with the party you are currently talking to ceases to be secure. The message "Nonsecure connection" also appears.

Prerequisite: Secure connection setup is the preference set by your administrator.

You can also configure this setting via the WBM interface → Page 206.



Press the key shown.



Settings

Select and confirm the option shown.

User

Select and confirm the option shown.

if nec.



Enter and confirm the User password.

Configuration

Select and confirm the option shown.

Connected calls

Select and confirm the option shown.

Secure call alert

Select and confirm the option shown.

Yes

Select and confirm the option shown in the context menu.

Save & Exit

Select and confirm the option shown.

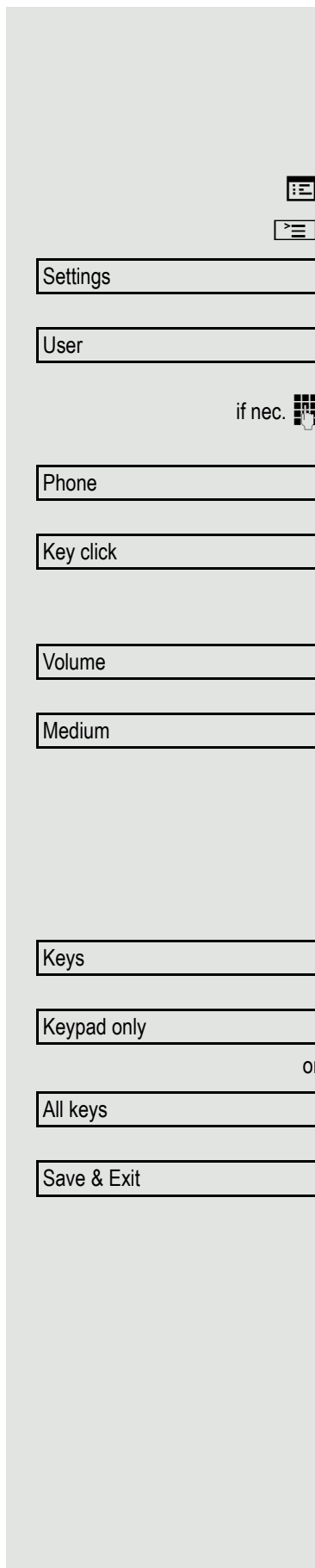

Key click

You can configure whether a key click should be audible when a key is pressed. You can also decide whether this should apply for all keys or only for the keys on the keypad. In addition, you can adjust the click volume or disable the sound.

You can also configure this setting via the WBM interface → Page 206.

Press the key shown.

Select and confirm the option shown.

Select and confirm the option shown.

if nec.  Enter and confirm the User password.

Select and confirm the option shown.

Select and confirm the option shown.

Adjusting the volume for the Key click

Select and confirm the option shown.

For instance, select and confirm a medium volume level. You can also select one of the following three options:

- Low
- High
- Off (for no click)

Key selection

Select and confirm the option shown.

Select and confirm if the setting is only to apply for the character input keys.

or

Select and confirm the option shown.

Confirm the option shown.

Setting the language and country

Selecting a language

You can also configure this setting via the WBM interface → Page 206.

Press the key shown.

Select and confirm the option shown.

Select and confirm the option shown.

Enter and confirm the User password.

Select and confirm the option shown.

Select and confirm the option shown.

Select and confirm the language^[1] in the context menu.

Confirm.

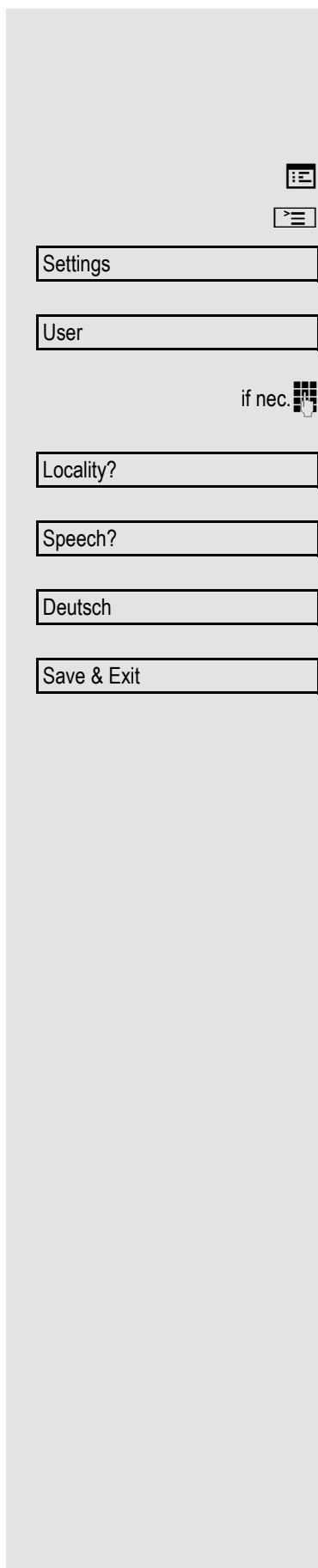

1. The phone displays the current setting.



You may choose from the following languages:

1. Bahasa Indonesia
2. Bahasa Malaysia
3. Brasileiro
4. Català
5. Čeština
6. Cymraeg
7. Dansk
8. Deutsch
9. Eesti keel
10. English
11. English(US)
12. Español
13. Français
14. Hrvatski
15. Italiano
16. Latviešu Valoda
17. Lietuvių Kalba
18. Magyar
19. Nederlands
20. Norsk
21. Polski
22. Português
23. Română
24. Slovenčina
25. Slovenski Jezik
26. Srpski Jezik
27. Suomi
28. Svenska
29. Türkçe
30. Ελληνικά
31. Български
32. Македонски Јазик
33. Русский
34. Српски Језик
35. 中文
36. 日本語



Country-specific setting

Adapt your phone settings to suit the country-specific conditions (for example, transmission parameters).

You can also configure this setting via the WBM interface → Page 206.

Press the key shown.

Select and confirm the option shown.

Select and confirm the option shown.

Enter and confirm the User password.

Select and confirm the option shown.

Select and confirm the option shown.

Select and confirm the country ^[1] in the context menu.

Confirm.

You may choose from the following countries:

- | | | | |
|-------------------|----|-----------------------|----|
| 1. Argentina | AR | 20.Luxembourg | LU |
| 2. Australia | AT | 21.Mexico | MX |
| 3. Austria | AU | 22.Netherlands | NL |
| 4. Belgium | BE | 23.New Zealand | NZ |
| 5. Brazil | BR | 24.Norway | NO |
| 6. Canada | CA | 25.Poland | PL |
| 7. China | CN | 26.Portugal | PT |
| 8. Chile | CL | 27.Russian Federation | RU |
| 9. Croatia | HR | 28.Singapore | SG |
| 10.Czech Republic | CZ | 29.Slovakia | SK |
| 11.Denmark | DK | 30.South Africa | ZA |
| 12.Finland | FI | 31.Spain | ES |
| 13.France | FR | 32.Sweden | SE |
| 14.Germany | DE | 33.Switzerland | CH |
| 15.Hungary | HU | 34.Thailand | TH |
| 16.India | IN | 35.Turkey | TR |
| 17.Ireland | IE | 36.United Kingdom | GB |
| 18.Italy | IT | 37.United States | US |
| 19.Japan | JP | 38.Vietnam | VN |

1. The phone displays the current setting.

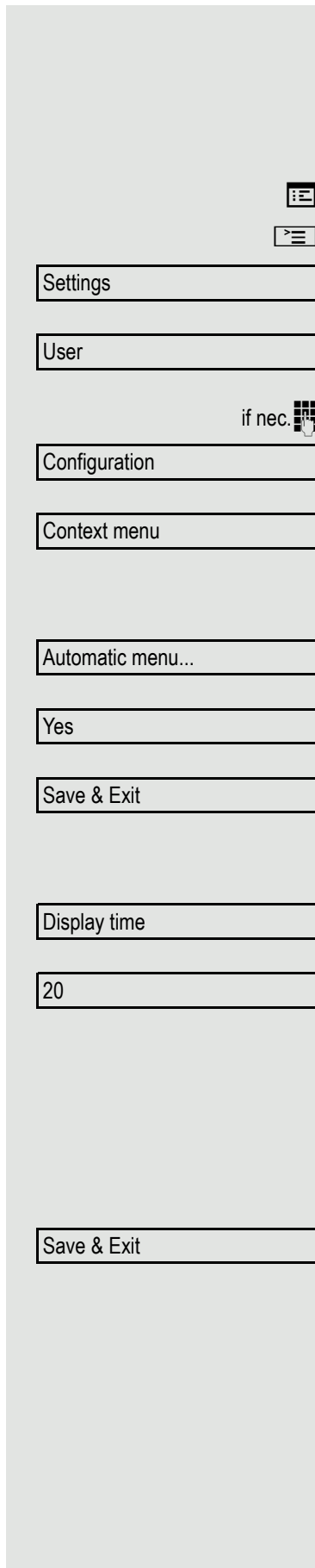

Context menu

After a connection is set up, a context menu appears with dependent functions. You can activate/deactivate the automatic display and can also set how long the context menu should be displayed.

You can also configure this setting via the WBM interface → Page 206.

Press the key shown.

Select and confirm the option shown.

Select and confirm the option shown.

Enter and confirm the User password.

Select and confirm the option shown.

Select and confirm the option shown.

Activating/deactivating automatic menu display

Select and confirm the option shown.

In the context menu select and confirm to activate automatic menu display.

Select and confirm the option shown.

Setting the display time

Select and confirm the option shown.

In the context menu select and confirm a value from the following options:

- 5
- 10
- 20
- 30
- 60
- 120
- Unlimited display

Select and confirm the option shown.

Alarm on changing the Impact Level

If a call switches from a higher to a lower Impact Level, this will be indicated by the pop-up text **Lower IL change**.

You can also configure this setting via the WBM interface → Page 206.

Press the key shown.

Select and confirm the option shown.

Confirm the option shown.

Enter and confirm the user password.

Select and confirm the option shown.

Select and confirm the option shown.

Select and confirm the option shown.

Select and confirm the option shown in the context menu. The advisory function is activated.

Select and confirm the option shown.

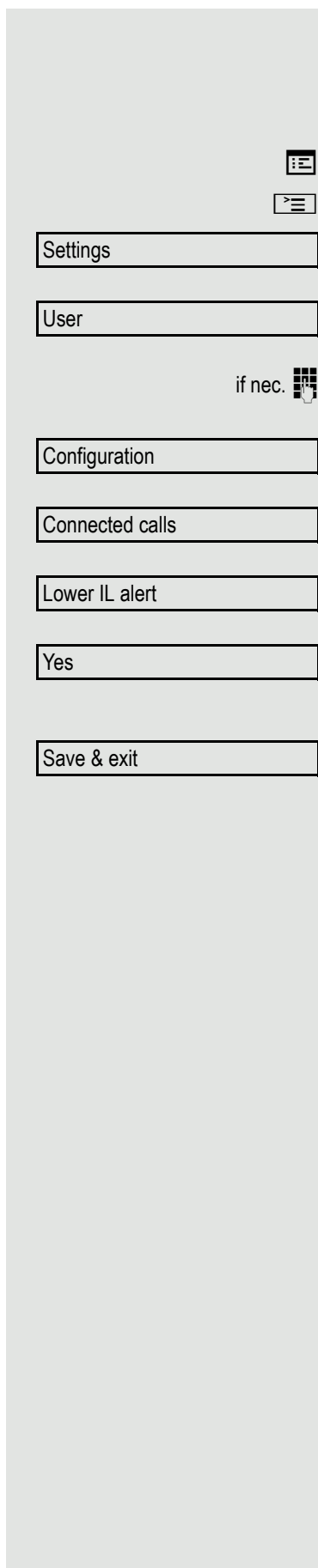

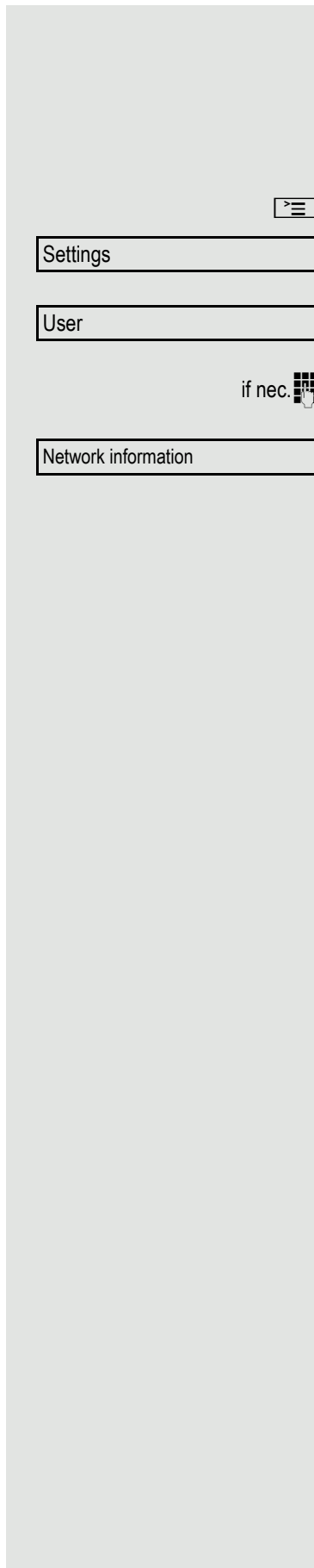

Network information

This information overview in the user area of the service menu provides you with information about the IP address or name of the phone and the HTML address of the WBM interface. It also provides real-time data about the network activity of the phone.

Press the key shown.

Select and confirm the option shown.

Select and confirm the option shown.

Enter and confirm the user password.

Select and confirm the option shown. You can browse the following overview:

Adresse des Telefons: Name or number of telephone.

Web-Adresse: HTTP address of the web interface. This address is specified in the address line of the Internet browser and is used to call up the web interface of the phone in the browser.

IP address: Displays the IP address or name that was assigned to the phone in the network.

Globale IPv6-Adresse: Displays the global IPv6 address

Lokale IPv6-Adresse: Displays the local IPv6 address

LAN/PC-RX: The network or PC interface data packets received are illustrated dynamically as columns.

LAN/PC-TX: The network or PC interface data packets sent are illustrated dynamically as columns.

LAN/PC autonegotiated: [Yes|No]: Displays whether the network or PC interface data transfer rate is set to automatic (**YES**) or manual (**No**).

LAN/PC information: [10|100|1000] Mbit/s: Data transfer rate of the network or PC interface. If an interface is not in use, **Link down** is displayed.

Resetting user data

The following user-specific settings changed via the phone menu or the WBM interface can be reset to factory settings.

- Display contrast
- Language setting
- Audio settings
 - Volumes
 - Settings
- Call lists
 - All entries are deleted
- Programmable keys
 - All personalised programming is deleted (see also → Page 81).

Attention: All data is reset **without** a warning tone.

Initiating the reset

Press the key shown.

Select and confirm the option shown.

Confirm.

Enter and confirm the user password.

Select and confirm the option shown.

Select and confirm "Reset all user data". The user data is reset to factory settings.

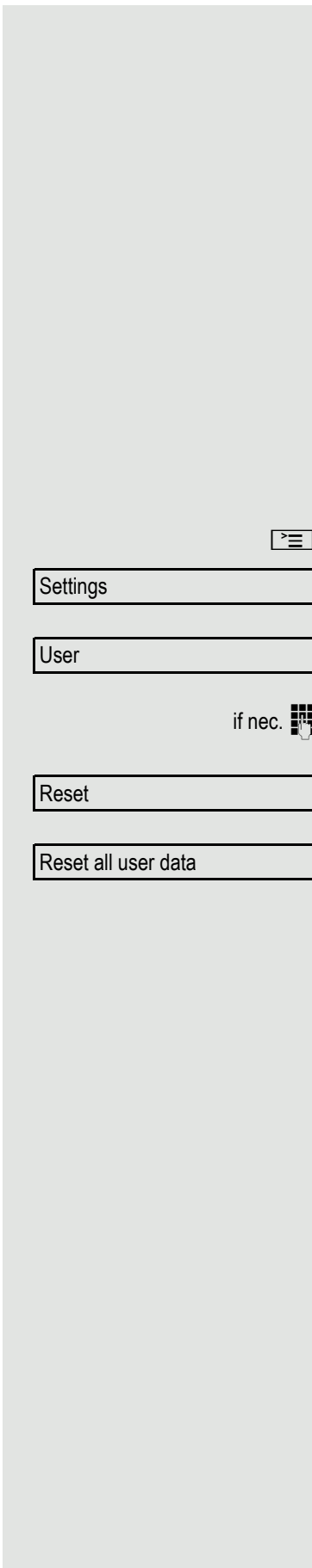

Call recording

A central voice recorder is installed in the network for recording calls to which your telephone connects in order to record the current voice traffic. The recorder records the entire voice flow of two or more participants.

You should configure a recording button in order to simplify handling of manual call recording → Page 75. It is assumed in the description below that a corresponding key has been configured.

Recording modes

The administrator can configure the following operating modes for call recording:

- Manual
- AutoStart
- All Calls
- Disabled

The following settings are possible to audibly signal the recording:

- Repeated
- Single Shot
- Off

Check with your administrator as to which settings were made for your phone.

Mode: ALL CALLS

The telephone starts and stops the recorder automatically in order to ensure that all calls are being recorded.

Mode: MANUAL

You decide when the recorder is started and stopped or paused. If the recorder is switched on, all further calls will be recorded. If you pause the recorder then nothing will be recorded. If there are no calls, then the recorder likewise pauses.

Mode: AUTOSTART

The telephone starts the recorder automatically. You can stop or pause the recorder yourself however and restart it. If a call has already been recorded, new incoming and outgoing calls will also be recorded. If you pause the recorder during a call, special calls such as consultation calls, call pickups and second calls will not be recorded as long as the recorder is paused. If the telephone reverts to idle status, the AutoStart process is set up again for the next call.

Explanations of recording

Recordable calls

A recordable call is any call that has a call connection status on the telephone. This can be any incoming or outgoing call. It is immaterial here whether a call is set up directly via the telephone or via an application.

- Outgoing
- Incoming
- Consultation
- Pickup
- Reconnect
- Second call
- Connected call
- Conference¹
- Automatic call acceptance
- Secured or unsecured line

Non-recordable calls

- Outgoing calls that have not yet reached full connection status, such as a ringing call.
- Calls on hold

1. Server-based conference only

Enhanced functions:

1. A conference¹ can be set up or cleared down during recording.
2. A consultation can be performed during recording.
3. Call transfer is also available during recording.
4. A second call can be accepted during recording.

The following features are not supported:

1. Playing back recordings over the telephone.
2. Deleting recordings over the telephone.
3. Functions for editing recordings over the telephone.

Recording tips

You will receive the following advisories while a call is being recorded:

- The recording symbol  on the display (permanent)
- Beep (repeated at intervals for you and your call partner)
- Beep (single at the start of recording for you and your call partner)

The audible advisory can also be switched off. Please check with the relevant administrator.

Multiline

In terms of call recording, no distinction is made between multiline and single-line. If recording has started, recording is performed, otherwise not. The recording status of a line persists as long as calls are connected to this line.

For example, if line A is being recorded (initiated manually) and you switch to line B or line A is placed on manual hold and you switch to line B, the recording is ended and a partial recording saved.





If you disable recording for the call on line B (mode = manual or auto start) and switch back to line A, the recording for line A is not started again.

The modes mentioned (All Calls, AutoStart or Manual) refer to the telephone and are therefore the same for all lines.

Recording conversations

Using the call recording feature

The recording function can be used in a similar way to a recorder, for example for recording music. The recorder can be:

- switched on (standby )
- switched off or stopped ()
- started ()
- paused ()

The symbols used here by way of example can be found on practically any hardware and software recorder.

1. Server-based conference only

Automatic call recording

This is the simplest mode. If you have accepted a call or called a subscriber and the subscriber answers, the call is recorded automatically. Refer to → Page 196 to check which calls this can be.

As soon as the recording starts, you will see the recording symbol  and hear a beep (see also → Page 196).

You cannot pause the recording manually in this mode.

Manual call recording

Activating or deactivating call recording when the telephone is in idle mode.

Prerequisite: Manual mode is selected. The recording button is configured and indicates the status.

Select the option shown in the telephone's context menu to enable the option.

or disable the option.

Press the recording button to enable the option - the LED key lights up.

or press the key shown to disable the option - the LED extinguishes.

The recording button also indicates the status change if you activated or deactivated call recording via the context menu.

Call recording with AutoStart

Standby mode is activated in principle in idle mode. The recording button LED lights up. You cannot switch off the recorder. As soon as a call is set up, call recording starts automatically.

Lift the handset.

Press the key shown.

The station answers. You hear a beep, the recording symbol  is shown on the display and the recording button LED remains lighting. The call is now being recorded (see also → Page 196)

You can pause the recording at any time and continue it again.

If you end the call, the AutoStart process is set up again for the next call.



or



or

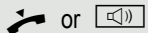

Controlling call recording

Starting call recording manually during a call

Prerequisite: Manual mode or AutoStart is selected. You are conducting a call. Recording has not started. The recording button LED is not lighting.

You are conducting a call (see also → Page 196).

Press the recording button to start the recording - the LED key lights up.

You hear a beep and the recording symbol  is shown on the display. The call is now being recorded (see also → Page 196)

Pausing call recording manually during a call

Prerequisite: Manual mode or AutoStart is selected. You are conducting a call. Recording has started. The recording button LED lights up.

You are conducting a call (see also → Page 196).

Press the recording button to pause the recording - the LED extinguishes and the recording symbol  on the display disappears.

You can start the recording again at any time, for example to continue recording the current call.

Ending call recording automatically

Prerequisite: You are conducting a call. Recording has started. The recording button LED lights up.

The recording is ended automatically as soon as the call is terminated or if the call status changes so that the call is no longer being recorded - for example if a line is placed on manual hold and another line is seized (Multiline).

The LED extinguishes and the recording symbol  on the display disappears.

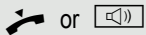

Consultation during call recording

Prerequisite: You are conducting a call. Recording has started. The recording button LED is lighting.

You initiate a consultation – your main call is placed on hold as a result while the consultation is being performed.



The recording is paused while you initiate the consultation. The recording symbol  on the display disappears.



If the consultation partner answers, the consultation call is recorded. You hear a beep and the recording symbol  is shown on the display again.

You can now terminate the consultation call or for example switch back to the first call party (alternate) while the consultation call is placed on hold.

Second call during call recording

Prerequisite: You are conducting a call. Recording has started. The recording button LED is lighting.



You are conducting a call. You hear a beep and the recording symbol  is shown on the display. The call is now being recorded.

A second call party camps on → Page 91.

In the pop-up menu:

Accept

Select and confirm the option shown.

You are connected with the second party. You hear a beep and the recording symbol  is shown in the line for the second call – this call is now being recorded. The first party is placed on hold.



Call recording while alternating

Prerequisite: You have an active or held consultation or second call. Recording has started. The recording button LED is lighting.

You are connected with the second party. You hear a beep and the recording symbol  is shown in the line for the second call.

Select and confirm the option shown in the context menu for this connection.

You are switched to the main call. You hear a beep and the recording symbol  is shown in the line for the main call – this call is now being recorded.

You can pause and restart the recording at any time in manual and auto start modes.

Your call is paused and reconnected during the recording.

Prerequisite: You are conducting a call that is being recorded.



Your call partner has placed the call on hold. You hear the music on hold. The recording is paused and the recording symbol  has disappeared from the display.



Your call partner resumes the call. You hear a beep and the recording symbol  is shown on the display.

Setting up a conference during recording

Prerequisite: You are conducting a consultation call → Page 52 or you have accepted a second call → Page 91 and the "System conference" feature was configured by the administrator. Recording has started. The main call is placed on hold. The recording button LED is lighting.

Conference

Select and confirm the option shown in the connection's context menu. You are connected to both parties at once. The conference is displayed with the current participants.

You hear a beep and the recording symbol  is shown in the line for the conference call.

Adding conference participants during the recording

Prerequisite: You have set up a conference. The "System conference" feature was configured by the administrator. The conference call is now being recorded.

You have performed a consultation or accepted a second call (→ Page 52 or → Page 91). The conference call is placed on hold.

You hear a beep and the recording symbol  is shown in the line for the consultation or second call. The call is now being recorded.

Conference

Select the option shown in the context menu for the consultation or second call in order to include the new participant in the conference. The conference is displayed with all current participants.

You hear a beep and the recording symbol  is shown again in the line for the conference call.

Your call is included in a conference during the recording.

Prerequisite: You are conducting a call that is being recorded. You are to be included in a conference by your call partner. You are placed on hold while the conference is being set up.



You hear the music on hold while your call partner is setting up the conference. The recording is paused and the recording symbol LD has disappeared from the display.



Your call partner answers again and you are connected to the conference. You hear a beep and the recording symbol LD is shown in the "Conference" line. The conference call is now being recorded.

Putting a line on hold manually during the recording

There are two options for placing a line manually on hold:

- You place the active line on hold during the call recording and then resume the call on this line.
- You seize a different line during call recording. The first line is placed on manual hold.

Prerequisite: The telephone has more than one line configured. The active line is being recorded. The recording button LED is lighting.

Holding and retrieving the call on the line



You are conducting a call, for example on line A. You hear a beep and the recording symbol LD is shown on the display. The call is now being recorded.



Press line key A. The line key LED starts flickering. The call is placed on hold. The recording is paused while the call is on hold. The recording symbol LD on the display disappears.

Retrieving a held call:



Press line key A. The line key LED lights up. The call is retrieved. You hear a beep and the recording symbol LD is shown on the display again. Call recording is continued.

Holding a call on the line and conducting a call on a different line



Press line key B – the LED lights up. You hear a beep and the recording symbol LD is shown on the display for line B – this call on line B is being recorded. Line A is placed on hold, call recording of line A has been terminated.



Press line key A to resume the call. You hear a beep and the recording symbol LD is shown on the display for line A – a new recording of line A commences.

Diagnostic information

This information overview in the user area of the service menu provides you with information on the current configuration of the telephone:

Press the key shown.

Select and confirm the option shown.

Confirm the option shown.

Enter and confirm the user password.

Select and confirm the option shown.

You see a numbered list of telephone parameters with the current settings.

You can see a more structured view of the list via the WBM interface
→ Page 206:

Example:

Diagnostic Information		
2011-05-17 08:23:40		
00	terminal.number:	3335
01	sip.server:	192.168.1.240
02	sip.port:	5060
03	sip.registrar:	192.168.1.240
04	sip.registrar.port:	5060
05	sip.gateway:	
06	sip.transport:	UDP
07	sip.gateway.port:	5060
08	server.features:	No
09	dns.results:	5060
10	multiline:	No
11	registered.lines:	5060
12	backup.active:	Yes
13	backup.proxy:	
14	software.version:	V3 R0.22.0 SIP 110502
15	display.message:	None
16	last.restart:	2011-05-11T13:46:46
17	memory.free:	17,801K free
18	ip.adress:	192.168.1.202
19	subnet.mask:	255.255.255.0
20	default.route:	192.168.1.2
21	primary.dns:	192.168.1.105
22	secondary.dns:	192.168.1.2
23	route.1.ip:	
24	route.1.gateway:	None

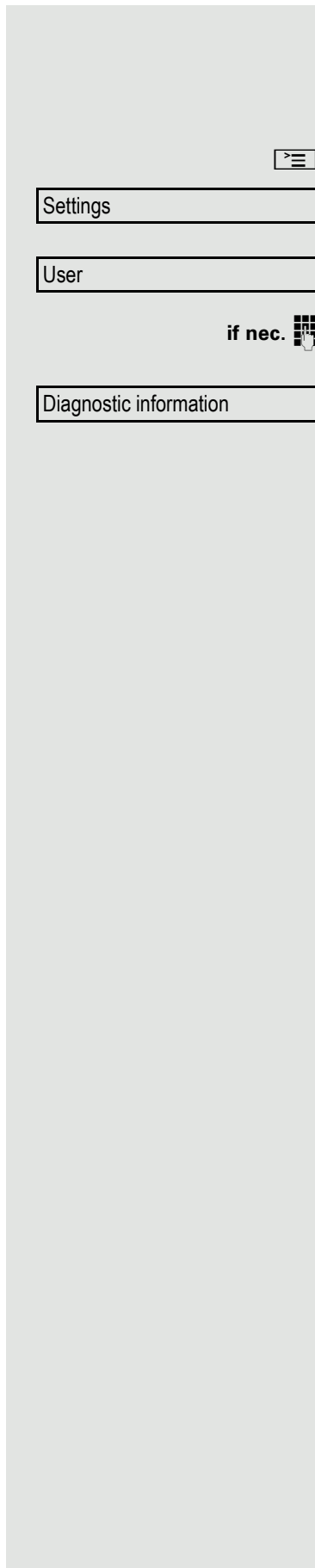

Diagnostic Information

25	route.1.mask:	None
26	route.2.ip:	None
27	route.2.gateway:	None
28	route.2.mask:	None
29	mac-address:	0001e32fc7be
30	discovery.mode:	Manual
31	dhcp.reuse:	No
32	lan.port.type:	0
33	pc.port.status:	None
34	pc.port.type:	0
35	pc.port.autoMDIX:	No
36	vlan.id:	
37	qos.layer.2:	No
38	qos.layer.2.voice:	5
39	qos.layer.2.signalling:	None
40	qos.layer.2.default:	0
41	qos.layer.3:	No
42	qos.layer.3.voice:	13
43	qos.layer.3.signalling:	7
44	lldp.med.operation:	No

Web interface (WBM)

General

You can configure a number of settings for your phone via the WBM interface. Communication is via a secure HTTPS connection. Access to the WBM interface must be activated by administrator.

Calling up the WBM interface

 For more information on the IP address, the WBM interface address, and how to connect the telephone to the network, refer to the section entitled "Network information" → Page 193.

To call up the WBM interface, open a Web browser and enter the following:

https://[IP address of the phone]

[IP address of the phone] is the IP address of your phone.

or

https://[Name of the phone]

[Name of the phone] which was assigned by administrator.

 You might receive a certificate notification from the browser. Follow the instructions to download the certificate.

You will be prompted to configure a user password the first time you call up the WBM interface → Page 142. You must log on with this password in future every time you want to open the User Pages.

Administrator Pages

This area lets you configure settings for administering your phone and the network environment. Access to the Administrator Pages is protected by the admin password. For more information, contact your administrator or refer to the administration manual.

User pages

The WBM interface homepage opens once you have entered and confirmed the phone's IP address.

1. Click a menu heading to display the individual menu entries. Click the menu heading again to close the menu.
2. Click a menu entry to open the corresponding form.
3. Make the desired changes.
4. Click the corresponding button to save or discard your changes.

Button functions

- "Login": Log on to the phone after you have entered the user password
- "Submit": Apply changes
- "Reset": Reset original values
- "Refresh": Update the values.
- "Logout": Log off the phone





User menu

All settings that you can make via the WBM interface's user menu can also be made via the phone's user menu → Page 36.







User Pages

User login  → Page 142



















Date and Time

































- Local time  → Page 176
- Local date (day, month, year)  → Page 176
- Allow daylight saving  → Page 177
- Difference (minutes)  → Page 177
- Auto time change  → Page 178

Audio

- Standard Ringer
 - Ringer melody  → Page 182
 - Ringer tone sequence  → Page 183
 - Ring file  → Page 181
 - Room Character  → Page 181
 - Open listening  → Page 42
- Special ringers  → Page 185
 - Internal
 - External
 - Recall (e.g. callback)
 - Emergency
 - Special 1
 - Special 2
 - Special 3

Configuration

- Outgoing calls
 - Autodial delay (seconds)  → Page 102
 - Callback option  → Page 58
 - Allow busy when dialling  → Page 103
 - Allow transfer on ring  → Page 96
 - Allow immediate dialling  → Page 50
- Incoming calls
 - Deflecting
 - Allow deflection ( → Page 83
 - Default deflect destination  → Page 83
 - Deflect to DSS  → Page 83
 - Forwarding (Call Forwarding by Call Type, see → Page 68)
 - Settings
 - Forwarding Favorites Destination 1 to Destination 5  → Page 63
 - Forward any call  → Page 66
 - to  → Page 65
 - Destination  → Page 62
 - Forward on busy  → Page 66
 - to  → Page 65
 - Destination  → Page 62
 - Forward on no reply  → Page 66
 - to  → Page 65
 - Destination  → Page 62
 - No reply delay (seconds)^[1]  → Page 67





- Alerts
 - Visual alerts  → Page 85
 - Audible alerts  → Page 85
 - Forwarding party  → Page 74
- Handling
 - Allow call waiting  → Page 93
 - Allow DND  → Page 141
 - Allow busy when dialling  → Page 103
- CTI calls
 - Allow auto-answer  → Page 97
 - Allow beep on auto-answer  → Page 97
 - Allow beep on auto-reconnect  → Page 98
- Connected calls
 - Allow call transfer  → Page 96
 - Allow call joining  → Page 56
 - Allow exit conference  → Page 106
 - Allow hold reminder  → Page 87
 - Hold reminder delay (minutes)  → Page 88
 - Hold and hang-up  → Page 89
 - Allow music on hold  → Page 90
 - Allow conferences  → Page 105
 - Allow secure call alert  → Page 186
 - Toggle associate  → Page 94
 - Lower IL alert  → Page 192
- Context menu
 - Auto show menu  → Page 191
 - Auto hide time (sec.)  → Page 191
- **Keyset**
 - Lines
 - Ring delay (seconds)  → Page 134
 - Allow in overview  → Page 133
 - Address¹
 - Primary line
 - Ring on/off
 - Ringer melody  → Page 136
 - Ringer tone sequence  → Page 136
 - Ringtone  → Page 135
 - Selection order
 - Hot-/Warmline
 - Hot warm destination  → Page 123
 - Overview
 - Use FPK order  → Page 136
 - Add all lines  → Page 136
 - Reordering directions: Move down, Move to bottom, Move to top, Move up  → Page 136
- BLF
 - Busy Lamp Field: **not** for OpenScape Voice
- **Call logging**
 - General
 - Enable call log  → Page 115
 - Missed calls²  → Page 116
 - Answered elsewhere
 - Delete entry

1. Only if "Server features" was deactivated by your administrator





1. Information - read only

2. Operation of the missed calls logging function for "Answered elsewhere" is dependent on support by the SIP server

Phone

- Display settings
 - Display brightness
 - -3
 - -2
 - -1
 - Default
 - +1
 - +2
 - +3
 - Contrast  → Page 172
 - Key module contrast  → Page 175
- Program keys
 - Normal
 - Edit  → Page 76.
 - Shifted
 - Edit  → Page 76.
- Key Module 1 (if available such as Program keys)
- Key Module 2 (if available such as Program keys)
- Key click
 - Volume
 - Off
 - Low
 - Medium
 - High
- Keys
 - Keypad only
 - All keys
- Energy saving
 - Backlight time
 - 1 minute (Preset)
 - 5 minutes
 - 30 minutes
 - 60 minutes
 - 2 hours
 - 4 hours
 - 8 hours



Locality

- Country  → Page 190
- Language  → Page 188
- Date format  → Page 179
- Time format  → Page 179

Security

- Password
 - Current Password
 - New password  → Page 142
 - Confirm password

Phone book

- Contact list  → Page 108
- New contact  → Page 108
 - Last name
 - First name
 - Number
- Delete all contacts  → Page 109
 - Confirm delete

Diagnostic information  → Page 204

Fixing problems

Caring for your telephone

- Never allow the telephone to come into contact with colouring, oily or aggressive agents.
- Always use a damp or antistatic cloth to clean the telephone. Never use a dry cloth.
- If the telephone is very dirty, clean it with a diluted neutral cleaner containing surfactants, such as a dish detergent. Afterwards remove all traces of the cleaner with a damp cloth (using water only).
- Never use aggressive or alcohol-based cleansers on plastic parts. The use of scouring agents is also forbidden.

Troubleshooting

Pressed key does not respond:

If the telephone is locked redial keys cannot be used. This also applies when an emergency number is saved on it.

Check whether your telephone is locked ("Phone locked. To unlock enter the PIN" appears on the screen). If the phone is locked, unlock it.

The phone does not ring on call:

Check whether the ringtone is deactivated (see icon in the status bar on the display → Page 24). If it is deactivated, activate the ringtone

The displayed time is incorrect:

The time is corrected automatically over night after 24 hours at the latest.

You cannot dial a number:

Check whether your telephone is locked ("Phone locked. To unlock enter the PIN" appears on the screen.). If the phone is locked, unlock it.

To correct any other problems:

First contact the relevant administrator. If the administrator is unable to correct the problem, contact Customer Service.

Contact partner in the case of problems

Contact your administrator if a fault persists for more than five minutes, for example.

Labeling keys

The following options are available for labeling keys of the OpenStage Key Module 15 (→ Page 17) with the functions or numbers assigned to them:

Labeling

- By hand:
Labeling strips are supplied with your OpenStage Key Module 15. Note the function or name in the white field on the strip and insert the strip on your OpenStage Key Module 15.
- With a computer via the Internet:
You can find the "online labeling tool" together with the user interface at http://wiki.unify.com/index.php/Key_Labeling_Tool.
- Select the appropriate key labeling tool in your language. You can use the tool online via the browser or you can download it for local use.

Local user menu

Opening the user menu on the phone

Press the  key to open the telephone menu.

On the **Settings** menu, open the **User** menu. You are prompted to enter the User password → Page 142. Confirm this with **OK**. The options of the user menu are available.

User menu display

The majority of settings that can be made via the user menu on the phone, can also be made via the WBM interface → Page 206.







Changes are usually confirmed using the **Save & Exit** option or discarded using the **Exit (Discard Changes)** option. You can exit the current menu level using the left key of the navigator (→ Page 19).

User

Date and time?

- Option: Save & Exit
- Exit (Discard Changes) → Page 176
- Time: hh:mm → Page 176
- Date: DD.MM.YYYY → Page 176
- Daylight saving: Yes → Page 177
 - Yes
 - No
- Difference (mins): mm → Page 177
- Auto DST: Yes/No → Page 178

Audio?

- Volumes?
 - Option: Save & Exit
 - Exit (Discard Changes)
 - Loudspeaker:  → Page 180
 - Ringer:  → Page 180
 - Handset:  → Page 180
 - Headset:  → Page 180
 - Handsfree:  → Page 180
 - Rollover:  → Page 180
- Settings?
 - Option: Save & Exit
 - Exit (Discard Changes)
 - Ringtone: Ring file → Page 181
 - Pattern
 - Ringer1.wav
 - Ringer2.wav
 - Ringer3.wav
 - Ringer4.wav
 - Ringer5.wav
 - Ringer6.wav
 - Ringer melody: 2 → Page 182
 - 1
 - 2

- 3
- 4
- 5
- 6
- 7
- 8
- Ringer tone sequence: 1 → Page 183
 - 1
 - 2
 - 3
 - 4
 - 5
 - 6
- Room character: Normal → Page 181
 - Normal
 - Echoing
 - Muffled
- Open listening: Standard mode → Page 183
 - Standard mode
 - US mode
- Headset socket: Cordless headset → Page 184
 - Wired headset
 - Cordless headset
 - Conference unit
- Special ringtones → Page 185
 - Internal
 - Option: **Save & Exit**
 - **Exit (Discard Changes)**
 - Available: Yes/No
 - Ringtone type: Ring file
 - Ringer6.wav
 - Ringer melody: 2
 - Ringer tone sequence: 1
 - External
 - Option: **Save & Exit**
 - **Exit (Discard Changes)**
 - Available: Yes/No
 - Ringtone type: Ring file
 - Ringer melody: 2
 - Ringer tone sequence: 1
 - Recall
 - Option: **Save & Exit**
 - **Exit (Discard Changes)**
 - Available: Yes/No
 - Ringtone type: Ring file
 - Ringer melody: 2
 - Ringer tone sequence: 1
 - Emergency call
 - Option: **Save & Exit**
 - **Exit (Discard Changes)**
 - Available: Yes/No
 - Ringtone type: Ring file
 - Ringer melody: 2
 - Ringer tone sequence: 1
 - Special 1
 - **Save & Exit**
 - **Exit (Discard Changes)**

- Available = Yes/No
- Ringtone = Ring file
- Ringer melody = 2
- Ringer tone sequence= 1
- Special 2
 - **Save & Exit**
 - **Exit (Discard Changes)**
 - Available = Yes/No
 - Ringtone = Ring file
 - Ringer melody = 2
 - Ringer tone sequence= 1
- Special 3
 - **Save & Exit**
 - **Exit (Discard Changes)**
 - Available = Yes/No
 - Ringtone = Ring file
 - Ringer melody = 2
 - Ringer tone sequence= 1
- Back

⊞ User Configuration?

- **Outgoing calls?**
 - Option: Save & Exit
 - Exit (Discard Changes)
 - Autodial delay: 6 → Page 102
 - 1
 - 2
 - 3
 - 4
 - 5
 - 6
 - 7
 - 8
 - 9
 - Callback: Yes → Page 58
 - Yes
 - No
 - Busy when dialling: Yes → Page 103
 - Yes
 - No
 - Transfer on ring: Yes → Page 96
 - Yes
 - No
 - Immediate dialling: Yes → Page 50
 - Yes
 - No
- **Incoming calls?**
 - Deflecting?
 - Option: Save & Exit
 - Exit (Discard Changes)
 - Allow deflection: Yes → Page 83
 - Yes
 - No
 - Default destination: → Page 83
 - Deflect to DSS: Yes/No^[1] → Page 83
 - Forwarding (Advanced call forwarding, see → Page 68)

1. Information - read only

- Settings?
 - All calls: 12345 → Page 66
 - Enter destination (context menu) → Page 63
 - List of saved numbers (context menu), if applicable
 - Edit favourites (Context menu) → Page 63
 - Option: Save & Exit
 - Exit (Discard Changes)
 - Destination 1
 - Destination 2
 - Destination 3
 - Destination 4
 - Destination 5
 - Copy → Page 63
 - Paste (if copying is active) → Page 63
 - Busy → Page 66
 - Enter destination (context menu) → Page 63
 - List of saved numbers (context menu), if applicable
 - Edit favourites (Context menu) → Page 63
 - Option: Save & Exit
 - Exit (Discard Changes)
 - Destination 1
 - Destination 2
 - Destination 3
 - Destination 4
 - Destination 5
 - Copy → Page 63
 - Paste (if copying is active) → Page 63
 - No reply: → Page 66
 - Enter destination (context menu) → Page 63
 - List of saved numbers (context menu), if applicable
 - Edit favourites (Context menu) → Page 63
 - Option: Save & Exit
 - Exit (Discard Changes)
 - Destination 1
 - Destination 2
 - Destination 3
 - Destination 4
 - Destination 5
 - Copy → Page 63
 - Paste (if copying is active) → Page 63
 - Set delay^[1] → Page 67
- Alerts
 - Option: Save & Exit
 - Exit (Discard Changes)
 - Visual alerts: No → Page 85
 - Yes
 - No
 - Audible alerts: No → Page 85
 - Yes
 - No
 - Forwarding party: Display last → Page 85
 - Display first
 - Display last
- Handling
 - Option: Save & Exit
 - Exit (Discard Changes)
 - Allow call waiting: Yes → Page 93
 - Yes

1. Only if "Server features" was deactivated by your administrator



- No
- Allow DND: Yes → Page 141
 - Yes
 - No
- Busy when dialling: Yes → Page 103
 - Yes
 - No
- CTI calls?
 - Option: Save & Exit
 - Exit (Discard Changes)
 - Auto-answer: Yes → Page 97
 - Yes
 - No
 - Beep on auto-answer: Yes → Page 97
 - Yes
 - No
 - Beep on auto-unhold: Yes → Page 98
 - Yes
 - No
- **Connected calls?**
 - Option: Save & Exit
 - Exit (Discard Changes)
 - Allow call transfer: Yes → Page 96
 - No?
 - Return?
 - Allow call joining: Yes → Page 56
 - Yes
 - No
 - Join in conferences: Yes → Page 106
 - Yes
 - No
 - Allow hold rem.: Yes → Page 87
 - Yes
 - No
 - Hold rem. delay: 8 → Page 88
 - 3?
 - 4?
 - 5?
 - 6?
 - 7?
 - 8?
 - 9?
 - 10?
 - 11?
 - 12?
 - 13?
 - 14?
 - 15?
 - Hold and hang-up Yes → Page 89
 - Yes
 - No
 - Music on hold: Yes → Page 90
 - Yes
 - No
 - Allow conferences: Yes → Page 105
 - Yes
 - No

- Secure call alert: Yes → Page 186
 - Yes
 - No
- Toggle associate: Yes → Page 94
 - Yes
 - No
- Lower IL alert → Page 192
 - Yes
 - No
- **Context menu**
 - Automatic display menu Yes → Page 191
 - Yes
 - No
 - Display time 20 → Page 191
 - 5
 - 10
 - 20
 - 30
 - 60
 - 120
 - Unlimited no.
- **⊞ Keyset?**
 - Lines?
 - Line (one of **eight** possible)
 - Option: Save & Exit
 - Exit (Discard Changes)
 - Ring delay: 0 → Page 134
 - Allow in overview: Yes → Page 133
 - Yes
 - No
 - Hot warm action^[1]: No action
 - Hot warm dest: nnnn → Page 123
 - Address^[1]: nnnn
 - Ring on/off^[1]: On
 - Selection order^[1]: 1
 - Ringtone = Ring file → Page 135
 - Ringer melody = 2 → Page 135
 - Ringer tone sequence = 1 → Page 135
 - Overview? → Page 136
 - Line (up to **eight** lines)
 - Move down
 - Move to bottom
 - Use FPK order
 - Add all lines
 - Save
 - Do not save
 - **BLF?** : Busy Lamp Field: **not** for OpenScape Voice
 - Return?
 - Call logging
 - General → Page 115
 - Option: **Save & Exit**
 - **Exit (Discard Changes)**
 - Enable call log -> Yes → Page 115
 - No
 - Missed calls → Page 116
 - **Save & Exit**

1. Information - read only

- **Exit (Discard Changes)**
- Answered elsewhere = Exclude
 - Include
- Delete entry = When called
 - Manually

☒ Phone?

- Display?
 - Option: Save & Exit
 - Exit (Discard Changes)  → Page 174
 - Brightness  → Page 172
 - Contrast:  → Page 175
 - Key mod. contrast:
- Program keys
 - Press the key to be programmed*
 - Option: Save & Exit
 - Exit (Discard Changes) → Page 76
 - Normal: Unallocated → Page 76
 - Unallocated
 - *Further functions, see* → Page 222
 - Label: *predefined or customised*
 - Settings: *function-dependent*
 - Shifted: Unallocated → Page 76
 - Unallocated
 - *Further functions, see* → Page 223
 - Label: *predefined or customised*
 - Settings: *function-dependent*
- Key Module (if available such as Program keys)
- Key click
 - Option Save & Exit
 - Exit (Discard Changes) → Page 187
- Volume → Page 187
 - Off
 - Low
 - Medium
 - High
- Keys → Page 187
 - Keypad only
 - All keys
- Energy saving mode → Page 174
 - Time for background lighting
 - Background lighting: 1 minute
 - Background lighting: 5 minutes
 - Background lighting: 30 minutes
 - Background lighting: 60 minutes
 - Background lighting: 2 hours
 - Background lighting: 4 hours
 - Background lighting: 8 hours
- Return?

Locality?

- Option: Save & Exit
 - Exit (Discard Changes) → Page 190
- Country: DE → Page 190
 - DE?
 - *Further countries, see* → Page 190
- Language: Deutsch → Page 188

- Deutsch
- *Further languages, see* → Page 189
- Date format: dd/mm/yy → Page 179
 - dd/mm/yy
 - yyyy/mm/dd
 - mm/dd/yyyy
- Time format: 24 hour → Page 179
 - 24 hour
 - 12 Hour (AM/PM)

Security?

- Change user password → Page 142
 - Option: Save & Exit
 - Exit (Discard Changes)
- Current password:
- New user password:
- Confirm New user password:
- Phone lock → Page 145
 - Option: Save & Exit
 - Exit (Discard Changes)
- Phone lock: No
- Yes

Network information?

- Option: Exit
- Phone address: → Page 193
- Web address:
- IP address:
- LAN RX:
- LAN TX:
- PC RX:
- PC TX:
- LAN autonegotiated: Yes
- LAN information: 10 Mbps full duplex
- PC autonegotiated: Yes
- PC information: Link down

Diagnostic information → Page 204**Reset?**

- Option: Cancel
- Cancel
- Reset all user data → Page 194
- Reset selected user data → Page 81
- Function key data: No? → Page 81
 - Yes
 - No

Key functions

Normal

You can program the following functions on the Normal of the function keys:

- Unallocated
- Selected dialing
- Repeat dialing
- CF unconditional
- CF no reply
- CF busy
- CF unconditional - any
- CF unconditional – int.
- CF unconditional – ext.
- CF busy - any
- CF busy – int.
- CF busy – ext.
- CF no reply - any
- CF no reply – int.
- CF no reply – ext.
- Ringer off
- Hold
- Alternate
- Blind transfer call
- Transfer call
- Deflecting
- Shift
- Conference
- Headset
- Do not disturb
- Group pickup
- Repertory dial
- Feature toggle
- Show phone screen
- Mobility
- Directed pickup
- Release
- Callback
- Cancel callbacks
- Consultation
- Call Waiting toggle
- Immediate ring
- PreView
- Call recording
- Start application
- Built in fwd
- Personal directory
- Pause callbacks
- Resume callbacks
- Opening the phonebook

Shifted

You can program the following functions on the Shifted of the function keys:

- Unallocated
- Selected dialing
- Repeat dialing
- Alternate
- Blind transfer call
- Transfer call
- Deflecting
- Conference
- Repertory dial
- Show phone screen
- Directed pickup
- Callback
- Cancel callbacks
- Consultation
- Open phonebook
- Pause callbacks
- Resume callbacks

Index

Numerics

2nd alert 47

A

Accepting calls
 multi-line 118
Administration 36
AICS Zip tone 53
Alternate 54
Announcing the local phone number 167
Answered elsewhere 116
Audio
 room character 181
 volume 180
Audio controls 18
Audio keys 18
Autodial delay 101
Auto-Headset 53
Auto-headset 39

B

Background lighting 174
Busy override 124
Busy when dialling 47

C

Call
 accepting 39
 deflect 82
 ending 43
 hold 86
 incoming 38
 transfer 95
Call control 47
Call forwarding
 Activate/deactivate 66
 Activating/deactivating 73
 Copy and insert destination phone numbers 63
 Copying/pasting destination phone numbers 71
 Destination phone number 62, 69
 Favourites 63, 71
 Last destination 69
 last destination 61
 Save destination phone number 63
 Saving a destination phone number 70
 Variable 62, 69

Call forwarding chain 74
Call forwarding favourites 63
Call forwarding information 120
Call lists 33, 111
Call log 33
Call recording
 alternating 201
 automatic 198
 AutoStart 198
 call types 196
 conference 202
 consultation 200
 controlling 199
 line key 203
 manual 198
 modes 195
 Multiline 197
 second call 200
 symbols 197
 tips 197
 using 197
Call settings
 CTI calls 181
 MultiLine 133
Call type 79
 All calls 68
 Assigning destination phone number 72
 External 68
 Internal 68
Call types 68
Call waiting 91
Callback 57
Calls
 Forwarding 60
 Rejecting 84
CE marking 3
Conference 104
conference
 starting conference 52
Connection options 15
Consultation 47, 52
Consultation call from second call 91
Context 50
Context menus 25
Copy and insert destination phone numbers 63
Copying/pasting destination phone numbers 71

- ## D
- Date 176
 - Deactivating the ringer temporarily 140
 - Delete the entry 116
 - Destination phone number 62, 69
 - Diagnostic call 37
 - Dial plan 101, 145
 - Display icons 24
 - Display settings
 - brightness 173
 - contrast 172
 - Do not disturb 140
 - DSS call
 - call deflection 127
 - DSS key
 - consultation 125
 - indirect pickup 126
 - reject call 126
 - During calls
 - multi-line 121
- ## E
- Emergency call 145
 - Emergency number 145, 146
 - Energy saving mode 174
 - Error message
 - Mobility expired 147
 - Executive/secretary 128
- ## F
- Favourites for call forwarding 71
 - Forced logoff 151
 - Forwarding primary line 120
 - Function keys 18
- ## G
- General information 12
 - Graphic display 24
 - call lists 34
 - icon indicating call status 27
 - Voicemail 32
 - Graphic display settings
 - brightness 173
 - contrast 172
 - Group call 44
- ## H
- Headset 82
 - answering call automatically 39
 - Automatically accept call 53
 - Hot line 51
 - for lines 123
- ## I
- Icons 24
 - Immediate dialing 50, 101
 - Immediate ring 80
 - Important information 4
 - Incoming calls
 - multi-line 118
 - Intercom 165
- ## K
- Key click 187
 - Key module contrast 175
 - Key modules 17
 - Keypad 22
- ## L
- Language setting 188
 - country setting 190
 - language for user prompts 188
 - LDAP 111
 - LED display
 - direct station selection keys 20
 - function keys 20
 - Line preview 137
 - Line utilization 21
 - Lines
 - hot/warm line 123
 - Lists (for phone numbers and contacts) 114
 - Location of the telephone 4
 - Logging on and off
 - as a mobility user 148, 150

M

Making calls	
multi-line	119
Microphone	43
Mobility	147
Expired	147
forced logoff	151
logon, logoff	148, 150
User-defined settings	147
Multi-line	
accepting calls	118
LED display	21, 127
Multiline	
busy override	124
Multi-line telephone	13

N

Navigator	19
Normal dialing	50

O

One-way Intercom	165
Open listening	42
OpenScape Voice	152
"last caller redial" function	51
abbreviated dialing	
two-key abbreviated dialing	157
accepting anonymous calls	156
call tracing	157
creating a list for selective calls	155
Feature toggle key	152
functions	152
hunt group	158
making anonymous calls	153
parallel call	161
parking	162
reachability	160
rejecting anonymous calls	156
serial call	160
silent monitoring	163
OpenStage Key Module 40	17
Operating instructions	3
Out-of-hours call	168
Overview tab	129, 132

P

Padlock icon	38
Parallel call	161
Parking	162
Pattern melody	182
Pattern sequence	183
Phantom line	21
Phone number directories	114
Phone settings	172
Phonebook	30
LDAP	31, 111
local phonebook	30
new contact	108
Picking up out-of-hours calls	168
Picking up the held call	40
Pop-up menu	27
Primary line	21
Privacy	139
Private line	21
Program/Service menu	35
Programmable sensor key	75
Programmable sensor keys	20

R

Reachability	160
Redial	51
multi-line	120
Redial keys	99
Resetting sensor keys	81
Ringer melody	136
Ringer off	139
Ringtone for lines	135
Ringtone sequence	136

-
- ## S
- Safety precautions 3
 - Save destination phone number 63
 - Saving a destination phone number 70
 - Search contacts, 30
 - Second call 91
 - deflecting 92
 - ignoring 92
 - rejecting 92
 - Second call with consultation call 91
 - Second ringing call 47
 - Secondary line 21
 - Security 139
 - Serial call 160
 - Set headset port 184
 - Settings 172
 - Shared line 21
 - Silent monitoring 163
 - Single-line telephone 13
 - Speakerphone mode 39, 41
 - speakerphone distance 4
 - Status icons 24
- ## T
- Telephone maintenance 212
 - Telephony interface
 - single line 27
 - Time 176
 - Time display format 179
 - Troubleshooting 212
 - Trunk keys 21
 - Two-way Intercom 165
- ## U
- Unlocking the phone 146
 - User interface 14
 - User support 13
 - Using Ethernet switches 16
 - Using network ports more efficiently 16
- ## V
- Variable call forwarding 62, 69
- ## W
- Warm line 51
 - for lines 123
 - Web interface 206, 214