

£2.00
There's no other choice!

Hi-Fi WORLD

APRIL 1995 £2.00 *For the love of music*

BUDGET LOUDSPEAKERS
- KEF CODA 7 AND
MISSION 731
BATTLE IT OUT
FIVE PAGES OF
BARGAIN USED HI-FI.
THE BEST CHOICE
AVAILABLE!

SCOOP!

MICHELL ORBE

THE BEAUTY OF VINYL

SUPPLEMENT NO. 14
banded to this issue



LINN MIMIK CD PLAYER

**HEYBROOK'S HEYSTAK
LOUDSPEAKERS**

**COMPETITION - WIN DPA'S
ENLIGHTENMENT CD PLAYER**



Trust your instincts.



 naim audio
FOR NATURAL LISTENERS

HI-FI CD PLAYERS AMPLIFIERS
TUNERS TONEARMS LOUDSPEAKERS

FOR FURTHER INFORMATION, A COLOUR BROCHURE OR THE NAME OF YOUR NEAREST STOCKIST PLEASE RING 01722 332266.
NAIM AUDIO LTD, SOUTHAMPTON ROAD, SALISBURY SP1 2LN.

This Month's World



This month we are focussing on the state of CD and LP today, bringing you the latest views and developments.

- Michell Engineering produce some fine turntables. This month we've pulled out all the stops to bring you their fabulous new Orbe, a turntable that will surely get the best from any record collection. Who wouldn't aspire to such an intriguing product in their home? There's still plenty of wonder left in vinyl - including its sound!
- Vinyl is enjoying a modest but significant revival worldwide, helped along by musicians, DJs and independent record companies who've campaigned strongly to preserve part of our musical heritage. We've been watching developments closely and bring you the full story on page 21.
- What happens when LP master craftsmen Linn turn their impressive skills to the CD player? Most of the Mimik, reviewed on page 13, is made in-house by their dedicated engineering facilities. Few British audio manufacturers make so much of a player themselves. This is the level of commitment they're bringing to improving of Compact Disc.
- When Pioneer launched Legato Link, they talked about capturing the secrets of analogue sound on CD. Denon have followed them with Alpha Processing, now available on their affordable DCD-1015 player. It too is meant to produce smooth, analogue-like sound. Does it succeed? See our detailed review on page 25.

How ironic that more and more people in the electronics and music business should now use "analogue sound" as a benchmark of quality! Once CD was believed to be perfect. Now people are talking of the need to recapture that certain 'magic' of original analogue sources. CD's hard, sterile presentation is now acknowledged as deficient, and the race is on for improvement.

At Hi-Fi World we've always tried our hardest to crank CD sound up to LP quality, but still the invisible barrier of its inadequate specification remains. Having heard improved CD at length, in the form of HDCD, we know that significant improvement is both needed and possible. This is the future - CD that sounds more like LP, but without its weaknesses.

Sadly, it's already looking a bit confused, with audio HDCD, Multimedia CD and now Super Density CD. Stay with us at Hi-Fi World and keep listening - we'll be keeping you abreast of these new developments.

Noel Keywood,
Editor

Distributed by:
COMAG, Tavistock Road,
West Drayton,
Middlesex, UB7 7QE
Tel: 0895 444055

Origination by:
Ashford Scanning
2 Norfolk Drive,
Fairwood Industrial Park,
Asford, Kent TN23 2FB
Tel: 0233 622042

Printed by:
Southernprint,
Poole, Dorset.
Tel: 0202 622226

All unsolicited submissions are made at the owners risk. We accept no responsibility for such submissions, nor do we undertake to return them.

No material may be reproduced from this magazine without the publisher's written permission.
© Audio Publishing Ltd

Editor
Noel Keywood
Assistant Editor
Dominic Baker
Production Editor
Ferewini T. Michael
General Manager
Mark Winfield
Marketing Manager
Richard Johnson
Advertising Executives
Tom Towry
Simon Reid
Design Engineer
Andy Grove
Technical Assistant
Nick Lucas

Contributors
Eric Braithwaite
Richard Brice
Giovanni Dadomo
Peter Herring
Simon Hopkins
Dominic Todd
Jon Clarke

CONTACT NUMBERS

10 am - 6pm
Tel: 071-289 3533
Fax: 071-289 5620

Individual queries cannot be answered by telephone.

MAIL ORDER

Tel: 071-266 0461
(24 hour answerphone)

SUBSCRIPTIONS

see page 68 for details

AUDIO PUBLISHING LTD

64 Castellain Road,
Maida Vale,
London W9 1EX.



AMPLIFIERS

LIFE ON A BUDGET

David Price gauges how five popular £250 amplifiers from Arcam, Aura, NAD, Pioneer and Pro-Ject cope with the rigours of daily life.

33



JAMO 307

Dominic Baker assesses the chances of Scandinavian manufacturer Jamo's latest £300 bookshelf loudspeaker.

57

TURNTABLE EXCLUSIVE!

MICHELL ORBE

John Michell's stunning new super-deck gets its first review by Eric Braithwaite.

18

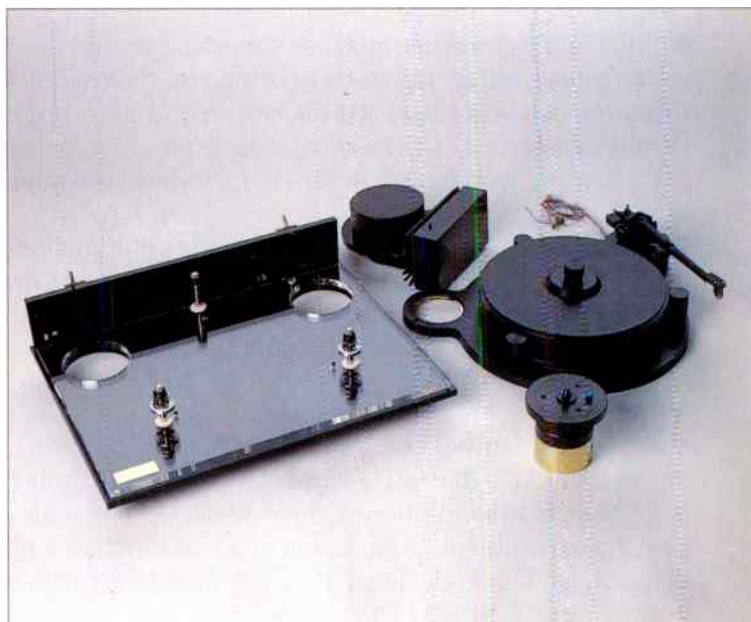

COMPACT DISC

LINN MIMIK

Noel Keywood and David Price find that Linn's most affordable CD player, the £800 Mimik, will be just the ticket for digital Linnies.

13

DENON DCD1015

Noel Keywood auditions Denon's new CD player, featuring the cheapest implementation of their Alpha Processing system to date.

25

JVC XL-Z574

David Price finds that the XL-Z574 is not in fact a cruise missile but a humble domestic JVC Compact Disc player, and quite a good one, too.

50

DIGITAL COMPACT CASSETTE

PHILIPS DCC 170

David Price auditions Philips' new portable 18-bit Digital Compact Cassette player.

51



LOUDSPEAKERS

MISSION 733

Yet another budget loudspeaker from Mission - how do they do it, we ask ourselves! Noel Keywood auditions these new £300 floorstanders.

42

HEYBROOK HEYSTAK

The Heystaks are the latest floorstander to emerge from the Heybrook factory. Lionel Coleman takes a listen.

26

KEF CODA 7 MEETS MISSION 731

David Price compares two of the best budget standmounters on the market.

29

TUNER

ROTEL RT-990BX

Avid radio listener Eric Braithwaite reviews Rotel's promising new Michi-based tuner.

58

HEADPHONES

SENNHEISER HD565

Dominic Baker auditions the latest from highly respected German headphone manufacturer Sennheiser.

65

REGULARS

NEWS 7

An in-depth look at what's happening in the hi-fi world.

LETTERS 40

World readers expound on issues that concern us all.

QUERIES 48

The team get to grips with your hi-fi problems

MEET YOUR MAKER 52

Who makes what and how to get in touch.

COLUMNS 61, 64, 69, 72

Comment, criticism and overviews on the ever-changing hi-fi scene.

NEXT ISSUE 60

What better way to while away April showers than with the latest issue of your favourite publication? Or you could always check out next month's Hi-fi World.

COMPETITION 66

Once again World offers you the chance of an instant upgrade!

SUBSCRIPTIONS 68

No more tedious trips to the newsagent and you'll have the pick of the classifieds. What greater reason for subscribing do you need?

WORLD FAVOURITES 70

The return of our list of essential auditions!

SPECIALIST HI-FI DEALERS 77

The place to go for expert hi-fi advice and service. If your video's broken or your cinema sound won't work, look elsewhere.

WORLD AUDIO DESIGN 82

A range of high performance kits for the enthusiast, from carbon-fibre coned 'speakers to parallel single-ended valve amps.

DIAL-A-DEALER 89

Who sells what, and how to get in touch.

ACCESSORIES 98

All you need to keep that system in the best of health.

HI-FI WORLD LIBRARY 100

A collection of highly readable titles, many of which are definitive publications in their sphere.

MEASURED PERFORMANCE SECTION 105

Noel and Dominic switch on the HP3561A and opine on matters technical.

READERS' CLASSIFIEDS 120

The best place to find the widest variety of 'previously owned' hi-fi equipment in the UK.

ADVERTISER'S INDEX 130

FEATURES

VINYL SPECIAL 21

David Price finds out exactly what's happening to that most treasurable of commodities, the vinyl disc.

HOW TO GET GOOD STEREO PART II 62

Noel Keywood brings proof positive that stereophonic sound does exist and can actually be recreated successfully in the home.

DIY SUPPLEMENT

In this month's DIY Supplement there's a transmission line monitor loudspeaker using HDA drivers, a feature on preamp valves, book reviews and much more for the hi-fi enthusiast.

MUSIC

Our guide to some of the best new releases.

ROCK RECORD OF THE MONTH:

Carter USM: Worry Bomb

CLASSICAL RECORD OF THE MONTH:

Leos Janacek: Msa Glagolskaja (Glagolitic Mass)

ROCK AND POP 73

JAZZ 86

CLASSICAL 93

COMPETITION

Win a DPA Enlightenment drive and convertor - one of the best ways to play CDs. 66





CHORD SOLID

"Suona magnificamente e costa accettabile"
Suona (Sound, Italy)

"A rare and wonderful sense of communication"
Hi-Fi Choice

*"Wonderfully transparent, polished sound that really
allows you to hear into the music easily"*
What Hi-Fi

*"Tamed unwanted sibilance making
the sound more natural"*
Audiophile

"Amazing upgrade that was worth every penny"
Mr. R. Ness, Zeals

PART EXCHANGE OFFER

*We will give £30 off rrp
of the Chord Solid
in exchange for
your old interconnect.*

(Offer valid 1/3/95 - 30/6/95)

For information on the finest handmade AV leads, interconnects, speaker cables and loudspeakers, please return the coupon.

Interconnects Please tick required box	Speaker Cables	Loudspeakers	AV Leads	ADDRESS _____
NAME _____				POST CODE _____

The Chord Company, 30a Sarum Business Park, Portway, Salisbury, Wiltshire SP4 6EA. Tel: 01722 331674 Fax: 01722 411388

TOSHIBA ANNOUNCES MULTIMEDIA CD RIVAL!

Out of the blue comes the announcement that there is to be a rival for the Philips/Sony Multimedia Compact Disc. Called the Super Density disc, or SD disc, it's a double-sided CD capable of storing nearly four and three-quarter hours of video (142 minutes per side) - enough to accept any film. Up to eight channels of audio will be available, either for surround sound or for multiple languages. Although double sided, the CD would not be turned over manually like an LP, but read from both sides sequentially by a couple of lasers.

We understand that Sony have already complained to MITI, Japan's governmental Ministry of International Trade and Industry, asking them to intervene in what could be a potentially disastrous battle between rival systems. Otherwise there could be a re-run of the VHS/Betamax/Video 2000 battle, but this time over non-recordable video discs. The general view is that such conflicts seriously undermine consumer confidence and do no one any good.

Sony and Philips are facing an overwhelmingly powerful alliance of rival manufacturers. In addition to Toshiba, who developed the new SD disc, Hitachi, Matsushita (Technics and Panasonic), Pioneer, Thomson and Time Warner are all supporting the format. Others giving it endorsement are Mitsubishi, JVC, Denon, and Toshiba-EMI.

With a storage capacity of no less than 10 Gigabytes, the new discs could offer fantastic audio quality. Furthermore, SD players could read today's CDs, possessing what's known as 'backward compatibility'. Needless to say, they could also act as computer read-only (ROM) memories.

The new SD player relies upon use of a shorter wavelength red laser, instead of infra red used at present, to pack more information onto a normal 5in disc. New modulation and error correction schemes also help, plus digital video data compression. So the system is much like that proposed by Philips and Sony, where standard CD is upgraded by using smaller pits on a tighter spiral than at present, plus more efficient information coding techniques. The official press release even mentions use of a blue laser in future.

Sony and Philips, in conjunction with 3M, are also developing a multi-layer disc that is read from one side by a laser able to re-focus to different depths. IBM has carried out research into this approach too. So we are now faced with a single-sided, multilayer video CD versus a double-sided disc which can hold similar amounts of data. Both are aimed primarily at the video replay market, where they offer a cheap (to produce), compact and lightweight alternative to the videocassette. But they could also store very high quality audio. First however, the consumer electronics industry has to decide whether it again wants to face consumers with confusingly similar rival technologies.

trade winds

trade winds

trade winds

trade winds

trade winds

trade winds

TOSHIBA

trade winds

trade winds

trade winds

trade winds

trade winds

No use showing you our amplifiers – as you can't listen to this advertisement.

Visit your Electrocompaniet dealer today
and experience the *real* thing.



Worldwide Electrocompaniet Distributors

Austria (02) 227992158 - Australia (03) 8820372 - Bangkok 22241669 - Belgium (011) 229659 - Canada (416) 4957485
Costa Rica (506) 2260282 - Croatia (05) 8589742 - Finland (914) 45751 - France (01) 48918907 - Germany (071) 214779 - Greece (01) 9597560
Hong Kong 3140811 - Italy (02) 2367595 - Japan 334873441 - Mexico 9054001962 - Norway 22112218
Portugal 19831112 - Russia (095) 2362377 - Spain (06) 3510798 - Singapore 3391991 - Sweden (031) 133535 - Switzerland (091) 431734
Taiwan 5512525 - Turkey 2125192280 - U.S.A. (516) 2617700 - U.K. (01243) 533030

Electrocompaniet AIS - P. O. Box 92 - N - 1473 Skårer - Norway - Fax: +47 67909787

MICHELL ORBE-IT!

It costs £1950, looks stunning and plays analogue records in an almost unsurpassed way! Yes, J.A. Michell Engineering have introduced a new turntable that takes over from the Gyrodec as their top deck. The Orbe features two acrylic bases for improved vibration immunity, a 60mm thick carbon-loaded acrylic platter, and the Gyrodec's Papst motor in a totally isolated 2.5kg machined brass and aluminium housing.

The Orbe is finished in black and clear acrylic with a black subchassis, and comes with Michell's QC power supply as standard, as

well as Gyro-style drop-in armboards. There's even an optional motor pulley available that provides a 78rpm facility! Gyrodec fans need not dismay, for it continues in production, now in its fourteenth year.

For an exclusive review of the Michell Orbe, see page 18 of this month's issue. It can also be seen at the Bristol Show in Room 306.

J.A. Michell Engineering Ltd.,
2 Theobald Street,
Borehamwood,
Herts.
Tel: 0181 953 0771

WAKONDA HAS BRILLIANT FUTURE?

Linn's new Wakonda preamp continues their passion for flexibility, future-proofing and multi-room systems. Designed to accept 'Sneaky' modules facilitating expansion at a later date, tuner, line driver or line receiver modules can be subsequently added. Linn claim that the Wakonda

"outperforms much more costly preamplifiers". It is priced at £524 for the line version, and £593 for the phono version.

Linn have also introduced what they describe as "the world's first universal hi-fi power supply", modestly dubbed the "Brilliant". Featuring switch mode technology, it is

designed to replace conventional transformer-based power supplies used in Linn products such as the Wakonda and Kairn preamplifiers, Kremlin tuner and Karik/Numerik CD player.

The Brilliant is claimed to yield "vastly improved sound quality", thanks to its better immunity from the mains supply, reduced interference and noise, superior energy efficiency and improved electro-magnetic compatibility. If it effects anything like the change that the Lingo had on the LPI2, Linn could be onto another winner.

As a retrofittable upgrade available through Linn dealers, the Brilliant costs £289 including VAT.

Linn Products,
Floors Road,
Waterfoot,
Glasgow G76 0EP.
Tel: 041 644 5111

EPOS STEP UP THE PACE

Epos Acoustics aren't quite the most prolific UK manufacturer when it comes to new models, so it's always an event when they launch a new loudspeaker! The three-way ES25 is said to be a "prestige floorstander", designed to complement existing models (all two of them) in the range. At £1505 it comes handsomely finished in real wood veneer.

Claimed to be suited to amplifiers rated between 40 and 200 watts, it seems the new speaker has been designed to go loud, having an above average 88dB sensitivity. The Epos ES25s are on demonstration now at dealers nationwide.

Epos Acoustics,
3 Ridgway, Havant,
Hampshire. PO9
1JS
Tel: 0705 407722



POMPEII ROCKS

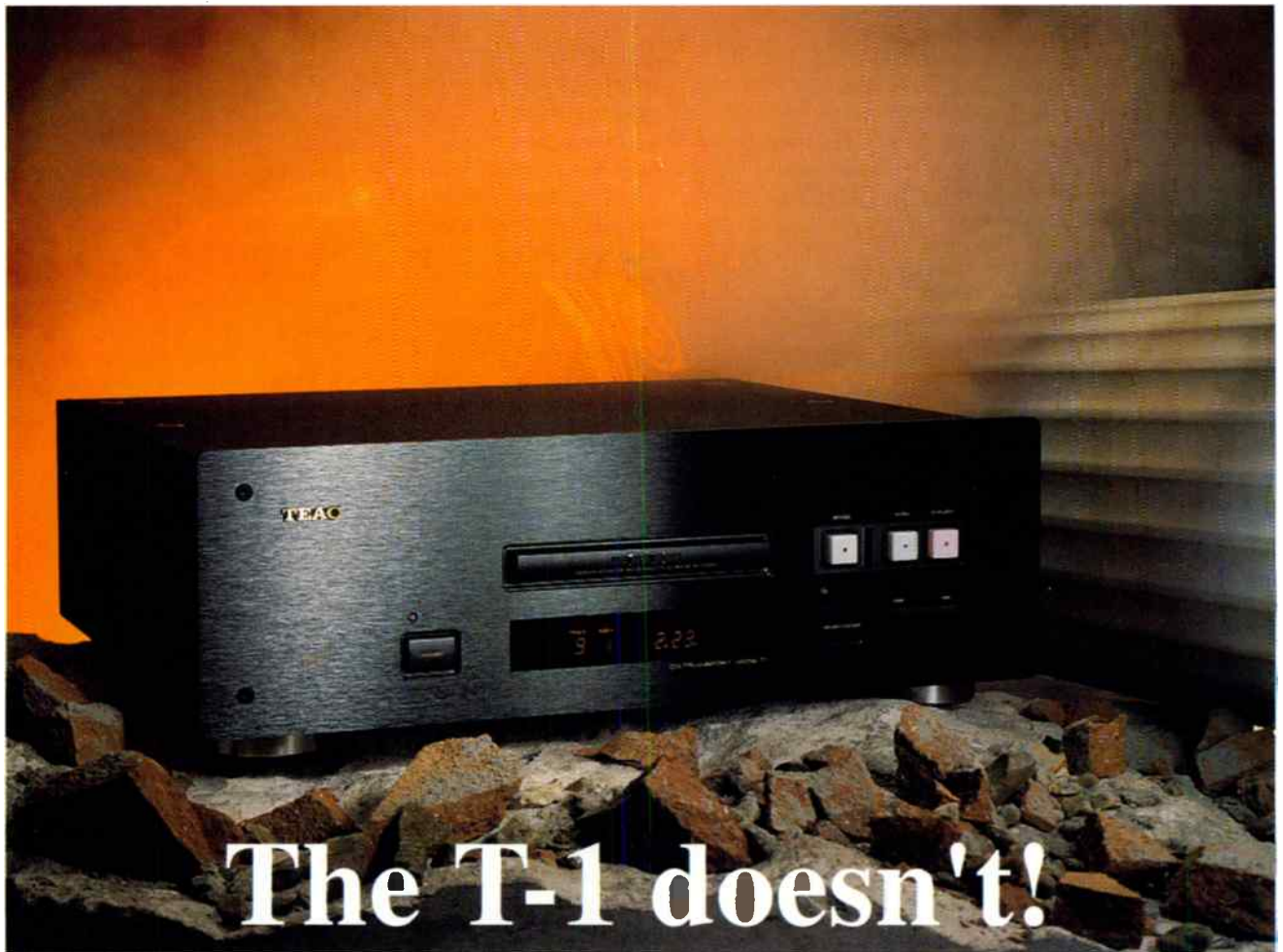

The T-1 doesn't!

Even in the shaky surroundings of old Pompeii the New TEAC T-1 CD Transport would still have delivered the goods.

The T-1 places the acclaimed vibration-free VRDS mechanism within reach of those looking for the cost effective path to CD upgrades.

What sets the VRDS mechanism apart from standard CD players is its ability to reduce the vibration induced in the spinning disc.

As the diagram on the right shows, a normal CD transport of the type used in budget and high end players alike, only clamps the CD at its centre.

As the diagram on the right shows, a normal CD transport of the type used in budget and high end players alike, only clamps the CD at its centre. As the disc itself is rotating at high speed it oscillates and vibrates making it difficult for the pickup lens to track the minute pits on the CD surface with the necessary accuracy.

VRDS Mechanism

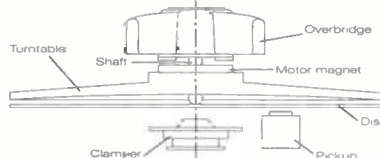

Standard CD Mechanism

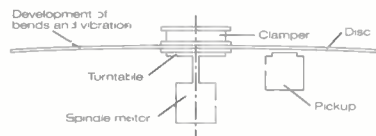

TEAC

VRDS

Much of the information available may be read incorrectly or in a corrupt form, contributing greatly to distortion within the signal that is fed to the DAC.

The VRDS mechanism significantly reduces this effect by clamping the whole width of the disc thus reducing the vibration that causes jitter.

This all adds up to a Transport that does the job of retrieving information better than any other comparable drive on the market, providing your DAC with the most accurate signal possible.

Because the T-1 does give you one of the best mechanisms in the world, you can buy in confidence knowing that you have the perfect source for any DAC upgrade, now or in the future.

If it was available to the ancient Romans they would probably still be using it now - in spite of earthquakes!

Please send me information on the TEAC VRDS range

Name _____

Address _____

Postcode _____

TEAC 5 Marlin House, The Croxley Centre, Watford, Herts
WD1 8YA TEL: 0923 819630 FAX: 0923 236290

World Radio History

AUDIOVECTOR PLOT A NEW DIRECTION

Danish manufacturer Audiovector has announced a new £3000 loudspeaker, the Audiovector 6. Finished in piano black, the 115cm high 6 weighs no less than 57kg and boasts super high 92.5dB efficiency, thanks to its modern Kevlar drivers. It is claimed to handle, "fast, powerful and very extended musical signals accurately".

The rest of the range demonstrates a similar concern with efficiency, using modern drive unit technology, and the £1200 model 3x is said to have particularly easy load characteristics, making it especially suited to modestly powered valve amplifiers. The range starts at around £600 for the Audiovector 1x.

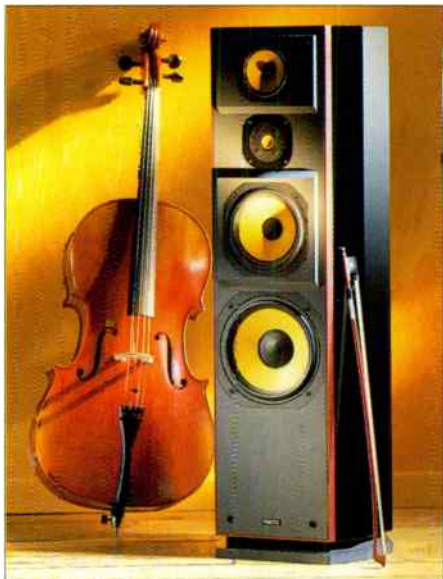

UK distributors:

**The Chord Company,
30a Sarum Business Park,
Portway,
Salisbury,
Wilts SP4 6EA.
Tel: 0722 331674**

CHORD COMPANY'S FLAT RESPONSE

The Chord Company have announced a range of loudspeaker cables comprising Flatline Gold, Flatline Twin and Blue Heaven. At £8.50, £15.50 and £58.00 per metre respectively, coming in customer specified lengths terminated or unterminated, there should be something to suit many audiophiles. Distinguished by its ultra-thin, light profile, Flatline will find itself popular in "real world" environments such as living rooms which require

cabling to be inconspicuous. And if the silver-plated copper Blue Heaven 'speaker cable sounds anything like its interconnect brother, then £1,182 for a 10 metre stereo pair may just be worth it after all!

**The Chord Company,
30a Sarum Business Park,
Portway,
Salisbury,
Wilts SP4 6EA.
Tel: 0722 331674**

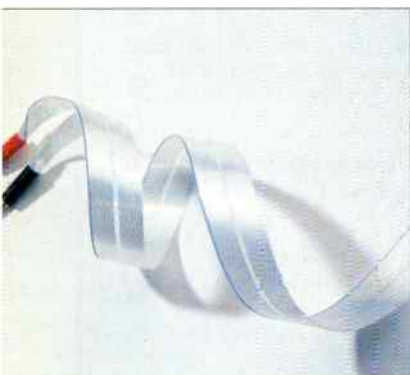

VDH IN AFFORDABLE CABLE SHOCK

Van den Hul have released a surprisingly affordable set of silver plated copper interconnects, claimed to "dramatically improve the sound" of audio systems. The VDH D-102 V costs £45.99 for a 1.2 metre stereo pair, and boasts silver-coated OFC copper conductors and braiding, plus claimed "extremely high quality RF shielding".

**Van den Hul,
Unit 12,
6 Wadsworth Road,
Perivale,
Middx UB6 7JJ.
Tel: 0181 810 9388**

AUDIOLAB LAUNCH A NEW PREAMPLIFIER

One of the reasons for Audiolab's success has been its evolutionary approach to product design, meaning equipment is constantly improved and seldom replaced.

And so the launch of a completely new model, the 8000Q preamplifier comes as something of a surprise. At £990.90 it's Audiolab's top preamp, boasting pure direct coupled design with no capacitors in the signal or feedback path. Resultantly, it's claimed that the sound is pure, with "nothing added and nothing taken away".

Interestingly, the 8000Q gets a more sophisticated user interface, with complex control logic incorporating automatic muting and remote control, including a motorised volume control. It also retains the flexibility of Audiolab's basic preamp, the 8000C, featuring 6 line inputs, 3 tape inputs and a direct coupled headphone amplifier.

**Cambridge Systems Technology Ltd.,
Spitfire Close,
Ermine Business Park,
Huntingdon,
Cambs PE18 6XY.
Tel: 01480 52521**



campaign audio design



Getting a better, more involving, sound often means spending a lot of hard earned money. It's such a waste, because every system can benefit from our cables and accessories, at a fraction of the cost of some new "black box". Here are some of the ways we can help.

We have Oxygen Free Copper interconnects (£12.48) up to Pure Silver cables (£120.00) and high definition loudspeaker cables in Silver plated Copper

or Pure Silver. Our main cables add weight, power and scale. Non inductive RF filtering (£10.00) and over voltage protection (£3.00) enhance performance still further. Gold plated AV cables, both RF (£19.95) and Scart (£23.52), help bring picture quality in line with NICAM sound resolution.

Valves, capacitors and transistors are all microphonic, they cannot perform optimally if vibrated. Our set of three Brass Isolation cones (£6.50) are worth their weight in gold - revealing low level resolution and dynamics hitherto hidden beneath electronic noise. We also have a cure for your noisy fridge or central heating motor (£3.50), enabling you to throw away your big mains noise suppressor, which has been giving you that "sat upon sound" for years.

There's lots we can do to bring you closer to the emotion and energy of the performance. So confident are we, that we offer a 14 day money back guarantee.

Ring or write for details:-

CAMPAIGN AUDIO DESIGN
Llandudno Road (HW)
Cardiff CF3 8PG
Tel:- 0222 779401

Trade and International Enquiries Welcome.

"SIMPLY STUNNING"

Alvin Gold, Hi Fi Choice



What Hi Fi praised the beautiful build, detailed performance and solid bass. Hi Fi Choice noted the warmth and grace of the sound. Hi Fi News found the treble "breathtaking", with a tight bass and a midrange which positively caresses the human voice". And

Dominic Baker in Hi Fi World summed up an enthusiastic review with the words "The Callas offer a winning combination".

If this sounds like your ideal loudspeaker, phone or

write for the inside story on the Callas and the complete range of solid wood Opera loudspeakers.

CALLAS

from UKD

U.K. Distribution
23 Richings Way
Iver, Bucks. SL0 9DA
Tel: 0753 652669
Fax: 0753 654531

No Compromise

Our SPHINX II Loudspeakers were designed to get the very best from each drive unit, by operating them in their ideal conditions.



The result is truly awesome sound stage with excellent detail and imaging. This coupled with a sensitivity of 99dB 1w/1m, so they can be matched with the very best single ended amplification. All this for only £2999.

So whether you require the very best for home, or studio call for details today.

fullers audio 01702 612116
20 Tunbridge Road, Southend-on-Sea, Essex SS2 6LT

Studio One

We are flexible with our opening times

117-119 HAMMERSMITH ROAD
LONDON, W14 0QH.
Tel: 071 371 3037
Fax: 071 371 1790
We are open Mon-Sat 9.30-6.30



Presents:
KINSHAW

ELECTRONICS
Power Amps, Pre-Amps, DAC and Phono Stages.



We offer home demos on Hi-Fi equipment and cables. So you can make your choice.

Agents for:- Alchemist, Audio Innovations, Audiolab, Aura, Alphason, Atacama, Audio Technica, Boston, B&W, Chord Company, Castle, Denon, Dynavector, Harmon-Kardon, L.A. Audio, JBL, Jecklin, Jamo Oriol, Kinshaw, Michell, Moth, Musical Fidelity, Nakamichi, Ortofon, Project, S.M.E., Sequence, Teac, Thorens, Totem, Tannoy, Townshend, Tube Technology, Van - Den - Hul, and many more.

* Home Installations*
* Free Local Deliveries*

"Introducing to the U.K."
Valve amps from L.A. Audio exclusive

"Call Joseph or Ossie now for Free advice"
"Unique Offer" - The Last Musical Fidelity A1 F.E.

"Final Edition" **Hurry Now!!**
"Records cleaned and sleeved on Nagaoka antistatic for £1.50 per album"

Pay us a visit, we are near Olympia



FAST COPY

Noel Keywood and David Price ask whether Linn's Mimik CD player sounds fast enough to bring a smile to the face of Linnies.

Linn won themselves many friends in the 1980s for their denunciation of Compact Disc. Shy, retiring Linn boss Ivor Tiefenbrun found himself speaking up for legions of vinyl fans who wouldn't buy Philips' claim that CD gave "pure, perfect sound". But commercial logic eventually mean't that Linn themselves had to produce a range of silver disc players, of which the £800 Mimik is now the cheapest.

Continuing their time-honoured tradition of small, discreet dark grey boxes, Linn's baby player looks unprepossessing. Barely longer than a couple of CD jewelcases, and seemingly not much heavier, it's obvious that it takes no aesthetic cues from its monster Japanese rivals.

Despite its lack of bulk and weight, the Mimik exudes a feeling of quality from the moment it's powered up. The row of six buttons on the left rather

cleverly provide all the functions you'll need in daily use. Aside from the standard transport controls, various combinations will bring track search, programme display and a rather interesting digital repeat function. Although Japanese-style combination button pressing is an ergonomic nightmare, with the Linn the process is a breeze.

The CD drawer moves in and out smoothly, but its flimsy build

To boldly go where no Hi-Fi has gone before

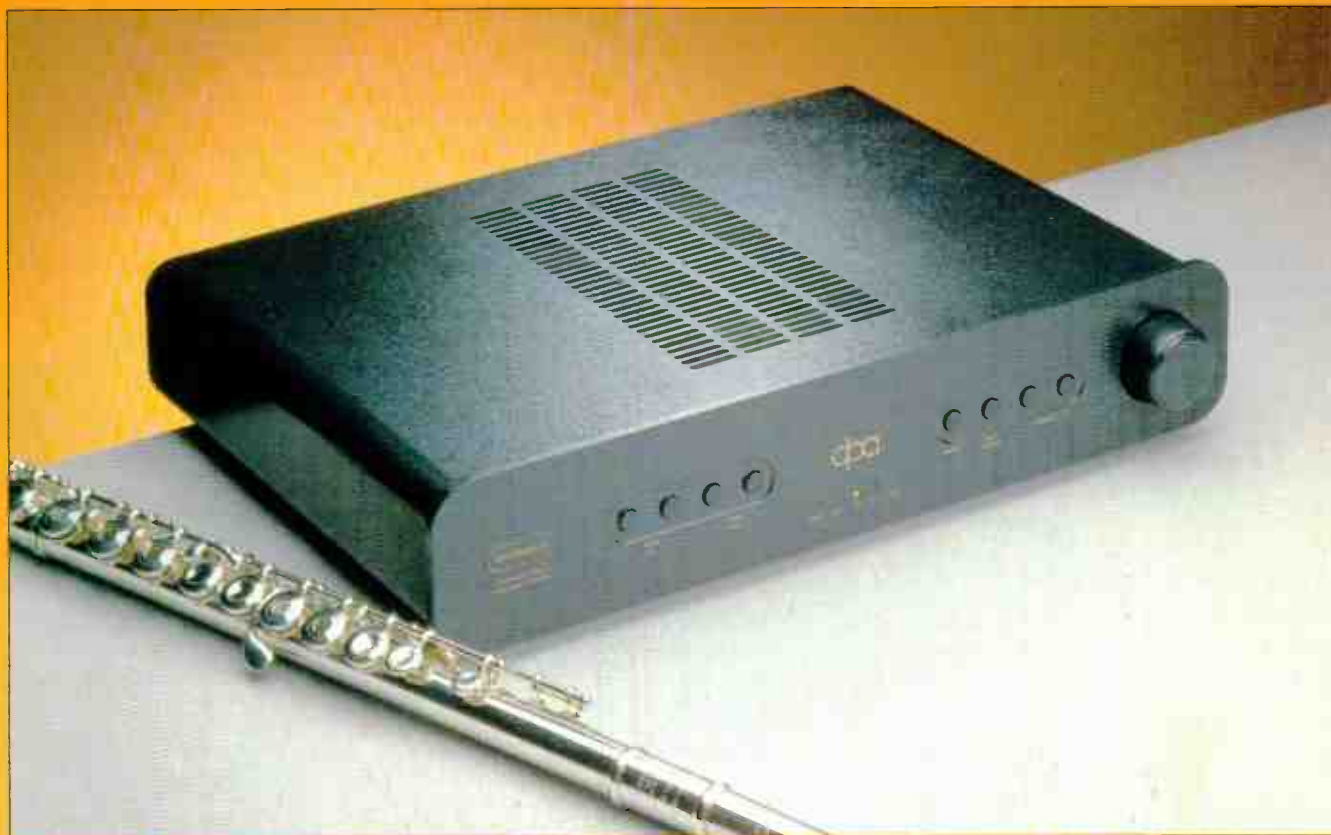

The Renaissance integrated amplifier - packed full of dpa innovations that redefine integrated amplifier performance.

Imagine being able to perceive subtle nuances and delicate details; and then exhilarating dynamics and power.

Imagine high performance electronics, advanced innovative design and construction.

Imagine all of the above but at an affordable price. Impossible? Not after you have experienced the Renaissance Integrated amp, CD player or DAC. Which explains why Hi-Fi World recently said of the integrated amp "the new Renaissance is difficult to beat in its composure, clarity and openness. It has a gentleness born of refinement, with superb stereo staging and imaging. I'd rate it very, very highly for serious listeners."

Renaissance - affordable High-End reborn



dpa Digital Ltd., 7&8 Willowbrook Lab Units, Crickhowell Rd., St Mellons, Cardiff, Wales CF3 0EF
Tel: (01222) 795621 Fax: (01222) 794267

misrepresents the quality of engineering inside. The control buttons are tactile and positive in use, reminiscent of the switchgear in high quality motor cars. The Mimik confines itself to track and index number display, by soothing green LEDs which default to “—” whilst playing unless told otherwise. Track access is quick and the player is quiet in use. Inside the player, the Mimik shows its engineering pedigree with high quality surface mount components, and a Crystal Semiconductors CS4328 1 Bit Delta-Sigma DAC.

NOEL SAYS

Mimik has a highly individual presentation that emphasises timing. This focus gives transients hair-trigger speed, bringing impressive perceived control, temporal order and tightness of rhythm to complex Latin American percussions that form Songhai 2, for example. The crack of striker against triangle, of stick against cymbal, was almost ferocious; percussion took on a more speedy, challenging presence than most players manage.

Much the same presentation brought real bite to strummed chords from Steve Earle's steel guitar at the start of 'Guitar Town'. Vivid as this was, I also know that those strings have a characteristic twang that seemed weak from the Mimik, and that Earle's Southern drawl has more character than I seemed to be hearing. As the drum kit kicked in, a hiss from the damped cymbals stabbed at my ears. Was this really 'Guitar Town'?

This track and many others from Earle has enormous treble energy that pushes many systems into embarrassing behaviour. I found the Mimik focussed on transients with rare skill, but it could make guitar strings sound somewhat cold and hard.

Across a wide range of music I became aware that the Mimik favours rich, smooth recordings, bringing temporal verve and control to them. On many bright CD recordings though, it turned from saint to sinner. Whilst Songhai 2 really cracked along, bass lines were a little suppressed and the instruments cold and a little characterless in nature; it was difficult to

tell brass from steel.

Hideko Udagawa's solo violin attained shimmering presence between the speakers, if not quite the body and character it exhibits on some systems. The Mimik possessed very strong projection here, although the sound of the bowed strings had more bite than usual. It was interesting to hear the challenge of the horns on Wagner's Rienzi, the vigour of the strings and the sheer orchestral pace this player brought to the Philharmonia, conducted by Otto Klemperer. It seemed better suited to the mood of the piece than I'd expected. **NK**

DAVID SAYS

In our super-smooth reference system with a parallel single-ended tube amp and the ever-polite KEF Reference, Series 2s, the odds were stacked in the baby Linn's favour.

The first track I put on was Primal Scream's 'Rocks', which has a processed, plastic quality that trips up also-ran players, but the Linn kept a grip on everything. Kick drums were extremely tight and fairly weighty, their interaction with the rest of the kit and the bass guitar well conveyed.

Moving on to Oasis' sublime 'Slide Away' the Mimik again impressed, carrying off the main guitar riff with spirit, capturing its epic feel, reminiscent of Hendrix's rendition of 'All Along the Watchtower'. Whilst the timing was spot on and the whole acoustic imparted with a sense of precision and grip, I started to identify Noel's criticisms of the player. Guitars tended to sound tonally flat. Were they miked up through valve amps or hard sounding Carlsbros? Sadly, the Mimik was too dry to tell.

The baby Linn continued in this vein with electronic music, capturing the sonority of the mid-Eighties digital synths on New Order's 'Vanishing Point'. In the face of competing rhythm patterns and synthetic electronic sounds with immense attack transients, the Mimik hung on tenaciously, sounding grippy and confident.

At this point I moved over to a reference Audiolab transport and DPA Enlightenment convertor. As expected at twice the price of the Linn, it greeted me with a brighter, more vibrant acoustic and far more natural sounding rhythms. It became clear that the Mimik's timing was both super-tight and unnatural at the same time. That's not a contradiction in terms - it seems to imbue everything with its interpretation of how rhythms should be played, which is thoroughly impressive but not strictly accurate.

Lou Donaldson's 'Alligator Bogaloo' threw more light on this. A classic Blue Note analogue recording made back in 1967, the playing is beautifully supple, oozing the warm studio vibe from the first bar of the title track. The DPA was fantastically fluid, approaching the

“Percussion took on a more speedy and challenging presence than most players manage.”

standards set by Linn's Sondek turntable, which has given the most musical rendition of this piece I've heard to date. But the Linn CD player went the other way, sucking out tonal colour and investing rhythms

with a mechanical, metronomic feel at odds with the looseness of the playing.

Therein lies the key to the Mimik. It's a good player by any standards, but works best on certain types of music. It has its own views on how rhythm should be conveyed which I found impressive, if a touch robotic. Tonally, it verges on hardness, but this can be assuaged by the right choice of partnering equipment. So the verdict is, as always, try before you buy! If it's musicality and warmth you're after, Linn still offer better performance for the money in the guise of their venerable LP12 turntable. Perhaps Ivor was right all along ●

LINN MIMIK

£798

Linn Products,
Floors Road, Waterfoot,
Glasgow G76 0EP
Tel: 041 644 5111

Measured Performance
see p105-111

Audio
Valve



UK Distributors
WOLLATON
A • U • D • I • O Tel/Fax 0115 9284147

World Radio History



DEFLEX[®] acoustic PANELS

The simplest and most cost effective way to upgrade your existing system

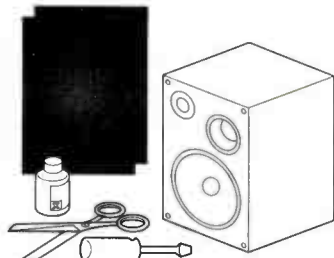

You need at least 2 Deflex panels for a pair of small bookshelf speakers, 4 panels for a pair of Tannoy 6's, and at least 6 panels for larger cabinets

Once you have gained access to the inside of the cabinet, remove foam and/or wool damping from the inside of the speaker (if fitted)

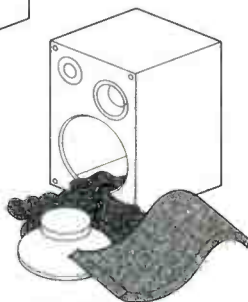

Place the flexible Deflex panel thru' the speaker cut-out and stick to the inside of the cabinet using the recommended adhesive

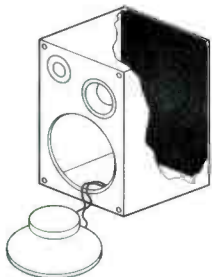

Now sit back and listen to the extra detail in sound, and far less distortion when played loud

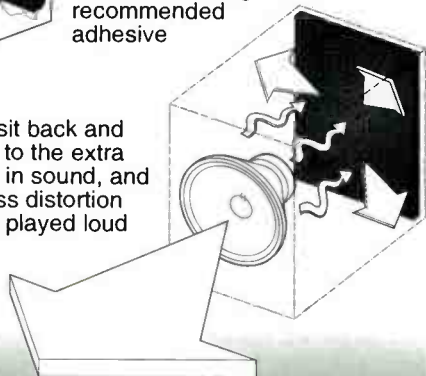

What the experts have to say...

"...a marked improvement was obvious from the first few bars of REM's *Automatic for the people* album..."
Hi-Fi News & Record Review - March 1994

"...Deflex panels seemed to give greater tightness and control, improved internal clarity, and pitch definition - all without deadening the sound in any way..."
Audiophile - January 1994

"...the result was sharper imaging, wider dynamics and a more natural sound..."

CHOICE VERDICT

Sound Quality ■■■■■
Value for money ■■■■□
Hi-Fi Choice - January 1994

"...But one thing for sure - the Deflex panels are no gimmick. They work..."
Audio Video - November 1994

Standard Panel £7.95 (28cm x 21cm)
Sub-Woofer Panel £11.95 (34cm diameter)
Adhesive £3.50 Delivery £4.00

For a FREE information pack and details of other products from SPECTRA DYNAMICS

Tel (01745) 571600 Fax (01745) 570194

Talargoch Trading Estate, Meliden Road, Dysarth, Clwyd LL18 8DD, United Kingdom.

DISTRIBUTORS WORLDWIDE: U.K. Tel. (01625) 500507 - Fax. (01625) 500508 - Australia Tel. (03) 429 2199 - Fax (03) 429 9309 - Austria Tel/Fax 43 7472 61529 - Belgium Tel/Fax 09 357 4937 - Canada Tel. 514 691 2584 - Fax 514 692 9980 - France Tel 78 95 04 82 - Fax 78 60 76 35 - Germany Tel 2961 512111 - Fax 2961 51640 - Greece Tel 01 246 6576 - Fax 01 246 6713 - Holland Tel 076 715010 - Fax 076 714773 - Hong Kong Tel (852) 898 8111 - Fax (852) 558 0073 - Indonesia Tel/Fax 31 311 598 - Israel Tel 3 924 7524 - Fax 3 924 5117 - Israel Tel 3 540 7279 - Fax 3 540 7438 - Norway Tel/Fax 755 25335 - Russia Tel/Fax (095) 917 4385 - S.Africa Tel 021 439 8450 - Fax 021 439 8451 - Singapore Tel 743 7124 - Fax 747 5330 - Spain Tel. 34 3 265 82 10 - Fax 34 3 265 77 94 - Sweden Tel 0660 560 30 - Fax 0660 561 01 - Switzerland Tel/Fax 21 824 11745 - U.S.A. Tel 415 669 7181 - Fax 415 669 7558 - U.S.A. Tel 608 831 3433 - Fax 608 831 3771

IF GREEN IS NOT YOUR COLOUR



Loudspeakers truly unique in look and sound, no other than

The Elvins Diamonds

FOR OTHER MODELS AND FINISHES PHONE 0181 986 8455 free colour brochure, price lists, news letters.



Elvins Acoustic Technology
MANUFACTURERS OF HIGH QUALITY AUDIO PRODUCTS

12 BRETT ROAD LONDON E8 1JP UK
TEL: 0181-986 8455 FAX: 0181-985 7285

NEW

FROM
K.A.L UK LTD.
AUDIO SPECIALIST



"EMPRESS" AMPLIFIER

MM, MMC, 3x LINE & FEATURES. ORIGINAL TELEFUNKEN MIC-MINIATURE VALVES

OUTSTANDING SOUND

£2980

K.A.L UK Ltd, P.O. BOX 84, HERNEBAY, KENT. CT6 7GA, TEL/FAX (0227) 742270

review

MUSIC OF THE SPHERES

Eric Braithwaite finds Michell's new Orbe turntable a legend from the moment of its inception.



Never say this magazine doesn't keep its promises. The ink was barely dry on the March issue and a reader's plea not to abandon vinyl, when Michell Engineering announced a new 'high end' turntable. It barely had a name - it has now been christened 'The Orbe' - before it was collared for review.

I've always rated the Gyrodec I've owned for years among the best of turntables, but to avoid accusations of partisanship, please remember it was another reviewer in another magazine who recently called it "the most desirable deck below £1500." The Orbe just has to be the most desirable deck for £2000. Or more precisely, £1950 including the same QC power supply that suddenly took the Gyrodec into another league. That's the conclusion over with. Now let's put the horse and cart the right way round.

Anyone who thinks vinyl belongs in the horse-drawn carriage days just hasn't been listening attentively. Splashing out on an SME V arm and an Ortofon MC7500 (each costing the same as the turntable, given a few quid either side) and the new Michell takes vinyl out of the blacksmith's right into Ferrari's new state-of-the-art racing stable. One for New Zealand rugby fans, dressed all in black, it possesses a dusky, brooding, purposeful elegance.

This Darth Vader of record decks uses the same superbly machined bearing, cast sub-chassis, springs and tubular spring covers as the Gyro, but all anodised black. The sub-chassis is now damped by a putty-like compound, derived from some arcane use in telecommunications. Gone however are those hypnotic strobing weights, replaced by a heavyweight, 3.8kg, 62mm deep platter, machined to within a thousandth of an inch from a carbon-loaded vinyl and acrylic mix.

The Papst motor is housed in a beautifully turned and finished brass housing, weighing more than 2.5kilos. Part of a determined effort to dissipate all vibrations that might affect a stylus tracking a groove, it sits on an 'O' ring inset underneath, entirely separate from the two acrylic bases on which the remainder rests. A black acrylic base

holds the three cone feet and three tiny PTFE plates on which three spikes set into the bottom of a second clear acrylic base - which supports the sprung chassis holding the bearing and arm-mounting outrigger - sit. These are adjustable for levelling, leaving a just-visible 2mm gap between the two. The Orbe is actually supplied in its component parts, but the setting-up takes only a few minutes. The final refinement is a new clamp, which screws onto a two-start threaded spindle. Designed to clamp warped records down like a limpet, it works a treat.

It wasn't just that the Rosencranz Sonatas sat on the platter more firmly than before, but the SME V, MC7500 and Orbe turned out the true high-end trick of showing every subtlety and nuance of playing in these weird and virtuoso pieces - not only of the violin but the tiniest semi-quaver from the relatively subdued organ continuo. The Orbe not only reproduces the dynamics of instruments, but plays them in perfect consonance with each other. On a Dave Grusin LP, it suddenly became obvious that what normally is a tinkling sound on the right somewhere was actually finger-cymbals and each finger was practically visible. No matter whether there was a studio-full of percussion, a bass and a piano playing together, each individual melodic line, rhythm and beat was absolutely pristine in its clarity and in precise musical proportion.

Said a fellow listener of the Tchaikovsky 1812 and Capriccio Italien, "it sounds like a brass band!" It was indeed as though the Grenadier Guards had marched off the vinyl into the living room, such was its life-size scale, with tuba roaring and trumpets and trombones blessed with an attack faster than a wing three-quarter. Yet while the bass drums and timps were stinging in their immediacy, both first and second violins were clearly distinguishable and sweet. It used to be said of one turntable - rather exaggeratedly - you could tell how many players were sharing a desk. In this case, it's probably true.

The physical perspective of a recording was obvious, not just in the rock-solid positioning of players, but in

the ambient detail that placed even tiny echoes off studio walls. On Art Blakey's *The African Beat* it defined the physical shape of everything from flute to deep - astonishingly deep! - tom-toms to the smallest flutter of fingers on a bongo. This hitherto has been where only the SME 30 has excelled.

This first production model has

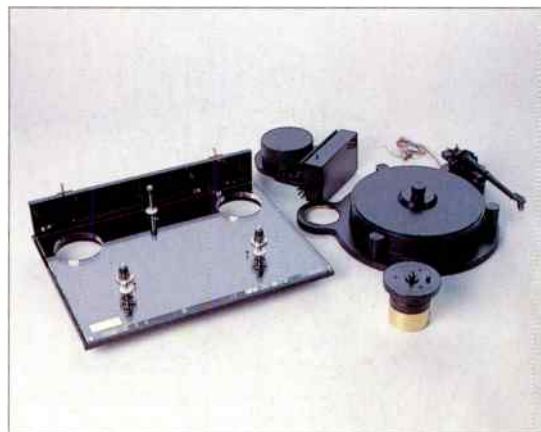

already been snapped up by a Belgian dealer. Suffice to say that in the same proportion the Gyrodec, the Orbe leaps a long drop-kick ahead of the Gyro. Fast? It accelerates like a Ferrari, alright. Detailed? It would have taken a prisoner in the Napoleonic Wars a decade to put as much into a piece of scrimshaw work. Tonally it is meticulously 'right' with crisp sheer treble and clean deep bass. And it's so beautifully finished you'd expect it to pop out of the back of a Rolls instead of the cocktail cabinet ●

Michell Black Orbe excluding arm, inclusive of QC power supply. £1950
With SME V 'Gold' tonearm. £3700

Custom finishes to order (black/aluminium/gold, bronze, clear or black acrylic lid).

Michell Engineering Ltd
2 Theobald Street,
Borehamwood,
Herts., WD6 4SE
Tel: 0181 953 0771



AUDIO ILLUSION

23 Langley Broom
Langley Berkshire SL3 8NB
(2 mins Junc. 5 off the M4)
TEL: (01753) 542761: (0860) 665662

OPENING HOURS:
Monday - Saturday
10.00am - 10.00pm

Sundays by Arrangement

ALL MAJOR CREDIT CARDS ACCEPTED

AGENCIES:

Air Tangent: Apogee: AudioResearch: Cary: Classe: Copland:
Davidson Roth: Densen: Earmax: Jadis: Koetsu: Krell: Lineaum:
Martin Logan: Micro Seiki: Mirage: Morel: Musical Fidelity: PS
Audio: Sonus Faber: Theta: Target: Wilson:
Puresonic: Silyech & Transparent
Cables: WBT

SPRING SALE:

COUNTERPOINT SA100 (new-£1495):		
Tube Hybrid 100W power amp.	As new S/H	£795
CLASSE 30:		
Remote Preamp Balanced	Ex Demo	£1150
CLASSE 70:		
Power Amp Balanced	Ex Demo	£1175
LINN KABER:		
Latest Spec. Tri Wire Loudspeakers	Mint S/H	£595
CELESTION 7000:		
Ribbon Hybrid Loudspeakers	S/H	£395
ACOUSTIC ENERGY AE2 (new-£1300+):		
Loudspeakers Including Stands		
Black Texture Finish	Mint S/H	£595
ARISTON Q DECK / AT 110		
Turntable	S/H	£75

Analogue lovers... **SME**



Our world
renowned precision
pick-up arms and turntables
await you.

Sales and service enquiries to:

SME LTD • STEYNING • SUSSEX • BN44 3GY • ENGLAND
☎01903 814321 ☎01903 814269

Art Audio MAESTRO

"They are just so stunningly gorgeous and open to listen to, I can barely imagine anything more alluring"

NK Hi-Fi World, June '91
Valve amplifiers from £750 to £4150 Cables from £27 to £1700

Select Audio
Glasgow (041) 226 4268

Doncaster Hi-Fi Studios
Sunnyfields (0302) 731387

Paul Green Hi-Fi
Bath, Avon
(0225) 316197

Hazlemere Audio
High Wycombe, Bucks
(0494) 437892

Audio Venture
Banbury, Oxon (0295) 261863

The Hi-Fi Consultants
London (071) 380 0866
Evenings (071) 482 0003

Audible Difference
Diss, Norfolk
(0850) 983233 or
(0379) 740227

K.A.L. (UK) Ltd
Folkstone (0303) 245005

The Hi-Fi Consultants
Nottingham (0602) 232450

Impulse Audio Consultants
Westcliff-on-sea, Essex
(0831) 616426 or 0374 277736

Sound Academy
Blaxwich, West Midlands
(0922) 473499

New A4 brochure containing full details of our amplifiers
and silver cable range contact

Art Audio (UK) Ltd., 130 Main Street, Calverton,
Nottingham, NG14 6LU
England UK
Tel. 0602 - 653604
Fax 0602 - 637795



THE HI-FI SPECIALISTS

STOCKISTS OF

ARCAM

AUDIOLAB

CHORD COMPANY

CREEK

CYRUS

DENON

EPOS

HEYBROOK

LINN

MARANTZ

MISSION

NAD

NAIM

NEAT

NAKAWICHI

ONIX

REGA

ROTEL

ROYD

TDL

...and she thought she was getting a new washing machine

6 HOTEL ST. LEICESTER
TEL: 0533 623754

32 GOLD ST. NORTHAMPTON
TEL: 0604 37871

VINYL REVIVAL

David Price
investigates the
worldwide revival in
vinyl, from Japan to
Britain to the U.S.A.
The plain truth is, the
LP just won't die.

Five years ago you couldn't buy a new LP record in Japan for love nor money. The Japanese, champions of technological change, seemed to have deemed it an expired, redundant format. Living and working there at the time, it was a shock realisation to me, as I'd never before experienced acute vinyl starvation.

Returning to the UK on holiday I'd notice a dwindling selection of records in High Street 'record' shops, so I found myself buying LPs in the fear that I'd never be able to get them again.

Then something strange happened. It was spring 1992 in Tokyo when I spotted some LP-shaped objects in a downtown music retailer. I thought they were LaserDiscs at first, but priced at 3000 Yen (£12 at the time), they were far too cheap. "My God, they're records!" True enough, the Beatles entire back catalogue had just been reissued on vinyl. Then Led Zeppelin albums started appearing, then Stones' repressings, then classic Japanese Blue Note reissues.

Back in the UK 'music software' retailers continued their love affair with CD. It doesn't take an MBA in retail management to know



why. It was a unique opportunity for an industry to sell the same old wares back to the public with enhanced profit margins. Not only that, but the new format was more space efficient, making it easier for shops to handle. If God had

sent the music business a gift, he couldn't have done better than CD.

Misleading claims about sound quality and durability were put aside and record companies, aided by certain hi-fi and music magazines, set

about telling the public what was best for them. What angered audiophiles and record fans alike wasn't so much the hype about CD, a constant source of hilarity to many of us, but the way it threatened our favourite format. In Japan, retailers seemed happy to let the re-emerging vinyl LP coexist with CD, to cater for a small but committed audience. But in the UK, major record companies and retailers, often linked (e.g. EMI and HMV), were continuing to withdraw their support for the format, pleading 'lack of demand' as the reason. In the best traditions of circular logic, if it's not there, there can't be a demand for it, can there?

But recently, British record buyers

PROJECT

State of the Art Analogue



Best Turntables
under £1000

Vinyl replay
systems from
£145

Ortofon (UK) Limited
Chiltern Hill,
Chalfont St. Peter,
Bucks. SL9 9UG
Tel: 0753 889949

may have noticed renewed interest in vinyl. Investigating an astonishing claim by Tower Records in a radio advertisement that "the LP is dead", we were told by an embarrassed UK spokesman that this was the personal view of a U.S. executive and in fact one of their branches, Tower Kingston, was doing a thriving business in black discs. But if you're expecting records to be back on the shelves of Woolies as well by the summer, you'll be disappointed - CD will remain the standard music carrier for the foreseeable future. Nowadays, vinyl is becoming something of a cult item.

This new trend in LP sales is borne out by recent figures. A British Phonographic Industry survey of trade deliveries in July/September 1994 shows that LPs rose by 14.2% and singles by 9.8% year on year. Although LP's market share remains small at 3.2%, compared to twenty times that for CD and ten for cassette, Martin Talbot of Musicweek called the figures "good news for anyone in the business of manufacturing vinyl and turntables".

Although this won't set the world alight, it's proof positive that those who speak of the death of vinyl have fallen for their own propaganda. Indeed, it's likely that vinyl sales have reached their bottom point, and will continue to show what the BPI calls "firm residual demand".

What's more, similar things are happening in the States. According to the Recording Industry Association of America, vinyl sales for the first half of 1994 increased by a staggering 80% over the same period of the previous year! This has led to a spate of dramatic headlines such as The New York Times' "Music Lovers are Voting for Vinyl". In truth, what the headline omits to say is that unit sales are up 400,000 to just 900,000 - peanuts against CD's 277,000,000 units!

Perhaps this revival has been catalysed by the recent spate of US

musicians found eulogising over the joys of black plastic. Pearl Jam are a case in point. Vitalogy, their latest album, was released on vinyl two weeks before the CD version. It notched up 35,000 sales and got to number 55 in the Billboard chart on the strength of vinyl sales alone. Recent albums by Nirvana, Sonic Youth and Johnnie Cash have gone the same way and musicians such as Bob Mould and Neil Young are never short of something to say on the delights of the LP record.

In Britain, virtually all new dance, indie and rock releases are available on black plastic, at least in limited edition form, often with extra tracks special to the LP version. From Primal Scream to Paul Weller, The Orb to Orbital, British music industry figures have also taken it upon themselves to talk up vinyl's appeal, often in a highly romanticised way. Factory Too Records supremo Tony Wilson confessed "the whole delight of being in the music business is the smell of the lacquers".

But vinyl isn't just about nostalgia; there's some sensible commerce in here too. Bob Bailey, Production Manager at EMI's Hayes pressing plant reported that he'd seen "a great deal of activity in the smaller companies", largely due to the fact that at just 40p a copy for a batch of 500-1000, vinyl is still "an economical package in small runs."

One of vinyl's greatest comebacks has been in the jazz scene. Towards the end of the 1980s, when many regarded CD as the salvation of humankind, Blue Note Records deleted their entire vinyl catalogue, provoking collective gasps from jazz lovers around the world. But recently, Blue Note UK launched their

'Connoisseur Series' of reissues.

Beautifully pressed on heavy 180 gram vinyl, they have proved so successful that many have been exported to the States, in turn swaying Blue Note US to start repressing vinyl.

In the sphere of dance music, vinyl has become more than just a format, it's now an icon with what's been called a "mythological tradition". Techno music, a veritable breeding ground for equipment freaks, continues its love affair with anything analogue. All promotional copies of new dance tracks are circulated to DJs on 12 inchers and, according to Adrians,

a specialist independent retailer, over 95% of dance music is bought on black plastic. Bob Bailey admitted that EMI's Hayes pressing plant is now pressing 6,750,000 records annually, of which about 90% are 12 inch singles.

Assessing vinyl's place in the great scheme of things can't be done by looking at naked statistics. It's finding a place for itself as a specialised music medium in a number of different contexts. Whether you'd want to call them 'subcultures' or 'niche markets' isn't really important. Vinyl's appeal spans national and cultural boundaries, giving as much pleasure to those who grew up listening to The Aphex Twin on a Technics SL1210 as Sonny Rollins on a Garrard 401. That has to make vinyl something very special indeed ●

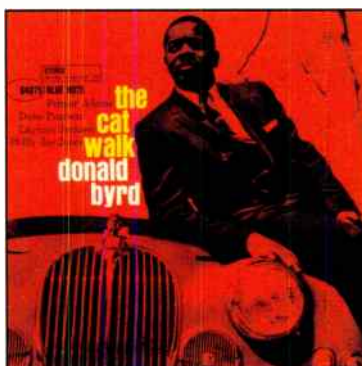

SOME VINYL RETAILERS TO TRY:

MAIL ORDER:

The Record Shop	0181 546 3880
Adrians Records	0268 733318
Gema Records	06135 867140
Sister Ray	0171 287 8385

AUDIOPHILE:

Audiophile International	01276 855578
Ray's jazz Shop	0171 240 3969

HELL GYR C POWE

D



A SYMBOL OF PRECISION



"THE MOST DESIRABLE DECK BELOW £1500"
Ken Kessler - Hi-Fi News & Record Review August '94

Michell Engineering, 2 Theobald Street, Borehamwood, Herts WD6 4SE
Tel:- 081 953 0771

Great tracking

Ortofon is famed the world over for the tracking capability of its cartridges. Cartridges which will breathe new life into a cherished LP collection, divulging detail as never before.

The cartridge is always the key factor in the reproduction of music from records and Ortofon has dedicated nearly 50 years to the manufacture of the finest pick-ups possible. Enjoying constant critical acclaim along the way.

So if you want to bring more out of your records than ever imagined, an Ortofon Cartridge will have you hot on the scent.



500 Series
Moving magnet cartridges from £30-£100



MC Series
Moving coil cartridges from £30-£110



Q Series
Moving coil cartridges from £140-£500



1000 Series
Moving coil cartridges from £300-£1500

ortofon

Ortofon (UK) Limited, Chiltern Hill, Chalfont St Peter, Bucks SL9 9UG.
Tel: 0753 889949.





PRODUCTION PROCESS

Denon claim Alpha processing in their new DCD-1015 CD player improves music reproduction. Noel Keywood finds it characterful.

I've always had time for Denon CD players. Smooth and civilised, they're a useful cut above the average. Alpha processing, seen previously only on top models, attempts to create "near 20-bit quality" from standard 16 bit CDs, supposedly lessening harshness endemic to silver discs.

This it did, but I wondered whether Denon had gone too far. There's smooth and there's dull - this player tripped the borderline between the two. Our measurements, made before listening tests gave warning. The frequency response trace plunged downward off the analyser screen, looking like a sales graph for ice cubes in Antarctica. Whoops!

The Denon paints an invitingly expansive, smooth sounding picture of performers on the soundstage. Violins of the Philharmonia playing Wagner's *Rienzi* had less edginess than usual. Horns seemed more laconic than urgent; there was a lack of real rasp and a tonal colour that wasn't especially reminiscent of brass, but then CD generally isn't too good in this department. Timpani thundered, bringing weight and gravitas to the performance; in this area - bass power - the Denon really had it.

But as the going got tough, with the

full weight and complexity of the orchestra coming into play, I felt that the Denon was blurring the picture. The steel strings of Buddy Guy's guitar lacked bite and as the band got moving on 'She's Nineteen Years Old' what should have been a clear lead line became submerged in the melee.

In keeping with their late night milieu, Eddie Reader's recordings, even in her Fairground Attraction days, have always been easy on the ear. I guessed the warmth of the Denon would take the effect too far and this is rather how it turned out, the performance coming across as muggy and ill-defined. The thrum of double bass and the sense of atmosphere were nicely captured, but temporal precision and insight were mediocre.

Whilst it was easy to catch the Denon out, I could still (literally!) warm to it. John Lee Hooker's 'Boom Boom' came in with real weight and it stayed smooth and easy on the ear. Bright recordings were usefully balanced and smoothed by the DCD-1015 - a useful property with CD.

Jamiroquai's 'Return of the Space Cowboy' proved illuminating. The Denon again pumped out full, rich basslines which managed to stop and start in a controlled fashion, but at the other extreme, cymbals gained a slightly

splasy quality reminiscent of other budget Japanese players.

The Denon always came across as having a great deal of clarity, although in truth it wasn't especially detailed. Morrissey's 'Piccadilly Palare' showed that it could be thoroughly engaging, combining good dynamics with competence in the timing department. Bass drums were also surprisingly weighty and percussive for a player of this price.

I ran the Denon with smooth KEF Reference Series 2 loudspeakers and both solid-state and valve amplifiers. Matched with a hard sounding transistor amp and bright loudspeakers, Denon's new DCD-1015 CD player has just the right balance and presentation to provide a useful tonic. So although not a player for all seasons, it has some great strengths. If you want a really smooth presentation from CD with good stereo staging and an impressively full bodied sound, check it out ●

Denon DCD-1015 £349.99
Hayden Laboratories Ltd.,
Hayden House, Chiltern Hill,
Chalfont St. Peter,
Bucks. SL9 9UG.
Tel: 0753 888447



HEYBROOK®

HEYSTAK
SINGLE

8578 / 1394 / 82

MADE IN MALAYSIA

Four
on the
Floor

HEYBROOK
SPEAKERS

USER GUIDE

Heybrook have just released their new floorstanding Heystak loudspeakers. Do they have a sunny future, Lionel Coleman asks?

Heybrook are the latest British entrant to the floorstanding loudspeaker market. The £499 Heystak is a response to demand for a floorstanding version of their HBI model, now in its fourteenth year of production. Heybrook see the Heystak first and foremost as a value-for-money product, designed to sound "involving" in a wide range of systems.

Certainly multi-driver loudspeakers can produce copious bass output, making the 90cm tall Heystaks likely, both sonically and physically, to be destined for larger listening rooms. Their complement of drivers comprises no less than three 120mm bass/mid units, with a 25mm fabric soft dome tweeter sandwiched between the top two. The bottom driver, complete with full magnet assembly, is left disconnected to augment the bass response by acting as a passive part.

One of the advantages of floorstanders is not having to buy stands, and this holds true for the Heystaks which come with their own, appropriate considering Heybrook's good reputation in this area. Square tubular steel frames screwed to the bases serve as a secure and stable mounting for the substantial floor spikes. One minor niggle is that the bi-wire terminals are mounted at the top of the back panel, making it difficult to tuck cables discretely out of sight.

After thorough running in, it was instantly apparent that the Heystaks have a big, weighty sound. My expectation of plentiful low bass was realised. The Heystaks are real sluggers, a characteristic that will win them many friends. Tina Turner's 'Steamy Windows' had a pile-driving bassline, almost powerful enough to drive me backwards into the settee. For those who want to be thoroughly pummeled, these speakers haven't got a lot of competition. Similarly, basslines from Black Uhuru were beautifully carried, with a great sense of occasion reminiscent of their live concerts. Kick drum behind Eddie Reader's 'The Right

Place' was just that - it kicked.

The sound was full without being overpowering. Although deliciously dynamic they're a wee bit ponderous in comparison to lighter, tighter balanced speakers. However, altering speaker position relative to the rear wall, my own preference being into the room by at least half a metre, tightened things up.

The overall tonal balance of the Heystaks depends on seating height. On the tweeter axis, which means sitting low, it has a fairly natural balance. Just above they go soft and warm, and higher up to standing, treble becomes altogether more obvious. But overall they're mellow speakers, albeit with a touch of hardness or steeliness in the upper mid-band/lower treble that pushed cymbals and vocals forward a

“With Widor's Toccata, the Heybrooks excelled, with as much scale and drama as the neighbours could stand.”

little, giving them a solid outline and presence. Our measurements clearly show this effect as a low peak in the frequency response.

Stereo imaging and sound staging were good - respectable but unexceptional. There was some lack of midband insight too, where the Heystaks exchange analysis for easiness. I've heard more insightful loudspeakers, but often they're less easy on the ear. The soundstage appeared behind the plane of the 'speakers with a truly expansive presentation, possibly more to do with the foundation of the bass notes than any sense of space.

For rock music these aren't the fastest 'speakers, but "oomph" was there by virtue of fine low bass dynamics, bass guitar lines being easy to follow. Power chords were just that,

although I'd have preferred more attack. Cymbals were tonally well differentiated even if the cutting edges of their crashes were slightly blunted. The location of instruments from further back in the mix, like castanets on Bryan Adams' 'Run to you', could have been more precise.

On the spoken word via Radio 4, normally lightweight male voices assumed the tone of continuity announcers. Sibilance wasn't a problem but there was a slight "breathy" effect. Both these traits meant that female voices became Kathleen Turner-esque, not necessarily a bad thing when you consider the effect her voice is supposed to have!

That old favourite war-horse of the organ repertoire was next. With Widor's toccata the Heybrooks excelled, with as much scale and drama as the neighbours could stand. Encouraged, I tried Saint-Saens 3rd (Organ) played by the BPO/Levine on DG. The speakers proved capable of creating the illusion of an orchestra, but the vocal anomalies noted earlier affected the tone of strings. Curtailed stereo depth also gave the impression that I was sitting quite a long way back in the concert hall.

Overall, the Heystaks offer a full toned, unfatiguing sound with body and warmth above precision and speed. Their plentiful deep bass suited organ or full orchestral music and brought real thunder to rock, yet an absence of boom meant that huge listening rooms wouldn't be essential. They displayed commendable efficiency, so a powerful amplifier isn't essential.

The Heybrook Heystaks will find many friends thanks to their smooth yet powerful presentation. They're the complete opposite of the shrill, reedy sounding type of 'hi-fi' speaker. Bass freaks in particular will love them!

Heybrook Heystaks £500
Heybrook Hi-Fi Ltd.,
Estover Industrial Estate,
Plymouth. PL6 7PL
Tel: 0752 731313

 **Klipsch****AUDIO AND HOME THEATER PRODUCTS***epic series*[®]
FLOOR STANDING SPEAKERS

**Klipsch — The
sound that will
open your eyes!**

Model Sensitivity(DB SPL @ 1Watt/Meter)

CF-1	96	750 watt (peak)
CF-2	98	1000 watt (peak)
CF-3	100	1250 watt (peak)
CF-4	102	1500 watt (peak)

With the above H-F sensitivity of Klipsch
loudspeakers your Valve, Transistor, or Hybrid
amplifier will give you 1st class sound.

UK Distributor: Midland Radio Supplies, Maypole Lane, Birmingham B14 4PE Tel: 021-430 7817

CIVIL ENGLISH WAR

Thanks to cut-throat competition in the budget sector, today's contenders are more sophisticated than ever. David Price pits KEF's new Coda 7 against Mission's 731.

There was once a time when KEF dominated the budget loudspeaker market. A decade ago, their budget Codas graced many an

accomplished stereo system. But just a few years later, they fell from favour, usurped by a more modern looking Mission loudspeaker, the

immensely popular 760.

Today, KEF's new Coda 7 looks set to turn the tables. They've responded with an extremely well-rounded budget

GET YOURSELF CONNECTED.....



reson®
DNM
THE ORIGINAL
SOLID CORE

Virtual Reality
audio systems

P.O. Box 383 Brentwood Essex CM14 4GB
Tel : 0277 227355 Fax : 0277 224103

loudspeaker, good enough to walk away with sales Mission justly regard as theirs by right these days. Yes, the Coda 7 is that good.

At £129, it's moving into a fierce market where the £129.90 Mission 731 (the latest replacement for the 760) reigns supreme, albeit by a whisker. Both products are proof positive that the British hi-fi industry can make superb value for money products to face off any competition the world can offer.

For their price, both 'speakers are beautifully built and finished - even before you plug them in you can't help thinking you're getting a lot for your money. Of the two, I'd say the Mission is better, with nicely turned cabinets and a general air of solidity. Rap the side of the 731 and you'll hear a dull thud, whereas the Coda 7 has a hollow ring, suggesting lighter construction.

As soon as our Garrard 401/SME 312/Ortofon MC25 and Audiolab 8000A system was powered up, it was clear that the 731 and Coda 7 had their own highly individual ways of doing things. Kicking off with the Missions, as the opening bars of Corduroy's 'Don't Wait for Monday' poured forth, I was struck by the 731's upfront sound. With powerful bass and crisp treble they instantly impressed. Indeed they sounded a better than their diminutive stature would suggest.

Treble was bright with a touch of coarseness, more than I remember from the 760i, investing a good measure of gusto. There was bass aplenty, which although not particularly fast or accurate, further contributed to their larger than life sound.

The Missions really got the basics right, giving a brusque, bold picture of musical goings on. Although not particularly detailed, they were revealing enough to tell whether the drummer

was hitting or brushing cymbals, or what was happening on Corduroy's vocal harmonies. Aided by their forward, crisp treble which emphasised leading edges of percussive instruments, timing was the 731's forte. In conjunction with an apparently dynamic sound, this made for plenty of enjoyment.

The KEF Coda 7s sounded less impressive, with an emphatic midrange and smoother treble. Not so upfront, they failed to engender the sense of surprise the 731s had. But it soon became evident that the KEFs were playing music better. With more rhythmic push they were better able to impart music's emotion and drama. Although smoother, they also proved more detailed, throwing out extra strands of percussion and conveying a better sense of space around instruments.

Dynamically, the two differed significantly. Run-of-the-mill compressed pop recordings were delivered vivaciously by the Missions, which appeared fast and dynamic. But the heavily modulated bass solo in Jamiroquai's 'Return of the Space Cowboy' proved too much for them. As the bassist mashed the fretboard, they sat on crescendos, stripping the music of its power. In contrast the KEFs hung on, getting louder with little distress.

Although the 731s had more upper bass, it's always quality not quantity that counts. United Future Organisation's 'United Future Airlines' threw more light on

proceedings, the KEFs again proving the most enjoyable. Bass was more tuneful, pushing along the song with a real sense of purpose. Unlike the Missions, which tended to one-note bass guitars, the KEFs made a valiant attempt to convey



the bassist's finger movements.

After listening to the KEFs, it was obvious that the Missions were imbuing everything they touched with the same tonal colour, which was rather grey and uninviting. With the KEFs instruments retained more of their original timbre and feel - you could almost hear the vintage of that Stratocaster.

Both loudspeakers imaged extremely well considering their modest cost, providing a wide open soundstage that was a pleasure to behold. The KEFs proved better than the Missions in this respect, the latter suffering some boxiness particularly noticeable on drums. Augustus Pablo's 'Rockers comes East' starts with a crashing snare roll that struggled out of the 731's box, whereas the Coda 7s projected it with ease.

I found this comparison an interesting one. Whilst I really enjoyed Mission's earlier 760 loudspeaker, I can't say the same of the 731. Doubtless as Mission engineers intended, it's sounds truly 'impressive', but lacks the charm and sophistication of their previous super-mini, the 760. This is where the new KEF Coda steps in. For all its faults it has a damn good go at playing music in an involving and entertaining manner ●

Mission 731 £129.90
Mission Electronics Tel: 0480 451777

KEF Coda 7 £129
KEF Audio Ltd. Tel: 0622 672261



Measured Performance
 see p105-111



Myers Audio

EST. 1972

6-7 Central Parade, Hoe Street,
Walthamstow, London E17 4RT
(Near Tube and Cinema) FAX: 0181-503 6677

MAIL ORDER

Our mail order service is fast and efficient. All we require are your credit card details when your order is placed. Our Data Post service operates daily, ensuring quick, safe delivery. Carriage is FREE OF CHARGE FOR ANY SALE OVER £100 throughout the UK, but not on price match* ex display. Delivery charge of £8 per unit below 10k.

FREE DELIVERY MAINLAND UK

0181-520 7277

FOR FAST & EFFICIENT
MAIL ORDER
HOTLINE
0181-520 7277

1. All goods fully guaranteed
2. All goods brand new
3. Delivery free
4. All prices include VAT

● Our own service department will make sure you continue to enjoy that great sound both during and after our one year warranty period.

Prices valid until end-March '95. E&OE

PRICE PROMISE

Our prices are competitive but should a product be available at a lower price or any options from an authorised dealer...

We will ^{also} beat it by up to £20!

MARANTZ

AUTHORISED DEALER

PM44SE Mk II	£199
AMPLIFIERS	
PM32/PM43	£139/£199
PM53/PM63	£249/£299
PM80M2	£479
PM44SEM2/54SEM2	£199/£329
PM80SEM2	£749
AV AMPLIFIERS	
SP50 PROCESSOR	£179
PM711AV	£440
AV5000/MA500	£699/£249
MS200	£399
AV600 THX/EC500	£899/£899
RECEIVERS	
SR73/SR82	£599/£899
TUNERS	
ST183	£169/£249
ST72	£299
CD PLAYERS	
CC45/CD53	£249/£199
CD63	£299
CD10/CD16	£1199/£1399
CD63S3	£349
VISION	
AV635 VIDE0	£549
VP500 PROJECTION SYSTEM	£699
SLIM SYSTEMS	
SYSTEM 1/3	£899/£999
SYSTEM 3/4	£749/£1099
PRO COMPONENTS	
CP230/CP430	£399/£499
PM101/201	£199/£249
EQUALISERS	
EO315/EO315	£129/£249

YAMAHA

AUTHORISED DEALER

AMPLIFIERS	
AX380	£199
AX470/570	£239/£289
TUNERS	
TX480/680RDS	£139/£199
CASSETTE DECKS	
KX380/480	£169/£199
KX580/670	£249/£289
TWIN CASSETTE DECKS	
DX480/580	£199/£249
DX380/CDX645	£299/£379
KW952	£499
CD PLAYERS	
CDX480/580	£199/£249
CDX380/CDX645	£299/£379
CD PLAYERS	
AV AMPS AND PROCESSORS	
RXV470/DSPA780	£399/£629
DSP4970/D2070	£799/£1099
DSP200/580	£369/£449
DSP1000	£869
EFFECT SPEAKERS	
NSE90/NSC80	£119/£99
NBC110/YS7S/W60	£149/£199
YTSW120/SW200	£299/£399

CINEMA SOUND

AUTHORISED DEALER

AMPLIFIERS			
KR V6060/7050	£349/£399	PIONEER VSAD802S	£569
KAV3700/7700	£299/£599	VX452	£379
SONY STR0 511/611	£279/£329	YAMAHA DESPE 200	£369
TAAV570 KIT	£499	DSPE 580/1000	£449/£669
DOLBY PRO KIT	£349	RXV1470	£399
SAVA3	£799	DSPA780/970	£629/789
TAAV510B	£399	DSPA2070	£1099
TECHNICS SAGX370	£449	MARANTZ AV500 PRE AMP	£599
SAGX350LK	£329	MA POWER AMP	£249
		SR73 RECEIVER	£699

SALE SALE SALE

EX DISPLAY BARGAINS

'Lots of products to sell so cheaply it's first come first serve'
All major manufacturers included
For huge reductions on many more items please call
NAD 705 Receiver was £329 NOW £239
Mission 765 Speakers was £679 NOW £499
Nakamichi DR3 Cassette was £359 NOW £299
Harman Kardon TD4200 Cass/Deck was £279 NOW £199

NAD

AUTHORISED DEALER

VISION	
AV635 VIDE0	£549
VP500 PROJECTION SYSTEM	£699
SLIM SYSTEMS	
SYSTEM 1/3	£899/£999
SYSTEM 3/4	£749/£1099
PRO COMPONENTS	
CP230/CP430	£399/£499
PM101/201	£199/£249
EQUALISERS	
EO315/EO315	£129/£249

Technics

AUTHORISED DEALER

AMPLIFIERS	
310/302	£129/£179
310/302	£239/£349
TUNERS	
402 AWARD WINNER	£169
CD PLAYERS	
501/502	£179/£229
513 MULTI PLAYER	£269
CASSETTE DECKS	
602	£199
CD PLAYERS	
SUA900K 80W.PCH	£399
SUA900 Mk2	£399
SUE2000K PREAMP	£699
SE4300K POWER-100W	£1049
TUNERS	
STGT 650LK-RDS	£229
STGT 550LK-RDS	£189
SLP610LK	£179
CASSETTE DECKS	
RST3737K TWIN	£129

Technics Technics Technics

AUTHORISED DEALER

AMPLIFIERS			
SUV2220K 30W.PCH	£129	RSTR747K TWIN	£195
SUV2200K 40W.PCH	£169	RSTR757K	£249
SUA600K 40W.PCH	£199	RSTR797K	£379
SUA700K 45W.PCH	£249	RSB2501K	£179
SUA800K 55W.MIG	£329	RSB2466K	£229
SUA900K 80W.PCH	£399	RSB4747K	£299
SUA900 Mk2	£399	CD PLAYERS	
SUE2000K PREAMP	£699	SLP0667	£179
SE4300K POWER-100W	£1049	SLP0867	£199
TUNERS		SLP0380AK	£139
STGT 650LK-RDS	£229	SLP0440AK	£159
STGT 550LK-RDS	£189	SLP0560AK	£199
SLP610LK	£179	SLP5740AK	£249
CASSETTE DECKS		SLP5840K	£449
RST3737K TWIN	£129	SLP2000K	£99
MINI SYSTEMS		NSX400	£299
Z650	£369	NSX430	£299
Z720	£399	NSX540	£399
Z1100	£399	NSX550G	£429
Z1000	£399	NSX560	£449
ZD3100M	£599	NSX737	£749
ZD1000M	£599	NSX737	£749
ZD700M	£399	NSX450G	£349
ZD9100M	£799	NSX520	£349
MINI SYSTEMS		LCX507	£249/£299
NSX270	£279	LCX605	£299/£299
NSX340	£299	LCX970M	£349/£379

SONY

AUTHORISED DEALER

TCK 611 Dolby S	£289
AMPLIFIERS	
AFR5800	£199
TAF245R/TAF244E	£149/£199
TAF444E/TAF542E	£249/£299
TUNERS	
ST3211/ST3311LB	£129/£199
ST3505ES	£249
CASSETTE DECKS	
TCK215B/415B	£129/£199
TCK155/TCK611S	£249/£289
TWIN CASSETTE DECKS	
TOWR445B/R445B	£149/£199
TWR645S	£249
CD PLAYERS	
CDP120/CDP345	£149/£229
CDP115E/CDP915E	£249/£229
CDPCX151	£599
CDPM302/CDPC325M	£129/£229
MINI DISC RECORDER PLAYER	
MDSS01 - FULL SIZE	£799
MZE2/MZR2	£349/£449
CD RECORDER PLAYERS	
WMDD1	£299
TC07	£499
TC020ES	£799
MINI SYSTEMS	
COMPACT 190/195	£329/£379
COMPACT 290/295	£399/£449
COMPACT 490 - 590	£499/£599
COMPACT PLUS 695AV	£799
COMPACT PLUS 795AV	£999
COMPACT PLUS 995AV	£1499
MINI SYSTEMS	
MHC400/MHC550	£299/£329
MHC850/MHC2900	£379/£499
MHC33/MHC700	£449/£599
MHC4900/MHC5900A	£799/£999
MHC7900AV	£1499
MICR PMC301	£299
AV AMPS AND RECEIVERS	
STR0516/15	£279/£329
TAAV570R	£399
TOTAL PROLOGIC PACKAGE	
DOLBY PRO KIT	£349
TAAV570 KIT	£499
SAVA3/SAVA1	£799/£599
PROLOGIC EFFECT SPEAKERS	
SS77/SS90AV	£49/£99
SAW900/DOLBY S KIT	£349/£419
LASER DISC PLAYERS	
MDP650/MDP850	£599/£699

PIONEER

AUTHORISED DEALER

A300X	£179
AMPLIFIERS	
AT03 30 W.PCH	£129.99
A203 40 W.PCH	£169.99
A300X40 W.PCH	£179.00
A400 60 W.PCH	£249.99
A400X60 W.PCH	£279.00
A602 80 W.PCH	£329.00
D802S	£599
TUNERS	
F303	£129
F303	£179
F502	£249
PROJECTION TV's	
SDT5000/4000TV	£3999/£3300
CD PLAYERS	
PD103/203	£139/£159
PD503/703	£199/£249
PD1785	£399/£499
CD PLAYERS MULTI	
PM0630/M703	£249/£299
PD1M3/DF100	£499/£599
CASSETTE DECKS	
CTS330/S430S	£169/£199
CTS630S/S630S	£299/£499
TWIN CASSETTE DECKS	
CTW 503R/W603R	£179/£229
CTW 803RS	£299/£379
CTM610R	£299/£379
TURNABLES	
PL225/335	£119/£149
GRAPHIC EQUALISERS	
GR555/777	£199/£249
MIDI SYSTEMS	
J200/300	£399/£549
3400/5000	£849/£1799
JV600/700	£879/£999
JV600LD Inc Laser Vision Disc Player	£1199
MINI SYSTEMS	
NS07/10W	£349/£399
N70W/M100W	£449/£499
N100/W1M	£549
LASER DISC PLAYERS	
CLD800/950	£399/£499
CLD 1950/M5	£999/£599
CLD 2950/160K	£999/£629

HARMAN KARDON

AUTHORISED DEALER

AMPLIFIERS	
HK6150/6550	£199/£299
HK6350/6550	£449/£499
HK6650/6850	£799/£999
CD PLAYERS	
HD7225/7325	£229/£299
HD7425/7525	£349/£449
HD7625/7725	£549/£749
AV/AMP/AVR300	£999/£1,999
CASSETTE DECKS	
TD4200/TA4500	£279/£449
TD4500/TA4600	£599/£799
TWIN CASSETTE DECKS	
SK3300/3400	£379/£499
RECEIVERS	
HK3500/3600	£699/£799

AIWA

AUTHORISED DEALER

AMPLIFIERS			
XA003 40W.PCH	£139	NSX400	£299
XA950 100W.PCH	£229	NSX430	£299
TUNERS		NSX540	£399
Y1100	£119/£149	NSX550G	£429
CASSETTE DECKS		NSX560	£449
AD5480S0	£119/£229	NSX737	£749
AD7480S0	£169/£199	NSX450G	£349
ADW9X29	£249	NSX520	£349
DOUBLE CASSETTE		LCX507	£249/£299
ADW77629	£169/£199	LCX605	£299/£299
CD PLAYERS		LCX970M	£349/£379
DXM100	£149	MINI SYSTEMS	
XC300	£149	NSX270	£279
		NSX340	£299
GRAPHIC EQUALISERS		KE2060/GE7000	£149/£299
TURNABLES		KD492F	£99
CD PLAYERS		PD100 MINI	£89
DP2060/DP3060	£159/£199	UD302/UD502	£399/£499
DP2060/DP7060	£249/£379	UD552/UD751M	£549/£749
DP2060/DP/M6000	£199/£249	UD952	£399
MINI SYSTEMS		M28/28MG	£499/£599
M28/28MG	£499/£599	M58/58P	£799/£899
M58/58P	£799/£899	M88/M88MP	£849/£949
M88/M88MP	£849/£949	M87GM/7MG	£1249/£1299

BOSE

SPEAKERS

SPECIAL OFFER	
PART EX. YOUR SPEAKERS & GET UP TO	
£200 OFF	
ACOUSTIMAS 7M2 £829 NOW £629	
ACOUSTIMAS 5M2 £759 NOW £559	
ACOUSTIMAS 3M2 £499 NOW £349	
ACOUSTIMAS 4M2 £599 NOW £449	
WHEN PART EXCHANGE NOW PRICES ARE VALID	
FREE COLLECTION	

SOLID STATE SURVIVORS



David Price rounds up a collection of enduringly popular budget amplifiers to see how they compare.

We wanted to find out just what's available to prospective purchasers of £250 amplifiers.

To get a perspective, we lined up the latest versions of some old

favourites, and got a few surprises - not least about the quality of sound possible at this modest price point. This, allied to high power outputs with excellent load driving ability, makes quality modern budget amplifiers fine all-round

packages. Each member of the test group, comprising Arcam's £229.90 Alpha 5, Pioneer's £229.95 A300X, NAD's £239 304, Aura's £279 VA-80 and the £259 Pro-Ject 7, proved this in some respect.

The Sound Room of Norbury

In 1986 we were the first and only dealer in the U.K. to supply Impulse Horn Loaded Loudspeakers. Over the years they have improved to the outstanding performance of today. We were the first and are the most experienced in horn system installations. Please phone for an audition of Impulse H7, H6 and H2 loudspeakers, plus other superb equipment from:

TOWNSHEND • AUDIO
INNOVATIONS • KISEKI-
MILLTEK • TUBE
TECHNOLOGY • SHEARNE
AUDIO • E.A.R. • VOYD
GOLDRING • SHAHINIAN •
MICHELL ENGINEERING •
SENNHEISER • ORTOFON •
PIONEER • VECTEUR •
LONDON DECCA • BEYER •
PLUS MANY MORE



Please contact us on (Croydon, London)

0850 230339

The amplifiers were used for an extended period with both Compact Disc and vinyl sources, driving speakers as diverse as KEF Reference Series 2s, our own KLS3 carbon-fibre coned monitors and Mission 733 floorstanders.

Arcam's Alpha 5 exudes quality, with switches that work smoothly and decent defeatable tone controls, sensibly subtle in effect. With six inputs, including phono (moving magnet) and outputs for two pairs of speakers, Arcam appreciate that in the real world, budget amplifiers need to serve a number of purposes. Better still, they've not let flexibility compromise sound, nor have they pandered to gaudiness in their provision of these facilities.

Unfortunately the same couldn't be said of the Pioneer A300X, which falls prey to Acute Japanese Styling Syndrome. The Japanese have a saying, "the nail that sticks out must be hammered back in". Perhaps this explains why all Nipponese hi-fi tends to be square, and painted black replete with tacky gold legends. We've only the Lord to thank that UK versions are devoid of the fake wood end cappings that adorn Japanese separates elsewhere! Aesthetics aside, it's well put together, with six inputs including a moving magnet phono stage, and useful independent listen and record selectors.

The 304 continues NAD's corporate look - not terribly awe inspiring - but picking up the 304 makes

you forget such things. It's heavy, doubtless due to its mains transformer which speaks volumes about its musical presentation before its power LED even so much as blinks. The 304 features the ubiquitous 'soft clipping' circuit, a great idea at parties, but it should normally be switched out as it can harden the sound.

The Pro-Ject 7 looks as oddball as ever, its finish a tad shoddy compared to the rest of the group - rather 'cottage industry'. The 7 also boasts a phono stage configurable for MM and MC cartridges, but as it's done from inside the casing, many will want their dealer to tackle this.

Most expensive of the group is the Aura VA-80, which continues the stripped bare 'UK audiophile' tradition. Unfortunately, not one of its six inputs has a phono stage (boo! shame!) and Aura don't produce an optional phono module. The VA-80 is well finished, but compared to the NAD seems insubstantially built.

LISTENING

Surprisingly, all the amps on test were happy driving the KEF Reference Series 2s, which although efficient, present a very difficult load. Best in this respect was the unimpeachable NAD, which didn't so much drive them as take them by the neck and shake them! Pioneer, Arcam and Aura all managed high volume levels, and the Pro-Ject gave good levels without sounding flustered.

The Arcam is the epitome of 'impressive' sound. Whilst the first few minutes of the audition had me thinking it was the best amp of the group, it soon

became clear that this wasn't the case. The bold, brusque sound instantly got feet tapping to Burning Spear's 'Fittest of the Fittest', but not far into the song I found myself losing interest. Basically, it lacks ultimate grip - its voluminous bass fairly sloppily controlled, and treble strong but lacking subtlety. The Arcam's

strengths lay in timing precision and its ability to go loud quickly, giving an insightful rendering of dynamics. But the more I listened, the more its uncouth treble made itself heard,

especially with CD. It definitely rewards warming up, exemplified by the Brand New Heavies' 'Midnight at the Oasis', where the Alpha was so bright it almost spat at me until it had been on for a good few hours. If sympathetic ancillaries are used you should be able to sidestep this - certainly the smooth Goldring 1042 cartridge used in our Garrard 401 went a long way to alleviate the problem. Overall, the Arcam never failed to sound engaging and musical, but left me wanting more detail and control.

The Pioneer also boasted a large, positive sound, but with rough edges smoothed out somewhat. More low level detailing came through - I could hear production tricks in Oasis' 'Live Forever' that the Arcam missed. But with this came a slight flattening of dynamics that the Arcam could never be accused of. The A300X had a sweeter upper midband which invested warmth into female vocals, making the Pioneer's presentation more palatable on a day to day basis. The A300X's increased control made for a more orderly presentation. On the Burning Spear track, it gave an extremely convincing performance - far tighter than the Arcam. It seemed to pull the listener further into the music as the song progressed, which is just how it

"If you've got a separate phono stage, the Aura is a formidable way to play records."



MAKING NEW FRIENDS AT **Doug Brady Hi-Fi**

While we are fully involved in the latest Digital Technologies, we are proud to add a new 'VINYL FLAGSHIP' from Michell to our range of turntables from Roksan, Pink Triangle and SME.



MICHELL ORBE

Doug Brady
Kingsway Studios,
Kingsway North,
Warrington.
Tel: 0925 828009

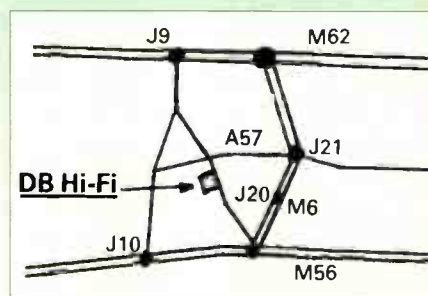

BRITISH AUDIO DEALERS ASSOCIATION

BADA
THE ULTIMATE IN
SOUND ADVICE



should be. Bass was tight and powerful, and treble was detailed and civilised, but tended towards sterility. Indeed my only criticism of the Pioneer was its propensity to sound 'antiseptic' and lacking in tonal colour.

Reminiscent of earlier classic NAD designs, the 304 was the smoothest amp I'd heard so far. Its beguiling quality meant that you could listen for extended periods at high levels without fatigue. Indeed, the 304 injected smoothness into anything it touched, introducing a slight lower mid bloom that I'd imagine would be just the ticket for thin sounding budget CD players or rough budget cartridges.

One of the NAD's finer qualities was bass, prodigious enough to worry seismologists. Although rather lackadaisical in the timing department, it went down very low. Not the fastest of amps, when the NAD did get hold of a bass line, it steam rolled it out with grin-inducing force that shamed the rest of the group. On phono, things weren't quite so good, the 304 tending to sit on rhythms whilst retaining its attractive tonal palette. Bass lines on Augustus Pablo's 'King Tubby Meets Rockers Uptown' retained their power but lost their swing, stripping the song of its atmosphere. All in all, the NAD deserves careful matching to give of its best.

In the context of our reference

system, the Pro-Ject exhibited the most grip and control. Although tonally dull, it felt the fastest and most musical of the group. The Pro-Ject always got to grips with rhythms, offering the least mechanical rendition of 808 State's 'Nimbus'. As you would expect from a well respected turntable manufacturer, its phono stage is also extremely good, losing little to its line inputs. Jazz also showed its powers of persuasion, the 7 giving the most fluid reading of Herbie Hancock's 'The Prisoner'. Where the Arcam blasted sound at you and the NAD rattled the floorboards, the Pro-Ject just played music.

The Aura was the other surprise. Although of modest power output, up on the Czech amp but down on the others, it was superbly grippy. It worked in any system, sounding consistently impressive. It came across as the most tonally neutral of all the amps on audition.

YMO's 'Music Plans' showed the VA-80 to be even more dynamic than the Pro-Ject, possibly a function of its brighter tonal balance. It displayed lots of control, allowing notes to start and stop with great speed, and communicated the dynamics of the song in a manner out of step with its modest price tag. Although the Aura couldn't pump current NAD-style, it showed a clean pair of heels in other respects.

THE VERDICT

Overall, I found myself splitting the amps into two groups - the good and the great. The Arcam, NAD and Pioneer belong to the former, the Pro-Ject and Aura the latter.

The Arcam was an impressive sounding design that was a breeze to live with, packed with useful features and finished superbly, but on balance it didn't endear itself to me. Likewise the NAD, consummately good at some things, could have done with a more rhythmic presentation. The Pioneer almost deserves the 'great' mantle, but sounds a touch too sterile for my tastes - nevertheless it's a highly capable all rounder - ignore at your peril!

And now for the serious kit! For vinyl junkies on a budget, there's only one choice - the Pro-Ject 7. Its excellent phono stage would suit bright moving coils like Ortofon's MC15 Super II, but will also work beguilingly well with Compact Disc. But it's an acquired taste, with question marks over its ability to work in a wide range of systems.

This is where the Aura comes in. If you've already got a separate phono stage, the VA-80 is a formidable way to play records. But it will also get the best from anything else you care to connect - indeed it soon found itself working as a reference amp, used to audition other equipment! Although the most expensive of the group, the Aura is still excellent value for money - a testament to how good modern budget transistor amplifiers can be.

Who said budget amplifiers weren't much fun?

MANUFACTURER'S TELEPHONE NUMBERS

Arcam	01223 861550
Aura	01903 750750
NAD	0181 343 3240
Pioneer	01753 789789
Pro-Ject	01753 889949

Records at Cost

Now you can buy your CDs at dealer's cost price

As a member of the WSL Records at Cost Service you can buy **any brand new CD** (subject to availability) at cost price plus a small handling charge of only 50p.

Now you have no need to shop around for the best discounts. Here at last clearly stated are CDs at the ultimate saving — **The Dealer's cost price.**

Only WSL — offering a mail order service for more than 30 years — can offer you such low cost listening.

So why not see what savings you really can make by checking our prices?

Return the coupon or write to us now and we'll send you full details of the Records at Cost Service, together with a special promotional membership offer.

Please send me full details of the new Records at Cost Service. Without obligation (I enclose two first class stamps for speedy reply).

Name: _____

Address: _____

Postcode: _____

To: Bill Wilson Wilson Stereo Library
PO Box 32 St. Leonards-on-Sea East Sussex TN38 0UZ
Telephone: (0424) 718254 Fax: (0424) 718262



HFN2/95

IT'S TOUGH AT THE TOP!

Only occasionally does an audio product of this originality, build quality and breathtaking performance, arrive on the market. Without any doubt, DA-X is a major advance in state-of-the-art digital to analogue converters

FEATURES:

- Extremely low time uncertainty in the digital domain.
- UltraAnalog's latest, most advanced and best sounding dac.
- Up to 6 inputs including ST (AT&T) glass optical.
- Optional dual UltraAnalog dacs for balanced outputs.

PERFORMANCE:

- The closest digital has ever come to actually being there.
- Effortless dynamics, soundstaging and ambience.
- Strong, tight, powerful and extended bass.
- Delicate natural detail and character at all frequencies.

DAX and PASSION are demonstrated at:

- WILMSLOW AUDIO, Cheshire. Tel: 0565 650605.
- RICHARD TRUSSELL, Hampshire. Tel: 0420 542060.
- RAY JACKSON, Cambridgeshire. Tel: 0480 406295

AUDIO synthesis

Audio Synthesis: 99 Lapwing Lane, Manchester M20 0UT U.K. Tel: 061 434 0126 (++44 61 434 0126)
PO Box 50, Nottingham NG9 U.K. Tel: 0602 224138(++44 602 224138) Fax: 0602 258431(++44602 258431)

Distributor clears stock, export-discount **50% or more**

HIGH END SALE

WELL TEMPERED



Record Player, Classic, Signature export price from **£590**

AUDIO RESEARCH

DAC1, SP9, SP15, D250 MkIIS, M300 MkII, Classic150

KOETSU Black, Rosewood Signature, Onyx Signature

MARK LEVINSON

MLC1, JC1, ML6, HQD-system (2xML6A, 2xLNC2, 6xML2, 2xHartley/Quad/Decca-array)



GOLDMUND Studietto, ST4, T5, Cartridge, Mimesis amplifier series, Super-Dialogue, Apologue (picture)

Also: **Berning, Bruer, Cotter, Eureka, Fidelity Research, Linn, Moersch...**

Call for catalogue!

Glotta AB, phone +46 8345251, fax +46 8346533

close your eyes and see



the new improved Arcam Alpha 5 system

Close your eyes and see the difference between Arcam's new Alpha 5 system of hi-fi components and anything else in its price range.

Ignore the fact that the Alpha 5 amplifier is our best 'budget audiophile' amplifier ever, outselling all others in the UK for the past year. Don't be tempted by its attractive styling or a price tag which looks too good to be true. Just listen, and discover for yourself a quality of sound that can only be described as exceptional.

Next, try the Alpha 5 FM tuner. Again, don't let its surprising affordability seduce you. Instead, listen to broadcast sound that is natural, clear and dynamic - qualities which gained it a class leading

Recommendation in the 1994 What Hi-Fi? Awards.

Finally, feast your ears on the new Alpha 5 Plus CD player - quite simply, the best value high performance CD player ever produced by a UK manufacturer. Over the past year the critics have heaped praise on its predecessor, the Alpha 5 CD player, calling it "the player to beat" (What Hi-Fi?) and "standing head and shoulders above the rest" (Hi-Fi News)*. Now, thanks to new master clock circuitry, the 5 Plus sounds even better and once again sets the standards for other CD players to match.

Just listen. Close your eyes, open your mind, and see the light.

*If you already own an Alpha 5 CD player, we'd be happy to update it to full 5 Plus specification. Please call our service department at the number below during office hours for full details and prices.

ARCAM

For more information, including the nearest place you can listen to Arcam, complete the coupon and post it to:

Arcam, Pembroke Avenue, Waterbeach, Cambridge CB5 9PB, England. Or telephone: (01223) 440964 (24 hours). Fax: (01223) 863384

Please send me information and reviews on (please tick boxes):

Please send me a brochure with details of all your products

Arcam CD players Arcam tuners Arcam amplifiers Arcam's cassette deck Arcam speakers AudioQuest cables

Title _____ First Name _____ Surname _____

Address _____ Postcode _____

In Australia: Stobmack Audio Pty. Ltd., P.O. Box 139, St Ives, N.S.W., 2075. Tel: (61) 2 440 8755. Fax: (61) 2 440 8441. In Canada: Enzokad Audio Resources, Sussex P.O. Box 19016, 720 Spadina Avenue, Suite 100A, Toronto, Ontario, M5S 3C9. Tel: (416) 596 7657. Fax: (416) 596 7171. In New Zealand: Arvilon Audio, 587 Mount Eden Rd., Auckland. Tel: (09) 369 9060. Fax: (09) 638 8888. In South Africa: Hi-Fi Specialists, Durban Road 152, Bellville, 7535. Tel: (021) 946 1441. Fax: (021) 946 4364. In USA: Audiohub Corporation, P.O. Box 381, Highland Lakes, NJ 07422. Tel: (201) 764-8958. Fax: (201) 764-8479.

HFW 4/95



World

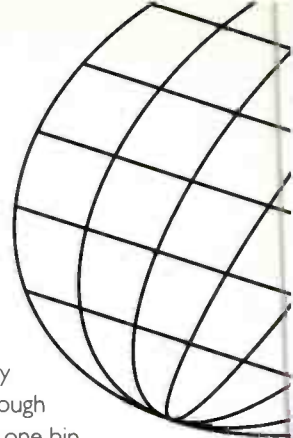

AUNTIE BEEB IN VINYL BLOOPER

I am writing to ask how many of your readers were incensed at the report by BBC News night on the "Return of Vinyl". Peter Snow interviewed a manager of Virgin Records and a Radio One 'dance' DJ, a pair so informed that there was no need for any vinyl purchasers or hi-fi specialists to enter the lofty debate. Sorry, sarcasm so

early in a letter is not a good sign is it?

The opinions expressed during the interview included the incredulous fact that people actually still wanted to buy vinyl, even though we have had the honour - not just the opportunity - to purchase those wonderful silver discs for the last ten years plus.

Another view was that unless you were a dedicated

dance fan who needs vinyl to "scratch" music together you were a trainspotter type for liking / buying vinyl and should by now have overcome your fetish and bought CDs.

The Virgin Manager condescendingly boasted of putting all the vinyl in one area for those who still want to buy it. This makes it easy for us to buy (?), and LP lovers easy to spot! A more likely reason is

because they only have enough vinyl for one bin.

Peter Snow showed us his impressive research abilities with flippant statements such as, "Why do people still buy records when you cannot buy record players anymore!", a comment that stirred the indignation in someone as lazy as me and caused my first ever

COGNITIVE DISSONANCE!

It was with sadness that I read your review of Roger Penrose's latest tome, *Shadows of the Mind*, in the February DIY Supplement.

There are many serious problems with the arguments laid forth by Penrose, many of which appear to be due to a lack of understanding of the basic mechanisms at work in neural systems. His thesis concerning 'quantum effects' taking place at the synapse is a case in point. It seems that he misinterpreted the fact that synaptic transmission is quantal (neurotransmitter is released in the form of small packets, each of which causes changes in the post-synaptic ion channels which are quite deterministic) to mean that he could start playing around with the type of quantum stochastic mechanisms which are found when dealing with sub-atomic particles.

Needless to say, this is

quite unjustified. Whilst probabilistic mechanisms are almost certainly present in the human brain, there is absolutely no evidence to suggest that this represents anything more than the Gaussian noise found in all macroscopic systems. Events at the synaptic cleft may occur on a small scale relative to everyday experience, but they are still very far removed from the arena of sub-atomic physics.

Unfortunately, it seems that Penrose has fallen prey to the most common trap in the philosophy of consciousness: Cartesian dualism, that old and rather arrogant notion that mind is necessarily separate from matter. Of course, he cannot openly profess belief in such mysticism without being ridiculed, so he introduces it covertly, but the mysticism is still there. We still find ourselves confronted by a black box whose workings are hidden from us.

Now, I am not going to

pretend that mechanist philosophy can provide a complete counter-argument to Penrose. Indeed this debate is only taking place because there are large gaps in our knowledge of the systems that produce human thought: we simply don't have the wherewithal to prove him wrong, and probably won't have for many years to come. There is, however, a simple and elegant philosophical tool that we should never forget: Occam's razor. It is simply not necessary to resort to obscure philosophical ramblings in the backwoods of quantum mechanics to explain human thought. All we need is a further elucidation of the deterministic mechanisms which have already been demonstrated so well over the past forty years.

Consciousness is indeed marvellously complex and it will take us a long time to tease out the full wonder of its mechanism. But the progress made in

neurosciences over the past half century has been astounding, all of it based firmly on the concept that the mind comprises of a system of interlocking, deterministic mechanisms.

**Dr C. King,
London.**

I think I should comment on some serious misunderstandings of my own viewpoint expressed in Dr King's letter. It appears that he is confusing the views put forward by Sir John Eccles with my own. I am not arguing that there is anything relevantly quantum mechanical in synaptic transmission. Instead I am suggesting that quantum mechanics (and even a physics beyond standard quantum mechanics) is playing an important role in the controlling activities of microtubules.

There appear to be at least three different ways in which microtubules influence the strengths of

Letter of

Send your letters to Hi-Fi World Letter Page,

writes

letter to a magazine.

Finally I must apologise for my insane rantings but then I LIKE VINYL, so that's my excuse and I'm sticking to it. Having a shoulder to cry on eases the pain.

Yours desperately seeking vinyl,

P.D. Brackley
Deptford,
London.

It wouldn't be the first time vinyl lovers have been patronised or marginalised in the mass media. Whilst we can shrug it all off with an air of superiority, the problem is that such misinformation actively threatens the survival of our favourite format.

What we all have to do is make it plain to record companies and retailers alike that there is still a demand

for black plastic, and that there's money to be made in supporting it. I hope my vinyl feature on page 21 does just that. In the meantime, you can count on everyone here at Hi-Fi World to keep vinyl on the map. **DP**

And, of course, billions of LPs exist in treasured music collections, world wide. That people will continue to want to play them curiously seems to pass ignored. **NK**

the fundamental tenet of hi-fi philosophy - your statement gives the impression that realism is irrelevant.

I would argue that if, for example, a virtuoso performance of an acoustic instrument or a vocal rendition is to be reproduced, then the reproduction should be as realistic as possible to capture the subtle nuances of the performance.

Also, in the situation where motion picture/TV material is being presented, if the reproduction of everyday sounds, (e.g. doors slamming, traffic, voices, etc.) is very realistic and the equivalent acoustic distance is about 3 feet, then it gives a much better sense of involvement in the drama.

This leads to the question, is realism attainable on the domestic scale? Two-loudspeaker intensity stereo has no direct correlation with real experience, but single-

continued on page 45...

the Month

synaptic junctions, perhaps the most promising being in how they control dendritic spines (probably via their influence on the actin within the spines).

According to my present viewpoint the action of the neuron signals within the brain at any one moment would not be unlike that of a computer. But the delicate strengths of the synaptic connections would be under the continual influence of global quantum-state-reduction within the microtubules across large regions of the brain.

There is nothing "dualistic" in this viewpoint, but it does require that present-day quantum mechanics should be appropriately extended in ways that are described elsewhere in *Shadows of the Mind*. The necessity for this kind of physics being involved is for reasons given in the first half of the book.

Professor R. Penrose,
Mathematical Institute,
University of Oxford.

Alright, so you can't see what all this has to do with hi-fi! And why did I review the book in the first place? In hi-fi there is little appreciation of the complexities and currently, mysteries, of the human cognitive process. *Shadows of the Mind* brings us some interesting views to bear on the way the mind may work, even if it doesn't touch specifically on human cognition. I feel this discussion at least gives us some idea of the magnitude of the problems facing us and why, even today, the world's largest manufacturers still have to resort to subjective listening tests to ultimately validate a sound processing systems like PASC and SBM. Only when we finally understand human cognition may we devise tests that truly inform us about sound quality. **NK**

MISLEADING?

In your reply to Manolis Koussaniotakis letter in the January '95 issue, you stated: "We do listen to live music, but this is hardly consequential. The notion that a hi-fi system can be compared to the real thing is a misleading oversimplification."

I'm afraid I cannot agree with this statement, and was horrified to see it in a hi-fi magazine. I always thought that to strive for realism was

WIN HI-FI WORLD INTERCONNECT CABLES

OR PERFECT PITCH'S FRANCIENSTIEN CD

ENHANCER

The writer of the most interesting or funniest letter will receive a choice of either: a free set of Hi-Fi World's silver plated copper interconnect cables, worth £69.95, or a Francinstien CD convertor enhancer worth £150.



64, Castellain Road, Maida Vale, London W9 1EX.

LITTLE AND LARGE

Mission's new 733 floorstanding loudspeaker may be little but it's got a large sound, Noel Keywood finds.

A little carpet space and £299.90 is all you'll need for Mission's new 733 floorstanding loudspeakers. I'm sure that space is going to appear in homes all over Britain whilst the said cash sum will disappear from an equal number of bank accounts. Mission know how to engineer an attractive and exciting sounding loudspeaker - the 733 is another example of their abilities in this area.

The black ash veneer cabinets are compact, having a footprint 205mm wide and 300mm deep. Spikes are supplied for firm location, but bi-wiring isn't possible on what's effectively a budget product. Despite this, Mission use an elegant and attractive moulded front panel which holds the two drivers and has an integral port. The bass/midrange unit has a white translucent polypropylene cone and a black rubber roll surround. Above it sits a metal dome tweeter, protected by a fine mesh grille. In an 850mm high cabinet, this assembly makes for a neat if sombre looking product.

Polypropylene is known to provide a smooth sound across the upper midrange, important with strings and vocals. The trade off is a little 'quack' in the sound, especially at high volume levels when cone breakup occurs. On balance though, polypropylene makes for a speaker that's easy to live with and doesn't jar the senses, important over long listening periods.



The Missions were used with an Aura VA-80 amplifier, fed by a Pink Triangle Da Capo/Audiolab transport combination.

The 733 has real get up and go. It's a breathtakingly fast rocker that grabbed my attention from the first few bars of Primal Scream's 'Rocks'. Fulsome, lithe bass lines, a good kick from drums, plus a great sense of midband clarity that has singers out of the mix and into the open, made for a vivid presentation. Soundgarden's 'The Day I Tried to Live' captured it all. The bass intro was powerful, yet the Mission's captured the descent of the bassline deftly, offering a wonderfully ominous introduction that set the scene perfectly for the band's feedback guitars. They cut in hard, raucous and jangling before the lead singer's guttural vocals fought their way out of the increasingly intense wall of sound. Many loudspeakers throw a fit with this sort of material, but the 733s lapped it up.

The Missions reproduced rock wonderfully, with strong dynamic contrasts, a great sense of expression with vocals, and basslines that were generous in level, yet nicely defined in terms of pitch. Light, spry treble complements the speaker's enthusiastic bass, allowing this modestly sized floorstander to develop a big sound in the home.

Precise stereo imaging brought a sense of presence to Eddie Reader's smooth, lilting vocals - her voice hung between the speakers beautifully, clear and believable. The strings of her acoustic guitar were reproduced cleanly and sweetly. Here I was struck by the delicacy of portrayal achieved by these speakers with simple programme material, good detailing contributing much to their captivating sound, richness of timbre shading vocal nuances nicely. Our tests show rising treble from the tweeter but I found it easy on the ear. All the same, the Da Capo and Aura are smoothies. The 733s will not partner a sharp sounding amplifier or CD player well.

First impressions are important, but reviewing has to look at underlying subtleties that emerge over a period of time. Here the 733s showed themselves

to be more suited to rock than classical. Down in the lower bass and deep bass regions the speakers are lightly damped, making them quick and vigorous in bass output, but also a little boomy. The sudden entry of cellos and even violins in Rachmaninov's Piano Concerto No.2, Opus 18, had the box adding a distinct whoomph, which I found disconcerting.

The drive units are well enough engineered to give smooth string tone, but on orchestral crescendos I noted muddle setting in. A degree of plastic quack was apparent with violins, plus a little nasality, just enough to add character. These lesser effects weren't really of much consequence under the relentless pressure exerted by rock programme, but classical imposes its own particular requirements, some of which can be peculiarly probing, as I found in this case.

It was those 25Hz heartbeats at the start of Pink Floyd's 'Dark Side of the Moon' that showed the 733's bass/midrange unit could reach its end stops at relatively low volume and this, I suspect, is why orchestral climaxes in Rimsky Korsakov's *Sherherazade*, backed by powerful timpany, pushed the 733s into muddle. Their very enthusiasm tempts you to turn up the volume, but this can easily push the speakers past orderliness. Headbangers should beware!

So much for 733's character traits. With such life and vigour at their disposal though, from an essentially well engineered sound that is fundamentally accurate, these low cost floorstanders are going to take listeners' heads off. They're great for rock and sweet enough with classical, but too resonant to come over as fully balanced. All the same, at the price Mission's new 733s have to be rated as something special. They bring music to life - and that's what good hi-fi should do ●

Mission 733 £299.90
Mission Electronics,
Stonehill,
Huntingdon,
Cambs. PE18 8ED
Tel: 0480 451777

Measured Performance
 see p105-111



ALL BILL HUTCHINSON HI-FI SHOPS ARE DEDICATED AUDIO VISUAL CENTRES

ALL BRANCHES ARE MAJOR LASER DISC STOCKISTS



Bill Hutchinson

Hi-Fi · CD · Audio Visual Centre

T H E P R O F E S S I O N A L S

When you purchase from Bill Hutchinson you're buying the best names in Hi-Fi from the best name for Hi-Fi. Our Product Guarantee and Pricing Policy ensure you obtain an excellent deal. My staff and I look forward to being of service to you. *Bill*



HEAR KENWOOD'S INNOVATION WINNING AV AMPLIFIER



- YAMAHA DSP-2070 - AV AMPLIFIER - INNOVATION WINNER '94
- KENWOOD KRV 6060 - AV RECEIVER - INNOVATION WINNER '94
- PIONEER PDS-703 - CD PLAYER - INNOVATION WINNER '94
- MARANTZ 1020 - LYFE STYLE SYSTEM - INNOVATION WINNER '94
- AIWA AD-450 - CASSETTE DECK - INNOVATION WINNER '94
- KEF 100 - CENTRE SPEAKERS - INNOVATION WINNER '94
- JVC UX-C7 - AV AMPLIFIER - INNOVATION WINNER '94

PRICE PLEDGE

Should you find any local dealer offering a better price for goods currently in stock at Bill Hutchinson and the alternative quoting retailer, we will better that deal.

LICENSED CREDIT BROKERS ASK FOR DETAILS

THE LARGEST SELECTION OF QUALITY HI-FI AND AUDIO VISUAL SYSTEMS

LEEDS

Bill Hutchinson

OPEN 7 DAYS

MANCHESTER

Bill Hutchinson

OPEN 7 DAYS

NEWCASTLE

Bill Hutchinson

GLASGOW

Bill Hutchinson

OPEN 7 DAYS

EDINBURGH

Bill Hutchinson

OPEN 7 DAYS

26-28 WOODHOUSE LANE
0532-42777

MON SAT 9.30AM - 6.00PM
SUNDAY 11.00AM - 4.00PM
THURSDAY LATE OPENING

50-52 DEANS GATE
061-832 1600

MON SAT 9.30AM - 6.00PM
SUNDAY 11.00AM - 5.00PM
THURSDAY LATE OPENING

87A CLAYTON STREET
091-230 3600

OPEN MONDAY SATURDAY
9.30AM - 5.30PM
THURSDAY LATE OPENING

43 HOPE STREET
041-248 2857

MON SAT 9.30AM - 6.00PM
SUNDAY 11.00AM - 5.00PM
THURSDAY LATE OPENING

43 SOUTH CLERK STREET
031-667 2877

MON SAT 9.30AM - 6.00PM
SUNDAY 11.00AM - 5.00PM
THURSDAY LATE OPENING

The fourth installment of the "Maximalist Preamplifier" brings me to the design of the digital interfaces. This is intended for purely domestic use so the emphasis is on the Sony/Philips Digital Interface (SPDIF), but because of my own involvement in professional digital audio I have incorporated an AES/EBU input as well.

Adhering to my principle of constructing an auditionable design as I go, the first stage (illustrated below) consists of input receiving, output transmitting and some switching in between. Later on, I intend to design some "glue-logic" which will decode the digital input, strip out copy code, and recode the data into the correct digital audio SPDIF/AES format.

Eventually the preamplifier will not only be able to receive SPDIF or AES, but also translate electrical levels (and channel-status information) into either standard. In other words the pre-amp will be a digital audio standards converter as well as switching unit. (Incidentally, last month's Recorded Message contained a description of both the AES/EBU and SPDIF interfaces and data structure).

There are many ways of constructing a digital audio interface. Probably the simplest consists of an HC-family inverter IC, biased at its midpoint with a feedback resistor and protected with diodes across the input to prevent damage from static or overvoltage conditions. I have to say that about the only real merit of this circuit is simplicity!

I have railed-on before about the short-sightedness of manufacturers who omit the transformer coupling of digital audio data, so I won't repeat myself. Suffice to say, transformer coupling (even of the analogue interfaces) is one of the underpinnings of this preamplifier design. Happily, whilst

analogue audio transformers are complex and expensive items, digital audio containing as it does no d.c. component and very little low-frequency component, can be coupled via transformers which are tiny and cheap! So it represents a false economy to omit them in the design of digital interfaces. I have found data-bus isolators manufactured by Newport - and easily available from RS Components (or via Electromail) - are very suitable. Two or four



DCC (or DAT) player is selected as the current input when the record button is depressed on the tape machine, a feedback loop is set up via the record-output circuit. The result is tweeter-bursting howl. Eventually this interlock will automatically prevent this expensive circumstance from ever occurring.

There are many ways of implementing digital audio I/O. I hope this exercise of thinking through the design of the Maximalist Preamplifier out loud will provoke debate. It isn't my

recorded message

Left by Richard Brice

within one IC-style package. Each transformer costs about £1.50 - a long way from the £15 or so required for analogue transformers.

Remember that "in digits" only one transformer is required to couple both channels of the stereo signal. You'll notice, looking at the circuit diagram, that I've opted to use RS422 (RS485) receiver-chips to buffer and re-slice the digital audio data. I've chosen the SN75173J, a quad receiver in a single 16 pin package costing a few pounds. This has the added advantage that to adapt the interface between SPDIF and AES, all that's required is to change the value of the terminating resistor on the secondary side of the input transformer.

One thing to watch on the SN75173 is the polarity of the second enable-pin (pin2) which differs from manufacturer to manufacturer. Digital switching is shown schematically in the diagram as a

selector switch, this is best implemented electronically but a mechanical switch is adequate. Digital output driving is performed by using two inverters which are used in tandem to increase the output drive. If AES/EBU output is required, an RS422 driver IC will do the trick beautifully.

I've chosen to transformer the output too, although this is not required as part of the digital audio standard. The record-interlock circuit block is shown dotted as it's not necessary to include it at this stage. It's there because digital audio is just the same as analogue in that if a

inductive series of articles so I'll close this month by proposing an entirely different approach to the receiving and buffering of digital audio signals.

It's quite possible to treat digital audio pulses as a high speed analogue signal! This approach works very well - I've tried it on the bench. If you're an analogue die-hard and looking for something different, you could try this technique yourself. Use a high-speed video op-amp like the el2020 from Elantec for the receiving and transmitting devices in 75 ohm matched-termination circuits ●

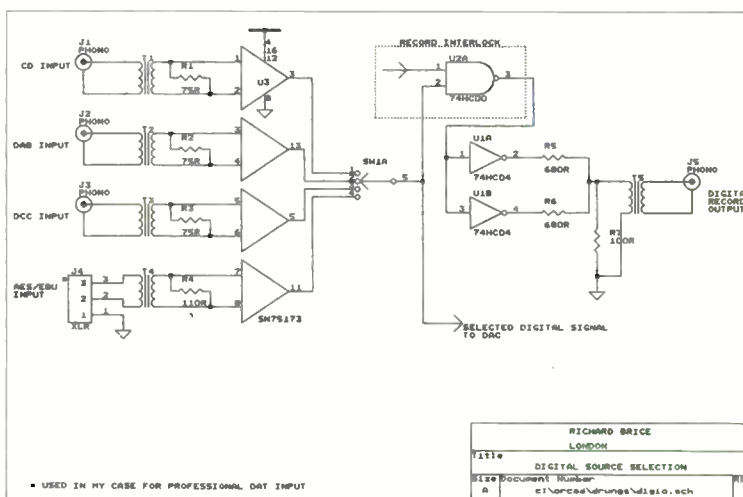

World favourites

COMPACT DISC PLAYERS

NAD 501	£180	A break from the MASH tradition, the Philips powered 501 gives excellent results.	Apr'94
ARCAM ALPHA 5+	£470	Sweet and detailed sound place the Alpha 5+ ahead of the pack.	Mar'95
QUAD 67	£790	A new breed of Quad. Lacking nothing in verve or excitement.	May'93
NAIM CDI	£1598	Single box, 16 bit player. Close to the two box CDS, has vital 'tingle factor'.	Apr'92

COMPACT DISC TRANSPORTS

TEAC VRDS-TI	£499	Good solid CD transport with a powerful sound, and reasonably priced too.	Feb'95
DPA ENLIGHTENMENT	£695	Ideal partner for Enlightenment DAC. Equipped with Deltran Sync-lock facility.	Mar'95
ARCAM DELTA 250	£750	Transport with sync-lock facility. Good partner to BB50	May'94

DIGITAL TO ANALOGUE CONVERTERS

DACULA	£376	This little devil from Select Systems really gets its fangs into the music.	Dec'93
DPA LITTLE BIT II	£450	Clean and confident sound with good resolution and focus.	May'94
DPA ENLIGHTENMENT	£695	Discrete design that portrays music with a sense of realism.	Mar'95
P. T. DA CAPO	£1450+	Pink Triangle's own one bit DAC reaches new standards in digital. One of the very best. Even better with DC supply and new filter options.	Mar'94
DPA 1024	£6000	A reference for all other convertors. DPA's own discrete design.	July'94

TURNTABLES

SYSTEMDEK IIX900	£230	£330 with RB250 tonearm. A fine all-rounder and easy to upgrade. Neutral character.	Sep'94
PRO-JECT 6.1	£435	Complete with Ortofon MC15 Super and can even play 78s for an optional £10.	Sep'94
TOWNSHEND ROCK III	£799	The MkIII has a fabulously stable, solid image and terrific bass.	Feb'94
PRO-JECT 6.1SA	£999	A top flight turntable complete with Sumiko arm and Ortofon MC30 Supreme MC.	Dec'94
P. T. ANNIVERSARY	£1200	Very neutral turntable. Excellent imagery and detail.	May'92
SME MODEL 20	£2495	The last great turntable, bettered only by the £11,000 Model 30.	Oct'92

TONEARMS

REGA RB 300	£139	Simple and superb; dynamic with solid bass.	Various
SME 309	£568	Based on IV and V: Aluminium armtube and detachable headshell.	Jan'93
SME IV	£850	Loses little to the fabulous V, possibly the best value for money SME.	Dec'93
SME SERIES V	£1232	A masterpiece of precision engineering, with a cohesive sound.	May'92

CARTRIDGES

ORTOFON VMS-2E	£10	Warm, full bodied, punchy, fast, good tracking - what else can you get for a tenner.	Nov'94
GOLDRING 1012 GX	£60	Rounded bass, slightly forward midband, clean transients. A bargain.	Jul'93
GOLDRING 1022GX	£80	Extra degree of dynamic range and speed over the 1012GX	Jul'93
GOLDRING 1042	£100	A reference to all other MMs regardless of price	May'92
ORTOFON MC15 SII	£110	Dry, accurate and revealing. A top MC at a budget price.	Mar'95
ORTOFON SUPREMES	£225-450	The MC10, 20, & 30 Supremes offer superb sound and value for money.	July'94
LINN KLYDE	£450	Soft treble, but a stonkingly good cartridge.	June'94
ORTOFON MC2000	£650	We came across this one by accident; used on a Garrard 401 with an SMEIV it gave one of the best results we've ever heard.	Dec'93
ORTOFON MC7500	£2000	The best MC available? Produces real-life scale of music.	May'94

CASSETTE RECORDERS

AIWA AD-F850	£230	Fine recording quality and good playback. A real bargain.	July'94
AIWA AD-S950	£299	A stable transport, superb head and Dolby S make this a superb recorder.	Feb'95
NAKAMICHI DR2	£500	Worth every penny, pushes recordings to the limit and remains unflustered.	Feb'94
NAKAMICHI DRI	£780	Nakamichi sound quality, and manual head azimuth adjustment.	Jun'93
NAKAMICHI CR-7	£1500	No Dolby 'S', but auto tape tuning and motorised head. The Best!	Aug'92

.... continued from page 41

channel reproduction on one loudspeaker does. An interesting test is to listen to single-channel playback, especially of voice or solo instruments, and judge how real the sound is. The result is often very disappointing, even with loudspeakers which are sold as being suitable for monitoring. Perhaps this explains why you made your comment?

My experience is that realism is definitely the province of two-way horn systems, and I have heard experimental, compact two-way horn loudspeakers which have been frighteningly realistic, therefore I know it is possible. Having looked at the market, I am not aware of a commercially available horn design, domestic or professional, which I believe capable of a realistic presentation, and indeed it may be that the most realistic-sounding loudspeakers belonged to a previous generation.

I would be interested to see opinions from every link in the chain; from performers, studio engineers, designers, reviewers and end-users.

M.J. Lawrence
Selly Oak,
Birmingham.

Striving for realism is a great notion and we do fully support it, of course. What I am wary about here is that recordings are not necessarily accurate portrayals in themselves. Professional microphones do not necessarily have a flat frequency response, for example; many have treble lift. To make vocals from such a source sound natural the hi-fi system would have to apply reciprocal treble cut. It will then offer neutrality, but it wouldn't be neutral!

Many CD players possess some treble roll-off, because this usefully smoothens the generally bright sound from

CD. Such players aren't accurate by definition, yet they are commonly deemed to sound more neutral and accurate. So in hi-fi we are commonly faced with an apparent contradiction; perceived neutrality does not always derive from truly neutral components.

If I say we unerringly strive for accuracy and neutrality, do I then have to say "even if you don't like it"? That's patronising. At the end of the day, we don't pursue petty dogma. We are prepared and do occasionally endorse products that are not strictly accurate, but may well give people pleasure in their music. Our way of handling this is to try and point out the compromise that is on offer and ask people to make up their own minds.

Horn loudspeakers may have "realistic" dynamics, but they certainly do not have a flat frequency response, so are they truly realistic? It strikes me this illustrates how notions of realism and accuracy are quickly inducted to defend viewpoints even when they are clearly open to question. That's precisely why we do not pursue such notions too ardently. Horn loudspeakers are a great experience and I for one would not attempt to counter that just to fit in with notions of accuracy, realism and truth. NK

TEAC REVIEW BEYOND COMPARISON

As a regular and committed reader of HFW (I'm now in my second year's subscription) I hope that you will accept some comment on your reviews as constructive observation rather than criticism. My point is that I find some of your equipment reviews to be a bit on the thin side, especially when it comes to relating performance to comparable equipment.

Your review of the TEAC VRDS-T1 in the February '95 edition was a case in point. In the first instance there was no mention of the facilities. I am one of the probable majority who would not use the more sophisticated facilities provided on some equipment these days, but I would certainly be interested to know if the TEAC comes equipped with a remote control and optical output. One was left to search the photograph to gain a clue!

Secondly, while I certainly appreciate the amount of space you devote to sound quality, and can see the merit in using a high-end Pink Triangle transport and DAC as a reference, surely of more interest to the reader (and especially to a prospective buyer) is how the TEAC sounds in relation to its competitors such as those from Arcam and DPA. Or, perhaps, in what areas the TEAC might bring improvements over the average integrated CD player being used as a transport - I currently use a Philips CD634 with a Little Bit Mk1 'The Power' and would have been interested to know whether the £500 TEAC was a worthwhile upgrade. All the review told me however, was how the TEAC fared against the much more expensive Cardinal.

Please, when reviewing equipment bear in mind that most of us are still on the (never-ending?) upgrade path and will often read reviews in relation to where we already are or where we might go next.

Mike Shipp
Coulton,
Surrey.

In dwelling too much on 'facilities', there's a danger of sounding like manufacturers' sales brochures or press releases, leaving less space in the review to deal with sound quality. Certainly if the review product has any interesting features, we will

mention them.

In a one page review, again due to space considerations, it's difficult to start making comparisons across the board. But now we've moved the measured performance to a separate section, I hope you'll appreciate the extra breadth we can bring to reviews. DP

SYNERGY PLEA

Seeing the review of the Thomas Transducers Brios brought back memories of the Lowther speakers which I once owned. It seems that horn loaded designs just won't curl up and die like some marketing departments would like them to, and certainly some of their characteristics are infectious. These days I simply do not have the available space and have settled for some Tannoy dual-concentrics which at least have some of the immediacy and clarity I used to enjoy, but I still miss the Lowthers. Even though they were merciless in highlighting circuit noise and recording imperfections and could sound less than impressive with certain material, when they shone, they really shone!

This brings me onto the subject of compatibility, not just objective technical compatibility but subjective matching of individual hi-fi components. I have long felt that this area deserves a little more attention. Many components are well received in isolation (and get good reviews in the media) but this is no guarantee that they will be suitable in certain combinations. The specialist retailers will of course endeavour to demonstrate the permutations available in their particular facility, but this is by no means comprehensive.

In my opinion HFW lead the way in adopting a sensible reviewing balance, but how about incorporating a few

continued on page 47

The new Audiolab 8000CDM Compact Disc Transport



The Audiolab product range:
8000A Integrated Amplifier
8000C Pre-amplifier
8000PPA Phono Pre-amplifier
8000P Stereo Power Amplifier
8000T FM/AM Tuner
8000M Monobloc Power Amplifier
8000DAC Digital-Analogue Converter
8000CDM Compact Disc Transport

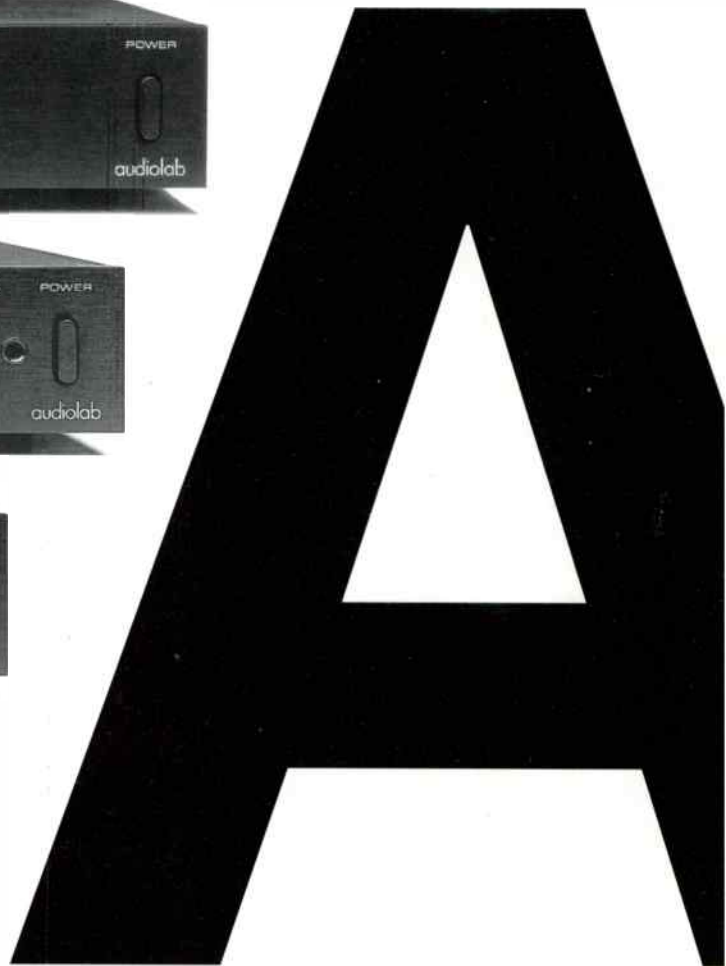
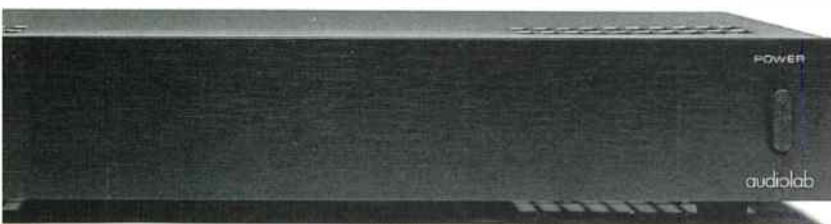

Audiolab 8000A
Best Integrated Amplifier
over £300

Audiolab 8000T
Best Tuner

Audiolab 8000DAC
Best Digital product

AUDIOLAB

Cambridge Systems Technology Limited, Spitfire Close, Ermine Business Park, Huntingdon, Cambs. PE18 6XY. Tel 01480 52521

.... continued from page 45

combination reviews, particularly within the important amp/speaker area. You could also have a World Favourite Combination section at the back.

**Julian Ashbourn
Berkhamsted,
Herts.**

WHAT DIFFERENCES?

Every two years or so, a strange affliction overcomes me and I develop a passionate interest in all things hi-fi. I start buying magazines, reading reviews and usually end up sorely tempted to get rid of some part of my system and replace it with something more expensive.

A few years back, I did this for a good reason. I had just moved, and my ageing Wharfedale Glendales and Cambridge Audio P50 amplifier sounded so boomy in the new lounge that they were virtually unlistenable to. 'Tweaking' had come into fashion by then and I indulged in all kinds of trickery to try and cure the problem, including new cables, removing the feet on some speaker stands and filing them into spikes, toeing in, leaning back, moving away from walls and so on. Nothing dramatic happened, so the set up was replaced with Mission 760s on shot-filled stands and a Pioneer A300X amplifier. The difference in sound was so dramatic that even casual listeners would be in no doubt as to the improvement. Since then, the only major purchase has been a Marantz CD52 because my Philips went wrong. This time the improvement was obvious but not dramatic.

These days, however, things are much more difficult when the affliction strikes. I have listened to more expensive loudspeakers, amplifiers, CD players and record decks in dealer's

audition rooms and in direct comparison with a similar set up to mine. Comparing my reactions to some of the comments made in various hi-fi magazines, I've come to the inescapable conclusion that I'm 'hi-fi deaf'. I have looked up this affliction in a medical dictionary, but it is not listed, so I think it would be a good idea to list the symptoms for the benefit of the readers.

- I cannot hear loudspeaker cables. Honestly, not a peep. The cheapest and most expensive seem to make the speakers sound exactly the same.

- I cannot tell the difference between biwired and conventionally wired loudspeakers.

- I have been unable to detect the improvements in SE versions of equipment over the standard version, described by reviewers in glowing terms.

- I have great difficulty differentiating medium range equipment just by listening. I can tell the difference much more easily when I can see it at the same time.

- I could not hear the difference between a free CD amp interconnect and the very expensive one I was recommended to buy.

- The only dramatic improvement in ambience and imagery is with Magnapan speakers (with Krell amps) over box-type speakers.

- I have not heard any difference at all in the sound produced by CDs on any player after the use of green pens, damping pads, etc.

- I can detect no audible effects from the use of special mats or equipment stands except for speaker stands.

I'm obviously in a very sorry state, but looking on the bright side, my hearing is normal in all other respects, and my enjoyment of classical music has not been in any way affected by my 'hi-fi deafness'. My enjoyment in reading articles and reviews is also unaffected, and so on

balance I do not suffer greatly.

**Peter Fox
Bracknell,
Berks.**

LENDING AN EAR

From previous letters of mine, you may recall that I had a Rock MkII, Myst TMA3 amp and Castle Pembroke II 'speakers. The Myst was changed for a Quad 44/405-2, which proved better in many ways, but something was still not right. So I bit the bullet and ordered an EAR 834P which I had heard at Hi-fi Confidential. This fed the 405-2 directly via the volume control. Amazing. Who said that Quads have no bass?

Now the gripes. The condition in which it arrived was definitely not new. There was no box or instruction manual - I was not interested in the "You have bought a wonderful product" type manual but something that includes specifications and valve types would have been nice. There wasn't even a serial number!

Now the praise. Luigi at Hi-fi Confidential replaced the unit with a new and aesthetically improved version without hesitation. That's service! EAR have produced a wonderful product of amazing value. I'm surprised Mr. T. de P. hasn't brought out a super version with regulated power supply, better valves, better transformer, better aesthetics (to match the EAR 834), etc., charge £6-700 and challenge the ISO head-on!

Regarding tests, if good lab performance does not necessarily translate to good listening performance, then there are some parameters that aren't or can't be tested. Is anyone trying to solve this?

I'm still an advocate of 'neutral' systems, and that something is only good if it is consciously engineered that way, even though NK chastised me on this. I just have difficulty believing in fairy dust...which applies

especially to cables!

Once again, keep up the excellent work and I look forward to receiving my copy on my doorstep every month.

Manolis Koussaniotakis.

Generally, a good lab performance, at least in certain key areas, is a prerequisite for a good audio performance. But, perplexingly, there are a growing number of exceptions; we are getting some strange measured performances from Pioneer, Arcam, DPA and Denon CD players/convertors, for example, and of course both manage to sound very good whilst turning in a relatively poor measured performance.

My apologies for seeming to suggest we don't care about neutrality or objectivity. We do, very much, but are wary of some of the simple tests for it, which can be misleading. The truth is we have invested large sums in sophisticated audio test equipment, carry out a lot of test work and will continue to do so. This equipment is vital to verify performance of products in for review, and it quite often does point to potential problems that will compromise neutrality. So we are strong supporters of objectivity and neutrality - it's testing them that's the nightmare!

I am not aware of any new tests for assessing audio equipment. These days audio isn't seen as important enough commercially to warrant heavy research and development budgets. A new type of 'super resolving analyser' that relies upon very heavy computing power is likely to be a help, when it becomes available.

Otherwise, there isn't a lot of faith in the use of measurement to determine sound quality; this approach has become discredited. **NK**

Readers' Queries

GOLDEN CONES

I own a pair of Tannoy Devon loudspeakers which require re-coning as the pliable foam surround has begun to part company with the chassis. The drive units are 12" monitor Gold HPD315A's and naturally the first people I contacted were Lockwood Audio, who quoted £156.71 per driver, which left me speechless. Obviously I would like them repaired, but surely there are companies capable of doing this work at a more affordable price, as £313.42 seems ridiculous for a change of cone, or is this the going rule? A friend who possesses Lowther drivers recently had a full rebuild with new magnets etc. at the factory for £130 per pair.

Could you supply me with the names of any other companies who could perform this work using proper Tannoy cones etc at what would be a more reasonable price?

**P. Kemp
Cleveland.**

I spoke at length with Roger at Lockwood Audio who confirmed the following. Firstly, although the 12" Tannoy cones you have are Gold in colour they are not Monitor Golds, they are, as you have correctly identified, HPD315A's. Although it sounds as if it is only the foam surround that has gone on your units, the only replacement available is a complete cone, voice coil and surround. This is part of the reason for the high cost of the re-cone. As Roger explained though, because these units were built to such a high tolerance, as the surround wears out the cone will sag, causing the voice coil to rub and wear, making a complete replacement necessary anyway.

There is some good news for you though. The old surround contained organic

material, which is why they deteriorate. The new surround that would be fitted uses a rubber compound that should give around 30 years life-span. More good news, is that since you last contacted Lockwood Audio, the cost of a new cone and surround has decreased, to £282/pair. Bear in mind that a professional re-cone like this will effectively give you a brand new driver, and that the cost of an equivalent replacement for the Devons from Tannoy would be well over £1000 these days. **DB**

RIP IT UP

On CD replay, but not on LP, and on any line input to my Exposure X amplifier I occasionally get a noise like ripping paper at moderate volume levels. Am I clipping the amp or tripping the speaker protection? Since it delivers 60W I would have thought it would cope with my B&W CM1 loudspeakers.

The sound is pretty bass heavy and doesn't give me the 3D effect I associate with good reproduction. Suggestions for upgrades if you please. My thoughts are to ditch the amp and go for a DPA or Audiolab and change the cartridge for a more up-market moving coil. The CD player will also go soon.

**C. J. Humpries
Leamington Spa,
Warwickshire.**

If you mean that you get this sound from CD, whichever line input is used, then it is almost certainly caused by the CD's error correction circuits being overwhelmed. Check the disc playing at the time; you'll probably find it is scratched quite badly.

Exposure amps do have a strong, driving sound much loved by rock fans, but as you say it isn't too subtle. The ever popular Audiolab 8000A

has excellent MM and MC input stages, plus 70watts per channel of power, and this might be a good choice. The DPA Renaissance costs £595 and is less butch in its delivery, if sweeter and more poised, but it has moving magnet only. For moving coil you'd need to get an additional DPA head amp at £495. This option is considerably more expensive. **NK**

UPGRADE PATH

My present system is: Audiolab 8000A amp, Arcam Alpha Plus CD, Linn Index II loudspeakers on Ku-Stone stands, Linn Basik turntable with K9 cartridge, K400 speaker cables. Careful setting up (initially using a test CD) has resulted in the speakers being positioned with 74" between them and 12" from the rear wall, in a 15' by 12' room.

My music collection covers rock and Country & Western. I find my present system a good compromise for my music tastes and I would now like to upgrade in two stages; pre/power amplifier now and a new CD player early in Spring.

The obvious choice would be an Audiolab 8000C/P and a Delta 270 CD player. I have been told that an Albarray pre/power amp is perfect for Linn Index loudspeakers. No one sells these amps in London and I have no address or product details - can you help? Can you give me your advice, £2000 is my limit after selling my existing CD player and amplifier.

My turntable is used for back-up on music that is not on CD. I am not impressed with the K9 cartridge as it has an ability to make some vinyl sound flat. What would you recommend?

**B. E. Gooch
Northolt.**

The Audiolab 8000A is a superb amplifier, one of our favourites, in fact. Not only has it got a punchy and detailed sound, but also comes with a top quality phono stage that is difficult to beat. Upgrading to the Audiolab 8000C/P will give you more power, but the improvement in sound quality would be small in comparison to the extra outlay involved, especially considering that the Index II loudspeakers are quite sensitive, and the 60W or so that the 8000A produces is ample.

So to start with, I'd keep the 8000A and concentrate your funds elsewhere for maximum improvement. The Delta 270 is a fine CD player, but before you take the plunge, have a long listen to the Quad 67. This has an especially smooth and inviting sound, one that's hard to resist. Another option open to you, and the one that would push your system furthest forwards in terms of sound quality, would be to add DPA's £795 Enlightenment CD convertor to your Alpha Plus, using its digital output. This convertor is one of the best we have ever listened to (there is even argument at the HFW offices as to whether it is better than Pink's Da Capo). I'd strongly recommend you take a long listen to your Alpha Plus/DPA Enlightenment verses the Delta 270 and Quad 67 CD players.

Whichever you choose, you will now have a top flight CD front end, so similar attention should be lavished on the turntable if it is still to give enjoyment. We recommend it a lot, but Goldring's I042 really is a fine cartridge. It has a super stylus, enabling it to dig tremendous detail out of the grooves, and has a solid and powerful sound that certainly



Readers' Queries

won't come over as 'flat'.

After sorting out your CD and vinyl front ends, I calculate you still have around £1100 of your budget left. Here you have two options: either the improvement made by the above suggestions will be enough to keep that upgrade bug at bay for a little while, in which case I suggest you treat yourself to some new albums, or you could investigate the possibility of upgrading your 'speakers, which I would consider as the next move in any case.

Here there are numerous models to audition, but two spring to mind which I think would be most suitable for your system and musical tastes. The UKD Callas Walnut loudspeakers use very high quality Focal drivers, which have an

Write in with your problems to Hi-Fi World, 64 Castellain Road, Maida Vale, London W9 1EX. Our panel of experts will endeavour to solve them, or at least offer some practical advice.

exceptionally open and crisp sound. They are finished in solid Walnut, so they look fantastic too. These are plenty sensitive enough for your Audiolab 8000A to drive with ease.

The other option open to you would be Harbeth's HL-P3s. These too have a lovely sound, very solid and focused, especially through the midrange. As these are a little harder to drive, you could also consider adding an 8000P power amp at some stage to drive the bass in

a bi-amp. system, your existing 8000A acting as the control amp. and driving the treble.

As far as we are aware, after speaking to their previous distributors and retailers, Albarry are no longer in business. **DB**

BACK AFTER TWENTY YEARS

Having recently come back to the hi-fi scene after a twenty year break, it is somewhat of a cultural shock and I would appreciate some advice regarding my present system.

My system comprises a recently acquired second-hand pair of Spondor BC1s driven by my 22year old Rogers Ravensbrook amplifier, Ravensbrook tuner, 2 x Akai GXC40Ds, Pink Triangle fitted with a Decca MkI arm and FFSS III cartridge. I have also recently acquired second-hand a Sansui D-150M cassette and TU533L tuner and have no idea of their pedigree (or lack of it) and use Audioquest Type 2 cables for the 'speakers.

I may well acquire a CD player in the near future, something like a Marantz CD63. I have two upgrades in mind at present: the amplifier and an arm/cartridge, although I like the sound of the FFSS. I recently read in your mag

about somebody considering a Quad 33/303 (second hand) which you said was fine for the museum. However I have been considering a similar move - logical if you consider the sound of the Rogers.

I would appreciate some suggestions in respect of a modestly priced arm and cartridge combination that has the similar sort of attack of the old Decca.

M. Stevens Kent.

The best choice of arm, within a reasonable budget, for your Pink Triangle tunable would be the Rega RB300. This uses a one-piece cast arm tube, making it extremely rigid, reflected in its powerful and coherent sound. The RB300, unlike most budget arms, can be used successfully with Moving Coil cartridges which I'd recommend for their faster and more detailed sound, as well as their transparency. Try fitting the RB300 with Ortofon's MC15 Super II, which, in your system, should balance the sound nicely.

Finding a smooth sounding amplifier to complement your system, with a good MC phono stage too, may be a little more difficult. Below £500 there

Continued on page 53...



DPA's Enlightenment DAC has a super sound. Highly recommended as an upgrade to existing players with a digital output.

That most maligned of hi-fi separates, the budget Compact Disc player, is no longer the shoddy, shrill article it used to be.

The JVC XLZ-574 is a case in point. Its build quality belies its £250 price tag, with a clean looking brushed metal front panel and quality feel. The display can be switched off for (theoretically) better sound, and a switchable digital output is provided for external converters. The disc tray is slow in use, but of good quality, and the transport fast and quiet. All in all, aesthetics and feel weren't far behind our current reference Audiolab transport!

Sonically the JVC is standard modern budget fare. This means that it's always pleasant to listen to, in both complimentary and derogatory senses.

This was best illustrated by a vintage slice of Ride, one-time purveyors of intense guitar noise, around which some great melodies are fashioned. 'Like a Daydream' is one such example where, if there are any faults in the system, the song comes across as a mass of confusion. Surprisingly, the JVC held on tight, delivering a well balanced acoustic through which drums and vocals cleanly cut. Hi-hats had a satisfying lustre, and kick

drums could be heard somewhere back in the mix powering along the song.

Problems presented themselves however, with an obvious flattening of dynamics. Percussion seemed robotic and lacking rhythmic nuances, culminating in a matter-of-fact delivery. I quickly moved to Denon's £350 DCD-1015, which threw some light on proceedings - the JVC was missing much of the low level information in the song, sublimating the music to its superficially smooth 'hi-fi' sound.

Raintree Crow's 'Pocketful of Change' showed it most comfortable with sparsely produced tracks. The grain of David Sylvian's voice was clear and well projected, imaging superbly behind the speakers. However, the low level synthesizer backing was barely audible, augering badly for the spacious feel of the song which better players manage to reproduce. Once again, drums lacked dynamics and the intricacies of cymbal work were lost, the JVC rendering the playing metronomic and underwhelming.

At no time did the JVC sound uncouth in the way that budget players used to. Lonnie Smith's 'Think' is a dynamic recording

that often throws CD players off course, but the XLZ-574 wasn't having any of this. Tenaciously clinging to the basic rhythm of the piece, it made a good job of Lee Morgan's rasping trumpet, and Melvin Sparks' impressive guitar fingering. It was only when I moved back to the Denon that I realised what I'd been missing - greater weight and body to the drum kit and much looser, more human playing. It was as if the baby JVC was imposing its own sense of order on the music, homogenising everything it touched.

It's a credit to JVC that they can produce such a refined package at this price. It wins respect for the way it covers its tracks, smoothing over its failings in a very convincing way. It's a thoroughly well-rounded product, the sort of thing UK manufacturers should be making more of. But if true fidelity is your goal, you'd still do better with Britain's own budget NAD or Arcam products ●

JVC XLZ-574 £249.99
JVC House, 12 Priestly Way,
London. NW2 7BA.
Tel: 081 450 3282

Measured Performance
 see p105-111

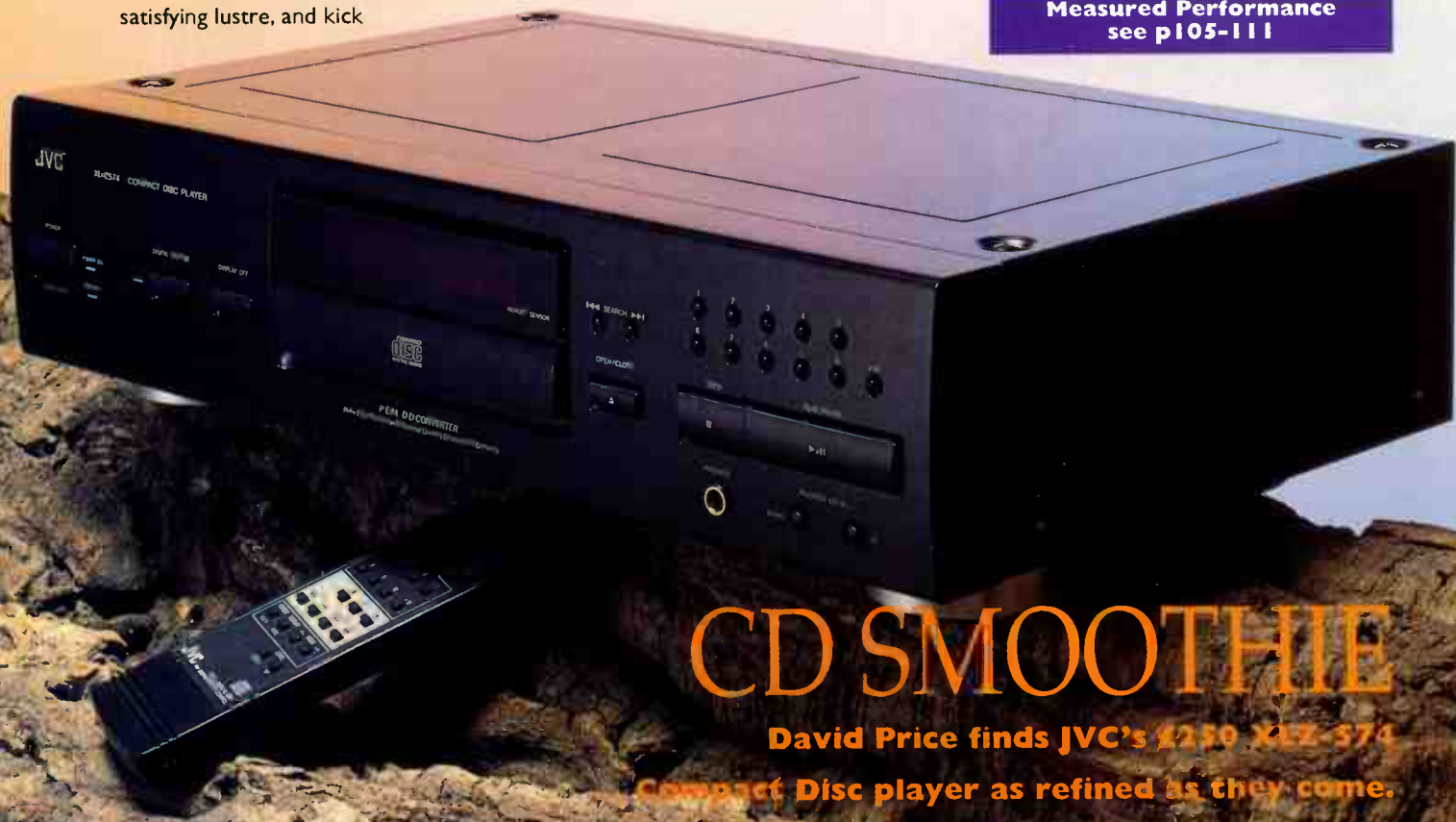

CD SMOOTHIE

David Price finds JVC's £250 XLZ-574 Compact Disc player as refined as they come.

Maybe it's because I'm an inveterate traveller, or perhaps it's my propensity for immersing myself in a Phil Spector-like wall of sound at any time, but I get on with high quality personal stereos just fine.

Being someone who constantly hauls around a Sony DAT Walkman in the cause of 'mobile fidelity', I was interested to see how Philips' new DCC170 personal would compare. The Sony, although a touch on the weighty side, turns in a superb sound and makes stunning recordings. Could Philips' DCC equivalent beat that, I wondered?

Certainly the DCC170 has superior ergonomics, is far lighter and more compact, and doesn't seem to sacrifice much in the build quality stakes either.

The top fascia contains transport controls, as well as a row of switches for DCC's time and text sub-coding facilities. Cassettes of both digital and analogue persuasion fitted in quickly and easily, and the rechargeable battery was small and light, with a claimed 3 hour recording, playback or recharging time.

Around the sides of the DCC170 are various controls for recording mode and level, Dolby B noise reduction (for analogue replay only), auto-reverse, volume and the obligatory but superfluous "Dynamic Bass Boost" facility.

On the move, the DCC170 was an eminently practical proposition. It bids

good riddance to the absurd rigmarole of skipping and jumping, a fact of life when using a CD Discman whilst in motion. The sound remains stable whatever you find yourself doing, and the supplied wired remote proved extremely useful.

Sound from the supplied headphones was mediocre, but judging by the quality available through line out, the headphones were more the culprit than the DCC170 itself. With this in mind, the rest of the testing was done in the calm (?) environs of our listening room, where aspects of the Philips' sound caused a number of eyebrows to be raised.

The most impressive facet was, ironically enough, its superb analogue playback abilities. I'd venture to compare its replay of Yazz's 'Fine Time' prerecorded to the Sony Walkman Professional. The soundstage was enormous, images superbly located and rock-solid. Treble quality was comparable to that available from the best of dual capstan cassette transports, and bass went extremely low with great power and control.

After this unexpected surprise, the DCC170's digital department came up for inspection. Firstly, recording digitally from a Marantz CD63SE showed Philips' onboard DAC to be far smoother - not a bad thing - and almost on a par in terms of detail

resolution. Direct digital recordings reflected the sweet tonal character of the DCC170's DAC, but lost a little low level detail.

Recording from the analogue inputs digitally was also impressive, the Philips producing almost as much bass as when replaying analogue cassettes, although it occasionally veered towards harshness. It seemed to lose a degree of space around instruments, wrongly shifting perspective closer to the listener. Treble was good but there was some 'digitalisation' going on, by which I mean sucking out the atmosphere and adding hardness and sterility.

As a mobile music maker, the Philips DCC170 is unlikely to disappoint, but unlike my ageing Sony DAT Walkman, it doesn't really hold a candle to the very competent fullsize DCC decks now gracing dealers' shelves. Nevertheless, it's an undeniably attractive package, bound to win many friends ●

PHILIPS DCC170 £249.99
Philips Consumer Electronics,
City House,
420-430 London Road,
Croydon.
Surrey CR9 3QR
Tel: 081 689 2166

mobile fidelity

**David Price asks whether
 Philips' DCC 170 successfully
 brings Digital Compact Cassette to the
 streets.**



Meet-Your-Maker

A reference guide to Britain's Manufacturers and Distributors.

ACOUSTIC ENERGY, 3a Alexandra Road, London W13 0NP. Tel. 081 840 6305. Acoustic Energy manufacture the award winning Reference Series AE1 and AE2 loudspeakers and the new Aegis Series Model 1, all of which feature the unique AE metal cone drive units. The AE distribution division offers superb high end products from WADIA, GRYPHON, ENSEMBLE and TARA LABS.

ALCHEMIST PRODUCTS, 4 Rosebury Mews, London N10 2LG. Call us for a list of our dealers in many areas including:- London, Kent, Hampshire, Wilts, Milton Keynes and N. Ireland and for product information on the Kraken, Freya, Bragi, Odin, Genesis and more. Tel: 081 883 3008

ALEMA UK LTD., 25 Montrose Road, Hove, BN3 1RD. Tel. 0273 202637. Audion 'Edison' Anderson * (Trade enquiries welcome for our newly extended range).

APPOLLO, The UK based designers and manufacturers of high quality speaker stands and equipment racks have now added to their comprehensive range a modular system ideal for housing audio visual products and CD storage. Please send for our free brochure to Zenith Crown Ltd. Tipton Rd, Dudley, West Midlands, DY14 Tel. 021 520 5070. Fax: 021 522 2055. - All export trade enquiries welcome

ARCAM, Pembroke Ave, Denny Industrial Centre, Waterbeach, Cambridge, CB5 9PB. Tel. 0223 440964 or Fax 0223 863384. Manufacturers of the Delta 290 Amplifier and the Delta 280 Digital FM Tuner. The two together produce a sound that has been described as 'subtle and intriguing' and that provide 'real clout' - discover this for yourself. For information on not only these products but also the Arcam CD Players, Speakers, Cassette Decks etc... Phone or write in to request a brochure - The pleasure is all yours!

ATACAMA AUDIO SUPPORTS from Sambell Engineering Ltd. We are the sole manufacturers of the 'SE' range of speaker stands, consisting of an 8", 12", 16", 20" and the award winning 24" high stand. Also three specialist models for the Tannoy sixes Loudspeakers.

AUDIONOTE CO Unit 1, Block C, Hove Business Ctr. Fonthill Road, Hove BN3 6HA. Tel. 0273 220511. Audionote supply a range of very high quality and very expensive audiophile components including valve output transformers.

AUDIO SYNTHESIS, 99 Lapwing Lane, Manchester, M20 0UT. Tel. 061 434 0126. Audiophile design, development and distribution. Please contact us for details of: PASSION the passive controller everyone's talking about. SILVERBLUE pure silver interconnect cable and the ultra analog based dac - DSM.

BANDRIDGE LTD are the premier suppliers of quality audio and video leads, connectors and speaker cables in the UK. In addition to probably the widest range available, including PROFIL GOLD, SUPER GOLD and SUPER +, offering a level of quality that meets the needs of the most exacting specification. Bandridge of London Ltd. Premier House, Deer Park Road, Wimbledon SW19 0B1 543 3633.

CABLE TALK PO Box 413, Woking, Surrey, GU22 8YZ. Telephone 0483 750667. Fax 0344 360866. Designers and manufacturers of British made high quality, value for money, interconnect and speaker cables. Phone or fax for a free full colour brochure on our What Hi-Fi? 5 star rated products.

CAMPAIGN AUDIO DESIGN, Llandudno Road, Cardiff CF3 8PG. Tel. 0222 779 401. Supplies / manufactures mailorder, high purity silver interconnects, loudspeaker cables, internal wires and bespoke mains cables. Generous two week trial period.

CANFORD AUDIO PLC, Crowther Road, Washington, Tyne & Wear, NE38 0BW. UK Sales 091 415 0205 Admin 091 417 0057 Fax 091 415 0392 UK's leading manufacturer and distributor of professional audio equipment 9000+ products are detailed in a bi-annual catalogue which is available free of charge to professional users. Next day deliveries when possible

CHORD ELECTRONICS, 3 Bower Mount Road, Maidstone, Kent, Tel. 0622 764874 Audition the Chord SPM 1200 at any of the following branches: Doug Brady HiFi - Liverpool

/Leeds/London/Cheshire, Audio Reflections - Leeds, Music Matters - West Midlands and many others. Please call us for details.

CREEK AUDIO LTD 2 Bellevue Road, Friern Barnet, London N11 3ES. Tel: 081 361 4133, Fax: 081 361 4136. Manufacturers of the 4240 Integrated Amp, P42 and A42 Pre/Power Amps, CD42 CD Player. Please write for further details.

The Exultant Power Amp fitted to Quad II Hardware.

DBS AUDIO, PO Box 91, Bury St. Edmunds, Suffolk, IP3 0NF. Tel: 0284 828926. Fax: 0284 828026. The DBS6 loudspeaker kit, as designed by Dave Berriman and featured in Hi-Fi News Feb/Mar 92, is still available - only from DBS Audio. To find out what these comprise, cost and how to order plus any other information on DBS products please telephone, fax or write in to the above address and numbers.

D H M DESIGN, - BUNDEE CD REPAIR PROTECTION SYSTEM - Tried and tested on Tomorrow's World. Repairs and protects over 50 CD's, even those scrubbed with steel wool. Effective for all laserdisc formats including CD ROM, MiniDisc and CDi. RRP £14.95. Why buy a new one when you can clean, repair and protect fifty? Contact David Mather for details of your nearest stockist or distributor. Export enquiries welcome. DHM Design Ltd, Studio 6, Bentinck Court, Bentinck Road, West Drayton, Middlesex. UB7 7RG. Tel: 0895 449559 Fax: 0895 420540

ECA DISTRIBUTION: For the "naturally neutral" chain. Nothing added, nothing taken away. The VISTA line-amp; The LECTERN S power-amp and the SERVO A.2 speakers. Resulting from their own Research and Development, the ECA Design Team provides a "super-symmetry" circuit with the barest minimum of wiring in the amps vacuum impregnated air-coils in the custom-made midrange unit for the speakers. P.O.Box 3023 London NW2 7RW. Tel: 081 830 5128

IAN EDWARDS, The Old Chapel, 282 Skipton Road, Harrogate, Yorks. Tel. 0423 500442. Somebody Somewhere must make better storage units for CDs, Music, LPs, HiFi, Books, etc. than Ian Edwards. BUT until he appears, why not send for the brochure showing a selection of HAND MADE units. To do this please send 3 x 2nd class stamps.

E J JORDAN DESIGNS, The Oak, Manor Bier, nr Tenby, S Pembrokeshire. SA70 8QR. Tel. 0834 871 209, or Fax. 0834 871 770. Curvilinear metal cones loud speakers were first developed by Ted Jordan in 1963.

EJ Jordan Designs are now World leaders in foil cone technology. First and foremost.

ELECTROMAIL, PO Box 33, Corby, Northants, NN17 9EL. Tel: 0536 204 555. The branch of the well known R.S. Components trade mail-order business that deals with the public. They have a huge range of components - and catalogues to match.

EMF, 2a Bellevue Road, Friern, Barnet, N11 3ES. Tel. 081 361 6734. Manufacturer of Sequel 50w integrated amplifier and the Crystal D2A converter Amplifier and DAC. Please write in for details.

FALCON ACOUSTICS LTD., Tabor House, Norwich Road, Mulbarton, Norwich, Norfolk, NR14 8JT. Tel. (0508) 78272. U.K. distributors of FOCAL drive units and SOLEN (chateauroux) polypropylene capacitors and the largest inductor manufacturer in the U.K. Comprehensive range of DIY Speaker Parts and Kits, Sub-Bass and Electronic Filters.

Everything but the wood

FULLERS AUDIO, 20 Tunbridge Road, Southend on Sea, Essex SS2 6LT. Tel. 0702 612116. Fuller's audio produce a range of innovative products. Amplification - a10 a single ended class A semiconductor power amplifier - £1200, b70 a mosfet power amplifier of high standard - £599, pre1 and pre1 + matching pre-amplifiers - £599/£649, geni phono stage for mm and mc cartridges £299. Loudspeakers - Pharaoh system, upgradable from 1 pair of cabinets to 3 pairs for truly extended bass, passive-active options £649-£2499, Sphinx a 3 way floor standing unit £849, Sultan H.E. 98dB sensitivity £439, matching Sub Woofer £559, Sultan, 91.5dB sensitivity £309

F & S TRADING LTD, 31 Brooks Road, Sutton Coldfield, West Midlands B72 1HP. Tel:- 021 321 3357. "Single-ended amplifiers"

J E SUGDEN & CO LTD., Valley Works, Station Lane, Heckmondwike, West Yorkshire, WF16 0NF. Tel. 0924 404088. Manufacturers of hand crafted audio products. "A world of Music". Call or write in for information on our SDA-1 Digital to Analogue Converter, SDT-1 CD Player, A21a Class "A" Amplifier, A25B Intergrated Amplifier, A48 Intergrated Amplifier, Au51c Pre Amplifier, Au51p Power Amplifier and more.

JORDAN WATTS ACOUSTICS LTD. Cyntia Place, 201 Mare Street, Hackney, London E8 3QE. Tel. 081 985 1646. Jordan Watts Acoustics for Sight AND Sound.

KESWICK AUDIO RESEARCH, 54 Coach Road, Outwood, Wakefield, W Yorks, WF1 3EX. Tel/Fax 0924 870606. 'I'd say that the Figaro is the best miniature speaker I have heard' Audiophile March 1993. Write in or call for details on our full product range and your nearest stockist.

KRONOS DISTRIBUTION, 35 Farlough Road, Dungannon, N. Ireland BT714 DU. Tel:0868 748632. Fax:0868 448281. Kronos is the UK distributor of some of the finest Hi Fi products in Europe. These include Audiomeca digital products and turntables; Lieder silver speaker and interconnect cables; Pro-Ject turn-ables and amplifiers; Triangle speakers and electronics; and YBA amplifiers. We also handle Frameworks equipment tables; Arion valve amplifiers and mains filters and Essex Audio digital products from the UK. Please telephone or write for product details and dealer lists

LANGREX SUPPLIES LTD., 1, Mayo Road, Croyden, Surrey, CR0 2QP. Tel: 081 684 1166 Fax: 081 684 3056. We are one of the largest stockists and distributors of electronic valves, tubes and semiconductor in the UK. Over 6,000 types in stock. We specialise in obsolete types including original UK and USA made audio valves. Telephone or fax for an immediate quotation.

LOCKWOOD AUDIO, Imperial Studios, Maxwell Road, Borehamwood, Herts. WD6 1WE. Tel. 081 207 4472

LORICRAFT AUDIO, 4 Big Lane, Goose Green, Lambourn, Berks. RG16 7SQ. Tel. 0488 72267. Specialist restoration of 301's and 401's using genuine spares and re-manufactured parts to original pristine standards in our newly built work shops designed primarily for these purposes.

LYNWOOD ELECTRONICS, Coley Lane Farm, Wentworth, Rotherham, S62 7SQ. Tel. 0709 873667. Lynwood Electronics is famous for manufacturing the only range of audio mains cleaners that really work. A complete range is now available to suit every system and every pocket.

MAY AUDIO MARKETING U.K. LTD. 83 Main Street, Burley in Wharfedale, North Yorkshire. LS21 7BU. Tel: 0943 864930. Distributors of High Quality audio products from Duson Electronics, Totem Loudspeakers, Jecklin Float Headphones and quality recordings from Proprius, Phonophone, Opus, MAP and Swedish Society. IF ITS MUSIC YOU LOVE, TELEPHONE OR WRITE FOR LITERATURE.

MICHELL, 2 Theobald Street, Boreham Wood, Herts, WD6 4SE. For full information on our full range of excellent products including the Gyrodec, Alecto, Iso, Argo and others please telephone us on 081 953 0771. Michell - Symbol of Precision

QUANTUM AUDIO LTD. PO Box 26, 1 Oliphant Drive, Kilmarnock KA3 7JA. Tel:- 0563 71122 Fax 0563 71133. Quantum's craftsmen produce the £899.99 MINSTREL 30 Watt, Ultra Linear, zero feedback correction, integrated, line level, valve amplifier. Don't buy any old fashioned valve amplifier before hearing the unique improvements modern technology provides to valve sounds. An audition will immediately convince the listener of the Minstrel's superiority.

SELECT SYSTEMS (PERFECT PITCH MUSIC), Hanworth Trading Estate, Hampton Road West, Feltham, Middlesex, TW13 6DH. Tel: 081 893 8662 Fax: 081 893 4318. We manufacture the Francinsten CD enhancement system. The Dacula DAC and Perfect Pitch digital and Analogue interconnects. Perfect Pitch also provide freelance design, manufacture, prototyping and test, also

valve and solidstate specials. Trade enquiries welcome.

REL ACOUSTICS, Unit 2, New Street, Bridgend Ind Est, Bridgend, Mid Glamorgan, CF31 3UD. UK. Tel. 0656 768 777, international +44 656 768 777. Fax. 0656 766 093. international. +44 656 766 093. The UK's only specialist sub-bass speaker manufacturer. "The only one that works". Get your dealer to give you a home demo and find out what the fuss is all about.

REL. HARMAN AUDIO, Unit 2, Borehamwood Ind. Park, Rowley Lane, Borehamwood, Herts. WD6 5PZ. Tel: 081 207 5050, Fax 081 207 4572. Sub Base Systems - Rel Strata, Stadium, Stentor, Studio

RICHARD ALLAN AUDIO, Bradford Road, Gomersal, Cleckheaton, W Yorks. BD19 4AZ. Tel. 0274 872442. Fax 0274 869935. Manufacturers of very high quality loudspeaker enclosures and drive units. Examples being the £270 RA8 series 2 as supplied to the BBC and the 5" reviewed Minette 2 at £120

SAMBELL ENGINEERING LTD. Winston Avenue, Croft, Leicestershire, LE9 6GQ. Tel 0455 283251.

SEQUENCE DESIGN LTD 83 Main Street, Burley-in-Wharfedale, Yorkshire. LS29 7BU. Tel. 071 495 0775. Fax 071 495 0281. Slim loudspeakers which stand close to a wall or hang like pictures. "Likely to cause a glint in the audiophile's eye" (Audiophile); "the answer to a prayer....a bargain in the extreme (HiFi News)". Available with light or dark grilles and various solid wood finishes. From £199.95 a pair. Call or write in for an information kit and reviews re-prints.

SHEARNE AUDIO, PO Box 22, Stevenage, Herts. SG2 8HF. Tel. 0438740953. Following the success of John Shearn's Phase 1 pre power combination (reviewed in HFW), is the phase2 reviewed earlier in HFW and listed as a world favourite. Having many of the design features of the phase 1 R.R.P. £549, 50 wpc and same finish as Phase 1 pre-power. Also, option of phono stage for phase 2 mm £65 mc £75

SLATE AUDIO, makers of "THE FINEST SPEAKER SUPPORTS IN THE WORLD" have never had a bad review, our reputation is legendary. Contact us now for details on our CUSTOM STANDS, as well as our solid marble GARRARD 301/401 PLINTH SYSTEM (Hi-Fi World Dec 93) THE GLASSMAT platter mat and the very special SME GARRARD 301 or 401 CELEBRATION ARMS. 47 Gemini Close, Leighton Buzzard, Bedfordshire, LU7 8UD. Tel: 0525 384174.

THE SPEAKER COMPANY, Unit 9, Waterside Mill, Waterside, Macclesfield, Cheshire, SK11 7HG. Tel. 0625 500507. The Speaker Company are a new company offering a wide range of loud speaker units from Audax, Celestion, KEF, Morel SEAS and many more. Also a wide range of speaker accessories the keen builders.

TARGET AUDIO PRODUCTS PLC, Britannia House, Leagrave Road, Luton, LU3 1RJ. The Audio equipment, rack and speaker stand specialist. For information on our products please telephone or write

TRICHORD RESEARCH LIMITED Following on from the highly acclaimed CD clock oscillator modifications the Pulsar Series One digital to analogue converter. This unique design is part multibit and part bitstream to give absolute linearity over an extremely wide dynamic range. Switchable between 18 or 20 bit resolution this converter will become the standard for CD replay. For details telephone (0684)573524

WOLLATON AUDIO, 134 Parkside, Wollaton, Notts, NG8 2NP. Tel/Fax. 0602 284147. Imported high end at lower prices. XLO interconnects and loudspeaker cables - "The Best in the World". Clements loudspraying ribbon and transmission line technology to reproduce the finest sounds. Monarchy digital - trant, DAC, DAC+ pre and DIP anti jitter module. Matches the best at a fraction of the price. "NEW" Audio Valve aers - Simply gorgeous. Call us for details.

WILMSLOW AUDIO LTD. Wellington Close Parkgate Trading Est. Knutsford, Cheshire, WA16 8DX. Tel. 0565 650605. Extensive range of drive units and over 30 different designs of self-assembly kits. Everything required for the loudspeaker builder and four dem rooms to listen to the kits in built-up form.

.... Continued from page 49

isn't a great deal to choose from, Pro-ject's new 7 being the only one that springs to mind. It has a very good MC stage and a smooth and detailed sound, so try and get an audition. Alternatively, you could use Rotel's bargain RQ-970BX phono stage, which is an absolute steal at £130. This would free up your choice of amplifier considerably, allowing you to audition a wider range from Aura, NAD, Arcam and Rotel for example. **DB**

IMPROVING A NAIM 32.5

I have Linn Isobariks, Linn grey speaker cable, two Naim 135 power amps, a Naim 32.5 preamp, Hi-Cap, fed by Linn LP12 turntable with Lingo and Ekos arm and a new old-stock Troika. All equipment on Tripod stands, except the LP12 which is on an Audiotech wall shelf. A Naim NAT-01 tuner works from a Ron Smith Galaxy 17 six stories up and a Nakamichi DR-1 provides cassette recordings.

My first query is on upgrading the preamp. The 32.5 is a bit long in the tooth. I listened to the 72 which is a little clearer, but not a big difference, then the 82 with Hi-Cap power supplies which had a fair bit more of everything and finally the 52 - aaah!! This blew the others away, but at £4.5k the price is

a little OTT. Can you recommend rivals, solid-state or thermionic, that would be equal or maybe go further than the 52? I need seven inputs, including MC phono.

My second query concerns my Nakamichi DR-1 cassette recorder. It's a fantastic machine, but the azimuth control has to be set to 1 o'clock to peak the treble on most pre-recorded tapes. Also, when making my own recordings and off-tape monitoring on headphones the treble is best at around 1 o'clock and with the red warning light on. Is this right? I only use TDK AR and, recently, TDK MA. The bias adjustment control seems to make no difference either when monitoring recordings, however it is set. Do I need a bias bug? Could you advise on recording levels for tapes to be played later on lesser machines, like a car player and Pro Walkman?

Recording off air from my NAT-01 I have to set the recording level controls to maximum to get a reasonable level. Is this normal?

I was taken aback recently to hear a simulcast of the Proms from my Nicam VHS recorder sound better than that from the NAT-01 which, by comparison, sounded muffled and closed-in. Why is this?

**Adrian Owen-Smith
London.**

I doubt that you'll find another pre-amp with the

52's tremendous information retrieval; it sounds like a master tape being run. A possible alternative, albeit with a different presentation, is the Michell Iso/Argo combination. Whilst not sounding quite so dry and upfront in its presentation, it has an unusually open and spacious sound that you may well take to - and it won't come as much of a culture shock, unlike valves. Your requirement for seven inputs as well just cannot be met!

I also found, when testing a DR-1 (June 1993), that the replay head adjuster had to be set to 1 o'clock for most pre-recorded tapes, due to small differences between Nakamichi and European (BASF) azimuth alignment tapes I imagine. This is of no great consequence in itself.

Recordings made on the machine should replay optimally (i.e. give most treble) with the replay head 'upright', shown by the azimuth control warning light glowing green. It sounds like your record head needs a little realignment if this isn't happening, something only Nakamichi should carry out ('phone 0903 750750).

The bias control should make a lot of difference whilst you are recording (rather than replaying a recording), providing you have Tape, not Source, selected on the Monitor switch. If you are certain it does not, then there may well be a fault.

Don't record much past 0VU on peaks for clean reproduction on lesser machines, irrespective of the tape used.

The problem with the NAT-01 and your Nakamichi DR-1 is well known. Naim advise you to return the tuner to one of their dealers and its output can be increased.

I asked BBC Engineering Information to explain why they felt Nicam 728 gave better sound. In a nutshell, their view was that because

the signal stays digital (14 bit at 32kHz sampling rate) after encoding in the Albert Hall (for the Proms) all the way through to your VHS recorder, it suffers less degradation. For VHF/FM transmission this same digital signal is converted back to analogue at the transmitter (Wrotham for London), before being encoded into a Zenith/GE composite signal for modulation of the carrier. The Naim subsequently demodulates and decodes this signal, applying yet more processing. There's quite a lot of analogue processing here, something digital avoids. That's most likely the reason for the degradation you heard. **NK**



Mission's 752 loudspeakers use a high tech Aerogel bass unit for a fast and detailed sound.

AGGRESSIVE AT VOLUME

I feel my system is lacking. At high listening levels the sound can become aggressive and tiring. I have a Thorens TD160 turntable, Ortofon MC20 Super, Arcam I70.3 transport, Arcam Black Box 5 upgraded by Arcam to 50 spec., Quad 34/405.2, Quad FM4 tuner, KEF I05 loudspeakers wired internally with QED Incon, a

Continued on page 55....



Nakamichi's DRI offers top class recordings.

Francinstien

STEREO ENHANCEMENT SYSTEM



Try the CD Filter with a difference in your own home

When we listen to music, both the high and low frequency sounds help our brains to paint a 3 dimensional stereo picture. But when we listen to CD, the high and low pictures do not perfectly realign. With their clinically clean electronics, CD players lack the beneficial, subtle signal handling of analogue equipment which can actually "re-converge" the two stereo images. So creating the convincing illusion that is the hallmark of good analogue systems.

Francinstien, designed by Hi-Fi World columnist Richard Brice, breathes life into digital stereo. By simulating the best aspects of analogue equipment, it restores the sense of depth - and even height - to digital recordings. And it does it without introducing any of analogue's vices!

Simply plug **Francinstien** between your CD player and pre-amplifier (or integrated amplifier) and you can have your cake and eat it. Analogue imaging and "involvement" with the clarity and "bite" of digital. But you don't have to believe us because you can try **Francinstien** on home trial.

"It's a gentle elegant effect - and a very even one...One simply becomes more aware of the music."
 — **Eric Braithwaite** - Hi-Fi World

"CDs sounded better defined, the soundstage having a more definite shape. It was as if there was more air around each strand in the mix, allowing you to hear it more distinctly, more separately...I didn't immediately want to switch the CD player off and relax with some LPs, instead I went on to make further explorations of my CD collection"
 — **Andrew Cartmel** - Hi-Fi Choice

Let the **Francinstien** improve the audio quality and stereo imaging of your system. To send you a demonstration unit we require either cheque or credit card payment for £7.00, to cover postage and administration. If you wish to purchase a **Francinstien** please call us and £7.00 will be deducted from the total price of £150 inc. VAT. However, if you do not wish to keep the **Francinstien** then simply return the unit to us within 10 days.

Title: _____ First Name: _____ Surname: _____
 Address: _____ Post Code: _____

Francinstien unit for home demonstration Further information on Perfect Pitch Music products

Credit card payment — I authorise you to debit my credit card account for the cost of goods despatched.

Visa Mastercard Tick one box

Credit card number: _____ Credit card expiry date: _____

N.B Goods will be despatched only if the above address is the cardholder's address.

Cardholder's signature: _____ Date: _____

Alternatively please make cheques payable to *Select Systems Ltd.*

Select Systems Ltd. Hanworth Trading Estate Hampton Road West Feltham Middx. TW13 6DH
 Tel: +44 (0)181-893-8662 Fax: +44 (0)181-893-4318



Perfect Pitch Music is a trademark of Select systems™

.... Continued from page 53

Revox A77 open reel and a Technics RS-BX606 cassette deck.

I decided to listen to alternative amplifiers, borrowing from DPA a 200 preamp and two monoblocked 200 power amps. with White Slink interconnects. I sat back and listened with Seal's first album, knowing that the bass sounded boomy and overblown. The sound was beautiful and the boom gone. I put on Michael McDonald's Blink of an Eye "I want you". Suddenly, I had boom where previously I had none. Why? The DPA sounded more dynamic than the Quad, so I contacted Quad and they weren't the least bit surprised. They felt that 12 year old equipment was unlikely to compete equally with new. They suggested that I should bring my equipment back for a service. Only then would I be able to make comparisons.

Two days after returning the equipment Quad rang me advising the units were ready for collection. The sound was amazing - dynamic, musical and portraying aspects that I hadn't heard before. I decided to listen to DPA again and frankly there's so little to choose between them that the Quads are staying put. All this cost £64. What a steal! Thank you Quad.

**Kevin Wood
Olney,
Bucks.**

The KEF 105 & 7 loudspeakers were remarkable for smothering amplifiers, letting very little real detail through. They benefit mainly by being driven from muscle amps, which will impose just a bit more tightness and control. A Quad 606 is a perfect partnering amplifier for the KEF105, in my view, and a serviced 405/2 little worse. By the way, Quad told me that they replace all electrolytics in the signal path

when servicing amplifiers of this age.

I strongly suspect that the "aggressive and tiring" quality comes from the 105's Mylar dome tweeter, in conjunction with distortion from Arcam's Black Box 50. This isn't a symbiotic combination.

I'd advise you to listen to modern KEFs, like the Reference Series 1s or 2s. Others you may like to try are Spondor SP7/1s, which are superb. If your budget does not stretch this far then Mission 752s are definitely worth auditioning. You'll find all these speakers very revealing, especially the Missions with their latest-technology HDA cones. Then amplifier changing will reveal greater differences. A Pink Triangle Ordinal convertor will work well with your Arcam Delta 170.3 transport and also inject some welcome smoothness. In part or in whole I feel these changes should bring the improvements you seek. **NK**

SMALL ROOM 'SPEAKERS

I would like to upgrade my speakers and your views would be appreciated. I am currently using a pair of Bose 305s which are wall mounted. The rest of my system comprises Goldring 1042, Rega RB250 arm on a Manticore Mantra, a Marantz CD52II, Leak Troughline, Audio Innovations Series 200 preamp., Leak TL25 Plus valve monoblocks. Interconnects/speaker leads are silver plated copper.

Owing to space restrictions the speakers will either have to stand in the room corners or be wall mounted at listening level. The room measures 13ft x 10ft with a concrete floor. My musical tastes vary from rock through to classical. I have a budget of around £500 initially, although future funds may be

found for a subwoofer. Any other comments you have would be welcome.

**Martin Knevet
Crawley,
Sussex.**

You are facing a basic difficulty here: small 'speakers that go low are generally insensitive and consequently need a powerful amplifier. We would recommend Harbeth HL-P3s, for example, except that your Leak's don't really have enough power to drive them, except to very modest levels. So it is with the Rogers LS3/5as, although these are more expensive. That leaves us with Systemdek Systym 931s or, to date heard only at a show, the new budget KEF Coda 7s. These are small but, KEF assure us, unusually sensitive too.

You will suffer terrible bass boom with the speakers in the corners. Look to wall mount them at ear height. It compromises stage depth and image sharpness a bit, but you will just have to accept this. Otherwise, your system is fine. **NK**

MODING A MARANTZ

I wonder if you could help me. I recently purchased an Arcam Alpha 5 Plus, replacing my venerable but extremely reliable Philips CD620. Now the problem is this: my amp, a

Marantz PM40 SE MkII suited the Philips perfectly, its warmth gently masking the sometimes over harsh treble of the CD player. Now, although the Arcam has more resolution than the Philips, I feel the Marantz is masking its better attributes. I can't afford a new amp so can you suggest any cheap and simple modifications I can make to it, perhaps in the way of component replacement. I'm quite handy with a soldering iron but don't have any real electronics knowledge. I'm willing to spend about £30 - after that I'll save for a new amp. If you really don't think there's any mods worth doing on this mass market black box can you make any suggestions for a new amp for sometime in the future, in the £400-£500 price range? My 'speakers are Spondor BC1s.

**Allen Walker
Handbridge,
Chester.**

Marantz told us that changing the power supply electrolytics will alter the sound. You could try Rubycon PS2s or Black Gates, available from Electromail and Audionote. However, if you are uncertain about how to effect replacement, then perhaps it's best not to tinker. Why not try a pair of silver cables from The Chord Company? **NK**

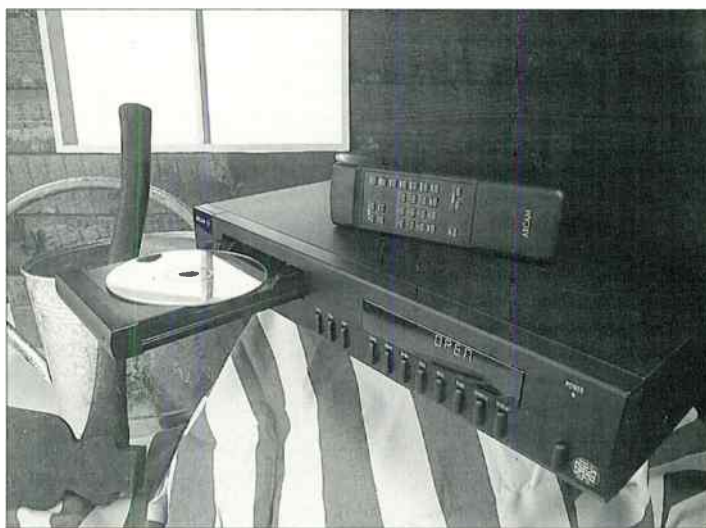

Arcam's Alpha 5+ has a sweet and gentle treble - but it may sound soft in some systems.

synergy
(sin' ə r jə)

definition; *simultaneous action of separate instances which, together, have a greater total effect than the sum of their individual accomplishments.*

Dual Mono 150W
per Channel,
Remote Controlled
All Tube Line Level
Integrated Amplifier.

Also available as a
Stereo Power
Amplifier.

For further details on
the Synergy and our
complete range,
including a UK
dealer list, please
call or write to:-

Tube Technology,
Foxhills Farm
Longcross Road
Ottershaw, Surrey
KT16 0DN, England

Tel: 01932 873444
Fax: 01932 873012

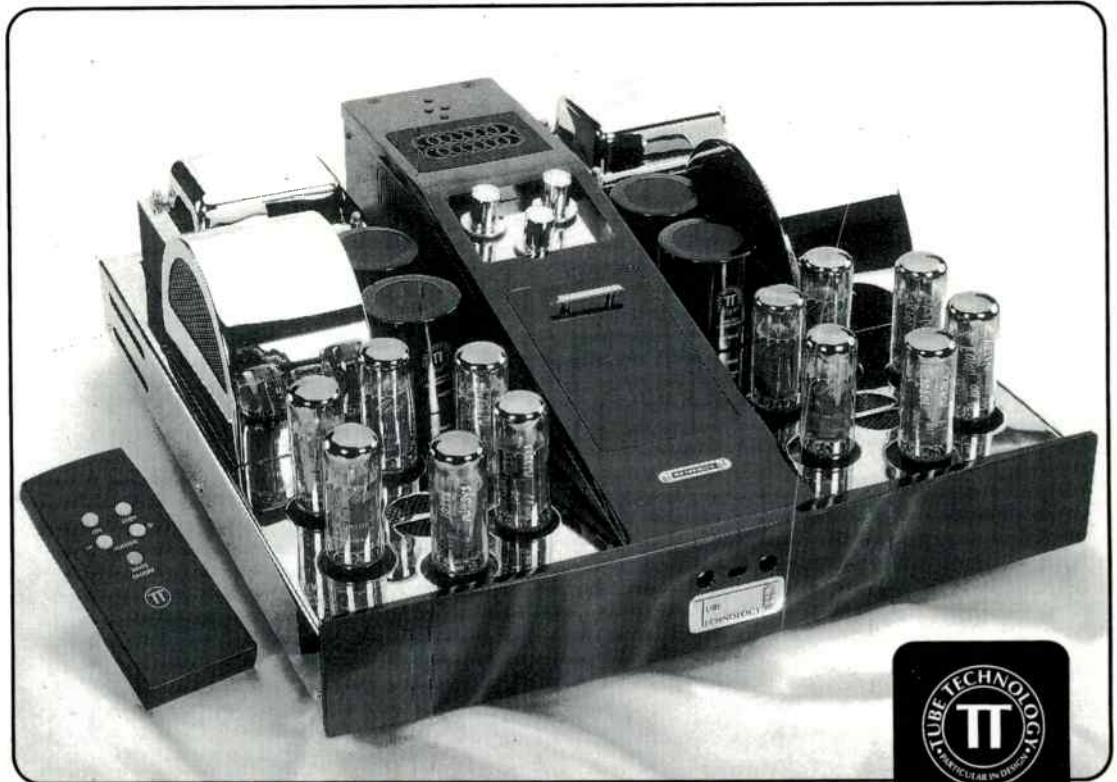

...Mesmerizing

Your Ideal Loudspeaker Hasn't Been Built Yet!



Learn about your stereo speakers
from the inside out.

Speaker Builder can help you
create great speakers without
having to recreate your budget!

YES! Send me my first issue of *Speaker Builder*. I pay just \$50.00 US for one year, eight big issues in all. Remit in US dollars drawn on a US bank only. International Postal Money Orders in US \$ accepted.

We accept Mastercard and VISA.

Payment Enclosed: Check or Money Order Mastercard VISA

Card No. _____ expires _____

Name _____

Street & No. _____

City _____ Country _____ Postal Code _____

Prices subject to change without notice.

Speaker Builder

PO Box 494 Dept. HFW5, Peterborough, NH 03458-0494 USA
Phone: (603) 924-9464 or FAX 24 hours a day to (603) 924-9467.



TAKING A STAND

Dominic Baker finds that Jamo's new 307 loudspeakers face stiff competition.

Jamo's 307s are smart, stylishly turned out standmounters of modest proportions. The moulded baffle and snugly fitting grille give the look of a high quality miniature, but the vinyl finish and light build quality quickly dispel this impression. Bear in mind though, that the 307s are priced at a competitive £299.99, so high marks for their pleasantly deceptive image.

Remove the grille, and the 307s still manage to carry off that 'quality' look. The injection moulded bass unit has its surround moulded directly onto the cone, which combined with the inverted dust cap lends it a smooth

profile. The tweeter too is nicely made, with a shallow flare in the face plate to help horn load the dome for higher efficiency.

Listening to the 307s proved an interesting experience. They've a strange presentation that conjures up a wide, spacious soundstage, but at times can disperse a performance, pushing it towards thinness. For example, The Stone Roses' 'Straight to the Man' was deep and solid with good power behind Ian Brown's vocals. But with the Throwing Muses' fabulously dynamic and catchy 'Snakeface', Kristin Hersh's voice became rather wispy and papery.

This continued with other female vocals, the Jamos losing body and projection in the upper midrange, making them compressed and flat. Giuseppe Tartini's Violin Sonata in G minor revealed a similar thinning and lightening of tone with violin. The lower resonances of the violin's body were conveyed in a precise and articulate manner, but on higher strings the 307s were less convincing, struggling with the delicate harmonic structure.

The 307s were more confident at extremes of the spectrum. Bass was full and rounded, not especially deep but tuneful enough. I managed to successfully use them on a bookshelf, which is an added bonus, their uncritical positioning requirements making them very versatile. Treble was clear and open, although not especially focused. This, along with the midrange gives them a delicate and detailed sound, albeit with rather imprecise and splashy imaging properties.

If this was the end of the story for the 307s, their strengths would make them worthy of recommendation. But a boxy resonance from the thin cabinet, provoked by upper strings of bass guitar or deep chesty vocals, acted against the 307. Even at low volumes the cabinet became excited, and at realistic listening levels this phenomenon became disconcerting.

So the 307s aren't without problems. The thinning of tone in the midrange and boxy vibration detract from what's otherwise a pleasantly open and articulate presentation. I suspect that the 307s would benefit strongly from sturdier cabinet construction, but there are always constraints in this area of the market. There were enough good qualities to make the 307s worth a listen, especially if they're to be used on a bookshelf ●

Jamo 307 £299.99
Jamo UK,
Jamo House,
5 Faraday Close,
Drayton Fields, Daventry.
Northants NN11 5RD
Tel: 0327 301300

Measured Performance
 see p105-111

review

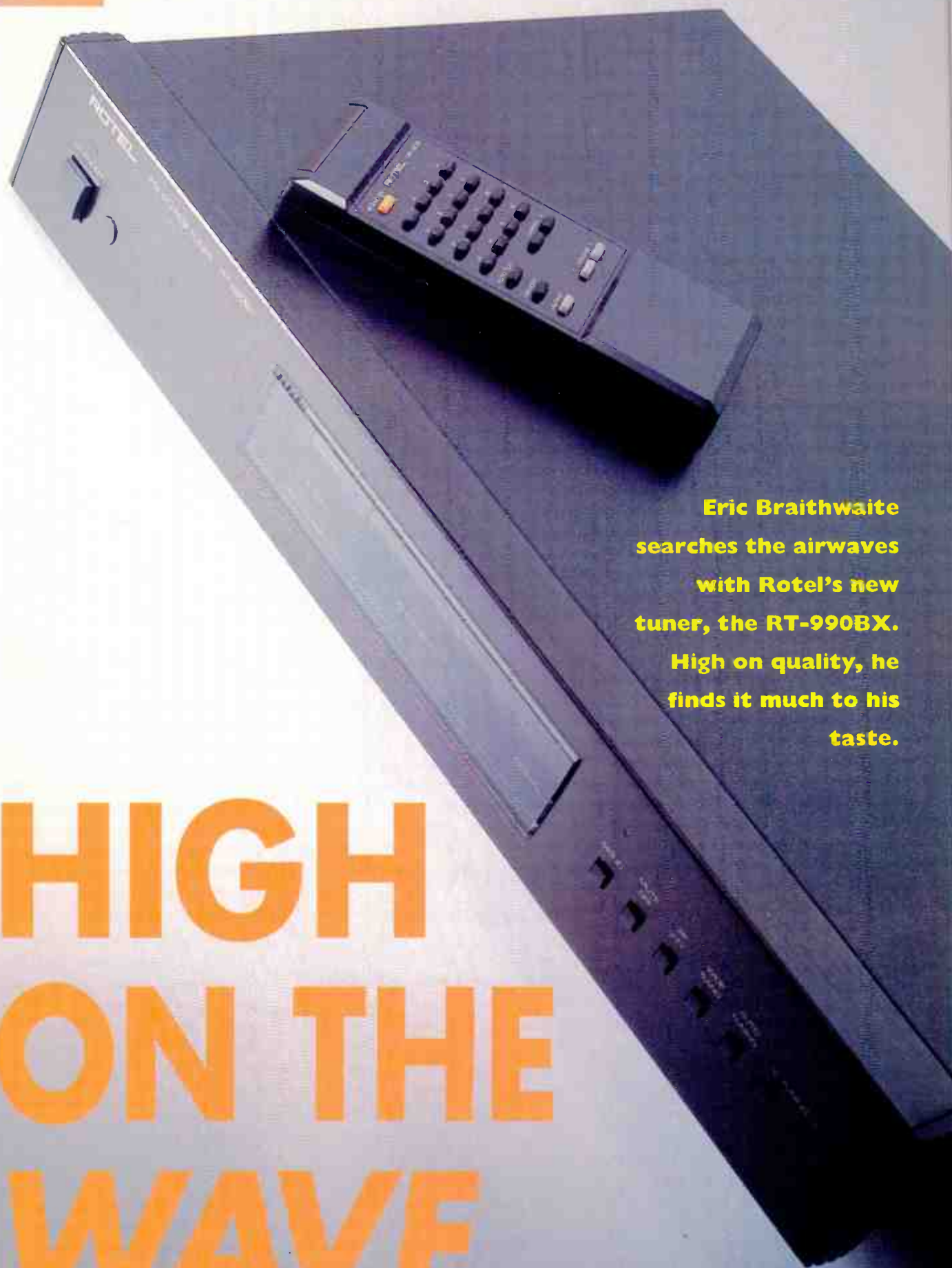

Eric Braithwaite searches the airwaves with Rotel's new tuner, the RT-990BX. High on quality, he finds it much to his taste.

HIGH ON THE WAVE

A seemingly ever-increasing supply of entrepreneurs - first Richard Branson and now Lord Hanson - are eager to make their mark on the airwaves. New broadcasting licences are being scattered about with the abandon of a sycamore tree scattering its seeds. If ever there was a time to take advantage of a multiplicity of radio stations, it has to be now. Yet the tuner is still the least regarded, and last purchased, of all hi-fi components.

This is a pity, since tuners have never been so good or so affordable. Rotel's latest offering is the RT-990BX and if any tuner alone could improve the audience figures, this is one of them. At the upper end of the marketplace, Rotel has its very desirable Michi, old gold, remote controlled and with rosy wooden end-cheeks. Now, in the middle, is a 'UK' version, priced at £500. In fact, this is not a 'Michi on the cheap', so much as a more cost-effective development of it. Although the circuit-board (plastic, as opposed to the Michi's glass fibre) layout is the same, the op-amps and resistors are cheaper components than the cost-no-object Vishays used in its more expensive brother. Some of the Michi's componentry in fact costs more than many tuner front-ends. Sound-wise though, the two do have some common elements. The RT-990BX is more akin to Rotel's mid-price CD players and amplifiers, which it matches with its casework and external design.

Like the Michi tuner, the RT-990BX has a higher than usual output. While this meant a good deal of leaping about to adjust the volume when switching back and forth between this and my Quad FM4 when making comparisons, it also means a listener is not suddenly deafened when swapping between tuner and CD inputs.

Despite the increasing prevalence of RDS, Rotel has stuck to its audiophile guns and eschewed it in this FM-only design, while catering for the couch-potato with full remote control. Dual-

purpose, this also operates the RC-990BX pre-amplifier.

In some respects, the new tuner makes few compromises. Switching out the 'Mute' function allows it to pick up a remarkable array of stations: given the right area and a big enough aerial, the Rotel proved to be one of the very few that could pick up a French classical station, albeit fairly crackly. More usefully, it added to the catch a number of weak local radio stations which are normally beyond the pale. In mono, maybe, but you never know where you might pick up something interesting.

Fortunately, during the listening

“Like the Michi, the RT-990BX had the ability to pretend that loudspeakers hardly existed, with a curtain of sound in front of the listener.”

sessions, Radio 3 was re-broadcasting a Prom performance of Mahler's Symphony No 1 by the Cleveland and Christoph Dohnanyi. These are still the only real test of a tuner's musical capabilities. Between the Quad FM4 and the Rotel there was little to choose. The orchestra was perfectly spread between the speakers, instrumental tonality near-perfect, the dynamics in this symphony unrestricted. Like the Michi, the RT-990BX had the ability to pretend that loudspeakers hardly existed, with a curtain of sound in front of the listener. Compared to the FM4, there was just a degree more forwardness, with a mild air of restriction at the top end and a degree less impact at the bottom. All the same, double-bass lines were firm. All that was really lacking of the Michi's performance was its remarkably spacious and airy depth and its ultra-smooth sound.

Not that the RT-990BX is not smooth, rather that it has a touch of a

current Rotel signature that the Michi doesn't. A piano recital of Chopin by Piers Lane rather gave the game away. Left hand was very strong and powerful, superficially beefier than the FM4, but the treble clef was fractionally subdued. It skewed the image slightly, with the piano appearing to be more 'sideways on' vis a vis the listening position. Without another tuner for comparison this would never have been noticed. Tonally, as a fellow listener remarked, the difference was as though the Rotel emphasised the woodenness of the sound-board.

Like Rotel's more specialised CD players, this tuner emphasises the degree of reverberation around notes, apparently enhancing - or finely revealing - its portrayal of depth. But piano is the very devil to reproduce in any medium, and the Rotel was one of very few tuners at any price to put the thing credibly, believably and with its proper size and shape in front of a listener.

Almost as good as CD, however, was Shirley Collins and the Albion Band, an old favourite of mine. Sparkling, bright, forward and vivacious, with Shirley Collins' husky voice caught perfectly and the Albion Band turning a living room into a folk club. Rock bands thrived on the Rotel's clarity of definition, punching rhythms into the room. As always, the only disappointment is the squashed effect the rock stations' compression engenders. Stick to Radio 3, Radio 4 and Jazz FM and the Rotel will have you falling in love with the ether. It's the price of twenty concert tickets, and for that you can listen to your own as though you are really there, every night of the week. That makes it a bargain ●

Rotel RT-990BX **£500**
Gamepath Ltd.,
25 Heathfields,
Stacey Bushes,
Milton Keynes,
Bucks. MK12 6HR
Tel: 0908 317707

Measured Performance
 see p105-111

IN THE MAY ISSUE

Next month's issue brings a host of all the latest hi-fi, including the long awaited replacement for the Marantz CD52SE, the 63SE. There are features to help you get the best from your system as well as news from the industry, readers' letters and Q&A, music reviews and more. Here's just some of what we hope to bring you in the May issue of Hi-Fi World.



MARANTZ CD63SE

The one the audiophiles have been waiting for. Marantz's SE version of the popular CD63 uses copper plated discrete output modules and a new oxygen free copper wound transformer, amongst other improvements. Could this be another class leader from Marantz?

AUDIOLAB 8000A Vs NAIM NAIT 3

The latest version of the Audiolab 8000A has an improved power supply and specially selected components. The Naim Nait 3 is regarded as one of the best sounding integrations around. So, we've decided to pit the two against each other to see who comes out top.

MERIDIAN A500

A sensitive floorstander from Meridian, the A500s use a pair of 6.5inch bass drivers coupled to a silk dome tweeter. Priced at £695 they look like a lot of loudspeaker for the money, see next issue for a full review.



GARRARD 401 Vs THORENS TD124

Two vintage classics, fully restored and installed into new Loricraft plinth systems, are pitted against each other in this head-to-head test.

Hi-Fi World is still only £2, but with more editorial than most rivals. With the most enthusiastic and expert editorial team in hi-fi journalism, can you afford to miss it? Make sure you don't by filling in this order form and handing it to your newsagent.

ORTOFON MC25FL

We test two of the latest MC cartridges from Ortofon. Both are based on the same body, but one using a special fine line stylus.

ARM/CARTRIDGE GEOMETRY

A practical feature explaining how to set up your arm/cartridge accurately.

SBM OR VINYL?

Is Sony's new SBM mastersound CD recording process all it's cracked up to be? We compare the original vinyl to the latest crop of SBM re-releases.



Please reserve/deliver* Hi-Fi World on a regular basis, commencing with the next issue, until further notice.

Name: _____

Address _____

Signed: _____ Date: _____

• Delete as appropriate

Distributed to the news
trade by

COMAG
MAGAZINE MARKETING

We're all glad that at last the LP is being belatedly recognised for the fine sound quality it can provide. Nowadays it is becoming accepted wisdom that CD isn't perfect and, as good as it may be in so many practical respects, there's still plenty of leeway for improvement in sound quality. The race is on upgrade it, although in this audio has to take a back seat; video and computers command a larger market and are the driving forces behind technological change. All the same, the end result should be that sometime in the next few years we'll be getting better sound quality from a higher specification CD.

We aren't being blindly sentimental about the LP at Hi-Fi World. Quite the reverse. Technically it can be defended quite easily against the CD. A lot of the arguments about CD's perfection are selective in their tilt, to say the least. Probably the most deceiving is the oft quoted 0.005% distortion figure. Many times I've got a distortion readout for CD - from a digital spectrum analyser I should add! - in excess of 100%. That's pretty good going. Nothing invented before the CD ever managed to generate more than 100% distortion. The first time I saw this figure pop up on the analyser screen I nearly fell of my chair! I realised that the CD player I was testing at the time just couldn't reconstruct the basic signal (fundamental) and was spewing out walls of distortion instead. Perfection huh?

That wonderful 0.005% figure for CD exists only at maximum output, which musical peaks hit on the odd rare occasion. Below full output distortion increases progressively, these days to a worst case figure of around 30%, a least with carefully tailored test signals that give best case results. Real life performance with music is

both more complex and - sadly - worse, so even these figures do not give an accurate picture of what we hear from CD. Clustering of the spectral lines of quantisation noise when music signals are phase coherent with the sampling frequency is an unnatural dynamic effect that almost certainly contributes to the hardness or harshness of its sound.

Expect all this to be 'revealed' as a new insight into the limitations of the today's CD when it's time to scrap the current



Reflections from Noel Keywood kaleidoscope

specification in favour of something better. Until then we've just got to stomach the tosh that CD is perfect, LP neanderthal and anyone who says otherwise can be simply dismissed as an 'anorak', 'young fogey', 'old fogey' - or whatever! The truth, unlike the hype, is difficult to get at without sophisticated test equipment and is, as you may imagine, quite different from views in common currency.

At normal music levels LP produces little more distortion than CD and what it does produce is less upsetting to the ear. In fact, much of it - second harmonic - can hardly be detected. It doesn't throw up aurally jarring uncorrelated distortions, such as quantisation noise modulation, and it has a wider bandwidth than CD too, something Pioneer tried to replicate in CD with Legato Link. LP can get up to 30kHz; CD stops dead at 21kHz.

But even these basic engineering views don't eke out the real truth about why LP can sound

so good. There are additional combinational effects we don't fully understand that, in totality, act to tell our ear and brain that the sound from LP is natural, even if we know it is flawed in a different way to that from CD. Some may even be fortunate euphonic enhancements. Talking to Mike Ritter, President of Pacific Microsonics, developers of HDCD (High Definition Compatible Digital, an improved form of CD) and reviewing the system clearly demonstrated to me what every "flat earther" has said in defence of LP: it does sound better than conventional CD. With HDCD it was something of a revelation to hear CD sound as natural and easy on the ear as the LP, if cleaner and tidier.

Yes, LP has its own problems, but it can sound great and - importantly - billions of LPs exist worldwide in treasured music collections. That's a fantastic body of recorded music that will demand good replay equipment is kept available for many

years to come. You might be interested to know that the average Hi-Fi World reader owns no fewer than 412 LPs and 89 CDs; many own thousands of LPs.

So here's to LP - and to the future of CD! We're pleased to be able to consider both mediums equally alongside each other in this issue, and to keep our eyes firmly on the future of CD as it tries to throw off its technically shaky beginnings. Let's hope that next time around the hype and deception won't be

necessary, and that CD will truly offer better sound quality, in addition to its undoubted convenience.

Couldn't resist buying Tina Turner's compilation 'Simply the Best' for that great classic River Deep Mountain High. The Phil Spector 'wall of sound' fronted by Tina Turner in her early days, with a voice so raw and powerful it could bring the house down, is a one-off. But it was the intro to Better Be Good to Me, a track I have on CD, that also caught my interest. I thought the tambourine at the start clanked and the bass line was obtrusive yet featureless. Wrong! That was the CD. On LP the tambourine was light and the tinkle of its bells intricate and sonorous. The bass guitar had real character in its overtones and the expressiveness of its playing became apparent. This wasn't the Better Be Good to Me I know - it was a whole lot better! Anyone want a frisbee?

HOW TO GET GOOD STEREO - PART II

Noel Keywood describes how to position your loudspeakers for good stereo sound stage and imaging.

Some build their homes around the speakers, others dedicate a listening room to them. You don't have to be so extreme. In my experience you can make an ordinary living room sound really good with just a little effort and a few tweaks, plus some nice furniture.

Last month I talked about what to expect from stereo and about positioning the loudspeakers. This month I want to consider listening distance, since the impact of room effects depends upon how far away you sit, as well as the way the room is furnished and laid out.

LISTENING DISTANCE

If you read Part I last month, your loudspeakers should already be the right distance apart, but how far away

do you sit? It's worth getting out of your armchair to check the effect distance can have and hear for yourself what I'm talking about. I've done a lot of crawling around many rooms in my endeavours to understand this one. Here's the nub of the problem.

When you sit close to a speaker you hear it as the manufacturer intended; when you sit a long way back you hear not just the speaker, but also a plethora of reflections from ceiling, walls and often the floor too. The two are quite different and neither listening position is, in extreme, satisfactory. Yet there is, in my experience, a boundary distance that you should be within for best stereo.

Sit close to a speaker - say a few feet - and you'll hear the tweeter acting as a distinct entity apart from the



woofer; in speaker parlance they don't integrate. Only concentric or point-source speakers (Tannoy dual-concentric, KEF Uni-Q and Quad ESL63) overcome this. But sitting close is rarely convenient in any case; headphones are perhaps a better solution for this sort of listening, since they cut out room effects completely.

Sit too far away and you get messy treble and equally messy stereo imaging. That's because you are hearing more reflected sound from walls and ceiling than direct sound from the speaker.

There are two reasons. Reflected sound is random in its arrival time and there are multiple arrivals, a situation that's confusing to the ear and brain. Also, reflected sound is "dirty". By this I mean that it has a very ragged, variable and random energy content. If you listen to reflected sound you are, in effect, listening to your loudspeaker after its sound has been mangled.

This phenomenon plagues reflected sound loudspeakers, like the Canon Omnidirectional with its 'sound mirror'. You cannot reflect sound, even from a dedicated acoustical mirror, without roughing it up by selective absorption. This is the key reason for having a speaker fire straight at your ears; fidelity comes from direct sound, not

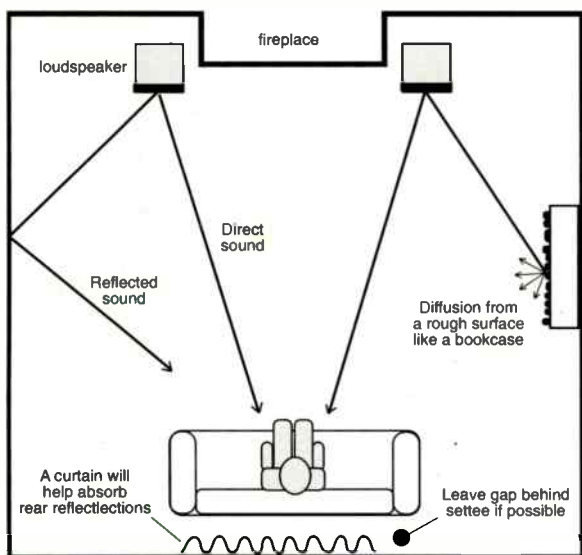

The strongest reflections within a room come from the side walls, rear wall and ceiling. Reflections from the side walls can be diffused with carefully positioned bookshelves or other similar furniture. A curtain behind the listening position will help to absorb rear reflections.



reflected sound. That's why speakers which bounce sound all round a room never catch on, remaining forever convenient mid-fi items.

How can you assess these reflections? Sit in your listening seat and look up at the ceiling. It's a hard acoustic reflector: how close is it? Closer than your speaker? I hope not; chances are you are listening to your ceiling as much as your speaker - and you don't want that. What to do?

There are a few practical solutions, but first try a check. Slowly move forward toward the speakers, a few feet at a time (this is where I use a small stool), stopping and listening as you go. Often you'll find the sound snaps into clean and clear focus past one particular point. This test aurally illustrates the fact that as you increase the direct sound content from the speakers in relation to the reflected sound from your ceiling (or walls or floor), the sound cleans and clears, the stereo stage becoming sharply defined in terms of placement and image sharpness or focus.

TAMING REFLECTIONS

Now let's look at solutions to the problem of too much reflected sound. You either sit closer to the speakers,

which is the easiest solution if it is practicable, or you treat the reflecting surfaces. A large pendant lampshade in the middle of the ceiling will act as a diffuser, breaking the direct path of reflected sound. Keep away from metal and glass shades, because they reflect and ring. Try making your own lampshade of heavy fabric on a wire or wood frame, always bearing in mind that if it gets heavy it may need to be hung from a chain rather than the lighting flex.

Walls are best 'broken up' by irregular objects that act as diffusers, bookshelves being most widely quoted in this role. Alternatively, move LP and CD racks, plants or any other items of furniture that will help to break up the main reflection path and diffuse it around the room. If you suffer a bright or splashy treble where you are hearing strong reflections off the walls and ceiling, try cardboard egg cartons which will diffuse sound between 2-4kHz, where the ear is most sensitive. Just a

bit of hardboard with the egg cartons stuck on it will do as a tester; hang it from a picture rail. I'd suggest 2ft x 2ft minimum size, up to 4ft x 4ft. This will give you some idea of whether you are on the right track or not.

CONCLUSION

Just remember that the direct/reflected ratio is determined by relative distances and that reflected sound is dirty. So, generalising, when listening keep away from walls, floors, and ceilings and don't stray too far from the speakers. Be aware that the wall behind you is an unwanted reflector too; if you sit against it try moving forward a foot or two.

Even though reflections are dirty, absorbing everything is not a solution either. If you absorb too much sound, the room will go dead on you; some reflected sound is necessary to prevent this. It is more a case of controlling the diffusion of the sound than completely eliminating it.

Because every room is different it isn't possible to provide specific rules. I've developed a fund of subjective techniques from my experience reviewing speakers and designing them for our kits, because we take room effects into account. It's one thing to

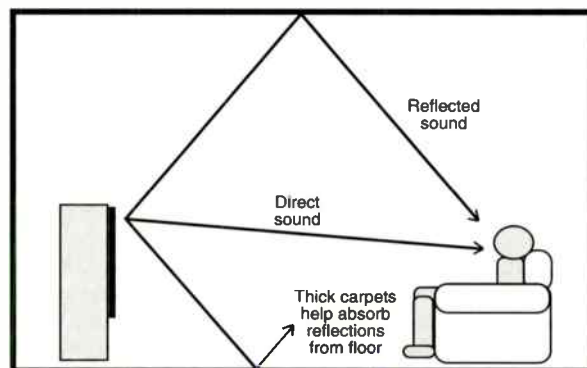

Reflections from the ceiling are more difficult to treat, but if you have selected your listening position carefully and tried to control other sources of reflection, this shouldn't be a problem.

measure, quite another to listen - and the latter is very important. And remember too that carpet, heavy furnishings and long, heavy curtains all act as good absorbers. This means that a good listening room can also be a wonderfully well furnished, warm and cosy room too; the two aren't mutually exclusive ●

You may have noticed a few things different about this month's Hi-Fi World. The changes are quite subtle, but have made a great improvement to the overall readability and quality. The most obvious change is that we've moved the Measured Performance sections that used to accompany each review to the back of the magazine. This was done for a number of reasons, most importantly because the extra space this leaves allows us to write more thorough, detailed explanations of the performance of the equipment we test.

When we assess a product it's auditioned by two or more members of the Hi-Fi World team. Between us we discuss its performance, and then the review is written by one of the listeners. But quite often a second listener has some valuable observations to make, drawn from their own experience and musical preferences. The extra room created by repositioning the Measured section has given us the space to include more of these second opinions, which brings greater insight into performance of the product on test.

Before we review any piece of equipment, it is subjected to a rigorous technical test procedure. Here we find any faults that could lead to a misrepresentative review, as well as forming an idea of the kind of system most likely to reveal its best qualities. On a simple level, for example, if we measure a single-ended valve amplifier with zero feedback that has a power output of 10watts, we know that to accurately gauge view its performance a loudspeaker of over 90dB sensitivity with a smooth impedance curve is necessary. It may well sound satisfactory on loudspeakers with a wildly varying impedance, but here you are auditioning the way two products interact. We can warn of this potential problem.

Once we have measured

a product, it's listened to in several different systems by different listeners to gain a representative picture of its performance. These days we used two different types of references. Benchmark products in any category are often used within a system or as a basis for comparison. For example, Mission 752 HDA loudspeakers are used to remind us of the standard reached by good modern floorstanders, and also during amplifier reviews. But quality standards are needed too, such as Quad Electrostatics,



Dominic Baker

dB on the level

to remind us just what a recording should really sound like. It all gets a little complicated at times, but there's no short cut to a good review.

Talking about short cuts brings me to something similar - the blind listening test fallacy. Blind listening with a panel seems like a good idea, but in practice it's absurd. With any group of listeners, many have to sit off-axis in a strange, disconcerting listening position. To utilise, say, four listeners to justify the amount of organisation involved means getting through a whole wedge of products quickly, so group tests are always slam bam affairs, with brutally short musical excerpts of just a few minutes being used. There's absolutely nothing representative of real life conditions here. Listeners don't relax, rarely are they familiar with the music excerpts they listen to and exposure to them is too short. Quite often one person will try to dominate proceedings by giving instant opinions like "that's rubbish".

There are other side issues, such as correctness

of loudspeaker positioning - group tests limit this. And how about amplifier loading? One speaker is used, so you get the sound of the amps with that speaker, which may not be representative. People familiar with blind listening tests reckon they pick up mainly on obvious properties, such as response errors, not on underlying properties that might be more influential in the long term.

Subjective tests still reign supreme and I believe they always will, but measurement provides a useful guide to ensure the subjective results are consistent. Long, relaxed listening with a variety of accompanying products and a good mix of opinion gets closer to the truth.

Other changes are taking place at Hi-Fi World that aren't necessarily visible from the magazine alone. We have recently had our listening room treated to give it a more neutral and representative acoustic. Previously, our in-house listening room had a preference for standmounters, where room reinforcement would give

them a deep and powerful bass, as well as some welcome warmth through the lower midrange. This match between room and most speakers gave a generally good result, even if some flattery occurred. But wheel in a big floorstander and it would boom, unless light-ish or well damped in the bass.

The treatment needed to control the main room modes comprised a couple of broadband acoustic absorbers which gave tighter bass without affecting the excellent

results we were already getting with standmounters. These absorbers work over a wide range, smoothing and controlling the bass without altering the basic character of the room. Floorstanders are still treated to a bigger room so they can show off their true potential, but the modifications made to our listening room, which include broadband diffusers as well, allow many listeners to cross check the sound, again leading to a more thorough appraisal.

In the 90s, with a return to higher quality, lower power designs, both solid state and valve, the need for careful system matching is back. It takes a little more effort, but the level of sound quality available from a properly set-up and matched system is now so high level that it's well worth the effort. Our job as a magazine is to make sure we use the most effective review techniques possible in order to reach accurate and representative views. This avoids wildly unrepresentative reviews and will help guide you towards the kind of system you're looking for ●

WELL CONNECTED

**Dominic Baker finds
Sennheiser's HD565
headphones a great
way of getting
connected to music.**

I always enjoy listening to headphones. I love the way they exclude all but the music, driving my eardrums with a wall of sound like a horn loudspeaker drives a room. They also allow me to play music at more realistic levels, without risk of further ruining the already delicate relations with neighbours and other household members.

I started listening to Sennheiser's HD565s with Stereo MCs' 'Connected'. This is boppy club music that begs to be played loud, so it was an ideal choice for headphones. The 565s responded well, underpinning bass lines by giving them terrific depth and power. The bass guitar on 'Playing With Fire' seemed to have unlimited freedom to go down the scale to the deepest depths.

In the upper bass the HD565s have a healthy dose of punch and drive, giving pace to up-beat pop tracks such as Blur's 'London Loves' which really kicked out. Damon Albarn was at home too with the Sennheisers, revelling in their transparent, uncoloured midrange. His voice projected clearly forwards of the instrumental backing to take up position in the front row centre seat of my head - a trick only headphones can pull off.

This uncoloured quality gives the HD565s a head start over just about any box loudspeaker, especially with classical music. Arcangelo Corelli's 'Concerto da Chiesa' was a wonderful performance, the lack of colouration

and precisely focused sound giving violins a naturalness and tonal accuracy rarely heard. Because a single diaphragm supplies the entire sound, there's no character change as notes climb upwards, giving the HD565s a seamless quality reminiscent of Quad electrostatics.

In the treble, the light and agile diaphragm again pays dividends. Grant

Lee Buffalo's steel strung guitars had a crispness and clarity to them that took the whole album onto a different plane of enjoyment. In my experience it's quite common to find headphone treble harsh, the sting sometimes making them fatiguing over long periods. The HD565s did extremely well here, with a sweet, delicate quality that although a whisker bright was never tiring.

Also in the 565's favour was the remarkable amount of atmosphere they conveyed. Headphones don't take advantage of reflections off room walls to create an impression of space like a loudspeaker; I found this aspect of the 565s especially gratifying. In the soundstage between my ears it was easy to pick out individual instruments and follow their melodies. The 565s separate instruments extremely well, remaining unconfused by complex passages, whilst still managing to convey them in an enjoyable manner.

At the start of this piece I mentioned the deep and powerful bass of these 'phones. After a few hours it can become a little overpowering, lacking subtlety. Some of the articulation of acoustic bass was lost, leading edges being smoothed over to give a slightly muffled quality. I rectified this situation and got a more listenable balance by using the tone controls of the Audiolab preamplifier I was using. Amplifiers lacking good tone controls won't prove so helpful.

At the end of the day though, this was just a small smudge on the large window Sennheiser HD565s open onto the music. Compared to loudspeakers at twice the price, the level of fidelity they offer is nothing short of astounding. Electrostatic type 'phones may be smoother and deliver even more music, but for the money the HD565s are super value ●

Sennheiser HD565 £129.95

Sennheiser UK
12 Davies Way,
Knaves Beech Business Centre,
Loudwater,
High Wycombe,
Bucks. HP10 9QY
Tel: 0628 850811



On offer in this month's Hi-Fi World competition is one of the top CD players available. Put simply, the DPA Enlightenment drive and convertor is one of the very best ways to play Compact Discs. It provides a level of musical entertainment that you rarely hear from silver discs. It communicates on an emotional level which draws you into music in a way few others can match.

The DPA Enlightenment is a two-box system featuring DPA's proven Deltran sync-locking system, which sends a signal from the convertor to the transport telling it precisely when to send the digital data. This means that jitter, time smear produced when the transport doesn't know exactly what the convertor is doing, is eliminated making for a smoother, clearer sound.

The Enlightenment convertor employs DPA's DX32 processor, a discrete design which first appeared in more complex form in the gold plated £6000 PDM1024 convertor! In last month's issue, Dominic and Noel greeted the Enlightenment's simpler implementation with great enthusiasm. Indeed Noel, who doesn't hand out praise lightly, was moved to call it "startlingly good".

To enter this competition, simply complete the questions and tie breaker opposite.

Please send your entry on a POSTCARD, or the back of a SEALED ENVELOPE, and completed in block capitals, to arrive no later than 5th April 1995 to:

**DPA ENLIGHTENMENT
COMPETITION**
Hi-Fi World Magazine,
64 Castellain Road,
Maida Vale,
London. W9 1EX.

Don't forget to include your name, address and a telephone number so we can contact the winners promptly ●

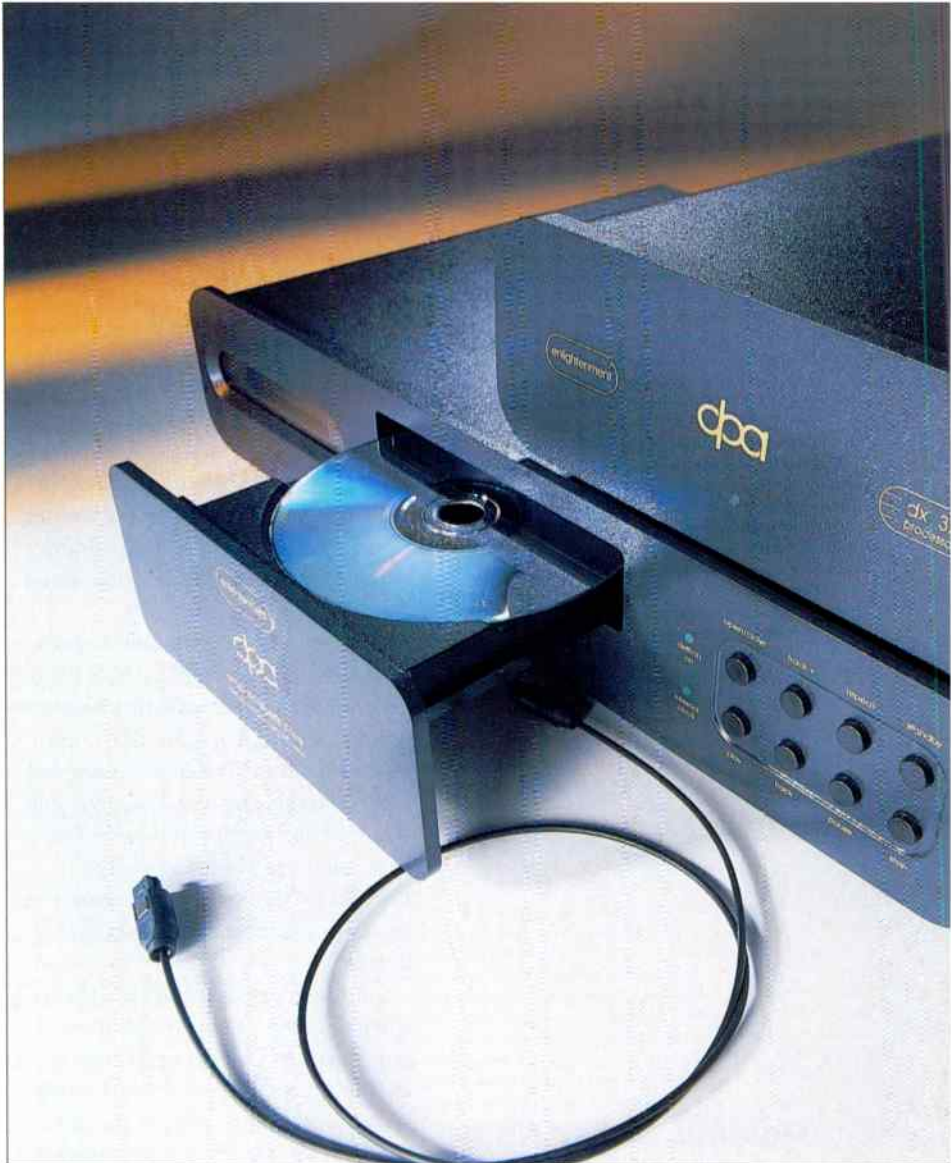

WIN A DPA ENLIGHTENMENT TWO BOX CD PLAYER

COMPETITION ENTRY QUESTIONS

- 1) What is the Deltran system designed to eliminate?
- A. digits
B. jitter
C. hum
D. music
- 2) What are Deltran's audible benefits?
- A. a vast increase in bass
B. a bright, piercing treble
C. a smoother, clearer sound
D. none to speak of
- 3) What else could you buy for the cost of DPA's PDM1024 convertor?
- A. a Porsche 959
B. a 100 year Hi-Fi World subscription
C. the Yucatan peninsula
D. a £6000 car
- 4) How did Noel describe the DPA Enlightenment drive and convertor?
- A. very agreeable
B. terribly ingratiating
C. absolutely fabulous
D. startlingly good

TIE BREAKER (Obligatory)

DPA kills the jitter bug,
With its cunning Deltran link,
A seductive sound you love,
Beauty to make you think. . .

.....
.....
.....
.....

Complete the ditty above in no more than thirty words.

COMPETITION RULES AND CONDITIONS OF ENTRY

Only one entry per household will be accepted. Multiple entries will be automatically disqualified.

In the event of more than one entrant submitting all the correct answers, the winners will be picked from the tie breaker by the editor. We will endeavour to publish the results in the June 1995 issue. Purchase of the magazine is not a precondition to entry.

No correspondence about this competition will be entered into and the editor's decision is final.

No employees of Audio Publishing Ltd. or any of the companies associated with production or distribution of the prizes may enter.

Please do not add my name to your mailing list.

Your name and address may be added to our mailing list only.
If you would prefer not to receive details of new products or special offers from us alone please tick the box.
Hi-Fi World magazine is published by Audio Publishing Ltd.

**FEBRUARY ISSUE
COMPETITION - WIN
ARCAM CD PLAYERS
WORTH £2250**

The lucky winners of the Arcam CD players are as follows:

1st Prize. Mr M. Chafer of Doncaster wins the Delta 250 transport and Black Box 500 Discrete convertor.

2nd Prize. Mr R. Walker of Co. Durham wins the Black Box 50 convertor.

3rd Prize. Jill Douglas of South Humberside wins the Alpha One CD player.

World favourites

TUNERS

NAD 402	£160	Stunning budget tuner, with a warm and open sound. Can compete with the best.	Jan'94
MISSION CYRUS FM7	£299	Clear and lucid sound. One of the best, regardless of price.	Apr'94
QUAD 66FM	£490	Among the very best in terms of tonal colour and imagery. Remote controllable.	Nov'92
NAIM NAT 03	£500	Warm and easy sound with a good sense of atmosphere. Good value.	Sep'93
FANFARE FT-1	£1350	A broadcast monitor that lives up to its name. Clear and powerful sound.	Mar'95
NAIM NAT 01	£1377	The best solid state tuner currently available. For better radio, live in the studio!	Mar'92

INTEGRATED AMPLIFIERS

NAD 310	£130	A full bodied sound and useful features put this budget amplifier ahead of the crowd.	Jan'95
NAD 302	£160	Lots of insight and detail, but could sound a little rough in the wrong system.	Jan 93
PRO-JECT 7	£259	A smooth and rich sound + good phono stage place this integrated up with the best	Feb'95
MISSION CYRUS III	£499	Superb engineering, a solid cast chassis and a clear and spacious sound.	Apr'94
STEMFOORT SF60	£549	Excellent bass drive and fine midband presence, powerful too.	Sep'94
DPA RENAISSANCE	£595	Rich and smooth, the Renaissance is one of the sweetest amps. around.	Dec'94
SUGDEN A21a	£639	Class A transistor amp. Sharp, crisp, deep, tight, and it images well too.	Feb'94
AUDIONOTE OTO SE	£1500	10watts of the sweetest sound around. Use sensitive speakers though	Aug'94

PRE-AMPLIFIERS

ROTEL RQ-970BX	£130	Audiophile quality components and sound with a bargain basement price tag.	Nov'94
ROSE RV23-S	£495	Valve/Transistor hybrid. Smooth and clean, rich and spacious.	Nov'93
DPA DSP 200S	£495	Not quite the 50S, but there's still nothing to match it at the price.	Jun'93
MICHELL ISO/HERA	£528	Fine midband and treble detail and taut bass from this MC only phono amplifier.	Oct'94
MICHELL ISO HR	£850	Impossible not to recommend. What more does your vinyl want?	May'93
NAIM NAC82	£1945	Remote control preamp. The NAC82 thrusts detail forwards in true Naim fashion.	Apr'94

POWER AMPLIFIERS

ROSE RP-190	£495	Used with the Rose pre-amp it gives 70 watts of smooth relaxing sound.	Nov'93
SUGDEN AU41P	£530	100 Watts of smooth, detailed, full bodied sound. And at a bargain price.	Apr'93
QUAD 606	£675	140W powerhouse. Smooth and civilized, with the legendary Quad back-up.	Aug'93
DPA DPA 200S	£750	Not as cold as the 50S. Better than anything else at the price.	July'93
NAIM NAPI80	£898	Partner to NAC82. Has real drive and grip on loudspeakers.	Apr'94
MICHELL ALECTO (S)	£1300	Valve like transparency, big warm easy going sound.	Sep'93
MICHELL ALECTOS	£1800	The Alectos have a lucidity and three dimensional realism that is rarely attained.	Dec'92
CHORD SPM 1200	£2995	Massively powerful, dynamic and detailed sound. Among the best of solid state.	Mar'93

LOUDSPEAKERS

GLL MAXIM	£120	Replacing the Maxim 3; not as tight in the bass but still one of the best at the price.	Aug'93
TDL RTL 2	£250	Bass on a budget. Solid, vibrant and spacious sound.	Dec'93
SYSTEMDEK 931	£330	Coherent and involving, these little gems really sing. Super value mini monitor.	Nov'94
HARBETH HL-P3	£479	Neutral and revealing sound that produces a fine, cohesive performance.	Nov'94
REL STRATA	£499	Rel's Strata offers excellent bass depth and power.	Mar'94
MISSION 752	£500	Using High Definition Aerogel drive units the 752s are clear, crisp and focused.	Oct'94
CASTLE CHESTER	£600	Good solid sound and beautiful finish. 1/4 wave bass bading.	May'94
TANNOY D100	£650	Believable 3D images produced by this small dual concentric speaker.	Jan'94
PROAC Studio 100	£699	Excellent monitors with detailed, natural sound and plenty of atmosphere	Feb'94
UKD CALLAS	£850	Powerful bass and high quality sound from a solid wood miniature.	Aug'94
SPENDOR SP3/1	£890	Beautifully built and finished. Superb midrange and treble detail and clarity.	Nov'94
KEF REFERENCE 2	£1500	Clarity, detail and precise imaging are just a few of the Model 2's properties.	Jan'95
SPENDOR SP7/1s	£1970	An easy load for valve amplifiers and a lucid sound make the SP7/1s very appealing.	Jan'95
TANNOY D700s	£1970	Dynamic and powerful. Needs a good clean power amplifier for best results.	Sep'93
QUAD ESL63	£3228	A reference to all others; superb imaging qualities and transparent sound.	Variou

With the increasingly popular Bristol Hi-Fi show (Hi-Fi 95) upon us, the thought of yet another London-based show seems a little perplexing; that makes four in all. We already have the highly commercial Live events which have attracted massive attendance and greater public awareness of hi-fi separates. Let's not forget Ramada either, which still attracts a good deal of international interest and has, until now, been the only affordable London show for smaller companies. The problem for many companies, however, is choosing between the two new Central London events. Being within a fortnight of one another, most companies simply can't afford the capital or manpower needed to attend both of them.

The two new London shows are planned to run at the same time as Live 95, but cater for real hi-fi enthusiasts. This may make sense for show goers who can attend all three shows during a single visit to London. But for exhibitors it represents yet another baffling choice. I can't see any exhibitors giving up the massive publicity and attendance rates of Live in favour of two untested events.

So what about the smaller (usually higher end) companies that normally exhibit at Ramada? In theory Ramada makes a lot of sense. As I said myself in the December issue of Hi-Fi World, last year, "...why on earth can't they (Ramada and Live) be on at the same time? Better still, if the organisers got their heads together, specialist hi-fi could be moved into some of the rooms around Earls Court, or a nearby hotel".

So what's the advantage claimed by these new shows? It might be a bit tough on poor old Ramada, but they would allow small high end companies to exhibit at a new affordable

venue, at a specialist show attracting Live's visitors, whilst leaving the major players at Live. Brilliant! Unfortunately there's a problem. The organisers of one new show have in their wisdom decided to christen it: "The A/V Event 95". Oh dear! Despite deliberately trying to attract hi-fi companies and larger dealers, the organisers have alienated half of their potential exhibitors, simply through the choice of name. Ramada possesses the advantage that it has nothing to do with anything except



and the new show has yet to be promoted. So, hopefully, the organisers will have the good sense to offer the specialist hi-fi show that central London really needs. Let's hope they do something about that name, too!

EDITORIAL FOOTNOTE: *The organisers must have read Dominic Todd's mind. We've just heard that the two new shows have now merged to form 'Sound & Vision London', which will run from 21st-24th September at the*

Fair Views

- from Dominic Todd, our man in Scarborough

hi-fi - it is a specialist hi-fi show. Therefore I can't see the companies that currently exhibit there moving to a venue whose title is totally alien to the products they sell.

It would be a great shame if the organisers persist with "The A/V Event 95" name, as the new show does have great potential. To be held at the Cumberland Hotel, Marble Arch, it's a prestigious location which has already played host to companies such as Goldstar and Hitachi during the Brown Goods Shows.

The layout of the hotel is also advantageous for a hi-fi show. There's a large conference floor at ground level which can be accessed

stalls. In addition to this, the show will consume the fifth floor, providing around 100 bedrooms and five suites. The idea of having two main "zones" is to reduce the likelihood of "dead spots" which visitors might miss. Something which other hi-fi shows could take note of, including Ramada, if the plan works in practice.

The sheer expanse of the Cumberland also leaves plenty of accommodation free for exhibitors (or at least those who can afford not to sleep with their kit!) and visitors. The service should be rather better than your average motel, too, with 24 hour room service and even the promise of a late opening bar for exhausted exhibitors to while away the small hours.

It's a shame to see such capable planning potentially ruined by the choice of name and the type of exhibitors sought. The organisers make no bones about trying to attract companies from both hi-fi and 'home theatre'. So in effect the new show appears to be trying to attract A/V from Live, rather than offering a base for specialist hi-fi companies that need proper demonstration rooms.

I understand that nothing's been finalised yet,

Cumberland Hotel, Marble Arch, in parallel with Live 95.

So that's London. But what about the rest of us sprawled around the country? Well, it's encouraging to see Bristol, Chester, Manchester and Edinburgh all having success with hi-fi shows. These four events, plus those held in London, seem to cover the country reasonably evenly, except for one area - the North East. If I could be allowed to plug my region for a minute, Yorkshire and the North East has an avid following of hi-fi enthusiasts, shown by the many dealer evening and clubs. Yet there's no major show. There used to be a major northern show at Harrogate, but plans to revive this event have fallen through. So if there are any show co-ordinators out there looking for a new venue, how about it?

In the meantime make sure you support your local hi-fi show, wherever you live. After all, it's the one time when manufacturers get a decent level of feedback from the consumer. Without hi-fi shows we might end up getting the hi-fi that we're given, instead of what we actually want ●

" I wish the new show luck because, lets face it, the more representation hi-fi can achieve before an unknowing public, the better. "

via the street. This consists of eight large rooms for demonstrations, plus a large floor space for exhibiting

The Music Dad

rock & pop

Giovanni Dadomo



ELASTICA
Elastica
BLUFF 018

● Arguably the best of the current British crop of girly bands (Echobelly, Sleeper, etc.), Elastica are built around the writing, singing and guitar talents of Justine Frischmann. Aided and abetted by fellow guitarist Donna Matthews, bassist Annie Holland and Justin Welsh (a bloke, this one!) on drums and "shouting", Frischmann has come up with an arresting distillation of easily traceable influence - primarily vintage punk clatter crossed with respectful tips of the cap to pioneers such as Debbie Harry and Chrissie Hynde.

Justine's other claim to fame is that she used to date Suede front man Brett Anderson, and now cohabits with Blur's Damon Albarn. This would be nothing but a cheap bit of gossip were it not for the fact that the album's opening cut has a strong Blur feel to it. That said, it's inevitable that two creative people are bound to bounce ideas off one another.

And it has to be said that 'Line Up', the group's second single release a year or so back, stands up as a toothsome slab of modern pop. With claws.

Even better, there's not a hint of Suede to be found, so Justine obviously has her musical as well as romantic priorities right. The sound is predominantly post-punk - dirty guitar chords and stampeding drums over which vocals are snarled, spat and delivered with admirably brattish hauteur. On the first few hearings it sounds under-produced, but then the hooks start to get you and it begins to feel like one of the first great pop records of the year.

'Connection', with its snotty delivery of sharp lyrics, busy guitars and a terrific booming bass fill is the record that gave the band its first real crossover from the indie to the national charts, a second Top Of The Pops slot and a well-deserved Single Of The Year 'Brat' award, courtesy of NME.

Other toughies like the pounding 'Smile' or the catchy fast-lane rock of 'Blue', are bound to be live favourites, while 'Allnighter' is an admirable tribute to classic Blondie. The current 45, 'Waking Up' is bound to be the band's biggest hit to date - all delicious Sixties guitar and bone-crusher hooks.

If the band fall down at all it's when they try and break their own formula - 'S.O.F.T.' is too dirge-like to be much more than a minor diversion, while the self-explanatory 'Indian Song' is just a mildly amusing re-run of the so-called Raga-Rock pioneered by the likes of The Byrds in the Summer Of Love.

So what? Two minor errors of judgement don't prevent this from being an exciting, effervescent debut. Not long now before gossips will be talking about "those blokes from Suede and Blur who used to play second fiddle to Justine Frischmann".

INDEX

RECORD REVIEWS

ROCK & POP73

Giovanni Dadomo

Jon Clarke

David Price

JAZZ86

Simon Hopkins

Simon Cooke

CLASSICAL93

Peter Herring



THE HUMAN LEAGUE

Octopus
EAST-WEST 4509 98750-2

● Of all the Eighties revival bands - Adam Ant with a balder, skinnier Marco Pirroni, the dreadful Duran Duran and Lord knows what other leftovers, only Phil Oakey's revitalised Human League are at all welcome. Having already proved themselves with twin chart smashes in 'One Man In My Heart' and 'Tell Me When', Octopus re-emphasises the fact that The Human League banner carried some of the most innovative and influential sounds of the last decade.

I say Phil Oakey's Human League because all the other original boy members left early on in the HL saga, and nobody outside of family and friends can ever say what the two pretties Phil works with are called anyway. Of course it doesn't help one jot that Oakey first saw the nubiles in question dancing together in a Sheffield disco, promptly chatted them up and, lo The Human League's second and most successful incarnation was made flesh.

No disrespect intended towards said female Leaguers, but it's always been Oakey's strong, distinctive vocal style that's given the group its unique stamp, even in the cerebral days of their original release 'Being Boiled', as well as the obviously more mass-market work heard on the phenomenally successful 'Dare'. So the ladies in question might just as easily be replaced as the boring geezers in Bucks Fizz.

Make no bones about it, this is very much Oakey's band, and Octopus is a slickly infectious pop confection that's bound to spawn at least a couple more hits. It features one of the year's best titles to date (affixed to the instrumental 'John Cleese: Is He Funny?') and should keep Phil Oakey in clover for a fair few seasons to come. Not bad for someone who had funny hair and the good sense to (eventually) visit the barber. A manifest example of from hair to eternity.

P.S. (Politically Correct P.S. at that): Phil

Oakey's collaborators in The Human League are of course the delightful Joanne and Suzanne. Only kidding, ladies!

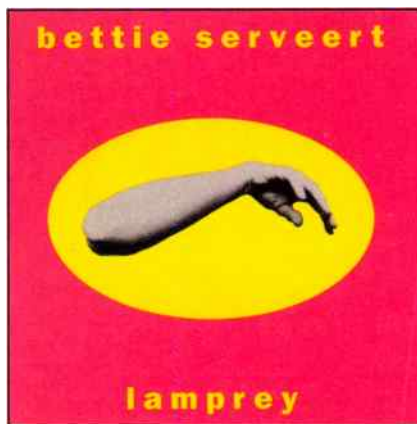

BETTIE SERVEERT

Lamprey
BEGGAR'S BANQUET BBQ CD 169

● "By the time we get there we won't know where we've been", sings Carol Van Dijk on this ingeniously titled LP from Dutch rockers Bettie Serveert (the temptation to use the band name's initials is strong - think about it), a quartet with a strong debt to the tangled emotions and matching tuneries of Throwing Muses.

I've always found foreign groups' use of English vastly amusing, particularly when they get it really wrong. But BS (there, did it!) manage to overcome that particular hurdle, partly because Ms Van Dijk is Canadian born, but mainly because of the inspired guitar colourings of Peter Vissner, who manages to fuse echoes of the past three decades with an ease and delicacy rare in these days of the three-chord thrash revival.

Once you get over (or should that be *if you get over*) the strong resemblance between Carol VD's (oops, here we go again) voice and that of Tanya Donnelly and half sister Kristen Hersh, this is a pleasant, if hardly earth shattering recording, that is by turns delicate, barbed and sensitive.



SEXPOD

Home
PLACEBO PILL MCD 6

● Cool name from yet another mixed-gender combo, hailing from the naked cities of New York and New Jersey. Sexpod are Karyn Kuhl (vocals/guitars), Alice Genese on bass, and drummer Billy Loose. Needless to say the vocals have that built-in scornful arrogance we associate with everyone from Johnny Thunders through Patti Palladin of Snatch, right up to the likes of Joan Jett or L7. It's tough, sturdy, punksome rock that any fan of Peter Bagge (simply The Best funniest Cartoonist On Earth Right Now - check out his 'Hate' comics) could fail to respond to this brash mix of abrasion, guitar thunder and (hardly appropriate for a young lady, what?) downright filthy cockiness. A buzz, and on the strength of this spunky (hardly appropriate for a girl either) double, Sexpod are a name to watch. Catchy as a social disease but rather more beneficial.

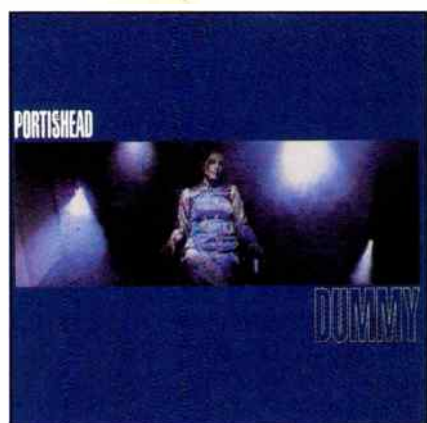

PORTISHEAD

Dummy
GO BEAT 828-522-4

● Sorry to be a trifle late in mentioning this debut from Bristol's latest biggies, especially now that it's top of the charts. Truth be told, I actually went out and paid hard cash for this

CARTER USM

Worry Bomb

CHRYSALIS 7343 8.321172.2

● *"The loneliness of the long distance drugs runner/ Ends on a crowded Bangkok death row."* Only Carter USM could come up with wordplay that. It's on 'Gas (man)', a typical example of Carter's ability to make a bitter-sweet piece of wordplay out of a theme as fresh as this morning's headlines. A fifth LP (plus a rousing freebie live disc from last year's tour of the former Yugoslavia) and it's more or less what we've come to expect from Jim Bob and Fruitbat, the duo now expanded with the addition of a live drummer, Wez. And sure it's pretty much the same mixture as before - clever words, catchy tunes, oodles of energy, anger and concern.

Along with Billy Bragg, Carter almost singlehandedly carried the torch lit by The Clash through the

Eighties and Nineties. Recent singles like the rousing 'Let's Get Tattoos' and the uproarious 'Young Offender's Mum' were ample proof that both verbally and musically, the boys are still on the ball, hearts firmly in the right place. They spit on the music industry's trendier camp-followers, 'Me And Mr Jones', attack apathy, 'My Defeatist Attitude', 'The Life And Soul

Of The Party Dies' and make a cynical sideswipe at orthodox religion in 'God, St Peter And The Guardian Angel'. In short, rapier wit, anthemic choruses, courageous and intelligent choice of subject matter.

Take the opening shot. 'Cheap 'n' Cheesy', a lament for love lost that features the line "I've got no family for my family car", a phrase as moving as any in recent pop. But it's not all gloom and misery: the two-part 'Airplane Food/ Airplane Fast Food' (a humorous comment on a torture we've all suffered) is a regular Carter stomp followed by a frenzied punk thrash The Ramones would have been proud of. And the closing 'Ceasefire' is as heartfelt a plea for peace as anyone has cut in years.

Carter USM may not be the trendiest of bands any more (if they ever were) but they're still relevant, quintessentially British pop craftsmen of the first order. 'Worry Bomb' is full of thundering good pop, words of wisdom and tunes that stick like leeches not fed in a month of Sundays. In other words, it's a gas, man.

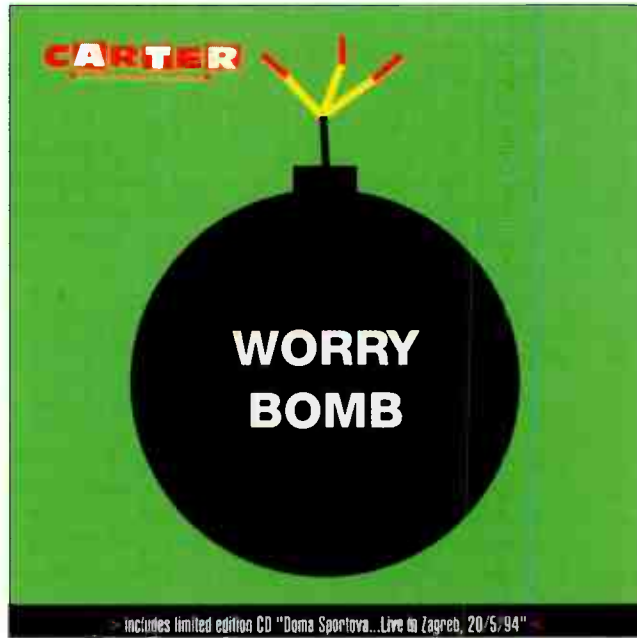

rock & pop

one largely on the basis of a plethora of rave reviews. It turned out to be a repetitive wander through laid-back, slightly funk-ed ambient territory. All ethereal (largely) female vox, bleepy, repetitious electronics and not a whole lot else. It's probably very relaxing and ideal for those with expensive in-car stereos - you know the sort of folks who like their music not too aggressive or intrusive. Why not? It's surely down to them if they want to enter the musical equivalent of a coma especially delivered with this sort of polish and panache. That said, this is music to

orchestrate riots by, but then that's hardly the intention. For some reason the name Enya springs to mind. if you get my drift. ZZZZZZZZ!

VARIOUS ARTISTS

Skynyrd Frynds

MCA MCD 11097

● Yet another tribute album, this time in remembrance of those good ole Southern boys Lynyrd Skynyrd, who almost single-handedly gave sleazy, bar-band rock'n'roll a licence to become a popular force in the mid-to-late-

Seventies. The collection is bookended by the band's two most famous songs - the creditable enough 'Sweet Home Alabama' by the imaginatively



named Alabama, yes but there's no way Wynonna - strong vox or not - can hope to match the original totemic splendour of the late group's 'Free Bird' anthem. Some things are sacred and should not be touched. In between come the likes of the Mavericks (hot), Hank Williams Jr. (tepid) and Charlie Daniels (venerable). But the whole affair's nothing to write home about, bringing the question "Why bother?" immediately and lastingly to mind.

Rock + Pop.

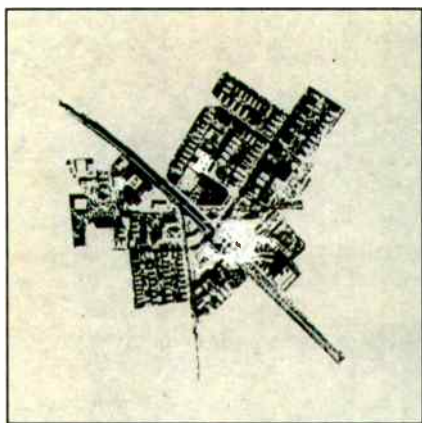

VARIOUS ARTISTS
This Is Fort Apache
 MCA 11179

● Now here's a fairly novel notion to drag a compilation album together by a welter of cuts from the famed Fort Apache Studios in Boston which, if you didn't know (and I didn't I have to confess) were set up between a bunch of independent entrepreneurs/producers/engineers including our own Billy Bragg. The label's just signed a distribution deal with MCA, hence this taste of past glories. Included are such indie hallmarks as Belly, Dinosaur Jr, Throwing Muses, Buffalo Tom, etc.

Not all the bands are at their best here (The Lemonheads hardly light up the room with 'Stove', a cut from their last precrossover album Lovey) but there are enough rarities, out-takes and rare B-sides to make the impassioned indie fan froth at the mouth, while the curious could do a lot worse as a way to explore some of the better exponents of the indie sound. And Cold Water Flat, Fort Apache's latest signing do, on the strength of sneak preview 'Magnetic North Pole', indeed sound like a sound whose time will come around.

Jon Clarke

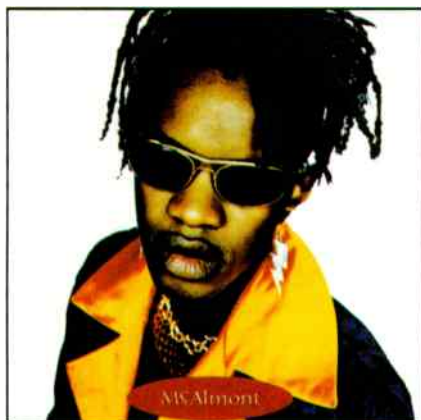

McALMONT
McAlmont
 VIRGIN RECORDS

● Stranger things have happened in the pop world! But if, as countless pundits have predicted, David McAlmont goes major this year, he'll be one of the most off-beat, quirky acts to grace the charts since the Bay City Rollers. Tipped as the new Seal, but image-wise he's nearer the two Georges - Boy and Clinton. His weird camped up look - big fur, lipstick and silly specs - really stands out. His recent appearance on The Word is testament to that. Nobody knew what to make of him, except that he was different. Prancing around like a pimp on acid, he looked outrageously stupid. Image aside, the debut single 'Either' sounded good.

Following on from the scene carved by Suede and Pulp, McAlmont's self-titled debut album is a strange mix of contemporary and '80s sounds. It's weird and original and makes for a interesting listen. Not everyone's cup of tea, a lot of people are going to really hate this record. But there's no doubt McAlmont's got talent and this is a powerful debut. His voice wavers eerily from high to low as the album waxes and wanes to its sad and twisted conclusion. Hard to describe, hard to pigeonhole. Almost grating, almost great. It's tricky to know what to make of McAlmont. Lets go for "strange".



TRICKY
Maxinquaye

● If McAlmont's debut release is strange, Tricky's debut Maxinquaye is bizarre. The album is best summed up by the opening lines of the haunting 'Abbaonfat' - a scary look at sexual perversity and low morals, this song stinks of decay and sadness. With Tricky's gravelly, degenerate-sounding voice rasping like an asthmatic Tom Waits, the listener is defied to be

unmoved.

Unless, you didn't already know, Tricky is a product and major player in Bristol's enigmatic Massive Attack. And the connection doesn't stop there. Two of the tracks on Maxinquaye sit on Massive's recent second LP, Protection - 'Overcome (Karmakoma)' and 'Hell Is Round The Corner' are further forward than on the laid back Massive LP, and both sound as good.

But the most notable track is the current 'Blue Steel' single, an excellent cover of Public Enemy's angry and controversial 'Blue Steel In The Hour Of Chaos', from their Nation Of Millions LP. It's as unrecognisable here as when Tricky recently aired it on The Word. Starting slowly it suddenly turns into a grungy, rocking track with a real kick to it.

While many expected a dance and roots-orientated LP, similar in vein to fellow Bristoleans Massive, Maxinquaye is surprisingly original. Largely experimental, it's as much at home with positive punk stalwarts Siouxsie and The Banshees and The The as with indie darlings Portishead and Massive. Borrowing from a host of influences, it has an alternative, leftfield and generally depressing feel - powerful stuff that can swing your mood.

Tricky's co-singer, the elusive and childish Martina has the sweetest but scariest voice around. Floating and trippy, her rich and varied melodies make Bjork sound like a choirgirl. Her succession of duets with Tricky are complex and original, and at times they appear to be battling to be heard.

Best moments other than 'Blue Steel', are found on side B, with 'Suffocated Love' and its classical overture samples, 'You Don't' a chill, dub-inspired number and the industrial 'Stugglin' - a kind of tuneful Einsturzende Neubauten with a haunting "they labelled me insane catchline". And the last track 'Feed Me' - complete with mystical Middle-Eastern samples and a trippy, grating off-beat is just brilliant. With an almost Joy Division vibe, Maxinquaye might be seen as an Unknown Pleasures for the nineties. Tricky's first LP is one to miss at your peril.

Continued on page 81

Rock + Pop.

Specialist Hi-Fi Dealers

BADA DEALERS COME HIGHLY RECOMMENDED



Hear the difference.

VOX MAGAZINE:
"You can be confident that BADA members are reputable, financially sound businesses which will sell you hi-fi in a professional manner."

HOMES & GARDENS:
"A tried and tested way of finding trustworthy dealers... BADA whose members are specialist Hi-Fi Dealers."

GRAMOPHONE:
"Over 100 member shops... from Aberdeen to Plymouth... Helping customers to identify, clarify and satisfy their needs through the demonstration of suitable hi-fi products."



LOOK FOR THE BADA LOGO WHEN YOU CHOOSE YOUR REAL HI-FI DEALER

Write for a FREE Fact Sheet, BADA benefits and full members list to P.O. Box 229, London N1 7UU. Tel: 0171 226 4044 Fax: 0171 359 7620

SOUTH



BUCKINGHAMSHIRE'S PREMIER HI-FI DEALER

Arcam, Denon, Linn Products, Naim Audio, Meridian, Rotel, Yamaha, NAD, Quad, Tripod, Nakamichi, Rega, Creek, Epos, Mordaunt Short, Celestion, Marantz, Mission, Cyrus, etc. ...

65 Castle Street, High Wycombe, Buckinghamshire.
Open Monday - Saturday
0494 531682 / 464670

LONDON & SOUTH EAST

"One of the 5 best hi-fi shops in the world"

GRAHAMS HI-FI

Canonbury Yard, 190a New North Road
London N1 7BS, ☎ 071-226 5500
Ring for a chat, an appointment and a map!



LONDON & SOUTH EAST



THE INNOVATIVE AUDIO AND VISUAL HI-FI RETAILER

SERVING LONDON FROM BATTERSEA

ORANGES & LEMONS
071- 924 2040/3665
61/63 WEBBS ROAD, SW11



7 ST. PANCRAS, CHICHESTER, WEST SUSSEX
CLOSED ALL DAY MONDAY
Tel: (0243) 776402

Appointed stockists of: A+R Cambridge, Castle Acoustic, Creek, Dual, Goldring, Linn Products, Monitor Audio, Naim, Nakamichi, Quad, Rega, Rogers, Royd Audio, Spendor

For the great sound of sound :

The Comflake Shop
37 Windmill Street London W1P 1HH
071 631 0472 Fax. 071 436 7165

We stock ATC, Arcam, Meridian, Naim, Rega, Royde, Roksan, AVI, Monitor Audio, DNM: as well as offering a marvellous mail-order worldwide service • Crunch •



27 BOND STREET, EALING
LONDON W5 5AS
TEL. 081 - 567 8703

AMC, Acoustic Energy, Aura, Audiolab, Audio Innovations, B&O, B&W, Cannon, Castle, Cyrus, Denon, Dual, Evolution, JPW, KEF, Marantz, Micromega, Mission, Monitor audio, Musical Fidelity, NAD, Nakamichi, Onix, Onkyo, Quad, REL, Rogers, Rotel, Systemdek, Target, Teac, Thorens, Van den Hul.

10 - 6 pm Mon., Tues., Friday, & Sat.
Late night Thur., closed Wed.

Two demonstration rooms.
Free local delivery and installation.
Repairs and Services



BRIGHTON'S LEADING HI-FI SHOP

Cyrus, Roksan, Micromega, Audionote, Audiolab, Rega, Arcam, Exposure, Aura, Epos, Thiel, Ruark, Rotel, Marantz and other fine equipment.

66 Upper North Street, Brighton
Telephone 0273 775978

alphason apollo audio innovations audion note audioquest dpa fuller helius heybrook impulse ixos kar lyra michell morel orlton pierre kurne project projekt qed royde sonic ink sound organisation soundstyle sterling sugden sumiko townshend trichord van den hul voyd home demonstrations, wide range valve/transistor/analogue/digital, nice people, peculiar adverts.....

hifi for grown-ups
signals
mantlesham heath ipswich (0473) 622866

WORTHING AUDIO

20 Treville Gate, W Sussex, BN11 1UA
(0903) 212133

The friendly shop with the best sound system in the South, Friendly advice

• 3yr guarantees • easy parking

Open Mon-Sat. 10am-6pm Late night Wed. 7.30pm
Agencies include: Arcam, Exposure, Kinshaw, Naim Audio, Marantz, Ruark, Audio Technica, Target, Tripod, JPW, TDL, Orelle, and many more.....

The Hi-Fi Shop

GUILDFORD'S SPECIALIST SINCE 1950

We are at:

3 BRIDGE STREET, GUILDFORD

(By the traffic lights - next door to Alfred Munks)

0483 504801 • 0483 304756

Access • Visa • Switch

Open Monday-Saturday 9am-6pm (later by appointment)



79/81 Fairfax Road
Swiss Cottage
London NW6 4DY
071 624 8855/6
Mon-Fri 10.7-Sat 10-6

Stockists of: ARCAM • CREEK • EPOS
HEYBROOK • MICROMEGA • NAIM AUDIO
NEAT • REGA • ROKSAN • ROTEL • ROYD
TEAC • YAMAHA

Infidelity
indecently good hi-fi

9 High Street, Hampton Wick, Kingston upon Thames, Surrey KT1 4DA. Tel: 081-943 3530
Open Tues - Sat 10.30am - 7.00pm.



Spaldings
ESTABLISHED IN SOUND

☎ 081-654 1231/2040

352/4 LOWER ADDISCOMBE RD.,
CROYDON, SURREY



27 HOCKERILL STREET, BISHOP'S STORTFORD, HERTS. CM23 2DH
0279 506576

41 VICTORIA ROAD, CAMBRIDGE CB3 4BW
01223 68305

Open Mon-Sat: 9.30-5.30
4 Demo rooms, Easy parking

LINN • NAIM • REGA • ARCAM • CYRUS • MISSION • DENON

Specialist Hi-Fi Dealers

LONDON & SOUTH EAST

**Near Norwich
Norfolk**
Tel. (0508) 570829



Basically Sound of Norfolk
STOCKISTS OF LEADING HI-FI

Arcam, Naim, Audiolab, Audio Innovations, Epos, Denon, Nakamichi, Acoustic Energy, Heybrook, Micromega, Rotel, Royd, TDL, The Chord Company, Sound Style etc...

STATION SOUNDS
W O R T H I N G
FOR A SELECTION OF VALVE AMPLIFIERS AND OTHER OLDER QUALITY EQUIPMENT

Valve amplifiers (combos and hi-fi) overhauled at sensible rates.
Audio Note speakers and used Audio Innovations amplifiers stocked
Valve and other equipment always wanted.

Mike Pointer 0903 239980 (including Fax)
DOWN PLATFORM WORTHING STATION SUSSEX

EIRE

We Never Compromise On Quality



55 Main St Blackrock Co Dublin
Tel 2889449/2888477 Fax 2834887
Open Tue/Sat 10AM-6PM. Thur/Fri 'till 9pm - Closed Monday

STAFFS & DERBY

HOW TO SAVE £100 ON YOUR HI-FI

Choosing the right Hi-fi and saving money is a difficult task, make it easy on yourself.
To get your copy of "Guide to Buying Hi-Fi" just telephone
FREephone 0800 373039

We will send you one Free of Charge together with our Fact Pack and see how you can save £100 on recommended Hi-fi Systems.

Active Audio

12 Osmaston Rd, 29 Market Street, 95 Stafford Street,
The Spot, Tamworth, Hanley,
Derby, Staffs, Stoke-on-Trent.
Tel: 0332 380385 Tel: (0827) 53355 Tel: 0782 214994

MIDLANDS

CREATIVE AUDIO
9 DOGPOLE, SHREWSBURY,
SHROPSHIRE
Tel: (0743) 241924
Closed Mondays

- Comfortable listening rooms
- Home demonstrations available
- Part exchange welcome
- Free home installation
- Interest Free credit

Authorised retailer for:
A & R ARCAM, AUDIOLAB, CELESTION, CYRUS, DENON, DUAL, MERIDIAN, MISSION, MONITOR, AUDIO, QUAD, REVOLVER, ROKSAN, ROTEL, YAMAHA, EPOS, NAIM, KEF, RUARK

Well engineered products for accurate sound reproduction from: Arcam, ATC, Audioquest, Audio Technica, AVI, Beyer, Cable Talk, Castle, Chord, Denon, Dual, Klipsch, Michell, Nakamichi, Ortofon, QED, Quad, Revox, Sennheiser, Sequence Design, SME, Spendor, Target, TDK, TDL, Thorens, etc., Keith Monks Record Cleaning Machine.

Five Ways Hi-Fidelity Ltd., (Est. 1972)
12 Islington Row
Edgbaston, Birmingham B15 1LD

MUSIC MATTERS

THE AUDIO SPECIALISTS
for the most exciting range of equipment available in the Midlands which includes:

Aiwa, AKG, Alchemist, Alphason, Apollo, Arcam, Audiolab, Audioquest, Audio Technica, Aura, Beyer, B+W, Cabletalk, Cambridge Audio, Canon, Celestion, Chord, Cyrus, Deltec, Denon, DPA, Dual, Epos, Exposure, Harman, Heybrook, Impulse, Infinity, KEF, Kenwood, Kinslaw, Lexicon, Lumley, Marantz, Meridian, Michell, Micromega, Mission, Mordaunt-Short, Monitor Audio, Monster, Musical Fidelity, NAD, Nakamichi, NVA, Onkyo, Panasonic, Pink Triangle, Pioneer, Polk, Pro-Ac, Pro-ject, REL, Revox, Rogers, Roksan, Rotel, Royd, Ruark, Sansui, SD Acoustics, Sennheiser, SME, Straitwire, Systemdek, System, Tannoy, Target, Thorens, Wharfedale, Yamaha etc...

OPENING TIMES:
Tues - Thurs 10.30 - 6.00
Friday 10.30 - 8.00
Saturday 10.00 - 5.00
Demonstration by Appointment

351 HAGLEY ROAD, EDGBASTON, BIRMINGHAM B17 8DL
Tel: 021-429 2811

156/7 LOWER HIGH STREET STOURBRIDGE, WEST MIDLANDS DY8 1TS
Tel: 0384 444 184

93-95 HOBSMOAT RD, SOLIHULL, WEST MIDLANDS B92 8JL
Tel: 021-742 0254

"We are a BADA dealer" and "full service facilities"
INTEREST FREE (for Ltd Period) APR 0%
Written details on request. Licensed Credit Broker
Switch card accepted

FRANK HARVEY

Hi-Fi EXCELLENCE

163 Spon Street, Coventry, CV1 3BB Tel: 0203 525200.
Mon to Sat 9.30 AM to 5.30. Closed Thursday

MUCH MORE THAN HI-FI
WE ARE A BADA DEALER

Audiolab - Audio Alchemy - Arcam - Alphason - Bose - Bang & Olufsen - Celestion - Cyrus - Denon - Dual - Foundation Kef - Marantz - Monitor Audio - Mission - Musical Fidelity Nakamichi - NAD - Quad - Rega - Rogers - Rotel - Target Tivoli - Tannoy - Thorens - Van Den Hul - Yamaha

MAILORDER - EXPORT - HOME TRIALS

3 Floors, 3 Dem rooms, 3000 sq feet in the pursuit of Hi-Fi Excellence



AUDIO EQUIPMENT FROM LEADING AND SPECIALIST BRANDS ON TWO FLOORS FOR YOU TO LISTEN AND CHOOSE FROM

- 3 Demonstration Rooms
- Home Trials
- Home Cinema - Instore Demonstration Theatre
- Audio Visual Equipment
- Evening Demonstrations by appointment
- Inhouse Service Department
- Mail Order Available
- Interest Free Credit on Selected Items (Apr. 0% - Written details on request)

Hi-Fi for the Beginner, the Enthusiast and the Audiophile Telephone (0922) 493499/473499

ACQUSTIC ENERGY • ARCAM • ALEM • AUDIO LAB • APOLLO • AT • AUDIO ALCHEMY • AUDIO QUEST • BAW • BOSE • BEYER • CABLE TALK • CHORD COMPANY • CHORD • CYRUS • CELESTION • DPA • EPOS • EXPOSURE • INFINITY JMW • KEF REFERENCE • KENWOOD • MARANTZ • MICHELL • MONITOR AUDIO • MONSTER • MORDAUNT SHORT • MERIDIAN • MICROMEGA • MISSION • MOTH • MUSICAL FIDELITY • NAKAMICHI • ORTOFON • PROJECT • QUAD ROKSAN • ROGERS • ROTEL • SENNHEISER • SONY • SPENDOR • SUMIKO • SYSTEMDEK • TARGET • TDL • THORENS • TRIANGLE • TUBE TECHNOLOGY • VAN DEN HUL • VANDERSTEEN • YAMAHA • YBA



CINEMA DVD

Quality, Clarity, Expertise... and that's just the service!



Sharing the ASDA Car park with ample free parking. Off High Street, Bloxwich, Nr. Walsall, West Midlands Near M6 Jnc. 10 & 11
Open 6 Days, 9am - 6pm
Late night Friday

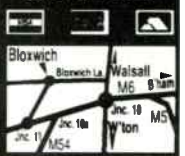

Specialist Hi-Fi Dealers

WEST & WALES

NORTH

NORTH

audio excellence **BADA**
THE ULTIMATE IN SOUND ADVICE

WHERE THE MUSIC MATTERS

Bristol 65 Park Street Bristol BS1 5PB (01179) 264975	Cardiff 134/6 Crwys Road Cardiff CF2 4NR (01222) 228565
Gloucester 58 Bristol Road Gloucester GL1 5SD (01452) 300046	Swansea 9 High Street Swansea SA1 1LE (01792) 474608

TUESDAY - SATURDAY 9.00 - 5.30
CLOSED MONDAY

Audio Reflections
DISCOVER **ACCURACY** IN FIDELITY

On permanent demonstration exclusively in Yorkshire and the North East of England - ATC: SCM10, SCM20, SCM20 Tower, SCM50A and SCM100A, AV International, Bryston Amplifiers, Castle, Concordant, Chord SPM Power Amplifiers, Equinox, Harbeth Acoustics, JPW, Sequence Loudspeakers, Marantz, Michell, Cyrodac, Michi, Ortofon premier range, Rotel, Sansul, reference grade fully balanced CD players and integrated amplifiers, SME, Spondor, Target, TEAC, Townshend Seismic Sink, O.E.D. van den Hul. The First & The second Cables.

Demonstrations by arrangement in LEEDS, or in your own home without obligation. For further details contact JOHN BLEAKLEY, Phone/Fax LEEDS (0532) 528850 (evening calls welcome)

Part Exchange and Second Hand Equipment available.

TEAC **MICHI** **spondor**
Perfectly Balanced Sound

Avi
BY INTERNATIONAL

JS **BOVSTON** **SANSUI**
ACOUSTIC ENGINEERS "VINTAGE LINE"

TECHNICAL & GENERAL

THE ORIGINAL TURNTABLE SPECIALIST for the Great Classical Turntable, Arms, Cartridges, Styli

CONNOISSEUR • GARRARD • GOLDRING • Lenco • ORTOFON • SHURE • S.M.E. • THORENS • WATTS

All available Genuine spares and our own re-manufacture obsolete parts

Service and Overhuls, to original technical specifications.

NO ILLUSORY 'IMPROVEMENT' NO DUBIOUS OR HARMFUL 'MODIFICATIONS'

Remedial Services available

Cartridge and styli, correct radius diamond, for early recording - 78s & Lps

TECHNICAL & GENERAL
P.O.Box 53 Crowborough, East Sussex TN6 2BY
Tel: 0892 65 45 34

ENGLISH audio **BADA**

CYRUS CENTRE
PINK TRIANGLE-AUDION-SYSTEMDEK-HEYBROOK-MICHI-KEF-REFERENCE-MICROMEGA-NAKAMICHI-CHORD-ARCAM-ROGERS-NAD-ROTEL-DENON-TANNOY-MARANTZ-MISSION-STAX-DUAL-TDL-JPW-EXPOSURE-YAMAHA-JOHN SHEARNE-AND OTHERS

Free installation: Credit facilities: Service department

Mon - Sat 9.30 - 5.30
37 Whitecross Road, Hereford. HR4 0DE

HI-FI YOU CAN'T AFFORD not to listen to

EQUIPMENT BY ABSOLUTE SOUNDS, AUDIO INNOVATIONS, SUGOEN, IMPULSE, MICHELL, ROKSAN, PINK TRIANGLE, ACCUPHASE, THIEL, COUNTERPOINT, SONIC FRONTIERS, TRICHORO REOARCH ETC.

By appointment only

SERIOUS KIT
061-707 4823

SOUNDS AROUND

NEW & USED HIFI

Professional Service Repairs and Accessories

146A Clarendon Park Road, Leicester
Telephone : 0533 702442

V'AUDIO 36 Druic Hill, Stoke Bishop
Tel: 0117 95686005

ATC, AVI, Acoustic Energy, Audio Innovations, Alon, Audiomeca, Audio Technica, AMC, Analogue Electronics, Cadence Valve, Chord Amps, Electrocompaniet, Exposure, Goldring, Harman Kardon, Heybrook, Jamo, LFD, Lyra, Ortofon, Perception, Pink Triangle, Ruark, Michell, REL, Sansul, SME (inc. 20A), Sonic Link, Stax, Sugden, Sumiko, Townshend, Triangle, Wadia.

Demos by appointment only. Home trial facilities.
Free installations. Servicing facilities.
We are not a shop

REPAIRS/DIY

CVC **Chelmer Valve Company** for Audio Valves

Buy CVC PREMIUM Hi-Fi valves direct from us. All valves processed for improved performance. We also have Stock of MAJOR BRAND types including :MULLARD, GEC, BRIMAR, RCA, GE, etc

130, New London Road, Chelmsford, Essex, CM2 0RG
Tel: 01245 265865 Fax: 01245 490064

Sussex Surplus

Original Mullard GEC Valves for sale & wanted for cash

Sussex Surplus
13 Station Road, Horsham, West Sussex.
Tel: 0403 251302

SOVTEK VALVES

6550WA. 6L6WGC/5881. E1.34G.
12AX7WB/7025. EF86/6267

Over 1000 different types of valves stocked S.A.E. for list
DEPT. HFW
Wilson Valves, 28 Banks Ave, Golcar, Huddersfield, West Yorks, HD7 4LZ.
Tel: 0484 654650/420774 Fax: 0484 655699
Mail order only, Visa etc.

NORTH

AUDIO COUNSEL
HI-FI SPECIALISTS

LINN, NAIM, REGA, ARCAM, ROTEL, ROYD, SHAHINIAN, DYNAVECTOR, EPOS, MARANTZ, NAKAMICHI, MICROMEGA and many more...

"Time spent with staff may prove to be a particularly wise investment"

Audiophile
12/14 Shaw Road, Oldham OL1 3LQ
Tel. 061 633 2602

Lockwood Audio

THE Authorized **TANNOY** Specialist

SPARES AND REPAIRS

DEALERS IN VINTAGE AND USED EQUIPMENT AND RECORDS

VISA Callers welcome by appointment

Imperial Studios Maxwell Road
Borehamwood Herts. WD6 1WE
Phone: +44(0)181 - 207 4472
Fax: +44(0)181 - 207 5283

Retailers of Fine Audio Equipment
Congleton

▶ ARCAM
▶ B&W
▶ DENON
▶ EPOS
▶ KEF
▶ LINN
▶ MISSION
▶ NAKAMICHI
▶ ONIX
▶ ROYD
▶ YAMAHA
▶ LOUSY COFFEE

▶ SUPERB DEMO FACILITIES
▶ FULL INSTALLATION & HOME DEMO SERVICE

OPEN 6 DAYS A WEEK
OTHER TIMES BY APPOINTMENT

0260 297544

1/1A Duke St Congleton Cheshire CW12 1AP

Sowter Transformers
EA Sowters Ltd
PO Box 36
Ipswich IP1 2EL
0473 219390/252794

Output and mains transformers for GEC KT88 circuits. Can also make any other transformer to order. Send SA for lists and data.

Specialist Hi-Fi Dealers

REPAIRS/DIY

GT AUDIO

Specialises in the repair of all types of audio equipment (including valve). All work is guaranteed and carried out to the highest standard.
Tel: 0895 833099

THE Service Specialists

From early VALVES [we'll happily re-align your HRO!] to the latest DIGITAL LASERDISC
REVOX • TEAC • QUAD • ROGERS • RADFORD • TRESHAM • KENWOOD • ALTOBASS • TASCAM • PIONEER (LASERDISC & HI-FI) YAMAHA etc.
 Our facilities are already used by Broadcasters, Recording Studios & leading Manufacturers. If you've a quality-equipment problem call us today
AUDIO LABORATORIES (LEEDS)
0113 2440378

MUSIC

CD SELECTIONS

The UK's leading suppliers of bargain CDs and music for your free catalogue contact
 CD SELECTIONS
 PO BOX 1011
 DORCHESTER DORSET D12 7YG
 Tel. 0305 848 725

OVERSEAS



Get on our list - to get closer to this list.

- MIT MultiCap • Wonder Cap • Kimber Kap • Solo • Hovland MusiCap
- Solen • Siemens • Wima • Holco • Rel-Cap • Draloric • IRC • Allen-Bradley
- Jensen • Resista • Vishay • Caddock • Mills • Matsushita • TKD • Noble
- Cardas • Kimber Kable • van den Hul • Discovery • Audioquest • MIT
- Alps • Bourns • Shalco • Elma • Electroswitch • Nichicon • Gold Aero • RAM
- Mallory • Panasonic HFQ • Nichicon • Elma • New Old Stock • Ruby Tubes
- UltraAnalog • Burr-Brown • Crystal • Linear Technology • Analog Devices
- Edison Price • International Rectifier • Hitachi • Motorola • UCC
- MagniQuest • Sonic Frontiers • Pearl • Tube Sockets • WBT • Neutrik
- Sound Coat • Curcio Audio Engineering • Assemblage and other kits

And it's growing and growing. To order The Parts Connection 1995 Catalog & Resource Guide, send £7 and mailing information. You'll also receive a Discount Coupon worth \$10 off a purchase over \$100 or \$25 off a purchase over \$250* as well as The Breadboard bulletin to keep you updated on our latest news, information and growth spurts.

*or \$10 US, or credit card information
 *discount coupon values are in US Dollars

THE PARTS CONNECTION

A DIVISION OF SONIC FRONTIERS INC

2790 Brighton Road, Oakville
 Ontario, Canada L6H 5T4

Toll Free Order Line
1-800-769-0747
 (U.S. & Canada only)
 Tel (905) 829-5858
 Fax (905) 829-5388

Vitamin - Q Caps

We have a limited supply of metal case, paper/oil caps, Sprague, Westcap, Gudeman, J.Fast etc. Send for a list
Karluff Enterprises
 4331 Maxson Rd., El Monte, CA 91732 USA
 818/444-7079 * Fax 818/444-6863

SERVICES & CONSULTANTS

REVOX SERVICE

A77, B77 PR99

For fully guaranteed professional service and repairs, call RamTek.
Tel: (081) 207 6159. Fax: (081) 953 1118
Suite 33, Kinetic Centre, Theobald Street, Borehamwood, Herts WD6 4SE

Hi-Fi World Specialist Dealer Directory Order

Book 12 Months For A 30% Discount!! Or 6 Months For A 20% Discount.

I wish to be included in Hi-Fi World's Specialist Dealer Directory starting the _____ issue for a total of _____ insertions.

Please find enclosed my artwork/copy details.

I wish to book _____ column centimetres at £12.50 per col. cm.

Name _____

Company _____

Address _____

Postcode _____

Telephone No. _____

Please return to:
Hi-Fi World, 64 Castellain Road, London W9 1EX

David Price

rock & pop



VARIOUS ARTISTS The Best Punk Album In The World VIRGIN RECORDS

● It had to happen. With their "Best Of" series of compilations coming out over the last couple of months, the Virgin crew have really been begging the question. First Rock, then House, then Reggae, it had to be Punk next, didn't it? So here it is and this huge double CD offering is by far the best of the series. Largely because it's the first time 50 odd, so-called punk tracks have been slammed so violently onto one slice of plastic, but also because it's full of special moments.

Anthems, oh sweet '70s anthems! These are classic punk tracks built to last, the lot of them. One strange point is the marked absence of The Clash. But apparently Virgin couldn't clear the rights in time. But they make up for it with the inclusion of PIL's brilliant 'Public Image', and the Skids' 'Into The Valley', not forgetting the good old Jam. Most sound as good today as they did back then. You can still appreciate the energy and anger on these great little tracks - 'Teenage Kicks', 'Ever Fallen In Love', and 'God Save The Queen' - in the late '70s these were the songs that really mattered.

With Best of Punk, you can still upset your mother and neighbours and crank up the volume. Or should it be deaf buy.



JAMES TAYLOR QUARTET In the Hand of the Inevitable ACID JAZZ

● Eight years ago, an obscure collection of jazzers released 'Mission Impossible', a quirky, nostalgic trip through sixties mod movie soundtracks, at a stroke establishing the James Taylor Quartet as a premier acid jazz combo. They went on to make steamrolling, Hammond-driven funk their trademark, peaking with 1989's Wait a Minute, packed with manic organ grooves laced with some of the best tunes around.

In the Hand of the Inevitable= sees the band on the newish Acid Jazz label, first amongst some highly accomplished equals in what's been dubbed the 'new wave of new mod'. The title alludes to their changing musical direction - although JTQ still have time for the odd Hammond groove or frantic instrumental workout, the emphasis is more and more on lilting funk stuffed with Philly strings and Stax brass sections.

With soulful vocals from Alison Limerick on 'Love Will Keep Us Together', it looks like JTQ are chasing mainstream success in the vein of The Brand New Heavies. But they haven't lost the humour of earlier material, with 'Whole Lotta Love' continuing the Acid Jazz tradition of outrageously funky covers of hard rock standards.

Whatever their intentions, James Taylor Quartet remain masters of bright, breezy modern dance music, and their latest outing sees them more focused than ever. In the Hand of the Inevitable will make its way into the best bars, cafes and jazz clubs the world over. You can almost taste the cappuccino now.



THE BLACK DOG Spanners WARP

● Popularised by The Orb and carried through the nineties by the likes of James Bernard and Pete Namlook, Ambient is yet another vibrant music to mutate from the eighties techno boom. With Spanners, The Black Dog have proved themselves one of its most accomplished exponents.

Darlings of the Internet and doyens of Fuji TV's 'Revolution 8', their new-found fame has coincided with their most cohesive album to date. It's definitely a case of third time lucky - unlike the earlier, fussier Bytes and The Temple of Transparent Balls, this one brims with confidence and purpose.

Where others fall back on impossibly dense, heavy beats and stock samples to disguise a lack of creative vision, Spanners drifts effortlessly from silliness to some of the most trancey, effusive melodies ever committed to DAT. The Black Dog travel through techno's eclectic past, laying sparse dub beats under gentle shuffling textures - reminiscent of everything from Jimmy Cautie's Space to Andrew Weatherall's Haunted Dancefloor. Grabbing at hip hop and funk, playing with Rai and Bhangra, alluding to Greek mythology and cod science-fiction, it's not every day you see such breadth brought together in such an original, charming way.

Indeed, Spanners is Black Dog's best testament so far to their confidence with, and fluency in, electronic music.

Rock + Pop.

KITS HAVE NEVER BEEN SO GOOD!

K588 I PSE KIT

£650

An audiophile parallel-single-ended valve amplifier at an affordable price. K588 I PSE uses the reliable Russian 5881 output valve, a military version of the American 6L6 designed for low distortion audio work in parallel-single-ended mode for outstanding detail and atmosphere. It produces 17watts, enough to drive most loudspeakers, making high-end sound quality and design available to everyone.

NEW!



The World Audio Design range of kits are engineered like no others. Features of World Audio Design valve amplifiers include:

- Pure Class A working
- 4/8/16Ω taps for optimum speaker matching
- Custom designed transformers for unrivalled performance.
- Audiophile components
- Choke regulated power supplies
- Can be easily monoblocked for double power
- Welded steel chassis
- Hard wearing 'baked on' powder coat finish



K588 I KIT

£395

A superb, Class A, 20watt stereo power amplifier that uses the Russian 5881 output valve, a military version of the American 6L6, designed for low distortion audio work.

Designed for long life, low running costs and excellent sound quality, K588 I is sensitive enough to be used with a simple passive pre-amp. or our own line-drive pre-amp, and it matches modern loudspeakers well.



300B VALVE AMP KIT

£850

This is a specialised amplifier based on the highly linear 300B triode valve. Our 300B runs in Class A, giving one of the most sweet open and neutral sounds possible today. Matched with good loudspeakers, it is unsurpassed. Can be monoblocked for 60watts.

All parts are included in the kit, except valves since different 300B makes are available.

4W SINGLE-ENDED VALVE AMP KIT

£385

The 4W Single-Ended amplifier kit is a line level integrated amplifier. It comes with three line level inputs and a tape output. High quality components are used throughout, including polypropylene signal capacitors, Alps volume control, custom C&K gold plated selector switch etc. Valves are included.



World Audio
design

VALVE LINE LEVEL PRE-AMPLIFIER £295

The line level preamplifier uses one of the simplest and most elegant circuits to give a sound with remarkable clarity and detail. The components are all high quality and include a special screened toroidal transformer. Military Spec. Russian valves, Alps potentiometer, polypropylene signal capacitors, silver plated copper wire etc.



THREE WAY CARBON-FIBRE DRIVER LOUDSPEAKER

KLS3 uses extremely light and stiff carbon fibre cone drive units for a fast and accurate sound. A dedicated 4inch carbon fibre micrange drive unit provides the cleanest, smoothest and most detailed midrange characterised by superb projection.

KLS3 has been engineered to get the best from your amplifier, be it valve, solid state, single-ended or zero feedback. Its high 90dB sensitivity and near flat 8Ω impedance make it one of the easiest loudspeakers to drive.

- Drive Unit & Crossover kit etc £350
- Drive Unit Pack £230
- Built £1500

HIGH DEFINITION LOUDSPEAKER

The High Definition loudspeaker is ideal for low power, high quality amplifiers, transistor or valve. It goes very loud with just 1-5watts, having an enormous sensitivity of 94dB - that's 8dB more than most other speakers. It is also a very easy load for valve amps (8ohms) and it gives a terrifically dynamic and fast sound. This speaker is also unusually suited to low powered vintage amplifiers, such as Quad IIs, Radfords, Pye Mozarts and such like.

- Drive Unit & Crossover kit etc £195
- Drive Unit Pack £145



HIGH TECH AUDAX DRIVE UNITS

The 1994 range of Audax drive units sees many modern high tech materials and technologies that would normally be unavailable to the home constructor. We offer a small range of the highest quality drivers, including High Definition Aerogel (HDA) units, carbon fibre and three superb soft dome tweeters. Sadly there isn't enough room to print the specs, but if you are interested in any of the following drivers, please ask us for a detailed spec sheet.

Audax Drive Units:

CAST CHASSIS UNITS

	4 inch mid	6.5inch bass/mid	8inch bass
HDA	HMI 30Z0	HMI 70Z0	HM210Z0
CARBON FIBRE.....	F-MI 30C0	HMI 70C0	HM210C0

NEW 3inch HDA mid, HMI00Z0

FABRIC DOME TWEETERS

- TW025M0 (25mm 92dB suitable for 2-way systems)
- TW025M1 (25mm 92dB suitable for 3-way systems)
- TW034X0 (34mm 93dB a large dome with powerful sound)

CLASS A 36W SOLID STATE MONOBLOCKS

A pure Class A transistor design offering superb clarity and transparency. The Class A monoblocks use special new super grade audio transistors. They are extremely fast and linear, giving a super measured performance without the need of high levels for feedback.

- Circuit board + output transistors £129.40

DEMONSTRATIONS!!

World Audio Design Products are on demonstration at:

Hi-Fi Confidential 34 Buckingham Palace Rd, Victoria, London. Tel: Luigi on 071-233-0774	Horsham Hi-Fi 28 Queensway, Horsham, W. Sussex. Tel: Jeff on 0403-251587	Hi Fi Corner 1 Haddington Place Edinburgh EH7 4AE Tel: Lennie on 031 556 7901
---	---	--

World Audio
design

See page 85 for order form...

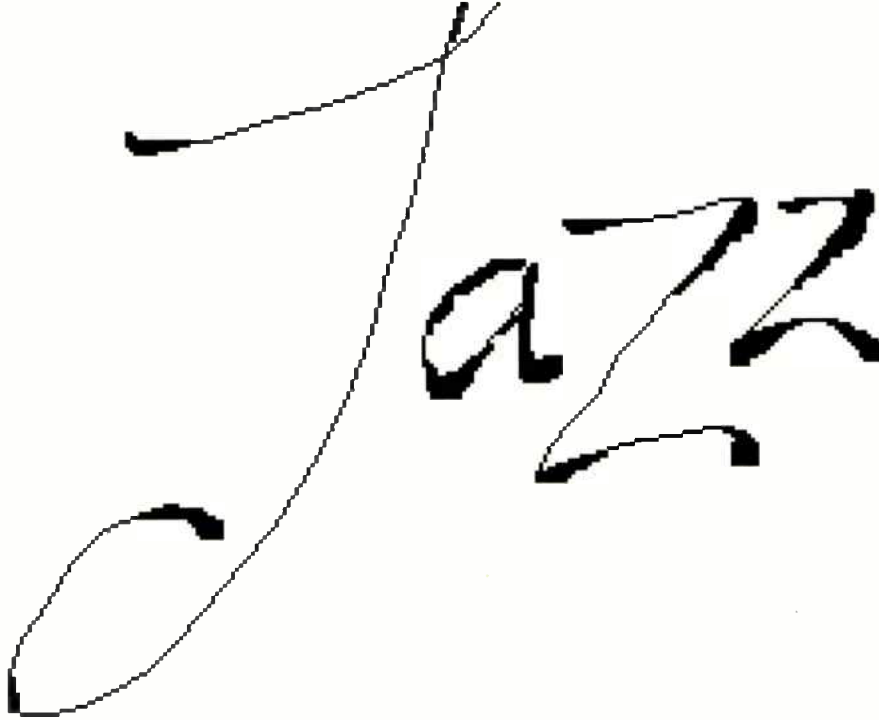

Simon Hopkins

TERJE RYPDAL If Mountains Could Sing ECM 1554

● A mixed bunch of new releases from the German ECM label this month, kicking off with one of the label's stalwarts. For over twenty years the Norwegian electric guitarist Terje

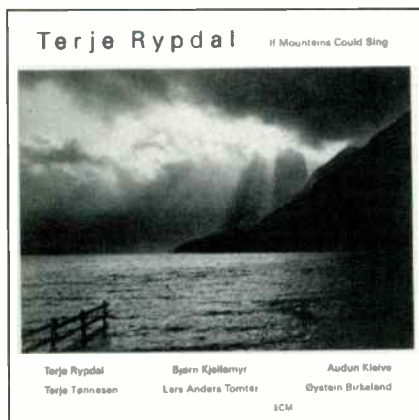

Rypdal has been making records for the label, building a canon of work which stands as one of the greatest that any guitarist working in any branch of contemporary music has ever turned in. Along the way he's melded blistering jazz rock, austere chamber music, free jazz and a constant love of Hank Marvin (yes, really!) into a unique and unmistakable style which is at once highly accessible and genuinely searching.

If Mountains Could Sing sees Rypdal joined by his regular fusion trio the Chasers - bassist Bjorn Kjellemyr and drummer Audun Kleve - plus a chamber trio of Terje Tonnesen on violin, Lars Anders Tomter on viola and Oystein Birkeland on cello. Previously, Rypdal has specifically combined jazz rock and chamber music on 1975's Mahvishnu-meets-Webern classic Whenever I Seem to be Far Away and the hope here is naturally that we'd get some of the same.

Which is unfair. If Mountains Could Sing is no Whenever I Seem to be Far Away, but doesn't set out to be. Rather, it's a subtle blend of his recent chamber work like QED and Dionysus with the jazz rock of the Chasers, a jazz rock which is altogether slicker than that of Rypdal's 70s groups, but still a group of great verve.

Overall, this is ascetic, beautiful music, shot through with some of the most blazing guitar work-outs that Rypdal's produced in years; the ring-modulated, distorted solo that bursts out of the second track 'It's in the Air' - which should be the album's opener - is worth the price of the CD alone.

Cracking stuff; I haven't enjoyed Rypdal this much in years.

DAVID DARLING Dark Wood ECM 1519

● American cellist David Darling is one of the label's less well known stars, although he too has been making records for them - albeit far less

prolifically than Rypdal - for well over a decade. Darling's work is rich, romantic, yet often rather bleak music which somehow avoids the all-too-New Age tendencies of multi-instrumentalist and singer (and, of course, ECM labelmate) Speghan Micus, yet is also less abrasive than the work of labelmate Paul Giger, whose solo records ostensibly have much in common with the multi-tracked solo work of Darling.

Dark Wood, a suite seemingly based on, or at least inspired by, "Disturbing the Night", a short story by Barry Lopez, works in much the

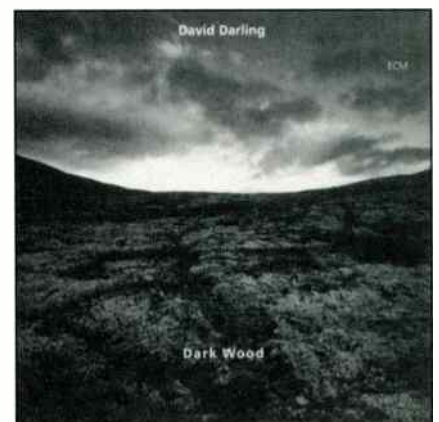

same area as Darling's album Cello, released in the early nineties. Again this album sees Darling playing plaintive, elegaic, undeniably moving - yet never syrupy - solo lines against a backing of his own plush pizzicato cello chording. In truth, this isn't a great development from Cello, but with music this undeniably beautiful, who gives a damn? This is a fabulous, highly enjoyable and highly recommended record.



ANOUAR BRAHEM
Khomsa
 ECM 1561

● Tunisian Anouar Brahem is a master of the oud, a North African relative - and very possibly ancestor - of the lute. Like fellow oud virtuoso Rabih Abou Khalil, with whom it's impossible not to draw comparisons, Brahem has taken his musical skills and culture into a multi-cultural environment. With its heavy leanings on jazz and non-jazz improvising, it's a hybrid artform which genuinely deserves inclusion in the meta-world music which trumpeter, composer and music theorist Jon Hassell has termed "Fourth World".

On last year's Madar he was joined by Norwegian tenor and soprano saxophonist and fellow musical border transgressor Jan Garbarek, to magical effect: that album featured some of Garbarek's finest and most unfettered playing for some time - a session which perhaps paved the way for Garbarek's further highly successful transgressions with Early Music specialists the Hilliard Ensemble.

On Khomsa Brahem is joined by a group of musicians with whom he's worked in varying combinations over the years: accordionist Richard Galliano, pianist and synthesiser player Francois Couturier, soprano saxophonist Jean Marc Larche and violinist Bechir Selmi. This group is in turn augmented with two further ECM mainstays, and one of the most accomplished yet underrated rhythm sections working in contemporary jazz: double bassist Palle Danielsson and drummer Jon Chistensen.

Together this septet work their way through a set of Brahem originals which have previously seem the light of day in the oud player's scores for the films of Tunisian director Nouri Bouzid. They do so in a vivacious and genre-gobbling spirit which takes in traditional North African melodies (naturally), Parisian street music and free jazz, and much more besides, matching their easy

virtuosity to a music of great charm and yet great mystery. Intoxicating stuff.

**PAUL BLEY/EVAN
 PARKER/BARRE PHILLIPS**
Time Will Tell
 ECM1537

● And wrapping up what I reckon is the most satisfying set of new releases ECM has produced in a good while is a trio session featuring, quite simply, three of the greatest names working in jazz today.

American pianist Paul Bley has been a regular in this column, one way or another. A leading pianist in contemporary jazz for over three decades, he emerged in the early sixties as very much a post-Bill Evans piano player, whose gentle lyricism was tinged with the threat of more violent musical tendencies. In the subsequent years he has developed both of these musical sides in tandem and his records as both a sideman and leader reveal an improviser equally at home in free jazz and post-bop jazz and one who combines an easy grace with a splendid furor.

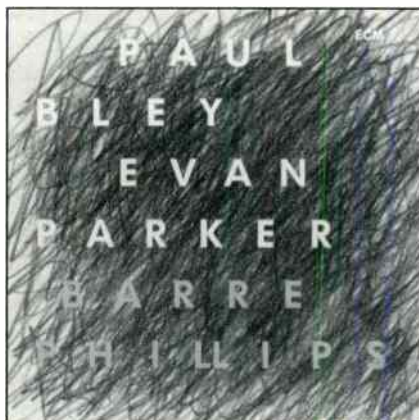

Barre Phillips is without doubt one of the finest bassists working in contemporary jazz. An alumnus of groups as famous and as diverse as those of Coleman Hawkins, Ornette Coleman, Jimmy Giuffre, John Surman and George Russell, like Bley he straddles the lyrical and the experimental with great musical confidence.

British soprano saxophonist Evan Parker should need no introduction, of course. There can be little doubt that Parker is one of the greatest jazz musicians this country has ever produced and one of the most virtuosic players the music has ever seen. Although he's been a regular in just about every style of music that European jazz has touched over the last decade and a half, he's best known for

work in two areas: for his involvement with the most extreme European free jazz, a music which in the late sixties married political idealism to artistic imperative and ostensibly severed all links with jazz history, producing a non-idiomatic, entirely spontaneous sound which at once galvanized a small community of the most adventurous musicians and listeners and alienated just about every bugger else; and for his increasingly huge body of solo work, in which he has developed his virtuosic (he's renowned for his circular breathing techniques which allow him to play continuously and for overtone playing which let him play polyphonically), chromatic, stream-of-consciousness soloing into one of the most consistent and adventurous voices in jazz today.

Remarkably, Bley and Parker have never played together, although both have played with Phillips in numerous and varying groups. But you'd never guess it from the results. Time Will Tell sees the trio work through eleven free improvisations which are the flip-side from the music that Parker has so often made with European noisemakers like Peter Brotzmann and Han Bennink and Albert Mangelsdorff and on and on. This music is equally spontaneous, equally searching, but has such a great debt to late-Romantic (and particularly late Romantic French) music that it never loses its grip on lyrical melody. Instead the group slip and slide their way through and endlessly shifting - and hugely restless - musical world in which consonant melodies momentarily, fleetingly appear and then, just as suddenly, and entirely unresolved, disappear.

Ultimately, this music, for all its essential quiet thought, is as discomforting and as provocative as anything in any European free jazz. A sublimely questing record.

CASPAR BROTZMANN
MASSAKER
Home

ROUGH TRADE RTD 195.1913.2

● Having mentioned one Brotzmann above, it's only fair to mention this latest offering from German improvising metal guitarist (and, yes, son of free jazz god and saxophonist Peter). Whether a Massaker record belongs here is a moot point, but until this publication, or any other for that matter, starts up a free jazz/death metal/goth improv/guitar murder column, we'll have to stick it here.

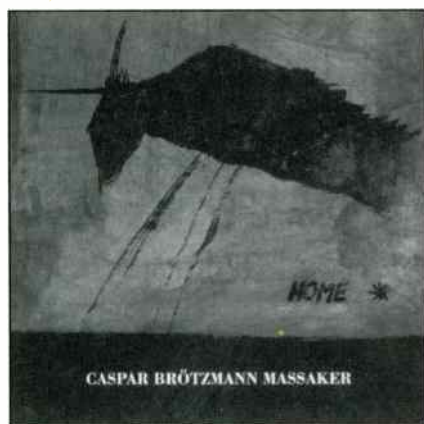

This column has been full of noisy guitarists from Japan and America and Europe and frankly Brotzman sits with the best of them. Some commentators have pointed out that Brotzman has reinvented the electric guitar, turned its conventions inside out, yet it's closer to the truth to say that he has simply taken the clichés of rock guitar - of Hendrix and Blackmore and Black Sabbath and Blue Oyster Cult - and at once taken them to one of their possible extremes and then fed them through his own psychotic free jazz background. The results undoubtedly make him one of the most exciting guitarists on the planet. Check him out.

Simon Cooke

TIM RICHARDS' SPIRIT LEVEL On The Level 33JAZZ021

● The concept of a jazz band described in publicity-parlance as 'modern' and 'eclectic' - both words used to describe Spirit Level in the liner notes - as actually being much cop is not one with which I have much truck, for various reasons. To find my initial doubts about this CD dispelled within the first two or three seconds of track



one came as a welcome surprise.

The CD simply romps out of the 'speakers and across the room with child-like exuberance, but such power doesn't mask ineptitude - pianist Tim Richards plays like a hammering metronome, working fluid, tuneful chords around solid rhythmic timing.

Jerry Underwood's tenor sax blows like Ariel (Shakespeare's, not Lever Brothers') through the proceedings, while his soprano has the sweeping cadences of Garbarek's with a more astringent, tendonous tone. Bassist Kubryk Townsend is a revelation of solid rhythm and throbbing chords, keeping the tone in those full-blooded regions where the bass belongs rather than straining upwards into flapping woodiness.

Kenrick Rowe on drums skitters through the proceedings and bounces rhythmic devices with Richards and Townsend with stunning ease. None of the performers are over emphasised, none ignored.

It's ten tracks of cracking rhythmic, melodic, swinging modern jazz. Oh, and the recording? Well, it's 33Records, so it's excellent. What did you expect?



THE CLARK TRACY SEXTET Full Speed Sideways 33JAZZ018

● Similar in type, if not style, to Tim Richards' Spirit Level, with Tracy's drums augmented by Nigel Hitchcock on alto sax, Dave O'Higgins on tenor, Mark Nightingale on trombone, John Donaldson on piano and Arnie Somogyi on bass.

Excellent as all these musicians are, they just don't have the ebullience of Spirit Level, and with three tracks and almost seven minutes less music, this one doesn't quite cut it.

That said, it's still a '33' quality recording of an excellent group, and heartily recommended.

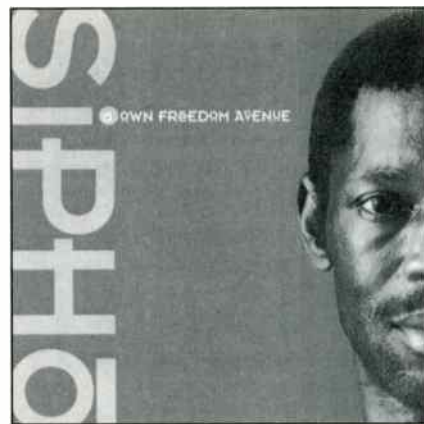

SIPHO GUMEDE Down Freedom Avenue BWR051

● An album of 'South African jazz' from the 'International Jazz' stable of B&W (the 'speaker people') Music and, like many other forms of 'global' jazz, it sounds like a take on the American variety flavoured with local influences. Happily, it's saved from ignominy by the past work of bands like Ladysmith Black Mambazo and the Bhundu Boys, who have managed to raise the profile of South African music in the wake of Paul Simon's 'Graceland' success a decade ago.

Gumede and the musicians on this album - made of real vinyl - have scattered enough SA influences around for the average world music punter to be able to follow them and based it solidly enough in the jazz idiom to produce an impressive jazz album.

Whilst the performances are excellent and the recording quality high, however I found the pressing, although better than many LPs, very noisy. Despite adjustments and checking of the Rega I was using, surface noise remained at distracting levels in the common quieter passages. Anybody more cynical than myself might be tempted to think that B&W are aiming to appear vinyl-friendly while weighting the scales in favour of CD sales. I don't know. I didn't hear the CD, but B&W should have harsh words with their pressing plant before their next vinyl release! Recommended, nonetheless.



Hi-Fi World Dial-a-Dealer

AUDIO EXCELLENCE 'Where the music matters', 65 Park Street Bristol BS1 5PB Tel 0272 264975 Fax 0272 251327. Great Hi-Fi carefully selected and demonstrated by friendly enthusiastic staff. Home installations and check-ups. Two year warranty from our own service department. Open 9.00-5.30 Tuesday - Saturday closed Monday.

PAUL GREEN HI-FI LTD. Kensington Showrooms, London Road, Bath, Tel (0225) 316197. Musical Fidelity, Krell, Creek Rogers, Quad, Cusi, car park. Best selection in the West.

V AUDIO, 36 Oruid Hill, Stoke Bishop, Bristol, BS9 1EJ. Tel 0272 686005. ATC, Acoustic Energy, Ruark, AVI, Exposure, Pink Triangle, Wadia, Audio Innovations, SME (incl 20A), Chord Amps, Michell AMC, Analogue Electronics, Cadence Valve, Jamo, LFD, REL, Sansui, Sonic Link, Stax, Townsend, Audio Technica, Goldring, Ltra, Ortofon Sumiko Demos by apt only home trial facilities, free install, service facilities.

HEREFORDSHIRE

TECHNSOUND LTD, 79 West Street, Ounstable, Beds. Tel 0582 663297 - See our main entry under Bucks.

HEREFORDSHIRE

NEWBURY AUDIO, 2 Weavers Walk, Northbrook Street, Newbury Berks RG13 1A1 Tel 0635 33929 Linn Creek, Epos, Denon, Nakamichi, Shahman, Marantz, Micromega, JPW, Ruark, Single speaker dem room. Apt. necessary. Home trial facilities, free install service dept. late apps Access/Visa interest free credit subject to status. 6 days 9.30am - 6.00pm.

ARC AUDIO, 9 Dukas Ride, Crowthorne, Berks, RG1 16L2. (0344) 762201. Denon, Harman Kardon, JPW, Marantz, Monitor Audio, Onyx, Rogers, Tannoy, Thorens, Yamaha. Demonstration facilities, no appointments necessary, home trial facilities, free installation. Access, Visa, Oiners. Open Mon-Sat 9-6pm (closed Wed at 1pm)

REAOING HI-FI CENTRE, 4 Queen's Walk, Reading RG1 7QF. Tel 0734 585463. "The best equipment, advice and service from Berkshire's premier Hi-Fi emporium". Products include Arcam, exposure, Audiolab, Meridian, Rotel, Sony, sennheiser. Top Tape Centre, and many more.

ASTLEY AUDIO, Wallingford, 0491 839305. See our entry under OXFORDSHIRE

BUCKS

D.L. CANTWEN LIMITED, 59-61 The Broadway, Chesham, Bucks, HP5 1BX (Opposite Boots) Tel: 0494 784441, Phillips, Denon, Kenwood, Canon Audio, Koss, Wharfedale, Mitsubishi, Target, Grundig, QED, Mordaunt-Short, Toshiba, Dolby Pro-logic Systems, Nicam TV and Video, Surround Sound, AV Systems, Showroom. Demonstrations from expert and friendly staff. No appointments necessary. Service Department. Credit facilities available. Open 8.30 to 5.30 Mon-Sat.

AUDIO INSIGHT - 53 Wolverton Rd, Stony Stratford, Milton Keynes, Bucks - 0908 561551 - See our main entry under Technosound.

DEJAC HI-FI CONSULTANTS, 21 The Broadway, Old Amersham, Bucks, HP7 0HL. Tel (0494) 433173. AMC, Arcam, Bose, Meridian, Quad, Denon, NAO, Tannoy, Mission, TDL, 2 dem rooms, Apts necessary, Free installation, Tricity finance, instant credit, open 9.30-5.30 pm, including Saturdays.

NORTHWOOD AUDIO II, 98 Cambridge St, Aylesbury, Bucks HP20 1BA. Tel: 0296 28790 (A/P). Selected sounds from Alchemist, Aura, Boston, B & W, Cabeltack, Castle, Celestion, Denon, Exposure, Gyrodek, Harman Kardon, Heybrook, Marantz, Micromega, Monitor Audio, Moth, NAO, Nakamichi, Rose, Rotel, Royd, Ruark, Systemdek, Tannoy, TDL, Thorens etc ect. Export orders welcome. 2 Dem rooms. Credit facilities available.

TECHNSOUND LTD, 7 Granville Square, Willen, Milton Keynes. MK15 9JL. Tel: 0908 604949. Audiophile Hi-Fi Specialists. All major brands stocked from Arcam to Yamaha. Demonstration facilities and expert advice. Mon-Sat 9.30-5.30 late night Friday. Credit Cards accepted. Finance available.

CAMBRIDGE

CAMBRIDGE HI-FI, 1-3 Hawthorne Way, Chesterton, Cambs. CB4 1AT. Tel 0223 67773. Kenwood, Pioneer, Ariston, Kef, Technics, Yamaha, Marantz, B&W, AR, Mordaunt-Short, Bose, Single speaker dem room. Tues-Sat 9.30-5.30pm. Closed Monday. Free install, service dept. Vis/Access credit facilities.

STEVE BOXSHALL AUDIO, 41 Victoria Road, Cambs. CB4 3BW. Tel: 0223 68305. 10.00-6.00pm 6 days. 3 dem rooms. Denon, Rotel, Yamaha, Mission, Nakamichi, Tannoy, Audiolab, Marantz, Krell, Martin Logan, Magnephanr, Wadia. Home trial facilities. Appointments preferred. Free install, and service dept. Access/Visa.

UNIVERSITY AUDIO, 1-2 Peas Hill, Cambridge. 0223 354237. Mission-Cyrus, Arcam, Rotel, Denon, Meridian, Ruark, ATC, AVI, Quad, Linn, E cems, 1 single speaker, Home trial, free install. Service Dept. VISA, ACCESS, AMEX, Credit Terms. Open 9-5.30

CHESHIRE

SWIFT HI-FI, St. Annes Parade, Wilmslow. 0625 526213. Aura, B&W, Denon, Kenwood, Marantz, Nad, Pioneer, Rotel, Systemdek, Tannoy, Revolver, J.P.W. M. Short, Mission, Celestion, Technics, Audiolab, Castle. Open 9.30-6.0em room. No pressure. BADA member

THE HI-FI SHOWROOMS, 12A West Str, Congleton, Cheshire (0260)280017. 1 Stanley St, Leek(0533)383780. Celestion, Creek, Exposure, Marantz, Musical Fidelity, Pink Triangle, Project, Rotel, Ruark, Systemdek, Tannoy, Technics, 5 Dem Rooms, Noappts nec, Home trial, Free install, Servicedept Access, Visa, Lombard Tricity. Open 9-5.30. Closed Wed

HALE HI-FI, 2 Bold St, Hale Road, Altrincham, Cheshire WA14 2ER. Tel:061 929 0834. Open Mon - Sat 10am-6pm & later by appointment. Specialising in equipment by: Nam, Quad, Royd, Nad, Denon plus selected others. Large range of quality accessories. On site service department. Installation & delivery. Home demonstrations a pleasure

ASTON AUDIO, 4 West Street, Alderley Edge, Cheshire. Tel 0625 582704. Products include: Bang & Olufsen, Arcam, Audiolab B&W, Cyrus, Denon, Epos, Meridian, Micromega, MF Mission, Nakamichi, Quad, Rotel, TDL & other leading brands. Demonstration Rooms, Installation Service, Interest Free Credit. Access, Visa. Open Mon-Sat

CHRIS BROOKS AUDIO, 29 Gaskell Street, Stockton Heath, Warrington, Cheshire WA4 2UN. Tel (0925) 261212. Tues-Sat 10.00-6.00 2 dem rooms credit facilities. All credit cards. Established 1978. Total absence of bulls**t.

DDUG BRADY HI-FI, Kingsway Studios, Kingsway North, Warrington, Cheshire, WA1 3WV (0925) 828009. "Largest choice of specialist hi-fi in NW. All credit cards 3 dem rooms. Fair demonstrations and home trial facilities. Open 6 days.

PRACTICAL HI-FI, 88 Bridge Street, Warrington WA1 2RF. Tel: 0925 632179. See our main entry under Preston, Lancs.

THE AUDIO COUNSEL, 14 Stockport Road, Cheadle, Cheshire Tel (0161) 428 7887 and 12 Shaw Road, Oldham, Manchester OL1 3LQ Tel (0161) 633 2602. Linn, Arcam, Naim, Audio Research, Martin Logan, Yamaha, Creek, Nakamichi, Denon, JPW, Marantz, Royd, Lexion 3 dem rooms, free install. VISA/ACCESS Full multi-room and A.V. installation 10.00 - 5.30pm Mon-Sat, till 8.00 Thursday.

CLEVELAND

GILSON AUDIO LTD, 172 Borough Rd, Middlesbrough, (0642) 248793. Linn, Exposure, Arcam, Mission, Cyrus, Denon, Marantz, Rotel, Pioneer, Audiolab, Tannoy. Demonstration facilities in main shop and one demonstration room. Appointments necessary. Home trial facilities. Free installation on request. Service department. Access, Visa, H.P. 10-5-6 days.

CORNWALL

RJF AUDIO VISUAL, 84 Pendarves Street, Tucking Mill, Camborne, Cornwall TR14 8NJ 0209 710777/612260. Audio Analysis, Audio Innovations, JBL, Teac, TDL, Monitor Audio, Musical Fidelity, NAO, Nakamichi, B&W, SME, Micromega, Pink Triangle, Pro-ject, Perception, Sugden, Harman Kardon, Triangle, Integral, dem/showroom and special home dems. Apts nec, home trial, free install, service dept. All cards Switch and Transax. Open Mon-Sat 9.30-5.30.

COUNTY DURHAM

HI-FI EXCHANGE DARLINGTON, 30a Larchfield Street, Darlington, County Durham. The North's only used Hi-Fi Specialist. Hear our Quad, Naim, Oracle, Neat, Thorens etc. Separate Dem Room. 3 months warranty on all systems. Full range of leading Japanese makes Technics, Sony etc. Tel: 0325 463007

CUMBRIA

MISONS SOUND & VISION, Viaduct House, Victoria Viaduct, Carlisle, CA3 8EZ. Tel (0228) 22620. Bang & Olufsen, B & W, Castle, Sonic Link, Quad, NAO, Yamaha, Sony, Rotel, Demo Suite. No appts nec. Home trial facilities. Free installation. Service Department 9 - 5.30 Mon - Fri, Thurs 9-1, Sat 9 - 5.

PETER TYSON, 6 Abbey Street, Carlisle, Cumbria, CA3 8TX. Cumbria's premiere hi-fi centre'. Part exchange welcome. (0228) 46756. Linn, Musical Fidelity, Cyrus, Marantz, Denon, Philips, Nakamichi, Technics, Pioneer, Creek and more. Dem Rooms. Demos without obligation. Home trial. Free installation. In-house service dept. Access, Visa, HP. 9-5.30pm

PRACTICAL HI-FI, 106 English Street, Carlisle, CA3 8ND. Tel: 0228 44792. See our main entry under Lancaster.

DEVON

THE HI-FI ATTIC, 58 New George St, Plymouth, Devon. PL1 1RR. 0752 669511. We stock most leading brands including Linn, Arcam, Denon, Pioneer, Musical Fidelity amongst others, and have an expert enthusiastic staff. Premises include attractive hi-fi and home cinema demonstration rooms. We offer free installation and credit facilities (written details on request) also a fully equipped service department. We can also provide a mail order service for all your LaserDisc requirements. We accept Visa Access, Amex. **CHRISTIAN**, 138 Walnut Road, Chelston Torquay, Devon TQ2 6HS. Tel: (0803) 606863. Denon, Marantz, Rotel, Musical Fidelity, Acoustic Energy, NAO, Castle, Heybrook, Celestion, JPW etc. Two dem rooms. Home trial. Free installation. Access, Visa, Amex, Oiners. HiFi Markets Chargetcard. Credit facilities. 9.30-7.30 Mon-Fri, 9.30-6.00 Sat.

UPTON ELECTRONICS, 31 Torquay Road, Paignton, Devon. TQ3 3DT. Tel: 0803 551329. Pioneer Reference Point Dealer. Denon, Sony, Technics, Harmon-Kardon, Orlele, Kinshaw, Creek, Quad, Audio-Innovations, Target, Tannoy, Mordaunt-Short, Castle, TDL, Ruark, JPW, Royd, Project, Monitor-Audio, Micromega, Chord, van den Hul, Jamo. Full range of accessories etc. Demonstration room. Home dems, free delivery and installation, own in-house service dept. Access, Visa, Amex. Credit facilities 9.00 - 5.30, 9.00 - 1.00 Wed.

DERBY

STRAD TRADITIONAL AUDIO, 29 Meadowfield, Whaleybridge n Buxton, Derbyshire, SK12 7AX. Tel: 0663 733383. We construct custom made reproductions of classic 1950's loudspeaker enclosure designs using authentic blueprints. These have never been bettered for valve amplification. Requests for specific designs considered and researched. Superb new speaker units from Richard Allan and Lovlier are used.

ACTIVE AUDIO, 12 Osbaston Street, The Spot, Derby Tel: 0332 380385. Fax: 0332 385185. We have three studios including a dedicated Audio Visual studio for the demonstration of quality equipment from the largest range in the Midlands. Open six days per week. Own service department. Free local delivery, home trial facility. Current special offers and buyers fact pack and quotation on request.

DORSET

SUTTONS HI-FI, 18 Westover Road, Bournemouth, Hants, Tel: 02025555*2. Linn, Arcam, Mission, Quad, Audiolab, Rotel, Yamaha, Denon, etc. 2 single speaker listening rooms. Home demonstrations and free installation. Mon-Sat 9.00-5.30. Call for details.

ESSEX

AUDIO T, 442-444 Cranbrook Road, Gants Hill, Ilford. (0181) 518-0095. Great Hi-Fi from Arcam, Audiolab, Cyrus, Denon, Marantz, Meridian, Mission, Micromega, Nakamichi, Rotel, Technics, Yamaha and many more. Mon-Sat 10-6. 3 Year Hi-Fi guarantee. Free delivery & installation. 30 day free upgrades. Home demonstrations. PX. Selected Interest Free Credit. 2 Listening rooms. Home Cinema specialists. BADA Bonded.

BRENTWOOD HI-FIDELITY, 2 Ingrave Road, Brentwood, Essex, CM15 8AT. Tel: 0277 221210. Aura, Audio Innovations, Castle, Chord, Crimson, Denon, ONM, E.A.R., Impulse, Marantz, Mission, Micromega, NAO, Pink Triangle, Project, QUAD, Ruark, Rehdero, Shearue Audio, Systemdek, Tannoy, TDL, Thule Audio. Single speaker dem rooms, home trials dems and installations. Mon-Sat 9.30-5.30. Access, Visa, service facilities. Simply THE place to visit if you're serious about music.

RAYLEIGH HI-FI, Chelmsford, 216 Moulsham St. 0245 265245. **RAYLEIGH HI-FI**, Rayleigh, 44a High Street. 0268 779762. **RAYLEIGH HI-FI**, Southend, 132/4 London Rd. 0702 435255.

Over 21 years experience of supplying the best. "The best dealer, the best Hi-Fi equipment, the best service" Carefully selected Hi-Fi from: Arcam, Audiolab, Cyrus, Denon, Epos, Linn, Meridian, Mission, Naim, Nakamichi, Quad, Rega, Roksan, etc. etc. 3 years guarantee on Hi-Fi systems. 0% credit facilities.

AUDIO T, 442444 Cranbrook Road, Gants Hill, Ilford, Essex, IG2 6LL. (081) 518 0915. Fax (081) 554 8463. Great Hi-Fi from Arcam, Audiolab, B&O, Bose, Cyrus, Denon, KEF, Marantz, Meridian, Mission, Micromega, Nakamichi, Rotel, Sony, Yamaha & many more. Mon-Sat 10-6 3 year guarantee on Hi-Fi. Free delivery & installation. 30 day free upgrade scheme. Home demonstrations. Part exchange. 2 listening rooms. Home Cinema specialists. BADA Bonded.

GLOUCESTERSHIRE

AUDIO EXCELLENCE 'WHERE THE MUSIC MATTERS', 58 Bristol Road, Gloucester, GL1 5SD. Tel: 0452 300046 Fax: 0452 310680. Great Hi-Fi carefully selected and demonstrated by friendly enthusiastic staff. Home installations and check-ups. Two year warranty from our own service department. Open 9.00-5.30 Tuesday - Saturday closed Monday.

AUDIO T, 40-42 Albion Street, Cheltenham, Gloucestershire, GL52 2RQ. (01242) 583960. Great Hi-Fi from Arcam, Audiolab, Aura, Denon, Epos, Linn, Marantz, Meridian,

Mission, Quad, Rotel, Technics, Yamaha & many more. Mon-Fri 10-6. Sat 9.30-5.30. 3 day Hi-Fi guarantee - Free delivery & installation. 30 day free upgrades. Home demonstrations. Part exchange. Selected Interest Free Credit. Listening room. BADA Bonded.

HAMPSHIRE

AUDIO GALLERY, Near Petersfield, Hampshire. Mana, Castle, Alchemist, Albany, Audio Innovations, Wadia, Deltec, Tube Technology, Denon, Pioneer, Alphason, Tripod, Nad, Teac, Audio Alchemy, Klipsch, AMC Proac, JPW, Moth, Pink Triangle. Mail order cabinets supplied to order in any size, wood & hand painted finishes, stone-granite-marble shelving. For a demonstration with home comforts call us for an appointment on 0730 895194.

HOPKINS HI-FI, 'FOR THE BEST SEAT IN THE HOUSE' experience home cinema sound with Technics, Denon and Kenwood. Award winning products. Now on demo at HOPKINS HI-FI, 38-40 Fratton Road, Portsmouth, Hants, PO1 5BX. Tel 0705 822 155. Fax 0705 830 753

HAMPSHIRE AUDIO LTD, 2-12 Hursley Road, Chandlers Ford, Hants SO5 2FU. (0703) 252827/265232. 3 hi-fi and 2 home cinema/surround sound dem studio's. Thurs late evening closed Mondays (except in December). Service dept on site (2 yr guarantee). Large free car park - junctions 4 (M27/M3), 5 (M27) 12 (M3) and 13 (M3) all within 3 miles. est. 1969.

AUDIO T, 4 Feathers Lane, Basingstoke, Hampshire, RG21 1AS. (01256) 24311. Great Hi-Fi from Arcam, Denon, Linn, Meridian, Mission, Naim, Rotel, Technics, Yamaha & many more. Mon-Sat 9.30-5.30. 3 year Hi-Fi guarantee. Free delivery & installation. 30 day free upgrades. Home demonstrations. Part exchange. Listening room. BADA Bonded.

HEREFORDSHIRE

ENGLISH AUDIO, 37 Whitecross Road, Hereford, HR4 0DG. (0432) 355081. Arcam, Castle, Ruark, Rogers, JPW, Micromega, Chord, Audio, Systemdek, Heybrook, Kef, Stax, Pink Triangle, Denon, Marantz, Mission-Cyrus, A.I., Rotel, NAO, Nakamichi, TDL, John Shearue, Yamaha and others. Single speaker dem room, home trial facilities, free installation, service dept. Access/Visa. Credit arranged. Open Mon-Sat, 9.30-5.30pm. BADA members.

HERTFORDSHIRE

DAVID ORTON AUDIO VISUAL, 6-8 Bancroft, Hinchin, Herts. Tel: 0462 - 452248. Mission, Cyrus, Denon, Pioneer, Marantz, Aura, Kenwood, Rotel, Ruark, Celestion, JVC, Polk and many more. Open Mon-Sat 9.30-5.30. All major credit cards accepted. Finance available. (See our main advert pg 106).

DYNAMICS, Welwyn, Herts - Europe's largest stockist of ex-demos and second hand equipment. High End Audio - Bought, Sold or Exchanged. Many items in stock. (see our main ad pg 128). Efficient servicing Dept. All items guaranteed. All major credit cards accepted. Please telephone 0438 - 714038 for appointment.

GOSPEL MUSIC AUDIO, 32a High Street, Kington, Herefordshire, HR5 3BJ (0544) 230254. Alphason, Allison, Revolver, Luxman, Yamaha, QED Audio, Systemline.

STUDIO 82, 82 High Street, Harpenden, Herts AL5 2SP. 0582 764246. Fax 0582 467022. ATC/AVI, Arcam, Aura, Audiolab, B&O, Denon, Epos, Mission, Cyrus, Naim Audio, Nakamichi, QUAD, NAO etc. Quiet single speaker dem room. Apts nec. Home trial, free installation. Service dept. Visa. Access and finance terms. 9-5.30 (Mon-Sat) Closed Weds.

THE AUDIO FILE, 27 Hockerill St., Bishop's Stortford, Herts, CM23 2DH. Tel 0279 506576. Fax 0279 506638. Linn, Naim, Roksan, Quad, Rega, Mission, Arcam, ProAc, Marantz, Sony etc. 4 dem rooms, installation service. Min 3 year warranty, 0%, BADA.

RADLETT AUDIO, 141 Watling Street, Radlett, Herts, W07 7NQ. Tel. 0923 856497. Mark Levinson, Proceed, Proac, Magnepan, Martin Logan, Tube Technology, Teac, Roksan, Audiolab, Stax, Systemdek, Jartis, Copland, ATC, Audio Alchemy, AVI, EAR, Sumiko, Quad, Sonus Faber, Home trial facilities, free installation. Service Dept. Visa/Access 9-5.30 Mon-Fri 10-5.30 Sat.

REVOX Service & Repairs, Suite 10, Smuggoak Business Centre, Lye Lane, Brickwood, Herts. AL2 3UG. Tel 0923 893711. Seventeen years experience, ex-Bauch. Authorised agents for Revox products, sales and spares. All enquiries carried out are guaranteed. Fast turnaround. Any repairs telephone: 0923 893711.

HUMBERSIDE

ZEN AUDIO - George Street, Hull Tel: (0482) 587397 - Evening (0964) 492049. Audiolab, Audio Innovations, Aura, B&W, Cabeltack, A/J, Heybrook, JPW, KAR, Micromega, Michell, Harmon Kardon, Impulse, Ruark, Rotel, Sugden, Comfortable Listening Room. Home Trial facilities, free installations - personal friendly service

Hi-Fi World Dial-a-Dealer

PROGRESSIVE AUDIO, 2 Maryland Court, Rainham, Nr Gillingham, Kent ME8 8QY. Tel. 0634 389004. Agencies include: Audio Innovations, Audion, Audionote, Audiostatic, Audiotecnica, Chord amps, Cogan Hall, Conrad Johnson, Convergent, DALI, Decca, Eminent Technology, Goldring, Impulse, Koetsu, Levinson, L.F.D., Lyr, Lumley Reference, Meridian, Michell, Micromega, Moth, Origin Live, Pink Triangle, Proac, Proceed, Ruark Silversounds, SME, Sugden, Sumiko, Systemdek, Snell, Target, T.D.L., Transfiguration, Townshend, Tube Technology, Voyd, V.P.I. etc. Demonstrations by appointment please.

JOHN MARLEY HI-FI CENTRES, 2 Station Road, West Canterbury, (0227)769329. Also at Dover - 0304 207562. Arcam, Audiolab, Aura, B&W, Heybrook, JPW, Proac, Pioneer, Rotel, Ruark, Tannoy, Technics. Dem rooms and home trial facilities. Mon-Sat 9.30-5.30. Free install. Credit to £1,000. Access. Visa and credit charge Service Dept.

KIMBERLEY HIFI, 193 Broadway, Bexleyheath, Kent. Tel. 081 3043272. Pioneer, Technics, Kenwood, Marantz, Denon, NAD, Aiwa, Tannoy, Mission, Rotel, Wharfedale, Castle. Separate dem room. no appt necessary. free installation, service dept. instant credit facilities. no early closing.

V.J. HIFI, 29 Guildhall Street, Folkestone, Tel. 0303 256860. Mon-Sat 9-6. NAD, Yamaha, Marantz, Sony, Tannoy, Denon, Kenwood, Rogers, Musical Fidelity, Quad, Aiwa, Aura, Heybrook, Castle, Mission, Yamaha, REL, JBL, Polk. Dem rooms in both stores. free install. Credit facilities available. specialists in home theatre. A. Demers, Divers, Visa, Access, Service Dept. We are BADA dealers.

THE WESTGATE HI-FI, 2 Station Road West, Canterbury, Kent. 0227 769329. Suppliers of quality hi-fi equipment including: Arcam, Akai, Aura, B&W, Denon, Jamo, JPW, Mordaunt Short, NAD, Panasonic, ProAc, Quad, Rotel, Ruark, TDL, Technics, Tannoy, Part exchange, Listening room. Service and repairs. Credit facilities. Access/Visa. Open 6 days 9-5.30.

DOVER HI-FI, 43 High Street, Dover. Tel: Dover 207562. Suppliers of quality hi-fi equipment including, Arcam, Akai, Aura, B&W, Denon, Jamo, JPW, Mordaunt Short, NAD, Panasonic, ProAc, Quad, Rotel, RuArc, TDL, Technics, Tannoy. Part exchange. Listening room. Service and repairs. Credit facilities. Access/Visa. Open 6 days 9-5.30.

LANCASHIRE

PRACTICAL HI-FI, 43 Friargate, Preston, Tel:- 0772 883958. The audio visual specialist, expert advice, instant demonstrations, best prices, instant free credit, part exchange welcome. Extended warranty. Stockists of Yamaha, Kenwood, Denon, Sony, Technics, Onkyo, Marantz, Pioneer, Mission, Kef, Jamo, Celestion, B&W. Also stockists of LaserDiscs.

PRACTICAL HI-FI, 84 Penny Street, Lancaster LA1 1XN. Tel:- 0524 39657. See our main entry under Lancaster.

PRACTICAL HI-FI, 39/35 Knowsley Street, Bolton, Lancs. Tel:- 0204 395789. See our main entry under Lancaster.

PRACTICAL HI-FI, 10 Preston New Road, Blackburn BB2 1AW. Tel:- 0254 691104. See our main entry under Lancaster.

PRACTICAL HI-FI, 81 Whigate Drive, Blackpool, FY3 9DA. Tel:- 0253 300599. See our main entry under Lancaster.

LEICESTER

LISTENING ROOM, 6 Hotel Street, Leicester. Tel. 0533 623754. fax 0533 623758. Linn, Audiolab, Arcam, Tannoy, Definition, Denon, Rotel, Nad, Heybrook, TDL etc. Open 10.00-5.30 (Six days.)

LINCOLNSHIRE

BOLTON HI-FI CENTRE, 65a Wide Bargate, John Adams Way, Boston, Lincs PE21 6SG. Tel: 0205 365477. Quad, Nakamichi, Arcam, Marantz, NAD, Castle, Tannoy, Rogers etc. Separate demonstration studio inc. home cinema. Free installation. Access. Visa. Tues-Sat 9-5 pm.

COTTAGE AUDIO, 17 Bridge Street, Saxilby, Nr Lincoln, Linc. NP2. Tel: (0522) 702834. Evenings: (0522) 696708. ATC, AVI, Chord amplifiers, Harbeth, LFD, Michell, Origin Live, Kinshaw, QED, Royd, Sansui, Sequence, Something solid, Sonic Link, etc. Demonstration rooms. Home trial facilities. Free installations and above all a personal, friendly service.

STAMFORD HIFI CENTRE - 9 Red Lion Square, Stamford Lincs. PE9 2AL (0780) 62128. Pioneer, Technics, Cyrus, Mission, Rotel, NAD, Yamaha, Kenwood, Marantz, Quad plus all major speaker manufacturers. Expert Advice, Comparator demonstrations, part-exchange Hifi purchased for cash. No appts necessary. Home trial facility, free installation. Service Dept. Mastercard, Visa and credit charge. Mon-Sat 9-5.30 pm. Closed Thursdays.

ANALOG AUDIO, 849 High Road, Finchly, N12. (081) 445 3267. For friendly service and advice. AR, AKG, Allison, AT, Cerwin, Vega, Denon, Dual, Harmon Kardon, Jamo, Infinity, Marantz, NAD, Pioneer, Rotel, Revolver, Sonab, Teac, Thorens, Tannoy, Wharfedale, Yamaha, Speaker cables and accessories. Free installation service.

AUDIO CONCEPT, 27 Bond Street, Ealing, W5 5AS. Tel: (081) 567 8703. Acoustic Energy, Audiolab, Aura, B&W, B&W, Boston Acoustics, Canon, Castle, Denon, Dual, Evolution, Infinity, JPW, KEF, Marantz, Mission, Monitor Audio, Musical Fidelity, NAD, Nakamichi, Onix, Quad, Revox, Rogers, Rotel, Systemdek, Target, Teac, Thorens, Van den Hul, Two dem rooms. interest free credit, free local delivery & installation, service department. 'Hi-Fi Specialists without the attitude'

AUDIO T, 190 West End Lane, West Hampstead, (071) 794-7848. Great Hi-Fi from Arcam, Audiolab, Aura, B&W, Denon, Epos, Linn, Marantz, Meridian, Mission, Rotel, Micromega, Nakamichi, Yamaha & many more. Mon-Sat 10-6. 3 Year Hi-Fi guarantee. Free Delivery & Installation. 30 Day Free upgrades. Home Demonstrations. PX Selected Interest Free Credit. 2 Listening Rooms. BADA Bonded.

BABBER ELECTRONICS, 158 Uxbridge Road, West: Ealing, London, W13 8SB. (081) 579 6315. Akai, Aiwa, A&R, Celestion, Dual, Goodmans, Harman Kardon, JBL, JVC, Kenwood, Marantz, Panasonic, Sennheiser, Sony, ES range, Tannoy, Technics, Wharfedale, Yamaha.

THE CARTRIDGE MAN - Front end problems? It doesn't have to cost an arm and a leg to get the best listen to my Koetsu - and - Decca - Eater. Also agents for Croft, Sugden, Thorens, Pentachord Speakers and Notts Analogue. (Plus a cartridge re-tipping service. Tel. 081 688 6565)

GOLF ELECTRONICS, 311 Kentish Town Road, NW5 2TJ. Tel 071 482 2518. Fax 071 284 6381. Authorised dealers for: Sony, Panasonic, Aiwa, Akai, Mitsubishi, Philips, Grundig, Bose. We carry an extensive range of hardware from Walkmans to camcorders, including a wide range of TV and video equipment. Free local delivery & installation on selected items. Open 10-6 Mon-Fri. We regularly have special offers on different products. A visit to GOLF ELECTRONICS could save you £££s.

HIFI & COMPONENTS, 84 Battersea Rise, London, SW11 1EH. (071) 223 1110. Denon, Tannoy, NAD, Rotel, Bose, Dual, QED, Wharfedale, Jamo, Celestion, Kenwood, Ortofon, Infinity, Shure, to name but a few! Established over 29 yrs. Appts necessary. Service Dept 10-6 (closed Weds)

HIFI EXPERIENCE, 227 Tottenham Court Road, London W11 071 580 3535. Arcam, Audiolab, Mission, Cyrus, Quad, Celestion, Kef, Meridian, Rogers, Tannoy, Yamaha, TDL, Thorens, Marantz, Nakamichi, Musical Fidelity and many more. Open 10.00-7.00 Mon-Fri. 9-6 on Sat. Service Dept. Credit facilities. delivery and free installation.

THE HIFI SURPLUS STORE, 62 Weymouth Street, W1 Tel: 071 486 9981/071 935 7582. Stock a full range of goods including: Aiwa, Akai, B&W, Bose, Dual, JVC, Jamo, Kenwood, Marantz, Mordaunt-Short, Mission, NAD, Pioneer, Rotel, Sony, Technics, Teac, Thorens, Tannoy, Wharfedale. Full range of Target speaker stands always on stock. All goods are brand new in sealed cartons with full 1 yr guarantee. We aim to be the cheapest however if you can buy any of our products cheaper, tell us & we'll try to beat it by £10. Access/Visa welcome. Open Mon-Sat 9.30-6pm. Late night till 6.30 Thurs.

KAMLA ELECTRONICS, 251 Tottenham Court Road, London W1P 9AD. Telephone 071 323 2747. Fax. 071 637 2690. Acoustic Research, Aiwa, Akai, Albarny, Alchemist, Alphason, Audio Alchemy, Audio Innovations, Audio Technica, Audioquest, Aura, Audiostatic, B&W, Cerwin Vega, Conrad Johnson, CopenHagen, Furukawa, Goldring, Infinity, IXOS, JPW, JVC, KEF, Kenwood, Kuzma, Lynwood, Maxell, Micromega, Mitsubishi, Monster, Mordaunt Short, Moth, Nakamichi, Oracle, Ortofon, Panasonic, Pioneer, Project, QED, Rotel, Ruark, Sansui, Stax, TDK and many more!!

K J WEST ONE, 26 New Cavendish St, London W1M 7LH. 0171 486 8262/63. Fax 0171 487 3452. Two hi-fi & two home cinema dem studios. Appts pref. Home trial. Installation by arrangement. Service dept. Major credit cards. Interest free credit on selected items. Major brands stocked: Arcam, Audio Alchemy, Audio Innovations, Audion, Aura, Audiolab, Audio Research, B&W, Chord, DPA, Epos, Harman Kardon, Impulse, Krell, Martin Logan, Meridian, Michell, Musical Fidelity, Nakamichi, Nitty Gritty, Orelle, Pink, ProAc, Quad, Rel, Roksan, Sonus Faber, Stax, Tannoy, Theta, Trichord. Open 6 days.

BILLY VEE SOUND SYSTEMS, 248 Lee High Road, London SE13 (081) 318 5755. Arcam, Linn, Naim, Quad, Creek, Cyrus, Marantz, Nad, Rotel, Rega, Denon, Yamaha, Tannoy, Mission, Micromega, Heybrook, etc., 2 dem rooms. instant free credit, Access/Visa, Closed Thursdays.

CONNECTIONS, 13 John Prince's Street, London W1M 9AH. Tel: 081 348 5676. Dealers in: Absolute, Audio Note, Audioquest, Deltec, Harmonix, Kimber, Mandrake, MIT, Siltech, Symo, Van den Hul, WBT and others.

THE LISTENING ROOMS, 161 Old Brompton Road, London SW5 0LJ. (071) 244 7750/59. Fax (071) 370 0192. Linn, Quad, Meridian, Nakamichi, Arcam, Audiolab, Acoustic Energy, SME, Audio Research, Krell, Wadia, Theta, Apogee, Martin Logan, Pioneer, Tannoy, Systemdek, Stax, Pink Triangle, Michell, Monitor Audio, Yamaha, Marantz, Kef, Bose, Celestion, Epos, Mission, Denon, Neat Petite. Mon-Sat 10-6pm.

THE CORNFLAKE SHOP, 37 Windmill Street, London W1. (071) 631 0472 (domestic). (071) 323 4554 (multiroom). Fax (071) 436 7165. Tues-Sat 10-7. Rega, Roksan, Naim, Monitor Audio, Arcam, Nakamichi, Rotel, Epos etc. 3 dem rooms (incl. home cinema). Friendly professional service. Home trial facilities, appts preferred. Full delivery and repair service. Multiroom specialists. Access & Visa.

MUSICAL IMAGES, 173 Station Road, Edgware, Middlesex. Tel (081) 952 5535. See advert under Middlesex for more information.

MUSICAL IMAGES, 45 High Street, Hounslow, Middlesex. Tel (081) 569 5802. See advert under Middlesex for more information.

AUDIO T, 190 West End Lane, West Hampstead, London, NW3 1SQ. (071) 794 7848. Fax (071) 431 3570. Great Hi-Fi from Adcom, Arcam, Audiolab, B&W, Denon, Epos, Marantz, Meridian, Michell, Mission, Philips, Rotel, Proac, Micromega, Nakamichi, Yamaha, & many more. Mon-Sat 10-6. 3 year guarantee on Hi-Fi. Free delivery & installation. 30 day free upgrade scheme. Home demonstrations. Part exchange. 2 listening rooms. BADA Bonded.

ORANGES & LEMONS, 61-63 Webbs Road, Battersea, SW11. Tel - 071 - 924 2040 3665. Juicy fruit from London's newest, freshest Hi-Fi/Home Cinema retailer. Telephone demonstrations, or just pop in. All the usual ie friendly and efficient service, free home installation, credit cards plus... all the very best from: Arcam, Audio Vector, Chord Co, Epos, Meridian, Mission, NAD, NAIM, Roksan, Rotel, Royd, Cable Talk, QUAD... with more to come. The innovative Audio-Visual retailer.

ZEBRA 18-24 Brighton Road, South Croydon. Tel:- 081 - 688 2093. The UK's First and Finest Home Cinema Store. 3 Demonstration Rooms. Laser Disc, CRT and Projection TV Centre. Many brands stocked including Arcam, Audiolab, Meridian, Linn, Kef, Pioneer, Rotel, Yamaha, REL and Panasonic. Mon-Sat 9.30-6.00pm. All major credit cards accepted. Finance available. Evening demonstrations by appointment.

SOUND SENSE, 350 Edware Rd, London W2 1DX. 071 402 2100. Alphason, B&W, Kenwood, Nakamichi, Celestion, Denon, Monitor Audio, Marantz, NVA, Sony ES, Yamaha. Appts preferred. Installations available. Access. Visa. Standard credit facilities. Mon-Sat 9.30-6.30.

GREATER MANCHESTER

THE AUDIO COUNSEL, 12 Shaw Road, Oldham, Manchester OL1 3LJ. Tel (0161) 633 2602 and 14 Stockport Road, Cheshire. Tel (0161) 428 7887. Linn, Arcam, Naim, Audio Research, Martin Logan, Yamaha, Creek, Nakamichi, Denon, JPW, Marantz, Royd.

Lexicon, 3 dem rooms, free install. VISA/ACCESS Full multi-room and A.V. installation 10.00 - 5.30pm Mon-Sat, till 8.00 Thursday.

OFFER HIFI (HOME DEMONSTRATION SPECIALIST)

for a 'Musical' system tailor-made (sonically and visually) to your Home requirements. Arion Acoustics (Valves), Audiomeca, Audio Synthesis, Audio Valve Amplification, Kinshaw, Lieder, Ortofon, Pro-ject, Teac, Triangle, YBA, Orpheus Audio. please tel: 0257 426100 or Fax: 0257 473175 for appointment.

BILL HUTCHINSON HIFI, 50-52 Deansgate, Manchester M3 2FE. (061) 8321600. For the largest selection of HiFi and audio visual equipment in the North West. Specialist A.V. demonstrations of the highest quality. Best prices guaranteed. Minimum 2 year warranty and an optional 5 yr guarantee available. Instant credit and mail order service on offer throughout the UK. Pioneer, Denon, Kenwood, Yamaha, Technics, Marantz, Mission, Tannoy plus many more.

PRACTICAL HI-FI 65 Bridge Street, Manchester M3 3BO. Tel:- 061 839 8869. See our main entry under Lancaster.

MERSEYSIDE

DOUG BRADY HIFI 401, Smithdown Road, Liverpool, L13 3JJ. (051) 733 6859. Fair demonstrations and home trial facilities. All credit cards. Largest choice of specialist hi-fi in N.W. Closed Wednesdays and lunch 1-2.15pm.

MIDDLESEX

HARROW AUDIO, 27 Springfield Rd, Harrow, Middlesex. Tel. 081 863 0938. Open Mon-Sat 9.30-5.30. Most brands available - see our regular advert for full range including Audiolab, Arcam, Audioquest, Apogee, Aura, B&W, Cyrus, Denon, Epos, Krell, Marantz, Mission, Nakamichi, Tannoy, Target, Yamaha etc. AV Specialists including installation. Interest Free Credit - ask for details. The largest range of accessories for miles around. 2 dem rooms. Plus Carriage Free Mail Order.

PURE SOUND/THE AUDIO ROOM, We specialise in high quality valve and solid state amplification, with matching quality speakers and signal source components, and we cover London and the South East. Call us for a personal demonstration of some of the finest equipment around. We offer to many brands to list here but they include Audio Note, Arion Acoustics, Audio Innovations, Lumley, Impulse, Townshend, Pink Triangle, Audiomeca, XL0, Micromega, Frameworks. 0784 458176, 081 893 4485.

AUDIO T, 159A Chase Side, Enfield (0181) 367-3132. Great Hi-Fi from Arcam, Audiolab, Cyrus, Denon, Linn, Marantz, Meridian, Micromega, Mission, Rotel, Yamaha and many more. Mon-Fri 10-6. Sat 9.30-5.30. 3 year Hi-Fi guarantee. Free delivery & installation, 30 day free upgrades. Home demonstrations. PX Selected Interest Free. 2 Listening Rooms. Home Cinema Specialists. BADA Bonded.

MUSICAL IMAGES, 45 High Street, Hounslow, Middlesex. Tel. (081) 569 5802. Fax (081) 569 6353.

TO FIND YOUR AREA Use our COLOUR REFERENCE



To Advertise in this section, please contact Hi-Fi World Sales Dept on:

0171 289 3533

Hi-Fi World Dial-a-Dealer

MUSICAL IMAGES, 173 Station Road, Edgeware, Middlesex. Tel. (081) 952 5535 Fax. (081) 952 5535. Most brands available - see full page advert. Interest free credit, ask for details. Demo rooms. Repairs & Service. Sunday opening - Open all week. A Home Cinema Specialist. Mail order. Part exchange.

AUDIO T, 159a Chase Side, Enfield, Middlesex EN2 8PW. (081) 367 3132. Fax (081) 367 1638. Great Hi-Fi from Adcom, Arcam, Audiolab, Celestion, Denon, Marantz, Meridian, Micromega, Mission, Philips, Rotel, Yamaha, & many more. Mon-Fri 10-6. Sat 9.30-5.30. 3 year guarantee on Hi-Fi. Free delivery & installation. 30 day free upgrade scheme. Home demonstrations. Part exchange. 2 listening rooms. Home Cinema specialists. BADA Bonded.

SHROPSHIRE

BASICALLY SOUND, The Old School, School Road, Bracon Ash, Norwich, Norfolk NR14 8HG. Tel. (0508) 57029. Arcam, Heybrook, Chord Co. Rotel, Sound Style, TDL, Royd, Denon, Naim, Spondor, Sound Organisation, Audio Technica, Creek, Epos etc. 2 comprehensive dem rooms. Home trial facilities, free installations, Visa Access, HP facilities. Tues-Fri 9.30-1.00pm. 2.00-5.30pm. Saturday 9.30-5.30pm.

PROTECT-A-DISC, Unit 4, Elwin Way, Sweetbriar Industrial Estate, Norwich NR3 2BB. Tel. 0603 482193. Producers and suppliers of finest quality card record and CD sleeves with taped edges, poly-lined or unlined, mailers and corksheets etc. Please send SAE for full current price list. Trade enquiries welcomed. Tel. 0603 482193.

NORTHAMPTON

THE AUDIO SHOP, 6 Hill Street, Raunds, Northants. NN9 6NN. Tel: 01933 622325. Rotel, Denon, Marantz, Philips, Kinshaw, Moth, Project, Royd, TDL, JPW, Bose, Wharfedale, Goldring, Ortofon, Chord Co. Van Den Hul, Audioquest, QED, Sound Org., Beyer, Sennheiser, etc. Service dept., Home Demos., Free Installation, Easy Parking, Open 9.30am to 5.30pm (closed Wednesdays).

LISTEN INN, 32 Gvd Street, Northants NN1 1RS. Tel. 0604 37871. Fax 0604 601430. Naim, Linn, Rega, Audiolab, Arcam, Cyrus, Royd, Nakamichi, Mission, Denon, Rotel, Nad, Heybrook, Marantz, Chord Co. etc. etc. Open 10.00-5.30 (Closed Thurs)

THE AUDIO SHOP, Hi-Fi Specialists. Appointed stockists of:- Ariston, Creek, Denon, Dual, Goodmans, JPW, Mordaunt-Short, Rotel, Royd, Tannoy, 6 Hill Street, Raunds, Northamptonshire. Tel. 0933 622325

NOTTINGHAMSHIRE

DEFINITIVE AUDIO, Tel. (0602) 813562. For a carefully considered approach to building a true high fidelity audio system with components derived from the following manufacturers: Audio innovations, Wadia, Micromega, Deltec, E.M.T., Horning, Voyd, Systemdek, SME, Revox, Impulse, Ortofon, Pioneer. Also the remarkable Living Voice Air Partner loud speaker system. Demos by appt. Please phone for further details. Install. free of charge. Mon-Sat 10.00-7pm. Closed Wed a.m.

PETER ELLIS AUDIO, 29 Kirkgate, Newark, Notts NG24 1AD. Tel. 0636 704571. QUAD, Castle, Arcam, QED, Sugden, Tannoy, Thorens, Marantz, Denon, Teac, Demo room, free install. Service dept. Access, Visa, American Express. Mon-Sat 9.5-3.30. Closed Thursdays PM.

CHANNY AUDIO, 18-18a Eldon Street, Tuxford, Nr Newark, Notts. NG22 0LH. Tel. 0777 870372. Pink Triangle, DPA, Rotel/Michi, Micromega, NVA, Alchemis, Michell, Monitor Audio, Lumley, SME, Audion, and much more! Three dem rooms, home trial, free installation, service department. Access & Visa. credit facilities, Mail order, Mon-Sat 9.30-6.00, Sun and evenings home dem by appointment.

NOTTINGHAM HI-FI CENTRE, 120-122 Alfreton Road, Nottingham. Tel:- 0602 786919. Over 25 years experience, superb demo rooms, extensive range, free parking. Mon-Sat 9.5-3.30

OXFORDSHIRE

AUDIO T, 19 Old High Street, Headington, Oxford, OX3 9HS (01865) 659611. Great Hi-Fi from Arcam, Cyrus, Denon, Marantz, Meridian, Mission, Rotel, Sony, Yamaha & many more. Mon-Fri 10-6. Sat 9.30-5.30. 3 year Hi-Fi guarantee. Free delivery & installation. 30 day free upgrades. Home demonstrations. PX. Selected Interest Free. 2 listening rooms. Home Cinema specialists. BADA Bonded.

WESTWOOD & MASON, 46 George Street, Oxford. Tel. 0865 247783. Creek, Marantz, Naim, Arcam, Rotel, Rega, Epos, Tannoy, Mission, Nakamichi, Denon, Aiwa, Quad, Yamaha, Monitor Audio. Open 9.30-5.00pm. Dem room. Closed Thursdays.

ASTLEY AUDIO LTD, 3 Marketplace, Wallingford (3 miles from Berkshire border). 0491 839305. Aura, B&W, Technics, Panasonic, Pioneer, Kenwood, Sony, Yamaha,

Denon, Dual, Marantz, Mission, Tannoy. 1 listening room. Home trial free installation. Service department. Access, Visa, Amex, Diners. Install credit. Tues-Fri 9-5.30, Sat 9-5. Records & CDs stocked.

SHROPSHIRE

AVON HIFI, 12 Barker Street, Shrewsbury, Shropshire, SY1 1QJ. Tel. 0743 355166. Aiwa, Beyer-Dynamic, NAD, Quad, B&W, Mordaunt-Short, Kenwood, Bose, Nakamichi, Onkyo, Teac, Sennheiser. Dem room. Home trial. Free install. Service dept. Access/Visa. £1,000 instant credit. Mon, Tues, Wed, Fri. Sat 9-5.30.

SHROPSHIRE HIFI, St Michael Street, Shrewsbury Shrops SY1 2ES. Tel. 0743 232065. Stockists of Musical Fidelity, Mordaunt Short, Sany, Kenwood, Pioneer, Rotel, Denon, B&W, Proac. Audio Visual. Products available. Open 9.30-5.30pm Mon-Sat.

MID SHROPSHIRE AUDIO, 24 Peveril Bank, Dawley, Telford TF4 2BU (0952) 502097. Pink Triangle, T.D.L., Marantz, Denon, JPW, Ortofon, Project, Yamaha, Ruark, Royd, Michell, Musical Fidelity, Yamaha, Target (Tables, Speaker Stands, best prices) Free Delivery nationwide. Good Discounts with no pfx. Surround sound specialist. Home demonstrations a pleasure. 0% finance.

MIKE MANNING AUDIO, 110 Middle Street, Yeovil, Somerset, BA20 1NE. Tel. (0935) 79361. Fax: (0935) 32923. Mobile (0850) 325965. Naim, Roksan, Pink Triangle, A&R (Arcam) ATC, AVI, NAD, Pioneer, Rotel, Denon, Teac, Dnyx, Mission, Rega, Marantz, Royd, Heybrook etc. Dedicated listening lounge, for relaxed and unpressured demonstrations. Appts not usually nec. but best to phone first. Home trial facilities on request. free installation, service department. Instant credit. Access & Visa etc. 9-5.30. closed Mondays

SOMERSET

MIKE MANNING AUDIO, 110 Middle Street, Yeovil, Somerset, BA20 1NE. Tel. (0935) 79361. Fax: (0935) 32923. Mobile (0850) 325965. Naim, Roksan, Pink Triangle, A&R (Arcam) ATC, AVI, NAD, Pioneer, Rotel, Denon, Teac, Dnyx, Mission, Rega, Marantz, Royd, Heybrook etc. Dedicated listening lounge, for relaxed and unpressured demonstrations. Appts not usually nec. but best to phone first. Home trial facilities on request. free installation, service department. Instant credit. Access & Visa etc. 9-5.30. closed Mondays

STAFFORDSHIRE

ACTIVE AUDIO, 95, Stafford Street, Hanley, Stoke-on-Trent, Staffs. Tel. 0782 214994. Fax: 0782 283346. We have four studios including a dedicated Audio Visual studio for the demonstration of quality equipment from the largest range in the Midlands. Open six days per week. Own service department. Free local delivery, home trial facility. Current special offers and buyers fact pack and quotation service on request.

MUSICAL APPROACH, Unit 7, Woodings Yard, Bailey Street, Stafford, Tel. 0785 55154. Also branch at 37 High Street, Aldridge, nr Walsall. Tel. 0922 57926. Linn, Rega, Arcam, Rotel, Royd, Heybrook, Marantz, Teac, Celestion, Apollo, Target. Mon-Sat 9.30-5.30. Home cinema equipment stocked. 2 single speaker dem rooms. Service dept and free install. Credit facilities. We are now agents for Rega products. Stafford branch only.

ACTIVE AUDIO, 29, Market Street, Tamworth, Staffs. Tel. 0827 53355. Fax. 0827 59513. We have two studios including a dedicated Audio Visual studio for the demonstration of quality equipment from the largest range in the Midlands. Open six days per week. Own service department. Free local delivery, home trial facility. Current special offers and buyers fact pack and quotation service on request.

SUFFOLK

AUDIO IMAGES, 7 All Saints Road, Pakefield, South Lowestoft, Suffolk, NR33 6JL. Tel/fax: 0502 582853. Quad, Triangle, Arcam, Castle, Rotel, Moth, JPW, Sugden, Mission, Project, Denon, Yamaha surround sound. Audio Innovations, plus the amazing ROTHWELL range. Separate dem room, no appts nec. 10-6.30 Tues-Thurs 7pm-Fri. 6pm-Sat.

SIGNALS Martlesham Heath, Ipswich. Tel. (0473) 622665. Display advertisement for brands: Turntables, high end CD drives/DAC's as well as integrated players, valve and solid state amplification, wide range of cables and loudspeakers. Home demonstrations/equipment trial service. Please telephone for directions and to book appointment.

BURY AUDIO, 47 Churchgate Street, Bury St Edmunds, Suffolk, IP33 1RG. Tel. 0284 724337. Arcam, Audio Alchemy, Heybrook, Marantz, Michell, Meridian, Nakamichi, Pink Triangle, Quad, Rotel, Sonus Faber, Stax, Tube Technology. Single speaker dem room. Free install. Credit facilities. Mon-Sat 9.30-6.00, closed Wed. Evening dems by appointment.

EASTERN AUDIO, 41 Bramford Road, Ipswich, Tel. 0473 217 217. Fax 0473 215705. Quad, Arcam, Audiolab, Meridian, Mission, Denon, Rotel, Marantz, NAD, Sony, Rogers, Nakamichi, Systemdek, Technics, Celestion, B&W, Tannoy, Morel, Thorens and Top Tape. Also stock a wide range of accessories, usual credit facilities. A BADA dealer.

SUSSEX

SPAININGS HI-FI, 352-4 Lower Addiscombe Rd., Croydon, Surrey. 081 654 1231/2040. 3 dem rooms and home dem. Free installation/credit. Linn, Naim, Quad, Arcam, Audiolab, Mission, Denon, Tannoy, Marantz, Ruark. Mon-Sat 9-6. Tues 9-8. Closed Wed. Service dept.

PJ HIFI, The HIFI Shop, 3 Bridge Street, Guildford, Surrey GU1 4RY. Tel. (0483) 504801. 9-6 Mon-Sat. Linn, Meridian, Rega, Arcam, Quad, Revox, Musical Fidelity, Rotel, NAD, Nakamichi, Marantz, KEF, Reference etc.

ROGERS HIFI, 13 Bridge Street, Guildford, Surrey, (0483) 61049. Aiwa, Creek, Denon, Dual, JPW, Marantz, Onix, Pioneer, Systemdek, Ruark, Tannoy, Teac. Dem facilities available, no appts necessary, free installation, service dept. Access/Visa. Instant credit upto £1,000 subject to status. Monday-Saturday, 9.30-6pm. Later by appt.

SURBITON PARK RADIO, 48 Surbiton Road, Kingston-upon-Thames, Surrey. (081) 546 5549. QUAD, Castle, Denon, Dual, Kenwood, Mordaunt-Short, JBL, Rotel, Pioneer, QED, B&W and Tannoy Demo facil. Access, Visa and Switch. 9.30-5pm.

SURREY HIFI, 45 High Street, Godstone, Surrey, RH9 8LS (0883) 744755. Specialist HiFi outlet demonstration room and parking available. Quad, Audiolab, TDL, Tube Technology, Rel Acoustics, Nakamichi, Kef, Thorens, Musical Fidelity, Van Den Hul cables, Bose, Sennheiser, Beyer headphones, Marantz, Denon, Michell, Van Den Hul, Musical Fidelity, Tannoy, Target, JPW, Single speaker dem rooms. Free installation service dept. Access/Visa/Mastercard. Open 9-6pm. Closed all day Wednesday.

SUSSEX (EAST)

THE POWERPLANT "Brighton's Leading HiFi Shop" 66 North Street, Brighton, Tel. 0273 775978. Comfortable listening rooms. Knowledgeable and approachable staff. Roksan, Micromega, Exposure, Audiolab, Epos, Rotel, Marantz, Cyrus, Regal, Arcam, Mission and more.

WORTHING AUDIO, 20 Treville Gate, W Sussex, BN11 1VA. Tel. 0903 212133. The friendly shop with the best sound systems in the South. Friendly advice. 3 yr guarantees, easy parking, open Mon-Sat 9-6pm. Late night Wed. Arcam, Exposure, Naim Audio, Marantz, Ruark, Restek, Clear Audio, Audio Technica, Target, Tripod, Sennheiser, AR and many more.

CHURCHERS HI-FI, 154 Montague St, Worthing, Sussex. BN11 3HH. Tel. 0903 821595. All major well know brands of Hi-Fi stocked. Please call for details.

HEATHERDALE AUDIO LTD, 202 Findon Road, Worthing, Sussex. Tel:- 0903 872288 or 0860 660001. eves. Three comfortable demonstration lounges where you can audition: Audiomote, Krell, Audio Research, Klipsch, Martin Logan, Apogee, Sonus Faber, Theta, S.M.E. Copland, Voyd, Magneplanar, E.M.F., Lumley Reference, Creek, Rotel, Heybrook, Clearaudio. Phone for used stock list. *We are the South Coast's Premier Hi-Fi Specialist*

SUSSEX (WEST)

BOWERS & WILKINS Ltd. (est. 1945) 1 Becket Buildings, Little Hampton Road, Worthing. Tel. (0903) 2 64141. Top names in HiFi and audio visual including B&W, Nakamichi, Castle, Denon, Philips, Quad, Technics, Aura, Teac, Sugden, Mission, Thorens and many more. 4 dem rooms (budget-high end) expert friendly advice, service dept., local installations free, one minute from A24 & A27, free local parking, Access/Visa, Instant Credit up to £1,000 subject to status. Open 6 days.

CHICHESTER HIFI, 7 St Pancras, Chichester, W Sussex. PO19 1SJ. Tel. 0243 776402. Linn, Naim, Rega, Creek, Nakamichi, A&R, Denon, Roksa, Epos, JPW, Ruark, Rotel, Quad, Spondor. Evening appts available.

CRAWLEY AUDIO, 1 Silkin, Dalton Close, Broadfield, Crawley, West Sussex. Tel. 01293 531190, Mob: 0860-911640. RCA "Living Voice" Recordings, Alchemist, Burnshire, Manhattan Acoustic, German Physiks, Chord Co, Cable Talk, Systemdek, Gravis Subwoofer, WAD, Apollo, CAD, Ortofon, Fullers Audio, Loricraft (Garrard) SME, Denon cartridges, Polk Audio, Atacama, Magneplanar. Purpose Built Dem Rooms, Home Oems available. Part Exchange, Credit Cards Accepted.

HORSHAM HI-FI, 28 Queensway, Horsham, West Sussex. Tel. 01403 251587 / 0831-418619. Suppliers of quality audio equipment including Mangepanar Loudspeakers, Gravis Active Subwoofer, World Audio Products, London (DECCA), Kiseki, Milltek, Spica, ZYP, Audio Technica, Teac, Path, Premier Products. Comfortable demonstration room, home trial facility. Free installation. Part exchanges welcome. Servicing and repairs. Open 6 days 10am to 7pm.

TYNE & WEAR

BILL HUTCHINSON HIFI, 87a, Castle Street, Newcastle-upon-Tyne. (091) 230 3600. For the largest selection of HiFi and audio visual equipment in the North East. Specialist A.V. demonstrations of the highest quality. Best prices guaranteed. Minimum 2 year warranty and an optional 5 yr guarantee available. Instant credit and mail order service on offer throughout the U.K. Pioneer, Denon, Kenwood, Yamaha, Technics, Marantz, Mission, Tannoy plus many more.

WARWICKSHIRE

STRATFORD HIFI, 25 Henley Street, Stratford-upon-Avon, CV3 0W. Tel. 0789 414533. Pioneer, Technics, Denon, Marantz, NAD, Rotel, Musical Fidelity, Monitor Audio, Mission, Tannoy, Quad, TDL, Sennheiser. 0% finance is available on selected products and all major credit cards accepted. Dem Rooms. Service facilities. open 9.30-5.30pm. Late night Thursday until 8.00pm.

WEST MIDLANDS

FRANK HARVEY HI-FI EXCELLENCE, 163, Spon Street, Coventry, CV1 3BB. Tel. 0203 525200. The Midlands first choice for specialist Hi-Fi. Audiolab, Audio Alchemy, Arcam, Audio Quest, Alphonso, Bose, Bang & Olufsen, Celestion, Cyrus, Denon, Dual, Foundation, Kef, Reference, Marantz, Monitor, Audio Mission, Musical Fidelity, Nakamichi, Nad, Rega, Rogers, Rotel, Quad, Systemdek, Target, Tripod, Tannoy, Thorens, Van den Hul, Yamaha, 3 floors, 3 demonstration rooms. Open 9.30 till 5.30. Closed Thursdays. All credit cards incl. Amex & Diners. Instant credit and interest free facilities. Home trials. Free installation, home cinema AV floor. We are a BADA dealer.

MIDLAND VALVE HIFI, Specialising in true fidelity systems built around valve amplification:- Audion 3008 Silver Nights, Audio Innovations Impulse, Audio Note, KAL, Townsend Audio, Ortofon, Voyd, Micromega, Edison, Stax, Apollo, Dynavector, Seismic Sink, Valves. Home demonstrations and part exchange. Also vintage: Leak, Quad, Croft, Radford, etc. Flexible opening 7 days. phone Gary 021 722 2317.

MUSIC MATTERS, 351 Hagley Road, Edgbaston, Birmingham, B17 8DL. Tel. 021 429 2811. Roksan, Nakamichi, Arcam, Audiolab, Kenwood, DPA, Tannoy, Royd, Heybrook, Michell, Panasonic, Aura, Celestion, Musical Fidelity, Mission/Cyrus, Meridian, Kef, Monitor Audio, Pink Triangle, Ruark, Epos, Exposure, Pioneer and many, many more! 2 single speaker dem rooms. Appts necessary. Home trial facilities and free install. Service dept. Access/Visa/instant credit upto £1,000. Interest free credit available also Tues-Thurs 10.30-6pm, Friday 10.30-8.00pm, Saturday 10.00-5.30pm. Check out the new branch in Solihul - Phil works there so it can't be bad! 021 742 0254.

COVENTRY HI-FI, 126 Church Lane (off Walsgrave Road), Coventry CV2 4AJ. Tel: 0203 440529. Quad sales & service agent, Pioneer Reference Point, Kenwood, Aiwa, T.D.L. B&W, Tannoy etc. Private listening room. 2 year guarantee on all new hi-fi. Open 9.30-5.30 Mon-Sat Closed Thursdays.

ELECTRO CENTRE, 244 Soho Road, Handsworth, Birmingham, Tel. 021 554 1878. Full range of HiFi, Pioneer, Technics, Kenwood, JVC, Sony, Aiwa, Akai, "Guaranteed the lowest price in the UK". 24 hour mail order facility available.

ELMDON AUDIO, Tel. 021 784 8765. Reference Imports Lumley, Alon etc. Esoteric Audio Research 834 integrated on demonstration. Home demonstration can be arranged. Top part exchange prices, lots of used bargains. Quad, Leak, etc. Valves and valve testers, new GEC KT66s available.

FIVEWAYS HI-FIDELITY LTD. 12 Islington Row, Edgbaston, Birmingham, B15 1LD. 021 4550667. Arcam, ATC, Audioquest, Audio Technica, AVI, Beyer, Cable Talk, Castle, Chord, CRD (Valve), Denon, Dual, Klipsch, Michell, Nakamichi, Ortofon, QED, Quad, Revox, Sennheiser, Sequence Design, SME, Spondor, Target, TDK, TDL, Thorens, Trilogy (Valve) etc. Keith Monks Record Cleaning Machine. Closed Mondays.

MUSICAL APPROACH, 37 High Street, Aldridge, nr Walsall. Tel. 0922 57926. Linn, Arcam, Rotel, Royd, Heybrook, Marantz, Teac, Celestion, Apollo, Target, and others. Mon-Sat 9.30 - 5.30. Closed Thursdays. Home Cinema equipment stocked. Dem rooms, service dept. Free installation and credit facilities. Free parking at rear of shop.

SOUND ACADEMY, The ultimate experience for those seeking HiFi. Ac. En., Arcam, Audiolab, AudioQuest, B&W, Bose, Chord, Cyrus, Cable talk, DPA, Epos, Kef, Ref, Marantz, Meridian, Mission, Mus. Fid, Nakamichi, Ortofon, Project, Quad, Roksan, Tube Tech, Rotel, Micromega, KAR, Kenwood, Lexicon, Cannon, Celestion, Beyer & more. 3 Single speaker dem. room on two floors incl. A.V Cinema. Open 6 days a week. Mon-Sat. All major credit cards taken. Part exchange, enquiries welcome. Just off the high street, Blaxhich, Walsall, W. Midlands. Tel. 0922 493499. (ample free parking)

Hi-Fi World Dial-a-Dealer

AMADEUS SOUND & VISION, 10 Boldmere Road, Sutton Coldfield, West Midlands, Tel. 021 354 2311. Audio Innovations, B&O, Castle, QED, Wharfedale. Single speaker demo, appts preferred, service available. Installations, B&O link install, home trials, Access/Visa, interest free credit available subject to status 9.30-6.00pm 6 days.

GRIFFIN AUDIO, 34 Bristol St., Birmingham, Tel. 021 622 2230/021 692 1359 Tues-Sat 10 a.m.-6 p.m. Enjoy music at home with a system from Griffin Audio. We demonstrate and install the very best hi-fi, with systems from £500 to £25,000. Ask for Bob, Tim or Alex. Linn, Naim, Shahinian, Quad, Arcam, Rega, Denon, Marantz, Rotel.

WILTSHIRE

THE AUDIO EXCHANGE, 52 Morse Street, Swindon, Wiltshire SN1 5QP, (0793) 539008. Acoustic Energy Audio Innovations, Beard, Cerwin Vega, C.R. Developments, Impulse, Magnum, Micromega, Michell, REL, Sequence. AV and single speaker demo room. Home trial facilities, free installation, service dept. Mon-Sat 10-6

AUDIO T, 60 Fleet Street, Swindon, Wiltshire, SN1 1RA (01793) 538222. Great Hi-Fi from Arcam, Denon, Linn, Marantz, Meridian, Mission, Naim, Rotel, Technics Yamaha & many more. Mon-Sat 9.30-5.30. 3 year Hi-Fi guarantee. Free delivery & installation. 30 day free upgrades. Home demonstrations. Part exchange, 2 listening rooms. Home Cinema specialists. BADA Bonded.

P.R. SOUNDS 58 Castle Street, Trowbridge, Wilts BA14 8AU Tel: 0225 777799. Authorised dealer for Pioneer Technics, Marantz, Kenwood, Mission, Jamo and many more. Cinema Sound Specialists with Listening Room. "For all that's best in Hi-Fi at a Price you can afford" Open Mon-Sat 9-6 Credit Cards accepted. Finance available.

WORCESTERSHIRE

LYNDEN AUDIO, 0527-873766. Exclusive Midlands Audio Synthesis Dealer, Audio Physic, Adyton, Essex Audio, LFD, Sequence Design Wall Speakers, Harman Kardon, JBL, REL, etc. Specialist Engineering Dept. offers Custom Design and Up-grades, all Kits etc. built to Customers requirements. Open Tues.-Sat. 10am-5pm. Evenings by appointment.

SPAINS HI-FI, 2 +2a New Rd., Bromsgrove, Worcs Tel: 0527 872460. Aura, B&W, Beyer, Denon, Heco, JVC Kenwood, Marantz, Mission, Monitor Audio, NAD Nakamichi, Pioneer, Rotel, Sennheiser, Soundstyle, Sony, Systemdeck, Tannoy, Target, Thorens. Integral demo room/showroom for instant comparisons on Hi-Fi & AV equipment. Free installation. Part exchange welcome. Service department, Access, Visa, 0% finance on selected products. Mon-Sat 9.00-5.30 pm. Closed Thursdays

COLORAMA HI-FI, 27 Kingfisher Walk, Kingfisher Centre, Redditch, Worcs B97 4EY (0527) 597260. Aura, NAD, Onkyo, Kenwood, Denon, TDL, Polk Audio, B&W, Tannoy. Full Pro-logic products. In-store integrated dem facilities. No appts required, service dept. Access, Visa. Open 9-5.30, closed Thursdays.

WEST MIDLANDS

WEST MIDLANDS AUDIO, 158 Ombersley Road, Worcester WR3 7HA Tel 0905 458046 Fax 0905 457585. Naim, Rega, Rotel, Marantz, Nakamichi, NAD, Audioblab, Roksan, Meridian, B&W, Audio Research, Krell, Martin Logan, Arcam. 9-5.30 Mon-Sat, eve's by appt only. Free

YORKSHIRE (SOUTH)

HIFI STUDIO'S, Sunnyfields, Doncaster, Tel 0302 781387 TDL, Sugden, ProAc, Ruark, Teac, Impulse, Systemdek, Alphason, Target, Albarray, Heybrook, Monitor Audio, JPW, Totem, Harbeth, Keswick Audio Research, Michell Engineering, AMC (CD and Valves), GR Developments (Valves), Art Audio (Valves), Rel Acoustics, Projekt, Origin Live, Dual, Yamaha plus home Cinema pro-logic dems. Listening room demo's. Home trial, free install, licensed credit broker. 2 yr guarantee on all equipment, service available. Access/Visa. 10-8pm 6 days. phone for further information and free fact pack.

TRC HIFI, 3 Kings Cross Street, Halifax, HX1 (0422) 366832. Agents for Kenwood, Denon, Castle, Rotel. Demonstrations and advice a pleasure. Call at any time to audition some of the best HiFi and pro-logic systems. Delivering and installation free within 20 miles. "The family firm where the customer matters most."

YORKSHIRE (NORTH)

AUDIO CLINIC, 22 Lord Mayors Walk, Yorks, YO3 7HA Tel. (0904) 646309. Revox-Qed-Audio Innovation-Allison-Celestion-Yamaha-Teac-Revolver-JPW-Kenwood-Bose-Thorens-Mission-Snell-B&W-Heco-Cannon-NAD-

JVC-Musical Fidelity-Wharfedale-Micromega-Ruark-Heybrook Surround sound and demo rooms. free installation. Service Dept. Credit facilities on request Access, Visa. Open 10am - 5pm 6 days a week.

THE SOUND ORGANISATION (YORK) 2b Gillygate, York, YO3 Tel. (0904)627108. Linn Meridian Micromega, Naim, Rega, Arcam, Creek, Nakamichi Mission, Denon, Epos, Royd, Rotel. 3 single speaker dem rooms. appts. preferred, home trial facilities, free install, service dept. Credit facilities on request. Access/Visa. 10.00am-5.30pm Tues-Sat Sony dealer award nominated '86, '87 and '88

VICKERS HIFI, 24 Gillygate, York. (0904) 629659. Audio Innovations, A. E. Audioblab, Beyer, Harmon Kardon, JBL, Kef, Kenwood, Marantz, Michell, Mission, Monitor Audio, Mordant Short Pickering, Pink Triangle Pioneer, Quad Rogers, Systemdek Tannoy Technics, Heybrook TDL, Thorens, Dual and lots more. Dem Rooms 4 (3 by appointment) Superb showrooms. 2 yr guarantee on all hifi products. Appts. as above. Home trial facilities, free install, service dept. Qualified and experienced staff, over 25 yrs experience. 12 mths interest free credit. 10.30-5.30 Mon-Sat

YORKSHIRE (WEST)

BILL HUTCHINSON HIFI, 26-28 Woodhouse Lane, Leeds (0532) 427777. For the largest selection of HiFi and audio visual equipment in the Yorkshire. Specialist A.V. demonstrations of the highest quality. Best prices guaranteed. Minimum 2 year warranty and an optional 5 yr guarantee available. Instant credit and mail order service on offer throughout the U.K. Pioneer, Denon, Kenwood, Yamaha, Technics, Marantz, Mission, Tannoy plus many more

DOUG BRADY HIFI, The Forge Cottage, 19 Cross Gate Oley, West Yorks, LS21 1AA Tel. (0343) 467689. Naim, Arcam, Rotel, Pink Triangle, Meridian, Epos, Castleleg, Two dem rooms, fair demonstrations and home trial facilities. Access/Visa. Open 10.00-6pm Tues-Sat.

Huddersfield Hi-Fi Centre, 4 Cross Church St, Huddersfield, (0484) 544668. B&W, Cyrus, Kenwood, Denon, Rotel, Arcam, Musical Fidelity, Quad, Audio Lab, Marantz, Mission ect. Dem facilities - appointment reqd. Mon-Sat 9-5.30, Thurs 9-8. Closed Wed. Free installation credit facilities. Access Visa

AUDIO PROJECTS, 45 Headingley Lane, Leeds. Tel: 0532 304565. A&R, Audioblab, Creek, Heybrook, Linn, Musical Fidelity, Naim, Quad, Rega, etc. Free installation home trial, 2 year warranty, appts preferred. Tues-Fri 9.30-6 Sat 2.30 - 5.30

ASTON AUDIO, 19 Crossgate, Oley, Leeds LS21 1AA 0943 467689. Products: Naim, Arcam, Audioblab, Cyrus, Denon, Epos, Meridian, Micromega, MF Mission, Nakamichi, Quad, Rotel, TDL & other leading brands. Demonstration Rooms, Installation Service, Interest Free Credit, Access, Visa, Open Tues - Sat.

SCOTLAND

EDINBURGH

BILL HUTCHINSON HIFI, 43 South Clark Street, Edinburgh, (031) 667 2877. For the largest selection of HiFi and audio visual equipment in Lothian Specialist A.V. demonstrations of the highest quality. Best prices guaranteed. Minimum 2 year warranty and an optional 5 yr guarantee available. Instant credit and mail order service on offer throughout the U.K. Pioneer, Denon, Kenwood, Yamaha, Technics, Marantz, Mission, Tannoy plus many more.

MUSIC MILL - 72 Newhaven Road, Edinburgh EH6 5QG. Tel: 031 555 3963. Stockists of Micromega Proac Audio Innovations, Lumley Reference, Tube Technology, DNM, B&W, Systemdek, Nottingham Analogue, Nakamichi, Rehdeko, Dali, Crimson, Harmon Kardon, Goldring, Mon-Sat 10-4.30 pm by appt. Closed Wednesdays. All Major Credit Cards Accepted. Contact Fraser or Mark

ABERDEEN

HOLBURN HI-FI, 441 Holburn Street, Aberdeen Tel: 0224 585713. Arcam, Audioblab, B&W, Celestion, Denon, Dual, Epos, Heybrook, ION, Kenwood, Creek, Marantz, Meridian Mission, Cyrus, M.S., NAD, Nakamichi, Pioneer, QED, Quad, Revox, Rotel, Ruark, Tannoy, Technics, Wharfedale, Yamaha. 9.30-5.30 Mon-Sat.

HI-FI EXCELLENCE, Hi-Fi innovators & product designers with 15 years experience. Very much in the business for the music. Musical Fidelity key dealer. Largest Rotel retailer in the area. Particularly keen to make the buying of Hi-Fi a fun experience. Situated in the West End away from the bustle of the City Centre - the perfect environment to enjoy quality Hi-Fi. Full time service engineer. Open Mon-Tues 10-6, Wed 10-1, Thurs 10-7, Sat 10-5 or later by appointment. Hi-Fi Excellence, 293 Union Grove, Aberdeen. Tel: 0224 322520

AUDIO SUITE 42 St Andrews Street, Aberdeen. Tel: 0224 625635 Single Room Demonstrations available. Full Service Department. Free Delivery and Installation anywhere in Scotland. Authorised dealer for Linn, Chord Proac, Mordant Short, Audio Research, Sonus Faber. All Major credit cards accepted.

AYRSHIRE

LASER AUDIO, Now at new premises: 1 St Marnock Place, Kilmarnock KA1 1DT. Tel: 0563 40292. Audioblab, Aiwa, Celestion, Cyrus, Denon, Dual, Marantz, Mission, Philips, Pioneer, Systemdek and Tannoy 2 demonstration rooms. AV dem room. Appointments preferred. Home trial facilities. Free installation, service facilities. Access, Visa and written credit. Open Tues-Fri 10-5.30 Sat 9.30-5.30.

THE SOUND FOUNDATION, 22 Nelson St., Kilmarnock, Ayrshire KA1 1BA 01563 74185 Agents for Sugden, Pink Triangle, Micromega, Audio Innovations, Harman Kardon, Castle, Revolver, Michell. Single speaker dem room. Home dems & delivery installation service available. Full credit facilities available. For more info, phone Kevin. Be Different Pay Us a Visit

GLASGOW

HI-FI MATTERS, 272 Vincent Street, Glasgow G25RL. Call Garry or Ewan on 0141 226 2400 for unbiased advice based on over 25 years experience in tailoring systems to individuals needs. Agencies include: Audio Innovations, Arcam, Shearane, Roksan, JPW, Aura, Heybrook, Michell, REL, Systemdek, Impulse, Moriarty & Rogers. Open 10-6 six days a week

STEREO STEREO, 278 St Vincent Street, Glasgow Scotland Tel 041 248 4079. Closed Tuesday. Installations throughout Scotland. Credit facilities available

BILL HUTCHINSON HIFI, 43 Hope Street, Glasgow (041) 248 2857. For the largest selection of HiFi and audio visual equipment in South West Scotland Specialist A.V. demonstrations of the highest quality. Best prices guaranteed. Minimum 2 year warranty and an optional 5 year guarantee available. Instant credit and mail order service on offer throughout the U.K. Pioneer, Denon, Kenwood, Yamaha, Technics, Marantz, Mission, Tannoy plus many more

INVERNESS

THE MUSIC STATION, 49 Church Street, Inverness, IV 1DR Tel: 0463 225523. Beyer Dynamic, Celestion, Denon, Jamo, Kef, Kenwood, Mission, Pioneer, Rotel, Sony. Listening room, service department, free local delivery, part exchange, full range of credit facilities.

TAYSIDE

J.S. BROWN, 28-36 Castle Street, Dundee DD1 9NZ. Tel: (0382) 26591. Rotel, Denon, Pioneer, Technics, Aiwa, Mission, Castle, Morant-Short, Monitor Audio, Bose, Infinity. All equipment ready for demonstration. No appt nec, free installation, service dept. Open 9.30-6pm six days a week, (close 5pm Sat)

IRELAND

DUBLIN

CLONEY AUDIO, 55 Main Street, Blackrock, Co Dublin, Tel 2889449/2888477 Fax 2834887 Products include Arcam, Classe, Philips, Rogers, Epos, B&W, Naim Audio, Meridian and others. Open Tues/Sat 10am-6pm Thurs/Fri till 9pm Closed Mondays

PETER DAND & CO LTD, 111 Clonskeagh Road, Dublin 6. Tel. 0103531 2694433. Products include: B&O, Quad, Kef, Thorens, TEAC & many more! 2 demonstration rooms and 2 year guarantee.

BELFAST

LYRIC HIFI, 163 Stanmilns Road, Belfast (0232) 381296. Linn, Naim, Rega, Arcam, Denon, Rotel and more. Mon-Sat, 10.00-6.00pm. Late night Thurs.

ZEUS AUDIO, 6 Hope Street, Belfast, (0232) 332522. Audio Innovations, Pink Triangle, Roksan, Marantz, Celestion, Meridian and more. Mon-Sat 10.00-5.30pm Late night Thursday

COUNTY DOWN

ASTON AUDIO, Unit 8, Kings Road Shopping Centre, Kings Road, Belfast (0232) 402220. Akai, Technics, JVC, Samsung, Toshiba, Panasonic and many more. Demos Open Mon-Fri 10-8pm Sat 10-5pm

LONDONDERY

ZEUS AUDIO, 23a Kingsgate Street, Colrairie, BT52 4LB. Tel (0265) 56634. Marantz, Mission, Cyrus, Aiwa, Akai, Alphason, Sony, Pink Triangle, Celestion, Rotel. Mon-Sat 10-5.30pm. Closed Thurs

WALES

ACTION STATE AUDIO, 4 Ruabon Road, Wrexham, North Wales, Tel 0978 364 500. Audio Visual Specialists. Aiwa, Arcam, AMC, Bose, B&W, Beard, Canon, Celestion, Castle, Cyrus, Jamo, Marantz, Michell, Mission, Mordant Short, Musical Fidelity, NAD, Nakamichi, Micromega, QUAD, Radford, Rotel, Rogers, Rega, Ruark, Spondor, Tannoy, Thorens, Wharfedale, UKD, Yamaha DSP Club Member, Demo Room, installation service, Easy Parking and Motorway access. All major credit cards accepted. 9.30 - 5.30 daily. Closed Weds pm

ELECTRO TRADER, 19 Colwyn Crescent, Rhos on Sea, Colwyn Bay, Chwyd, Wales, LL28 4RN (0492) 548932. NOW APPOINTED SUGDEN DEALER FOR THE NORTH WEST Rotel Yamaha NAD Harman Kardon Teac, Alphason Heco Infinity, Kef, JBL, Sugden Tannoy, Rotel, Michell, Heybrook, Acoustic Research, RUARC and Soundstyle tri-pod racks etc. Dem room appts. preferred. Home trial. Free install. Access, Visa, Open 9.30 - 1.00, 2.00 - 5.30 Mon-Sat

AUDIO EXCELLENCE 'WHERE THE MUSIC MATTERS', 134-6 Cruys Road, Cardiff CF2 4NR. Tel 0222 228565 Fax 0222398201. Great Hi Fi carefully selected and demonstrated by friendly enthusiastic staff. Home installations and check-ups. Two year warranty from our own service department. Open 9.00-5.30 Tuesday - Saturday closed Monday.

AUDIO EXCELLENCE 'WHERE THE MUSIC MATTERS', 9 High Street, Swansea, SA1 1LE. Tel 0792 474608 Fax 0792 645087. Great Hi Fi carefully selected and demonstrated by friendly enthusiastic staff. Home installations and check-ups. Two year warranty from our own service department. Open 9.00-5.30 Tuesday - Saturday closed Monday.

I&H GRIFFITHS & SONS, 313 High Street, Bangor LL57 1YA. 0248 370655. Audio Visual Specialists in Dolby Prologic systems, Yamaha, Tannoy, Teac, Sony B&W, Wharfedale, Rotel, JVC, Home trial facilities, free installation, service dept. After hours dems by appointment. Access, Visa. Lombard credit charge. Mon-Sat 9.30-5.30 Wed 9-1.

TOP TAPE, 1 Crystal Way, Elm Grove Road, Harrow, Middlesex HA1 2RJ. Tel 081 427 1404. The UK's oldest and largest Tape Mail Order Service. TDK, Maxell, Sony, Ampex audio cassettes plus Fuji JVC, Konica, Memorex, Scotch & TDK video tapes. Send for complete list of latest prices and offers including Video 8, VHS-C, S-VHS, DAT, MiniDisc and Open Reel and tape accessories including Allsop Local Dealer Listing available. Telephone orders on 081 427 1404 Mastercard, Visa & Switch accepted

TO ADVERTISE IN THIS SECTION PLEASE CALL THE HI-FI WORLD SALES DEPARTMENT ON 0171 289 3533

Peter Herring

Any resemblance between these pages and 'Songs of Praise' is entirely coincidental! It is simply that some rather fine recordings of sacred music have come my way of late, hence the appearance of Moses, Daniel and Belshazzar, choral masterpieces of the eighteenth and twentieth centuries, and a medieval liturgical drama. To restore the balance though, there's an iconoclast among the pianists, Glenn Gould.



JOHANN SEBASTIAN BACH Mass in B minor BWV232

Catherine Dubosc, Catherine Denley, sopranos; James Bowman, counter-tenor; John Mark Ainsley, tenor; Michael George, bass; The Sixteen; Orchestra of The Sixteen; conductor, Harry Christophers.

**COLLINS CLASSICS 70322 (2 CDS)
(DDD/106.24)**

● Whether sacred or secular Bach's music was functional. He wrote concertos for his patrons and liturgical music to meet the requirements of his ecclesiastical employment. That it was also music of genius was a bonus. In his last years however, evidence points to Bach seeking to write works that would somehow sum up his whole musical ethos. He may not have been consciously leaving a legacy to posterity, but he was acutely aware of his own heritage and the strong traditions of the Bach family, which had been making music in Germany for generations. Therefore, we see the appearance of works such as The Musical Offering, the Goldberg Variations and the compendious Art of Fugue, where just about every compositional technique at Bach's disposal is deployed.

But was the B minor Mass also part of this summation of a life's work? The

evidence would seem to bear this out. In practical terms, the Mass would have been unacceptable to both the Lutheran and Catholic Churches. The Lutherans used only the Kyrie, Gloria and Sanctus of the Latin rite and Bach's textual amendments would have barred the work from use in Catholic services, apart from which the festive music of the Osanna and Benedictus would have been wholly inappropriate during the reverential atmosphere of the distribution of Communion. The mystery deepens when the origin of the individual sections of the Mass is explored. The Sanctus is thought to date from the 1720s and may have been first performed at Christmas 1724.

The Kyrie and Gloria were first heard in Dresden on April 21, 1733, on the occasion of the taking of the oath of fealty by the new Elector of Saxony. The Credo - the Symbolum Nicenum - may have been composed for the re-dedication of the rebuilt St Thomas's School in Leipzig on June 5, 1732.

All of this may suggest that the B minor Mass - one of the cornerstones of western music - is something Bach cobbled together in his declining years from bits-and-pieces he happened to have lying around! And, using rather more academic terminology, that is still a theory propounded by some musicologists. However, this overlooks the unassailable evidence of both musical and structural unity within the work. True, it was 'assembled' mainly from existing compositions but such recycling was wholly acceptable in Bach's time, when there was much less emphasis on originality. It cannot be an accident that we have a complete Latin Mass, in the correct liturgical sequence and utterly consistent in its performing forces and key. And surely the reappearance of the *Gratias* from the Gloria in the concluding

Continue on page 94 ▶▶

Dona Nobis Pacem is a quite intentional effort by Bach to bind the whole Mass together?

Bach appears to have worked on score of the B minor Mass between 1746 and 1748 but never heard the work performed in its entirety. Indeed, no-one heard the complete Mass until a performance in Leipzig in 1859, one hundred and nine years after the composer's death. The score first passed to one of Bach's sons, Carl Phillip Emmanuel, who subjected it to much rearrangement and 'modernisation' to suit the taste of his time.

Since its 'rediscovery' in the nineteenth century, the Mass has been subjected to wide extremes of interpretation, from the monumental, with huge choirs and orchestras, to the minimalist - Joshua Rifkin's 'one voice-to-a-part' version which appeared in the 'seventies. The watershed, though, was Nikolaus Harnoncourt's pioneering period instrument recording for Teldec in 1968 which restored the freshness and colour to the work in the same way that cleaning revitalises an old master painting. It was revelatory, and still sounds well, over a quarter-of-century on. Arguably the finest among more recent recordings have come from Philippe Herreweghe and John Eliot Gardiner. Now, to those, can be added Harry Christophers on Collins Classics.

Christophers, and his colleagues in The Sixteen choir and the Orchestra of The Sixteen, seem to go from strength-to-strength and this Bach issue joins their superb recordings of, for example, Vivaldi's Gloria and Handel's Israel in Egypt (also for Collins Classics). I recall criticising the latter, however, for its over-reverberant acoustic with consequent blurring of the choral and orchestral edges. No such complaint here: the balance is first-rate, with the choral contribution exceptionally clear (as befits what has developed into one of our very finest choirs), while the important instrumental interludes shine out from within the sound picture. There is some beautiful playing to be savoured.

We have mercifully escaped from the era when Bach came clothed in Beethoven's sound but important questions of instrumentation, numbers of performers, tempo and articulation remain to be resolved by any interpreter and, in the main, Harry Christophers' solutions work well.

Tempos are generally brisk but without losing the mystery and poignancy evident at many points in the score. Gardiner exhibits greater rhythmic flexibility, but I have been conscious at moments during his performance (on DG Archiv) of this flexibility becoming mannered. Christophers is more conservative in this respect, embracing contemporary scholarship but not entirely eschewing tradition. The result has all the exultant splendour Bach's last, great choral masterpiece demands.

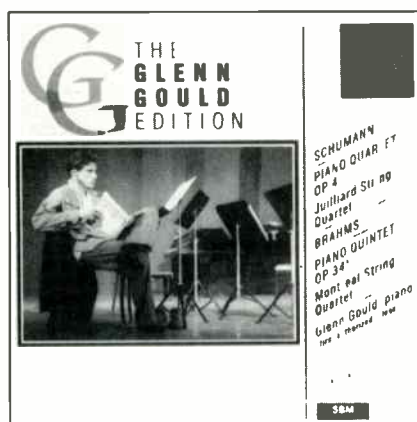

**JOHANNES BRAHMS
Piano Quintet in F minor
Op34#**

**ROBERT SCHUMANN
Piano Quartet in E flat Major
Op47***

Glenn Gould, piano; members of the Julliard String Quartet*; Montreal String Quartet#

SONY CLASSICAL SMK52684 (ADD/65.07)

● Chamber music playing is generally assumed to rely on collaboration; for Glenn Gould, it appears to have been more confrontation. The late 'fifties found the young Canadian pianist at his most temperamental: recording projects were abandoned because he was finding the repertoire 'boring'; studio sessions were frequently cancelled at short notice. Yet, during this period, Gould discovered an unexpected affinity with the music of Brahms. He included the Intermezzi in his recitals and played the First Piano Concerto in concert on at least ten occasions. Gould also performed five of the chamber works: the Violin Sonatas in G Major and A Major, Opp78 and 100; the Cello Sonata in E minor Op38; the Piano Trio in C minor Op10; and the F minor Piano Quintet Op34.

Founded in 1955, the Montreal String Quartet had rapidly established itself as one of the finest chamber ensembles in North America. So the concert on August 20, 1957, in which the quartet was joined by Glenn Gould to play the Brahms Op34, must have been eagerly anticipated. What the audience and radio listeners made of the performance can only be imagined. From the outset, it is clear that Gould and his colleagues have very different ideas about the underlying mood of the work; the strings seek the traditional, lyrical approach while Gould opts for a crisp, classical austerity. And it is Gould who dictates proceedings; his view of the work prevails and the expansive tendencies of the strings are reined in. Any opportunity to project warmth and intensity is eagerly seized, witness the broadening of pace at the end of the andante as the main theme returns.

At Gould's tempo, the scherzo takes on an almost martial quality and the tension between the players is almost

palpable, which explains the fiery passion of the finale, where the playing of both quartet and pianist is electrifying. The recording is a remarkable document: provocative, certainly, but - at a time when many modern recordings seem so bland and synthetic, even 'safe' - charged with personality and drama.

This was to be the last collaboration between Gould and the Montreal String Quartet. Whether this was a direct consequence of the divergence of views on the fundamental nature of the Brahms Quintet, or a more general antipathy between the performers is not known. Coming two years after Gould had signed an exclusive recording deal with CBS, the tape of the Brahms performance made by the Canadian Broadcasting Corporation was precluded from release on LP. This is its first authorised appearance in any format and, while the sound is very forward, it does have an immediacy which suits the interpretation; no glowing, long-breathed lines here, floating off into an airy acoustic. Closely integrated with the strings, Gould's piano-playing dominates the texture, but not to the detriment of all else.

Much less controversial than the Brahms is the studio recording of Schumann's E flat Piano Quartet which Gould made in 1968. Here, he is joined by three members of the much-revered Julliard String Quartet - Robert Mann, violin; Raphael Hillyer, viola; and Claus Adam, cello. Although the performance has none of the inner turbulence of the Brahms, there appears to have been a deepening and ultimately irreparable rift developing between Gould and the Julliard at the time of the recording. Perhaps here, while there was a meeting of minds when it came to points of interpretation, the personalities of those involved remained incompatible.

Surprisingly, Schumann did not figure in Gould's solo repertoire. He had played none of his music before this recording, and was to perform nothing more by Schumann throughout the rest of his career. Tantalisingly, the CBS session notes suggest that this performance of the Quartet was to have been coupled with one of the magnificent Op44 Piano Quintet; if so, it became another of Gould's cancelled projects and, when the Julliard did record the Piano Quintet, it was with Leonard Bernstein at the piano.

Whatever the prevailing tensions at the time of the recording, this performance of the Piano Quartet fizzes with vitality, urgency and involvement. Whatever Glenn Gould himself may have thought about 'boring' repertoire, that description could never be applied to his playing. Neither the Brahms nor the Schumann qualifies for the 'library recommendation' status, but the challenge presented, especially in the Brahms, deserves to be investigated, if only to confirm that tradition for once may still have it right.



ALEXANDER GOEHR The Death of Moses Op53

Michael Chance, counter-tenor; Stephen Richardson, baritone; Sarah Leonard, soprano; Gautam Rangarajan, tenor; Paul Robinson, bass; Sawston Village College Chamber Choir (conductor, Ian Macleod); Cambridge University Musical Society Chorus (soloist, Lynette Levitt); instrumental ensemble; conductor, Stephen Cleobury Unicorn-Kanchana. **DKP(CD)9146 (DDD/55.25)**

● Alexander Goehr was born in Berlin in 1932, the son of the conductor, Walter Goehr, but his family moved to England when he was just a few months old. His colleagues at the Royal Manchester College of Music between 1952 and 1955 were Harrison Birtwistle and Peter Maxwell Davies and, like Davies, Goehr's early compositions explore the kinship between medieval techniques and twentieth century serialism. After Manchester, Goehr studied with Olivier Messiaen in France and came to prominence in the early 'sixties with two highly individual works, the cantatas *Sutter's Gold* and *The Deluge* whose expressive ferocity taxed both performers and audience.

Thirty years on, *The Death of Moses* represents the culmination of Goehr's choral writing; the idiom has softened, but remains highly personal with its adaptation of serial and modal techniques with conventional part-writing. It is also richly imaginative music, and Goehr sets the texts with great sensitivity and feeling for dramatic interplay between the characters. The result is nowhere near as sombre as the title of the work may suggest; indeed, the sequence of poems by John Hollander, which draw upon the collection of Hebrew poetry edited and translated by the poet and scholar, T. Carmi, are not without moments of black humour, as when Moses helps the gravediggers to measure and dig his own tomb.

At the heart of the work, though, according to the composer is "Moses' refusal to accept the fate of all men, and his search for a reason for it". It is significant that, in the fifth and sixth movements of the work, Goehr incorporates the two opening chords of Schoenberg's opera *Moses and Aron*,

chords which prove to be fundamental to the entire harmonic structure of Schoenberg's composition. Like his father, who was a pupil of the composer, Goehr's musical roots are deeply embedded in Schoenberg and he also inherited from his father a lifelong affection for the music of Claudio Monteverdi. There is more than a touch of the Venetian Baroque in *The Death of Moses*, with its highly-effective use of spatial relationships and its thirteen-piece instrumental ensemble consisting of flutes, saxophones, trombones, harp, keyboards, bass guitar and percussion. Goehr describes the instrumentation as "Monteverdi as heard by Varese", with the saxophones the equivalent of the Baroque cometti and the bass guitar playing the role of a "latter-day archlute". There is certainly no lack of colour or contrast, and the same can be said of the voices with, in particular, the counter-tenor Michael Chance making an outstanding contribution to this recording.

In *The Death of Moses*, Goehr has succeeded in combining a striking originality with simplicity and directness. It is music that is at once accessible and involving, and ultimately rewarding, and thoroughly worthy of a place in the English choral tradition. This recording, made with assistance from the Arts Council and the John S. Cohen Foundation, is full of vitality and commitment and is keenly directed by Stephen Cleobury, who seems utterly at one with Goehr's musical idiom. And, making the most of the glorious acoustic of the Chapel of King's College, Cambridge, the sound - engineered by Tryggvi Tryggvason and Geoff Miles - is outstanding.

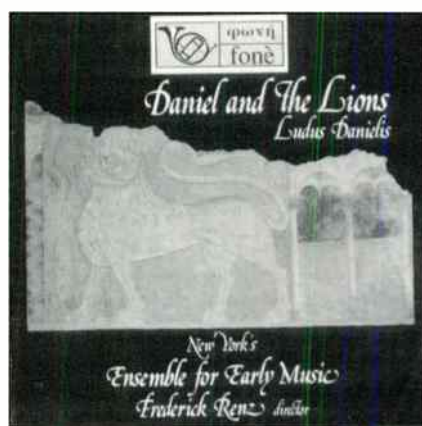

DANIEL AND THE LIONS (LUDUS DANIELIS)

Ensemble for Early Music; director, Frederick Renz
FONE 88F.09-29 CD (DDD/70.37)

● It is twelfth century France and the Christian clergy is charged with spreading the gospel to a largely illiterate and ignorant populus. How to do it? One method was to convey the Biblical

message in a way that all could respond to, by acting out the stories with a suitable musical accompaniment. Enter the medieval liturgical drama. It was distinguished from the later mystery, or miracle plays by being performed exclusively by the clergy, the dialogue in Latin rather than the vernacular, and by being staged within a church or cathedral.

The most famous of surviving liturgical dramas is *Daniel and the Lions* (*Ludus Danielis*) which history suggests was first realised by the scholars of the Episcopal School in Beauvais around 1140. It is a wonderful piece, full of dramatic effect and with a musical part rich in melody, colour and rhythm. The subject matter consists of familiar episodes from the Old Testament Book of Daniel: Belshazzar's sumptuous banquet; the writing on the wall; Daniel's interpretation and reward for his prophecy; Belshazzar's defeat by Darius; Daniel's appointment as Darius's regent; the envious counsellors' plot against Daniel; his casting into the lions' den and safe-keeping by the angel; and, finally, his prophecy of the advent of the Messiah.

No-one can vouch for the absolute authenticity of this performance by New York's Early Music Ensemble, but that is largely irrelevant. What matters is its impact on contemporary ears, which is utterly compelling. Some of the passages - the Entry of Darius's Court and the episode in the lions' den, for example - are spectacular in their colours and effects.

This recording of the *Ludus Danielis* was made in 1986 in the Church of Santa Sabina in Rome and the booklet helpfully provides a ground plan of the church to help the listener visualise the action. But I felt the presentation could have been better, perhaps with more photographs taken of the performance, and certainly by the provision of texts to allow the drama to be followed exactly. However, this should not distract from what is a terrific recording, one with its fair share of surprises.

If my interpretation of the technical information - in Italian only - is correct, then two recordings were made: one using a Sony PCMI630 to produce a digital master for the CD and the other employing a Studer - of the valve variety! - to generate the master tape for the vinyl LP. Sadly, the latter was not supplied for comparison - it might have proved illuminating.

Illumination, of course, was the purpose of the *Ludus Danielis* and, in that respect, it must have worked wonderfully well in medieval France. Thanks to the Early Music Ensemble, that impact has successfully transcended eight centuries.

Incidentally, if you do invest in this Fone CD, I would recommend, if feasible, checking track 7 - the review copy exhibited a pronounced glitch which was impossible to identify as either a 'one-off' or as an inherent mastering problem.

*Cheshire's premier
Hi-Fi and
Home Cinema specialists*

Congleton

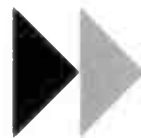

*Come and sample the finest selection
of Hi-Fi and home cinema equipment in one of
our luxuriously appointed listening rooms.*

1/1A Duke St Congleton Cheshire CW12 1AP

01260 297544

LINN ▶ ARCAM ▶ KEF ▶ YAMAHA
 DENON ▶ CANON ▶ NAD ▶ B&W

Loricraft Audio

Specialists in Garrard, Thorens and SME.

Loricraft exhibited a Garrard 401 with an SME Series IV arm, complete with electronic power supply which gave stunning results at the RCA Living Stereo Records launch.

Many thanks to Impulse Loudspeakers for their generosity and glorious sounds.

Manufacturer of dedicated power supplies for Garrard 301/401 and Thorens TD124 (review copies available). Supply and service of Garrard, Thorens and other high quality turntables using genuine and manufactured parts to original specifications. Also manufacturers of high quality plinths for Garrard 301/401 and Thorens TD124.

We are happy to quote on any aspect of high quality equipment, electronic, electrical and mechanical.

Loricraft high quality record cleaning machines as used by the professionals. Please send for details

High quality Audiophile Records stocked including, RCA, Living Stereo, Decca SXL with many more titles to follow, also good condition cleaned second hand list in preparation.

T.M. O'Sullivan

**4 Big Lane, Goose Green Lambourn,
Berks RG16 7XQ**

•New 1995 catalogue in preparation•

Fax /
Ansaphone:

0488 72267



Chord Electronics Ltd

**3 Bower Mount Road
Maidstone ME16 8 AX**

Tel. 0622 764874/692000 Fax. 0622 688480

Chord UK Dealers

Cottage Audio	0522 702834
KJ Leisuresound London W1	071 486 8262
Brentwood Music Centre, Brentwood, Essex	0277 221210
Progressive Audio, Gillingham, Kent	0634 389004
Doug Brady Hi-Fi, London WC2	071 379 4010
Doug Brady Hi-Fi, Warrington, Cheshire	0925 828009
Doug Brady Hi-Fi, Liverpool, Mersyside	051 733 6859
Doug Brady Hi-Fi, Leeds, Yorkshire	094 346 7689
Photocraft Hi-Fi, Ashford, Kent	0233 624441
The Reference Studio, Heathfield, Sussex	0435 868004
Paul Green Hi-Fi, Bath, Avon	0225 316197
Eastbourne Audio, Eastbourne, Sussex	0323 25828
Surrey Hi-Fi, Godstone, Surrey	0883 744755
Sound Academy, Wallsall, West Midlands	0922 493499
English Audio, Hereford, HR4	0432 355081
Hi-Fi Experience, London W1	071 580 3535
London Hi-Fi Services, London	071 263 1015
Music Matters, Birmingham, West Midlands	021 429 2811
Music Matters Stourbridge	0384 444184
V'audio, Stoke Bishop, Bristol	0272 686005
In Hi-Fi	031 225 8854
Audio Reflections	0532 528850
Audible Difference	0379 740227

In recent years we have become accustomed to musicologists cutting a swathe through the blithe assumptions of performing tradition in an effort to get closer to a composer's original intentions, and to allow us to hear a familiar work free of the distortions and accretions of time. The effort has largely concentrated on Renaissance, Baroque and Classical periods, sometimes with startling results and sometimes coming up with decidedly tenuous theories. It's only to be expected that scores from three or four hundred years ago would

suffer at the hands of editors, copyists and revisers, and that our notion of performance would have to be based on a mixture of scholarship, intuition and inspiration.

More recently, the nineteenth century throws up several examples of doubtless well-intentioned but ill-conceived 'revisions': the 'monumental' approach to Bach performance, for instance, quite at odds with the nature of the music; Rimsky-Korsakov's sanitising of Mussorgsky's stark, raw sonorities; and - most indefensible of all - the crude

editing of Bruckner's symphonies.

In the twentieth century, we like to feel we are more enlightened, more sensitive than our predecessors in this respect. Moreover, the accuracy of documentation is such that there can surely be no doubt that, when a modern work is played, it's the right version that's being performed. In general you would be right to think that but, as the musicologist Paul Wingfield has demonstrated even our own century has the capacity to deliver the occasional surprise to music scholarship.

LEOS JANACEK
Msa Glagolskaja
(Glagolitic Mass)

ZOLTAN KODALY
Psalmus Hungaricus Op 13

Tina Kiberg, soprano; Randi Stene, alto; Peter Svensson, tenor; Ulrik Cold, bass; Per Salo, organ; Copenhagen Boys' Choir; The Danish National Radio Choir; The Danish National Radio Symphony Orchestra; conductor, Sir Charles Mackerras.
CHANDOS CHAN9310 (DDD/62.44)

● According to Paul Wingfield, for the past sixty five years or so, the world's conductors, orchestras and choirs have been performing an adulterated version of Janacek's glorious Glagolitic Mass. However, it's not some misguided or careless editor that we have to point the finger at, but the composer himself, or more accurately, the circumstances of the first performance.

Around 1907-08, Janacek began work on a setting of the Latin Mass in the *Missa Brevis* style. But the idea was abandoned and the sketches were laid aside for some seventeen years until he was once again attracted to the challenge. This time however, not only was the work planned to be of a much greater scale, but instead of the Latin, Janacek employed Old Church Slavonic, the literary language established in his native Moravia in the ninth century by the missionaries Cyril and Methodius. The term 'Glagolitic' derives from the ornate script which the missionaries devised for the language.

The first drafts of the Mass were prepared by August 1926 but extensive revisions saw the relationship to the 1907-08 sketches diminish considerably. By any measure, the end result was a choral masterpiece of striking originality and impact. The first performance was scheduled to take place in the

composer's home town of Brno in December 1927 under the baton of Jaroslav Kvapil. As rehearsals progressed it became clear to Janacek that there would be insufficient instrumental resources in Brno to meet the demands of the score and that, for all their enthusiasm, the provincial singers weren't going to be up to the task. To salvage the performance, he made substantial revisions to the score. Unfortunately, these changes - surely intended only to be temporary - became permanent when the full score was published in 1929, the year after Janacek's death. And it is this somewhat diluted and less audacious version of the Glagolitic Mass which has been

organ solo that prefaces the 'Raspet' ('Crucifixus') is punctuated by explosive interjections played principally by three sets of pedal timpani. The overall effect of the 'reconstruction' is to intensify the dramatic impact of the Mass - witness the apocalyptic music of the Crucifixus.

There could be no better choice of conductor to bring Janacek's 'new' score to life than Sir Charles Mackerras, whose understanding of Janacek's musical idiom seems intuitive. Using Danish forces (the recording was made in cooperation with the Danish Broadcasting Corporation), he produces a blazing performance that reaches to the heart of this extraordinary work.

The orchestral playing and choral singing are outstanding and if I have a criticism, it is that the soloists do not always sound entirely comfortable with the Slavonic texts. However, the end result is a thrilling realisation of the Glagolitic Mass as Janacek conceived it and it's hard to see how anyone could henceforward use the revised version in performance or recording. We shall see.

Along with the Janacek, Mackerras offers a splendid performance of a highly-appropriate coupling, Kodaly's *Psalmus Hungaricus*, written in 1923 to commemorate the fiftieth anniversary of the coming together of the three cities which form Budapest. This was Kodaly's first large-scale composition but he handles the orchestral and

performed ever since. However, diligent research by Paul Wingfield in Brno and Vienna has allowed him to 'reconstruct' the score following Janacek's original intentions and, as this first recording vividly demonstrates, the effort was wholly justified.

The differences are many and varied. Janacek simplified rhythmic structures and changed time signatures to make things easier for the Brno performers. There are fourteen extra bars in the 'Svet' ('Sanctus') and the

choral forces with confidence and imagination and a keen sense of structure. The text comes from a sixteenth century religious poem, itself based on Psalm 55, but whose message of retribution for persecution would have had a contemporary resonance in a Hungary still full of bitter memories of the First World War. In typical Chandos fashion, the recorded sound is full, with an impressive scale and projection, and entirely apt for the brilliance of this music.



AUDIO ACCESSORIES

RECORD STORAGE CUBE

Designed to hold about a hundred LPs, with an internal width of 37cm, height of 32.5cm and depth of 32cm. The cubes can be stacked or placed alongside each other - and are even strong enough to be used as seats! Made from 15mm MDF (Medium Density Fibreboard) with

a smart durable black paint finish, the cube is supplied in flat-pack form ready for home assembly.

RECORD STORAGE CUBE£45.00 EACH

SIX CUBES FOR THE PRICE OF FIVE..... £225.00
EIGHT CUBES FOR THE PRICE OF SEVEN!

.....£315.00



SOUND SWIVEL

A rotating, upright, double-sided, storage cabinet with space for up to 160 Compact Discs, including 8 double jewel-cases. Mounted on an all-steel turntable, it swivels smoothly through 360 degrees giving easy access to the storage

compartments either side. Manufactured in durable MDF with a Black Ash effect finish, the Sound swivel comes packed for self assembly with full instructions.

SOUND SWIVEL£49.95

8-WAY MAINS BLOCK

New from Campaign Audio Design, this 8-Way mains block features a high quality silver plated copper cable, silver soldered to an MK plug which itself is fitted with a VDR, which prevents mains spikes reaching your equipment. The cable is plaited together to reduce noise. The 8-Way block represents the highest quality way to supply eight items of hi-fi from one socket.

8-WAY + 1M CABLE£93

8-WAY + 2M CABLE£107

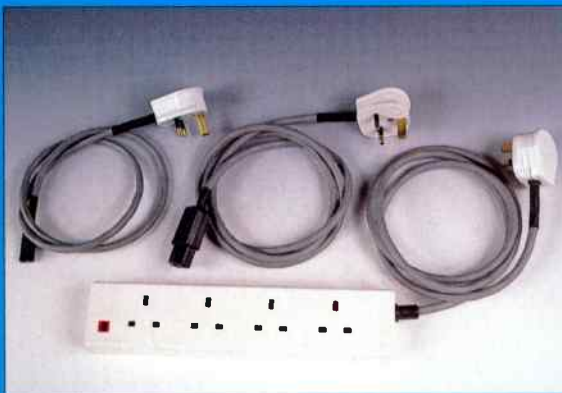

HIGH QUALITY MAINS CABLES.

Supplied to Hi-Fi World by Campaign Audio Design these mains cables are screened to reduce Radio Frequency and Electromagnetic Noise. They also come with a VDR fitted which protects equipment from mains spikes. The MK plugs have a silver plated fuse and holder for the cleanest supply. Available with IEC or Figure eight (Marantz/Philips CD players) equipment plugs or with a hard wired, soldered 4-way mains block.

1M WITH IEC PLUG£19.20

1M FIGURE 8 PLUG£15.75

1M 4-WAY BLOCK£31.95

4-WAY MAINS BLOCK WITH RF FILTER

Similar to the standard 4-way mains block featuring 2m screened mains cable, MK plug with silver plated fuse and holder and VDR to stop mains spikes reaching your equipment. A special RF filter has now been added which cuts out even more mains borne interference. Suitable for top-end systems

£45.50

ELASTOMER DAMPED EQUIPMENT SPIKES

In addition to the standard equipment isolation spikes, Campaign Audio Design have now added an improved version with Elastomer damping. As the spike transmits energy away from your sensitive equipment, the Elastomer absorbs any energy that may be reflected and cause the spike to resonate. There are three in a pack.

ELASTOMER ISOLATION SPIKES£22.50

EQUIPMENT SPIKES

Machined from solid brass these equipment spikes can be placed under equipment to help ground harmful vibration and enhance the visual appearance of your equipment. The spikes come in sets of three and will support equipment weighing up to 10kg. We hope to introduce a larger spike suitable for heavier

equipment and loudspeakers within the coming months.

£6.50



Hi-Fi World WORLD LIBRARY

VALVE BOOKS

AN APPROACH TO AUDIO FREQUENCY AMPLIFIER DESIGN, seventeen circuits from 5 to 1100watts. General Electric Co. £19.95

Seventeen high quality amplifier designs from the Research Laboratories of the General Electric Company (UK). Designs range from 5 to 100watts, using KT66s, KT88s, DA100s, etc. Also includes two valve pre-amplifiers complete with valve phono stages.

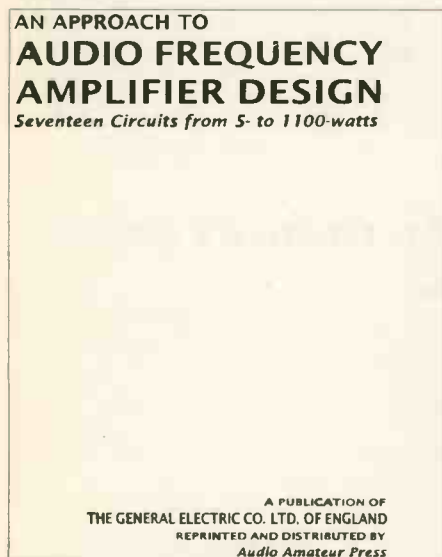

MULLARD TUBE CIRCUITS FOR AUDIO AMPLIFIERS. £13.95

First published in 1959 by Mullard, this book includes full designs for eleven power and control amplifiers, including the 5-20, using valves. This book begins with a four-chapter tutorial on getting the best sound from valve amplifiers.



THE WILLIAMSON AMPLIFIER, by D. T. N. Williamson. £9.95

In April 1947, Williamson's valve power amplifier became an overnight success. The author takes you deep into his design decisions and offers practical advice on how to build the amplifier and set it up for best performance.

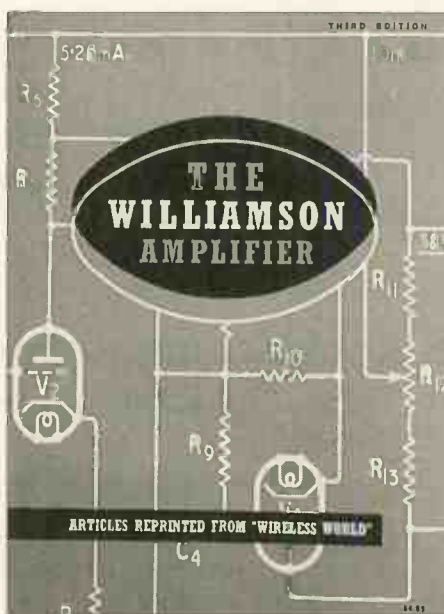

LOUDSPEAKERS

LOUDSPEAKERS: THE WHY AND HOW OF GOOD REPRODUCTION, by G. A. Briggs. £10.95

A popular and easy to understand book on building loudspeakers, using empirical techniques that pre-date computer analysis. A fine grounding, written by a manufacturer with first hand experience - recommended for beginners.

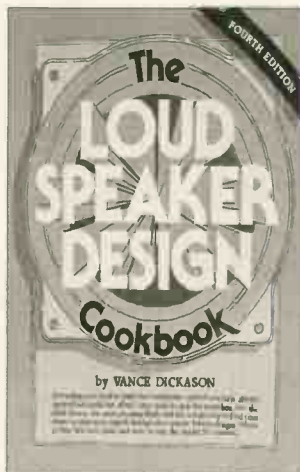

ELECTROSTATIC LOUDSPEAKER DESIGN AND CONSTRUCTION, by Ronald Wagner. £19.95

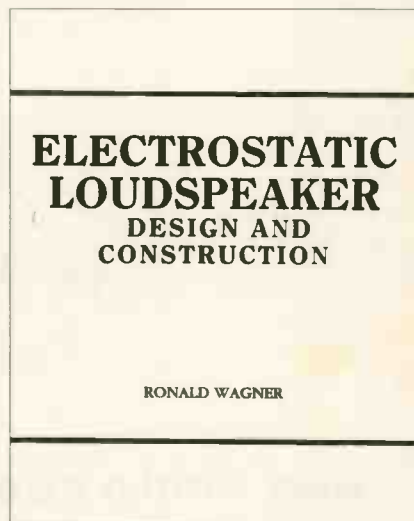

This book takes you step by step through the design and construction of a full range electrostatic loudspeaker, including the basic operating principles behind electrostatics. Whether you intend to build your own electrostatic, repair and restore a vintage electrostatic or are just interested in the principles behind electrostatics, this book is a must.

THE LOUDSPEAKER DESIGN COOKBOOK, by Vance Dickason. £23.75

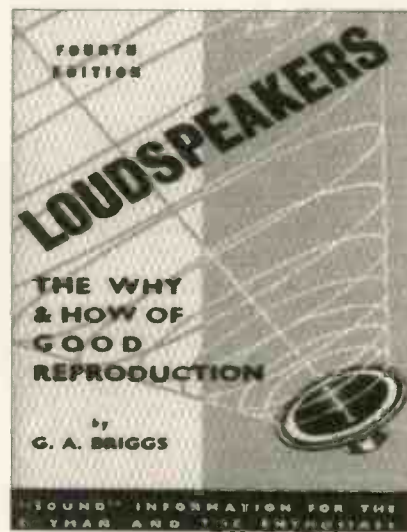

This best selling book in the field of loudspeakers offers good, up-to-date practical design information for the home constructor. Like today's manufacturers it uses modern Thiele Small theory and parameters

WORLD LIBRARY

QUICK & EASY TRANSMISSION LINE SPEAKER DESIGN by Larry D. Sharp.
£10.95

A practical approach to designing and building your own transmission line loudspeaker. Covers the background theory, but is very practical in approach. Design examples and equations, even a computer package to run under Lotus 123 which takes care of the maths.

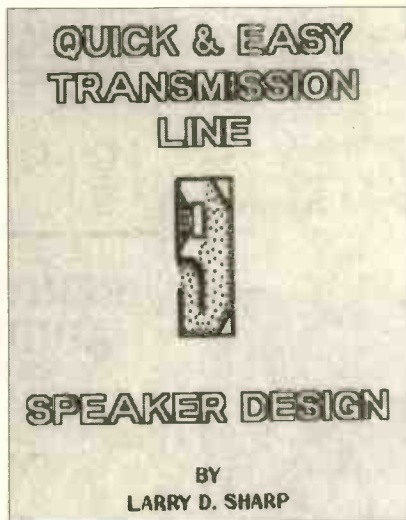

THEORY AND DESIGN OF LOUDSPEAKER ENCLOSURES by J. E. Benson.
£23.95

This book covers loudspeaker enclosure design; infinite baffle, reflex, passive radiator etc in great detail, with a highly mathematical approach, making this book unsuitable for beginners, but highly authoritative to experienced designers with a good foundation in acoustics.

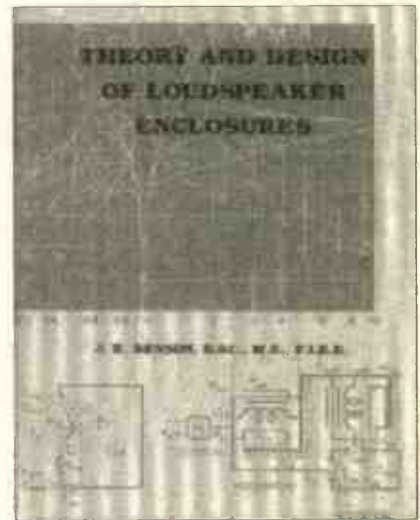

HI-FI WORLD AUDIO ACCESSORIES & WORLD LIBRARY ORDER

Please send me:

- CD sound swivel.....£49.95
- Equipment Spikes.....£6.50
- Standard Silver Plated Copper Interconnects (1m pair).....£28.00
- Hi-Fi World Silver Plated Copper Interconnects (1m pair).....£69.95
- Hi-Fi World Solid Silver Interconnects (1m pair).....£139.95
- Hi-Fi World Aerial Leads.....£19.95 per m + £2.00 per extra m
- Record storage cube.....£45.00 each
- Screened Mains Cable With 4-Way Block (1m).....£31.95
- Screened Mains Cable With RF FILTER 4-Way Block (2m).....£45.50
- Screened Mains Cable With Fig 8 Plug (1m).....£15.75
- Screened Mains Cable With IEC Plug (1m).....£19.20
- 8-Ways + 1m Cable.....£93
- 8-Ways + 2m Cable.....£107
- Elastomer Isolation Spikes.....£22.50

Prices are exclusive of postage & packing, please add £1.00 for postage in the UK and £2.00 for postage overseas. With the exception of the Record Cleaning Systems which are £4.00 UK and £10.00 overseas.

Books

VALVE BOOKS

- An Approach to Audio Frequency Amplifiers.....£19.95 + £2.00 p&p
- Mullard Circuits for Audio Amplifiers.....£13.95 + £2.00 p&p
- The Williamson Amplifier.....£9.95 + £1.00 p&p

LOUDSPEAKERS

- Loudspeakers: The Why & How.....£10.95 + £1.00 p&p
- Electrostatic 'Speaker Design & Construction.....£19.95 + £2.00 p&p
- The Loudspeaker Design Cookbook.....£23.75 + £2.00 p&p
- Transmission Line Speaker Design.....£10.95 + £2.00 p&p
- Theory and Design of Loudspeaker Enclosures.....£23.95 + £4.00 p&p

SOLID STATE ELECTRONICS

- The Art of Electronics.....£35.00 + £4.00 p&p
- The Art of Linear Electronics.....£16.95 + £2.00 p&p

Your name and address may be added to our mailing list only. If you would prefer not to receive details of new products or special offers please tick box.
Hi-Fi World magazine is published by Audio Publishing Ltd.

AUDIO ANTHOLOGIES

- Volume One.....£14.95 + £2.00 p&p
- Volume Two.....£14.95 + £2.00 p&p
- Volume Three.....£14.95 + £2.00 p&p
- Volume Four.....£14.95 + £2.00 p&p
- Volume Five.....£14.95 + £2.00 p&p
- Audio Anthologies - complete set.....£69.95 inc p&p

All prices are exclusive of postage & packing. For U.K. please see above. For 10 or more books p&p is free.
Outside UK please contact us for rates.

I enclose cheque/PO for £.....made payable to
World Audio Publishing Ltd.

I wish to pay by Visa/Access, please debit my account no:

--	--	--	--	--	--	--	--	--	--	--	--	--	--	--	--	--	--	--	--

Expiry date:

--	--	--	--

Signature:.....

Name.....

Delivery Address.....

N.B. If delivery address if different to the credit card holder's address please supply both.

Tel:.....

Please send completed order form together with your cheque/PO to:



HI-FI WORLD,
64 Castellain Road,
Maida Vale,
London W9 1EX.

Credit Card Orders
Telephone 071 - 266 0461
24 hour Mail Order Answerphone

Hi-Fi World WORLD LIBRARY

SOLID STATE ELECTRONICS

THE ART OF ELECTRONICS, by P. Horowitz and W. Hill. £35

The definitive electronics book. The Art of Electronics is an ideal book for the beginner through to the engineer. Written in easy to understand English, each chapter takes you from basic first principles through to full design exercises and practical circuits.

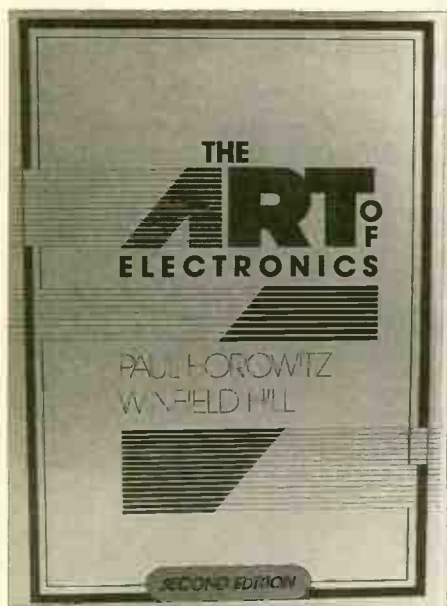

THE ART OF LINEAR ELECTRONICS, by J. Linsley- Hood. £16.95

Concentrates specifically on analogue electronics for audio and goes into detail on obscure topics like the drawbacks of feedback, as well as its advantages. Covers mainly solid state but also includes valves. A must for serious enthusiasts and budding designers.

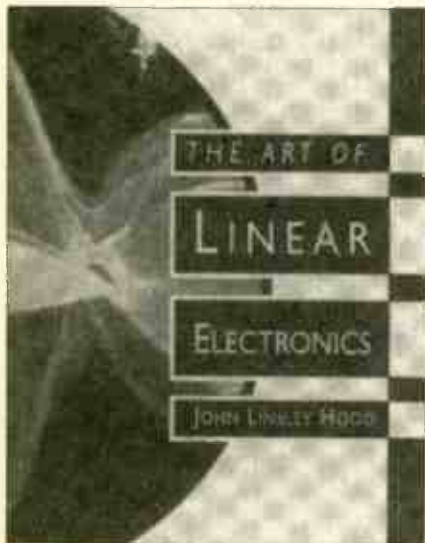

AUDIO ANTHOLOGIES

Audio Anthologies - When Audio Was Young

There are five volumes of the Audio Anthologies, listed below with a brief description and guide to their contents. They cover one of the most exciting and important eras of hi-fi, from the end of the second world war, through the introduction of stereo, magnetic recording, binaural recording and the FM Multiplex decoder. They contain many ground breaking circuits and theory covering all aspects of hi-fi design. A must for valve enthusiasts.

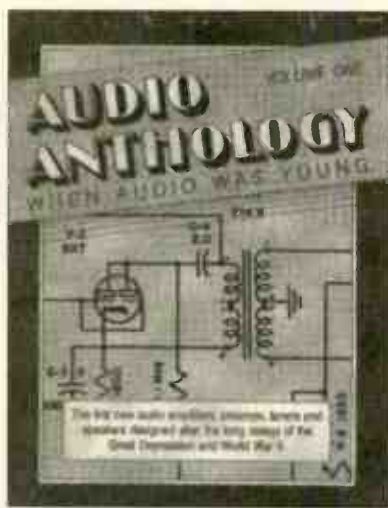

Volume One - May 1947 to December 1949

The first new audio amplifiers, tuners and speakers designed after the long delays of the Great Depression and World War II.

Summary of Contents: 9.5watt, 5watt and 6.5 watt 6AS7G amplifiers, 30watt 300B amplifier, valve FM tuning indicator, 30watt 211 power amplifier, cathode follower amplifier using 6V6, an adaptation of the Williamson amplifier, valve phono preamplifier, several horn and reflex loudspeaker designs and much more.

Volume Two - January 1950 to July 1952

More great amplifiers, preamps, loudspeaker designs, and the first glimmer of the stereo revolution plus magnetic recording aids.

Summary of Contents: Ultra linear 6L6 design and operation of the Williamson, a direct coupled amplifier, Williamson type amplifier using 6A5s, 40watt 845 push-pull amplifier, valve phono and line preamps, valves and loudspeaker damping, design and construction of reflex and horn loudspeakers.

Volume Three - August 1952 to June 1955

Seven power amplifiers, eighteen preamps, twelve loudspeaker designs, including four horn types and binaural recording techniques.

Summary of Contents: Simple valve phono stage, transformerless amplifier using 6082, 20watt 5881 amplifier, 10watt 6V6 amplifier, stereo valve preamp, high quality valve phono stage, a preamp for the Williamson, low distortion tone control preamp, binaural or stereophonic?, transistor phono amp, corner horn loudspeaker, concrete horn loudspeaker.

Volume Four - July 1955 to December 1957

How to plan an audio system, twelve amplifiers and preamps, solid state techniques and circuits introduced and six loudspeaker designs.

Summary of Contents: 18watt 5881 amplifier, 4watt single-ended tweeter amplifier, budget 11watt amplifier, versatile bass/treble control, transistor theory, transistor preamp, transistor techniques, battery powered transistor phono preamp, loudspeakers explained.

Volume Five - January 1958 to December 1959

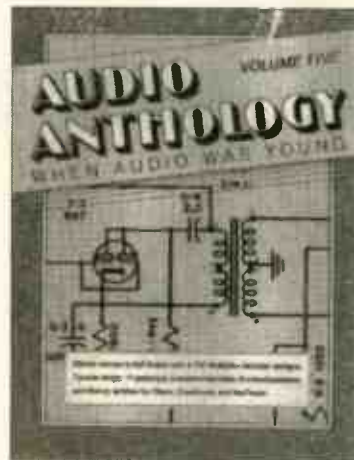

Stereo comes to full flower with four FM Multiplex decoder designs, seven power amps, eleven preamps, a commercial killer, five loudspeakers, and theory articles by Olson, Crowhurst and McProud.

Summary of Contents: Stereo valve multiplex decoder, 7watt EL84 amplifier, valve active crossover and 20watt treble amp/50watt bass amp., monaural, binaural, monophonic and stereophonic explained, heterodyne FM multiplex adapter, transistor preamp, 60watt EL34 amplifier, high power audio amplifiers, hi-fi loudspeaker enclosure.

Price
All five for

£14.95each
£69.95

AUDIOPHILE INTERNATIONAL LTD

WORLD WIDE MAIL ORDER - RETAIL/WHOLESALE/DISTRIBUTION

TO ORDER VISA/ACCESS 01276 855578
OR FAX 24 HOURS 01276 855580

PO BOX 303, CHOBHAM, WOKING, SURREY, GU24 8YP

For our huge Catalogue and to join our world wide mailing list, send us £2.00 in stamps, Overseas x5 IRC's, you will then receive high quality updates containing used mint condition LPs and be able you take advantage of all promotions we have from month to month. Orders over £35 from this advert will receive a catalogue free of charge. All retail orders go out 'SUPERPACKED' first class recorded. (first LP £3 each additional 75p, first CD £2 each additional 50p (Overseas customers please call))



ART PEPPER + 11
180gm HQ VINYL & GOLD CD £25

VISIT US AT BRISTOL HI - FI SHOW & THE CHESTERFIELD HI - FI SHOW

WE ARE IN: *The Second Bay*

We have a fantastic selection of CDs, new and used LPs.

ON: 22 - 23 April 95,

AT: BUXTON PALACE, DERBYSHIRE. !FREE ENTRY!



HM 7010 HANDEL - Water Music
Vinyl LP (Linn Select) £10

GRAPEVINE: VINYL

- MARY BLACK - Mary Black £9
- MARY BLACK - Collected £9
- MARY BLACK - Without The Fanfare £9
- MARY BLACK - By The Time It Gets Dark £9
- MARY BLACK - Babes In The Wood £9
- MARY BLACK - No Frontiers £9
- MARY BLACK - The Collection £9
- MARY BLACK - The Holy Ground £9

HARMONIA MUNDI: VINYL

- HM 7010 HANDEL - Water Music (Mc Gegan) £10
- HM 7014 CORELLI - Concerti Grossi £10
- HM 7020 KAPSBERGER - Il Tedesco Della Tiorba £10

AUDIOQUEST :HQ 180gm LP & CDs CD PRICES FOR THE FOLLOWING ALBUMS ARE £15

- ROBERT LUCAS - Usin' Mans Blues *Recommended*
- TUXEDO COWBOYS - Woman Of The Heart
- ROBERT LUCAS - Luke & The Locomotives
- TRIO GALANTERIE - Trio Galanterie
- MOKAVE - Mokave
- MOKAVE - Mokave Volume II
- VICTOR LEWIS - Family Portrait
- ROBERT LUCAS - Built For Comfort
- BRUCE KATZ BAND - Crescent Crawl *Amazing*
- SASHA MATSON - Steel Chords *2LP Set*
- JEFF PALMER/VICTOR LEWIS - East On 2LPSet
- MIGHTY SAM McCLAIN - Give It Up To Love
- RONNIE EARL & THE BROADCASTERS - Still River
- LES ARBUCKLE - No More No Less
- ROBERT LUCAS - Layaway
- MOKAVE - Afrique *New release*
- BRUCE KATZ - Transformation *New release*
- DOUG MACLEOD - Come To Find *New release*
- KEI AKAGI - Mirror Puzzle *New release*

RCA LIVING STEREO HQ 180gm VINYL LIMITED EDITION.

- £17 LSC 1806 STRAUSS - Also Sprach Zarathustra £28
- £17 LSC 1817 OFFENBACH - Gaité Parisienne £28
- £17 LSC 1900 BERLIOZ - Symphony Fantastique £28
- £17 LSC 1934 BARTOK - Concerto For Orchestra £28
- £17 LSC 2201 MUSSORGSKY - Pictures At An Exhibition £28
- £17 LSC 2222 DEBUSSY - Iberia (Reiner) £28
- £17 LSC 2225 WITCHES BREW (Gibson) £28
- £17 LSC 2313 SOLTI - Venice (Royal Opera House) £37
- £17 LSC 2449 GOUND - Faust/BIZET - Carmen £28
- £27 LSC 2456 LALO - Symphonie Espagnole £28
- £27 LSC 6065 THE ROYAL BALLET - Gala Performances £50
Stunning 2LP with colour book (RRP £57)
- £17 **NEW TITLES - AVAILABLE AND IN STOCK**
- £17 LSC 2285 WALTON - Facade £28
- £17 LSC 2298 BORODIN - 2nd Symphony (Martion, LSO) £28
- £17 LSC 2343 REINER - Festival (Chicago S.O) £28
- £17 LSC 2500 STRAUSS - Waltzes (Reiner, C.S.O) £28
- £17 LSC 2541 LISZT - TODTENTANZ £28

ALTO: 180gm HQ LIMITED EDITION VINYL ONLY 2000 PRESSED OF EACH TITLE

- CLIFFORD JORDON - Film Roots
- DEXTER GORDON - Swiss Nights Volume 1
- ARCHIE SHEPP & HORACE PARLAN - Goin' Home
- CEDAR WALTON QUARTET - First Set
- CHET BAKER QUARTET - No Problem
- JOHNNY DYANI - MbiZo
- CHET BAKER - This Is Always
- JOHNNY BAKER - Africa
- ARCHIE SHEPP & NIELS H. PEDERSEN - Looking At Bird
- N.H. PEDERSEN QUARTET - Dancing On Tables
- CHET BAKER TRIO - Day Break
- CHET BAKER TRIO - Some Day My Prince Will Come

CHESKY: HQ 180gm LPs

- BERLIOZ - Symphony Fantatique (Freccia, RPhil.) £17
- RACHMANINOFF - Piano Concerto No. 2 £17
- SIBELIUS - Symphony No. 2 (Barbirolli) £17
- RIMSKY-KORSAKOV - Scheherazade (Reiner, CSO) £17
- RESPIGNI - Pines / Fountains Of Rome (Reiner, CSO) £17
- BRAHMS - Symphony No. 4 (Reiner, CSO) £17
- TCHAIKOVSKY - Francesca Da Rimini (Munch) £17
- GERSHWIN - American In Paris (Fiedler) £17
- THE REINER SOUND (Reiner, CSO) £17
- RAVEL - Daphnis & Chloé (Munch) £17
- STRAVINSKY - Petruska (Danon, RPO) £17
- SIR ADRIAN BOULT - Concert Favourites £17
- TCHAIKOVSKY - Swan Lake & The Nutcracker Suite £17

HIGH QUALITY CDs, HDCDs & 24kt GOLD CDs

DCC: 24kt GOLD CD FROM ORIGINAL SOURCE

- BOB SEGER - Night Moves
- RAY CHARLES - Ingredients For Soul
- PAUL McCARTNEY - Paul McCartney
- PAUL McCARTNEY & WINGS - Venus & Mars
- FRANK SINATRA - Duets *Limited edition*
- THE BAND - Stage Fright
- CREDENCE CLEARWATER REVIVAL - Green River
- STAN GETZ & CHARLIE BYRD - Jazz Samba
- BLONDIE - Parallel Lines
- BEACH BOYS - Pet Sounds

NEW RYKO: 20BIT 24kt GOLD CDs

- HART/AIRTO/PURIM - Dafos *Already out of print*
- TAS *recommended, absolutely stunning dynamics*
- MICKEY HEART - Planet Drum *Already out of print*
- Fantastic percussion 'World Music Album Grammy 91'*
- RICHARD & LINDER THOMPSON - Shoot Out The Lights £25
- DAVID BOWIE - Ziggy Stardust & The Spiders From Mars £25



TRAFFIC - The Low Spark Of High Heeled Boys
200gm SUPER VINYL £25 & GOLD GAIN CD £24

MOBILE FIDELITY: 24kt GOLD CDs

- £24 SUPERTRAMP - Crime Of The Century
- £24 BLIND FAITH - Blind Faith
- £24 POLICE - Synchronicity
- £24 MOODY BLUES - Days Of Future Passed
- £24 MOODY BLUES - In Search Of The Lost Chord
- £24 MOODY BLUES - On The Threshold Of A Dream
- £24 JETHRO TULL - Thick As A Brick
- £24 JETHRO TULL - Stand Up
- £24 CARPENTERS - A Song For You
- £24 ELTON JOHN - Goodbye Yellow Brick Road (2 on 1)
- FRANK SINATRA - Songs For Swinging Lovers
- PINK FLOYD - Dark Side Of The Moon
- PINK FLOYD - Meddle
- £25 PINK FLOYD - The Wall (2CD out of print)
- £25 PINK FLOYD - Atom Heart Mother
- £25 THE WHO - Tommy (2 on 1)
- SANTANA - Abraxas
- STEELY DAN - Gaucho
- STEELY DAN - Aja
- ERIC CLAPTON - Slowhand
- ERIC CLAPTON - 461 Ocean Boulevard
- ERIC CLAPTON - Just One Night (2CD)
- TRAFFIC - Mr. Fantasy
- TRAFFIC - Low Spark Of High Heeled Boys
- JOHN LENNON & YOKO ONO - Double Fantasy
- THE NEVILLE BROTHERS - Fiyo On The Bayou
- JOHN MELLENCAMP - Scarecrow
- JOHN COLTRANE - Giant Steps
- RUSH - Signals
- RUSH - 2112
- RUSH - Moving Pictures
- ARETHA FRANKLIN - I Never Loved A Man The Way I...
- ALBERT KING - Bom Under A Bad Sign
- QUEEN - News Of The World
- QUEEN - Night At The Opera
- QUEEN - The Game
- EMERSON LAKE & PALMER - Trilogy *New release*
- DR. JOHN - The Right Place And Gumbo *New release*
- CREAM - Cream Live *New 2CD*
- ROBBIE ROBERTSON - Robbie Robertson

GRP: HQ 20 BIT 24kt GOLD LTD EDITION CDS

- £24 LEE RITENOUR - Wes Bound £25
- £24 GLENN MILLER - In The Digital Mood £25
- £24 DAVE GRUSIN - The Gershwin Collection £25
- £24 DIANE SCHUUR - In Tribute £25
- £24 ROBBEN FORD & THE BLUE LINE £25
- £24 JOHN COLTRANE - The Gentle Side Of John Coltrane £25

THREE BLIND MICE: GOLD CDS

IMPORTED FROM JAPAN; TRANSFERRED FROM THE ORIGINAL MASTER TAPES ON 24kt GOLD CDS

- £25 TBM 004 WONDERFUL SOUND OF TBM
- £25 TBM 006 MISTY MOOD OF TBM

POPE MUSIC HQ 24kt GOLD CDS

- £25 LORI LIEBERMAN - A Thousand Dreams
- £24 UNLIKELY SILHOUETTE
- £24 Marc Gorenstein conducts the State Symphony

REFERENCE HDCDs

RECOMMENDED RETAIL PRICE £13.95 SAVE 95p

- £35 JOHN RUTTER - REQUIEM £13
- £24 POMP & PIPES £13
- £24 DICK HYMAN - Age Of Swing £13
- £24 ELEMA FARRELL - £13
- £24 **DIRECT TO 24kt GOLD CD - LIMITED EDITIONS**
- £24 DICK HYMAN - Plays Fats Waller £27
- £24 DICK HYMAN - Plays Duke Ellington £27

SHEFFIELD LAB CDs

RECOMMENDED RETAIL PRICE £19.95 SAVE OVER £4

- £24 THELMA HOUSTON & THE PRESSURE COOKER £15
- £24 DAVE GRUSIN - Discovered Again £15
- £24 AMANDA McBroom - West Of Oz £15
- £24 MICHAEL RUFF - Speaking In Melodies £15
- £24 PAT COIL - Schemes & Dreams £15
- £35 KODO - Heartbeat Drummers Of Japan £15
- £24 THE SHEFFIELD DRUM & TRACK DISC £15

ANALOGUE PRODUCTIONS

LTD ED. 180gm HQ VINYL & 24ct GOLD CDs.

THE WEAVERS - Reunion At Carnegie Hall 1963
 SONNY ROLLINS - Way Out West *A classic*
 BILL EVANS TRIO - Waltz For Debby
 ART PEPPER - Meets The Rhythm Section *Stunning*
 BEN WEBSTER - Live At The Renaissance
 BENNY CARTER - Jazz Giant
 LIGHTNIN' HOPKINS - Goin' Away *Recommended*
 DUKE ELLINGTON - This Ones For Blanton
 ART PEPPER + 11

JIMMY ROGERS - Blue Bird *HQ Vinyl LP*
 JIMMY ROGERS - Blue Bird *Aluminum CD*

NEW RELEASES AVAILABLE NOW

RALPH SUTTON - Partners In Crime
 THE DON EWELL QUARTET - Yellow Dog Blues *-(LP)*

NEW RELEASES AVAILABLE SOON

CHICO FREEMAN - Spirit Sensitive
 BASIE JAM - Basie Jam
 THE GUITAR ARTISTRY OF CHARLIE BYRD

GRP JAZZ : VINYL

DAVID BENOIT - Freedom At Midnight
 DAVID BENOIT - Every Step Of The Way
 DAVID BENOIT - Urban Daydreams
 DAVID BENOIT - Waiting For Spring
 DAVID BENOIT - Inner Motion
 GARY BURTON - Times Like These
 GARY BURTON - Reunion
 LARRY CARLTON - Collection
 BILLY COBHAM - Powerplay
 BILLY COBHAM - Best Of
 BILLY COBHAM - Picture This
 BILLY COBHAM - Warning
 CHICK COREA - Akoustic Band
 CHICK COREA - Light years
 EDDIE DANIELS - Breakthrough
 EDDIE DANIELS - To Bird With Love
 EDDIE DANIELS - Memos From Paradise
 MARK EGAN - Touch The Light
 THE DUKE ELLINGTON ORCHESTRA - Digital Duke
 KEVIN EUBANKS - Sundance
 KEVIN EUBANKS - Opening Nights



LSC 2500 STRAUSS - Waltzes
 180gm SUPER HQ VINYL £28

JAZZ ON VINYL

AZYMUTH - Spectrum
 AZYMUTH - Outubro
 AZYMUTH - Light As A Feather
 AZYMUTH - Rapid Transit *Sale*
 BILLY COBHAM - Spectrum *Sale*
 JOHN COLTRANE - Soul Train *U.S. Import*
 MILES DAVIS - Kind Of Blue *U.S. Analogue*
 MILES DAVIS - Sketches Of Spain *U.S. Analogue*
 MILES & QUINCY - Live At Montreux
 ELEMENTS - Elements
 ELEMENTS - Blown Away
 ELEMENTS - Illumination
 ELIANA ELIAS - Cross Currents
 BILL EVANS - More From The Vanguard
 BILL EVANS - Blue In Green *U.S. Import*

COOKING VINYL:

BILLY BRAGG - Back To Basics 2LP
 BILLY BRAGG - Victim Of Geography 2LP
 BILLY BRAGG - Don't Try This At Home
 REV HAMMER - The Bishop Of Buffalo
 JACKIE LEVEN - The Mystery Of Love Is Greater... 2LP
 TOM ROBINSON - Love Over Rage
 C. GREGSON & C. COLLISTER - Home & Away
 BRUCE COCKBURN - Live
 JUNE TABOR - Against The Stream

MOBILE FIDELITY: 200gm HQ LP

BUY ANY TWO TITLES @ £22 - SAVE £6 OR MORE

BUY ANY FIVE TITLES @ £21 - SAVE £20!

(ALSO AVAILABLE ON 24 ct GOLD CD @ £24 EACH)

MANHATTAN TRANSFER - Extensions £25
 MUDDY WATERS - Folk Singer *Stunning* £25
 PINK FLOYD - Atom Heart Mother £25
 EMERSON LAKE & PALMER - Tarkus £25
 ALAN PARSONS PROJECT - Tales Of Mystery... £25
 MODERN JAZZ QUARTET - Blues At Carnegie £25
 STAN GETZ & JOAO GILBERTO - Getz/Gilberto £25
 TRAFFIC - Low Spark Of High Heeled Boys £25
 JEAN MICHELL JARRE - Oxygene *Classic* £25
 MODERN JAZZ QUARTET - Modern Jazz Quartet £25
 DAVE BREWBECK - We're All Together Again *Features the legendary Gerry Mulligan* £25
 THE MOODY BLUES - Threshold Of... £25
 QUEEN - The Game £25
 DUKE ELLINGTON - Anatomy Of A Murder £25

GRP JAZZ: VINYL

KEVIN EUBANKS - Face To Face £9
 KEVIN EUBANKS - Heat Of The Heat £9
 KEVIN EUBANKS - Shadow Prophets £9
 KEVIN EUBANKS - The Searcher £9
 GARFIELD - Am I Cool Or What £9
 DIZZY GILLESPIE - New Faces £9
 DAVE GRUSIN - The NY LA Dream Band £9
 DAVE GRUSIN - One Of A Kind £9
 DAVE GRUSIN - Mountain Dance £9
 DAVE GRUSIN - Sticks And Stones £9
 OMAR HAKIM - Rhythm Deep £9
 JOHN PATITUCCI - John Patitucci £9
 JOHN PATITUCCI - On The Corner £9
 RIPPINGTONS - Tourist In Paradise £9
 RIPPINGTONS - St. James £9
 ARTURO SANDOVAL - Flight To Freedom £9
 LEE RITENOUR / DAVE GRUSIN - Harlequin £9
 LEE RITENOUR - Rio £9
 LEE RITENOUR - Earth Run £9
 LEE RITENOUR - Portrait £9
 LEE RITENOUR - Festival £9
 LEE RITENOUR - Color Rit £9

ROCK & POP ON VINYL

ACOUSTIC ALCHEMY - Natural Elements
 ACOUSTIC ALCHEMY - Blue Chip
 ACOUSTIC ALCHEMY - Red Dust & Spanish Lace
 ANITA BAKER - The Songstress *U.S. Original*
 CHUCK BERRY - 6LP Box Set £28
 DAVID BOWIE - Black Tie White Noise £12
 TONI BRAXTON - Toni Braxton £12
 ERIC CLAPTON - Unplugged 2LP £15
 PHIL COLLINS - Hello I Must Be Going £8
 RY COODER - Borderline *Sale* £9
 RY COODER - Get Rhythm *Sale* £9
 RY COODER - Bop Till You Drop *Sale* £9
 RY COODER - The Slide Area *Sale* £9
 RY COODER - Johnny Handsome *Sale* £9
 ELVIS COSTELLO - Spike *Sale* £8
 ELVIS COSTELLO - Armed Forces *Sale* £8
 ELVIS COSTELLO - Imperial Bedroom £10
 TOMAS DOLBY - Aliens Ate My Buick *Sale* £6
 DOORS - Full Circle £9

JAZZ ON VINYL

CURTIS FULLER - Four On The Outside £8
 FUSE ONE - Silk £10
 STAN GETZ - Billy Highstreet Samba £10
 STAN GETZ - Voyage £10
 BOB JAMES - Ivory Coast *Superb* £10
 AL JARREAU - High Crime *Sale* £12
 CAROL KIDD - When I Dream £10
 STEVE LACY - Anthem £10
 JEFF LINSKY - Up Late £15
 LORNE LOFSKY - Guitarist £8
 PAT METHENY - Road To You 2LP £8
 PAT METHENY - Still Life Talking £8
 PAT METHENY - Secret Story 2LP £8
 FRANK MORGAN / GEORGE CABLES - Double Image £10
 MYNTA - India Times *Indo jazz fusion* £9

BLUES ON VINYL:

JOHNNY ADAMS - Room With A View Of The Blues £8
 WILLIE DIXON - Ginger Ale Afternoon £9
 BUDDY GUY & JUNIOR WELLS - The Original Blues Brothers £8
 JOHN LEE HOOKER - Boom Boom £10
 JOHN LEE HOOKER - In Person £8
 LIGHTNIN' HOPKINS - Double Blues £13
 BLIND LENNON JEFFERSON - One Dime Blues £9
 B.B. KING - At The Apollo £7
 MUDDY WATERS - I'm Ready £8
 SONNY TERRY - Sonny's Story £10

ORIGINAL MASTER RECORDING™

SAVE £20

MUDDY WATERS

folk singer

MUDDY WATERS - Folk Singer
 200gm SUPER VINYL £25 & GOLD GAIN CD £24

GRP JAZZ: VINYL

DIANNE SCHUUR - Deedles £9
 DIANNE SCHUUR - Pure Schuur £9
 DIANNE SCHUUR - Collection £9
 DIANNE SCHUUR - Schuur Thing £9
 DIANNE SCHUUR - Talkin' About You £9
 DIANNE SCHUUR - With The Count Basie Orchestra £9
 TOM SCOTT - Flashpoint £9
 TOM SCOTT - Streamlines £9
 SPECIAL EFX - Special EFX £9
 SPECIAL EFX - Modern Manners £9
 SPECIAL EFX - Slice Of Life £9
 SPECIAL EFX - Mystique £9
 SPECIAL EFX - Double Feature £9
 SPECIAL EFX - Confidential £9
 SPYRO GYRA - Fast Forward £9
 SZAKSI - Sa-chi £9
 DAVE VALENTIN - Live At The Blue Note £9
 DAVE VALENTIN - Jungle Garden £9
 DAVE VALENTIN - Light Struck £9
 DAVE VALENTIN - Mind Time £9
 DAVE VALENTIN - Flute Juice £9
 UTAKA - Yutaka £9

ROCK & POP ON VINYL

DOORS - L.A. Woman £9
 BOB DYLAN - Good As I Been To You £8
 EAGLES - Hotel California *Sale* £7
 EAGLES - Best Of The Eagles *Sale* £7
 EARTH WIND & FIRE - Way Of The World £10
 DONALD FAGEN - Kamakiriad £12
 ENYA - The Celts *Recommended* £12
 FLEETWOOD MAC - Mirage £8
 GENESIS - Duke £8
 GENESIS - Wind & Wuthering £8
 GENESIS - Invisible Touch £8
 NANCY GRIFFITH - Late Night Grand Hotel *Sale* £6
 CHRIS ISAAK - San Francisco Days £12
 SLY & THE FAMILY STONE - Riot Going On *U.S. pressing* £10
 U2 - Achtung Baby *Sale* £8
 U2 - Zoozopa *Sale* £8
 Neil Young - Harvest £10
 NEIL YOUNG - Zuma £10
 NEIL YOUNG - American Stars & Bars £9

JAZZ ON VINYL

ART PEPPER - No Limit *U.S. Analogue* £10
 FLORA PURIM - 500 Miles High *At Montreux* £10
 FLORA PURIM - Love Reborn *Sale* £8
 JASON REBELLO - A Clearer View £8
 JOE SAMPLE - Carmel £8
 JOE SAMPLE - The Hunter £7
 DAVID SANBORN - Backstreet £9
 DAVID SANBORN - Up Close *U.S. Import* £8
 MOACIR SANTOS - Opus 3 No. 1 *Brazilian jazz* £10
 CAL TJADER - Aqua Dulce *Analogue* £8
 CAL TJADER - Last Night When We... *U.S. Import* £8
 BEN WEBSTER - Ben & Sweets £7
 KIRK WHALUM - And You Know That £7
 YELLOW JACKETS - The Spin £10
 ZAWINUL SYNDICATE - Black Water £6

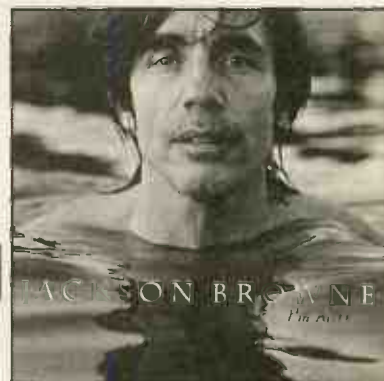

JACKSON BROWNE - I'M ALIVE
 Vinyl LP £12.50

WHAT PEOPLE ARE SAYING

"YOUR CATALOGUE IS AN ALADIN'S CAVE FOR ANY MUSIC LOVER."

MR. S. CLAYTON - BOURNEMOUTH.

"LET ME CONGRATULATE YOU ON THE FASTEST, MOST EFFICIENT MAILORDER SERVICE THAT IT HAS BEEN MY PLEASURE TO PURCHASE FROM. MOREOVER MY RECORDS ARRIVED IN PRISTINE CONDITION."

MR. A. HUTCHINS - WESTERN AUSTRALIA

Hearing Is Believing

Equipment by Sugden, Pink Triangle, ProAc, Castle, Audio Innovations, Michell, Harman Kardon, NAD, Revolver, Rothwell, Trichord Research.

Demonstration by Appointment

Only Sugden and ProAc Dealer in West Scotland

=====
=====
=====
The
Sound
=====
=====
=====
Foundation

01563 574185

22 Nelson St., Kilmarnock, Ayrshire, KA1 1BA

Simply The Best

NORTHWOOD AUDIO

0% credit
part exchange
Mail Order

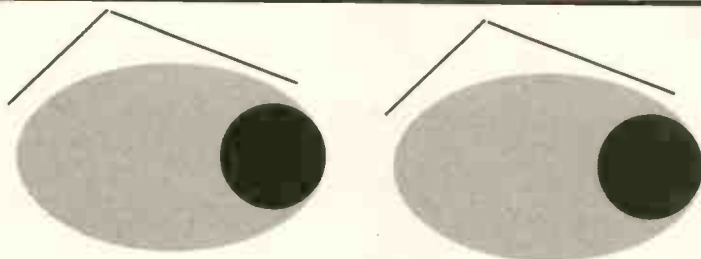

Dem Rooms
7 - Day Exchange
Free Installation

Look At What We Offer

Part Exchange, 0% Credit Facilities, Dem rooms, Wide choice of equipment, Free installation and delivery, 7 day exchange plan, Mail Order

We are at:
126 PINNER ROAD
NORTHWOOD
MIDDX
HA6 1BP
Tel: 0923 820877

and also at:
98 Cambridge Street
Aylesbury
Bucks
HP20 1BP
Tel: 0296 28790

Products stocked include:

Alphason, Aura, Akai, Alchemist Products, Audio Alchemy, Audio Innovations, Audio Technica, B&W, Boston, Cable Talk, Canon, Castle, Celestion, Cerwin Vega, Denon, Exposure, Harmon Kardon, Heybrook, Infinity, Ixos, JBL, JPW, KEF, Marantz, Michell, Micromega, Moth, NAD, Nakamichi, NVA, Ortofon, Perfect Pitch (Dacula), Pioneer, Project, QED, Rose, Rotel, Royd, Ruark, Sequence, Sennheiser, Stax, Tannoy, Target, TDL, Thorens, Triangle



MEASURED PERFORMANCE

It's important to measure products to assess performance, find explanations of sound quality and warn of peculiarities or faults. Only Hi-Fi World has an advanced in-house laboratory with digital signal analysis for this purpose. In conjunction with this facility we assess sound quality in our own acoustically treated listening room. We measure most products reviewed. Here's a simple guide on our test results.

LOUDSPEAKERS

Smooth, flat frequency response is important to ensure a balanced sound. Look carefully at overall trends; rising treble will give a bright sound, falling treble a dull sound. A rise through the midrange normally corresponds with good projection.

High sensitivity (better than 86dB) means less power is needed for a certain volume, meaning a low power amp. can be used.

The impedance curve tells us how easy loudspeakers are to drive. Low or wildly varying impedance is bad; a flat impedance around 8Ω is good.

CD PLAYERS

Even small trends in frequency response of CD players can effect their subjective balance. Generally, those with a gently rolled off treble and, more rarely, a rising

bass will sound best. Rising treble can produce a sharp sound.

The distortion plot we show is taken at -30dB, to represent a typical music signal. High distortion at this level, combined with rising treble can result in a harsh sound. Yet other effects have to be considered, especially low level linearity, which we also test for, including -90dB signals with dither applied.

AMPLIFIERS

The lower the distortion, the smoother an amplifier will sound. Distortion from solid state amplifiers should be no more than around 0.2%. Even order (2nd, 4th, 6th etc) distortion is aurally innocuous, but odd order (3rd, 5th, 7th etc) distortion makes for a glassy hard sound, or grittiness.

Frequency response can be band limited, with bass and treble rolled off just out of the ear's range, or wideband. Each has its own characteristics. Small wideband response variations colour tonal balance.

Power output is easy to understand: the higher the figure, the louder it will go. Just make sure there's enough power output to drive any loudspeakers you intend to use.

TUNERS

Frequency response, as always, says much about tonal balance and character traits, like

peaky treble (due to a mis-matched MPX filter). Distortion and channel separation need to be less than 0.3% (according to harmonic structure) and better than 25dB.

Hiss level must be better than -70dB for Radio 3 silences to be just that - silent. And full quieting, the strength of aerial signal needed for optimum results, should be around 1mV or less

Selectivity, the ability to separate stations under the most difficult conditions should be better than 60dB and sensitivity better than 30µV on stereo.

CASSETTE DECKS

Replay performance is measured to IEC 94 Standards using IEC test tapes. This ensures that recordings made on a machine transfer to a car player, personal stereo or another domestic recorder properly, as well as ensuring optimum results with commercially prerecorded tapes. Look for a quoted replay response of 40Hz-10kHz, no more than 1% speed error and hiss in the replay amps lower than -58dB.

Recording quality considers frequency response, bias variation, head performance and alignment. Frequency response should stretch from 40Hz-15kHz or so. Head overload (MOL315) must be above 0dB, reaching around +4dB for good results.

From the transport mechanism look for less than 0.15% wow or flutter. Overall (DIN weighted) wow and flutter should be no more than 0.1% or so.

AMPLIFIERS

FIVE AMPLIFIER TEST

PRO-JECT 7

The Pro-ject has a beefy power supply, demonstrated by its ability to nearly double from 36watts into 8Ω to 64watts into 4Ω. It will cope with difficult loads with ease. The disc stage has a warp filter at 24Hz, giving a little protection to the loudspeakers, but also providing deep and powerful bass from LP. Sensitivity was low though, so the volume will have to be turned up high with MM and MC cartridges.

Power	36watts
Distortion	0.03%

AURA VA-80

Aura's VA-80 only managed 56watts into a 4Ω load; ideally it should be double the 8Ω figure of 50 watts, so driving low impedance loads will not be a strong point. Separation was surprisingly low at 36dB, which will help

to strengthen central images. The Aura VA-80 has no disc stage

Power	50watts
Distortion	0.025%

PIONEER A-300X

The Pioneer has a wide frequency response on both line and phono inputs. This will give good subsonic extension to CD, but record warps will be amplified through the phono stage which may cause some reflex loudspeaker problems. Sensitivity was high at 170mV for line level inputs and the MM was only disc stage extremely quiet.

Power	50watts
Distortion	0.07%

ARCAM ALPHA 5

Frequency response is wide and stretches low to 4Hz giving good subsonic extension for CD. Input sensitivity measured 170mV which makes the Alpha 5 compatible with all

sources. The disc stage has a warp filter at 50Hz, which may give a light bass quality with LP, but will prevent warps from LP reaching the loudspeakers.

Power	55watts
Distortion	0.07%

NAD 304

The NAD is able to deliver high power (150watts) for around one second, which enables it to deal with transients without overload distortion. At heart it is a 50watt amplifier though. The disc stage has a warp filter at 30Hz, which will prevent warp reaching the 'speaker cones without reducing bass weight much. The disc stage is also extremely quiet.

Power	50watts
Distortion	0.013%

SLATE AUDIO



HI-FI Design & Cable Services



THE SPEAKERSTAND

The finest speaker supports in the world.

THE SPEAKER STAND State of the art in both performance and design. custom made to suit any loudspeaker. solid slate, supremely rigid and totally stable.

◀◀ *"Immaculately finished, sublimely rigid, on a par with the best stands I've used." Ken Kessler, Hi-Fi News R/R. "An astonishing degree of instrumental separation, stable and holographic, with great precision and remarkable poise. The ultimate in high fidelity supports." David Prakel, Hi-Fi Answers. Superbly finished, the sound quality was considered to be first rate." Martin Colloms, Hi-Fi News R/R. "The sound quality when using the Slate Audio stands proved to be a revelation, something special." Paul Messenger, Hi-Fi Choice. "the finish is excellent, the sound quality magnificent and breathtaking." Tom Bryant, The Telegraph. "The Slate stand is unusual and expensive. But if you are after an exceedingly neutral stand it's the leading contender. This stand offers an exceptionally neutral platform for speakers; highly transparent sound leads to musical performances with real insight." SOUND QUALITY: ■■■■■ Malcolm Steward Hi-Fi Choice.*

SLATE AUDIO GARRARD 401

The most musical record players in the world.

Dear Mr. Soper,
Thanks for sending me the plinth for my Garrard 401. I must confess, that I was a bit sceptical about it, when I ordered one - after all, I bought it, without the possibility of listening to it first. But the results I get are really unbelievable. There is no rumbling, instead deep, deep bass and an authority, I never heard before from my records. And believe me, I tried some of the best turntables around (LP 12, Xerxes). Now I'm waiting for the forthcoming power-supply. The day I place my order for it, I will do so without being a bit sceptical. Thanks again for a marvellous piece of art.

Yours

MR TEILINGER



THE GLASSMAT

The definitive platter mat.

◀◀ The Glassmat was developed to improve the performance of the Garrard 301 and 401 record players. However it also gives astonishing results when used on other turntables. So effective is its performance, we have now made it available as a universal replacement mat. In all cases other mats introduce colorations of their own, robbing the music of large amounts of detail and ambience. In order to achieve maximum information retrieval with optimum damping, a hard and unyielding material is required. Glass is ideal in every respect, damping is complete, the playing surface being quite simply sublime. In terms of detail resolution and sheer three dimensional ability, no other mat comes close. But then you still have to consider the absolute clarity, precision and solidity of the presentation. This is the ultimate platter mat.

£65.00 PLUS £3.50 FREIGHT. UK MAINLAND

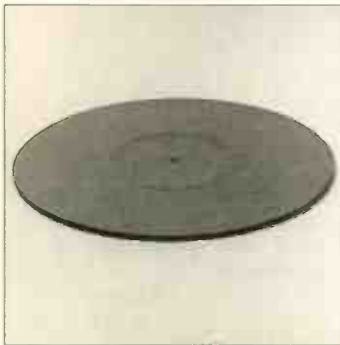

ARRIVING SOON

THE ULTIMATE GARRARD 301/401 POWER SUPPLY

Slate Audio make the best loudspeaker stands in the world, we are able to demonstrate this and prove that a correctly engineered support is not merely an accessory. Having established ourselves as world leaders in stand design, we have now turned our attention to other areas of interest. We continue to apply the same strict design principles to all of the projects that we take on. We believe in quality products that people will want to own not just for their performance, but also for their aesthetic appeal. Our insistence on perfection is reflected in all the products that we make. We make no apologies for boasting that our reputation is now legendary.

THE SPEAKERSTAND THE TURNTABLETABLE THE TURNTABLESLAB THE RACK THE TABLESLAB THE SPIKEKIT THE STONESSET

THE SPEAKERCABLE THE TONEARM THE GLASSMATTHE SAQQARA VALVEAMP THE PHONOSTAGE THE POWERHOUSE

SME GARRARD CELEBRATION ARMS SLATE AUDIO GARRARD 301

SLATE AUDIO GARRARD 401

47 GEMINI CLOSE, LEIGHTON BUZZARD, BEDS, LU7 8UD. TEL: 0525 384174

CD PLAYERS

DENON DCD-1015

Denon's Alpha Processing system throws up some peculiar effects on the DCD-1015. Frequency response from a convolved impulse reached just 8kHz (-1dB), a very low value. The usual limit is 21kHz. Our analysis clearly shows early treble roll-off, which was accentuated enough to give a dull sound on cymbals and triangles for example.

Like other digital processing systems, notably PASC, Alpha processing can only be assessed subjectively

Distortion levels were low, if above those of its peers. A peculiar spectrum of distortion harmonics can be seen in our analysis. The sonic impact of this analogue-like spectrum is again best judged by listening tests, but I doubt whether it would be especially noticeable. **NK**

TEST RESULTS

Frequency response	4Hz-8kHz	
Distortion (%)		
-6dB	0.009	0.009
-30dB	0.069	0.069
-60dB	0.47	0.47
-90dB	12	13
-90dB dithered	8	11
Separation (dB)	left	right
1kHz	106	106
10kHz	81	80
Noise	-93dB	
with emphasis	-93dB	
Dynamic range	109dB	
Output	2.15V	

JVC XL-Z547

The JVC XL-Z574 has a beautifully engineered frequency response. It is extremely flat with just a slight lift in the bass to add solidity to the sound, plus a smooth treble roll off with no peaking or ripple.

Distortion was very low too, bettering the Pink Triangle Ordinal's 0.38% (previously the lowest we've measured) distortion at -60dB with an amazingly low 0.32%. At -30dB, the smallest amounts of 2nd and 3rd harmonic are just visible, but so low that I wouldn't expect them to affect the sound adversely.

Elsewhere the JVC shows quality engineering with wide separation, low noise and output only fractions of a volt below the 2V standard. **DB**

TEST RESULTS

Frequency response	4Hz-21.1kHz	
Distortion (%)		
-6dB	0.005	0.005
-30dB	0.006	0.006
-60dB	0.32	0.32
-90dB	28.5	28.3
-90dB dithered	9.6	8.2
Separation (dB)	left	right
1kHz	120	120
20kHz	102	101
Noise	114dB	
with emphasis	114dB	
Dynamic range	111dB	
Output	1.98V	

LINN MIMIK

The Mimik's frequency response has been tailored to give a small amount of treble lift, which will either give the impression of extra detail or sharpness, depending on the level of distortion this player produces, and its nature. Bass has a subtle lift too, which will help to give the Mimik a solid bottom end.

Distortion, although low at -30dB as shown in the plot below, rose strongly as signal level decreased. Here the similar Quad 67 measured considerably better, having around half of the distortion, but, at the end of the day, the effects of this can only be judged in a listening test.

Elsewhere the Mimik measured well enough; output was very close to the Philips 2V standard, noise a little higher than normal at -86dB and dynamic range reduced to 97dB because of the high distortion at -60dB (EIAJ test). **DB**

TEST RESULTS

Frequency response	4Hz-21.25kHz	
Distortion (%)		
-6dB	0.007	0.007
-30dB	0.03	0.03
-60dB	1.25	1.73
-90dB	57.7.0	43.5
-90dB dithered	15.9	16.3
Separation (dB)	left	right
1kHz	83	87
20kHz	81	80
Noise	-81dB	
with emphasis	-86dB	
Dynamic range	97dB	
Output	1.98V	

Distortion

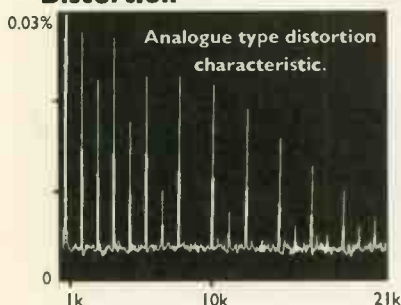

Distortion

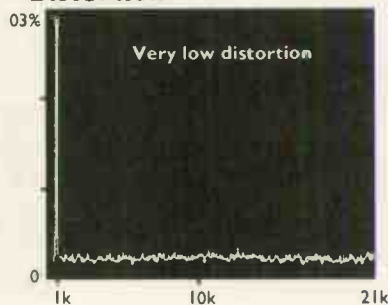

Distortion

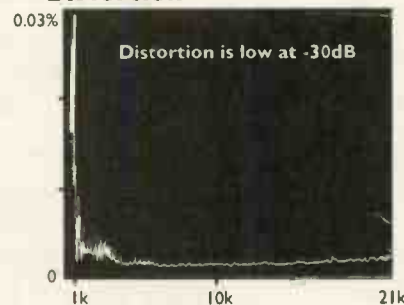

Frequency Response

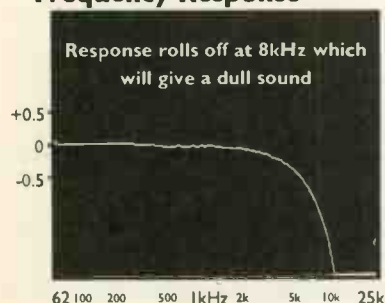

Frequency Response

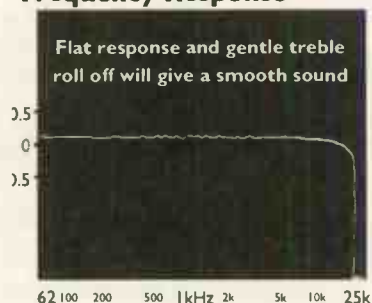

Frequency Response

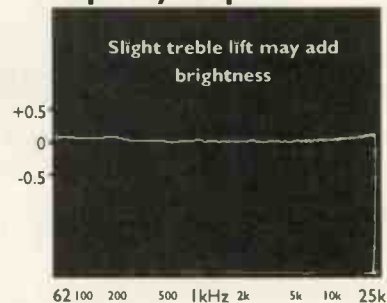

hi Best prices for new, xdem & s/h equipment fi

Jadis JA500 (new tube/service)	mint s/h	£9000	ATC SCM 20	mint s/h	£995
Jadis DEFY 7	as new	£3500	Apogee Dueta Sig.	mint s/h	£1995
Krell KSA 250	mint s/h	£3500	Apogee Diva + DAX	mint s/h	£4995
Krell KSA 200	mint s/h	£2750	Apogee Caliper Sig.	mint s/h	£1495
Krell KSA 80	mint s/h	£1795	Apogee Stage	mint s/h	£1495
Gold Mund MIMES/S 3	mint s/h	£2995	Magneplanar 2.5R	mint s/h	£995
Jeff Rowland Model 1	mint s/h	£1500	Epos ES 14 + stds	mint / g.c	£495/£395
Chord SPM 1400 monoblocks	mint s/h	£3500	Spica TC 50	x-dem	£350
Lumley Stereo 70	as new	£1295	Spica Angelus	x-dem	£895
Musical Fidelity P180 + CRPS	mint s/h	£895	Infinity Kappa 9	mint s/h	£1795
Musical Fidelity P270 mkII	mint s/h	£795	Infinity IRS BETA	mint s/h	£4995
Conrad Johnson MV50	mint s/h	£795	Acustat Spectral 2	mint s/h	£995
Conrad Johnson MV 125	mint s/h	£2250	Meridian M2 active + stds	mint s/h	£350
Mark Levinson No 27	mint s/h	£2500			
Grant G100/AMS pre/monoblocks	mint s/h	£895	Mark Levinson 30.5/31	mint s/h	£14995
Cadence M2/MA2 pre/monoblocks	x-dem	£1995	Wadia 15 D to A	x-dem	£2250
Michaelson Chronos pre/pwr	mint s/h	£3500	Wadia 20 transport	x-dem	£3500
YBS Signature monoblocks	mint s/h	£5995	Meridian DPS 565	as new	£1500
Nestorovic A1 monoblocks	mint s/h	£1995	Wadia 3200 transport	mint s/h	£995
LFDA PA1 pwr amp	mint s/h	£495	Wadia 6 transport	mint s/h	£2250
Roksan M1 monoblocks + L1 pre	mint s/h	£2995	Meridian 206 Delta/Sigma	mint s/h	£650
Audio Note OGANKU	mint s/h	£22500	Meridian 206 B	mint s/h	£595
Audio Note M7 pre	mint s/h	£6500	Meridian 206	mint s/h	£550
Naim 52/135/CDs	mint s/h	£7500	Pioneer PD 802	as new	£250
Audio Research SP15 mkII	mint s/h	£2995	Arcam Alpha Plus	mint s/h	£250
Audio Research SP14	mint s/h	£1995	Pioneer PD 19	mint s/h	£450
Audio Research SP11 mkII	mint s/h	£1695	Revox H2	as new	£595
Jeff Rowland Coherence II	mint s/h	£2995	Meridian 606 D to A	mint s/h	£795
Audio Research LS5	mint s/h	£2995	Sony 337 ESD	mint s/h	£350
Conrad Johnson PREM 7B	mint s/h	£6995	Philips CD 850 mkII	mint s/h	£175
Audio Innovations S1000	mint s/h	£895	Krell DT 10 transport	mint s/h	£5500
Meridian 201	mint s/h	£795	DPA 1024 D to A	mint s/h	£3500
Sonic Frontier SFL-1	mint s/h	£795	Naim CDI	mint s/h	£1200
Classe DR6	as new	£2800	Meridian 263 Delta Sigma	mint s/h	£295
CAT SL1 pre/phono	mint s/h	£3300	Stax Talent D to A	mint s/h	£795
Tesserac Reference pre-amp	x-dem	£3995	Teac T 700 transport	mint s/h	£695
Tesserac Reference monoblocks	x-dem	£3995	Microseiki CDM 100	as new	£2250
Tesserac Line pre-amp	x-dem	£995			
			Alphason Symphony/HR 100mcs	mint s/h	£1295
Sonus Faber Extrema + stands	mint s/h	£3995	Atlas psu.		
Quad ESL 63 + Gradient s/woofer	mint s/h	£2800	Pier Lume J1/SME V	mint s/h	£1995
Gradient sub woofer (SW63)	mint s/h	£1395	Roksan Xerxes/RB 250/XPS2	mint s/h	£550
Sonus Faber Minima Amators	mint s/h	£995	TNT mkII	mint s/h	£1995
Acoustic Energy AE1	x-dem	£595	Roksan Radius/Tabriz	mint s/h	£350
Acoustic Energy AE2	x-dem	£795	Koetsu 80th Anniversary	mint s/h	£1295
Snell JII's	mint s/h	£450	Koetsu Red	mint s/h	£395
Audio Note ANK	mint s/h	£250	Van Den Hul MC1	mint s/h	£395
Naim SBL's	mint s/h	£995	Linn Klyde	mint s/h	£295
Celestion SL600 si	mint s/h	£495	Kinshaw phono stage	mint s/h	£295
ProAc EBS	mint s/h	£895	VPI 16.5 and 17 Record Cleaning	m/c	£450/£75

MINT S/H - Second hand as good an example as we've seen anywhere

AS NEW - Typically less than 4 months old in new condition

X-DEM - Typically 'as new' but may be older

G.C/V.G.C - In perfect working condition but may be marked

hi CHOICE fi

(081) 392 1959

(081) 392 1994 phone/fax

Equipment bought or part exchanged

Full demonstration facility - by appointment

Major credit cards accepted
9.30am - 8.00pm 7days

STILL CAN'T FIND WHAT YOU'RE LOOKING FOR TRY The Hi-Fi Exchange

The Hi-Fi Exchange is a new and unique service that allows you to buy and sell equipment using our sophisticated data base.

Please call 081 392 1963
for details.

CLASSIQUE SOUND (LEICESTER)

VINTAGE HI-FI SPECIALIST

QUAD 11 PAIR EX COND	£1350 00	LEAK STEREO 2C REBUILT	£350.00
RADFORD STA25 REBUILT	£425 00	RADFORD SC22 PRE AMP	£99.00
LEAK TL10 PAIR REBUILT	£350 00	LEAK STEREO 2C REBUILT	£225.00
ARMSTRONG 410 & P/AMP	£125 00	QUAD 11 PAIR GOOD COND	£325.00
AEI VALVE AMP & P/AMP	£100 00	QUAD FM2 TUNER VALVE	£95.00
QUAD FM1 MONO TUNER	£40 00	LEAK TROUGHLINE 3 STEREO	£150.00
LEAK TROUGHLINE 2 MONO	£75 00	SME 3009 TONE ARM	£60.00
QUAD 22 PRE AMPLIFIER	£50 00	DECCA MARONJ CARTRIDGE	£40.00
DECCA FE55 ARM & HEAD	£70 00	DECCA PROFESSIONAL ARM	£35.00
SHURE V15 MK3	£40.00	SHURE V-5 MK4	£50.00
QUAD 406 MK2	£199.00	ACOS LUSTRE ARM BOXED	£50.00
THORENS TD 150	£30.00	LEAK 300 SPEAKERS	£50.00

QUAD ELS63 SPEAKERS IN MINT CONDITION	£1195.00
QUAD ELECTROSTATIC SPEAKERS PAIR BRONZE FINISH EX CONDITION	£495.00
QUAD ELECTROSTATIC SINGLE BRONZE FINISH	£75.00
LECSON HL 1 HORN LOADED LOUDSPEAKERS MINT CONDITION	£325.00
TOWNSEND AVALON/MOTH TONE ARM	£79.00
AUDIO INNOVATIONS S/500 INTEGRATED AMPLIFIER MINT CONDITION	£495.00
QUAD 605 POWER AMPLIFIER UPGRATED TO MK11 BY QUAD	£395.00
REVOX G36 GOOD CONDITION SUITABLE FOR SPARE OR REPAIR	£25.00
REVOX G36 VALVE HALF TRACK REEL TO REEL EX CONDITION MINT	£475.00
TROUGHLINE 3 MONO STEREO DECODER FITTED NEEDS REPAIR	£40.00
GARRARD 301 CHASSIS FULLY SERVICED IN GOOD CONDITION	£150.00
GARRARD 401 CHASSIS FULLY SERVICED IN GOOD CONDITION FROM GARRARD 301/401 AND THORENS 124 PLINths FROM GARRARD 301/401 POWER SUPPLY USING TOROIDAL TRANSFORMERS	£100.00

VINTAGE VALVE AMPLIFIER REBUILDS

LEAK TL10 (PAIR)*	£175.00	LEAK TL12+ (PAIR)*	£175.00
LEAK STEREO 2C*	£176.00	QUAD 11 (PAIR)*	£150.00
AVATIC DL7/35 (PAIR)	£200.00	ROGERS CADET 2/3 PWR AMP*	£100.00
RADFORD STA12/15	£200.00	RADFORD STA25	£300.00

ALL REBUILDS INCLUDE GOLD PLATED SOCKETS AND ALL PARTS EXCEPT VALVES. OTHERS BY NEGOTIATION. RING FOR QUOTE.

ITEMS MARKED WITH * AVAILABLE ON SAME DAY SERVICE. ADD £20.00 (STRICTLY BY APPOINTMENT ONLY)

301/401 SERVICE £50.00 THORENS 124 SERVICE £50.00

INTERCONNECT CABLES USING 99.99% PURE SILVER STRANDS FOR UNDER £60.00. IMPOSSIBLE OR IS IT?

UNLIKE MANY CABLES CLASSIQUE SOUND NEW "TRANSLUCENT" INTERCONNECT CABLES ARE MADE USING PURE 99.99% PURE SILVER STRANDS ON THE POSITIVE AS WELL AS THE NEGATIVE RETURN OF THE CABLES. MANY MORE EXPENSIVE CABLES USE SILVER STRANDS FOR THE POSITIVE AND SILVER PLATED OR COPPER FOR THE NEGATIVE RETURN. IN VARIOUS LISTENING TESTS IT WAS FOUND THAT BY USING PURE SILVER FOR THE NEGATIVE RETURN, A MORE DETAILED AND MORE DYNAMIC SOUND WAS HEARD WITH A MUCH DEEPER AND WIDER SOUNDSTAGE.

ALL CABLES ARE TERMINATED USING QUALITY GOLD PLATED PLUGS AND ARE DOUBLE SCREENED. HALF METRE TERMINATED £59.99 ONE METRE TERMINATED £79.99 EACH ADDITIONAL 1 METRE ADD A FURTHER £5.00

VINTAGE VALVE EQUIPMENT ALL WAYS WANTED FOR CASH
CLASSIQUE SOUNDS, CLASSIQUE HOUSE, 61 AYLESTONE DRIVE, AYLESTONE, LEICESTER, LE 2 8QE TEL/FAX PAUL GREENFIELD UK + (0116) 2835821 ANYTIME EXPORT ENQUIRIES WELCOME

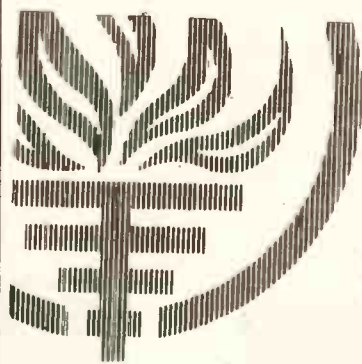

REFRESHINGLY DIFFERENT

the powerplant

CYRUS, REGA and ARCAM products now on demonstration

Roksan, Micromega, Audiolab, Rega, Arcam, Aura, ATC, Exposure, Marantz, Ruark, Epos, Thiel and other fine equipment

66 Upper North Street Brighton O273 775978

LOUDSPEAKERS

MISSION 733

Using pink noise to measure frequency response I could hear deep and powerful bass from these speakers. This was confirmed by the response plot, which shows that the 733s extend well down and have a rising bass response.

This extra bass output is balanced at the other end of the spectrum by a rising treble, seen clearly between 12-16kHz. Depending on the quality of the tweeter used, this will manifest in listening tests either as added sharpness or extra apparent detail in the high treble. However, to be on the safe side, I'd steer clear of matching with bright sounding ancillaries.

As with most of Mission's loudspeakers, the 733s are easy to drive. Sensitivity was above average at 87.5dB at 1m using a nominal watt (2.83V) pink noise test signal, and overall impedance high at 9.5Ω. So the 733s will go loud with few watts, and won't demand high current from partnering amplifiers. I'd recommend a minimum of 20watts for good level in a typical room. **DB**

Frequency Response



Impedance

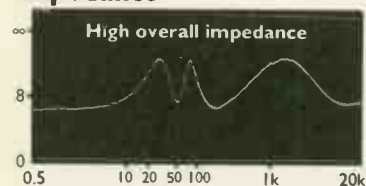

the plane of the drivers. I suspect that this will result in a less than cohesive image at the listening position, although the sound may be spacious and open.

As far as driving the Heystaks goes, they're easy. A smooth impedance curve never dipping below 5Ω and averaging out at 7.5Ω means that even valve amplifiers will have little difficulty driving them. A high measured sensitivity of 90.5dB means that few watts will be needed for high sound pressure levels too. I'd recommend amplifiers of 20watts or more for best results. **DB**

Frequency Response



Impedance

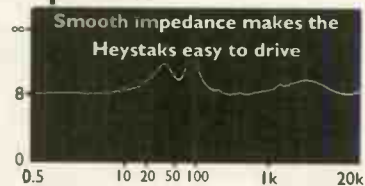

JAMO 307

Jamo's 307s don't go especially deep, as can be seen from the falling bass response in the plot below, but this is no bad thing if they are to be used on a shelf against a wall where some reinforcement will take place. I would expect them to sound tight and clean as a result, where some speakers would boom.

Further up in the response the 307s are reasonably tame; a slight lift around 1kHz will help to push detail forwards and the rising level towards the upper treble may give them a lightweight balance, but they should stay smooth all the same.

With a sensitivity of 86dB, measured at 1m using a nominal watt (2.83V) pink noise signal, the 307s will go quite loud for a miniature. Their overall impedance of 7.2Ω means they will draw a little more power

than a typical British loudspeaker which tend to average around 10Ω, but any modern solid state amplifier should have no problems. I'd recommend 30watts minimum for good volume. **DB**

Frequency Response

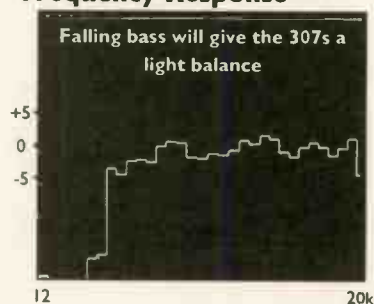

Impedance



MISSION 731

Whilst the 760s are an affordable audiophile loudspeaker aimed at the UK, the new 731s are a Euro-speaker preened for success overseas. They have a treble peak and bass lift, to give a more exciting balance, with sparkling treble and punchy bass. These speakers won't necessarily be the last word in refinement or neutrality, but they could certainly add some useful speed and excitement to budget hi-fi systems possessing limited dynamic ability.

Mission's 731s are easy to drive. They have a high overall impedance and just above average sensitivity, exactly the kind of easy load that is needed for budget amplifiers. The impedance curve holds no nasty surprises either, staying high over the audio band and never dipping below 6Ω at any point.

The 731s are an interesting loudspeaker. They have been boosted up at frequency extremes for a lively and exciting balance and are an easy load for low power amplifiers. They could well bring a pleasant injection of energy to budget systems. **DB**

HEYBROOK HEYSTAK

Although Heybrook's new Heystaks appear to have an extremely flat response from the plot below, moving the microphone just centimetres altered the response completely, suggesting strong phase problems. Even with the pink noise test signal I could hear the tweeter coming in and out of phase as I moved my head up



Don't let your
LISTENING ROOM
spoil his performance.

With the help of

Room Acoustics Services

you can achieve near concert hall realism,
in harmony with your home decor.

Full details, reviews etc, of our computerised postal
Hi-Fi room acoustics consultancy available from:-

ROOM ACOUSTICS SERVICES

3, Queen Elizabeth Way, BARTON-upon-HUMBER,
South Humberside, DN18 6AJ. Tel: (0652) 635523

CLEARAUDIO, S.M.E, AUDIO RESEARCH, CREEK, E.M.F, GRAHAM

HEATHERDALE AUDIO LTD.

202, Findon Road, Findon Valley, Worthing, West Sussex.
Tel. 0903-872288 or 0860 660001 (after hours) Fax 0903-872234

This months pre-owned bargains:		
Audio Research SP9 pre-amp (black)		£1295
Linn LP12/SME/Drt.MC20 cartridge		£795
Musical Fidelity P180 p/amp & psu	£895	Audionote ANJ speakers, from;
Musical Fidelity MX pre-amp	£295	Apogee Centaur Minor loudspeakers
Grant G200 AMS valve mono amps (pair)	£1995	Tannoy Buckingham loudspeakers
Grant G100P/PSU1 pre-amp	£350	Pioneer CT 93 Reference cass' deck
Magnum Reference 300 pre-amp	£325	Linn Sara speakers
Musical Fidelity A100 int. amp	£250	Diamond Acoustic ref. 2 nd inc. stands
Audio Innovations 1 st Audio	£995	Nakamichi Hi-Com Noise red' system x 2
Audio Innovations 1000 pre-amp	£995	Classe' Stereo power amp 100 watt
Audio Innovations 200 power amp	£295	Lumley 120 monoblocks (switchable)
Audio Innovations 300 int. amp	£375	Nakamichi 1000 ZXL cassette deck (rare)
Audio Innovations 800 MC transformer	£120	Magnepan SMGb speakers (new unopened)
Linn LP12	£395	Audio Research D400 amp (ex demo)
Wadia X 32 DAC	£795	Mitchell ISD phono stage
Sony 702 DAC	£795	Naim NAT 02 Tuner
		£550

THREE COMFORTABLE DEMONSTRATION LOUNGES.
VISA SWITCH MASTER CARD WELCOME.
WE TAKE PART EXCHANGE ON NEW & USED STOCK

HEYBROOK, MAGNEPLANAR, MARTIN LOGAN, ROTEL, THETA, BASIS

LUMLEY REFERENCE, KRELL, LUMLEY MONITOR, MAGNUM/DYNALAB

VOUD, KLIPSCH, APOGEE, COPLAND, SONNIS FABER, AUDIONOTE, C.A.T

THE EMPORIUM

28 St. Nicholas Street, Diss, Norfolk.
TEL (01379) 650744 FAX (01379) 641932
Open MON - SAT 10.30am - 5.30pm

On demonstration

Posselt speakers 92dB wife friendly with real bass!
fantastic with Leak, Audio Innovations, Naim amps.
Trade in these Isobariks! £2000 pair.

EKOS Arm up to £650, Naim ARO Arm up to £450 &
SME V Arm up to £750 trade in when you buy a
Nottingham Analogue Paragon Arm at £1600.
Parallel tracking you know it makes sense.

•SALE•SALE•SALE•

IAN HARRISON HI-FI
TEL: 0283 702875

SENNHEISER	BEYER	AUDIO TECHNICA		
HEV70 £399	DT911 £170			
HE60 £399	DT901 £155			
HD580P £150				
HD585 £105	IRS990 £155	ATH911 EPOA		
HD1000 £173	IRS790 £140	ATH910P EPOA		
HD25 £115	DT811 £140	ATH90811 EPOA		
ORPHEUS EPOA	DT801 £119			
IS850 EPOA	DT511 £77	KOSS		
IS550 £140	DT431 £89			
IS450 £119	DT411 £55	ESP950 £850		
OTHER MODELS EPOA	OTHER MODELS EPOA	OTHER MODELS POA		
NAKAMICHI	TEAC	AIWA		
DRAGON £2150	V7010 EPOA	XKS9000 EPOA		
CR7E £1850	V8888S £825	XKS7000 EPOA		
DR1 EPOA	R90008 £450			
DR2 EPOA	VRDS-7 £550			
DR3 EPOA	VRDS-10 £699	SONY		
OTHER MODELS EPOA	VRDS-20 £1170			
	X-1 EPOA	DTG60ES £699		
	X-1S EPOA	TCDD7 EPOA		
		PCM2300 EPOA		
		PCM2700 EPOA		
QUAD	OED			
CD67 £725	DIGIT £109	MARANTZ		
77 POA				
86 £775	DIGIFLEX £16			
806 £625	DAC PACK £169	CD63 £199		
34 £265	DIGIT REF £350	CD53 £160		
FM4 £390	POSITRON £69	CD52 EPOA		
FM66 £485	AMPS EPOA	SD63 £215		
ESL-83 £2500	OPTIFLEX £20	SD53 £185		
		SD415 £169		
DENON	SHURE	ST53 £139		
DL 304 £160	VNSMR £115	ST40L £115		
DL110 £50	OTHER			
DL103 £75	STYL1 EPOA	PM700AV £375		
DL103D EPOA		PM53 £199		
DL160 £70	ME97HE EPOA	PM43 £185		
		PM32 £115		
I also supply				
Kuzma, Benz	TTR117	SR82 £699		
Micro, & Conrad	TEST £12.50	SR73 £599		
Johnson.	RECORD	SR63 £265		

CARTRIDGES

I SUPPLY: AUDIO TECHNICA, ORTOFON, DENON, DYNVECTOR, SHURE, GOLDRING ARCAM & STANTON. TRADE IN YOUR OLD MOVING COIL(S). ANY MAKE, ANY CONDITION AND SAVE UP TO 45% OFF THE NORMAL SELLING PRICE!! NO OLD MOVING COIL? DON'T WORRY, JUST PHONE.

HI FI FURNITURE

I SUPPLY: APOLLO, SOUND ORGANISATION, SOUND FACTORY TRIPOD, SOUNDSTYLE. PLEASE PHONE OR WRITE FOR BROCHURES & PRICES.

CABLES

I SUPPLY: AUDIOQUEST, SONIC LINK, OED & GOLDRING.

TEST CASSETTES AND CDs

I SUPPLY MY OWN REAL TIME, INDIVIDUALLY MASTERED RANGE OF AUDIO TEST CASSETTES FROM £5-£20. THE MULTI-PURPOSE TEST CASSETTE TESTS; DOLBY LEVEL, AZIMUTH, REPLAY FREQUENCY RESPONSE (30Hz-15KH), DOLBY B/C TRACKING & TAPE SPEED. AVAILABLE IN 120us & 70us eq VERSIONS. £20 POST FREE.

I ALSO SUPPLY DENON TEST CD'S INCLUDING THE AUDIO TECHNICAL TEST CO. £12 POST FREE.

BLANK TAPES & ACCESSORIES

I SUPPLY: TOK, MAXELL, SONY, JVC, SCOTCH, AMPEX, BASF, CONICA, PANASONIC, FUJI.

PLEASE NOTE

ALL GOODS ARE BRAND NEW WITH FULL U.K. GUARANTEES
NO EX-DEM EQUIPMENT. INSURED DELIVERY IS £5.
CARTRIDGES ARE POST FREE. PLEASE PHONE PRIOR
TO ORDERING TO CONFIRM PRICE & AVAILABILITY.
MAIL ORDER FROM: IAN HARRISON HI FI,
7 MILL HILL, REPTON, DERBY, DE65 6GQ.
TEL: 0283 702875 9am-9pm. Inc. Sunday



For information on MANA products please contact:
MANA ACOUSTICS, 59 Jubilee Close, Pinner, Middx. HA5 3TB. Tel/fax 081-429 0118

LOUDSPEAKERS

MISSION 73 I

Frequency Response

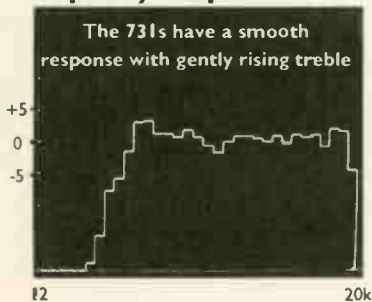

Impedance



KEF CODA 7

KEF's new Coda 7s have a smooth and well balanced frequency response. There is a rising trend towards high frequencies, so they may sound a little lightweight, or bright, although bass extension was good for their size.

Driving the Coda 7s is relatively easy. They have a high sensitivity of 87.5dB, meaning they will go loud with few watts. Their overall impedance averages out to 8Ω, so they will not demand much current either. The impedance curve is a little lumpy, suggesting the Codas are a reactive load. In the bass, impedance falls to around 4Ω, but it is high through the midrange and treble at 10Ω or so. For balanced results, a solid state amplifier will be best because of this, or, possibly, a valve amp. 4Ω tap.

Overall, the KEFs are well engineered for their purpose. An amplifier capable of producing 20watts or more will be sufficient for good levels. **DB**

Frequency Response



Impedance



ROTEL RT-990BX

The RT-990BX has a wide, flat frequency response characterised by a little plateau treble lift, shown in our analysis, and a similar amount of bass lift - just +0.5dB but enough to add some 'weight' to bass

Otherwise, the RT-990BX measured normally - that is to say, well. It has wide channel separation on stereo, produced minimal distortion at less than 0.1%, as our distortion analysis shows, and also produces little hiss. With 0.8mV or more from the aerial, a comparatively low figure suggesting good sensitivity, hiss dropped to -75dB, a little better than usual.

Although the response trace shows no sign of the usual MPX notch filter at 19kHz, there was little unwanted pilot tone (19kHz) or sub-carrier (38kHz) to upset tape recorders by Dolby blocking. An audio output of 800mV was high, allowing this tuner to match into all amplifiers.

Sensitivity was high too and selectivity well defined and both Wide and Narrow IF modes, so the '990 has a good, tidy RF performance. Even the rather crude looking

red LED 'Signal' level display (aerial signal, that is) usefully only lit all five red diodes when the signal was strong enough for best sound quality, namely 1mV. **NK**

TUNER TEST RESULTS

Frequency response	8Hz-17kHz
Stereo separation	42dB
Distortion (50% mod.)	0.07%
Hiss (CCIR)	-75dB
Signal for minimum hiss	0.8mV
Selectivity (at 0.4MHz)	62/80dB

Sensitivity	
mono	2μV
stereo	20μV

signal strength meter

LED No.	level (μV)
1	4
2	10
3	50
4	125
5	1000

Distortion

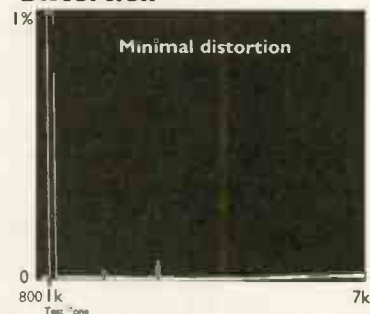

Frequency Response

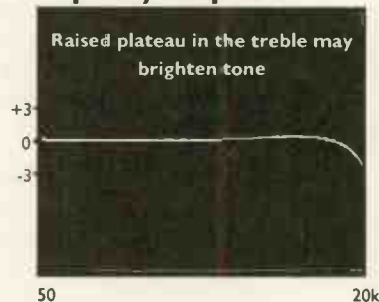

Hi-Fi World Laboratory

Hi-Fi World is Britain's only hi-fi magazine with a sophisticated in-house laboratory. New equipment is put through a rigorous test procedure developed over many years. Four staff engineers ensure that all equipment we review is tested properly and then partnered with suitable equipment, both to show its strengths and to reveal potential weaknesses.

Hi-Fi World's engineers design esoteric

loudspeakers and amplifiers for the DIY Supplements. These designs attract strong interest world wide. Now regular export shipments are made to a number of Far East countries by World Audio Design. Once, only Japan produced magazines sufficiently knowledgeable to design circuits. Now Britain has a magazine that designs, production engineers and exports!

Our aim is simply to find ways of helping

you improve your enjoyment of music, preferably for a reasonable outlay. We are all dedicated music lovers and hi-fi enthusiasts - and we know you are too. In spite of all the tests and engineering - or perhaps because of it - we feel no need for techno-talk in the magazine. But be assured that our reviews are amongst the most accurate and informed anywhere in the World today.

THE RECORD SHOP

66 FIFE ROAD
KINGSTON-UPON-THAMES
SURREY
KT1 1SP
TEL: 0181-546 3880
FAX: 01372 360996
EST. 1968

SPECIALIST IN NEW VINYL RECORDS

John Lee Hooker - Chill Out 9.49
(with Carlos Santan/Van Morrison/Booker T.)

John Mayall - Spinning Coin 9.49
(Follow-up to the excellent LP 'Wake Up Call')

Siouxie & The Banshees - Rapture 8.99
(U.S. Vinyl)

Jayhawks - Tomorrow The Green Grass 9.49
(U.S. Vinyl - eagerly awaited new LP - will be a high point of '95 and we had only heard 4 tracks when putting this together!)

Blues Band - Wireless 8.49
(Unplugged - Acoustic LP)

COMPILATION ALBUM OF '95

Red Hot on Impluse 10.99

Double vinyl with Pharoah Sanders, Alice Coltrane, John Coltrane, Oliver Nelson, Max Roach, Charlie Mingus and Archie Shepp. Pure Magic, cannot recommend more highly - has replaced Buckshot Le Fonque on the deck!

Ween - Chocolate and Cheese 9.49

Porcupine Tree - The Sky Moves Sideways 8.49
(Ambient space rock, sounds like Pink Floyd mid 70's - more like Floyd than Floyd!)

Bruce Springsteen - Greatest Hits 12.95
(Double vinyl with 4 new tracks)

The The - Hanky Panky 9.49
(Double vinyl 2 x 10" Matt Johnson's tribute to Hank Williams)

Esquivel - Space-age Bachelor Pad Music 10.99
(Mega soundtrack sounding stuff from Juan Garcia Esquivel, recorded between 1958-1967, amaze your friends with this one!)

Eric Clapton - Unplugged 10.49

Eric Clapton - From the Cradle 10.49

MOBILE FIDELITY NEW TITLES @ £22

Albert Collins/Johnny Copeland/Robert Cray - Showdown

Allman Brothers Band - Brothers and Sisters

Eric Clapton - (Self titled 1970 album)

Features: Delaney and Bonnie, Carl Radle, Leon Russel, Stephen Stills, Rita Coolidge, Jim Gordon, Bobby Keys & Jim Price.

Emerson, Lake & Palmer - Trilogy

BARGAIN SECTION

David Sanborn - Upfront 5.99

John Martin - Piece by Piece 5.99

Daniel Lanois - Beauty of Wynona 5.99

Frank Sinatra - Greatest Hits (Reprise) 6.99

Paul Brady - Trick or Treat 4.99

Enya - The Celts 6.99

Enigma - Cross of Changes 7.99

John Fahey - Visits Washington D.C. 4.99

POSTAGE & PACKING £2.00 +50p PER ALBUM
THEREAFTER, WE DON'T SKIMP ON THE PACKING - AND ALL LPS
ARE POSTED WITH POLY-LINED INNER SLEEVES

SO PICK UP THE PHONE AND ASK FOR TIM OR MARTIN
(SECOND HAND VINYL ALSO AVAILABLE)

ACCESS/VISA WELCOME

DYNAMICS

HIGH END AUDIO
BOUGHT/SOLD
EXCHANGED

	SALE		LIST
MARK LEVINSON ML7A PREAMP. MINT	2995	S/HAND	£6800
MERIDIAN 602 TRANSPORT 806 DAC 7 LATEST. MINT	£2250	EX/DEMO	£3,100
CARY CAD 5505S PREAMP PREAMP & PROCESSOR. MINT			
MARK LEVINSON ML2 REFERENCE MONO POWER AMPS, BALANCED SUPERB V.G.C.	£1,295	S/HAND	PHONE
METAXIUS ICARUS INTEGRATED AMPLIFIER CHROME. MINT	£595	EX/DEMO	£895
PINK TRIANGLE PIP 2 MK2 VISHAY MODIFIED PREAMP. MINT	£1,795	S/HAND	£4,500
DYNAUDIO CONSEQUENCE SPEAKERS FLAGSHIP MODEL IN CHERRYWOOD DYNAMIC DRAMA. STUNNING MINT	£995	EX/DEMO	£2,250
MERIDIAN ARGENT 3 SPEAKERS ROSEWOOD MINT	£3,995	S/HAND	£15,000
PROAC PROSTATIC ELECTROSTATIC SPEAKERS RARE V.G.C.	£1,295	S/HAND	£8,250
SNELL A3 SPEAKERS WALNUT V.G.C.	£1,795	S/HAND	£4,500
METAXIUS IRAKLIS MK2 POWER AMP CHROME MINT	£3,995	S/HAND	£15,000
AUDIO RESEARCH DI25 KT80 VALVES AMP. MINT	£3,995	S/HAND	£8,250
MUSICAL FIDELITY P270 MK2 POWER AMP. MINT	£5,500	S/HAND	£13,000
APOGEE CALIFORNIA TURNTABLE SPEAKERS GREY MINT	£1,295	S/HAND	£2,500
METAXIUS CHARISMA PREAMP CHROME MINT	£1,795	S/HAND	£4,500
EQUATION ZERO SPEAKERS PIANO BLACK MINT	£3,995	S/HAND	£15,000
QUICKSILVER PREAMP MINT	£2,250	S/HAND	£4,650
MERIDIAN 601 DSP PRE AMP BALANCED MINT	£3,995	S/HAND	£1,500
CARY 2A3 VALVE POWER AMP 15 WATT TRIODE MINT	£1,995	EX/DEMO	£2,750
CARY 300B VALVE MONO POWER AMPS 40 WATT TRIODE	£2,995	EX/DEMO	£4,800
HELVIS CYALENE ARM MINT	£795	S/HAND	£1,400
PINK TRIANGLE DECAPO DAC MINT.	£1,195	EX/DEMO	£1,500
AUDIO RESEARCH M300 MK2 VALVE MONO AMPS MINT.	£4,995	S/HAND	£12,000
CHORD 1200 POWER AMP. MINT.	£1,995	S/HAND	£3,000
CABSSE IROISE MC SPEAKERS CHERRYWOOD MINT.	£1,995	EX/DEMO	£2,700

NEW IN THIS MONTH

MUSICAL FIDELITY 3A PREAMP MINT	£225	S/HAND	£400
RESTEK CHALLENGER INTEGRATED AMP. MINT NEW	£799		
RESTEK EXPONENT REFERENCE MONO BALANCED MINT	£7,495	EX/DEMO	£12,000
DIAMOND ACOUSTIC REF 2 SPEAKERS & STANDS OAK MINT	£395	S/HAND	£2,250
B & W ACTIVE 1 SPEAKERS OAK & STANDS VGC	£395	S/HAND	£1,400
BURMEISTER 846 LINE PREAMP CHROME BALANCED MINT	£795	S/HAND	£1,650
ROKSAN DPI CD TRANSPORT MINT.	£795	S/HAND	£1,195
ENLIGHTENED AUDIO DSP1000 DAC MINT	£595	S/HAND	£1,000
CONRAD JOHNSON PREMIER 3C VALVE PREAMP MINT.	£1595	S/HAND	£3600
CJ PREMIER 4 POWER AMP	£795	S/HAND	£1450
LYNX PULSAR PRE & POWER AMPS MINT	£2495	S/HAND	£4499
MICROMEGA TRIO CD PLAYER MINT	£1495	S/HAND	£2750
KLYNE SK 5A PREAMP MINT	£295	S/HAND	£650
CITATION 18 TUNER ORIGINAL AMERICAN V.G.C	£495	S/H	£1100
MUSICAL FIDELITY MVT 3 PREAMP MINT	£395	S/HAND	£1800
SUGDEN AU51C PREAMP 2 BOC MODIFIED BY AVONDALE V.G.C	£2495	S/HAND	£4000
ROWLAND MODEL 3 MONOS POWER AMP BALANCED MINT	£1550	E/D	£1900
MERIDIAN 605 MONO AMPS BALANCED MINT.	£5995	S/HAND	£11,000
MARK LEVINSON NO 20 REFERENCE MONO BALANCED	£1995	S/HAND	£4400
SOTA COSMOS VACUUM PLATTER MINT	£1495	S/HAND	£2500
CRYSTAL REFERENCE TURNTABLE (WALLMOUNT)	£795	S/HAND	£1500
NAKAMICHI OMS 7E CD PLAYER VGC	£3985	S/HAND	£8000
GRYPHON LTD EDITION PREAMP BALANCED MINT.	£1295	S/HAND	£2550
SNELL TYPE C SPEAKERS WALNUT MINT	£1395	S/HAND	£2100
KEF 105/3 SPEAKERS BLACK ASH MINT.	£1495	S/H	£3395
MENTOR TURNTABLE & ARM GRAPHITE PLATTER MICROSCANNER	£2995	S/H	£6450
CRYSTAL SIGNATURE TABLE TOP TURNTABLE BRUJAR 8 ARM	£2995	S/H	£3800
MARK LEVINSON NO 20 PREAMP FULLY BALANCED MINT	£2995	S/H	£3995
MARK LEVINSON NO 38 PREAMP FULLY BALANCED MINT	£3995	S/H	£7450
MARK LEVINSON NO 23.5 POWER AMP BALANCED MINT	£4795	S/H	£8900
SONUS FABER EXTREMAS & STANDS WALNUT WALNUT MINT	£6495	S/H	£13000
WILSON WATT 2 PUPPY 1 SPEAKERS PIANO BLACK MINT MINT	995	S/H	2500
ORACLE DELPHI MK2 SME IV ARM BIG SUPPLY MINT	2995	S/H	4700
SONIC FRONTIERS SFD-2 DAC BALANCED MINT	595	E/D	900
PINK TRIANGLE ORIGINAL DAC, VARIOUS CHIPS MINT	395	S/H	600
DENON 4400 MONO POWER AMPS BALANCED MINT	2750	S/H	5250
ROWLAND MODELS POWER AMP BALANCED MINT	995	S/H	2000
TDL MONITOR SPEAKERS TEAK MINT			

SALE

SOTA STAR SAPPHIRE 3 TURNTABLE MINT	995	E/D	2500
MARK LEVINSON ML7 PREAMP MINT	1995	S/H	5800
AUDIO RESEARCH SP15 REVISION A BLACK MINT	2995	S/H	7000
COUNTERPOINT SA11 & SA9 PREAMP REMOTE MINT	4995	S/H	12600
QUICKSILVER PREAMP VALVE MINT	795	NEW	1750
QUICKSILVER SILVER MONO AMPS KT88 VALVES MINT	1295	E/D	2250
NRG A401M MONO 400W CLASS A AMPS BAL. MINT	3995	S/H	13000
NRG A201S STEREO AMP 200W CLASS A MINT	2995	S/H	6600
NESTROVIC A1 VALVE MONO AMPS BALANCED MINT	1595	S/H	6600
DYNAUDIO ST70 SERIES 2 VALVE POWER AMP MINT	495	S/H	1100
RUNTESKI CROWN PRINCE SPEAKERS BLACK VGC	2995	S/H	3500
DIAMOND ACOUSTIC REF2 SPEAKERS OAK & STANDS MINT	795	S/H	2250
AUDIO PLAN KONTRAST 2 SPEAKERS ROSEWOOD MINT	1295	S/H	2800
SUMO ARIA PANEL SPEAKERS OAK VGC	795	S/H	3900
GENESIS 8300 SPEAKERS & STANDS PIANO BLACK/MINT	995	E/D	1895
MARTIN LOGAN CLS 1 ELECTROSTATIC SPEAKERS MINT	1095	S/H	3900
MARTIN LOGAN MONOLITH SPEAKERS OAK/MINT	2495	S/H	8000
CONRAD JOHNSON SYNTHESIS REF. SPEAKER SYSTEM 4 TOWER SYSTEM FINISHED IN OAK MINT	3495	S/H	8800
MERIDIAN 204 TUNER MINT	£ 495	E/D	£895
MARK LEVINSON ML7A PREAMP MM/MC MINT	£1395	S/H	£3800
BURMEISTER 838 PHONO STAGE BALANCED MINT	£ 495	S/H	£1500
AUDIO RESEARCH LS1 PREAMP MINT	£795	S/H	£1797
SONUS FABER ELECTA AMATORS & STANDS MINT	£1995	S/H	£3489
KEF 107/2 SPEAKERS & CUBE MAHOAGANY MINT	£2395	S/H	£3800
LYNX ISOBARIC SPEAKERS & STANDS TRIFRAME MINT	£1195	S/H	£2700
ROKSAN XERXES TABLE ARTHEMIZ DS4 SUPP. MINT	£1995	S/H	£2980
CAL TEMPEST 2 VALVE CD PLAYER	£1595	S/H	£3900
ROKSAN DAC & DS4 POWER SUPPLY MINT	£495	S/H	£990
PRIMARE 204 CD PLAYER & REMOTE MINT	£3500	S/H	£5694
MARANTZ 112 TUNER FM MINT	£80	S/H	£190
PHILIPS BLACK TULIP TUNER AM FM MINT	£250	S/H	£560
AUDIO RESEARCH SP9 PREAMP SILVER MINT	£995	S/H	£1899
AUDIO RESEARCH SP14 PREAMP BLACK MINT	£1795	S/H	£3300
FRYSTON 12B PREAMP BALANCED OUTPUT MINT	£1695	S/H	£1295
QUAD 34 PREAMP GREY MINT	£225	S/H	£399
ROWLAND MODEL 1 POWER AMP BALANCED MINT	£1595	S/H	£3150
CLASSE AUDIO DR15 POWER AMP BALANCED MINT	£1895	S/H	£3400
JADIS DEFY DA7 VALVE POWER AMP MK3 MINT	£3500	S/H	£5290
ACOUSTIC ENERGY AE1 SPKS & STDS BLACK MINT	£595	S/H	£1100
APOGEE STAGE SPEAKERS ANTHRACITE MINT	£1595	S/H	£2945
APOGEE STAGE SPEAKERS TAUPE MINT	£1895	NEW	£2945
APOGEE MINI GRAND GS SPEAKS PIANO BLK MINT	£4995	S/H	£8999
DYNAUDIO KRAFT SPEAKERS & STANDS V.G.C.	£1295	S/H	£2720

"ODDLES OF HIGH END CARRIAGES AVAILABLE RING FOR DETAILS" MANY MORE ITEMS IN

STOCK, EFFICIENT SERVICING DEPARTMENT. WE ARE LOCATED IN WELWYN, HERTS

ALL ITEMS GUARANTEED - ALL MAJOR CREDIT CARDS ACCEPTED RING FOR DETAILS AND

DEMONSTRATION 0438 714038

10.00 AM - 7.00 PM MON - SAT 10.00 AM - 1.00 PM SUN

Mobile Tel. 0831 250985

FREE Audio Catalogue

**That Will Change
The Way You Buy Hifi**

Inside the new RDL
catalogue you'll discover:

- The secret to picking the right speakers.
- Why your home is the only place to test audio equipment.
- How to get more audio for your money.
- How to buy home theatre systems.
- Why the reviewers say RDL offers superior audio equipment at unbelievably low prices.



Buying from RDL is easy and risk free with our 100% "no strings attached" money back guarantee.

Roy Allison, President and Chief Designer of RDL Acoustics has put together two new, superb ranges of speakers to fit every situation at prices well below normal shop retails.

FREE
32 pg.
AUDIO
catalogue

Order your free catalogue, call:
0484 603333

or fax on 0484 607774

RDL
ACOUSTICS

20 Cleveland Way, Shelley
Huddersfield, HD8 8NQ

Audiophile CD?! Free???

Yes! This is a unique opportunity to obtain *absolutely FREE* one of these Audiophile CDs from 'Clarity Recordings' value £19.95R.R.

'Clarity's' Audiophile quality Silver Disks are recorded to the highest standard, using twin back to back microphone technique, valve amplification and 3 step mastering.

Foundation Audio are offering ONE FREE DISK for every pair of Foundation Speaker Stands purchased on selected models.

This offer is for a limited period only while stocks last.

For further information on this offer/catalogue please contact your dealer or:-



Foundation Audio Ltd

53 Beecroft Way, Dunstable, Beds., LU6 1EE.

Tel: 0582 477550

Fax: 0582 604001

MARTIN LOGAN • ALCHEMIST • AUDIO RESEARCH • AUDIO INNOVATIONS

AUDIO GALLERY

NR PETERSFIELD
MISSION, MUSICAL FIDELITY, KLIPSCH, DECAP, AEGIS, SPEAKERS, LARA CARTRIDGES, DPA2008 HEYBROOK

HAMPSHIRE
FOR OPENING HOURS AND APPOINTMENTS PLEASE RING 9.30am - 7pm

HOME DEMO
AUDIO SYNTHESIS • ACOUSTIC ENERGY
WADIA 6, MICROMEGA STAGE, DAC-IN-A-BOX, TDL, SME, TEAC, ARDS 10, AUDIONOTE + AV

0730 - 895194

VALVE SPECIALISTS ON A SUPERIOR LEVEL

AUDIO ALCHEMY • TEAC • NAD • TRIPOD • ALPHASON • PIONEER • DENON

Now Performing at ...
ASTRAL AUDIO



Pink Triangle + Alema Impulse

Serving the Enthusiast in Scotland...

Phone 01224 582825 for more information

V'audio

Hi-Fi Consultants

WHAT'S IN A NAIM - PART 2?

Well, my comments last month about Naim amps certainly rang a bell, in particular the one on my phone! Far be it for me to criticise Naim amplifiers but I do regularly wonder why people are prepared to pay £8k for a NAC52 Pre-amp and two NAP 135 mono blocks delivering 75 watts/channel when for a tenth of that price they can now buy an AVI integrated amplifier producing 100 watts/channel, 250 watts peak with 20 amp current capability. Alright, this amp is new, but even the previous cheapest AVI pre/power costs only £1400 including remote control. Is it just that some people relate cost to quality? I know of one importer of American speakers who was told that they were too cheap and that they would have to put the price up to convince customers they were as good as they were. It's a funny world out there but we will continue to do our bit to sort out the bargains. At the two extremes in speakers are (a) the Jamo Cornet 30 I referred to last week (£99), which is amazing customers when driven by the AVI CD player and integrated amp, and (b) the new Active 300's which will fill a concert hall for around £11k and are a bargain if you have a room and bank balance large enough to take them.

WHY V'AUDIO IS DIFFERENT

A recent case I feel is a good indication of the sort of service we aim to provide as consultants as opposed to many shops which sell boxes and give little real assistance to the customer. A gentleman contacted me about buying a new amplifier to improve the sound he was getting from his old Wharfedales. I explained that the only way I could recommend anything was to go along and listen to the system

and in particular see if it was worth persevering with such an old loudspeaker. The result was by the end of the afternoon it was clear that in fact his amplifier was the best component in the system and that both CD player and speakers needed replacing. So instead of the customer wasting £700 on a new amplifier, I am piecing together a complete system for about £700 which will probably consist of my favourite AMC CD6 (£350), the Pro-lect amp at £260 and a pair of bargain Jamo Cornet 30 loudspeakers at a mere £99. Possibly however we may be able to piece together a cheaper s/h CD and amp with the ever popular Ruark Templars which will sit nicely in the window bay. This in my opinion is the only way to really help customers and stop them going around in circles wasting money.

RUARK CRUSADERS

As regular readers will know, Ruark speakers are a favourite of mine and in particular the Accolade and the ATC 50 are my two favourite speakers. For those who can't quite stretch to the size and price of the Accolade, the Crusader comes close but again needs a good amp to drive it properly. The price of achieving that has now come down to £800 with the new AVI integrated. This combination has scale, warmth, detail and excitement in abundance!

Ian C. Vaudin
36 Druid Hill, Stoke Bishop,
Bristol BS9 1EJ
Tel/Fax: Bristol (0117)
9686005

*Gramex
Audio*

**DAN
DULEY**

**SECONDHAND QUALITY HI-FI.
CUSTOM BUILT EQUIPMENT AND ACCESSORIES.
KITS BUILT TO ANY SPECIFICATION.**

AMONG THIS MONTH'S SECOND-HAND EQUIPMENT IS AN EXCELLENT
NAKAMICHI DRAGON, RECENTLY FULLY SERVICED, FOR £1200;
A RADFORD RA15 PRE-POWER COMBO FOR £550; A PAIR OF RADFORD MONOBLOCKS
AND VARIOUS 301/401 TURNTABLES UNMOUNTED.

WE ALSO HAVE NEW AND USED SME PICKUP ARMS AND A SELECTION OF QUAD EQUIPMENT.

WE HAVE A LARGE SELECTION OF SECOND HAND CLASSICAL
VINYL AND CDs TO PLAY ON YOUR SYSTEM!

FREE AND FRIENDLY ADVICE ALWAYS AVAILABLE,
WHY NOT DROP IN FOR AN INFORMAL CHAT AT

25 LOWER MARSH, LONDON SE1 7AJ

WE ARE ADJACENT TO WATERLOO MAINLINE STATION.
TEL 0171 401 3830 FAX 0171 928 3999

OPENING HOURS ARE TUES. TO SATURDAY, 12:30 TO 18:30

**SECOND HAND QUALITY HI-FI ALWAYS REQUIRED, ESPECIALLY VALVE
EQUIPMENT, WORKING OR NOT.**



Vacuum Tubes for Audio Are Back!

Glass Audio brings together yesterday's tube with today's improved components, voltage control, and the exciting new Soviet tubes, to make smooth sound in your livingroom possible again!

YES!

Please send my first issue of *Glass Audio*. I'll pay just \$45.00 for six issues (1 year); \$80.00 for 12 issues (2 years) of the best information on tubes to be found anywhere. I understand that my satisfaction is guaranteed!

Name _____

Street & Number _____

City _____ Postal Code _____

Country _____ REMIT IN US \$ DRAWN ON A US BANK ONLY. PRICE GOOD THROUGH DECEMBER 31, 1995.

We Accept MC/VISA.

Glass Audio

PO Box 176, Dept. HFWS, Peterborough, NH 03458-0176 USA
Phone: (603) 924-9464 or FAX 24 hours a day (603) 924-9467

STEREO DECODER FOR MONO VALVE TUNERS

Experience REAL stereo from your Troughline, Quad, RCA, Rogers, etc. Just connect this great sounding decoder to the multiplex output from your mono tuner. Available as an assembled, mains powered boxed unit, or as a **complete** kit of parts, or a fully aligned module only. No special alignment needed. Has level control to match to any mono tuner.

**Complete unit £48.50. Kit £28.50.
Assembled module £12.50. (Inc. P&P)**

Enquiries to:

STUDIO 12 Nanjivey Terrace, St Ives, Cornwall,
TR26 1BQ. Tel: (01736) 798393

Audio Physics

PROFESSIONAL DESIGNERS AND SUPPLIERS OF
COST EFFECTIVE UPGRADE SERVICES INCLUDING:

- The CLEANLINE range of modifications to Naim Hi Cap and Snaps power supplies. Also an expanding range of upgrades to most other high quality audio equipment. e.g. better power supplies, precision clocking.
- COMPUTER AIDED DESIGN service for your special requirements. eg active crossovers, passive pre-amps.
- A build & test service for your kits, prototypes and one offs. Specialists in the IMP LOUDSPEAKER TESTING KIT.

Call Geoff Mead on (895) 637846 for details

AMADEUS SOUND & VISION

Audio Innovations,
Aura,
Bang & Olufsen,
Castle Acoustics,
Micromega, Marantz,
Musical Fidelity,
NAD, Pioneer,
Quad, Spendor,
Technics

10 BOLDMERE ROAD
SUTTON COLDFIELD,
WEST MIDLANDS
Tel: 021 -354 2311

Oxford Audio Consultants

HI-FI SPECIALISTS



Our superb service is the same, regardless of price.

AUDIO RESEARCH LS7/VT60

At last a combination at an affordable price. Quite sensational sound quality to boot!

NOW DEMONSTRATING

QUAD 77 INTEGRATED AMP - ABSOLUTELY BRILLIANT!!
 KRELL KPS 201 CD PLAYER - THE BEST ONE BOX CD PLAYER BAR NONE!!
 AUDIO RESEARCH CD1/CDT 1
 AUDIO ALCHEMY DAC IN THE BOX - STAGGERING SOUND FOR £199.95
 MICROMEGA STAGE - THE NEW CONCEPT IN UPGRADEABILITY
 THETA DATA BASIC & GENERATION V - REAL HIGH END
 TEAC VRDS 7/10/20 AND 700 2 BOX SYSTEM
 SME 20 - THE FINEST ENGINEERING WITH SUPERB SONICS
 PROJECT TURNTABLES - VALUE FOR MONEY
 LYRA CLAVIS MK 2 - EVEN BETTER AND ONLY £995
 AUDIO INNOVATIONS ALTO - LOVELY SOUND AND STYLING
 COPLAND CSA 14 - BARGAIN OF THE CENTURY!!
 DPA 200 SERIES PRE/POWER
 KRELL KRC/KRC 2 PREAMPS WITH THE LATEST S SERIES POWER AMPS - SERIOUSLY HIGH END
 - WAIT TILL YOU SEE THE NEW KPS DIGITAL SERIES
 MUSICAL FIDELITY F SERIES - VERY, VERY GOOD VALUE
 MARTIN LOGAN AERIUS - MAGIC LOOKS AND SOUND
 QUAD ESL 63 - WE ARE NOW MAIN AGENTS FOR THE COMPLETE RANGE OF QUAD REL STRATA AND STADIUM SUBWOOFERS
 RUARK EQUINOX - FURNITURE FOR THE LIVING ROOM
 SONUS FABER - NO APOLOGIES!! THESE ARE OUR FAVOURITES
 DENON DF 10 - MINI SIZE COMPONENTS AVAILABLE SEPARATELY
 NEW DPA CD PLAYER/RENAISSANCE INTEGRATED
 B&W P SERIES SPEAKERS - SUPERB SOUND AND FINISH
 MUSICAL FIDELITY ELEKTRA RANGE - BRITISH AT ITS BEST
 PINK TRIANGLE DACAPO/ORDINAL/CARDINAL
 MICHELL GYRODECK - STILL THE ONE TO BEAT!!

EX DEM & P/EX BARGAINS

KRELL DT10 CD TRANSPORT MINT £6495 (£9090)
 DPA 1024 D/A CONVERTER MINT £3995 (£6000)
 AUDIO RESEARCH LS5 PREAMPLIFIER £2995 (£5290)
 CHORD SPM1400B MONOBLOCK POWER AMPS PIANO BLACK £3995 (PAIR)
 SONUS FABER GUARNERIS AS NEW £4500 (£5500)
 PIONEER PDS901 CD PLAYER EX DEM £299.90 (£499)
 LINN LP12/BASIK PLUS/REGA R100 £395
 RAM OSIRIS LOUDSPEAKERS £250
 HEYBROOK HB1 MK1 £100
 HEYBROOK HB2 £100
 MAGNEPLANAR 2.5R £995
 ORELLE DA180 D/A CONVERTER £350
 MICROMEGA T DRIVE/ T DAC EX DEM £1595
 AUDIO RESEARCH V 70 POWER AMP £2750
 MUSICAL FIDELITY PRE 3A PREAMP £100
 HEYBROOK SEXTETS EX DEM £895
 COPLAND CTA401 EX DEM £1195
 THETA DATA BASIC EX DEM £1695
 DPA BIGGER BIT EX DEM £395
 RUARK TALISMAN ROSEWOOD EX DEM £599
 ORELLE CD 480CD PLAYER EX DEM £299
 ORELLE PRE POWER £649
 AUDIO RESEARCH SP9 MK3 EX DEM £1995
 ARAGON 2004 POWER AMP £650
 ORACLE DELPHI / SME V £1595 (MIGHT SPLIT)



Please ask for details or our current list
 Agencies include: Aura, Accuphase, Acoustic Energy, Air Tangent, Apogee, Audio Alchemy, Audio Research, Audio Technica, B&W, Castle, Cable Talk, Classe, Copland, Denon, DPA, Dual, Goldring, Harmonix, Heybrook, HPW, Koetsu, Jadis, Krell, Lyra, Mandrake, Marantz, Martin Logan, Michell, Micromega, Music Fidelity, NAD, Nakamichi, Onix, Orelle, Ortofon, Pink Triangle, Pioneer, Proceed, Projekt, PS Audio, QED, Quad, REL Subwoofer, Rogers, Roksan, Rotel, Ruark, Selsmic Sink, Sennheiser, Slate Audio, SME, Sonus Faber, Stax, Target, TDL, Teac, Theta, Thorens, Transparent Cables, Van den Hul, Wadia, Wilson

TAX-FREE EXPORT SERVICE
 MAIL-ORDER AVAILABLE ON MANY ITEMS
 Open Mon-Sat 10am-6pm

Oxford Audio Consultants

Oxford Audio Consultants, Cantay House, Park End Street OX1 1JE
 Telephone: Oxford (0865) 790879 Facsimile: Oxford (0865) 791665

VRR

VALVE HI - FI



"ADUR"

Monoblock Amplifiers

Hand-wired — without PCBs!

Single-Ended
 or Push-Pull
 Triode or Pentode
 but always
 Class A₁

*
 for
 further
 information
 please telephone
 Worthing
 (01903) 501158

AUDIO LINKS

SUPPLIERS OF HIGHEST
 QUALITY COMPONENTS

eg. Elna Cerafine

10,000pf/80V. £20.00

TEL: 01724 870432

AUDIO LINKS

7 Fairmont Crescent, Scunthorpe
 South Humberside, DN16 1EL

definitive audio nottingham

Tel/Fax +44 (0)1159- 813562

Import/Export

QUALITY & INTEGRITY

DEFINITIVE AUDIO services a national and international market. Conveniently situated 20 minutes from Junction 24, M1 and East Midlands International Airport (London 2 hours, Birmingham 50 minutes).

Quality advice and guidance. Appointment only demonstrations. Premium service. Mon to Fri 10.00am - 6.30pm. Sat 10.00am - 5.30pm.

LIVING VOICE - The least compromised implementation of horn loudspeaker technology currently available. Effortlessly dynamic - dynamically coherent. A 10 ohm nominal impedance and a 105 dB/W broad band sensitivity facilitates the use of ultra high quality, simple amplification. Two models - Tone Scout and Air Partner.

HoRNING - Danish hybrid horn loudspeaker systems. Beautiful cabinet work. Lowther full range drive units. Acoustic cross-over. 96dB/W. Easy, even load. Two models - Agathon and new Micro.

IMPULSE - new range, Ta'us, Lali and Kora.

DALI 104 and 104MS - A two-way, floor standing, reflex loudspeaker. A free and open presentation with scale and panoramic stereo. Arguably the best all round performance for under £1500. Standard 104 £450. 104MS £650.

WADIA - Distinguished digital source components. Powerful, calm, tonally coherent. Models 16, 21 and 23.

MICROMEGA - The full six model 'Stage' series available for demonstration.

AUDIO INNOVATIONS - Full range. VOYD Turntables, MONARCHY Digital, LOWTHER VOIGT, VITAVOX, XLO, SME, TOWNSHEND, ORTOFON, LYRA, STAX Electrostatic Headphones, PIONEER, JPW, SYSTEMDEK and many other selected items.

Introducing LIVING VOICE 'LVC1' Interconnect cable. Strong, clear, nimble and absolutely grain free. Money back guarantee if you are not convinced of its superiority over your existing cable (errspetive of price). Phone or fax +44 (0)115 9813562 giving your name, address, visa details, the length(s) required, termination type (eg BNC, RCA, Cannon etc.) £150.00 per metre, £15.00 termination P&P inclusive UK. Overseas £2.00.

LOWTHER drive units always in stock (PM6A/7A/2/4) Enclosure drawings £29.00 per model (Mini Acousta, Acousta, Audio Vector (Auditorium), TP1 etc).

Full VITAVOX components and applications - please phone for details.

USED GOODS FOR SALE # DENOTES FULL WARRANTY CARRIAGE EXTRA

	PRICE	RRP
KRELL KRSP2 4 BOX DUAL MONO PRE	£3000	£8000
TANNOY ARDEN FULLY REFURBISHED	#	£1400
HORNING AGATHON EX-REVIEW	#	£2250
SNELL A II MAHOGANY	#	£1900
WADIA 6 INTEGRATED CD	#	£2500
IMPULSE H2 ASH	#	£1600
IMPULSE H6 OAK	#	£900
ACOUSTIC ENERGY AE 2 ROSEWOOD	#	£599
AUDIO INNOVATIONS S. 500 INTEGRATED	#	£550
AUDIO INNOVATIONS S. 800C PRE.	#	£250
KRELL PAM DUAL MONO PRE.	#	£650
MUSICAL FIDELITY M.A. 100 MONOS.	#	£700
AUDIO INNOVATIONS S. 800 MCT	#	£140
IMPULSE H5 ASH	#	£900
SILVER SOUNDS WHISPER 12/4S/C	#	£120
REGA RB 250	#	£65
SOUTHER LINEAR TRACKING ARM	£500	£1350
GAUSS 1502 HF BULLET TWEETERS (PAIR)	£300	£460

Phone or fax direct +44 (0)1159-813562

Connect the dots.

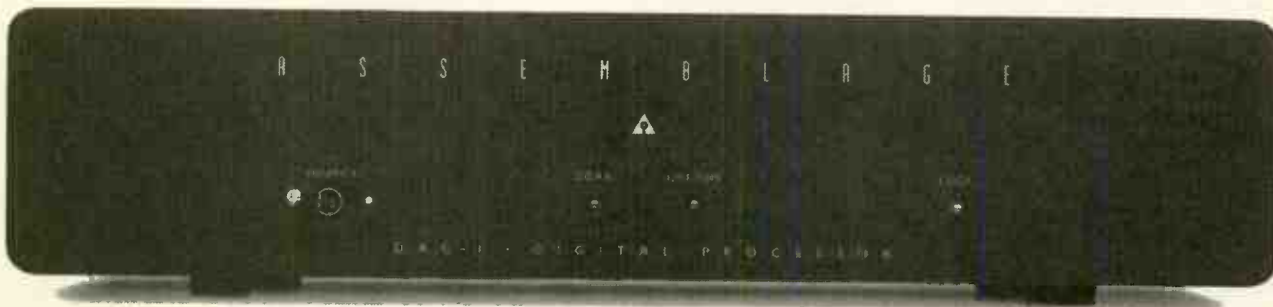

Introducing The Parts Connection's first complete DIY kit: the Assemblage DAC-1 Digital Processor.

It comes in a small package (24cm x 5cm x 18cm chassis), but packs a big punch and a very musical sound. Designed for the rookie or first time kit builder, the only tools required are a pencil tip soldering iron, a screw driver, a wrench, a pair of electronics pliers, and a wire stripper or hobby knife. With only 21 solder joints and a handful of nuts and bolts, this kit goes together in one evening (typically about an hour). It's as easy as connecting the dots.

The parts quality is top notch. The board comes assembled and tested, implementing the Burr Brown 1702 DAC, a Crystal 8412 input receiver, an NPC 5813 digital filter, Analog Device's AD844 and 847 op amps and a custom potted toroidal power transformer.

At \$449 US, the Assemblage DAC-1 offers an outstanding value in digital conversion and comes with a Satisfaction Guarantee (return it with-

in 30 days of purchase for a full refund) and an Assembly Guarantee (if you can't get it running, we will!). We challenge you to find a DAC anywhere near this price with better measured performance, component quality, and most importantly, sound quality. Call us for more specific information on the performance or construction features.

To order the DAC-1 kit or to order The Parts Connection 1994 Catalog (for £3), full of a lot of other exciting stuff (including a \$10 US discount coupon good on your first order over \$100 US), send us your request and mailing address - or call with credit card information.

ASSEMBLAGE

THE PARTS CONNECTION
A DIVISION OF SONIC FRONTIERS INC

2790 Brighton Road, Oakville, Ontario, Canada L6H 5T4
Telephone 0101-905- 829-5858 Facsimile 0101-905-829-5388

Toll Free Order Line 1-800-769-0747 (U.S. & Canada only)

The British Hi-Fi Awards 1995

Vote for your favourite hi-fi separates and

WIN A HI-FI SYSTEM worth over £2000



The annual British Hi-Fi Awards sponsored by the British Federation of Audio and **VOX** will be held in April at a gala dinner in aid of the Cancer Research Campaign. These awards provide an opportunity for you to vote and give recognition to some of the world's finest hi-fi equipment.

To mark this occasion we are giving away a hi-fi system comprising:

- ARCAM** Delta 270 CD player (£799),
- AUDIOLAB** 8000A integrated amplifier (£499),
- RUARK** Talisman loudspeakers (£749),
- The Chord Company** Cobra Mono interconnect (£49) and 5 metres Flatline speaker cable (£172).



VOTING FORM

Please tick one product in each section and then answer the questions below. Return this form to: The British Federation of Audio, Landseer House, 19 Charing Cross Road, London WC2 0ES - to arrive no later than 10th March 1995

CD PLAYERS UP TO £500

- ROTEL RCD930AX, CD Player £199
- PIONEER PD-S703, CD Player £249
- NAD 513, CD Multiplayer £269
- ARCAM ALPHA 5 plus, CD Player £469

CD PLAYERS and DACs over £500

- ARCAM BLACK BOX 500, DAC £749
- QUAD CD67, CD Player £825
- NAIM CD3, CD Player £898
- AUDIOLAB 8000CDM/DAC, CD Transport/DAC £2099

TUNERS

- NAD 402, Tuner £169
- ROTEL RT950BX, 3 band tuner £219
- NAIM NAT03, FM Tuner £499
- AUDIOLAB 8000 T, Tuner £749

INTEGRATED AMPLIFIERS up to £300

- HARMAN KARDON HK610, Integrated Amplifier £189
- ROTEL RA930BX, Integrated Amplifier £199
- PIONEER A-400X, Integrated Amplifier £299

INTEGRATED AMPLIFIERS over £300

- ARCAM DELTA 290, Integrated Amplifier £479
- AUDIOLAB 8000A, Integrated Amplifier £499
- MISSION CYRUS 3, Integrated Amplifier £499
- NAIM NAIT 3, Integrated Amplifier £499

HOME CINEMA AMPLIFIERS

- PIONEER VSA-303, Pro-Logic AV Amplifier £299
- ARCAM XETA ONE, Home Cinema Amplifier £999
- ONKYO TXSV919THX, Home Cinema Receiver £1949

HOME CINEMA SPEAKERS

- CELESTION CENTRE 2, Centre Channel Loudspeaker £179
- KEF 100, Centre Channel Loudspeaker £349
- SONY SA-VA1, Pro-Logic Powered Loudspeaker System £599
- BOSE ACoustiMASS 4, Home Cinema Speaker System £750
- REL/JBL, Home Cinema Loudspeaker System £999

SUBWOOFERS

- CELESTION CSW, Powered Subwoofer £299
- INFINITY RS10, Active Subwoofer £499
- REL STRATA, Active Subwoofer £499

LOUDSPEAKERS up to £300

- SONY SS-86E, Hi-Fi Loudspeakers £99
- WHARFEDAILE Diamond 6R, Compact Loudspeaker £109
- CANON SV-15, Wide Dispersion Loudspeaker £129
- MISSION 731, Bookshelf Loudspeaker £129
- KEF CODA 7, 2 way Bookshelf Loudspeaker £129
- MORDAUNT-SHORT MS10, Loudspeaker £139
- CELESTION MPI, Multi-Purpose Loudspeaker £149
- TANNOY 632, Loudspeaker £189
- PIONEER S-4UK, Loudspeaker £249

LOUDSPEAKERS over £300

- MISSION 753, Floorstanding Loudspeaker £699
- BOSE ACoustiMASS 5, Hi-Fi Speaker System £760
- KEF MODEL ONE, 3 Way Floorstanding £999
- EPOS ES25, Loudspeaker £1505
- RUARK EQUINOX, Loudspeaker £1749

Which is your favourite Music magazine?

Which is your favourite album of 1994?

In your opinion, which album of 1994 has the best recording quality?

Name: _____

Address _____

Post Code _____

RULES: Entries must be on an official voting form and must bear your own name and address. The judges will award the prize to the first entry drawn after the closing date. The prize must be accepted as offered there is no cash alternative. If the winner is under 18, parental permission must be obtained before the prize is awarded. Forms received after the closing date will be disqualified. The decision of the judges is final. No responsibility can be accepted for entries lost or delayed in the post. No correspondence can be entered into. Voting is open to all readers resident in the UK. The winner will be notified by post.

HFV

VALVES

OIL/PAPER CAPACITORS

300	£50 EA	1 UF 600V	£6	PRIMARY
EL34	£10 EA	2 UF 600V	£60	10/0/110/200/220/240
KT66	£10 EA	4 UF 600V	£6	SECONDARY
KT88	£20 EA	8 UF 600V	£8	325-0-325 200mA
KT100	£25 EA	8 UF 800V	£10	5V 3A £35 EA
GZ34	£15 EA	8 UF 1000V	£12	
		5 UF 1000V	£8	MANY OTHER TRANSFORMERS
OIL FILLED CHOKES 12 UF 350V £8 IN STOCK H.T. AND HEATER, PLEASE RING WITH YOUR REQUIREMENTS.				
16H 80MA	£15	25 UF 1000V	£8	
10H 180MA	£20	1 UF 1500V	£8	

10H 75MA	£15	8 UF 1500V	£30
10H 250MA	£30	4 UF 1000V	£12
10H 350MA	£35	4 UF 800V	£12
50H 50MA	£15	2 UF 1000V	£10
1H 300MA	£15		
16H 120MA	£20	OIL FILLED H.T. TRANSFORMERS	
16H 150MA	£25		
5H 200MA	£15	PRIMARY	10/0/200/220/240V
20H 120MA	£20	SECONDARY	325-0-325 250MA
		300 0 300 100MA	£35 EA

P&P £5 PER ORDER

VAT AT 17.5% ON ORDERS

OVERSEAS POSTAGE AT COST.

All Items tested and come with 30 days warranty

VAT at 17.5% to be added to orders.

Please add £10 P+P Vat for each item order U.K. only overseas postage at cost.

THE EMPORIUM

28 St. Nicholas Street, Diss, Norfolk.

TEL (01379) 650744 FAX (01379) 641932

Open MON - SAT 10.30am - 5.30pm

SALE

Leak Point One/Oaroscope Stereo	£50
Leak Troughline Mono/Stereo	£50/75
Garrard 401 (with orig. box & manual) Rega Arm/Plinth	£200
Lowther PM6A pair orig. magnets	£150
Avantic 5PA 21 Integrated Stereo	£250
Tannoy TL12+ pair gold phono sockets etc.	£350
Quad 22/II/II FM Stereo, AM	£450
Leak TL10, 12, 50	Just In Phone/Fax
Grundig Stereo power amp (valve)	£100
Armstrong pair valve tuner amp 227m	£80

On demonstration Posselt speakers 91dB wife friendly with real bass! Fantastic with Leak, Audio Innovations, Naim amps.

Trade in these Isobariks! £2000 pair.

WANTED

Gryphon pre amp/line stage	Leak TL12+/25	£75
Quad 22/II/II	Audio Research SP8	£450
Radford amps	SME 12" Arm also Ortofon	£75
Pamphonic/PYE amps	'Lowther TP1 (pair)	£500
with KT66	Ittok arm	
Leak Stereo 20/50/60		£100/150

MANTRA AUDIO

• CARTRIDGES AND STYL
• MAIL ORDER DIRECT 1-10 DAYS
• COMPETITIVE PRICE (inc P&P)

MAKE	MODEL	CARTRIDGE	STYLUS	MAKE	MODEL	CARTRIDGE	STYLUS
Audio Technica	AT 95 E	£21.00	£13.50	Ortofon	510	£29.00	£19.00
	AT 110 E	£26.00	£16.00		520, 520P (T4P)	£49.50	£36.00
	AT 450 E	£57.00	£33.00		MC 1 TURBO	£54.00	£45.00*
	AT420 E	£36.00	£22.00		MC 3 TURBO	£99.00	£82.50*
	AT OC 3	£96.00	£64.00*		MC 18	£76.00	£65.00
	AT OC 5	£110.00*	£90.00*		MC 15	£99.00	£82.00
Denon	DL 110 MC	£85.00	£52.00*		MC 10 Supreme	£290.00	£150.00*
	DL 160 MC	£75.00*	£58.00*		MC 20 Supreme	£315.00*	£236.00*
	DL 304 MC	£180.00	£155.00*	Shure	VN 35 MR	(V 15 III)	£63.00
Goldring	ELECTRA	£24.00	£16.00		VN 45 MR	(V 15 IV)	£90.00
	106	£44.00	£29.00		V 15 VMR	£225.00	£130.00
	1012 GX	£58.00	£38.00	SWISS QUALITY DIAMOND STYL			
	1022 GX	£76.00	£49.00		ADC	R20 XE, DLM 32/34/36, XLM III	£12.50
	1042	£94.00	£51.00		Alwa	AN 5/11/8745	£8.00
	1060	£90.00	£55.00*		Alka	RS 33/35/38/84/85/90	£8.00
Hagaoka	I-roca (LX)/(H)	£25.00	£12.50		Dual	DN 145/155/165E, DN 149S	£12.50
	MP 11 Boron	N/A	£26.00		Ortofon	FF 15A/VMS 10/20 EIL, DM/P 10/20	£12.50
Ortofon	OM10, DM/P10 (T4P)	£25.00	£18.00		Shure	N75 ED/EJ T2, N95 ED/EJ	£10.00
	OM20, DM/P20 (T4P)	£34.00	£31.50		Sony	ND 133/134/142/150/155/200 G	£8.00
	OM30, DM/P30 (T4P)	£72.00	£58.00		Technics	EPS 23/24/25/27/290, P-30/33 D	£8.00
	OM40 CLUB S	£29.00	£18.00				

* Exchange any MC *** Over 500 styli type stocked *** Tel (0757) 288652

All items UK supplied (UK guarantee) - No grey imports

MANTRA AUDIO (HFW), 22 GARTH AVENUE, NORTH DUFFIELD, SELBY, NDRTH YORKS YO8 7RP

CABLE TALK

BRITISH MADE

★★★★★ Rated interconnects and speaker cables are available from your local specialist dealer.

.....STOP PRESS.....STOP PRESS.....STOP PRESS.

"Talk 3's great sound quality and value for money"
(Dec '92 WHAT HI-FI?)

Can now be obtained in a convenient bi-wire format at £4.50 per metre.

Please telephone 0483-750667 Fax 0344-360866
For Further Information



HI-FI SHACK



Your equipment wanted!

BEST PRICES PAID!

Tel. 081- 255 0274

Impulse H2.....	£1699	Ex Dem
Impulse H6.....	£999	Ex Dem
Triangle Alcante.....	£699	Ex Dem
Triangle Scalane.....	£499	Ex Dem
Triangle Comet.....	£199	Ex Dem
Proac Super Towers.....	£1399	VGC
Proac 100.....	£475	New
Linn Kanns.....	£225	VGC
Jadis Defay 7 Mk II.....	£2850	Mint
YBA Power 3.....	£899	Ex Dem
YBA Pre 2.....	£999	Ex Dem
Audion 300B Mono Blocs.....	£1250	VGC
Lumley 120s.....	£1899	VGC
Lumley ST70.....	£1699	Ex Dem
Audio Innovations The 2nd Audios.....	£1699	Mint
Audio Innovations L2 Preamp.....	£499	Mint
Triangle Alion Amplifier.....	£695	Ex Dem
Audio Innovations Alto.....	£225	Ex Dem
Audio Note Meishu.....	£1899	Ex Dem
Audio Note P2 SE.....	£1199	Ex Dem
Audio Note Otto.....	£899	VGC
Audio Note DAC 2.....	£799	Ex Dem
Micromega Duo pro.....	£999	Ex Dem
Micromega CD3.1.....	£1100	Ex Dem
Counterpoint DAC V/A chip.....	£2150	Ex Dem
Counterpoint Transport.....	£1350	Ex Dem
Audiomecca Mephisto Transport.....	£1699	Ex Dem
Audiomecca Kreature.....	£899	Ex Dem
Kelvin Labs M60 Mono Blocs.....	£799	VGC
Naim 42.5 Hi Cap 250.....	£1199	Mint
TNT Mark 2 Wheaton Triplaner arm.....	£2995	Mint

Plus various cables and stands

Classified Ads

For details on how to place a Classified Advertisement, please see page 129

PAIR AUDIO INNOVATIONS 2nd Audio Triodes. 6B4G 15watts. Superb Dynamics. Mint condition, £1,000. Tel: 0242 236981, Gary.

QUAD ESL - 63 Speakers. Outstanding Condition, £1,250. Tel: Cambridgeshire 01487 822093, evenings and weekends.

GARRARD 301, very good condition, £130. Garrard 401, good condition, plinth £100. Early Quad Model M-30, with valves, wanted plinth for Thorens TD-124/II. Tel: Adrian (0892) 662424 evenings.

QUAD ESL - Bronze £350. Bastin serviced Garrard 301, mint in custom slate plinth, with Rega RB300 £300. ono. Tel: (0116) 2553176.

IMPLUSE H2 Loudspeakers, mahogany, mint condition. Fitted with Spectra Deflex panels and XLO patch wires. 18 months old. Cost new £2,500, will accept £1,450 ono. Tel: 081-291 1744.

FINESTRA PRE-AMP and Sumo Polaris power amp, powerful, beautifully balanced combination £700 the pair, Hitachi FT5500 tuner £45, Sony CDP-228ES CD player £75. All boxed and in immaculate condition. Tel: 01252 844248

MUSICAL FIDELITY Ref 2 Speakers. Walnut veneer finish, little used, £100. Target welded speaker stands, 200mm high, £20. Marantz 65mk2 CD player, £60. Tel: Essex (01268) 795235.

TRANSMISSION LINE Loudspeakers. Hi-Fi News/McDonald Design, superb full sound. Built as an exercise. Kit £450, sell £200 ono. Connoisseur BD2. Turntable in plinth, with cover. Lenco arm, excellent £25 ono. Tel: 0275-872777.

MERIDIAN M3 Active speakers, stands and Meridian 101B Preamp £495; Thorens TD125 Grace 707 mint £125; Musical Fidelity A1 £110. Tel: (01993) 776195 Oxfordshire.

LOUDSPEAKERS NAIM IBL (passive) £450; Tuner Sony ST-3950 £40; TV Sound Tuner Minim TV-1000 £10; M.C. Step-up Transformer Lenteck £40; M.C. Step-up Transformers Ortofon T-5 £40. Tel: Ludlow 876040.

LINN SARA Nines. Bi-Wireable. With stands. Black Ash. As new. Original owner. £450. Tel: 0508-470211 (Norwich).

MERIDIAN 206 CD £250; Michell Argol Hera pre-amp £490; Lynx Pulsar power amp (130 WPC) £290; PT T00, Mission Mechanic, Goldring Excel £500; Audiolab 8000DAC £350; Proac Studio 1MK2 Speakers, £300; Target T2 Stands £95; Aura Tu50 Tuner £130; Yamaha KX260 Cassette £90. Tel: (0962) 841 268.

AIWA AD-F450 Cassette, boxed, unused £95. Yamaha K-220 Cassette £40. Pioneer F-77L preset tuner £45. 2X Bartolomeo Class A stereo amplifiers £695 each, used preferred to Naims in active system. Tel: 01384 265058.

WANTED: Meridian 101 pre-amp with M/C module. (Note 101 not 101B). Tel: 0161 351 1598 after 6pm.

EPOS ES11 good condition £200.00 ono. Tel: Dave 0732 740040 day or 0732 866817 evening.

CONRAD-JOHNSON P.V.II pre-amp (18 months) £975 (£2,200) nothing better at this price. Micromega Duo C.D.3 and B.S. DAC (8 months) hardly used £975 (£1,800). Tel: Mike 0884 - 32465.

LINN LP12 rosewood, latest specification, Lingo, Cirkus, Trampolinn, Naim ARO arm, excellent condition, £950. Tel: 031 667 3168.

LINN LP12 Ekos Klyde Tramp Cirkus Lingo £1,350, Kairn LK280S/Spark £1,150, Sara 9 (walnut) and Stands £250, S/O Stak (4 Shelf) and Wall Shelf £100. Tel: 0947 811286.

AUDION 300B Silver Knights Monoblocks £1,275; B+W DM70 Electrostatic Loudspeakers - real wood veneer £450. Beautiful in combination. May split, part ex etc. Tel: 021 486 2705 after 6.00pm (Paul).

AUDIOLAB 8000A II integrated amplifier, immaculate condition, boxed with instructions. Upgrade forces sale. £375 ono. Tel: Harrow 081-863 9449/081-421 4920.

PROAC RESPONSE Three Speakers black ash. Very late sample - and unmarked. £1,900 (£3,060). Audio Research SP9 - also unmarked. £650 Arcam 170.3 CD Transport £450 Audio Synthesis Ultra-Analogue DAC £550. Both units include rare AT & T option, also Sync-Lock. Tel: 081-659 9538.

AUDIONOTE VALVE DAC 3 Signature DA Converter. Unused prize. New £2,700 accept £1,600. Audionote AN-L speaker cable 5 meters Bi wired pair unused new over £600 accept £300. Tel: 01303 840 303.

NAIM SBL Speakers. walnut finish, very little used in mint condition. Superb sound. Cost £1,800+, bargain at £1,150 ono. Tel: 0435-862986 after 5.00pm.

FOR SALE: Sound Organisation CD Two-tier Support Table - with granite/marble (green) top shelf and MDF lower shelf. £50. Tel: Dave (0256) 54941 B/stoke B4 6pm.

NAKAMICHI CR7E Cassette Deck purchased new from manufacturer by present owner 3 years ago. Superb example £1,000.00 buyer collects. Tel: 0275 206 767 7-10.00pm (answerphone at other times).

TRANSFIGURATION AFI Moving Coil Cartridge. low hours in ARO arm. Mint £550. Tel: Mike 0895 440602. Mobile: 0860 155521.

ARMSTRONG 625 FM Receiver £90. KEF Reference 101 Loudspeakers £180. All teak, pristine, boxed with instructions. Tel: 0246 237816 evenings (Chesterfield).

LEAK TROUGHLINE 3 stereo tuner. Recently renovated by G.T. Audio, superb sound. £190 ono. Denon TU 260L tuner £80 ono. QED 2way speaker switch £15. Tel: 0287 639179 (North Yorkshire).

AUDIO INNOVATIONS 200 pre-amp (passive line level) with valve phono stage, Audio Innovations 1000 Mark 3 valve mono blocks 50 watts Class A - 8 months old, mint condition - £1,250. Tel: 0733 840746.

SONY TUNER ST5370L. What Hi-Fi Tuner Of The Year 1991. RDS excellent sound. £80. Small Loudspeaker stands on spikes. £10. Tel: 081-289 2172 Bromley, South London. Answerphone.

FOR SALE: Linn Lingo £550; Linn Ekos MK2 £900. Daytime Phone No: 0628 604455 ext. 385; Evening Phone No: 0344 488342.

EXPOSURE XI Pre-Amp, VI PSU, IV Power Amp £1,700. Excellent condition. Tel: 01934 522 635.

MOD SQUAD HIGH quality passive pre-amp, excellent with valve power amps, some scratches on case top, £150. Goldring 1042 MM cartridge. 30 hours use, £40. Tel: 01962 774218.

MICHELL ARGO pre-amp with Hera power supply. £575 ono. Orelle DA180 D/A converter. £325 ono. Both sound superb. boxed and in excellent condition. Upgrades force sale. Tel: (01734) 875964.

WANTED CYRUS 3 Amp or Sugden AU41 pre and power and Royd Abbot speakers. For sale or exchange Mission 753 R/Wood £500 and Sugden A21a Int amp £300. Tel: 01222 732 732.

QUAD II POWER AMPS with Hafler pre amp inc. Quad 22 and all original books £350. Tel: Hereford 0432 268484.

CASTLE PEMBROKE MK2 speakers, mahogany, with stands £175. Musical Fidelity P150 power amp £150. QED C300 preamp with Super Analogue phono board £175. Tel: 0636 71387 (Notts).

LINN KABERS, unmarked black, with Long Linn Tri-Wire Cables, upgraded to latest standard at Linn factory. £650. Sugden T48 MK II FM push-button Tuner, excellent condition. £75. Tel: 0489-798890.

WANTED - NAIM NAC82 pre-amp (no phono needed), also want REL subwoofer (not Strata). For sale - Headphones Sennheiser 560 Ovation, boxed £75. Burton-on-Trent. Tel: 01283-513126 (leave message).

QUAD 66 Pre-Amp with remote control (list £863) £550. Also 66 Tuner (list £532) £350. Both V.G.C. with original packing. Tel: 0625 425301 (Cheshire).

DAYSTROM VALVE Stereo Amplifier with handbook, down on one channel. Matching Tuner A.M., L.W., S.V., F.M., Mono. £75 the pair. Armstrong Valve Receiver, model 127, £25. All good condition. Tel: Milton Keynes 674193.

LINN LP12, plus LVX tonearm and Target turntable shelf. £200. Nottingham. Tel: 0773 710800 (evenings).

WANTED. Exposure 6 or 12 Pre-amp power supply. Tel: (0223) 243377.

SUGDEN A48II Amp £135, Musical Fidelity A1 £115, Sony WM6DC Pro/sennheisers £130, Thorens TD165 £40, CS505 £40, Philips CD940 £100. Wanted Quad ELS (purchase or negotiate). Tel: Merseyside 0860 109014 (evenings).

QED DIGIT/Positron/Digiflex, 9 Months old, £130. Marantz CD873 £75. Together £180. Mission Cyrus I Amp £75. Tel: 0780 64149 Stamford, Lincs.

WANTED BY PRIVATE Collector, original chrome edged Gale loudspeakers - price negotiable depending on model and condition - phone Steve on 0181 299 3001.

FLOORSTANDING Speakers (Focal-Kevlar units) bi-wired £220.00 o.o.o. Arcam Black Box D.A.C. (original) £85.00. Tel: 0454 260103 (near Bristol).

QUAD 67 CD Player. Superb sound quality, excellent up-grade from budget player. Hi-Fi Choice Best Buy 11/93, 'World Favourite' 5/93. Immaculate condition and boxed. £570 (new £825). Tel: 0522 568330.

AUDIO RESEARCH SP14 Preamplifier, Black, mint condition £1,495 (new £3,300). Denon TU406L Tuner, very little use £50. Wanted Audiolab 8000T Tuner. Tel: Chris 081-993 2006.

WADIA 16, £4,995 (£7,400), mint. Krell KSL balanced line-stage, £995, (£2,300). All perfect, boxed. Alphason 4-shelf table, Rosewood, £100 (£240). Various cables. Tel: 0442 877853.

LINN LP12 (Valhalla), Ittok Ortofon MC20S "Sound Organisation" table; Mission Cyrus 2 plus PSX; Mission 781 loudspeakers plus target stands. £799 o.n.o. May split. Tel: 0908 510 852 (Milton Keynes).

LINN LP12 Lingo/Tampolin/Circus and Naim Aro Tonearm as new £1,200. Tel: Manchester 0457 834465.

HART PHONO STAGE with power supply £135. MOD Squad Line Drive £200. Bruce Rae Audio Active Cable system, great with Passive Pre Amps comes with 5 metre Interconnect, but can run up to 100 metre £250. Ringmat £15. Sound Org Turntable Wall Shelf £15. Four counterpoint 6DJ8 £20. Four P.M. comp 6DJ8 £20. AKAI F15 Video Recorder £140. Robin 500T Multimeter £25. Tel: 081 502 3017.

Hi-Fi Confidential Can Reveal All

Under our magnifying glass goes the fine range of audio equipment that we stock, ensuring you the customer, a purchase of the best value and best sounding products to match your given budget.

To make your important buying decision even easier, we offer Home Demonstrations, Part Exchange, Interest Free Credit, Home Installation and a Three Year Warranty on selected products. Relax in our demonstration room as experienced staff guide you through your individual requirements, be it digital, analogue, loudspeaker, amplification, or just plain old friendly advice. Just 1 minutes walk from Victoria mainline station, and open until 9 pm on Thursday Hi-Fi Confidential welcomes you.

Enjoy the Magic of Valves



SYNERGY

HI -FI CONFIDENTIAL

34 Buckingham Palace
Road, London, SW1W

Products Include;

Valve Amplifiers by:

EAR, D.D. Audio,

Tube Technology, Conrad

Johnson, Lumley Reference,

Audio Innovations, *Amplifiers*

by: Musical Fidelity, Kinshaw,

Quad, Alchemist, Denon, Orelle,

Albary, Pioneer, John Shearne.

Loudspeakers by: Monitor

Audio, ProAc, System, Spendor,

Tannoy, Celestion, Castle,

Triangle, KEF, UKD *Digital by:*

Pink Triangle, Quad, Sony, DPA,

Audio Alchemy, Pioneer, Orelle,

Musical Fidelity, Micromega,

Kinshaw, QED, Marantz,

Sugden, TEAC *Analogue Replay*

by: Pink Triangle, Systemdek,

Alphason, Thorens, Townsend

Cassette Decks by: Yamaha,

Sony, Marantz, Nakamichi,

Arwa, Denon *Accessories:* Gold

Aero Tubes, QED Audioquest.

0%

INTEREST FREE
CREDIT
ON SELECTED
ITEMS

NEW PRODUCTS

PINK Δ DAC
VENTRICLE

TUBE TECH SEER PRE
PEARL VALVE COOLERS

DYNAUDIO SPEAKERS
EAR 859

HI-FI CONFIDENTIAL LTD.

34 Buckingham Palace Road,

London, SW1W 0RE

Tel: 071 233 0774 ~ Fax: 071 233 7226

H I - F I Y O U
C A N ' T A F F O R D
n o t t o l i s t e n t o

EQUIPMENT BY ABSOLUTE SOUNDS, AUDIO INNOVATIONS,
SUGDEN, IMPULSE, MICHELL, ROKSAN, TRICHORD RESEARCH,
VOYD, LYRA, MICROMEGA, WILSON BENESCH, ORTOFON, TARGET,
KINSHAW.

By appointment only

SERIOUS KIT

061-707 4823

21, ALGERNON ST., MONTON, ECCLES, MANCHESTER, M30 9QA.
A STATE OF THE ART COMPANY

PRIVATE

AUDIOLAB 8000A '91 £250, 8000P '93 £400, Epos ES11 plus stands £350 all very good condition 90's classics. Tel: 0603 633451.

WANTED QUAD ELS original design, good working order, preferably Quad serviced. Also Quad 34 or 44 Preamp. Tel: 0782 773885 with details and price.

AUDIO SYNTHESIS Pro Passion. All Vishay unblanced £325. Acoustat Spectra 1100 Electrostatic Hybrids £500. MOD Squad Line Drive £200. Tel: (0843) 584030.

FOR SALE. TEAC X-1000R 4 Track open reel tape deck, boxed in excellent condition, hardly used. Dust cover £495.00 ono. Tel: 0270 651415 (Crewe).

SD1 SPEAKERS complete with Linn K600 cable (2 x 7m) too big for location £500 o.n.o. Arcam Delta 90 amp £175. Naitamichi 700/11 £150 o.n.o. Micromega Microdac £175 o.n.o. Grace G.707 tonearm £40. SME Plinth £25. Tel: 091-4877796.

QUAD 34 £240, Quad FM4 £260, Quad 405/2 (very late Serial No.) £260, Quad 67CD £590. Ruark Crusader IIs £1,150. Tel: 0892 536919. W. Kent.

JOHN LINSLEY-HOOD discrete phono stage, plus power supply. Excellent design and sound - £200. Tel: 0724 870432.

AUDIONOTE DAC 3 Signature £2,000. Kenwood DP-X9010 Transport £300. Will consider p/ex (inc. Voyd Valdi) for Voyd Reference. Audio Innovations Nova Transformer £500. All immaculate. Tel: 0635 36599.

MISSION 753 speakers in mint condition, boxed as new. £490.00 (Birmingham). Tel: 021-411 3220 (Day); 021-705 6980.

IMPLUSE H6 Horn Loudspeakers £795. Tel: Worthing 0903 756582.

VALFET AUDIO Monoblocks 75 watt Class A, 200 watt Class B. As new. Cost £4,000 sell £1,000. Kudos S100 stands cost £300 sell £100. Tel: 0432 275203.

SONY TAE 1000 ESD. Superb sounding Digital processing pro-logic A.V. pre-amp. Built in DAC full remote. Immaculate, boxed, £475. Denon POA 440 monoblock power amps 160 W.P.C. Excellent sound. Hardly used. Boxed £475. Arcam Alpha integrated amp 30 W.P.C. £80. Boxed. Brenell open reel recorder 4 speed matching tape pre-amp. valve. Many tapes. Nice condition. Offers. Tel: 0937 844547.

WANTED Keith Monks or Nitty Gritty Mini Pro 1 record cleaning machines. Tel: 0905 - 723831 evenings.

MALE HI-FI ENTHUSIAST (37 years). Reborn to the joys of fidelity after marital interruption! Most music covered for. Would like to talk/write to females with similar interest. Tel: Mike (0634) 270495 - Medway.

ALPHASON SOLO T/T, Moth 33/45 PSU. Xenon Arm. Athene and Adonis Pre/Power, 100W RMS. Orpheus speakers and stands. All black ash. £3,900 new. Offers. Will split. Tel: 051-637 0816.

QUAD 22 CONTROL Unit, Quad II output amplifiers (pair), FM tuner with stereo decoder, excellent condition in original boxes, £300. Tel: 081-500 2241.

QUICKSILVER VALVE preamp, 60wpc valve monoblocks, superb £1,495, Naim MC Boards £25, CD boards £25; Musical Fidelity A1 £165; Linn Helix £175; Xerxes; Tabriz, Ortofon Quartz £495. Tel: (0449) 676335.

MERIDIAN 208 £725. Sonus Faber Electas/Slate Audio stands £975. Exposure VIII monoblocks £800. Denon AVC 1530 prologic £350. Canon S30/Bass Station subwoofer £250. Canon V100, SC10 £250. Tel: 01252 878200.

WANTED BRITISH TUNER. By Linn/Meridian/Naim/Quad (FM4). Also Quad 606II power amp. Tel: (Dorset) 0935 812736.

TEAC STEREO X10R. Tape Deck. Reverse Playback after Record Etc. 6 Heads, 2 Motors, mint condition has hardly had any use. Boxed. Manuals. Nabs Reels £400 ono. Pair. Wharfedale "Airdales" £240. Immaculate. Tel: 0392 860182.

LEAK STEREO 20 amp. pre-amp and tuner. All mint with original papers £200 - Leak TL 12s plus (pair). Leak 70. Leak Tuners (2) Leak pre-amps (2). Enthusiasts clear out £400. 0392 860182.

STUDER REVOX B77, 30/4 71/2 IPS. Excellent condition, with perspex dust cover, £700 ono. Tel: 071-385 6968 most evenings.

PHILIPS CD880 - NAIM NAIT - Dual C808, Cassette Deck - Linn Kans on Stands. Naim Cable. All in mint condition with receipts. £800. Tel: 081-590 6100.

MUSICAL FIDELITY A100 Class A Amp £200; Manicore Mantra; M8 Arm; Ortofon MC15 Super £200; Musical Fidelity Reference 4 Loudspeakers £100. Complete Budget High End Vinyl System, without cables, for £500. What more could anyone ask for!? Tel: 0202/482110.

NAIM 42.5 PRE-AMP £75. NAIM 110 Power Amp £125. Both in good working order. Tel: 0895 - 443573.

KRELL PAM5 and KSA100MKII Pre/Power combination £2,250. Apogee Centaur Minor incl. stands £650; KEF 103.4MS in Rosewood - hardly used £680. All mint condition, boxed, Soniclink Violet and care less than half price. Tel: 081-942 6241.

FOR SALE: BANDOR units : 6 x 50mm, 8 x 100mm; 2 crossovers (150Hz) 2 x 100mm Audaxs, Designs, wool, cabinet parts. Lowther Designs, 7" x 101/2" opn reel tapes. £180. Will split. Tel: Kettering 710375.

SONY TAN 5JES Power Amp, mint £225; Pioneer TX9500 Tuner Exc. £95; Garrard 401 Deck Exc. £110. Tel: evenings 0908-260112.

NAIM 62-140 pre/power amps. Hi-cap Power Supply. Old type boxes. Naim S.B.L. L/Speakers. All cables £1,700. Tel: 0482 - 641261, 3.30pm to 7.00pm.

LEAK MONO TROUGHLINE Tuner £65; Garrard 401, S.M.E. 3012 Arm, S.M.E. Plinth, Ortofon Cartridge £200; toshiba and Mordaunt Short Speakers £50 per pair. Wharfedale Laser 100 Cabinets £25. Tel: 0274 572924.

LINN KLYDE CARTRIDGE, low hours £225. Linn LK20 Speaker Cable, 2 x 6m pairs for bi-wiring, £50. Micromega OFC Digital cable 0.6m (co-ax) £25. Tel Richard 071 586 2390 Eves W/end

ORIGINAL CRANFIELD ROCK, Excilber arm, £500. Naim 101 tuner plus SNAPs power supply £400. Rogers Cadet pre & power Mark III, £80. Wharfedale sand filled baffle loudspeakers, £150. Tel: 0742 738153 or 0742 723621

NAKAMICHI SR7 cassette recorder, new (£1995) £700. Will demonstrate. Target HS28 speaker stands, height 710mm, top 160x160mm £30. Tel: 081 889 6457

HEYBROOK TT2, original arm, AT cart (new). Also Thorens TD150II, original arm, no cart. offers invited or part ex for good quality tuner. Tel: David 01952 680249 or 0802 305236

FOR SALE. NAIM pre/power 42.5/110 £350 ono. Tel: Work 081 893 4187, Home 0256 475139. Ricky.

COLLECTORS ITEM. Leak Stereo 30 amplifier, fully transistorised, working order, with brand new spare on/off volume control potentiometer. Also QED variable attenuator for CD use pre set to match amplifier input. All paper work c't etc. £145.

MERIDIAN 206B CD Player with remote control £550. NAIM 62/90 pre/power combo with MC cards £500. All excellent condition, boxed with manuals. Can deliver (within reason) Rob 081-673 4896.

PROAC MINI TOWER MKII Floor standing speakers (walnut) complete with matching 'Sonic Stabilisers'. As new condition and boxed. £550 o.n.o. Target TT1 wall shelf £25. Tel: 0843 589554 (anytime).

GYRODEC RB300 Linn K18 MK2 Gyropower. Low use, as new. 21/2 years old, £550. Lynwood Equaliser Head Amp. 1 year old, £60. Gary, Telephone: 0765 605009 (N. Yorks).

MISSION POWER Amplifier Model 772 Mk 2, Class A/B dsign, 150 watts RMS per channel, 3 sets of Loudspeaker terminals, powerful sound, boxed, £200. Tel: 0902 782015 (Wolverhampton).

IMPULSE H2 Horn loudspeakers, in cherry, little use, less than 1 year old, mint, boxed, £1,400. Audion 300B Silver Night monoblocks, export model (20 WPC), little use, mint, boxed £1,500. Tel: 01734 664001 (Reading). Buyer collects.

SUMO POLARIS 100 wpc class AB solid state stereo power amplifier, £300 ono. Art Audio VPI active/passive valve preamplifier, including phono stage. £275 ono. Sage Digitrap £10. Tel: 01962 851802.

WANTED. LYNWOOD MaIns Conditioner in mint condition. Full details and price. Selling. Shure VSTV cartridge. Special edition. Test performance cert. Boxed, as new. £99. Tel: 01225-421773. Bath.

AUDIOPHILE EQUIPMENT CLEAROUT! Counterpoint SA-3000 preamp (cost £1,995) asking £895; NEAR speakers from the USA top of the line model NEAR50 (cost £2,000+) asking £995; Systemdek original transcription turntable £90; Sumiko Bluepoint special £60. Tel: 071-281 0821.

RIVELIN ECLIPSE Turntable inc. power supply AT1503MK5 arm ATOC9 M/C £795. Sugden A21A pure class A MM/MC (699) £450 as new. Apollo Aria 4 shelf stand £65. Tel: 0429 274638.

LINN AKITO Arm with K18 cartridge - mint - £150. Sumo Aurora FM/AM Tuner (USA) £395 (£750 new). Sony ICF 7600 World Band Radio Receiver - mint - £140. Wanted: Audiolab FM Tuner. Tel: 081-651 5711.

WANTED: QUAD FM3 & AM3 (Overseas) Tuners in good condition. Have available for sale, or will trade on Tuners: Radiotron Designers Handbook; BRIGGS on - Amplifiers; Audio & Acoustics; Cabinet Handbook; More about L/spkrs; sound Reproduction; stereophony. BBC - Sound Recording & Reproduction. Write: Mike Coatham, 61 Moana Crescent, Dunedin, New Zealand.

AUDIO INNOVATIONS Series 800 pre/power amp. £600. Quad 44/405 pre/power amp (1982) £250. Pioneer A400 £150. Tel: 081-393 4265 day. 081-393 4147 evenings.

EDISON I2 amp. £200. Also NAD 3020 amp. £55. Both v.g.c. Happy to demonstrate. Wanted: Pair Leak TL 12+. Tel: 0484 546789.

AUDIOLAB 8000C & P £400. DELTEC Little Bit DAC £150. Both mint condition and boxed. Tel: 051-339 4857.

NAKAMICHI WANTED: Cassette decks RX505 or CR5. Phone Steve 0753-879468 (office), 0753-529926 (evenings).

MERIDIAN 200, 263, £850, NAIM NAC72 NAPI40 £750, Heybrook HB3/2 including stands £300 Mission DAC5, new, unopened £200, NAIM NAC72 £400, Arcam Alpha CD £220. Wanted: ISOBARIKS, SBLs. Mick: 01926 831388.

Try me & see

U.K.'s No.1 Specialist
Mail Order Company

For the very best deal on any Hi-Fi, Home Cinema, A/V unit - including all Award Winners!

- TMS is Britain's first dedicated Hi-Fi mail order company
- Over 1,500 satisfied customers



"...
I'm so delighted, that
words fail me. Thank goodness
I contacted TMS."

- Over 40% of
business is recommended
or repeat



"...
What choice, what advice,
what knowledge.
Wow! What next?"

AMAZING PRICES GUARANTEED

... you'll get first-class
**service
savings
and support**

You can always buy from TMS with the complete confidence that we will never let you down.
We always put our customers first and constantly upgrade and update our systems in order to improve our service.

OUR COMMITMENT TO YOU

- ✓ To supply budget, regular and esoteric equipment.
- ✓ To deliver, insured, anywhere in the world within one week* - or your money back!
- ✓ To accept cheque, cash or major credit/debit cards.
- ✓ To offer a comprehensive warranty on all goods.
- ✓ FREE collection (within 24 hours) and delivery of repairs.
- ✓ To offer extended warranties up to 5 years.

* Subject to stock availability

If you are serious about
buying hi-fi, phone
(0181) 563 0003
NOW!

Fax (0181) 563 0300



"... no
hesitation in recommending
TMS to my friends"

... We will be opening a new showroom soon...

Try Me & See Ltd, 5 Rocks Lane, Barnes, London SW13 0DB

TANNOY J95 3-way, floorstanding speakers, mass loaded and deflex panelled, awesome at £390. AVI 52000 MP preamp, virtually unused, £530. Both mint.
Tel: 0222-499561.

S.D.I Acoustics (MK2 upgrade), 3-way floor standing speakers. 250 watts / easily driven. Superb open sound, will demonstrate, £600 (£900 saving on new).
Tel: 0276 477256 (Bagshot / Surrey).

AUDIO INNOVATIONS 1st Audio Monoblocks, £1,250. E.C. Audio Pre with Pandora £795. Snell J11s with Pirate stands £750. Series 200 power amp £350. Epos ES11s with stands £375. All boxed. ANV cable available.
Tel: 0472 882928.

AUDIO QUEST Jade loudspeaker cable. A 5m terminated single bi-wire pair, cost new over £800, asking £350. Deltec Black Slink interconnect, £100. KEF Cube 200, £100.
Tel: 0296 437314 evenings (Aylesbury).

AUDIO INNOVATIONS L2 Preamp and 2nd Triode power amps, exquisite sound, both just 4 months old, new priorities force sale. As new £3,700 asking £2,450.
Tel: 0296 437314 evenings (Aylesbury).

TUBE TECHNOLOGY Integrated valve amplifier £795. Exposure VI pre amp, VII power supplies (two) and VIII Super power amp £495. Spondor SPI speakers (Teak) £360, Foundations stands £45. All as new.
Tel: Stafford 0785 665933.

AMPLIFIER MUSICAL Fidelity power amp P270 + MVT pre amp. Both excellent condition. Can demonstrate. £950 ono.
Tel: Edinburgh: 031 661 6040.

FOR SALE: Acoustic Energy AE1 speakers. Piano Black with dedicated stands. Mint condition, boxed. £650 ono.
Phone: 051 229 4734 day or 051 722 2916 evenings.

NAIM/LINN Buy Sell: 52 CDS, 250 135, 140, ARO etc.
Tel: Bob 0382 819732.

AUDIO SYNTHESIS Passion controller. Original model, factory built, as new. £250.00. PAS-02 controller £100.00.
Tel: 0181-994 2030 after 7pm.

GOODSELL GW180G service info needed. Will buy; have McIntosh literature to exchange. Also want Quad valve amps. Provide description; price. Anthony Schultz, 10020 Vista Montanoso, Escondido, California 92026 U.S.A. (619) 751-1552.

QUAD CD67. Absolutely mint, boxed, £550. No offers. Gale 301, Black Ash, good condition £75. Up-grading. Can demonstrate both.
Tel: 0795 536574 (Kent-Daytime).

MAGNEPLANAR MG11a and SMGa. Boxed and in pristine condition. Genuine reason for sale. Cost £2,000 and £650. Asking £975 and £340 respectively.
Tel: 0585 731083 after 1pm.

WANTED: Target AERS equipment rack; Hitachi 7500 power amp; Cambridge C70 power amp; Phase Linear Series 700 amplification Spares. Enrico.
Tel: 0222-499561.

ATC SCM50A, 350W/GH active spks with stands and boxes. 2 years old. Fabulous sound. Reluctant sale (4497) 2999 ono.
Tel: 0279 813450 (Ian).

BARGAIN EQUIPMENT: Celestion SL600 loudspeakers £250, Meridian tuner £75, Epos ES11 loudspeakers £170, Cambridge CD2 £290.
Tel: 071 286 4143

ORELLE D.A.C. 180 (boxed) £480 o.n.o. Audio Alchemy Datastream Transceiver (boxed) £140 (£200 new). Motion Electronics Nicam TV Stereo tuner with remote £140.
Tel: 0229 470259.

LIINN KABERS, Black, immaculate, £700. AVI 52000MA stereo power amp, £350. Naim, 2 sets, 6 metres Tri-wire NAC5 cable, terminated £90.
Tel: 081-689 6855, evenings/weekend (Croydon, Surrey)

QUAD 67 CD Player and 606 MK2 power amp wanted.
Christchurch (01202) 479800.

NAKAMICHI 600 cassette deck, 610 preamp, 620 power amp and 630 FM Tuner preamp in free standing, black metal System One cabinet £650.00 with original manuals.
Evenings 081-398 1943 (Surrey).

REVOX PAIR F-36 Stereo valve recorders, new heads on one £375. Sugden Craftsman 3 turntable chassis, 3-speed £75. Mono Pickups: Garrard TPA 10/Goldring 600 £35. Leak Dynamic/78rpm MC Head/Transformer £45. Heals Wall Cabinets for Quad Valve system £75. Heals, folding wall cabinet with Thorens TD 124/Shure M212 £275. Single Lowther Mini Acousta PM6 £85, 3x Leak Sandwich 600 £145.
Tel: 071 372 3724.

WANTED! WANTED! WANTED! WANTED! WANTED! WANTED!
1x Goodmans Axiom 300, 1x Quad II near serial number 2727, 1x Quad II. Near serial number 51518. 1x Leak TL 10, 1x TL 12, SME 3012/Early 3009 2x Rogers LS3/5A, your (reasonable!!) price paid for near mint items!
Tel: 071-372 3724.

HEYBROOK POINT 5 mark one loudspeakers on HBSI stands. Little used. Cost £200. Accept £110 ono. Lewes, East Sussex.
Tel: 0273 477683.

JBL 3x L-100 Monitors, Signature Series, £395 pair Tannoy Chevening, HPD 295, £275 pair Rogers 2-way export monitors, £195. Yamaha B-2 poweramp, massive dual supply, £495. Thorens TD-126 MK4, Thorens arm, Brandnew, £295, Vitavox S-3 Drivers, new + Vitavox Radial Horns, used, £595.
Tel: 071-625 8966.

MUSICAL FIDELITY A100 (integrated Class A amplifier), excellent condition, one owner. Cost £550, sell for £230. Inherited upgrade forces sale.
Call Jim on 0202-717746 anytime.

SPENDOR SPI/2 and M.A.F. stands 5 months old £900, or exchange for KEF Reference 2 or Magneplan SMGb speakers. Leak Stereo 20 £220. Sony CDP103 CD player £150.
Phone: 081-531 5979.

COLLECTION OF quality Hi-Fi equipment (47 pieces) for sale. Includes Quad, Yamaha, Burmester, Nakamichi, Sugden, Thorens, Luxman, Meridian, SME, etc.
For details Ring: 0372 273774.

QUAD ELS63 speakers, new/boxed £1,995, SME V (Gold version) new/boxed £995, Quad II (pair) £350, Quad ELS £350, Revox B77 Mk2 2T-Mid Speed, mint condition £795.
Tel: 01444 459196.

FOR SALE: Naim Hi-Cap, 7 months old, 30 hours use as new £500.
Tel: 0886 821577.

NAIM 32.5. Good condition, boxed £220.00. Audiotech T/Table Wall shelf - £30.00.
Tel: 071-606 0888 days, 081-665 6183 evenings/weekends.

MERIDIAN 208 CD player / preamp / incl. phono stage with 209 Master R.C., Remote volume control, superb sound and appearance. £525.00. Rodgers Cadet III Stereo valve amp/pre amp. Good condition, working + circuit / components List £60.
Tel: 0628 822040

LIINN SONDEK LP12, Valhalla power supply Ittok arm, A&R cartridge £550. Sheffield. 0114 248 2483.

WANTED: LIINN ITTOK LVIII tonearm, mint condition.
Tel: 01952 249627 Harold, Telford.

QUAD II AMPLIFIERS, serviced £260 o.n.o. Quad AM3, mint £120. Leak Troughline 3 (mono). £60. Sugden C51, Sugden Stereo tuner (working mono) both mint £60 pair o.n.o.
Tel: 0482 53192.

3 MONTHS OLD Arcam Alpha 5 plus C.D. £430. Boxed, as new.
Tel: 0895-443573.

NAKAMICHI 1000 ZX1. The cassette deck (rare) truly little used, unmarked, mint. £2,300.00 ono. One owner from new. Meridian 203 DAC. Mint. £200.00.
Tel: 0364 72292.

NAIM NAC 62 Pre-amp. Old style case. Selling due to upgrade to NAC 72. £225 o.n.o. boxed.
Tel: 0425 620022 (day) 0590 682710 (evenings) (Hampshire).

MUSICAL FIDELITY A100 amplifier £150. SIRAC 50 watt valve power amp KT88, re-built. £250. Appollo 24" Lead shot filled speaker stands £75.
Tel: (Tamworth) 01827-261082.

LIINN LP12 Lingo Ekos Ortofon MC3000. Afro finish, 1990 spec. £1,200. Meridian 208 pre-amp/cd + 209 remote control £550. Both mint/boxed. No offers.
Tel: 01924-290749 (Yorkshire).

PROAC STUDIO Ones mark two £385. Audio Dimensions custom four pillar stands for above £115. 10 metres of Sugden Sound Stage cable £30. Will haggle.
Call: 0634 377339.

OXFORD CRYSTAL Reference turntable SME V tonearm. £1,400 or split £700 each.
Tel: Steve 0623 755347 after 7pm (Notts).

NAIM NAP 180 power amp, 9 months old. Mint condition. Cost £940. Sell £700.
Tel: 0181 840 7000 Pager: 0814723. N. London.

PIONEER CLD 1750 PAL/NTSC Laserdisc player, immaculate, boxed, never used, £395; Meridian 203 DAC excellent condition, £195.
Tel: 081-467 6220.

NAIM CDI, Immaculate condition, eighteen months old, boxed, remote, £1,375 ono. Naim NAP 250, 1989. Model (Silver edged). Also immaculate, £800.

Ask for Chris on 01793-612210, or 01793-534104 (Swindon, Wilts).

FOR SALE: Proac Studio 3 EBS floorstanding speakers. Black ash. Excellent condition. £700 ono.
Tel: 081-952 2044 evening and weekends.

ROKSAN DARIUS Speakers. Latest spec. in Rosewood complete with T-bar stands and crossovers, in perfect condition with original boxes. £1,000.00. Telford (0952) 727866.

OFFERS WANTED FOR: Technics SL110 Turntable, SME 3009 arm, Shure V15 and Ortofon cartridges, Technics SU8600 amp and ST9600 tuner, Celestion Ditton 66 speakers and Revox A66 tape deck.
Phone: 0494-715282.

CABLES. V.D. Hul source 4 x 3 metre £70. Silver Sounds 2 x 3 metre £150. Monster 2 x 3 metre £25. Burmester pre phono £1,800. New £380. Yamaha. DSP £85.
Tel: 0753 857530.

WANTED KEF CELESTE or Concord speakers. Must be in good condition. Will collect.
Tel: (Ruislip) 0895-633687.

SUGDEN SDT1 CD player £550, Audioquest speaker cables: Jade 2m pair £120, Midnight 3m pair £80. All in excellent condition.
Southend 0702-618922.

A.V.I. MONO BLOCK amps 150 Watts £750, Sumo pre amp £300, Quad FM4 Tuner £230, Musical Fidelity P150 power amp, Ruark Sabres plus ATAcama stands £260, Myst TMA3 amp £120, Technics PS 700 C.D. player £170, Quad 33/405 amp £210, Michell ISO £230.
Tel: 0977-643629.

VINYL BARGAINS FROM BLACKMAIL

Snap up these special offers now, we have very limited quantities of some of these titles so order today and list alternatives if possible

LP's AT £3.99 each

Larry Jinx Alexander - Riverboat Man.....	F139
Band Of Blacky Ranchette - Sage Advice.....	F181
Band Of Blacky Ranchette - Heartland.....	Z14
Cliff Bennett & The Rebel Rousers - Slow Down.....	ED 148
Big Dipper - Craps.....	F132
Big Dipper - Heavens.....	F136
Charles Brown - One More For The Road.....	F88
Jean Jacques Burnell - Euroman Cometh.....	plcdisc PMAU601
T-Bone Burnett - Trap Door.....	VEX2
Dharma Bums - Haywire.....	S3
Al Green - Call Me..HI409/Livin' For You..HI411/Explores Your Mind..	
..HI413 /Is Love..HI415/Full Of Fire..HI417/Have A Good Time..HI419/	
Trust In God..HI423/Love Ritual..HI443	
Hex - Hex.....	F156
Jellyfish Kiss - Plank.....	F192
Julle London - Julie Is Her Name.....	ED 108
Julle London - Calendar Girl.....	ED 109
Willie Mitchell - That Driving Beat.....	HI408
Moonlighters - Rush Hour.....	F10
NRBQ - Tapdancin' Bats.....	F51
NRBQ - Through The Eyes Of A Quartet.....	F57
Ann Peebles - 99 lbs.....	HI402
Skeletons - Rockin' Bones.....	F177
Skeletons - In The Flesh.....	F178
Textones - Back In Time.....	F179
True West - Drifters.....	Z4
Bob Willis - TheTiffany Transcriptions Vol.1..ED 321/Vol.2..ED 322/	
Vol.3..ED 323/Vol.4..ED 324/Vol.5..ED 325/Vol.6..ED 326/Vol.7..ED 327	
Vol.8..ED 328	
Wood Children - Shopaholic.....	F155
Various Artists - From Hell To Obscurity.....	B1
Various Artists - This Is Black Top.....	BTS1
Various Artists - Slippin' Around.....	HDH010
Various Artists - Hi R&B.....	HI439

LP's AT £4.99 each

Alpha Band - Interviews.....	ED 272
T-Bone Burnett - Proof Thru The Night..F14/Truth Decay..F71/Behind	
The Trap Door..VEX3	
Edwyn Collins- Hope & Despair..F144/Hellbent On Compromise..F195	
The Damned - Not The Captain's Birthday Party.....	VEX7
Ian Dury & The Blockheads - Warts And Audience.....	F777
The Everly Brothers - Two Yanks In England.....	ED 297
The Everly Brothers - Pass The Chicken And Listen.....	ED 319
Giant Sand - Long Stem Rant ..F164/Swerve..F204	
The Gutter Brothers - Gone To The Dogs.....	XX21
Sean O'Hagan - High Llamas.....	F192
David Halley - Stray Dog Talk.....	F187
John Wesley Harding - It Happened One Night.....	F137
Paul Kelly - Hangin' On In There.....	ED 316
Kursaal Flyers - In For A Spin.....	ED 142
Clive Langer & The Boxes - Hope, Honour, Love.....	F127
Ted Nugent - Call Of The Wild..ED 278/Tooth Fang & Claw.....	ED 295
Pink Fairies - Kill 'Em And Eat 'Em.....	F105
Gerry Rafferty - Blood And Glory.....	TR3
The Roulettes - Russ,Bob,Pete & Mod.....	ED 113
Thin White Rope - In The Spanish Cave.....	F114
Sandra Wright - Wounded Woman.....	F138



LP's AT £5.99 each

The Attractions - Mad About The Wrong Boy.....	F25
Autosalvage - Autosalvage.....	ED 286
The Big Three - Cavern Stomp.....	ED 111
Brinsley Schwarz - Please Don't Ever Change.....	ED 237
Solomon Burke - A Change Is Gonna Come.....	R4
Randy California - Kapt Kopter & The Fabulous Twirlybirds.....	ED 164
Chairmen Of The Board - Salute The General.....	HDH001
Copperhead - Copperhead.....	ED 136
The Deviants - The Deviants.....	TR8
Bo Diddley - 20th Anniversary.....	ED 318
Diesel Park West - Versus The Corporate Waltz.....	F747
Dillard & Clark - Through The Morning, Through The Night.....	ED 195
The Dillards - I'll Fly Away.....	ED 246
John Fahey - I Remember Blind Joe Death.....	R25
Flying Burrito Brothers - The Gilded Palace Of Sin.....	ED 191
Jimmie Dale Gilmore - Jimmie Dale Gilmore.....	F145
Clive Gregson - Strange Persuasions.....	F45
Screamn' Jay Hawkins - Stone Crazy.....	F728
The Men They Couldn't Hang - Night Of A 1000 Candles.....	F50
New Riders Of The Purple Sage - Same.....	ED 265
Nilsson - The Point.....	ED 340
Graham Parker - The Up Escalator..F121/The Mona Lisa's Sister..F122/	
Live Alone In America..F141/Human Soul..F163/Struck By Lightning..	
..F201/Burning Questions..F721	
Rockpile - Seconds Of Pleasure.....	F28
The Shamen - In Gorbachev We Trust..F666/Drop..MAU613	
That Petrol Emotion - Manic Pop Thrill.....	F70
Loudon Wainwright III - A Live One..ED 223/Unrequited..ED 273/	
Loudon Wainwright III..ED 308/Album II..ED 310/Fame & Wealth..F5/	
I'm Alright..F54	
Bobby Womack - Home Is Where The Heart Is..ED 172/Lookin' For A	
Love Again..ED 291	
Steve Young - Rock, Salt And Nails.....	ED 193
Youngbloods - Point Reyes Station..ED 244/Earth Music..ED 274/	



LP's AT £6.99 each

Gene Clark & Carla Olson - So Rebellious A Lover.....	F89
Guy Clark - Texas Cookin'.....	ED 287
Mary Coughlan - Love For Sale.....	F730
French, Frith, Kaiser & Thompson - Live, Larf, Love & Loaf.....	F102
Nancy Griffith - Last Of The True Believers.....	R13
Emmylou Harris - Elite Hotel.....	ED 306
John Hiatt - Bring The Family.....	F100
John Lee Hooker - The Detroit Lion.....	F154
Nick Lowe - Rose Of England.....	F73
Nick Lowe - Pinker & Prouder Than Previous.....	F99
The Merseybeats - Beat And Ballads.....	ED 105
Christy Moore - Ordinary Man.....	F82
Randy Newman - Trouble In Paradise.....	ED 305
Phil Ochs - A Toast To Those Who Are Gone.....	ED 242
Graham Parker - Live In Japan.....	F735
Peanut Butter Conspiracy - Turn On A Friend.....	DO2000
Ann Peebles - I'm Gonna Tear Your Playhouse Down.....	HI422
Otis Rush - Right Place, Wrong Time.....	ED 220
John Sebastian - John B Sebastian.....	ED 304
Son House - Death Letter.....	ED 167
Spirit - The Family That Plays Together.....	XED 162
George Thorogood & The Destroyers - George Thorogood & The	
Destroyers..F55/Move It On Over..F58	



To take advantage of these offers simply:- send a cheque/P.O. made payable to BLACKMAIL or send your VISA/ACCESS credit card details (Card No./Expiry date/Cardholder's Name And Address) To: BLACKMAIL, FREEPOST (TK 974). P.O. 80X 9, BRENTFORD, MIDDLESEX, TW8 8BR.

You can also call us on our credit card hotline 0181 569 7820 (24 hours), or even FAX your order on 0181 568 8223. All prices are inclusive of p&p. A 172 PAGE BLACKMAIL CATALOGUE WILL BE SENT FREE WITH EVERY ORDER

AUDIO RESEARCH LS5 (Black). All valve tube pre mint condition £2,800.00. DPA 100s pre brand new, £950.00.
Tel: David 071-272 7380.

LINN KEILIDH speakers with ceramic plinths £425 ono. Naim Nac 62/Hi-Cap/NAP90, NACA5 speaker cable, Chord Cobra interconnect, Naim MM Boards £925 ono (no split on amps).
Tel: Damian (01233) 641993.

AKAI AMPLIFIER £70 speakers £70, cassette deck. GMX M10 £60. Digital tuner AT VOT £80. Yamaha Graphic Equaliser EQ550 £60. Technics CD player PG 100A with Trichord Clock 2 fitted £90.
Tel: 0667-456009 (evenings).

ROTEL MICHI RHT-10 tuner £495.
Tel: 0628-26085.

LINN KABER ACTIVE loudspeakers including Linn Kaber Active crossover unit £750, 2 x Linn LK280 amplifiers £325 each, all boxed immaculate condition. Cash sale.
Tel: after 6pm: 0924 383935.

FOR SALE: LINN LP12 (black) Valhala, Naim ARO tonearm, Linn cartridge, mint condition, never been used £850.00. Early Linn Kans and Sound Organisation wall stands £180.00.
Tel: Paul 0737-762196 (Surrey) evenings/weekends.

DUAL 32 Function remote control Auto Reverse Hi-Fi system. Strobe T/ Table, tuner, amp, receiver, speakers, rack system, perfect. Probably best system from Germany cost over £1,500, accept £750.
Tel: 0895-253259 (Hillingdon).

AUDIOLAB 8000T tuner £550. Shearpe Phase 2 amplifier £400. Project 6, exquisite heavy hardwood plinth (easily restored to standard) £300. All items beautifully cared for.
Tel: 0233-860737 evenings (Ashford, Kent).

LINN AXIS BASIK plus P77, Naim Nait Mk1, Sendor Preludes, Heybrook speaker stands. £200 complete.
Tel: 0279-504926.

NAIM NAIT II (mm) £200. Linn Kan II with Kan II stands (black) £275. Mission Cyrus II (Mk1) £160. Demonstration possible. Ealing area.
Tel: 081-723 0967 (evenings).

A.V.I. 2000 Series D.A.C. £250. AKG 1000 Headphones £250. Both in very good condition.
Tel: (0703) 738271

AUDIOLAB 8000A amplifier. Excellent working order. Owned from new. 8 years. £100.
Tel: 0823-490913 (Taunton, Somerset).

ENTHUSIASTS CLEAR OUT. Aura VAI00 Evolution amplifier, the original and still the best! £200 o.n.o.; Tannoy 609IIs £200 o.n.o.; Celestion DL3IIs £75 o.n.o.; Dual CS 505II £65 o.n.o. All boxed U.G.C. wanted Goodmans Maxim 20. In good condition, reasonable price paid.
Tel: 0202-475781.

ROKSAN ROK-DPI CD transport, £600. Audio Alchemy DDE DAC, £220. Sony Walkman Pro, £150. Audio Synthes Passion Passive pre-amp, £300. Hart Audiophile MC/MM pre-amp, £120. All boxed.
Tel: 01202-884148.

LEAK STEREO 20, Varislope 2 preamp, Trough Line 3 tuner, Garrard 301, Decca FFSS Pickup, little used, original valves, original boxes, original invoice for most £550.
Tel: 01442 822355.

DYNACO CLASSIC USA Valve equipment. ST70 power amp £275. PAS 3 preamp £150. FM 3 tuner £120. PAT 4 transistor preamp £100. FM5 transistor tuner £100. All excellent.
Esher 0372 467 264.

MERIDIAN 206B CD player. Boxed, mint condition. Hardly used. £500 ono.
Oxon (0235) 817258 (evenings).

NAIM 42/110 pre/power amp, moving coil, £395. Naim 110 power amp, £250. Naim Nait 2 integrated amp, £250. Linn Sondek LP12. Valhala. Ittok, Audio Technica OC5, £600. Ruark Crusaders, rosewood. £700.
Tel: 01383 410851 or 0374 864541 (Fife).

NAIM 32 pre-amp (32.5 conversion), moving coil, variable auxiliary, £150. Bandridge Super Goldline interconnect. £15. "Esoteric Audio" speaker cable (US import), 20 metres, £30.
Tel: 01383 728076 (Fife).

MERIDIAN M1 Active loudspeakers, rosewood, nice condition with original packaging £650.00 ono. MERIDIAN M30 Active Loudspeakers, black, with stands and original packaging £550.00 ono. EAR 802 valve preamp, black, £600.00.
Tel: 0985 844651 (Wiltshire).

WANTED: TECHNICS, Stereo / Mono DC power amplifier, model SE-9060 and FM stereo tuner ST-9030. Call Mr. Butt on,
Tel: 273 592495 work, 273 422308 home.

KEF 105-3 Reference speakers, rosewood finish, excellent sound and condition. Bargain £1,000 Denon 33,000 CD player. Cost new £1,200, sell for £395 o.n.o. P.X. considered.
Tel: (0225) 400911.

MONITOR AUDIO / Creek equipment, M.A. R852. Metal dome speakers with Linn Sara stands. £135. CAS3140. Tuner £90. CAS4140II. Amplifier £85. All immaculate, boxed with manuals. Gaddy dem. No offers.
Tel: 0254 261162.

LINN LP12/Ittok/Asaka (1987/88/90) — £600; Linn LK280 (1990) — £350; various Hi-Fi magazines, 1970's onwards — offers? Northampton (01604) 403947 after 7pm.

LFD PA2 stereo power amplifier 80 wpc. Superb sound and excellent condition. Owner up-graded to monoblocks. £950. Audio Synthesis type, dual mono passive pre-amp (stepped attenuator) £300. Tequipment oscilloscope £50.
Tel: 0621-860 630.

ROGERS HG88 MkIII stereo valve integrated amp, matching tuner, £200. Strathclyde turntable 305m, brushed steel heavy plinth. SME 3009-11 arm, £100. Swaps, Croft Micro, FM4, British CD, Sony Elcassette.
Liverpool 280 3216.

MUSICAL FIDELITY CDT, triode valve CD player, black/chrome, £375. Art VP-1 rack size valve pre-amplifier, £375. Leak Troughline 3 stereo tuner, £85.
Tel: Brighton (0273) 684424.

LINN NEXUS speakers in excellent condition. Finished in black ash veneer, complete with dedicated Ku-Stone stands. Good imagery and tonal balance, powerful bass. £450 o.n.o.
Phone: Horsham (0403) 253873, evenings/weekends.

LEAK TRANSCRIPTION turntable, Arcam P77, both excellent £80. Cyrus PSXII Pristicine, 12 hours use, boxed, guarantee £190 (£300) or swap de Parvacini 834P phono stage, in good condition.
Tel: 01446-721871 PHK.

LINN LP12, Lingo, Ekos, Troika. Little used. £1,350
Tel: (Taunton) 0823 443825.

AUDIO RESEARCH D125, STAX LAMBDA Signatures SRMT1 new diaphragms, Macintosh MR67 valve tuner, custom Audionote M7 valve preamp, S.E. Monoblocks, Brook 12a, EMT tonearm, M.C. transformers, Meridian 206 delta/sigma.
Tel: 01642-559543.

COMPLETE QUALITY Stereo — Rotel AM/FM receiver RX-940AX. Rotel CD RCD-965BX. TEAC Double auto reverse cassette WV-525R. Rogers loudspeakers LS4a/2. Target stands. Isolating transformer. £650.00.
Tel: 0860-459799. Great Dunmow.

PINK TRIANGLE EXPORT, Tabrizi arm, Corus Black, mint, £425 o.n.o. Kelvin Labs integrated amplifier 22+22. Superb sound 2 years old. Mint £350 o.n.o.
Tel: 0663-733119.

WANTED MERIDIAN M2 loudspeaker must be in good condition and preferably walnut. Can collect.
Phone: 0604 643383 after 6pm.

AUDIO NOTE K/SP loudspeakers, silver-wired, black finish with Huygens K4 stands £425.
Tel: 081-572 2504 (evenings).

LEAK TROUGHLINE 3 Stereo, serviced, aligned by London Sound, written report, superb £160. Naim Nait 2, £250. Rega 3, RB300, K9 £200, both mint and boxed. J.P.V. Sonata £55.
Tel: 0753-653765.

MANTICORE MAGICIAN tone arm chrome finish, van den Hul wired, Linn fitting, excellent condition. £650 new, bargain at £200 including part worn ATOC9 cartridge.
Tel: 0525-382710.

LINN ISOBARIKS, recently serviced inc. stands. 5" NAC A4 very good condition. £650.00. Naim Nac 42.5 and NAP90 £450.00. Rotel RC 870 pre I40 RB850 x2 £220. KEF 103/4 unused £800. Audio Technica OC9 Cartridges, brand new £160.00.
Tel: Jules on 0792-280061.

WHARFEDALE HAREWOOD SPEAKERS, were £900, only £350, 5 star review "What Hi-Fi" September 1992. Ortofon SPU cartridge, recently re-built and re-tipped by the cartridge man £300. Harman Kardon Citation Twelve power amp £150. Linn Linnk, Naim made MC to line level step-up £100. F & S Trading single-ended Class A 12w valve monoblock power amps, Gold Dragon valves £380 new, £230.
Phone: 081-767 2660.

SITUATIONS WANTED: Graduate and Hi-Fi enthusiast seeks work in sales or as rep. Good communicator, good product knowledge.
Tel: (0116) 812074 (based in Midlands).

TRADE

VINTAGE RADIO RESTORATION. Fully resprayed Quad II valve amplifiers from £400 pair. Leak TL12+ monoblocks £250 pair. AE1 monoblocks £40 pair. Leak Stereo 60 £400. All fully rebuilt.
Tel: 01903 501158.

MOTH THIRTY SERIES Pre + Power amplifier £299.00. Pioneer A400X amplifier £240. Rega RB300 tonearm £149. SME 309 tonearm £425. Townshend Seismic Sink £145.00. Castle Chester speakers £595.00. Mission 780SE speakers R/wood £195.00. Deltec Black Slink balanced leads £200. Royd Minstrals speakers £199.00. All new and guarantee. Credit Cards accepted.
Tel: 0582 24414.

MERIDIAN 602/606 (£3,200) £1,495. 200T/203 £639. Alpha 5 CD £349. Deltec Little Bit £210. Alpha CD/Black Box £279. Roksan DA1/ROK DS4 £399. Meridian 200T/Roksan DA1 £695. Heybrook Integra. Integrated amplifier (£555) £390. TEG70 Power Amp (£465) £349. Both XDem, mint.
Objective Audio: 01279-426647 or 0850-484464.

EX-DEMO SALE: DPA T1 transport £700, Bigger Bit DAC £500, both £1 000. ORELLE 10T transport £600, DAC 180 £450, SC200 pre, MM/MC, £350, SP200 power £600, ORATOR Speakers £500, System Price £2,250. LINAEUM LFX £500. Sonus Faber Elceta £1,250, Minuetto £750. CLASSE 30 pre £1,095, 70 power £1,095, both £2,000. MAGNEPAN SMGb £695. Telephone/Fax: 01252 377952 (till 10pm).

EXPOSURE XX amplifier for sale: Virtually new, boxed and in mint condition. Bargain at £445. Mission Cyrus 780 speakers £95. Origin Live OLIA speakers. Ex dem £240.
Phone: Origin Live 0703 442183 / 671237.

PROAC RESPONSE One "S" Latest spec £699. Monitor Audio MA14 £259. KEF 102.2 £375. Rogers Studio 1A £299. LST £249. Neat Petits £329. Proac Super Towers £649. EPOS ESII £299. Heybrook Quartets £399. Hi-Fi bought for cash.
Objective Audio: 0279-426647 or 0850-484464.

Are you making the right connections?

Send for Britain's biggest catalogue of specialist cable and connections.

All available by mail order.

Phone 081-9429124 or clip the coupon for your Free copy.

CUSTOM CABLE SERVICE

PO Box 4007, London SW17 8XG

Please send me your FREE Custom Cable Catalogue

Name _____

Address _____

Postcode _____

NO FURTHER INFORMATION REQUIRED

Send to: Custom Cable Service

PO Box 4007

London SW17 8XG

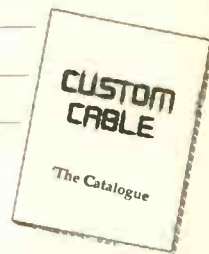

HFV4/95



THE MINSTREL BY QUANTUM AUDIO LTD

30 Watt, Ultra Linear, integrated, hybrid, valve, line level amplifier



You must hear this amplifier, your ears will convince you of its sonic superiority. There is nothing whimsical about the sound, the Minstrel is promoted as quick and dynamic. It is . . . but it could equally have been called solid and meaty. This is a big hearted amplifier, which can put on a surprising burst of volts and amps when pushed, and quickly too. When the pushing is done by a piano recording or something similarly percussive.

I was surprised, even shocked by the Minstrel's dynamic range, which is utterly convincing and un-tube like, yet the delicacy and fine detail of Debussy or Ravel orchestral music is beautifully handed. A real mailed first in a velvet-glove type performance. Alivn Gold, Hi Fi, Choice, October 1994.

For further details, dealers lists and demonstration appointments, contact the producers:

Quantum Audio Ltd., PO Box 26, 1 Oliphant Drive, Kilmarnock, Scotland KA3 7JA

Tel: (01563) 571122

LOUDSPEAKERS WHEN MUSIC MATTERS



FEATURING

ACTIVE/PASSIVE X-OVERS

REAL WOOD VENEERS

ALUMINIUM CONES

OFC CABLING · STANDS

Q.T.A. SYSTEMS

2 WHEATSHEAF WAY · LINTON
CAMBS · CB1 6XB · TEL: 01223 891091

Thinking of buying new Hi-Fi or AV loudspeakers?

well

Richard Allan make ★★★★★ reviewed speakers which are better than the competition and at up to 50% less you'll ask

HOW DO THEY DO THAT?

PHONE NOW TO DISCOVER HOW

01274 87 24 42

or fax 01274 86 99 35

CAN YOU AFFORD NOT TO

Richard Allan

Manufacturing quality British loudspeakers since 1947
BRADFORD ROAD GOMERSAL CLECKHEATON WEST YORKSHIRE BD19 4AZ

MUSICAL TECHNOLOGY, ATC, HARBETH,

EX-DEMONSTRATION & SECONDHAND

LFD, MICHELL, ORIGIN LIVE, KINSHAW, CHORD

AVI S2000MA 90wpc p/amp	£400
AVI S2000MD DAC	£375
Quad 606mk1 power amp	£400
Kinshaw Perception preamp	£420
Stax SR Lambda Pro headphones,	
SMR-X drive unit, BPS 600 Ni-Cd pack	£545
Meridian 206 Delta Sigma	£600
ATC SCM50A loudspeakers	£3995
Mordant short MS55 (bi-wire)	£150
Target Single column 22" stand	£65
Chord SPM 800 power amp	£1099
Audio Synthesis PAS-02 preamp	£190
Origin Live OL2 ldsdrs	£450
Quad 44 preamp	£250
Target open frame 20" stand	£35
Sumo Polaris mk2 power amp	£300
Meridian 203 DAC	£250
Harbeth LS5/12A loudspeakers	£799
Sansui AU-X 417R int amp	£195
DPA PDM2 mkII DAC	£1150
Sansui CD-X 217 CD player	£150
Sansui AV7000 a/v amp	£499
Harman Kardon 655 int amp	£150
Harbeth P3 loudspeakers	£375

Cottage Audio

17 Bridge Street, Saxilby, Nr. Lincoln. LN11 2PZ

Tel: (0522) 702834 eve: (0522) 696708

DELPH, QED, PROJECT, THORENS

ROYD, SANSUI, SEQUENCE, SONIC LINK,

Advertisers' Index

MAIN ISSUE					
AMADEUS S & V	115	HEATHERDALE AUDIO	110	THE EMPORIUM	110,119
ARCAM	39	HI-FI CONFIDENTIAL	122	THE RECORD SHOP	112
ART AUDIO	20	IAN HARRISON	110	TRY ME AND SEE	124
AUDDIO SYNTHESIS	38	KAL	17	TUBE TECHNOLOGY	56
AUDIO AMATEUR	56	KLIPSCH	26	UK DISTRIBUTION	12
AUDIO GALLERY	113	LISTEN INN	20	V'AUDIO	114
AUDIO ILLUSION	20	LORICRAFT	96	VIRTUAL REALITY	30
AUDIO LINKS	116	MANA ACOUSTICS	110	VRR	116
AUDIO PHYSICS	115	MANTRA	119	WILSON STEREO LIBRARY	38
AUDIOLAB	46	MEET-YOUR-MAKER	52	WOLLATON AUDIO	16
AUDIOPHILE INT.	102,103	MEYERS	32	WORLD AUDIO DESIGN	82,83,85
BILL HUTCHINSON HI-FI	44	MICHELL ENGINEERING	24		
BLACKMAIL RECORDS	126	NORTHWOOD AUDIO	104	SUPPLEMENT	
BRITISH HI-FI AWARDS	118	ORTOFON	22,24	AP ELECTRONICS	22
CABLE TALK	119	OXFORD AUDIO CONS	116	AUDIO TECHNOLOGY	4
CAD	12	POWERPLANT	108	AUDIONOTE	20,21
CHOICE HI-FI	108	QTA SYSTEMS	128	B.D. ELECTRONICS	14
CHORD ELECTRONICS	96	QUANTUM AUDIO	128	BILLINGTON EXPORT	IBC
CLASSIQUE SOUNDS	108	RDL ACOUSTICS	113	BORBELY AUDIO	14
CONGELTON HI-FI	96	RICHARD ALLAN	128	CHELMER VALVE CO	BC
CHORD COMPANY	6	ROOM ACOUSTIC SERVICES	110	CRICKLEWOOD ELECTRONICS	4
COTTAGE AUDIO	128	ROYAL AIRFORCE ASSC.	84	GLASS AUDIO	18
CUSTOM CABLE	128	S.M.E.	20	HART ELECTRONICS	8
DAIL-A-DEALER	89,90,91,92	SELECT SYSTEMS LTD	54	I.P.L. ACOUSTICS	18
DAN DULEY/GRAMEX AUDIO	114	SERIOUS KIT	122	KIT SUPPLIERS	24
DEFINITIVE AUDIO	117	SLATE AUDIO	106	LANGREX SUPPLIES	14
DOUG BRADY	36	SONIC FRONTIERS	117	P.M. COMPONENTS	26
DPA	14	SOUND FOUNDATION	104	PATH PREMIER	IFC
DYNAMICS	112	SOUND ROOM	34	SEAS	12
ELECTROCOMPANIET	8	SPECIALIST HI-FI		SJS	12
ELVINS ACOUSTIC	17	DEALERS	77,78,79,08	SONIC FRONTIERS	12,22
FOUNDATION AUDIO	113	SPECTRA DYNAMICS	17	SOWTER	4
FULLERS	12	STUDIO 12	115	SPEAKER CO.	10
GLASS AUDIO	115	STUDIO ONE	12	TECHNICAL AND GENERAL	22
GLOTTA AB	38	SUSSEX SURPLUS	119	WOLLATON AUDIO	12
		SYSTEMDEK	84		
		TEAC	10		



SUGDEN

HAND CRAFTED ■ FAIT À LA MAIN

DESIGNERS & MANUFACTURERS OF HI-FI & AUDIO EQUIPMENT

J. E. SUGDEN & CO. LTD.

Valley Works,

Station Lane, Heckmondwike,

West Yorkshire WF16 0NF

Tel. Heckmondwike 0924 404088/9

Fax No 0924 410069

World Radio History

TMS



*HOTCAKE Loudspeakers
What Hi-Fi? Best Design 1989
"Recommended"*

*DARIUS Loudspeaker
Hi-Fi Choice - Product
Excellence 1990
"Recommended"*

*TABRIZ Tonearm
1991 What Hi-Fi? Awards
"Recommended"*

*CORUS Cartridge
What Hi-Fi? - Best cartridge
1991
"Recommended"*

*RADIUS Turntable
1992 British Hi-Fi Awards
Best turntable under 500*

*RADIUS Turntable
1992 F. B. A. - Best turntable
under 500
"Winner"*

*ROK-DP1 CD Transport
Audiophile - Award for
excellence 1992
"Winner"*

*Touraj Mogbaddam
Signature (TMS) Turntable
Audiophile - Award for
excellence 1993
"Winner"*

*Touraj Mogbaddam Signature
(TMS) Turntable
Stereo Sound - Reviewers Top
Turntables 1993
"Number 1"*

*XERXES Turntable
Stereo Sound - Reviewers Top
Turntables 1993
"Number 2"*

*OJAN 3 Loudspeaker
Hi-Fi Choice - 1994
"Recommended"*

*ATTESSA ATT DP2P
CD player of the year 1994
Suono Magazine
"Winner"*

L 2.5 Pre-Amp



S 1.5 Stereo Power Amp



DS 1.5 Power Supply

M 1.5 Mono-Power Amplifiers



L 1.5 Pre-Amp



ATT DS5 Power Supply



ATT DA2 DAC

AtteSSa ATT DP2 CD Transport

Ojan 3X



ROKSAN

ROKSAN • Stockley Close •
Stockley Road • West Drayton
• Middlesex UB7 9BB •

Telephone: 01895 436 384 •
Facimile: 01895 436 385