

NEWS AND TECHNOLOGY ■ INSTALLATION ■ SERVICING ■ DEVELOPMENTS

TELEVISION

AND COMMUNICATIONS

TELEVISIONS

APRIL 2005

£3.20

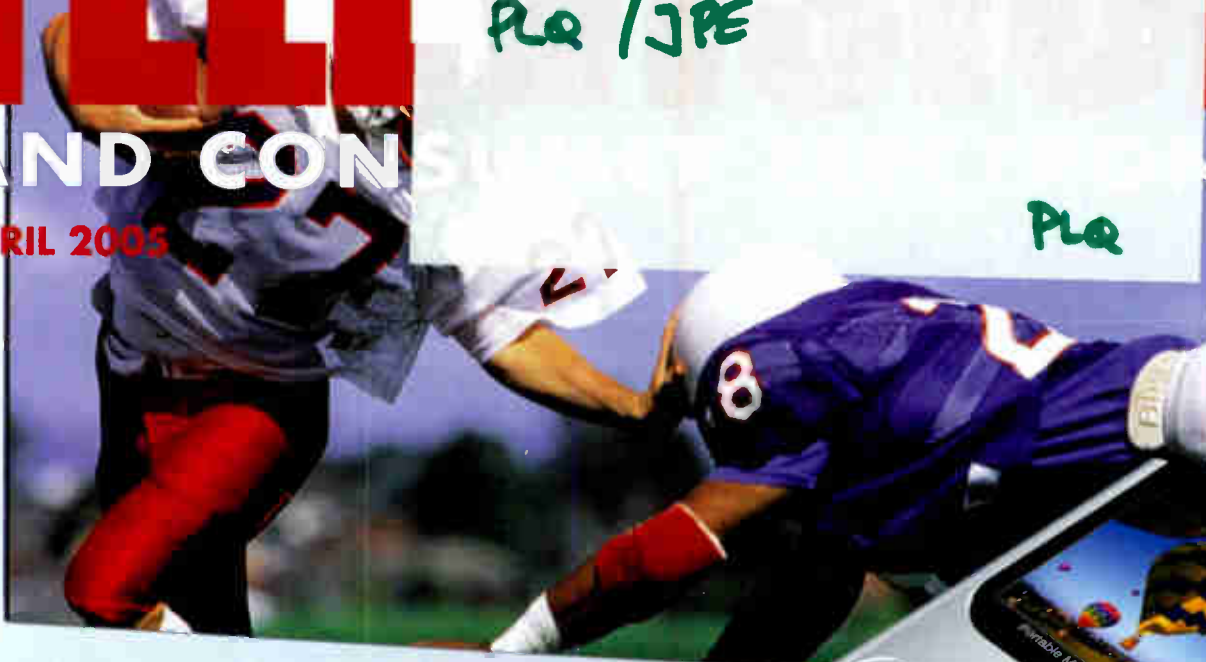

PLQ / JPE
PLQ

CES 2005 report

Vintage repairs:
the PYE 202BQ
pocket radio

Sony TV chassis guide

Test report:
Fortec Star satellite
receivers

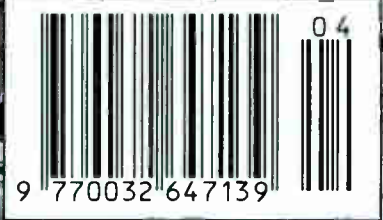

FAULT FINDING FOR TV ■ AUDIO ■ SATELLITE ■ VIDEO ■ IT

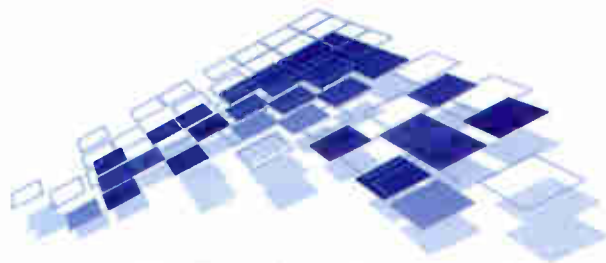

Digi Repairs
U K & I r e l a n d



sky+ **TRADE REPAIR
SERVICE FOR THE
UK & EIRE**

Are you looking for a reliable company to repair your sky digiboxes?
We offer **FREE SAMEDAY** Collection when you send more than
one box for repair!

● **FIXED PRICES**

Pace, Grundig, Amstrad **Fixed price £38 + VAT includes return delivery**
Panasonic, Sony

Sky + (Standard repair) Fixed price £45 + VAT includes return delivery
(Hard Drive replacement) **Fixed price £75 + VAT includes return delivery**

- Prices include all faults Micro processor, Modem, Software corruption and BGA replacement. *Send more than one box at a time we collect for FREE.*
- Specialists in the repair of Amstrad & Sony digiboxes.
- Refurbished digiboxes for sale (subject to availability).
- Fast Turnaround Time.
- All repairs fully guaranteed (6 months).
- Collection arranged from anywhere in the United Kingdom and Eire.
- Authorised Sky Digital Repair Centre.

*Receive our latest Satellite and technical newsletter **FREE** through email. Just send us an email with Newsletter in the Subject title to:
info@digirepairs.co.uk*

Contact:

DIGI REPAIRS (UK & Ireland)
UNIT 25, ENNISKILLEN BUSINESS CENTRE
TEMPO ROAD, ENNISKILLEN BT74 4RL
TEL: 02866327293 (NATIONAL RATE)
0845 6441628 (LOCAL RATE)
Email: info@digirepairs.co.uk

CONTENTS

April 2005

Vol. 55 No. 6

323 Comment

Technology and the market.

324 News

Ofcom's analogue switch-off timetable. BSkyB HDTV interface. 5.1-channel sound equipment. Fujitsu reduces FDP interests.

326 Test report: Fortec Star satellite receivers

The new range of Fortec Star digital satellite receivers incorporates a blind-search facility, an essential feature for those interested in satellite



hopping. Nick Harrold reports on an extended test with the Lifetime Diamond DVB-S/T model.

330 CES 2005

George Cole reports on the International Consumer Electronics Show in Las Vegas, where the world's leading companies in the CE and IT fields displayed their latest developments.

336 Sony TV chassis guide

A chassis-model listing update, compiled by Giles Pilbrow.

338 Vintage repair: the Pye P202BQ pocket radio

Pete Roberts on restoring life to one of these transistor pocket radios that dates from about 1962.

340 Bench notes

This month Adrian Gardiner starts on a new tack: how to develop your servicing business. It is still possible, despite today's difficult conditions, to run a profitable servicing organisation. The key factor is customer satisfaction.

344 The Vestel thyristor

Not many people appreciate why there's a thyristor on the secondary side of many Vestel power supplies. Alan Dent explains its purpose and operation, with particular reference to the 11AK19 chassis.

346 Sixty years of the SCTE

Graeme Young pays tribute on the sixtieth anniversary of the founding of the Society of Cable Telecommunication Engineers.

348 Letters

Poor aerial/dish installations. Noisy scan coils. Large-screen TV. Manuals via the internet. DTT reception. AVO meters. Line cords. Correction.

351 Help wanted

352 Signal distribution via optical-fibre cable

Distribution of signals via optical-fibre cables provides huge bandwidth and signal capacity. K. Rutherford looks at the technology involved.

355 Service Casebook

Michael Maurice describes recent TV problems.

356 DX and Satellite Reception

Terrestrial DX and satellite TV reception reports. The tsunami. Illegal equipment? Broadcast and satellite TV news. Fringevision's Band 1 aerials. The wavefront tilt effect. Roger Bunney reports.

360 Audio faults

362 VCR clinic

364 TV fault finding

367 DVD and home cinema fault reports

368 Books to buy

370 Extended fault reports

A few longer reports on complex or tricky TV faults.

371 Test Case 508

372 What a Life!

Hire-purchase protection. A collection of Dysons. Shopping in Spain. The Sony KVX2962. That record-player deck. Emails. Donald Bullock's monthly commentary

374 Satellite notebook

HDTV tests via Eutelsat W6. Test cards. Digital channel update (28.2°E). The Humax Fox PSU.

377 Web service

Useful websites for TV professionals, technicians and enthusiasts.

378 Monitor faults

379 Next month in Television

Editor

John A. Reddihough

Tveditor@highburybiz.com

Deputy Editor

Tessa Winford

Production Editor

Jane Massey

Production Executive

Dean Turner

01322 611206

Group Advertisement

Sales Executive

Mike Traylen

01322 611 289

Fax 01322 616 376

Editorial Assistant

Ann Price

01322 611 365

Publishing Director

Tony Greville

Note that we are unable to answer technical queries over the telephone and cannot provide information on spares other than that given in our Spares Guide.

Disclaimer

We work hard to ensure that the information presented in *Television* is accurate. However, *Television's* publisher - Highbury Business - will not take responsibility for any injury or loss of earnings that may result from applying information presented in the magazine. It is your responsibility to familiarise yourself with the laws relating to dealing with your customers and suppliers, and with safety practices relating to working with electrical/electronic circuitry - particularly as regards electric shock, fire hazards and explosions.

**Next issue, dated
May, on sale April 20**

GV 198



PROMAX



NEW!

TELEVISION TEST PATTERN GENERATOR

FEATURES INCLUDE :

- ◆ Suitable for Televisions, projectors and flat screens
- ◆ Covers 4:3 and 16:9 formats
- ◆ Tunable RF modulator between 37MHz and 865MHz
- ◆ Tunable by channel (CCIR, OIRT or FCC) or frequency
- ◆ PAL / SECAM / NTSC Colour Systems
- ◆ B / G / D / K / L / I / M / N Standards
- ◆ Composite Video and Sync outputs
- ◆ High Quality Construction
- ◆ 10 Front panel memories
- ◆ EUROCONNECTOR interface
- ◆ Electronic Attenuator
- ◆ Compact and Strong
- ◆ User friendly
- ◆ Attractive Price
- ◆ Clear LCD Display
- ◆ Available from Stock
- ◆ Full After Sales Service

WIDE SCREENS

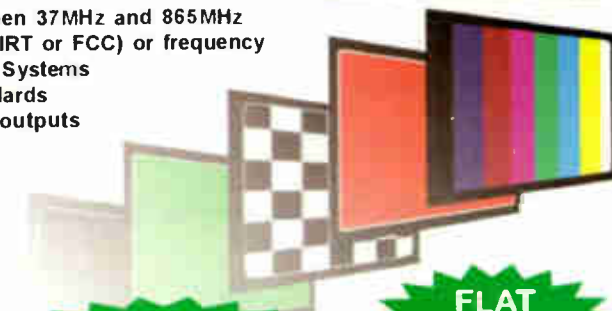

PROJECTORS

FLAT SCREENS

AA 930 AUDIO ANALYSER



The AA-930 has been designed to facilitate the repair, tuning and analysis of audio frequency equipment in general. Hence, why the six indispensable measurement instruments from an audio service workshop have been combined into this one piece of test equipment. The AA-930 is equipped with RCA 600 Ω and DIN 47 k Ω connectors for the inputs and outputs. In addition, two BNC connectors on the front panel and two RCA connectors on the rear panel allow the user to view all of the signals measured by the instruments.

- ◆ Low Frequency Generator
- ◆ Wow and Flutter Measurement
- ◆ Distortion Meter
- ◆ Stereo Watt Meter
- ◆ Millivolt Meter
- ◆ Azimut



TA 903B CRT REJUVENATOR

The TA-903B has been designed to analyse and rejuvenate the cathode ray tubes (CRT) of colour and black and white televisions and monitors. The user can detect and depending upon circumstances repair the leakage or short circuits, simultaneously measure the current of the RGB cathodes in the cut off point, trace the voltage / current characteristics and rejuvenate each of the three cathodes independently.



PROMAX

FOR ELECTRONIC TEST EQUIPMENT, THERE IS NO WIDER CHOICE THAN WITH PROMAX



GV 241

COMPUTER MONITOR PATTERN GENERATOR

In the world of computer monitors, unlike those for televisions, there is a multiplicity of different systems involved. To satisfy this incredible demand, PROMAX has designed the GV-241, a universal generator for the testing of computer monitors, which greatly facilitates their adjustment, control and repair.

- ◆ Test Patterns : Colour Bars; Red; Green; Blue; Scale of Greys; Cross hatch; Multiburst and White
- ◆ Outputs : R; B; G; CVS; HS; VS; CS; C1, C2, and C3

Alban

ALBAN ELECTRONICS LIMITED

THE PROMAX SERVICE CENTRE

6 Caxton Centre, Porters Wood, St. Albans, Hertfordshire, AL3 6XT.

TEL: 01727 832266

FAX: 01727 810546

WEB: www.albanelectronics.co.uk

EMAIL: info@albanelectronics.co.uk

SALES + SERVICE + CALIBRATION

COPYRIGHT

© Highbury Business, 2005. All rights reserved. No part of this publication may be reproduced, stored or transmitted in any form or by any means without the written permission of the publishers.

All reasonable precautions are taken by *Television* to ensure that the advice and data published are reliable. We cannot however guarantee it and we cannot accept legal responsibility for it.

CORRESPONDENCE

All correspondence regarding advertisements should be addressed to the Advertisement Manager, *Television*, Highbury Business, Media House, Azalea Drive, Swanley, Kent, BR8 8HU. Editorial correspondence should be addressed to *Television*, Editorial Department, Highbury Business, Media House, Azalea Drive, Swanley, Kent, BR8 8HU.

INDEXES AND BINDERS

Indexes for Vols. 38 to 53 are available at £3.50 each from SoftCopy Ltd., who can also supply an fifteen-year consolidated index on computer disc. For further details see page 379.

Binders that hold twelve issues of *Television* are available for £6.50 each from Modern Bookbinders, Pringle Street, Blackburn, BB1 1SA. Telephone: 01254 59 371

Make cheques payable to "Television Binders".

Newstrade Enquires

Distributed by Seymour Distribution Ltd, 86 Newman St, London, W1T 3EX.

Newstrade Hotline

If you are experiencing problems getting copies through your newsagent, please call Debbie Jenner on 01322 611210

ISSN 0032-647X

SUBSCRIPTIONS

Customer Interface Ltd

Cary Court,

Somerton

TA11 7BR

Telephone 0870 4287950

Fax 01458 271146

Subscription rates:

UK 1 year £33.80

2 years £61.00

3 years £81.00

Republic of Ireland 1 year £38.95

2 years £70.00

3 years £94.00

Mainland Europe 1 year £49.00

2 years £88.00

3 years £118.00

Rest of World 1 year £63.50

2 years £114.00

3 years £152.00

Cheques should be made payable to *Television*.

BACK NUMBERS

If available issues are £4.00 each.



HIGHBURY
BUSINESS

A MEMBER OF THE COMMUNICATIONS GROUP

Technology and the market

The onward march of technology is remorseless. As one development occurs, several others become possible. Things we once wondered at soon become commodity items, today's 'wallpaper'. Who now recalls when television was something miraculously new or, in more recent times, domestic video recording? They are now just standard fittings. One problem is that as the pace of development quickens it seems to become more difficult to make any significant profit from bringing the results to the market. It's part of the intense competitiveness of modern capitalism. We all benefit from this as consumers but, if manufacturers get so little return from their R&D investments, what incentive is there for them to continue? In the West, much research is now university based. In the Far East major companies persist because otherwise they risk becoming commodity producers, licensing the technology they use from others. There's clearly a danger that manufacturers could abandon R&D investment. LCD and plasma displays are a case in point. It has required huge investment to develop them to produce today's screen quality. But there doesn't seem to be any profit in the technology, which appears to be why Fujitsu is largely withdrawing from this field (see page 325).

Despite this, R&D goes on and there are continuous announcements about what's in the pipeline. I was intrigued by Intel's announcement that it has made a breakthrough in developing a laser based on silicon. This could reduce the cost of these devices considerably and, because of their usefulness, there could be any amount of change in equipment architecture. Until now, lasers have been based on the use of compound semiconductor materials such as gallium arsenide and yttrium aluminium garnet. When suitably biased, a pn junction in such material produces photons and their generation can be increased by stimulated emission, producing a coherent light source. The problem with silicon is that it's opaque. When infra-red radiation is applied however it becomes transparent and the laser effect becomes possible. This is known as the Raman Effect, after the Indian scientist who discovered it. But Intel encountered a problem known as two-photon absorption: free electrons were absorbing the light generated in the silicon. The solution was to develop a semiconductor structure that enabled these electrons to be removed, thus making possible the generation of a continuous light

beam. It seems that the first practical outcome, an optical modulator, could be on the market within three to five years. Will Intel make anything much out of it, or will we simply benefit from cheaper lasers?

Another advance that's relevant to our field is the development by IBM, Sony and Toshiba of the Cell microprocessor chip – work on it started in 2001, in a laboratory at Austin, Texas. It has been described as a "supercomputer on a chip", able to operate ten times faster than the current generation of advanced PC microprocessors. Fresh information on it was presented at the recent Solid-state Circuits Conference in San Francisco. Why should it be desirable to have such a device for consumer electronics use, something that the traditional microprocessor companies Intel and AMD can't provide? What started it off was video games. To get really high-quality graphics and action calls for massive data processing capability. So, when the Sony PlayStation 3 appears next year, it will use the Cell chip. It seems that other uses of the chip planned for next year will be in high-definition TV sets from Sony and Toshiba and in a Sony home server computer for broadband content. Once you have incorporated this data-handling capability in CE products however all sorts of things become possible, for example transcoding to convert media from one format to another. An example is to take an HDTV signal and convert it to a lower bit rate so that it can be stored in a personal video player for mobile viewing.

A key to such an advanced processor design is the use of more than one 'core' in a single device, in effect more than one processor in a single chip, so that several tasks can be undertaken simultaneously. The chip has to be able to split up a complex operation so that it can be carried out in this way. It seems that the Cell chip has nine cores and operates at over 4GHz. The Cell consortium points out that the device's architecture, which is described as "scalable", gives it the capability of carrying out wide-ranging functions that could, for example, improve the quality of video delivered via the internet and, going back to video games, increase their realism. Scalability relates to the ability of the device to be configured for use in different equipment, from small consumer devices to massive supercomputers.

Cell has involved a massive R&D programme. Perhaps on this occasion the members of the consortium will get a worthwhile pay-off.

Analogue switch-off timetable

Ofcom has issued a proposed timetable for switching off analogue TV transmissions in the UK. Rather than go for a 'big-bang' approach, transmissions would cease on a region-by-region basis. If the proposals are accepted by the government, the first switch-offs could be in the Border, West Country and HTV Wales regions within three years (see specific details in box).

According to Ofcom digital terrestrial transmissions at present reach 73 per cent of UK households and, because the UHF spectrum is so crowded, it will not be possible to extend DTT coverage significantly beyond this level without switching off the analogue transmissions. Planning for the digital switchover assumes that three of the frequencies currently used by the analogue terrestrial services available nationally (BBC1, BBC2, ITV and Channel 4) will be reused for the three digital public-service multiplexes. These are expected to be multiplexes 1 and B (used by the BBC) and multiplex 2 (used by Digital 3 and 4, an ITV-Channel 4 joint venture). According to a report from the House of Commons Public Accounts Committee on BBC investment in Freeview, following the switch-off DTT coverage could be increased to 99.7 per cent of UK households,

Analogue switch-off timetable

2008: Border, West Country and HTV regions.

2009: Granada, Grampian, Scottish TV and HTV West regions.

2010: Central, Anglia and Yorkshire regions.

2011: Meridian, Carlton/LWT, Tyne Tees and Ulster regions.

2012: Channel Islands.

while 37 per cent would be able to receive the signals using a set-top aerial. The report queries the latter BBC belief however, and suggests that field trials should be carried out urgently.

Ofcom says that to give remaining analogue viewers sufficient time to make the switch, and to ensure that all the transmitters in a region are converted, a period of six months should be allowed for the conversion in each region. The transition process would begin with one analogue service being replaced by a digital multiplex that would also carry a number of other public-service channels. This multiplex would be broadcast throughout the region, via all main transmitters and relays, with sufficient power to replicate the analogue coverage throughout the region. The other analogue services would continue to be transmitted, giving the remaining analogue-only viewers several months in which to

make arrangements for watching digital TV via either terrestrial, satellite or cable services.

At the end of the transition period the remaining PSB digital multiplexes would move to their new high-coverage assignments and the remaining analogue transmissions in the region would cease. At this point the three commercial multiplexes would also move to new high-power frequencies at the sites they intend to adopt. The suggested regional analogue switch-off timetable is as shown in the table.

Ofcom adds that three technical factors have determined the suggested regional sequence for the switchover. First, interference management. The planners have considered carefully how to arrange the sequence so as to minimise the impact that any one region being converted will have on analogue and digital viewers in an adjacent region. The risk of interference between

transmission sites in neighbouring regions places a constraint on the degree of freedom with respect to the regional order.

Secondly there are infrastructure constraints. In developing the switch-off order it was necessary to ensure that the number of transmitters which have to be converted is approximately the same for each year of the switchover period. This would reduce the potential problems that could arise as a result of shortages of relevant resources and thus the risk of delay in implementing the switchover. Similar consideration has been given to the needs of manufacturers, platform operators and retailers.

The other factor is international spectrum negotiations. International considerations (interference etc.) add a further degree of complexity to the planning. The aim is to minimise any risk that the switchover process might be affected by the international negotiations currently underway for a Europe-wide digital switchover. These negotiations are due to be completed in 2006.

Soon after Ofcom's announcement, Sony revealed that from now on all its TV sets with screen sizes of more than 26in. will be integrated digital TVs.

Videophone-TV link

A Harrogate-based firm, RedCom, is planning to launch a set-top box plus camera to enable a cordless phone to be used with a TV set. The aim is to promote it as part of the 3G phone system. Unlike other videophone services, the RedCom system is aimed at the fixed-line market, using a broadband connection with the image of the caller displayed on the TV screen. If the call is to a mobile 3G phone, the image appears on the handset's screen.

Akai has launched a multi-format DVD recorder (see photo) at a price of about £200. Model ADR5800i is able to record on DVD-R/RW and +R/RW discs and can play other formats such as CD-R/RW and MP3. The LP mode provides a recording time of up to eight hours, and there's an iLink/IEEE 1394 input for direct recording and editing from DV camcorders. There are RGB scart and PAL progressive-scan component video outputs, and different quality levels can be set for each recording.

Lite-On has launched a DVD recorder with an integrated 160GB hard-disk drive that can store up to 198 hours of video. Model LVW5045 has a suggested price is about £350. The Taiwan-based IT hardware company, which is one of the world's largest optical device manufacturers, made its first step into the UK CE market about a year ago with a DVD recorder. This has since been updated, and DVD recorders with additional features will be launched in the UK later this year. The company manufactures various CE products, including LCD and plasma TV sets, in China.



BSkyB HDTV interface

BSkyB has announced that it will use the HDMI (High Definition Multimedia Interface) system when it starts transmitting high-definition programmes next year, because this makes it possible to copy-protect the material. The decision has caused some alarm in the CE industry, as many of the flat-screen sets currently advertised as HDTV-compatible do not have an HDMI or DVI socket and would thus be

unable to receive the service.

BSkyB has also confirmed that its HDTV transmitting system will be able to use either of the two proposed formats, 720p/50 and 1,080i/25. Broadcasters will be able to choose which format to use. BSkyB considers that a progressively-scanned format is more suitable for flat-panel displays but accepts that the 1080i format may be better for some types of programming. BSkyB

is also evaluating the H.264 (MPEG-4) and VC-1 compression formats, which would enable more channels to be transmitted in a given bandwidth. Digital broadcasters currently use MPEG-2 compression.

BSkyB has indicated that it is likely to start making use of the second card slot in its digital set-top boxes. The slot could be used for services such as home shopping and betting.

5.1-channel sound equipment

Sony has demonstrated a DVD-type camcorder, Model DCR-DVD403, that incorporates multi-channel microphones and Dolby Digital 5.1 Creator, enabling the user to record home movies with 5.1-channel digital surround sound. The audio encoding technology formats audio content as a multi-channel Dolby Digital bit stream. Less data is required than for stereo PCM, so there's a saving in disc space. No price details, or a possible UK release date, have been announced.

Yamaha has launched what it claims to be the world's first single-unit 5.1-channel surround-sound system, Model YSP1. It will sell in the UK at about £800. The unit uses 'digital sound projection technology' to control the orientation of the sound by focusing it into beams. Sound is both direct and reflected from walls, and is thus heard from the front, sides and back. The unit can be placed in different positions in the room – at the front centre or in either of the front corners. It delivers a total power output of 120W, and is compatible with Dolby Digital, Dolby Pro Logic II and DTS Neo 6 sound. Set up is with three buttons. There are no speaker leads.

HD video rasteriser from Tektronix

The Tektronix WVR7100 video rasteriser, now available from TTI (Thurlby Thandar Instruments), enables HD and SD TV, composite analogue video and digital and analogue audio signals to be monitored using a single instrument. It enables engineers, technicians, video editors and colourists to ensure conformity to broadcast specifications. With its FlexVu display, users can configure the instrument to display waveform, vector, gamut, picture, alarm screens, error log and audio signal levels and Lissajous figures. Tektronix-patented gamut displays (diamond, split diamond and arrow-head) ensure that broadcast material meets gamut compliance in component and composite colour form. The Tektronix WVR7100 has been designed for ease of use and,

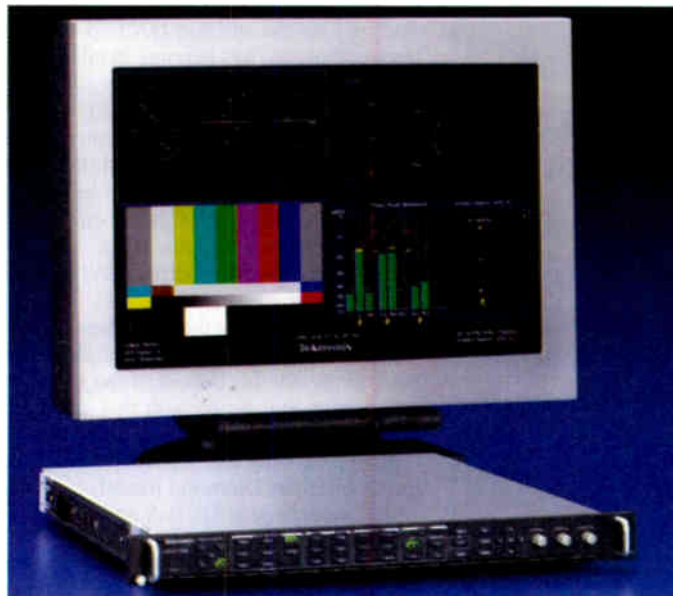

with passive loop-through inputs, can be installed within the actual signal path. It caters for all current HD formats at a

variety of frame rates. For further information phone 01480 412 451 or email sales@tti-test.com

Fujitsu reduces FDP interests

Fujitsu, a pioneer in both LCD and PDP (plasma display panel) technology, is substantially reducing its flat display panel (FDP) operations to concentrate on its core IT activities. The move reflects the current intense competition and falling prices in the FDP field.

Fujitsu and Sharp have entered into an agreement that will transfer Fujitsu's entire LCD operation to Sharp. This includes the

LCD research and development, manufacturing and sales operations of its consolidated subsidiary Fujitsu Display Technologies Corporation, and the related R&D equipment at Fujitsu Laboratories. The agreement is expected to come into effect by the end of March. Fujitsu's intellectual property rights in this field will be acquired by Sharp.

Hitachi is to increase its stake in the

Fujitsu-Hitachi Plasma Display (FHPD) joint venture from 50 per cent to just over 80 per cent. The deal will include the transfer of about 140 PDP patents from Fujitsu to Hitachi. Fujitsu's involvement in the PDP field has been much larger than its LCD operations. FHPD was set up in April 1999.

The moves will leave Hitachi and Sharp amongst world leaders in the PDP and LCD fields respectively.

Test report:

Fortec Star satellite receivers

The new range of Fortec Star digital satellite receivers incorporates a blind-search facility, an essential feature for those interested in satellite hopping. Nick Harrold reports on an extended test with the Lifetime Diamond DVB-S/T model, which also incorporates a terrestrial tuner

Fortec Star range with blind-search facility

Lifetime Ultra FTA	Incorporates Powerscan (blind-search facility).
Lifetime Diamond	As above but also incorporates a Freeview terrestrial tuner.
FS5100 Ultra	Incorporates Powerscan with dual common interface.
FS5100 Diamond	As above but with Freeview terrestrial tuner. Conditional access module works with satellite and terrestrial signals.
FS Dragon	Incorporates Powerscan, dual common interface and Dragon CAM.
FS Ultimate	With Powerscan, dual common interface and twin tuner; PVR ready.

A new range of satellite receivers that incorporate a blind-search facility, which is essential for the satellite DX hopping enthusiast, has become available recently. Until now I have been using a Humax VACI-5300 for satellite DXing. This performed well enough over the years, but the transponder parameters have to be entered manually each time when searching for new signals. It's a very time-consuming activity. What I needed was a receiver with a blind-search facility that searches for new channels automatically. See table alongside for details of the new Fortec Star range with this facility.

The following test report relates to the Lifetime Diamond model, which incorporates DVB-S and DVB-T (satellite and terrestrial) reception facilities in a single set-top box (see accompanying photos). It was supplied by Wizard

Satellite of Leicester, but is also available from other sources. Delivery was prompt, packaging good, and it arrives safely via a DHL white van.

First impressions

The receiver has a well-screened metal case and is approximately 290 x 60 x 210mm in size. Unfortunately no connecting cables were supplied with it, and the mains lead is terminated with a two-pin mains plug. A free Universal 0.4dB NF LNB was supplied with it however. The front panel, see Photo 1, is quite sparse in appearance. There are two channel-select up/down buttons and a power/standby button. A green four-digit, seven-segment display indicates the programme number.

The rear panel, see Photo 2, has two scart sockets labelled VCR and TV. Composite video together with left-right audio is available via



Photo 1: Front view of the Fortec Star Lifetime Diamond DVB-S/T satellite receiver.



Photo 2: The rear panel, where the sockets and a mains on/off switch are mounted.

three phono sockets. An IF loopthrough for a second satellite receiver and a terrestrial receiver is provided via two F sockets and two coaxial sockets respectively. There's a mains on/off switch and an RS232 serial port. The latter is used to upgrade the software when required – uploader software is available from the Fortec Star website. A modulated RF output is also available. This is menu-driven and can be tuned through channels 21-68. RF outputs can be in PAL I, PAL G, PAL K or NTSC format.

I'll deal with satellite and terrestrial reception separately, satellite first.

Initial problems

The receiver was connected to a 1.2m Channel Master dish fitted with an 0.4dB NF LNB for Ku-band operation and a 1.5m dish fitted with a 15°K down-converter with selectable RHD/LHD polarisation for C-band reception. See Photo 3.

While the receiver was under test some patterning was noticed on the menu screens and on both satellite and terrestrial TV pictures. It appeared from time to time and seemed to be related to temperature. To prevent the receiver getting too warm I decided to fit it in a small rack together with a small fan. This cured the patterning problem, but it would have been better if the manufacturer had come up with a solution. Other DX enthusiasts have reported similar patterning with the Lifetime Ultra FTA and FS5100 Diamond models. It spoils what is otherwise a good receiver.

A Philips DVD recorder was connected to the VCR scart socket at the back of the receiver. This produced video but no audio. When the plug was transferred to the TV scart socket both video and audio were produced. This seems to be a compatibility problem.

The results were disappointing when the audio was fed to a hi-fi system: there was a constant-level background hiss on the audio channels, even when the volume was set at minimum. It was therefore better to keep the audio turned up fully at the satellite receiver and use the hi-fi volume control to obtain the level required.

Operation

The on-screen menus are all easy to use. You can set the video output to match the TV/monitor's aspect ratio, either 4:3 or 16:9. There's no letterbox or full-screen option however – more on this later. The TV

type (PAL, NTSC, auto) can also be specified. This enables the output to be in the PAL mode when receiving NTSC, a useful feature when a multi-standard receiver/monitor is not available. When the receiver was operating in this standards-conversion mode there was some jerkiness with picture movement.

The LNB oscillator-frequency variants are well catered for. With C-band reception it's simply a matter of going into the menu and selecting the oscillator frequency (5,150 or 5,750MHz).

Full DiSEqC switching and 1.2 motor USALS control is possible with the receiver, but this was not tested during the review.

Satellite scan

Different scan options are available, as follows. They are largely self-explanatory.

(1) Transponder scan. The selected transponder is scanned for channels.

(2) Network scan. Scans for updated information provided by the satellite's network index table.

(3) Advanced scan. You can carry out the advanced scan by entering the parameters you wish to search.

(4) Powerscan. This is by far the most useful, as it will scan for all signals by doing a blind search. It takes about 15-20 minutes to search one satellite completely. This is a vast improvement on the old Humax receiver, which took several hours!

When in the blind-search mode, see Photo 4, the parameters displayed for all signals detected are frequency, polarisation and symbol rate. Forward error correction is not displayed: this is unimportant and is not required, as the receiver searches for FEC automatically.

When a search is carried out, low-band vertical/horizontal polarisation is done first then high-band vertical/horizontal polarisation. Once the search has been completed it takes just a few minutes to save the information and start receiving the new channels.

Performance

The signals were very strong and no problems were experienced with Ku-band reception using the 1.2m dish. Photo 5 shows reception of MSNBC from New Jersey at 11.522GHz/H (SR 1,500), via Telstar 12 (15°W), with an NTSC



Photo 3: The dishes used during the test.



Photo 4: The parameters displayed in the blind-search mode.



Photo 5: Reception of MSNBC from New Jersey via Telstar 12 (15°W), with an NTSC monitor used for the display.

monitor used for the display.

Several signals at varying strengths were obtained using the 1.5m C-band dish. The signals at 27.5°W (Intelsat 907) were strong, and both this receiver and the Humax one produced good reception. The signals at 34.5°W (Intelsat 903) were weaker. The Fortec receiver provided good reception while the Humax receiver produced only intermittent broken pictures. Photo 6 shows KNR-TV (Greenland) at 3.716GHz (SR

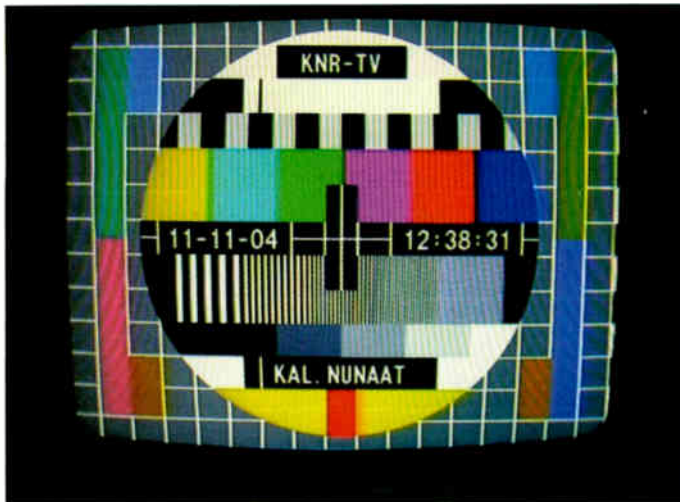

Photo 6: Reception of KNR-TV (Greenland) via Intelsat 903 (34.5°W) at 3.716GHz.



Photo 7: Some DVB-T channels are shown in 4:3 aspect ratio but not full-screen, with a black band all round.

2,915) with LHD polarisation.

Terrestrial reception

The Freeview terrestrial receiver covers 470-860MHz at UHF and also 174-230MHz at VHF. This VHF coverage is not relevant to the UK at the present time, but could be useful for DXing with a suitable aerial. There is no card slot, so only the FTA channels can be viewed.

You can select either DVB-S or DVB-T from the menu screen. There is an automatic scan for all available channels when you go into the DVB-T set-up – a manual scan option is available if required. The menu also indicates the multiplex frequency being received and its strength and quality. Once the

channels have all been scanned they are saved. Unfortunately this is not done in any logical manner. For example ITV2 programming comes in on Ch. 1 and Channel 4 comes in on Ch. 2. The channels can be organised manually in either alphabetical, FTA/scrambled or transponder order. Use of the MOVE function enables all channels to be set to their correct channel number, though this takes some time to do.

Screen aspect ratios 4:3 or 16:9 can be selected from the menu, but there's no full-screen option. This is unfortunate, particularly with some channels – the pictures are displayed as 4:3 but small in size, with a black band at both sides as well as at the top and bot-

tom of the screen (see Photo 7).

Summary

The DVB-S section of the receiver performs very well, the Powerscan blind-search facility being particularly impressive. This was the main reason for buying the receiver and fulfils all present requirements. The performance of the DVB-T section was disappointing, with the small-sized 4:3 pictures on some channels and the awkward channel numbering.

It is hoped that future software upgrades will overcome some of the deficiencies, which spoil an otherwise good receiver.

The Fortec Star Lifetime Diamond DVB-S/T receiver is currently priced in the region of £120.

Make sure of your copy of *Television*

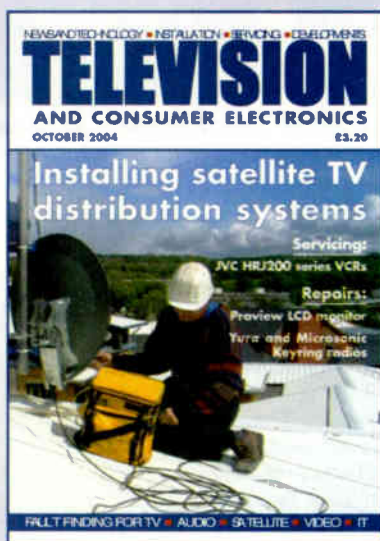

It can be difficult finding a copy of *Television* at local newsagents.

The number of magazines being published keeps increasing, which means that newsagents have less shelf space for the display of individual titles. Specialist magazines in particular get crowded out.

There's a solution to the problem. Most newsagents provide "shop-save" and/or home-delivery services. There's no charge for a shop save. You simply ask your newsagent to order a copy for you: it will be kept on one side each month ready for you to collect. Home-delivered copies are ordered in the same way, but generally incur a delivery charge.

A newsagent can order any magazine for you, whether or not the shop normally stocks it.

If you buy your copies of *Television* from a newsagent and want to make sure you get every issue, just ask at the counter.



COLOUR TRADE

**POSSIBLY
LARGEST & OLDEST
EST. IN
THE UK EST FOR
30 YEARS**

Wholesaler Distributors & Expert Agents of
Domestic Electronics & Appliances

**FULL RANGE OF FACTORY
GRADED TV's DVD / VIDEOS
HI-FI SMALL & LARGE
DOMESTIC GOODS**

www.colourtrade.com
**WHOLESALE MADE EASY ON LINE, SIGN UP
NOW FOR OUR WHOLESALE PRICES.
ALL ORDERS DISPATCHED ON THE SAME DAY.**

**Now Available
TV's, DVD's, VCR & AUDIO**

Over 40 years of genuine experience

Experts on:-

Thomson • Sanyo • Beko • LG • Tatung • Ferguson
Bush • Funai • Pacific • Dansai • Samsung & more

**TECHNICAL SUPPORT
0907 076 70 80**

Call cost 60p min

MAIN DEALER

- Thompson
- Sanyo
- Beko



Tel: 0121 359 7020 Fax: 0121 359 6344

Phoenix House, 190 Bridge St. West, Newtown, Birmingham B19 2YT

Email: inquiries@colourtrade.com

FREEDOM OF VISION



LIBERTY - FTA 786

- Offering 4000 TV and Radio channels
- Separate TV / Radio List and Favorite group
- DiSEqC 1.2 function and USALS function
- Small size (260x180x55mm)
- Games Included: Tetris, Block out
- 12 languages OSD, (English, Arabic, Russian, French, German, Italian, Spanish, Polish, Turkish, Persian, Dutch and Greek.
- Fast channel switching and downloading



LIBERTY - CI 9800

- 2 slots common interface
- Offering 4000 TV and Radio channels
- Separate TV / Radio List and Favorite group
- DiSEqC 1.2 function and USALS function
- Small size (260x180x55mm)
- Games Included: Tetris, Block out
- 12 languages OSD, (English, Arabic, Russian, French, German, Italian, Spanish, Polish, Turkish, Persian, Dutch and Greek.
- Fast channel switching and downloading

MAIN DEALER:

Freddie's Satellite Shop

64 Chadwell Heath Lane
Romford, Essex RM6 4N2

Tel. 020 8586 4111

Fax: 020 8597 6295

E-mail - sales@liberty-sat.com

Web site - www.liberty-sat.com

DEALERS:

Kent: JAY'S Satellite and TV Tel: 01474 537746

Lincolnshire: T K Electronics Tel: 01525 344102

Dagenham: RTV Satellite Tel: 020 8592 5152

LIBERTY

Dishes, Cams, LNBS, and other satellite related equipment also available.



CES 2005

George Cole reports on the International Consumer Electronics Show in Las Vegas, where the world's leading companies in the CE and IT fields displayed their latest developments and products, setting the pattern for the coming year

The annual International Consumer Electronics Show is held at Las Vegas in early January. This year's event was attended by more than 140,000 visitors from 115 countries. They saw products from more than 2,500 exhibitors, displayed over some 1.6m square feet of floor space.

The highlights this time included the drive by PC companies to gain a stronger foothold in the consumer electronics market. HDTV, and the format battle over the next generation of optical-disc video recorders. There were over 350 conference sessions.

PC companies

Ever since the world of consumer electronics moved from analogue to digital technology, PC and CE companies have been manoeuvring to become the dominant providers of entertainment in the home. It was therefore no surprise to find that PC companies maintained a high profile at CES.

Microsoft chairman Bill Gates, delivering one of the keynote speeches, described his company's plans and technology. It has developed the Media Center PC Edition standard for Windows XP PCs. This basically turns a home PC into

a device for storing and playing back various forms of digital content, such as music, still images and video. Media Center PCs can also include a built-in TV tuner, and have large hard drives for storing video programmes. This can provide PVR-like (Personal Video Recorder) features such as the ability to pause a live TV broadcast.

Media Center PC's can be operated by a remote-control handset: at CES companies such as Philips and Logitech announced multi-RC handsets that can control PCs and traditional CE items such as TV sets and DVD players. Microsoft announced that Digitrex is developing a 46in. LCD HDTV set that will use Windows Media software to play music and images stored on a PC. LG is developing a DVD recorder that uses Windows CE, a cut-down version of the Windows operating system, for burning recorded TV content on to a DVD disc.



A prototype Microsoft IPTV (Internet Protocol TV) unit. IPTV enables TV programming to be distributed via the internet.

Microsoft was also pushing its IPTV (Internet Protocol TV) technology, which has been developed for cable and telecoms operators. It uses Windows Media 9 (WM9) audio-video software to provide sound and video via a broadband connection. Microsoft claims that WM9 is four times more efficient than MPEG-2 compression and twice as efficient as MPEG-4.

Microsoft has formed an alliance with TiVo, the company that launched the first PVR technology. TiVo pulled out of the UK but continues to promote its service in the US, and has launched Series 2 products. The TiVoToGo system enables Series 2 TiVo PVRs to transfer their recordings to a Windows XP PC. The next step will involve transferring the content from a PC to a mobile digital device such as a Pocket PC or Smartphone.

All very impressive. Not quite so impressive were several demonstrations Bill Gates attempted. One of them, designed to show how images stored in a digital camera could be transferred to a Windows PC via 802.11 (WiFi) wireless technology, crashed the PC. An attempt to control a Media Center PC via a remote-control handset also failed. In terms of reliability and ease-of-use PC technology has come a long way (who can recall the days of struggling with MS-DOS?), but it clearly has some way to go before it's as stable as the technology inside most CE devices.

Carly Fiorina, at the time chairman and CEO of Hewlett-Packard (she was removed from the posts in early February), also gave one of the keynote presentations, outlining HP's plans. HP has formed alliances with companies such as Philips and Panasonic (see below) and was promoting its HDTV Hub, a digital entertainment centre that combines an HDTV set-top box, a PVR and an email system. The company is putting its software into seventeen HDTV and home-theatre

projectors. Based on HP's Visual Fidelity technology, one of the systems has the delightful name 'wobulation' and is designed to increase the resolution of digital projectors (remember beam 'wobulation' in the days of 405-line receivers?). HP is also working with Orca Interactive on IPTV.

HDTV

US viewers have had HDTV for more than six years now, with services available via cable, terrestrial and satellite transmission. The stores are full of HDTV sets. But, if US experience is anything to go by, it takes a long time for consumer education to affect the mass market.

The Consumer Electronics Association (CEA) used the occasion to announce that it and the Starz Entertainment Group, which provides an HDTV service, have

jointly produced a brochure that describes what consumers need in order to receive HDTV, and the programming available.

You couldn't move for giant-screen HDTV at CES.

LG Electronics showed various models that between them use all the current flat-screen technologies. Model 62SY2D is a 62in. DLP (Digital Light Processor) set with 1,920 x 1,080p (progressive scan) resolution and a contrast ratio of 3,000:1. DLP technology, developed by Texas Instruments, uses Digital Micromirror Devices (DMDs): these are microchips on which a vast number of micromirrors that act like fast-moving shutters are mounted. The 62SY2D has an HDMI (High Definition Multimedia Interface), an IEEE 1394 (FireWire) port and can receive FTA HDTV broadcasts using its ATSC tuner (ATSC = Advanced Television Systems Committee, the US HDTV standard). The 55in. Model 55LP1D HDTV set has an LCD screen. Model MW-71PY10 is a 71in. HDTV plasma-screen monitor, the largest plasma screen available in the CE market. It incorporates LG's XD engine technology that's designed to provide crisp, lifelike images. The suggested price is rather daunting – the equivalent of about £42,000! There are also 60 and 50in. plasma HDTV models,



Panasonic's display included Model TH-42PD50U, a 42in. plasma set with an HDMI interface.

DVD recorders: it makes good sense to combine the two.

The Panasonic DMR-EH50 DIGA is a DVD recorder with a 100GB hard drive that can store up to 177 hours of video. It can record in the DVD-R, DVD-RW and DVD-RAM formats and can read these and DVD+R and DVD+RW discs, also DVD-Video and audio CD discs and CD-R/RW discs that contain JPEG or MP3 files. Model DMR-ES30V is a combined DVD and VHS recorder. Toshiba showed the RS-TX20, a DVD-RAM/-R/-RW recorder with a 120GB hard drive, and the RS-TX60 with a 160GB hard drive able to store up to 200 hours of video, also the D-VR4, a combined DVD and VHS recorder. Sony's RDR-HX715 DVD recorder is compatible with the +RW and -RW formats and their write-once versions and includes a 160GB hard drive. The Philips HDR720 DVD+R/RW recorder has a 120GB hard drive.

The Pioneer stand was awash with DVD recorders, including Models DVR-533H (with 80GB hard drive) and DVR-633H (with 160GB hard drive) that enable viewers to find TV shows via an on-screen programme guide. Both models include a DV terminal on the front panel for connecting a digital camcorder to create a home movie on DVD. A Help button answers basic user questions, which are displayed on an on-screen menu. Model DVR-233-S is an entry-level recorder with VCR Plus+. Model DVR-RT501 combines DVD and VHS recorders and provides transfer from one to the other.

Samsung and LG showed DVD players that convert the standard DVD to HDTV performance. The Samsung Models DVD-HD850, DVD-HD950 and DVD-HD9500 convert 480p to 1,080i or 720p resolution while the LG LDA-511 converts to 1,080i resolution. The latter has a memory-card slot that can read eight different types of card.

HP and Panasonic announced plans to incorporate each other's recordable DVD technologies into their products. Panasonic plans to

add DVD+RW read/write capability to its DVD recorders while HP will add DVD-RAM operation to its DVD burners. HP is also working with Philips to develop a copy-protection system for the next generation of DVD+RW/+R recorders. The system, known as VCPS (Video Content Protection Scheme), works in conjunction with the US Federal Communications Commission's broadcast flag initiative. This will enable broadcasters to insert digital codes (flags) that tell a digital recorder whether content can be copied freely, once or not at all.

It will be introduced in the US on 1 July.

Portable DVD players are not new, but the Pixa MP-810 includes a wireless headphone facility and a plug-in TV tuner. Other features include an 8.4in. widescreen LCD panel and a playing time of up to three hours with a rechargeable battery.

Camcorders

Samsung showed the latest version of its Duocam, a combined digital camcorder and high-resolution digital camera. Its features include a 5-Megapixel CCD image sensor, 10x optical zoom, 900x digital zoom, a USB 2.0 port and a memory-card reader that's compatible with Memory Stick, SD and MultiMedia cards.

Sony introduced a very interesting camcorder, Model DCR-DVD403, which can record with 5.1-channel surround sound. It uses a new audio system called Dolby Digital 5.1 Creator which, with multiple microphones, enables six-channel sound to be recorded. It's an efficient encoding system that uses less data than conventional stereo PCM sound.

The Sony DCR-DVD7 DVD camcorder can be held like a digital camera: it has a 2.5in. screen touch-pad.

JVC highlighted two new cam-

recorder technologies, Live Slow and Data Battery. The former enables the user to record scenes in slow motion and play them back at speed with normal sound. Data Battery provides an instant read-out of battery power and available recording time.

The Samsung SC-D557 DVD camcorder is compatible with DVD-RW/-R discs and can record in the MPEG-2 or MPEG-4 mode. It has USB 2.0 and IEEE 1394 connections.

The Sanyo VPC-C4 camcorder uses MPEG-4 compression and offers 8-Megapixel resolution – by using interpolation to up-convert the signal from the unit's 4-Megapixel CCD image sensor.

Home networking

Various home networking systems and products that link devices to each other or to the internet were on show. The Philips Streamium range uses the WiFi standard (IEEE 802.11b with a data speed of up to 11Mbps/sec and IEEE 802.11g with



The Sony DCR-DVD7 DVD camcorder can be held like a digital camera: it has a 2.5in. screen touch-pad.



The Sanyo VPC-C4 camcorder uses MPEG-4 compression and offers 8-Megapixel resolution – by using interpolation to up-convert the signal from the unit's 4-Megapixel CCD image sensor.



The Philips HDR720 DVD+R/RW recorder has a 120GB hard drive.

The Ovideon AVIAh multimedia player, recorder and TV has a 521 x 218 pixel OLED (Organic Light Emitting Diode) screen, an integrated TV/cable tuner, weighs less than 150g and is small enough to fit into a shirt pocket.

data speeds up to 54Mbps/sec). TV Models 42PF9830A (with 42in. LCD screen) and 50PF9830A (with 50in. plasma screen) can produce audio and video content that's streamed from the internet and home PC.

Various forms of streaming video and MP3 music files can be handled. Thomson showed the Acoustic Research Digital MediaBridge which uses WiFi technology to transfer high-definition images from a PC to an HDTV set.

Radio is not the only way in which data can be carried around networks. There was a lot of interest in the use of PLC (Power Line Communication) technology. This has been around for more than sixty years and is in theory a good way of sending data around the home. It works by sending HF data via conventional power lines. To connect to a PLC network, you simply insert a special plug into a mains socket. The technology offers benefits that include high data speeds (several times faster than a standard ADSL link) and ease of installation. But the technology has been dogged by problems, including interference and security. It seems that these have now been resolved. There remains a need for standardisation however, so that PLC products from one manufacturer will work with those from another.

Matsushita (Panasonic), Mitsubishi and Sony announced the formation of an alliance, tentatively called the CE-Powerline Communications Alliance (CEPCA), to establish PLC specifications that will provide

Korean company PQI showed its mPack personal video player, which has a 3.5in. LCD screen, an 80GB hard drive and can handle WMV (Windows Media Video), MPEG-1, MPEG-2, MPEG-4 and DivX files.



smooth interfacing between different systems for audio, video and data networking. The Alliance will promote PLC home networking worldwide and encourage other consumer electronics and PC companies to collaborate.

Meanwhile the HomePlug Powerline Alliance (HPA) announced a major development of its BPL specification: HomePlug AV is a 200Mbps/sec power-line networking technology designed for home digital multimedia networks. Members of the HPA include Arkados, Conexant, Intellon and Sharp.

Mobile entertainment

TiVo announced its new TiVoToGo enhancement and said that it is rolling out the software update for standalone TiVo Series 2 boxes. The enhancement enables subscribers to transfer programmes from their TiVo box to a laptop PC. This involves downloading TiVo Desktop software to the computer. TiVoToGo encrypts programming during transfer to the laptop. Once programmes have been transferred, subscribers enter a password that enables the files to be decrypted and played back. TiVo says that it has designed the service to respect copyrights: programming that is protected with Macrovision, such as pay-per-view movies, will not be transferable to a laptop. The great success of Apple Computer's iPod digital music player is being complemented by personal video play-

ers. A particularly interesting one is the Ovideon AVIAh multimedia player, recorder and TV.

It has a 521 x 218 pixel OLED (Organic Light Emitting Diode) screen, an integrated TV/cable tuner, weighs less than 150g and is small enough to fit into a shirt pocket. Users can transfer audio and video files via a high-speed USB 2.0 link – the AVIAh can handle MP3, AVI, WMA, WMV9, DivX and JPEG files. It also functions as an audio or video/audio recorder that can be connected to a camcorder, DVD player, CD player or VCR to record directly on to its 5GB hard drive.

Korean company PQI showed its mPack personal video player, which has a 3.5in. LCD screen, an 80GB hard drive and can handle WMV (Windows Media Video), MPEG-1, MPEG-2, MPEG-4 and DivX files. The Mustek PVR H140 has a 3.6in. LCD screen and a hard drive. The Archos PMA43030 has a 40GB hard drive that can store up to 120 hours of video from a TV set, VCR or a DVD recorder. ■

2006 International CES

**Be there next year
5 - 9 January 2006
Las Vegas,
Nevada, USA**

www.cesweb.org

Horizon Digital Satellite Meter

HDSM

- Signal Strength and BER displayed together
- 32 Transponders or 16 satellites, horizontal & vertical
- Audible tune-in, with back light
- DVB, C&Ku band, Mpeg, V Sat compatible
- Figure of 8 mains input connector. 2.1 mm Female PSU plug

HORIZON

For a reliable solution!

www.horizonhge.com

For a threesome to remember choose Horizon Satellite Meters

Horizon Digital Terrestrial Meter

HDTM

- Displays Signal Strength (R.F level) and Pre and Post BER together
- 32 pre programmed transmitters (via website) or all channel step through
- Audible tune-in, with back light
- Automatic constellation
- RF Input range 167-862 MHz
- Input dynamic range -72dBm~-20dBm



MiniSAT

- Cost effective
- Small and Compact
- Measure two sets at same time
- Self powered via rechargeable NiMH batteries
- Powered via built in batteries, charger or transfer



Also available from the following distributors

Eurosat Midlands 01922 639299 www.eurosatmidlands.com

Eurosat North 01924 423602 www.eurosatmidlands.com

Grax Nottingham 0115 927 9993 www.grax.co.uk

Grax Manchester 0161 747 2007 www.grax.co.uk

Grax Leeds 0113 26 33 500 www.grax.co.uk

Solutions Group 08456 444 000 www.solutionsgroup-plc.com

Or contact Horizon direct for your local supplier

on +44 (0)20 8344 8230

or email sales@horizonhge.com

Economic Devices

PO Box 73, Oakengates TF2 8WR

Tel ++ 44 (0)1952 273130

Fax ++44 (0)1952 405478

Remote Controls from £5.95 each

Stock held in the year 5,300,000 different models

SEMICONDUCTORS

over 34,000 types of transistors, IC's, diodes etc. or equivalents stocked

We take your hassle Some suppliers just won't help. We will work really hard to find those difficult parts - just ask and let our 'no holds barred' enquiry hound work for you.!!

...and look at the special offers.....

BUT11A @ 99p each BUT11AF @ 61p each
BU508A @ 13p each Fully wired scart lead 69p

a slight inconvenience....

....you must buy more than one.

BU208A X 5	75p ea	TEA2018A X 5	99p ea
BU508A X 5	79p ea	UC3842 X 5	59p ea
BU508AF X 5	85p ea	CNX62A X 5	29p ea
BU508D X 5	89p ea	S2000AF X 5	84p ea
BUT11A X 5	29p ea	TDA3653B X 5	55p ea
BUT11AF X 5	47p ea	TDA3654 X 5	82p ea
Philips type 1.2 volt	Back up battery	X 5	59p ea
Philips type 2.4 volt	Back up battery	X 5	120p ea
Scart - Scart lead 1.5m	Fully wired	X 2	89p ea
Positor PT37, TH98009	(White)	X 5	59p ea
Thom TX100 Chassis	110 DGR LOPTX	each	£11.24
Philips CP90 Chassis	LOPTX	each	£11.63

...and now ask about our value for money full price list. Remember £1.50 post & handling. All major credit cards accepted

www.telepart.co.uk

The web page where you can look up the price and order all things TV, VCR and Satellite. Web search by model for video part, remote control, LOPTX etc. overseas enquiries particularly welcome

New CCTV catalogue out NOW
cameras, monitors, switches, quads, multiplexers, the lot.

P.J.HILL

TV. VCR. SPARES

FLYBACK TRANSFORMERS BY ELDOR, OREGA, TERMAL, CLASSIC ALSO BUDGET RANGE.

Enquire by No's off old transformer & model No. For Akai, Akora, Alba, Aiwa, Bush, Beko, Daewoo, Ferguson, Formentii, Goodmans, Grundig, Hinari, ITT, JVC, Matsui, Net, Orion, Panasonic, Philips, Samsung, Sanyo, SEG, Sharp, Sony, Thomson, Tatung, Toshiba, etc

REMOTE CONTROL BY CLASSIC

Video heads & spares, CD Lasers, belts, mains switches, semi conductors, valves, switch mode transformers (including Matsui 2196N) service kits, T/V, VCR & satellite resistors, capacitors, valves, tuners, triplers etc.

ASK ABOUT OUR SERVICE MANUAL LIBRARY FOR TV VIDEO & MICROWAVE & AUDIO.

MOST CREDIT & DEBIT CARDS

P.J.HILL

classic
DISTRIBUTOR

E7 NORTHWAY TRADING EST,
NORTHWAY LANE, TEWKESBURY,
GLOS, GL20 8JH,
TEL: 01684 296902
FAX: 01684 294317



Sony TV chassis

A chassis-model listing update, compiled by Giles Pilbrow, to make it easier to find relevant

The last guide to the various chassis used in Sony TV sets sold in the UK was published in our November 2002 issue. In the intervening two or so years Sony has been quite active in introducing new TV products. Several models have continued in production however, so there is some overlap with the previous listing. Table 1 lists the models, while notes on the various chassis are given below.

AE6A: Introduced in 2002, current models. These are high-end 100Hz sets that follow on from the successful AE5A chassis. The KV32FQ80U was the first Sony model to incorporate a Memory-stick slot to enable still images and movies taken with a digital still camera to be played back directly. There's a separate EHT generator circuit, as used in some AE6B models (see below).

Remote-control units RM945 and RM936.

AE6B: Introduced in 2002, current models. The chassis superseded the AE5 and is based on the Micronas VSP9402 100Hz processor chip. Because of the high level of integration, there's no separate 100Hz processing board. All signal processing is carried out on main board A. A small daughter board M is used for system control and teletext: different models have different versions of the processor/software IC.

The deflection circuitry is based on the same principles first used in the AE5/AE5A chassis, though the power supply is improved. This uses the same robust design as in the FE2 chassis. FX66 and FQ70 models have a separate, regulated EHT generator. This gives greatly improved regulation, with no noticeable change in image size with beam-current variation. The downside for the service engineer is greater complexity – and several additional protection circuits!

The FX66 models have a unique remote-control locator system that uses a low-power radio transmitter within the set. When this is

activated, the remote-control unit emits a beeping sound until it's located.

Remote-control units RM932, RM937, RM938 and RM947.

AE6BA: Introduced in 2004, current model. A hybrid between the AE6A and AE6B chassis with more sophisticated video processing than the AE6B models.

Remote-control unit RM945.

AE6D: Introduced in 2001, current models. Similar to the AE6A chassis but combines 100Hz processing with a digital tuner board. DX200 and NX200 models incorporate the improved EHT regulation circuitry first used in the AE6B chassis. NX200 models include a Memory-stick slot.

Remote-control units RM933 and RM939.

AE6X: Used in CRT rear-projection models on sale 2002-4. Model KP44DX2U incorporates a digital tuner.

Remote-control unit RM948.

AE7A: Introduced in 2004, current models. This is a very sophisticated chassis that's based on the power and deflection circuitry in the AE6A with new video-processing circuitry. Model KV36HQ100B was the first in the UK to have a Super Fine Pitch Trinitron tube. Memory-stick slots are standard with both models.

AT2: Introduced in 2002, current models. These are small-screen LCD sets with stereo sound and, in some models, a Memory-stick slot. Larger sets have a built-in power supply, smaller ones don't. The 26in. model can accept progressive-scan and high-definition signals via its component input.

Remote-control units RM932 and RMY1101.

BX1: Introduced in 2003, current models. A new entry-level 4:3 chassis with mono sound

to replace the FE2 for some sets.

Remote-control unit RMW100

FE2: Introduced in 2000, current models. This core 50Hz chassis took over from the BE3E and FE1 chassis. It uses a single-board design, much simplified in comparison with previous sets. Most of the circuitry is centred around the Philips TDA9394 IC, which contains the main microcontroller, teletext, colour decoder, video switching and timebase generator circuitry.

Remote-control units RM887, RM889, RM932 and RM947.

FE2D: Introduced in 2001, current models. Entry-level 50Hz sets that include an analogue and a digital terrestrial tuner. The digital section has gone through three revisions since the first DX40 models. DX50 and DL10 sets have a faster processor for improved digital teletext. The most recent DL11 and DX51 models include a new user interface and EPG.

Remote-control units RM933 and RM949.

LE3A: Used in sets sold during 2002-3. These are LCD rear-projection sets that provide much improved picture quality and brightness in comparison with the previous LE1 chassis. The compact optical unit means that sets are much slimmer in comparison to the previous CRT and LCD projection models. Later sets have a sealed optical unit that's assembled and must be serviced in a clean-room environment to prevent dust getting into the assembly.

Remote-control unit RM905.

LE4A: Introduced in 2003, current models. A redesign of the previous LE3 chassis providing improved picture quality and contrast ratio with a reduced component count. These sets also have an HD15 connector for a computer input.

Remote-control unit RM906.



guide

nt servicing information

MR1: Sold during 2003-4. The sets have more sophisticated features than Triton TS1 models (see below), using a separate media box and panel. The KVL30MR1 has a 30in. LCD screen while the 42 and 50in. models use plasma technology. The sets have a computer and a variety of AV inputs, also a Memory-stick slot to view pictures and MPEG movies taken with digital cameras.

Although they look identical physically, it's important to know that the media boxes are not interchangeable between LCD and plasma models: LCD sets use the MBT-MRL1 media box, plasma sets the MBT-MR1 box.

Remote-control unit RM972.

MRX1: Introduced in 2004, current models. These sets represent the state of the art in Sony's TV range. They are again based on the use of a separate media box and display panel. The 32in. set uses an LCD panel while the 42in. sets are available in LCD or plasma versions. The 50 and 61in. sets have plasma screens. All are capable of displaying high-definition 1,080i video as well as normal AV and computer inputs.

The new MBD-MRX1 media box is slimmer than its predecessor and includes both digital and analogue tuners. Unlike the MR1 series, the same media box can be used with any of the MRX1 series display panels.

A Memory-stick slot is incorporated, with the ability to record video from either a digital or analogue source in MPEG-4 format then play it back via a handheld device such as one of Sony's Clio PDAs.

Remote-control unit RMY1013.

Triton: Sony's first consumer plasma TV sets, sold during 2002-4. Features include an integrated analogue tuner and table-top stand.

Remote-control unit RM932.

WA1: Introduced 2004, current models. A small-screen LCD chassis with stereo sound.

Remote-control unit RMY1108.

Models shown opposite: Left - KF50SX200U Centre - KVL30MR1 Right - KD32DX150U

Table 1: Model/chassis listing

<i>Model</i>	<i>Chassis</i>	<i>Model</i>	<i>Chassis</i>
KD28DL10U	FE2D	KLVL23M1	AT2
KD28DL11U	FE2D	KLVL32M1	AT2
KD28DX200U	AE6D	KP44DX2U	AE6X
KD28DX40U	FE2D	KP44PX2U	AE6X
KD28DX50U	FE2D	KV14CL10U	BX1
KD28DX51U	FE2D	KV14CT1U	BX1
KD32DX100U	AE6D	KV14LM1U	FE2
KD32DX150U	AE6D	KV14LT1U	FE2
KD32DX200U	AE6D	KV21CL10U	BX1
KD32DX40U	FE2D	KV21CT1U	BX1
KD32DX50U	FE2D	KV21FT1U	FE2
KD32DX51U	FE2D	KV21LS30U	FE2
KD32NX100U	AE6D	KV21LT1U	FE2
KD32NX200U	AE6D	KV24LS35U	FE2
KD36NX200U	AE6D	KV28CS70U	AE6B
KDEP42MRX1	MRX1	KV28EW20U	FE2
KDEP50MRX1	MRX1	KV28FQ70U	AE6B
KDEP61MRX1	MRX1	KV28FX66U	AE6B
KDLL32MRX1	MRX1	KV28FX68U	AE6B
KDLL42MRX1	MRX1	KV28HX15U	FE2
KE32TS2E	Triton	KV28LS35U	FE2
KE42MR1	MR1	KV28LS36U	FE2
KE42TS2E	Triton	KV28LS60U	AE6B
KE50MR1	MR1	KV29LS30U	FE2
KF42SX200U	LE3A	KV32CS70U	AE6B
KF42SX300U	LE4A	KV32FQ70U	AE6B
KF50SX200U	LE3A	KV32FQ80U	AE6A
KF50SX300U	LE4A	KV32FQ86U	AE6BA
KF60SX300U	LE4A	KV32FX66U	AE6B
KLV15SR1	AT2	KV32FX68U	AE6B
KLV15SR2	AT2	KV32HQ100B	AE7A
KLV17HR1	AT2	KV32HX15U	FE2
KLV17HR2	AT2	KV32LS35U	FE2
KLV17HR3	WA1	KV32LS36U	FE2
KLV20SR3	WA1	KV32LS60U	AE6B
KLV21SG2	AT2	KV36FS76U	AE6A
KLV21SR2	AT2	KV36HQ100B	AE7A
KLV26HG2	AT2	KZ32TS1E	Triton
KLV30MR1	MR1	KZ42TS1E	Triton

Vintage repair:

the PYE P202BQ pocket radio

Pete Roberts on restoring life to one of these transistor pocket radios



The Pye P202BQ is a British-made transistor pocket radio receiver that dates from about 1962. The one that arrived recently for repair was a non-worker. Circuitry is fairly standard – it's a six-transistor superhet. There are five pnp transistors and an npn one, germanium types supplied by Newmarket Transistors. Do you remember them? They were housed in distinctive oblong cans. The name comes from the famous horseracing town, and the company had been taken over by Pye.

It's nominally a two-band receiver, with the long-wave fix-tuned to Droitwich. The *Trader* service sheet for this model shows a balanced push-pull output stage with driver and output transformers. But this set was an 'issue 2' version with a transformerless complementary-symmetry output stage, see Fig. 1. The full circuit diagram is shown on page 267 of the 1962-63 volume in the *Radio and Television Servicing* series of books. It also applies to Models P200BQ and P201BQ. The receiver is powered by a 9V battery of the PP3 type.

Testing and initial repair

I fed 9V from my bench power to the set and, after ensuring that the current taken was not excessive (it

was about 5mA), started to check various voltages. The output stage's centre voltage was decidedly low at just over 1V. The cause was the NKT258 driver transistor VT4, which was leaky. An AC125 replacement restored a more realistic 4.7V centre voltage and some signs of life.

After looking askance at the several small low-voltage electrolytic capacitors on the board, and taking

into account their 40 years' hard labour, I decided to replace all the decouplers. Tantalum-bead types were fitted as they wouldn't detract too much from the original appearance of the chassis. A conventional subminiature aluminium electrolytic was used to replace the speaker coupling/bootstrap capacitor C27 (50 μ F): a tantalum bead capacitor can't be used in this position as any appreciable ripple current will damage it.



Photo 1: Appearance of the Pye Model P202BQ transistor pocket radio receiver, which dates from about 1962.

Pete Roberts in his workshop.

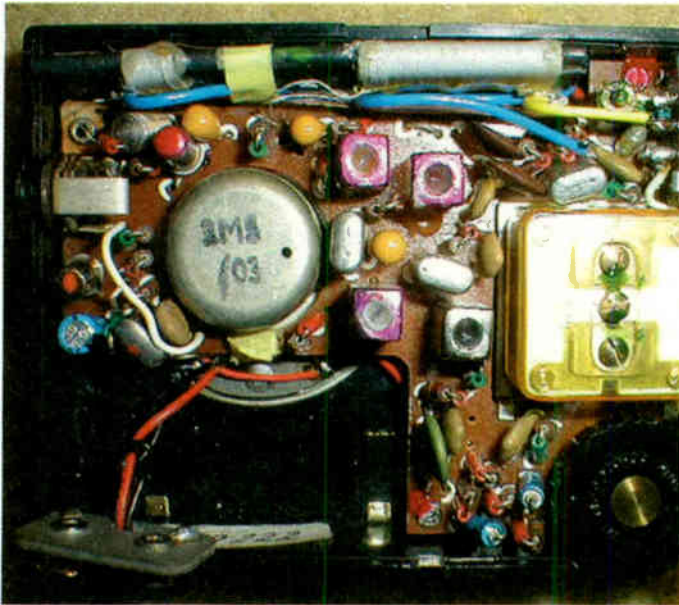

Photo 2: Component side of the PCB, with replacement tantalum-bead electrolytic capacitors fitted.

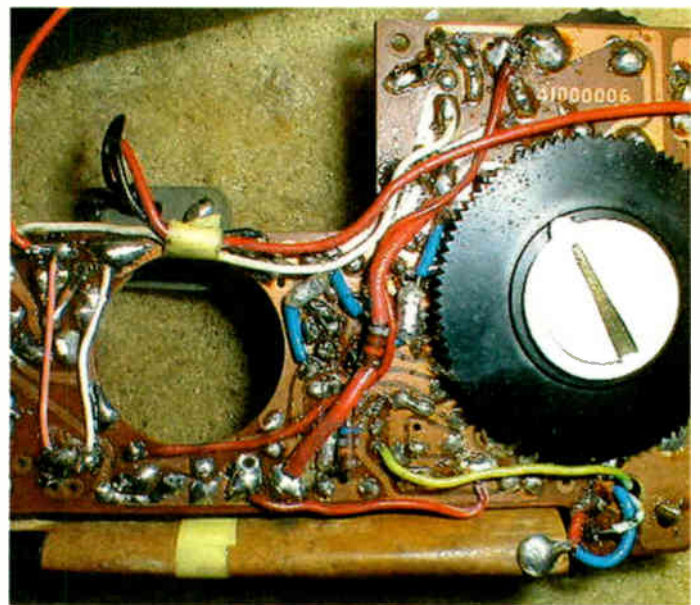

Photo 3: Track side of the PCB – some of the components are mounted on this side.

Alignment

I now had reception of sorts, and on closer examination it was obvious that the IF cores had been disturbed. Time to reach for my trusty Advance E2 signal generator. I had a cuppa while waiting for it to warm up – the recommendation is to allow twenty minutes after switching on. With the tuning capacitor fully closed I injected 470kHz via a loop round the ferrite-rod aerial. The three tiny IF transformers were considerably off tune and needed careful adjustment, reducing the generator's output as the gain came up to prevent the AGC action masking the signal peak. The signal level should be just sufficient for it to be heard over the background noise. When tuning by ear, use of an earpiece may be helpful.

It's essential to use a proper trimming tool for this task, otherwise there is a real risk of cracking the cores.

These radio sets don't have a tuning scale as such, so it was only necessary to ensure that I had full MW coverage then slightly move the aerial coil along the ferrite slab for maximum sensitivity at the LF end of the band. The cause of sudden loss of reception at the HF end of the band was traced to someone having tampered with the solid-dielectric tuning capacitor's centre bearing screw, the result possibly being vane fouling. I slacked it off a fraction of a turn, then tweaked the oscillator and aerial trimmer screws.

All that was needed to finish off was a slight tweak of the LW oscillator trimmer to repeak reception of

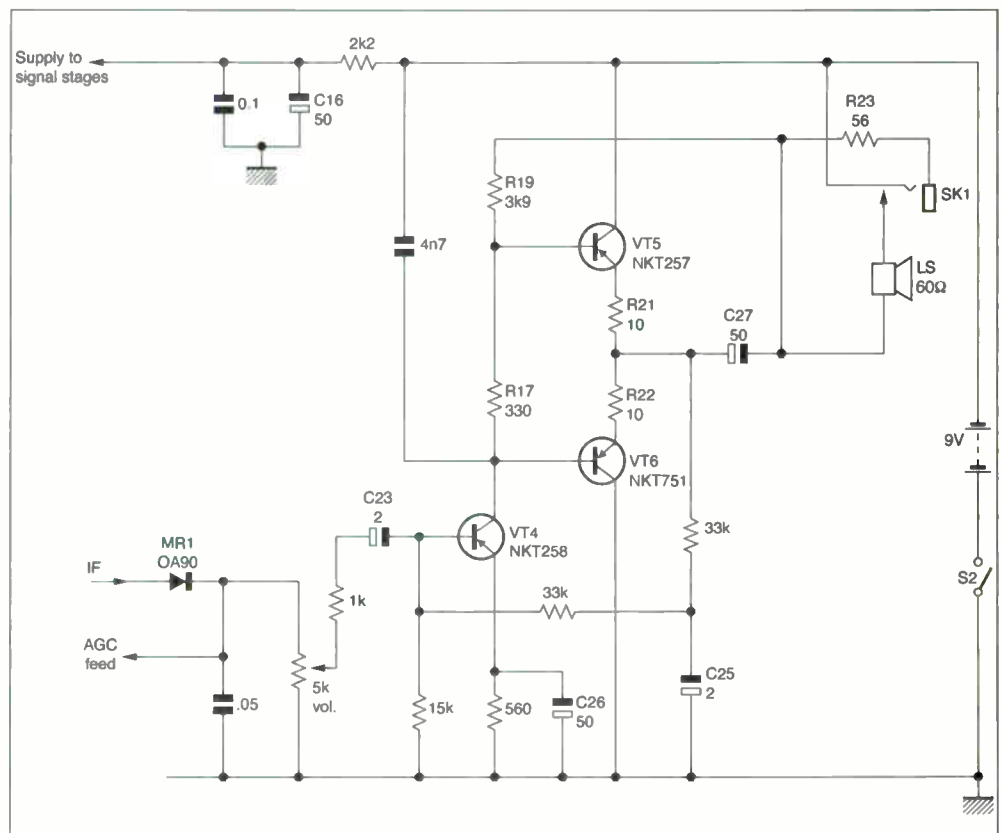

Fig. 1: Audio circuitry used in the issue 2 version of the Pye Model P202BQ, with driver transistor VT4 and complementary-symmetry output transistors VT5/6. The value of R23 seems to have been different in the set Pete Roberts had for repair.

Radio 4, which is now at 198kHz of course. I finally ran a small amount of hot paraffin wax into the IF and oscillator cans to secure the cores and discourage any further 'user adjustments'.

In conclusion

After giving the set a soak test I boxed it up and returned it to its owner.

Incidentally the set had a 1.5k Ω bypass resistor (R23) which is switched in when an earpiece is used.

This provides a DC path to the driver stage with the speaker out of circuit, presumably to allow the use of a crystal earpiece.

I didn't try a magnetic earpiece, but a crystal unit sounded very clear indeed.



Bench Notes

This month Adrian Gardiner starts on a new tack: how to develop your servicing business. It is still possible, despite today's difficult conditions, to run a profitable servicing organisation. The key factor is customer satisfaction

This month I am starting a short series of articles on business development, related obviously to the consumer electronics servicing trade. Any questions that readers might have about this are welcome, and I will endeavour to deal with as many of these as possible at the end of the series. You can contact me via the magazine (email or post).

Past experience

Before I begin, I should perhaps outline my experience in our field. I've been in the trade for the past seventeen years though, like so many of you I expect, my repair experience started some years before that! My working career in the industry has been in various sectors, including spells in the IT and broadcast sectors. But for most of the time I have been involved with repairs to consumer electronics products. The positions I've held during the past thirteen years have been in middle and senior management, though I have always continued to work on a daily basis as a hands-on bench engineer.

Present position

The company I work for at present has been established for over thirty years. I was taken on just over a year ago as Service and Business Development Manager, with a remit to modernise the company and take it forward to participate in the next generation of electronics servicing. Like many established companies, it has been concerned about the way in which the trade is developing, with more and more products either being uneconomical to repair or just too complex.

When I joined it the company had one full-time engineer, one part-time engineer, one full-time office/administration assistant, one full-time delivery driver and, of course, the MD/owner. Twelve months later the staff has increased, with four full-time engineers, including myself, an extra part-time office assistant, and an extra part-time delivery driver. The workload has obviously increased, and continues to do so. Turnover is up 28 per cent. Projections for the next twelve months aim for an increase of 50 per cent. Even more importantly perhaps, customer satisfaction has improved dramatically. This has led to more recommendations. Another improvement that has come from my efforts is that

many manufacturers are now giving the company greater support and take us seriously.

So, having given you this brief insight into my background, I aim over the next few months to pass on a little of the know-how I have gained. I hope this will provide you with a few pointers that may help you to improve your own businesses.

Customer satisfaction

First on the agenda is customer satisfaction. We all know that recommendations are by far the best form of advertising. Happy customers talk, but so do unhappy ones! You cannot please everyone, but you should always try your utmost. Even in an extreme case, I would much rather come to a satisfactory solution than alienate a walking advertisement board. Further, I rarely give refunds.

Here are a few ideas that we have incorporated into our everyday policy.

- (1) We guarantee that all jobs that come into our workshop will be looked at next day. Where possible, a repair will be carried out at this time or, when requested, an estimate will be provided.
- (2) The customer will be informed as soon as the equipment has been examined. Updates will be given (estimate/repaired/parts on order etc.)
- (3) We will endeavour to complete all repairs within five days. When this is not possible, the customer will be kept fully informed with regular updates.
- (4) When the repair involves a TV set, a loan set will wherever possible be provided.
- (5) Contract repairs carry a standard three-month warranty. Customer-chargeable repairs carry a twelve-month warranty however, parts and labour, on the work that has been carried out.
- (6) Replace rather than refund.

Let's look at some of these points in more detail.

Workshop organisation

When a product breaks down its owner is

inconvenienced. Yes, some people should get a life, but the fact is that the customer is annoyed when the equipment is faulty and wants it working again yesterday. By far the biggest improvement I have been able to make within the company is in turnaround time.

We now operate a strict policy (within reason) of looking at all repairs the day after the equipment arrives in the workshop. We aim to do this by lunchtime, shelving any really complex faults after about twenty-thirty minutes. The afternoon is then free to fit parts that have arrived and investigate the more involved faults.

The office phones customers during the afternoon, providing updates and estimates and arranging for the delivery of repaired products. The quicker the repair turnaround, the happier the customer will be.

Communication

Communication is the key to keeping a customer happy when the fault is a more difficult one. Whether it's a nasty fault that requires time to be resolved, or there's a delay in obtaining the parts required, phone the customer regularly to let them know what's happening. This avoids the customer phoning you and complaining, and reassures them that as a company you are doing everything you can.

Guarantees

Are you confident about the quality of your work? If so, why not guarantee it? Our twelve-month guarantee on our own chargeable jobs sets us apart from the competition.

Customers are generally happy to pay a little more to a professional company that guarantees its work. A guarantee also helps persuade those who are not sure whether it's worth spending money on having an item repaired to give the OK.

Replacement

We keep a few second-hand products that can be supplied to customers when their original equipment continually breaks down. By offering a replacement instead of a refund, you solve the customer's basic problem. The result is a much happier customer who will shout your praises!

More next month.

Grandata Ltd

distributor of electronic components

Tilttable Wall Bracket for Plasmas



Universal tilttable (+15% / -15%) wall support for large plasma and LCD TV's.

Max. display weight: 75kg

Display size: 30-63" (76-160cm)

Colour: Silver

Order Code : PLASBKT1S Price : £ 75.00 + vat

Carriage charged at £ 6.00 + vat

Swivel LCD Bracket



Inclinable wall bracket with one articulation.

Max. display weight 20kg

Tilttable: +20% / -20%

Display size: 10-30" (25-74cm)

Colour: Silver

Order Code : LCDBKT1S Price : £ 15.00 + vat

Carriage charged at £ 6.00 + vat

Double Swivel LCD Bracket



Inclinable wall bracket with two articulation.

Max. display weight 20kg

Tilttable: +20% / -20%

Display size: 10-30" (25-74cm) - Colour: Silver

Order Code : LCDBKT2S Price : £ 25.00 + vat

Carriage charged at £ 6.00 + vat

Universal Fibre Optic Cable 1.5m



Order Code :26477H

Price : £ 7.00 + vat

Carriage £ 2.00 + vat

Home Cinema Scart Cable 1.5m



Order Code :26481H

Price : £ 8.00 + vat

Carriage £ 2.00 + vat

Home Cinema 3 Phono Cable 1.5m



Order Code :26455H

Price : £ 7.00 + vat

Carriage £ 2.00 + vat

Home Cinema S-Video Cable 1.5m



Order Code :26495H

Price : £ 4.75 + vat

Carriage £ 2.00 + vat

Scart to 3 Phono



Order Code : PLG17

Price : £ 1.00 + vat

10 or more
£ 0.75 + vat each

3 Phono to Scart



Order Code : PLG18

Price : £ 1.00 + vat

10 or more
£ 0.75 + vat each

Scart to 3 Phono (Switched)



Order Code : PLG85

Price : £ 2.00 + vat

10 or more
£ 1.00 + vat each

Gold Scart to 3 Phono (Switched)



Order Code : PLG86

Price : £ 2.70 + vat

10 or more
£ 1.75 + vat each

Double Phono to Phono Adapter



Order Code : PLG13

Price : £ 0.45 + vat

10 or more
£ 0.35 + vat each

Single Phono to Phono Adapter



Order Code : 19011R

Price : £ 0.20 + vat

10 or more
£ 0.16 + vat each

Phono Splitter



Order Code : 19055R

Price : £ 0.25 + vat

10 or more
£ 0.21 + vat each

BNC to Phono Adapter



Order Code : 19002R

Price : £ 0.40 + vat

10 or more
£ 0.30 + vat each

3.5mm Jack to 2 Phono



Order Code : PLG6

Price : £ 0.60 + vat

10 or more
£ 0.45 + vat each

6.3mm Stereo to 3.5mm Stereo



Order Code : 19012R

Price : £ 0.30 + vat

10 or more
£ 0.25 + vat each

High Quality Fully Shielded Foil Wrapped Scart Lead

Length : 1.5m Width : 12mm



Order Code : PLG26

Box of 25 Price

£ 30.00 + vat

Box of 50 Price

£ 50.00 + vat

Fully Shielded 21 Pin Connected Scart Lead

Length : 1.5m Width : 8mm



Order Code : PLG23

Box of 50 Price

£ 30.00 + vat

Box of 100 Price

£ 55.00 + vat

Coax Fly Lead Plug to Socket

Length : 2m



Order Code : COXCABLE

Box of 50 Price

£ 17.50 + vat

Box of 100 Price

£ 30.00 + vat

Home Cinema Installation

Cables and Connectors

K.R. House , Unit 14 , Pop In Commercial Centre , Southway , Wembley , Middlesex . HA9 0HB England

Tel: (020) 8900 2329

Fax : (020) 8903 6126

Email : sales@grandata.co.uk

48 Element Digital Compatible Aerial

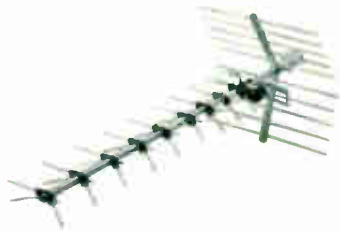

Receives both digital and analogue signals
 For poor to weak strength signal areas
 Robust design for low wind loading - 2 peices boom with aluminium wire rod elements
 Supplied with F connector and clamp for horizontal and vertical (fits up to 57mm masts)
 Ideal for areas with bad picture ghosting
 Supplied part assembled - no tools required

Order Code : 27884R Price : £ 20.00 + vat
 Carriage charged at £ 6.00 + vat

SLx Masthead Amplifiers

UHF TV and FM radio antenna preamplifiers designed for professional aerial installers.

1 way amplifiers come with screw terminals

2 and 4 way amplifiers come with F connectors

Requires 12V DC power supply connected via a downlead



Description

- 1 way UHF TV Masthead Amplifier - 15dB Gain**
Order Code : 27830R Price : £ 4.30 + vat
- 1 way UHF TV Masthead Amplifier - 26dB Gain**
Order Code : 27831R Price : £ 4.50 + vat
- 2 way UHF TV Masthead Amplifier - 10dB Gain**
Order Code : 27837R Price : £ 9.00 + vat
- 4 way UHF TV Masthead Amplifier - 10dB Gain**
Order Code : 27838R Price : £ 9.50 + vat
- 4 way UHF TV & FM Masthead Amp - 10dB Gain**
Order Code : 27839R Price : £ 10.00 + vat

Masthead Amplifier Power Supply

Order Code : 27832R Price : £ 5.00 + vat

Carriage charged at £ 2.00 + vat or £ 6.00 + vat for 2 or more

SLx Distribution Amplifiers



A range of Aerial amplifiers designed to allow distribution of TV , Satellite and FM signal without the loss of picture and sound quality.

Available with intergrated Digital bypass - to allow the use of SKY™ digieye (B).

Main Operated , comes with full instructions

Description	Gain	Order Code	Price
2 way	18dB	SLX2	£ 8.00 + vat
2 way with Bypass	6dB	SLX2B	£ 9.25 + vat
4 way	12dB	SLX4	£ 13.00 + vat
4 way with Bypass	6dB	SLX4B	£ 14.00 + vat
6 way	12dB	SLX6	£ 18.00 + vat
6 way with Bypass	6dB	SLX6B	£ 19.00 + vat
8 way	12dB	SLX8	£ 18.50 + vat
8 way with Bypass	6dB	SLX8B	£ 20.00 + vat

Carriage charged at £ 2.00 + vat or £ 6.00 + vat for 2 or more

Satellite Finder



Compact design - Backlit meter scale
 Audible signal strength reading
 Adjustable level control
 Adjustable sensitivity adjustment
 Frequency Range : 950 - 2250Mhz

Order Code : 27860R
 Price : £ 10.00 + vat

Coax Plug Aluminium



Order Code : PLG51
 Bag of 10
 Price : £ 1.25 + vat
 Bag of 100
 Price : £ 9.00 + vat

Screw Type Coax Plugs



Order Code : PLG62
 Bag of 10
 Price : £ 1.60 + vat
 Bag of 100
 Price : £ 12.50 + vat

Twist on F Connectors



Order Code : PLG101
 Bag of 10
 Price : £ 1.00 + vat
 Bag of 100
 Price : £ 6.00 + vat

Sky™ Remote Controls



Order Code : RCSKY
 Price : £ 8.50 + vat

5 or more
 £ 7.99 + vat each

10 or more
 £ 7.50 + vat each

20 or more
 £ 6.75 + vat each

Carriage charged at £ 6.00 + vat

Sky™ Remote Controls & SLx Link Eye



Order Code : SKYPACK2

Price : £ 13.00 + vat

5 or more
 £ 11.50 + vat each

10 or more
 £ 10.50 + vat each

Carriage charged at £ 6.00 + vat



RG6 Digital Satellite Coaxial Cable

Suitable for both TV and Satellite signal distribution

1mm Copper Conductor , Air Spaced dielectric , 64 strand copper braiding with aluminium foil shielding

Comes on 100m drum

Available in either black or white colour



Black - Order Code : SATCABLE

Price : £ 11.00 + vat each

Box of 4 - £ 40.00 + vat (£ 10.00 + vat each)

White - Order Code : SATCABLEW

Price : £ 11.00 + vat each

Box of 4 - £ 40.00 + vat (£ 10.00 + vat each)

Carriage charged at £ 6.00 + vat

Part No	Code	Price	Part No	Code	Price	Part No	Code	Price	Part No	Code	Price	Part No	Code	Price
BUSH			FERGUSON...continued			GOODMANS...continued			L.C...continued			SONY...continued		
10559.6	LOT1814	£16.50	103194 B0	LOT1262	£16.50	1372 0052 B	LOT2262	£22.00	3313110	LOT2238	£26.00	1-439-332-52	LOT100	£10.00
1055960	LOT1814	£16.50	10319410	LOT1262	£16.50	1372.0062	LOT2262	£22.00	58 834	LOT2238	£26.00	1-439-387-11	LOT311	£14.50
105936 4	LOT1148	£19.00	10319411	LOT1262	£16.50	1372 0062 A	LOT2262	£22.00	M 12-130	LOT2238	£26.00	1-439-387-21	LOT311	£14.50
10593640	LOT1148	£19.00	10319480	LOT1262	£16.50	1372.0066	LOT2262	£22.00	M 12-133	LOT2238	£26.00	1-439-416-11	LOT255	£11.00
10593640.P2	LOT1148	£19.00	10319480	LOT1262	£16.50	1372 0066 A	LOT2262	£22.00	M 12-138	LOT2238	£26.00	1-439-416-12	LOT255	£11.00
106122.8	LOT1814	£16.50	104061 2	LOT1262	£16.50	1372 00662	LOT2262	£22.00	M 12-157	LOT2238	£26.00	1-439-416-21	LOT255	£11.00
1061280	LOT1814	£16.50	104061 6	LOT1262	£16.50	40313-16	LOT1814	£16.50	M12130	LOT2238	£26.00	1-439-416-23	LOT255	£11.00
106552.2	LOT1545	£19.00	10406120	LOT1262	£16.50	40330-10	LOT1262	£16.50	M12133	LOT2238	£26.00	1-439-416-41	LOT255	£11.00
10655220	LOT1545	£19.00	10406160	LOT1262	£16.50	40330-11	LOT1262	£16.50	M12138	LOT2238	£26.00	1-439-416-51	LOT255	£11.00
106699	LOT2184	£16.00	104525 2	LOT1262	£16.50	40330-26	LOT1262	£16.50	M12157	LOT2238	£26.00	1-453-308-11	LOT2196	£31.50
10669500	LOT2184	£16.00	104525 3	LOT1262	£16.50	40330-27	LOT1262	£16.50	RO 682	LOT2238	£26.00	1-453-308-21	LOT2196	£31.50
10669900.P1	LOT2184	£16.00	10452520	LOT1262	£16.50	40348-01	LOT1933	£49.00	RO 685	LOT2238	£26.00	1-453-308-31	LOT2196	£31.50
106966 6	LOT2184	£16.00	10452530	LOT1262	£16.50	40348-02	LOT1148	£19.00	TR 682	LOT2238	£26.00	1-453-310-11	LOT2196	£31.50
10696660	LOT2184	£16.00	10452530	LOT1262	£16.50	40348-06	LOT1545	£49.00	TR 685	LOT2238	£26.00	1-453-314-21	LOT2196	£31.50
10696660.P1	LOT2184	£16.00	GOODMANS			40348A-01	LOT1933	£19.00	OREGA			1-453-372-11	LOT2196	£31.50
11030936351000	LOT2262	£22.00	1142 5057	LOT1164	£15.00	40348A-02	LOT1148	£19.00	40153201	LOT349	£17.50	8-598-834-00	LOT2196	£31.50
11030936351136	LOT2262	£22.00	1142.5077	LOT1164	£15.00	40348A-03	LOT1814	£16.50	PANASONIC			8-598-834-10	LOT2196	£31.50
11040102331136	LOT2262	£22.00	1142 5079	LOT1164	£15.00	40348A-06	LOT1545	£19.00	TLF 14512 F	LOT39	£5.00	8-598-834-20	LOT2196	£31.50
BEKO			1142 5081	LOT1164	£15.00	40348A-09	LOT2184	£16.00	TLF 14521 F	LOT39	£5.00	8-598-834-30	LOT2196	£31.50
057 834 TR 2	LOT2238	£26.00	1179 0387	LOT1147	£16.00	40348A-10	LOT1148	£19.00	TLF 14567 F	LOT39	£5.00	8-598-834-50	LOT2196	£31.50
058 434 TR 4	LOT2238	£26.00	1192 0527	LOT1147	£16.00	40348A-12	LOT2184	£16.00	TLF 14568 F	LOT40	£8.50	THOMSON		
058 834 TR 1	LOT2238	£26.00	1342 0006	LOT1148	£19.00	GRUNDIG			PHILIPS			105009 8	LOT1505	£19.00
058.834 TR 2	LOT2238	£26.00	1352.5008	LOT1167	£15.00	29201 029 63	LOT1987	£18.00	3119 108 31260	LOT90	£11.00	10500980	LOT1505	£19.00
058.834 TR 5	LOT2238	£26.00	1352.5016	LOT1934	£19.00	29221 029 63	LOT1987	£18.00	3119 108 31290	LOT73	£10.00	10500980.P1	LOT1505	£19.00
3311159	LOT2238	£26.00	1352 5027	LOT1270	£16.00	M 29221 029 63	LOT1987	£18.00	3119 198 62930	LOT57	£9.50	10531460	LOT1505	£19.00
3311167	LOT2238	£26.00	1352 5033	LOT1270	£16.00	HANTAREX			3122 138 36922	LOT57	£9.50	10566060	LOT1505	£19.00
3311187	LOT2238	£26.00	1352-5016	LOT1934	£19.00	1242 0178	LOT1153	£20.00	3122 138 36923	LOT57	£9.50	10566060.P2	LOT1505	£19.00
3313110	LOT2238	£26.00	1192 1421	LOT1262	£16.50	28020280	LOT1158	£20.00	3122 138 36922	LOT57	£9.50	10566060	LOT1505	£19.00
58 834	LOT2238	£26.00	1342 0006	LOT1148	£19.00	28029390	LOT1153	£20.00	3122 138 36923	LOT57	£9.50	105880 8	LOT1505	£19.00
M 12-130	LOT2238	£26.00	1342 0006 A	LOT1148	£19.00	HITACHI			3122 138 37050	LOT132	£19.50	10588080	LOT1505	£19.00
M 12-133	LOT2238	£26.00	1342 0006 B	LOT1148	£19.00	2433891	LOT273	£8.00	3122 138 37620	LOT90	£11.00	10588080.P2	LOT1505	£19.00
M 12-138	LOT2238	£26.00	1342 00062	LOT1148	£19.00	2433892	LOT784	£5.00	3122 138 37992	LOT1116	£10.00	151128140	LOT1505	£19.00
M 12-157	LOT2238	£26.00	1342 0060	LOT1148	£19.00	2433893	LOT273	£8.00	3122 138 38040	LOT73	£10.00	1512814 4	LOT1505	£19.00
M12130	LOT2238	£26.00	1352 0052	LOT2262	£22.00	2433952	LOT333	£7.50	3139 128 30400	LOT90	£11.00	153144 6	LOT1505	£19.00
M12133	LOT2238	£26.00	1352 0052 A	LOT1814	£16.50	2434141	LOT333	£7.50	40348-08	LOT1577	£16.00	15314460	LOT1505	£19.00
M12138	LOT2238	£26.00	1352 5006 A	LOT1814	£16.50	2434393	LOT405	£10.00	40348A-09	LOT1577	£16.00	1531447 A	LOT1505	£19.00
M12157	LOT2238	£26.00	1352 5006 R	LOT1814	£16.50	2435131	LOT251	£5.00	4812 140 10369	LOT90	£11.00	1532873 A	LOT1505	£19.00
RO 682	LOT2238	£26.00	1352 5008 E	LOT1167	£19.00	2436201	LOT90	£11.00	4822 140 10381	LOT128	£10.00	3233500	LOT244	£14.50
RO 685	LOT2238	£26.00	1352 5008 R	LOT1814	£16.50	45150504	LOT362	£16.00	4822 140 10306	LOT57	£9.50	3233900	LOT244	£14.50
TR 682	LOT2238	£26.00	1352 5008 E	LOT1933	£19.00	953 X 0624-001	LOT1986	£30.00	4822 140 10406	LOT128	£10.00	40112200	LOT244	£14.50
TR 685	LOT2238	£26.00	1352 5033 A	LOT1933	£19.00	953 X 0624-001	LOT1986	£30.00	AT 2076 / 10	LOT57	£9.50	40148300	LOT244	£14.50
FERGUSON			1352 5033 B	LOT1933	£19.00	2433891H	LOT273	£8.00	AT 2079 / 40	LOT73	£10.00	TOSHIBA		
473197	LOT304	£11.00	1352 5036	LOT1545	£19.00	2436771	LOT1149	£18.00	AT 2079 / 99	LOT276	£14.00	23236098	LOT288	£11.00
06 D-3-084-001	LOT23	£8.00	1352 5036 A	LOT1545	£19.00	42-0719-00	LOT1986	£30.00	SHARP			23236198	LOT288	£11.00
06 D-3-087-001	LOT23	£8.00	1352 5036 F	LOT1545	£19.00	53 X 0624-001	LOT1986	£30.00	RTRNF 1220 CEZZ	LOT39	£5.00	23236255	LOT289	£12.00
06 D-3-088-001	LOT84	£5.00	1352 5037	LOT2184	£16.00	BW 00231	LOT1986	£30.00	RTRNF 2001 CEZZ	LOT338	£12.00	23236425	LOT288	£11.00
06 D-3-093-001	LOT204	£16.00	1352 5037 A	LOT2184	£16.00	L.C.			RTRNF 2023 CEZZ	LOT310	£11.00	23236428	LOT289	£12.00
06 D-3-508-003	LOT276	£14.00	1352 5037 D	LOT2184	£16.00	057 834 TR 2	LOT2238	£26.00	SONY					
06 D-3-512-001	LOT204	£16.00	1352 5058	LOT1933	£19.00	058 434 TR 4	LOT2238	£26.00	1-439-332-41	LOT100	£10.00			
102706	LOT1262	£16.50	1352 5058 A	LOT1933	£19.00	058 834 TR 1	LOT2238	£26.00	1-439-332-42	LOT101	£8.50			
102706 4	LOT1262	£16.50	1352 5058 C	LOT1933	£19.00	058 834 TR 2	LOT2238	£26.00						
10270640	LOT1262	£16.50	1362 3005	LOT1262	£16.50	058 834 TR 5	LOT2238	£26.00						
102706E0	LOT1262	£16.50	1362 5001	LOT2262	£22.00	3311159	LOT2238	£26.00						
102756 4	LOT1262	£16.50	1362 5001 A	LOT2262	£22.00	3311167	LOT2238	£26.00						
10275640	LOT1262	£16.50	1362 5002	LOT2262	£22.00	3311187	LOT2238	£26.00						
103194.1	LOT1262	£16.50	1362 5002 A	LOT2262	£22.00									
103194 11	LOT1262	£16.50	1372.0052	LOT2262	£22.00									
103194 8	LOT1262	£16.50	1372.0052 A	LOT2262	£22.00									

We are stockist of both Konig and HR Diemen LOPT's
This is just a selection of the LOPT's that we stock.
Please call on 020 8900 2329
for a copy of our latest LOPT catalogue



**Vestel 11AK37
PSU Repair Kit**

Designed to work with Bush , Goodmans
Hitachi and Toshiba.

Models BD2851S , BD2951S , BD2581S , BD3251S



**Order Code : MODKIT51
Price : £ 10.00 + vat**

**Vestel 11AK19
4.3 Chassis PSU & EW Kit**

Designed to work with Alba , Amstrad ,
Black Diamond and Bush



**Order Code : MODKIT52
Price : £ 11.00 + vat**

**Vestel 11AK19
16.9 Chassis PSU & EW Kit**

Designed to work with Alba , Amstrad ,
Black Diamond and Bush



**Order Code : MODKIT52A
Price : £ 15.00 + vat**

Amstrad DRX 400 Repair and Upgrade Kits

Repair Kit

Upgrade Kit

Must be fitted as well as SATKIT42

**Order Code : SATKIT42
Price : £ 10.00 + vat**

**Order Code : RELKIT42
Price : £ 12.00 + vat**

Check out our Online Catalogue at
www.granddata.co.uk

This advertisement is just a selection of our stock.
Please contact us if you cannot find the part you are looking for.

* Please add £1 p+p and VAT to all orders (Unless Otherwise stated) * All components are brand new
* We accept payment by Access , Switch , Visa , Cheque and Postal Order
* All prices quoted are subject to availability and may be changed without prior notice

E & OE

Line Output Transformers

Repair / Mod Kits

The Vestel thyristor

Not many people appreciate why there's a thyristor on the secondary side of many Vestel power supplies. Alan Dent explains its purpose and operation, with particular reference to the 11AK19 chassis, and also provides fault-finding guidance

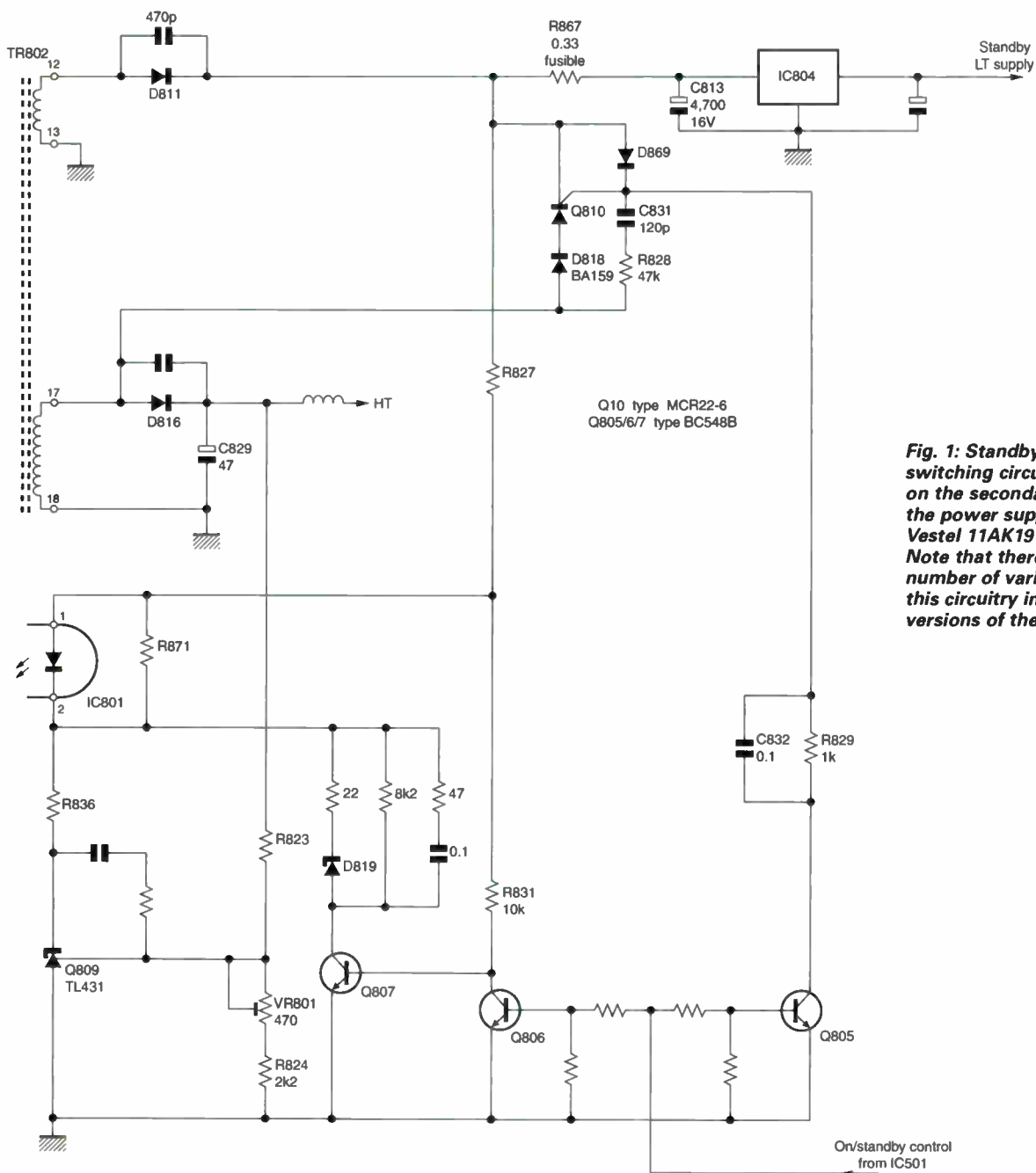

Fig. 1: Standby/on switching circuitry used on the secondary side of the power supply in the Vestel 11AK19 chassis. Note that there are a number of variations in this circuitry in different versions of the chassis.

The Vestel 11AK19 chassis and its subsequent variants uses a fairly straightforward chopper power supply, the primary side in particular. The secondary side can provide a few headaches however, because of the use of a thyristor (Q810) and three switching transistors (Q805/6/7). Fig. 1 shows the relevant circuitry. Note that there are variations in the different versions of the 11AK19 chassis. For example the fusible resistor R867 may be omitted or it may be on the other side of the feed from Q810. IC804 may be a 5V regulator or an LM317 regulator arranged to provide a 3.3V output: it depends on the type of microcontroller chip (IC501) used. See also Fig. 2.

Circuit operation - the thyristor

The thyristor Q810 is active only when the set is in the standby mode. In this mode the base of Q805 (BC548B) is at 0V and the transistor is thus switched off. Pulses from pin 17 of the chopper transformer TR802 are fed via R828/C831 to the gate of Q810, firing the thyristor on every half cycle. The anode of Q810 is fed from the same point, via D818. As a result, pulses are fed to the input of the standby LT supply regulator IC804 - to supplement the low output from D811 in this mode. The large reservoir capacitor C813 smooths the input to IC804, the ripple here being negligible.

When the microcontroller chip brings the set out of standby it switches Q805 on. This effectively earths the gate of Q810 so that it is no longer triggered.

Why is this arrangement necessary? When the set is in the standby mode, the voltages produced on the output side of the chopper transformer are all vastly reduced - to conserve power. If something was not done, the supply to the microcontroller chip IC501 would be inadequate. C813 is large and can hold a reasonable charge when the microcontroller chip is quiescent, as the load is high-impedance. But as soon as IC501 is asked to come out of standby and switch the set on, the current drawn will be much increased, draining C813. Thus IC501 would revert to the 'sleep' mode. If the microcontroller was repeatedly asked to operate, this could lead to severe oscillation and possibly damage. To overcome the problem, D818 and Q810 provide an auxiliary feed to top up C813.

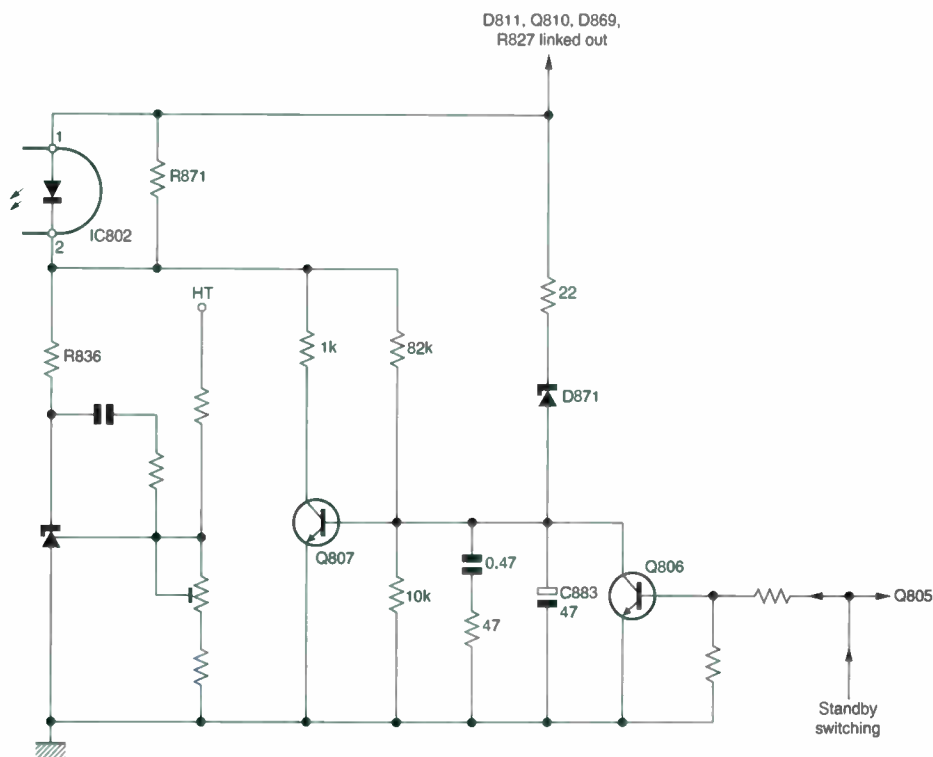

Fig. 2: The optocoupler standby/on switching arrangement used in the 11AK19E-3 version of the chassis. Somewhat different!

When the set is brought out of standby Q810 is no longer active and the voltages on the secondary side of the power supply rise to the normal operating levels.

Fault-finding

Various fault conditions can occur when the thyristor is not switched off. The most notable is a tripping 'squeak' because the HT supply is being virtually shorted to chassis via IC804. If the symptom stops when the anode or cathode of Q810 is disconnected, you still have the problem of persuading the microcontroller chip to come out of standby. The thing to do in this event is to disconnect the output from D811 then use a battery to feed IC804.

Standby switching - the optocoupler

Optocoupler IC801 provides regulation and standby-switching feedback to the primary side of the circuit. In the standby mode Q807 is switched on, connecting zener diode D819 in series with the diode section of IC801. As a result, the power supply operates in the low-power mode.

When the set is brought out of standby Q806 is switched on, thus switching Q807 off. The current through the diode section of IC801 is now controlled by the TL431 'variable' constant-current device Q809, which monitors the HT sup-

ply at its gate connection. If the HT voltage falls, the resistance of the optocoupler rises and the primary side of the circuit responds by feeding more energy to the transformer. VR801 sets the HT voltage.

As mentioned earlier, considerable variation in circuit detail exists in the various versions of the 11AK19 chassis. Fig. 2 shows the optocoupler standby/on switching arrangement used in the 11AK19E-3 chassis.

Fault conditions

When problems are experienced in this part of the circuit it is helpful to consider it as two separate sections, Q809 which controls the voltage regulation and Q806/7 which carry out standby/on switching. If Q807 is short-circuit, the HT won't rise when an attempt is made to bring the set out of standby. But Q810 will be inactive, reducing the supply to the microcontroller chip. So it won't be possible to make the microcontroller chip operate.

It's impossible to override this situation, so the obvious thing to do is to check whether Q807 is short-circuit. The same situation will arise if Q806 is open-circuit.

Various other fault conditions that are outside the scope of the present article can arise. But whatever the situation, it helps to treat the circuit as described above - as separate sections. ■

Sixty years of the SCTE

Graeme Young pays tribute on the sixtieth anniversary of the founding of the Society of Cable Telecommunication Engineers

The Society of Telecommunication Engineers was founded in 1945 by a group of engineers who were working in what was then the radio relay industry. They felt that there was a need for a forum to discuss and share concepts and technology in what was a developing and challenging new industry. It was first known as The Society of Relay Engineers, and was formed at what was a turning point in wired broadcasting.

This 1952 picture was taken at Link Relays control station at Gloucester, the UK's first CATV network. It was an HF multi-pair system on the Rediffusion pattern.

At the start

At the time of its inception cable systems carried audio signals only. But, when television transmission restarted after the war years, there was a need to carry both vision and sound signals, preferably via the existing cable with minimal modification. There were two major systems in operation, those designed and operated by British Relay Wireless and Rediffusion.

Provision of TV via cable required a new approach, sending a carrier frequency along the line. It was pioneered principally by Multi-Broadcast Engineering Ltd. at a large network in Rugby.

The challenges presented by the change to carrier-frequency transmission via cable were met and overcome with great success by members of the fledgling society, though the new system was slow to take off commercially. One reason for this was the need for mains power in subscribers' homes to operate the receiver. Radio relay with just a loudspeaker terminal had grown in popularity because it was much less expensive to run than the battery-operated receivers commonly used in the pre-war era. For a fixed price of about 7.5p (1/6d) a week it could be on all day and every day, with no need for batteries or a mains supply in the home for it to work.

TV via cable

When TV restarted, first in London then spreading out gradually into the provinces, the chances of receiving good pictures and sound were for many households doubtful. The alternative to the problems associated with off-air VHF reception was cable. There were considerable interference problems, both mains- and air-

borne, with off-air reception, and the large Yagi arrays required were abhorred by many landlords and property companies.

Low carrier frequencies, 3-10MHz, were used to minimise cable attenuation, and special receivers or adapters for use with standard receivers were required to obtain sound and vision from the cable signals. The Society provided a vital forum through which members could make their problems and experiences known, to the benefit of the cable TV industry as a whole.

It could be said that the above-ground cabling used until the late Eighties was as much an eyesore as forests of roof-top aerials, but the nuisance of overhead cabling could, with care, be minimised.

The HF carrier networks that were evolved from the older audio-only ones were known as multi-pair systems, because separate pairs were used for each service. The sound went out as baseband audio, with the HF carrier superimposed on it – much like DSL today. Balanced 600Ω lines were used, and careful installation and maintenance were required to prevent imbalance and as a result crosstalk between adjacent pairs. Subsequently carrier frequencies gradually increased to 65MHz then 230MHz. Today the uppermost frequency extends to 860MHz, using coaxial copper cable to carry TV, radio and data to customers' homes. Coaxial cable is used for the 'last mile', a high-quality fibre-optic distribution network taking the signals to local centres, called hubs, where they are converted back to RF. The hub amplifies the RF carriers than passes them to the coaxial distribution network.



Growth of the Society

Membership of the Society was countrywide from the start. To keep provincial members in touch with what was happening in London, a journal was launched. The first edition of the Proceedings of the Society of Relay Engineers was published in 1946, and formed part of the Relay Association Journal in August that year. Lecture meetings were reported in the Proceedings, along with verbatim reports of the discussions that followed each presentation – the rising cost of reporting the latter led to the practice being abandoned in later years however.

The Proceedings were published independently from 1948 onwards, and remained in the same format for 23 years. In January 1971 the SRE changed its name to The Society of Cable Television Engineers: the Proceedings changed as well, becoming known as Cable Television Engineering. For three years, from 1989 to 1992, the CTE was incorporated in a US publication called International Cable. It then returned to independent, quarterly publication, available to members and supporting organisations and companies only.

The journal is still known as CTE, but this now stands for Cable Telecommunication Engineering. This followed the Society's last change of name, to the present one, in 1994, the idea being to embrace the whole field of cable communications. The journal carries a wide range of content, some high-level technical material to keep members informed about new technology and techniques, with some more basic information to fill in the gaps in general electronics training – this should help younger members in particular. The journal also reports social events and provides information on coming events and the movement of people in the industry.

Training is considered by the SCTE to be of vital importance. Its courses on telecommunications provide the basic knowledge required for NVQs at Level 3 in all Links and CATV units. The course consists of eleven modules, which are designed for instructor-led classes or home study. The Society

awards its own universally-recognised certificate to students who achieve a pass.

The Society today

One man was the undisputed leader of the Society, first as secretary and journal editor then as Director, through all the changes in broadcasting technology. The late Tom Hall, MBE, was a founding member and was, at the time of his death in 2002 at the age of 89, the only surviving member of the original far-sighted group.

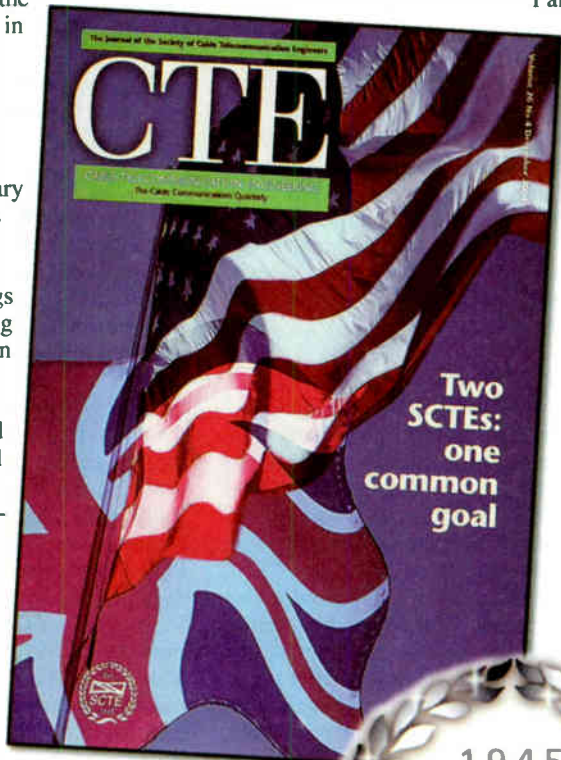

Today the Society flourishes as the principal body that looks after the interests of engineers involved in cable telecommunications, embracing telephony, cable television, data communications, optical communications and networks of all sizes. It is a partner in the hugely successful IBC, whose annual show is reported in these pages. Quarterly lecture meetings are held at the IEE in London, on the Thames Embankment, and the social calendar includes golf days, the annual dinner and various outings.

The US SCTE was modelled on the UK one, and links between the two remain strong. A Benelux

chapter was formed in 2003 and is also flourishing. Farther afield there are branches in Romania and the Ukraine. The training course was translated into Romanian in 2002, and several hundred students have already achieved passes. Translation of the SCTE journal and the training courses into Russian is under active consideration, in conjunction with the organisers of the Eastern European Broadband Convention. Farther east still, there are the beginnings of a further chapter of the SCTE in Pakistan.

The Society's website, at www.scte.org.uk carries much information about its activities, technical standards, reports of exhibitions and shows, and lecture presentation downloads.

A small shop and a membership application area are also featured.

The word 'broadband' is on everyone's lips today. In the cable telecommunications industry it involves a skill set that's increasingly important, covering the interchange of digital data, multi-channel TV, multimedia entertainment and the interconnection of people across the globe. The SCTE's members are all engineers, engaged in cable telecommunications in a technical capacity.

The Society has a voice at international gatherings where standards are evolved

and, through its publications, training, lecture meetings and social events, aims to share its technical expertise and open lines of communication with others in the industry. The SCTE has a welcome to all, from the engineer commissioning a subscriber connection to a CATV network to those who plan and operate vast global networks of submarine and land-borne systems.

Cable telecommunications has, as with all branches of electronics, seen immense changes in the technology over the past 60 years. Throughout this time the SCTE has been a major player in providing training, technical backup and sensible international standards. ■



December 2004 cover of the CTE magazine that featured the British and American societies.

LETTERS

Send letters to "Television", Highbury Business, Media House, Azalea Drive, Swanley, Kent, BR8 8HU or e-mail t.winford@highburybiz.com using subject heading 'Television Letters'.

Please send plain text messages. Do NOT send attachments. Be sure to type your full name, address, postcode, telephone and e-mail address (if any). Your address and telephone number will not be published but your e-mail address will unless you state otherwise.



Poor aerial/dish installations

The January gales damaged a lot of aeri-als and dishes in our area. So, by the end of the month, our scrapheap was quite large. Years ago the scrapheap was pre-dominantly black or dark grey but, recently, I've noticed that it has been getting more and more shiny – see Photo 1. The cause is quite simple: poor installation. Aerials used to fall down when they were old, usually because corrosion led to failure of a component. These days a lot of aerials and dishes fall down because they weren't put up properly in the first place. Badly rigged installations tend to be the first to come down when there's a gale, and their life expectancy might well be measured in months rather than decades!

Quite why aerial and dish installation standards have fallen so dramatically I don't know. It seems that as many aspects of the job have become more demanding technically some installers have forgotten the basic rules of aerial rigging. Even the simple use of a little common sense

would help. Think of a 70cm dish, and imagine how it would catch the wind on a rooftop in a gale. A strong man wouldn't be able to hold it, would he? Would you consider fixing a dish of that size at the top of a 6ft length of 1.5in. diameter mast? And that's aluminium mast with a thin tube wall, not steam pipe! Of course you wouldn't. Yet this is the sort of thing that cowboy riggers do on a regular basis. Photos 2 and 3 show some examples. Sometimes I despair of my trade.

*Bill Wright,
Rotherham.*

Noisy scan coils

A Philips TV Model 25PT4456 came in recently because of a very loud rattle that came from the scan coils – so loud in fact that its elderly owner thought the set was about to explode! The cure is simple, and doesn't involve the cost of obtaining and fitting a new yoke.

The following tip will cure most noisy scan coils. If you've tried bending, pushing, twisting etc. and the rattle persists, coming from somewhere you can't get to inside, try this. Remove the scan coils and carefully melt a couple of small holes on the inside plastic surface using the tip of a soldering iron – make sure you avoid the wires. Mix a little fibreglass resin with hardener, preferably warmed, so that it flows freely. Pour this into the holes,

then tip the coils from side to side to ensure that the mixture spreads well into the windings. Leave to set for an hour or two.

I've done this quite a few times over the years. It works a treat!
*Chris Plaise,
Swansea.*

Large-screen TV

For a number of years I watched a 28in. Philips Matchline TV set, and subsequently a Dual 28in. Nicam set. Because my eyesight is distorted, it is now a strain to watch a screen of this size. Seeing in the CPC magazine that projectors are affordable, I decided that this would be the solution to obtaining a very large picture. In addition there wouldn't be the problem of a large-screen set taking up a lot of room and being cumbersome. So, in September 2003, I bought a Sanyo PLC-SW20A projector, and have been very pleased with it.

A customer saw my projector in operation and decided that she would like one – she also suffers from poor eyesight. I obtained for her a Sanyo PLC-SW30 Multimedia projector, as this model had superseded the PLC-SW20A. That was back in January 2004. This was fine for a few months, using a VHS Nicam VCR as the receiver. The projector is at one side of the room and projects a picture about



Photo 1 (left): Bill Wright's scrapheap, showing a surprisingly large amount of shiny new metal. Photo 2 (centre): Installed last April, this mast had suffered a trying winter. Photo 3 (right): Installed just seven months ago, this was an accident waiting to happen. A pathetic attempt had been made to support the dish with guy ropes. Note that the DAB aerial is incorrectly polarised, and that the three aerials are much too close together.

6ft diagonal on to the opposite, blank off-white wall.

But at the end of October 2004 I had a phone call to say that the projector had "gone bang – just as the hammer was coming down on Big Ben!" The glass or quartz tube in the high-pressure mercury lamp had shattered. We worked out that the projector had been used for only a maximum of 700 hours, in the 'economy' mode. There were no obstructions to air flow, and the filters had hardly any dust on them. The warning 'lamp replace' yellow indicator hadn't come on.

I looked in the CPC magazine and others for a replacement lamp, but couldn't find the right type. When I phoned CPC I was told that a replacement, which is mounted in an assembly, costs over £400, about half the cost of a new projector. As the projector had a one-year warranty and had been in the customer's possession for less than ten months, I was reluctant to dismantle it. This is necessary because the tube has a wire around it to help ionisation of the mercury vapour. Pieces of this wire were poking through the metal gauze, and more might be on the PCBs. There was also the possibility of some other cause of the early failure, such as a faulty lamp-control circuit or failure of a low-voltage regulator. So I was advised to return the projector to CPC. The service is simple and efficient, using UPS for the pick up. I've used the service several times. The projector was returned in early November.

I subsequently decided to check on eBay and saw the same projectors advertised for auction, including a lamp assembly, at a good buy-now price. So I bought one and then enquired when the projector would be returned. I was subsequently told that as I didn't want a new lamp assembly fitted, which would have cost over £300, the Sanyo Service Centre proposed to charge a fee of £61-69 and wouldn't return the projector to CPC until this was paid. You can imagine what my customer would have said when told that the lamp was several times the price expected and that a charge would be made for looking at it when it was under warranty. CPC were very good however, and said that they would absorb the cost. My only complaint was that the return took some time, and I had to do some chasing. I pity service engineers who have to spend a lot of time doing this.

In the past TV sets have usually lasted for ten or more years. I gather that current large-screen sets may not, unless of the CRT type, last nearly so long. Back-projection sets probably use an LCD matrix, like a projector, and would have one or

three expensive lamps with an uncertain life time – anywhere between 500 and 5,000 hours. Plasma screens provide the best pictures and longest life but are expensive and are not guaranteed against the possibility of early failure.

LCD sets are probably going to be the best to go for, but I would like to see a system where units about 12in. diagonally fit together like a brick wall. This would enable the screen to be enlarged at a later date or, if a fault developed in one of the units, it could be replaced or repaired. The software to provide the 'bricks' with the right part of the picture exists.

When I left school I spent six weeks in the back of a radio shop helping with repairs and remember a White-Ibbotson projection TV set with 25kV EHT. I think it was black and white but, later, colour ones were produced. Does anyone know how reliable such sets were?

*Ray Throssell,
Oriol Electronics,
Horsham, West Sussex.*

Manuals via the internet

Like many readers I often have to search for service manuals. A limited number can be downloaded from the internet, but it takes quite a lot of searching to find them. I've just used the following website <http://www.getmanual.com/index.php> to obtain a CD with several Sony manuals on it. The cost was \$30 (£16.38), which I paid by PayPal. The CD took between two and three weeks to arrive, as it came from Russia. Once I had paid however I was given the option to download one manual from the CD at no extra cost. I was sent an email asking which manual I wanted and, after replying, was sent an email with a 'URL' where I was able to download the manual. The website claims to have 162,637 manuals, with more being added all the time.

You don't have to order a CD: you can just pay to download a specific manual – a small one costs \$5. You can search the catalogue free, but to buy you have to register. This is a simple matter. You can ask questions about a manual and a reply comes back within 24 hours, often much quicker.

In connection with the Sony manual I required, I was emailed the actual manual indexes so that I could make sure I received the correct one. Emails are in very good English.

David, North Wales.

DTT

Bill Wright has established his credentials with his excellent articles over the years, but I can't agree with him about DTT

reception (letters February). It's a pity he didn't use the standard CCIR picture-quality classification, because we'd then know exactly what his analogue reception was like. I don't, using a new, far-from-cheapest 32in. widescreen set with a digital comb filter and 100Hz display, recognise his description of PAL.

With a good analogue installation within the service area of a transmitter the only picture noise is that transmitted – yes one does for instance have to tell the broadcasters that they have a noisy blue channel in the newsreader camera. The blacks in my channel 1, 2, 3 and 4 pictures are just that (5 is 'out-of-area' noisy, just bearable with noise reduction but subject to co-channel effects). Thanks to the comb filter, colour bleed and subcarrier visibility at complementary-colour boundaries occur very rarely indeed. And, unlike older sets, the video doesn't vanish at about 4MHz, cut off by a simple subcarrier filter, but is displayed out to full bandwidth or, rather, the limits of the shadowmask. Nicam 10+4 bit sound is usually superb, better than FM when there's a simulcast. I did have a problem with low BBC1 signal strength when I first moved here: there are fearsome diffraction patterns that lead to quite large areas of low signal level, but big aerials and tall poles, used to try to get decent DTT reception, solved that. I grade my reception as CCIR 2 when it's at its best (more on that later), with very slight close ghosting visible when you look for it a foot from the screen.

The fundamental problem that annoys me most with analogue reception is poor transmitted quality, because of poor original material (some films seem to be played from VHS) or caused by the broadcasters' distribution systems. The best pictures are nearly always the local newsroom newsreader on live camera. The worst reception here comes from either OBs (the BBC's *Question Time* is now consistently fuzzy, though it used to be excellent from some locations) or via the link from Northern Ireland, though ITV could keep its tape heads cleaner – breakup into colour squares with analogue reception is caused by that.

DTT is fundamentally of lower definition than UK analogue. There's no point in arguing that it isn't, as the number of pixels along the line just doesn't equate with analogue TV's 6MHz bandwidth. The DTT "effects of compression" that Bill Wright finds "sometimes annoying" are to me completely unacceptable: not only are they continually visible, but they destroy dramatic effect. A stubbly-faced actor becoming clean-shaven as he moves

is totally distracting, as are moving water or tree leaves that jerk instead of fluttering, and so on (though ageing lady presenters might welcome the wrinkle removal). Bill refers to Radio 3 as "not faltering" while he was writing his letter. But a fraction of a second gap that destroys the leading edge of an orchestral climax destroys the whole work. One might as well go through the score deleting notes at random. It's worse than a mobile phone going off at a concert. The pops, swishes and ticks of LP records are unbearable in this CD age. I'm not paying to get them back. DAB is just as bad: Radio 4 in mono at 48kbits/sec! 1,500m LW neither sounds so rough nor stops, starts, coughs and spits as you walk round the room.

My experiences of the other DTT faults tally with those previously described by others, with one other problem that's caused by long-distance reflections, outside the permitted DTT time window. Mine seem to come from aircraft landing and taking off at Stanstead, in line with and on the other side of the Sudbury transmitter. Incidentally on analogue 5 (transmission directed inland, towards the airport) the reflections result in a perfect duplicate ghost that travels across and down the direct picture as the plane moves.

I must have tried nearly every 'recommended-best' box for DTT. Some are better than others. And I've spent good money with reputable aerial contractors (I'm too old for roof-climbing now). Higher transmitter powers will help, and 16QAM instead of 64 should be enforced by Ofcom. But nothing can make a silk purse out of a sow's ear – and it's a pig's ear that is being forced on us. The fact is that the system is defective.

I'm not a digital refusenik: I have always loved good CDs, Nicam is superb, and I just lose myself in the reality of a good DVD film. Something like good DVD is what DTT should provide, not a regression to below the 3MHz video of 405 lines (4.5MHz equivalent with 625 lines). Basically, it's broadcaster greed for more channels at the expense of quality (and content) and government foolishness in believing "that's money in them thar channels" that's driving DTT – and DAB.

So why did I want DTT? I thought it might avoid co-channel trouble. Most of the time my analogue TV and FM is good to excellent. But those inland would be horrified by what comes across the North Sea when the weather helps it. Even picked up on the back of the aerial, it has completely replaced the local channel

once or twice – with no sound of course. Usually the interference is to only one channel, but we have lost three completely on bad evenings. Now J. LeJeune has disillusioned me about DTT for the co-channel problem.

And, of course, what about the millions of deaf people who depend on subtitles? DTT text is at present useless. You can record the subtitles from the box on an ordinary VCR of course, but you can't then watch without them. I can't understand why the RNID tells people that there's nothing available to record 888 analogue subtitles. Hard disks and DVDR should but, sadly, don't. S-VHS does however and, if you choose your tape carefully, even S-VHS-ET can.

For goodness sake let's, for the future, abandon toastracks on chimneys and transmission towers (and the MegaWatts they swallow). Come on, Ofcom. Analogue should continue until most of the sets have died. The BBC, 3, 4 and 5 and terrestrial commercial radio must be free now via satellite. By all means let the broadcasters charge for cards for the rest, but we've paid for the BBC with our licences, and about twice that again at the supermarket checkouts for commercial radio, 3, 4 and 5 and possibly some more of ITV's offerings. The only losers will be the little pocket TVs – and TV with mobiles is here already.

*Dick Oliver,
Colchester, Essex.*

AVO meters

Eugene Trundle's article on the AVO 8 (February) made interesting reading. In my opinion the AVO 8 is the Rolls-Royce of analogue meters, having survived so long in various versions. I bought my AVO 8 Mk 2 second-hand in 1977, and it was twenty years old then! It is still giving me excellent service today, alongside my more modern DMM. For certain applications, e.g. checking transistor junctions, the AVO 8 gives more meaningful readings than a digital meter.

Some years ago I worked in the standards laboratory of a large factory, where several hundred AVO 7s and 8s were calibrated and repaired. I have seen cases where an AVO had been accidentally dragged off the bench on to the floor, the result being a broken or cracked case or cracked glass. I've also seen pointers bent like a dog's back leg on the rare occasion when the safety cut-out failed to operate. In most cases the AVO would be repaired and put back into service, unlike other makes of meter that would usually be scrapped. Any AVOs considered to be 'beyond economical repair' would be

kept in the bottom of a cupboard for use as a source of spare parts.

*David T. North,
Bolton, Lancs.*

Although I've not worked in the radio/TV field, being basically an electronics engineer, I occasionally buy a copy of *Television* when something catches my eye, such as the article about the AVO 8. When I first entered the electronics industry, in 1952, the AVO 7 set the standard for test meters. It had a sensitivity of 1k Ω /V. Then the AVO 8 came along, offering a much improved sensitivity of 20k Ω /V.

In about 1959, while teaching radar etc. at RAF Locking, one of my trainees was short of cash. He sold me his AVO Multiminor for £5, a substantial sum in those days. I still use it: only yesterday I had it out to check a fuse.

In 1961 I helped set up a section at RAF Locking to teach fault-finding as a separate subject, rather than being included in the main courses as and when possible. We set up a small production line to produce basic radio sets and radar chassis, with plug-in component boards, many of which were doctored to produce faults. In addition we collected a mixed range of actual RAF gear with faults, so that apprentices could get some exposure to the 'real' thing.

One of these was a mains-driven EHT power supply, though we never actually powered it. All fault-finding was done by nose, eye and AVO 8 (or, less acceptable, a GEC Selectest). One apprentice tackled this power supply and, having found nothing amiss by nose and eye, started to use the AVO 8 on its resistance side. Suddenly he yelped, saying he had received a shock. He couldn't say why, and the explanation provided a good practical lesson. He was puzzled because the meter used low-voltage batteries. But the transformer's secondary winding had a large number of turns, i.e. a high inductance. He had been rubbing the AVO's prods about on the transformer's dirty terminals to get a good contact. This meant that they were making and breaking contact/circuit quite rapidly. The result was a very large back-EMF, hence the shock.

In the mid-Eighties, in addition to programming, systems analysis and general trouble-shooting anywhere in the company, I was made responsible for the LAN infrastructure, which extended over several widely-spaced buildings. It had started as a current-loop system and was gradually adapted to RS232 before being superseded by Ethernet. Particularly during the RS232 phase, I had need to track

down individual CL cables, for splitting for RS232. The junction boxes could be up to 2,000ft apart, scattered through the different buildings (yes, RS232 could work over those distances!).

One JB was in the reception area, where visitors would often find me up step-ladders trying to sort out the mare's nest. They would see me tracking down individual quads and pairs with an AVO 8. Younger visitors would be slightly disparaging; older ones would comment that they hadn't seen an AVO 8 for years – "great meters, far better than those DMMs". But the AVO 8 wasn't really satisfactory for the initial tracing. It needed an audio oscillator or something similar.

I eventually stumbled on an answer – the electronics from a musical Christmas Card! I would connect the audio output to the known cable end, then go to the remote JB and probe through the pairs with the little speaker from the card until I heard the jingle. The AVO 8 was then used for confirmation.

You can imagine the reactions of visi-

tors who suddenly heard this Christmas Card jingle emanating from the speaker. You would hardly expect computer signals to sound like that! When I explained how easy it made cable identification, they would see the logic of this approach.

*Alex Dow,
Cowdenbeath, Fife.*

Line cords

I wonder how many readers remember the line cord fitted in many radio receivers in the Forties? It enabled a 110V model to work with a 230/240V mains supply, dissipating the heat safely.

I seem to recall that Radiospares sold line cords until the Sixties, but may be wrong. One engineer I knew repaired a radio with a new line cord, which the owner rather unfairly criticised because of the dangling lead. She wound the lead into a circle near the radio and said that her cat liked a warm bed to lie on! Some people would shorten the cord, with disastrous results.

I knew a couple whose long-haired cat usually slept on top of the TV set, for

Correction

In the article on cable testing last month the resistor in series with the base of the transistor in the continuity tester circuit (Fig. 4) should have been shown as 100Ω, not 100kΩ. Assuming that the transistor has a gain of approximately 60, the test current will be about 3mA.

The author comments:

The charging circuit (Fig. 1, left-hand side) would be more correctly described as a series constant-current source at input voltages exceeding 5V. It's not a 'shunt' regulator – that seems to have been an editorial slip.

obvious reasons. Unfortunately its tail would often drop in front of the screen. The owner then shouted at the cat, who had no idea what the fuss was about!

*Philip Bearman,
New Barnet, Herts.*

HELP WANTED

Wanted: Service manual or circuit diagram for the Goodmans C530 5in. colour TV receiver. Also the full IC number for the 52-pin chip IC01 in the set. Costs covered. Phone Frank Willing on 01277 374 166 (Brentwood) or email irene@rosewilling.wanadoo.co.uk

Wanted: Mechanical assembly/timing information for reassembly of the 3 x CD shuffle-deck CD-changer section (Model CD-007) of a Sanyo midi system. D. Johnson, 47 Kenilworth Avenue, London, E17 4PD. Phone 020 8523 3161.

Wanted: Can someone tell me whether the W66 EGV023X015 CRT can be replaced with a W66 EDX013X10? Are any books that give CRT equivalents and characteristics available? Please phone J. Williams on 020 7622 7762.

Wanted: Service information for the BT Contour 50 payphone and the Canon BS200BJ printer/fax machine. Phone Steve Roberts on 01687 462 189 (Mallaig, Scotland).

Wanted: Circuit diagram, including control board, for the Philco washer/dryer Model WD2002S. Also a maintenance manual for the Olivetti photocopier Model 8515 or information on where details can be found, i.e. websites etc. Email Tony Rigby at

The help wanted column is primarily intended to assist readers who require a part, circuit etc. that's difficult to obtain. Requests are published at the discretion of the editor. Send them to the editorial department – do not write to or phone the advertisement department. If you have access to email they can be sent to t.winford@highburybiz.com

113670.25@compuserve.com

Wanted: Does anyone have any spindly legs? What I need is four legs of the type used by Thorn in the late Sixties and early Seventies with their last-generation monochrome sets, i.e. those fitted with the 850, 950 etc. chassis. The ones I need are die-cast hollow metal that push on to ferrules, but the wooden ones with angled plates to splay them out would do. I need a set of legs for an Alba radiogram, and can pick them up within fifty miles of Wigan. A previous request for these produced a reply, but I mislaid the phone number. Jim Littler, 363 Atherton Road, Hindley Green, Wigan, Lancs, WN2 3XD. Phone 07990 963 918.

Wanted: Circuit diagram for the Panasonic fax machine power supply, Model KX-F3550BE. Barry Walker, 44 Aldergrove Crescent, Lincoln, LN6 0SJ. Phone/fax 01522 696 061 or email barry.walker77@ntlworld.com

For disposal: Philips VCR plus two new video heads. Free to collect. O. Stanchens, 55 Victoria Road, Shipley, W. Yorkshire, BD18 3JR. Phone 01274 595 207.

Wanted: Old half-inch diameter ferrite rods. Must be six inches or more long. Will pay very good money for them. Peter Tankard, 16A Birkendale Road, Sheffield,

S6 3NL. Phone 0114 231 6321 between 9 a.m. and 10.30 p.m.

Wanted: Back cardboard covers for the Bush TV22 and TV22A 405-line TV sets to help complete two restorations. Please phone/fax Phil Marrison on 01283 790 747 or email philipg@pgmarrison.freemove.co.uk

Wanted: Scrap PCB that has a TDA8361 or TDA8362 IC fitted, any make – Goodmans, Toshiba, etc. – LOPT not required. The board is needed for experimental use only. Post etc. paid. Also require a manual (photocopy OK) for the Philips oscilloscope Model PM8363, and a scrap one for spares. Costs paid. Jim Stone, 8 Fixby View Yard, Clough Lane, Brighouse, Yorkshire, HD6 3QS. Phone 01484 722 430.

Wanted: Quad 33, 34 or 44 preamplifiers, 405 power amplifiers and FM3 tuners for spares. Also boards and modules for these. Contact Mike on 01758 613 790.

Wanted: Meter movement for the AVO Multiminor Mark 4. Also a circuit diagram or good photocopy for the Taylor 127A multimeter, and details of the type of batteries used in this model. Please phone Reg Bolton on 02841 762 560 any time after 7 p.m. from Monday to Friday.

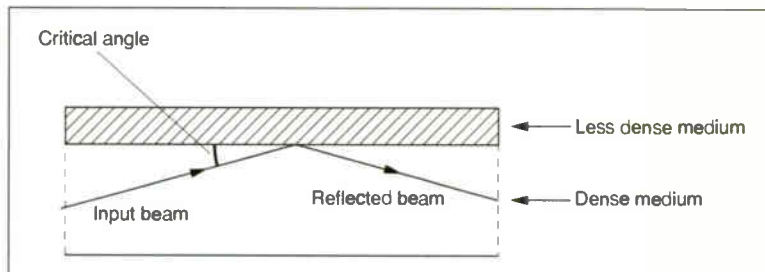

Fig. 1: Principle of total internal reflection.

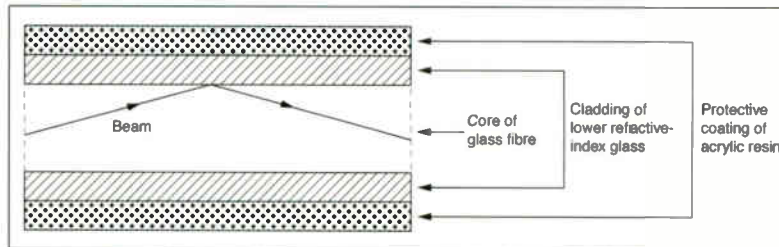

Fig. 2: Construction of an optical fibre.

Signal distribution via optical-fibre cable

Distribution of signals via optical-fibre cables provides huge bandwidth and signal capacity. K. Rutherford takes a look at the technology involved

Optical-fibre communication is based on modulation of a coherent light beam that's obtained from a semiconductor laser. The output from the laser is modulated, coupled to an optical fibre, then propagated along it by what is called total internal reflection. This occurs at the boundary between the fibre's core and its cladding. These have marginally different refractive indexes – as little as one per cent.

When light passes, at a certain angle, from one transmission medium to a less dense one there is total reflection of the light. Optical fibres are constructed to make use of this effect. The point at which total reflection occurs is called the critical angle. Fig. 1 illustrates the beam reflection action graphically. This internal reflection traps the light beam within the fibre's core, by deflecting it back into the denser medium from the boundary with the less-dense medium. Modulated light can in this way be transmitted over tens of kilometres without the need to amplify or re-transmit it.

Two bands are in use for optical-fibre communication, 1,310 and 1,550nm. The longer wavelength provides longer transmission paths, because the attenuation contributed by the fibre is less. Use of wavelength division multiplexing enables optical beams of slightly different wavelength to be transmitted along an optical fibre – it's similar to feeding several RF signals at different frequencies along a coaxial cable. Optical fibres can be branched to send a beam in two directions, or a small amount of optical energy can be extracted and fed to equipment for local distribution or monitoring. In fact the same things can be done with optical signals as with RF ones. Fig. 2 shows the basic construction of an optical fibre.

Optical transmitters

An optical transmitter consists of a source of coherent light that's modulated by RF signals. These may come from an RF cable TV network's head-end, at frequencies up to 860MHz. For telephony, the individual voice-frequency channels are modulated on to carriers that are stacked up and applied to the optical transmitter, in much the same way as the channels are in a cable TV system. Theoretically they could share the same fibre, but in practice this is not done.

Two types of semiconductor laser transmitter are in use. In both, photons are generated mainly by stimulated emission. The recombination of electrons and holes in the semiconductor material generates photons (this is spontaneous emission). Above a certain threshold, these photons generate additional ones by stimulation of extra recombinations. Pumping the active layer

of the semiconductor device with a high current produces a beam of coherent light, i.e. one with a very narrow spectrum.

On its own, this light output would be of little use. The addition of an optical resonator however amplifies the relatively weak light output from the semiconductor wafer. The resonator consists of two semi-transparent mirrors: as the light beam oscillates back and forth between the mirrors, the optical equivalent of positive feedback takes place. The laser beam that passes out through the end mirror is coupled to the fibre by a special conical tail of fibre material, to match the laser beam diameter to that of the optical fibre.

The laser in a distributed feedback (DFB) transmitter is modulated directly by the RF signals from the network or head-end. Linearity is achieved by careful setting of the laser diode's operating current, and by pre-distorting the RF modulation signals. DFB laser transmitters normally provide a power output in the range 8-14mW.

A yttrium aluminium garnet (YAG) laser is operated as a CW source and must be modulated externally. Fig. 3 shows a YAG laser modulation system. The electro-optic modulator has a single input and two outputs. Unfortunately, the transfer characteristic is non-linear to the point of being a sinewave shape. Biasing the modulator at the mid-point of its characteristic drastically reduces combined second-order distortion but, as the characteristic remains compressive, feedback is used to reduce the excessive combined triple beat distortion to an acceptable level. The feedback loop

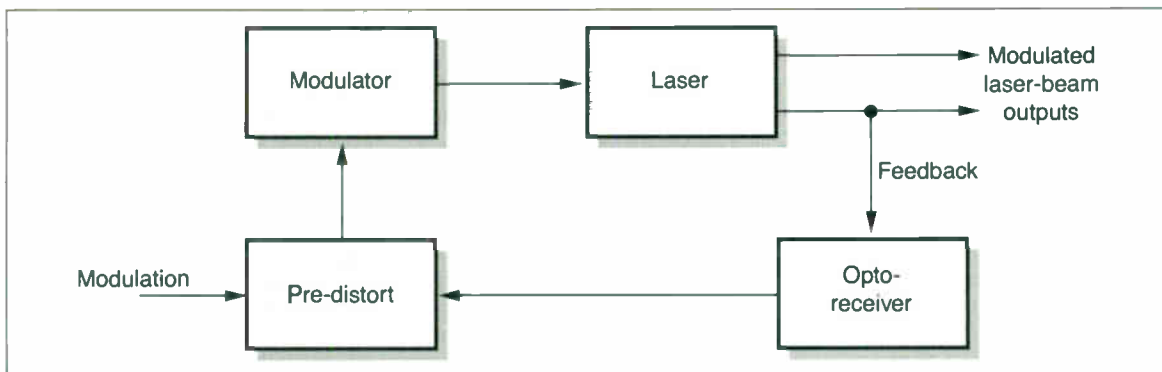

Fig. 3: Basic block diagram of a YAG laser modulation system.

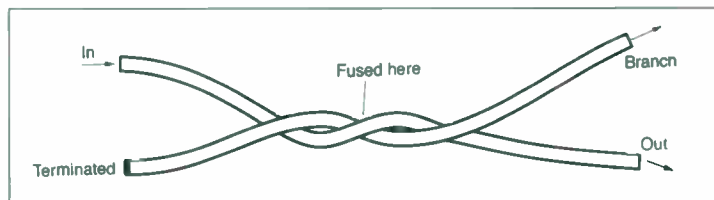

Fig. 4: An optical-fibre coupler/splitter.

includes an optical receiver/monitor to demodulate the beam, the retrieved modulation being used as a form of negative feedback. A YAG transmitter provides two outputs at about 20mW.

Laser transmitters include monitoring circuits to regulate the RF drive amplitude, the temperature and to shut the device down if an output is left without a termination. The monitoring facilities are integrated into the network management system, permitting remote supervision of active elements in the network.

Loss budget

An optical-link loss budget defines the distance between an optical transmitter and the point at which the transmitted beam has fallen to its minimum usable level, in other words the reach of the link. In terms of kilometres, it will depend on the attenuation introduced by the cable and the losses introduced by any couplers, splitters and splices used.

Those involved in planning runs of optical-fibre cable also have to make provision for any future modifications to the link, including splices and couplers.

The loss budget also depends on the channel loading at the transmitter. An increase in the loading will require an output-power reduction in order to maintain a low distortion level. This has a direct effect on the carrier-to-noise ratio of the link unless the level at the end can be maintained.

A typical loss of 0.35dB per kilometre would give a distance of about 42km, provided there was a straight run with no splices, and a link-loss budget of 15dB. This is obviously impractical: manageable lengths of cable have to be spliced together.

Splices

Splicing optical-fibre filament is a matter of joining two strands of glass fibre together to form one continuous piece. The process is tricky, but modern tools make it fairly simple. The best form of splice with the lowest through-loss is the fusion type. This involves fusing together the two neatly cleaved ends of the fibre in a small furnace: an electric arc is used, and the process is automated as much as possible. As with all splices, the ends of the fibres have to be cut or 'cleaved' so that they are as flat as possible, and within one degree of a right-angle between the mating surface and the fibre wall. The ends to be fused are cleaned rigorously and then aligned under a microscope that's part of the fusion splicer. The ends are butted together and, in some splicers, can be rotated to achieve the lowest through-loss. The butt-joint is then preheated to burn off any remaining contaminants, after which the main heat is applied to fuse the ends together. To prevent excessive light leakage, the completed splice is protected by a small sleeve and fitted into a plastic tray. One tray can hold several spliced fibres, and several trays can be grouped together in a waterproof housing to make a convenient junction box.

Mechanical splices do not go as far as fusion of the prepared ends of the fibre filament. Instead, a stable mechanical frame holds the ends together in close contact. A gel that has the same refractive index as the core is sometimes used to reduce the through-loss.

Polishing the cleaved ends helps to reduce through-loss and optical alignment of the ends before

clamping in the splice frame, further reducing the loss to about 0.15dB.

Splitters and couplers

Signals can be extracted from a fibre by use of an optical coupler or splitter. A splitter will divide the beam equally between two outputs at slightly less than half the power of the input. A coupler will extract a smaller proportion of the beam energy for feeding to an optical amplifier or a receiver/demodulator. Both devices are formed of strands of fibres that are closely aligned alongside each other or twisted together and fused. Fig. 4 shows the basic idea.

Optical receivers

An optical receiver uses a photodiode, which is biased at its most linear point, to detect the light beam and recover the original modulation. With a cable TV system the output of a receiver is a band of RF signals, from 60-860MHz, that carry the radio and TV channels. This can then be distributed to subscribers' homes via an on-going copper-cable network.

A pin photodiode is generally used, followed by a low-noise broadband RF amplifier. The optical input power is normally 0dBm \pm 2dB, and is monitored by a micro-processing section with interfaces to the network management system. This enables the status of the optical receivers to be monitored from a central point, and can assist with the location of problem areas in a network.

Optical-fibre cables

Optical cables consist of a bundle of fibres, sometimes with two dif-

ferent types of fibre for different applications. Multimode fibre can be used for telephony and local-area networks. It has a typical inner core diameter of 50-100 microns. Several modes of propagation can take place within it. This has the disadvantage of parallel propagation of data in more than one mode at the same time. Since these parallel paths have different propagation times the pulses will, on arrival, be blurred. The result is a poor bit error ratio (BER) at high data rates. Multimode fibre is widely used for telephony, CCTV surveillance and small local area networks however.

As its name implies, single-mode fibre propagates light in one mode only. So it has a higher bandwidth, which makes it suitable for CATV and high-speed data applications. The fibre has an inner core of only 8-10 microns. Its lower refractive-index cladding increases the overall diameter to about 120 microns. An outer coloured acrylic sheath completes the cable, which has an outer diameter of 250 microns – the colour is for identification. The refractive index of the outer fibre coating is high, so it traps and removes any

modes of propagation within the cladding layer. This is referred to as cladding-mode stripping.

When a fibre is bent, light is lost as it escapes from the core. This effect is used in optical splitters and couplers and, in splicers, for the injection and extraction of light for alignment purposes.

Cables are available with a mixture of propagation modes, and in a variety of fibre numbers and groupings, to suit the application. The single-mode fibres are most vulnerable and are grouped around a central steel cable core – there are often eight or sixteen of these fibres. Around them there are further bundles of fibres for telephony, CATV return paths and supervisory applications. The outer casing is often reinforced with steel wire, and a tough plastic is used to resist water, acid and rodent attack.

The cables are placed in ducts of plastic piping, normally under ground, but in some parts of the world they can be seen strung from poles by a catenary wire.

Safety

Workers in the optical-fibre commu-

nications industry have to protect themselves against two possible sources of danger. The filament of glass that forms the fibre is extremely small and can easily penetrate the skin. Anyone who has handled fibreglass loft insulation will know of the irritation that's caused when a single filament gets into a finger. Most telecommunications companies have simple offcut containers that they supply for use where work on fibres is carried out.

The second source of danger is from the end of an active fibre. Safety goggles with infra-red filtering must be worn when dealing with illuminated fibres, though most companies lay down that no work should be done on them. The highly-concentrated beam of intense and invisible light can injure unprotected eyes. For safety's sake it is always assumed that the laser equipment in use is Class 3b and therefore dangerous. It is prudent to check every fibre for activity, using an optical power meter or detector card. Rigorous rules are in force, and a procedure that involves a master key which operates a shut-down control system is in use.

Do you want a deeper knowledge of circuits & electronic systems?

Then take out a subscription to **Electronics World**

Every month you will receive details on what's new in electronic circuits and associated equipment. We will keep you up-to-date with the latest research, technology, applications, products and theory in areas such as audio, RF, components, CAD design, simulation software, PC and micro-based products.

Your subscription includes:

- 12 magazines a year sent to your office or home
- Money saving offers on components and equipment

Each issue is packed with:

- Electronic design solutions
- Electronic applications
- Circuit diagrams
- Industry comment

Risk-free offer

As a subscriber we offer you a money-back guarantee. So you may cancel at any time and receive a full refund on all unmailed magazines.

SUBSCRIBE NOW!

COMPLETE AND RETURN THE FORM OPPOSITE



Subscription Order Form

Yes - I would like to subscribe to Electronics World for:

- 1 year at: **£38.95 (UK)** **€95 (Europe)** **US\$125 (Worldwide)**
 2 years at: **£70 (UK)** **€170 (Europe)** **US\$225 (Worldwide) save 10%**
 3 years at: **£94 (UK)** **€225 (Europe)** **US\$295 (Worldwide) save 20%**

Three Ways to Pay:

- Invoice my company
 I enclose a cheque payable to Electronics World

Charge my: Visa Mastercard Amex Switch Delta

Issue No. (Switch/Delta) Expiry date /

Name:

Company name:

Address:

.....

Postcode:

Telephone Number:

Fax Number

Email:

- Please tick here if you are happy for us to contact you by email

Post to: Debbie Jenner, Freepost SEA 11435, Electronics World, Media House, Swanley, Kent BR8 8BR (no stamp required) UK only
OVERSEAS SUBSCRIBERS please send to: Debbie Jenner, Electronics World, Media House, Swanley, Kent BR8 8BR, UK.

- If you prefer not to receive promotional mailings from other companies, please tick box

Ref: 125

Service Casebook

Michael Maurice



Bush 2768NTX

There was sound but no picture with this set, which I suppose made a change from the usual dead set with a ticking noise. Checks showed that the 2SC1753A line driver transistor was the cause of the problem. It had to be obtained to special order: no one stocks it locally, and there's no equivalent.

Sanyo CE32FWN2

This set appeared to be dead, with the LEDs flashing green and red alternately. It didn't take long to establish that there was virtually no output from the 8V regulator chip. The IC itself was at fault, a replacement restoring normal results.

Grundig CUC120 chassis

It's not often that I get a call to an old-timer like this. But it had gone off during a thunderstorm, and its elderly owner wanted it to be repaired. I found that the BU208 chopper transistor had failed, so I decided to replace it along with the electrolytic capacitors in the power supply. But the set just ticked when it was switched on. I then found that the HT rectifier diode had also gone short-circuit. A replacement restored normal operation, and the picture was very good. This set must be at least 23 years old.

Sanyo CE28WN5

It is always nice when customers come back to you, especially when you learn that they've had an unfortunate experience in between. The last time I visited this one, on a recommendation, the problem had been with a Sharp set fitted with the CS chassis. I was able to repair the set by replacing several capacitors in the power supply. The next call came while I was attending a friend's function abroad. As the customer wanted a new set tuned in urgently, he called in the local cowboy who, apparently, messed things up. This time I was called when his Sanyo set needed attention – it was dead.

It took little time to discover that the secondary winding of the transformer in the standby power supply was open-circuit. I ordered a replacement transformer, which arrived a couple of days later: once it had been fitted the set sprang to life. Another satisfied customer!

Mitsubishi CT2553STX (Euro 4Z chassis)

These sets were solidly built and produce excellent pictures. But they suffer from three problems: leaky electrolytic capacitors; Japanese Evostick that becomes hard and conductive; and dry-joints in the tuner.

The first fault I had with this set was par-

tial field collapse, to some extent because of those capacitors. I replaced several in the field output stage and around the regulators, but the real cause of the trouble was that the Evostick-type adhesive had been used around the TDA2579A sync/deflection generator chip IC501 and was causing havoc. It took some time to clean it off thoroughly, but this cured the fault.

Two weeks later I was called back because there was no sound or vision via the tuner, AV operation being OK. The cause of the problem was the standby transformer, where the same glue had corroded the secondary winding that provides the -30V supply for the memory. The transformer is no longer available, so I had to repair it. When I removed it I could see where the wire that goes to the pin had been corroded. There was enough of the wire protruding to be able to solder a strand of wire between it and the pin. This worked, and the delighted customer was once more able to use the set properly.

These sets are now 15-16 years old. I wonder how many of today's new sets will be around in 2020?

Philips 32PW9763

A nice easy one for a change. The symptoms, from switch on, were an arcing noise, a totally defocused and dim picture for a few seconds then standby. The cause was that a previous repairer hadn't refitted the EHT cap correctly.

Decca CV1371 (130 chassis)

This was another old-timer. The complaint was poor field sync from cold. Fortunately the set was cold when I called to see it, and heating up the area around the sync/deflection generator chip produced stability. The fault was cured by replacing C402, C403, C406 and C407.

Wharfedale 550S

The usual cause of a burning smell from one of these sets is a faulty on/off switch. This, in turn, is normally because of a dry-joint. But with this set the line output transformer was arcing over. I replaced it and, for good measure, the switch.

Hitachi C2558TN

The complaint with this set was intermittent poor pictures and sound. The first thing I did was to replace C931 (220 μ F, 200V), C932 (1,000 μ F, 16V) and C933 (2,200 μ F, 25V), which are all reservoir capacitors on the secondary side of the chopper power supply. After that the set was stuck in standby! It's not easy to trace the print on these boards, but I eventually discovered a hairline break in the 8V supply.



DX and Satellite Reception

Terrestrial DX and satellite TV reception reports. The tsunami. Illegal equipment? Broadcast and satellite TV news. Fringevision's Band I aerials. The wavefront tilt effect. Roger Bunney reports



*The ABC News Colombo feed (NTSC) via Europe*Star (45°E).*

A rather bleak January to start 2005, and a very bleak period for reception. High pressure during the middle of the month (15-16th) lifted tropospheric propagation, with reception from France, the Benelux countries, Germany and, just, Denmark, in Band III and at UHF. With the rapid move to DTT in Germany and the closure of the analogue transmitters there, conventional DX reception from that country is becoming a rarity. There was at least some Sporadic E reception: Tele A (Italy) ch. E2- on the 3rd, and short-duration, unidentified ch. E3 programming on the 1st and 15th. There was strong auroral activity on the 21st, with reception from NRK (Norway) ch. E2, RAI (Italy) ch. IA and unidentified programmes in chs. R1 and R2. My thanks to Cyril Willis and Peter Schubert for reception reports that lifted the gloom slightly!

VHF DTT

Now that VHF DTT is established in parts of Europe, how can we receive it? In the absence of VHF digiboxes, could we perhaps feed the IF output from a standard VHF DX-TV tuner to a UHF upconverter with the output from this fed to a standard UK Freeview box whose input is tuned to the upconverter's output? I'd be interested to hear from anyone who tries this or any other approach.

The tsunami

Bandula Gunasekera, a long-standing reader and pioneer satellite enthusiast in Sri Lanka, has sent me an email describing the effects of the 30-50ft high waves that swept up to 2km inland on Boxing Day. He has seen flooding before, but never the sea overflowing. Fortunately he lives just far enough inland to have escaped. I've also had an email from Sam Arajeewa, another old friend, with whom I worked at TVS and Meridian. He had retired to Sri Lanka and built a house on the shoreline.

While reading a newspaper on December 26 he noticed that two normally uncovered rocks about a quarter of a mile offshore were covered. Minutes later the rocks and the reef, which had never been seen before, were exposed. A little later the rocks were covered again then reappeared, with the sea retreating to perhaps double the depth of the beach. Having watched a BBC documentary a few years back, Sam realised that this could be a tsunami. He and his wife made a quick departure but the sea returned at great speed: by the time they reached the gate it was crashing through their neighbour's garden. They ran with many others along a narrow road and managed to reach high ground. Next day he returned to debris and wreckage 4ft deep. His house, built on brick pillars, was safe but many of his relatives, neighbours and friends have disappeared. Sam mentions that local radio stations had warned about tidal waves, though most people ignored the warnings.

One of the emails included photographs that show the true horror of the disaster.

Satellite sightings

During late December and early January there was much reporting on the aftermath of the tsunami. A number of broadcasters established uplinks in the area, time-sharing the facilities with others. All three major US networks sent units to Sri Lanka, linking back to Europe via Europe*Star (45°E). ABC News Colombo was first to set up a news operation, which sent reports at 11.484GHz V (SR 5.632, FEC 3/4). A few days later NBC appeared as Sri Lanka 1 at 11.578GHz V (3,199, 7/8) and CBS News Galle appeared at 11.598GHz V (5.632, 3/4). These were all 525-line NTSC transmissions. For several nights veteran broadcaster Dan Rather presented live reports from the seashore for the CBS New York news programme.

Sky News based a reporting unit at Galle but used a flyaway Newslink terminal, transmitting at 11.537GHz V (3,199, 3/4). A Colombo Path 1 carried reports for several broadcasters, including ZDF and Australian stations, via Eutelsat W1 (10°E) at 10.967GHz V (4,167, 7/8). There were at least six permanent

feeds via Eutelsat W3A (7°E). EBU-Reut-Colombo, TV and NL.USSD14 used individual frequencies while a multiplex at 10.985GHz V (13,328, 7/8) carried Phuket-U19, Non E/S Path 1 and Cat_Sng Thailand.

Europe*Star, which is normally a very quiet satellite, has been busy with material from South Africa. Moto GP S-Africa transmitted interviews on Aids and the death of Nelson Mandela's son, who had just died from the condition. The funeral was on the following day, January 7. There was coverage of this, further news reports and a live report for BBC News, signing as GlobeCast Africa. A few days later in a happier vein Telemedia SNG carried an Ajax Cape Town v. Ajax Amsterdam football match from 1800 hours GMT. These transmissions were all at 11.525GHz V (5,632, 3/4).

Channel 4 in the GlobeCast multiplex at 11.016GHz H (20,145, 3/4) via Atlantic Bird 1 (12.5°W) gave us a preview of the latest revolution in motor transport when General Motors revealed, to a large and enthusiastic gathering of US automobile media people in Detroit, its GCV – Graphite Concept Vehicle. This was described as a two-mode hybrid vehicle, powered by hydrogen cylinders with an on-board computer to control power, steering, braking and other functions. Outwardly it looks like a conventional 4 x 4 Jeep.

Best wishes to Edmund Spicer (Littlehampton) who has had health problems in recent times but is now recovering – he was nevertheless able to maintain his voluntary work at Chichester Hospital Radio (CHR). Edmund reports that the Israeli satellite company R.R.Sat runs its programme distribution business via Hot Bird (13°E) at 11.013GHz H (27,500, 3/4). At times the multiplex carries news/sports feeds as well as programming. The multiplex at 10.992GHz V is also operated by R.R.Sat. He has seen Ocasional 1 and Ocasional 2 with Telefonica PM5544 test cards at 11.221GHz H (27,500, 3/4), so check for Espana feeds etc. here. GlobeCast 1 and GlobeCast 2 have appeared at 12.597GHz V (27,500, 3/4) but are not the same as GlobeCast via Atlantic Bird 1.

There was great excitement in Mid-January when pictures were transmitted back to Earth from the Explorer module after its landing on Titan, one of Saturn's moons. European Space Agency (ESA) feeds were carried via Astra 1 (19.2°E) at 10.832GHz H and 12.522GHz V (both 22,000, 5/6) and also Eutelsat W1 (10°E) at 10.967GHz V (4,167, 5/6).

Jordan is uncomfortably wedged between Israel to the west and Syria, Iraq and Saudi Arabia along its other borders. The previous and present King Hussein have both managed to steer a path of relative peace in this troubled area. On January 16 Service 1 carried an interview with the present King for over 90 minutes after 1800 GMT. This was carried by Eutelsat W1 (10°E) at 11.081GHz V (5,632, 3/4). Various political matters relating to the area were discussed, but the sound quality was peculiar. It resembled that provided by a stand microphone positioned at a distance sufficient to produce a low-level, 'open' echoing sound, totally unacceptable for modern broadcasting. The same quality was present when I checked the other sound options, such as LH, RH, mono etc.

Eventually Service 1 closed down, but I inadvertently left the receiver running at 11.081GHz. At about 1945 hours colour bars and the identification WWW.PACTV.COM appeared. This changed to Pacific Television Center with a London phone number. At 2000 hours the Golden Globe Awards appeared live from Los Angeles, with various film personalities and general glitz. During the preliminaries a live two-way interview was conducted with Sky News.

Another annual event, the Fina Swimming World Cup Series from Stockholm, appeared a few days later on the 18/19th. This was via Telecom 2D/Atlantic Bird 2 (8°W) at 12.638GHz V (13,328, 7/8), starting at about 1800 each day.

Finally John Locker (Wirral) has sent by email a dramatic picture (see accompanying photograph) of the Astra 1 orbital position at 19.2°E, taken telescopically. The main group of satellites can be clearly seen at the right-hand side. To the left there's another, slightly brighter satellite – Astra 1B. It appears to have wandered from the rest of the Astra 1 group. The sunlight reflected from



The Astra 1 slot at 19.2°E, photographed by John Locker (Wirral) with the aid of a telescope. One of the satellites, 1B, has wandered well away from the rest of the group.

1B's solar panels makes it look brighter but, as it slowly tumbles, it dims and the other ones in the group are then brighter. SES Astra maintains that the satellites at this orbital position are all under control, but one can't help wondering about 1B. For more information, check at John's website <http://www.satcom.freemove.co.uk/geos.htm> where you will find many other pictures and animations relating to the 19.2°E slot.

Illegal equipment?

An interesting item appeared recently at an internet site after the Pentagon had agreed to the use of the 390MHz spectrum for radio-communications within military bases in the US. It appears that this frequency is also used extensively by low-power devices such as automatic gate and garage-door openers, and it has been suggested that the users of such equipment in the vicinity of a military base (at a range of possibly up to ten miles) could suffer from interference and incorrect operation. *The UK Scanning Directory* reveals that this frequency is allocated to military use in the UK, by both the RAF and the USAF. The massive current importing of electronic equipment of various types from the Far East suggests that 390MHz may now be in illegal use in the UK.

Broadcast news

France: The ERPs of all the main TDF analogue transmitters in the UHF network have been reduced. The 1MW transmitters are running at much lower powers, for example Lille is down to 490kW and Paris channels TF1, TF2 and TF3 are running at 215kW. A Band III DTT transmitter for RTL Luxembourg is now operating in ch. D7 at 20kW H; another transmits in ch. D41 at 2kW.

UK: The Solent TV RSL station that went off-air in mid-October following destruction of the aerial, feeder and transmitter by a lightning strike is now back in operation. The new, slightly higher-powered ch. 54 H transmitter has been on test on a 24-hour basis since about January 12, with rolling publicity material interspersed with local news at regular intervals. Full programming was due to resume on January 31.

South Korea: Samsung has developed a new digital TV receiver chip, type S5H1406, that can differentiate between the wanted and unwanted signal under difficult reception conditions, such as a built up area with blocks of flats where signal reflection (ghosting) is high. Where there are multiple signal paths, the new IC selects the one that gives best-quality reception.

The Netherlands: The Dutch Culture and Media secretary has

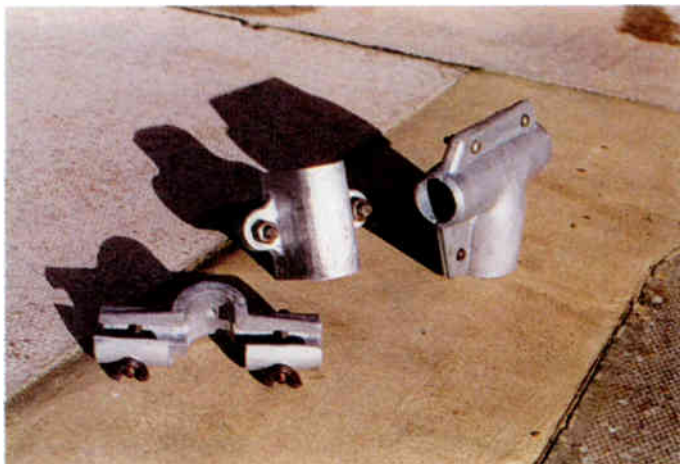

Fringevision aerial clamps, unearthed after some 45 years. The mast-to-boom clamp, right, was also available with a 6° upwards tilt, to compensate for the wavefront-tilt effect.

decided that broadcaster AVRO, along with certain others, must retain its public-service broadcasting remit until at least 2008, when the request to go commercial will be reconsidered. AVRO had been seeking commercial backing for its operations.

Satellite news

At the recent Las Vegas CES exhibition US satellite broadcaster DirecTV demonstrated the world's first live MPEG-4 HDTV transmissions, as a prelude to the start of full-time HDTV transmissions later in the year. Use of the new AVCV/DVB-S2 compression mode makes it possible to reduce the bandwidth required for an HDTV service. DirecTV's MPEG-2 service will continue for standard-definition TV, but conversion to MPEG-4 is likely by 2008, when DVB-S2 will become the standard compression mode. As HDTV expands over the next few years DirecTV will be using four Ka-band satellites for HDTV delivery.

The Sirius satellite radio service in the US has become affordable with the launch of the Pioneer SIR-PNR1 radio, which is selling for about \$120 including the aerial. The Sirius service provides 65 free commercial music channels and 55 channels devoted to sport, news, weather etc. In total some 120 radio channels are available for a monthly subscription of \$12.95.

In Europe Sirius means the 5°E slot. Lockheed-Martin has been awarded the contract to construct Sirius-4, which should be ready for launch in the summer of 2007. It will provide backup for the other Sirius satellites, improve the coverage across eastern Europe and Russia and add a Ka-band downlink footprint across the Baltic/Scandinavia region. Further tasks are to provide a Saharan beam to complement Astra 2B coverage in that area and to support the future launch of Astra 4A craft in the Ku and Ka bands.

Bad news for Intelsat whose IS804 satellite (174°E) expired at 0532 hours EST on January 4 as a result of electrical power failure. This means that it's a total loss. Other Intelsat craft are being used to make good its customers' loss of communications across the Pacific region.

Fringevision

During the Christmas break I needed to check through a large box of aerial clamps, U-bolts and various bits and pieces of hardware that had accumulated over the years. At the bottom I found relics of my very early days of TVDXing and aerial construction. While not yet suitable for eBay disposal, these historical components nevertheless reflect all that was good when the 405-line network was expanding.

Many small companies were turning to aerial manufacture – once an acceptable design had been adopted, a VHF aerial was simple to construct. If you look through copies of *Practical Television* published in the early Sixties you will see advertise-

ments for Band I and Band III aerials that were available from a number of companies. Some of them, such as Maxview and Antiference, survive to this day. Others, such as Wolsey and Labgear, are now manufacturing distribution equipment. Aerialite of Congleton, Cheshire is no longer with us.

In the late Fifties/early Sixties Fringevision, of Elcot Lane, Marlborough, Wiltshire, diversified from metal fabrication into the manufacture of Band I/II/III aerials, and was happy to supply aerial components to other manufacturers and enthusiasts alike. An early catalogue dating from about 1962 shows a vast range of aerial clamps, element clips, rubber insert element-to-boom clips to minimise Band I element hum, masthead/boom mounting clamps and even shorting clamps to create folded dipoles.

I found several unused 45 year old cast alloy components from this range in my box. The accompanying photo shows, left to right, a simple Band I element clip for 1in. boom to half-inch aerial element; a vertical mast-extension clamp (two of these would be required to bolt an extension mast safely); and a masthead/boom clamp for a 2in. mast to 1in. boom. A clamp of the latter type cost 8s 9d (about 44p). Complete aerials were also supplied. The Senior Band I aerial with three elements and 'T' match was priced at £9.10s.0d (£9.50) for the channel 1 and 2 versions, slightly less for the channel 3, 4 and 5 versions. The highest gain four-element Senior cost £10.5s.0d (£10.25) for the channel 1 and 2 versions. A two-element in-line aerial "to receive the new BBC/FM station at Wrotham on the 90Mc/s band" cost £2.5s.0d. The Band III Yagi aerials were really solid British engineering: a five-element array with cranked mast and (wall) bracket sold for £3.0s.0d. You paid £3.17s.6d for a ten-element channelised Band III "head only" – the chimney bracket and mast cost an extra £1.

As ITV opened across the country, many viewers simply bought an outboard 'ITV converter' that accepted Band I and III inputs and converted the latter to the local Band I channel, with switch selection of BBC or ITV – hopefully with no direct BBC breakthrough via the connecting cable! Fringevision was one of the few manufacturers that produced Band III add-on aerials, consisting of two or three elements that were clamped on to and around the main Band I aerial. This was a compromise that was suitable only in areas where there was a strong local Band III signal.

Wavefront tilt

Can anyone offer a brief explanation of 'wavefront tilt'? Fringevision's three- and four-element Senior Band I aerials were offered with an alternative masthead bracket that provided a 6° upwards tilt which, the company explained, "is desirable in extreme fringe areas to help counteract wavefront tilt". You paid an extra 3d (1.5p) for the upwards tilting bracket!

Telerection, a large aerial company that was part of the Thorn group, created a classic range of Band I aerials. The three- and four-element, delta-matched Multimus range of Band I aerials also featured a significant upwards tilt. The remains of some of these aerials can be seen even today. In fact there's an intact one for channel 5 (B5) on a chimney at Swanage, aimed hopefully at Wenvoe – where channel 5 closed down over twenty years ago!

When I checked the internet there were over 18,000 entries on waveform tilt. Many were related to military applications, and I couldn't find a clear explanation. So I consulted our aerials oracle Bill Wright who suggested, based on recollection from the dim past, that it was something to do with ground conductivity. Apparently some ground conditions can cause a phase error between the wave propagated in the air and ground currents. The result is a tilted wavefront that's received most efficiently when the aerial is tilted to match. The wavefront tilts forwards in the direction of propagation, so an aerial will produce maximum output if it's tilted upwards slightly. The effect is greatest when an aerial is one or two wavelengths above ground level, which was very often the case with a Band I aerial. Bill suggests that tilting relates to vertically-polarised signals only. Every microvolt counted when you were using a Cyldon turret tuner with a PCC84 RF amplifier!



Reader offer:
x1, x10 switchable
oscilloscope probes,
only £21.74 a pair,
fully inclusive*

*Additional pairs as part of the same order, only £19.24 each pair.

Seen on sale for £20 each, these high-quality oscilloscope probe sets comprise:

- two x1, x10 switchable probe bodies
- two insulating tips
- two IC tips and two sprung hooks
- trimming tools

There's also two BNC adaptors for using the cables as 1.5m-long BNC-to-BNC links. Each probe has its own storage wallet.

To order your pair of probes, send the coupon together with £21.74 UK/Europe to **Probe Offer, Caroline Fisher, Highbury Business, Media House, Azalea Drive, Swanley BR8 8HU**

Readers outside Europe, please add £2.50 to your order.

Please supply the following:

Probes

Total _____

Name _____

Address _____

Postcode _____ Telephone _____

Method of payment (please circle)

Cheques should be made payable to Electronics World

Access/Mastercard/Visa/Cheque/PO

Credit card no _____

Card expiry date _____ Signed _____

Please allow up to 28 days for delivery

Specifications

Switch position 1

Bandwidth	DC to 10MHz
Input resistance	1MΩ – i.e. oscilloscope i/p
Input capacitance	40pF+oscilloscope capacitance
Working voltage	600V DC or pk-pk AC

Switch position 2

Bandwidth	DC to 150MHz
Rise time	2.4ns
Input resistance	10MΩ ±1% if oscilloscope i/p is 1MΩ
Input capacitance	12pF if oscilloscope i/p is 20pF
Compensation range	10-60pF
Working voltage	600V DC or pk-pk AC

Switch position 'Ref'

Probe tip grounded via 9MΩ, scope i/p grounded



AUDIO FAULTS

Reports from
Chris Avis
Geoff Darby
Chris Bowers
and
Philip Rosbottom

We welcome fault reports from readers – payment for each fault is made after publication.

Reports can be sent by post to:

Television Magazine Fault Reports,
Highbury Business,
Media House,
Azalea Drive, Swanley,
Kent BR8 8HU

or e-mailed to:
t.winford@highburybiz.com

NAD 3020B

At switch on there was a loud hum that faded out slowly to leave normal operation. Scope checks during the brief presence of the fault showed that a large ripple was present around the muting FETs Q509 and Q510. These are powered by a $-62V$ supply that's obtained from a voltage-doubler arrangement. Checks here revealed that C533 ($47\mu F$, $50V$) had a high ESR which gradually reduced as the operating temperature rose. C.A.

JVC CA-D672

The owner said he had been wiggling the headphone plug to get a headphone signal but there was now no speaker output. Easy-peasy I thought: go straight to the headphone socket soldering, which was badly cracked of course and, my lucky day, accessible without removing the front panel with its dozens of screws. Just resolder, connect up, switch on and wait for the sound of music.

Unfortunately it was the sound of silence. I then discovered that the owner's earlier gymnastics with the plug had succeeded in leaving a broken tip stuck down the end of the socket, operating the mute contacts permanently. It would have taken time to obtain a replacement socket, and neither I nor the owner wanted the job to be delayed. So it was time for the mother of invention.

As it was impossible to pull the tip back out through the front of the socket, I removed and tediously dismantled the front panel to gain access, eventually, to the headphone socket board. I removed the socket, carefully drilled a small hole through the back, and used a small screwdriver to push out the remains of the plug. Resistance checks on the socket showed that the internal connections had not been damaged and that the important mute contacts were OK. After reassembling everything I tried again. This time I was rewarded with music to my ears. C.A.

Pioneer XC-L11

There were two reported problems with this unit. First, that it suffered from odd, intermittent powering down. The usual cause of this is the capacitors in the VFD supply inverter, which is located behind the square connector that goes out to the display panel at the top of the system – I've described the problem before. In this case the capacitors read OK when checked with an ESR meter but the inverter transistors, which run quite hot, were badly dry-jointed. So I treated them to a rework, using fresh solder.

The other problem was that the 'feather-touch' controls for open/close and

play/pause intermittently lost their sensitivity. They are for 'finger-brush' operation rather than having any moving parts. The sensing contacts are part of the front panel, which is itself part of the upper case. Connection is made via two termination PCBs, using phosphor-bronze spring contacts. In both cases these had quite a tarnished appearance, as were the wire-contact faces with which the springs make. Treatment with a fibreglass contact-burishing pen, following by contact retensioning, provided a complete cure. G.D.

Sony HCD-CP300

This one had me guessing for a while. The owner's complaint was that the tape decks didn't work. On test I found that they carried out all their mechanical functions correctly but neither of them produced any audio. I checked for a supply on the record/playback sub-board and found that this was missing. Maybe the decoupling capacitor C412, at pin 18, was short-circuit. It didn't read short to ground at its positive leg, but then it didn't at its negative leg either! When I checked back at the flexiprint connector on the main PCB I found that there was a supply voltage and a good ground connection. It then dawned on me – the flexiprint had been inserted in the connector upside down, the result being no connection to the main PCB at all. Once this had been corrected the tape decks worked normally.

When I later quizzed the dealer who had sent me the unit, to find out whether there was any story to the job, I was told that the owner had had a CD fault repaired elsewhere some time back. This had been dealt with satisfactorily, and she didn't use tape very much. It was only a considerable time after the CD repair that the tape fault was discovered, and by then she felt that it had been too long to return the unit to the original repairers to get them to sort out what had gone wrong. It had come to us instead! G.D.

Sony HCD-A490

The complaint was that every time a different function was selected for tape deck B a loud mechanical noise came from within. It sounded like slipping nylon gear teeth, and I initially suspected that it was something to do with the main cam drive. As it turned out I was right about my identification of the noise, but not about the location from which it came.

The deck mechanism employs a separate motor and drive system for take-up, fast forward and rewind. Its shaft has a small nylon pinion that meshes with a drive gear



Left - The Carver Cube's rear panel.

Right - Internal view of the Carver Cube.



on a swinging-arm arrangement. The cause of the problem was simply that the pinion had worked its way up the shaft until it was only just meshing with the gear. When the motor started up initially, the gears slipped until they caught. The problem was easily fixed by repositioning the pinion and securing it with a spot of superglue. **G.D.**

Sony HAR-LH500

There was no power with this CD/hard-disk audio recorder. Checks on the power board revealed the cause, which was C412 (220 μ F, 400V). When this item fails the replacement should be 150 μ F, 450V, part no. 1-110-970-11. The replacement restored normal operation. **C.B.**

Sony CDP-XE370

This unit's CD drawer went in and out when it was switched on. Investigation of the CD mechanism revealed the cause, which was grease on the loading belt. It had come from the CD tray, and as a result the belt slipped on the loading pulley. Cleaning the grease off the belt restored normal closing and loading operation. **C.B.**

Sony MZR-700PC

No sound came from the left-hand side of this MiniDisc player's audio jack. The cause of the fault was quickly traced to the headphone amplifier chip IC302, which had become unseated on one side from the main board. All that was required was to resolder this surface-mounted IC, after which there was normal sound output. **C.B.**

Sony HCD-CPX1

Every time this new unit's standby button was pressed the function mode would change instead. Investigation inside revealed the cause, which was a solder splash that shorted pins at the microcontroller chip IC401 on the main board. Normal standby operation was restored once the solder splash around the IC had been carefully cleaned off. **C.B.**

The Carver M400

The Carver Cube was introduced by Bob Carver in 1980 in an attempt to produce a high-power amplifier that was compact and light, for "a dollar a watt". It's a 6-75in. cube with two rows of LEDs for the left/right channel outputs on the front panel and speaker and input connections at the back. Early models also had a mono/stereo switch at the back. It altered the power-supply regulation.

The power supply was the main area for updating/modifications. The supply uses a triac in series with a transformer, a simple circuit consisting of a LED and a phototransistor being used to vary the phase-angle of the triac's firing point. The LED and phototransistor were discrete in early models, later ones using a 6-pin DIP chip. Reliability wasn't a strong point with early models, and several modifications were introduced. Small TO5/TO220 triacs were used until, in later versions, a TO3 type was adopted. There are two adjustments, a 'smooth firing' potentiometer and another one to adjust the 75V supply on the secondary side.

If the amplifier makes a ticking sound, this indicates that the triac isn't firing at the correct point during the cycle (the circuit is triggered at twice the input frequency). In later versions there's a single potentiometer, to adjust the HT supply.

The power amplifier section remained basically the same throughout the life of the unit, with only minor changes. Basically there's a 20W amplifier for each channel, with ± 25 V supplies. When the drive to the output transistors reaches a level close to maximum power, another pair of transistors in the \pm feeds is switched on to increase the supplies to ± 50 V. If the drive is increased still further, another pair of transistors switches on to provide ± 75 V supplies. The transistors are OEM branded, but I suspect that they are complementary MJ115015/16 pairs or similar.

An unusual aspect of the 400 is that

one channel is a standard non-inverting amplifier while the other is an inverting type. This enables the 400 to be used as a mono bridged amplifier with no switching, as the inverted output is reversed at the speaker connections when one speaker is connected as shown on the rear panel. Model 400T was introduced to emulate the valve sound, but the circuitry was little different from the standard model.

Access to the inside is quite easy. The front panel with the LEDs on a small PCB can be pulled off when the four screws are removed from the sides. The LED PCB can be unplugged from the front panel. Most of the power supply is then accessible. For better access the U-shaped cover can be removed by taking out the nine screws towards the back. Plenty of heatsink is used on the surfaces, so it can be messy.

The small vertical PCB is the power board. The triac should be at the front, mounted on the case as a heatsink. The two large capacitors towards the back smooth the 75V supplies - they are fastened to the PCB. Other capacitors on the PCB smooth the 25V and 50V supplies.

The LED in the optocoupler is fed from a couple of transistors that monitor the 75V supply. If the LED is full on, the triac is prevented from firing by the phototransistor, which is connected across a diode bridge. This is also the overload condition, which is monitored as the DC level at the speaker terminals. I'm not sure if this circuit detects the negative voltage at the output, as a diode is used for each channel.

The large bridge rectifier on the board is for the ± 75 V supplies. There are smaller ones in parallel for $\pm 25/50$ V.

The accompanying photos show the rear panel and internal views. **P.R.**

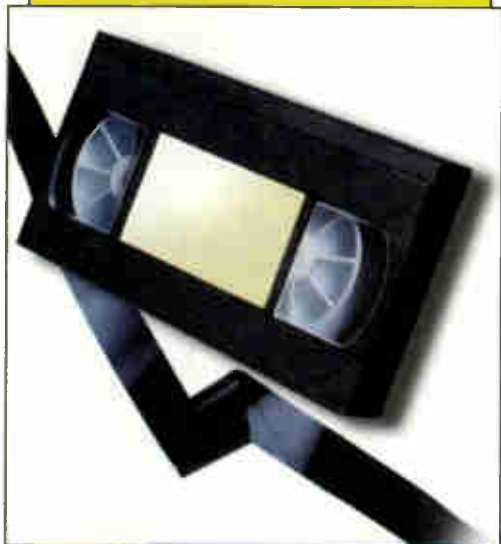

VCR CLINIC

Reports from
Eugene Trundle
Bob Flynn
Roy Blaber
 and
Martin McCluskey

We welcome fault reports from readers – payment for each fault is made after publication.

Reports can be sent by post to:

Television Magazine Fault Reports,
 Highbury Business,
 Media House,
 Azalea Drive, Swanley, Kent BR8 8HU

or e-mailed to:
 t.winford@highburybiz.com

Panasonic NV-FJ620B (Z mechanism)

There were dozens of mistracking lines on the off-tape pictures. On investigation I saw that at lace-up the loading arms didn't push the tape guides fully home. Two teeth had sheared off the inner pinion of the take-up loading arm assembly. It's item 43 in the exploded diagram in the manual, and is part no. VXL2670. I believe the cause of the trouble was that the assembly had not been tight on its shaft. E.T.

Toshiba V711UK (DX9R chassis)

The cassette would go down but, after some spinning of motors, it would be ejected. The cause was the take-up loading arm, which consists of a plastic arm (item B500) and a metal arm (item B501). The metal arm had broken loose from the loading arm and the pole base because of a broken clip on the plastic arm. To replace item B500 is easy, as alignment is clearly marked.

The design of both tape arms differs from that in earlier models such as the V229B and V709B. B.F.

Sanyo VHR-H792E

A cassette was jammed in this VCR because a large amount of tape was stuck to the wrong side of the video head drum. After removing the cassette I tested the machine and found that during rewind or wind, which is very fast, it would suddenly jerk or stop and throw tape into the deck. The cause was the lever that moves the clutch up and down for different speeds. It had come adrift because of a broken clasp.

This VCR is of GoldStar manufacture and is the same mechanically as the LG Model LV713. Order the lever (item 060) using part no. 4510R-0040A. B.F.

LG S909NI

This machine appeared to be dead although there were some voltages on the secondary side of the power supply. I decided to carry out electrolytic capacitor checks with my ESR meter and found that CP12 (1,000µF, 16V) produced a high reading. A replacement brought the machine back to life. R.B.

Goodmans TVC146TWS

This VCR/TV combi unit was dead though the green LED lit up. It has two separate power supplies, a standby one that was working and the main one which was producing very low outputs. It's based on an STRS5707 chopper chip, IC1801. A replacement cured the fault. R.B.

Toshiba SD22VB

"Cassette won't eject" was the complaint with this combined VCR/DVD player. In fact the carriage and videocassette could be lifted up to the eject position without turning the mechanism, because a piece of plas-

tic had broken from the right-hand carriage loading arm. The part is called "loading arm cassette housing" and is available from Charles Hyde and Son under the code no. ALB1448. M.McC.

Goodmans SD1600

When a cassette was inserted the E-E picture muted and the tape was played back with the drum and capstan speeds way out. Heat and freezer treatment revealed that the cause of the trouble was C802 (47µF, 16V), which is on the regulator panel. Once a new capacitor had been fitted this elderly VCR produced first-class results. M.McC.

Aiwa HVGX935K

This machine was dead with a tape stuck inside. I removed the deck carefully, loosening the carriage to get at the deck-fixing screws underneath the trapped cassette, and carried out some checks on the main circuit board. The power supply was running, but there was no +5V output at the cathode of rectifier diode D106 because the reservoir capacitor C116 (1,000µF, 16V) was open-circuit. A replacement capacitor restored normal operation. M.McC.

JVC HRJ420

This machine would accept a cassette then, after a few seconds, eject it. The cassette-down microswitch is on a little sub-panel and is operated by a white plastic 'plunger' on the carriage. The bottom part of this plunger is made of very thin, flexible plastic, and this had broken away completely. If a complete new carriage had been required the repair would have been uneconomical (from the customer's point of view anyway). But the rest of the machine appeared to be in showroom condition, so I decided to have a go at repairing the broken part.

Two large blocks of thick foam rubber material are stuck to the screening cans. I cut away a small square, 7mm thick, and glued it to the underside of the plunger (see Fig. 1). This provided a complete cure and, six months later, the machine has not been back to me again. M.McC.

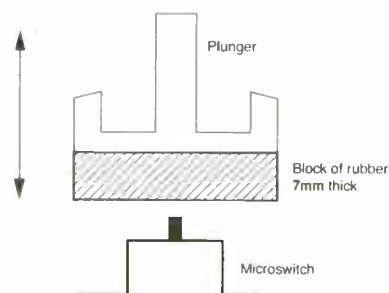
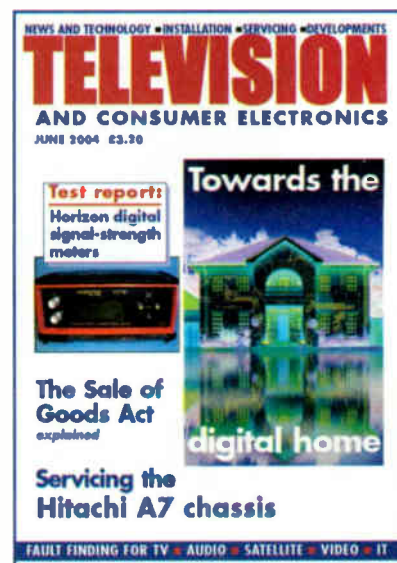
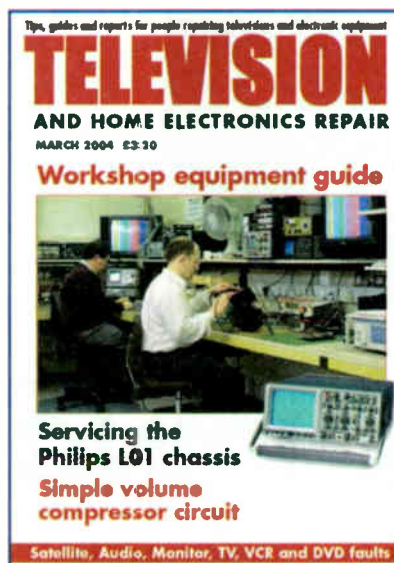
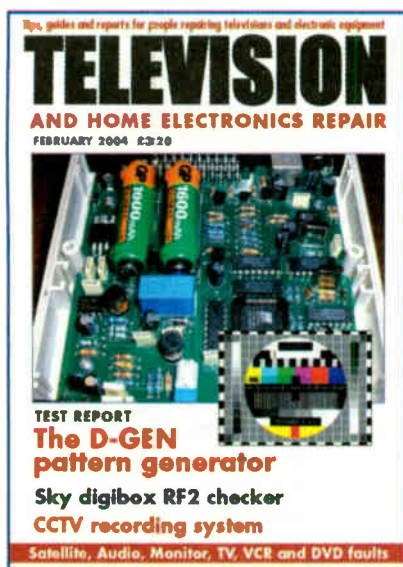

Fig. 1: Repair to the carriage-down microswitch operating system in the JVC HRJ420.

NEWS AND TECHNOLOGY ■ INSTALLATION ■ SERVICING ■ DEVELOPMENTS

TELEVISION

AND CONSUMER ELECTRONICS



Television and Consumer Electronics magazine is the only magazine for technicians who deal with consumer electronic products, in particular TV, video, satellite and audio equipment.

- Launched in 1935 this respected journal is the longest established consumer electronics magazine
- Tips and guides on repairing television and electronic equipment including satellite receivers,, PCs, monitors, VCRs, DVD, audio equipment and much more
- Keep up to date with the latest information and changes affecting the industry
- Essential reference and in-depth features covered monthly
- Essential reference and in-depth features covered monthly

Make sure of your copy now...

Subscription rates for 1 year:

UK £33.80 ● Europe £49.00 or €92
USA \$104 ● Rest of the World £63.50

Subscription rates for 2 years

UK £53 ● Europe £78.40 or €146
USA \$166.65 ● Rest of the World £101

Contact

Highbury Fulfilment Services,
Link House, 8 Bartholomew's Walk, Ely, Cambridge CB7 4ZD.

Telephone 01353 654 431

Fax 01353 654 400

Email hbc.subs@highbury-wyvern.co.uk



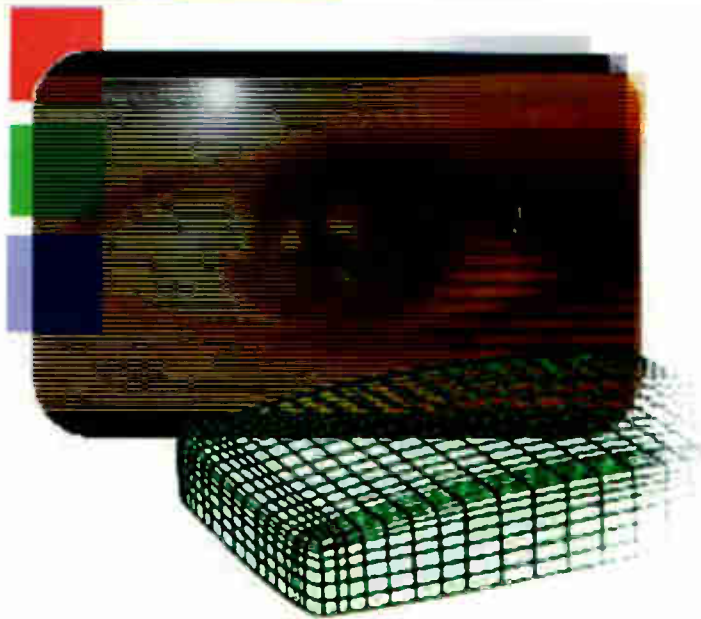

TV FAULT FINDING

Reports from
Philip Salkeld
Charles Arundel
Martin McCluskey
Bob Flynn
Charles Ritchie
Uel Harte
Steve Hague and
Jerry Mumford

We welcome fault reports from readers – payment for each fault is made after publication.

Reports can be sent by post to:

Television Magazine Fault Reports,
 Highbury Business,
 Media House,
 Azalea Drive, Swanley,
 Kent BR8 8HU

or e-mailed to:
t.winford@highburybiz.com

Sharp 32LW92H (11AK45B5 chassis)

This set had a narrow picture at the centre of the screen. The first thing I noticed was that L603 was overheating. As I couldn't run the set in this condition, I had to switch off and carry out some cold checks. D611 (UF5407), one of the EW modulator diodes, proved to be short-circuit. When I tried again after fitting a replacement the picture was wider and curved and still didn't fill the screen. Further checks brought me to R613 (33Ω, 1W) which was open-circuit. There was a normal picture once this item had been replaced.

This chassis is now being used by many manufacturers. P.S.

Grundig MW70-505-1RDT (CUC2059 chassis)

Do you remember the good old days when TV sets used an EHT tripler? The tripler either suffered from insulation breakdown and cracked down to chassis, or went short-circuit, shunting the line output transformer to produce the dead-set symptom, generally with a tripping noise. The latter fault was present in this set. It was not that old, and I was amazed to find a tripler in use again. The replacement was obtained from CPC, code no. GR29201-474-01. P.S.

Daewoo DWX28W5GB

This set came in dead with both the mains plug fuse and the internal fuse open-circuit. A resistance check across the mains

bridge rectifier's reservoir capacitor produced a short-circuit reading. I then removed the STRF6654 chopper chip 1801 and found that two of its pins were short-circuit. Further checks were carried out in the power supply, but everything seemed to be OK. A replacement chip, plus fuses of course, restored normal operation. P.S.

Tatung T28W440

The complaint was sound motorboating – the picture was OK. Switching to AV made no difference, so I assumed that the cause of the fault must be on the audio output side. Checks around ICS6 (TDA9860) varied the symptom, and you could hear the sound coming through. A replacement, part no. S063198609, restored normal sound. P.S.

Sony KV-32FQ75U (AE5A chassis)

There was patterning on the screen when a picture was present. Use of freezer and the hairdryer seemed to alter the shape of the patterning, but that was about it. After spending some hours on the fault a decision had to be made. The patterning seemed to alter more when I worked on board B3. So I decided to order a replacement board, part no. A1620148A. It was quite a risk, as the board costs about £185 plus VAT. I had my fingers crossed when I fitted it and switched on. Fortunately my guess had been correct. P.S.

Beko NR20272TDS

The fault symptom displayed by this four-month old set was field judder. It gave me the impression that there was a dry-joint, but use of heat and freezer proved that the TDA8174AN field output chip was the cause. The part no. is 452648.

The number of in-warranty repairs is certainly on the increase. P.S.

Sharp 28JF73H

The set produced a tripping noise, with the LED jumping from red to green. This corresponded with the HT supply going from 60V to 145V. As the line output transformer was getting rather warm I decided to fit a replacement, part no. RTRN-FA014WJZZ. This got the set up and running again. P.S.

Hitachi C2154S

This model is fitted with some form of Vestel chassis. The sets are coming in with the fault symptoms stuck in standby and a tripping noise. The cause can be in the power supply or the line output stage. To check on this, remove the line output transistor. If the HT voltage is then correct the fault is in the line timebase. More often however the cause is in the power

supply. You will notice that there are a number of small black silicon diodes with strange numbers here. I generally fall back on the reliable old BA159. The one to go for is D806, which tends to go short-circuit. P.S.

Daewoo DWF28W8GB (WP895 chassis)

There was an unusual fault symptom with this set: field pairing towards the centre of the screen plus two intertwined sinusoidal white lines across the centre. It occurred when the set was first switched on, and gradually cleared after about half an hour. The cure is to move the 1 Ω , 0.5W fusible resistor R398 away from the line linearity coil L401. The resistor, which is in the field circuit, was picking up line pulses from the coil. C.A.

Daewoo DSC3210EGB (SC140 chassis)

The fault report from the customer was that the set would die when it was switched on using the on/off switch. Our field engineer found that the 4A quick-blow mains fuse was open-circuit. Replacing it with a 4A anti-surge fuse restored the set to life.

The fault never occurred when the customer used the standby mode to switch on and off. This was because the actual cause of the fault was a low-impedance degaussing coil. Some of these sets were fitted with a 9 Ω instead of a 24 Ω degaussing coil during manufacture, when there was a shortage of coils.

The correct procedure is to replace the coil and the quick-blow fuse. An anti-surge fuse should not be fitted. C.A.

Daewoo DWF28W5GB (WP895 chassis)

The problem with this set was that it reverted to standby after a few minutes. The cause was in the excess current protection circuit, which is connected to pin 64 of the main microcontroller/video processor chip I501. A call to Daewoo technical revealed that a modification to this part of the circuit is sometimes necessary – change the value of R598 from 15k Ω to 22k Ω . C.A.

Decca D14RFG5 (F series chassis)

At switch on there was sound but no raster. Then, after a few seconds, the set cut out with the front LED flashing four times, pausing, then flashing four times again and again. This error code indicates a beam-current monitoring fault. In fact R915 (0.68 Ω), in the feed to the CRT's heaters, was open-circuit. It's on the CRT base panel. M.McC.

Daewoo GB14HIT

If one of these TV/VCR combi units has been locked and no one can remember the PIN number, key in blue, yellow, green, red, standby, standby (standby twice) very quickly. Try this several times, as it's difficult to get the timing exactly right. My thanks to Alan Dyson of Techline Services for this information. M.McC.

Hitachi C2114R

This set was stuck in standby. A check on the voltage at the gate of trip thyristor Q703 showed that the set was in the trip condition. This can occur when the line output stage is drawing excessive current, the usual cause being the TA8427K field output chip – it takes its supply from the line output transformer and there is no safety resistor in the feed. A new TA8427K restored normal operation. M.McC.

Philips 14PT156A (Anubis A-AB chassis)

This portable was dead apart from a faint noise that came from the power supply. A dead short-circuit could be measured between the collector and the emitter of the line output transistor, but the cause was an internal short in the transformer. M.McC.

Goodmans 1410 (Ferguson TX805 chassis)

This set tripped slowly every two seconds or so, with a clicking noise that came from the speaker. It uses a Wessel circuit, with a single transistor as the chopper and line output device. Even when you have the circuit diagram in front of you there seems to be no logical way of carrying out fault diagnosis. I wasted a lot of time checking the various supply lines for overloads and short-circuits then discovered, by accident, that the set came to life (after a fashion, displaying a bright spot in the centre of the screen) when the plug for the line scan coils was left off. This suggested lack of field scanning.

So I carried out some checks in the field scan circuit, where I discovered that DF04 (BA157) was open-circuit. It's the rectifier for the flyback boost supply at pin 3 of the LA7830 field output chip IF01. All was well once a replacement had been fitted. M.McC.

Black Diamond BDS295 (11AK19PRO chassis)

When this set was powered the LED turned green then the set reverted to standby. No shorts could be measured across any of the outputs on the secondary side of the power supply. As an

experiment, I disconnected the drive from the base of the line output transistor and switched the set on again. A puff of smoke came from D807 (BA159) in the power supply. It's the diode in the snubber network on the primary side. A replacement restored the sound and picture. M.McC.

Sony KV29F2U (BE3D chassis)

There was a brief burst of EHT then nothing, except that the set responded to the remote-control unit (the LED at the front lit when a command was sent). The cause of the fault was the STV9379 field output chip IC500. The usual result when it fails is that the standby LED flashes twice. B.F.

Bush 2868NTX (11AK19 chassis)

This set would come on for a while then go off with a popping noise that came from the tube neck area. Fortunately the cause was not the tube itself but the tube base socket. This can be obtained from CPC under part no. AB3862021000. B.F.

Ferguson B59N (ICC8 chassis)

This set would try to come on, then go off with a short flash from the red standby LED. The brief period of action left no time for fault diagnosis, though it did provide a clue – a noise from the line output transformer. When I removed the final anode lead from the transformer I saw that the wire end was corroded. It seemed to be best to replace both the lead and the transformer. I had them in a scrap chassis, and it would have been impossible to clean the contacts inside the transformer. B.F.

Philips 25PT4523 (MD1.2E chassis)

This set was dead apart from a couple of loud squeaks at switch on. I found that there was a low-resistance reading across the line output transistor. The cause had to be traced all the way back to the secondary side of the power supply, where C2588 (330pF, 1kV) was faulty. B.F.

Hitachi C32WF810N (A/D8 chassis)

This set would blow the fuse in the plug and the 4A fuse in the set itself. The cause was a faulty power switch. While the set was on test after fitting a replacement it would intermittently turn off then on again. The cause is normally poor joints at the links on the horizontally-mounted PCB, but in this case the cause was poor joints at regulator IC952, which is next to the power relay. B.F.

Goodmans 1428T (Daewoo CP330 chassis)

This set was dead with the 2SD1555 chopper transistor Q801 short-circuit. The cause was that R802 (150k Ω) had risen in value to 750k Ω . B.F.

Mitsubishi CT25A5STX (Euro 14 chassis)

When this set came on there was no colour, progressing quickly to poor sync or the line frequency being way off. The cure was to replace the 4.43MHz crystal (X601) that's connected to pin 35 of the TDA8361 jungle chip. B.F.

Sanyo 14MT4 (EC8-A14 chassis)

This set appeared to be dead because the BU808DFI Darlington-type line output transistor Q432 was leaky. A replacement got the set working, but after a few minutes it started to get hot. I decided to check the driver stage, and found that C434 (47 μ F, 50V) produced a high ESR reading. When a new capacitor had been fitted Q432 no longer overheated. C.R.

Grundig T55-731 (CUC7303 chassis)

This set was dead with fuse S1600 (2.5AT) black and open-circuit. I couldn't find any shorts in the power supply so, suspecting the degaussing posistor, I removed it and connected a 500W halogen lamp across the fuseholder. When I switched the set on again the lamp lit up at full brightness and I saw a flash in the vicinity of the IRFBC40 chopper FET T665. The cause of the fault was obvious once T655 had been removed. A hole in the insulated washer on the heatsink was shorting T665's drain to chassis.

A new washer and fuse got the set working again, and the job was completed by refitting the posistor. C.R.

Black Diamond BDS1451T (11AK36 chassis)

This set produced a blue screen with flyback lines. When I examined the CRT base PCB I saw that R921 (1.5k Ω , 0.25W) was burnt. The reason for this was that during manufacture the ribbon cable on the CRT base PCB had pushed R915 (18k Ω) over, shorting it to R921. But pushing R915 back to its correct position and replacing R921 didn't cure the fault. Q906 (BF421) also had to be replaced to obtain a normal picture. C.R.

Beko 19321T (AT3 chassis)

This set was stuck in standby with the front LED flashing dimly. I found that the HT supply (U1) to the line output stage

was low at 90V. In addition the 17.5V supply (U2) was missing. The cause was D110 (BYW72) which was short-circuit. The set worked normally once a replacement had been fitted. C.R.

Philips 28PW6515/05 (A10 chassis)

This set refused to come out of standby. On investigation I found that there was no line drive, and immediately suspected the painter chip on the small-signals panel. As I didn't have a spare PCB to try as a check, I decided to replace the painted chip. Forty minutes later the chip had been installed and, with fingers crossed, I powered the set. All that was required was a lengthy geometry set up. It was the EP version of the painter chip – the part no. has changed to 9352 710 77557. U.H.

Akai CT2155UK (Samsung P58CH chassis)

The fault with this set, an easy one for a Monday morning, was field collapse. It didn't take long to discover that the 24V supply was missing at pin 9 of the field output chip IC301. It's derived from the line output transformer, via safety resistor R412 (1 Ω) and rectifier diode D401. The diode was open-circuit, a replacement restoring normal operation. U.H.

Hitachi C28W430N-311 (A7 chassis)

The HT regulation was poor and, with the preset at maximum, the voltage was 137V. This time the HT preset VR950 and its feed resistor R950 were both OK. The problem was with the BZV10 reference diode ZD950, which was leaky. The correct part should be used, obtained from Hitachi. For good measure I also replaced the optocoupler IC901 and the BF422 error-sensing transistor Q954. U.H.

Toshiba 2500TB

Field collapse is often caused by a dry-joint at the scan-coil plug. Not this time however. Further checks showed that the supply at pin 7 of the AN5521 field output chip IC303 was low – 14V instead of 26V. The cause was the flyback boost capacitor C313 (220 μ F, 35V), which was leaky. U.H.

Philips 32PW9763/05

We've had three of these sets in now with exactly the same mysterious symptoms. All three had the same initial problem – stuck in the protection mode with the red LED flashing, because of a leaky flyback tuning capacitor. When the capacitor was replaced the sets came on very briefly

then again shut down in the protection mode, with the red LED flashing approximately twice a second.

If we put the sets into the default service mode they came on and worked perfectly, with all voltages correct. If they were put into the self-diagnostic mode, when they initially started up they indicated that there was a problem with the 140V module. It provided exactly 140V however, and when self-diagnosis was reset we were told that there was no fault! Eventually the culprit turned out to be the IRF620 FET Tr7470. It is worth noting that the replacement supplied isn't insulated like the original and is clamped against a heatsink. S.H.

Samsung WS-28M64N (KS3A chassis)

This 'Plano' 28in. widescreen set was dead apart from a soft, slow ticking sound that came from within. I soon found that the 2SD5703 line output transistor Q401 was short-circuit. As no other fault could be found, a replacement was tried. It became very hot in just two seconds, then destroyed itself. As usual in such circumstances, the line output transformer had a short-circuit primary winding. A new transformer and transistor restored an excellent display. G.M.

Grundig W70-2030 (Gorenje E9 chassis)

This smart silver 28in. widescreen set intermittently refused to switch on, with no power, display or LED illumination. The cause was the 75k Ω , 2W start-up resistor R604, which had not been soldered in correctly during manufacture – one leg was not through the PCB, and only intermittently touched the soldered pad underneath. Resoldering it cured the fault. G.M.

Bush 6690D (11AK19 chassis)

The fault symptoms with this 28in. integrated digital widescreen set were reduced width and EW distortion. Inspection revealed many dry-joints in the line output and EW stages. As a result, R629 (5.6 Ω , 0.5W) had gone open-circuit. Some resoldering and a replacement resistor produced a perfect display. G.M.

Goodmans W288NS-A (Formenti F19 chassis)

When this 28in. widescreen set powered up it briefly produced a display then made a loud arcing noise and switched to standby. The line output transformer was suspected initially, but the cause turned out to be the CRT base socket. A replacement provided a complete cure. G.M.



DVD

**Fault reports from
Eugene Trundle
David Ingrey
Chris Bowers and
Geoff Darby**

**We welcome fault reports from
readers – payment for each fault is
made after publication.**

Reports can be sent by post to:

**Television Magazine Fault Reports,
Highbury Business,
Media House,
Azalea Drive, Swanley,
Kent BR8 8HU**

**or e-mailed to:
t.winford@highburybiz.com**

Sony DAV-S400

The complaint with this all-in-one home-cinema system was no sound output with the word 'earphone' shown in the front-panel display. On investigation several dry soldered joints were found at connector CN309 and both ends of C313 were unsoldered. These items are on the audio amplifier PCB. There was normal sound once they had been resoldered. **E.T.**

Pioneer DV-U7

This DVD player was completely dead. The power supply is easy to work on once it has been removed from the unit. I soon found the cause of the fault: R74 (2.2M Ω) was open-circuit. **D.I.**

Sony AVD-K150G

The problem with this DVD/video unit was dots on the display with video playback. Investigation inside showed that the cause was a poor earth connection between the mechanical deck assembly and the main board. All that was needed to restore normal picture playback was to raise the earthing plate below the deck assembly slightly to ensure a better connection. **C.B.**

Sony DVP-NS300

The problem with this unit was no power. Meter checks on board IF-80 revealed that the 1A fuse PS401, which is an IC link, was open-circuit. A replacement restored power and normal operation. The part no. is 1-576-509-21. **C.B.**

Sony SLV-D930GI

This DVD/video unit had no display and appeared to be dead. Checks in the chopper power supply on the main PCB revealed that diode DISS17, type FIT4, was faulty. It's the rectifier for the 24V

line. A replacement restored full operation. The part no. is 1-804-412-22. **C.B.**

Sony HCD-S800

There was no DVD operation. Voltage checks on the DVD PCB revealed that the 12V supply at connector CN008 was missing. Tracing back, I found that the 10 μ H inductor L904 on the power board was faulty. A replacement restored normal operation. The part no. is 1-414-398-11. **C.B.**

Toshiba SD42HKS8

This home-cinema system came to me from another dealer. The reported fault was "noise from the speakers". When I powered it there was a harsh rasping hiss from the centre channel only. When the input to the centre speaker was disconnected the other channels were quiet. FM radio could be selected, and a station could be tuned in. RDS data appeared in the display, which suggested that the tuner was working correctly. But the other five channels remained quiet, apart from an occasional pop when the volume encoder was rotated. At this stage the DVD deck's laser didn't home, the drawer wouldn't open, and the disc motor ran backwards at high speed. After about five minutes the unit burst into life, producing normal audio from the five channels still connected and, when the centre speaker was reconnected, from that one too. The DVD section remained much as it had been before, except that disc motor had stopped.

About the only thing that connected these various symptoms was the power supply. Blasts here with a can of freezer were inconclusive, so I decided to check the ESR of C939 (470 μ F, 10V) because it had very slight doming at its top. The reading was over 11 Ω , which was clearly out of specification. But a replacement, rated at 16V, made no difference at all to the fault symptoms.

I was still convinced that the problem was in the power supply, so I decided to check the ESR of the rest of the electrolytics there. The first one I tried, largely because it was right by a heatsink and the board in the area looked a bit heat-stressed, was C938 (1,000 μ F, 16V). The ESR reading was off the scale. When I removed it from the board I saw that the sealing bung had forced its way out of the bottom of the can. This is the alternative way in which electrolytics are designed to fail safe when pressure builds up inside, and doesn't result in the can rupturing along the deliberately weak spot lines at the top.

A replacement, uprated at 25V, restored immediate clean sound from all channels and full DVD section operation. C938 and C939 seemed to be part of the same supply. **G.D.**

TELEVISION BOOKS

AND HOME ELECTRONICS REPAIR

The Television Book Service offers access to our team of specialist publishing experts. We can order any book or CD-ROM currently in print from *War And Peace* to the *Newnes Guide to Television and Video Technology*. All books are delivered free of charge within the UK unless otherwise stated. Contact us at the numbers below:

Telephone: **01737 812727** or **01737 812676**

Fax: 01737 813526

Email: salesteam@boffinbooks.demon.co.uk

DVD PLAYERS AND DRIVES

K F Ibrahim
(College of North West London)

This text is based on hands-on experience and acts as a guide to DVD technology and its application, with a special focus on design issues. The principles of the subject are introduced from the basics, and DVD applications are illustrated by genuine technical information.

Aug 2003 ▲ 256 pages ▲ Glossary ▲ Index
PB ▲ Published in UK

Code 0 7506 5734 7

£24.99



ELECTRONIC CLASSICS: COLLECTING, RESTORATION AND REPAIR

Andrew Emmerson

This text encompasses all aspects of buying, collecting, restoring, repairing, sourcing parts, professional services, clubs and societies. The first part covers technical aspects of restoration and details where components can be found; the second presents useful information for collectors.

Aug 1998 ▲ 256 pages ▲ Index
10 halftones ▲ 50 line illustrations ▲ PB
Published in UK

Code 0 7506 3788 9

£21.99



CLOSED CIRCUIT TELEVISION: CCTV INSTALLATION, MAINTENANCE AND OPERATION

Joe Cieszynski

CCTV surveillance is one of the fastest growing areas in the security industry, and this is a thorough guide to the technical side of CCTV – including installation, maintenance, video recording, cameras and monitors. The second edition is fully dual-standard for PAL and NTSC systems.

2nd edition ▲ Sept 2003 ▲ 256 pages
Glossary ▲ Index ▲ PB ▲ Published in UK

Code 0 7506 5728 6

£24.99



DICTIONARY OF VIDEO AND TELEVISION TECHNOLOGY

Jack Tsatsoulis

This work provides comprehensive and contemporary information on the essential concepts and terms in video and television, including coverage of test and measurement procedures. The CD accompanying the text includes an electronic version of the book.

Sept 2002 ▲ 365 pages & CD-Rom
Published in UK

Code 1 878707-99 X

£29.99



NEWNES GUIDE TO TELEVISION & VIDEO TECHNOLOGY

Eugene Trundle

An exploration of television and video technology. It covers the fundamentals of digital television (satellite, cable and terrestrial) and digital video, as well as providing a grounding in analogue systems.

3rd edition ▲ Feb 2001 ▲ 432 pages ▲ Index
PB ▲ Published in UK

Code 0 7506 4810 4

£17.99



NEWNES GUIDE TO DIGITAL TV

Richard Brice

Covering all aspects of digital television, this text encompasses the electronics of the equipment, data compression, television production, servicing and the different transition methods – terrestrial, satellite and cable. The text has been updated with developments since the 2000 edition.

2nd edition ▲ Oct 2002 ▲ 304 pages ▲ Index
45 illustrations ▲ 15 photographs ▲ HB
Published in UK

Code 0 7506 5721 9

£24.99



PRACTICAL ELECTRONIC FAULT FINDING AND TROUBLESHOOTING

Robin Pain (Design Engineer, Cotag International Ltd)

A text using simple circuit examples to illustrate principles and concepts fundamental to the process of analog and digital fault finding. It aims to help the reader tackle any job, from fixing a TV to improving the sound of a hi-fi. A digital multimeter and oscilloscope are needed for these jobs.

Apr 1996 ▲ 284 pages ▲ Index
50 line illustrations ▲ PB ▲ Published in UK

Code 0 7506 2461 2

£21.99



PRACTICAL ELECTRONICS HANDBOOK

Ian Sinclair

A collection of all the key data, facts, practical guidance and circuit design basics needed by a spectrum of students, electronics enthusiasts, technicians and circuit designers. It provides explanations and practical guidance, and includes new sections on SHF techniques and intruder alarms.

5th edition ▲ Feb 2000 ▲ 571 pages
Illustrations ▲ PB ▲ Published in UK

Code 0 7506 4585 7

£16.99



RSGB RADIO & ELECTRONICS COOKBOOK

Radio Society of Great Britain

Only a basic knowledge of electronics is assumed for this collection of electronics projects, and it is ideal for all electronics and DIY enthusiasts and experimenters. Designed by the RSGB, the UK radio amateurs federation, the projects are clearly explained step by step.

Nov 2000 ▲ 336 pages ▲ PB ▲ Illustrations
Published in UK

Code 0 7506 5214 4

£17.99



REFERENCE DATA FOR ENGINEERS: RADIO, ELECTRONICS, COMPUTERS AND COMMUNICATIONS

Mac E Van Valkenburg; Edited by Wendy Middleton

Written by professionals for professionals, this is a complete reference for engineers. As well as addressing radio technology data, it covers digital electronics, computers and communications.

9th edition ▲ Aug 2001
1568 pages & CD-Rom ▲ 1385 line illustrations
HB ▲ Published in UK

Code 0 7506 7291 9

£90.00



SERVICE ENGINEER'S POCKET BOOK

Lewis & Sinclair

This title aims to provide the service engineer with all the necessary information to carry out work on domestic electronics equipment. The coverage ranges from satellite reception to NICAM. Both analogue and digital equipment are covered, and there are chapters on common problems.

Jan 1998 ▲ 238 pages ▲ HB

Code BUTO 7506 3486 0

£14.99



SERVICING TV, SATELLITE & VIDEO EQUIPMENT

Eugene Trundle

A practical hands-on guide for service engineers, installation technicians and servicing students, this text emphasises the practical business of fault diagnosis and repair of TV, satellite and video equipment.

Revised 2nd edition ▲ Nov 2001 ▲ 336 pages
Symptom index ▲ PB ▲ Published in UK

Code 0 7506 5507 0

£21.99



TELEVISION MICROPROCESSOR IC DATA FILES

J Edwards

Microprocessor ICs are the most complicated part of TV equipment and present special problems to the engineer. This text covers the most popular microprocessor ICs. Each device is presented graphically with the relevant data information given against each pin.

Mar 1997 ▲ 240 pages ▲ 200 line drawings

PB ▲ Published in UK

Code 0-7506-3335-2

£19.99

TELEVISION IC DATA FILES

J Edwards

A compendium of data on all the most common integrated circuits used in televisions. Each device is illustrated with a pin-out diagram, and all the measurements and signal data in the book were taken under actual working conditions. This second edition contains over 70 new ICs.

2nd edition ▲ Jan 2000 ▲ 245 pages

PB ▲ Published in UK

Code 0-7506-4581-4

£18.99

TV FAULT-FINDING GUIDE

Edited by Peter Marlow

A distillation of the most-used fault reports from 11 years of *Television* magazine. Arranged by make and model, it features over 200 reports on over 300 models of television, including diagnosis and repair advice.

Mar 2000 ▲ 387 pages ▲ Illustrations

PB ▲ Published in UK

Code 0-7506-4433-0

£20.99

VALVE AMPLIFIERS

Morgan Jones

The author's straightforward approach, using as little maths as possible, should be of use to those with only a limited knowledge of the field as well as being the standard reference for experts in valve audio. Design principles and construction techniques are also provided.

3rd edition ▲ Aug 2003 ▲ 624 pages ▲ Index

PB ▲ Published in UK

Code 0-7506-5494-8

£29.99

VCR FAULT-FINDING GUIDE

Edited by Peter Marlow

A distillation of the most-used fault reports from 11 years of *Television* magazine. Arranged by make and model, it features over 2000 reports on over 200 models of VCR, including diagnosis and repair advice.

Mar 2000 ▲ 447 pages ▲ Illustrations ▲ PB

Published in UK

Code 0-7506-4634-9

£20.99

VCR IC DATA FILES

J Edwards

This text aims to provide the workshop technician and the field engineer with a convenient method of fault-finding without the need to consult workshop manuals. The most popular ICs used in video recorders are covered. Each device is presented graphically with data given against each pin.

Jul 1998 ▲ 448 pages ▲ 200 line illustrations

PB ▲ Published in UK

Code 0-7506-3993-8

£20.99

VIDEO AND CAMCORDER SERVICING AND TECHNOLOGY

Steve Beeching

A comprehensive guide to domestic VCR technology and repair techniques. This edition brings the information fully-up-to-date, with expanded coverage of camcorders, sections on DVD equipment and the latest VCR technology.

5th edition ▲ Apr 2001 ▲ 323 pages

Illustrations ▲ PB ▲ Published in UK

Code 0-7506-5839-7

£20.99

VIDEO DEMYSTIFIED

Keith Jack

This edition has been updated to include information on digital television, datocasting, interactive video, digital camcorders and VCRs, and video interfacing. Coverage is international, including European, Asian and North/South American video standards, methods and techniques.

3rd edition ▲ Jul 2001 ▲ 784 pages & CD-Rom

References ▲ Glossary ▲ Index ▲ PB

Published in UK

Code 1-878787-50-6

£50.00

THE DIGITAL SATELLITE TV HANDBOOK

Mark E Long

A handbook and CD-ROM pack on digital satellite television. It provides an overview of all the digital TV platforms in use world-wide. It includes satellite coverage maps and transmission parameters that readers will need to receive digital TV services from any location in the world.

Sept 1999 ▲ 207 pages & CD-Rom ▲ PB

Code BUT 0-7506-7171-8

£41.99

NEWNES GUIDE TO RADIO AND COMMUNICATIONS TECHNOLOGY

Ian Poole

This is a guide to the technology and applications of modern radio and communications equipment. The author's approach provides a useful foundation for college students and technicians seeking an update on the latest technology.

Jul 2003 ▲ 352 pages ▲ Index ▲ PB

Published in UK

Code 0-7506-5612-3

£16.99

VALVE RADIO & AUDIO REPAIR HANDBOOK

Charles Miller

A practical manual for collectors, dealers and service engineers of valve audio and radio equipment. This edition includes new material on restoration and valve amplifiers.

2nd edition ▲ Apr 2000 ▲ 280 pages

▲ 10 halftones ▲ 50 line illustrations ▲ PB

Published in UK

Code 0-7506-3995-4

£20.99

NEWNES TV & VIDEO ENGINEER'S POCKET BOOK

Eugene Trundle

This updated text provides a pocket tool for service engineers. It presents a range of essential information in a compact form, covering television reception, satellite and cable television, video recorders, colour camera technology, teletext and fault-finding.

3rd edition ▲ Oct 1999 ▲ 512 pages ▲ HB

Code BUT 0-7506-4194-0

£17.99

TELEVISION ORDER FORM

Please order or search the following:

Code	Description	Qty	Price

POSTAGE & PACKING FREE IN THE UK* TOTAL

Name _____ Daytime Tel _____
Address _____
Postcode _____

I enclose a cheque/postal order value £ _____ payable to 'Boffin Books Ltd'

Please debit my Access/Visa/Switch/Delta card Issue number (Switch only) _____

Card Number _____ Expiry Date _____

Signed _____

*Postage charges outside the UK available upon request or email: salesteam@boffinbooks.demon.co.uk

Post to: Boffin Books Ltd, 24 Walton Street, Walton-on-the-Hill, Tadworth, Surrey KT20 7RT, UK

If you are ordering by credit card, need further information, or would like to use our search facilities, call

01737 812727 Fax 01737 813526

The order/helpline is open from 9am to 5pm, or leave your order on our out-of-hours answerline or email us at

salesteam@boffinbooks.demon.co.uk

When placing orders please quote ● Name ● Address (home & delivery) ● Daytime telephone number ● Debit/Credit card number ● Expiry date ● Details of order. Please note that prices may change, but are correct at time of going to press.

Extended Fault Reports

Reports on complex or tricky TV fault conditions are sometimes too long for inclusion in our basic fault-finding section. We've put a few of them together in this extended fault report feature

**Reports from
Michael Dranfield
Uel Harte and
Philip Laws**

We welcome fault reports from readers – payment for each fault is made after publication.

Reports can be sent by post to:

**Television Magazine Fault Reports,
Highbury Business,
Media House,
Azalea Drive, Swanley,
Kent BR8 8HU**

**or e-mailed to:
t.winford@highburybiz.com**

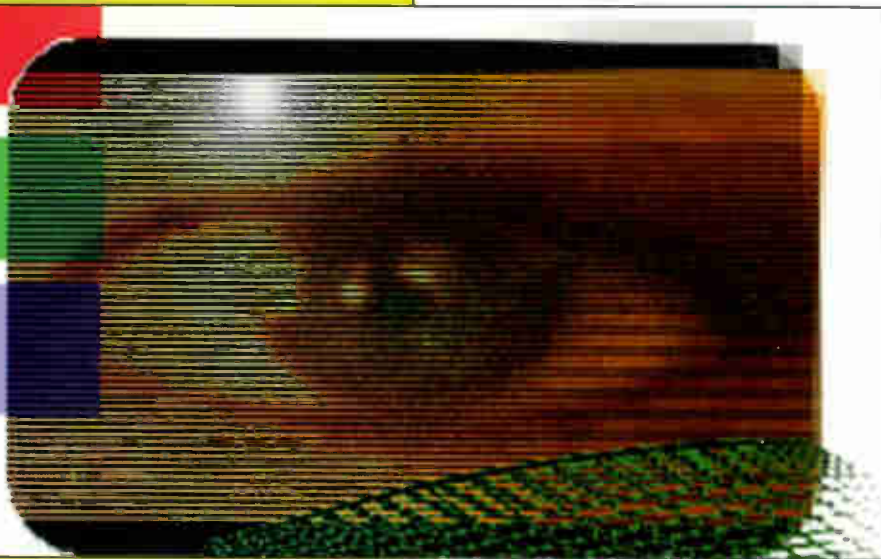

Sharp DV5937

This set was stuck in standby. After carrying out some checks I decided that the EEPROM was responsible, probably because of bad data. I asked a Sharp dealer friend of mine if he had an EEPROM dump for this model, so that I could reprogram the chip. He didn't, but he did have a paper copy of the EEPROM map that I could use to program it manually. This is not an easy task, but is cheaper than buying a replacement EEPROM.

After a few attempts at correcting the data, making multiple errors in the process, I came to the conclusion that it would be easier to erase the chip completely and type all the 512 hex codes in by hand, using my programmer. This took some time but cured the fault – the set now came on. After setting up the geometry I read the EEPROM again and stored a copy on my computer for future use.

This was not the end of the story however. When the set had been on test for a few hours I noticed an intermittent disturbance on the picture, followed by a reduction in height and the contrast going to zero. The set then switched off, and was again stuck in standby. Once again the data in the EEPROM had changed on its own.

My friend came to the rescue again, with a copy of the Sharp technical bulletin that relates to intermittent data corruption in this chassis. It said that the cause of the problem is the MR852 5V supply rectifier diode D709, which should be replaced even though it might test OK. I fitted a replacement and again reprogrammed the EEPROM. After that the set ran for a week without any problems, and has not returned since. M.D.

Thomson ICC20 chassis

According to the customer this set would switch itself off when teletext was select-

ed, with the LED at the front flashing an error code. When I had it on the bench it wouldn't come on at all. Instead, it flashed up error code 26 (tube not getting warm in time). After checking for dry-joints in the CRT heater supply and finding everything here OK, I turned my attention to the safety circuit. This is connected to pin 5 of the TDA9330H chip IV200. The set reverts to standby when the voltage at this point rises above 2V. In this set the voltage rose to 4V. Various circuits are monitored. Rather than disconnecting various surface-mounted components, I decided that it would be quicker to short pin 5 to chassis and see what happened.

The set now came on, with sound and a picture, but when switching through the different sizes the picture became unstable. In addition something in the line output stage was getting hot. I found that this was the Cinerama switching FET TL100, which read faulty when checked with my FET analyser. As a quick test I tried a different type, but this produced the same fault. The set worked correctly in all picture modes only when the correct type of FET (STP10NB20FB) was fitted.

Another thing to watch out for with this chassis is a dry-joint at the scan-coupling capacitor CL035. It can be very hard to see, and can result in the set reverting to standby after a few hours' use. But don't just resolder the capacitor: take it out and measure its value. This can often be low as a result of internal heating. M.D.

Goodmans GTV601

The reported fault with this ageing set was sound distortion. The customer omitted to mention that there were also lines on the picture, with slight field cramping at the bottom. The sound was like an outboard boat engine. Within five minutes the field fault was getting worse.

For a change I decided that the faults were related. The circuit diagram was of the guess-the-voltage type, but there were only two outputs from the power supply. It seemed to be a good idea to scope for noise on these outputs. The 110V HT supply was OK but when I came to the 15V supply, at the cathode of D905, there was a 2V AC ripple. As a quick check, I disconnected the cathode of D905 and fed 15V to this point from my bench power supply. The result was perfect sound and vision.

There are only three components in the 15V supply. I decided to replace D905 and the reservoir capacitor C917, but this made no difference. The only component left was the 0.68Ω surge-limiter resistor R619. I had already checked it in-circuit, and when I removed it and checked it again it still read OK. At this point I was ready for the men in white coats. The only thing left

to do was to replace it and hope for the best. To my surprise, this cured the fault.

Out of interest I decided to heat the resistor and measure its resistance. The heating made no difference. My conclusion is that the resistor's value increased under load. U.H.

Grundig Monolith 70-290

This set was dead. A check on the voltages around the TDA4601 control chip in the chopper power supply showed that there was only 5.8V at pin 9. No less than 9V is required here for the chip to work correctly. The obvious thing to do was to check the reservoir capacitor for this supply, C633 (100 μ F, 40V), which turned out to be open-circuit. But when I fitted a replacement and switched on there was still nothing.

Time to check the output voltages at the secondary side of the circuit. The HT and the +8V and +5V supplies were present and correct, but the -12V and +12V supplies were both missing. When I traced back to pin 10 of the chopper transformer I found that there was an 0.22 Ω resistor, R661, that was open-circuit. A replacement cured the fault.

The initial mistake I made for the second fault was that the blue relay on the secondary side of the power supply wasn't being activated. U.H.

Bush 28ZKF

This set is fitted with a Tatung chassis – I've come across it in the Tatung Model 28W441. The symptoms were as follows. The set came on in standby, which is normal with these sets, and a red light. When the remote-control unit was used to switch on, the light went green but nothing else appeared to happen. There was no sound or raster, and no further response to the remote-control unit.

I opened up the set and found that the supply to the line output stage was OK and the field scan circuit was running. The only explanation I could think of was that there was something wrong in the microcontroller (ICR1) circuitry. Checks here showed that the voltage at pins 38 and 39 was low at only 2.7V. This led me back to the power supply, where I found that the BD441 5V regulator transistor TP6 was faulty – it had visibly overheated. In fact it looked as if its heatsink clip had been missing from new. A replacement BD441 transistor and a clip from a scrap chassis cured the fault. P.L.

JVC AV-28WFR1EK

Goes to standby was the reported fault with this set. And that's what happened, sometimes after only a few seconds and

sometimes after running for a few hours. When it went off there was just the red standby light. No amount of tapping or flexing would instigate the fault: it just happened when it wanted to. There was a clue however. When the set went off, it had to be switched off at the mains before it could be brought back out of standby. This indicated that the protection line was being activated. A scope connected to a suitable point proved that this was the case.

After disconnecting the various monitoring diodes I found that transistor Q593 was being turned on, because the voltage at the potential-divider network R595/6 was exceeding its turn-on threshold. This circuit monitors the voltage (60V) at pin 8 of the line output transformer. I found that the voltage here was high and was varying, as were all the secondary voltages derived from the line output transformer, though the HT supply to the stage was rock solid.

It was time to check components in the line output stage. C521 (3.5nF, 1.6kV) in the flyback tuning circuit turned out to be low in value. A replacement provided a permanent cure.

Note that the value of the capacitor used in this position depends on the tube size etc. P.L.

Test Case 508

Ever since there have been TV sets there have been whistling ones, though the incidence of this is much less now than it used to be. In the days of 405-line scanning the frequency was 10-125kHz: a whistle at that rate could be quite excruciating. The most common cause of an audible whistle is magnetostriction, where the ferrite core of a wound component vibrates at a frequency related to the current flowing through the winding. Most modern sets contain fewer wound components than older ones but the main suspect, where one is used, is the line linearity coil assembly.

So it was that Real Technician headed for the line linearity coil in a whistling TV set that appeared on his bench one fine winter morning recently. It was a Tatung Model T20TD51, a 20in. receiver of many years' standing. It's fitted with the D chassis, which is a good one – easy to understand and service, and predictable though not particularly reliable. The whistle was very loud and disturbing, but it was surprisingly difficult to trace the cause. Poking and flexing the wound components in the line output stage – the driver transformer T401, output transformer T402 and

the linearity/width adjustment coil L407 – had no effect on the piercing whistle that came from within the set. A replacement linearity coil obtained from a scrap chassis also made no difference. Nor was it obvious exactly where the sound was coming from! Real Technician had the bright idea of connecting an electrically-screened microphone to his oscilloscope and waving it about over the chassis. This proved that the whistle was not coming from anything in the line output stage. In fact it was coming from the chopper transformer T801. What a surprise!

It took very little time to transplant a chopper transformer from a scrap chassis in the set on the bench, much less time to discover that it hadn't cured the fault. It seemed unlikely that both transformers were noisy, so RT looked elsewhere. He found an old technical bulletin that recommended changing the value of C806 to 2.2nF to cure power-supply noise in the standby mode. He then found that C806 was already 2.2nF, and that a replacement didn't help. After all, this was suggested as a cure for noise in the standby mode only! He next checked for hash on the DC lines

in the power supply: the 320V supply on the primary side and the 115V and 17V outputs on the secondary side. None of them had excessive ripple, either before or after replacement of the relevant reservoir capacitors C808, C813 and C410.

RT was by now a desperate man! He went on to check by substitution various other capacitors in the power-supply section: C803, C813 and C805. They all proved to be OK, but the value of C805 was changed to 22nF on the recommendation of another technical bulletin. RT discovered that there were three little ferrite beads in the power supply, FB801/2/3. Could they have been responsible in some way? Substitutions from the scrap chassis proved not.

At this point it was almost decided to scrap the set and give the customer a replacement. After all we are knee-deep in similar ex-rental TV sets. At the last minute however clever-clogs Sage suggested something to RT, and in next to no time the cause of the trouble was found and cured. This was a somewhat unusual case. Any ideas? You will find the solution on page 379.

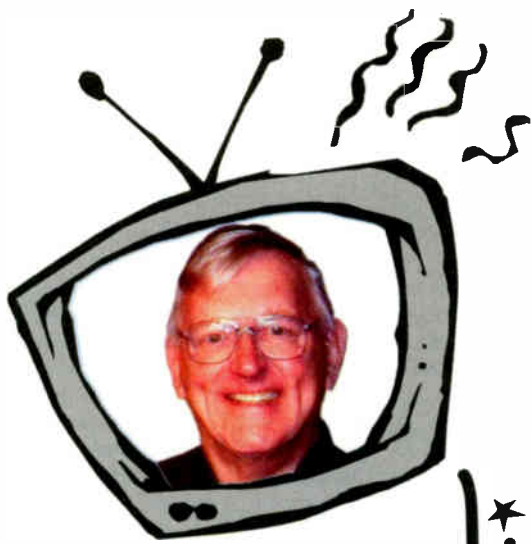

What a life!

Donald Bullock's servicing commentary

Hire-purchase protection ▶ A collection of Dysons ▶ Shopping in Spain
The Sony KVX2962 ▶ That record-player deck ▶ Emails

Years ago when we used to sell a £65 monochrome TV set on three years' hire-purchase (and suffer the financial consequences if, during that time, the financial company deemed the purchaser 'bad') we used to fill in a Proposal Form then relay the information, by phone, to the local branch of our Trade Protection Society – to get the low-down on the proposed buyer. The phone was always answered, to the melody of others ringing in the background, by a mature, fruity-sounding, deep and round-voiced eccentric who always seemed to be in a hurry, to answer the other phones I expect. His name was Eustace Manning, and he was also a lay preacher.

"What is it m'dear?" he would boom at me, "tell me now, quick as you can!"

"Oh!" I'd say, "can you tell me if Mr Ransome of 1, Nut Lane, Pleabury is good or bad?" Or it might have been Mr Brownett or Sally Springer of Sunnyside Avenue or whoever. He never once had to refer to his files. He knew all about everybody, and his response was always immediate.

"Hoo-hoo! Ho-ho-hahh!" he might laugh, "don't touch him with a barge-pole m'dears! Ho-ho! Old Ransome trying it again! I say, whatever next!" Or "Hah!, I see old Sally is back out!" Or "Poor old Mr Brownett. Best of intentions, but he just never manages to pay anybody a penny!"

Other times, he would be optimistic and complimentary. "Oh, a most wonderful fellow! Built his business on credit and paid every penny on time.

Even when his wife ran off with his partner and cleared his account of every penny. Worked tooth and nail and paid everything back. Wonderful chap!"

Another Manning

Even farther back in time, when I was a boy, I used to make my own fishing tackle. I would cadge pieces of cork, for making floats, from Corky Manning's dusky little cork-cutting workshop down by the river. Corky, who was noted for his kindness, lived on fistfuls of coarse brown snuff, which he frequently grabbed from a huge wooden box. Much of it would lace the air or join the thick layer on the front of his waistcoat. You would start wanting to sneeze as soon as you entered. And, because you could hardly speak, he would get impatient and rasp at you "Come on now, speak up! I haven't got all day you know!"

Then he would slap his waistcoat with both hands, sending a cloud of the concentrated stuff up into the air. This would make one's eyes stream and you'd have to grope out through the door. You'd be sneezing and spluttering for a hundred yards or more.

It was only when I mentioned Eustace to the editor that I recalled Corky as well. Two Mannings. Both eccentric. Both kind. I must try to discover whether they were related.

Spanish finds

In our part of Spain there are no milkmen and no postmen. Nor are there any household refuse collectors. Instead we

have to deposit our rubbish in the large, plastic bins that every village or area provides in a frequently-cleared walled-off compound. There is also an area for dumping anything that's too large for the bins, like old wheelbarrows or broken furniture or TV sets. There is often an assortment of large-screen sets. I've often remarked that one could open a reconditioned TV shop here, getting one's stock from the tips.

Anyway about two months ago Greeneyes saw a yellow-and-grey Dyson 04 vacuum cleaner that had been dumped and brought it back to my workshop here (our own Dyson at the time had been one of the much inferior 03 models). The one she found was crammed solid and the mains lead had been snipped off flush at its point of entry. I cleared it out, cleaned and oiled it, replaced the mains lead then tried it. The machine worked perfectly, and I was able to present Greeneyes with a mint and efficient Dyson 04.

A month later we saw another 04 that had been dumped in exactly the same place. This time it was a purple and grey one called a Zorbster, with a dry-powder carpet-shampooing facility. This machine was also crammed full of impacted dog hair but was otherwise in mint condition – and the mains lead was intact! Was I going to go on finding a Dyson a month? Maybe it should be a reconditioned appliances not a TV shop.

Yesterday I found a third one, at a different but equally nearby site. This one was a Model 01. It had been carefully emptied, cleaned and polished,

then deprived of its life-giving mains lead. So I decided to take it home to check over. Because the latest one was so immaculate, it occurred to me that the cleaner might have been taken somewhere for a quote, been condemned then dumped. Perhaps it had a burnt-out motor. When I inspected the stump of the mains lead I saw that the inner cables had burnt where they take the strain.

A mains lead later, we have a third mint and working Dyson cleaner. I've always thought that I seem to lead an interesting life, without really trying! Previously, Greeneyes had come back with a compact silver and mint-condition Matsui VP94061 VCR she'd seen there. It worked when tried, and is still working merrily.

Shopping in Spain

Here's another thing that happens to me, whenever Greeneyes and I go out shopping together. Last time was typical. I wanted a hardened-steel five-eighths metal drill to help me make my latest dog-restraining grill to stop Greeneyes' pack of hounds from streaming out under the front gates whenever anyone dares to walk along the road outside. So into the ironmongers we went.

"I want a hardened-metal drill please" I said to the fellow there, in my best Spanish.

He looked at Greeneyes. "What size, madam?" he asked.

Greeneyes turned to me and I told her. "A half-inch one" she repeated to the fellow.

He took a long one and a short one from a drawer. "Are either of these suitable?" he asked her.

I looked at them, then at him, and pointed to the short one. "This one will do" I said.

He held it up and looked at Greeneyes. "This one, you think?" he enquired.

"Yes please" she smiled.

From there we went to a bar. "Two beers please" I said.

The woman looked at Greeneyes. "Draught or bottled?" she asked.

I looked at her, then around the place. "Bottles please" I replied.

She looked at Greeneyes. "Bottles?" she asked.

I don't know why this is. Could it be because she looks as if she might be Spanish, while I don't?

A Sony K VX2962 (AE2 chassis)

My correspondent Grantley Best of West Norwood has asked how to get his Sony K VX2962 into the tuning mode. He also mentioned that it's dead, with the LEDs flashing. I asked Steven, who's the Sony expert around here. His

advice is as follows.

Once the set is working again access to the tuning mode is via the remote-control unit. There are two LEDs side-by-side at the front of the set. The number of flashes indicates the fault area. The first LED flashes up to thirteen times, then the second one flashes once to indicate that the sequence will restart with the first LED. Usually the first LED flashes thirteen times then starts again, indicating a fault in the field output stage or, less likely, a line output stage fault. It could be the line output transistor, but the usual cause is undetectable dry-joints around the TDA8179S field output chip IC501. Try resoldering every pin. If this doesn't cure the fault, replace the IC and the small number of associated electrolytic capacitors.

While on the subject here's the flashing fault code for the set:

- (1) I²C bus SDA line low.
- (2) EEPROM IC072 fault.
- (3) Fault in tuning PLL.
- (4) TDA9145 colour decoder chip fault.
- (5) CXA1587 jungle chip fault.
- (6) TDA6612 sound processor fault.
- (7) CDX2018 digital deflection processor fault.
- (8) CXA1545 AV switch chip fault.
- (11) SDA5248 text chip fault (applies only when there's a separate text PCB).
- (13) Vertical protection in operation. Field or line output stage problem.

That Sony PS-LX50 fault

Many thanks to the readers who have emailed me about the fault I have with this record-player deck, which uses electronic speed control instead of a stepped drive wheel. The two motor leads are connected to the first and fourth legs of a semiconductor output device that had been running hot and is well cooked. One problem is to identify this device. The printing on it is faint and microscopic, and has been affected by the overheating.

Martin Pickering, who has vast knowledge of and technical data on semiconductor devices, suggests that it might be a uPC1470. This looks like a four-legged BD131 and is described in the data as a motor-speed control IC. Looking again at the original, with the aid of a magnifier, I am convinced that he is right. I have a pair of them winging their way to me now!

But I still don't have a circuit diagram, though the ever-helpful Colin of Fryern's (FES) is making enquiries for me. He advertises most months in the Service Data section at the end of the magazine.

Adverts

Talking about advertisements, I was

pleased to see that Pete Hill was in the magazine recently (P.J. Hill Components of Tewkesbury). I remember Pete from more years past than I care to recall, when he first started in business from his home. During his calls all workshop activity would cease. We would perch on the tops of a couple of sets for an hour, laughing like loons as Pete spun me the latest trade funnies.

Pete gave me the following couple of jokes at the time. Remember, they've had several years to do the rounds.

First:

Patient: "Doctor, I feel insignificant."

Doctor: "Next!"

Second:

Elderly patient: "I used to think I was undecided, now I'm not too sure!"

If they still make you cringe, call Pete not me! He's available for your complaints (and TV/VCR spares orders) on 01684 296 902.

Emails

Terry Robinson of Woodend, Victoria, Australia comments that the TV programmes there are worse than those in the UK. "Thank goodness for our video machines and DVD players" he says.

Ron Bravery, who hails from closer home, asks me to keep up the column and keep taking the tablets! He mentions an old customer, Mrs Blabber, who had been on the phone about her TV. Not having seen her for ages, he asked about her health.

"Terrible!" she replied, "just exploded with a terrible noise! Me heart's all a flutter and there's a peculiar smell. I'm telling you straight, I need a good man right away!"

Bill (of aerial fame) and Hillary Wright have written again, referring to my compilation of a video library of TV-transmitted films. He mentions an old customer of his who also built up a vast collection of televised films. Then, one day, Bill fitted a new array for him. This provided much improved reception. "It'll be lovely to enjoy the improvement when we watch our old tapes" was the comment as Bill tip-toed away.

Two years later Bill called to cheer him up after the death of his wife. He laughed at his earlier gaff, then went on "Never mind, it's given me something to do - I'm recording them all again!"

Referring to my bit about early video recorders, Bill says "I too had an early Panasonic. It cost me £711, then! But it lasted a lot longer than today's machines. One day, in 1981, Hillary thought she had broken it. The Channel 4 test transmission had begun on its output channel!"

Emails are always welcome. You can reach me at donald@wheatleypress.com



SATELLITE NOTEBOOK

**Reports from
Christopher Holland
and
Pete Haylor**

HDTV tests via Eutelsat W6

Various experimental high-definition TV tests, using the European 1.080-line system that's now known as HDE, have been mentioned in this column over the past

year or so. High Definition Forum signals have now started to be transmitted via Eutelsat W6 (21.5°E), which was known as W3 until recently. It seems to have been renamed to avoid confusion with Eutelsat W3A at 10°E. The frequency used is 12.520GHz H, with a symbol rate of 21.700 and a forward error correction value of 1/2. The signals appear to originate from France. Some examples are shown in Photos 1-4. High-definition satellite receivers are still thin on the ground, but the signals can be received fairly easily using a PC-based satellite

Table 1: Latest digital channel changes at 28.2°E

<i>Channel and EPG no.</i>	<i>Sat</i>	<i>TP</i>	<i>Frequency/pol</i>
Authentic TV (687)	EB	D10S	11.642GHz/V
Gay Network (688)	EB	C2	11.265GHz/H
Look 4 Love TV (685)	EB	D9S	11.623GHz/H
Reality TV UK + 1 (188)	EB	C2	11.265GHz/H
Smooth FM (878)	2B	32	12.324GHz/V
Teachers' TV (686)	2B	45	12.422GHz/H
Vectone World News (537)	EB	D10S	11.642GHz/V
William Road Colour Bars	2D	41	10.714GHz/H

EB = Eurobird 2B, 2D = Astra 2B and 2D

receiver.

Eutelsat W6 is located quite close to the Astra 1 slot at 19.2°E, which produces very strong signals. Thus if a small dish with a consequently larger acceptance angle is used some interference from Astra may be experienced.

Eutelsat W6 was also used recently to link some of the satellite feeds relating to the tsunami disaster. BBC feeds from Sri Lanka were present at 11.499GHz H (SR 5.632, FEC 3/4), see Photo 5. A French TF1 uplink was nearby at 11.526GHz H, using the same SR and FEC values – see Photo 6. C.H.

Test cards

Real test cards are rarely broadcast these days. I've recently found one however. It's present in the Hot Bird (13°E) Spanish multiplex that carries TVE International plus some other scrambled channels, and is accompanied by a Spanish radio soundtrack. The multiplex is transmitted at 11.785GHz H (SR 27.500, FEC 3/4). The test card has the EPG identification Libre Carta, which translates as Free Card in English.

Photo 7 shows the card, which was first used by Spanish TV in the mid Seventies, after their changeover to colour. It's not seen much terrestrially now that, as with most other countries, Spanish TV broadcasting continues for virtually twenty-four hours a day. C.H.

Digital channel update

The latest channel additions at 28.2°E are listed in Table 1. Where allocated, the EPG number is shown in brackets after the channel name.

Transponder 41 aboard Astra 2D has been activated for the first time and is at present transmitting William Road colour bars, see Photo 8. It's due to be used by ITV.

One TV, Max TV, ACTV and Fizz TV, listed last month, have been assigned EPG numbers 670, 669, 217 and 468 respectively.

Life TV (EPG no. 160), which had been transmitted via Eurobird transponder D12S (11.680GHz V), came to an end in late January but reappeared two weeks later via Astra 2B transponder 36 (12.402GHz V). At the time of writing it's still not back in the Sky EPG.

The South African channel Nsat TV, EPG no. 837, suddenly stopped being transmitted in early February. It had been available via Astra 2B transponder 36 (12.402GHz V).

Sky Movies 7 and 9, and Sky Cinema 1 and 2, have moved from Astra 2B transponder 20 to transponder 30 (12.285GHz V). Various Sky Box Office channels that were transmitted via transponder 30 have moved to Astra 2A transponder 11 (11.914GHz H).

The ITV News channel has moved to

Astra 2D transponder 49 (10.831GHz H). When this happened we came across an early Pace 2200 digibox that hadn't updated its EPG listings and was displaying NTL colour bars at EPG no. 525 where ITV News should have been. Resetting the digibox by unplugging it from the mains supply for a minute then repowering it brought the News channel back again.

The NTL colour bars took the place of ITV News at its previous transponder 17 slot for a few days. C.H.

Intelsat 603 update

We looked at Intelsat 603, which in an inclined orbit at 20°W, only last month. Since then several more frequencies have come into use.

A channel identified as ITV Birmingham is present for much of the time at 11.518GHz H (SR 3,437, FEC 7/8). It often shows ITV network programming, Central TV local news studio shots and a variety of interesting captions and cards, such as those shown in Photos 9-13. It's interesting that Photo 13 shows colour bars titled Anglia News. Just above, at 11.524GHz H, ITV Nottingham is present with colour bars (see Photo 14) unless transmitting material for Central TV News. These transmissions use the MPEG 4:2:2 format and thus require the use of a specialised satellite receiver or a PC-based one.

Other frequencies now in use are 11.504GHz H, 11.509GHz H and 11.519GHz H, all with the same symbol rate. They are used mainly for ITV regional news reports.

I've seen some weekend BBC Scotland sports transmissions at 10.968GHz H, with the unusual symbol rate of 12,600 and 3/4 FEC.

Occasional ITV regional newsfeeds have been seen at 10.994GHz H, 10.999GHz H and 11.004GHz H, but with the lower symbol rate of 3,437 and 7/8 FEC.

An error crept into last month's listings. The symbol rate and FEC for all ITN and ITV transmissions above 11.461GHz H are 3,437 and 7/8, not 4,224 and 7/8, though the latter values are used in the lower frequency block up to 11.200GHz, as listed last month. C.H.

The Humax Fox PSU

"Do you repair Humax?" a new customer asked.

"Yes" I replied, "they usually suffer from a power supply fault, and I stock replacement parts."

A day was arranged for my call. When I arrived I found that the receiver was a Humax Fox, which has a small power supply – not the usual type used in the 5XXX series.

On inspection, the electrolytic capacitors all appeared to be OK, with no leakage or splitting, but the power supply was dead.



Photo 1: High Definition Forum transmission via Eutelsat W6 at 21.5°E.



Photo 2: High Definition Forum transmission via Eutelsat W6 at 21.5°E.



Photo 3: High Definition Forum transmission via Eutelsat W6 at 21.5°E.



Photo 4: High Definition Forum transmission via Eutelsat W6 at 21.5°E.



Photo 5: BBC feed from Sri Lanka via Eutelsat W6 for tsunami reporting.



Photo 6: French TF1 uplink from Sri Lanka via Eutelsat W6 for tsunami reporting.

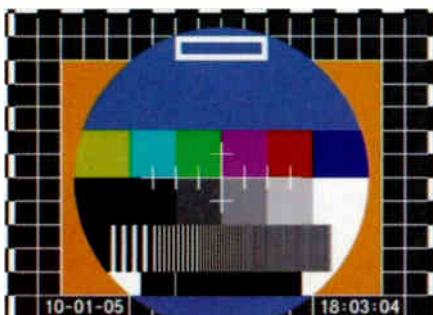

Photo 7: The Spanish test card that's transmitted via Hot Bird (13°E) in the multiplex at 11.785GHz H.



Photo 8: William Road colour bars transmitted via the newly activated Astra 2D transponder 41.

I took the receiver back to the workshop and replaced all the electrolytic capacitors. The power supply then burst into life, with the customer's Russian channels selected.

A time was arranged for its return the following day. The customer met me and quickly installed his receiver. He was more than happy when his channels appeared. Fortunately there was no long vodka session!

Must try to obtain a spare power supply to meet possible future need. Fig. 1 shows the electrolytic capacitor layout. P.H.



Photo 9: Reception from Intelsat 603 at 11.518GHz H. The channel is identified as ITV Birmingham.

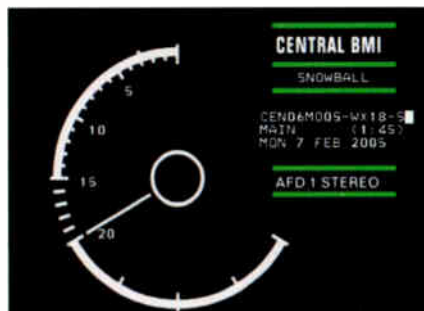

Photo 10: Reception from Intelsat 603 at 11.518GHz H. The channel is identified as ITV Birmingham.



Photo 11: Reception from Intelsat 603 at 11.518GHz H. The channel is identified as ITV Birmingham.



Photo 12: Reception from Intelsat 603 at 11.518GHz H. The channel is identified as ITV Birmingham.

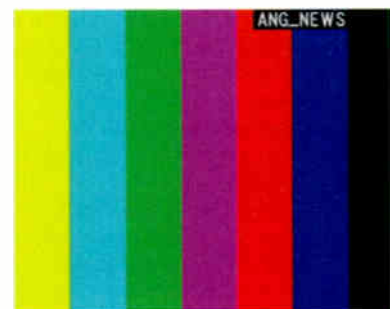

Photo 13: Reception from Intelsat 603 at 11.518GHz H. The channel is identified as ITV Birmingham.



Photo 14: Reception from Intelsat 603 at 11.524GHz H. The channel is identified as ITV Nottingham.

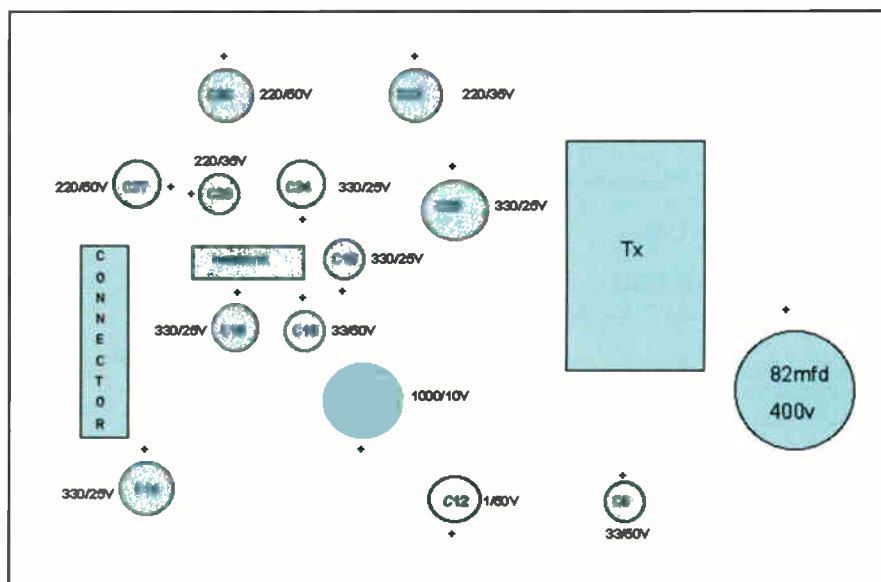

Fig. 1: Electrolytic capacitor layout in the Humax Fox satellite receiver's power supply.

WEB SERVICE

To reserve your web site space telephone
 Tel: 01322 611291 Fax: 01322 616339
 E-MAILS m.traylen@highburybiz.com



Alltrade Aerial & Satellite Ltd

www.alltrade.co.uk

Leading distributor to the trade. Full e-commerce site with over 1500 products with in-stock quantities!! We supply everything associated with Digital/Analogue Terrestrial & DTH/Motorised Satellite reception. All Antennas. All Brackets. All Cables. All Connectors. All Amplifiers. We provide a free MATV/SMATV planning service as well. Trade Counters @ Brighton, Cardiff, Darford and Watford
 Phone 0845 075 0751
 Fax 0870 770 9151



Charles Hyde & Son Ltd

www.charleshyde.co.uk

Search for both original and copy spare parts in our extensive database covering Akai, Alba, Bush, Ferguson, Goldstar, Hitachi, LG, Matsui, Nokia, Saisho, Sanyo, Sony, Sharp, Thomson, Panasonic, Philips, Samsung, Tascam, Teac, Toshiba, Yamaha and many more. In addition huge ranges of Lasers, Laptops, Remote controls and Semiconductors may be accessed.



College of North West London

www.cnwl.ac.uk

The College of North West London is one of the largest further education colleges in the UK with three major centres in north west London. Most of our students use the College as a stepping stone to employment or higher education – we have links with Middlesex, Westminster and Thames Valley universities. Once they begin their careers they often come back to us for further qualifications and more specialised training. This means we are a College with a great mixture of ages, backgrounds and experience and this creates an interesting and lively atmosphere. One great benefit of our size is the exceptionally wide choice of courses. With few exceptions, whatever you want to do, and at whatever level, you can do it at the College of North West London. Most of our staff have considerable experience working in the area of their specialism and they know their industries thoroughly.

See page 274 in the March issue for details of our Plasma Technology Course.

For just £29.17 per month you could advertise your website in this section.

It will be seen by over 8,000 repair and installation engineers.

Call Mike on 01322 611291 to secure your space today.



SOFTCOPY

www.softcopy.co.uk

As a PC data base or hard copy, SoftCopy can supply a complete index of Electronics World articles over the past ten years. Photo copies of articles from back issues are also available.



Swires Research

www.swires.com

Swires Research produce high quality instruments for the television industry, including portable signal level meters and spectrum analysers for digital and analogue RF signal measurements.



Wizard Distributors

www.wizard-distributors.co.uk

Main distributor for major brands. Search by make/model for LOPTX; switches; remotes etc. Find ICs; semiconductors; service kits; lasers; capacitors; resistors and a huge range of service aids, tools and other products.

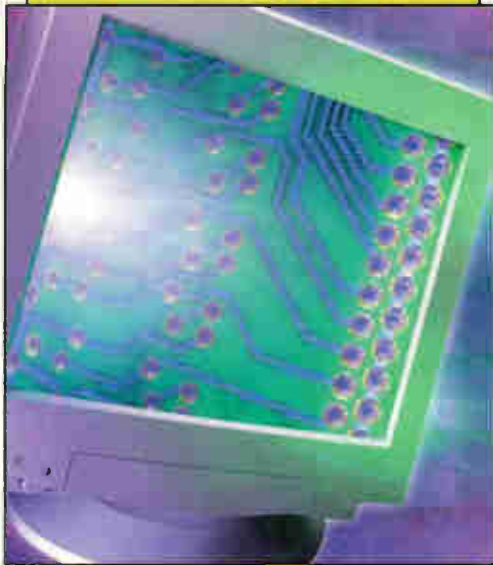

MONITORS

Fault reports from
Bob Bradley
and
Ian Field

We welcome fault reports from readers – payment for each fault is made after publication.

Reports can be sent by post to:

Television Magazine Fault Reports,
Highbury Business,
Media House,
Azalea Drive, Swanley,
Kent BR8 8HU

or e-mailed to:
t.winford@highburybiz.com

Philips 107MB

The following fault seems to occur with Models 17B2302N and 17C2321N. At switch on the green power LED lights but there's no display on the screen. Checks will show that the outputs from the power supply are OK, and that there is line drive at the base of the line output transistor.

The cause of the trouble is dry-joints at FET Tr7621, which is mounted on the heatsink of the screening can in the line output stage. It's also worth resoldering transistors Tr7622 and TR7605, which are mounted on the same heatsink. **B.B.**

Compaq S910

This 19in. monitor was brought into the workshop by the field engineers, the complaint being that it made a hissing noise intermittently. Suspecting that the cause might be an EHT leakage, I started to strip away the screening metalwork that surrounds the chassis and CRT to gain access. Before switching on I inspected the EHT cap and lead for cleanliness and any sign of damage on its route to the line output transformer, but these items both seemed to be OK.

I couldn't hear the hissing noise at switch on, so I left the monitor on test in its stripped down state and carried on with something else, returning periodically to check on its condition. After a couple of hours or so I started to notice a faint hissing noise, which increased in loudness as time went on. It was difficult to detect the area from which the hissing came, but it was not EHT leakage as I had first suspected. So, armed with a can of freezer, I cooled down various areas of the chassis while monitoring the effect. A noticeable change occurred when I started to apply freezer in the power supply. In fact the fault disappeared until the components here started to warm up again.

I stripped the chassis down further to gain better access to the power supply, then tried to find the faulty component by applying freezer to individual ones. The fault was too sensitive for this approach however. I next tried block replacement of the four electrolytic capacitors associated with the KA3543 chopper drive IC: C812, C804 (both 100 μ F, 25V), C810 (0.47 μ F, 50V) and C828 (1 μ F, 50V). Unfortunately this made no difference. The fault was cured by replacement of the IC itself, as a soak test lasting several hours proved. **B.B.**

Dell D1428E-LS

This monitor came back as a return, because the CRT was dud. Blue flashes in its neck suggested a soft vacuum. The original fault had been the usual dry-joints

at the TO220-cased three-terminal regulator, causing a sync fault (multiple images). As usual, I had resoldered almost everything to eliminate random power supply chirping, the dry-joints that occasionally plague the LM1203 video chip, and the various problems that affect the IRF9610 and EW driver transistors.

This time, after a consultation with the customer, the monitor was written off. I nevertheless decided to see what could be done by way of tube swapping. The Samsung M34KUK35X02(VK) tube that was fitted can be replaced with the Samsung M34KUN35X92(J)-K or Chunghwa

M34AFA83X03K/CPJ370BUAPIS-TC with minimum modification (scan plug adaptor). These were available in scrapped Elonex MN069 (A9S etc.) monitors. The results were disappointing when the Samsung alternative was fitted, and the same results were obtained when the Chunghwa tube was tried. The service company from which the MN069s had come indulges in panel swapping, cannibalisation and tube swapping, so it was possible that both CRTs were dud. But, on a hunch, I disconnected one end of C14 (10nF, 1kV disc ceramic) on the CRT base panel. The resulting improved display revealed that the Chunghwa tube had a loose shadowmask in addition to out-of-range unbalanced emission from the guns. Matters were better when I reverted to the previously-tried Samsung CRT, but its emission needed improvement.

As usual the heater voltage was low, this time 6.21V. I then found that the HT preset had been advanced in an attempt to improve the performance. Once the 6.3V rectifier had been replaced with a Schottky-barrier type it was possible to reset the HT voltage to its correct value without compromising the heater supply.

The scrapped MN069s also provided the basis for replacement multisync cables. When removed from the scrap chassis, cut the green and orange wires – these are plug-and-play SCL and SDA. One is pin 12 which, if grounded, could cause older video cards to initialise in the monochrome mode. R, G and B go to the male 9-pin D-connector straight, pin 1 to 1, 2 to 2 and 3 to 3, with the respective earths likewise at pins 6, 7 and 8. Pin 4 is H sync, from pin 13, while pin 5 is V sync, from pin 14. Pin 9 is listed as ID, using the wire from VGA pin 5 – "POST" seems to work OK. Most cables have a braid wire that should be soldered to the plug body. If a separate wire is provided for pins 4, 10 and 11, it should share pin 9 of the 9-pin D-connector with the wire from pin 5. **I.F.**

Solution to Test Case 508

- see page 371 -

Most irritating whistles from TV sets come from components in the line output stage. This whistle was unusual in coming from the chopper transformer in the power supply. The suggestion Sage made was to check the waveform at the drain of the chopper transistor Q801. When this was done it was seen to be very different from the one shown in the service manual, waveform 802. What RT and Sage saw was a spiky squarewave with three distinct levels during the period of a complete cycle. There were damped oscillations at some of the transitions. It was a messy waveform indeed, and looked none too good for the health of the chopper transistor, though the output voltage levels were exactly correct.

Casting around for possible reasons, they soon discovered that the waveforms at the two ends of R818 in Q801's drain circuit were the same. This led them to the correct conclusion that the snubber capacitor C809 (1.5nF, 1.5kV), which is in series with R818, was open-circuit. Its replacement, from that same good old scrap chassis, changed the chopper transformer's drive waveform radically. It now corresponded far more closely with the one shown in the manual, with two voltage levels and much less spurious oscillation. The whistle had also disappeared, thus solving the problem.

It's likely that in many TV chassis designs an open-circuit in the snubber network would wreck the chopper transistor.

NEXT MONTH IN TELEVISION

Spares Guide 2005

The annual *Television* TV/VCR spares guide, an updated list of sources of spares for TV and video products. It's essential reference information for the service department.

Wireless CCTV with remote switching

There are times when it's not possible to connect a CCTV camera at a particular location via cable. A 2.4GHz audio/video sender can be used to overcome this problem. But where more than one camera is involved, remote switching is required. The sender includes a 430MHz return path for this purpose. Ian Rees describes a design that implements this option for a two-camera manually-switched system.

Servicing the Mitsubishi HS621V

This VCR is fitted with the U deck, which appears to have been the last one from Mitsubishi. John Coombes provides a guide to fault-finding with these machines.

Vintage push-pull audio output stages

J. LeJeune takes a look at some of the push-pull audio output stage circuitry used in the era of valve equipment, including a transformerless circuit from Philips.

TELEVISION INDEX & DIRECTORY 2005

Plus hard-copy index and reprints service

Here's the essential repair information you need! The Television Index & Directory 2005, in CD-ROM form, contains the text of over 16,000 high quality fault reports on TVs, VCRs, Camcorders, DVD players, Monitors, Satellite TV units, Audio equipment and CD players, searchable by make and model, plus the text of 200 Test Cases and over 300 major servicing articles, from seventeen years of Television magazine. It also contains a full seventeen-year index of Television, a Spares Guide, a directory of Trade and Professional Organisations, an International TV Standards guide, a satellite TV Channel Finder, a TV transmitter list and a compendium of internet resources for service engineers. The software is quick and easy to use, and runs on any PC with Windows 95, 98, ME, NT, XP or 2000.

Television Index & Directory 2005 CD-ROM, £199

Television Index & Directory 2005 CD-ROM upgrade, £47 (to qualify for this upgrade you need to have purchased a previous version of the Television Index on floppy disk or on CD-ROM)

A six-month update of the index and fault reports will be available in May 2005. If you wish to take advantage of this, £10 should be added to your order.

Television Index only, 1988—2004, £36

Television Index only upgrade from previous versions, £20

Hard-copy indexes of Television magazine are available for Volumes 38 (1988) to 54 (2004) at £3.50 per volume.

Reprints of articles from Television back to 1988 are also available, at the flat rate of £4.00 per article — you can order through our web site, or write to the address below.

The above prices include UK postage and VAT where applicable. Add an extra £1 postage for non-UK EC orders, or £5 for non-EC overseas orders, although Channel Island residents do not need to add any extra postage. Cheques should be made payable to SoftCopy Ltd. All major credit and debit cards are accepted. Please use our new secure website for your orders, details below. Allow up to 28 days for delivery (UK).

SoftCopy Limited, 1 Vineries Close, Cheltenham, GL53 0NU, UK

**Telephone 01242 241 455 Fax 01242 241 468
e-mail: sales@softcopy.co.uk**

web site: <http://www.televisionmag.co.uk>

Published on the third Wednesday of each month by Highbury Business, Media House, Azalea Drive, Swanley, Kent, BR8 8HU. Highbury Business is a division of Highbury House Communications PLC. Filmsetting by Impress, Unit 2, Parkway, Southgate Way, Orton Southgate, Peterborough PE2 6YN. Printed in England by William Gibbons Ltd, 26 Planetary Road, Willenhall, West Midlands, WV13 3XT Distributed by Seymour Distribution Ltd, 86 Newman St, London, W1T 3EX. Sole Agents for Australia and New Zealand, Gordon and Gotch (Asia) Ltd.; South Africa, Central News Agency Ltd. Television is sold subject to the following conditions, namely that it shall not, without the written consent of the Publishers first having been given, be lent, resold, hired out or otherwise disposed of by way of Trade at more than the recommended selling price shown on the cover, excluding Eire where the selling price is subject to currency exchange fluctuations and VAT, and that it shall not be lent, resold, hired or otherwise disposed of in a mutilated condition or in any unauthorised cover by way of Trade or affixed to or as part of any publication or advertising, literary or pictorial matter whatsoever.

ELECTRONICS WORLD

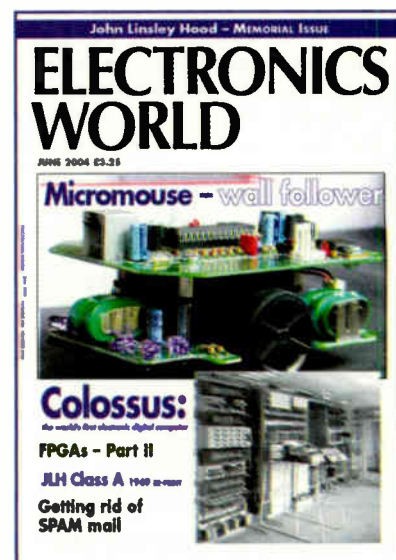

The world's leading electronics magazine, Electronics World is a must read for any electronics professional or serious hobbyist.

Featuring every month most aspects of the global electronics industry, it covers research, technology, applications, products and theory in areas such as audio, RF, components, CAD design, simulation software, PC & micro based products, test and measurement, semiconductors and much much more...

● Keep up to date with the latest information affecting the industry

● Essential reference and in-depth features covered monthly

Make sure of your copy now...

Subscription rates for 1 year:

UK £38.95 ● Europe €93.52

USA \$106.40 ● Rest of the World £64.50

Subscription rates for 2 years

UK £62 ● Europe €150

USA \$170 ● Rest of the World £103.20

Contact

Highbury Fulfilment Services,
Link House, 8 Bartholomew's Walk, Ely, Cambridge CB7 4ZD.

Telephone 01353 654 431

Fax 01353 654 400

Email hbc.subs@highbury-wyvern.co.uk



Does your company promote itself using Brochures, Catalogues, Leaflets or other promotional literature?

Would you like them read by approx. 9000 relevant people within the Consumer Electronics industry?

By inserting them into Television & Consumer Electronics magazine, you will be able to target a large number of potential customers, enabling your brochure or leaflet to be strategically distributed throughout the UK within the magazine.

For further information on how Inserts can work for you, call Mike on 01322 611291 or email: m.traylen@highburybiz.com

sky & Freesky

Making Television look better.

An opportunity for repairers and retailers

No FREEVIEW in your area, or maybe you and your customers want more channels than FREEVIEW can offer, we have two solutions for you and your Customers, SKY and Freesky.

The first consists of FREE equipment with a SKY subscription, and the second, Freesky is FREE from subscription when they buy their equipment. The latter is also ideal for existing SKY subscribers who want a second or third box without any additional subscriptions.

We have the equipment for both systems, and in both cases there is money to be made. Do not let your customers take their business elsewhere because you cannot provide for their needs right now.

They may not come back in the future.

If you are interested in the above opportunities, then become an SDS Buddy. Fax a letterhead to us on 01271 329163, or email sales@sdstrade.co.uk, state your company details and whether you have installation capabilities or not. SDS are also part of a national installation network, and we may be able to arrange installations for you if you do not wish to carry out your own.

Refurbished equipment also available, as well as an excellent repair service for most types of digital receivers, call us.

SDS - Satellite & Digital Services Ltd 01271 325888

Unit 5, Branhams Crescent, Barnstaple, Devon. EX31 3TD

PLEASE ENSURE YOU TELEPHONE TO CHECK AVAILABILITY OF EQUIPMENT BEFORE ORDERING OR CALLING MISCELLANEOUS CLEARANCE STOCK

OSCILLOSCOPES	Dranert 606 Line Distribution Analyser	£35	HP 37204 HP1B Extender	£10	Megger 1000V X2 Wind Up	£10
Tektronix 4659 Dual Trace 100MHz Delay fitted into 13" rack frame	Wayne Kerr B601 Radio Frequency Bridge	£25	Harfield 2115 Attenuator 75ohm 100dB	£10	Edgcombe 30A Clamp Meter Analogue	£10
HP 1740A Dual Trace 100MHz delay (no lock)	Feedback TF607 Transfer Function Analyser	£25	Harfield 2115R Attenuator 75ohm 100dB	£10	Unstead G1000 Generator 10MHz Sine/Sig/CMOS/TTL	£20
HP 1740A Dual Trace 100MHz Delay	Wavelek 52 Data Multimeter	£60	Harfield 2118R Attenuator 75ohm 100dB	£10	Circumate FS2 Function Generator 1Hz-2MHz	£30
HP 1741A Dual Trace 100MHz Analogue Storage	Gould SG200 RF Signal Generator	£20	Harfield 2135 Attenuator 600ohm 100dB	£20	Klippon UT2 Combi Check	£10
HP 1744A Dual Trace 100MHz Analogue Storage	Chaffoll Force Meter	£15	Tektronix 1103 Tekprobe Power Supply	£10	AVO 1200R clamp meter 0-600V 0-1200A Analogue	£10
Philips PM3264 4 Ch 100MHz	Alfred E105 Variable Attenuator 4-8GHz	£20	Syston Donner 6243A Frequency Counter 20Hz-1250MHz	£35	AVO TT169 Insitu Transistor Tester	£10
Gould OS3000A Dual Trace 40 MHz	Cammetric 6 Decade Resistance Box	£15	Lowell TG301 Function Generator 1MHz Sine/Sq/Tn	£30	Thurby Thandar TG102 Func. Generator 2MHz	£25
Tico CS1040 Dual Trace 40MHz	Sullivan C8710 Precision 5 Decade Capacitor Box	£20	HP 8404A Leveling Amplifier	£30	Farnell PA122 Programmable Attenuator 500MHz	£15
GoStar OS9020P Dual Trace 20MHz	Marconi 60339 Waveguide	£20	HP 3455A Digital Voltmeter	£50	Farnell ES31 Oscillator 1MHz	£20
Iwatsu SS5702 Dual Trace 20MHz	Marconi 2169 Pulse Modulator	£20	Feedback FM10 Digital Frequency Meter	£25	HP 5004A Signature Analyzer	£20
Kikusui COS5020 Dual Trace 20MHz	Marconi 2430A Frequency Meter 80MHz	£30	Farnell TM8 True RMS RF Millivoltmeter	£40		
POWER SUPPLIES	Marconi 6950 RF Power Meter - No head	£35	Thurby 1503 Digital Multimeter	£15		
Farnell L30BT 0-30V 0-1A Twice	Marconi 6960 RF Power Meter - No head - Digital	£50	Sullivan 6666 Milliohmeter	£15		
Farnell L30AT 0-30V 0-500mA Twice	HP X382A Variable Attenuator Waveguide	£20	K&L Tunable Bank Recept Filter	£15		
Farnell LT30-1 0-30V 0-1A Twice Scruffy	HP 5318A Counter	£30	Barr & Stroud EF-01 Bank Pass Filter 1Hz-100kHz	£15		
Farnell L30-2 0-30V 0-2A Scruffy	HP 8750A Storage Normalizer	£60	Barr & Stroud EF-02 LP/HP Filter 1Hz-100kHz	£15		
Farnell L30-1 0-30V 0-1A Scruffy	HP 907A Co-axial Sliding Load	£20	Fluke 8810A Digital Multimeter	£20		
Farnell L30B 0-30V 0-1A	Programma TM2 Timer	£20	Fluke 8502A Digital Multimeter	£35		
Farnell L30AT 0-50V 0-500MA	Racal 9009 Modulation Meter	£40	Racal 9009A Modulation Meter	£50		
Farnell C1 0-50V 0-1A - 2 Meters	Tacan SA59 102dB in 10B steps	£15	Tacan SA59 102dB in 10B steps	£15		
Farnell T0P51 5V 1A +/- 15V 200MA	HP 907A Co-axial Sliding Load	£20	RS 555-279 UV Exposure Unit	£20		
Coulant LB500 0-30V C-5A - 2 Meters	Bird 8341-200 Coaxial Attenuator 20dB 40W 50ohm	£25	Microdome Corp Receiver	£50		
Coulant LA200 2 0-3V 0-2A - 2 Meters	Bird	£1	Varian VZL-6941FI Travelling Wave Tube Amplifier	£150		
Coulant L07200 0-15V 0-2A - Twice	Wattmeter 6 & 30W 50ohm 30-50MHz	£40	Moore Read SFC500M1 AUXR Static Frequency Converter 120 Volts 400 Hz	£20		
Coulant L07100 0-30V 0-1A Twice	Telonic TP95-5-SEE Tunable Band Pass Filter	£20	Drager 21/21 Multi Gas Detector	£10		
Coulant L07500 0-50V 0-500MA	Telonic 190-3EE Tunable Band Recept Filter 125-250	£15	Phillips PM8237B Multipoint Data Recorder	£20		
Weir 761 0-30V 2A or 0-15V 4A	Telonic 95-3EE Tunable Band Recept Filter 60-125	£15	Endelex 4417 Signal Conditioner X 2	£10		
Weir 762 0-30V 2A or 0-15V 4A	Helper Inst CML1 Sinadder	£30	Pulsatex 132 DC Current Calibrator	£30		
Weir 431D 0-30V 1A - 5V 4A	Helper Inst S103 Sinadder 3	£30	PM1038-014 Display with 1038-N10 Network Analyser No Heads	£50		
Weir 406 0-4V 0.3A - 10V 1A	SXP100 Parallel to Serial Converter	£10	Megger MJ4MK2 Wind Up 1000V M0hm	£30		
Weir 460 0-60V 0.3A - 20V 1A	Micromaster LV	£40	Metrohm 250V Pat Tester	£10		
HP 6256B 0-40V 0-5A - 2 Meters	Dataman S3 Programmer	£50	Sullivan AC1012 4 Decade Resistance Box 0.05%	£10		
HP 6256B 0-10V 0-20A 2 Meters	RS 424-103 Logic Pulser	£5	Brandenburg Q20 Static Free Converter 110/240V input	£15		
HP 6111A 0-20V 0-1A	Global SD1 Shortcircuit	£20	50/60Hz Output 115V 40Hz 20VA	£40		
HP 6235A +6V 1A +/- 19V 200MA	RS 180-7127 Conductivity Meter	£35	Narda 706 Attenuator	£10		
Kingshill 36V2C 0-36C 0-2A	Eagle DC30 Probe 30Ku DC	£5	Analyse Associates X800 Audio Amplifier 800watt (400w per Channel no DC Protection)	£60		
Marconi TP2158 0-30V 0-2A Twice	AVD 100AMP Shunt for AVO 8	£5	W&G PG52 PCM Channel Generator	£30		
Lambda 422PM 0-40V 0-1A Twice 4 Meters	Southern California BTXRM-5-10 2000 0MHz	£50	Shivers Lab 12400 - 18000 MHz	£10		
Lambda LK345A FM 0-60V 0-10A 2 Meters	Mikrotron R2001D Communication System Analyser	£250	Siemens 5212 2500 - 4000MHz/CC264	£10		
Power Conversion PLC1600 Line Conditioner 1000VA	Weston 1149 Standard Cell 1.01859 ABS Volts at 20C	£10	Cropico V150 DC Standard 10V	£30		
Syston Donner SRH40-2V0 40V 0-2A - 2 Meters	Muirhead A-6-B Resistance Box	£10	Dawe 14050 Sound Level Meter	£15		
Sorenson SRL60-0 0-60V 0-4A	Racal 9917A UHF Frequency Meter 10Hz-560MHz	£45	Cambridge 44228 Potentiometer in Wooden Case	£10		
Grenson BP14 +5V 2.5A & +/- 15V 0.5A	Racal 9917 UHF Frequency Meter 10Hz-560MHz	£40	Weircliffe Model 6 Bulk Eraser	£30		
RS 813-9912 2 x 5V 2A or 2 x 12V 1.5A or 2 x 5V 1A	Racal 9915M UHF Frequency Meter 10Hz-520MHz	£30	Castella T8620 Heat Strain Monitor	£20		
RS 205-197 Line Voltage Conditioner - Output 240V 0.65A	Racal 9911 Universal Counter Timer DC-50MHz	£15	Castella Drum Recorder	£20		
Power Conversion PLC1600 Line Conditioner 1000VA	Racal 9900 Universal Counter Timer 30MHz DC-30MHz	£15	Negretti 0-55C Drum Recorder	£20		
Hirayn Automation PPS5200 System Power Supply	Wavelek 136 VCG/VCA Generator	£20	Negretti 125 Series Drum Recorder	£20		
Poverline LAB807 0-30CV AC 0.75A	HP 435A Power Meter - No lead no head	£15	Sato Keiryoku NS307 Hydrothermograph Dual Channel -15C to +40C	£30		
Power Supply Model 12030 0-20V 0-30Amps - On Wheels	HP 8015A Pulse Generator	£30	KAC Industries CECC00-015 Surface Resistivity/Resistance to Ground Meter - No Probe	£10		
Harmer Simmons 50/25/110 Input 240V 10A Output 50V 25A	HP 1038 AC Voltmeter	£15				
Centronic M100 Regaovw Input 240V 25V VA Output 240V 1000VA	Q-Loop PPA15 Phase Rotation Indicator	£10				
	Mxywom O2080 Digital Indicator	£10				

STEWART OF READING

17A KING STREET, MORTIMER, NR. READING RG7 3RS
Telephone: 0118 9331111 Fax: 0118 9332375
www.stewart-of-reading.co.uk
Open 9am-5pm Monday to Friday (other times by arrangement)

USED EQUIPMENT - GUARANTEED. Manuals supplied.

This is a VERY SMALL SAMPLE OF STOCK. SAE or telephone for lists. Please check availability before ordering. CARRIAGE all units £16. VAT to be added to total of goods and carriage.

TUBES

Offers invited for the following CRTs

16 x 9	4 x 3
28" W66EGV ...Thomson	20" 48LWH.....B P L
28" W66EHK ...Panasonic	20" 48EEBPhilips
28" W66EJUThomson	21" 51EERSamsung
28" W66EJYThomson flat	21" 51LPT.....Sony flat
28" W66LLX ...Sony flat	21" 51LVG.....Toshiba
28" W66QDE...Samsung flat	26" 66EAKPhilips
28" W66QBD...LG	26" 66EMZ.....Telsa
32" W76EDX ...Thomson	29" 68EDG.....Thomson
32" W76EGV ...Thomson	29" 68LNH.....Sony flat
32" W76EGX ...Thomson	29" 68QCPSamsung flat
32" W76EKW ..Panasonic	37" 90AFXThomson
32" W76EJYThomson flat	
32" W76ELC....Thomson flat	
32" W76LPX....Panasonic flat	

Ring Harry or Irene

EXPRESS TV SUPPLIES LTD
The Mill, Mill Lane. Rugeley, Staffs WS15 2JW
Tel: 01889 577600 Fax: 01889 575600

FRUSTRATED!

Looking for ICs TRANSISTORS?

A phone call to us could get a result. We offer an extensive range and with a World-wide database at our fingertips, we are able to source even more. We specialise in devices with the following prefix (to name but a few).

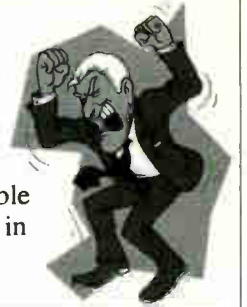

2N 2SA 2SB 2SC 2SD 2P 2SJ 2SK 3N 3SK 4N 6N 17 40 AD
ADC AN AM AY BA BC BD BDT BDV BDW BDX BF
BFR BFS BFT BFW BFX BFY BLY BLX BS BR BRX BRY BS
BSS BSV BSW BSX BT BTA BTB BRW BU BUK BUT BUY
BUW BUX BUY BUZ CA CD DX CXA DAC DG DM DS
DTA DTC GL GM HA HCF HD HEF ICL ICM IRF J KA
KIA L LA LB LC LD LF LM M M5M MA MAB MAX MB
MC MDA J MJE MJF MM MN MPS MPSA MP SH MP SU
MRF NJM NE OM OP PA PAL PIC PN RC S SAA SAB
SAD SAJ SAS SDA SG SI SL SN SO STA STK STR STRD
STRM STRS SV1 T TA TAA TAG TBA TC TCA TDA TDB
TEA TIC TIP TIPL TEA TL TLC TMP TMS TPU U UA
UAA UC UDN ULN UPA UPC UPD VN X XR Z ZN
ZTX + many others

Please visit our website at
www.cricklewoodelectronics.com
17 thousand components in stock

Mail, phone, Fax, Credit Card orders & callers welcome.



Cricklewood Electronics Ltd

40-42 Cricklewood Broadway, London NW2 3ET
Tel: 020 8452 0161 Fax: 020 8208 1441

Visit our new www.cricklewoodelectronics.com
Email: sales@cricklewoodelectronics.com

WEB SITE WWW.JOHNSRADIO-UK.COM WWW.JOHNRRADIO.COM
JOHNRRADIO ELECTRONICS TEST AND COMMUNICATION EQPT

LARGE QUANTITY SALE EX M.O.D.

MARCONI TF2019A Synthesized Signal Generators - 80Khz to 1040Mc/s
AM - FM - High Class with many functions - £285 each.

TEKTRONIX 2445 A OSCILLOSCOPE 150Mc/s Four Channel £300.

HP COMMUNICATION TEST SET 8922M - 10 - 1000Mc/s + GMS 83220E
Converter 1710 - 1900Mc/s - DCS - PCS - MS £500

HP COMMUNICATION TEST SET 8922M OPT 010(Dual) etc, £750.

ALL UNITS AND PRICED EX WORKS WITH INSTRUCTIONS - TESTED BASIC
WORKING. CARR + PACKING IF REQUIRED EXTRA.

Phone for appointment or to request item lists, photos, site map.

All welcome, Private or Trade, sales, workshop repairs or calibration

PLEASE CONTACT PATRICIA AT WHITEHALL WORKS, 84 WHITEHALL ROAD
EAST, BIRKENSHAW, BRADFORD, WEST YORKSHIRE, BD11 2ER.

Tel: 01274 684007 Fax: 01274 651160

WEB SITE WWW.JOHNRRADIO-UK.COM WWW.JOHNRRADIO.COM

inStore
ELECTRICS LIMITED

1043 LEEDS ROAD,
BRADFORD BD3 7DB

Tel: 01274 665670

01274 660196

01274 665246

Email: instorelectrics@btconnect.com

PHILIPS

AWARD WINNING PLASMA & LCD TV

AT COMPETITIVE PRICES RING FOR STOCK & PRICE

- * REAL FLAT TV'SFrom **£215**
- * INTEGRATED DIGITALFrom **£239**
- * 14" COMBIFrom **£65**
- * DVDFrom **£34**
- * VCRFrom **£39**
- * MICRO SYSTEMSFrom **£27**
- * DVD / VCR COMBI **£79**
- * DVD SURROUND SYSTEMSFROM **£96**

* Always a full selection of current models with slight
marks at knock down prices

* **FAX** your letter heading for bulk trade price list

AS NEW MANUFACTURERS GRADED PRODUCT

NO MARKS • ORIGINAL PACKING • FULLY GUARANTEED

NEXT DAY DELIVERY • CREDIT CARDS WELCOME

This Magazine reaches over

10,000

potential customers

To advertise in this space
call Mike on

01322 611291

**WATCH SLIDES ON TV
MAKE VIDEOS OF
YOUR SLIDES
DIGITISE YOUR
SLIDES**
(using a video capture card)



"Liesgang diatv" automatic slide viewer with built in high quality colour TV camera. It has a composite video output to a phono plug (SCART & BNC adaptors are available). They are in very good condition with few signs of use. For further details see www.diatv.co.uk
.....£91.91+ vat = £108.00

Board cameras all with 512x582 pixels 8.5mm 1/3 inch sensor and composite video out. All need to be housed in your own enclosure and have fragile exposed surface mount parts. They all require a power supply of between 10 and 12v DC 150mA.

47MIR size 60x36x27mm with 6 infra red LEDs (gives the same illumination as a small torch but is not visible to the human eye).....£37.00 + vat = £43.48
30MP size 32x32x14mm spy camera with a fixed focus pin hole lens for hiding behind a very small hole.....£35.00 + vat = £41.13

40MC size 39x38x27mm camera for 'C' mount lens these give a much sharper image than with the smaller lenses.....£32.00 + vat = £37.60

Economy C mount lenses all fixed focus & fixed iris
VSL1220F 12mm F1.6 12x15 degrees viewing angle.....£15.97 + vat = £18.76

VSL4022F 4mm F1.22 63x47 degrees viewing angle.....£17.65 + vat = £20.74

VSL6022F 6mm F1.22 42x32 degrees viewing angle.....£19.05 + vat = £22.38

VSL8020F 8mm F1.22 32x24 degrees viewing angle.....£19.90 + vat = £23.38

Better quality C Mount lenses
VSL1614F 16mm F1.6 30x24 degrees viewing angle.....£26.43 + vat = £31.06

VWL813M 8mm F1.3 with Iris 56x42 degrees viewing angle.....£77.45 + vat = £91.00

1208 surface mount resistors E12 values 10 ohm to 1M ohm 100 of 1 value £1.00 + vat 1000 of 1 value £5.00 + vat

866 battery pack originally intended to be used with an orbital mobile telephone it contains 10 1.6Ah sub C batteries (42x22dia the size usually used in cordless screwdrivers etc.) the pack is new and unused and can be broken open quite easily.....£7.48+vat = £8.77



Please add 1.66 + vat = £1.95 postage & packing per order

JPG ELECTRONICS

Shaws Row, Old Road, Chesterfield, S40 2RB

Tel 01246 211202 Fax 01246 550959 Mastercard/Visa/Switch

Callers welcome 9:30 a.m. to 5:30 p.m. Monday to Saturday

**Repair SMDs on
PCBs in seconds
with the NEW
Hot Jet 'S'**

Desoldering and soldering of SMDs by hot air and without contact is the fast and efficient way for the modern repair workshop. And now, Welwyn Tool can offer the complete package - a range of hot air tools, SMD Rework Stations, nozzles to suit all SMD requirements, free colour demonstrations and free colour instructional brochure ... all available from Distributors nation-wide.

For further information, please ask for Reference No. TMS

**WELWYN
TOOL
CO.LTD.**

4 SOUTH MUNDELLS,
WELWYN GARDEN CITY
HERTS AL7 1EH.

TEL: (01707) 331111.

FAX: (01707) 372175.

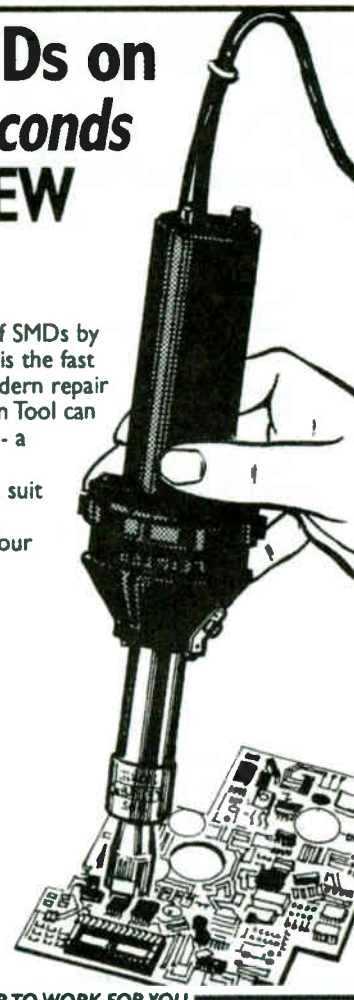

PUT HOT AIR TO WORK FOR YOU

**Are Colour Picture Tubes
causing you problems?**

We can help!

- 1 D'Lec supply tubes from Philips, Thomson, Panasonic etc. all are new, from stock and with a one year Guarantee.
- 2 All tubes are delivered on our own transport eliminating transit damage.
- 3 D'Lec are able to collect the old glass and dispose of it in line with current regulations.
- 4 If you are an OEM service centre we can despatch your tubes for you, using your own paperwork.

Full storage and logistic service available for fragile items (Plasma, LCD etc)
Export no problem!

GIVE US A CALL!

D'Lec Components, Limited, 3 Manor Court, Sole Street, Cobham, Kent. DA13 9BU
Tel 01474 361276/327677 Fax 335228

Email sales@dlecc.co.uk

Visit www.dlecc.co.uk



**ADVERTISERS
INDEX**

ALBAN.....	OBC, 322
COLOURTRADE	329
CRICKLEWOOD	382
DIGI REPAIRS.....	IFC
D'LEC.....	383
ECONOMIC DEVICES	335
EXPRESS TV	382
GRANDATA.....	341-343
HORIZON.....	335
INSTORE.....	382
JPG	383
JOHNS RADIO	382
P. J. HILL	335
SATELLITE & DIGITAL.....	381
SR ELECTRONICS.....	329
STEWART OF READING	381
T.W. ELECTRONICS	IBC
WELWYN.....	383

Service Link

TELEPHONE 01322 611254 FAX 01322 616376

FOR SALE

inStore
ELECTRICS LIMITED
171 HAREHILLS LANE,
LEEDS LS8 3QE
Tel: 0113 240 1114

Tatung LCD 15".....£239
Philips LCD 15".....£299
Philips LCD 17".....£299

Other models available.
CALL FOR FULL PRICE LIST

"The television engineer's
wholesaler"

ICC17 LOPTX Kit
Ferguson W7023U etc.
Thomson 24WK23U etc
Pt no. 10608670P1 £24.95

GRUNDIG EHT TRAY
BG1899022644 £18.95

www.IrwinElectronics.co.uk
Telephone 0114 273 9622

Ex Rental TVs
**Sony, Philips,
Hitachi**

32 and 28 Widescreens
Portables, Combis

For stock and price
Telephone
Barry McDonald
07836 789528

? STOP

LOPT'S. REMOTES
ALL TV COMPONENTS

TIDMAN MAIL ORDER LTD
236 SANDYCOMBE RD
KEW RICHMOND
SURREY TW9 2EQ
(1/2 MILE FROM KEW BRIDGE)
PHONE: 020-8948-3702

For a
FREE
consultation on how best to market
your products/services to a
professional audience contact
MIKE on
01322 611291

LINEAGE

PRIVATE RETAILER has excellent part
exchange colour televisions and videos to
clear. Tel: 01494 814317.

PROJECTOR SPARES

Spare parts and service
information for

VIDIKRON
video projectors from
PROJECTSPARES
Tel: 01444 831769
Fax: 01444 831580
E-mail:
projectspares@btinternet.com

SERVICE DATA

Fryerns
Service Information **FES** Circuit Diagrams

TV's, VCR's, SATELLITE
CAMCORDERS, AUDIO &
HI-FI's

Prices are from £5.50 + £2.75 P&P
add a further £5.50 per item
in the same order
note: some items priced individually
we now supply universal
tv/video remotes at competitive
prices

Payment by credit card, PO or cheque
Tel: Fax 01206 211570
e-mail: colin@fryerns.fsbusiness.co.uk

2 The Lodge
Easthorpe Green
Marks Tey, Colchester
CO6 1HA

U-VIEW
Television Servicing 9 CD
Special Price **£49***

Contains Schematics, Adjustments,
Circuit Descriptions, Parts Lists,
Fault-finding Guides.
Over 300 models covered.
Leading manufacturers and
supermarket brands included.

Previous TV & VCR books also available
including TV Book 6 (Limited Stock)

*Price applies to purchasers of
TV7 or TV8 CD, otherwise £59.
(Please add £2.50 p&p)
Most credit cards accepted

U-VIEW PUBLISHING
73 St. Martins Ave. Doncaster Yorkshire
DN5 8JA Tel: 01302 780270

tvinfo@u-view-circuits.co.uk

SERVICE DATA

NEED HELP NOW?

Then ring the
★ **ELECTRON TECHNICAL
HELPLINE** ★
Genuine help available to all
repairers of
T.V. - V.C.R. - SAT - AUDIO
(Inc Valves)
Over 30 years experience and vast
data base
9 Chapel Street, Donisthorpe,
Derbyshire DE12 7PS
0906 470 1706
Calls cost 60p per minute

**SERVICE
MANUALS**
and Service Sheets for
TV - VIDEO - AUDIO

Prices start at

CTV	s/sheet	5.00
VCR	s/sheet	7.00
CTV	s/man	10.00
VCR	s/man	13.00

No p/p or VAT
- Other items POA -
AMTEL
Huna,
Caithness KW1 4YL
01955 611313
www.amtel.co.uk

**OPEN
6 DAYS** TV/VCR CIRCUITS
(WE DO NOT STOCK
AUDIO OR MONITOR
INFORMATION)

TEL A.T.V. on
0114 285 4254

CTV Circuits from £5.00
VCR Circuits from £7.00
CTV Manuals from £10.50
VCR Manuals from £14.50
(P/P add £2.50 to each order)
**419 LANGSETT ROAD
SHEFFIELD S6 2LL**
www.atvcircuitsandservicemanuals.co.uk
MANUAL COLLECTIONS PURCHASED.
(POST 1995)

WANTED

WANTED Surplus or Obsolete Electronic Components
Turn your excess stock into instant cash!
SEND OR FAX YOUR LIST IN STRICTEST CONFIDENCE
Will collect anywhere in the UK



28 College Street, Kempston, Bedfordshire, MK42 8LU
Tel: 01234 363611 Fax: 01234 326611
E-mail: sales@mushroom.co.uk
Internet: www.mushroom.co.uk

SERVICE DATA

SERVICE MANUALS

Have you ever turned away
work for want of a Service
Manual? Have you ever brought
a Service Manual and never
used it more than once?
Then why not join ...

THE MANUALS LIBRARY

For details and membership
application form write,
phone or fax:

HARVEY ELECTRONICS
43 Loop Road, Beachley,
Chepstow, Mons, NP16 7HE
Tel/Fax No: 01291 623086
Visa: Mastercard accepted

TECHNICAL ADVICE

Technical Advice From Service-Link.co.uk

Missing Part? Burnt Out Part??
No Service Manual???
No Problem. Call Us Today.
We Have A Huge Database.
Most Consumer Electronics
Covered.
Hard To Diagnose Fault?
Parts Hard To Find?
Call Us Now For Assistance.
Available Seven Days A Week.
9-00AM—11-00PM

0906 287 2 287

Calls Cost 60p Per Minute From BT Landlines
PO Box 7453 LE2 3XR

WANTED

BEST CASH PRICES PAID

FOR VALVES KT88,
PX4 AND MOST
AUDIO/OTHER
TYPES.

Tel: 01403 784961

Billington Export Ltd
Sussex RH14 9EZ
Fax 01403 783519
Email: sales@bel-tubes.co.uk
Visitors by appointment

WANTED



Freeview is great,
but lose or break
your remote and
the only red button
you'll want to press
will be this one...

**EVEN
MORE NEW
HANDSETS &
MODELS ADDED
THIS MONTH!**

With over 6 million Freeview boxes sold the market for remote controls offers your business enormous potential. Remember, for most Freeview boxes you need the remote to operate interactive services and EPG navigation.

Classic now have the solution. A range of remotes which carry out all the functions of the originals and are designed to be user friendly.

Classic remotes for the models listed are available now. Additional handsets for Freeview receivers are in development

To order your remotes contact your Classic distributor. For up to date cross reference information or for more information on the Classic range visit our website www.classic-serviceparts.com, phone us on 01635 278678 or email us at uksales@classic-serviceparts.com

Brand	Model	Classic remote
Alba	STB1X1	IRC83079
Black Diamond	BD65DSF	IRC83079
Bush	DFTA 1X1	IRC83079
Bush	DFTA1	IRC83079
Daewoo	DS608P	IRC83082
Dijam	32VU DVB-T	IRC83082
Ferguson	FDT2000	IRC83077
Ferguson	FDT500	IRC83077
Goodmans	GDB1	IRC83079
Goodmans	GDB2	IRC83079
Goodmans	GDB3	IRC83079
Goodmans	GDB4	IRC83079
Grundig	GDT1000	IRC83081
Grundig	GDT1500	IRC83081
Grundig	GDT2000	IRC83077
Hitachi	HDB60	IRC83079
Labgear	DTT100	IRC83082
Matsui	DTR 1	IRC83079
Matsui	DTR 2	IRC83079
Nokia	121T	IRC83078
Nokia	221T	IRC83078
Philips	DTR1500	IRC83083
Philips	DTX6370	IRC83087
Philips	DTX6371	IRC83087
Philips	DTX6372	IRC83087
Techwood	TWDFV1	IRC83079
Thomson	DTI1000	IRC83080
Thomson	DTI2300	IRC83086
Thomson	DTI550	IRC83080
Triax	DVB2000T	IRC83082



Technical helpline 01635 278678

TELEVISION TEST PATTERN GENERATORS

The new **GV 998** is a digital pattern generator offering more advanced features at again a realistic price. Those features include :

- ◆ MPEG-2 format Transport Stream generation
- ◆ Video and audio included in the TS
- ◆ Video and audio inputs
- ◆ Generation of a variable frequency sound carrier for decoding verification
- ◆ Multistandard and multisystem analogue TV signal generation
- ◆ Possibility to edit different fields of the TS database to present the name of the service provider
- ◆ Remote control via a personal computer
- ◆ Moving video patterns to check MPEG-2 decoders

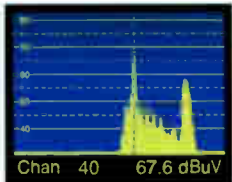
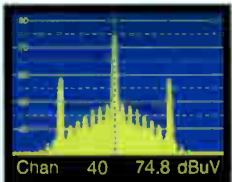

IDEAL FOR PLASMA DISPLAYS

IDEAL FOR WIDE SCREEN

PROMAX GV SERIES

- ◆ Choice of 12 instruments
- ◆ NICAM and Teletext
- ◆ 4:3 and 16:9 Formats
- ◆ Full field and VITS
- ◆ Computer Controlled
- ◆ Front panel memories
- ◆ Own Company Logo
- ◆ Computer Monitor testers
- ◆ Hand Held Models
- ◆ Multi Standard, PAL, NTSC, SECAM
- ◆ High Quality Construction
- ◆ Attractive Price Levels
- ◆ Full After Sales Service
- ◆ Available from Stock



FOR TELEVISION PATTERN GENERATORS, THERE'S NO WIDER CHOICE THAN WITH PROMAX



PROMAX

**AA 930
AUDIO ANALYSER**

**TA 903B
CRT
REJUVENATOR**



PROMAX

SELECTED ITEMS FROM THE PROMAX RANGE OF TEST EQUIPMENT

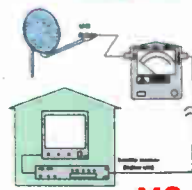

MS 250

Analogue and Digital Satellite Detector.



PRODIG 1+

Satellite Dish Installer's Meter
Does more than just BSkyB



PRODIG 2

Analogue & Digital Aerial Meter
Measures digital channel power and C/N



MC 577

Analogue & Digital, Satellite & Terrestrial
Measures channel power and C/N



PROLINK 3 + 4 PREMIUM

Satellite & Terrestrial, Analogue & Digital,
Spectrum Analyser with BER (optional on P3)

Alban

ALBAN ELECTRONICS LIMITED

THE PROMAX SERVICE CENTRE

6 Caxton Centre, Porters Wood,
St. Albans, Hertfordshire, AL3 6XT.

TEL: 01727 832266 FAX: 01727 810546

WEB: www.albanelectronics.co.uk

EMAIL: info@albanelectronics.co.uk

SALES + SERVICE + CALIBRATION