

**ESTABLISHING BASELINE DATA ON SEASONAL PHYSIOLOGICAL
REQUIREMENTS FOR *GAMMARUS ACHERONDYTES* AND
GAMMARUS TROGLOPHILUS IN RELATION TO
MICROBIAL OXYGEN DEMAND**

Steven J. Taylor¹, Frank M. Wilhelm²,
Ginny L. Adams² and Michael P. Venarsky²

¹Center for Biodiversity
Illinois Natural History Survey
607 East Peabody Drive
Champaign, IL 61820-6970
217-33-6846 sjtaylor@inhs.uiuc.edu

²Department of Zoology
Southern Illinois University at Carbondale
1125 Lincoln Drive
Carbondale, IL 62901-6501
618-453-4121 fwilhelm@zoology.siu.edu



**25 June 2003
Illinois Natural History Survey
Center for Biodiversity Technical Report
2003(20)**

Prepared for

**Division of Natural Heritage, Attn: Glen Kruse
Illinois Department of Natural Resources
One Natural Resources Way
Springfield, IL 62702-1271**

Introduction

Dissolved oxygen is a critical environmental factor for Crustacea (Ivleva 1980), and for groundwater organisms in general (Malard and Hervant 1999, Hüppop 1985). Studies of respiration in subterranean amphipods have mainly focused on taxa inhabiting interstitial spaces in the hyporheic zone (e.g., Henry and Danielopol 1999; Hervant and Mathieu 1995, Hervant *et al.* 1995, 1996, 1998, 1999a), where dissolved oxygen concentrations are often below $3 \text{ mg}\cdot\text{L}^{-1}$ (Malard and Hervant 1999). Under hypoxic conditions (oxygen concentrations typically < 2 to $3 \text{ mg}\cdot\text{L}^{-1}$), these animals utilize anaerobic metabolism to fuel their metabolic needs (Hervant *et al.* 1996). Less well studied are the metabolic oxygen requirements of cavernicolous species including amphipods (e.g., Hervant *et al.* 1999b), which typically exist where oxygen concentrations are higher (averaging $8.8 \text{ mg}\cdot\text{L}^{-1}$ in caves of Illinois' sinkhole plain [Taylor *et al.* 2000]) than in the hyporheos. Many stygobitic (cave-limited) taxa have reduced metabolic rates compared to related surface dwelling species because of low nutrient availability, reduced predation pressure and relatively constant environmental conditions in caves (Hüppop 1985). Hervant *et al.* (1999b) present data that suggest cave populations of the stygophile (cave and surface dwelling) *Gammarus minus* are much less tolerant of low oxygen levels than hyporheic taxa including: *Stenasellus virei*, *Niphargus rhenorhodanensis*, and *Niphargus virei* which are able to function in the low oxygen concentrations of their habitat. To adequately protect the fauna of cave streams it is important to know the ambient oxygen concentrations they require to survive.

The Illinois Cave Amphipod, *Gammarus acherondytes* Hubricht and Mackin (Amphipoda: Gammaridae), is the only federally endangered *Gammarus* species in the United States. It is known to exist only in several small subterranean drainage basins covering an area of 230 km^2 (89 sq miles) in the southwestern Illinois karst of Monroe and St. Clair counties (USFWS 1998, 2002). This area is characterized by high density of sinkholes (> 90 sinkholes km^{-2}) (Panno *et al.* 2003), losing streams, caves, and springs. Shallow conduit flow in this karst region can rapidly transport contaminants from the surface to cave streams. Land use in this area is typically row crop agriculture, livestock grazing, and rural home sites. However, in recent years rapid urbanization has become a serious threat (USFWS 1998, 2002). The status of *G. acherondytes* in individual caves has been discussed in detail elsewhere (Lewis 2001; Lewis *et al.* 1999, 2003; Webb 1993, 1995; Webb *et al.* 1993, 1998; USFWS 2002).

One of the major suspected threats to *G. acherondytes* is elevated fecal coliform bacteria and associated decreased availability of dissolved oxygen. Fecal coliform bacteria are attributable to human and/or livestock sources (Taylor *et al.* 2000) and are often but not always associated with high water levels and increased turbidity (Taylor *et al.* 2000). Generally, high coliform bacteria reflect an influx of abundant organic material and fertilizer to the cave environment, which could increase the metabolic activity of microorganisms in cave streams

and thus reduce the amount of oxygen available for *G. acherondytes* (Del Giorgio and Cole 1998). Taylor *et al.* (2000) and Panno *et al.* (1996, 1997) reported elevated levels of nitrates and fecal coliform bacteria in the shallow karst groundwaters of Monroe and St. Clair counties. Total aerobic bacterial concentrations sometimes exceeded 30,000,000 colony forming units (cfu) per 100 ml of water, and total coliform bacteria occasionally exceeded 9676 cfu in major cave streams within the geographic range of *G. acherondytes* (Taylor *et al.* 2000). Furthermore, Taylor *et al.* (2000) found lower dissolved oxygen concentrations in Stemler Cave (St. Clair County), where *G. acherondytes* is apparently extirpated (or only present in numbers below detection limit) than in other caves in the region. Thus, one might expect that elevated microbial concentrations could have a noticeable impact on oxygen availability in cave streams, and could negatively influence the abundance of *G. acherondytes* and its continued survival.

Respiration in cave invertebrates generally falls into two categories: oxyconformers, which gradually reduce their metabolic rates as oxygen becomes less available in the environment; and oxyregulators, which maintain at least a minimum metabolic rate, and which therefore accumulate an oxygen debt when oxygen availability drops below a certain level. Thus, as long as oxygen levels are not lethal, oxyconformers can survive relatively long periods of hypoxia, whereas oxyregulators cannot survive long periods of low oxygen, as they are limited by their minimum metabolic rate. In addition, the metabolic demands of cave amphipods may vary seasonally. For example, females of the epigeal amphipod, *Crangonyx pseudogracilis*, increased levels of ventilatory brooding behavior in response to decreased oxygen levels and increased temperature (Dick *et al.* 1998). If higher demands for oxygen associated with brooding were exacerbated by seasonally increased microbial activity in cave streams, there could be adverse effects on populations of *G. acherondytes*. Precopulatory behavior in related amphipod species such as, *Gammarus minus* Say, typically peaks in the winter, with young released in the spring (Culver 1971, Jones 1990). If such a pattern exists for *G. acherondytes*, energetically demanding activities such as brood care (Dick *et al.* 1998) may coincide with seasonally high microbial densities. While high microbial densities may mean increased food availability (there is evidence that some cave amphipods may use filter feeding strategies to consume bacteria [Culver *et al.* 1995]), it also may result in increased competition for available dissolved oxygen. Finally, although a reduced metabolic rate is generally considered a common adaptation of hypogean faunas, and, in particular, cave faunas (Hüppop 1985), this is not always the case with cave amphipods. Culver and Poulson (1971) reported higher metabolic rates for cave populations relative to surface populations of *G. minus*. Thus, it is unclear if the oxygen demands of cave amphipods including *G. acherondytes* can be generalized.

Another concern relates to the interactions within the cave invertebrate communities in response to nutrient enrichment (reflected in elevated microbial



A



B

Figure 1. Amphipod species (Crustacea: Amphipoda: Gammaridae) examined in this study. **A)** *Gammarus troglophilus*, **B)** *Gammarus acherondytes*.

activity). *Gammarus acherondytes* co-occurs with a variety other macroinvertebrates in the cave streams, including crustaceans (amphipods: *G. minus*, *G. pseudolimnaeus* (Bousfield), *G. troglophilus* (Hubricht and Mackin),

Crangonyx forbesi (Hubricht and Mackin), *Baetrus barchycaudus* Hubricht and Mackin, and *Stygobromus subtilis* (Hubricht); isopods: *Caecidotea brevicauda* (Forbes), *Caecidotea packardi* Mackin and Hubricht); flatworms (*Sphalloplana hubrichti* (Hyman)); and aquatic oligochaetes (e.g., *Limnodrilus hoffmeisteri* (Claparède), *Rhyacodrilus subterraneus* (Hrabe)) (Lewis *et al.* 1999, 2003; Peck and Lewis 1978; Taylor and Webb 2000; Wetzel and Taylor 2001). Because *G. acherondytes* is a stygobite, we suspected that it would have a metabolic rate that was less than that of stygophilic taxa such as the amphipod *G. troglophilus*. *Gammarus acherondytes* and *G. troglophilus* are similar in appearance (Figure 1), and commonly co-occur within individual microhabitats in cave streams of southwestern Illinois (Taylor and Webb 2000). As stated earlier, the range of *G. acherondytes* is restricted to portions of Monroe and St. Clair counties, Illinois. *Gammarus troglophilus*, however, is more widespread in distribution, occurring commonly in caves, springs and springruns along the border counties of southwestern Illinois and southeastern Missouri (Holsinger 1976). Studies of coexisting cave faunas in the eastern United States (Culver 1970, 1971, 1973, 1981; Culver *et al.* 1991, Holsinger 1969) demonstrate that co-occurring taxa may compete for limited resources such as food (Belcher 1985) and shelter (Culver 1970, 1973). If *G. acherondytes* has a low metabolic rate compared to *G. troglophilus*, it may have an advantage under food-poor conditions. However, *G. troglophilus* may be favored when nutrients are more widely available (as would be the case with fecal contamination of the cave stream).

The objectives of this study are to examine i) the seasonal metabolic rate of *G. acherondytes* and *G. troglophilus*, by measuring oxygen consumption; ii) examine the microbial oxygen depletion rate and compare it to that of *G. acherondytes* and *G. troglophilus* and iii) compare streamflow and microbial abundance.

Study Site

All samples were collected at Illinois Caverns, a 9.6 km long cave in Monroe County, Illinois with a drainage basin of approximately 5.4 km² (Figure 2, Aley *et al.* 2000). Discharge of the perennial cave stream, measured near the main entrance, averages $4.88 \times 10^{-3} \text{ m}^3 \times \text{s}^{-1}$ (range 4.83×10^{-4} to $2.49 \times 10^{-2} \text{ m}^3 \times \text{s}^{-1}$) (Taylor *et al.* 2000), and the mean annual water temperature is 13.2 °C (range 11.8 to 15.6 °C) (Taylor *et al.* 2000). Stream substrate ranges from fine particles and clay in pools to large boulders in riffles. However, cobbles 3 to 5 cm in diameter predominate in areas where the stream channel is broad and the water is <10 cm deep. Other physico-chemical parameters are summarized in Taylor *et al.* (2000).

Physical measurements

Flow was measured on each visit using a Global Flow Probe (FP101, Global Water, Gold River, CA). Cave stream width was measured with a fiberglass open reel tape or meter stick. The stream width was then divided into equal segments, generally 20-30 cm in width. The water depth was measured in each segment and the average velocity was calculated by averaging the velocity

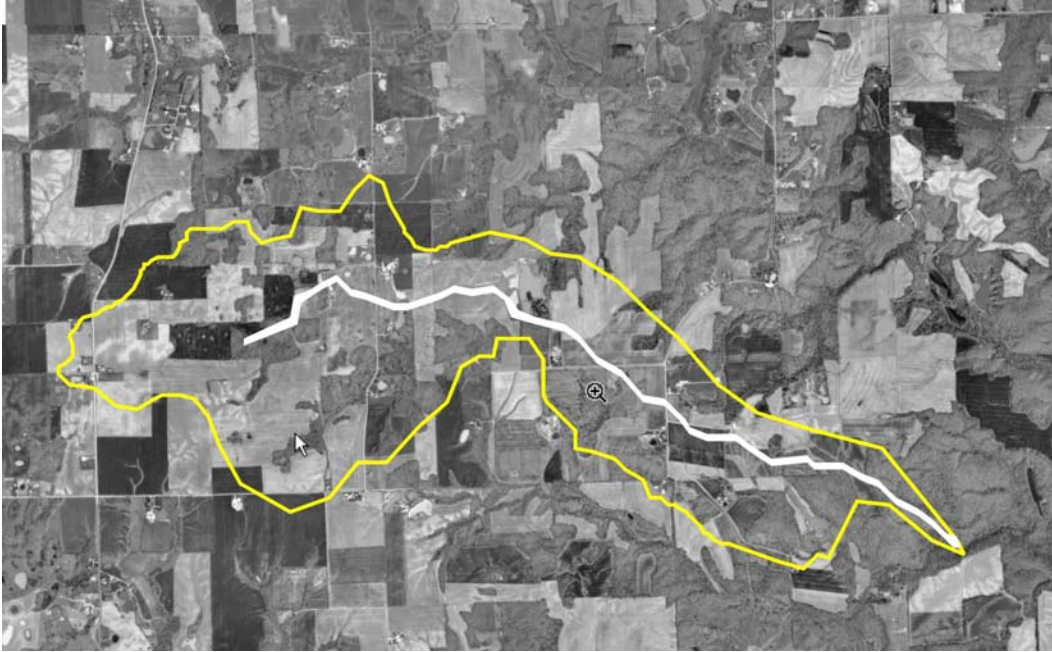

Figure 2. The drainage basin of Illinois Caverns, after Aley *et al.* (2000).

at each depth measurement point. Velocity was averaged while slowly moving the probe up and down from just below the water surface to the stream bottom. This technique was chosen because it allows direct comparison of our data with data collected by Taylor *et al.* (2000) and Panno and others at the Illinois State Geological Survey at various sites in Illinois' Salem Plateau. The flow value within each segment was recorded when a steady average velocity reading was achieved. Volume of flow was calculated using the formula:

$$R = \sum_{s=1}^i w_s d_s v_s$$

Where **R** is the volume of flow (m³/sec), **s** is the segment number, **i** is the number of segments, **w** is the segment width (m), **d** is the segment depth (m), and **v** is the segment average current velocity (m/sec). Flow data are presented in gallons/minute (gpm). These calculations were coded into SAS so that all calculations could be done on a computer. Flow measurement was taken near the main entrance of Illinois Caverns, and only represents a portion of the total

flow in the downstream reaches of the cave (after several tributary passages have contributed to the flow). Stream stage data were collected during each visit by measuring the distance to the water surface from a fixed point. Data for each site are reported as deviations (cm) from the average of the distance measurements for the site.

Dissolved oxygen concentrations, water temperature and conductivity were measured in the stream on each collection date with a YSI model 85 meter.

Bacterial sampling and analysis

Bacterial water samples were collected on the dates of amphipod collections (see below). Samples were stored in sterilized 250 mL plastic bottles and were analyzed within 24 hours for total aerobic bacteria, total coliform bacteria, fecal coliform bacteria, and fecal streptococcus bacteria using standard methods (Clesceri *et al.* 1989). Species determination methods for isolation and identification of bacterial colonies followed Clesceri *et al.* (1989) and Cason *et al.* (1991). All bacterial analyses were conducted by the Illinois Department of Agriculture's Animal Disease Laboratory in Centralia, Illinois. To examine the



Figure 3. Frank Wilhelm and JoAnn Jacoby in typical *Gammarus acherondytes* habitat upstream of the main entrance to Illinois Caverns. Note clear, low water – typical of normal flow conditions.

hypothesis that bacterial load increased with flow we regressed bacterial counts (colony forming units/100 ml) versus discharge.

Amphipod collections and transport

Amphipods for the determination of oxygen consumption were collected In July-August 2002, February 2003 and May 2003. We chose these times because they coincided with historically low, medium and high flows and covered the full range of water temperatures recorded for the stream (Taylor *et al.* 2000).

Amphipods were collected upstream from the cave entrance (Figure 3)

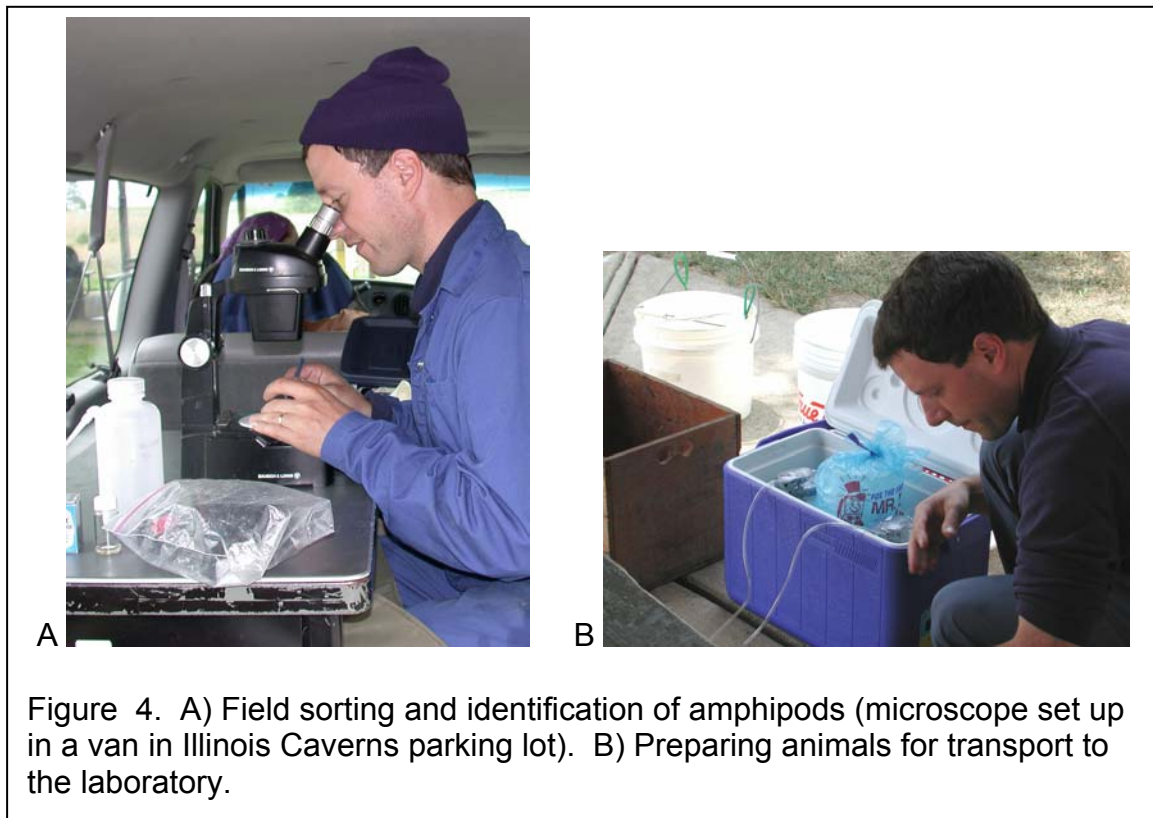

to where the passage became less than 1.2 m high. We used fine-meshed aquarium nets held on the downstream side of rocks, which were gently lifted. Silt and amphipods from under the rocks were washed into the nets by the current. Amphipods retained in the nets were emptied into 3L buckets containing cave stream water for transport out of the cave.

At the surface (just outside of the cave entrance), large amphipods were visually separated by one of us (FMW) by species into separate containers using a series of characteristics including color, body size, and body shape while swimming. Each individual in these groupings was then checked on-site with a stereo microscope using morphological features detailed in taxonomic keys (Figure 4A). Only one *G. acherondytes* was misidentified as a *G. troglophilus*

during these initial visual separations, while no *G. troglophilus* were identified as *G. acherondytes*. This indicates that it is possible to field identify the large amphipods. Small amphipods required the use of a microscope.

Amphipods were placed in 4L containers equipped with an airstone for transport to the laboratory. Containers were packed in coolers with crushed ice to prevent large temperature fluctuations (Figure 4B). In the laboratory, specimens were maintained in darkness in an incubator at 12 ± 1.0 °C. A supply of cave water (~75-150 L) for use in maintaining cultures of amphipods and for running oxygen trials also was brought back to the laboratory with each batch of amphipods.

Respiration and Monitoring of Activity

To obtain measures of oxygen consumption, we transferred individual amphipods into a respiration chamber (Figure 5) containing 0.22- μ m-filtered air saturated cave water and inserted the lid with oxygen probe (Figure 6) ensuring that no air bubbles remained in the chamber. Four small aquarium rocks were also placed in each respirometer so amphipods could wedge themselves into a crevice, hang on to the substrate, or move about as they wished. We did not starve animals prior to experiments because we were interested in obtaining rates of routine metabolism. Routine metabolism includes activities related to maintenance of the individual (Brett and Groves 1979). Previous studies of animal metabolism have utilized a variety of

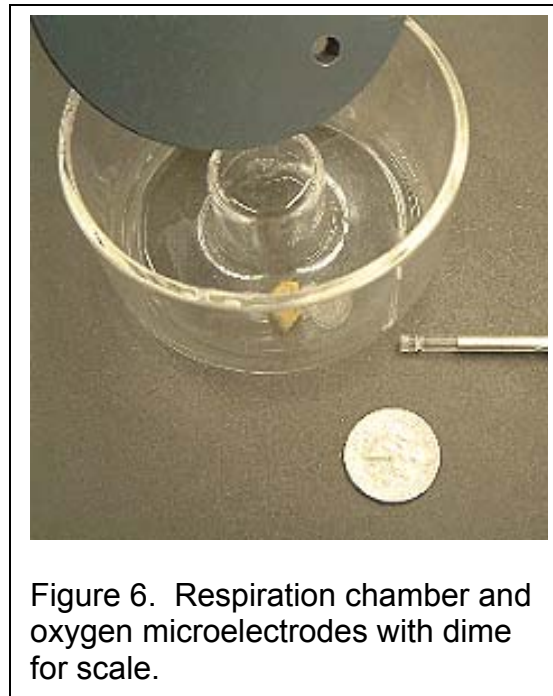

Figure 5. Cold chamber with respiration chambers. Note data cables and laptop to right.

activity measurement techniques including visual observation under dim red light (Hervant *et al.* 1997), red light/photocell logging (Culver and Poulson 1971), radio wave interference logging (Wilhelm *et al.* 1997), and impedance conversion logging (Davies *et al.* 1992, Gerhardt *et al.* 1994). Although we had intended to simultaneously record activity with an infra-red LED activity recorder, we encountered numerous technical difficulties with this device (see Appendix 1). Instead we made visual observations during the first series of experiments which showed that amphipods undertook a variety of activities including sitting still and swimming around the chamber. None of the amphipods were observed to swim as rapidly as during an escape response (e.g., physical disturbance during collection of individuals from the stream), and chamber size did not appear to restrict movement of the amphipods, thus activity was not forced (Fry 1957, Winberg 1956). Thus, we are confident that our rates are representative of routine metabolism.

The partial pressure of oxygen inside each chamber was recorded with a Microelectrodes (Bedford, NH) model MI-730 Clark-style microelectrode oxygen sensor connected to a PC computer set to log once every 10 s (Figure 7). To calibrate probes prior to each run, they were sequentially inserted in 100% air saturated 0.22- μm -filtered cave water for 10 to 20 minutes, 0% (nitrogen bubbled, for minimum of 30 minutes) 0.22- μm -filtered cave water for 10 to 20 minutes, and returned to 100% 0.22- μm -filtered cave water until the voltage had stabilized at the same reading prior to inserting them in 0%. The probes were then inserted into the respirometer

chambers for the duration of the particular trial. Water temperature, and barometric pressure during the calibration trial were recorded with an Onset Computer Co. (Pocasset, MA) model H8 Hobo temperature logger and a Fisher Scientific (Palantine, IL) digital barometer, respectively. Oxygen content of the water in the respirometers was calculated using equations provided in Standard Methods (Table 4500-O:1, APHA 1995). The mean temperature of the environmental chamber was set at $12.2 \pm 1.0^\circ\text{C}$, and $11.3 \pm 1.0^\circ\text{C}$ for the Jul/Aug. 2002 and Feb/May 2003 experimental periods, respectively. These temperatures were selected to reflect both the long-term seasonal average temperature in the cave, while at the same time avoiding large acclimation temperatures for amphipods collected during different seasons. In addition, we



avoided the potential bias associated with applying temperature correction factors to respiration rates.

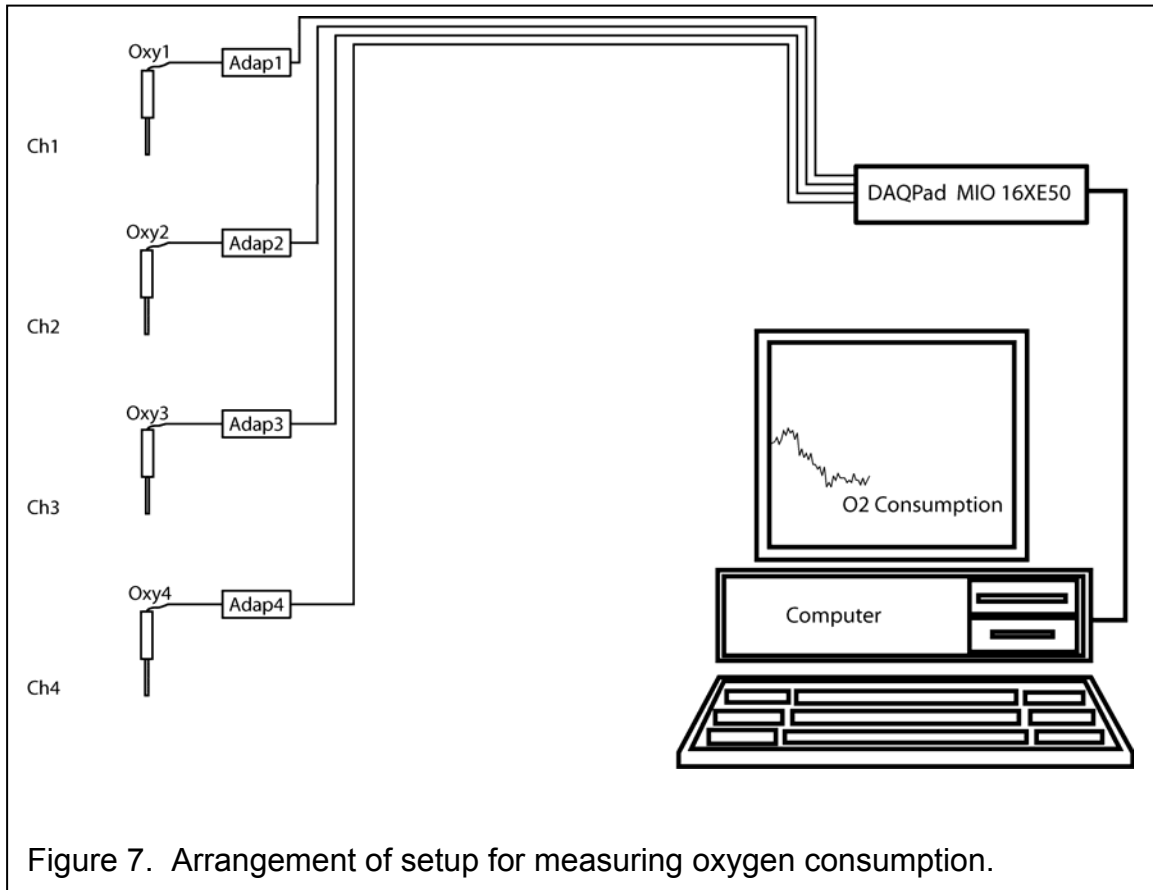

Figure 7. Arrangement of setup for measuring oxygen consumption.

To test the oxygen consumption of bacteria present in the stream water, oxygen consumption runs with unfiltered (raw) and filtered ($0.22 \mu\text{m}$) water were completed immediately upon return to the laboratory. Results of oxygen consumption from these runs were compared using t-tests.

Analysis

After each experimental run, amphipods were removed from the chambers and photographed with the aid of a digital camera (Fuji FinePix 6800Zoom, Fuji Photo Film Co, Japan) mounted to a Leica MZ-9.5 (Leica Microsystems Wetzlar GmbH, Germany) dissecting microscope (Figure 8) before being returned live to holding tanks in the temperature controlled chamber. Amphipods were maintained in the lab until respiration runs had been completed with all individuals, at which time they were returned to the upstream section in the cave.

Amphipod dry weight was calculated from a head capsule-dry weight relationship established earlier (see Appendix 2). Oxygen consumption ($\mu\text{g O}_2$ per animal per hour) was calculated from the slope of the linear regression of

oxygen concentration versus time between hours 1 and 4 for each individual run. The 3-h interval was chosen to allow the amphipods to consume detectable amounts of oxygen, while avoiding potentially confounding problems of metabolic waste buildup and declining oxygen concentrations. The first hour was not analyzed to avoid biasing results related to increased respiration from handling the amphipods.

To compare oxygen consumption between seasons and species, we analyzed results with analysis of covariance (ANCOVA) with oxygen consumption as the

response variable, body dry weight as the covariate and population or season as the grouping variable. Relationships were log-log transformed to conform to the expected relationship between surface area and body mass (Peters 1983). This also satisfied assumptions of homogeneity of variance and normality (Sokal and Rohlf 1982).

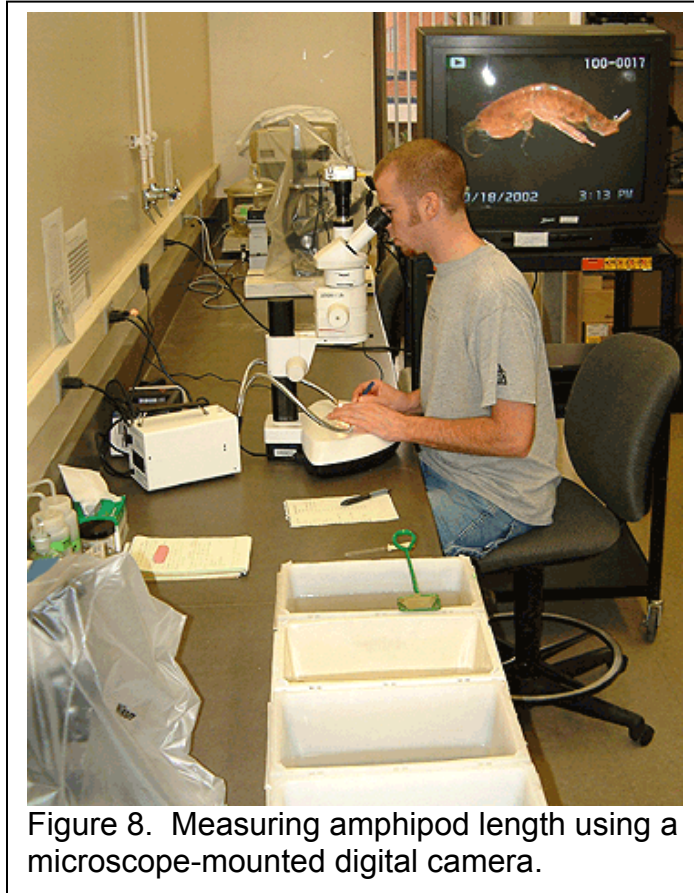

Figure 8. Measuring amphipod length using a microscope-mounted digital camera.

Results

Water temperature, specific conductance, dissolved oxygen, and volume of flow data collected during each field visit are presented in Table 1. Values ranged from 13.3 to 16.0 °C for water temperature, from 458.0 to 617.0 $\mu\text{S}/\text{cm}$ for specific conductance, from 94.6 to 101.0 for % saturation, and from 10.0 to 10.26 mg/L for dissolved oxygen, and from 82.8 to 11495.7 gpm for volume of flow.

Total aerobic, total coliform, fecal coliform and fecal streptococcus counts from water samples collected at Illinois Caverns were low in August 2002 and quite high in May 2003 (Table 2). The most abundant microbial taxa identified were *Bacillus* species, and fecal-associated taxa were present in all samples (Table 3). When colony counts were plotted against the volume of flow (gallons per minute), total aerobic and total coliform bacterial regression lines were

suggestive of a correlation, but was not significant for total aerobic bacteria (Figure 9). We corrected for density of bacteria for the gallons per minute of flow to produce total aerobic bacteria per minute. When this metric was plotted against dissolved oxygen (mg/L) (Figure 10), no obvious trend is apparent.

Table. 1. Basic water chemistry data collected at Illinois Caverns (Monroe County, Illinois), compared to typical (mean) values from the same cave reported by Taylor *et al.* (2000).

Date	Water Temperature °C	Specific Conductance $\mu\text{S}/\text{cm}$	Dissolved Oxygen % Saturation	Dissolved Oxygen mg/L	Flow Gallons / Minute
23-Jul-02	13.3	617.0	97.1	10.16	123.6
18-Aug-02	16.0	609.0	101.0	10.00	82.8
23-Feb-03	11.5	458.3	94.6	10.26	421.7
15-May-03	13.8	585.0	98.1	10.13	11495.7
Taylor <i>et al.</i> (2000)	13.15	543.53		9.07	76.79

Table 2. Microbial sample counts in colony forming units/100 ml for water collected during three amphipod sampling periods at Illinois Caverns.

	Collection Date		
	18-Aug-02	23-Feb-03	4-May-03
total aerobic	27,500	1,800,000	13,500,000
total coliform	537	10,580	374,500
fecal coliform	10	160	4,365
fecal streptococcus	70	1,025	674,500

Table 3. Microbial taxa identified from water samples collected during three amphipod sampling periods at Illinois Caverns. Mean ranks based on two samples. Bold indicates rank based on occurrence in only one sample.

Taxon	18-Aug-02	23-Feb-03	4-May-03
<i>Aeromonas hydrophilia</i>	6.0		
<i>Bacillus</i> spp.	2.0	2.0	1.0
<i>Citrobacter freundii</i>		6	
<i>Enterococcus faecium</i>		7.0	3.5
<i>Enterococcus faecalis</i>	4.0	8.0	3.5
<i>Enterobacter aerogenes</i>	3.0	3.0	5.0
<i>Escherichia coli</i>	5	9.0	8.0
<i>Klebsiella pneumoniae</i>		4.0	
<i>Proteus mirabilis</i>			6.5
<i>Pseudomonas</i> spp.	1.0	1.0	
<i>Pseudomonas aeruginosa</i>			2
<i>Pseudomonas cepacia</i>			2
<i>Serratia</i> spp.	5	5.0	7.5
<i>Staphylococcus aureus</i>		7	8.0

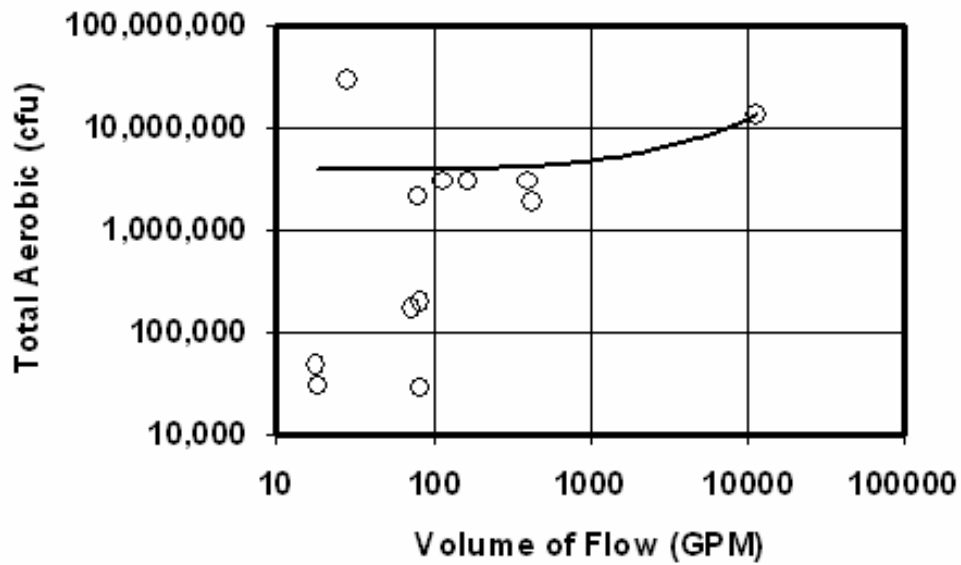

A

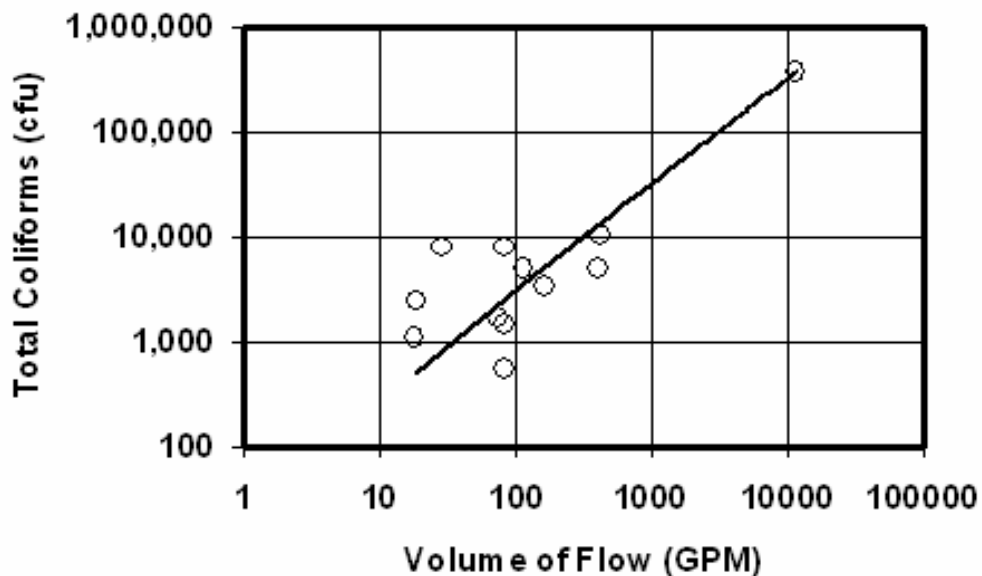

B

Figure 9. Correlation of stream flow and elevated microbial contamination at Illinois Caverns, Monroe County, Illinois. **A**) Log_{10} transformed volume of flow (gallons per minute [gpm]) with Log_{10} transformed Total Aerobic Bacteria (cfu) ($R^2=0.2793$, $P=0.0773$), linear regression line is total aerobic bacteria = $822.95\text{GPM} + 3849298$. **B**) Log_{10} transformed volume of flow (gpm) with Log_{10} transformed Total Coliform Bacteria (cfu) ($R^2=0.6531$, $P=0.0015$), linear regression line is total coliforms = $32.553\text{GPM} - 85.67$. 1999-2003 data from Taylor et al. (2000) and supplemented with data collected during the present study.

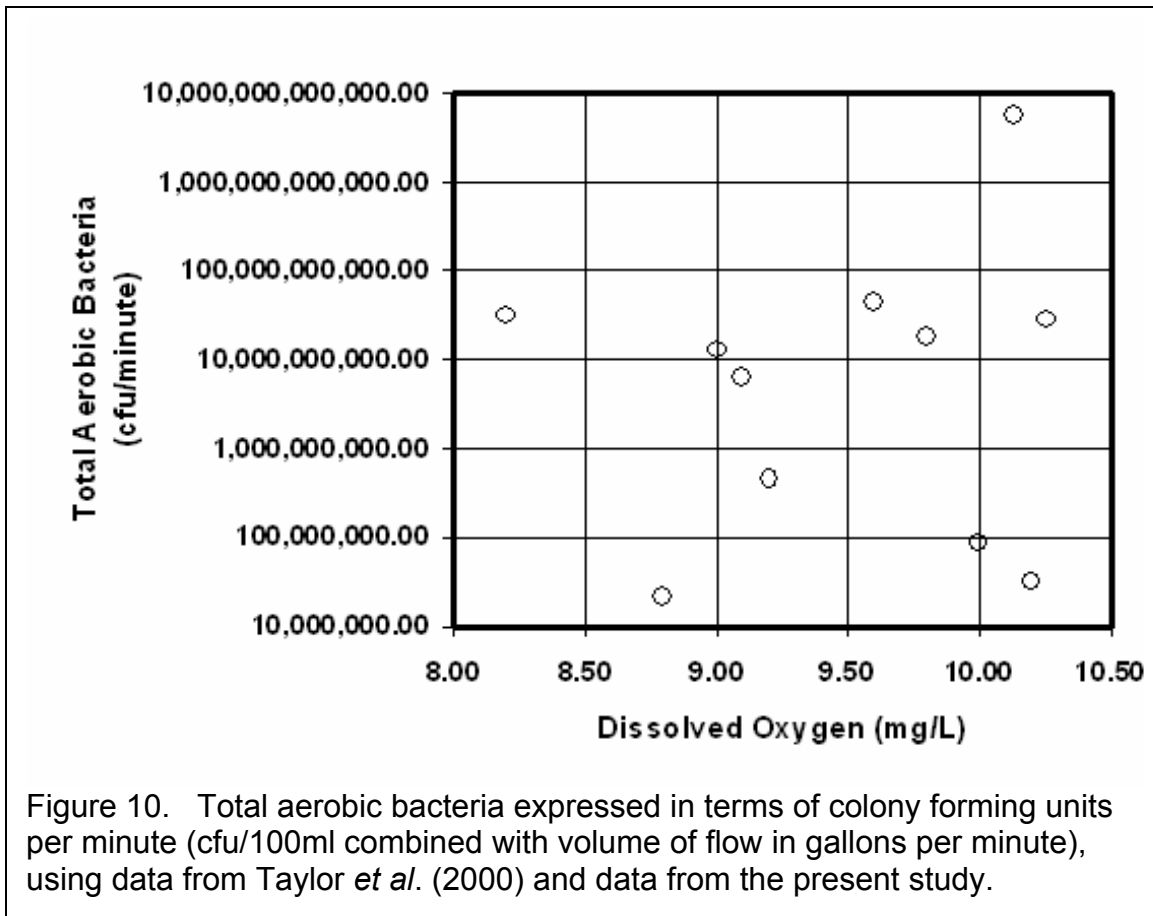

Amphipod collections

The total number of amphipods collected per cave visit varied from 0 to 109 (Table 4) and depended on flow and turbidity in the stream. High flow and turbidity made it difficult for researchers to see into the stream to locate suitable substrate/rocks and amphipods. Hence several visits were required per seasonal time interval to collect sufficient numbers of amphipods to complete the respiration runs. Of the *G. acherondytes* collected, more were returned to the cave than sampled, due to the release of young by gravid females (e.g., Figure 11) during the maintenance in the laboratory (Table 4). Several medium sized individuals died in the laboratory between collection and return trips. All mortalities, both for *G. acherondytes* and *G. troglophilus*, were associated with improper/incomplete molting. Of these individuals, all were found partially in and out of the old exoskeleton. We believe these molting related mortalities would have occurred in the field as well, and thus do not reflect laboratory maintenance efficacy. Molting related deaths also may indicate hormonal problems/interferences in the molt cycle. Amphipods varied in size from 0.88 to 34.5 mg and 5.6 to 17.5 mm for *G. acherondytes*, and 0.88 to 68.8 mg and 6.4 to 25.3 mm for *G. troglophilus*. This included immature to reproductive adults in the population. The size of adult *G. acherondytes* was smaller compared to *G.*

troglophilus and overall few very large *G. acherondytes* were collected or seen in the cave.

Oxygen Consumption Experiments

Probe calibrations

During initial probe calibrations, individual amphipods were used in more than one trial with the same and different probes to ensure that all probes were functioning properly and giving the same output. Figure 12 shows the 100% and 0% calibration traces for 3 probes prior to starting a respiration run with amphipods. Probe response over the range of 0 to 100% saturation was linear. Stirring artifacts were not present because of the small cathode diameter in the probe. Figure 13 shows a typical trace for an amphipod trial. The slope of the line between hours 1 to 4 represents the oxygen consumption rate in $\text{mg animal}^{-1} \text{h}^{-1}$.



Figure 11. Adult female of *Gammarus troglophilus* showing marsupium (midventral, between legs) with developing young.

Table 4. Summary of seasonal sampling intervals, actual dates of sampling and return of individuals to Illinois Caverns for *Gammarus acherondytes* and *Gammarus troglophilus*.

Sample Period	Date	Number of specimens			
		<i>Gammarus acherondytes</i>		<i>Gammarus troglophilus</i>	
		Collected	Returned	Collected	Returned
Jul/Aug 2002	Jul 24	20	0	89	0
	Aug 18	16	24	49	0
	Aug 24	0	41	42	16
Feb/Mar 2003	Feb 23	20	0	23	0
	Mar 07	0	19	0	23
May 2003	May 04	6	0	3	0
	May 09	0	5	0	2
	May 15	14	0	15	0
	May 20	0	14	0	15
Totals		76	102^a	221	56

^a - total returned to cave exceeds number taken because females collected in July 2002 released young which were kept alive in lab and returned with specimen initially collected for respiration monitoring

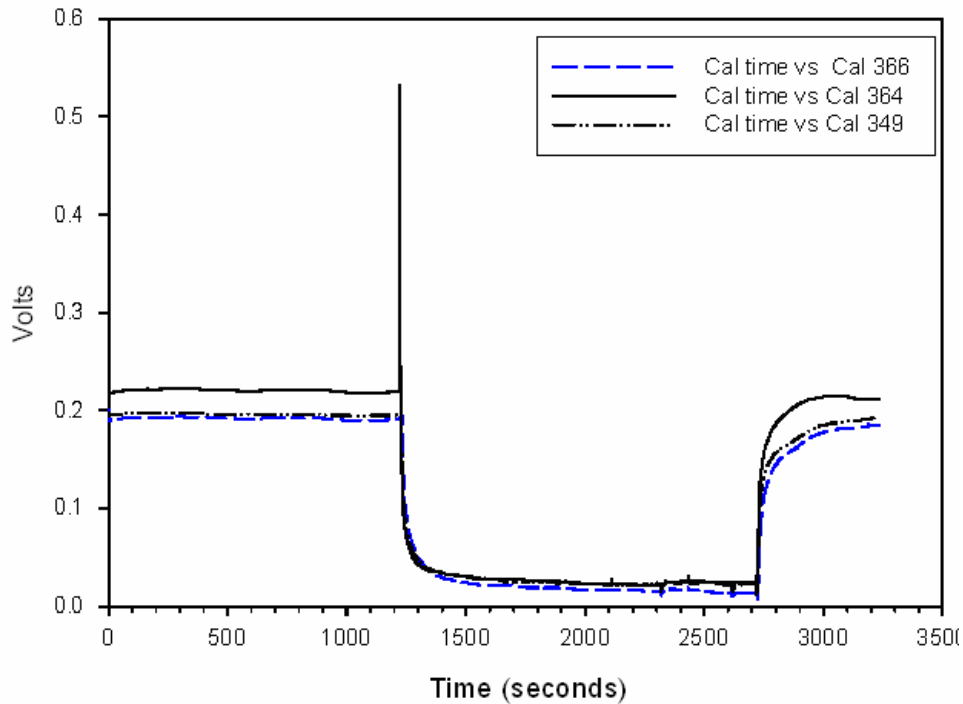

Figure 12. Pre-respiration run probe calibration trace showing probe stability at 100% and response time to 0% saturation. For 100% saturation filtered cave stream water was aerated with an airstone, while 0% saturated water was nitrogen bubbled for a minimum of 30 minutes to displace all oxygen. The voltage spike is associated with physically moving the probes into the 0% water.

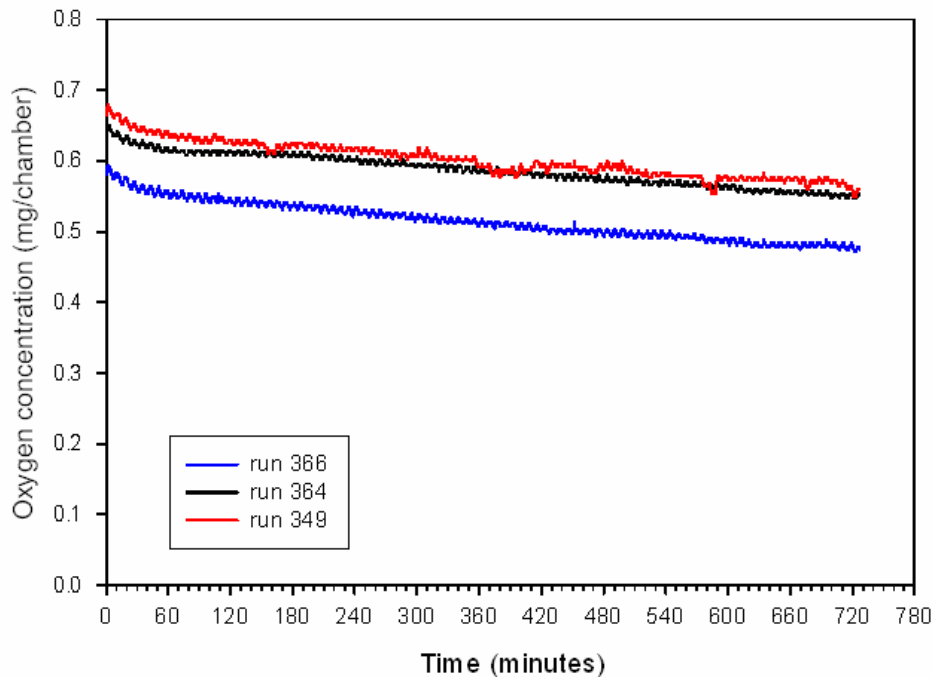

Figure 13. Typical respiration run trace with amphipods.

Unfiltered versus filtered water

Unfiltered water always had a higher mean oxygen consumption than filtered water (Table 5), however, these differences were only significant on May 4, 2003 in advance of a large storm event but during a time when the cave catchment had received large amounts of rainfall. The consumption of $0.085 \text{ mg O}_2 \text{ L}^{-1} \text{ h}^{-1}$ is approximately 2/3rds higher than the amount of oxygen consumed by the largest amphipod (see below). Thus, in stagnant areas of the stream microbial and bacterial respiration could deplete dissolved oxygen in the stream.

Table 5. Seasonal oxygen consumption rates of unfiltered and filtered water from Illinois Caverns during 2002 to 2003. The high rates on May 04, 2003 were associated with heavy rains in the catchment of the cave and flooding of the cave stream. *** Indicates difference (*t*-test, $P < 0.05$) between filtered and unfiltered water. Means \pm 1 Standard Error are presented.

Sample Period	Unfiltered Water ($\text{mg O}_2 \text{ L}^{-1} \text{ h}^{-1}$)	Filtered (0.22 μm) Water ($\text{mg O}_2 \text{ L}^{-1} \text{ h}^{-1}$)
Jul/Aug 2002	0.0312 \pm 0.007	0.011 \pm 0.009
February 2003	0.055 \pm 0.029	0.005 \pm 0.005
May 2003	0.085 \pm 0.009	0.040 \pm 0.001***

Oxygen consumption of *Gammarus acherondytes* and *Gammarus troglophilus*

A total of 57 and 62 respiration runs were successfully completed with *G. acherondytes* and *G. troglophilus*, respectively, (Table 6). Seasonal regressions of oxygen consumption versus amphipod dry mass did not differ from zero ($P > 0.05$) for *G. acherondytes* except in May 2003 (Figure 14A). Because two data points had undue influence on the relationship for May but the data were within

bounds of previous oxygen consumption rates, we analyzed all *G. acherondytes* data together. The overall relationship did not differ from zero ($P > 0.05$), indicating that for *G. acherondytes* oxygen consumption per animal was independent of body size and averaged $8.77 (\pm 0.93 \text{ SE}) \mu\text{g animal}^{-1} \text{ h}^{-1}$ (Figure 14A). Seasonal regressions for *G. troglophilus* versus amphipod dry mass differed from zero ($P < 0.05$; Figure 14B). Slopes of lines were similar (ANCOVA, $F_{2, 58} = 1.636$, $P = 0.204$), but elevations of lines differed significantly (ANCOVA, $F_{2, 60} = 42.58$, $P < 0.001$). *Post hoc* comparisons showed that elevations for February and May 2003 were similar but differed from Jul/Aug 2002 (Figure 14B).

Table 6. Summary of number of seasonal respiration runs completed with *Gammarus acherondytes* and *Gammarus troglophilus* from Illinois Caverns.

Sample Period	Number of Respiration Runs	
	<i>Gammarus acherondytes</i>	<i>Gammarus troglophilus</i>
Jul/Aug 2002	23	26
February 2003	20	20
May 2003	14	116
Total	57	62

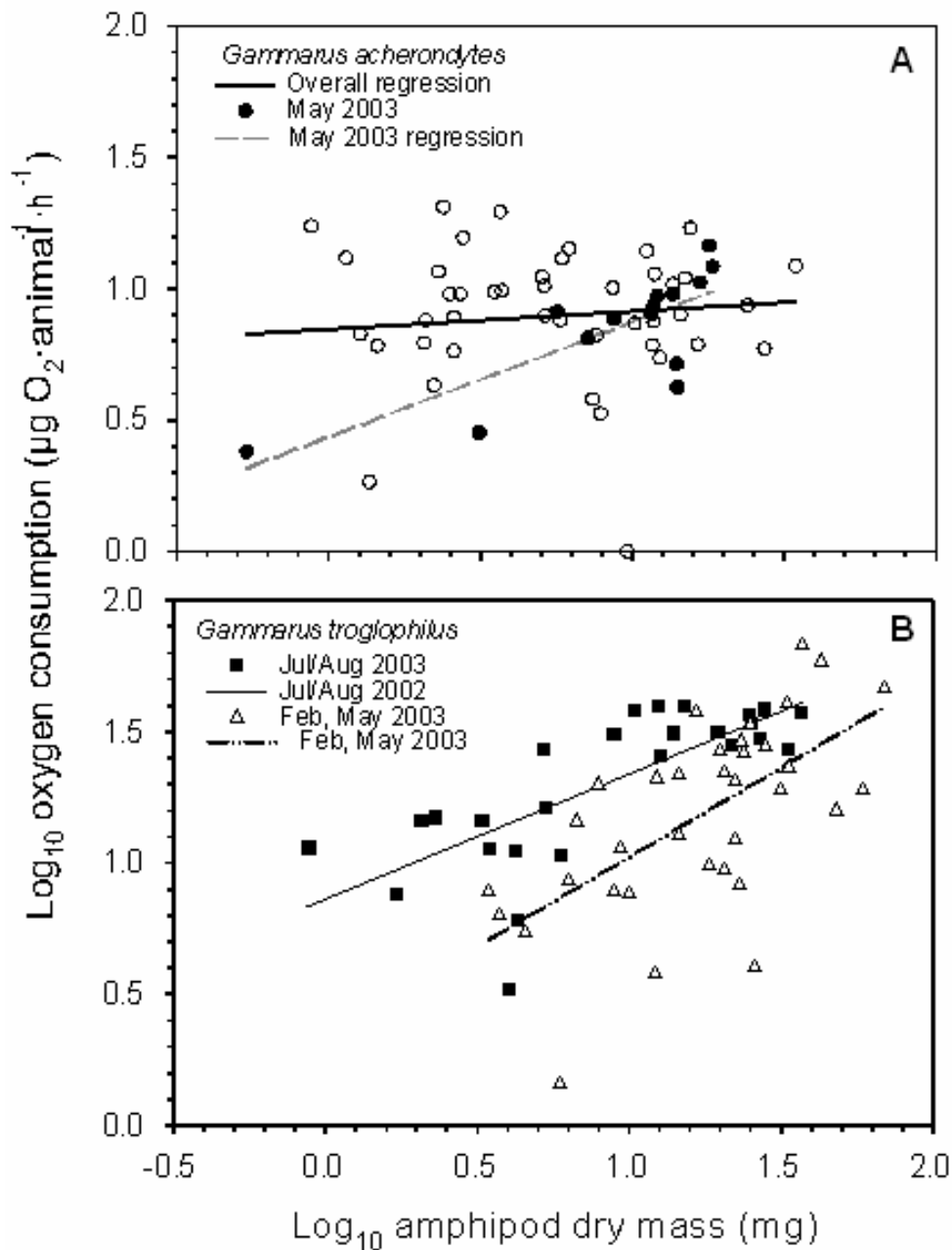

Figure 14. The seasonal relationships between oxygen consumption and amphipod dry mass for *Gammarus acherondytes* (A) and *Gammarus troglophilus* (B) from Illinois Caverns, IL. Regression equations in the form Log_{10} Oxygen consumption ($\mu\text{g O}_2 \cdot \text{animal}^{-1} \cdot \text{h}^{-1}$) = $\text{Log}_{10}a$ [\pm 95% CI (confidence interval)] + b (\pm 95% CI) Log_{10} Amphipod dry mass (mg) are: *G. troglophilus* Jul/Aug 2002 $\mu\text{g O}_2 \cdot \text{animal}^{-1} \cdot \text{h}^{-1}$ = $0.862(\pm 0.19) + 0.477(\pm 0.18) \text{Log}_{10}$ Amphipod dry mass (mg) and February and May 2003 $\mu\text{g O}_2 \cdot \text{animal}^{-1} \cdot \text{h}^{-1}$ = $0.339(\pm 0.38) + 0.682(\pm 0.30) \text{Log}_{10}$ Amphipod dry mass (mg). Because the relationship for *G. acherondytes* was not significant, oxygen consumption $8.77(\pm 0.93 \text{ SE})$ is constant with regard to body weight.

Discussion

Basic water chemistry parameters measured during this study (Table 1) were generally within the range of values reported for Illinois Caverns by Taylor *et al.* (2000). Specific Conductance was slightly higher in July 2002 than in previously recorded values. The volume of flow was generally higher than typical readings reported by Taylor *et al.* (2000), and during the May 2003 sampling period the highest flow was recorded (Figure 15, 16) in association with the peak of a large flood pulse. The values for temperature, dissolved oxygen, and specific conductance obtained during this study are also typical of other large cave streams in Monroe County (Taylor *et al.* 2000).

There seemed not to be a clear relationship between stream stage (or volume of flow) and available oxygen. It may be that during very high flow events the turbulence associated with rapid flow keeps enough oxygen in the water that the microbial oxygen

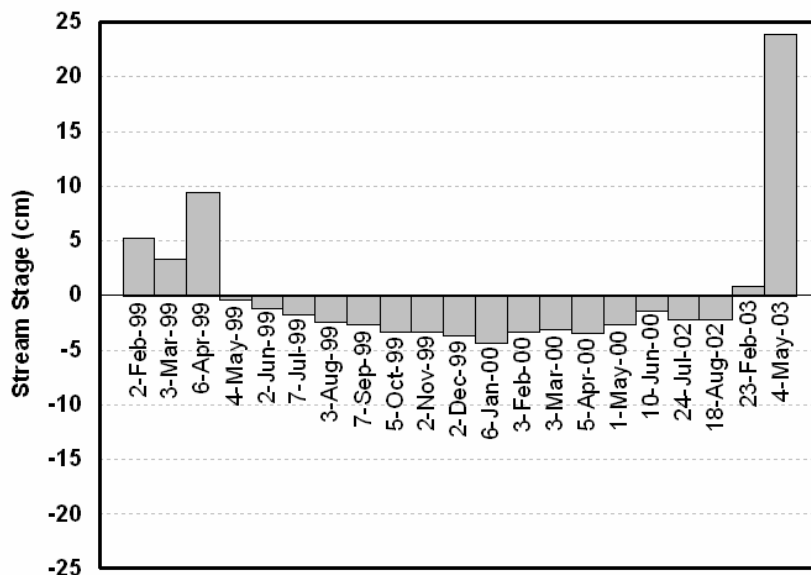

Figure 15. Stream flow (as stream stage deviation from mean value) at Illinois Caverns, including historical data (February 1999 - June 2000) from Taylor *et al.* (2000) as well as data from the present study.

consumption is masked. Taylor *et al.* (2000, see their Figures 50 and 51, pg 88) observed that elevated microbial levels sometimes occur in low flow conditions in major cave streams of Monroe County. It still may be that microbial oxygen demand could deplete available oxygen during low (non-turbulent) flow conditions to the point that oxygen availability becomes problematic for *G. acherondytes*, but we did not have sufficient data to test the idea in the present study. Our data comparing oxygen demand of filtered versus unfiltered cave stream water certainly seem to support this hypothesis (Table 5).



Figure 16. Mike Venarsky at the entrance to Rimstone River, the largest side passage of the main stream in Illinois Caverns, in high flood stage (4 May 2003). Note foam and extremely high turbidity.

Respiration rates of amphipods

The distinct differences in respiration rates between *G. acherondytes* and *G. troglophilus* suggest fundamental physiological differences between the two amphipod species. These differences may be related to the degree the species depend on cave ecosystems. *Gammarus acherondytes* is a cave obligate species, while *G. troglophilus* is a cave facultative species. To place our rates in context we compared them to respiration rates of other amphipods obtained with similar methods (Table 7). Our rates fall within the oxygen consumption range reported for other species. (Note that oxygen consumption rates are strongly temperature dependent and many rates in Table 7 are reported for low temperatures).

The lack of a positive relationship between oxygen consumption and amphipod body mass for *G. acherondytes* is difficult to explain. To our knowledge this is the first instance that such a relationship has been observed or reported. Given the number of data points, we believe that the trend is real, i.e. too many data points to consider the trend due to outliers. Adams and Johnson (2001) recorded a negative relationship between oxygen consumption and body mass for winter measurements of oxygen consumption versus body size in an Ozark cavefish. However, they commented on the lack of sufficient data to fully verify their pattern. A possible explanation for the independence between

respiration rate and body mass could be the low metabolic rate adaptation of stygobitic species. Generally stygobites have lower metabolic rates than related epigean species (Hüppop 1995, 2000) due to the constancy of the cave environments and the lack of food sources. Thus the lack of an increase in metabolic rate with size may be an 'extreme' adaptation to cope with food poor environments. Because respiration data in the literature have previously been reported per unit weight (e.g. Hervant *et al.* 1997, 1998, Hobak and Barnhart 1996), it is impossible to discern if similar patterns exist in other data sets. The high variability in our data especially among the young (lighter individuals) suggests some physiological difference among different sized individuals. Stress could explain some of this variability. Young animals may have been more stressed by handling than large adults. However, we treated all individuals in a similar manner. Therefore, variability due to stress would have had to have a seasonal component. Another source of variation could be the presence of food in the guts of some individuals. Although we did not provide food to the animals before experiments, many animals did not void the sediment packed in their guts after collections from the field. Although food and stress may have increased the variability, we doubt that reduction in variability among young would result in a positive relationship. This body mass independent respiration rate deserves further investigation in this and other stygobites.

The differences in the respiration rates of *G. troglophilus* between Jul/Aug and Feb/May could be related to several factors. Differences in seasonal metabolic rate related to environmental temperature could be one explanation. Many organisms undergo changes in metabolic rate linked to season, e.g. hibernation of bats in winter. Although temperature does not fluctuate greatly in Illinois Caverns (Taylor *et al.* 2000), constancy of temperature is a trait in cave environments (Hüppop 1995), the intrusion of cold water from surface snow melt can depress water temperatures in caves of the Salem Plateau in Illinois (Taylor *et al.* 2000). Thus, animal metabolism may be cued to seasonal surface phenomena. Although we attempted to control the effect of temperature by using a constant temperature for the experimental runs, which minimized the difference between laboratory and ambient temperature, we did not undertake any rigorous acclimation period to decouple possible environmental temperature effects. Temporal heterogeneity in the availability of food also could explain the differences in seasonal metabolic rates. Because of the absence of autochthonous food production in cave environments the majority of food is allochthonous in origin and is imported into the cave by other organisms or flood events. Floods are directly linked to rain events, which have a distinct seasonal pattern in southwestern Illinois and are more frequent in late spring and summer than in winter (Taylor *et al.* 2000). To survive such temporal changes in food availability, stygobites increase metabolic rates to store energy during periods of high food abundance and reduce metabolic rates during periods of low food abundance (Culver and Poulson 1971, Hüppop 1995, 2000). Thus the seasonal respiration rate may be a direct reflection of the availability of food. Further experiments with individuals acclimated to different water temperatures and food

conditions would be needed to separate the effects of each on the seasonal respiration rates of *G. troglophilus*.

We believe our results indicate that *G. troglophilus* can displace *G. acherondytes* under high food conditions. Because large individuals of *G. troglophilus* have a higher metabolic rate than *G. acherondytes*, they will grow faster and reach maturity sooner. As a result *G. troglophilus* will dominate the amphipod community numerically. During food poor conditions, *G. troglophilus* should be able to then outcompete *G. acherondytes* at the species level from a numerical perspective alone. We do not have any information about interactions (possible space limitation, aggressive encounters over food or encounters in general) between the species at times when food abundance is low. Such information is important to eliminate the speculative aspect in predicting the long-term viability of *G. acherondytes*. Our data suggest that numerical dominance of *G. acherondytes* in caves of Illinois' Salem Plateau would require long periods of food-poor conditions, a stark contrast to current nutrient conditions in the caves. This research highlights the need to focus recovery efforts on surface activities, which reduce nutrient and material inputs into the caves.

Table 7. Respiration rates of amphipods (per individual) reported in the literature. All rates have been converted to $\mu\text{g O}_2\cdot\text{animal}^{-1}\cdot\text{h}^{-1}$ and are given for a 2 mg individual, °C indicates temperature at which respiration rates were determined. The habitat of each species is indicated as follows: CS - cave stream; SS - surface stream; LL - littoral lake; PL - profundal lake; and OA - oceanic Antarctica.

Rate	°C	Species	Habitat	Source
8.77	12.2	<i>Gammarus acherondytes</i>	CS	This study
10.1	12.2	<i>Gammarus troglophilus</i>	CS	This study (Jul/Aug)
3.5	11.3	<i>Gammarus troglophilus</i>	CS	This study (Feb/May)
4.29-10.3	13	<i>Gammarus minus</i>	CS	Culver and Poulson 1971
0.40	10	<i>Gammarus minus</i>	SS	Soumalainen 1958
2.03	12	<i>Gammarus fossarum</i>	SS	Franke 1977
41.82	20	<i>Gammarus pulex</i>	SS	Rumpus and Kennedy 1974
1.5-5.67	2-15	<i>Gammarus pulex</i>	SS	Nilsson 1974
2.26	15	<i>Hyalella azteca</i>	LL	Mathias 1971
3.27	7	<i>Diporeia hoyi</i>	PL	Wilhelm <i>et al.</i> 1997
0.53	7	<i>Pontoporeia hoyi</i>	PL	Johnson and Brinkhurst 1971
1.5	4	<i>Pontoporeia hoyi</i>	PL	Nalepa 1991
0.98	4.6	<i>Pontoporeia affinis</i>	PL	Cederwall 1979
0.70	4.6	<i>Pontoporeia femorata</i>	PL	Cederwall 1979
2.61	2	<i>Parammoera walkeri</i>	OA	Opalinski 1974

Future Work

We are also concerned by the lack of knowledge of the basic ecology of the amphipod. For example, no data are available on seasonal reproductive periods, number of young produced, longevity, age at first reproduction, energy transfer rates, food choice, and trophic levels, and very little data are available on microhabitat use and behavior. Furthermore, we do not adequately understand how or if populations of *G. acherondytes* in different caves are related. Answers to such questions are fundamental to the development and implementation of a realistic recovery plan. We believe our collective research expertise on the ecology of aquatic and cave invertebrates combined with our developing knowledge (e.g., ability to distinguish *G. acherondytes* and *G. troglophilus* in the field) of these amphipod species makes us an ideal group to undertake such initiatives.

Acknowledgements

We thank JoAnn Jacoby (University of Illinois) and Stacey Clementz (Illinois Natural History Survey) for assistance with field work and Nina Baki (Southern Illinois University at Carbondale) for her work in the laboratory. Chris Hespino and Vic Hamer (Illinois Department of Natural Resources) kindly facilitated our visits to Illinois Caverns. Ellen Stormont and Steve Kasten (Animal Disease Laboratory, Illinois Department of Agriculture) analyzed of microbial samples. We are especially grateful for Glen Kruse's patience and vote of confidence in continuing to facilitate financial support of this project in spite of various problems we encountered early on. We thank Jeff Fairchild, University of Illinois Life Sciences Electronics Shop, for design and construction of the activity monitoring device. Funding for this study was provided by the Illinois Department of Natural Resources.

Literature Cited

- Adams, G. L. and J. E. Johnson. 2001. Metabolic rate and natural history of Ozark cavefish, *Amblyopsis rosae*, in Logan Cave, Arkansas. *Environmental Biology of Fishes* 62: 97-105
- Aley, T. 1998. An editorial: the Illinois Cave Amphipod; a collection of classical problems. *American Caves* 11(1):8-11.
- Aley T., P. Moss, and C. Aley. 2000. Delineation of recharge areas for four biologically significant cave systems in Monroe and St. Clair Counties, Illinois. Final Report to the Illinois Nature Preserves Commission and the Monroe Country Soil and Water Conservation District, Protem, Missouri. 254 pp.

- American Public Health Association (APHA). 1985. Standard methods for the examination of water and wastewater. 19th ed.
- Bechler, D. L. 1985. Structure and foraging behavior in hypogean crustacean assemblages. *Hydrobiologia* 127:203-211.
- Brett, J. R. and T. D. D. Groves. 1979. Physiological energetics, In Fish physiology. Vol. 8. Edited by W. S. Hoar, D. J. Randall, and J. R. Brett. Academic Press, New York. pp. 279-352.
- Cason, E., L. Greiman, and D. Reynolds. 1991. Bacterial species isolated from well water in southern Illinois. *Dairy, Food and Environmental Sanitation* 11(1):645-649.
- Cederwall, H. 1979. Diurnal oxygen consumption and activity of two *Pontoporeia* (Amphipoda, Crustacea) species. In Cyclic phenomena in marine plants and animals. Edited by Naylor, E. and Hartnoll, R. G. Pergamon Press, Oxford. pp. 309-316.
- Clesceri, L. S., A. E. Greenburg, and R. R. Trussel. 1989. Standard Methods for the Examination of Water and Wastewater. 17th Edition. American Public Health Association. Washington, D.C.
- Culver, D. C. 1970. Analysis of simple cave communities: niche separation and species packing. *Ecology* 51(6):949-958.
- Culver, D. C. 1971. Analysis of simple cave communities III. Control of abundance. *American Midland Naturalist* 85(1):173-187.
- Culver, D. C. 1973. Competition in spatially heterogeneous systems: an analysis of simple cave communities. *Ecology* 54:102-110.
- Culver, D. C. 1981. The effects of competition on composition of some cave stream communities. *Proceedings of the Eighth International Congress of Speleology, Bowling Green, KY* 1:207-209.
- Culver, D. C. and T. L. Poulson. 1971. Oxygen consumption and activity in closely related amphipod populations from cave and surface habitats. *American Midland Naturalist* 85: 74-84.
- Culver, D. C., D. W. Fong, and R. W. Jernigan. 1991. Species interactions in cave stream communities: experimental results and microdistribution effects. *American Midland Naturalist* 126:364-379.

- Culver, D. C., T. C. Kane, and D. W. Fong. 1995. Adaptation and natural selection in caves. The evolution of *Gammarus minus*. Harvard University Press, Cambridge, MA. 223 pp.
- Davies, R., F. Wrona, and V. Kalarani. 1992. Assessment of activity-specific metabolism of aquatic organisms: an improved system. *Canadian Journal of Fisheries and Aquatic Sciences* 49:1142-1148.
- Del Giorgio, P. A. and J. J. Cole. 1998. Bacterial growth efficiency in natural aquatic systems. *Annual Review of Ecology and Systematics* 29:503-541.
- Dick, J. T. A., S. E. Faloon, and R. W. Elwood. 1998. Active brood care in an amphipod: influences of embryonic development, temperature and oxygen. *Animal Behavior* 56(3):633-672.
- Franke, U. 1977. Experimentelle untersuchungen zur respiration von *Gammarus fossarum* Koch 1835 (Crustacea: Amphipoda) in abh angigkeit von temperatur, sauerstoffkonzentration und wasserbewegung. *Arch. Hydrobiol.* 48 (Suppl.): 369-411.
- Fry, F. E. J. 1957. The aquatic respiration of fish. Pages 1-55 in M. E. Brown (ed.). *The physiology of fishes*. Vol. 1. Academic Press, New York.
- Gerhardt, A., E. Svensson, M. Clostermann, and B. Fridlund. 1994. Monitoring behavioral patterns of aquatic organisms with an impedance conversion technique. *Environmental International* 20(2):209-219.
- Henry, K. S. and D. L. Danielopol. 1998. Oxygen dependent habitat selection in surface and hyporheic environments by *Gammarus roeseli* Gervais (Crustacea, Amphipoda): experimental evidence. *Hydrobiologia* 390(1-3):51-60.
- Hervant, F. and J. Mathieu. 1995. Ventilatory and locomotory act in anoxia and subsequent recovery of epigean and hypogean crustaceans. *Comptes Rendus de l'Academie des Sciences Serie III-Sciences de la Vie-Life Sciences* 318(5):585-592.
- Hervant, F., J. Mathieu, D. Garin and A. Freminet. 1995. Behavioral, ventilatory and metabolic responses to severe hypoxia and subsequent recovery of the hypogean *Niphargus rhenorhodanensis* and the epigean *Gammarus fossarum* (Crustacea: Amphipoda). *Physiological Zoology* 68(2):223-244.
- Hervant, F., J. Mathieu, D. Garin and A. Freminet. 1996. Behavioral ventilatory and metabolic responses of the hypogean amphipod *Niphargus virei* and the epigean isopod *Asellus aquaticus* to severe hypoxia and subsequent recovery. *Physiological Zoology* 69(6):1277-1300.

- Hervant, F., J. Mathieu, H. Barre, K. I. Simon, and C. Pinon. 1997. Comparative study on the behavioral, ventilatory, and respiratory responses of hypogean and epigean crustaceans to long-term starvation and subsequent feeding. *Comp. Biochem. Physiol.* 118A(4):1277-1283.
- Hervant, F., J. Mathieu, and G. Messana. 1988. Oxygen consumption and ventilation in declining oxygen tension and post hypoxic recovery in epigean and hypogean crustaceans. *Journal of Crustacean Biology* 18:717-727.
- Hervant, F., J. Mathieu, and H. Barre. 1999a. Comparative study on the metabolic responses of subterranean and surface-dwelling amphipods to long-term starvation and subsequent refeeding. *Journal of Experimental Biology* 202(24):3587-3595.
- Hervant, F., J. Mathieu, and D. C. Culver. 199b. Comparative responses to severe hypoxia and subsequent recovery of closely related amphipod populations (*Gammarus minus*) from cave and surface habitats. *Hydrobiologia* 392(2):197-204.
- Holsinger, J. R. 1969. Biogeography of the freshwater amphipod crustaceans (Gammaridae) of the Central and Southern Appalachians, Pages 19-50 *In*: P.C. Holt, Ed. *The Distributional History of the Biota of the Southern Appalachians. Part I: The Invertebrates.* Virginia Polytechnic Institute Press, Research Division Monographs, Blacksburg, Virginia.
- Holsinger J. R. 1976. The freshwater amphipod crustaceans (Gammaridae) of North America. *Water Pollution Control Research Series 18050 ELD04/72* (second printing). 89 pp.
- Hüppop, K. 1985. The role of metabolism in the evolution of cave animals. *Bulletin of the National Speleological Society* 47:136-146.
- Hüppop, K. 2000. How do cave animals cope with the food scarcity in caves? Chapter 8, pp 159-188. *In* Wilkens, H., Culver, D. C. and Humphreys, W. F. editors. *Ecosystems of the World 30: Subterranean Ecosystems.* Elsevier, New York.
- Johnson, M. G. and R. O. Brinkhurst. 1971. Production of benthic macroinvertebrates of the Bay of Quinte and Lake Ontario. *J. Fish. Res. Board Can.* 28:1699-1714.
- Jones, R. 1990. Evolution of cave and surface populations of the amphipod *Gammarus minus*. Ph.D. dissertation. Northwestern University, Evanston, Illinois.

- Lewis, J. J., P. L. Moss, and D. L. Tecic. 1999. A conservation focused evaluation of the imperiled troglobitic fauna of the Sinkhole Plain karst of southwestern Illinois. Final report to The Nature Conservancy, 30 September 1999. 97 pp.
- Lewis, J. J. 2001. Establishing population sizes for the Illinois Cave Amphipod, *Gammarus acherondytes*, in cave stream communities in the Sinkhole Plain karst of southwestern Illinois. Final report to the Endangered Species Prog., U.S. Fish and Wildlife Service. 18 pp.
- Lewis, J. J., P. Moss, D. Tecic, and M. E. Nelson. 2003. A conservation focused inventory of subterranean invertebrates of the southwest Illinois karst. *Journal of Cave and Karst Studies* 65(1): 9-21.
- Malarad, F. and F. Hervant. 1999. Oxygen in groundwater: a critical factor for life? *Freshwater Biology* 41(1):1-30.
- Mathias, J. A. 1971. Energy flow and secondary production of the amphipods *Hyalella azteca* and *Crangonyx richmondensis occidentalis* in Marion Lake, British Columbia. *J. Fish. Res. Board Can.* 28: 711-726.
- Nalepa, T. F. 1991. Status and trends of the Lake Ontario macrobenthos. *Can. J. Fish. Aquat. Sci.* 48: 1558-1567.
- Nilsson, L. M. 1974. Energy budget of a laboratory population of *Gammarus pulex* (Amphipoda). *Oikos.* 25: 35-42.
- Opalinski, K. W. 1974. Standard, routine, and active metabolism of the antarctic amphipod *Paramoera walkeri* Stebbing. *Polsk. Arch. Hydrobiol.* 21: 423-429.
- Panno, S. V., I. G. Krapac, C. P. Weibel, and J. D. Bade. 1996. Groundwater contamination in karst terrain of southwestern Illinois. Illinois State Geological Survey Environmental Geology Series Report 151. Champaign, Illinois. 43 pp.
- Panno, S. V., E. C. Stormont, C. P. Weibel, and I. G. Krapac. 1997. Bacterial species isolated from groundwater from springs, caves and wells in southwestern Illinois' Sinkhole Plain and their potential sources. Proceedings of the Annual Environmental Laboratories Seminar, October 2-3, 1997, Springfield, Illinois. Pages 1-4.
- Panno, S. V., W. R. Kelly, C. P. Weibel, I. G. Krapac, and S. L. Sargent. 2003. Water quality and agricultural loading in two groundwater basins of

- Illinois' sinkhole plain. Illinois State Geological Survey, Environmental Geology Series 156. 36 pp.
- Peters, R. H. 1983. Implications of body size. Cambridge University Press, NY, USA.
- Rumpus, A. E. and C. R. Kennedy. 1974. The effect of the acanthocephalan *Polymorphus laevis* upon the respiration of its intermediate host, *Gammarus pulex*. Parasitol. 68: 271-284.
- Soumalainen, P. 1958. Der Sauerstoffverbrauch einiger finnischer *Gammarus*-Arten. Verh. Internat. Verein. Limnol. 13: 873-878.
- Taylor, S. J. and D. W. Webb. 2000. Subterranean Amphipoda (Crustacea) of Illinois' Salem Plateau; spatial and temporal components of microdistribution. Illinois Natural History Survey, Center for Biodiversity, Technical Report 2000 (27):1-62.
- Taylor, S. J., D. W. Webb, and S. V. Panno. 2000. Spatial and temporal analyses of the bacterial fauna and water, sediment, and amphipod tissue chemistry within the range of *Gammarus acherondytes*. Illinois Natural History Survey, Center for Biodiversity, Technical Report 2000(18):1-115.
- United States Fish and Wildlife Service, Department of the Interior (USFWS). 1998. Endangered and threatened wildlife and plants; Final rule to list the Illinois Cave Amphipod as endangered. Federal Register 63(171):46900-46910.
- United States Fish and Wildlife Service, Department of the Interior (USFWS). 2002. Illinois Cave Amphipod (*Gammarus acherondytes*) recovery plan. 63 pp.
- Webb, D. W. 1993. Status survey for a cave amphipod, *Gammarus acherondytes*, Hubricht and Mackin (Crustacea: Amphipoda) in southern Illinois. Illinois Natural History Survey, Center for Biodiversity, Technical Report 1993(9): 1-7.
- Webb, D. W. 1995. Status report on the cave amphipod *Gammarus acherondytes* Hubricht and Mackin (Crustacea: Amphipoda) in Illinois. Illinois Natural History Survey, Center for Biodiversity, Technical Report 1995(22): 1-22.
- Webb, D. W., L. M. Page, S. J. Taylor, and J. K. Krejca. 1998. The current status and habitats of the Illinois cave amphipod, *Gammarus acherondytes* Hubricht and Mackin (Crustacea: Amphipoda). Journal of Cave and Karst Studies 60(3): 172-178.

- Webb, D. W., S. J. Taylor, and J. K. Krejca. 1993. The biological resources of Illinois caves and other subterranean environments. Illinois Natural History Survey, Center for Biodiversity, Technical Report 1993(8): 1-157.
- Wetzel, M. J. and S. J. Taylor. 2001. First records of freshwater oligochaetes (Annelida, Clitellata) from caves in Illinois and Missouri, USA. *Journal of Cave and Karst Studies* 63(3):99-104.
- Wilhelm, F. M., D. C. Lasenby, R. M. Wilhelm, and R. Plante. 1997. A new recorder for simultaneously recording the activity and oxygen consumption of small benthic invertebrates. *Can. J. Fish. Aquat. Sci.* 54: 2888-2893.
- Wilhelm, F. M. and D. C. Lasenby. 1998. Seasonal trends in the head capsule length and body length/weight relationship of two amphipod species. *Crustaceana* 71: 399-410.
- Winberg, G. C. 1956. Rate of metabolism and food requirements of fishes. Fisheries Research Board of Canada, Translation Series 194, 1960, Ottawa, Canada.

Appendix 1. Preliminary attempts to use a custom-built Infra-red activity recorder to record amphipod activity.

An amphipod activity detector, for the amphipod respiration experiments, was built during the initial phase of this project with the intention of using it to monitor activity during respiration trials. Unfortunately this device was plagued with problems, including a) delayed production of the detector device by the electronics expert, physical failure (breakage) of the glass respiration chambers, calibration problems with the analog to digital board, design problems with the gasketed stoppers for the respiration chambers, broken oxygen microelectrodes (a problem not diagnosed correctly at first), variable power output by individual infrared LEDs (resulting in irresolvable [on our timescale and budget] problems calibrating the activity chambers), and inadequate sensitivity. Many of these problems were discussed in progress reports we submitted during the course of our research. The concept of using the IR activity detector clearly has merit, but its effective use will entail significant reconfiguration of the electronics. Such changes, while desirable, are well beyond the scope of this study.

Because considerable resources were invested in the activity detector, and because we believe the method still has great value, we describe the details of the operation of the device (see below). Pin assignments for the circuit board are given in Table A1-1, and a list of parts used in the construction of the activity monitor is given in Table A1-2. A circuit diagram (Figure A1-1) and pin diagram for plugs (Figure A1-2) are provided, along with a series of photographs of the activity monitor device (Figures A1-3 through A1-7) and the entire setup in our early attempts to make it all work. (Figures A1-8 and A1-9).

Infrared Amphipod Activity Monitor - Chassis 1047 Theory of Operation

The IR Amphipod Monitor is an apparatus for monitoring the activity and oxygen consumption of one to four amphipods. Each amphipod will be in its own glass chamber. The chamber will be filled with stream water and sealed. An oxygen probe connected to a computer's data acquisition card will monitor the oxygen level in the chamber. The chamber will be placed on an IR Sensor Assembly. The IR Sensor Assembly will monitor the activity of the amphipod with eight infrared light beams and detectors. A cable will connect the IR Sensor Assembly to the Amphipod Monitor Chassis at one of its "Chamber" connectors. The Amphipod Monitor Chassis can accommodate up to four of the IR Sensor Assemblies. Therefore up to four amphipods can be studied separately but simultaneously. The Amphipod Monitor Chassis processes the signals from the infrared light detectors. It provides one activity signal for each of the four chambers at the "Computer" connector. A cable connects this port to a computer's data acquisition card. When an amphipod moves in front of an infrared beam, it blocks the beam and causes its corresponding activity signal at the "Computer" connector to go to a TTL high level, approximately 5 volts. When an amphipod moves out of the infrared beam, the activity signal goes to a TTL low, approximately 0 volts.

The Amphipod Monitor Chassis and the four IR Sensor Assemblies were designed and built by Jeff Fairchild of the University of Illinois Life Sciences Electronics Shop for Steve Taylor of the Illinois State Natural History Survey. Design began in October of 2000 and construction was completed in March of 2001.

The IR Sensor Assembly is made up primarily of H23B1 emitters and detectors, which are made by QT Optoelectronics and are available from Newark Electronics. The H23B1 light emitting diode, topped with black paint, provides the infrared beam. It is biased on with an 82-ohm 1/2 watt resistor tied to 5 volts provided by the Amphipod Monitor Chassis power supply. A ring of eight emitters is placed in the center of the Sensor Assembly circuit board and face outward. A ring of eight H23B1 infrared detectors, topped with yellow paint, is placed concentrically outside the emitter ring and face inward to receive the infrared beams. The detector is a Darlington pair with the collector tied through a 560-ohm resistor to 5 volts.

When the infrared beam strikes the detector, the detector puts out a signal approximately 0 to 1 volt DC. When the infrared beam is blocked, the detector puts out a signal of approximately 5 volts DC. This signal is fed to the inverting input of an LM339 op amp set up as a comparator. The non-inverting input of the LM339 is connected to an adjustable "Threshold" voltage, which is used as the switching point of the comparator. The 1-megohm resistors increase the switching hysteresis. If the detector signal is below the "Threshold" voltage, the comparator gives a high output- approximately 5 volts. If the detector signal is above the "Threshold" voltage, the comparator gives a low output- approximately 0 volts.

The comparator output feeds one input of the 74LS30 eight-input NAND gate. This NAND gate will monitor all eight sensor pairs of one Sensor Assembly in the manner described above. Normally each infrared beam will be unblocked. Therefore each input of the 74LS30 will be at a high TTL level. Under this condition, the 74LS30 puts out a low TTL level. If any input goes to a low TTL level, the 74LS30 will output a high TTL voltage. So if an amphipod is not blocking an infrared beam, the output for that chamber at the Amphipod Monitor Chassis' "Computer" connector will be around 0 volts. If an amphipod blocks the beam, the output becomes about 5 volts.

The glass chambers can be adjusted in height relative to the emitters and detectors by turning the three screws underneath the IR Sensor Assembly. These screws can be turned by hand; a screwdriver is not needed. When adjusting these screws, ensure that the chamber is level.

To set up the IR Amphipod Monitor, connect each IR Sensor Assembly to its cable. Attach the cable to its corresponding Amphipod Monitor Chassis "Chamber" connector. Attach a cable from the Amphipod Monitor Chassis "Computer" connector to your data acquisition card. Plug the chassis power cord into a wall receptacle. Turn on the Chassis with the power switch. Power is now provided through the Chassis to all IR Sensor Assemblies.

Table A1-1. Pin assignments for PC board edge connector of infrared amphipod activity monitor.

Signal Source	PCB Destination	Edge Connector Pin #	Wire Color
+5 V.	+5 V bus	1,2	Red
Power Common	Ground plane	3,4	Black
Chamber 1, Sensor 1	U1, pin 4	5	Black
Chamber 1, Sensor 2	U1, pin 6	7	Brown
Chamber 1, Sensor 3	U1, pin 8	9	Red
Chamber 1, Sensor 4	U1, pin 10	11	Orange
Chamber 1, Sensor 5	U2, pin 4	8	Black
Chamber 1, Sensor 6	U2, pin 6	10	Brown
Chamber 1, Sensor 7	U2, pin 8	12	Red
Chamber 1, Sensor 8	U2, pin 10	14	Orange
Chamber 2, Sensor 1	U4, pin 4	17	Yellow
Chamber 2, Sensor 2	U4, pin 6	19	Green
Chamber 2, Sensor 3	U4, pin 8	21	Blue
Chamber 2, Sensor 4	U4, pin 10	23	Violet
Chamber 2, Sensor 5	U5, pin 4	20	Yellow
Chamber 2, Sensor 6	U5, pin 6	22	Green
Chamber 2, Sensor 7	U5, pin 8	24	Blue
Chamber 2, Sensor 8	U5, pin 10	26	Violet
Chamber 3, Sensor 1	U7, pin 4	29	Gray
Chamber 3, Sensor 2	U7, pin 6	31	White
Chamber 3, Sensor 3	U7, pin 8	33	Black
Chamber 3, Sensor 4	U7, pin 10	35	Brown
Chamber 3, Sensor 5	U8, pin 4	32	Gray
Chamber 3, Sensor 6	U8, pin 6	34	White
Chamber 3, Sensor 7	U8, pin 8	36	Black
Chamber 3, Sensor 8	U8, pin 10	38	Brown
Chamber 4, Sensor 1	U10, pin 4	41	Red
Chamber 4, Sensor 2	U10, pin 6	43	Orange
Chamber 4, Sensor 3	U10, pin 8	45	Yellow
Chamber 4, Sensor 4	U10, pin 10	47	Green
Chamber 4, Sensor 5	U11, pin 4	44	Red
Chamber 4, Sensor 6	U11, pin 6	46	Orange
Chamber 4, Sensor 7	U11, pin 8	48	Yellow
Chamber 4, Sensor 8	U11, pin 10	50	Green
Chamber 4 Activity	U12, pin 8	49	Yellow
Chamber 3 Activity	U9, pin 8	51	Orange
Chamber 2 Activity	U6, pin 8	53	Red
Chamber 1 Activity	U3, pin 8	55	Brown

Table A1-2. Parts list for infrared amphipod activity monitor.

PART	QUANT.
H23B1, IR emitter/detector pair	32
LM339N, quad op amp	8
74LS30, 8-input NAND	4
EMI filter, 6 amp 6EEA1	1
5V. 3A. power supply, IHB5-3.0	1
Vector board, 4610	1
Edge connector, R656-1, 28/56 pins	1
Chassis, Bud AC-414, 10x14x3	1
Chassis bottom plate, BPA-1524, 10x14	1
.1 uF monolythic capacitors	12
6.8 uF Tantalex capacitor	1
82 ohm 1/2 watt resistor	32
560 ohm 1/4 watt resistor	32
2.7 kohm 1/4 watt resistor	32
1 megohm 1/4 watt resistor	64
10 kohm 10-turn pot, 3296W	1
5 minute EPOXY glue	1
1/2 inch Rubber Feet	20
3/4 inch Angle Brackets	12
4-40 x 1 inch spacer	16
6-32 x 3/8 inch spacer	14
6-32 x 1/4 inch spacer	4
D-sub 15 pin connector, male	9
D-sub 15 pin connector, female	8
Metal hoods for 15 pin connectors	8
D-sub 9 pin connector, female	1
D-sub 9 pin connector, male	1
Metal hood for 9 pin connector	1
10-conductor, 24 ga. Cable, Belden 9540	1
HKP panel fuse holder	1
4.5x6.5 inch circuit board, Radio Shack	4
SPDT 6 amp toggle switch, MTA- 106D	1
Red Tineon indicator light	1

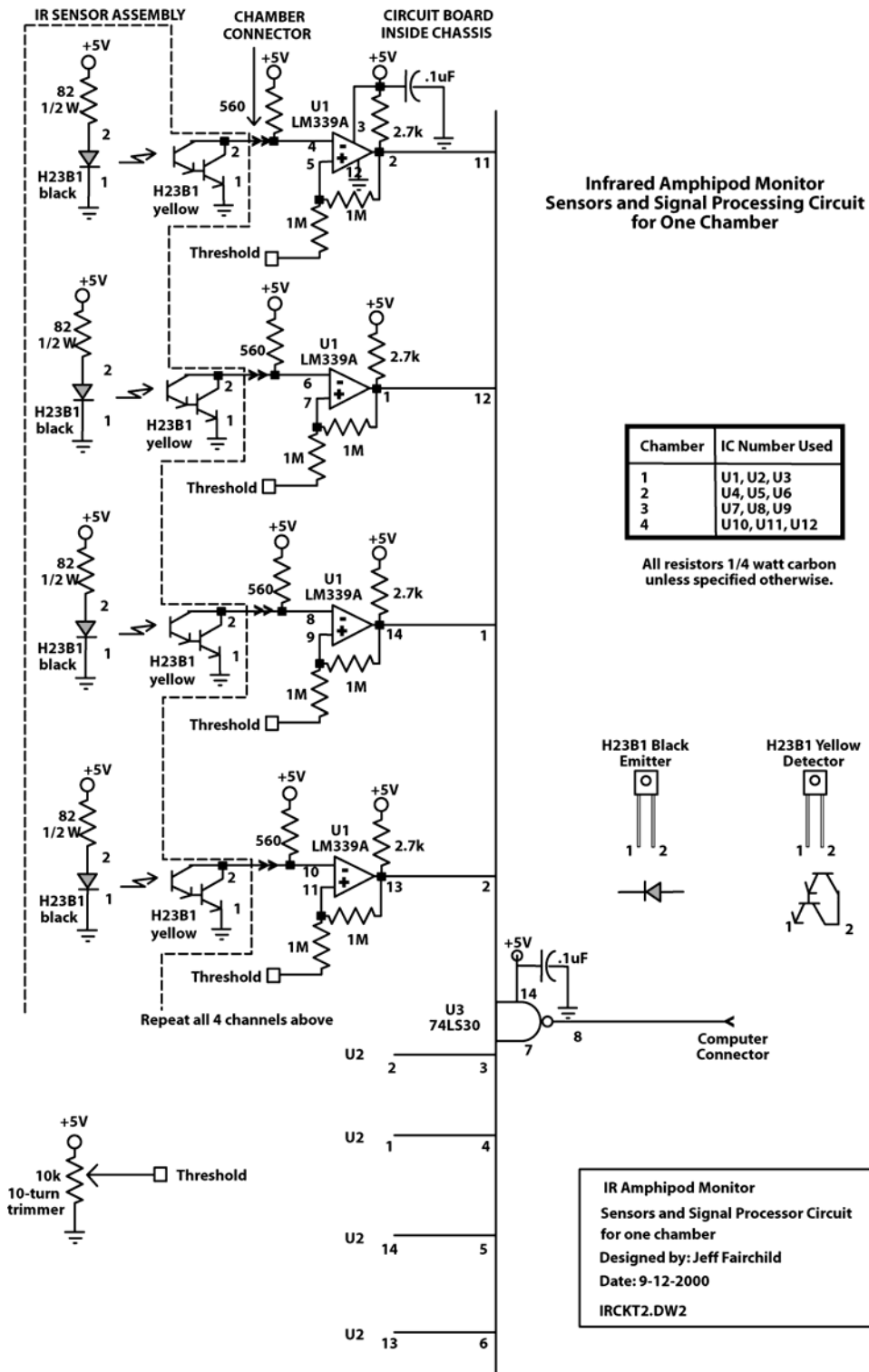
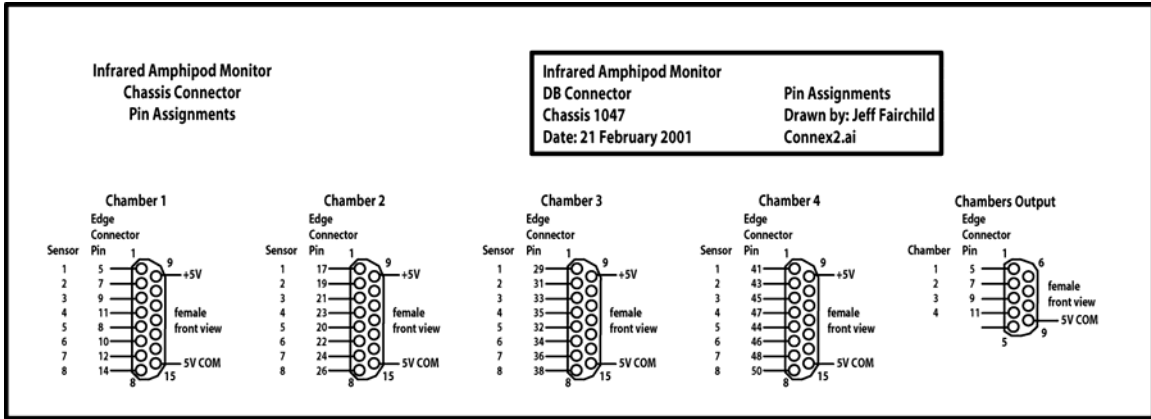
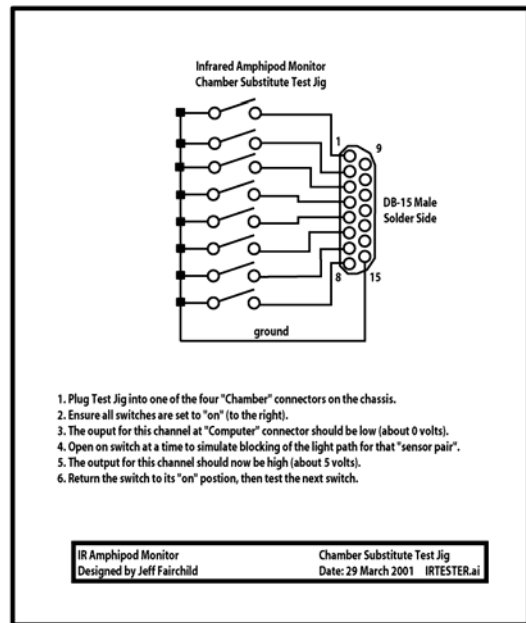

Figure A1-1. Infrared amphipod activity monitor: Sensors and signal processing circuit for one chamber.



A



B

Figure A1-2. Infrared Amphipod Activity Monitor: A. Chassis 1047 connector pin assignments; B. Substitute test jig (Instructions: 1. Plug Test Jig into one of the four "Chamber" connectors on the chassis; 2. Ensure all switches are set to "on" [to the right]; 3. The output for this channel at "Computer" connector should be low [about 0 volts]; 4. Open "on" switch at a time to simulate blocking of the light path for that "sensor pair"; 5. The output for this channel should now be high [about 5 volts]; and 6. Return the switch to its "on" position, then test the next switch.).



A

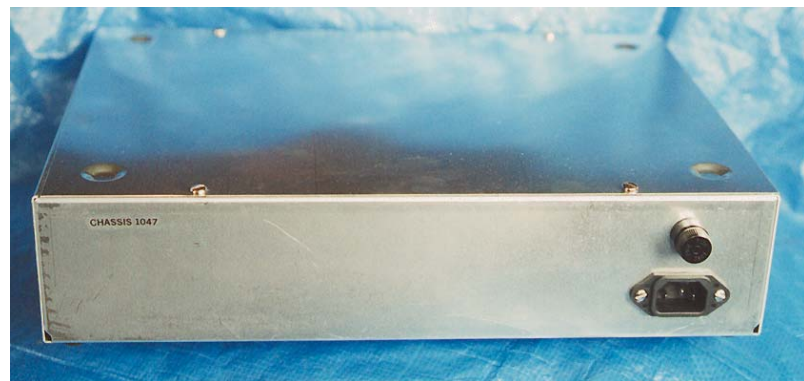

B

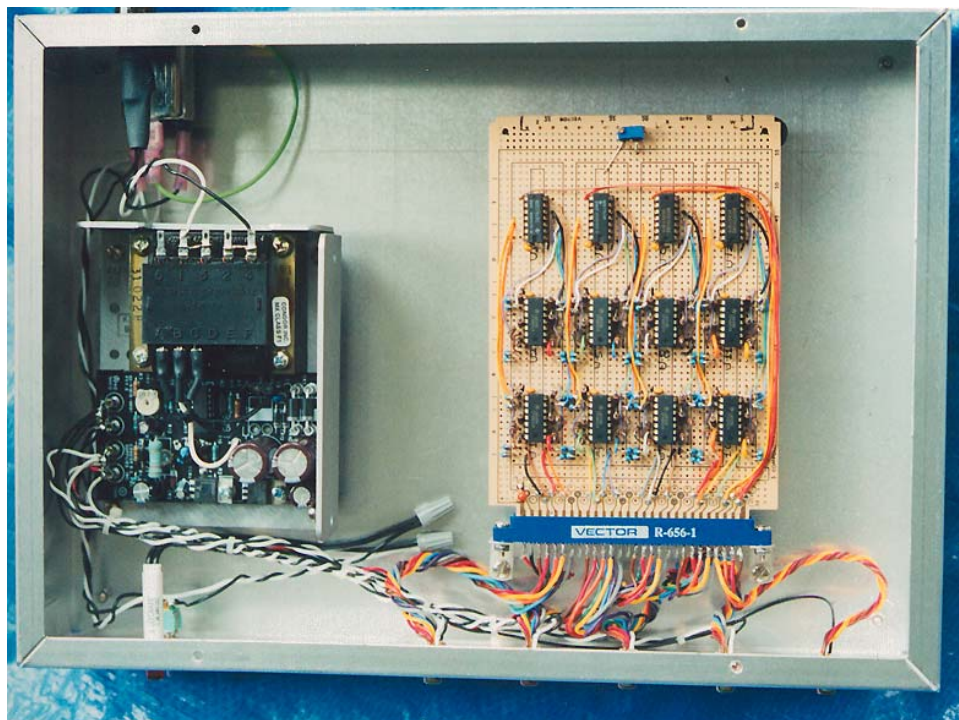

C

Figure A1-3. Chassis 1047. A. front view; B. back view; C. top view (cover removed to show power supply and circuit board).

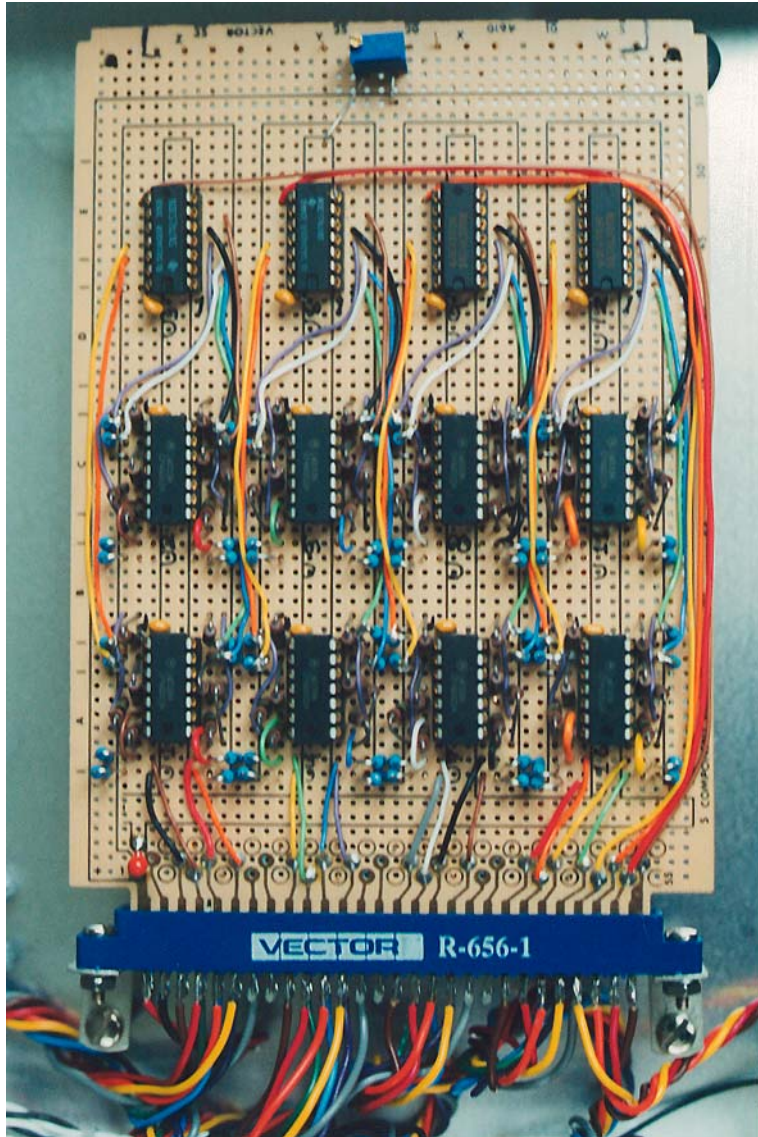
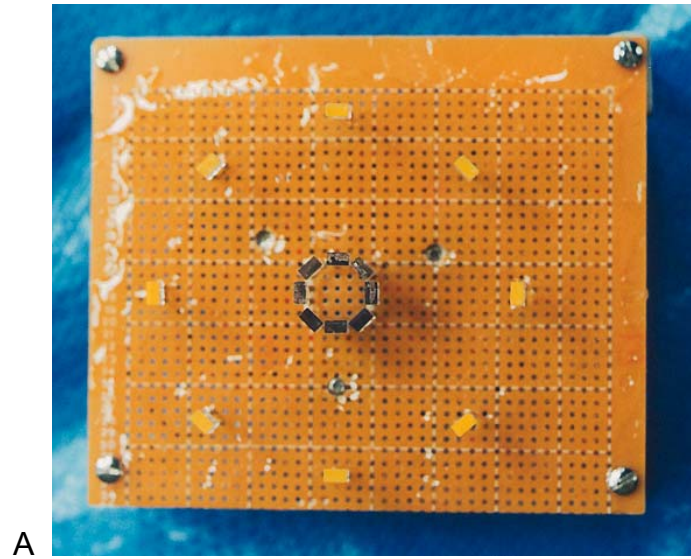
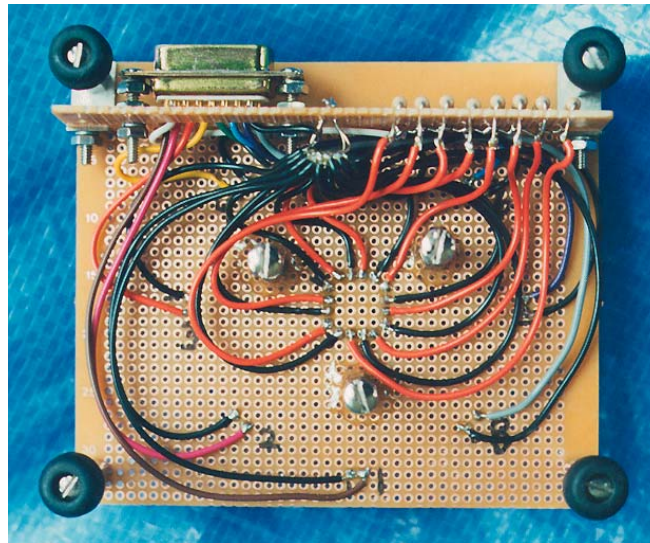

Figure A1-4. Detail of circuit board inside of Chassis 1047.



A



B

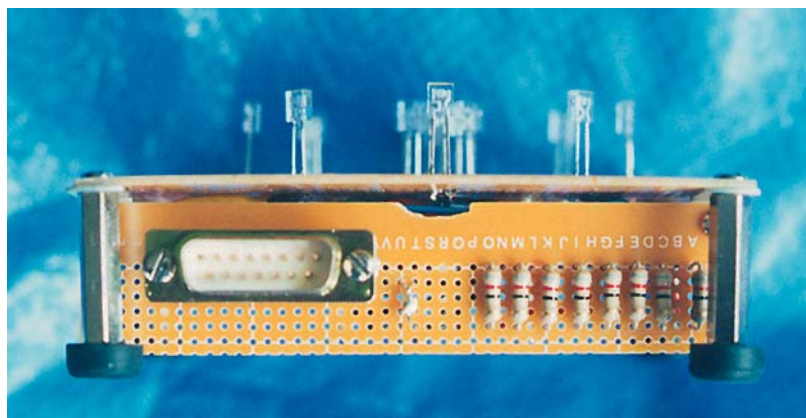

C

Figure A1-5. Infrared activity sensor. A. top view; B. bottom view; C. side view.

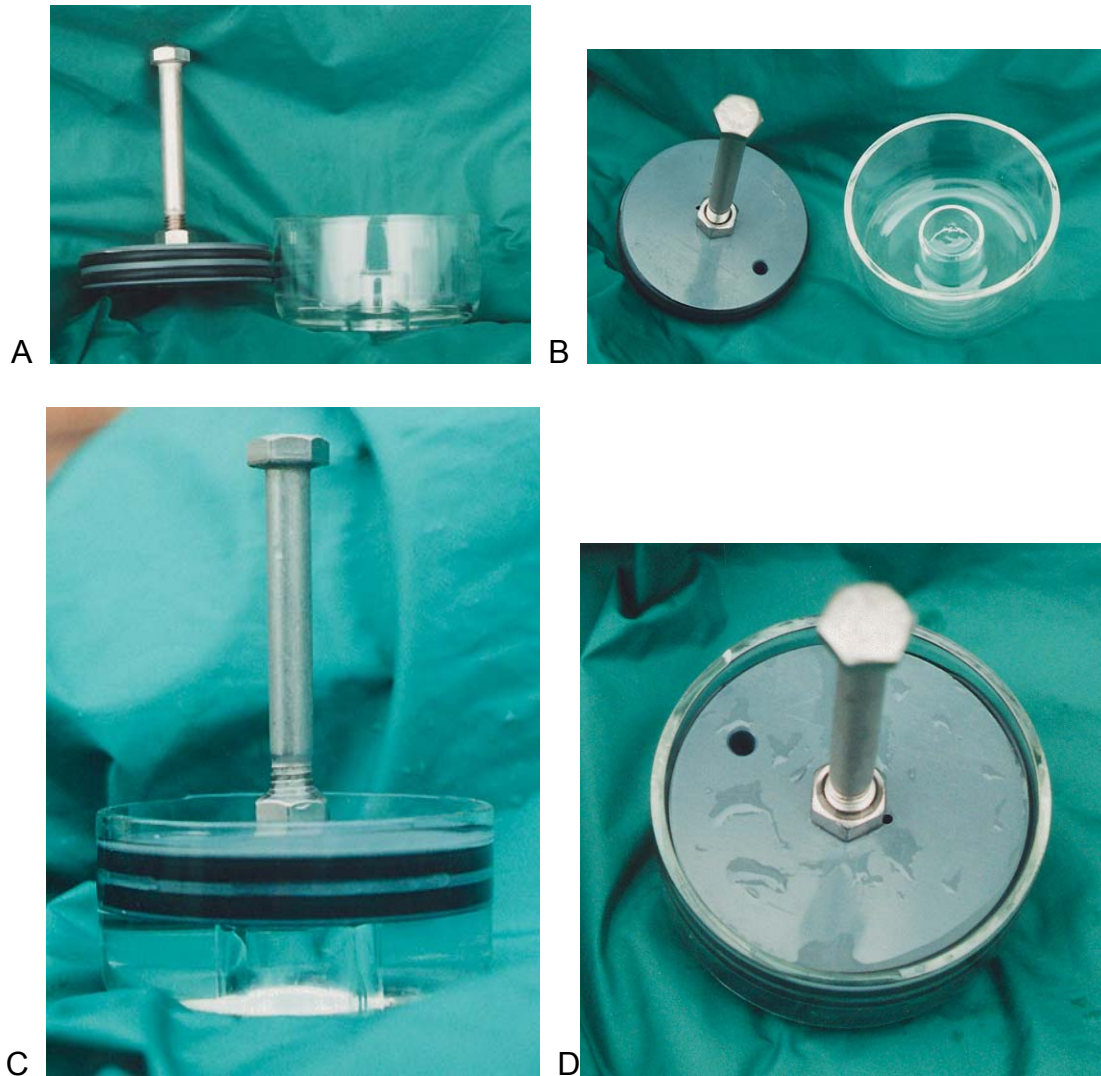

Figure A1-6. Pyrex experimental chamber and stopper with gasket. Disassembled side (A) and top (B) views; assembled top (C) and side (D) views. Oxygen electrodes not shown.

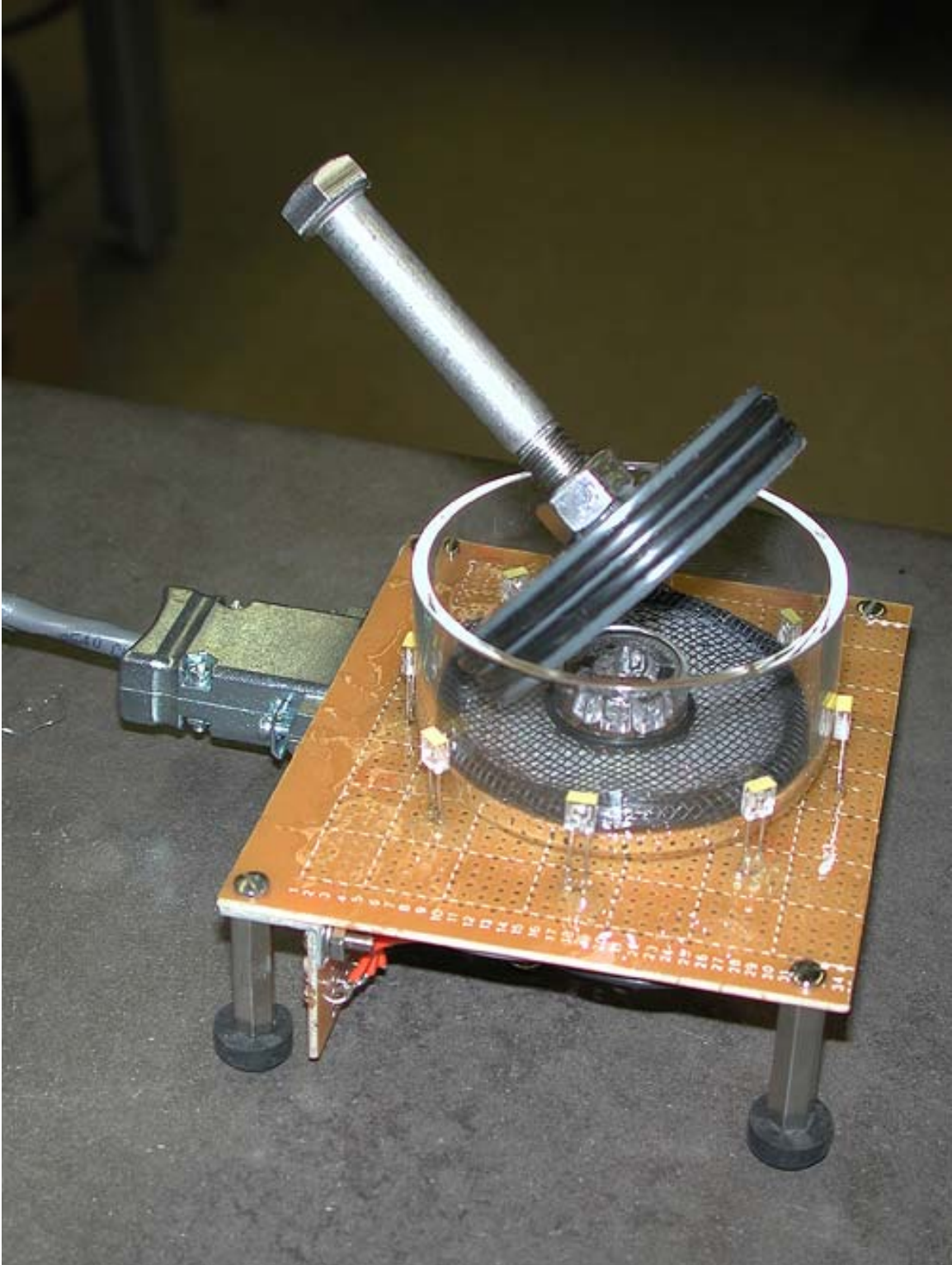

Figure A1-7. The activity chamber. Doughnut shaped screen elevates amphipods to a level where they will be detected by the infrared sensors. The stopper, with two o-rings, is sitting on top at an angle, and the cable to the left goes to the analog to digital board.



Figure A1-8. Attempting (unsuccessfully) to solve the problems with the oxygen probes. The white plastic circles were intended to isolate the oxygen adapters, which convert the signals from the oxygen microelectrodes (here in glass jars) to signals which can be processed by the analog to digital board. Activity chambers are in the background on left.



Figure A1-9. Another view of the apparatus. The custom made box to the left (described in the Quarter 2 report) converts the activity meter infrared detector signals (center, rear) to a voltage readable by the analog to digital board (just left of the laptop). Activity data and oxygen data feed into the analog to digital board, which then transfers converted data to the laptop.

Appendix 2. Length weight relationship for *Gammarus acherondytes* and *Gammarus troglophilus*.

Biologists often establish relationships among variables to estimate difficult to measure quantities. This is especially true for metrics such as body dry weight, which would require the sacrifice of organisms. This is usually not a problem for small-bodied organisms, which are abundant in the environment. Although, the amphipod *Gammarus acherondytes* is a relatively small invertebrate, its endangered status and unknown population abundance makes it undesirable to indiscriminantly remove individuals from the wild. To estimate dry body weight, we determined the best estimator (body length or head capsule length) for each of *G. acherondytes* and *G. troglophilus*.

Gammarus troglophilus and *G. acherondytes* were collected from Illinois Caverns as described above (see methods). Individuals were photographed with the aid of a digital camera and dissecting microscope as described above (see methods). Total length (mm) of individuals was measured from the tip of the rostrum to the base of the telson using ImageJ software (National Institute of Health, Bethesda, Maryland). Head capsule length (mm) was measured from the tip of the telson to the back of the head (cf. Wilhelm and Lasenby 1998). A small subset of amphipods was sacrificed to obtain dry weight to calibrate the relationships. Selected amphipods were placed in pre-weighed aluminum foil boats and dried to constant weight at 50°C. Individuals were cooled for a minimum of 24 hours in a desiccator before re-weighing. Regressions of head capsule length versus body length for both species were compared using analysis of covariance (ANCOVA) with body length as the response variable, head capsule as the covariate and species as the grouping variable. To test if body length influenced dry mass, we performed a regression analysis of body dry mass as a function of body size. Data were log-log transformed to meet assumptions of homogeneity of variance and normality. Finally, we compared predicted versus dry weights using both head capsule length and total length as the predictors.

Analysis of covariance of body length as a function of head capsule length between species showed that slopes were similar ($F_{1,186} = 0.397$; $P = 0.529$) but intercepts differed in elevation ($F_{1,187} = 53.6$; $P < 0.001$) (Figure A2-1). For a given head capsule size, *G. acherondytes* had a longer body compared to *G. troglophilus* suggesting that dry weight estimates for *G. acherondytes* may need to be based on body length rather than head capsule length given the few individuals in the dry mass relationship compared to *G. troglophilus*.

The analysis of amphipod dry mass versus body length relationship was restricted to the combined data because few *G. acherondytes* were sacrificed. Those that were analyzed for dry weight were similar to the *G. troglophilus* (Figure A2-2). Further analyses indicated that dry body mass was best

estimated via direct measures of total length for *G. acherondytes* and via head capsule length for *G. troglophilus* (Figure A2-2).

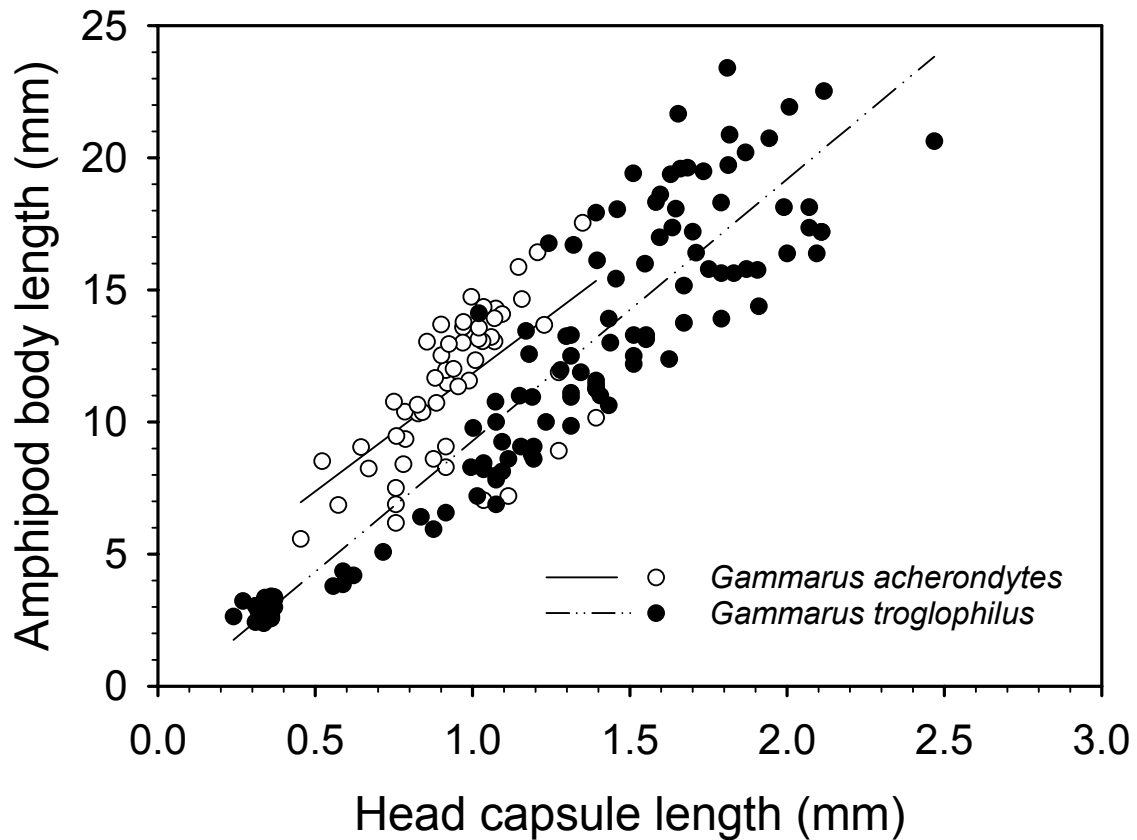

Figure A2-1. The relationship between amphipod body length and head capsule length for *Gammarus acherondytes* and *Gammarus troglophilus*. Regression equations in the form $y = mx (\pm 95\% \text{ CI} - \text{confidence interval}) + b (\pm 95\% \text{ CI})$ are: *Gammarus acherondytes* Body length (mm) = $8.92(\pm 3.11)$ Head capsule (mm) + $2.91(\pm 2.99)$, $R^2 = 0.39$; and *Gammarus troglophilus* body length (mm) = $9.90(\pm 0.62)$ Head capsule (mm) - $0.62(\pm 0.80)$, $R^2 = 0.88$.

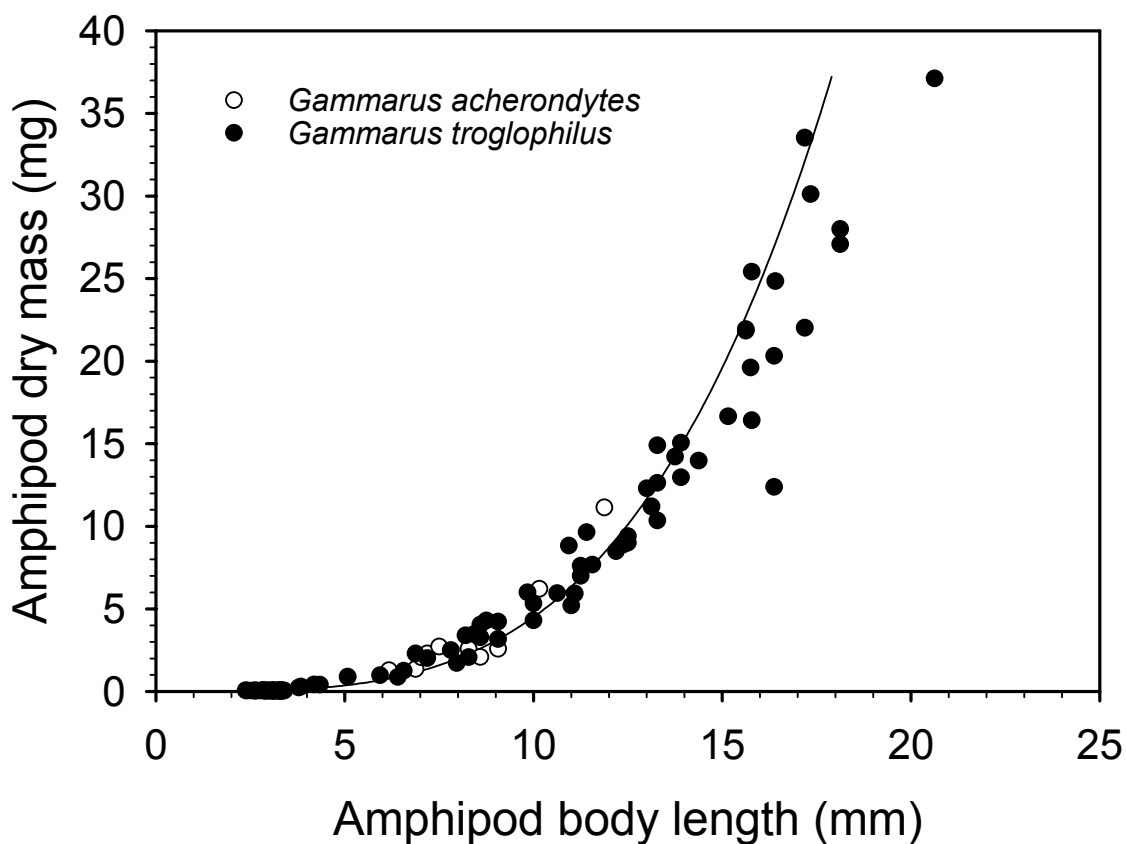

Figure A2-2. Relationship of amphipod dry mass versus amphipod body length for *Gammarus acherondytes* and *Gammarus troglophilus*. The relationship in the form $\text{Log}_{10} \text{Wt (mg)} = \text{Log}_{10} a(\pm 95\% \text{ CI}) + b(95\% \text{ CI}) \text{ Body length (mm)}$ is: $\text{Log}_{10} \text{Wt (mg)} = -2.98(\pm 0.096) + 3.63(\pm 0.11) \text{ Body length (mm)}$, $R^2 = 0.98$. However, for *G. troglophilus* a better estimate can be achieved by using the head capsule estimate for total length giving the equation $\text{Log}_{10} \text{Wt (mg)} = -2.98(\pm 0.096) + 3.63(\pm 0.11) (9.904 \text{ Head capsule length (mm)} - 0.621)$.